



VICTORIA GOVERNMENT GAZETTE.

Published by Authority.

[Registered at the General Post Office, Melbourne, for transmission by post as a newspaper.]

No. 460]

WEDNESDAY, MAY 24.

[1950

Land Act 1928.

AREAS OF LANDS COMPRISED IN CERTAIN CLASSES DIMINISHED OR INCREASED.

PROCLAMATION

By His Excellency the Governor of the State of Victoria and its Dependencies in the Commonwealth of Australia,
&c., &c., &c.

WHEREAS by the *Land Act 1928* it is amongst other things enacted that the Governor in Council may, by Proclamation to be published in the *Government Gazette*, at any time diminish or increase the area of land comprised in any of the classes mentioned in Part I., Division 1, section 5, of the said *Land Act 1928*, but that the area of lands which may be sold by auction (Class 6) shall not be increased except as in certain cases in the said Act provided: Now therefore I, the Governor of the State of Victoria, in the Commonwealth of Australia, by and with the advice of the Executive Council of the said State, and in accordance with the provisions of sections 94 and 117 of the *Land Act 1928* aforesaid, do hereby diminish or increase (as the case may be) the areas of Crown lands comprised in Classes 1, 2, 3, 6 and 7 of the classes mentioned in section 5 of the *Land Act 1928* aforesaid to the extent set forth in the subjoined Schedule (that is to say):—

Schedule referred to.

CLASSES DIMINISHED OR INCREASED.

County.	Parish.	Allotment.	Section.	Area.	Diminished.	Increased.	Description.
					Class.	Class.	
				A. R. P.			
Evelyn	Greensborough ..	162	C	23 1 10	2	6	West of the Township of Kingston (Panton Hill). (1788/44)
Moira	Taminick ..	100A	..	27 1 14	3	..	In north-east of parish (H020726).
Bendigo	Nerring, Borough of Eaglehawk	352c	A	2 0 0	7	6	Fronting Letheby's-road (W62345).
Bourke	Goldie ..	68c	..	2 0 0	..	6	In the middle of parish (C92005)
Weeah	Underbool ..	3	A	7 0 0	1	6	In west of parish (07137/198)

Given under my Hand and the Seal of the State of Victoria aforesaid, at Melbourne, this sixteenth day of May, in the year of our Lord One thousand nine hundred and fifty, and in fourteenth year of the reign of His Majesty King George VI.

(L.S.)

DALLAS BROOKS.

By His Excellency's Command,

R. C. GUTHRIE,
Commissioner of Crown Lands and Survey.

GOD SAVE THE KING!

Soldier Settlement Act 1946 (No. 5179).

UNUSED AND UNMADE ROADS CLOSED.

Parish of Bumbang, County of Karkaroc, being the roads indicated by hachure on plan hereunder.—(B.660⁽⁴⁾) (GR4/5).

PROCLAMATION

By His Excellency the Governor of the State of Victoria and its Dependencies in the Commonwealth of Australia, &c., &c., &c.

WHEREAS section 6 (1) of the *Soldier Settlement Act 1946 (No. 5179)* prescribes that where any road (whether used or unused and whether formed or unformed) forms part of or intersects any estate and the Soldier Settlement Commission, after consultation with the council or councils of the municipality or municipalities concerned, certifies that the said road is unsuited to the proper subdivision of the estate:

And whereas the Soldier Settlement Commission, after consultation with the councils of the municipalities concerned, has so certified:

Now therefore, I, the Governor of the State of Victoria, in the Commonwealth of Australia, by and with the advice of the Executive Council of the said State, and in pursuance of section 6 of the *Soldier Settlement Act 1946 (No. 5179)* do by this my Proclamation direct that the unused and unmade roads, as described hereunder, be closed, that is to say:

Parish of Beerik, County of Dundas, being the road between allotments A and B, section 7.—(B.393⁽²⁾) (D.3656).

Parish of Bruk Bruk, County of Dundas, being the road between allotments B2, B1, C, section 14, Parish of Bruk Bruk and allotment A, section 14, Parish of Beerik.—(B.470^(B2)) (B.393⁽²⁾) (D.3656).

Parish of Connewarren, County of Hampden, being the road between allotments 1C, 2C, 3B, 4B, section 3, allotments 1B, 2B, 3B, 4A, 4B, 5B, section 2, and allotments 18, 19, 20, 21, 22, 23.—(C.297⁽²⁾) (D.7697).

Parish of Connewarren, County of Hampden, being the road between allotments 19 and 20.—(C.297⁽²⁾) (D.7697).

Parish of Connewarren, County of Hampden, being the road between allotments 21 and 22.—(C.297⁽²⁾) (D.7697).

Parish of Beerik, County of Dundas, being the roads indicated by hachure on plan hereunder.—(B.393⁽²⁾) (D.3656).

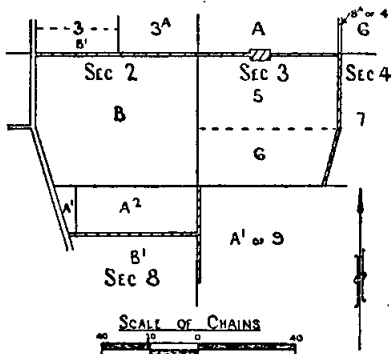

Parish of Bruk Bruk, County of Dundas, being the road indicated by hachure on plan hereunder.—(B.470^(B2)) (D.3656).

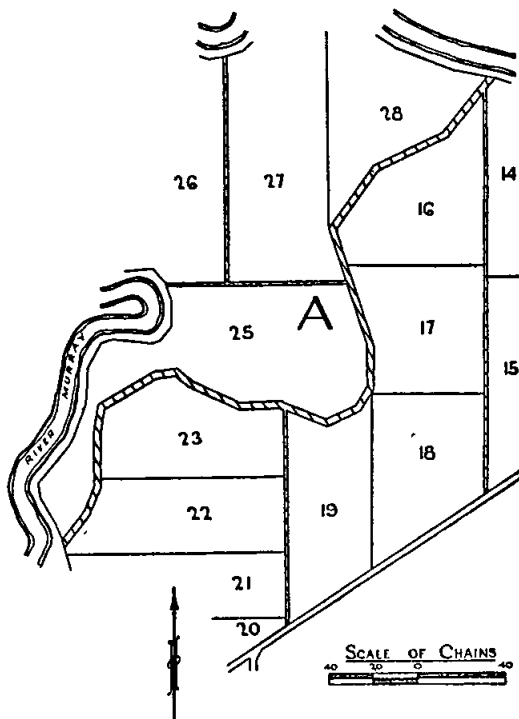
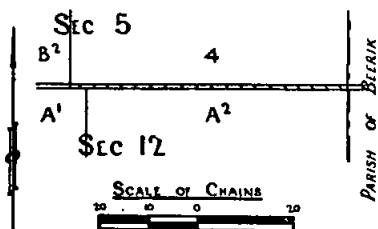

Parish of Bumbang, County of Karkaroc, being the roads indicated by hachure on plan hereunder.—(B.660⁽⁴⁾) (B.660⁽⁴⁾) (T.303⁽³⁾) (GR4/5).

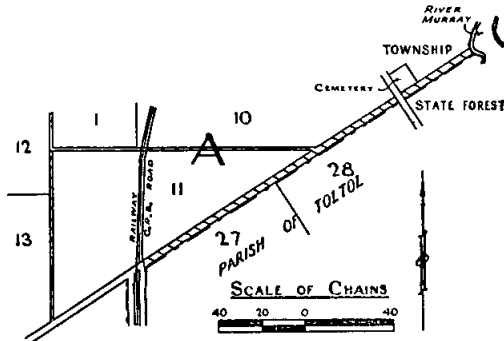

Parishes of Carraragarmungee and Wangaratta North, County of Bogong, being the roads indicated by hachure on plan hereunder.—(C.188⁽³⁾) (W.85⁽⁷⁾) (D.2435).

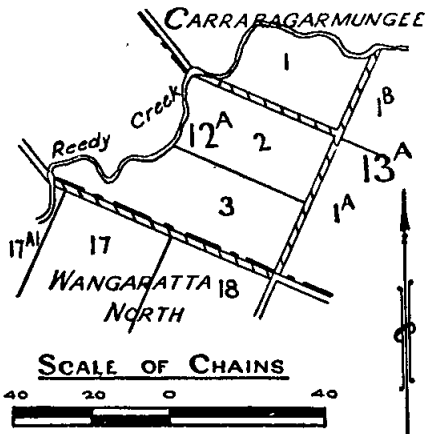

Parish of Condah, County of Normanby, being the roads indicated by hachure on plan hereunder.—(C.362(3) (D.9259).

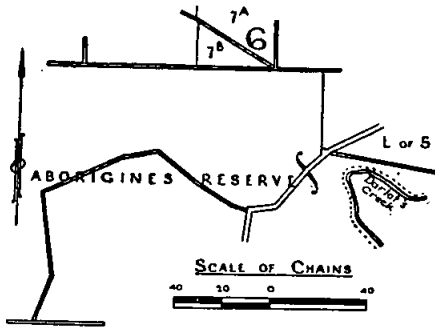

Parish of Willaura, County of Ripon, being the road indicated by hachure on plan hereunder.—(W.246(2) (D.1829).

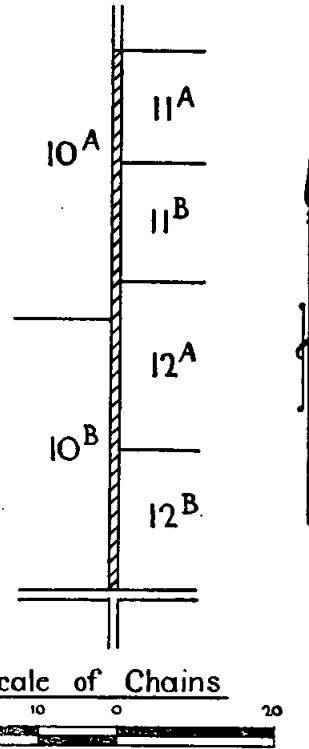

Parish of Jeruk, County of Gladstone, being the roads indicated by hachure on plan hereunder.—(J.35(2) (D.7765).

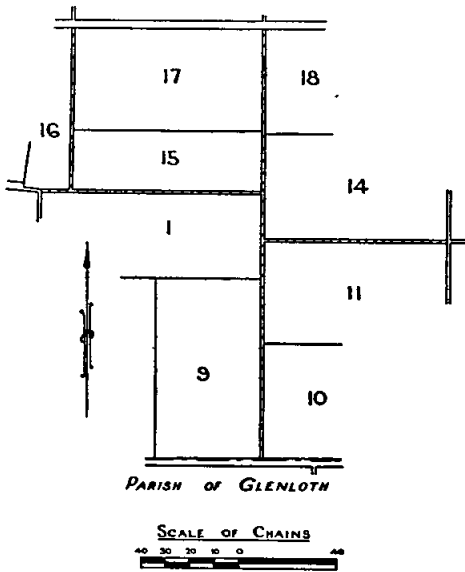

Parish of Willaura, County of Ripon, being the road indicated by hachure on plan hereunder.—(W.246(2) (D.1829).

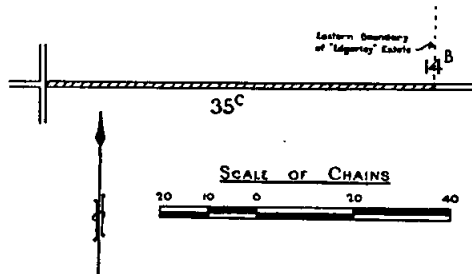

Parish of Wagra, County of Benambra, being the road indicated by hachure on plan hereunder.—(W.292(5) (D.7696).

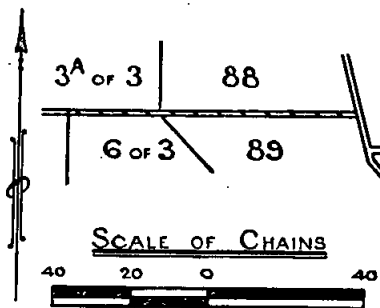

Parish of Willaura, County of Ripon, being the road indicated by hachure on plan hereunder.—(W.246(2) (D.1829).

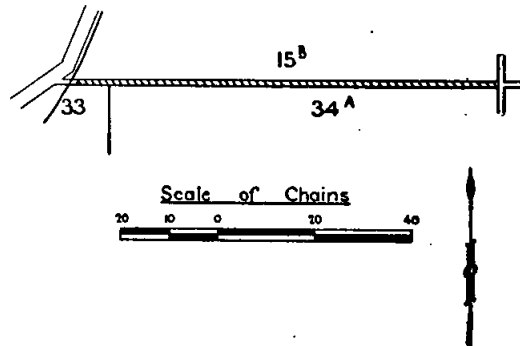

Parish of Yalla-y-poorra, County of Ripon, being the portion of road indicated by hachure on plan hereunder.—(Y.41(2) (D.392).

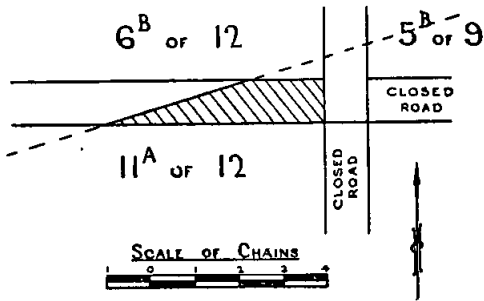

Parish of Yalla-y-poorra, County of Ripon, being the portion of road indicated by hachure on plan hereunder.—(Y.41(2) (D.392).

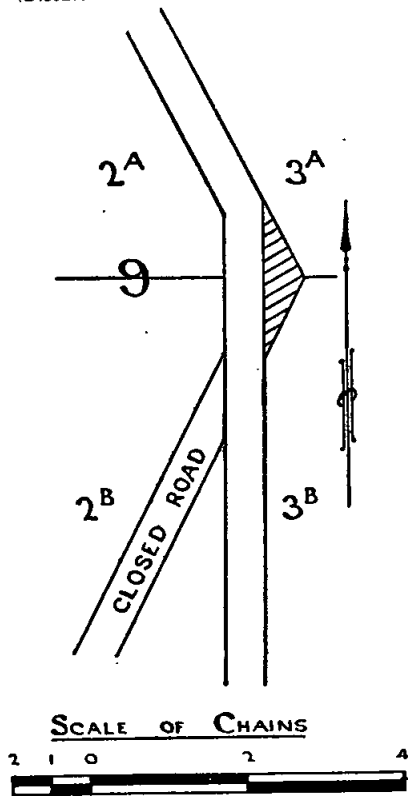

Given under my Hand and the Seal of the State of Victoria aforesaid, at Melbourne, the twenty-third day of May, in the year of our Lord One thousand nine hundred and fifty, and in the fourteenth year of the reign of His Majesty King George VI.

L.S. DALLAS BROOKS.
By His Excellency's Command,
R. C. GUTHRIE,
Commissioner of Crown Lands and Survey.
GOD SAVE THE KING!

KING'S BIRTHDAY HOLIDAY.

IT is hereby notified that on—

MONDAY, THE 12TH JUNE, 1950,
the Public Offices throughout Victoria will be closed, that day having been proclaimed by the Governor in Council, under the powers conferred by the *Public Service Act 1946* (see the *Victoria Government Gazette* of the 30th November, 1949), to be observed as a holiday in the Public Offices.

W: WATT LEGGATT,
Chief Secretary.

LEVEE AT PARLIAMENT HOUSE, MELBOURNE.

IN honour of the birthday of His Majesty The King, His Excellency the Governor of Victoria, General Sir Dallas Brooks, K.C.B., C.M.G., D.S.O., K.St.J., will hold a Levee at Parliament House, Spring-street, Melbourne, at 11.30 a.m., on Thursday, 8th June, 1950.

On the occasion of the celebration of the King's birthday, His Excellency is anxious to receive as many citizens as possible.

In accordance with the custom followed at Levees held by His Majesty the King, there will be no precedence in the order of presentation, but it is requested that members of services and all public bodies group themselves together for presentation as far as possible.

It is requested that those entitled to wear uniform or official dress will do so on this occasion, but His Excellency will be pleased to receive those not entitled to wear uniform or official dress in their ordinary morning or business dress.

Private entree cards will admit recipients to the south door of the Spring-street entrance at Parliament House, at 11.15 a.m. All other citizens are requested to enter by the north door of the Spring-street entrance, at 11.30 a.m.

It is particularly desired that gentlemen attending the Levee should provide themselves with a card on which should be printed or typed in capitals, or written in block letters, their styles of address for presentations, in order to facilitate announcement to His Excellency.

By His Excellency's Command,

R. W. SPRAGGATT,
Private Secretary to His Excellency the Governor.

APPOINTMENTS.

HIS Excellency the Governor of the State of Victoria, by and with the advice of the Executive Council thereof, has, by Orders made on the 16th day of May, 1950, been pleased to make the under-mentioned appointments, viz.:

DEPARTMENT OF CHIEF SECRETARY.

Electoral Registrars (Acting).

THOMAS LINEHAN
to be Electoral Registrar (Acting) for the Ballarat North, Clunes, Creswick, Daylesford, Gong Gong, and Learmonth Subdivisions of the Electoral District of Allendale; for the Ballarat, Ballarat East, and Ballarat West Subdivisions of the Electoral District of Ballarat; for the Ballan and Meredith Subdivisions of the Electoral District of Grant; and for the Sebastopol and Warrenheip Subdivisions of the Electoral District of Hampden, to take effect on and from the 15th May, 1950, during the absence on leave of Arthur Robert Mallett; and

KEITH REGINALD JONES
to be Electoral Registrar (Acting) for the Berwick Subdivision of the Electoral District of Gippsland West; for the Carrum and Mentone Subdivisions of the Electoral District of Mentone; for the Dromana and Frankston Subdivisions of the Electoral District of Mornington; and for the Cranbourne Subdivision of the Electoral District of Scoresby, to take effect on and from the 18th May, 1950, during the absence on leave of William John Champion Furlonger.

Superintendent (Acting) of a Reformatory Prison.

JOHN HENRY CHAPMAN,
pursuant to the provisions of the *Crimes Act 1928*, to be Superintendent (Acting) of the Reformatory Prison at French Island, from the 12th May, 1950, to the 31st May, 1950, both dates inclusive, during the absence on leave of Alan James Jack.

DEPARTMENT OF HEALTH.

Trustees of Cemeteries.

JOHN PATRICK SHARRY
to be a Trustee of the Horsham Public Cemetery, *vice* M. F. Kelly, resigned;
LAURENCE OWEN JONES and
ROBERT OWEN LEWIS
to be Trustees of the Yarram New Cemetery;
ALBERT ALEXANDER HEATHER
to be a Trustee of the Castlemaine General Cemetery, *vice* J. Bennett, deceased;
JOHN JOSEPH McDONALD
to be a Trustee of the Birregurra Public Cemetery, *vice* J. B. Shepherdson, deceased;

GERALD RAHILL

to be a Trustee of the Tylden Public Cemetery, *vice* E. P. Guthrie, resigned;

DANIEL GINNIVAN and
GEORGE EXTON

to be Trustees of the Moorngag Public Cemetery, *vice* J. W. Ginnivan, deceased, and E. Exton, resigned, respectively; and

ALEC ENSCOE and
EDWARD GOODE

to be Trustees of the Merino Public Cemetery, *vice* H. Enscoe, resigned, and William R. Bryce, resigned, respectively.

DEPARTMENT OF LANDS AND SURVEY.

Trustees of Site.

TREVOR WILLIAM PROCTOR and
WILLIAM HORACE RICHARDS

to be Trustees of the land permanently reserved on the 17th December, 1888, and 19th April, 1914, as a site for a Mechanics' Institute and Free Library at Warburton, in the place of Gordon Honneus Bussell, resigned, and William John Richards, deceased.

DEPARTMENT OF LAW.—ATTORNEY-GENERAL.

Sworn Valuator.

ROYCE THOMAS GRANGER HODGES, 367-369 Chapel-street, South Yarra,

to be a Sworn Valuator, pursuant to the provisions of section 14 of the *Transfer of Land Act 1928* (No. 3791), for the Counties of Bourke and Mornington.

DEPARTMENT OF LAW.—SOLICITOR-GENERAL.

Commissioners for Taking Declarations, &c.

SAMUEL GEORGE BIRTLES, Insurance Officer, State Electricity Commission of Victoria, 22-32 William-street, Melbourne,

to be a Commissioner for taking Declarations and Affidavits, pursuant to the provisions of Division 8 of Part IV. of the *Evidence Act 1928*, to refrain from charging fees, and to resign upon ceasing to occupy his present position; and

CHARLOTTE ALICE WILSON, 108 Rochester-road, Balwyn, and

ARTHUR ERNEST HOLMES, 4 Parkside-avenue, Box Hill, to be Commissioners for taking Declarations and Affidavits, pursuant to the provisions of Division 8 of Part IV. of the *Evidence Act 1928*, to resign upon removing from the neighbourhood of the addresses stated.

Bailiff of County Court.

CHARLES ALFRED ANDERSON, First Constable of Police, Woomelang,

to be also a Bailiff of the County Court at Mildura, *vice* G. S. Bock, resigned, to take effect from the date of commencement of duty.

Magistrates.

ANTHONY JANIS, 224 Little Collins-street, Melbourne, and

JOHN SAMUEL AUGUST, 15 Yarrbat-avenue, Balwyn, to Keep the Peace in the Central Bailiwick of the State of Victoria;

WILLIAM FRANCIS BROWN, Allansford, and
JAMES MURRAY, Dunlop-street, Mortlake,

to Keep the Peace in the Western Bailiwick of the State of Victoria; and

HAROLD ROBERT MADDERN, 1005 Dana-street, Ballarat, and

LEONARD MADDERN, 21-23 Lydiard-street north, Ballarat, to Keep the Peace in the Southern Bailiwick of the State of Victoria.

Sheriff's Bailiff and Bailiff of County Court.

JAMES NORMAN BREWIS, First Constable of Police, Lismore,

to be also a Sheriff's Bailiff and a Bailiff of the County Court at Geelong, *vice* G. N. Hornsby, resigned, to take effect from the date of commencement of duty.

Senior Government Pathologist.

KEITH MACRAE BOWDEN, M.B., B.S., 12 Collins-street, Melbourne,

to be Senior Government Pathologist, with fees as prescribed by or under the *Coroners Act 1928*.

Government Pathologists.

ROBERT JOHN FLEMING, M.B., B.S., 73 Beach-road, Beaumaris, and

ERNEST WILLIAM BATE, M.B., B.S., 20 St. George's-avenue, Mont Albert,

to be Government Pathologists, with fees as prescribed by or under the *Coroners Act 1928*.

DEPARTMENT OF TREASURER.

Collector of Imposts (Acting.)

WILLIAM PATRICK CUMMARE

to act temporarily as Collector of Imposts, State Immigration Office, during the absence of T. L. Stack, on leave.

Receiver of Revenue (Acting.)

GODFREY THOMAS BROMLEY

to act temporarily as Receiver of Revenue, Railways Department, during the absence of E. H. Bryan, on leave.

A. G. COULTHARD,

Acting Clerk of the Executive Council.

At the Executive Council Chamber,
Melbourne, 16th May, 1950.

RESIGNATIONS.

HIS Excellency the Governor of the State of Victoria, by and with the advice of the Executive Council thereof, has, by Orders made on the 16th day of May, 1950, accepted the resignations of the persons named hereunder of the offices mentioned, *viz.*:—

DEPARTMENT OF LAW.—SOLICITOR-GENERAL.

GEORGE SPENCER BOCK, as a Bailiff of the County Court at Mildura.

GEORGE NORMAN HORNSBY, as a Sheriff's Bailiff and a Bailiff of the County Court at Geelong.

JAMES STANLEY HANSON, as a Commissioner for taking Declarations and Affidavits, pursuant to the provisions of the *Evidence Act 1928*.

CYRIL GORDON NUNN PECK, from the Commission of the Peace for the Midland and Western Bailiwicks.

DEPARTMENT OF LABOUR.

JOHN ALFRED CONNELL, as a Member of the Apprenticeship Commission.

A. G. COULTHARD,

Acting Clerk of the Executive Council.

At the Executive Council Chamber,
Melbourne, 16th May, 1950.

THE MELBOURNE HARBOR TRUST COMMISSIONERS.

IN pursuance of the *Melbourne Harbor Trust Act 1928*, the Melbourne Harbor Trust Commissioners make the following Regulations:—

1. The Regulations made by the Commissioners on the 21st October, 1942, approved by the Governor in Council on 2nd November, 1942, and published in the *Government Gazette* on the 27th November, 1942, and any amendment thereto, are hereinafter referred to as "the Principal Regulations."

2. Sub-regulation 3 (a) of Regulation 118 of the Principal Regulations is hereby repealed and in lieu thereof the following sub-regulation is substituted:—

"3. (a) that such notice shall not be given prior to 5 p.m. on the third day after the vessel from which the goods were unshipped ceased to discharge at the berth."

Dated at Melbourne this nineteenth day of April, 1950.

The common seal of the Melbourne Harbor Trust Commissioners was hereunto affixed by order of the Commissioners, in the presence of—

(SEAL) A. D. MACKENZIE, Chairman.
A. G. ALLNUTT, Commissioner.
A. C. COOK, Secretary.

Approved by the Governor in Council,
16th May, 1950.

A. G. COULTHARD,
Acting Clerk of the Executive Council.

CONTRACTS ACCEPTED.—(Series 1949-50.)

VICTORIAN RAILWAYS.

77. "GY" class wagons, at £1,663 9s. 10d. each (Contract 57640).—Knox Schlapp Pty. Ltd. 78. Supply and erection of chain wire fence at Newport Workshops for £3,999 12s. (Contract 57981).—Cyclone Co. of Aust. Ltd. 79. Clearing and earthworks of siding, Morwell, at rates (Contract 58006).—Melbourne Tractor Co. 80. Construction of roadways, footpaths, stormwater drains, &c., South-road Development Area, Tottenham, at rates (Contract 58262).—Victoria Roads Pty. Ltd.

By order of the Victorian Railways Commissioners,
N. QUAIL,
Secretary.

Melbourne, 19th May, 1950.

PUBLIC WORKS.

5333. (1) Ararat, Mental Hospital, installation of two washing machines, £260.—J. Walsh.
5334. (2) Baranduda, State School No. 2222, electrical installations in Teacher's Residence, £102.—J. Catterall.
5335. (1) Bairnsdale, Public Works Department, Assistant District Architect's Residence, supply and erection of plaster sheets, &c., £248 7s.—Brownriggs Pty. Ltd.
5336. (1) Broadmeadows, Attwood Camp, Stud Depot, erection of timber hut and mast, £466.—F. Phillip.
5337. (1) Belgrave South, State School No. 3551, additional out-offices, screen, and painting of old out-offices, £385 10s.—H. S. Bolger, Jr.
5338. (6) Box Hill, Police Station, internal and external painting and repairs, £423 11s. 6d.—Hopkins and McCarthy.
5339. (1) Brunswick West, Police Station, erection of new police station and residence, £7,243 5s.—G. A. Hurse.
5340. (4) Brunswick, State School No. 1213, attention to foundations, repairs, and painting to residence, £317 11s. 6d.—Hopkins and McCarthy.
5341. (2) Camp Pell, Emergency Housing, Area 3, sewerage and sanitary installation, £541.—B. Brown and Son.
5342. (1) Carlton, State Offices Annexe, State School No. 1073, sewerage, sanitary plumbing, and water supply, £598.—B. Brown and Son.
5343. (2) Carlton, State Offices Annexe, State School No. 1073, electrical installation, £2,370.—Lecol Electrical Co.
5344. (1) Carlton, Teachers' College, supply and erection of new cyclone fence, £308.—Cyclone Co. of Australia Ltd.
5345. (1) Chelsea, State School No. 3729, repairs to fencing, £190 12s.—H. Rogasch.
5346. (1) Chiltern, State School No. 327, provision of blackboards, cupboards, &c., £1,240.—J. Law and Son.
5347. (1) Dundonnell, State School No. 2795, painting and repairs, £175.—J. J. Batty.
5348. (1) French Island, McLeod Settlement Reformatory Prison, electrical installation, £534 13s. 6d.—R. G. Harris Pty. Ltd.
5349. (2) Upper Ferntree Gully, State School No. 3926, additional out-offices, £215 10s.—H. S. Bolger, Jr.
5350. (3) Geelong South, State School No. 2143, completion of building, ex-Marshall, £144 10s. 6d.—T. Doolan.
5351. (3) Greenvale, Sanatorium, installation of electric lighting on Tennis Court, £295 9s.—L. W. Carter.
5352. (2) Horsham, High School, provision of new concrete floors and underpinning main building and sewerage connexions, &c., £5,379 18s.—T. H. Stewart.
5353. (4) Inglewood, Court House, repairs and painting and attention to fencing, £486 15s.—E. W. Foley.
5354. (3) Kingsville, State School No. 3988, provision of cupboards under blackboards, £300.—W. S. Wood.
5355. (1) East Kew, State School No. 3161, renewal and repairs to spouting, £170.—E. T. Walker.
5356. (1) Larundel, Mental Hospital, supply and erection of chain-wire fencing, Airing Courts; supply only of chain wire, Perimeter fence, £2,719 14s.—Cyclone Co. of Australia Ltd.
5357. (3) Lockington, Consolidated School, supply and installation of central-heating system, £485 18s.—A. E. Rosendale.
5358. (1) Maffra, State School No. 861, new out-offices, £1,350.—A. J. Warry.
5359. (1) Murtoa, Court House, re-building of brick wall, £435.—P. Hussey.
5360. (4) Maldon, State School No. 1254, supply and fixing of slow combustion heaters, £112.—A. Cox.
5361. (1) Mont Park, Mental Hospital, supply and delivery of portable meat containers for Butcher's Shop, £318.—Butchers Service Engineering Co.
5362. (1) Moe, State School, M.A., erection of "Bristol" prefabricated school building, £5,485.—Overseas Corporation (Aust.) Ltd.

5363. (4) Melbourne, Technical School, erection of superstructure of Commerce School, £70,700.—Thompson and Chalmers Pty. Ltd.

5364. (2) Melbourne, Emily McPherson College of Domestic Economy, supply and installation of oil-firing equipment, £606 14s.—Automatic Heating Appliances Pty. Ltd.

5365. (2) Melbourne, Law Courts, sewerage and sanitary plumbing, £5,911 15s.—W. J. Bugg.

5366. (1) Melbourne, Fumigation and Inspection Depot, 605 Flinders-street, electrical installation, £172 5s.—Lecol Electrical Co.

5367. (1) Nhill, State School No. 2411, painting and repairs to Teacher's Residence, £462 12s.—G. Lange.

5368. (1) Royal Park, Mental Hospital, supply and installation of mechanical ventilation systems, £670.—H. J. Creek.

5369. (1) Scoresby, Research Station, Manager's Residence, supply and installation of a kerosene hot-water service, £118 16s. 8d.—J. D. Reid.

5370. (1) Speed, State School No. 386, erection of Teacher's Residence (labour only), £890.—G. Braithwaite.

5371. (1) Tawonga, State School No. 2282, electrical installation, Teacher's Residence, £142.—J. M. Catterall.

5372. (1) Timboon, Consolidated School, electrical installation, £284 13s. 6d.—McArthur Bros.

5373. (2) Wendouree, State School No. 1813, internal repairs and renovations to residence, £118 13s.—C. W. Pennant.

5374. (1) Wangaratta, Technical School, supply of blackboards (48 ft. 6 in. run.); supply of hat and coat hooks (80 feet run.), £272.—J. Law and Son.

5375. (2) Wonthaggi, State School No. 3650, repairs, painting, and fencing to Cleaner's Residence, £376 10s. 9d.—A. B. Shaw.

5376. (1) Yallourn, State School No. 4085, repairs, painting, and sewerage installation, £750.—A. F. and C. S. Angus.

5377. (1) Yallourn, High School, renewal of water service, £552 10s.—A. F. and C. S. Angus.

5378. (1) Bairnsdale, Technical School, supply of metal and screenings, £121 17s. 6d.—W. Lennen.

5379. (1) Various, Harbor Works, supply timber, £120 19s. 1d.—Wm. Haughton and Co.

5380. (1) Various, Harbor Works, supply of timber, £117 13s. 11d.—Wm. Haughton and Co.

5381. (1) Williamstown, Dredging Depot, supply of two battery chargers, £127 18s.—Replacements Parts Pty. Ltd.

5382. (1) Winton, State School No. 1870, provision of wash basin, water closet, garage, and woodshed, £186 18s.—H. L. Hobbs.

5383. (1) Port Melbourne, Public Works Depot, supply Allis Chalmers Speed Patrol grader with canopy, £1,305 9s.—Tutt Bryant Pty. Ltd.

5384. (1) Port Melbourne, Public Works Depot, supply five Bristand super rooters, £2,045.—Queens Bridge Motor and Engineering Co. Pty. Ltd.

5385. (1) South Melbourne, Public Works Storeyard, Teachers' Residences, supply of angle iron, £386 15s.—Steels and Metals Pty. Ltd.

5386. (1) South Melbourne, Public Works Storeyard, supply and delivery of 50 tons of galvanized wire, £2,428 15s.—Heine Bros. (Australia) Pty. Ltd.

5387. (1) Melbourne, Government House, hire of china and glassware for garden parties, £627 10s.—Turners Catering Service.

5388. (1) Carlton, Motor Registration Branch, supply and delivery of eleven Brownbuilt cupboards, £141 4s. 3d.—E. T. Brown Ltd.

5389. (3) Geelong, Matthew Flinders Girls' School, supply and delivery of twenty desks, £195.—Johnstone and Morrison Pty. Ltd.

5390. (1) Melbourne, Law Courts, supply of timber, £320 12s. 2d.—W. S. Neelands Pty. Ltd.

5391. (1) Seaford, State School No. 3835, erection of one "Bristol" type prefabricated classroom unit, £995.—Overseas Corporation (Australia) Ltd.

5392. (1) Port Melbourne, Housing General, supply of timber, £120 15s. 10d.—W. S. Neelands Pty. Ltd.

5393. (4) Manangatang, District Hospital, supply and delivery of sump pump, £121 10s.—Harland Engineering (Australia) Pty. Ltd.

5394. (1) Tankerton, Jetty, Supply of piles, £265.—Wm. Haughton and Co. Ltd.

5395. (1) Hawthorn, Swinburne Technical College, repairs and painting to new chemistry school, £298.—F. T. Jeffrey.

5396. (1) Janefield, Mental Hospital, supply screenings, £105 9s. 9d.—Willis Quarries.

5397. (1) Various, Harbor Works, supply of bolts, £364 17s. 8d.—West Footscray Engineering Works Pty. Ltd.

5398. (1) Various, Harbor Works, supply of timber, £146 15s. 5d.—Wm. Haughton and Co. Ltd.

5399. (1) South Melbourne, Public Works Storeyard, supply of red gum for Teachers' Residences, £107 8s.—Wm. Cook Pty. Ltd.

5400. (1) Kew, Mental Hospital, installation of steam-heated pans, &c., £350.—Charles E. Guy and Co.

5401. (2) Bendigo, Male Teachers' Hostel, supply and delivery of kitchen equipment, £468 16s.—Brice Scale and Slicer Co.

5402. (1) Parkdale, State School No. 4171, supply and fixing of floor tiles for "Bristol" prefabricated school building, £197 10s.—Dunlop Semtex Pty. Ltd.

5403. (1) Mont Park, Mental Hospital, supply and delivery of two floor-polishing machines, £127 4s.—Spartan Paints Pty. Ltd.

5404. (2) Melbourne, Cancer Institute, supply and delivery of three oil-immersed electric radiators for X-ray treatment, £120.—Gutwirth and Sons Pty. Ltd.

5405. (1) Carlton, State Offices Annexe, State School No. 1073, supply and delivery of "Aladdin" blue-flame heaters, £143 2s.—Aladdin Industries Pty. Ltd.

5406. (1) Mt. Beauty, State School No. 4644, erection of school building, £14,700.—State Electricity Commission of Victoria.

5407. (1) Parkville, The Zoological Board of Victoria, Zoological Gardens, supply and delivery of one (1) Allen self-propelled motor scythe, ratchet drive, No. R.46407, £121 9s. 6d.—Scott Bonnar (Vic.) Pty. Ltd.

5408. (1) Port Melbourne, Public Works Depot, Salmon-street, six (6) D.P. 3-inch Ajax diaphragm pumps, £908 7s. 6d.—McPherson's Ltd.

5409. (1) Collingwood, Technical School, supply of Inclined power press, &c., £435 2s. 6d.—McPherson's Ltd.

5410. (1) Janefield, Mental Colony, supply and laying bitumin felt on roof, £172 16s.—Flat Top Roofing Co.

5411. (1) South Melbourne, Public Works Storeyard, supply of 160 sheets 12 feet x 4 feet Caneite, £141 2s. 5d.—J. Murray More Pty. Ltd.

5412. (1) Echuca, Technical School, painting and colouring Residence No. 7, £170.—L. A. Skelton.

5413. (1) Moonee Ponds, State School No. 3987, supply of ashes, £175.—Neal and Meighan.

5414. (1) Frankston, High School, supply and fixing blackboards, cupboards, hat and coat hooks, £340.—F. T. Pulling.

5415. (1) Frankston, High School, supplying and laying floor tiles, £408.—Dunlop Semtex Pty. Ltd.

5416. (1) Sunshine, Technical School, painting of machines, £155.—W. Joy.

5417. (1) Melbourne, Police Depot, St. Kilda-road, supply and delivery of boiler, £125.—Johnsons Tyne Foundry Pty. Ltd.

5418. (3) Langi Kal Kal, Penal and Gaols, Training Centre, supply and delivery of 22-inch motor mower, £138 18s. 2d.—Gippsland and Northern Co-Operative Co. Ltd.

5419. (1) Walpeup, Mallee Research Station, supply and delivery of four 5,000-gallon tanks, £144.—Howie Bros.

5420. (1) Port Melbourne, Public Works Depot, supply one model R.33c Bristand roofer, £409.—Queens Bridge Motor and Engineering Co. Pty. Ltd.

J. A. KENNEDY, Commissioner of Public Works. 19.5.50.

ORDERS IN COUNCIL.—(Series 1949-50.)

STATE ELECTRICITY COMMISSION.

5282. The supply of 80 polyphase A.C. kilowatt-hour meters for consumers' installations, to Specification No. 49-50/168.—Landis and Gyr Ltd.

Approved by the Governor in Council, 15th March, 1950.—A. G. COULTHARD, Acting Clerk of the Executive Council.

5283. Amendment to the contract approved on 28th March, 1950, with C. and R. Suland Bros. for the erection of six out-buildings for pre-cut houses, Newborough, to provide for this work to be undertaken by C. and R. Ireland Bros.—C. and R. Ireland Bros.

Approved by the Governor in Council, 9th May, 1950.—A. G. COULTHARD, Acting Clerk of the Executive Council.

5284. The supply of 4,000 feet piping for drainage purposes, Morwell Project, to Quotation No. 5651.—Armco (Aust.) Pty. Ltd.

5285. The supply of 24 duo-directional polyphase relays for system protection, to Specification No. 48-49/160.—Australian General Electric Pty. Ltd.

5286. The supply of two black steel wire ropes for 1,066-bucket wheel dredger, Yallourn Open Cut, to Quotation No. 4455.—Australian Wire Rope Works Pty. Ltd.

5287. The supply of twenty Dodge 25-cwt. tray body trucks, to Quotation No. 6215.—Canada Cycle and Motor Co. (Vic.) Pty. Ltd.

5288. The erection of hostel for accommodation of personnel, Watson-avenue, Morwell, to Specification No. 49-50/241.—T. R. and L. Cockram Pty. Ltd.

5289. The erection of additional accommodation facilities at hostel, Rubicon, to Specification No. 49-50/289.—Cumming, Culhane, and Co. Pty. Ltd.

5290. The supply of 100 tons mild steel reinforcing bars, to Quotation No. 6294.—Elder, Smith, and Co. Ltd.

5291. The supply of two 50-cwt. mobile cranes, to Quotation No. 6216.—Electronic Industries Imports Pty. Ltd.

5292. The erection of timber house at Rubicon, to Specification No. 49-50/290.—O. D. Fyfe.

5293. The supply of 30 pneumatic tires for Federal prime movers, to Quotation No. 5396.—Goodyear Tyre and Rubber Co. (Aust.) Ltd.

5294. The supply of 513 feet rubber conveyor belting for coal handling plant, Yallourn Power Station, to Quotation No. 5412.—Goodyear Tyre and Rubber Co. (Aust.) Ltd.

5295. The supply of feed roller assemblies for cross-arm workshop, Bairnsdale, to Quotation No. 5415.—Graham Engineering Co.

5296. The supply of 214 tons bright steel shafting for general maintenance and new works, to Quotation No. 3771.—Halesowen Steel Co. Ltd.

5297. The supply of six haulage winches, Kiewa Hydro-Electric Scheme, to Quotation No. 3357.—Hardware Co. of Australia Pty. Ltd.

5298. The supply of two Hawksley aluminium alloy buildings, Kiewa Hydro-Electric Scheme and Morwell.—John Hart Pty. Ltd.

5299. The supply of one 10-ton electric derrick crane, Morwell.—John M. Henderson.

5300. The supply of engine parts for compressors, to Quotation No. 5189.—Ingersoll-Rand (Aust.) Pty. Ltd.

5301. The supply of scraper loader for movable conveyor installation, Yallourn North Open Cut, to Quotation No. 5727.—Ingramweld.

5302. The supply of natural round wooden poles and bed-logs for transmission and distribution lines, Gippsland area, for a period of twelve months.—H. J. Joyce.

5303. The supply of 2,250 natural round wooden poles for transmission and distribution lines, to Quotation No. 6182.—Hector C. Kennedy.

5304. The supply of 250 metal folding beds for accommodation of personnel, metropolitan area, to Quotation No. 5701.—Wm. Latchford and Son.

5305. The supply of three two-speed differentials for eleven-passenger buses, Kiewa Hydro-Electric Scheme, to Quotation No. 5086.—E. A. Machin and Co. Ltd.

5306. The supply of two portable air compressors, metropolitan area, to Specification No. 49-50/124.—McPherson's Ltd.

5307. The supply of one second-hand reduction gear-box for mine winder, No. 4 Power Station, Kiewa Hydro-Electric Scheme, to Quotation No. 6181.—Miller and Co. (Machinery) Pty. Ltd.

5308. The supply of 5,000 aluminium line clamps and clamping pieces, to Quotation No. 4953.—Miller Cyclone Forgings Pty. Ltd.

5309. The supply of 2,500 galvanized forged steel ball strain eyes for Kiewa-Melbourne transmission line, to Quotation No. 5324.—Miller Cyclone Forgings Pty. Ltd.

5310. The supply of 500 galvanized extension eyebolts, to Quotation No. 5381.—Miller Cyclone Forgings Pty. Ltd.

5311. The supply of 400 dressed wooden poles, Yallourn and Morwell, to Quotation No. 6295.—L. Mooney.

5312. The supply of 90 sheets of insulating panel for Shepparton and Warrnambool Power Stations, to Quotation No. 5002.—Noyes Bros. (Melb.) Ltd.

5313. The supply of one 6,000 kW. back-pressure steam turbo-generator and associated spare parts for Yallourn Power Station extensions, to Specification No. 49-50/3.—C. A. Parsons and Co. Ltd.

5314. The supply of 750 bucket teeth for overburden dredger, Yallourn, to Quotation No. 5256.—The Steel Co. of Australia.

5315. The supply of three "Armco" steel buildings for storage purposes, Kiewa Hydro-Electric Scheme.—Sutex Ltd.

5316. The supply of two fire service pumps, Yallourn Power Station, to Specification No. 49-50/239.—Thompson's (Castlemaine) Ltd.

5317. The supply of 100,000 precast concrete masonry blocks, Shepparton Power Station, to Specification No. 49-50/299.—H. C. Turner.

5318. The supply of six tounaloders and six power control units, Kiewa Hydro-Electric Scheme, Morwell, and Yallourn, to Quotation No. 6258.—Tutt, Bryant (Vic.) Pty. Ltd.

5319. The supply of five motor-driven air compressors, Yallourn Open Cut, to Quotations Nos. 4340 and 4339.—Westinghouse Brake (Australia) Pty. Ltd.

5320. The supply of 115 air circuit-breakers, Yallourn "C" Power Station, to Quotation No. 4958.—Westinghouse, Rosebery Pty. Ltd.

5321. The supply of 150 fire extinguishers, Kiewa Hydro-Electric Scheme, to Quotation No. 5423.—Wormald Bros. (South) Ltd.

5322. The supply of eight cable-operated rooters for attachment to tractors, Kiwa Hydro-Electric Scheme and Morwell, to Quotation No. 3853.—Queen's Bridge Motor and Engineering Co. Pty. Ltd.

5323. The supply of two heavy-duty rippers for attachment to tractors, Kiwa Hydro-Electric Scheme, to Quotation No. 3853.—Tutt, Bryant (Vic.) Pty. Ltd.

5324. The supply of two lathes and accessory equipment for maintenance workshops, Morwell, to Specification No. 49-50/66.—Norman N. Benson.

5325. The supply of one lathe and accessory equipment for maintenance workshops, Morwell, to Specification No. 49-50/66.—Knox, Schlapp Pty. Ltd.

5326. The supply of two lathes and accessory equipment for maintenance workshops, Morwell, to Specification No. 49-50/66.—McPherson's Ltd.

5327. The supply of 500 movable track trolley wire masts, Morwell Project, to Specification No. 48-49/206A.—Ingramweld.

5328. The supply of 1,000 movable track trolley wire masts, Morwell Project, to Specification No. 48-49/206A.—F. Long and Co.

5329. The supply of six 12-ton semi-trailers for use in the haulage of stores and equipment from Melbourne to Kiwa and Yallourn, to Quotation No. 4388.—McGrath Trailer Equipment Pty. Ltd.

5330. The supply of five 7-ton semi-trailers for use in the haulage of stores and equipment from Melbourne to Kiwa and Yallourn, to Quotation No. 4388.—Victorian Industrial Sales and Service Pty. Ltd.

5331. The supply of submersible borehole pump accessories for pumping of artesian water, to Quotation No. 4476.—Horwood and Bagshaw Ltd.

5332. The supply of submersible borehole pump accessories for pumping of artesian water, to Quotation No. 4476.—Stewarts and Lloyds (Aust.) Pty. Ltd.

Approved by the Governor in Council, 16th May, 1950.—
A. G. COULTHARD, Acting Clerk of the Executive Council.

SHIRE OF ARARAT.

DECISION OF MINISTER AND COUNCIL THAT A CERTAIN ROAD IS NOT REQUIRED FOR PUBLIC TRAFFIC.

WHEREAS a certain road, being portions of allotments 1b, 2a, 2b, and 3b, section 19, Parish of Mellier, commencing at a point on the northern boundary of allotment 1b, bearing N. 89 deg. 40 min. E. 3,505 links from the north-west angle of allotment 1a; thence N. 89 deg. 40 min. E. 128 1/10 links; thence S. 39 deg. 0 min. E. 1,581 links; thence S. 45 deg. 18 min. E. 3,124 links; thence S. 25 deg. 24 min. E. 748 links; thence S. 44 deg. 48 min. E. 641 links to a point on the eastern boundary of allotment 3b; thence S. 1 deg. 59 min. E. 147 1/10 links; thence N. 44 deg. 48 min. W. 766 links; thence N. 25 deg. 24 min. W. 748 links; thence N. 45 deg. 18 min. W. 3,112 links; thence N. 39 deg. 0 min. W. 1,667 links to the point of commencement, and containing by admeasurement 6 acres 0 roods 14 perches, or thereabouts, and coloured pink on the plan attached to correspondence deposited in the office of the Public Works Department, Melbourne, is situated within the municipal district of the Shire of Ararat and was declared a public highway by notice published in the *Government Gazette* on the third day of August, 1900:

And whereas it is alleged that the said road is no longer required for public traffic, and the question whether the said road is or is not required for public traffic has been referred to the Council of the said Shire of Ararat and to the Honorable Sir James Arthur Kennedy, M.L.C., in his capacity as the responsible Minister of the Crown for the time being administering section 552 of the *Local Government Act 1946*:

Now, therefore, the said Council and the said the Honorable Sir James Arthur Kennedy, M.L.C., as such Minister as aforesaid, having taken the said question into their consideration, do, under the powers vested in them by this present instrument under the seal of the President, Councillors, and Ratepayers of the Shire of Ararat and the hand and seal of the said Sir James Arthur Kennedy, M.L.C., as such Minister as aforesaid, hereby decide that the said road is not required for public traffic.

Dated the twenty-first day of April, in the year of our Lord One thousand nine hundred and fifty.

The seal of the President, Councillors, and Ratepayers of the Shire of Ararat was affixed hereto, in the presence of—

(SEAL) ALEX. McDONALD, President.
A. W. VANSTAN, Councillor.
K. N. BISHOP, Secretary.

Signed, sealed, and delivered by the said Sir James Arthur Kennedy, in the presence of C. C. GALE—

(SEAL) J. A. KENNEDY.

Water Acts.

STATE RIVERS AND WATER SUPPLY COMMISSION. ALLANSFORD URBAN DISTRICT.

NOTICE to the owners of the under-mentioned tenements in the Allansford Urban District:—

Prince's Highway.

Lots 1, 2, 3, 4, 5, and 6 on plan of subdivision of allotment 20A¹, Parish of Mepunga, by Andrew Kerr.

Lots 15, 16, 17, 18, 19, 20, and 21 on lodged plan of subdivision No. 3152.

Lots 24 and 25 on lodged plan of subdivision No. 275.

Tooram-road.

Lots 27, 28, 29, 30, 31, and 32 on said plan of subdivision of allotment 20A¹, Parish of Mepunga, by Andrew Kerr.

The main pipes being laid down for the supply of water to the above-mentioned tenements, the owners thereof are hereby required, on or before the 30th day of June next, to cause proper pipes and stop cocks to be laid, so as to supply water within such tenements from the main pipes.

A. D. BROWN, Acting Secretary,
State Rivers and Water Supply Commission.

Melbourne, 18th May, 1950.

Water Acts.

STATE RIVERS AND WATER SUPPLY COMMISSION. ALLANSFORD AND CHELSEA—FRANKSTON URBAN DISTRICTS.

NOTICE to owners of tenements in the under-mentioned streets in the above-mentioned urban districts and the private streets, lanes, courts, and alleys opening thereto:—

Allansford Urban District.

Prince's Highway, from Catherine-street to a point opposite lot 19 on plan of subdivision of allotment 20A¹, Parish of Mepunga, by Andrew Kerr, about 16 chains easterly.

Chelsea—Frankston Urban District.

Chelsea.

Scotch-parade, from Sherwood-avenue to Thames-promenade,

The main pipe in the said streets being laid down, the owners of all tenements situated as above are hereby required, on or before the 30th day of June next, to cause proper pipes and stop cocks to be laid, so as to supply water within such tenements from the main pipe.

A. D. BROWN, Acting Secretary,
State Rivers and Water Supply Commission.

Melbourne, 18th May, 1950.

Water Acts.

STATE RIVERS AND WATER SUPPLY COMMISSION. URBAN DISTRICT SUPPLIED WITH WATER FROM THE COLIBAN SYSTEM OF WATERWORKS.

NOTICE to owners of tenements in the under-mentioned streets in the urban district supplied with water from the Coliban system of waterworks, and the private streets, lanes, courts, and alleys opening thereto:—

Harcourt.

Government-road, forming the eastern boundary of allotments 1 and 2A, section 13, Town and Parish of Harcourt, from the south-eastern angle of said allotment 2A to Calder Highway.

Calder Highway, from said Government-road north-easterly to Station-road.

Station-road, from end of existing main (about 2½ chains south-westerly from Calder Highway) to Calder Highway.

The main pipe in the said streets being laid down, the owners of all tenements situated as above are hereby required, on or before the 30th day of June next, to cause proper pipes and stop cocks to be laid, so as to supply water within such tenements from the main pipe.

A. D. BROWN, Acting Secretary,
State Rivers and Water Supply Commission.

Melbourne, 18th May, 1950.

Transport Regulation Acts.
TRANSPORT REGULATION BOARD.
NOTICES OF PUBLIC HEARINGS.

NOTICE is hereby given that the applications made by the persons named below for licences to operate the commercial goods vehicles on the route or routes, or in a manner set out opposite their names, will be heard at a time and place to be communicated to the parties concerned.

Name and Address; Nature of Application.

ADAMS, R. R., Powelltown; 1 commercial goods vehicle (200 cwt.) for the carriage of:—

1. Logs from any forest landing in the Upper Yarra forestry district—(a) to the railway station at Noojee and to any mill or dump which is located within a radius of 20 miles of such landing, or of the railway station at Noojee, (b) to any mill situated—(i) on or within 5 miles of the Princes Highway east, between Warragul and Berwick, (ii) south of the River Yarra, within a radius of 25 miles, but not within 8 miles of the G.P.O., Melbourne.

2. Logs from such other area or to such other destinations as may be authorized in writing by the Board from time to time.

3. Sawm timber from Kauri Timber Company's mill at Noojee to the Noojee railway station, or to any timber merchant or builder, if delivered *en route* to such railway station, or to a timber yard or building site located within a radius of 20 miles of such railway station.

BEER, R. E., Crystal Springs, Free Bag, via Tallangatta; 1 commercial goods vehicle (63 cwt.) for the carriage of—(a) general goods within a radius of 20 miles from Tallangatta, (b) livestock, farm produce, fodder and farm machinery, from and to places situate within the area defined under paragraph (a) above, and to and from Wodonga and the Victoria-New South Wales border *en route* Albury, New South Wales.

BOUCHER, W. T., 266 Mackenzie-street, Golden Square, Victoria; 1 commercial goods vehicle (20 cwt.) for the carriage of drapery in the course of business as "hawker" throughout the State of Victoria.

CLYDESDALE, R. H. & B. C. (trading as "Clydesdale & Clydesdale"), 243 Beaconsfield-parade, Middle Park; 1 commercial goods vehicle (30 cwt.) for the carriage of water boring plant in the course of business as "water boring contractor" also windmills, plumbers suppliers and plant incidental to the installation of water supply and sewerage systems throughout the State of Victoria.

DUNLOP SEMTEX PRY. LTD., 130 Flinders-street, Melbourne; 1 commercial goods vehicle (50 cwt.) for the carriage of flooring tiles, rubber floor coverings, tools of trade, and materials used in connexion with the laying of such coverings throughout the State of Victoria.

KIRKPATRICK, E. D., 123 McCrae-street, Bendigo; 1 commercial goods vehicle (60 cwt.) to operate as a water carrier at projects being undertaken by the Country Roads Board throughout the State of Victoria.

NESTLES FOOD SPECIALITIES AUSTR., LTD., 591 Little Collins-street, Melbourne; 1 commercial goods vehicle (90 cwt.) for the carriage of milk products, baby foods, and confectionery in the course of own business within a radius of 50 miles from Melbourne.

NEWBY, A. D., Dodemaides-road, Trafalgar; 1 commercial goods vehicle (80 cwt.) to operate in the course of business as "sanitary contractor" within a radius of 100 miles from Trafalgar.

ROBERTS, C. T., Tungamah, Victoria; 1 commercial goods vehicle (50 cwt.) for the carriage of—(a) general goods within a radius of 20 miles from Tungamah, (b) livestock and petroleum products within a radius of 50 miles from Tungamah.

SHEATHER, A. F., Corryong—

1. One commercial goods vehicle (100 cwt.) for the carriage of—(a) general goods within a radius of 20 miles from Corryong, (b) general goods from and to Corryong, to and from Wodonga and the Victoria-New South Wales border *en route* Albury, New South Wales.

2. Application to vary the conditions of Licence No. D4285 by inclusion of the ability to carry in accordance with paragraph (b) of application (1) listed above.

SMITH, L. F. J., 152 Hope-street, West Brunswick; 1 commercial goods vehicle (10 cwt.) to operate in the course of business as "hawker" throughout the State of Victoria.

STAFF, W. J., 8 Hurley-street, Ballarat; 1 commercial goods vehicle (10 cwt.) for the carriage of tools of trade and materials in the course of business as "builder" throughout the State of Victoria.

WHATMAN, R. G., Foster-street, Stawell West; 1 commercial goods vehicle (80 cwt.) for the carriage of road-making plant and materials under contract to the Country Roads Board, throughout the State of Victoria.

NOTICE is hereby given that the applications made by the persons named below for licences to operate the commercial passenger vehicles on the routes or route, or in the manner set out opposite their names, will be heard at a time and place to be communicated to the parties.

Name of Applicant; Nature of Application.

TAXIS, D. & K., PRY. LTD., 27 Fryers-street, Shepparton; 6 commercial passenger vehicles, each with seating capacity for five persons, to operate as follows:—(a) at separate and distinct fares within a radius of 5 miles of Shepparton, (b) under private hire conditions within a radius of 50 miles of Shepparton (subject to the cancellation of licences numbered A.16, A.29, A.39, A.60, A.901, and A.1199, at present held by F. S. Dunn, Shepparton).

GREENDA, G. F., 3B Warrigul-road, Oakleigh; 1 commercial goods vehicle, with seating capacity for thirty persons, to be purchased to operate as an additional vehicle under the same terms and conditions as contained in applicant's existing stage omnibus licences.

PORTSEA PASSENGER SERVICE, Station-street, Frankston; 1 commercial passenger vehicle, with seating capacity for five persons, to operate as follows:—(a) at separate and distinct fares, within a radius of 5 miles of Rosebud, (b) under private hire conditions, within a radius of 50 miles of Rosebud.

RECHNER, L. G., Rushworth; 1 commercial passenger vehicle, with seating capacity for five persons, to operate as follows:—(a) at separate and distinct fares, within a radius of 5 miles of Rushworth, (b) under private hire conditions, within a radius of 50 miles of Rushworth.

(This replaces application gazetted on 26th April, 1950, in the name of V. Rechner, Rushworth.)

UNDERWOOD, G. H., Anderson-street, Euroa; 1 commercial passenger vehicle, with seating capacity for 30 persons, to operate for the carriage only of school children between Avenel and Seymour, in accordance with the terms of a contract entered with the Education Department, and under charter conditions within a radius of 20 miles of Avenel.

TURNER, C. G., Buninyong; 1 commercial passenger vehicle, with seating capacity for 5 persons, to operate as follows:—(a) for the carriage of passengers, mails, and parcels between Buninyong and Mt. Mercer, (b) under private hire conditions from Buninyong to places throughout Victoria.

WILSON, A. T., 7 Ilex-street, Red Cliffs; 1 commercial passenger vehicle, with seating capacity for 5 persons, to operate as follows:—(a) at separate and distinct fares, within a radius of 5 miles of Red Cliffs, north of a line drawn east and west through Red Cliffs, (b) at separate and distinct fares, within a radius of 20 miles of Red Cliffs, south of a line drawn east and west of Red Cliffs, (c) under private hire conditions, within a radius of 100 miles of Red Cliffs (subject to the cancellation of licence No. A.2798, at present held by A. Oxley, Red Cliffs).

APPLICATIONS for licences to operate commercial vehicles, each with seating capacity for five persons, for the carriage of passengers otherwise than at separate and distinct fares for each passenger throughout Victoria:—

ALEXANDER, R. R. 7 Irwell-street, St. Kilda.

CAPP, A. H., 22 Goodwin-street, Preston.

TAXI, D. & K., PRY. LTD., 27 Fryers-street, Shepparton (subject to the cancellation of licence No. P.H.560, at present held by F. S. Dunn, Shepparton).

TAXI, D. & K., PRY. LTD., 27 Fryers-street, Shepparton (subject to the cancellation of private hire licence at present in the course of issue to F. S. Dunn, Shepparton).

GANGE, A., 214 Brunswick-street, Fitzroy.

NOONAN, H. W., Swanston-street, Terang.

PROPOSCH, H. D., Drouin-road, Longwarry.

WHITE, J. P., and G. T. CARROLL, 16 Tucker-street, Port Melbourne.

Notice of any objection should be forwarded to reach the Secretary to the Board not later than Wednesday, 7th June, 1950.

E. V. FIELD,
Secretary.

Exhibition Buildings, Rathdown-street, Carlton, 23rd May, 1950.

LIST OF STOCK FOODS AND STOCK LICKS.

REGISTERED AT THE OFFICE OF THE DIRECTOR OF AGRICULTURE UNDER THE STOCK FOODS ACT 1936 (No. 4382) FOR THE YEAR 1950.

Distinguishing Brand Name.	Guaranteed Composition.			Where Obtainable.
	Crude Protein (N x 6.25). Minimum.	Crude Fat. Minimum.	Crude Fibre. Maximum.	
CONCENTRATED STOCK FOODS.				
* <i>Feeding Blood Meal.</i>				
Imperial	85.0	..	5.0	W. Angliss and Co. (Aust.) Pty. Ltd., Lynch-street, Footscray
Pannifex	75.0	2.0	5.0	H. C. Pannifex and Co. Pty. Ltd., 53-57 Munster-terrace, North Melbourne
Champion Protein	75.0	..	5.0	Sims Cooper Freezing Works Pty. Ltd., 31 Queen-street, Melbourne
Brooklyn, T. B. and S. in diamond	75.0	1.5	1.0	Thos. Borthwick and Sons (A/asia) Ltd., 84 William-street, Melbourne
Portland, T. B. and S. in diamond	75.0	1.5	1.0	" " " " " " "
V.I.M.A.	77.0	..	1.5	Victorian Inland Meat Authority, 54 Market-street, Melbourne
† <i>Feeding Meat Meal.</i>				
M.C.C. (with bone)	57.0	10.0	5.0	Melbourne City Council, Town Hall, Melbourne
Imperial Liver Meal	85.0	18.0	..	W. Angliss and Co. (Aust.) Pty. Ltd., Lynch-street, Footscray
Pannifex	55.0	5.0	3.0	H. C. Pannifex and Co. Pty. Ltd., 53-57 Munster-terrace, North Melbourne
V.I.M.A.	55.0	13.0	1.6	Victorian Inland Meat Authority, 54 Market-street, Melbourne
Champion Protein Liver Meal	60.0	20.0	5.0	Sims Cooper (Freezing Works) Pty. Ltd., 31 Queen-street, Melbourne
A.B.C. Fish Meal	64.0	4.0	2.0	E. T. Moulden and Son Pty. Ltd., 204 Victoria-street, North Melbourne
T. B. and S. in diamond Brooklyn Liver Meal	63.0	18.0	1.0	Thos. Borthwick and Sons (A/asia) Ltd., 84 William-street, Melbourne
T. B. and S. in diamond Portland Liver Meal	63.0	18.0	1.0	" " " " " " "
‡ <i>Feeding Meat and Bone Meal.</i>				
V.I.M.A.	45.0	12.0	1.6	Victorian Inland Meat Authority, 54 Market-street, Melbourne
Mercury	50.0	12.0	1.6	Process Refiners Pty. Ltd., 55 Hobson's-road, South Kensington
Pannifex	45.0	5.0	5.0	H. C. Pannifex and Co. Pty. Ltd., 53-57 Munster-terrace, North Melbourne
Imperial Protein	50.0	10.0	2.0	W. Angliss and Co. (Aust.) Pty. Ltd., Lynch-street, Footscray
Cal-Phoric	45.0	15.0	2.5	Mulgrave By-Products Co., North-road, East Oakleigh
Champion Protein	50.0	12.0	5.0	Sims Cooper Freezing Works Pty. Ltd., 31 Queen-street, Melbourne
T.B. and S. in diamond Brooklyn	50.0	12.0	4.0	Thos. Borthwick and Sons (A/asia) Ltd., 84 William-street, Melbourne
Dandy	45.0	12.0	1.60	Gippsland Co-op. Bacon Curing Co. Ltd., Dandenong
Pridham's	45.0	12.0	1.0	W. Pridham Pty. Ltd., Evans-street, Braybrook
Pennell's	50.0	6.0	4.0	G. W. Pennell, Burke-street, Braybrook
Ibis	50.4	8.85	3.0	Flecken, Halliday, and McClelland Pty. Ltd., 634 Bourke-street, Melbourne
M.S.C.	45.0	10.0	3.5	The Mildura Shire Council, Mildura
Portland, T.B. and S. in diamond	50.0	12.0	4.0	Thos. Borthwick and Sons (A/asia) Ltd., 84 William-street, Melbourne
<i>Bone and Meat Meal.</i>				
Kitchens	40.0	7.0	2.5	J. Kitchen and Sons Pty. Ltd., Ingles-street, Port Melbourne
Pannifex	40.0	5.0	5.0	H. C. Pannifex and Co. Pty. Ltd., 53-57 Munster-terrace, North Melbourne
Apex	40.0	10.0	3.0	North-Eastern Bone Products, Wangaratta
<i>Milk Products.</i>				
Krafco (Dried Whey)	10.0	0.5	..	Kraft Walker Cheese Co. Pty. Ltd., Riverside-avenue, South Melbourne
Kraftone (Dried Whey)	10.0	0.5	..	" " " " " " "
Lactokraft (Dried Whey)	10.0	0.1	..	" " " " " " "
Maffco Buttermilk Powder	30.0	5.0	..	Maffra Co-op. Milk Products Co. Ltd., Maffra
K.B.F. Buttermilk Powder	30.0	6.0	..	Korumburra and District Co-op. Butter Factory and Trading Co. Ltd., Korumburra
Acme Buttermilk Powder	31.2	14.0	..	Warrnambool Cheese and Butter Factory Co. Ltd., Albansford
Milway Milk Product	20.0	18.0	1.5	Kraft Walker Cheese Co. Pty. Ltd., Riverside-avenue, South Melbourne
Colac Dried Milk Albumen	54.0	5.0	0.2	Colac Dairying Co. Ltd., Colac
<i>Oil-Seed or Cake Meals and Nuts.</i>				
Eta Peanut Meal	45.0	2.0	6.0	Nut Foods Pty. Ltd., 271 Grant-street, South Melbourne
Meggitt's Linseed Oil Meal	28.0	5.0	10.0	Meggitt Ltd., Hobson's-road, South Kensington
Meggitt's Linseed Sheep Nuts	28.0	5.0	10.0	" " " " " " "
Barnes' Linseed Oilmeal	33.0	2.0	10.0	James Barnes' Pty. Ltd., Bank-place, Melbourne
Barnes' Coconut Oilmeal	21.0	1.5	12.0	" " " " " " "
MIXED STOCK FOODS.				
<i>For Pigs.</i>				
Barastoc Pig Cubes	15.0	3.0	6.0	Barastoc Products, 385 Collins-street, Melbourne
Barastoc Topping-off Pig Cubes	12.5	3.0	6.0	" " " " " " "
Osmond's Codliverine (Pigs)	19.0	14.0	9.0	Osmond and Sons (Aust.) Pty. Ltd., 35 William-street, Melbourne
Clark's Pig Starter	17.0	4.0	6.0	Clark, King, and Co. Pty. Ltd., 237 Queen-street, Melbourne
Clark's Gro-Pig	16.0	3.0	4.0	" " " " " " "
Hutmill Pig Meal	14.0	2.5	7.5	Hutchinson's "Finley" Flour "Milling" and Agency Co. Ltd., Glenroy

* Standard not less than 75 per cent. crude protein and not more than 5 per cent. crude fibre.
 † Standard not less than 55 per cent. crude protein and not more than 7 per cent. phosphoric acid. 100 per cent. must pass through a 10-mesh sieve.
 ‡ Standard not less than 45 per cent. crude protein. 100 per cent. must pass through a 10-mesh sieve.

LIST OF STOCK FOODS AND STOCK LICKS—continued.

Distinguishing Brand Name.	Guaranteed Composition.			Where Obtainable.
	Crude Protein (N x 6.25). Minimum.	Crude Fat. Minimum.	Crude Fibre. Maximum.	
MIXED STOCK FOODS—continued.				
<i>For Calves.</i>				
Harper's Star Calf Food	12.0	12.5	7.0	Robert Harper and Co. Ltd., 390 Flinders-lane, Melbourne
*Parsons' Calf Food	12.0	2.0	6.0	Parsons Bros. and Co. Pty. Ltd., 554-562 Flinders-lane, Melbourne
Ayrshire Calf Food	13.3	2.45	4.0	James Ralton, 133 Elizabeth-street, Melbourne
Ward's Calf Food	9.0	3.0	7.0	H. S. K. Ward Pty. Ltd., 24-38 Spencer-street, Melbourne
Vetamac Calf Food	15.35	7.5	1.5	A. H. McDonald, 627 Bridge-road, Richmond
Velox Calf Food	14.6	2.9	4.0	H. C. Allen, Newcombe-street, Portarlington
Gro-calf	20.0	4.0	4.0	Clark, King, and Co. Pty. Ltd., 237 Queen-street, Melbourne
Kaf-o-vite	16.5	9.5	7.5	Goldsbrough, Mort, and Co. Ltd., 526 Bourke-street, Melbourne
Barastoc Calf Pellets	17.0	4.0	6.5	Barastoc Products, 395 Collins-street, Melbourne
Federal	20.4	8.2	5.1	E. T. Moulden and Son Pty. Ltd., 294 Victoria-street, North Melbourne
Rudduck's Calf Food	17.0	2.3	3.5	Rudduck and Co. Pty. Ltd., 556 Lonsdale-street, Melbourne
Chief Calf Food	12.0	5.0	5.0	Verona Products, 592 Burwood-road, Auburn
Hutmill Calf Food	13.0	4.0	10.0	Hutchinson's Finley Flour Milling and Agency Co. Ltd., Glenroy
Vet-N-Ary Calf Food	17.0	4.0	7.0	Creamota Ltd., Sunshine-road, West Footscray
Calfmilk Calf Food	21.0	3.0	3.0	British United Dairies Pty. Ltd., 33 King-street, Melbourne
<i>For Dairy Cows.</i>				
Lambert's Dairy Mixture No. 3	15.0	5.0	10.0	H. V. and L. Towers, 696 High-street, Kew
Barastoc Dairy Cow Cubes	14.0	3.5	10.5	Barastoc Products, 395 Collins-street, Melbourne
Barastoc Dairy Cow Meal	14.0	3.5	10.5	H. C. "Panrifex" and "Co. Pty. Ltd., 53-57 "Munster-terrace, North Melbourne
Mormilk No. 2y	20.0	4.75	14.0	Clark, King, and Co. Pty. Ltd., 237 Queen-street, Melbourne
Clark's Dairy-Mex	18.0	3.0	8.0	Parsons Bros. and Co. Pty. Ltd., 554 Flinders-lane, Melbourne
*Parsons' Dairy Cow Meal	17.0	3.5	17.0	Verona Products, 592 Burwood-road, Auburn
Chief Cow Meal	15.0	5.0	11.0	Hutchinson's Finley Flour Milling and Agency Co. Ltd., Glenroy
Hutmill Dairy Meal	17.0	3.0	8.0	Creamota Ltd., Sunshine-road, West Footscray
Vet-N-Ary Dairy Cowmeal	15.0	3.5	14.0	
<i>General.</i>				
Osmond's Codliline	20.0	14.0	9.0	Osmond and Sons (Aust.) Pty. Ltd., 35 William-street, Melbourne
Purity Protein Meal	15.0	3.0	5.0	Wise Bros. Pty. Ltd., Tocumwal
Parsons' Stock Mixture	15.0	6.0	16.0	Parsons Bros. and Co. Pty. Ltd., 554 Flinders-lane, Melbourne
Barastoc Sheep Cubes	14.5	3.0	9.0	Barastoc Products, 395 Collins-street, Melbourne
Barastoc Ewe and Lamb Cubes	18.0	3.0	8.0	" " " " " "
<i>Poultry Foods.</i>				
Harper's Prepared Grain	8.5	8.0	4.5	Robert Harper and Co. Ltd., 390 Flinders-lane, Melbourne
Clark's Laymor	17.0	4.0	6.0	Clark, King, and Co. Pty. Ltd., 237 Queen-street, Melbourne
Clark's Gro-chick	16.0	4.0	6.0	" " " " " "
Eggoleen	40.0	10.0	3.0	" " " " " "
Clark's Chick-starter	18.0	4.0	6.0	" " " " " "
Clark's Turkey Starter	27.0	4.0	6.0	" " " " " "
Clark's Breeders' Mash	16.0	4.0	6.0	" " " " " "
Clark's Broiler Feed	20.0	3.0	6.0	" " " " " "
Clark's Finner	14.0	4.0	6.0	" " " " " "
Warragul Laying Mash	14.0	4.5	4.2	Warragul Egg Circle, Warragul
Warragul Growing Mash	14.0	5.9	5.2	" " " " " "
Cowling's Laying Mash	14.0	2.5	7.0	W. Cowling, Market Square, Bendigo
Cowling's Chick Mixture	10.0	1.25	3.0	" " " " " "
Cowling's Chick Starter	15.5	3.0	5.0	" " " " " "
Cowling's Growing Grain	12.0	1.5	4.0	" " " " " "
Barastoc Poultry Pellets W (Layers)	17.0	4.0	7.0	Barastoc Products, 395 Collins-street, Melbourne
Barastoc Chick Pellets	18.0	4.5	7.0	" " " " " "
Barastoc Poultry Grower's Pellets	15.0	4.0	7.0	" " " " " "
Barastoc Poultry Pellets W (Growers)	15.0	4.0	7.0	" " " " " "
Barastoc Poultry Layers' Pellets	17.0	4.0	7.0	" " " " " "
Barastoc Turkey Starter Pellets	22.0	4.5	7.0	" " " " " "
Ward's Chick Meal	10.0	4.0	5.0	H. S. K. Ward Pty. Ltd., 24-38 Spencer-street, Melbourne
Osmond's Codliline for Poultry	19.0	12.0	9.0	Osmond and Sons (Aust.) Pty. Ltd., 35 William-street, Melbourne
Excello Growing Mash	9.0	3.4	7.0	Lyall and Sons Pty. Ltd., 39-51 Leveson-street, North Melbourne
Excello Laying Mash	13.0	4.0	7.0	" " " " " "
Clark's Vitamilk	31.0	6.0	1.0	Clark, King, and Co. Pty. Ltd., 237 Queen-street, Melbourne
Mercury Poultry Food Concentrate	20.0	5.0	2.0	Process Refiners Pty. Ltd., 55 Hobson's-road, South Kensington
Lambert's Chicken Starter	17.0	4.0	6.0	H. V. and R. Towers, 696 High-street, Kew
Lambert's Laying Mash	17.0	4.0	6.0	" " " " " "
A.B.C. Growing Mash	14.0	4.0	5.3	E. T. Moulden and Son Pty. Ltd., 294 Victoria-street, North Melbourne
A.B.C. Laying Mash	16.0	3.5	7.0	" " " " " "
A.B.C. Werribee Mash	11.0	3.5	4.5	" " " " " "
Marvel Laying Mash	15.0	2.4	6.0	J. McBeth, 207 Neerim-road, Carnegie
Marvel Chick Mash	18.0	4.0	6.0	" " " " " "
Marvel Growing Mash	16.0	4.0	6.0	" " " " " "
Par-Meal Special Laying Mash	15.0	4.25	5.5	Parsons Bros. and Co. Pty. Ltd., 554 Flinders-lane, Melbourne
Parsons' Poultry Mash	16.0	8.0	11.0	" " " " " "
Parsons' Special Chick Mash	14.0	4.0	7.0	" " " " " "
Cole's Chick Food	13.6	2.9	5.0	Cole's Poultry Farm, Carisbrook

* Contains 1 per cent. salt.
† Contains 2 per cent. salt.

LIST OF STOCK FOODS AND STOCK LICKS—continued.

Distinguishing Brand Name.	Guaranteed Composition.			Where Obtainable.
	Crude Protein (N x 6.25), Minimum.	Crude Fat, Minimum.	Crude Fibre, Maximum.	
MIXED STOCK FOODS—continued.				
<i>Poultry Foods—continued.</i>				
Gem Laying Mash	10.0	4.0	0.0	Burrows Hume Flour Mills, Albury
Pannifex Poultry Pusher*	32.0	7.0	8.0	H. C. Pannifex and Co. Pty. Ltd., 53 Munster-terrace, North Melbourne
V.W.C. Growing Mash	13.0	3.75	5.5	Victorian Wheatgrowers Corp. Ltd., 17 Queen-street, Melbourne
V.W.C. Laying Mash	17.0	2.0	2.5	" " " " " "
V.W.C. Chick Starter	16.0	2.25	4.0	" " " " " "
V.W.C. Kibbled Maize and Wheat	9.25	1.6	3.0	" " " " " "
Chief Laying Mash	16.0	5.0	7.0	Werona Products, 592 Burwood-road, Auburn
Hutmill Growing Mash	16.0	3.0	7.0	Hutchinson's Finley Flour Milling and Agency Co. Ltd., Glenroy
Hutmill Laying Mash†	17.0	3.0	7.0	" " " " " "
Hutmill Chicken Mixture	10.0	2.4	2.0	" " " " " "
Hutmill Chicken Mash	18.0	4.0	7.0	" " " " " "
Bush's Laying Mash	14.9	3.9	7.2	Albert Bush, Williamson-street, Bendigo
Bush's Chick Mash	15.4	3.6	6.9	" " " " " "
J (in shield) Chick Grain	11.0	4.0	6.0	O. W. Jochinke Pty. Ltd., Wimmera-street, Dimboola
Vet-N-Ary Layer Pellets	17.0	4.5	7.0	Creamota Ltd. Sunshine-road, West Footscray
Vet-N-Ary Grower Pellets	14.5	4.5	7.0	" " " " " "
Vet-N-Ary Chick Pellets	17.0	4.5	7.0	" " " " " "
Vet-N-Ary Breeders Pellets	17.0	4.0	7.0	" " " " " "
V.W.C. Chicken Mash	14.5	4.3	3.6	Victorian Wheatgrowers Corporation Ltd., 17 Queen-street, Melbourne
Harper's Star Chick Flakes	9.8	9.7	1.5	Robert Harper and Co. Ltd., 390 Flinders-lane, Melbourne
Master Mix Chick Food	10.0	2.0	3.0	Northern Seed Supply Co., Market-street, Bendigo
Master Mix Chick Mash	17.0	3.0	5.0	" " " " " "
Master Mix Laying Mash	17.0	3.0	5.0	" " " " " "
Burrow's Chicken Mixture	10.0	2.0	4.0	Burrows Hume Flour Mills, 570 Young-street, Albury
WHEAT AND WHEAT BY-PRODUCTS.				
Lyall's Wheat Meal	9.0	3.0	4.0	Lyall and Sons Pty. Ltd., 39 Leveson-street, North Melbourne
Clark's Wheat Meal	9.0	1.0	3.0	Clark, King and Co. Pty. Ltd., 237 Queen-street, Melbourne
Connell's Wheat Polishing No. 1	14.0	4.0	3.5	John Connell and Co. Ltd., 578 Bourke-street, Melbourne
Connell's Wheat Polishing No. 2	13.5	5.0	0.0	" " " " " "
Maryborough Crushed Wheat	9.5	2.0	2.5	Maryborough Flour Mills Pty. Ltd., Maryborough
Wangaratta Crushed Wheat	8.5	1.5	2.5	Wangaratta Flour Mills Co. Pty. Ltd., Wangaratta
Water Wheel Ground Wheat	9.5	1.5	2.5	Water Wheel Flour Mills Pty. Ltd., 83 William-street, Melbourne
Darling's Wheat Meal	10.5	2.5	3.5	John Darling and Son, 44 King-street, Melbourne
Garden City Stock Meal	9.6	1.5	2.5	Garden City Flour Mill, Ballarat
Kimpton's Crushed Wheat	8.5	1.5	3.0	W. S. Kimpton and Sons, 305 Collins-street, Melbourne
McLennan's Wheat Meal	9.5	2.0	2.5	McLennan and Co. Pty. Ltd., Mooroolbarn
Willis' Wheat Stock Feed	9.5	2.0	3.0	Willis Bros, Kyneton
Minifie's Ground Wheat	9.0	1.5	3.0	Jas. Minifie and Co. Pty. Ltd., 422 Collins-street, Melbourne
Stratton's Wheat Meal	9.5	2.0	3.0	Stratton and Co. Pty. Ltd., 68 Lullie-street, Abbotsford
Cowling's Ground Wheat	9.5	2.0	2.5	W. Cowling, Market Square, Bendigo
Noske Crushed Wheat	9.5	2.0	2.5	Noske Flour Mills Pty. Ltd., 108 Queen-street, Melbourne
Schutt and Barrie Stock Meal	9.5	2.0	2.5	Schutt and Barrie Flour Mills Pty. Ltd., Geelong-road, West Footscray
Thomas' Crushed Wheat	9.5	2.0	2.5	W. C. Thomas and Sons Pty. Ltd., 55 William-street, Melbourne
Hutmill Wheat Meal	9.5	2.0	2.5	Hutchinson's Finley Flour Milling and Agency Co. Ltd., Glenroy
Gem Stock Meal	9.0	2.0	3.5	Burrows Hume Flour Mills, Albury
Lambert's Wheat Meal	9.5	2.0	2.5	H. V. and R. Towers, 696 High-street, Kew
Williams' Rolled Wheat	9.5	2.0	2.5	Henry E. Williams and Sons Pty. Ltd., 9 High-street, Maryborough
Parsons' Wheat Polishings	13.5	3.75	5.5	Parsons Bros. and Co. Pty. Ltd., 554-562 Flinders-lane, Melbourne
Moregrain Wheat Meal	9.0	2.5	3.0	Norris and Wilkinson, Tinning-street, Brunswick
Williams' Rolled Wheat Meal	9.5	2.0	2.5	Henry E. Williams and Sons Pty. Ltd., Maryborough
Marvel Wheat Meal	9.5	2.0	3.5	J. McBeth, 207 Neerim-road, Carnegie
A.B.C. Wheat Meal	9.0	3.0	4.0	E. T. Moulden and Son Pty. Ltd., 294 Victoria-street, North Melbourne
Grant and Wilson Crushed Wheat	8.5	1.5	2.5	Grant and Wilson, Yarrowonga
Tomlin's Simmie Ground Wheat	9.5	2.0	2.5	Tomlin, Simmie and Co., Bendigo
Lanray Wheat Polishings	16.0	3.0	5.0	Lanray Milling Co. Pty. Ltd., 131 Queen-street, Melbourne
Tyner's Wheat Meal	9.5	1.5	2.5	W. Tyner Pty. Ltd., 623 Collins-street, Melbourne
V.W.C. Crushed Wheat	9.5	1.5	3.0	Victorian Wheatgrowers Corp. Ltd., 17 Queen-street, Melbourne
V.W.C. Ground Wheat	9.5	1.5	3.0	" " " " " "
Echuca Crushed Wheat	9.5	2.0	3.0	Echuca Flour Mills Pty. Ltd., Echuca
Crushed Wheat	9.5	1.5	2.5	North-Eastern Co-op. Soc. Ltd., Wangaratta
Crushed Wheat	9.5	1.5	3.5	British United Dairies Pty. Ltd., 33-35 King-street, Melbourne
Malcolm's Crushed Wheat	9.5	2.0	3.0	James Malcolm and Co. Pty. Ltd., St. Arnaud
Bransum Wheat Flakes	10.0	2.0	3.5	Cromarty Animal Food Mill, Spring Vale South
Cromarty No. 1 Rolled Wheat	8.5	1.5	2.5	" " " " " "
Polplus Wheat Semolina	9.0	2.0	2.0	" " " " " "
Cromarty Wheat Mealings	9.5	2.0	2.0	" " " " " "
Kerang Gristed Wheat	9.6	1.5	2.5	Kerang Flour Milling Co. Pty. Ltd., Kerang
Bush's Crushed Wheat	9.5	1.5	3.0	Albert Bush, Williamson-street, Bendigo
Bush's Ground Wheat	9.5	1.5	3.0	" " " " " "
Master Mix Ground Wheat	10.5	1.5	2.5	Northern Seed Supply Co., Market-street, Bendigo
Wimmera Crushed Wheat	8.5	1.5	2.5	Wimmera Flour Mill Co. Pty. Ltd., Taylor-street, Stawell
Williams Wheat Meal	9.5	1.5	3.0	Henry E. Williams and Sons Pty. Ltd., 3 High-street, Maryborough

* Contains 2 per cent. of salt.
† Contains 1 per cent. of salt.

LIST OF STOCK FOODS AND STOCK LICKS—continued.

Distinguishing Brand Name.	Guaranteed Composition.			Where Obtainable.
	Crude Protein (N x 6.25) Minimum.	Crude Fat. Minimum.	Crude Fibre. Maximum.	
BRAN AND POLLARD.				
The following firms have registered distinguishing brand names for Bran and Pollard:—				
T. Brunton and Co. Pty. Ltd.	531 Collins-street, Melbourne
Burnley Flour Mills Pty. Ltd.	376 Swan-street, Burnley
Darling (John) and Son	44 King-street, Melbourne
Echuca Flour Mills Pty. Ltd.	Echuca
Garden City Flour Mill	Trench-street, Ballarat
Graut and Wilson	McNally-street, Yarrowonga
Kimpton (W. S.) and Sons	395 Collins-street, Melbourne
Maryborough Flour Mills Pty. Ltd.	Maryborough
McLennan and Co. Pty. Ltd.	Mooroopna
Minife (James) and Co. Pty. Ltd.	422 Collins-street, Melbourne
Noske Flour Mills Pty. Ltd.	198 Queen-street, Melbourne
Schutt and Barrie Flour Mills Pty. Ltd.	Geelong-road, West Footscray
Silver Lake Flour Mill Pty. Ltd.	Sale
Smith (W. and P.)	35 Cusack-street, Wangaratta
Stratton and Co. Pty. Ltd.	88 Lullis-street, Abbotsford
Swan Milling Co.	Swan Hill and 1 Bent-street, Northcote
Thomas (W. C.) and Sons Pty. Ltd.	55 William-street, Melbourne
Tomlins, Simmie and Co.	87 Charleston-road, Bendigo
Wangaratta Flour Mills Co. Pty. Ltd.	Wangaratta
Willis Bros.	Kyneton
Wimmera Flour Mill Co. Pty. Ltd.	Stawell
Water Wheel Flour Mills Pty. Ltd.	83 William-street, Melbourne
Wise Bros. Pty. Ltd.	Tocumwal
Howard Jackett and Co. Pty. Ltd.	534 Bridge-road, Richmond
Hutchinson's Finley Flour Milling and Agency Co. Ltd.	Glenroy
Burrows Hume Flour Mills	Albury
Corowa Milling Co. Ltd.	Corowa
Elmore Flour Mills Pty. Ltd.	Elmore
James Malcolm and Co. Pty. Ltd.	St Arnaud
Kerang Flour Milling Co. Pty. Ltd.	Kerang
† The 1950 Chemical Standard for Bran is	14.0	2.5	10.0	
† The 1950 Chemical Standard for Pollard is	14.0	3.0	6.25	
OAT PRODUCTS.				
Parsons' No. 1 Oat Branning	10.0	6.75	16.0	Parsons Bros. and Co. Pty. Ltd., 554-562 Flinders-lane, Melbourne
Parsons' No. 2 Oat Branning	7.5	5.75	15.25	
Harper's Star Oat Branning	8.0	6.5	15.0	Robert Harper and Co. Ltd., 390 Flinders-lane, Melbourne
Ward's Oat Branning	6.0	4.0	25.0	H. S. K. Ward Pty. Ltd., 24-38 Spencer-street, Melbourne
CConnell's Oat Branning	8.0	5.5	24.0	John Connell and Co. Ltd., 578 Bourke-street, Melbourne
McKenzie's Oat Branning	7.0	4.0	20.0	J. F. McKenzie and Co., 74 Queensbridge-street, South Melbourne
Parsons' No. 2 Oat Screenings	8.5	5.5	13.25	Parsons Bros. and Co. Pty. Ltd., 554-562 Flinders-lane, Melbourne
Parsons' No. 3 Oat Screenings	7.0	5.0	21.25	
CConnell's Oat Pollard	11.8	9.0	2.0	John Connell and Co. Ltd., 578 Bourke-street, Melbourne
Lyall's Oat Pollard	10.0	7.0	7.0	Lyall and Sons Pty. Ltd., 39 Leveson-street, North Melbourne
McKenzie's Oat Pollard	10.0	8.0	5.0	J. F. McKenzie and Co. 74 Queensbridge-street, South Melbourne
T.B. and S. Oat Screenings	9.0	5.0	15.0	T. Borthwick and Sons (A/asia) Ltd., 84 William-street, Melbourne
T.B. and S. Oat Pollard	13.0	7.0	2.0	
T.B. and S. Oat Branning	10.0	5.0	15.0	
Lanray No. 1 Oat Branning	10.0	0.75	16.0	Lanray Milling Co. Pty. Ltd., 131 Queen-street, Melbourne
Lanray No. 2 Oat Branning	7.5	3.0	25.0	
A.B.C. Oat Branning	6.0	4.0	25.0	E. T. Moulden and Son Pty. Ltd., 294 Victoria-street, North Melbourne
A.B.C. Oat Pollard No. 2	10.0	8.0	5.0	
Garden City Crushed Oats	10.7	6.5	11.5	Garden City Flour Mill, Ballarat
Crushed Oats	8.0	3.0	3.5	North-Eastern Co-op. Soc. Ltd., Wangaratta
Crushed Oats	10.0	4.5	11.5	British United Dairies Pty. Ltd., 33-35 King-street, Melbourne
Echuca Crushed Oats	9.0	4.5	16.0	Echuca Flour Mills Pty. Ltd., Echuca
Malcolm's Crushed Oats	7.5	4.0	18.0	James Malcolm and Co. Pty. Ltd., St. Arnaud
Lyall Oat Bran	9.4	4.5	13.7	Lyall and Sons Pty. Ltd., 39 Leveson-street, North Melbourne
BARLEY PRODUCTS.				
Harper's Star Barley Meal	12.5	5.5	7.0	Robert Harper and Co. Ltd., 390 Flinders-lane, Melbourne
Ward's Barley Meal	10.0	4.0	10.0	H. S. K. Ward Pty. Ltd., 24-38 Spencer-street, Melbourne
Lyall's Barley Meal	10.0	2.0	5.0	Lyall and Sons Pty. Ltd., 39 Leveson-street, North Melbourne
CConnell's Barley Meal	10.4	4.5	7.0	John Connell and Co. Ltd., 578 Bourke-street, Melbourne
A.B.C. Barley Meal	10.0	4.0	10.0	E. T. Moulden and Son Pty. Ltd., 294 Victoria-street, North Melbourne
Lanray Barley Meal	7.5	2.2	21.5	Lanray Milling Co. Pty. Ltd., 131 Queen-street, Melbourne
CConnell's Barley Branning	10.4	6.0	20.0	John Connell and Co. Ltd., 578 Bourke-street, Melbourne

LIST OF STOCK FOODS AND STOCK LICKS—continued.

Distinguishing Brand Name.	Guaranteed Composition.			Where Obtainable.
	Crude Protein (N x 6.25). Minimum.	Crude Fat. Minimum.	Crude Fibre. Maximum.	
BARLEY PRODUCTS—continued.				
Harper's Star Barley Branning	10.0	5.0	15.0	Robert Harper and Co. Ltd., 390 Flinders-lane, Melbourne
Parsons' Barley and Oat Pollard	11.0	5.5	10.0	Parsons Bros. and Co. Pty. Ltd., 554-562 Flinders-lane, Melbourne
Lyall's Barley and Oat Meal	10.0	4.0	7.0	Lyall and Sons Pty. Ltd., 39 Leveson-street, North Melbourne
McKenzie's Barley Pollard	12.0	3.0	20.0	J. F. McKenzie and Co., 74 Queensbridge-street, South Melbourne
Parsons' Barley Meal	14.0	6.0	9.0	Parsons Bros. and Co. Pty. Ltd., 554-562 Flinders-lane, Melbourne
Kelric No. 1 (Dried Distillers' Grains) ..	27.0	9.0	11.0	K.B. Stock Food Co. Pty. Ltd., 48 Wellington-street, Collingwood
Kelric No. 2 (Dried Brewers' Grains) ..	18.0	4.0	17.0	E. T. Moulden and Son Pty. Ltd., 294 Victoria-street, North Melbourne
A.B.C. Barley and Oat Pollard	11.0	5.5	10.0	" " " " " "
A.B.C. Dried Brewers' Grain	18.0	4.0	17.0	" " " " " "
RICE PRODUCTS.				
Harper's Star White Rice Meal	9.0	12.5	5.0	Robert Harper and Co. Ltd., 390 Flinders-lane, Melbourne
Harper's Star Brown Rice Meal	10.0	16.0	7.5	Parsons Bros. and Co. Pty. Ltd., 554-562 Flinders-lane, Melbourne
Parsons' Rice Meal	10.0	19.0	9.5	Robert Harper and Co. Ltd., 390 Flinders-lane, Melbourne
Harper's Rice Bran	5.0	7.0	20.0	J. F. McKenzie and Co., 74 Queensbridge-street, South Melbourne
McKenzie's Rice Pollard	10.0	15.0	8.0	E. T. Moulden and Son Pty. Ltd., 294 Victoria-street, North Melbourne
A.B.C. Rice Bran	5.0	6.0	40.0	" " " " " "
A.B.C. Rice Pollard	10.0	15.0	8.0	" " " " " "
MAIZE PRODUCTS.				
Polly Gluten Feed	20.0	3.0	9.0	Maize Products Pty. Ltd., corner Parker and Maribyrnong streets, Footscray
Maize Oil Meal	16.0	12.0	10.0	H. S. K. Ward Pty. Ltd., 24-38 Spencer-street, Melbourne
Ward's Maize Meal	7.0	3.0	4.0	Lyall and Sons Pty. Ltd., 39 Leveson-street, North Melbourne
Lyall's Maize Meal	9.0	3.0	2.0	Clark, King, and Co. Pty. Ltd., 237 Queen-street, Melbourne
Clark's Maize Meal	9.0	3.0	3.0	Parsons Bros. and Co. Pty. Ltd., 554-562 Flinders-lane, Melbourne
Parsons' Wet Maize Bran	3.0	1.0	2.0	E. T. Moulden and Son Pty. Ltd., 294 Victoria-street, North Melbourne
A.B.C. Maize Meal	7.0	3.0	4.0	Norris and Wilkinson, Tinning-street, Brunswick
Moregrain Maize Meal	7.0	3.0	4.0	Victorian Wheatgrowers Corp. Ltd., 17 Queen-street, Melbourne
V.W.C. Maize Meal	9.0	3.0	2.0	J. McBeth, 207 Neerim-road, Carnegie
Marvel Maize Meal	8.0	3.0	4.0	Cromarty Animal Food Mill, Spring Vale South
Cromarty Maize Meal	9.0	3.0	2.0	Northern Supply Seed Co., Market-street, Bendigo
Master Mix Maize Meal	9.5	3.0	3.0	Hutchinson's Finley Flour Milling and Agency Co. Ltd., Glenroy
Huttmill Maize Meal	9.0	3.0	4.0	" " " " " "
PEA PRODUCTS.				
Parsons' Pea Meal	16.0	1.5	18.75	Parsons Bros. and Co. Pty. Ltd., 554-562 Flinders-lane, Melbourne
Ward's Pea Meal	14.0	1.0	18.0	H. S. K. Ward Pty. Ltd., 24-38 Spencer-street, Melbourne
Harper's Split Pea Screenings	9.0	0.75	22.0	Robert Harper and Co. Ltd., 390 Flinders-lane, Melbourne
Parsons' Pea Screenings	16.25	1.0	6.0	Parsons Bros. and Co. Pty. Ltd., 554-562 Flinders-lane, Melbourne
McKenzie's Pea Pollard	20.0	1.0	10.0	J. F. McKenzie and Co., 74 Queensbridge-street, South Melbourne
A.B.C. Pea Meal	20.0	1.0	10.0	E. T. Moulden and Son Pty. Ltd., 294 Victoria-street, North Melbourne
HULLS.				
Parsons' Barley Hulls	2.5	0.6	39.75	Parsons Bros. and Co. Pty. Ltd., 554-562 Flinders-lane, Melbourne
Connell's Barley Dust	5.0	0.25	18.0	John Connell and Co. Ltd., 578 Bourke-street, Melbourne
Ward's Barley Hulls	2.0	0.8	32.0	H. S. K. Ward Pty. Ltd., 24-38 Spencer-street, Melbourne
McKenzie's Pea Hulls	6.0	0.5	40.0	J. F. McKenzie and Co., 74 Queensbridge-street, South Melbourne
Parsons' Pea Hulls	3.5	0.4	46.25	Parsons Bros. and Co. Pty. Ltd., 554-562 Flinders-lane, Melbourne
Ward's Pea Hulls	5.0	0.25	40.0	H. S. K. Ward Pty. Ltd., 24-38 Spencer-street, Melbourne
Parsons' Oat Hulls (A)	1.25	0.4	40.75	Parsons Bros. and Co. Pty. Ltd., 554-562 Flinders-lane, Melbourne
Parsons' Oat Hulls (B)	4.25	3.0	30.0	" " " " " "
Parsons' Oat Hulls (C)	5.0	1.25	34.0	" " " " " "
Ward's Oat Hulls	1.5	0.7	35.0	H. S. K. Ward Pty. Ltd., 24-38 Spencer-street, Melbourne
Connell's Oat Hulls	0.5	0.5	35.0	John Connell and Co. Ltd., 578 Bourke-street, Melbourne
Harper's Oat Hulls	1.0	0.75	35.0	Robert Harper and Co. Ltd., 390 Flinders-lane, Melbourne
T.B. and S. Oat Hulls	1.5	0.4	40.0	T. Borthwick and Sons (A/asia) Ltd., 84 William-street, Melbourne
Lanray Oat Hulls	1.25	0.4	40.75	Lanray Milling Co. Pty. Ltd., 131 Queen-street, Melbourne
Lanray Barley Hulls	2.5	0.8	40.0	" " " " " "
A.B.C. Oat Hulls	1.5	0.7	35.0	E. T. Moulden and Son Pty. Ltd., 294 Victoria-street, North Melbourne
Lyall's Oat Hulls	2.0	1.0	35.0	Lyall and Sons Pty. Ltd., 39 Leveson-street, North Melbourne

LIST OF STOCK FOODS AND STOCK LICKS—continued.

Distinguishing Brand Name.	Guaranteed Composition.			Where Obtainable.
	Crude Protein (N x 6.25). Minimum.	Crude Fat. Minimum.	Crude Fibre. Maximum.	
MISCELLANEOUS.				
	%	%	%	
Lucerne Meal	13.0	3.0	25.0	Lyall and Sons Pty. Ltd., 39 Leveson-street, North Melbourne
Lupol	10.0	1.0	35.0	E. C. Robertson Pty. Ltd., 527 Collins-street, Melbourne
Biscuit Sweepings	2.0	2.0	2.0	Swallow and Ariel Ltd., 60 Stokes-street, Port Melbourne
Bakehouse Sweepings	2.0	2.0	2.0	" " " " " "
V.W.C. Milo Meal	7.9	2.6	1.8	Victorian Wheatgrowers Corp. Ltd., 17 Queen-street, Melbourne
F.P.C. Flax Meal	16.0	14.0	15.0	Flax Production Committee, 440 Little Collins-street, Melbourne
F.P.C. Crushed Flax Chaff	11.0	6.0	28.0	" " " " " "

VITAMIN OILS.

Distinguishing Brand Name.	Guaranteed Composition. (In International Units per gram.)		Where Obtainable.
	Vitamin A. (Minimum.)	Vitamin D. (Minimum.)	
Sol-Vit-Ax Cod Liver Oil	1,000	100	G. P. Embleton and Co. Pty. Ltd., 208 Little Lonsdale-street, Melbourne
Unicod Double Vitaminized Blended Feeding Oil	2,000	200	Atlantic Union Oil Co. Ltd., 396 Collins-street, Melbourne
Unicod Emulsion Vitaminized Blended Feeding Oil	1,000	100	" " " " " "
Vetemul Blue Label Vitaminized Emulsion	5,000	Nil	Nicholas Pty. Ltd., 37 Swanston-street, Melbourne
Vetemul Green Label Vitaminized Emulsion	5,000	500	" " " " " "
Vetemul Brown Label Vitaminized Emulsion	1,000	100	" " " " " "
Apsolene 2,500	2,500	Nil	Australian Packers' Corp. Pty. Ltd., 414 Collins-street, Melbourne
Apsolene	5,000	Nil	" " " " " "
Apsolene 2,500 A.D.	2,500	250	" " " " " "
Apsolene A.D.	5,000	500	" " " " " "
Ocean Gold A	5,000	Nil	Clark, King, and Co. Pty. Ltd., 237 Queen-street, Melbourne
Ocean Gold A and D3	5,000	500	" " " " " "
Vitoll	2,000	200	" " " " " "
Deol.	1,000	400	Australian Packers' Corp. Pty. Ltd., 414 Collins-street, Melbourne
Seal	1,000	100	" " " " " "
Vitaminized Poultry Emulsion	5,000	500	Tally Ho Products, 29 Courtney-street, North Melbourne
Vetamac Vitamin Oil	2,000	200	A. H. McDonald, 627 Bridge-road, Richmond
Avol	5,000	Nil	Australian Vitamin Oils Pty. Ltd., 456 Flinders-lane, Melbourne
Avol A and D3	5,000	500	" " " " " "
Ovadol	5,000	500	F. H. Faulding and Co. Ltd., 123 Lonsdale-street, Melbourne
Straight A	5,000	Nil	Palmer's Pastoral Products, 15 Rokeby-street, Collingwood

STOCK LICKS.

Distinguishing Brand Name.	Guaranteed Composition.							Where Obtainable.
	Salt.	Phosphoric Acid.	Lime.	Magnesia.	Iron.	Sulphur.	Iodine.	
STOCK LICKS.								
<i>Common Salt.</i>								
Hart's Rokilk	100.0							Hart and Co. Pty. Ltd., 38 Clarendon-street, South Melbourne
Lepp Salt Lick	100.0							J. S. Gorden and Co. (Vic.) Pty. Ltd., 44-54 Spencer-street, Melbourne
Ram Salt Lick	100.0							Cheetham Salt Pty. Ltd., 71 Little Malop-street, Geelong
Ramille	97.0					3.0		" " " " " "
Hart's Iodised Block Lick	99.0				0.5		Trace	Hart and Co. Pty. Ltd., 38 Clarendon-street, South Melbourne
Hart's Sulphurised Block Lick	98.0						2.0	" " " " " "
<i>Bone Meal, &c.</i>								
Apex Sterilized Bone Meal		25.2	29.8					North-Eastern Bone Products, Wangaratta
Tricalos Sterilized Bone Flour		30.0	40.0					Glues and By-Products Pty. Ltd., 88 King-street, Melbourne
Pannifex Bone Meal		22.0	26.0					H. C. Pannifex and Co. Pty. Ltd., 53-57 Munster-terrace, North Melbourne
D.B.G. Bone Meal		25.0	32.0					W. Anglin and Co. (Aust.) Pty. Ltd., Lynch-street, Footscray
Siekle in Diamond Dicalcic Phosphate		37.5	29.6					Commonwealth Fertilizers and Chemicals Ltd., 65 William-street, Melbourne

LIST OF STOCK FOODS AND STOCKS LICKS.—continued.

Distinguishing Brand Name.	Guaranteed Composition.							Where Obtainable.
	Salt.	Phosphoric Acid.	Lime.	Magnesia.	Iron.	Sulphur.	Iodine.	
	% (Max.)	% (Min.)	% (Min.)	% (Min.)	% (Min.)	% (Min.)	% (Min.)	
MIXED STOCK LICKS.								
<i>Non-Salt.</i>								
Cobaltised Concentrated Vita-Lick †	..	24.0	29.9	..	5.8	..	Trace	Wilcox, Moffin Ltd., 84 King-street, Melbourne
Vita-Lick D Concentrated Sheep Lick	..	24.0	29.9	..	2.9	..	Trace	" " " "
Vita-Lick G Concentrated Sheep Lick	..	24.0	29.9	..	5.8	..	Trace	" " " "
Vita-Lick Concentrated D	23.5	30.0	..	1.3	2.0	Trace	Goldsbrough, Mort, and Co. Ltd., 526 Bourke-street, Melbourne
Vita-Lick Concentrated G	23.5	31.0	..	3.5	4.0	Trace	" " " "
Vita-Lick Cattle Concentrated G	..	25.0	32.5	..	4.7	1.15	Trace	" " " "
Vita-Lick Cobaltised Concentrated G*	..	23.5	31.0	..	3.5	4.0	Trace	" " " "
Vita-Lick Cattle Concentrated D	..	21.2	29.0	..	3.4	0.4	Trace	" " " "
Vita-Lick Cobaltised Concentrated D*	..	23.5	30.0	..	1.3	2.0	Trace	" " " "
Vetsolick Mineral Concentrate	..	11.0	14.0	0.7	1.5	16.6	Trace	A. H. McDonald, 627 Bridge-road, Richmond
Eureka Poultry Minerals	2.1	4.4	0.1	0.1	0.25	Trace	S. Cochran, 14 Chesterville-road, Cheltenham
Rawleigh's Poultry Powder†	8.9	33.0	..	0.4	4.0	Trace	The W. T. Rawleigh Co. Ltd., 60 Dawson-street, Brunswick
Osmond's Concentrated	9.0	18.6	1.3	0.4	2.2	Trace	Osmond and Sons (Aust.) Pty. Ltd., 35 William-street, Melbourne
<i>Low Salt.</i>								
Allkon Concentrate ..	8.0	12.0	30.0	..	1.0	..	Trace	Allkon Pty. Ltd., 36 Clarendon-street, South Melbourne
Vita-Lick Concentrated Cattle Lick	5.5	28.0	29.0	..	2.9	..	Trace	Wilcox, Moffin Ltd., 84 King-street, Melbourne
Immunolck Concentrate ..	8.0	12.0	30.0	..	1.0	..	Trace	Hart and Co. Pty. Ltd., 38 Clarendon-street, South Melbourne
<i>Medium Salt.</i>								
Rudduck's Improved Mineral Lick	22.2	11.3	20.3	0.6	0.6	2.4	Trace	Rudduck and Co. Pty. Ltd., 556 Lonsdale-street, Melbourne
Rawleigh's Mineralized Supplement	15.0	7.1	25.2	..	1.0	3.6	Trace	The W. T. Rawleigh Co. Ltd., 60 Dawson-street, Brunswick
<i>High Salt.</i>								
Vetamac Medicated ..	53.0	5.7	7.5	0.1	0.7	4.0	Trace	A. H. McDonald, 627 Bridge-road, Richmond
Hart's Block Lick ..	91.0	1.0	3.0	Hart and Co. Pty. Ltd., 38 Clarendon-street, South Melbourne
Salvitis No. 1 ..	90.0	1.8	2.5	0.2	0.8	0.4	Trace	Cheetham Salt Pty. Ltd., 71 Little Malop-street, Geelong
Salvitis No. 2 ..	70.0	7.1	8.8	0.2	0.8	4.0	Trace	" " " "
Hart's Cobalt Block Lick† ..	91.0	1.0	3.0	Hart and Co. Pty. Ltd., 38 Clarendon-street, South Melbourne
<i>Lime Licks.</i>								
Allkon Organic Lime Compound	7.0	Allkon Pty. Ltd., 36 Clarendon-street, South Melbourne
Hart's Immunol Organic Lime Compound	7.0	Hart and Co. Pty. Ltd., 38 Clarendon-street, South Melbourne
Hart's Organic Lime Powder	13.0	" " " "
Hart's Immunol Special Organic Lime Compound	7.0	" " " "
Allkon Special Organic Lime Compound	7.0	Allkon Pty. Ltd., 36 Clarendon-street, South Melbourne
Fargher's Calcium Lick	4.5	65.0	W. J. Fargher, 610 Ligar-street, Ballarat

* Contains trace of cobalt.
† Contains cobalt and copper.

W. R. JEWELL, M.Sc.
Chemist for Agriculture.

Melbourne, 1st May, 1950.

Local Government Act 1946, Part 48, Section 87b.

LICENCES TO OCCUPY UNUSED ROADS.

NOTICE is hereby given that Licences to occupy Unused Roads have been issued to the following approved applicants, and that the Licence Fee specified in each case has been received by the Accountant, Lands Department, Melbourne, C.2.

Number of Licence.	Name and Address of Licensee.	Municipality.	Parish.	Abutting— Allotments and Sections.	Area.		Fee for Licence.	Date of Issue of Licence.	Date of Expiry of Licence.
					A. R. P.	£ s. d.			
36481	Mahoney, J. P., Apsley ..	Kowree ..	Edenhope	South of 86 (western half)	4 0 0	0 8 0	1.1.49	31.12.51	
36482	Perry, G. and R. H., Landsborough	Avoca ..	Landsborough	South-west of X.6 ..	2 0 0	0 2 6	1.1.49	31.12.51	
36483	Walters, T. R. and A. A., Mt. Gambier, S.A.	Portland ..	Wanwin ..	South of 22A ..	3 2 0	0 2 6	1.1.49	31.12.51	
36484	Brian, K., Macarthur ..	Minhamite	Ardonachie	East of 9 ..	4 3 0	0 2 6	1.1.49	31.12.51	
36485	Corporation of the Society of the Missionaries of the Sacred Heart, Macarthur	Dundas ..	Yulecart ..	East of 10, Section 1	3 0 22	0 15 5	1.1.49	31.12.51	
36486	Annett, L. B., Branzholme	Portland ..	Town of Branzholme	Between Sections 30 and 31	1 1 0	0 7 6	1.1.49	31.12.51	
36487	Mibus, M. V., Moutajup ..	Mt. Rouse	Jennawarra	West of 6, Section C ..	1 0 0	0 6 9	1.1.49	31.12.51	
36488	Macgugan, A. J., Branzholme	Portland ..	Branzholme	Part-road north of 1, Section 6A	1 3 0	0 8 9	1.1.49	31.12.51	
36489	Wallis, G. T., Serviceton ..	Kaniva ..	Leeor ..	East of 4, Section 4 ..	5 3 0	0 2 6	1.1.49	31.12.51	
36490	Huf, J. E., Croxton East, via Hamilton	Mt. Rouse	Corea ..	East of 17B and part 18A	3 0 0	0 18 0	1.1.48	31.12.50	
36491	Huf, J. E., Croxton East, via Hamilton	Mt. Rouse	Boonawah	East of 9B, 11B, 10B, and part 12B, Section E	7 0 0	2 2 0	1.1.48	31.12.50	
36492	Vanrenen, H. P., Glen-thompson	Mt. Rouse	Yuppeckiar	West of 81A, 81B, K1, and K2	8 0 0	2 0 0	1.1.49	31.12.51	
36493	Vanrenen, A. D., Glen-thompson	Mt. Rouse	Yuppeckiar	West of 66A, 66B, 69A, and 69B	8 0 0	2 0 0	1.1.49	31.12.51	
36494	Potter, H. P., Condah ..	Portland ..	Condah ..	North of part 1, Section 6	1 0 0	0 3 0	1.1.48	31.12.50	
36495	Kenna, K. A., Coleraine ..	Wannon ..	Coleraine ..	North of 13, south of 43, Section 3	7 0 0	2 2 0	1.1.49	31.12.51	
36496	Bromell, J. H., Cavendish	Dundas ..	Kanawalla, Mooralla, Jerry-warook, Cavendish	Various ..	212 2 0	29 7 6	1.1.49	31.12.51	
36497	Callander, W. G. L., Portland	Portland ..	Myamyn ..	West of 4A, Section 17	2 0 0	0 2 6	1.1.49	31.12.51	
36498	Huf, P. H., Hamilton ..	Mt. Rouse	Boonawah	North of 9A and 9B ..	6 2 0	1 19 0	1.1.48	31.12.50	
36499	Ross, E. C., Corea South ..	Mt. Rouse	Corea ..	East of 18A, part 18B	3 0 0	0 18 0	1.1.48	31.12.50	
36500	Francis, E. A., Lower Norton	Arapiles	Darragan ..	Between 82, 81, and 84	4 3 0	0 9 6	1.1.49	31.12.51	
36501	Lory, A. H., Private Bag, Stawell	Stawell ..	Wallaloo ..	North of 71 ..	4 2 0	0 6 9	1.1.49	31.12.51	
36502	Reading, A. M., Wallaloo ..	Stawell ..	Wallaloo ..	East of 115 and 119 ..	5 0 0	0 7 6	1.1.49	31.12.51	
36503	Brian, W. S., Condah Swamp	Portland ..	Myamyn ..	East of 3A1 and 4A1 ..	4 0 0	1 4 0	1.1.48	31.12.50	
36504	Quick, K., Noradjuha ..	Arapiles ..	Darragan ..	East of 7 ..	8 0 0	0 16 0	1.1.49	31.12.51	
36505	Punchard, W. A., Glenorchy	Stawell ..	Bolangum	Between 167A and 159	6 3 0	0 6 9	1.1.49	31.12.51	
36506	Brooksbey, L. M., Harrow ..	Wannon ..	Pawbymbyr	Part between 5 and 15; part between 6 and 5	6 2 16	0 6 6	1.1.49	31.12.51	
36507	Squire, C. E., Callawadda ..	Stawell ..	Callawadda	South of 9 and 10, Section 1, Township Callawadda	0 2 0	0 2 6	1.1.49	31.12.51	
36508	McIntosh, A., Digby ..	Portland ..	Hotspur ..	North of 5 ..	0 2 0	0 2 6	1.1.49	31.12.51	
36509	Punchard, J. B., Stawell ..	Stawell ..	Callawadda	West of 194, 195 ..	8 0 0	0 8 0	1.1.49	31.12.51	
36510	Cuming, A. W. and M. J., Goroke	Kowree ..	Dopewora	West of 14 ..	4 2 0	0 11 3	1.1.49	31.12.51	
36511	Reading, J. H., Wallaloo East	Stawell ..	Warngar ..	Between 3, 6, 7, Section 1	6 0 0	0 9 0	1.1.49	31.12.51	
36512	Lory, J. A., Stawell ..	Stawell ..	Wallaloo ..	North of 44, 45A, 45B	8 0 0	0 12 0	1.1.49	31.12.51	
36513	Lory, J. A., Stawell ..	Stawell ..	Wallaloo ..	North of 68 ..	3 2 0	0 5 3	1.1.49	31.12.51	
36514	Howard, S. R. and R., Port Fairy	Minhamite	St. Helens	North and west of 105	11 0 0	0 5 6	1.1.49	31.12.51	
36515	Laidlaw, W., and Co., c/o A.M.L. and F. Co.	Kowree ..	Boikerbert and-Town of Apsley	East of 6, west and south of Leah Swamp Reserve, north-west 13 and 13A, north 13A and 11, east 13A, between 20a and 20c, in 20, east 21B, east 23B, north 19, 16, 13; west 19, 20, 21, 22, 23; north 21, 24, 27, 28, 31	47 2 0	5 18 9	1.1.49	31.12.51	
36516	McDonnell, J. A. and A. F. E., Edenhope	Kowree ..	Durong ..	North and south of 12A, Section A	20 0 0	0 5 0	1.1.48	31.12.50	
36517	Milburn, C. W., Casterton	Glenelg ..	Bruk Bruk	West of B1, Section 18	8 1 0	1 13 0	1.1.50	31.12.52	
36518	Cowland, H. K., Wando Vale	Glenelg ..	Bruk Bruk	South of B1, B2, Section 10	6 3 0	1 7 0	1.1.50	31.12.52	
36519	Hausler, H. A., Ullswater ..	Kowree ..	Awonga ..	South of 32; west of 40 and 41	26 2 0	0 16 0	1.1.49	31.12.51	
36520	Mercer, A. A. C., Wannon	Dundas ..	Redruth, Toolka	Various ..	222 0 0	27 7 7	1.1.49	31.12.51	
36651	Stewart, E., Greens Creek	Stawell ..	Joel Joel ..	South of 1, north of 3	6 0 0	0 9 0	1.1.50	31.12.52	
36652	Niewand, E., Minyip ..	Stawell ..	Warra	Between 58 and 61 ..	4 0 0	0 4 0	1.1.50	31.12.52	
36653	Doyle, E. F., Sandford ..	Glenelg ..	Town of Sandford, Parish of Casterton	East of 1, Section 7 ..	0 2 0	0 10 0	1.1.50	31.12.52	

LICENCES TO OCCUPY UNUSED ROADS—continued.

Number of Licence	Name and Address of Licensee.	Municipality.	Parish.	Abutting— Allotments and Sections.	Area.	Fee for Licence.		Date of Issue of Licence.	Date of Expiry of Licence.
						A. R. F.	£ s. d.		
36654	Blaubaum, A. K., Coleraine	Wannon ..	Beerik ..	East of 1 and 2, Section 24, 6589 links ..	6 2 14	1 13 0	1.1.50	31.12.52	
36655	Stewart, C. A., Mildura South	Stawell ..	Morri Morri	East of 20, Section 1 ..	3 2 16	0 3 9	1.1.50	31.12.52	
36656	Moyles, E. F., Konongwootong	Wannon ..	Beerik ..	North of 4, Section 18	6 1 24	3 4 0	1.1.50	31.12.52	
36657	Shrive, W. C., H. M., and O. L., Harrow	Kowree ..	Wombelano	South of 18, 19, 20B ..	10 0 0	1 0 0	1.1.50	31.12.52	
36658	Greedy, H. M., Wal Wal ..	Stawell ..	Warranook	East of 64, 65A, 65B ..	60 0 0	4 10 0	1.1.50	31.12.52	
36659	Greedy, M. E., Wal Wal ..	Stawell ..	Warranook	Half-road between 226A, 225 and south of 64	7 2 0	0 11 3	1.1.50	31.12.52	
36660	Hayes, Roy, Condah ..	Portland ..	Winyayung	West of 74E ..	4 0 0	0 4 0	1.1.50	31.12.52	
36661	McDonald, J., Jallumba ..	Arapiles ..	Carchap ..	East of 82 and 88 ..	6 0 0	0 13 6	1.1.50	31.12.52	
36662	McDonald, H. E., Jallumba	Arapiles ..	Carchap ..	East of 81 ..	1 3 0	0 3 9	1.1.50	31.12.52	
36663	McDonald, S., Jallumba ..	Arapiles ..	Carchap ..	East of 89 ..	5 2 16	0 12 6	1.1.50	31.12.52	
36664	Watt, N. R., Narrawong ..	Portland ..	Narrawong	East of 20, 23, 25, and part 27	2 2 0	0 10 0	1.1.50	31.12.52	
36665	Duncan, J. M., Branzholme.	Portland ..	Branzholme	North of 9 and 9A, Section 12	4 3 0	1 1 3	1.1.50	31.12.52	
36666	Norman, H. G., Mt. Gambier, S.A.	Portland ..	Wanwin ..	South and east of 24A	15 3 0	0 7 9	1.1.50	31.12.52	
36667	Curtis, R. T., Wonwondah South	Arapiles ..	Wonwondah	North of 18, west of part 20	22 1 0	1 13 4	1.1.50	31.12.52	
36668	Roberts, G. F., Codrington	Minhamite	St. Helens	West of 103 ..	9 0 0	0 9 0	1.1.50	31.12.52	
36669	Phelan, A. M., Glenorchy ..	Stawell ..	Riachella ..	East of 166 ..	8 0 0	0 12 0	1.1.50	31.12.52	
36670	Binns, L. T., Antwerp ..	Dimboola ..	Tarranyurk	South of 17 ..	6 3 0	0 13 6	1.1.50	31.12.52	
36671	Winter, M. G., Casterton ..	Kowree ..	Awonga ..	West of 42 ..	20 0 0	0 10 0	1.1.49	31.12.51	

Licences Nos. 36488, 36505, 36507, 36509, 36511, 36512, 36513, rent charged from 1st July, 1949, only.—Licence No. 36489, swing gate condition.—Licence No. 36501, rent charged from 1st July, 1949.—Licence No. 36503, rent charged from 1st September, 1948, only.—Licence No. 36515, rent charged from 1st June, 1949, only.

R. C. GUTHRIE,

Department of Lands and Survey (Unused Roads and Water Frontages Branch),
Melbourne, 24th May, 1950.

Commissioner of Crown Lands and Survey.

Marriage Act 1928.

MINISTERS OF RELIGION REGISTERED TO CELEBRATE MARRIAGES IN VICTORIA.

It is hereby notified that in pursuance of the provisions of the *Marriage Act 1928*, 19 Geo. V. No. 3726, Section 11, the under-mentioned Officiating Ministers of Religion have been registered at this Office for the celebration of marriages in Victoria:—

Number in Register.	Name.	Designation.	Denomination.	Residence.	Date of Registration.
10235	Miles, Ian Charles ..	Probationer	Methodist ..	Bogong ..	3.4.50
10236	Ogier, Kenneth Cecil ..	Probationer	Methodist ..	Goroko ..	4.4.50
10237	Jeffrey, Alfred Gardiner ..	Probationer	Methodist ..	Pyramid Hill ..	4.4.50
10238	Higgins, William Leslie ..	Probationer	Methodist ..	Underbool ..	1.4.50
10239	Renshaw, John Rutherford ..	Probationer	Methodist ..	Summerhill-road, Burwood ..	4.4.50
10240	Huxtable, Reginald Charles ..	Probationer	Methodist ..	Creswick ..	3.4.50
10241	Silverwood, Bruce William ..	Probationer	Methodist ..	Chelsea ..	6.4.50
10242	Weeks, Stanley Irvine ..	Minister ..	Methodist ..	Ivanhoe ..	6.4.50
10243	Coady, Nicholas ..	Priest ..	Roman Catholic ..	St. Michael's, North Melbourne ..	6.4.50
10244	Baker, Bruce Lance ..	Pastor ..	Baptist ..	Baptist Church, Wonthaggi ..	4.4.50
10245	Wilson, Stanton Henry ..	Minister ..	Church of Christ ..	Church of Christ, Hampton ..	5.4.50
10246	Burt, Frederick Barton ..	Pastor ..	Church of Christ ..	Church of Christ, Doncaster ..	6.4.50
10247	McMullan, John ..	Priest ..	Roman Catholic ..	St. Patrick's Cathedral, Ballarat ..	10.4.50
10248	Balcinas, Joseph ..	Priest ..	Roman Catholic ..	Migrant Camp, Sale ..	11.4.50
10249	Grech, Augustine ..	Priest ..	Roman Catholic ..	Salesian Chapel, Brunswick ..	13.4.50
10250	Griffen, John Joseph ..	Priest ..	Roman Catholic ..	St. Patrick's Cathedral, Melbourne ..	26.4.50
10251	Reid, Robert Hutchison ..	Minister ..	Presbyterian ..	Mooroopna ..	29.4.50
10252	Leigh, Keith B. ..	Probationer ..	Methodist ..	Kilmore ..	6.4.50
10253	Walsh, Michael ..	Priest ..	Roman Catholic ..	Saints Peter and Pauls', South Melbourne ..	2.5.50
10254	Coulthard, Leonard ..	Minister ..	Methodist ..	Pakington-street, West Geelong ..	14.4.50
10255	Cronau, Theodore Christian ..	Minister ..	Baptist ..	Naringal ..	21.4.50

Office of the Government Statist,
Melbourne 15th May, 1950. M.S.

O. GAWLER,
Government Statist.

Local Government Act 1946, Part 48, Section 876.
LICENCES TO OCCUPY WATER FRONTAGES.

NOTICE is hereby given that Licences to occupy Water Frontages have been issued to the following approved applicants, and that the Licence Fee specified in each case has been received by the Accountant, Lands Department, Melbourne, C.I.

Number of Licence.	Name and Address of Licensee.	Municipality.	Parish.	Abutting on— Allotments and Sections.	Fee for Licence.	Date of Issue of Licence.	Date of Expiry of Licence.
					£ s. d.		
22501	Estate of G. Little, c/o A. G. Little, Mumbannar	Portland	Kinkella	7	0 6 0	1.1.49	31.12.51
22502*	S. C. Saunders, Hotspur	Portland	Hotspur	1, Section 1A	0 9 0	1.1.49	31.12.51
22503	T. G. Jarrett, Portland	Portland	Heywood	9, Section 6	0 15 0	1.1.49	31.12.51
22504	J. Crute, Glenorchy	Wimmera	Warra Warra	4	0 7 0	1.1.49	31.12.51
22505	W. G. Cowland, Greenwald	Portland	Drik Drik	16, 16A and 17 of Section A	0 14 0	1.1.49	31.12.51
22506*	A. V. and S. R. Martin, Morri Morri	Stawell	Bolangum	73 and 75	0 6 0	1.1.49	31.12.51
22507*	H. H. Duxson, Wallaloo East	Stawell	Wargar	10 and 11, Section 3	0 10 0	1.1.49	31.12.51
22508	M. and J. Edwards, Portland	Portland	Heywood	Part 9, Section 6	1 7 0	1.1.49	31.12.51
22509	L. J. Gellatly, Lubeck	Stawell	Warranook	94 and 96	0 15 0	1.1.50	31.12.52
22510*	W. R. King, Hotspur	Portland	Town of Hotspur	4, Section 1A	3 2 0	1.1.49	31.12.51
22511	B. L. Wilkins, Portland	Portland	Wataepoolan	49	0 5 0	1.1.50	31.12.52
22512	A. H. Maybery, Mitre	Wimmera	Vectis East	264	1 12 0	1.1.50	31.12.52

* Rent charged from 1st July, 1949, only.

R. C. GUTHRIE,
Commissioner of Crown Lands and Survey.

Department of Lands and Survey,
Melbourne, 24th May, 1950.

To JAMES HENRY HUSSEY, formerly of 30 Vine-street, Windsor, in the State of Victoria, but whose present whereabouts are unknown and to all others whom it may concern.

THE PUBLIC TRUSTEE, of 412 Collins-street, Melbourne, hereby gives notice that on the 9th day of May, 1950, an Order was made by a Judge of the Supreme Court of Victoria under the provisions of section 6 of the *Public Trustee Act 1948* conferring upon the said Public Trustee power to pay to Mary Hussey (the wife of the above-named James Henry Hussey) for or towards the maintenance of the said Mary Hussey until some further Order might be made varying or revoking the power so conferred the sum of One pound weekly out of any moneys which had been received, or which might afterwards be received, by the Public Trustee in exercise of any of the powers conferred upon him by an Order made by a Judge of the Supreme Court on the 27th day of June, 1949 (by which last-mentioned Order the said Public Trustee was empowered to receive from the Australian Mutual Provident Society all moneys payable under or in respect of two policies respectively numbered 827666 and 853531 issued by the said Australian Mutual Provident Society in respect of the life of the said James Henry Hussey), and that it is the intention of the Public Trustee to exercise the said power conferred upon him by the said Order made on the said 9th day of May, 1950.

Dated the 16th day of May, 1950.

C. J. GARDNER,
Public Trustee.

NOTICE.

ADMINISTRATION of the estate of each of the under-mentioned deceased persons has been granted to me, and creditors, next of kin, and all others having claims against the estate of any of the persons so mentioned are required to send particulars of their claims to the Public Trustee, No. 412 Collins-street, Melbourne, on or before the 26th July, 1950, or they will be excluded from the distribution of the estate when the assets are being distributed:—

BATH, GEORGE ALBERT, late of 484 Church-street, Richmond, labourer, died 14th October, 1949, intestate.

*BETTES, WILLIAM HENRY, late of 56 McPherson-street, Footscray, retired railwayman, died 26th March, 1950.

BOWLER, CLARA, late of 66 Nicholson-street, East Coburg, home duties, died 11th March, 1950, intestate.

*CROCKETT, MARGARET, late of 89 Buckley-street, Essendon, widow, died 28th September, 1949.

*COUNDON, SIDNEY COWPERTHWAITTE, late of Long Plain, near Waratah, Tasmania, formerly general storekeeper, but late mine manager, died 30th April, 1937.

GLEESON, EDWARD JOHN DAVID, also known as Edward John Gleeson, formerly of Stawell-street, Burnley, but late of 29 Argyle-street, St. Kilda, labourer, died 24th December, 1949, intestate.

HANIECKI, ANTONI, late of Cairn Curran, Baringhup, labourer, died 4th December, 1949, intestate.

*HOWES, ETHEL MARY, late of 39 Avenue-road, Camberwell, married woman, died 24th February, 1950.

HUTCHINS, GEORGE, late of Benevolent Home, Bendigo, labourer, died 18th October, 1949, intestate.

HUTCHINSON, THOMAS, late of Maindample, farmer, died 22nd November, 1949, intestate.

LYONS, PERCY GEORGE, formerly of 16 Kooyong-road, Armadale, but late of 9A Royston-avenue, East Malvern, gardener, died 20th February, 1950, intestate.

†SMYTH, MABEL, late of 46 Boston-avenue, East Malvern, married woman, died 12th March, 1950.

WILSON, JOHN, late of 121 Queensberry-street, North Melbourne, labourer, died 1st January, 1950, intestate.

* With the will annexed.

† According to the provisions of the will.

C. J. GARDNER,
Public Trustee.
Melbourne, 17th May, 1950.

4 GEORGE VI. No. 4755, SECTION 6.

I HEREBY give notice that on the 10th May, 1950, I filed elections to administer the following deceased persons' estates, in accordance with section 6 of the *Public Trustee Act 1940*:—

BATH, GEORGE ALBERT, late of 484 Church-street, Richmond, labourer, died 14th October, 1949, intestate.

BOWLER, CLARA, late of 66 Nicholson-street, East Coburg, home duties, died 11th March, 1950, intestate.

GLEESON, EDWARD JOHN DAVID, also known as Edward John Gleeson, formerly of Stawell-street, Burnley, but late of 29 Argyle-street, St. Kilda, labourer, died 24th December, 1949, intestate.

HANIECKI, ANTONI, late of Cairn Curran, Baringhup, labourer, died 4th December, 1949, intestate.

HUTCHINS, GEORGE, late of Benevolent Home, Bendigo, labourer, died 18th October, 1949, intestate.

*SMYTH, MABEL, late of 46 Boston-avenue, East Malvern, married woman, died 12th March, 1950.

WILSON, JOHN, late of 121 Queensberry-street, North Melbourne, labourer, died 1st January, 1950, intestate.

*According to the provisions of the will.

C. J. GARDNER,
Public Trustee.
412 Collins-street, Melbourne, C.I., 17th May, 1950.

MOUNT MACEDON WATERWORKS TRUST.

RATING BY-LAW FOR YEAR 1950.

THE Mount Macedon Waterworks Trust, in pursuance and exercise of the powers conferred by the Water Acts, doth hereby make a rate for the supply of water for domestic purposes of One shilling and six pence in the pound of the municipal valuation of lands and tenements liable to be rated within the Mount Macedon Urban District.

Provided that in no case shall the amount of rate payable per annum in respect of any tenement (other than land on which there is no building) be less than Twenty shillings, and in respect of any land on which there is no building less than Twenty shillings.

Such rates are made and shall be levied upon the occupiers or owners of the said lands and tenements for the year commencing the 1st day of January, 1950, and shall be payable on the 31st day of May, 1950, at the office of the said Trust.

The maximum quantity of water to be supplied in any one year without further charge to any property rated by the Trust is hereby fixed at the quantity which, at a charge of One shilling and six pence per 1,000 gallons, would produce an amount equal to the amount of rate levied on such property for the said year.

The charge for water supplied by measure to any property rated by the Trust in excess of such maximum quantity, computed as in the last preceding clause, is hereby fixed at Two shillings per 1,000 gallons up to 300,000 gallons, and One shilling and six pence per 1,000 gallons in excess of this amount.

The charge for water supplied by measure shall be payable, on demand, at the office of the Trust.

Passed this 11th day of April, 1950.

(SEAL) V. R. SANSOM, Chairman.
W. R. McINNES, Commissioner.
R. E. RUTHERFORD, Secretary.

Approved by the Governor in Council,
16th May, 1950.

A. G. COULTHARD,
Acting Clerk of the Executive Council.

DEVENISH WATERWORKS TRUST.

RATING BY-LAW FOR 1950.

THE Devenish Waterworks Trust, in pursuance and exercise of the powers conferred by the Water Acts, doth hereby make the following rates for the supply of water for domestic purposes on lands and tenements liable to be rated within the Devenish Urban District.

On such lands and tenements a rate of Four shillings in the pound on the amount of the annual municipal valuation not exceeding Twenty-five pounds, and Three shillings in the pound on the amount of the annual municipal valuation exceeding Twenty-five pounds but not exceeding Seventy-five pounds, and One shilling in the pound on the amount of the annual municipal valuation exceeding Seventy-five pounds.

Provided that in no case shall the amount of the rate payable per annum in respect of any tenement (other than land on which there is no building) be less than Five pounds, and in respect of any land on which there is no building less than Ten shillings.

Such rates are made and shall be levied upon the occupiers or owners of the said lands and tenements for the year commencing on the 1st day of January, 1950, and shall be payable on the 24th day of May, 1950, at the office of the said Trust.

The maximum quantity of water to be supplied in any one year without further charge to any property rated by the Trust is hereby fixed at the quantity which, at the charge of Two shillings per 1,000 gallons, would produce an amount equal to the amount of the rate levied on such property for the said year.

The charge for water supplied by measure to any property rated by the Trust in excess of such maximum quantity, computed as in the last preceding clause, is hereby fixed at One shilling per 1,000 gallons.

The charge for water supplied by measure shall be payable, on demand, at the office of the said Trust.

Passed this 4th day of May, 1950.

(SEAL) JAMES T. MARTIN, Chairman.
C. B. GRANT, Secretary.

Approved by the Governor in Council,
16th May, 1950.

A. G. COULTHARD,
Acting Clerk of the Executive Council.

HAMILTON WATERWORKS TRUST.

BY-LAW No. 56.

Rating By-law for the Year 1950.

THE Hamilton Waterworks Trust, the waterworks district of which Trust has been proclaimed an urban district for the purposes of the Water Acts (hereinafter referred to as the Trust), in pursuance and exercise of the powers conferred by the Water Acts, doth hereby make this By-law for such urban district for determining the rate to be paid in respect of the several lands and tenements to be supplied with water for domestic purposes, and directs as follows:—

1. The said Hamilton Waterworks Trust doth hereby make a rate for the supply of water for domestic purposes of One shilling and five pence in the pound on the annual municipal valuation of lands and tenements liable to be rated within the Hamilton Waterworks Urban District. Provided that in no case shall the amount of rate payable in respect of any land on which there is a building be less than Fifteen shillings, and in respect of any land on which there is no building less than Ten shillings. Such rates are made and shall be levied upon the occupiers of the said lands and tenements for the year commencing on the 1st day of January, 1950, and shall be payable on the 1st day of June, 1950, at the office of the said Trust.

2. The maximum quantity of water to be supplied in any one year without further charge to any property rated by the Trust is hereby fixed at the quantity which, at a charge of One shilling per 1,000 gallons, would produce an amount equal to the amount of the rate levied on such property for the said year.

3. Except where water is supplied by special agreement, and except as provided by By-law No. 30 of the Trust—

(a) The charge for water supplied by measure to any property rated by the Trust in excess of such maximum quantity, computed as in the last preceding clause, is hereby fixed at One shilling per 1,000 gallons.

(b) The charge for water supplied by measure to any property not rated by the Trust is hereby fixed at One shilling per 1,000 gallons, and the minimum quantity of water to be charged for in cases where water is so supplied is hereby fixed at 10,000 gallons.

4. The charge for water supplied by measure shall be payable, on demand, at the office of the Trust.

5. Such person or persons as the Trust may from time to time appoint for the purpose shall be authorized to demand, receive, collect, and recover the rates and charges aforesaid, and each of them. And in the absence of such appointment, the secretary and/or rate collector of the Trust shall be deemed to have been appointed for the purpose aforesaid, and every one of them.

Passed the 23rd day of February, 1950.

The common seal of the Hamilton Waterworks Trust was hereto affixed this 23rd day of February, 1950, in the presence of—

(SEAL) C. H. WOODBRIDGE, Chairman.
R. W. LONSDALE, Commissioner.
W. F. HEWETT, Commissioner.
A. WALLS, Secretary.

Approved by the Governor in Council,
16th May, 1950.

A. G. COULTHARD,
Acting Clerk of the Executive Council.

YARRAWONGA URBAN WATERWORKS TRUST.

FIXING THE LIMIT OF A BANK OVERDRAFT.

HIS Excellency the Governor of the State of Victoria, by and with the advice of the Executive Council thereof, doth, by Order made on the twenty-third day of May, 1950, in pursuance of the provisions of section 273 of the *Water Act 1928* (No. 3801), hereby fix the limit of the overdraft to be obtained by the Yarrowonga Urban Waterworks Trust from the Commercial Bank of Australia Limited, Yarrowonga, at an amount not to exceed at any one time the sum of One thousand five hundred pounds (£1,500).

A. G. COULTHARD,
Acting Clerk of the Executive Council.

At the Executive Council Chamber,
Melbourne, 23rd May, 1950.

MACEDON WATERWORKS TRUST.

RATING BY-LAW FOR THE YEAR 1950.

THE Macedon Waterworks Trust, in pursuance and the exercise of the powers conferred by the Water Acts, doth hereby make a rate for the supply of water for domestic purposes of Two shillings and eight pence (2s. 8d.) in the pound of the annual municipal valuation of lands and tenements liable to be rated within the Macedon Urban District.

Provided that in no case shall the amount of the rate payable per annum in respect of any tenement (other than land on which there is no building) be less than Fifty-five shillings (55s.), and in respect of any land on which there is no building less than Ten shillings (10s.).

Such rates are made and shall be levied upon the occupiers or owners of the said lands and tenements for the year commencing the 1st day of January, 1950, and shall be payable on the 1st day of June, 1950, at the office of the Trust.

The maximum quantity of water to be supplied in any one year without further charge to any property rated by the Trust is hereby fixed at the quantity which, at a charge of One shilling (1s.) per 1,000 gallons, would produce an amount equal to the amount of rate levied on such property for the said year.

The charge for water supplied by measure to any property rated by the Trust in excess of such maximum quantity, computed as in the last preceding clause, is hereby fixed at One shilling (1s.) per 1,000 gallons.

The charge for water supplied by measure to any property not rated by the Trust is hereby fixed at Three shillings (3s.) per 1,000 gallons, and the minimum quantity of water to be charged for in cases where water is so supplied is hereby fixed at Sixty-six thousand (66,000) gallons.

The charge for water supplied by measure to the Victorian Railways for engine purposes is hereby fixed at Six pence (6d.) per 1,000 gallons.

The charge for water supplied by measure shall be payable, on demand, at the office of the Trust.

Passed this 4th day of May, 1950.

(SEAL) F. W. H. MANN, Chairman.
W. E. MCLEOD, Secretary.

Approved by the Governor in Council,
16th May, 1950.

A. G. COULTHARD,
Acting Clerk of the Executive Council.

RUSHWORTH WATERWORKS TRUST.

RATING BY-LAW FOR YEAR 1950.

THE Rushworth Waterworks Trust, in pursuance and exercise of the powers conferred by the Water Acts, doth hereby make a rate for the supply of water for domestic purposes of Three shillings in the pound on the annual municipal valuation of lands and tenements liable to be rated within the Rushworth Urban District.

Provided that in no case shall the amount of rate payable in respect of any tenement (other than land on which there is no building) be less than Three pounds, and in respect of any land on which there is no building less than One pound ten shillings.

Such rates are made and shall be levied upon the occupiers or owners of the said lands and tenements for the year commencing the 1st day of January, 1950, and shall be payable on the 1st day of June, 1950, at the office of the said Trust.

The maximum quantity of water to be supplied in any one year without further charge to any property rated by the Trust is hereby fixed at the quantity which, at a charge of One shilling per 1,000 gallons, would produce an amount equal to the amount of rate levied on such property for the said year.

The charge for water supplied by measure to any property rated by the Trust in excess of such maximum quantity, computed as in the last preceding clause, is hereby fixed at One shilling per 1,000 gallons.

The charge for water supplied by measure shall be payable on demand.

Dated the 10th day of May, 1950.

(SEAL) F. V. HAMMOND, Chairman.
A. WILSON, Secretary.

Approved by the Governor in Council,
16th May, 1950.

A. G. COULTHARD,
Acting Clerk of the Executive Council.

DONALD WATERWORKS TRUST.

RATING BY-LAW FOR THE YEAR 1950.

THE Donald Waterworks Trust, in pursuance and exercise of the powers conferred by the Water Acts, doth hereby make a rate for the supply of water for domestic purposes of One shilling and nine pence in the pound of the net annual value of lands and tenement: liable to be rated within the Donald Urban District.

Provided that in no case shall the amount of rates payable per annum in respect of any tenement (other than land upon which there is no building) be less than Twenty shillings, and in respect of any land upon which there is no building less than Ten shillings.

Such rates are made and shall be levied upon the occupiers or owners of the said lands and tenements for the year commencing on the 1st day of January, 1950, and shall be payable on the 10th day of June, 1950, at the office of the Trust.

The maximum quantity of water to be supplied in any one year without further charge to any property rated by the Trust is hereby fixed at the quantity which, at a charge of One shilling per 1,000 gallons, would produce an amount equal to the amount of the rate levied upon such property for the said year.

The charge for water supplied by measure to any property rated by the Trust in excess of such maximum quantity, computed as in the last preceding clause, is hereby fixed at One shilling per 1,000 gallons.

The charge for water supplied by measure shall be payable on demand.

The foregoing By-law was made by the Donald Waterworks Trust on the 1st day of May, 1950, and the common seal of the Trust was hereunto affixed on the 1st of May, 1950, in the presence of—

(SEAL) G. D. MOORE, Chairman.
W. J. FLANAGAN, Commissioner.
H. C. SMALE, Secretary.

Approved by the Governor in Council,
16th May, 1950.

A. G. COULTHARD,
Acting Clerk of the Executive Council.

FOSTER WATERWORKS TRUST.

RATING BY-LAW 1950.

THE Foster Waterworks Trust, in pursuance and exercise of the powers conferred by the Water Acts, doth hereby make a rate for the supply of water for domestic purposes of One shilling and nine pence in the pound on the annual municipal valuation of lands and tenements within the Foster Urban District.

Provided that in no case shall the amount payable per annum in respect of any tenement (other than land where there is no building) be less than Thirty-seven shillings, and in respect of any land on which there is no building less than Twelve shillings per annum.

Such rate is made for the year commencing the first day of January, 1950, and shall be payable on the 31st day of May, 1950, at the office of the said Trust.

The maximum quantity of water to be supplied in any one year without further charge to any property rated by the Trust is hereby fixed at the quantity which, at the charge of One shilling per 1,000 gallons, would produce an amount equal to the amount of rate levied on such property for the said year.

The charge for water supplied by measure to any property rated by the Trust in excess of such maximum quantity, computed as in the last preceding clause, is hereby fixed at One shilling per 1,000 gallons.

The charge for water supplied by measure to any property not rated by the Trust is hereby fixed at One shilling per 1,000 gallons, and the minimum quantity of water to be charged for in cases where water is so supplied is hereby fixed at 42,000 gallons.

The charge for water supplied by measure shall be payable, on demand, at the office of the Trust.

Passed at a meeting of the Trust, on the 8th day of May, 1950.

(SEAL) R. G. RUDD, Commissioner.
A. E. LINTON, Commissioner.
W. S. PEARL, Secretary.

Approved by the Governor in Council,
16th May, 1950.

A. G. COULTHARD,
Acting Clerk of the Executive Council.

APOLLO BAY WATERWORKS TRUST.

RATING BY-LAW FOR THE YEAR 1950.

THE Apollo Bay Waterworks Trust, in pursuance and exercise of the powers conferred by the Water Acts, doth hereby make a rate for the supply of water for domestic purposes of One shilling and six pence (1s. 6d.) in the pound of the annual municipal valuation of lands and tenements liable to be rated within the Apollo Bay Urban District.

Provided that in no case shall the amount of rate payable per annum in respect of any tenement (other than land on which there is no building) be less than Twenty-six shillings and eight pence (26s. 8d.), and in respect of any land on which there is no building less than Ten shillings (10s.).

Such rates are made and shall be levied upon the occupiers or owners of the said lands and tenements for the year commencing the 1st day of January, 1950, and shall be payable on the 1st day of June, 1950, at the office of the said Trust.

The maximum quantity of water to be supplied in any one year without further charge to any property rated by the said Trust is hereby fixed at the quantity which, at a charge of One shilling and six pence (1s. 6d.) per 1,000 gallons, would produce an amount equal to the amount of the rate levied on such property for the said year.

The charge for water supplied by measure to any property rated by the Trust in excess of such maximum quantity, computed as in the last preceding clause, is hereby fixed at One shilling and six pence (1s. 6d.) per 1,000 gallons.

Water supplied to cricket, tennis, or bowling clubs, and to Government Departments, showgrounds, and similar properties shall be charged for at the rate of One shilling and six pence (1s. 6d.) per 1,000 gallons, provided that the minimum quantity to be charged for shall not be less than 15,000 gallons.

The charge for water by measure shall be payable, on demand, at the office of the Trust.

Passed this 29th day of April, 1950.

(SEAL) C. S. SIMS, Chairman.
W. O. CORKE, Secretary.

Approved by the Governor in Council,
16th May, 1950.

A. G. COULTHARD,
Acting Clerk of the Executive Council.

RIDDELL'S CREEK WATERWORKS TRUST.

RATING BY-LAW FOR 1950.

THE Riddell's Creek Waterworks Trust, in pursuance and exercise of the powers conferred by the Water Acts, doth hereby make a rate for the supply of water for domestic purposes of Two shillings and nine pence in the pound of the annual municipal valuation of lands and tenements liable to be rated within the Riddell's Creek Urban District.

Provided that in no case shall the amount of rate payable per annum in respect of any tenement (other than on land on which there is no building) be less than Two pounds fifteen shillings, and in respect of land on which there is no building less than One pound.

Such rates are made and shall be levied upon the occupiers or owners of the said lands and tenements for the year commencing the 1st day of January, 1950, and shall be payable on the 7th day of June, 1950, at the office of the said Trust.

The maximum quantity of water to be supplied in any one year without further charge to any property rated by the Trust is hereby fixed at the quantity which, at a charge of One shilling per 1,000 gallons, would produce an amount equal to the amount of the rate levied on the property for the said year.

The charge for water supplied by measure to any property rated by the Trust in excess of such maximum quantity, computed as in the last preceding clause, is hereby fixed at One shilling per 1,000 gallons.

The charge for water supplied by measure shall be payable, on demand, at the office of the Trust.

Passed this 2nd day of May, 1950.

(SEAL) J. R. BOLITHO, Chairman.
UNA I. WRIGHT, Secretary.

Approved by the Governor in Council,
16th May, 1950.

A. G. COULTHARD,
Acting Clerk of the Executive Council.

BEALIBA WATERWORKS TRUST.

RATING BY-LAW 1950.

THE Commissioners of the Bealiba Waterworks Trust, in pursuance and exercise of the powers conferred by the Water Acts, doth hereby make a rate for the supply of water for domestic purposes of One shilling and four pence in the pound on the annual municipal valuation of the lands and tenements liable to be rated within the Bealiba Urban District.

Provided that in no case shall the amount of rate payable per annum in respect of any tenement (other than land on which there is no building) be less than Thirty-six shillings and eight pence, and in respect of any land on which there is no building less than Five shillings.

Such rates are made and shall be levied upon the occupiers or owners of the said lands and tenements for the year commencing 1st January, 1950, and ending on the 31st December, 1950, and shall be payable on the 14th day of June, at the offices of the Trust, Dunolly.

The maximum quantity of water to be supplied in any one year without further charge to any property rated by the Trust is hereby fixed at the quantity which, at a charge of One shilling and four pence per 1,000 gallons, would produce an amount equal to the amount of rate levied on such property for the said year.

The charge for water supplied by measure to any property not rated by the Trust in excess of such maximum quantity, computed as in the last preceding clause, is hereby fixed at One shilling and four pence per 1,000 gallons.

The charge for water supplied by measure to any property not rated by the Trust is hereby fixed at One shilling and four pence per 1,000 gallons, and the minimum quantity of water to be charged for in cases where water is so supplied is hereby fixed at 33,000 gallons.

The charge for water supplied by measure shall be payable, on demand, at the offices of the Trust, Dunolly.

Passed this 26th day of April, 1950.

(SEAL) W. K. CAMERON, Chairman.
K. A. G. LOWE, Secretary.

Approved by the Governor in Council,
16th May, 1950.

A. G. COULTHARD,
Acting Clerk of the Executive Council.

MORTLAKE WATERWORKS TRUST.

RATING BY-LAW FOR YEAR 1950.

THE Mortlake Waterworks Trust, in pursuance and exercise of the powers conferred by the Water Acts, doth hereby make a rate for the supply of water for domestic purposes of One shilling and four pence in the pound on the annual municipal valuation of lands and tenements liable to be rated within the Mortlake Urban District.

Provided that in no case shall the amount of rate payable per annum in respect of any tenement (other than land on which there is no building) be less than Twenty shillings, and in respect of any land on which there is no building be less than Five shillings.

Such rates are made and shall be levied on the occupiers or owners of the said lands and tenements for the year commencing on the 1st day of January, 1950, and shall be payable on the 1st day of July, 1950, at the office of the said Trust.

Passed this 9th day of May, 1950.

(SEAL) JAMES CAMERON, Chairman.
N. TURNBULL, Secretary.

Approved by the Governor in Council,
16th May, 1950.

A. G. COULTHARD,
Acting Clerk of the Executive Council.

MURRAYVILLE WATERWORKS TRUST.

RATING BY-LAW FOR THE YEAR 1950.

THE Murrayville Waterworks Trust, in pursuance and exercise of the powers conferred by the Water Acts, doth hereby make a rate for the supply of water for domestic purposes of Twenty-four pence in the pound on the annual municipal valuation of lands and tenements liable to be rated within the Murrayville Urban District.

Provided that in no case shall the amount of rate payable per annum in respect of any tenement (other than land on which there is no building) be less than Fifty shillings, and in respect of land on which there is no building be less than Ten shillings.

Such rates are made and shall be levied upon the occupiers or owners of the said lands and tenements for the year commencing on the 1st day of January, 1950, and ending on the 31st day of December, 1950, and shall be payable on the 31st day of May, 1950, at the office of the said Trust, at the Shire Hall, Ouyen.

The maximum quantity of water to be supplied in any one year without further charge to any property rated by the Trust is hereby fixed at the quantity which, at a charge of One shilling and six pence per 1,000 gallons, would produce an amount equal to the amount of the rate levied on such property for the said year.

The charge for water supplied by measure to any property rated by the Trust in excess of such maximum quantity, computed as in the last preceding clause, is hereby fixed at One shilling and six pence per 1,000 gallons.

The charge for water supplied by measure to any property not rated by the Trust and where no agreement exists is hereby fixed at One shilling and six pence per 1,000 gallons, and the minimum quantity of water to be charged for in cases where water is so supplied is hereby fixed at 34,000 gallons.

The charge for water supplied by measure shall be payable, on demand, at the office of the Trust.

Dated this 30th day of March, 1950.

(SEAL) J. G. FISHER, Chairman.
C. F. LACKMANN, Commissioner.
K. MATHESON, Secretary.

Approved by the Governor in Council,
16th May, 1950.

A. G. COULTHARD,
Acting Clerk of the Executive Council.

SHIRE OF DANDENONG.

NEW PUBLIC HIGHWAY.—ORDER OF COUNCIL OF SHIRE OF DANDENONG.

IN pursuance of the powers conferred by sections 521 and 525 of the *Local Government Act 1946*, the Council of the Shire of Dandenong doth hereby order that the lands next hereinafter described shall be a public highway from the date of the publication of this Order in the *Government Gazette*, that is to say:—

All that piece of land being part of Crown portion 22, Parish of Dandenong, County of Bourke, and commencing at a point 134 ft. 10 in. in a westerly direction from the intersection of the west side of Frank-street with the north side of Joy-parade, and bounded on the south by the north side of Joy-parade by a line bearing west for a distance of 20 ft. 6½ in.; thence by a line bearing north for a distance of 160 ft. 1 in.; thence by a line bearing south 89 deg. 54 min. east for a distance of 10 ft. 6½ in.; thence by a line bearing south 55 deg. 11 min. east for a distance of 4 feet; thence by a line bearing south 34 deg. 49 min. west for a distance of 5 ft. 9 in.; thence by a line bearing south for a distance of 143 ft. 1 in.; thence by a line bearing south 45 degrees east for a distance of 14 ft. 1½ in. to the commencing point.

And the said Council doth hereby declare that the lands above described shall from the said date of publication in the *Government Gazette* be a public highway, in lieu of the land hereinafter described, that is to say:—

All that piece of land being part of Crown portion 22, Parish of Dandenong, County of Bourke, and commencing at a point 165 feet from the intersection of the south side of Douglas-street and the west side of Frank-street, and bounded on the east by the west side of Frank-street by a line bearing south 34 deg. 49 min. west for a distance of 10 feet; thence by a line bearing north 55 deg. 11 min. west for a distance of 206 ft. 3½ in.; thence by a line bearing north 34 deg. 49 min. east for a distance of 10 feet; thence by a line bearing south 55 deg. 11 min. east for a distance of 206 ft. 3½ in. to the commencing point.

Dated the nineteenth day of December, 1949.

The common seal of the President, Councillors, and Ratepayers of the Shire of Dandenong was hereunto affixed, in the presence of—

(SEAL) VICTOR R. THARLE, Councillor.
J. C. MILLS, Councillor.
R. BOOTH, Shire Secretary.

Confirmed by the Governor in Council,
16th May, 1950.

A. G. COULTHARD,
Acting Clerk of the Executive Council.

MELBOURNE AND METROPOLITAN BOARD OF WORKS.

GENERAL NOTICE.

THE Melbourne and Metropolitan Board of Works, having made sewers for carrying off the sewage from each and every property which, or any part of which, abuts on the streets or parts of streets in which such sewers are laid, and which are included within the sewerage areas hereinafter described, doth hereby declare that on and after the 24th day of June, 1950, each and every property which, or any part of which, abuts on the said streets or parts of streets shall be deemed to be a seweraged property within the meaning of the *Melbourne and Metropolitan Board of Works Act 1928*.

The sewerage areas hereinbefore referred to are:—

Sewerage Area No. 1,285.

CITY OF BOX HILL.—Commencing at the intersection of Warrigal-road and Riversdale-road; thence easterly along Riversdale-road to the boundary of Sewerage Area No. 759, northerly and westerly following Sewerage Areas Nos. 759 and 685 to the intersection of Boisdale-street and Warrigal-road, southerly along Warrigal-road to the commencing point.

Sewerage Area No. 1,286.

CITY OF MOORABBIN.—Commencing at the intersection of Latrobe-street and the Frankston railway line; thence north-westerly along the Frankston railway line, westerly along Park-road, southerly and easterly along the western and southern boundaries of Cheltenham Park, further easterly by a line to the north-west corner of No. 21 Glebe-avenue, southerly along the western boundary of the said No. 21, easterly along Glebe-avenue, southerly along the western boundary of lot 10, Glebe-avenue, easterly along the southern boundaries of properties on the south side of Glebe-avenue to the north-west corner of No. 205 Charman-road, southerly along the western boundaries of the said No. 205 and No. 201 Charman-road, easterly along Coape-street, southerly along Charman-road, easterly along Latrobe-street to the commencing point.

Sewerage Area No. 1,287.

CITY OF CAMBERWELL.—Commencing at the intersection of St. George's-crescent and Karnak-road; thence south-westerly along Karnak-road, north-westerly along the southern boundaries of lot 108, Karnak-road, and lot 105, St. George's-crescent, south-westerly along Taylor-street to the boundary of Sewerage Area No. 1,237 in Winton-road, generally northerly and westerly following Sewerage Area No. 1,237 to the intersection of Comas-grove and Solway-street, northerly along Solway-street, easterly along St. George's-crescent to the commencing point.

Further particulars regarding the streets or parts of streets in which sewers have been laid may be ascertained on inquiry at the Board's office.

By order of the Board,

CHAS. J. W. BRIGGS,

Secretary.

110 Spencer-street, Melbourne, C.1, 23rd May, 1950.

Cemeteries Acts.

SCALE OF FEES OF THE LANDSBOROUGH PUBLIC CEMETERY.

IN pursuance of the powers conferred by the *Cemeteries Act 1928*, the Trustees of the Landsborough Public Cemetery hereby make the following scale of fees, which shall come into operation on publication in the *Government Gazette*, and from and after such publication every scale of fees heretofore made by the said Trustees shall be and is hereby rescinded to the extent to which it conflicts with this scale:—

Private Graves.

	£	s.	d.
Sinking any grave 6 feet	3	0	0

CHAS. PEACOCK, Trustee.

A. D. FRIEND, Trustee.

JNO. FRIEND, Trustee.

W. WEBB HODGETTS, Secretary.

29th March, 1950.

Approved by the Governor in Council,
16th May, 1950.

A. G. COULTHARD,
Acting Clerk of the Executive Council.

Cemeteries Acts.

HORSHAM PUBLIC CEMETERY.

IN pursuance of the powers conferred on them by the Cemeteries Acts, the Trustees of the Horsham Public Cemetery hereby rescind the scale of fees published in *Government Gazette* No. 44 of the 26th January, 1949, and substitute the following scale of fees, which shall come into operation on publication in the *Government Gazette*—

Private Graves.

	£	s.	d.
Land selected by applicant (per burial block) ..	7	5	0
Land selected by Trustees (per burial block) ..	6	10	0
Sinking grave and number plate (only), adult ..	3	10	0
Sinking grave and number plate (only), child ..	2	10	0
Stillborn in private compartment ..	2	0	0

Public Graves.

Sinking of grave, number plate, and interment (adult) ..	2	10	0
Sinking of grave, number plate, and interment (child) ..	1	10	0
Burial of stillborn child ..	1	5	0

Miscellaneous Charges.

Cemetery fee (adult) ..	1	10	0
Cemetery fee (child under twelve years) ..	1	0	0
Sinking each additional foot past 6 feet ..	1	0	0
Cancellation of order to sink (if commenced) ..	2	2	0
Re-opening grave for deepening ..	2	10	0
Oversize casket ..	1	15	0
Exhuming body and re-burying in same position ..	5	0	0
Sinking or re-opening grave inside fence railing or kerbing—extra ..	1	0	0
Removing and replacing ledgers or breaking through sealings ..	1	0	0
Interment not in prescribed hours—extra ..	1	0	0
For certificate of reserved land ..	0	10	0
Burial right ..	0	10	0
Transferring of rights and land certificates ..	0	15	0
Burials on weekly half-holidays and gazetted public holidays—			
Extra for grave 4½ feet ..	0	10	0
Extra for grave 6 feet ..	1	0	0
Extra for grave 7 feet ..	1	10	0
Permission to erect monuments, &c.—5 per cent. on value of all work, with a minimum charge of £1.			
Added inscriptions—5 per cent. on value of all work, with a minimum of 10s.			

Dated at Horsham, this 20th day of March, 1950.

(SEAL) SIDNEY R. SMITH, Trustee.
C. W. DOUGALL, Trustee.
N. R. WHITELOCK, Trustee.
K. H. LOVETT, Secretary.

Approved by the Governor in Council,
16th May, 1950.
A. G. COULTHARD,
Acting Clerk of the Executive Council.

Cemeteries Act.

SCALE OF FEES, BIRCHIP PUBLIC CEMETERY.

IN pursuance of the powers conferred upon them by the *Cemeteries Act 1928*, the Trustees of the Birchip Public Cemetery hereby make the following scale of fees, which will come into operation upon publication in the *Government Gazette*, and from and after such publication every scale of fees heretofore made by the said Trustees shall be and is hereby rescinded to the extent to which it conflicts with this scale—

Private Graves.

	£	s.	d.
Sinking 6 feet ..	5	0	0
Re-opening ..	4	0	0

M. W. McLOUGHLAN, Trustee.
H. G. TAYLOR, Trustee.
W. B. HARROWFIELD, Trustee.

Approved by the Governor in Council,
16th May, 1950.
A. G. COULTHARD,
Acting Clerk of the Executive Council.

Cemeteries Act.

SCALE OF FEES, CUDGEWA PUBLIC CEMETERY.

IN pursuance of the powers conferred upon them by the *Cemeteries Act 1928*, the Trustees of the Cudgewa Public Cemetery hereby make the following scale of fees, which will come into operation upon publication in the *Government Gazette*, and from and after such publication every scale of fees heretofore made by the said Trustees shall be and is hereby rescinded to the extent to which it conflicts with this scale—

Private Graves.

	£	s.	d.
Land 8 ft. x 4 ft. ..	2	0	0
Sinking 4 ft. 6 in. ..	2	10	0
Sinking 6 feet ..	3	15	0
Sinking 7 feet ..	4	15	0
Lifting slabs, extra ..	1	0	0
Sinking on public holidays (Saturday and Sunday), extra ..	1	0	0

REUBEN T. JARVIS, Trustee.
DAVID A. ROSS, Trustee.
CLIFTON J. SLOAN, Trustee.

Approved by the Governor in Council,
16th May, 1950.
A. G. COULTHARD,
Acting Clerk of the Executive Council.

Cemeteries Acts.

SCALE OF FEES, MOYSTON PUBLIC CEMETERY.

IN pursuance of the powers conferred upon them by the *Cemeteries Act 1928*, the Trustees of the Moyston Public Cemetery hereby make the following scale of fees, which will come into operation immediately after its publication in the *Government Gazette*, and from and after such publication every scale of fees heretofore made by the said Trustees shall be and is hereby rescinded to the extent to which it conflicts with this scale—

Miscellaneous.

	£	s.	d.
Permission to erect monumental work on a single grave ..	1	10	0
Permission to erect monumental work on a double grave ..	3	0	0

W. J. MILLER, Trustee.
S. Y. HEWITT, Trustee.
D. McDONALD, Trustee.

Approved by the Governor in Council,
16th May, 1950.
A. G. COULTHARD,
Acting Clerk of the Executive Council.

Cemeteries Acts.

SCALE OF FEES, ST. KILDA GENERAL CEMETERY.

IN pursuance of the powers conferred by the *Cemeteries Act 1928*, the Trustees of the St. Kilda General Cemetery hereby make the following scale of fees, which will come into operation upon publication in the *Government Gazette*, and from and after such publication every scale of fees heretofore made by the said Trustees shall be and is hereby rescinded to the extent to which it conflicts with this scale—

Private Graves.

	£	s.	d.
Land in special positions—Minimum ..	15	0	0
Maximum ..	20	0	0
Sinking 7 feet ..	4	5	0
Sinking 8 feet ..	4	10	6
Sinking 9 feet ..	5	0	0
Sinking 10 feet ..	5	10	0
Re-opening graves 2 feet wide ..	4	0	0
Re-opening graves over 2 feet wide, extra ..	0	10	0
Maintenance, single grave, per annum ..	1	10	0
Maintenance, double grave, per annum ..	2	10	0

A. H. WOODFULL, Trustee.
G. W. MINTY, Trustee.
E. H. SMITH, Trustee.
M. G. ELLIS, Trustee.

Approved by the Governor in Council,
16th May, 1950.
A. G. COULTHARD,
Acting Clerk of the Executive Council.

Cemeteries Act 1928.

SCALE OF FEES OF THE EAGLEHAWK CEMETERY TRUST.

IN pursuance of the powers conferred by the Cemeteries Acts, the Trustees of the Eaglehawk Cemetery Trust make the following scale of fees, which shall come into operation on publication in the *Government Gazette*, and from and after such publication any scale of fees previously made by the said Trustees shall be and is hereby rescinded to the extent to which it conflicts with this scale:—

Open Ground.

	£	s.	d.
Single interment of body	6	0	0
Single interment of child under ten years ..	3	0	0
Child, stillborn	1	0	0

Private Graves.

8 ft. x 4 ft., in positions selected by applicants— additional land at proportionate rates ..	9	0	0
8 ft. x 4 ft., in position selected by Trustees ..	7	0	0
8 ft. x 4 ft., in special position in cemetery ..	12	0	0

Extra Charges.

For interments as under—

Between 6 a.m. and 10 a.m.	0	10	0
At other times not in the usual hours ..	1	0	0
On public holidays	1	0	0
When order is given after 4 p.m. on the day previous to funeral	0	12	6
Exhumation of a body	3	3	0
Re-interment of a body in same grave ..	0	10	0
Re-interment of a body elsewhere within the cemetery	6	0	0
Where gads or explosives are used, extra per grave	0	10	0

Signed and sealed this 3rd day of April, 1950.

(SEAL) A. L. G. JENKINS, Mayor.
E. J. TAYLOR, Councillor.
P. J. FINCH, Councillor.
L. D. COOK, Town Clerk.

Approved by the Governor in Council,
16th May, 1950.

A. G. COULTHARD,
Acting Clerk of the Executive Council.

Cemeteries Acts.

SCALE OF FEES, KERANG GENERAL CEMETERY.

IN pursuance of the powers conferred by the *Cemeteries Act 1928*, the Trustees of the Kerang General Cemetery hereby make the following scale of fees, which shall come into operation immediately after its publication in the *Government Gazette*, and from and after such publication every scale of fees heretofore made by the said Trustees shall be and is hereby rescinded:—

Public Graves.

	£	s.	d.
Single interment of an adult, including sinking grave	4	0	0
Single interment of a child under ten years, including sinking grave	3	10	0
Single interment of a stillborn child, including sinking grave	0	15	0
Interment of an adult by a Government con- tractor, including sinking grave	2	10	0
Interment of a child under ten years by a Govern- ment contractor, including sinking grave ..	2	0	0

Private Graves.

Land 8 ft. x 4 ft.	4	0	0
Land 8 ft. x 8 ft.	8	0	0
Extra fee for own selection of land ..	1	0	0
Sinking a grave for an adult	3	0	0
Sinking a grave for a child under ten years ..	2	10	0

Miscellaneous.

Tablet for each grave	0	10	6
Re-opening a grave for an adult	3	0	0
Re-opening a grave for a child under ten years ..	2	10	0
Exhumation of a body	5	10	0
Re-interment of a body in the same grave ..	3	0	0
Re-interment of a body elsewhere within the cemetery	3	0	0
Interment without due notice, extra ..	1	0	0
Oversize graves, extra	0	15	0

Interment on Saturday, Sunday, or public holiday
—50 per cent. additional charge.
Permission to erect kerbing, memorial, or other
erection—2½ per cent. of total cost.

A. F. HARRIDGE, Trustee.
R. THOMAS, Trustee.
E'ST PAY, Trustee.
W. B. MURPHY, Trustee.

Approved by the Governor in Council,
16th May, 1950.

A. G. COULTHARD,
Acting Clerk of the Executive Council.

CITY OF HEIDELBERG.

ORDER CONFIRMED SUBJECT TO A VARIATION.

PURSUANT to section 513 of the *Local Government Act 1946*, the Minister of the Crown administering the said Act on the 8th day of May, 1950, confirmed the Order of the City of Heidelberg, made on the 21st day of March, 1949, for the purpose of widening Kitchener-street, and creation and extension of Oriol-road from Bond-street to Ford-street, subject to the variation that the land to be compulsorily acquired under such Order shall be that described hereunder, such land being within the municipal district of the City of Heidelberg:

1. All that piece of land described in certificate of title, volume 4303, folio 860404, situated at the corner of Kitchener-street and Livingstone-street, and having a frontage of 50 feet to Livingstone-street.

2. All that piece of land commencing at the south-west corner of land described in certificate of title, volume 4897, folio 979282; thence proceeding on a bearing of 0 deg. 10 min. for a distance of 66 feet; thence on a bearing of 89 deg. 45 min. for a distance of 14 ft. 10½ in.; thence on a bearing of 180 deg. 10 min. for a distance of 66 feet; thence on a bearing of 269 deg. 45 min. for a distance of 14 ft. 10½ in. back to the commencing point.

3. All that piece of land commencing at the south-west corner of land described in certificate of title, volume 5559, folio 1111745; thence proceeding on a bearing of 0 deg. 10 min. for a distance of 50 feet; thence on a bearing of 89 deg. 45 min. for a distance of 14 ft. 10½ in.; thence on a bearing of 180 deg. 10 min. for a distance of 50 feet; thence on a bearing of 269 deg. 45 min. for a distance of 14 ft. 10½ in. back to the commencing point.

4. All that piece of land commencing at the south-west corner of land originally described in certificate of title, volume 3083, folio 616459, and now particularly described in certificate of title, volume 7059, folio 1411299; thence proceeding on a bearing of 0 deg. 10 min. for a distance of 30 ft. 1½ in.; thence on a bearing of 89 deg. 54 min. for a distance of 15 ft. 5 in.; thence proceeding on a bearing of 185 deg. 50 min. for a distance of 5 ft. 4½ in.; thence on a bearing of 180 deg. 10 min. for a distance of 24 ft. 9 in.; thence on a bearing of 269 deg. 45 min. for a distance of 14 ft. 10½ in. back to the commencing point.

5. All that piece of land commencing at the south-west corner of land described in certificate of title, volume 4115, folio 822963; thence proceeding on a bearing of 0 deg. 10 min. for a distance of 84 feet; thence on a bearing of 89 deg. 54 min. for a distance of 23 ft. 9 in.; thence on a bearing of 185 deg. 50 min. for a distance of 84 ft. 5½ in.; thence on a bearing of 269 deg. 54 min. for a distance of 15 ft. 5 in. back to the commencing point.

6. All that piece of land commencing at the south-west corner of land described in certificate of title, volume 3923, folio 784412; thence proceeding on a bearing of 0 deg. 10 min. for a distance of 66 feet; thence on a bearing of 89 deg. 54 min. for a distance of 30 ft. 3½ in.; thence on a bearing of 185 deg. 50 min. for a distance of 66 ft. 4½ in.; thence on a bearing of 269 deg. 54 min. for a distance of 23 ft. 9 in. back to the commencing point.

7. All that piece of land described in certificate of title, volume 4056, folio 811046, being land situated at the corner of Ford and Kitchener streets, and having a frontage of 44 feet to Ford-street.

8. All that piece of land commencing at the south-west corner of land described in certificate of title, volume 2304, folio 460629, and proceeding on a bearing of 359 deg. 44 min. for a distance of 4 ft. 5 in.; thence on an arc of radius 20 feet and chord bearing 109 deg. 14 min. for a length of 13 ft. 6½ in.; thence on a bearing of 269 deg. 49 min. for a distance of 12 ft. 6½ in. back to the commencing point, and all that piece of land commencing at the north-west corner of land described in certificate of title, volume 2304, folio 460629; thence proceeding on a bearing of 89 deg. 56 min. for a distance of 8 ft. 9 in.; thence on a bearing of 189 deg. 36 min. for

a distance of 51 ft. 1½ in.; thence on a bearing of 359 deg. 44 min. for a distance of 50 ft. 5 in. back to the commencing point.

9. All that piece of land described in certificate of title, volume 4733, folio 946489, having a frontage of 66 feet to Stanley-street, Ivanhoe.

10. All that piece of land described in certificate of title, volume 5387, folio 1077281, having a frontage of 66 feet to Stanley-street, Ivanhoe.

11. All that piece of land described in certificate of title, volume 4579, folio 915796, having a frontage of 66 feet to Stanley-street, Ivanhoe.

12. All that piece of land commencing at the south-east corner of land described in certificate of title, volume 5511, folio 1102145, and proceeding on a bearing of 269 deg. 49 min. for a distance of 33 ft. 1 in.; thence on an arc of radius 20 feet and chord bearing 49 deg. 42½ min. for a length of 28 feet; thence on a bearing of 9 deg. 36 min. for a distance of 77 ft. 10½ in.; thence on a bearing of 179 deg. 44 min. for a distance of 93 ft. 4½ in. back to the commencing point.

13. All the piece of land commencing at the south-east corner of land described in certificate of title, volume 4704, folio 940749; thence proceeding on a bearing of 269 deg. 44½ min. for a distance of 32 ft. 3 in.; thence on an arc of radius 20 feet and chord bearing 45 deg. 9 min. for a length of 31 ft. 1½ in.; thence on a bearing of 0 deg. 33 min. for a distance of 135 ft. 3½ in.; thence on a bearing of 89 deg. 44½ min. for a distance of 12 ft. 6½ in.; thence on a bearing of 180 deg. 33 min. for a distance of 155 feet back to the commencing point.

14. All that piece of land commencing at the north-east corner of the land described in certificate of title, volume 4704, folio 940748; thence on a bearing of 180 deg. 33 min. for a distance of 115 ft. 9½ in.; thence on a bearing of 269 deg. 54 min. for a distance of 12 ft. 6½ in.; thence on a bearing of 0 deg. 33 min. for a distance of 95 ft. 6 in.; thence by an arc of radius 20 feet, chord bearing 215 deg. 9 min. for a distance of 31 ft. 8½ in.; thence on a bearing of 89 deg. 44½ min. for a distance of 32 ft. 10 in. back to the commencing point.

15. All that piece of land commencing at the south-east corner of land described in certificate of title, volume 3430, folio 685843; thence proceeding on a bearing of 269 deg. 54 min. for a distance of 2 feet; thence on a bearing of 5 deg. 50 min. for a distance of 20 ft. 1½ in.; thence on a bearing of 180 deg. 10 min. for a distance of 20 feet back to the commencing point.

16. All that piece of land commencing at the south-east corner of land described in certificate of title, volume 6822, folio 1364359, and proceeding on a bearing of 269 deg. 45 min. for a distance of 5 ft. 1½ in.; thence on a bearing of 0 deg. 10 min. for a distance of 50 feet; thence on a bearing of 89 deg. 45 min. for a distance of 5 ft. 1½ in.; thence on a bearing of 180 deg. 10 min. for a distance of 50 feet back to the commencing point.

17. All that piece of land commencing at the south-east corner of land described in certificate of title, volume 3164, folio 632613, and proceeding on a bearing of 269 deg. 45 min. for a distance of 5 ft. 1½ in.; thence on a bearing of 0 deg. 10 min. for a distance of 50 feet; thence on a bearing of 89 deg. 45 min. for a distance of 5 ft. 1½ in.; thence on a bearing of 180 deg. 10 min. for a distance of 50 feet back to the commencing point.

18. All that piece of land commencing at the south-east corner of land described in certificate of title, volume 3189, folio 637637, and proceeding on a bearing of 269 deg. 45 min. for a distance of 5 ft. 1½ in.; thence on a bearing of 0 deg. 10 min. for a distance of 50 feet; thence on a bearing of 89 deg. 45 min. for a distance of 5 ft. 1½ in.; thence on a bearing of 180 deg. 10 min. for a distance of 50 feet back to the commencing point.

19. All that piece of land commencing at the south-east corner of land described in certificate of title, volume 5181, folio 1036188; thence proceeding on a bearing of 269 deg. 45 min. for a distance of 5 ft. 1½ in.; thence on a bearing of 0 deg. 10 min. for a distance of 50 feet; thence on a bearing of 89 deg. 45 min. for a distance of 5 ft. 1½ in.; thence on a bearing of 180 deg. 10 min. for a distance of 50 feet back to the commencing point.

20. All that piece of land commencing at the south-east corner of land described in certificate of title, volume 3164, folio 632723, and proceeding on a bearing of 269 deg. 45 min. for a distance of 5 ft. 1½ in.; thence on a bearing of 0 deg. 10 min. for a distance of 66 feet; thence on a bearing of 89 deg. 45 min. for a distance of 5 ft. 1½ in.; thence on a bearing of 180 deg. 10 min. for a distance of 66 feet back to the commencing point.

21. All that piece of land described in certificate of title, volume 4645, folio 928873, situated at the corner of Livingstone and Kitchener streets, and having a frontage of 50 feet to Livingstone-street, Ivanhoe.

J. A. KENNEDY,
Commissioner of Public Works.

CEMETERIES ACT 1928.—DEPARTMENT OF HEALTH.

At the Executive Council Chamber, Melbourne, the sixteenth day of May, 1950.

PRESENT:

His Excellency the Governor of Victoria.
Sir James Kennedy | Brigadier Tovell.

CHURCH OF ENGLAND BURIAL GROUND TO BE PART OF THE GEELONG WESTERN PUBLIC CEMETERY.

WHEREAS by the *Cemeteries Act 1928*, it is amongst other things enacted that the Governor in Council may direct that any land which before the 6th day of September, 1867, was set apart for the interment of the dead, may be annexed or united to any cemetery under any law then in force relating to cemeteries:

And whereas all that piece or parcel of land described in the Schedule hereunder was by Crown grant dated the 4th day of January, 1849, granted to Edward Brown Addis, William Roadknight, Frederic Champion, and Charles Sladen, their heirs and assigns forever upon trust for the interment of the dead, according to the use of the United Church of England and Ireland, as by law established:

Now therefore, His Excellency the Governor of the State of Victoria in the Commonwealth of Australia, by and with the advice of the Executive Council of the said State, doth hereby direct that pursuant to the provisions of section 41 of the *Cemeteries Act 1928*, the said land shall be annexed and united to the Geelong Western Public Cemetery, and shall be held in trust and managed by the trustees of the Geelong Western Public Cemetery as an integral part of the said cemetery.

SCHEDULE.

All that piece or parcel of land containing by ad-measurement 2 acres more or less, situated in the County of Grant and Parish of Corio, commencing at the south-west corner and bounded on the west by a line bearing north 5 chains, on the north by the Wesleyan Burial Ground containing 2 acres, being a line bearing east 4 chains, on the east by the Presbyterian Burial Ground containing 2 acres, being a line bearing south 5 chains, and on the south by a line bearing west 4 chains.

And the Honorable Charles Percival Gartside, His Majesty's Minister of Health for the State of Victoria, shall give the necessary directions herein accordingly.

A. G. COULTHARD,
Acting Clerk of the Executive Council.

APPRENTICESHIP ACTS.

At the Executive Council Chamber, Melbourne, the sixteenth day of May, 1950.

PRESENT:

His Excellency the Governor of Victoria.
Sir James Kennedy | Brigadier Tovell.

APPRENTICESHIP COMMISSION OF VICTORIA.

IN pursuance of the provisions of the Apprenticeship Acts, His Excellency the Governor of the State of Victoria, by and with the advice of the Executive Council thereof, doth by this Order appoint:—

ALBERT WILLIAM HENDERSON, a person nominated by the body known as the Trades Hall Council of Melbourne, to be a member of the Apprenticeship Commission of Victoria, *vice* John Alfred Connell, resigned, for the remainder of the term of three years for which the said John Alfred Connell was appointed.

And the Honorable Allan Elliott McDonald, His Majesty's Minister of Labour for the State of Victoria, shall give the necessary directions herein accordingly.

A. G. COULTHARD,
Acting Clerk of the Executive Council.

Apprenticeship Acts.
APPRENTICESHIP COMMISSION OF VICTORIA.

*At the Executive Council Chamber, Melbourne, the
sixteenth day of May, 1950.*

PRESENT:

His Excellency the Governor of Victoria.
Sir James Kennedy | Brigadier Tovell.

AMENDMENT OF AIRCRAFT TRADES REGULATIONS
(No. 1).

IN pursuance of the powers conferred by the Apprenticeship Acts and the Acts Interpretation Acts, His Excellency the Governor of the State of Victoria, by and with the advice of the Executive Council thereof, doth hereby rescind Regulation 9 of the Aircraft Trades Regulations (No. 1) as from the beginning of the first full pay period to commence in May, 1950, and doth hereby substitute therefor the following, that is to say:—

1. The rescission of any Regulations by these Regulations shall not affect any right accrued or accruing to any person or the liability of any person under such rescinded Regulations, where such right accrued or such liability was incurred prior to the coming into operation of these Regulations.

2. The minimum rates of pay to be paid as wages to apprentices in the said trades in each year of their apprenticeship course shall be as follows, as from the beginning of the first full pay period to commence in May, 1950, on, from, and after which date all indentures of apprenticeship heretofore executed under the provisions of the Acts and of the Regulations made in respect of the aforesaid trades shall be deemed to be amended accordingly:—

1st year—at the rate of 38s. 6d. per week.
2nd year—at the rate of 54s. 6d. per week.
3rd year—at the rate of 72s. 6d. per week.
4th year—at the rate of 114s. 6d. per week.
5th year—at the rate of 143s. 0d. per week.

AMENDMENT OF BOILERMAKING AND/OR STEEL
CONSTRUCTION TRADES REGULATIONS (No. 2).

IN pursuance of the powers conferred by the Apprenticeship Acts and the Acts Interpretation Acts, His Excellency the Governor of the State of Victoria, by and with the advice of the Executive Council thereof, doth hereby rescind Regulation 7 of the Boilermaking and/or Steel Construction Trades Regulations (No. 2) as from the beginning of the first full pay period to commence in May, 1950, and doth hereby substitute therefor the following, that is to say:—

1. The rescission of any Regulations by these Regulations shall not affect any right accrued or accruing to any person or the liability of any person under such rescinded Regulations, where such right accrued or such liability was incurred prior to the coming into operation of these Regulations.

2. The minimum rates of pay to be paid as wages to apprentices in the said trades in each year of their apprenticeship course shall be as follows, as from the beginning of the first full pay period to commence in May, 1950, on, from, and after which date all indentures of apprenticeship heretofore executed under the provisions of the Acts and of the Regulations made in respect of the aforesaid trades shall be deemed to be amended accordingly:—

(a) With respect to the term of apprenticeship of five years—

1st year—at the rate of 38s. 6d. per week.
2nd year—at the rate of 54s. 6d. per week.
3rd year—at the rate of 72s. 6d. per week.
4th year—at the rate of 114s. 6d. per week.
5th year—at the rate of 143s. 0d. per week.

(b) With respect to the term of apprenticeship of four years—

1st year—at the rate of 44s. 0d. per week.
2nd year—at the rate of 72s. 0d. per week.
3rd year—at the rate of 114s. 6d. per week.
4th year—at the rate of 143s. 0d. per week.

AMENDMENT OF BOOT TRADES REGULATIONS.

IN pursuance of the powers conferred by the Apprenticeship Acts and the Acts Interpretation Acts, His Excellency the Governor of the State of Victoria, by and with the advice of the Executive Council thereof, doth hereby rescind Regulation 9 of the Boot Trades Regulations as from the beginning of the first full pay period to commence in May, 1950, and doth hereby substitute therefor the following, that is to say:—

1. The rescission of any Regulations by these Regulations shall not affect any right accrued or accruing to any person or the liability of any person under such rescinded Regulations, where such right accrued or such liability was incurred prior to the coming into operation of these Regulations.

2. The minimum rates of pay to be paid as wages to apprentices in the said trades in each year of their apprenticeship course shall be as follows, as from the beginning of the first full pay period to commence in May, 1950, on, from, and after which date all indentures of apprenticeship heretofore executed under the provisions of the Acts and of the Regulations made in respect of the aforesaid trades shall be deemed to be amended accordingly:—

(a) With respect to the term of apprenticeship of six years—

1st year—
1st six months—at the rate of 30s. 0d. per week.

2nd six months—at the rate of 34s. 9d. per week.

2nd year—

1st six months—at the rate of 41s. 0d. per week.

2nd six months—at the rate of 50s. 9d. per week.

3rd year—

1st six months—at the rate of 61s. 6d. per week.

2nd six months—at the rate of 81s. 0d. per week.

4th year—

1st six months—at the rate of 101s. 9d. per week.

2nd six months—at the rate of 114s. 9d. per week.

5th year—

1st six months—at the rate of 128s. 6d. per week.

2nd six months—at the rate of 131s. 9d. per week.

6th year—at the rate of 159s. 0d. per week.

(b) With respect to the term of apprenticeship of five years—

1st year—

1st six months—at the rate of 30s. 0d. per week.

2nd six months—at the rate of 34s. 9d. per week.

2nd year—

1st six months—at the rate of 41s. 0d. per week.

2nd six months—at the rate of 50s. 9d. per week.

3rd year—

1st six months—at the rate of 61s. 6d. per week.

2nd six months—at the rate of 81s. 0d. per week.

4th year—

1st six months—at the rate of 101s. 9d. per week.

2nd six months—at the rate of 114s. 9d. per week.

5th year—

1st six months—at the rate of 128s. 6d. per week.

2nd six months—at the rate of 131s. 9d. per week.

(c) With respect to the term of apprenticeship of four years—

- 1st year—
1st six months—at the rate of 34s. 6d. per week.
2nd six months—at the rate of 47s. 0d. per week.
- 2nd year—
1st six months—at the rate of 61s. 6d. per week.
2nd six months—at the rate of 81s. 0d. per week.
- 3rd year—
1st six months—at the rate of 101s. 9d. per week.
2nd six months—at the rate of 114s. 9d. per week.
- 4th year—
1st six months—at the rate of 128s. 6d. per week.
2nd six months—at the rate of 131s. 9d. per week.

(d) With respect to the term of apprenticeship of three years—

- 1st year—
1st six months—at the rate of 61s. 6d. per week.
2nd six months—at the rate of 81s. 0d. per week.
- 2nd year—
1st six months—at the rate of 101s. 9d. per week.
2nd six months—at the rate of 114s. 9d. per week.
- 3rd year—
1st six months—at the rate of 128s. 6d. per week.
2nd six months—at the rate of 131s. 9d. per week.

AMENDMENT OF BRICKLAYING TRADE REGULATIONS (No. 1).

IN pursuance of the powers conferred by the Apprenticeship Acts and the Acts Interpretation Acts, His Excellency the Governor of the State of Victoria, by and with the advice of the Executive Council thereof, doth hereby rescind Regulation 10 of the Bricklaying Trade Regulations (No. 1) as from the beginning of the first full pay period to commence in May, 1950, and doth hereby substitute therefor the following, that is to say:—

1. The rescission of any Regulations by these Regulations shall not affect any right accrued or accruing to any person or the liability of any person under such rescinded Regulations, where such right accrued or such liability was incurred prior to the coming into operation of these Regulations.

2. The minimum rates of pay to be paid as wages to apprentices in the said trade in each year of their apprenticeship course shall be as follows, as from the beginning of the first full pay period to commence in May, 1950, on, from, and after which date all indentures of apprenticeship heretofore executed under the provisions of the Acts and of the Regulations made in respect of the aforesaid trade shall be deemed to be amended accordingly:—

- 1st year—at the rate of 39s. 6d. per week.
2nd year—at the rate of 53s. 0d. per week.
3rd year—at the rate of 72s. 6d. per week.
4th year—at the rate of 103s. 0d. per week.
5th year—at the rate of 134s. 0d. per week.

AMENDMENT OF BUTCHERING AND/OR SMALL GOODS MAKING TRADES REGULATIONS (No. 1).

IN pursuance of the powers conferred by the Apprenticeship Acts and the Acts Interpretation Acts, His Excellency the Governor of the State of Victoria, by and with the advice of the Executive Council thereof, doth hereby rescind Regulation 10 of the Butchering and/or Small Goods Making Trades Regulations (No. 1) as from the beginning of the first full pay period to commence in May, 1950, and doth hereby substitute therefor the following, that is to say:—

1. The rescission of any Regulations by these Regulations shall not affect any right accrued or accruing to any person or the liability of any person under such rescinded Regulations, where such right accrued or such liability was incurred prior to the coming into operation of these Regulations.

2. The minimum rates of pay to be paid as wages to apprentices in the said trade in each year of their apprenticeship course shall be as follows, as from the beginning of the first full pay period to commence in May, 1950, on, from, and after which date all indentures of apprenticeship heretofore executed under the provisions of the Acts and of the Regulations made in respect of the aforesaid trade shall be deemed to be amended accordingly:—

(a) With respect to the term of apprenticeship of five years—

- 1st year—at the rate of 45s. 0d. per week.
2nd year—at the rate of 59s. 6d. per week.
3rd year—at the rate of 88s. 6d. per week.
4th year—at the rate of 113s. 6d. per week.
5th year—at the rate of 148s. 6d. per week.

(b) With respect to the term of apprenticeship of four years—

- 1st year—at the rate of 52s. 6d. per week.
2nd year—at the rate of 74s. 6d. per week.
3rd year—at the rate of 113s. 6d. per week.
4th year—at the rate of 148s. 6d. per week.

AMENDMENT OF CARPENTRY AND JOINERY REGULATIONS (No. 1).

IN pursuance of the powers conferred by the Apprenticeship Acts and the Acts Interpretation Acts, His Excellency the Governor of the State of Victoria, by and with the advice of the Executive Council thereof, doth hereby rescind Regulation 9 of the Carpentry and Joinery Regulations (No. 1) as from the beginning of the first full pay period to commence in May, 1950, and doth hereby substitute therefor the following, that is to say:—

1. The rescission of any Regulations by these Regulations shall not affect any right accrued or accruing to any person or the liability of any person under such rescinded Regulations, where such right accrued or such liability was incurred prior to the coming into operation of these Regulations.

2. The minimum rates of pay to be paid as wages to apprentices in the said trades in each year of their apprenticeship course shall be as follows, as from the beginning of the first full pay period to commence in May, 1950, on, from, and after which date all indentures of apprenticeship heretofore executed under the provisions of the Acts and of the Regulations made in respect of the aforesaid trades shall be deemed to be amended accordingly:—

- 1st year—at the rate of 42s. 2d. per week.
2nd year—at the rate of 58s. 4d. per week.
3rd year—at the rate of 80s. 6d. per week.
4th year—at the rate of 113s. 8d. per week.
5th year—at the rate of 147s. 4d. per week.

AMENDMENT OF DENTAL MECHANIC TRADE REGULATIONS (No. 1).

IN pursuance of the powers conferred by the Apprenticeship Acts and the Acts Interpretation Acts, His Excellency the Governor of the State of Victoria, by and with the advice of the Executive Council thereof, doth hereby rescind Regulation 9 of the Dental Mechanic Trade Regulations (No. 1) as from the beginning of the first full pay period to commence in May, 1950, and doth hereby substitute therefor the following, that is to say:—

1. The rescission of any Regulations by these Regulations shall not affect any right accrued or accruing to any person or the liability of any person under such rescinded Regulations, where such right accrued or such liability was incurred prior to the coming into operation of these Regulations.

2. The minimum rates of pay to be paid as wages to apprentices in the said trade in each year of their apprenticeship course shall be as follows, as from the beginning of the first full pay period to commence in May, 1950, on, from, and after which date all indentures of apprenticeship heretofore executed under the provisions of the Acts and of the Regulations made in respect of the aforesaid trade shall be deemed to be amended accordingly:—

- 1st year—at the rate of 41s. 6d. per week.
2nd year—at the rate of 56s. 6d. per week.
3rd year—at the rate of 74s. 6d. per week.
4th year—at the rate of 116s. 6d. per week.
5th year—at the rate of 145s. 6d. per week.

AMENDMENT OF ELECTRICAL TRADES
REGULATIONS (No. 1).

IN pursuance of the powers conferred by the Apprenticeship Acts and the Acts Interpretation Acts, His Excellency the Governor of the State of Victoria, by and with the advice of the Executive Council thereof, doth hereby rescind Regulation 9 of the Electrical Trades Regulations (No. 1) as from the beginning of the first full pay period to commence in May, 1950, and doth hereby substitute therefor the following, that is to say:—

1. The rescission of any Regulations by these Regulations shall not affect any right accrued or accruing to any person or the liability of any person under such rescinded Regulations, where such right accrued or such liability was incurred prior to the coming into operation of these Regulations.

2. The minimum rates of pay to be paid as wages to apprentices in the said trades in each year of their apprenticeship course shall be as follows as from the beginning of the first full pay period to commence in May, 1950, on, from, and after which date all indentures of apprenticeship heretofore executed under the provisions of the Acts and of the Regulations made in respect of the aforesaid trades shall be deemed to be amended accordingly:—

Within 20 miles of G.P.O., Melbourne, within 10 miles of G.P.O., Geelong, at Warrnambool, and within Mildura and Gippsland districts—

- 1st year—at the rate of 38s. 6d. per week.
- 2nd year—at the rate of 54s. 6d. per week.
- 3rd year—at the rate of 72s. 6d. per week.
- 4th year—at the rate of 114s. 6d. per week.
- 5th year—at the rate of 143s. 0d. per week.

At Yallourn—

- 1st year—at the rate of 40s. 6d. per week.
- 2nd year—at the rate of 57s. 0d. per week.
- 3rd year—at the rate of 76s. 0d. per week.
- 4th year—at the rate of 119s. 6d. per week.
- 5th year—at the rate of 149s. 6d. per week.

Other parts of Victoria where this Regulation applies—

- 1st year—at the rate of 38s. 0d. per week.
- 2nd year—at the rate of 53s. 0d. per week.
- 3rd year—at the rate of 71s. 0d. per week.
- 4th year—at the rate of 112s. 0d. per week.
- 5th year—at the rate of 140s. 0d. per week.

AMENDMENT OF ELECTROPLATING TRADE
REGULATIONS (No. 1).

IN pursuance of the powers conferred by the Apprenticeship Acts and the Acts Interpretation Acts, His Excellency the Governor of the State of Victoria, by and with the advice of the Executive Council thereof, doth hereby rescind Regulation 9 of the Electroplating Trade Regulations (No. 1) as from the beginning of the first full pay period to commence in May, 1950, and doth hereby substitute therefor the following, that is to say:—

1. The rescission of any Regulations by these Regulations shall not affect any right accrued or accruing to any person or the liability of any person under such rescinded Regulations, where such right accrued or such liability was incurred prior to the coming into operation of these Regulations.

2. The minimum rates of pay to be paid as wages to apprentices in the said trade in each year of their apprenticeship course shall be as follows as from the beginning of the first full pay period to commence in May, 1950, on, from, and after which date all indentures of apprenticeship heretofore executed under the provisions of the Acts and of the Regulations made in respect of the aforesaid trade shall be deemed to be amended accordingly:—

(a) With respect to the term of apprenticeship of five years—

- 1st year—at the rate of 38s. 6d. per week.
- 2nd year—at the rate of 54s. 6d. per week.
- 3rd year—at the rate of 72s. 6d. per week.
- 4th year—at the rate of 114s. 6d. per week.
- 5th year—at the rate of 143s. 0d. per week.

(b) With respect to the term of apprenticeship of four years—

- 1st year—at the rate of 44s. 0d. per week.
- 2nd year—at the rate of 72s. 0d. per week.
- 3rd year—at the rate of 114s. 6d. per week.
- 4th year—at the rate of 143s. 0d. per week.

AMENDMENT OF ENGINEERING TRADES
REGULATIONS (No. 2).

IN pursuance of the powers conferred by the Apprenticeship Acts and the Acts Interpretation Acts, His Excellency the Governor of the State of Victoria, by and with the advice of the Executive Council thereof, doth hereby rescind Regulation 7 of the Engineering Trades Regulations (No. 2) as from the beginning of the first full pay period to commence in May, 1950, and doth hereby substitute therefor the following, that is to say:—

1. The rescission of any Regulations by these Regulations shall not affect any right accrued or accruing to any person or the liability of any person under such rescinded Regulations, where such right accrued or such liability was incurred prior to the coming into operation of these Regulations.

2. The minimum rates of pay to be paid as wages to apprentices in the said trades in each year of their apprenticeship course shall be as follows as from the beginning of the first full pay period to commence in May, 1950, on, from, and after which date all indentures of apprenticeship heretofore executed under the provisions of the Acts and of the Regulations made in respect of the aforesaid trades shall be deemed to be amended accordingly:—

(a) With respect to the term of apprenticeship of five years—

- 1st year—at the rate of 38s. 6d. per week.
- 2nd year—at the rate of 54s. 6d. per week.
- 3rd year—at the rate of 72s. 6d. per week.
- 4th year—at the rate of 114s. 6d. per week.
- 5th year—at the rate of 143s. 0d. per week.

(b) With respect to the term of apprenticeship of four years—

- 1st year—at the rate of 44s. 0d. per week.
- 2nd year—at the rate of 72s. 0d. per week.
- 3rd year—at the rate of 114s. 6d. per week.
- 4th year—at the rate of 143s. 0d. per week.

The sum of 4s. 0d. per week shall be added to the above rates where the apprentice is in the trade of Pattern-making.

AMENDMENT OF ENGINEERING TRADES
REGULATIONS (No. 4).

IN pursuance of the powers conferred by the Apprenticeship Acts and the Acts Interpretation Acts, His Excellency the Governor of the State of Victoria, by and with the advice of the Executive Council thereof, doth hereby rescind Regulation 10 of the Engineering Trades Regulations (No. 4) as from the beginning of the first full pay period to commence in May, 1950, and doth hereby substitute therefor the following, that is to say:—

1. The rescission of any Regulations by these Regulations shall not affect any right accrued or accruing to any person or the liability of any person under such rescinded Regulations, where such right accrued or such liability was incurred prior to the coming into operation of these Regulations.

2. The minimum rates of pay to be paid as wages to apprentices in the said trades in each year of their apprenticeship course shall be as follows as from the beginning of the first full pay period to commence in May, 1950, on, from, and after which date all indentures of apprenticeship heretofore executed under the provisions of the Acts and of the Regulations made in respect of the aforesaid trades shall be deemed to be amended accordingly:—

Within 10 miles of G.P.O., Geelong, at Warrnambool, and within Mildura and Gippsland districts—

(a) With respect to the term of apprenticeship of five years—

- 1st year—at the rate of 38s. 6d. per week.
- 2nd year—at the rate of 54s. 6d. per week.
- 3rd year—at the rate of 72s. 6d. per week.
- 4th year—at the rate of 114s. 6d. per week.
- 5th year—at the rate of 143s. 0d. per week.

(b) With respect to the term of apprenticeship of four years—

- 1st year—at the rate of 44s. 0d. per week.
- 2nd year—at the rate of 72s. 0d. per week.
- 3rd year—at the rate of 114s. 6d. per week.
- 4th year—at the rate of 143s. 0d. per week.

At Yallourn—

- (a) With respect to the term of apprenticeship of five years—
- 1st year—at the rate of 40s. 6d. per week.
 - 2nd year—at the rate of 57s. 0d. per week.
 - 3rd year—at the rate of 76s. 0d. per week.
 - 4th year—at the rate of 119s. 6d. per week.
 - 5th year—at the rate of 149s. 6d. per week.
- (b) With respect to the term of apprenticeship of four years—
- 1st year—at the rate of 46s. 0d. per week.
 - 2nd year—at the rate of 75s. 6d. per week.
 - 3rd year—at the rate of 119s. 6d. per week.
 - 4th year—at the rate of 149s. 6d. per week.

Other parts of Victoria where this Regulation applies—

- (a) With respect to the term of apprenticeship of five years—
- 1st year—at the rate of 38s. 0d. per week.
 - 2nd year—at the rate of 53s. 0d. per week.
 - 3rd year—at the rate of 71s. 0d. per week.
 - 4th year—at the rate of 112s. 0d. per week.
 - 5th year—at the rate of 140s. 0d. per week.
- (b) With respect to the term of apprenticeship of four years—
- 1st year—at the rate of 43s. 0d. per week.
 - 2nd year—at the rate of 70s. 6d. per week.
 - 3rd year—at the rate of 112s. 0d. per week.
 - 4th year—at the rate of 140s. 0d. per week.

The sum of 4s. 0d. per week shall be added to the above rates where the apprentice is in the trade of Pattern-making.

AMENDMENT OF LADIES' AND/OR MEN'S
HAIRDRESSING TRADES REGULATIONS (No. 1).

IN pursuance of the powers conferred by the Apprenticeship Acts and the Acts Interpretation Acts, His Excellency the Governor of the State of Victoria, by and with the advice of the Executive Council thereof, doth hereby rescind Regulation 10 of the Ladies' and/or Men's Hairdressing Trades Regulations (No. 1) as from the beginning of the first full pay period to commence in May, 1950, and doth hereby substitute therefor the following, that is to say:—

1. The rescission of any Regulations by these Regulations shall not affect any right accrued or accruing to any person or the liability of any person under such rescinded Regulations, where such right accrued or such liability was incurred prior to the coming into operation of these Regulations.

2. The minimum rates of pay to be paid as wages to apprentices in the said trades in each year of their apprenticeship course shall be as follows, as from the beginning of the first full pay period to commence in May, 1950, on, from, and after which date all indentures of apprenticeship heretofore executed under the provisions of the Acts and of the Regulations made in respect of the aforesaid trades shall be deemed to be amended accordingly:—

Ladies' Hairdressing.

- 1st year—at the rate of 29s. 3d. per week.
- 2nd year—at the rate of 40s. 3d. per week.
- 3rd year—at the rate of 60s. 9d. per week.
- 4th year—at the rate of 92s. 0d. per week.

Men's Hairdressing.

- 1st year—at the rate of 34s. 3d. per week.
- 2nd year—at the rate of 51s. 9d. per week.
- 3rd year—at the rate of 75s. 0d. per week.
- 4th year—at the rate of 117s. 9d. per week.

Ladies' and Men's Hairdressing.

- 1st year—at the rate of 34s. 3d. per week.
- 2nd year—at the rate of 51s. 9d. per week.
- 3rd year—at the rate of 75s. 0d. per week.
- 4th year—at the rate of 117s. 9d. per week.
- 5th year—at the rate of 147s. 0d. per week.

AMENDMENT OF MOTOR MECHANICS TRADES
REGULATIONS.

IN pursuance of the powers conferred by the Apprenticeship Acts and the Acts Interpretation Acts, His Excellency the Governor of the State of Victoria, by and with the advice of the Executive Council thereof, doth hereby rescind Regulation 9 of the Motor Mechanics Trades

Regulations as from the beginning of the first full pay period to commence in May, 1950, and doth hereby substitute therefor the following, that is to say:—

1. The rescission of any Regulations by these Regulations shall not affect any right accrued or accruing to any person or the liability of any person under such rescinded Regulations, where such right accrued or such liability was incurred prior to the coming into operation of these Regulations.

2. The minimum rates of pay to be paid as wages to apprentices in the said trades in each year of their apprenticeship course shall be as follows, as from the beginning of the first full pay period to commence in May, 1950, on, from, and after which date all indentures of apprenticeship heretofore executed under the provisions of the Acts and of the Regulations made in respect of the aforesaid trades shall be deemed to be amended accordingly:—

Within 20 miles of G.P.O., Melbourne, within 10 miles of G.P.O., Geelong, at Warrambool, and within Mildura and Gippsland districts.

- (a) With respect to the term of apprenticeship of five years—
- 1st year—at the rate of 38s. 6d. per week.
 - 2nd year—at the rate of 54s. 6d. per week.
 - 3rd year—at the rate of 72s. 6d. per week.
 - 4th year—at the rate of 114s. 6d. per week.
 - 5th year—at the rate of 143s. 0d. per week.
- (b) With respect to the term of apprenticeship of four years—
- 1st year—at the rate of 44s. 0d. per week.
 - 2nd year—at the rate of 72s. 0d. per week.
 - 3rd year—at the rate of 114s. 6d. per week.
 - 4th year—at the rate of 143s. 0d. per week.

At Yallourn.

- (a) With respect to the term of apprenticeship of five years—
- 1st year—at the rate of 40s. 6d. per week.
 - 2nd year—at the rate of 57s. 0d. per week.
 - 3rd year—at the rate of 76s. 0d. per week.
 - 4th year—at the rate of 119s. 6d. per week.
 - 5th year—at the rate of 149s. 6d. per week.
- (b) With respect to the term of apprenticeship of four years—
- 1st year—at the rate of 46s. 0d. per week.
 - 2nd year—at the rate of 75s. 6d. per week.
 - 3rd year—at the rate of 119s. 6d. per week.
 - 4th year—at the rate of 149s. 6d. per week.

Other Parts of Victoria.

- (a) With respect to the term of apprenticeship of five years—
- 1st year—at the rate of 38s. 0d. per week.
 - 2nd year—at the rate of 53s. 0d. per week.
 - 3rd year—at the rate of 71s. 0d. per week.
 - 4th year—at the rate of 112s. 0d. per week.
 - 5th year—at the rate of 140s. 0d. per week.
- (b) With respect to the term of apprenticeship of four years—
- 1st year—at the rate of 43s. 0d. per week.
 - 2nd year—at the rate of 70s. 6d. per week.
 - 3rd year—at the rate of 112s. 0d. per week.
 - 4th year—at the rate of 140s. 0d. per week.

AMENDMENT OF MOULDING TRADES REGULATIONS
(No. 2).

IN pursuance of the powers conferred by the Apprenticeship Acts and the Acts Interpretation Acts, His Excellency the Governor of the State of Victoria, by and with the advice of the Executive Council thereof, doth hereby rescind Regulation 8 of the Moulding Trades Regulations (No. 2) as from the beginning of the first full pay period to commence in May, 1950, and doth hereby substitute therefor the following, that is to say:—

1. The rescission of any Regulations by these Regulations shall not affect any right accrued or accruing to any person or the liability of any person under such rescinded Regulations, where such right accrued or such liability was incurred prior to the coming into operation of these Regulations.

2. The minimum rates of pay to be paid as wages to apprentices in the said trades in each year of their apprenticeship course shall be as follows, as from the beginning of the first full pay period to commence in May, 1950, on, from, and after which date all indentures of apprenticeship heretofore executed under the provisions of

the Acts and of the Regulations made in respect of the aforesaid trades shall be deemed to be amended accordingly:—

- (a) With respect to the term of apprenticeship of five years—
- 1st year—at the rate of 38s. 6d. per week.
 - 2nd year—at the rate of 54s. 6d. per week.
 - 3rd year—at the rate of 72s. 6d. per week.
 - 4th year—at the rate of 114s. 6d. per week.
 - 5th year—at the rate of 143s. 0d. per week.
- (b) With respect to the term of apprenticeship of four years—
- 1st year—at the rate of 44s. 0d. per week.
 - 2nd year—at the rate of 72s. 0d. per week.
 - 3rd year—at the rate of 114s. 6d. per week.
 - 4th year—at the rate of 143s. 0d. per week.

AMENDMENT OF PAINTING, DECORATING, AND SIGNWRITING REGULATIONS (No. 2).

IN pursuance of the powers conferred by the Apprenticeship Acts and the Acts Interpretation Acts, His Excellency the Governor of the State of Victoria, by and with the advice of the Executive Council thereof, doth hereby rescind Regulation 8 of the Painting, Decorating, and Signwriting Regulations (No. 2) as from the beginning of the first full pay period to commence in May, 1950, and doth hereby substitute therefor the following, that is to say:—

1. The rescission of any Regulations by these Regulations shall not affect any right accrued or accruing to any person or the liability of any person under such rescinded Regulations, where such right accrued or such liability was incurred prior to the coming into operation of these Regulations.

2. The minimum rates of pay to be paid as wages to apprentices in the said trades in each year of their apprenticeship course shall be as follows, as from the beginning of the first full pay period to commence in May, 1950, on, from, and after which date all indentures of apprenticeship heretofore executed under the provisions of the Acts and of the Regulations made in respect of the aforesaid trades shall be deemed to be amended accordingly:—

- 1st year—at the rate of 42s. 2d. per week.
- 2nd year—at the rate of 58s. 4d. per week.
- 3rd year—at the rate of 80s. 6d. per week.
- 4th year—at the rate of 113s. 8d. per week.
- 5th year—at the rate of 147s. 4d. per week.

AMENDMENT OF PASTRYCOOKING TRADE REGULATIONS (No. 1).

IN pursuance of the powers conferred by the Apprenticeship Acts and the Acts Interpretation Acts, His Excellency the Governor of the State of Victoria, by and with the advice of the Executive Council thereof, doth hereby rescind Regulation 10 of the Pastrycooking Trade Regulations (No. 1) as from the beginning of the first full pay period to commence in May, 1950, and doth hereby substitute therefor the following, that is to say:—

1. The rescission of any Regulations by these Regulations shall not affect any right accrued or accruing to any person or the liability of any person under such rescinded Regulations, where such right accrued or such liability was incurred prior to the coming into operation of these Regulations.

2. The minimum rates of pay to be paid as wages to apprentices in the said trade in each year of their apprenticeship course shall be as follows, as from the beginning of the first full pay period to commence in May, 1950, on, from, and after which date all indentures of apprenticeship heretofore executed under the provisions of the Acts and of the Regulations made in respect of the aforesaid trade shall be deemed to be amended accordingly:—

- (a) With respect to the term of apprenticeship of five years—
- 1st year—at the rate of 34s. 3d. per week.
 - 2nd year—at the rate of 47s. 3d. per week.
 - 3rd year—at the rate of 63s. 0d. per week.
 - 4th year—at the rate of 89s. 6d. per week.
 - 5th year—at the rate of 121s. 3d. per week.
- (b) With respect to the term of apprenticeship of four years—
- 1st year—at the rate of 47s. 3d. per week.
 - 2nd year—at the rate of 63s. 0d. per week.
 - 3rd year—at the rate of 89s. 6d. per week.
 - 4th year—at the rate of 121s. 3d. per week.

AMENDMENT OF PLASTERING REGULATIONS (No. 2).

IN pursuance of the powers conferred by the Apprenticeship Acts and the Acts Interpretation Acts, His Excellency the Governor of the State of Victoria, by and with the advice of the Executive Council thereof, doth hereby rescind Regulation 8 of the Plastering Regulations (No. 2) as from the beginning of the first full pay period to commence in May, 1950, and doth hereby substitute therefor the following, that is to say:—

1. The rescission of any Regulations by these Regulations shall not affect any right accrued or accruing to any person or the liability of any person under such rescinded Regulations, where such right accrued or such liability was incurred prior to the coming into operation of these Regulations.

2. The minimum rates of pay to be paid as wages to apprentices in the said trade in each year of their apprenticeship course shall be as follows, as from the beginning of the first full pay period to commence in May, 1950, on, from, and after which date all indentures of apprenticeship heretofore executed under the provisions of the Acts and of the Regulations made in respect of the aforesaid trade shall be deemed to be amended accordingly:—

- (a) With respect to the term of apprenticeship of six years—
- 1st year—at the rate of 42s. 2d. per week.
 - 2nd year—at the rate of 58s. 4d. per week.
 - 3rd year—at the rate of 80s. 6d. per week.
 - 4th year—at the rate of 113s. 8d. per week.
 - 5th year—at the rate of 147s. 4d. per week.
 - 6th year—at the rate of 180s. 0d. per week.
- (b) With respect to the term of apprenticeship of five years—
- 1st year—at the rate of 42s. 2d. per week.
 - 2nd year—at the rate of 58s. 4d. per week.
 - 3rd year—at the rate of 80s. 6d. per week.
 - 4th year—at the rate of 113s. 8d. per week.
 - 5th year—at the rate of 147s. 4d. per week.

AMENDMENT OF PLUMBING AND GASFITTING TRADES REGULATIONS.

IN pursuance of the powers conferred by the Apprenticeship Acts and the Acts Interpretation Acts, His Excellency the Governor of the State of Victoria, by and with the advice of the Executive Council thereof, doth hereby rescind Regulation 9 of the Plumbing and Gasfitting Trades Regulations as from the beginning of the first full pay period to commence in May, 1950, and doth hereby substitute therefor the following, that is to say:—

1. The rescission of any Regulations by these Regulations shall not affect any right accrued or accruing to any person or the liability of any person under such rescinded Regulations, where such right accrued or such liability was incurred prior to the coming into operation of these Regulations.

2. The minimum rates of pay to be paid as wages to apprentices in the said trades in each year of their apprenticeship course shall be as follows, as from the beginning of the first full pay period to commence in May, 1950, on, from, and after which date all indentures of apprenticeship heretofore executed under the provisions of the Acts and of the Regulations made in respect of the aforesaid trades shall be deemed to be amended accordingly:—

- (a) With respect to the term of apprenticeship of six years—
- 1st year—at the rate of 42s. 2d. per week.
 - 2nd year—at the rate of 58s. 4d. per week.
 - 3rd year—at the rate of 80s. 6d. per week.
 - 4th year—at the rate of 113s. 8d. per week.
 - 5th year—at the rate of 147s. 4d. per week.
 - 6th year—at the rate of 180s. 0d. per week.
- (b) With respect to the term of apprenticeship of five years—
- 1st year—at the rate of 42s. 2d. per week.
 - 2nd year—at the rate of 58s. 4d. per week.
 - 3rd year—at the rate of 80s. 6d. per week.
 - 4th year—at the rate of 113s. 8d. per week.
 - 5th year—at the rate of 147s. 4d. per week.

AMENDMENT OF PRINTING AND ALLIED TRADES REGULATIONS.

IN pursuance of the powers conferred by the Apprenticeship Acts and the Acts Interpretation Acts, His Excellency the Governor of the State of Victoria, by and with the advice of the Executive Council thereof, doth hereby rescind Regulation 9 of the Printing and Allied Trades Regulations as from the beginning of the first full pay period to commence in May, 1950, and doth hereby substitute therefor the following, that is to say:—

1. The rescission of any Regulations by these Regulations shall not affect any right accrued or accruing to any person or the liability of any person under such rescinded Regulations, where such right accrued or such liability was incurred prior to the coming into operation of these Regulations.

2. The minimum rates of pay to be paid as wages to apprentices in the said trades in each year of their apprenticeship course shall be as follows, as from the beginning of the first full pay period to commence in May, 1950, on, from, and after which date all indentures of apprenticeship heretofore executed under the provisions of the Acts and of the Regulations made in respect of the aforesaid trades shall be deemed to be amended accordingly:—

(a) With respect to the term of apprenticeship of six years—

- 1st year—at the rate of 34s. 3d. per week.
- 2nd year—at the rate of 45s. 6d. per week.
- 3rd year—at the rate of 59s. 3d. per week.
- 4th year—at the rate of 80s. 0d. per week.
- 5th year—at the rate of 100s. 6d. per week.
- 6th year—at the rate of 139s. 0d. per week.

(b) With respect to the term of apprenticeship of five years—

- 1st year—at the rate of 45s. 6d. per week.
- 2nd year—at the rate of 59s. 3d. per week.
- 3rd year—at the rate of 80s. 0d. per week.
- 4th year—at the rate of 100s. 6d. per week.
- 5th year—at the rate of 139s. 0d. per week.

AMENDMENT OF PRINTING TRADES REGULATIONS (No. 1).

IN pursuance of the powers conferred by the Apprenticeship Acts and the Acts Interpretation Acts, His Excellency the Governor of the State of Victoria, by and with the advice of the Executive Council thereof, doth hereby rescind Regulation 11 of the Printing Trades Regulations (No. 1) as from the beginning of the first full pay period to commence in May, 1950, and doth hereby substitute therefor the following, that is to say:—

1. The rescission of any Regulations by these Regulations shall not affect any right accrued or accruing to any person or the liability of any person under such rescinded Regulations, where such right accrued or such liability was incurred prior to the coming into operation of these Regulations.

2. The minimum rates of pay to be paid as wages to apprentices in the said trades in each year of their apprenticeship course shall be as follows, as from the beginning of the first full pay period to commence in May, 1950, on, from, and after which date all indentures of apprenticeship heretofore executed under the provisions of the Acts and of the Regulations made in respect of the aforesaid trades shall be deemed to be amended accordingly:—

(a) With respect to the term of apprenticeship of six years—

- 1st year—at the rate of 34s. 3d. per week.
- 2nd year—at the rate of 45s. 6d. per week.
- 3rd year—at the rate of 59s. 3d. per week.
- 4th year—at the rate of 80s. 0d. per week.
- 5th year—at the rate of 100s. 6d. per week.
- 6th year—at the rate of 139s. 0d. per week.

(b) With respect to the term of apprenticeship of five years—

- 1st year—at the rate of 45s. 6d. per week.
- 2nd year—at the rate of 59s. 3d. per week.
- 3rd year—at the rate of 80s. 0d. per week.
- 4th year—at the rate of 100s. 6d. per week.
- 5th year—at the rate of 139s. 0d. per week.

AMENDMENT OF SHEET METAL TRADE REGULATIONS (No. 2).

IN pursuance of the powers conferred by the Apprenticeship Acts and the Acts Interpretation Acts, His Excellency the Governor of the State of Victoria, by and with the advice of the Executive Council thereof, doth hereby rescind Regulation 7 of the Sheet Metal Trade Regulations (No. 2) as from the beginning of the first full pay period to commence in May, 1950, and doth hereby substitute therefor the following, that is to say:—

1. The rescission of any Regulations by these Regulations shall not affect any right accrued or accruing to any person or the liability of any person under such rescinded Regulations, where such right accrued or such liability was incurred prior to the coming into operation of these Regulations.

2. The minimum rates of pay to be paid as wages to apprentices in the said trade in each year of their apprenticeship course shall be as follows, as from the beginning of the first full pay period to commence in May, 1950, on, from, and after which date all indentures of apprenticeship heretofore executed under the provisions of the Acts and of the Regulations made in respect of the aforesaid trade shall be deemed to be amended accordingly:—

(a) With respect to the term of apprenticeship of five years—

- 1st year—at the rate of 38s. 6d. per week.
- 2nd year—at the rate of 54s. 6d. per week.
- 3rd year—at the rate of 72s. 6d. per week.
- 4th year—at the rate of 114s. 6d. per week.
- 5th year—at the rate of 143s. 0d. per week.

(b) With respect to the term of apprenticeship of four years—

- 1st year—at the rate of 44s. 0d. per week.
- 2nd year—at the rate of 72s. 0d. per week.
- 3rd year—at the rate of 114s. 6d. per week.
- 4th year—at the rate of 143s. 0d. per week.

AMENDMENT OF WATCH AND/OR CLOCK MAKING TRADES REGULATIONS (No. 1).

IN pursuance of the powers conferred by the Apprenticeship Acts and the Acts Interpretation Acts, His Excellency the Governor of the State of Victoria, by and with the advice of the Executive Council thereof, doth hereby rescind Regulation 9 of the Watch and/or Clock Making Trades Regulations (No. 1) as from the beginning of the first full pay period to commence in May, 1950, and doth hereby substitute therefor the following, that is to say:—

1. The rescission of any Regulations by these Regulations shall not affect any right accrued or accruing to any person or the liability of any person under such rescinded Regulations, where such right accrued or such liability was incurred prior to the coming into operation of these Regulations.

2. The minimum rates of pay to be paid as wages to apprentices in the said trades in each year of their apprenticeship course shall be as follows, as from the beginning of the first full pay period to commence in May, 1950, on, from, and after which date all indentures of apprenticeship heretofore executed under the provisions of the Acts and of the Regulations made in respect of the aforesaid trades shall be deemed to be amended accordingly:—

- 1st year—at the rate of 36s. 0d. per week.
- 2nd year—at the rate of 46s. 6d. per week.
- 3rd year—at the rate of 65s. 0d. per week.
- 4th year—at the rate of 88s. 6d. per week.
- 5th year—at the rate of 117s. 6d. per week.
- 6th year—at the rate of 150s. 0d. per week.

And the Honorable Raymond Walter Tovell, for and on behalf of His Majesty's Minister of Labour for the State of Victoria, shall give the necessary directions herein accordingly.

A. G. COULTHARD,
Acting Clerk of the Executive Council.

Apprenticeship Acts.
APPRENTICESHIP COMMISSION OF VICTORIA.

At the Executive Council Chamber, Melbourne, the
 sixteenth day of May, 1950.

PRESENT:

His Excellency the Governor of Victoria.
 Sir James Kennedy | Brigadier Tovell.

**AMENDMENT OF BOILERMAKING AND/OR STEEL
 CONSTRUCTION TRADES REGULATIONS (No. 3).**

IN pursuance of the powers conferred by the Apprenticeship Acts and the Acts Interpretation Acts, His Excellency the Governor of the State of Victoria, by and with the advice of the Executive Council thereof, doth hereby rescind the Schedule to the Boilermaking and/or Steel Construction Trades Regulations (No. 3) made by the Governor in Council on the 11th day of July, 1938, and published in the *Victoria Government Gazette* on the 13th day of July, 1938, and doth hereby substitute therefor the following, that is to say:—

SCHEDULE.

Classes for Instruction in the Subjects of the Apprenticeship Course for the Trades of Boilermaking and/or Steel Construction.

		Hours Per Week.
First Year—		
Trade Theory	Grade I. ..	2
Trade Practice	Grade I. ..	2
Trade Drawing	Grade I. ..	2
Trade Mathematics ..	Grade I. ..	1
Trade Science	Grade I. ..	1
Second Year—		
Trade Theory and Calculations	Grade II. ..	2
Trade Practice	Grade II. ..	2
Trade Drawing	Grade II. ..	3
Trade Science	Grade II. ..	1
Third Year—		
Trade Theory and Calculations	Grade III. ..	2
Trade Drawing	Grade III. ..	2
Welding Oxy-acetylene (special course) or approved trade experience	Grade I. ..	2
(If welding taken, Trade Drawing Grade III. optional)		
Fourth Year—		
Trade Theory and Calculations	Grade IV. ..	2
Trade Drawing	Grade IV. ..	2
Welding Electric (special course) or approved trade experience	Grade II. ..	2
(If welding taken, Trade Drawing Grade IV. optional)		

The detailed syllabus of the above-mentioned subjects shall be as determined by the Commission from time to time.

And the Honorable Allan Elliott McDonald, His Majesty's Minister of Labour for the State of Victoria, shall give the necessary directions herein accordingly.

A. G. COULTHARD,
 Acting Clerk of the Executive Council.

**MELBOURNE AND METROPOLITAN BOARD OF
 WORKS ACT 1928.**

At the Executive Council Chamber, Melbourne, the
 sixteenth day of May, 1950.

PRESENT:

His Excellency the Governor of Victoria.
 Sir James Kennedy | Brigadier Tovell.

**ORDER VESTING CERTAIN LAND IN THE
 MELBOURNE AND METROPOLITAN BOARD
 OF WORKS.**

IN pursuance of the provisions of section 264 of the *Melbourne and Metropolitan Board of Works Act 1928*, His Excellency the Governor of Victoria, by and with the advice of the Executive Council thereof, doth by this Order determine that that area of land situated in the municipal district of the City of Melbourne, contain-

ing 27 perches, and indicated by hachure on plan hereunder, is vested in the Melbourne and Metropolitan Board of Works constituted under the said Act.

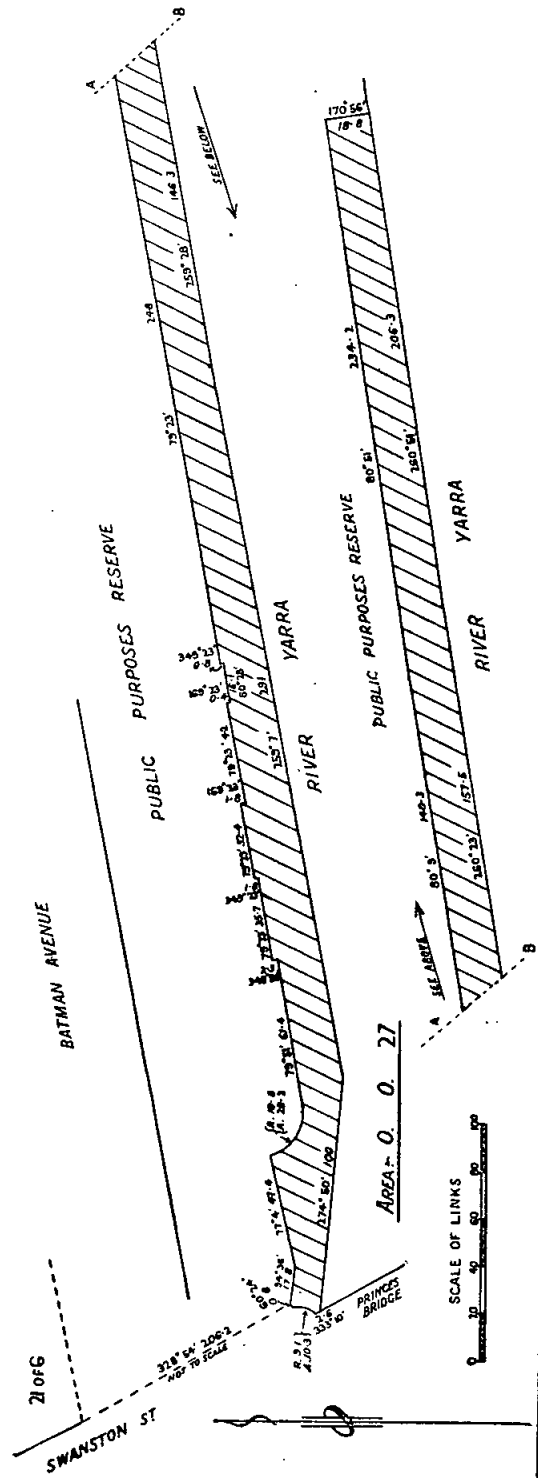

And the Honorable Sir James Kennedy, His Majesty's Commissioner of Public Works for the State of Victoria, shall give the necessary directions herein accordingly.

A. G. COULTHARD,
 Acting Clerk of the Executive Council.

COUNTRY ROADS BOARD.

At the Executive Council Chamber, Melbourne, the sixteenth day of May, 1950.

PRESENT:

His Excellency the Governor of Victoria.
Sir Jas. Kennedy | Brig. Tovell

ORDER APPROVING OF A MAIN ROAD IN THE SHIRE OF FERN TREE GULLY.

WHEREAS the Country Roads Board constituted under the *Country Roads Act 1928* (No. 3662) has represented to His Excellency the Governor in Council that it appears to be desirable that the new Belgrave-Emerald Road in the Shire of Fern Tree Gully should be made by the said Board: And whereas the said Board in accordance with the requirements of section 19 of the said cited Act has caused to be prepared a map plan and estimate showing the points between which and on and through what land the said new road is proposed to be made and the cost of acquiring the land and constructing the said new road: And whereas on an inspection of the said map and plan and a consideration of the said estimate His Excellency the Governor in Council is satisfied that there are funds legally available for acquiring the land and constructing the said new road: Now therefore be it known by this present Order that His Excellency the Governor of the State of Victoria with the advice of the Executive Council thereof doth hereby approve of the said road being made, that is to say:—

All those pieces of land in the Parish of Narre Warren, the boundaries of which are as follow:—

- (a) Commencing at the north-western angle of lot 1 on plan of subdivision numbered 6306, lodged in the Office of Titles and being part of allotment 70e of the said parish; thence by lines bearing respectively 109 deg. 6 min. 279 links, 89 deg. 51 min. 140.7 links, 247 deg. 57 min. 59 links, 255 deg. 22 min. 96.9 links, and 298 deg. 15 min. 290.5 links to the point of commencement.
- (b) Commencing at the north-eastern angle of lot 1b on plan of subdivision numbered 7023, lodged in the Office of Titles and being part of allotment 70E of the said parish; thence by lines bearing respectively 171 deg. 12 min. 135.5 links, 216 deg. 3 min. 60.9 links, 270 deg. 23 min. 78.8 links, 40 deg. 43 min. 90 links, and 17 deg. 6 min. 119.7 links to the point of commencement—

which said pieces of land are particularly delineated and shown coloured red on survey plan numbered 5172, lodged in the office of the Country Roads Board.

And the Honorable Sir James Arthur Kennedy, His Majesty's Commissioner of Public Works for the State of Victoria, shall give the necessary directions herein accordingly.

A. G. COULTHARD,
Acting Clerk of the Executive Council.

COUNTRY ROADS BOARD.

At the Executive Council Chamber, Melbourne, the sixteenth day of May, 1950.

PRESENT:

His Excellency the Governor of Victoria.
Sir Jas. Kennedy | Brig. Tovell

ORDER APPROVING OF A DEVIATION FROM A STATE HIGHWAY IN THE SHIRE OF DONALD.

WHEREAS the Country Roads Board constituted under the *Country Roads Act 1928* (No. 3662) has represented to His Excellency the Governor in Council that it appears to be desirable that the deviation hereinafter referred to from the existing Borung Highway in the Shire of Donald (declared to be a State Highway under the said Act which declaration was confirmed by the Order in Council published in the *Government Gazette* of the 21st January, 1948, on pages 362-3) should be made by the said Board: And whereas the said Board in accordance with the requirements of section 19 of the said cited Act has caused to be prepared a map plan and estimate showing the points between which and on and through what land the said deviation is proposed to be made and the cost of acquiring the land and constructing the said deviation: And whereas on an inspection of the said map

and plan and a consideration of the said estimate His Excellency the Governor in Council is satisfied that there are funds legally available for acquiring the land and constructing the said deviation: Now therefore be it known by this present Order that His Excellency the Governor of the State of Victoria with the advice of the Executive Council thereof doth hereby approve of the said road being made, that is to say:—

All that piece of land in the Parish of Banyenong, the boundaries of which are as follow:—Commencing at the north-western angle of allotment 2, section 4, of the said parish; thence by lines bearing respectively 90 deg. 0 min. 1,095.2 links, 251 deg. 25 min. 577 links, 237 deg. 18 min. 752 links, 224 deg. 11 min. 526 links, and 25 deg. 0 min. 1,067.4 links to the point of commencement—which said piece of land is particularly delineated and shown coloured red on survey plan numbered 5178, lodged in the office of the Country Roads Board.

And the Honorable Sir James Arthur Kennedy, His Majesty's Commissioner of Public Works for the State of Victoria, shall give the necessary directions herein accordingly.

A. G. COULTHARD,
Acting Clerk of the Executive Council.

ADULT EDUCATION ACT 1946.

At the Executive Council Chamber, Melbourne, the sixteenth day of May, 1950.

PRESENT:

His Excellency the Governor of Victoria.
Sir James Kennedy | Brigadier Tovell.

APPOINTMENT OF MEMBERS OF THE COUNCIL OF ADULT EDUCATION.

IN pursuance of the powers conferred by the *Adult Education Act 1946*, and all other powers thereto him enabling, His Excellency the Governor of the State of Victoria, in the Commonwealth of Australia, by and with the advice of the Executive Council of the said State, doth by this Order appoint the following persons to be members of the Council of Adult Education for the term commencing on the 1st day of May, 1950, and ending on the 30th day of April, 1953.

- (a) MARY LANE, a legally qualified medical practitioner, nominated by the Minister of Health.
- (b) RONALD ARTHUR GORDON, nominated by the governing body of the Trades Hall Council of Melbourne.
- (c) WILLIAM GORDON STANLEY, nominated by the governing body of the Victorian Chamber of Manufactures.
- (d) SAMUEL MACMAHON WADHAM, nominated by the Chamber of Agriculture of Victoria.
- (e) FRANCIS CREAN, nominated by the Free Library Service Board.
- (f) RONALD REAY MACKAY, nominated by the Victorian State Advisory Committee of the National Film Board.
- (g) DARYL LINDSAY, nominated by the Trustees of the National Gallery of Victoria.
- (h) RICHARD THOMAS MARTIN PESCOFF, nominated by the Trustees of the National Museums of Victoria.
- (i) THOMAS MCAUGHTRIE, representing the Adult Education Association, being an association, department or organization interested in adult education.
- (j) HAROLD ERNEST LOADER, representing the Victorian Teachers' Union, being an association, department or organization interested in adult education.
- (k) DORIS NELLIE RICHARDS, representing the Country Women's Association, being an association, department or organization interested in adult education.
- (l) ALEXANDER GLADSTONE SCHOLES, representing the National Fitness Council of Victoria, being an association, department or organization interested in adult education.
- (m) FRANCIS MCMANUS.

And the Honorable Raymond Walter Tovell, His Majesty's Minister of Education for the State of Victoria, shall give the necessary directions herein accordingly.

A. G. COULTHARD,
Acting Clerk of the Executive Council.

BALLARAT SEWERAGE AUTHORITY.

At the Executive Council Chamber, Melbourne, the sixteenth day of May, 1950.

PRESENT:

His Excellency the Governor of Victoria.
Sir James Kennedy | Brigadier Tovell.

EXTENT OF SEWERAGE DISTRICT INCREASED.

UNDER the powers conferred by the Sewerage Districts Acts and all other powers enabling him in that behalf, His Excellency the Governor of the State of Victoria, by and with the advice of the Executive Council of the said State, doth hereby declare, order, and direct as follows:—

That the extent of the Sewerage District of the Ballarat Sewerage Authority be increased by adding to the same the lands comprised within the boundaries described in the Schedule hereto, and as on and from the date hereof the extent of such District shall be deemed to be increased accordingly.

SCHEDULE.

Commencing at a point on the southern boundary of Crown portion 3, Parish of Ballarat, County of Ripon, and distant 3147.4 links from its most easterly angle, being a point on the northern boundary of the existing Ballarat Sewerage District; thence northerly by a line parallel to the western boundary of the said Crown portion 3, across the said Crown Portion 3 to a point on its northern boundary; thence easterly along the northern boundary of the said Crown portion 3 to its north-eastern angle; thence easterly by a line being a continuation thereof across a road, the Ballarat and Maryborough railway, Crown portion 5, and Crown allotment 7, section F, to a point on the eastern boundary of the said Crown allotment 7; thence southerly along the eastern boundary of the said Crown allotment 7 to its south-eastern angle, being a point on the northern boundary of the existing Ballarat Sewerage District; thence westerly along the northern boundary of the existing Ballarat Sewerage District to the point of commencement.

All of which boundaries are shown on a plan approved by the Governor in Council and deposited in the office of the State Rivers and Water Supply Commission, Melbourne.

And the Honorable Henry Edward Bolte, His Majesty's Minister of Water Supply for the State of Victoria, shall give the necessary directions herein accordingly.

A. G. COULTHARD,
Acting Clerk of the Executive Council.

LOCAL GOVERNMENT ACT.

At the Executive Council Chamber, Melbourne, the sixteenth day of May, 1950.

PRESENT:

His Excellency the Governor of Victoria.
Sir James Kennedy | Brigadier Tovell.

DECLARATION OF THE TOWN OF ARARAT AS A CITY.

HIS Excellency the Governor of the State of Victoria, by and with the advice of the Executive Council thereof, in pursuance of the provisions contained in the *Local Government Act 1946* (No. 5203), and in compliance with the prayer of a petition presented by the Council of the Town of Ararat, notice of which was duly published in the *Government Gazette* of the 6th January, 1950, doth hereby declare that the said Town shall be a City under the designation of the Municipality of the City of Ararat.

And the Honorable Sir James Kennedy, His Majesty's Commissioner of Public Works for the State of Victoria, shall give the necessary directions herein accordingly.

A. G. COULTHARD,
Acting Clerk of the Executive Council.

LOCAL GOVERNMENT ACT.

At the Executive Council Chamber, Melbourne, the sixteenth day of May, 1950.

PRESENT:

His Excellency the Governor of Victoria.
Sir James Kennedy | Brigadier Tovell.

DECLARATION OF BOROUGH OF ST. ARNAUD AS A TOWN.

HIS Excellency the Governor of the State of Victoria, by and with the advice of the Executive Council thereof, in pursuance of the provisions contained in the *Local Government Act 1946* (No. 5203), and in compliance with the prayer of a petition presented by the Council of the Borough of St. Arnaud, notice of which was duly published in the *Government Gazette* of the 14th April, 1950, doth hereby declare the said Borough to be a Town under the designation of the Town of St. Arnaud.

And the Honorable Sir James Kennedy, His Majesty's Commissioner of Public Works for the State of Victoria, shall give the necessary directions herein accordingly.

A. G. COULTHARD,
Acting Clerk of the Executive Council.

DEPARTMENT OF LANDS AND SURVEY.

At the Executive Council Chamber, Melbourne, the sixteenth day of May, 1950.

PRESENT:

His Excellency the Governor of Victoria.
Sir James Kennedy | Brigadier Tovell.

LAND TEMPORARILY RESERVED FROM SALE.

HIS Excellency the Governor of the State of Victoria, by and with the advice of the Executive Council thereof, doth hereby, in pursuance of the provisions of the *Land Act 1928*, reserve, temporarily, and also except from occupation for mining purposes under any miner's right, the lands hereinafter described:—

WYCHEPROOF.—Site for Public Recreation, 4 acres, 2 roods, 3 perches, Township of Wycheproof, Parish of Bunguluke, County of Kara Kara, as indicated by hachure on plan hereunder.—(W.287(2) (Rs.681).

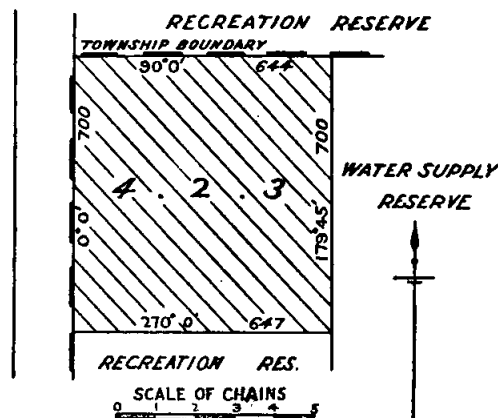

And the Honorable Rutherford Campbell Guthrie, His Majesty's Commissioner of Crown Lands and Survey for the State of Victoria, shall give the necessary directions herein accordingly.

A. G. COULTHARD,
Acting Clerk of the Executive Council.

DEPARTMENT OF LANDS AND SURVEY.

PORT FAIRY SEWERAGE AUTHORITY.

At the Executive Council Chamber, Melbourne, the sixteenth day of May, 1950.

At the Executive Council Chamber, Melbourne, the sixteenth day of May, 1950.

PRESENT:

His Excellency the Governor of Victoria.
Sir James Kennedy | Brigadier Tovell.

PRESENT:

His Excellency the Governor of Victoria.
Sir James Kennedy | Brigadier Tovell.

UNUSED AND UNMADE ROADS CLOSED.

HIS Excellency the Governor of the State of Victoria, by and with the advice of the Executive Council thereof, doth hereby direct that, in pursuance of the provisions of section 304 of the *Land Act* 1928 (No. 3709), the unused and unmade roads referred to hereunder be closed, viz.:—

Parish of Heywood, County of Normanby, being the road between allotments 12, a drainage reserve, and 13, and the railway reserve.—(H.87^(s)) (Z.35443).

Parish of Springfield, County of Bourke, being the road indicated by hachure on plan hereunder.—(S.312⁽²⁾) (Misc.2362).

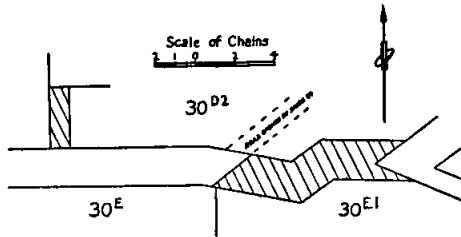

Parish of Whitfield, County of Delatite, being the road indicated by hachure on plan hereunder.—(W.317⁽²⁾) (H.019116).

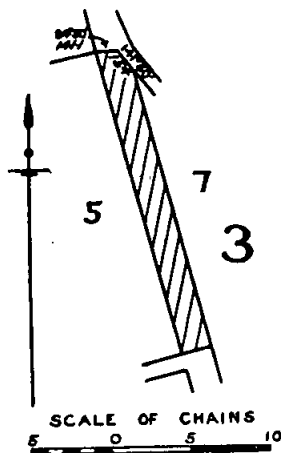

And the Honorable Rutherford Campbell Guthrie, His Majesty's Commissioner of Crown Lands and Survey for the State of Victoria, shall give the necessary directions herein accordingly.

A. G. COULTHARD.
Acting Clerk of the Executive Council.

SEWERAGE DISTRICT PROCLAIMED AND AUTHORITY CONSTITUTED.

UNDER the powers conferred by the Sewerage Districts Acts and all other powers enabling him in that behalf, His Excellency the Governor of the State of Victoria, by and with the advice of the Executive Council of the said State, doth hereby approve of the application of the Port Fairy Borough Council for the proclamation of a Sewerage District and for the constitution of a Sewerage Authority to carry out works for the sewerage of Port Fairy, in accordance with the provisions of the said Acts, and doth hereby appoint as follows:—

(a) That the amount of loan moneys which may be borrowed by such Sewerage Authority shall be One hundred thousand pounds (£100,000), and the amount which may be borrowed by way of overdraft shall be Two thousand pounds (£2,000).

(b) That the principal works to be constructed or carried out by the Sewerage Authority shall consist of reticulation and branch sewers, main sewers, sewage pumping stations, rising mains, and ocean outfall.

(c) That the limits of the land within which the said Sewerage Authority shall have authority shall be those within the following boundaries:—

PORTION I.

Commencing at the south-eastern angle of lot 12, section 13, on lodged plan of subdivision No. 1067, on J. Atkinson's Crown special survey, Town of Port Fairy, Parish of Belfast, County of Villiers; thence northerly along the eastern boundaries of the said lot 12 and of lots 11, 10, 9, and 8 to the north-eastern angle of the said lot 8; thence westerly along the southern boundary of lot 4 to its south-western angle; thence northerly along the eastern boundaries of lots 7, 6, and 5 to the north-eastern angle of the said lot 5; thence westerly along the northern boundary of the said lot 5 and by a line being a continuation thereof across a road and through portion of Southcombe Park to a point in line with the western boundary of Market-street; thence northerly by a line through Southcombe Park and across a road to the south-eastern angle of lot 5, section 9, being a point on the northern boundary of Campbell-street; thence westerly along the said northern boundary of Campbell-street to the south-western angle of lot 3, section 11, Town of Port Fairy; thence southerly by a line being a continuation of the western boundary of the said lot 8, across a road, and through portion of the Southcombe Park to a point distant 300 links from the northern boundary of the said Southcombe Park; thence westerly through portion of Southcombe Park and across a road by a line parallel to and distant 300 links from the southern boundary of Campbell-street to a point on the eastern boundary of a State School reserve; thence southerly, westerly, and northerly along the eastern, southern, and western boundaries of the said State School reserve to a point in line with the southern boundary of lot 3, section 23; thence westerly by a line across a road to the south-eastern angle of the said lot 3; thence westerly along the southern boundaries of the said lot 3 and of lot 2 to the south-western angle of the said lot 2; thence northerly along the western boundary of the said lot 2 to its north-western angle; thence north-westerly by a line across a road to the south-eastern angle of a Roman Catholic Church reserve; thence westerly, northerly, and easterly along the southern, western, and northern boundaries of the said Roman Catholic Church reserve to its north-eastern angle; thence north-easterly by a line across a road to the north-western angle of lot 4, section 22, being a point on the eastern boundary of College-street; thence northerly along the said eastern boundary of College-

street to its intersection with the northern boundary of Regent-street; thence by a line being a continuation thereof a distance of 300 links; thence easterly by a line parallel to the northern boundary of Regent-street to a point distant 300 links westerly from the western boundary of Prince's Highway; thence northerly and north-easterly by lines parallel to the western and north-western boundaries of Prince's Highway a distance of 8,730 links; thence south-easterly by a line being at right angles to the north-western boundary of Prince's Highway to a point distant 500 links south-easterly from the south-eastern boundary of Prince's Highway; thence south-westerly and southerly by a line parallel to and distant 500 links from the south-eastern and eastern boundaries of Prince's Highway to a point distant 300 links northerly from the northern boundary of Regent-street; thence easterly by a line parallel to the said northern boundary of Regent-street to a point in line with the eastern boundary of lot 8, section 2, Town of Port Fairy; thence southerly by a line across Regent-street to the north-eastern angle of the said lot 8, being a point on the southern boundary of the said Regent-street; thence easterly along the said southern boundary of Regent-street to its intersection with the eastern boundary of Sackville-street; thence by a line being a continuation thereof across the Port Fairy station ground along the northern boundary of section 1 to its north-eastern angle; thence by a line being a continuation thereof to a point on the right bank of Moyne River; thence generally southerly along the said right bank of Moyne River to the most easterly angle of lot 26, Town of Port Fairy; thence south-westerly along the south-eastern boundary of the said lot 26 to its most southerly angle; thence westerly by a line across a road to the most easterly angle of section 13; thence westerly along the southern boundary of the said section 13 to the point of commencement.

PORTION II.

Commencing at the most easterly angle of Crown allotment 9, section 7, Town of Port Fairy, Parish of Belfast, County of Villiers; thence south-westerly along the south-eastern boundaries of the said Crown allotment 9 and Crown allotments 8, 7, 6, 5, 4, 3, and 2 to the most southerly angle of the said Crown allotment 2; thence south-westerly by a line across a road to the most easterly angle of Crown allotment 9, section 6; thence south-westerly along the south-eastern boundaries of the said Crown allotment 9 and Crown allotments 8, 7, 6, 5, 4, 3, and 2 to the most southerly angle of the said Crown allotment 2; thence south-westerly by a line across a road to the most easterly angle of Crown allotment 9, section 5; thence south-westerly along the south-eastern boundaries of the said Crown allotment 9 and Crown allotments 8, 7, 6, 5, 4, 3, and 2 to the most southerly angle of the said Crown allotment 2; thence south-westerly by a line across a road to the most easterly angle of Crown allotment 8, section 4; thence southerly along the eastern boundaries of the said Crown allotment 8 and Crown allotments 7, 6, 5, 4, 3, 2, and 1 to the south-eastern angle of the said Crown allotment 1; thence southerly by a line across a road to the most northerly angle of Crown allotment 9, section 3; thence southerly along the eastern boundaries of the said Crown allotment 9 and Crown allotments 8, 7, 6, 5, 4, 3, and 2 to the most easterly angle of the said Crown allotment 2; thence southerly by a line across a road to the most northerly angle of Crown allotment 9, section 2; thence southerly along the eastern boundaries of the said Crown allotment 9 and Crown allotments 8, 7, 6, 5, 4, 3, and 2 to the most easterly angle of the said Crown allotment 2; thence south-easterly by a line across a road to the most northerly angle of Crown allotment 9, section 1; thence south-easterly along the north-eastern boundaries of the said Crown allotment 9 and Crown allotments 8, 7, 6, 5, 4, 3, and 2 to the most easterly angle of the said Crown allotment 2; thence south-westerly along the south-eastern boundaries of the said Crown allotment 2 and Crown allotment 1 to the most southerly angle of the said Crown allotment 1; thence by a line being a continuation thereof a distance of 150 links; thence north-westerly and northerly by lines parallel to the south-western boundary of section 1 and the western boundary of section 2 to a point in line with the southern boundary of section 3; thence westerly by a line being a continuation of the said southern boundary of section 3 to a point on the left bank of the Moyne River; thence generally northerly along the left bank of the Moyne River to a point in line with the north-western boundary of Crown allotment 1, Town of Port Fairy; thence north-easterly by a line across the Botanic

Gardens to the most westerly angle of the said Crown allotment 1; thence north-easterly along the south-eastern boundary of the said Botanic Gardens to the most north-easterly angle of the said Botanic Gardens; thence north-easterly along the south-eastern boundary of Crown allotment 11 to its most easterly angle; thence north-easterly by a line across a road to the most southerly angle of Crown allotment 18; thence north-easterly along the south-eastern boundaries of the said Crown allotment 18 and Crown allotment 21 to the most easterly angle of the said Crown allotment 21; thence south-easterly along the north-eastern boundary of Crown allotment 20 to its most easterly angle; thence south-easterly by a line across a road to the most northerly angle of Crown allotment 10, section 7; thence south-easterly along the north-eastern boundaries of the said Crown allotment 10 and Crown allotment 9 to the point of commencement

—all of which boundaries are shown on a plan approved by the Governor in Council, and deposited in the office of the State Rivers and Water Supply Commission, Melbourne.—(Corres. 49/22626).

(d) That the Councillors for the time being of the Borough of Port Fairy shall be the members of the Sewerage Authority.

(e) That the name of the Authority shall be Port Fairy Sewerage Authority.

And the Honorable Henry Edward Bolte, His Majesty's Minister of Water Supply for the State of Victoria, shall give the necessary directions herein accordingly.

A. G. COULTHARD,
Acting Clerk of the Executive Council.

CROYDON FRUIT COOL STORES ACT 1949 (No. 5441).

At the Executive Council Chamber, Melbourne, the sixteenth day of May, 1950.

PRESENT:

His Excellency the Governor of Victoria.
Sir James Kennedy | Brigadier Tovell.

ABOLISHING THE CROYDON COOL STORES TRUST AND THE CROYDON COOL STORES AREA.

WHEREAS, in accordance with the provisions of the *Croydon Fruit Cool Stores Act 1949* (No. 5441), orchardists in the Croydon district have formed a co-operative company known as the Croydon Cool Stores Co-operative Limited, with the object of taking over from the Croydon Cool Stores Trust and operating the cool stores constructed by the said Trust; And whereas the sum of Five thousand pounds has been paid by the Croydon Cool Stores Co-operative Limited to the Treasurer of Victoria and accepted by the Treasurer in full settlement of all moneys owing by the said Trust to the Treasurer: And whereas the said Trust has transferred to the Croydon Cool Stores Co-operative Limited the land of which the Trust was proprietor in fee simple, together with all cool stores and buildings thereon, and all assets, rights, and liabilities of the said Trust: Now therefore, His Excellency the Governor of the State of Victoria, by and with the advice of the Executive Council thereof, doth by this Order hereby declare that the Croydon Cool Stores Trust, appointed pursuant to the *Fruit Act 1915*, and the Croydon Cool Stores Area, created pursuant to the *Fruit Act 1915* and the *Fruit and Vegetables Act 1928*, shall be abolished.

And the Honorable Alexander Henry Dennett, His Majesty's Minister of Agriculture for the State of Victoria, shall give the necessary directions herein accordingly.

A. G. COULTHARD,
Acting Clerk of the Executive Council.

DISCHARGED SERVICEMEN'S PREFERENCE ACT 1943.

*At the Executive Council Chamber, Melbourne, the
sixteenth day of May, 1950.*

PRESENT:

His Excellency the Governor of Victoria.

Sir James Kennedy | Brigadier Tovell.

REGULATIONS.

IN pursuance of the powers conferred by the *Discharged Servicemen's Preference Act 1943*, the *Acts Interpretation Act 1928*, and all other powers thereto enabling, His Excellency the Governor of the State of Victoria, by and with the advice of the Executive Council thereof, doth hereby amend the Regulations made respectively on the 17th day of July, 1944, the 26th day of July, 1949, and the 26th day of April, 1950, in the manner following, that is to say:—

For the First Schedule, as amended by the said last-mentioned Regulations, the following Schedule shall be substituted:—

FIRST SCHEDULE.

Office; Salary Range; Annual Increments.

Secretary: £852 per annum, as on and from the 20th April, 1950.
Investigation Officer: £501, as on and from the 20th April, 1950.
Shorthand Writer and Typist (female), Senior: £286 per annum, as from the 1st January, 1950, with one increment of £13, as from the 1st January, 1951.

Shorthand Writer and Typist (female)—

Junior—under 16 years of age, £117 per annum.
at 16 years of age, £130 per annum.
at 17 years of age, £143 per annum.
at 18 years of age, £156 per annum.
at 19 years of age, £195 per annum.
at 20 years of age, £221 per annum.

Adult, £247 to £273 per annum; two of £13, as from and including 1st January, 1950.

Typist (female)—

Junior—under 16 years of age, £104 per annum.
at 16 years of age, £117 per annum.
at 17 years of age, £130 per annum.
at 18 years of age, £143 per annum.
at 19 years of age, £182 per annum.
at 20 years of age, £208 per annum.

Adult, £234 to £260 per annum; two of £13, as from and including the 1st January, 1950.

The above-mentioned salaries shall be subject to automatic adjustment in accordance with variation in the cost of living, upon the basis and method prescribed in regard to the salaries of officers in the Victorian State Public Service.

And the Honorable Trevor Donald Oldham, His Majesty's Attorney-General for the State of Victoria, shall give the necessary directions herein accordingly.

A. G. COULTHARD,
Acting Clerk of the Executive Council.

INFECTIOUS DISEASES HOSPITAL ACT 1928.

*At the Executive Council Chamber, Melbourne, the
sixteenth day of May, 1950.*

PRESENT:

His Excellency the Governor of Victoria.

Sir James Kennedy | Brigadier Tovell.

AMENDMENT OF REGULATIONS WITH RESPECT TO THE
DISEASES WHICH MAY BE TREATED AT THE FAIRFIELD
HOSPITAL.

UNDER the powers conferred by section 39 of the *Infectious Diseases Hospital Act 1928*, and all other powers enabling him in that behalf, His Excellency the Governor of the State of Victoria, by and with the advice of the Executive Council of the said State, doth hereby make the Regulations following, that is to say:—

1. These Regulations shall come into operation upon publication in the *Government Gazette*.

2. Regulation 2 of Regulations under the *Infectious Diseases Hospital Act 1928*, published in the *Government Gazette* of the 3rd December, 1930, on page 3182, as amended by any Regulations, is hereby further amended by the addition at the end thereof of the following list of diseases:—

- (s) Small Pox.
- (t) Cholera.

And the Honorable Charles Percival Gartside, His Majesty's Minister of Health for the State of Victoria, shall give the necessary directions herein accordingly.

A. G. COULTHARD,
Acting Clerk of the Executive Council.

FIRE BRIGADES ACTS.

*At the Executive Council Chamber, Melbourne, the
twenty-third day of May, 1950.*

PRESENT.

His Excellency the Governor of Victoria.

Lieut.-Col. Leggatt | Brigadier Tovell
Mr. Bolte | Lieut.-Col. Hipworth.

REGULATION.

WHEREAS by the Fire Brigades Acts it is amongst other things enacted that the Governor in Council may, as to the whole or any part of Victoria, make Regulations for all or any of the purposes set forth in the said Acts: And whereas by section 40 of the *Fire Brigades Act 1928* it is further enacted that all Regulations as to the metropolitan district shall be prepared by the Metropolitan Fire Brigades Board and submitted to the Minister for approval prior to being made by the Governor in Council: And whereas the Regulation set forth hereunder was prepared by the Metropolitan Fire Brigades Board and submitted to the Minister for his approval: And whereas such Regulation has been approved by the Minister: Now therefore His Excellency the Governor of the State of Victoria, in the Commonwealth of Australia, by and with the advice of the Executive Council of the said State, and in pursuance of the powers conferred by the Fire Brigades Acts, doth hereby make the Regulation following (that is to say):—

The Metropolitan Fire Brigades Board Appeal Tribunal Regulations are hereby amended as follows:—

“In sub-clause (1) of clause 12 of the said Regulations, for the words ‘six months’ there shall be substituted the words ‘fourteen days.’”

And the Honorable William Watt Leggatt, His Majesty's Chief Secretary for the State of Victoria, shall give the necessary directions herein accordingly.

A. MAHLSTEDT,
Clerk of the Executive Council.

PRICES REGULATION ACTS.

At the Executive Council Chamber, Melbourne, the
twenty-third day of May, 1950.

PRESENT:

His Excellency the Governor of Victoria.

Lieut.-Col. Leggatt		Brigadier Tovell
Mr. Bolte		Lieut.-Col. Hipworth.

NOTICE OF REVOCATION OF DECLARATION OF CERTAIN
GOODS AS DECLARED GOODS FOR THE PURPOSES OF
PART II. OF THE PRICES REGULATION ACT 1948.

IN pursuance of the powers conferred upon him by the *Prices Regulation Act 1948*, His Excellency the Governor of Victoria, by and with the advice of the Executive Council thereof, doth hereby revoke the Declaration heretofore made of the following goods as declared goods for the purposes of Part II. of the Act, that is to say:—

The following item of Paper and Stationery, viz.:—
Printing Paper.

And the Honorable Trevor Donald Oldham, His Majesty's Attorney-General for the State of Victoria, shall give the necessary directions herein accordingly.

A. MAHLSTEDT,

Clerk of the Executive Council.

LANDLORD AND TENANT ACTS.

At the Executive Council Chamber, Melbourne, the
twenty-third day of May, 1950.

PRESENT:

His Excellency the Governor of Victoria	
Lieut.-Col. Leggatt	Brigadier Tovell
Mr. Bolte	Lieut.-Col. Hipworth.

ORDER EXCLUDING CERTAIN PREMISES FROM THE
OPERATION OF PARTS III. AND V. OF THE
LANDLORD AND TENANT ACT 1948.

IN pursuance of the powers conferred upon him by the *Landlord and Tenant Act 1948*, as amended by the *Landlord and Tenant (Amendment) Act 1948*, His Excellency the Governor of Victoria, by and with the advice of the Executive Council thereof, doth hereby declare that the premises described in the Schedule hereto shall be excluded from the operation of the whole of the provisions contained in Parts III. and V. of the *Landlord and Tenant Act 1948*.

SCHEDULE.

The premises situated upon all that piece of land in Emily-street, Seymour, having a frontage of 2 chains to the northern side of Emily-street by a depth of 5 chains, commencing at a point 2 chains north-easterly from Whitehead's Creek.

And the Honorable Trevor Donald Oldham, His Majesty's Attorney-General in and for the State of Victoria, shall give the necessary directions herein accordingly.

A. MAHLSTEDT,
Clerk of the Executive Council.

EXPLOSIVES ACT 1928.

At the Executive Council Chamber, Melbourne, the
twenty-third day of May, 1950.

PRESENT:

His Excellency the Governor of Victoria.	
Lieut.-Col. Leggatt	Brigadier Tovell
Mr. Bolte	Lieut.-Col. Hipworth.

CLASSIFICATION OF EXPLOSIVES.

HIS Excellency the Governor of the State of Victoria, by and with the advice of the Executive Council thereof, and in pursuance of the provisions of section 53 of the *Explosives Act 1928*, doth by this Order classify the under-mentioned explosives as follows:—

CLASS 3.—NITRO-COMPOUND.

Division 1.

Gelignite.
Geobel.
Geobel No. 2.
Geobel No. 3.
N.S. Gelignite.
S.N. Gelignite.

Division 2.

Commercial Waterproof Primers.
Nobel's Explosive No. 896.

And the Honorable William Watt Leggatt, His Majesty's Chief Secretary for the State of Victoria, shall give the necessary directions herein accordingly.

A. MAHLSTEDT,
Clerk of the Executive Council.

APPROACHING LAND SALES.

SALES of Crown lands, in fee-simple, will be held at the under-mentioned places and dates, viz.:—

	No. of Gazette
Benalla.—Tuesday, 6th June, 1950 ..	302
Castlemaine.—Wednesday, 14th June ..	424
Daylesford.—Wednesday, 14th June ..	424
Foster.—Thursday, 25th May, 1950 ..	300
Korumburra, Friday, 30th June, 1950 ..	460
Warragul, Wednesday, 21st June, 1950 ..	460

SALES OF CROWN LANDS BY AUCTION.

The lands will be sold in fee-simple, and subject to the covenants, conditions, exceptions, and reservations directed by the Governor in Council by an Order in Council dated the 5th August, 1930, and published in the *Government Gazette* of the 8th August, 1930, varied as herein.

A deposit of at least twelve and a half per centum of the price at which each lot is sold must be paid by the purchaser at the time of sale, and all such payments shall be made in bank notes or cheques approved by the officer conducting the sale, and the residue of such price will be payable in equal instalments, in accordance with the scale hereunder, on the last day of each successive period of six months from the time of sale, or, if the purchaser choose, at any earlier time or times; such residue of the price shall bear interest at the rate of £5 per centum per annum, to be computed between the time of sale and the time when payment of such residue or instalment of such residue is made. If the residue of the price be paid within thirty days after the time of the sale no interest will be payable thereon.

The Governor in Council may allow a transfer of the purchaser's interest to an approved person at any time before the final payment of the purchase money is made. The fee for transfer shall be One pound, and such transfer will be subject to payment of stamp duty.

SCALE OF PAYMENTS OF RESIDUE.

£20 and under, 6 instalments.
Over £20, and not exceeding £50, 8 instalments.
Over £50, and not exceeding £100, 10 instalments.
Over £100, and not exceeding £200, 12 instalments.
Over £200, and not exceeding £300, 14 instalments.
Over £300, and not exceeding £400, 16 instalments.
Over £400, and not exceeding £500, 18 instalments.
Over £500, 20 instalments.

FEES, ETC.

The fees payable for Crown grant and assurance (One halfpenny for each pound of purchase price) must be paid with the balance of purchase money. The following is the scale:—

50 acres and under, £1-10s.
Over 50 acres, £2.

Where the purchase money does not exceed £5, the grant fee is £1.

Valuations of improvements (if not purchased by the owner thereof), and charges for survey must also be paid at the time of sale.

R. C. GUTHRIE,
Commissioner of Crown Lands and Survey.

Office of Lands and Survey,
Melbourne, 22nd May, 1950.

WARRAGUL.—Sale (No. 10794) of Crown lands in fee-simple, by auction, will be held at the COURT HOUSE, WARRAGUL, on WEDNESDAY, the 21st June, 1950, at ELEVEN o'clock a.m. To be conducted by C. E. RICE, Land Officer, Melbourne.

LONGWARRY, PARISH OF DROUIN WEST, COUNTY OF BULN BULN.

In the North-west of the Township.

Upset price £30 the lot. Charge for survey £5 15s.

Lot 1. Area 3r. 7p., allotment 36 of section 6,

NOOJEE, PARISH OF NEERIM, COUNTY OF BULN BULN.

In the East of the Township.

Upset price £15 per lot. Charge for survey £5 per lot.

Lot 2. Area 1r. 8p., allotment 4 of section 6.

Lot 3. Area 1r. 8p., allotment 5 of section 6.

Lot 4. Area 1 r. 9 8/10p., allotment 6 of section 6.

Lot 5. Area 1r. 9 3/10p., allotment 7 of section 6.

PARISH OF YARRAGON, COUNTY OF BULN BULN.

In the North of the Parish. Formerly held by J. T. Elliott.

Upset price £153 the lot. Charge for survey £22 2s. 6d.

Lot 6. Area 203a. 1r. 29p., allotment 63B. Valuation of improvements £91 5s., to be paid for in full at the sale.

KORUMBURRA.—Sale (No. 10795) of Crown lands in fee simple, by auction, will be held at the COURT HOUSE, KORUMBURRA, on FRIDAY, the 30th JUNE, 1950, at TWELVE o'clock noon. To be conducted by C. E. RICE, Land Officer, Melbourne.

Lot 1. Withdrawn.

PARISH OF LEONGATHA, COUNTY OF BULN BULN.

About Three Miles South-west of the Township of Leongatha.

Upset price £90 the lot. Charge for survey £12 17s. 6d.

Lot 2. Area 60a. 1r. 28p., allotment 52B.

PARISH OF KORUMBURRA, COUNTY OF BULN BULN.

In the South-west of Parish.

Upset price £37 17s. 6d. the lot. Charge for survey £6 2s. 6d.

Lot 3. Area 1a. 3r. 23p., allotment 16A of section 8. Valuation of improvements £37 10s. (Crown).

Also

Freehold Land under the Transfer of Land Act offered for and on behalf of the Minister of Education.

PARISH OF KORUMBURRA, COUNTY OF BULN BULN.

In the South-west of the Parish.

Lot 4. Area 1r. 10p., part of former Government road adjoining allotment 16A of section 8, being the area more particularly described in freehold certificate of title, volume 5318, folio 1063455.

Upset price £14 15s. the lot (land and improvements).

Sale of lot 4 is subject to the following conditions:—

- the purchaser shall pay the purchase money in full at the sale;
- the preparation and registration of the transfer under the Transfer of Land Act shall be attended to by the purchaser or his solicitor, and all costs relating thereto shall be borne by the purchaser.

SOLDIER SETTLEMENT ACT 1946.

IN pursuance of section 88 (1) of the *Soldier Settlement Act 1946*, I, Rutherford Campbell Guthrie, Commissioner of Crown Lands and Survey, hereby declare the farming land specified in the Schedule hereunder to be land suitable for soldier settlement.

SCHEDULE.

All those pieces of land, being firstly Crown allotment 1A, section 8, Parish of Yackandandah, being the land in title volume 4120, folio 823841, and secondly allotment 2n, section 8, Parish of Yackandandah, being the land in Crown Grant, volume 5839, folio 1167659, and lastly Crown allotments 2a, 3a, 2b, 2c, and 3b, section 8, Parish of Yackandandah, the whole being in the County of Bogong and comprising 428 acres 3 roods 23 perches, more or less.

Signed at Melbourne, this 17th day of May, 1950.

R. C. GUTHRIE,
Commissioner of Crown Lands and Survey.

LAND PROPOSED TO BE PERMANENTLY RESERVED.

The following notice was published 1° on the 24th May, 1950, pursuant to an Order of the 16th May, 1950.

IN pursuance of the provisions of the *Land Act* 1928, notice is hereby given that it is the intention of the Governor in Council to permanently reserve and except from occupation for mining purposes under any miner's right, the land hereunder described, viz.:—

TYNTYNDER.—Land to be permanently reserved as a site for Public purposes, 216 acres, more or less, Parish of Tyntynder, County of Tatchera, as indicated by hachure on plan hereunder.—(T.244⁽¹⁰⁾) (Rs.5634).

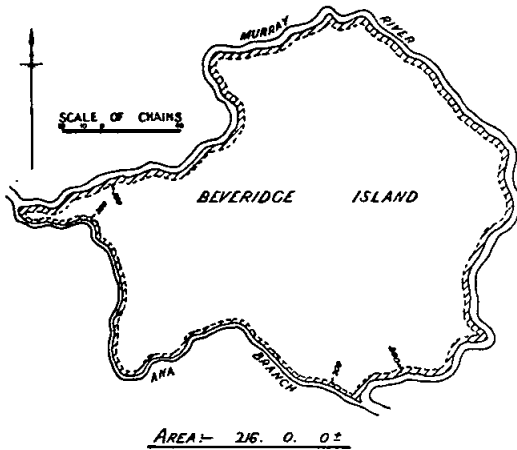

R. C. GUTHRIE,
Commissioner of Crown Lands and Survey.

PUBLIC HEARINGS BY PERSONS APPOINTED UNDER THE 34TH SECTION OF THE LAND ACT 1928.

NOTICE is hereby given that at the times and places mentioned in the Schedule hereunder, applications for leases and licences under the Land Acts, objections to such applications, objections to proposed proclamations, alterations, additions, diminutions, revocations, or unions of commons, and reasons against forfeiture of any leases or licences under the Land Acts deemed liable to forfeiture, will be publicly heard by the persons whose names are set opposite such places respectively in such Schedule, being persons appointed by me, the responsible Minister of the Crown administering the Land Acts, to hear the same and report thereon in writing to me.

SCHEDULE.

- LAND OFFICE BAIRNSDALE, Wednesday, 14th June, 1950, at half-past One p.m., R. A. Walker, Land Officer.
- LAND OFFICE, CASTLEMAINE, Wednesday, 14th June, 1950, at half-past Two p.m., H. J. Henkel, Land Officer.
- LAND INSPECTOR'S OFFICE, CASTERTON, Thursday, 15th June, 1950, at Ten a.m., H. E. Michell, Land Officer.
- SHIRE HALL, TALLANGATTA, Thursday, 15th June, 1950, at Ten a.m., C. A. Gourlay, Land Officer.
- BENDIGO, Thursday, 22nd June, 1950, at Ten a.m., H. J. Henkel, Land Officer.

R. C. GUTHRIE,
Commissioner of Crown Lands and Survey, and
President of the Board of Land and Works.
Department of Lands and Survey,
Melbourne, 24th May, 1950.

HEARING OF REASONS AGAINST THE FORFEITURE OF CERTAIN LICENCES AND LEASES BY PERSONS APPOINTED UNDER 34TH SECTION OF THE LAND ACT 1928.

NOTICE is hereby given that reasons against the forfeiture of the licences and leases in the Schedule hereto, which are deemed liable to forfeiture under the provisions of the Land Acts, will be publicly heard by the persons appointed by me, the Responsible Minister of the Crown administering the said Acts, to hear the same and report thereon in writing to me, when the persons in the said Schedule mentioned as holders of such licences and leases will be allowed to show cause against the same at the places and on the dates mentioned in the Schedule hereto.

SCHEDULE.

LAND OFFICE, BAIRNSDALE, Wednesday, 14th June, 1950, at half-past One p.m., R. A. Walker, Land Officer—

90/129, Reginald Nelson Kearns, 2 acres, Township of Bruthen, Parish of Tambo.

TALLANGATTA, Thursday, 15th June, 1950, C. A. Gourlay, Land Officer—

781/44, R. H. Cleland, 140 acres, Tallandoon.

R. C. GUTHRIE,
Commissioner of Crown Lands and Survey,
being the Responsible Minister of the Crown
administering the Land Acts.

Department of Lands and Survey,
Melbourne, 24th May, 1950.

COMMITTEES OF MANAGEMENT OF RESERVES.

APPOINTMENTS.

WHEREAS by section 184 of the *Land Act* 1928 it is provided that it shall be lawful for the Governor in Council or the Board of Land and Works to appoint and remove any number of persons, not less than three, or any municipal council, or the governing body of any corporation, to be a Committee of Management of any specified Crown land reserved either temporarily or permanently for any of the purposes set out in section 14 of the *Land Act* 1928, and not conveyed to or vested in trustees: Now therefore the Board of Land and Works doth hereby appoint the under-mentioned persons to be members of the Committee of Management of the Reserves named:—

"GORAE WEST RESERVE."

Leslie George Beauglehole, Roy Hutchinson, Benjamin Charles Amor, James Henry Smith, and John Nicol Black as a Committee of Management for a period of three (3) years from 29th April, 1950, of the land temporarily reserved by Order in Council dated 30th January, 1940, as a site for Public purposes in the Parish of Mouzie, and known as the "Gorae West Reserve."—(Corres. Rs.5011.)

"BEACONSFIELD PUBLIC HALL RESERVE."

Dorothy Barnes, Annie Trebilcock, James Norman Parkes, William Archer Nixon, Patricia Joan Roberts, Florence Mary Baker, Charles Barnes, and Herman Roberts as a Committee of Management for a period of one (1) year from 13th February, 1950, of the land temporarily reserved by Order in Council dated 8th November, 1943, as a site for a Public Hall in the Parish of Pakenham, and known as the "Beaconsfield Public Hall Reserve."—(Corres. Rs.5406.)

"MURCHISON RECREATION RESERVE."

Claude Harold Neely, Edward Ernest Hammond, James Goulburn Lyons, Henry Albany Bradbury, John Andrew Orr, James George Kenny, and John Kenneth Finlay as a Committee of Management for a period ending 3rd November, 1952, of the land temporarily reserved by Order in Council dated 26th April, 1950, as a site for Public Recreation in the Parish of Murchison.—(Corres. Rs.1864.)

"TERANG RACECOURSE RESERVE."

Neville Bazett Palmer, Arthur William Noel, John Francis Scally, Cyril Tehan, and Patrick Gerald Moloney as a Committee of Management for a period of three (3) years from 25th February, 1950, of the land temporarily reserved by Order in Council dated the 29th May, 1865, as a site for Racecourse and Recreative purposes at Terang, and by Order in Council dated the 20th March, 1899, as a site for Racecourse and Public Recreation purposes in the Parish of Terang, and known as the "Terang Racecourse Reserve."—(Corres. Rs.2222.)

"SAN REMO FORESHORE RESERVES."

Norris Arnaud Mitchelson, George Edward Williams, Jack Vorwerg, Leonard John Bagley, John Arthur McKenzie, Eivind Hansen Ingbritsen, and Albert Leslie Andrews as a Committee of Management for a period of three (3) years from 31st March, 1950, of such portions of the Reserves for Public purposes in the Township of San Remo as are indicated by red colour on plan marked S.R./22.1.35 with Lands Department Correspondence Rs.3972, and known as the "San Remo Foreshore Reserves."—(Corres. Rs.3972, Rs.3973.)

"DROMANA RACECOURSE RESERVE."

Frederick Wallace Jarman, Charles Walter Donne, Hugh Harold Strickland, George Walter Brown, George Arthur Bishop, Herbert Alfred Jackson, Charles Eldred Roberts, Thomas Couacaud, and Tuisko Turso Seppelt as a Committee of Management for a period of three (3) years from 27th April, 1950, of the remaining portion of the land reserved for Racecourse and General Recreation purposes in the Parish of Kangarong, as is indicated in red colour on plan marked D/27.3.47, with Lands Department Correspondence Rs.56.—(Corres. Rs.56.)

"BORUNG PUBLIC HALL RESERVE."

John Zachariah Perryman, James Leslie Coghill, Edward Marshall Perryman, James Leslie Bell, Edward Andrews, Lindsay Alexander Bell, James William Harrison, and Thomas Joyce Smith as a Committee of Management for a period of three (3) years from 10th May, 1950, of the land permanently reserved by Order in Council dated the 25th February, 1941, as a site for a Public Hall in the Parish of Kinypanial, and known as the "Borong Public Hall Reserve."—(Corres. Rs.5162.)

LAND RESERVED AS AN ADDITION TO THE "BIRREGURRA PARK AND RECREATION RESERVE."

Phillip Bellair Hayes, Harold Edwin Beach, Geoffrey Bellair Hayes, Ronald Keith Campbell, and Eric Clarence White as a Committee of Management for the period ending 23rd September, 1950, of the land in the Township of Birregurra temporarily reserved by Order in Council dated 18th April, 1950, as a site for Public Park and Public Recreation, in addition to and adjoining the site temporarily reserved therefor by Order in Council dated 8th June, 1926.—(Corres. Rs.3080.)

"WELSHPOOL PUBLIC HALL RESERVE."

Vivian Walter Bennett Wood, David Francis O'Neill, James Cook Kelt, Charles Royned James, Walter Linforth, Alan Charles Hackwell, and John Parry as a Committee of Management for a period of three (3) years from 12th May, 1950, of the land temporarily reserved by Order in Council of 24th February, 1947, as a site for Public Hall purposes in the Parish of Welshpool, and known as the "Welshpool Public Hall Reserve."—(Corres. Rs.5899.)

"RAYWOOD MECHANICS' INSTITUTE RESERVE."

John Hugh Collins, Arthur Edgar Stanley Johnson, Percy Hooper, Herbert E. Aldridge, John Thomas Rayner, Thomas Robert Phelan, and Richard Neville Smith as a Committee of Management for a period of three (3) years from 24th April, 1950, of the land permanently reserved by Order in Council dated the 28th July, 1873, as a site for Mechanics' Institute purposes at Raywood, and known as the "Raywood Mechanics' Institute."—(Corres. Rs.1947.)

"WAGGARANDALL RECREATION RESERVE."

Michael Valentine O'Connor, James Roy Fyffe, William John Nobes, Clement James Righetti, John Leo McLaughlin, Allan Fyffe, and Henry Francis Ludeman as a Committee of Management for a period of three (3) years from 29th August, 1949, of the lands temporarily reserved by Orders in Council dated 28th January, 1905, and 16th June, 1930, as sites for Public Recreation in the Parish of Waggarrandall, and known as the "Waggarrandall Recreation Reserve."—(Corres. Rs.4011.)

"WILLUNG RECREATION RESERVE."

Halfred Milne Morley, Carl Frederick Wilson, William Eric Mowat, Walter Edward Mowat, and Charles Henry Attenborough as a Committee of Management for a period of three (3) years of the land temporarily reserved by Order in Council dated 7th February, 1950, as a site for Public Recreation in the Township of Willung.—(Corres. Rs.6512.)

"BREAMLEA RECREATION AND PUBLIC HALL RESERVE."

John Wilfred Pescud, W. A. Marshall, Francis George Horwood, Archibald James Laidlaw, and Charles Leslie Squire as a Committee of Management for a period of three (3) years from 24th February, 1950, of the land temporarily reserved by Order in Council of 16th November, 1942, as a site for Public Recreation and by Order in Council of 22nd June, 1948, for the additional purpose of a Public Hall in the Parish of Conewarre, Township of Breamlea, together with that portion of the reserved Crown lands in the Parish of Conewarre as is indicated in red colour on plan marked C/17.6.42 attached to Lands Department Correspondence Rs.151, and known as the "Breamlea Recreation and Public Hall Reserve."—(Corres. Rs.151.)

"BRIGHT RECREATION RESERVE."

William Courtney Snell, William Dunlop Walker, John Farrington, Alfred Charles Price, Reginald George Butler, Edward John Delany, and Albert Francis Antonio Masciorini as a Committee of Management for a period of three (3) years from 27th April, 1950, of the land temporarily reserved by Orders in Council dated the 29th June, 1891, 6th May, 1913, 10th January, 1924, and 16th November, 1936, as sites for Public Recreation and Show Yards in the Parish of Bright, and known as the "Bright Recreation Reserve."—(Corres. Rs.790.)

"PUCKAPUNYAL MECHANICS' INSTITUTE AND FREE LIBRARY RESERVE."

John Hall Waugh, Samuel Alfred Jones, and Edwin Hector Russell as a Committee of Management for a period of three (3) years of the land temporarily reserved by Order in Council dated 3rd October, 1887, as a site for a Mechanics' Institute and Free Library in the Parish of Puckapunyal, and known as the "Puckapunyal Mechanics' Institute and Free Library Reserve."—(Corres. Rs.5920.)

"BYADUK CRICKET AND RECREATION RESERVE."

Russell Alexander Christie, John Christie Holcombe, Francis James Holmes, and Wilfred Ronald Knight as a Committee of Management for a period of three (3) years from 25th April, 1950, of the land temporarily reserved by Order in Council dated 3rd March, 1897, as a site for Cricket and other purposes of Public Recreation in the Parish of Byaduk, and known as the "Byaduk Recreation Reserve."—(Corres. Rs.3287.)

"MERINGUR PUBLIC HALL RESERVE."

Robert Arthur Ferguson, Frederick Alfred Summerhayes, Arnold Elmo Harmer, William Edward Hards, Ernest Paul Johan Ruchel, Thomas William Whitefoot, and Henry Albert Shilling as a Committee of Management for a period of three (3) years from 27th April, 1950, of the land temporarily reserved by Order in Council dated the 23rd December, 1943, as a site for a Public Hall in the Township and Parish of Meringur, and known as the "Meringur Public Hall Reserve."—(Corres. Rs.5470.)

"TRENTHAM MECHANICS' INSTITUTE."

William Donnan, Vernon J. L. Fairless, Hilda Jane Watson, G. R. Plan, Marie Jean Brown, Jean V. Shaw, John Deline, and Thos. H. Stanyer as a Committee of Management for a period of three (3) years from 26th April, 1950, of the land temporarily reserved by Order in Council dated the 17th February, 1879, as a site for a Mechanics' Institute in the Town of Trentham, and known as the "Trentham Mechanics' Institute Reserve."—(Corres. Rs.2874.)

"GREENWALD RECREATION RESERVE."

William George Cowland, Herbert Hills, and James Bald as a Committee of Management for a period of three (3) years of the remaining portion of the land temporarily reserved by Order in Council dated 2nd October, 1923, as a site for Public Recreation purposes in the Parish of Drik Drik, and known as the "Greenwald Recreation Reserve."—(Corres. Rs.2853.)

"KAMAROOKA RECREATION RESERVE."

Hans Frederik Pedersen, Bruce Albert Cail, Claus Henry Ludemann, John Home Hay, and Thomas Keith Watson as a Committee of Management for a period of three (3) years of the land temporarily reserved by Order in Council of 18th April, 1950, as a site for Public Recreation in the Parish of Kamarooka, and known as the "Kamarooka Recreation Reserve."—(Corres. Rs.6529.)

In witness whereof the common seal of the Board of Land and Works was hereunto affixed this 17th day of May, One thousand nine hundred and fifty, in the presence of—

(SEAL)

R. C. GUTHRIE, President.
J. E. HUNTER, Member.

Land Act 1928.

LICENCES UNDER THE LAND ACTS 1915 AND 1928 DECLARED VOID.

NOTICE is hereby given that the Licences in the Schedule hereunder have been declared void for the reason specified in each case.

District.	Corr. No.	Name of Licensee.	Section of Land Act under which Licensed.	Parish.	Allotment.	Section.	Area.	Annual Rental.	Reasons for Voiding.
							A. R. P.	£ s. d.	
Bairnsdale	25/129	George De Courcey James	129	Bairnsdale ..	Opposite 164	..	Shed and jetty site	0 10 0	Expired
Geelong ..	75/129	Idris Cyrmic Jones ..	129	Paywit ..	Abutting 8 and 9	3	15 0 0	1 0 0	Non-compliance with conditions
Geelong ..	34/129	Estate of John Henry Martin (deceased)	129	Durridwarrah	69c	..	2 0 0	1 0 0	Non-payment of rent and non-compliance with conditions
Melbourne	02291/129	Jane Eliza Little ..	129	Neerim, Township of Crossover	16	..	2 3 39	1 0 0	Non-compliance with conditions
Stawell ..	814/145	Bessie Jack ..	145	Boroka ..	Adjoining 6A	..	2 3 37	0 1 0	Non-payment of rent and non-compliance with conditions

Department of Lands and Survey,
Melbourne, 24th May, 1950.

R. C. GUTHRIE,
Commissioner of Crown Lands and Survey.

THE CLOSER SETTLEMENT ACTS.

NOTICE is hereby given that the Board of Land and Works has accepted the surrender of the leases mentioned in the Schedule hereunder for the reason specified.

LEASES UNDER THE CLOSER SETTLEMENT ACT 1938.

Corr.	District.	Lessee.	Allotment.	Section.	Parish.	Area.	Reason.
						A. R. P.	
595/12	Mallee ..	Dennis, E. A. ..	27, 27A and 29	..	Karawinna ..	1,524 1 4	The Lessees named have accepted compensation pursuant to the provisions of the North-west Mallee Settlement Areas Act 1948
637/12	Mallee ..	Found, A. E. ..	8 and 9	..	Tunart ..	1,229 0 26	" " "
891/12	Mallee ..	McMahon, J. H. ..	13, 27 and 27A	..	Morrinee ..	1,579 2 2	" " "
689/12	Mallee ..	Harker, F. H. ..	2 and 3	..	Tunart ..	1,608 2 0	" " "
552/12	Mallee ..	Collard, F. F. ..	18 and 19	..	Yarrara ..	1,562 0 27	" " "
506/12	Mallee ..	Bury, R. W. (deceased)	8 and 9A	..	Meringur ..	1,181 0 23	" " "

J. E. HUNTER,
Secretary for Lands.

24th May, 1950.

LIST OF CROWN LANDS AVAILABLE.

THE under-mentioned areas are available for application as provided by various sections of the Land Act 1928, and all applications received on or before Wednesday, 21st June, 1950, will be deemed to have been simultaneously made, but any application lodged after such date may be considered if received in time for inclusion in the advertisement of the cases to be heard at the Local Land Board. Applications on proper form, accompanied by 5s. duty stamp uncancelled (registration fee), may be delivered or forwarded by post to the Local Land Officer or to any Crown Lands Office in Victoria. Applicants may obtain from Local Land Officers, or the Lands Department, Melbourne, a certificate authorizing the issue by the Railway Department of a return ticket at concession fares to enable them to inspect available areas or to attend Local Land Boards. When an applicant is granted an allotment he may, if travelling by rail, obtain reduced fares for his family and also freight concessions in regard to some of his effects.

Subject to the approval of the Secretary for Lands, when the survey fee exceeds £25 but does not exceed £50, a deposit of £25 may be paid, and when the fee exceeds £50 a deposit of 50 per cent. of the fee, the balance in either case being payable over six years in half-yearly instalments.

Marked plans of any particular area, application forms, and any further information may be obtained from the Lands Department, Melbourne, and Land Officer, Bendigo.

Department of Crown Lands and Survey,
Melbourne, 24th May, 1950.

R. C. GUTHRIE,
Commissioner of Crown Lands and Survey.

* Improvements may be subject to re-valuation after land has been granted to an applicant.

Local Land Office.	County.	Parish.	Allotment.	Section.	Area.	How Available.		Survey Fee.	Valuation of Improvements (if any).	Location of Land, &c.	Nearest Railway Station and Distance in miles therefrom.	How Accessible.	Water Supply.	General Description of Land—Soil, Timber, Suitability (grazing, &c.).	
						Classification.	Value per Acre.								
						A. R. P.	£	s.	d.						
Bendigo (a) b)	Gladstone	Tarnagulla	12j	C	92 0 0	3rd	1 0 0	15 10 0	Nil	In north-west of parish	Arnold about 4 miles	By road	To be conserved	Undulating; covered with green box and mallee; soil poor and gravelly; suitable for grazing. (W.63061)	
AVAILABLE UNDER SECTION 129, LAND ACT 1928.															
Bendigo (a)	Bendigo	Borough of Eaglehawk Parish of Sandhurst	484C	M	0 0 28	Residence	Annual rental to be fixed	3 15 0	Nil	Fronting Wood-street	Eaglehawk R.S., 1 1/4 mile	By road	Reticulation	Good sloping well drained land; suitable for a residence site. (W.66753)	
"	"	"	484D	M	0 0 28	"	"	3 15 0	"	"	"	"	"	"	
"	"	"	484E	M	0 0 28	"	"	3 15 0	"	"	"	"	"	"	
"	"	"	484F	M	0 0 28	"	"	5 12 6	"	In north-west of parish	Yungerra R.S., 4 miles	"	To be conserved	Dwelling site. (M.32627)	
"	Tatchera	Narrung	1A	"	2 0 0	"	"	"	"	"	"	"	"	"	

(a) Subject to survey. (b) Subject to mining condition.

PUBLIC SERVICE NOTICES.

PUBLIC SERVICE OF VICTORIA.—VACANCY.

TEMPORARY APPOINTMENT.

APPLICATIONS will be received by the Public Service Board up to Wednesday, the 7th June, 1950, from persons who are qualified, for appointment to the under-mentioned position:—

Inspector, Grade I, Department of Water Supply.

Yearly Salary.—£396, minimum; £422, maximum.

Duties.—To carry out general inspection of buildings and quarters; to prepare reports, and to supervise the erection and maintenance in connexion therewith.

Qualifications.—To have approved technical qualifications and a comprehensive knowledge of the building trades; to be capable of preparing estimates of costs of works.

NOTE.—In addition to the salary rates quoted, a cost of living adjustment £114 a year for adult males, which varies in accordance with the rise or fall in the index number of the cost of living, is payable.

By order,

E. F. FITZGIBBON,
Secretary.

Office of the Public Service Board,
Melbourne, 22nd May, 1950.

PUBLIC SERVICE OF VICTORIA.—VACANCIES.

APPLICATIONS will be received by the Public Service Board up to Wednesday, the 7th June, 1950, from persons employed in the Public Service of Victoria, who are eligible and qualified, for appointment to the under-mentioned positions:—

PROFESSIONAL DIVISION.

Inspector of Boilers, Grade I, Class "C1," Boiler Inspection Branch, Department of Mines.

Yearly Salary.—£553, minimum; £605, maximum.

Duties.—To inspect and test steam boilers and pressure vessels, under the Boilers Inspection Act.

Qualifications.—To possess a Degree in Mechanical Engineering, a Technical School Diploma in Mechanical Engineering, or a Board of Trade Certificate (Marine); to have had not less than five years' practical experience in the manufacture and working of boilers and other pressure vessels; to be of average build.

NOTE.—The successful applicant may be required to reside at a country centre.

Draughtsman, Class "D," Department of Public Works.

Yearly Salary.—£325, minimum; £436, maximum.

Duties.—To draft plans for civil engineering works, and to assist in making field surveys, reports, estimates, &c.

Qualifications.—To be a competent survey and engineering draughtsman, with technical school training in civil engineering.

TECHNICAL AND GENERAL DIVISION.

Head Attendant, Grade I, Kew Mental Hospital, Department of Health.

Salary.—£493 a year.

Duties.—Under direction of Medical Superintendent, to have charge of male division—staff and patients.

Qualifications.—To possess Mental Hygiene Nursing Certificate, experience in a senior position in a mental hospital, tact and ability to control patients and staff, and to compile reports and records relating to these duties.

Head Attendant, Grade II, Bundoora Mental Hospital, Department of Health.

Salary.—£462 a year.

Duties.—Under direction of Medical Superintendent, to have charge of male division—staff and patients.

Qualifications.—To possess Mental Hygiene Nursing Certificate, experience in a senior position in a mental hospital, tact and ability to control patients and staff, and to compile reports and records relating to these duties.

Forest Overseer, Grade II, Department of State Forests.

Yearly Salary.—£371, minimum; £423, maximum.

Duties.—To supervise operations of forest employees and licensees, and to carry out general and fire patrol duties.

Qualifications.—To possess a knowledge of the Victorian Forests Act and Regulations, and of office procedure, and to have practical experience of field methods and operations in the State Forests Department.

Attendant (Male), Children's Welfare Branch, Department of Chief Secretary. (Two vacancies.)

Yearly Salary.—£299, minimum; £351, maximum.

Duties.—To assist in the care and supervision of junior and senior boys, and to perform such duties as the Medical Superintendent may from time to time direct.

Qualifications.—To be temperamentally and otherwise competent to supervise boys either individually or in a group. The possession of First Aid and Home Nursing Certificate and experience in conducting physical training and organizing games are desirable.

Assistant (Female), Grade IV., Motor Registration Branch, Office of the Chief Commissioner of Police, Department of Chief Secretary.

Yearly Salary.—£286, minimum; £299, maximum.

Duties.—To assess new registrations and re-registrations from country police stations, and to assess insurance premiums on same.

Qualifications.—To possess a thorough knowledge of the Motor Car Acts and Motor Car (Third-Party Insurance) Act; to be a competent typist.

NOTE.—In addition to the salary rates quoted, a cost of living adjustment (£114 a year for adult males and £76 a year for adult females, which varies in accordance with the rise or fall in the index number of the cost of living, is payable.

By order,

E. F. FITZGIBBON,
Secretary.

Office of the Public Service Board,
Melbourne, 22nd May, 1950.

PUBLIC SERVICE EXAMINATION.—ADMINISTRATIVE DIVISION.

AT the examination held on 22nd April, 1950, the under-mentioned candidates passed the required standard, in the order of merit indicated:—

Order of Merit.	Name.
1	*Pick, Walter.
2	*Petherick, Alfred Eustace.
3	*Burgoyne, Alfred Leonard.
4	*Ames, Robert Allen.
5	*Cumming, George Hector.
6	*Hearsum, Michael Corbett.
7	*Walter, Noel George.
8	*Wilson, John Donald.
9	*Gould, Sydney.
10	*Malouf, Kevin Michael.
11	*Dreger, William Maurice.
12	*Goodwin, Robert Templeton.
13	Vanderfeen, John Joseph.
14	Barrett, John Joseph.
15	Blackall, Michael Damien.
16	Douglas, John Gordon.
17	Nelson, John William Pengilly.
18	De Kretser, Percival Shirley.
19	Franklin, John Alister.
20	Thorley, Carlyle Howard.
21	Boreham, Leslie Squire.
22	Drayton, Eric Noel.
23	Scully, Thomas Joseph.
24	Alhadeif, Nissim.
25	Favaloro, Phillip Reginald.
26	Kerrins, Francis Gerald.
27	Rosetti, Geoffrey Sands.
28	Whisson, Kenneth Ronald.
29	Wallach, Arthur.
30	Croft, Donald Linton.
31	Pearce, Brian Redmond.
32	Serong, Thomas Andrew.
33	Hamilton, Alan Bruce.
34	Fountain, Ian Findlay.
35	Uhd, Robert Gordon Patrick.
36	Dugan, John Milton.
37	Jones, Donald Ivor.
38	Lescai, Thomas Vincent Michael.
39	Boyes, Raymond Keith.
40	Healy, James Joseph Francis.
41	Rose, Kevin Ronald.
42	Levin, Osher.
43	Catania, Carmel Renato.

* Discharged serviceman.

Candidates who have not already done so should immediately furnish the Board with documentary evidence of their educational qualifications.

By order,

E. F. FITZGIBBON,
Secretary.

Office of the Public Service Board,
Melbourne, 23rd May, 1950.

No. 765.

Public Service Act 1946, Section 50.

REGULATIONS.—PART III.—SALARIES, INCREMENTS, AND ALLOWANCES.

THE Public Service Board, in pursuance of the powers conferred by the Public Service Act 1946, hereby amends its Regulations as shown below:—

SIXTH SCHEDULE.

TEMPORARY EMPLOYEES.

Designations of Positions and Rates of Salaries.

Department and Designation of Position.	Yearly Rate of Salary.		Increments (Annual).
	Minimum.	Maximum.	
DEPARTMENT OF PREMIER.			
SOIL CONSERVATION AUTHORITY.			
<i>Delete—</i>			
Field Officer	397	462	2 of £26 and 1 of £13
<i>Add—</i>			
Field Officer, Assistant—Junior—			
At 18 years of age		254	
At 19 years of age		267	
At 20 years of age		280	
Adult	345	384	1 of £13 and 1 of £26
<i>Add—</i>			
Field Officer	436	501	2 of £26 and 1 of £13
<i>Add—</i>			
Field Officer, Assistant—Junior—			
At 18 years of age		254	
At 19 years of age		267	
At 20 years of age		280	
Adult	371	423	2 of £26
DEPARTMENT OF AGRICULTURE.			
<i>Delete the existing yearly rates of salary for the following positions and insert the rates shown hereunder in lieu thereof—</i>			
Apiary Inspector	410	462	2 of £26
Assistant Herd Survey Officer	416	462	1 of £20 and 1 of £26
Butter Maker, Assistant, School of Dairy Technology		344*	
Dairy Factory Foreman, School of Dairy Technology		455*	
Dairy Herd Foreman	422	461†	1 of £26 and 1 of £13
Dairy Produce Inspector	553	618	2 of £26 and 1 of £13
Dairy Supervisor	423	488‡	2 of £26 and 1 of £13
Dairy Supervisor, Senior	540	566‡	1 of £26
Farm Produce Inspector	384	488‡	4 of £26
Field Officer	436	501‡	2 of £26 and 1 of £13
<i>Add—</i>			
Field Officer, Assistant—Junior—			
At 18 years of age		254	
At 19 years of age		267	
At 20 years of age		280	
Adult	371	423‡	2 of £26 and 1 of £13
Fruit Inspector	384	488‡	4 of £26
Fruit Packing Instructor, Assistant	384	488‡	4 of £26
Herd Test Organiser	384	436	2 of £26
Horticultural Supervisor	449	527	3 of £26
Inspector of Stock	423	488‡	2 of £26 and 1 of £13
Live Stock, Field Officer	371	449	3 of £26
Orchard Supervisor	397	488‡	3 of £26 and 1 of £13

SIXTH SCHEDULE—continued.

Department and Designation of Position.	Yearly Rate of Salary.		Increments (Annual).
	Minimum.	Maximum.	
DEPARTMENT OF AGRICULTURE—continued.			
Orchard Inspector	£	£	
Potato Inspector	384	488‡	4 of £26
Poultry Expert, Assistant	330	408	3 of £26
Seeds Inspector	384	488	4 of £26
Vegetable Supervisor	371	475‡	4 of £26

* Subject to a charge of 10 per cent. of total emolument payable by way of salary for rent, or of £52 a year for board and lodging as the case may be.

† With quarters.

‡ Employees appointed prior to the 25th February, 1946, shall receive a further increment of £13 after twelve months' satisfactory service on the maximum rate of salary.

This Regulation shall have effect as on and from the 1st January, 1950.

D. D. PAINE, Chairman.

E. F. FITZGIBBON, Secretary.

Office of the Public Service Board,
Melbourne, 12th May, 1950.

No. 763.

Public Service Act 1946.

REGULATIONS.—PART III.—SALARIES, INCREMENTS, AND ALLOWANCES.

THE Public Service Board, in pursuance of the powers conferred by the Public Service Act 1946, hereby amends the Public Service (Public Service Board) Regulations as follows:—

FOURTH SCHEDULE.

ADMINISTRATIVE DIVISION.

Amount or Range of Salary Assigned to Offices in Class "A1," Classes "A" and "A1," and Class "A."

Office.	Yearly Rate of Salary.	
	Minimum.	Maximum.
DEPARTMENT OF EDUCATION.		
CLASS "A."		
<i>Add—</i> Chief Clerk	900	950

D. D. PAINE, Chairman.

E. F. FITZGIBBON, Secretary.

Office of the Public Service Board,
Melbourne, 11th May, 1950.

No. 766.

Public Service Act 1946, Section 50.

REGULATIONS.—PART III.—SALARIES, INCREMENTS, AND ALLOWANCES.

THE Public Service Board, in pursuance of the powers conferred by the Public Service Act 1946, hereby amends its Regulations as shown below:—

SIXTH SCHEDULE.

TEMPORARY EMPLOYEES.

Designations of Positions and Rates of Salaries.

Department and Designation of Position.	Yearly Rate of Salary.		Increments (Annual).
	Minimum.	Maximum.	
DEPARTMENT OF HEALTH.			
GENERAL HEALTH.			
<i>Add—</i>			
Social Worker (Female), Grade I	338	364	
Social Worker (Female), Grade II	377	429	2 of £26
Social Worker (Female), Assistant	299	338	

D. D. PAINE, Chairman.

E. F. FITZGIBBON, Secretary.

Office of the Public Service Board,
Melbourne, 8th May, 1950.

No. 764.

Public Service Act 1946, Section 50.

REGULATIONS—PART III.—SALARIES, INCREMENTS, AND ALLOWANCES.

THE Public Service Board, in pursuance of the powers conferred by the Public Service Act 1946, hereby amends its Regulations as shown below:—

SECOND SCHEDULE.
TECHNICAL AND GENERAL DIVISION.
Offices and Rates of Salaries.

Department and Office.	Yearly Rate of Salary.		Increments (Annual).
	Minimum.	Maximum.	
DEPARTMENT OF PREMIER.	£	£	
SOIL CONSERVATION AUTHORITY.			
<i>Delete—</i> Field Officer	397	475	3 of £26
<i>Add—</i> Field Officer	436	514	3 of £26
DEPARTMENT OF AGRICULTURE.			
<i>Delete—</i> Herd Tester, Senior	408	434	1 of £26
<i>Delete the existing yearly rates of salary for the following offices and insert the rates shown hereunder in lieu thereof—</i> Apiary Inspector, Senior	475	514	1 of £26 and 1 of £13
Apiary Inspector	410	475	2 of £26 and 1 of £13
Beet Field Supervisor	324	415	2 of £13, 2 of £26, and 1 of £13
Butter Substitutes Officer	384	501	4 of £26 and 1 of £13
Curator, Egg Laying Competition, Burnley	362	388*	1 of £26
Dairy Produce Inspector, Accounts	579	670	3 of £26 and 1 of £13
Dairy Produce Inspector, Senior	696	761	2 of £26 and 1 of £13
Dairy Produce Inspector	553	618	2 of £26 and of £13
Dairy Supervisor, Senior	540	579	1 of £26 and 1 of £13
Dairy Supervisor	423	501	3 of £26
Engineer, Second, Government Cool Stores	462	534	2 of £26 and 1 of £20
Farm Produce Inspector	384	501	4 of £26 and 1 of £13
Field Officer, Potato	436	514	3 of £26
Field Officer	436	514	3 of £26
Field Officer, Assistant— Junior— At 18 years of age	254	
At 19 years of age	267	
At 20 years of age	280	
Adult	371	436	2 of £26 and 1 of £13
Fruit Inspector, Assistant, Senior	514	540	1 of £26
Fruit Inspector	384	501	4 of £26 and 1 of £13
Fruit Packing Instructor	514	540	1 of £26
Fruit Packing Instructor, Assistant	384	501	4 of £26 and 1 of £13
Inspector of Stock, Senior	501	527	1 of £26
Inspector of Stock	423	501	3 of £26
Officer in Charge, Wahgunyah Nursery	488	527	1 of £26 and 1 of £13

SECOND SCHEDULE—continued.

Department and Office.	Yearly Rate of Salary.		Increments (Annual).
	Minimum.	Maximum.	
DEPARTMENT OF AGRICULTURE— <i>continued.</i>	£	£	
Orchard Inspector, Senior Assistant	553	605	2 of £26
Orchard Supervisor, Grade I. . .	501	527	1 of £26
Orchard Supervisor, Grade II. . .	397	501	4 of £26
Potato Inspector, Senior	540	618	3 of £26
Potato Inspector	384	501	4 of £26 and 1 of £13
Seeds Inspector, Senior	540	618	3 of £26
Seeds Inspector	384	501	4 of £26 and 1 of £13
Technical Assistant, Plant Research Laboratory, Burnley	423	514	3 of £26 and 1 of £13
Technician Projectionist	540	
Tomato Supervisor	384	501	4 of £26 and 1 of £13
Vegetable Supervisor	384	501	4 of £26 and 1 of £13
MLK BOARD.			
Inspector, Senior	540	579	1 of £26 and 1 of £13
Inspector	423	501	3 of £26
Provincial Officer, Senior	507	546	1 of £26 and 1 of £13

* Less deduction of £30 a year for quarters, &c.

This Regulation shall have effect as on and from the 1st January, 1950.

D. D. PAINE, Chairman.

E. F. FITZGIBBON, Secretary.

Office of the Public Service Board,
Melbourne, 12th May, 1950.

No. 767.

Public Service Act 1946, Section 39.

REGULATIONS.—PART III.—SALARIES, INCREMENTS, AND ALLOWANCES.

THE Public Service Board, in pursuance of the powers conferred by the Public Service Act 1946, hereby amends its Regulations as shown below:—

FIRST SCHEDULE.

PROFESSIONAL DIVISION.

Offices and Rates of Salaries.

Office.	Yearly Rate of Salary.	
	Minimum.	Maximum.
DEPARTMENT OF PUBLIC WORKS.	£	£
CLASS "B."		
<i>Add—</i> Pilot and Harbour Master, Portland*	709
CLASS "C."		
<i>Delete—</i> Pilot and Harbour Master, Portland	462	534

* Subject to a charge of 10 per cent. of total emolument payable by way of salary for rent.

This Regulation shall have effect as on and from the 1st January, 1950.

D. D. PAINE, Chairman.

E. F. FITZGIBBON, Secretary.

Office of the Public Service Board,
Melbourne, 16th May, 1950.

PUBLIC SERVICE (PUBLIC SERVICE BOARD) REGULATION 36A.—RECLASSIFICATIONS.

THE Public Service Board has raised the classification of the under-mentioned offices as shown, and the Permanent Heads of the Departments have recommended the officers named for appointment.

Office and Present Classification.	Revised Classification.	Duties.	Qualifications.	Officer Recommended for Appointment.		
				Name.	Classification.	Date of Classification.

ADMINISTRATIVE DIVISION.

DEPARTMENT OF FORESTS.

Clerk, Class "D"	Class "C"	To prepare wages sheets and act as Pay Clerk; to supervise the receipt and issue of spare parts, tools, &c.; to attend to correspondence and supervise the clerical work at the Commission's Brookwood workshops	To have a thorough knowledge of awards relating to engineering workshop employees; to have a knowledge of the operation of a store having large stocks of spare parts, tools, &c.; to be competent in the calculation of wages; to have a good general knowledge of the costing of mechanical engineering repair jobs and capable of controlling and directing staff	Tregillis, L. E.	Clerk, Classes "E" and "D"	2.9.35
------------------	-----------	--	--	------------------	----------------------------	--------

DEPARTMENT OF WATER SUPPLY.

Clerk, Class "C"	Class "C1"	To assist the officer in charge of the Records Branch and to take charge of the branch in his absence	To have a good general knowledge of the operations of the Commission; to have a thorough knowledge of records procedure and filing systems and to have had extensive experience in handling correspondence	Morris, J. W.	Clerk, Class "C"	21.3.48
------------------	------------	---	--	---------------	------------------	---------

Appeals against such recommendations should be lodged with the Secretary to the Public Service Board not later than Saturday, the 3rd June, 1950.

By order,

Office of the Public Service Board,
Melbourne, 22nd May, 1950.

E. F. FITZGIBBON,
Secretary.

Teaching Service Act 1946.

TEACHING SERVICE (TEACHERS TRIBUNAL) REGULATIONS.

THE Teachers Tribunal, in pursuance of the powers conferred by the *Teaching Service Act 1946*, hereby amends Regulation 1 of the Teaching Service (Teachers Tribunal) Regulations, made on the twenty-ninth day of October, 1946, and published in the *Government Gazette* of the thirtieth day of October, 1946, in the manner following, that is to say.—

REGULATION 1.

In sub-clause 11 (a) "Committed Allowances for District Inspectors", delete the following expressions:—

"Bairnsdale"	£310 a year.
Ballarat"	£95 a year.
Geelong"	£140 a year.
Seymour"	£275 a year.
South Gippsland"	£250 a year."

W. H. ELLWOOD, Chairman.

E. V. B. HIGGINS, Acting Secretary.

Office of the Teachers' Tribunal,
Melbourne, 17th May, 1950.

TENDERS.

TENDERS will be received at this office until **TEN A.M.** on the days and for the purposes under mentioned.

Particulars may be learnt at this Office and also at places shown in parenthesis.

W.O. means Inspector of Works Office; P.S.—Police Station; T.S.—Technical School; H.E.S.—Higher Elementary School; S.S.—State School; H.S.—High School; P.D.—Preliminary deposit; F.D.—Final deposit.

The Board of Land and Works will not necessarily accept the lowest or any tender.

30th May, 1950.

Anglesea.—Installation of septic tank system and alterations to out-offices, S.S. No. 4332. (W.O., Geelong; S.S., Anglesea.) P.D., £5. F.D., 2 per cent.

Ararat.—Erection of timber and brick storage sheds for vegetables and fertilizer, Mental Hospital. (W.O., Ararat; P.S., Stawell; Mental Hospital, Ararat.) P.D., £15. F.D., 2 per cent.

Ararat.—Remodelling and re-equipment of main and staff kitchen, Mental Hospital. (W.O., Ararat, Ballarat; P.S., Stawell; Mental Hospital, Ararat.) P.D., £25. F.D., 2 per cent.

Balook.—Erection of standard teacher's residence, S.S. No. 2719. (W.O., Traralgon; S.S., Balook.) P.D., £15. F.D., 2 per cent.

Camperdown.—Extension of central heating, H.S. (W.O., Camperdown.) P.D., £5. F.D., 2 per cent.

Coghill's Creek.—Installation of septic tank and alterations to out-offices, S.S. No. 1523. (W.O., Ballarat; S.S., Coghill's Creek.) P.D., £5. F.D., 2 per cent.

Eaglehawk.—Supply and installation of a hot-water service, teacher's residence, Victoria-street. (W.O., Bendigo; S.S., Eaglehawk.) Deposit, £3.

Geelong.—Alterations, &c., Teachers College Hostel, "Lauriston," 23 Aberdeen-street. (W.O., Geelong.) P.D., £15. F.D., 2 per cent.

Hawthorn.—Repairs and painting to eaves and roofs, "Loch Rae," 12 Lisson-grove. P.D., £10. F.D., 2 per cent.

Kooroocheang.—Provision of new porch, alterations, repairs, and painting, S.S. No. 1055. (W.O., Ballarat; P.S., Daylesford; S.S., Kooroocheang.) P.D., £10. F.D., 2 per cent.

Macarthur.—Alterations to school building, S.S. No. 1561. (W.O., Hamilton, Warrnambool; S.S., Macarthur.) P.D., £5. F.D., 2 per cent.

Melbourne.—Supply and installation of fuel hot-water service, Transport Regulation Board, Exhibition Building. P.D., £15. F.D., 2 per cent.

Melbourne.—Supply and installation of dishwasher and benches at Hostel, Emily McPherson College of Domestic Economy. P.D., £5. F.D., 2 per cent.

Merino.—Alterations and additions, Consolidated School. (W.O., Hamilton, Warrnambool.) P.D., £20. F.D., 2 per cent.

Mirboo.—Repairs, painting, &c., to school and residence, S.S. No. 3437. (W.O., Korumburra; P.S., Trafalgar; S.S., Mirboo.) P.D., £5. F.D., 2 per cent.

Preston.—Repairs to all single-storey roofs and to parapets, gutters, flashings, &c., T.S. (T.S., Preston.) P.D., £10. F.D., 2 per cent.

Stawell.—Re-covering roofs to main and "Syme" ward buildings, repairs and painting to all buildings, Pleasant Creek Special School. (W.O., Ararat, Horsham; Pleasant Creek Special School, Stawell.) P.D., £15. F.D., 2 per cent.

Sunbury.—Provision of six (6) skylights in kitchens of "Hill Wards" Nos. F.4, F.5, F.6, M.4, M.5, and M.6, Mental Hospital. (Mental Hospital, Sunbury.) P.D., £5. F.D., 2 per cent.

Swan Hill.—Removal of S.S. No. 4291, Nowie South, and S.S. No. 4391, Bulga West, re-erection, repairs, and painting, H.S. (W.O., Swan Hill.) P.D., £10. F.D., 2 per cent.

Tarnagulla.—Extension to partitions, provision of new doors, heating stoves and skylights, S.S. No. 1023. (W.O., Bendigo, Maryborough; P.S., Castlemaine; S.S., Tarnagulla.) P.D., £4. F.D., 2 per cent.

Terang.—Conversion of residence at corner of Dow and Emeny streets, Terang, into No. 2 self-contained flats, H.E.S. (W.O., Warrnambool, Camperdown; H.E.S., Terang.) P.D., £15. F.D., 2 per cent.

Tongala.—Removal of S.S. No. 1851, Tongala East, and re-erection, &c., S.S. No. 3776. (W.O., Shepparton; P.S., Tongala; S.S., Tongala.) P.D., £5. F.D., 2 per cent.

West Melbourne.—Alterations and additions to existing building, Printing Trades School, Queensberry-street. P.D., £25. F.D., 2 per cent.

Yallourn.—Extension and restoration of building from Hillside No. 4, H.S. (W.O., Traralgon; P.S., Warragul; H.S., Yallourn.) P.D., £15. F.D., 2 per cent.

6th June, 1950.

Armada.—Installation of new toilet and enclosing balcony, "Trelowarren," After-Care Home, 39 Orrong-road. P.D., £4. F.D., 2 per cent. (Amended specification.)

Brighton.—Additional lavatory accommodation, Infants' School, S.S. No. 1542. (S.S., Brighton.) P.D., £5. F.D., 2 per cent.

Carlton North.—Erection of brick station, P.S., Fenwick-street. P.D., £20. F.D., 2 per cent.

Dooen.—Additions to Experimental Barn, Longerenong Agricultural College. (W.O., Horsham; Longerenong Agricultural College, Dooen.) P.D., £5. F.D., 2 per cent.

Kaniva.—Electrical installation, Senior Wing, Consolidated School. (W.O., Horsham; P.S., Kaniva.) P.D., £5. F.D., 2 per cent.

Kew.—Supply and installation of additions, &c., to hot-water services, Mental Hospital. P.D., £15. F.D., 2 per cent.

Kyabram.—Extension of sleep-out and kitchen, and connection to town sewerage, residence, S.S. No. 2902. (W.O., Shepparton; S.S., Kyabram.) P.D., £7. F.D., 2 per cent.

Melbourne.—Supply and installation of extensions to central heating system, Physics School, University. P.D., £20. F.D., 2 per cent.

Port Melbourne.—Erection of new film store, Lands and Survey Department, Salmon-street. P.D., £20. F.D., 2 per cent.

Richmond.—Erection of new building and demolition of existing building on completion, Girls' School. P.D., £100. F.D., 2 per cent. (Quantities available.)

Rutherglen.—Remodelling and additions to dairyman's cottage, Research Station. (W.O., Wangaratta; P.S., Wodonga; Research Station, Rutherglen.) P.D., £15. F.D., 2 per cent.

Stanhope South.—Supply and installation of a fuel hot-water service, teacher's residence, S.S. No. 4325. (W.O., Shepparton; P.S., Echuca.) P.D., £3. F.D., 2 per cent.

Williamstown.—Supply and delivery of twelve steel buoys, Ports and Harbors.

13th June, 1950.

Ararat.—Erection of new building, P.S. (W.O., Ararat, Ballarat; P.S., Ararat, Stawell.) P.D., £25. F.D., 2 per cent.

Camberwell.—Additional lavatory accommodation, S.S. No. 888. P.D., £4. F.D., 2 per cent.

Eagle Point.—Erection of teacher's residence, S.S. No. 3215. (W.O., Bairnsdale; S.S., Eagle Point.) P.D., £15. F.D., 2 per cent.

Footscray.—Erection of a safety fence, S.S. No. 1912. P.D., £5. F.D., 2 per cent.

Hamilton.—Erection of timber residence, S.S. No. 295. (W.O., Hamilton; S.S., Hamilton.) P.D., £15. F.D., 2 per cent.

Hamilton.—Erection of two (2) teachers' residences in timber, H.S. (W.O., Hamilton; H.S., Hamilton.) P.D., £20. F.D., 2 per cent.

Hazelwood South.—Erection and completion of teacher's residence and out-buildings, S.S. No. 3350. (W.O., Traralgon; P.S., Warragul; S.S., Hazelwood South.) P.D., £15. F.D., 2 per cent.

Lake Tyers.—Alterations to dairy and butcher's shop, Aboriginal Station. (W.O., Bairnsdale; Aboriginal Station, Lake Tyers.) P.D., £4. F.D., 2 per cent.

Learmonth.—Erection of new police office and two (2) new out-offices, P.S. (W.O., Ballarat; P.S., Learmonth.) P.D., £10. F.D., 2 per cent.

Mardan South.—Alteration and restoration of teacher's residence, S.S. No. 3166. (W.O., Korumburra; S.S., Mardan South.) P.D., £10. F.D., 2 per cent.

Melbourne.—Chimney sweeping, from 1st July, 1950, to 30th June, 1951, Government Buildings. Deposit, £5.

Melbourne.—Removal of garbage, from 1st July, 1950, to 30th June, 1951, Public Buildings. Deposit, £5.

Nhill.—Erection of new residence in timber, H.S. (W.O., Warracknabeal; H.S., Nhill.) P.D., £15. F.D., 2 per cent.

Seymour.—Additional out-office accommodation, H.S. (W.O., Alexandra; H.S., Seymour.) P.D., £10. F.D., 2 per cent.

South Yarra.—Renovations and new blackboards, S.S. No. 583. P.D., £10. F.D., 2 per cent.

Speewa.—Erection of new timber residence, type E.4.R., garage, out-buildings, and fencing, S.S. No. 4200. (W.O., Swan Hill; P.S., Echuca, Kerang.) P.D., £15. F.D., 2 per cent.

Tallangatta Valley.—Erection of teacher's residence, S.S. No. 2337. (W.O., Wangaratta; S.S., Tallangatta Valley.) P.D., £15. F.D., 2 per cent.

Yarra Park.—Internal painting and renovations, S.S. No. 1406. P.D., £10. F.D., 2 per cent.

Tenders to be addressed to the Honorable the Commissioner of Public Works, and envelope containing tender marked "Tender for

J. A. KENNEDY,

Commissioner of Public Works,

Melbourne, 23rd May, 1950.

PRIVATE ADVERTISEMENTS.

I, EDWARD JAMES THORPE, of 41 Charles-street, Ascot Vale, in the State of Victoria, hardware salesman, heretofore called and known by the name of Edward James Unwin, hereby give public notice that by a deed poll dated the 24th day of April, 1950, duly executed and attested and deposited with the Registrar-General of the said State, on the 28th day of April, 1950, I formally and absolutely renounced and abandoned the said surname of Unwin and declared that I had assumed and adopted and intended thenceforth upon all occasions whatsoever to use and subscribe the surname of Thorpe, instead of the said surname of Unwin, and so as to be at all times thereafter called and known and described by the said surname of Thorpe.

Dated the 1st day of May, 1950.

E. J. THORPE.

Witness—ELEANOR B. QUINTON, Justice of the Peace.

2907

NOTICE OF INTENTION TO APPLY FOR A LICENCE TO DIVERT WATER AND CUT RACES FROM THE MURRAY RIVER AT KARADOC.

I HEREBY give notice that I intend to apply for a licence empowering me to divert water for a term of fifteen years to the extent of 80 acre-feet per annum at a maximum rate of 3 acre-feet per day of 24 hours for irrigation purposes, and to occupy certain Crown lands for works of storage and diversion, and to cut a race thereon. Any objection to such application must be forwarded, in writing, to the State Rivers and Water Supply Commission, Melbourne, within 30 days of the date hereof.

CHARLES COTTRELL.

Red Cliffs, 18th May, 1950. 2875

AUSTRALIAN BARLEY BOARD.

FINAL DATE FOR DELIVERY OF BARLEY, No 11 POOL, SEASON 1949/50.

IN accordance with sub-clause 2 of clause 16 of the *Victorian Barley Marketing Act 1948*, the Australian Barley Board hereby notifies barley growers that the 30th June, 1950, is the final day on which barley of the No. 11 Pool, 1949/50 season's crop will be accepted, unless the grower makes and forwards a declaration in accordance with sub-clause 1 of clause 16 of the *Victorian Barley Marketing Act 1948*.

Dated 17th May, 1950.

2862

K. K. ANGEL, Secretary.

CITY OF BRUNSWICK.

BY-LAW No. 144.

A By-law of the City of Brunswick, made under the Uniform Building Regulations Victoria, prescribing types of materials to be used in the construction of certain classes of buildings.

IN pursuance of the powers conferred by the Uniform Building Regulations Victoria, clause 907, and of all other powers thereunto it enabling, the Mayor, Councillors, and Citizens of the City of Brunswick order as follows:—

1. No person shall construct or cause to be constructed in any portion of the municipal district of Brunswick any building of Class III., Class IV., Class V., Class VI., Class VII., Class VIII., or Class IX. occupancy, as described in Chapter 6 of the Uniform Building Regulations of Victoria, unless such building is Type 1, Type 2, or Type 3 construction, as described in Chapter 7 of the said Regulations.

2. In all other respects such building shall conform to the requirements of the said Uniform Building Regulations Victoria.

3. Any person guilty of an offence against this By-law shall be liable to penalties, impositions, and requirements prescribed by Regulations 301 to 307 inclusive of Chapter 3 of the Uniform Building Regulations 1945, Victoria.

In witness whereof the common seal of the Mayor, Councillors, and Citizens of the City of Brunswick was hereunto affixed this 24th day of April, 1950, in the presence of—

(SEAL)

JOHN HOLBROOK, Mayor.
C. A. J. DOLLMAN, Councillor.
H. W. FOLETTA, Town Clerk.

The aforesaid By-law was passed by Special Order of the Council on the 6th day of March, 1950, and was confirmed on the 17th day of April, 1950.—H. W. FOLETTA, Town Clerk.

Approved by the Governor in Council, 9th May, 1950.

2860

CITY OF FOOTSCRAY.

REGULATION No. 139.

A Regulation of the City of Footscray, numbered 139, made under section 4 of Part VI. of the Fifteenth Schedule of the *Local Government Act 1946*, in force in the City by virtue of a By-law of the above-named City, numbered 28, for appointing the times and hours during or at which respectively any registered hall or other building in the City of Footscray used for public meetings or any registered building or any registered ground within the said City in which public amusements are conducted shall be used for the purpose for which it is registered, or shall be closed.

IN pursuance of the powers conferred by the *Local Government Act 1946* and of every power it thereunder enabling, the Mayor, Councillors, and Citizens of the City of Footscray make the following Regulations, which shall apply to and have operation throughout the whole of the municipal district of the said City of Footscray:—

1. Regulations Nos. 32 and 68 are hereby repealed.

2. The times and hours during or at which respectively any registered hall or other building situate in the said City of Footscray used for public meetings or any registered building or any registered ground within the said City in which public amusements are conducted shall be used for the purpose for which such hall, building, or ground is registered shall be as follows:—

On the Monday, Tuesday, Wednesday, Thursday, Friday, and Saturday of each week from the hour of Eight o'clock in the morning until the hour of Twelve o'clock midnight.

3. The times and hours during or at which respectively any such registered hall or other building used for public meetings or any registered building or any ground in which public amusements are conducted shall be closed shall be from Twelve o'clock midnight on each week-day night to the hour of Eight o'clock in the morning of the next succeeding week-day.

Provided always that nothing in this Regulation contained shall extend or be applied to any registered hall or building to prevent the holding of public worship therein on Sundays, or lectures (without the use of a biograph or such like apparatus) of an educational nature between the hours of half-past Two and half-past Five o'clock on Sunday afternoons, or free instrumental performances conducted by bands or orchestras subsidized by the Council of the City of Footscray whereat collections only are to be made to defray expenses, between the hours of half-past Eight and half-past Ten o'clock on Sunday evenings.

Further provided that nothing in this Regulation contained shall extend or be applied to any registered hall or building to prevent the extension of the time for the holding of a ball therein on any Monday, Tuesday, Wednesday, Thursday, and Friday until Two o'clock a.m. on the next succeeding day.

Resolution for passing this Regulation agreed to by the Council of the City of Footscray on the 3rd day of April, 1950, and confirmed on the 8th day of May, 1950.

The common seal of the Mayor, Councillors, and Citizens of the City of Footscray was hereunto affixed by order of the Council, in the presence of—

(SEAL) H. J. McIVOR, Mayor.
W. W. HATTFELD, Councillor.
E. J. SMITH, Town Clerk.

2857

Local Government Act 1946.

CITY OF HEIDELBERG.

NOTICE TO ALL WHOM IT MAY CONCERN.

WHEREAS the Council of the municipality of the City of Heidelberg, in the State of Victoria, deems it expedient to execute a certain work or undertaking for the purpose of providing a place of public resort and recreation, for the purposes whereof it is in the opinion of the said Council necessary and desirable that the said Council exercise its power of taking land compulsorily within the municipal district of the said Council, as provided by the *Local Government Act 1946*, and the said Council has caused its surveyor to prepare specifications, maps, plans, sections, and elevations of the said work or undertaking as are necessary and in which are expressed the nature and extent of such work or undertaking and the exact site and admeasurements thereof and on and through what land the said work or undertaking is proposed to be placed and the names of the owners or reputed owners, lessees or reputed lessees, and the occupiers of such land so proposed to be taken so far as known, and the said specifications, maps, plans, sections, and elevations so prepared have been approved by the said Council.

In pursuance of the provisions of the *Local Government Act 1946*, the said Council doth hereby publish and give notice that the description shortly of the purport of the said work or undertaking and of the said specifications, maps, plans, sections, and elevations is as follows:—

The providing of a place of public resort and recreation in Austin and Alphington streets, Fairfield.

And the said Council doth hereby give further notice that the said specifications, maps, plans, sections, and elevations are deposited at the office of the said Council, Town Hall, Upper Heidelberg-road, Ivanhoe, and are there open for inspection and perusal on all the days and between the hours the Municipal Office is appointed to be open, for the space of 40 clear days from the date of the publication of this notice in the *Government Gazette*. And the said Council doth hereby call upon all persons interested in or affected by the said proposed work or undertaking to set forth, in writing, addressed to the said Council, or the Town Clerk thereof, at the Town Hall, Upper Heidelberg-road, Ivanhoe, within 40 clear days from the date of the publication of this notice as aforesaid, all objections which they may have to the said work or undertaking.

Dated this 15th day of May, 1950.

The common seal of the Mayor, Councillors, and Citizens of the City of Heidelberg was hereto affixed by me,

F. PHILLIPS, Town Clerk,
in the presence of—
(SEAL) C. E. TUTTLEBY, Mayor.
H. GRAHAM, Councillor.

2872

CITY OF MOORABBIN.

ORDER CHANGING NAME OF STREET.

NOTICE is hereby given that at a Meeting of the Council of the City of Moorabbin held on 1st May, 1950, the said Council, in pursuance of the provisions of the *Local Government Act 1946*, did make an order changing the name of the street set out hereunder, that is to say:—

Old name.—Huntly-road.

New name.—Wallace-crescent.

Location.—Between Alfred-street and Wallace-crescent, Cheltenham.

2887

WILSON B. THOMAS, Town Clerk.

TOWN OF CASTLEMAINE.

BY-LAW No. 100.

A By-law of the Town of Castlemaine, made under section 80 of the Health Acts, and numbered 100, for the purpose of regulating or prohibiting of the keeping of any place of any animals (including birds) or the storage of any things in the opinion of the Council offensive, injurious to health, or dangerous.

IN pursuance and in exercise of the powers conferred by the Healths Acts and every other Act or power enabling it in that behalf, the Mayor, Councillors, and Citizens of the Town of Castlemaine, with the approval of the Governor in Council, doth hereby make the following By-law, and order as follows:—

1. All existing By-laws of the Council (if any) so far as they relate to matters and things provided for herein shall be and are hereby repealed.

2. This By-law shall have force and apply throughout the whole of the municipal district of the Town of Castlemaine, and shall come into operation on its approval by the Governor in Council and immediately after its publication in the *Victoria Government Gazette*.

3. Throughout this By-law, unless inconsistent with the context or subject matter:—

"Council" means the Council of the Town of Castlemaine.

"Inspector" means the Inspector of Health of the Town of Castlemaine, or person authorized by the Council to act under this By-law.

"Animal" shall mean and include every animal other than an animal described as a domestic animal.

"Domestic animal" shall mean and include the ass, mule, cow, calf, goat, dog, cat, and horse.

"Bird" shall mean and include every bird other than a bird described as a domestic bird.

"Domestic bird" shall mean and include turkey, goose, duck, fowl, pigeon, and song bird.

"Property" shall include any tenement or land in separate occupation.

"Dwelling" includes living room, sleepout, or tent.

"Poultry yard" includes buildings, pens, roosts, yards, runs, or other enclosures or places wherein domestic birds are kept or congregate.

4. No person shall keep or cause or permit to be kept any animal or bird other than domestic animals or domestic birds on any property without the written permission of the Council.

Before granting such permission the Council shall satisfy itself that the accommodation provided for the housing of same is adequate and not likely to become offensive or injurious to health.

5. No person shall keep or cause or permit to be kept on any property any domestic animal other than a dog or cat except in a suitable enclosure, every part of which shall be a clear 30 feet from any dwelling.

6. No person shall keep or cause or permit to be kept any domestic birds other than song birds except in yards, pens, or runs having an area of not less than 100 square feet, provided that if more than 25 head of birds are kept at any one time, then for every 25 head in excess of such number there shall be an additional space of 100 square feet.

Provided further that such yards, pens, or runs shall at all times be kept in a clean, wholesome, and sanitary state to the satisfaction of the Council or its inspector.

All such yards, or pens or runs shall be a clear 30 feet from any dwelling, and if, in the opinion of the Council, the removal of a poultry yard any part of which is within 30 feet of any house is necessary, the Council may order the owner or occupier of the premises whereon such poultry yard is situated to remove such portions as may be within 30 feet of any house.

7. No person shall within 30 feet of any house establish or construct or cause, permit, or suffer any poultry yard to be newly constructed or established, nor within such distance cause, permit, or suffer any land or place to be used afresh or for the first time as a poultry yard.

8. The occupier or owner of any property whereon any animals or birds or domestic animals or domestic birds are kept or housed shall cause the place of keeping to be thoroughly cleansed from time to time as often as may be necessary for the purpose of keeping such place in a clean, wholesome, and sanitary state and condition with particular attention to the drainage.

9. (a) Any person who fails to do anything directed to be done or does anything forbidden to be done by or under this By-law shall be guilty of an offence against this By-law.

(b) Any person guilty of an offence against this By-law shall for every such offence be liable to a penalty of not more than Twenty pounds, and in the case of a continuing offence to a further daily penalty of not more than Five pounds for each day upon which the offence shall continue after the expiry date of the time limit, as specified in the notice served on such person by the Council.

A resolution adopting the foregoing By-law was passed by the Council on the 18th day of August, 1949, and confirmed on the 9th day of March, 1950.

The common seal of the Town of Castlemaine was affixed on the 3rd day of April, 1950, in the presence of—

(SEAL) G. WEYNTON, Mayor.
R. A. BAILIE, Councillor.
G. R. GOUGH, Town Clerk.

Submitted to the Commission of Public Health at its meeting on the 18th day of April, 1950.—J. WHITLOCK, Secretary.

Approved by the Governor in Council, 16th May, 1950.—
A. G. COULTHARD, Acting Clerk of the Executive Council. 2898

Local Government Act 1946.—Part XIX., Division 10.

TOWN OF COLAC.

IN pursuance of the provisions contained in Part XIX., Division 10, of the *Local Government Act 1946*, the Mayor, Councillors, and Burgesses of the Town of Colac do hereby declare Johnstone-crescent and Selwood-street, being streets more than 15 feet in width and situate on part of Crown allotments 193, 194, and 195, Town of Colac, Parish of Colac, to be dedicated to the public as public highways.

Dated this 17th day of May, 1950.

The common seal of the Mayor, Councillors, and Burgesses of the Town of Colac was affixed hereto, in the presence of—

(SEAL) R. AMEZZDROZ, Councillor.
P. B. BORWICK, Councillor.
A. N. WALLS, Town Clerk.

2890

SHIRE OF HEALESVILLE.

BY-LAW No. 29.

A By-law of the Shire of Healesville made under section 197 of the *Local Government Act 1946*, and numbered 29, for appointing in streets and roads standing places for motor cars and for regulating the use of any such standing places.

IN pursuance of the powers conferred by the *Local Government Act 1946* and every other power it thereunto enabling, the President, Councillors, and Ratepayers of the Shire of Healesville order as follows:—

1. In By-law No. 28 of the Shire of Healesville in the definition of "Motor Car" in paragraph 1 thereof, the expression "Sub-section 7" shall be amended to "Sub-section 1."

2. Clause 14 of By-law No. 28 is hereby repealed.

Resolution for the passing of this By-law No. 29 agreed to by the Council of the Shire of Healesville on the 27th day of March, 1950, and confirmed on the 24th day of April, 1950.

The common seal of the President, Councillors, and Ratepayers of the Shire of Healesville was hereunto affixed in the presence of—

(SEAL) R. G. POLLARD, President.
R. M. SWIFT, Councillor.
J. HANSEN, Shire Secretary.

Approved by the Governor in Council, the 9th day of May, 1950.—A. G. COULTHARD, Acting Clerk of the Executive Council. 2859

SHIRE OF HEALESVILLE.

BY-LAW No. 28.

A By-law of the Shire of Healesville, made under section 197 of the *Local Government Act 1946*, and numbered 28, for appointing in streets and roads, standing places for motor cars and for regulating the use of any such standing places.

IN pursuance of the powers conferred by the *Local Government Act 1946* and every other power it thereunto enabling, the President, Councillors, and Ratepayers of the Shire of Healesville order as follows:—

1. In this By-law and the Schedule hereto unless the context otherwise requires—

"Council" means the Council of the Shire of Healesville.

"Driver" includes any person in charge of a motor car.

"Limit of Parking" where parking lines are painted on a street or road means within the lines indicating the space in which a motor car may be parked or left standing.

"Motor Car" means a motor car within the meaning of section 3 of the *Motor Car Act 1928*, not being a vehicle of any class for which stands or standing places may be fixed or appointed by the council of any municipality under the powers conferred by any enactment other than sub-section 7 of section 197 of the *Local Government Act 1946*, but shall not include a motor truck or motor bus as herein defined.

"Motor Bus" means any motor vehicle designed primarily for the carriage of passengers which vehicle has seating accommodation for more than seven passengers.

"Motor Truck" means any motor vehicle designed primarily for the carriage of goods, which vehicle, including any trailer or semi-trailer (if any) attached thereto exceeds twenty feet in length.

"Parking Area" means any standing place for motor cars duly appointed by the council under any By-law.

"Parking Lines" means the lines painted on the street or roads to indicate the position to be taken up by a motor car and to define the limit of parking or standing space within which a motor car shall park or stand.

2. By-law No. 26 is hereby repealed.

3. This By-law shall apply to and have operation throughout that portion of the municipal district within the Township of Healesville set out in the Schedule hereto.

4. The streets and roads and/or parts of streets and roads set out in column 1 of the First Schedule hereto (hereinafter called "car parking areas") shall be and are hereby appointed standing places for motor cars and horse-drawn vehicles within the Township of Healesville on the days during the hours and for the periods of time as set out in the said First Schedule in columns 2, 3, and 4 thereof.

5. The streets and roads and/or parts of streets and roads set out in column 1 of the Second Schedule hereto (hereinafter called "bus parking areas") shall be and are hereby appointed standing places for motor buses within the Township of Healesville on the days during the hours and for the periods of time as set out in the said Second Schedule in columns 2, 3, and 4 thereof.

6. The streets or roads and/or parts of streets or roads set out in column 1 of the Third Schedule hereto (hereinafter called "truck parking areas") shall be and are hereby appointed standing places for motor trucks within the Township of Healesville on the days during the hours and for the periods of time as set out in the said Third Schedule in columns 2, 3, and 4 thereof.

7. The method of parking in the several parking areas shall be as set out in column 5 of the said respective Schedules opposite the parking area described in column 1 of the said Schedule.

8. (a) A driver of a motor car or horse-drawn vehicle shall not park a vehicle driven by him in a bus parking area or a truck parking area.

(b) A driver of a motor bus shall not park a vehicle driven by him in a car parking area or a truck parking area.

(c) A driver of a motor truck shall not park a vehicle driven by him in a car parking area or a bus parking area.

9. Every driver shall conform to the method of parking set out in the Schedule applicable to the parking area in which he shall park his vehicle and—

(a) as directed by the parking attendant in charge of the parking area if an attendant be present, or

(b) if no such attendant be present shall park his vehicle in the order of his arrival at the parking area and in such manner as will enable him to take up or leave such position without disturbance to a vehicle already parked and in such manner as not to cause obstruction to a vehicle parking or moving from the place occupied by it.

10. A driver of a motor car shall not cause, allow, or permit a motor car to be parked or left standing in such a manner as to extend beyond the painted lines (if any) marking the limit of parking in any parking area.

11. A driver of a vehicle used or adopted for use in the carrying of live stock shall not cause, allow, or permit such motor car to be parked in any parking area set out in the First, Second, or Third Schedule to this By-law.

12. A driver of a motor car, motor bus, motor truck, or horse-drawn vehicle shall not cause, allow, or permit a motor car to be parked in any street or road or portion of a street or road in a position—

(1) (a) marked on the street or road "no park" or by a "no parking" traffic standard, or
(b) marked on the roadway "bus stop", or
(c) marked on the roadway "safety zone".

(2) In any position prohibited as set out in clause 26 of the Road Traffic (Country) Regulations 1944.

(Copy of clause 26 is set out at the foot of this By-law for information of persons consulting the By-law.)

13. The Council may from time to time fix or appoint openings through and in any parking area for cross traffic, and may vary such openings.

14. The Council may appoint, alter, or vary the hours during which parking areas or any of them shall be available for use.

15. A driver of a vehicle shall not cause, permit, suffer, or allow any vehicle driven by him to obstruct or occupy in a parking area any opening prescribed or established or set apart for any purpose prescribed by this By-law or for any cross traffic, and such obstruction or occupation by any vehicle of any such opening is prohibited.

16. The Council may by resolution from time to time—

(a) discontinue for such period as it thinks fit any standing place for motor cars, motor buses, motor trucks, or horse-drawn vehicles appointed under any By-law, and

(b) may appoint or employ officers and attendants for any standing places so appointed and remove any such officer or attendant.

17. No person not being an officer or employee of the Council, or otherwise authorized by the Council, shall destroy, remove, or in any other manner interfere with any notice (including any standard or other erection supporting any such notice) which has been fixed or placed by the said Council upon any street, roadway, or building, or other public place, or upon any verandah or other building.

18. No person not being an officer or employee of or otherwise authorized by the Council shall affix any notice,

sign, or other thing on to or in any street or footway, or erect, drive, or fix any post, spike, peg, erection, or other thing upon or into any street or footway.

19. Any wilful contravention of the foregoing provisions by act or omission shall be an offence against this By-law, and every person who is guilty of any such offence shall be liable upon conviction to a penalty of not exceeding Ten pounds.

FIRST SCHEDULE.

PARKING AREAS FOR MOTOR CARS AND HORSE DRAWN VEHICLES.

Column 1.	Column 2.	Column 3.	Column 4.	Column 5.
Street or Road or Part Thereof (Excluding Those Parts in or on which Parking is Prohibited by Clause 26 Road Traffic (Country) Regulations 1944).	Days.	Hours.	Times.	Method of Parking.
Nicholson-street (both sides) from its intersection with Church-street easterly to a line drawn across Nicholson-street between the western boundaries of Crown Allotment 7, Section M, and Crown Allotment 6, Section L, Township of Healesville	Sunday, Monday, Tuesday, Wednesday, Thursday, Friday, and Saturday	Eight o'clock in the forenoon to six o'clock in the afternoon	The whole time	As indicated by and within the limit of parking lines painted on the roadway distant approximately 7 feet from the kerb line and approximately parallel thereto <i>Or,</i> In the absence of such lines with both the near side wheels at a distance not greater than 10 inches from the kerb line and with the vehicle approximately parallel thereto and not nearer than 4 feet to any other vehicle

SECOND SCHEDULE.

PARKING AREAS FOR MOTOR BUSES.

Column 1.	Column 2.	Column 3.	Column 4.	Column 5.
Street or Road or Part Thereof (Excluding Those Parts in or on which Parking is Prohibited by Clause 26 Road Traffic (Country) Regulations 1944).	Days.	Hours.	Times.	Method of Parking.
Green-street (both sides) from its intersection with Nicholson-street to its intersection with Symons-street	Sunday, Monday, Tuesday, Wednesday, Thursday, Friday, and Saturday	Eight o'clock in the forenoon to six o'clock in the afternoon	The whole time	As indicated by and within the limit of parking lines painted on the roadway distant approximately 7 feet from the kerb line and approximately parallel thereto <i>Or,</i> In the absence of such lines with both the near side wheels at a distance not greater than 10 inches from the kerb line and with the vehicle approximately parallel thereto and not nearer than 4 feet to any other vehicle

THIRD SCHEDULE.

PARKING AREAS FOR MOTOR TRUCKS.

Column 1.	Column 2.	Column 3.	Column 4.	Column 5.
Street or Road or Part Thereof (Excluding Those Parts in or on which Parking is Prohibited by Clause 26 Road Traffic (Country) Regulations 1944).	Days.	Hours.	Times.	Method of Parking.
Green-street (both sides) from its intersection with Nicholson-street to its intersection with River-street	Sunday, Monday, Tuesday, Wednesday, Thursday, Friday, and Saturday	Eight o'clock in the forenoon to six o'clock in the afternoon	The whole time	As indicated by and within the limit of parking lines painted on the roadway distant approximately 7 feet from the kerb line and approximately parallel thereto <i>Or,</i> In the absence of such lines with both the near side wheels at a distance not greater than 10 inches from the kerb line and with the vehicle approximately parallel thereto and not nearer than 4 feet to any other vehicle

For the information of persons consulting this By-law, clause 26 of the Road Traffic (Country) Regulations 1944 is as follows:—

The driver of a vehicle (other than a tram car) shall not permit such vehicle to remain stationary in any of the following places:—

- (i) Within 30 feet of an intersection.
- (ii) Within 30 feet of a place on a tram route indicated by either of the notices "Cars Stop Here" or "Hail Cars Here", and on the side thereof which is the nearer to approaching vehicular traffic.
- (iii) Between a safety zone and the adjacent footway, or within 20 feet of points on the kerb immediately opposite the ends of a safety zone.
- (iv) Within 15 feet of a fire hydrant or a postal pillar box or a petrol pump erected on the kerb of any street.
- (v) In front of a right-of-way, passage, or private drive.
- (vi) Alongside or opposite any street, excavation, or obstruction when traffic would be thereby obstructed.

Provided that this Regulation shall not apply to a fire brigade vehicle standing at or near a fire hydrant, or to a postal vehicle standing at or near a postal pillar box, or to a motor car whilst being supplied with petrol from a petrol pump erected on the kerb of any street, or to a horse or to a horse-drawn vehicle which is standing at or near a trough or other fixed receptacle for the purpose of watering such horse, or to a bicycle standing in a bicycle rack erected by the council of any municipality.

Penalty £10.

Resolution for the passing of this By-law No. 28 agreed to by the Council of the Shire of Healesville on the 31st day of October, 1949, and confirmed on the 28th day of November, 1949.

The common seal of the President, Councillors, and Ratepayers of the Shire of Healesville was hereunto affixed in the presence of—

(SEAL) R. G. POLLARD, President.
R. M. SWIFT, Councillor.
J. HANSEN, Shire Secretary.

Approved by the Governor in Council, the 21st day of March, 1950.—A. G. COULTHARD, Acting Clerk of the Executive Council. 2858

SHIRE OF BROADMEADOWS.

BY-LAW No. 48.

A By-law of the Shire of Broadmeadows, made under the provisions of the *Local Government Act 1946*, and the *Uniform Building Regulations Victoria*, and numbered 48, for the determining, applying, dispensation or regulating such matters or things as are left to be dispensed with or regulated by the Council of the said Shire under the *Uniform Building Regulations*.

IN pursuance of the powers conferred by the *Local Government Act*, the President, Councillors, and Ratepayers of the Shire of Broadmeadows order as follows:—

Brick Areas.

1. No building shall be built or erected on land fronting to or abutting upon any of the streets or roads, or portions of streets or roads set out in the First Schedule to this By-law, and for a distance of 140 feet on each side thereof, unless such building is enclosed by walls of brick or stone laid in mortar or concrete, or other approved hard or incombustible material.

Minimum Area, Depth, and Width of Frontage.

2. (a) The minimum area, depth, and width of frontage specified in column 3, of Table 803 of the *Uniform Building Regulations Victoria* (hereinafter called the *Regulations*) are hereby adopted as the minimum area, depth, and width of frontage of land on which a building shall be constructed throughout those portions of the Municipal District, set out and described in paragraph 1 hereof, relating to brick areas.

(b) The minimum area, depth, and width of frontage specified in column 3 of Table 803 of the *Uniform Building Regulations Victoria*, are hereby adopted as the minimum area, depth, and width of frontage of land on which a building shall be constructed throughout all portions of the Municipal District, other than those set out and described in the said paragraph 1.

Distance from Street Alignment.

3. The minimum distance of the outer walls of any building of Class I. or II. occupancy from the street alignment of any land is hereby specified as 25 feet.

Sites Below Minimum Requirements.

4. Subject to the Regulations made pursuant to section 17 of the *Slum Reclamation and Housing Act*, the Council may, upon written application being made to it, permit any person to:—

- (a) construct a building of Class I. occupancy on land having a lesser area, depth, or width of frontage, or at a lesser distance from boundaries than those specified in column 3 of Table 803 of the *Regulations*, or in clause 806 of the *Regulations*; or
- (b) construct a building of Class III., V., VI., VII., or VIII. occupancy, or a building to which a building of Class VI. occupancy is attached, on land having an area, depth, or width of frontage less than that prescribed in clause 808 of the *Regulations*.

provided in all such cases that on the date of commencement of the *Regulations* such land existed as a separate allotment and has not since been reduced in area or was shown on a plan of subdivision approved by the Council and lodged in the Office of Titles.

Rear Access.

5. In the case of a building on any land forming part of a subdivision approved by the Council and lodged with the Office of Titles prior to the date of commencement of the *Regulations*, the Council may, upon written application being made to it, dispense with the requirements of clause 811 of the *Regulations*.

FIRST SCHEDULE.

Brick Areas.

Woodlands-street, north side,
Uplands-road, both sides,
Wickham-grove, both sides,
Hillsyde-parade, both sides,
North-avenue, both sides,
Rosebank-avenue, both sides,
The Crossway, both sides,
Columban-avenue, both sides,
Madel-avenue, both sides,
Napier-street, east side, between Woodland-street and Uplands-road,
Downes-street, both sides,
Head-street, both sides,
Glenbervie-road, north side, between Napier-street and James-street,
Pascoe Vale-road, both sides,
Glenroy-road, both sides,
Pascoe-avenue, west side,
Hartingdon-street, both sides, Marlborough street to Glenroy-road,
Blenheim-street, both sides,
Marlborough-street, Glenroy, both sides.

The Resolution passing By-law No. 48 was agreed to at meeting of Council held on February, 23rd, 1950, and confirmed on 30th March, 1950.

As witness the common seal was attached in our presence this 31st day of March, 1950—

(SEAL) KEITH J. ROBINSON, President.
ALASDAIR CAMERON, Councillor.
E. F. SMILEY, Shire Secretary.

Approved by the Governor in Council, 2nd May, 1950.—
A. G. COULTHARD, Acting Clerk of the Executive Council. 2871

SHIRE OF KEILOR.

LOAN No. 10.

Notice of Intention to Borrow the Sum of Seven Thousand Five Hundred Pounds (£7,500) for Permanent Works and Undertakings in the Shire of Keilor.

TAKE notice that the Council of the Shire of Keilor proposes to borrow on the credit of the President, Councillors, and Ratepayers of the Shire of Keilor the sum of Seven thousand five hundred pounds (£7,500), such sum to be raised by the issue of debentures in accordance with the provisions of the *Local Government Acts*.

The maximum rate of interest that may be paid is £3 7s. 6d. per centum per annum.

Such moneys shall be repayable by thirty equal half-yearly instalments of £320 13s. 2d., each including principal and interest by providing out of the Municipal Fund such

amounts on the 1st day of June and the 1st day of December in each respective year during the currency of the Loan.

Such moneys shall be repayable at Melbourne at the Commercial Banking Company of Sydney Limited, or at the Council's bankers for the time being in Melbourne.

The purposes for which the Loan is to be applied are:—

	£
(a) Construction of channel along Foster's-road (part), Keilor ..	900 0 0
(b) Making and increasing width of McNab's-road (part) between Arundel and Barbiston roads, Keilor ..	1,200 0 0
(c) Making and increasing width of Annandale-road, (part), Tullamarine ..	800 0 0
(d) Making and increasing width of Keilor-St. Albans road (part), St. Albans ..	700 0 0
(e) Making and increasing width of Taylor's-road (part) St. Albans ..	900 0 0
(f) Construction of channel along both sides of Keilor-road, North Essendon, westwards of Hoffman's-road to Newman-street ..	3,000 0 0
Total	7,500 0 0

The plans, specifications and estimate of the cost of the works referred to above and a statement showing the proposed expenditure of the money to be borrowed are open for inspection at the Shire Office, Keilor.

Dated this 8th day of May, 1950.

N. A. WOODS, Shire Secretary.
2868

SHIRE OF MANSFIELD.

BY-LAW No. 34.

A By-law of the Shire of Mansfield, made under Part XXX. of the *Local Government Act 1946*, and numbered 34, for the purpose of altering By-law No. 23, for regulating the Mansfield Corporation Sale Yards for licensing yards and premises for the sale of cattle within the municipal district, for fixing the dues to be paid for such licences, and for appointing tolls and dues to be demanded from every person exposing or offering for sale or selling any cattle in the Mansfield Corporation Sale Yards, and from any person who shall at any time use for the sale of cattle any licensed yards or premises within the municipal district.

IN pursuance of the powers conferred by the *Local Government Act 1946* and by every other Act and power enabling it in that behalf, the President, Councillors, and Ratepayers of the Shire of Mansfield order as follows:—

That the words—

- "For every head of store cattle sold—6d.
- For every head of store cattle unsold—3d.
- For every head of dairy cattle—9d.
- For every head of sheep unsold—4d.
- For every head of store pigs sold—3d.
- For every head of store pigs unsold—4d."—

in Regulation No. 1 of such By-law No. 28 be and are hereby repealed, and that the words—

- "For every head of store cattle sold—1s.
- For every head of store cattle unsold—1s.
- For every head of dairy cattle—1s.
- For every head of sheep unsold—1d.
- For every head of store pigs sold—6d.
- For every head of store pigs unsold—6d."—

be substituted therefor.

The Resolution for making and passing this By-law was agreed to by the Council at a meeting held on the 1st day of March, 1950, and confirmed at a meeting held on the 5th day of April, 1950.

The common seal of the President, Councillors, and Ratepayers of the Shire of Mansfield was hereunto affixed, in the presence of—

(SEAL) J. R. ROSS, President.
JOHN A. BOSTOCK, Councillor.
R. WOMERSLEY, Secretary.
2888

SHIRE OF TUNGAMAH.

BY-LAW No. 46.

A By-law of the Shire of Tungamah, made under section 561 of the *Local Government Act 1946*, and numbered 46, for applying the provisions of Division 9 of Part XIX. of the *Local Government Act 1946* to that part of the Shire of Tungamah covered by the Cobram Town Planning Scheme.

IN pursuance of the powers conferred by the *Local Government Act 1946*, the President, Councillors, and Ratepayers of the Shire of Tungamah, *inter alia*, order as follows:—

The provisions of Division 9 of Part XIX. of the *Local Government Act 1946*, and any statutory modification of the same, shall apply throughout that part of the municipal district covered by the Cobram Planning Scheme.

This By-law shall come into operation immediately upon its publication in the *Government Gazette*.

Copy of the above By-law may be inspected, free of charge, at the office of the Council, in Barr-street, Tungamah, during office hours.

Resolution for passing this By-law was agreed to by the Council of the Shire of Tungamah on the 20th day of March, 1950, and confirmed on the 17th day of April, 1950.

In witness whereof, the common seal of the President, Councillors, and Ratepayers of the Shire of Tungamah was hereunto affixed on the 15th day of May, 1950, in the presence of—

(SEAL) W. MEAD, President.
M. A. STOKES, Councillor.
R. B. WEBB, Secretary.
2896

NOTICE is hereby given that the partnership lately subsisting between the undersigned Arthur Edward Drew and Walter Henry George, carrying on business as general engineers at Little Mercer-street, Geelong, under the style or firm name of "G. D. Manufacturing Engineers," has been dissolved by mutual consent as from the 29th day of April, 1950. All debts due to and owing by the said firm will be received and paid by the said Walter Henry George, who will continue to carry on the business at the same place, under the name of "G. D. Manufacturing Engineers."

Dated the 15th day of May, 1950.

Witness—JOHN P. HASE. ARTHUR E. DREW.

Witness—ANDREW R. PHILLIPS. W. H. GEORGE.

Andrew R. Phillips, of 57A Yarra-street, Geelong, solicitor for the above-named Walter Henry George.

John Peter Hase, of 130 Moorabool-street, Geelong, solicitor for the above-named Arthur Edward Drew.
2886

NOTICE is hereby given that the partnership heretofore subsisting between Arthur William Ward, Jean Ward, Frank George Greenland, and Norma Eileen Greenland, carrying on business under the style of Arthur W. Ward, as delicatessen shop proprietors, at 31 Glenhuntly-road, Esternwick, has been dissolved as from the 15th day of May, 1950. The said Frank George Greenland and Norma Eileen Greenland have retired from the said business, which will henceforth be carried on by the said Arthur William Ward and Jean Ward, under the same firm name.

Dated this 15th day of May, 1950.

J. M. WARD.
A. WARD. }
F. G. GREENLAND.
N. E. GREENLAND.
2852

NOTICE is hereby given that the partnership heretofore subsisting between Cyril Howard Pritchard and Victor Fairchild Williamson, in the business of café and delicatessen proprietors and mobile snack bar, carried on at 60 Queen-street, Warragul, and Prince's Highway, Warragul, under the name of "Cyril's Silver Grill," has been dissolved as from 20th April, 1950, by mutual consent. The said Victor Fairchild Williamson retires, and the said Cyril Howard Pritchard continues as sole proprietor.

C. H. PRITCHARD.
V. F. WILLIAMSON.
Hamilton and Telford, solicitors, Drouin. 2891

NOTICE is hereby given that the partnership heretofore subsisting between Richard John Boyd, Olive Florence Boyd, Leslie Roy Boyd, all of 574 High-street, East Prahran, and Allan Liguria Blackney, of 665 Malvern-road, Toorak, carrying on business as "Boyd's Highland Weaving and Knitting Mills," at 574 High-street, Prahran, has been dissolved by mutual consent as from the 9th day of March, 1950, so far as concerns the said Allan Liguria Blackney, who retires from the said firm.

Dated this 18th day of May, 1950.

L. R. BOYD.
O. F. BOYD.
R. J. BOYD.
A. L. BLACKNEY.
2916

NOTICE is hereby given that the partnership heretofore subsisting between Linley Gladstone Curnow and Emma Desborough Curnow, both of Laanecoorie, in the State of Victoria, farmer and grazier and married woman respectively, carrying on business as dairy and poultry farmers at Laanecoorie aforesaid, under the style or firm of "L. and E. Curnow," has been dissolved as from the 30th day of June, 1949. All debts due to and owing by the said late firm will be received and paid respectively by the said Linley Gladstone Curnow.

Dated the 12th day of May, 1950.

L. G. CURNOW.
E. D. CURNOW.

Witness to signatures—W. J. McLAY, accountant,
Bendigo.

Cohen, Kirby, and Co., solicitors, Pall Mall, Bendigo.
2893

NOTICE is hereby given that the partnership heretofore existing between Roland Arthur Samuel James Douglas and James Harold Gordon Douglas, carrying on business as dry cleaners at Railway-road, Blackburn, under the name of Blackburn Dry Cleaning Service, has been dissolved by mutual consent as from the 18th day of May, 1950. The said James Harold Gordon Douglas will continue the business at the said address under the above name and will pay and receive all moneys owing by or to the said firm.

Dated the 18th day of May, 1950.

R. A. DOUGLAS.

Witness—D. B. TUNNOCK, solicitor, Melbourne.

J. G. DOUGLAS.

Witness—H. LINDSEY YUNCKEN, solicitor, Melbourne.
2903

NOTICE is hereby given that the partnership heretofore subsisting between William Robert Paterson, Douglas Allan Roy Newton, Eric Norman Horne, and Edwin McLure, carrying on business as real estate and business agents, at 266 Swan-street, Richmond, has been dissolved, and is no longer being carried on by them.

Dated this 22nd day of May, 1950.

D. NEWTON.
EDWIN McLURE.

2925

NOTICE is hereby given that the partnership heretofore carried on by Francis Palmer Selleck and John Fryday, as hotelkeepers, at the Australian Hotel, Marysville, under the name or style of "Marysville (Australian) Hotel," was dissolved by mutual consent as on and from the 24th day of March, 1950. The said business will be continued by the said Francis Palmer Selleck and Pierre Gorman, who will receive all moneys owing to the firm and pay all debts of the firm.

Dated the 16th day of May, 1950.

F. P. SELLECK.

Oswald Burt and Co., solicitors, 394 Collins-street, Melbourne.
2922

PACIFIC TIMBERS PROPRIETARY LIMITED.

SPECIAL RESOLUTION TO WIND UP, PURSUANT TO SECTION 226.

AT an Extraordinary General Meeting of the above-named company duly convened and held at Lorimer-street, South Melbourne, on Monday, the 15th day of May, 1950, the following Resolution was duly passed as a Special Resolution:—

"That the company be wound up voluntarily, and that William Kirkhope, chartered accountant (Aust.) be appointed liquidator of the company."

Dated the 16th day of May, 1950.

2919 E. A. ALSTERGREN, Chairman.

Companies Act 1938.

NORTHERN AND BENDIGO BRICK COMPANY PTY. LTD.

PURSUANT TO SECTION 236.

NOTICE is hereby given that a General Meeting of the company will be held at my office, Shamrock Buildings, Williamson-street, Bendigo, on Monday, 26th June, 1950, at Two o'clock p.m., for the purpose of having laid before it an account of the winding up, showing how the winding up has been conducted and the property of the company disposed of.

Dated this 22nd day of May, 1950.

2895 E. R. GRELLIS, Liquidator.

A. J. REILLY PROPRIETARY LIMITED
(IN LIQUIDATION).

NOTICE is hereby given that at an Extraordinary Meeting of the above-named company, duly convened and held at 100-104 Queen-street, Melbourne, on the 13th day of May, 1950, in the forenoon, the following Special Resolution was duly passed:—

"That the company be wound up voluntarily and that Alexander George Forrest, of 100-104 Queen-street, Melbourne, assistant manager, be appointed liquidator for the purpose of the winding up."

Dated this 15th day of May, 1950.

A. G. FORREST,
Liquidator.

Harwood and Pincott, of 472 Bourke-street, Melbourne, and 51 Yarra-street, Geelong, solicitors for the company.
2904

Companies Act 1938.

G. TILLEY PROPRIETARY LIMITED (IN LIQUIDATION).
NOTICE TO CREDITORS OF INTENTION TO DECLARE FIRST AND FINAL DIVIDEND.

NOTICE is hereby given that a First and Final Dividend of Twenty shillings in the £1 is intended to be declared in the matter of G. Tilley Proprietary Limited (in Liquidation). Creditors who have not proved their debts by 8th June, 1950, will be excluded from participation therein.

Dated this 18th day of May, 1950.

V. N. MOGG, Liquidator.

Sloman and Mogg, chartered accountants (Aust.), 401 Collins-street, Melbourne, C.I.
2930

Companies Act 1938.

THE EUREKA INVESTMENT AND BUILDING CO. PTY. LTD. (IN VOLUNTARY LIQUIDATION).

NOTICE OF FINAL MEETING.

NOTICE is hereby given, pursuant to section 236 of the Companies Act 1938, that a General Meeting of the members of the above-named company will be held at 360 Collins-street, Melbourne, on 21st June, 1950, at half-past Twelve o'clock in the afternoon, for the purpose of laying before it an account of the winding up showing how the winding up has been conducted and the property of the company has been disposed of.

Dated this 16th day of May, 1950.

2921 H. W. BUCKLEY, Liquidator.

LEXA MANUFACTURING CO. PTY. LTD.

NOTICE is hereby given that a meeting of the creditors of the above-named company will be held at the Board Room, Temple Court, 422 Collins-street, Melbourne, on Friday, the 26th day of May, 1950, at Two o'clock in the afternoon, for the purpose of considering the company's affairs, the company having convened an Extraordinary General Meeting of its members to be held at 218 Latrobe-street, Melbourne, on Thursday, the 25th day of May, 1950, at Two o'clock in the afternoon, for the purpose of considering and, if deemed expedient, passing as an Extraordinary Resolution the Resolution following, that is to say:—

"That it has been proved to the satisfaction of this meeting that the company cannot by reason of its liabilities continue its business, and that it is advisable to wind up the same, and accordingly that the company be wound up voluntarily."

A Resolution will be submitted to the meeting for the nomination of a person acceptable to the creditors to be the liquidator of the company for the purposes of the winding up.

Dated this 16th day of May, 1950.

By order of the Board,

2863 J. A. GANGE, Secretary.

CREDITORS, next of kin, and others having claims in respect of the estate of Ada Maria Nichols (formerly Ada Stanley), late of 16 Chamberlain-street, Ballarat East, in Victoria (who died on the 26th day of December, 1949), are to send particulars of their claims to the executor, The Fidelity Trustee Company Limited (formerly The Ballarat Trustees, Executors, and Agency Company Limited), whose registered office is at 101 Lydiard-street north, Ballarat, by the 20th day of July, 1950, after which date the executor will distribute the assets of the said deceased, having regard only to the claims of which it then has notice. 2864

PURSUANT to the *Trustee Act 1928*, all persons having claims against the estate of Elizabeth Carstairs Hake (sometimes known as Elizabeth Carstairs Napier Hake), late of Bailey's Hotel, Gloucester-road, London, in England, widow, deceased (who died on the 21st day of July, 1949, and letters of administration (with the will and codicil as are contained in sealed certified photostat copies thereof issued out of His Majesty's High Court of Justice in England annexed) of whose estate were granted by the Supreme Court of Victoria on the 17th day of May, 1950, to Bernard Gore Brett, of 120 William-street, Melbourne, in Victoria, solicitor, the duly constituted attorney under power of The Royal Trust Company, the executor named in the said will, are hereby required to send particulars of such claims to the said administrator, care of Messieurs Blake and Riggall, solicitors, of 120 William-street, Melbourne, on or before the 29th day of July, 1950, after the expiration of which time the said administrator will, in pursuance of section 86 of the *Administration and Probate Act 1928*, pay and/or hand over to the said executor the assets of the said deceased which shall have come to his hands or possession, having regard only to the claims of which he shall have had notice.

Dated this 22nd day of May, 1950.

BLAKE & RIGGALL, 120 William-street, Melbourne,
solicitors for the said administrator. 2920

PURSUANT to the *Trustee Act 1928*, notice is hereby given that all persons having claims against the estate of Emily Blanche Connell Russell (also known as Emily Blanch Connell Russell), late of Rose Bay, in the State of New South Wales, widow, deceased (who died on the 26th day of September, 1947, the exemplification of probate of whose estate was sealed with the seal of the Supreme Court of Victoria on the 27th day of June, 1949, on the application of Permanent Trustee Company of New South Wales Limited, of 23-25 O'Connell-street, Sydney, in the State of New South Wales), are hereby required to send particulars, in writing, of such claims to the above executor, care of the solicitors below, on or before the 25th day of July, 1950, after which day the said executor will proceed to distribute the assets of the said Emily Blanche Connell Russell, deceased, which shall come to its hands amongst the persons entitled thereto, having regard only to the claims of which it shall then have had notice. And notice is hereby further given that the said Permanent Trustee Company of New South Wales Limited will not be liable for the assets so distributed, or any part thereof, to any person of whose claim they shall not have had notice as aforesaid.

Dated this 25th day of May, 1950.

NORVAL H. DOOLEY & BREEN, solicitors, 31 Queen-street, Melbourne. 2901

THE PERPETUAL EXECUTORS AND TRUSTEES ASSOCIATION OF AUSTRALIA LIMITED, whose registered office is situate at Nos. 100-104 Queen-street, Melbourne, in the State of Victoria, and Hilda Eileen Stoffers, widow, and Dorothy Hilda Gerlach, married woman, both of "Pine Grove," Birchip, the executors of the will of Julius Fritz Stoffers, formerly of 740 Station-street, Box Hill, and Flat No. 4, "Avoncourt," 24 Avoca-street, South Yarra, but late of 4 Boston-avenue, East Malvern, investor (who died on the 13th day of February, 1950), require all creditors, next of kin, and others having claims against the property or estate of the said deceased to send to the said executors, in the care of the said association at its said registered office, on or before the 10th day of August, 1950, particulars, in writing, of such claims, after which date the said executors intend to convey or distribute such property or estate to or among the persons entitled thereto, having regard only to the claims of which they shall have had notice.

Dated the 19th day of May, 1950.

OAKLEY, THOMPSON & CO., solicitors, 443 Little Collins-street, Melbourne. 2905

CREDITORS, next of kin, and others having claims against the estate of Amelia Elizabeth White, late of the Farmers Arms Hotel, Newry, widow, deceased (who died on the 21st day of July, 1949), are required by Albert George White, of the Farmers Arms Hotel, Newry, hotelkeeper, the executor of the will of the deceased, to send to him, addressed to the care of the undersigned solicitors, particulars thereof, on or before the 31st day of July, 1950, after which date he will distribute the assets of the deceased, having regard only to the claims of which he then has notice.

GAVAN DUFFY & KING, solicitors, 95 Queen-street, Melbourne. 2902

PURSUANT to the *Trustee Act 1928*, all persons having claims against the estate of James Ryan, late of Elmore, in the State of Victoria, Catholic clergyman (who died on the 14th day of July, 1949, and probate of whose will and codicil thereto was granted by the Supreme Court of the State of Victoria in its probate jurisdiction, to William Henry Taylor, of 299 Hargreaves-street, Bendigo, in the said State, solicitor, and James Leo Ryan, of Catholic presbytery, Wonthaggi, in the said State, Catholic clergyman, executors appointed by the said will), are hereby required to send particulars, in writing, of such claims to the said executors, care of the under-mentioned solicitors, on or before the 21st August, 1950, after which date the executors will proceed to distribute the estate of the said deceased amongst the persons entitled thereto, having regard only to the claims of which they shall then have had notice, and the said executors will not be liable for the assets so distributed, or any part thereof, to any person of whose claim they shall not then have had notice.

Dated the 23rd day of May, 1950.

MACOBOY, TAYLOR, & TAYLOR, solicitors, 299 Hargreaves-street, Bendigo. 2894

PURSUANT to the *Trustee Act 1928*, all persons having claims against the estate of Edmond Nelson, late of 113 Neale-street, Bendigo, in the State of Victoria, traveller, formerly of Strathallen, in the said State, manager, deceased (who died on the 2nd day of September, 1948, and letters of administration of whose estate were granted by the Supreme Court of the said State, in its probate jurisdiction, to Sandhurst and Northern District Trustees, Executors, and Agency Company Limited, of View-street, Bendigo, the administrator of the said estate), are hereby required to send particulars, in writing, of such claims to the said administrator (the said company) on or before the 21st August, 1950, after which date the said administrator (the said company) will proceed to distribute the estate of the said deceased amongst the persons entitled thereto, having regard only to claims of which it shall then have had notice, and the said administrator (the said company) will not be liable for the assets so distributed, or any part thereof, to any person of whose claim it shall not then have had notice.

Dated the 22nd day of May, 1950.

MACOBOY, TAYLOR, & TAYLOR, 299 Hargreaves-street, Bendigo, solicitors for the administrator (the said company). 2885

PURSUANT to the *Trustee Act 1928*, all persons having claims against the estate of Eugene Thomas Nelson, late of 113 Neale-street, Bendigo, in the State of Victoria, traveller (who died on the 2nd day of September, 1948, and letters of administration with the will annexed of whose estate were granted by the Supreme court of the said State, in its probate jurisdiction, to Sandhurst and Northern District Trustees, Executors, and Agency Company Limited, of View-street, Bendigo, the administrator of the said estate), are hereby required to send particulars, in writing, of such claims to the said administrator (the said company) on or before the 21st August, 1950, after which date the said administrator (the said company) will proceed to distribute the estate of the said deceased amongst the persons entitled thereto, having regard only to claims of which it shall then have had notice, and the said administrator (the said company) will not be liable for the assets so distributed, or any part thereof, to any person of whose claim it shall not then have had notice.

Dated the 22nd day of May, 1950.

MACOBOY, TAYLOR, & TAYLOR, 299 Hargreaves-street, Bendigo, solicitors for the administrator (the said company). 2884

PURSUANT to the *Trustee Act 1928*, all persons having claims against the estate of Sarah Ann Seal, late of 38 Fairview-street, Newtown, Geelong, in the State of Victoria, widow, deceased (who died on the 15th day of January, 1950), are hereby required to send particulars, in writing, of such claims to Arthur Seal, of Skene-street, Newtown, Geelong, and William George Seal, of Canberra-street, West Brunswick, the executors named in the will of the said deceased, care of Whyte, Just, and Moore, at its address below appearing, on or before the 31st day of July, 1950, after the expiration of which time the said executors will proceed to convey or distribute the assets of the said deceased amongst the persons entitled thereto, having regard only to the claims of which they shall then have had notice, and will not be liable to any persons of whose claim they shall not have had notice as aforesaid.

Dated this 24th day of May, 1950.

WHYTE, JUST, & MOORE, 27 Malop-street, Geelong, solicitors for the said executors. 2877

NOTICE TO CLAIMANTS.

PURSUANT to the *Trustee Act 1928*, The Perpetual Executors and Trustees Association of Australia Limited, whose registered office is situate at Nos. 100-104 Queen-street, Melbourne, in the State of Victoria, and Joseph Hunt, of Woorarra East, in the said State, the executors of the will of Matthew Richard Hunt (who died on the 17th day of September, 1949, probate of whose will was granted to the said executors by the Supreme Court of Victoria, in its probate jurisdiction, on the 3rd day of May, 1950), require all creditors, next of kin, and others having claims against the property or estate of the said deceased to send to the executors, in the care of the said association, on or before the 31st day of August, 1950, particulars, in writing, of such claims, after which date the said executors intend to convey or distribute such property or estate to or among the persons entitled thereto, having regard only to the claims of which they shall then have had notice.

Dated the 20th day of May, 1950.

P. J. WILSON, solicitor, Toora. 2914

NOTICE TO CLAIMANTS.—ALFRED VICTOR PARSONS, DECEASED.

ANNIE EDITH PARSONS, of Warracknabeal, widow, and Andrew James Parsons, of Sheep Hills, farmer, the executors of the will of Alfred Victor Parsons, late of Warracknabeal, retired farmer (who died on the 15th day of July, 1949), require all creditors, next of kin, and others having claims against the property or estate of the said deceased to send to the said executors, care of E. C. W. Kelly, solicitor, 144 Scott-street, Warracknabeal, on or before the 6th July, 1950, full particulars, in writing, of such claims, after which date the said executors intend to convey or distribute such property or estate to or among persons entitled thereto, having regard only to the claims of which they shall have had notice.

Dated the 18th day of May, 1950.

E. C. W. KELLY, Warracknabeal, solicitor for the executors. 2917

NOTICE TO CLAIMANTS.—RE OSCAR JAESCHKE, DECEASED.

ANNA BERTHA JAESCHKE, of Warracknabeal, widow, and Erwin Rheinhold Graetz, of Yellanyip, farmer, the executors of the will of Oscar Jaeschke, late of Yellanyip, farmer (who died on the 21st day of February, 1949), require all creditors, next of kin, and others having claims against the property or estate of the said deceased to send to the said executors, care of E. C. W. Kelly, solicitor, 144 Scott-street, Warracknabeal, on or before the 6th July, 1950, full particulars, in writing, of such claims, after which date the said executors intend to convey or distribute such property or estate to or among the persons entitled thereto, having regard only to the claims of which they shall have had notice.

Dated the 18th day of May, 1950.

E. C. W. KELLY, Warracknabeal, solicitor for the executors. 2918

CREDITORS, next of kin, and all others having claims in respect of the estate of Ida Alma Thurgood, formerly of 18 Dandenong-road, Caulfield, but late of Merton Private Hospital, South-road, Brighton, in the State of Victoria, widow, deceased (who died on the 28th day of January, 1950), are to send the particulars of their claims to her executor, The Trustees, Executors, and Agency Company Limited, of 401 Collins-street, Melbourne, by the 31st day of July, 1950, after which date it will distribute the assets, having regard only to the claims of which it then has notice.

HADEN SMITH & FITCHETT, solicitors, 405 Collins-street, Melbourne. 2942

GEORGE VERNON WALLACE, formerly of 112 Ophir-street, Bendigo, but late of 15 Chum-street, Bendigo, journalist, DECEASED.

PURSUANT to the *Trustee Act 1928*, creditors, next of kin, and all others having claims against the estate of the above-named deceased (who died on the 16th day of January, 1950), are required by the Public Trustee of the State of Victoria, of 412 Collins-street, Melbourne, and Charles Frederick Walshe, of 1 Wattle-grove, Coburg, real estate agent, the executors to whom probate of deceased's will has been granted, to send particulars of such claims to the care of the undersigned, Hogan and Hogan, on or before the 31st day of July, 1950, after which date the said executors will distribute the assets, having regard only to the claims of which they shall then have had notice.

HOGAN & HOGAN, 68 Bull-street, Bendigo, solicitors for the executors. 2879

CREDITORS, next of kin, and all others having claims in respect of the estate of Frederick Merritt, late of 5 Queen-street, Kew, in the State of Victoria, retired boot salesman, deceased (who died on the 5th day of December, 1949), are to send the particulars of their claims to his executor, The Trustees, Executors, and Agency Company Limited, of 401 Collins-street, Melbourne, by the 31st day of July, 1950, after which date it will distribute the assets, having regard only to the claims of which it then has notice.

HADEN SMITH & FITCHETT, solicitors, 405 Collins-street, Melbourne. 2943

CREDITORS, next of kin, and others having claims in respect of the estate of Helen Isabel Cook, late of 262B Pakington-street, Newtown, Geelong, in the State of Victoria, married woman, deceased (who died on the 29th day of January, 1950), are to send the particulars of their claims to National Trustees, Executors, and Agency Company of Australasia Limited and Edward George Cook, the executors appointed by the will of the said deceased, care of the registered office of the said company, at No. 95 Queen-street, Melbourne, in the said State, by the 28th day of July, 1950, after which date the said executors will distribute the assets, having regard only to the claims of which they then have had notice.

NEIL M. FREEMAN, solicitor, 57 Yarra-street, Geelong. 2865

CREDITORS, next of kin, and others having claims in respect of the estate of Marion Watson McGillivray, late of 1112 Dana-street, Ballarat, in Victoria, clerk, deceased, intestate (who died on the 31st day of January, 1950), are to send particulars of their claims to the administrator, The Fidelity Trustee Company Limited (formerly The Ballarat Trustees, Executors, and Agency Company Limited), whose registered office is at 101 Lydiard-street north, Ballarat, by the 20th day of July, 1950, after which date the administrator will distribute the assets of the said deceased, having regard only to the claims of which it then has notice.

2867

CREDITORS, next of kin, and others having claims in respect of the estate of Sarah Olson, sometimes known as Sarah Jenner Olson, late of 31 Eastham-street, North Fitzroy, widow, deceased (who died on the 10th day of January, 1950, and letters of administration, with the will and codicils thereto annexed, of whose estate were on the 1st day of May, 1950, granted to The Perpetual Executors and Trustees Association of Australia Limited, of 100-104 Queen-street, Melbourne), are to send the particulars of their claims to the said company, at its said address, by the 31st day of July, 1950, after which date the said company, as administrator, will distribute the assets, having regard only to the claims of which it then has notice.

A. C. McLEAN, 150 Queen-street, Melbourne, solicitor for the said company. 2874

THE PERPETUAL EXECUTORS AND TRUSTEES ASSOCIATION OF AUSTRALIA LIMITED, whose registered office is situated at Nos. 100-104 Queen-street, Melbourne, in the State of Victoria, and William Alphonzo Raymond, of "Carn," Carn-avenue, Ivanhoe, in the said State, director, the executors of the will of Elizabeth Raymond, late of "Carn," Carn-avenue, Ivanhoe aforesaid, married woman, deceased (who died on the 30th January, 1950), require all creditors, next of kin, and others having claims against the property or estate of the said deceased to send to the said executors, in the care of the said association, on or before the 4th day of August, 1950, particulars, in writing, of such claims, after which date the said executors intend to convey or distribute such property or estate to or among the persons entitled thereto, having regard only to the claims of which they shall have had notice.

Dated the 22nd day of May, 1950.

HENDERSON & BALL, of 430 Little Collins-street, Melbourne, solicitors for the executors. 2926

HORACE EDGAR LEIGH, late of Ceres, builder, DECEASED.

CREDITORS, next of kin, and all other persons having claims against the estate of the said deceased are required by the executors of the will, Louisa Jane Leigh, of Ceres, widow, Ronald Walter Leigh, of Highton, engineer, and Edward Lindsay Leigh, of Ceres, textile employee, to send particulars to them, in writing, care of the undersigned, on or before the 31st day of July, 1950, after which date they will distribute the assets, having regard only to the claims of which they then have notice.

W. & W. HIGGINS, solicitors, 55 Yarra-street, Geelong. 2876

NOTICE TO CLAIMANTS.—RE WILLIAM NICHOLAS TIPPETT, DECEASED.

NOTICE is hereby given that creditors, next of kin, and all other persons having claims against the property or estate of William Nicholas Tippett, late of Highton, in the State of Victoria, general storekeeper, deceased (who died on the 1st day of August, 1949, and probate of whose will was granted to Charles Kingston Daws, of 44 Errol-street, North Melbourne, in the said State, minister of religion, the surviving executor appointed by deceased's will), are hereby required to send, in writing, particulars of such claims to the said Charles Kingston Daws, care of the undersigned solicitor, on or before the 9th day of August, 1950, after which date he will convey or distribute such property or estate to or among the persons entitled thereto, having regard only to the claims of which he shall then have had notice.

ANDREW R. PHILLIPS, LL.B., A.I.C.A., of 57A Yarra-street, Geelong, solicitor for the said Charles Kingston Daws. 2878

CREDITORS, next of kin, and others having claims in respect of the estate of Vera Beatrice Strickland, late of Barwon Downs, in the State of Victoria, married woman, deceased, intestate (who died on the 15th day of October, 1949), are to send particulars of their claims to The Fidelity Trustee Company Limited (formerly called "The Ballarat Trustees, Executors, and Agency Company Limited"), of Lydiard-street north, Ballarat, in the said State, by the 10th day of August, 1950, after which date it will distribute the assets, having regard only to the claims of which it then has notice.

Dated the 20th day of May, 1950.

SEWELL & SEWELL, Colac, solicitors for the said company. 2912

PURSUANT to the *Trustee Act 1928*, all persons having claims against the property or estate of Andrew Leslie Gilmour, late of Chiltern, in the State of Victoria, merchant, deceased (who died on the 24th day of September, 1949, and probate of whose will was granted by the Supreme Court of Victoria, on the 10th day of May, 1950, to Annie Rose Gilmour, widow, and Mary Rogers (formerly Mary Gilmour), married woman, both of Chiltern, aforesaid, the executrices named in and appointed by the said will), are hereby required to send particulars of such claims to the said executrices, addressed to the care of Frank B. Lethbridge, solicitor, Chiltern, on or before the 31st day of July, 1950, after the expiration of which time the said executrices will proceed to distribute the assets of the said deceased amongst the persons entitled thereto, having regard only to the claims of which they will then have had notice.

Dated the 17th day of May, 1950.

FRANK B. LETHBRIDGE, of Chiltern, solicitor for the executrices. 2910

PURSUANT to the *Trustee Act 1928*, all persons having claims against the property or estate of Margaret Josephine Howell, late of Rutherglen, in the State of Victoria, married woman, deceased (who died on the 28th day of September, 1949, and probate of whose will was granted by the Supreme Court of Victoria on the 4th day of May, 1950, to Kevin Patrick Howell, of 9 Denmark-street, Kew, in the State of Victoria, clerk, the executor named in and appointed by the said will), are hereby required to send particulars of such claims to the said executor, addressed to the care of Frank B. Lethbridge, solicitor, Rutherglen, on or before the 31st day of July, 1950, after the expiration of such time the said executor will proceed to distribute the assets of the said deceased amongst the persons entitled thereto, having regard only to the claims of which he shall then have had notice.

Dated the 17th day of May, 1950.

FRANK B. LETHBRIDGE, of Rutherglen, solicitor for the executor. 2911

MARY TERESA MURPHY, late of 246 Beaconsfield-parade, Middle Park, spinster, DECEASED (who died on 22nd August, 1949).

CREDITORS, next of kin, and all others having claims against the estate of the deceased are required by Margaret Mary Reddie and Winifred Connell, the executrices to whom probate of the will of said deceased has been granted, to send particulars to them, care of the undersigned, on or before the 26th day of July, 1950, after which date they will distribute the assets, having regard only to the claims of which they then have notice.

FITZGERALD & FITZGERALD, 396 Little Flinders-street, Melbourne, solicitors. 2924

PURSUANT to the *Trustee Act 1928*, all persons having claims against the estate of Catherine Nelson, late of 113 Neale-street, Bendigo, in the State of Victoria, widow (who died on the 9th day of August, 1947, and letters of administration with the will annexed of whose estate were granted by the Supreme Court of the said State, in its probate jurisdiction, to Sandhurst and Northern District Trustees, Executors, and Agency Company Limited, of View-street, Bendigo, the administrator of the said estate), are hereby required to send particulars, in writing, of such claims to the said administrator (the said company) on or before the 21st August, 1950, after which date the said administrator (the said company) will proceed to distribute the estate of the said deceased amongst the persons entitled thereto, having regard only to claims of which they shall then have had notice, and the said administrator (the said company) will not be liable for the assets so distributed, or any part thereof, to any person of whose claim they shall not then have had notice.

Dated the 22nd day of May, 1950.

MACOBOY, TAYLOR, & TAYLOR, 299 Hargreaves-street, Bendigo, solicitors for the administrator (the said company). 2886

THE PERPETUAL EXECUTORS AND TRUSTEES ASSOCIATION OF AUSTRALIA LIMITED, whose registered office is situate at Nos. 100-104 Queen-street, Melbourne, in the State of Victoria, and Arthur Dean Pearce, formerly of 11 Elizabeth-street, Elsternwick, articulated clerk, now of 430 Little Collins-street, Melbourne, solicitor, and Jack Martin, of 55 Serrell-street, East Malvern, tram conductor, the executors of the will of William Francis Rae, late of 22 Kokaribb-road, Carnegie, retired clerk (who died on the 7th day of November, 1949), require all creditors, next of kin, and others having claims against the property or estate of the said deceased, to send to the said executors, in the care of the said association, on or before the 3rd day of August, 1950, particulars, in writing, of such claims, after which date the said executors intend to convey or distribute such property or estate to or among the persons entitled thereto, having regard only to the claims of which they shall have had notice.

Dated the 19th day of May, 1950.

VROLAND, PEARCE, & WEBSTER, solicitors, of 430 Little Collins-street, Melbourne. 2934

PURSUANT to the provisions of the *Trustee Act 1928*, notice is hereby given that all persons claiming against the estate of Robert Thornton, late of Arnold-road, Elland, Yorkshire, England, master cotton doubler, deceased (who died on the 7th day of March, 1949, and probate of whose will was on the 27th day of April, 1950, resealed by the Supreme Court of Victoria upon being produced by Roy James McArthur, of 46 Queen-street, Melbourne, solicitor, the duly constituted attorney under power of the executors appointed thereby), are hereby required to send particulars, in writing, of such claims to the said Roy James McArthur, to care of Malleson, Stewart and Company, at the address below, on or before the 26th day of July, 1950, after which date the said executor will proceed to convey or distribute the said estate to or among the persons entitled thereto, having regard only to the claims, whether formal or not, of which he shall then have had notice, and will not be liable for the assets so distributed to any person of whose claim he shall not then have had notice.

MALLESON, STEWART & CO., solicitors, 46 Queen-street, Melbourne. 2928

SOPHIA TUCKER, late of 29 Seacombe-street, North Fitzroy, married woman, DECEASED, intestate.

CREDITORS, next of kin having claims against the estate of the above-named deceased are required by the administrator of her estate, Henry William Tucker, of 29 Seacombe-street, North Fitzroy, pensioner, to send particulars thereof to the said administrator, care of the under-mentioned solicitors, on or before the 28th day of July, 1950, after which date he will distribute the assets, having regard only to the claims of which he then has notice.

VROLAND, PEARCE, & WEBSTER, solicitors, of 430 Little Collins-street, Melbourne. 2941

MARGARET BLAIR HAYBITTEL, late of Maldon, in the State of Victoria, widow, DECEASED.

CLAIMS to the executor, Farmers and Citizens Trustees Company Bendigo Limited, of Charing Cross, Bendigo, in the said State, in care of the undersigned solicitors, on or before the 29th day of July, 1950.

TACHELL, DUNLOP, SMALLEY, & BALMER, solicitors, Williamson-street, Bendigo. 2899

CREDITORS, next of kin, and others having claims against the estate of Otto Ludlow Nase Fawcett, late of No. 1 Belford-street, Canadian, near Ballarat, retired poultry farmer, deceased (who died on the 20th day of December, 1949), are required to send particulars of their claims to The Fidelity Trustee Company Limited (formerly The Ballarat Trustees, Executors, and Agency Company Limited), of 101 Lydiard-street north, Ballarat, and Arthur Hereward Nevett, of No. 11 Lydiard-street south, Ballarat, care of the undersigned, by the 24th day of July, 1950, after which date the executors will distribute the assets, having regard only to the claims of which they then have notice.

NEVETT, NEVETT, & GLENN, 11 Lydiard-street south, Ballarat. 2883

CREDITORS, next of kin, and others having claims against the estate of Robert Herbert Heslop Nichol, late of Buninyong, gentleman, deceased (who died on the 23rd day of November, 1949), are required to send particulars of their claims to The Fidelity Trustee Company Limited (formerly The Ballarat Trustees, Executors, and Agency Company Limited), of 101 Lydiard-street north, Ballarat, and Margaret Nichol, of Buninyong, care of the said company, by the 24th day of July, 1950, after which date the executors will distribute the assets, having regard only to the claims of which they then have notice.

NEVETT, NEVETT, & GLENN, 11 Lydiard-street south, Ballarat. 2882

PURSUANT to the *Trustee Act 1928*, all persons having claims against the estate of Mary Masterson, late of 185 McCrae-street, Bendigo, in the State of Victoria, spinster (who died on the 15th day of October, 1948, and probate of whose will was granted by the Supreme Court of the said State, in its probate jurisdiction, on the 21st day of November, 1949, to Farmers and Citizens Trustees Company Bendigo Limited, of Charing Cross, Bendigo, and William James Chapman, of 238 McCrae-street, Bendigo aforesaid, sharebroker, the executors of the will of the said deceased), are hereby required to send particulars, in writing, of such claims to the said executors, care of the said company, on or before the 14th August, 1950, after which date the executors will proceed to distribute the estate of the said deceased amongst the persons entitled thereto, having regard only to claims of which they shall then have had notice, and the said executors will not be liable for the assets so distributed, or any part thereof, to any person of whose claim they shall not then have had notice.

Dated the 20th day of May, 1950.

MACOBY, TAYLOR, & TAYLOR, solicitors, 299 Hargreaves-street, Bendigo. 2881

PURSUANT to the *Trustee Act 1928*, all persons having claims against the estate of Julia Masterson, late of 185 McCrae-street, Bendigo, in the State of Victoria, widow (who died on the 7th day of February, 1880, and letters of administration of her unadministered estate were granted by the Supreme Court of the State of Victoria, in its probate jurisdiction, to Farmers and Citizens Trustees Company Bendigo Limited, of Charing Cross, Bendigo, and William James Chapman, of 238 McCrae-street, Bendigo aforesaid, sharebroker, the administrators of the unadministered estate of the said deceased), are hereby required to send particulars, in writing, of such claims to the said administrators, care of the said company, on or before the 14th August, 1950, after which date the administrators will proceed to distribute the estate of the said deceased amongst the persons entitled thereto, having regard only to claims of which they shall then have had notice, and the said administrators will not be liable for the assets so distributed, or any part thereof, to any person of whose claim they shall not then have had notice.

Dated the 20th day of May, 1950.

MACOBY, TAYLOR, & TAYLOR, solicitors, 299 Hargreaves-street, Bendigo. 2880

RUBY MAY MORRISON, late of Newmans-road, Templestowe, married woman, DECEASED.

CREDITORS, next of kin having claims against the estate of the above-named deceased are required by the executor of her will, Harold Morrison, of Newmans-road, Templestowe, farmer, to send particulars thereof to the said executor, care of the under-mentioned solicitors, on or before the 28th day of July, 1950, after which date he will distribute the assets, having regard only to the claims of which he then has notice.

VROLAND, PEARCE, & WEBSTER, solicitors, of 430 Little Collins-street, Melbourne. 2936

NOTICE TO CREDITORS.

CREDITORS, next of kin, and others having claims in respect of the estate of Mary Catherine Tyrrell, late of 50 Armstrong-street, Middle Park, married woman, deceased (who died on the 29th day of March, 1950), are to send particulars of their claims to the National Trustees, Executors, and Agency Company of Australasia Limited, the registered office of which is situate at 95 Queen-street, Melbourne, by the 31st day of July, 1950, after which date it will distribute the assets, having regard only to the claims of which it then has notice.

Dated the 22nd day of May, 1950.

R. P. BARRETT, LL.B., 89 Queen-street, Melbourne, proctor for the applicant. 2906

JANE ANNIE COLLINS, formerly of Maud-street, Deepdene, but late of 66 Maud-street, North Balwyn, married woman, DECEASED.

CREDITORS, next of kin having claims against the estate of the above-named deceased are required by the executrix of her will, Louisa Lilburn, of 66 Maud-street, North Balwyn, married woman, to send particulars thereof to the said executrix, care of the under-mentioned solicitors, on or before the 28th day of July, 1950, after which date she will distribute the assets, having regard only to the claims of which she then has notice.

VROLAND, PEARCE, & WEBSTER, solicitors, of 430 Little Collins-street, Melbourne. 2937

FREDERICK WILLIAM FRICKE, formerly of the Public Works Department, Melbourne, but late of 323 Walsh-street, South Yarra, in the State of Victoria, retired public servant, DECEASED.

CREDITORS, next of kin having claims against the estate of the above-named deceased are required by the executrix of his will, Florence Fricke, of 323 Walsh-street, South Yarra, widow, to send particulars thereof to the said executrix, care of the under-mentioned solicitors, on or before the 28th day of July, 1950, after which date she will distribute the assets, having regard only to the claims of which she then has notice.

VROLAND, PEARCE, & WEBSTER, solicitors, of 430 Little Collins-street, Melbourne. 2938

LUIGINA ALAIMO, late of 56 Claremont-avenue, Malvern, married woman, DECEASED.

CREDITORS, next of kin having claims against the estate of the above-named deceased are required by the executor of her will, Giovanni Alaimo, of 56 Claremont-avenue, Malvern, retired greengrocer, to send particulars thereof to the said executor, care of the under-mentioned solicitors, on or before the 28th day of July, 1950, after which date he will distribute the assets, having regard only to the claims of which he then has notice.

VROLAND, PEARCE, & WEBSTER, solicitors, of 430 Little Collins-street, Melbourne. 2939

JOHN ALBERT VICTOR LLOYD COVERDALE, late of Dickson-street, Bacchus Marsh, retired water bailiff, DECEASED.

CREDITORS, next of kin having claims against the estate of the above-named deceased are required by the executors of his will, Edward Clyde Victor Coverdale, of 173 Sydney-road, South Brunswick, railway employee, and Harold Stanley Coverdale, of 220 Highfield-road, Camberwell, public works employee, to send particulars thereof to the said executors, care of the under-mentioned solicitors, on or before the 28th day of July, 1950, after which date they will distribute the assets, having regard only to the claims of which they then have notice.

VROLAND, PEARCE, & WEBSTER, solicitors, of 430 Little Collins-street, Melbourne. 2940

RE A. J. CASTLEMAN, late of Avoca, in the State of Victoria, boot salesman, DECEASED, intestate.

CREDITORS, next of kin, and all persons having claims against the estate of the above-named deceased (who died on the 31st day of January, 1950, intestate, and letters of administration of whose estate were granted to Edward Arthur Castleman, of Rathscar West, in Victoria, farmer, on the 2nd day of May, 1950), are hereby requested to send particulars, in writing, to the said Edward Arthur Castleman, on or before the 20th day of July, 1950, after which date he will distribute the assets, having regard only to the claims of which he then has notice.

Dated 4th day of May, 1950.

F. D. COUTTS, solicitor, A.M.P. Chambers, Nolan-street, Maryborough. 2892

ETHEL MAY SKURRIE, late of 30 Tennyson-street, Kew, married woman, DECEASED.

CREDITORS and next of kin having claims against the estate of the above-named deceased are required by the executor of her will, Ernest Arthur Skurrie, of 30 Tennyson-street, Kew, carrier, to send particulars thereof to the said executor, care of the under-mentioned solicitors, on or before the 28th day of July, 1950, after which date he will distribute the assets, having regard only to the claims of which he then has notice.

VROLAND, PEARCE, & WEBSTER, solicitors, of 430 Little Collins-street, Melbourne. 2935

CREDITORS, next of kin, and others having claims in respect of the estate of Janet Maxwell Hyland, late of Chiltern, in the State of Victoria, widow, deceased (who died on the 5th day of December, 1949), are to send the particulars of their claims to The Trustees, Executors, and Agency Company Limited, of 401 Collins-street, in the City of Melbourne, in the State of Victoria, by the 31st day of July, 1950, after which date it will distribute the assets, having regard only to the claims of which it then has notice.

Dated the 17th day of May, 1950.

FRANK B. LETHBRIDGE, of Chiltern, solicitor for the executor. 2908

CREDITORS, next of kin, and all others having claims against the estate of Constance Myrtle Pendlebury, formerly of 4 Ireton-street, Malabar, New South Wales, but late of Highbury-avenue, Moorabbin, in the State of Victoria, married woman (who died on the 13th day of September, 1949, and probate of whose will was granted to the Union Trustee Company of Australia Limited, of 2 O'Connell-street, Sydney, on the 28th day of December, 1949), are required to send particulars to The Union Trustee Company of Australia Limited, 333 Collins-street, Melbourne, in the State of Victoria, on or before the 22nd day of July, 1950, after which date the assets of the deceased will be distributed, having regard only to the claims of which have then been received. 2932

CREDITORS, next of kin, and others having claims in respect of the estate of Reginald Mew Hill (sometimes known as Reginald William Hill), late of Moorabbin-road, Cheltenham, attendant, deceased, intestate (who died on the 7th day of February, 1948), are to send particulars of their claims to The Equity Trustees, Executors, and Agency Company Limited, of 472 Bourke-street, Melbourne, by the 28th day of July, 1950, after which date it will distribute the assets, having regard only to the claims of which it then has notice.

TREVOR MORRIS, solicitor, 287 Collins-street, Melbourne. 2929

FREDERICK HAROLD MILLARD, late of Woorinen, storekeeper, DECEASED (who died on the 27th August, 1949).

CREDITORS and others persons having claims against the estate of the deceased are required to send particulars of same to the executrix, Mary Elizabeth Millard, care of the undersigned, on or before the 31st July, 1950, after which she will distribute the assets, having regard only to the claims of which she then has notice.

GERALD E. DELANY, solicitor, 63 Campbell-street, Swan Hill. 2909

CREDITORS, next of kin, and others having claims in respect of the estate of Mary Hargen Gamble, late of 48 Milton-street, Elwood, spinster (who died on the 19th day of July, 1946), are to send particulars of their claims to her administrator, John Henry Stanley Gamble, care of the undersigned solicitors, by the 26th day of July, 1950, after which date they will distribute the assets, having regard only to the claims of which they then have notice.

GODFREY & GODFREY, 325 Collins-street, Melbourne, solicitors. 2900

CREDITORS, next of kin, and others having claims in respect of the estate of Joseph James Bennett, late of Yuille's-road, Mornington, retired farmer, deceased (who died on the 25th August, 1949), are to send particulars of their claims to Henry William Bennett, the administrator, care of the undersigned, by the 31st July, 1950, after which date he will distribute the assets, having regard only to the claims of which he then has notice.

COOK & McCALLUM, solicitors, 422 Collins-street, Melbourne. 2923

SARAH ANN USHER, late of Bacchus Marsh, widow, DECEASED.

CREDITORS and next of kin having claims against the Estate of the above-named deceased are required by the executors of her will, Albert Ernest Usher, of Main-street, Bacchus Marsh, process worker, and Alfred John Usher, of 73 Little Charles-street, Abbotsford, postal employee, to send particulars thereof to the said executors, care of the under-mentioned solicitors, on or before the 3rd day of August, 1950, after which date they will distribute the assets, having regard only to the claims of which they then have notice.

VROLAND, PEARCE, & WEBSTER, solicitors, of 430 Little Collins-street, Melbourne. 2933

CREDITORS, next of kin, and all others having claims against the estate of Ernest William Lycett, late of "Whins," St. Brelade, in the island of Jersey, gentleman, deceased (who died on the 27th day of February, 1949), are required to send particulars of their claims, in writing, to William John Home, of Hastings, in the State of Victoria, solicitor, the duly appointed attorney of Midland Bank Executor and Trustee Company (Channel Island) Limited, the executor of the estate of the said deceased, on or before the 29th day of July, 1950, after which date the assets of the said deceased will be distributed among the persons entitled thereto, having regard only to the claims of which the said attorney has had notice.

Dated the 17th day of May, 1950.

HOME, WILKINSON, & LOWRY, solicitors, 401 Collins-street, Melbourne. 2927

CREDITORS, next of kin, and others having claims in respect of the estate of Eliza Kingsford, late of Langston-street, Northcote, in the State of Victoria, widow, deceased (who died on the 14th day of October, 1949), are required to send particulars of their claims, in writing, to the executor, Percy Charles Mostyn Loughhead, care of the undersigned, by the 25th day of July, 1950, after which date he will distribute the estate, having regard only to the claims of which he then has notice.

TOLHURST, DRUCE, & EMMERSON, 352 Collins-street, Melbourne, solicitors. 2931

In the Supreme Court of the State of Victoria.—*Fi Fa.*

NOTICE is hereby given that under and by virtue of certain process issued out of the Supreme Court of the State of Victoria and directed to the Sheriff, requiring him to levy certain moneys of the real and personal estate of Margaret Jeffree, formerly of 22 Donaldson-street, Whyalla, in the State of South Australia, but now of 221 Robin-road, Semaphore, in the State of South Australia, married woman, such sums and costs to be payable out of her separate property not subject to any restriction against anticipation, unless by reason of section 22 of the *Married Woman's Property Act 1928*, the property shall be liable to execution notwithstanding such restriction, the said Sheriff will, on Wednesday, the 28th day of June, 1950, at the hour of half-past Two o'clock in the afternoon cause to be sold at Euroa (unless the said process shall have been previously satisfied or the said Sheriff be otherwise stayed):—

All the right, title, estate, and interest (if any) of the said Margaret Jeffree in and to all that piece of land being lot 2 on plan of subdivision, No. 15331, lodged in the office of Titles and being part of Crown allotments 2, 3, and 4, section 9, Town and Parish of Euroa, County of Delatite, and being the land more particularly described in certificate of title, volume 6763, folio 1352569.

N.B.—Terms: Cash. No cheques taken.

Dated at Euroa this 16th day of May, 1950.

R. O. MACKLIN,
First Constable, 607, Sheriff's Officer.
Violet Town. 2854

IMPOUNDINGS.

GISBORNE.—Impounded at Gisborne, by Shire Council.

1 black draught gelding, hind feet white
1 bay draught mare, hind and one front feet white

If not claimed and expenses paid, to be sold on 7th June, 1950.

J. M. MORTON,
2856—6/5 Poundkeeper.

HORSHAM.—Impounded at Horsham.

1 black pony gelding, star
 1 bay gelding, light delivery, star, near front foot white
 If not claimed and expenses paid, to be sold on 10th June, 1950.

2913—6/5
 A. G. FRASER,
 Poundkeeper.

KANIVA.—Impounded at Kaniva.

3 red and white Hereford steers, mark on ear
 If not claimed and expenses paid, to be sold on 8th June, 1950.

2855—5/6
 C. H. CHARMAN,
 Poundkeeper.

LAKES ENTRANCE.—Impounded by the Shire Herdsman.

1 draught brown mare, white spot on top of each shoulder, no visible brand
 If not claimed and expenses paid, to be sold on 2nd June, 1950.

2853—6/5
 T. NORTHROPE,
 Poundkeeper.

LEXTON.—Impounded at Lexton Shire Pound, by C.R.B. Inspector, A. C. Wilson.

1 bay pony gelding, near hind foot white, saddle mark, indistinct brand near shoulder
 If not claimed and expenses paid, to be sold on 1st June, 1950.

2889—7/4
 C. F. LOXLEY,
 Poundkeeper.

MILDURA.—Impounded at Mildura City Pound.

1 brown draught mare, blazed face, white feet, like IH3 near shoulder
 If not claimed and expenses paid, to be sold on 25th May, 1950.

2861—6/5
 P. C. FAULKHEAD,
 Poundkeeper.

OXLEY.—Impounded at Oxley, by Shire Ranger.

26 Comeback ewes, eight with green saddle mark on back, two with red T on rump, various marks
 If not claimed and expenses paid, to be sold on 1st June, 1950.

2870—6/5
 H. A. SIMPSON,
 Acting Poundkeeper.

PORTLAND.—Impounded at Portland, on Thursday, 11th May, 1950, from Allestree roads.

1 bay draught mare, white face, hind feet white, off front foot white, no visible brand
 If not claimed and expenses paid, to be sold on 8th June, 1950.

2869—7/4
 A. M. MERRETT,
 Poundkeeper.

SHEPPARTON.—Impounded at Shepparton.

3 Border Leicester ewe lambs, one has two notches and one has one notch in off ear, no visible brand
 If not claimed and expenses paid, to be sold on 8th June, 1950.

2944—6/5
 G. F. WALTERS,
 Poundkeeper.

WARRNAMBOOL.—Impounded at Warrnambool.

1 black, brown, and white poley or dehorned cow, notch lower right ear, no visible brand
 1 black, brown and white heifer, no visible brand
 1 black Jersey cross heifer, no visible brand
 1 red and white heifer, no visible brand
 If not claimed and expenses paid, to be sold on 7th June, 1950.

2915—9/2
 I. HILDER,
 Poundkeeper.

WHITTLESEA.—Impounded at Epping, by J. Hughes.

1 grey pony mare, branded like 38
 1 chestnut pony gelding, white blaze, hind fetlocks white, no visible brand

If not claimed and expenses paid, to be sold on 8th June, 1950.

2897—7/4
 J. HERD,
 Poundkeeper.

AGENTS FOR THE "VICTORIA GOVERNMENT GAZETTE."

THE following have been appointed agents to receive Advertisements and Subscriptions for the *Victoria Government Gazette*.—

ARMSTRONG'S AGENCY, 143 Queen-street, Melbourne.
 ARMSTRONG BROS., Kyneton.
 MESSRS. ARNALL & JACKSON, 115 Barkly-street, West Brunswick.
 MR. M. R. BADE, Tobacconist, Sturt-street, Ballarat.
 MR. WM. DAVIS, Mildura.
 A. J. DIGBY (B. S. and N. W. CASH), Main-street, Bairnsdale.
 EDGAR'S NEWS AGENCY, Hargreaves-street, Bendigo.
 EDGAR'S NEWS AGENCY, 53 Murphy-street, Wangaratta.
 MESSRS. HENRY FRANKS & CO., Booksellers and Stationers, Market-square, Geelong.
 MESSRS. GORDON & GOTCH, News Agents, 511 Little Collins-street, Melbourne; and corner Barrack and Clarence streets, Sydney.
 W. GORDON HAMPTON, 243 Mitchell-street, Bendigo.
 MESSRS. HARSTON, PARTRIDGE, & CO., 455 Little Collins-street, Melbourne.
 MR. C. F. LATIMER, News Agent, Casterton.
 MR. F. T. McCORMICK, Nunn-street, Benalla.
 MESSRS. H. PAYNE & R. N. LOWE, 4 View Point, Bendigo.
 MESSRS. R. H. & W. M. PETTY, News Agent, Wangaratta.
 PIKE'S AUTHORIZED NEWS AGENCY, Sale.
 J. PURDIE & CO., 138 Moorabool-street, Geelong.
 MESSRS. A. S. RICHARDSON and T. C. GARDNER, trading as The Mercantile Exchange, 380 Collins-street, Melbourne.
 ROBERTSON & MULLENS LTD., Elizabeth-street, Melbourne.
 R. & A. SMALLMAN, News Agents, Toora.
 MESSRS. SMITH & DUNNON, Hamilton.
 TRAINOR & McBRIDE, 246 Wyndham-street, Shepparton
 A copy of the *Gazette* filed at each place for public reference.

THE "VICTORIA GOVERNMENT GAZETTE."

SUBSCRIPTIONS.—*The subscription, including postage, is £1 12s. 6d. per annum, 16s. 3d. half-yearly, or 8s. 2d. per quarter, payable in advance.*

Subscriptions are required to commence and terminate with a month.

A lesser period than three months cannot be subscribed for.

Subscribers do not receive the Acts of Parliament with the GAZETTE.

ADVERTISEMENTS are charged at the rate of ELEVEN PENCE per line single column, and ONE SHILLING and TEN PENCE per line double column.

The title (65 Reward, Dissolution of Partnership, &c.) forms one or more lines as a heading.

On an average, ten words make a line.

Every signature must likewise be counted as a line.

The final words of a paragraph, though only portion of a line, must be counted as one line.

SIGNATURES (in particular) and proper names must be written very plainly in the text; ONE SIDE ONLY of each slip of paper should be WRITTEN UPON.

ALL COMMUNICATIONS should be addressed to "The Government Printer, Melbourne."

ALL DOCUMENTS illegibly written will be returned unpublished, and, where brands occur unprovided for by the ordinary letters of the alphabet, a worded explanatory description must be furnished.

THE VICTORIA GOVERNMENT GAZETTE is published on WEDNESDAY EVENING in each week, and Notices for insertion will be received by the Government Printer at or before Two p.m. at ordinary rates, and late advertisements between Two p.m. and Five p.m. at double rates on the day preceding the day of publication.

Single copies of the VICTORIA GOVERNMENT GAZETTE are Six pence, posted Eight pence, each.

No GAZETTES prior to January, 1939, in stock.

*** ALL PAYMENTS ARE REQUIRED IN ADVANCE.—Remittances should be made by postal note, money order, or draft in favour of the Government Printer. Advertisements unaccompanied by a remittance sufficient to cover the cost of insertion will be returned unpublished.

PUBLICATION OF OFFICIAL MATTER.

ATTENTION is invited to the following procedure in relation to the publication of official matter in the *Government Gazette*:—

1. Matter submitted to the Executive Council.

Matter submitted to the Executive Council which requires gazettal will normally be published in the issue of the following week.

Where urgent gazettal is required, special arrangements should be made with the *Gazette* Officer.

Publication will be facilitated by the submission of carbon copies for the use of the *Gazette* Officer.

2. Other matter.

(a) All other matter duly certified by a responsible officer for publication should be lodged with the *Gazette* Officer not later than half-past Ten a.m. on Tuesday.

(b) Lengthy or involved notices should be forwarded several days before publication.

(c) Proofs, which will be supplied only when specifically requested or at the direction of the *Gazette* Officer, should be returned promptly to avoid delay in publication.

(d) No additions or amendments to matter for publication will be accepted by telephone.

CONTENTS.

	PAGE
Appointments	3052
Cemeteries—Scale of Fees	3071
Contracts	3054
Country Roads Board	3082
Estates of Deceased Persons	3067
Government Notices	3053
Impoundings	3110
King's Birthday Holiday	3052
Lands	3089
Levee at Parliament House	3052
Licences to Occupy Unused Roads	3065
Licences to Occupy Water Frontages	3067
List of Stock Foods and Stock Licks	3058
Melbourne and Metropolitan Board of Works Notices	3071
Ministers of Religion Registered to Celebrate Marriages in Victoria	3066
Orders in Council	3074
Private Advertisements	3099
Proclamations	3049
Public Service Notices	3094
Resignations	3053
State Rivers and Water Supply Commission	3056
Tenders	3098
Transport Regulation Board—Public Hearings	3057
Waterworks Trusts	3068



VICTORIA GOVERNMENT GAZETTE.

Published by Authority.

[Registered at the General Post Office, Melbourne, for transmission by post as a newspaper.]

No. 461]

WEDNESDAY, MAY 24.

[1950

FIXING THE TIME FOR HOLDING THE FIRST SESSION OF THE THIRTY-EIGHTH PARLIAMENT OF VICTORIA.

PROCLAMATION

By His Excellency the Governor of the State of Victoria and its Dependencies in the Commonwealth of Australia, &c., &c., &c.

I, THE Governor of the State of Victoria, in the Commonwealth of Australia, do by this my Proclamation, fix Tuesday, the twentieth day of June, 1950, as the time for the commencement and holding of the First Session of the Thirty-eighth Parliament of Victoria, for the despatch of business, at the hour of Eleven o'clock in the forenoon, in the Parliament Houses, situate in Spring-street, in the City of Melbourne: And the Honorable the Members of the Legislative Council and the Members of the Legislative Assembly are hereby required to give their attendance at the said time and place accordingly.

Given under my Hand and the Seal of the State of Victoria aforesaid, at Melbourne, this twenty-fourth day of May, in the year of our Lord One thousand nine hundred and fifty, and in the fourteenth year of the reign of His Majesty King George VI.

(L.S.)

DALLAS BROOKS.

By His Excellency's Command,

T. T. HOLLWAY,

Premier.

GOD SAVE THE KING!



[3116]



VICTORIA
GOVERNMENT GAZETTE.

Published by Authority.

[Registered at the General Post Office, Melbourne, for transmission by post as a newspaper.]

No. 462]

WEDNESDAY, MAY 24.

[1950

SUPPLEMENTARY REGISTER OF TEACHERS
AND SUPPLEMENTARY REGISTER OF
SCHOOLS FOR THE YEAR ENDED
31ST DECEMBER, 1949.

THE subjoined Supplementary Lists, showing the alterations, additions, revisions, and removals made in the Register of Teachers and in the Register of Schools during the year ended 31st December, 1949, are published in accordance with the provisions of Section 104, sub-section (2), of the *Education Act* 1928.

A. H. RAMSAY, President.

W. R. STEVENSON, Registrar.

The Council of Public Education,
Education Office, Melbourne, C.2.
31st January, 1950.

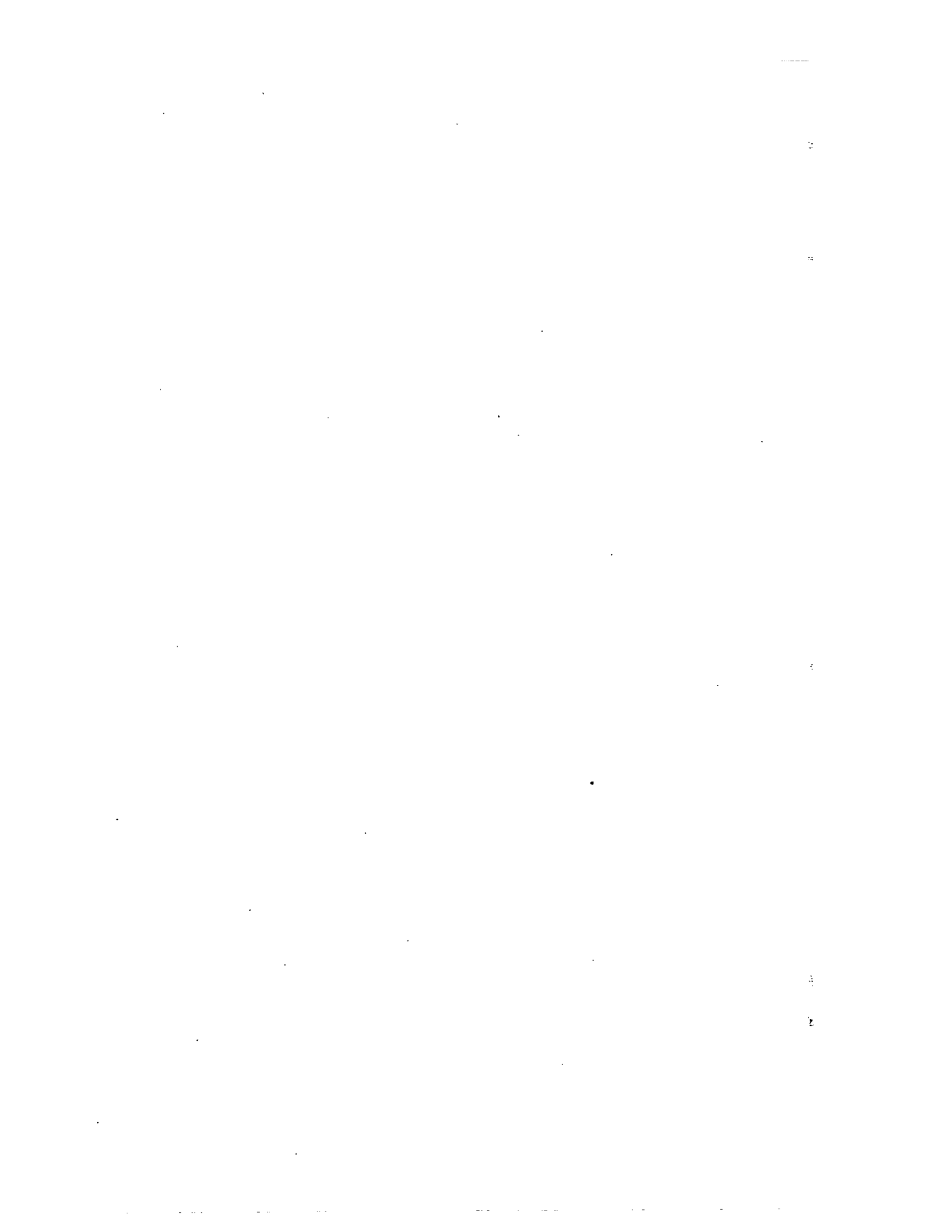

TABLE OF ABBREVIATIONS.

A.A.A.	Associate, Association of Accountants.
A.C.M.M.	Associate, Conservatorium of Music, Melbourne.
A.C.P., Eng.	Associate, College of Preceptors, England.
A.F.I.A.	Associate, Federal Institute of Accountants, Australia.
A.I.C.A.	Associate, Institute of Commonwealth Accountants.
A.I.I.A.V.	Associate, Incorporated Institute of Accountants, Victoria.
A.A.I.S.	Associate, Australian Institute of Secretaries.
A.L.C.M.	Associate, London College of Music.
A.M.	Assistant Master.
A. Mus. V.C.M.	Associate in Music, Victoria College of Music, London.
A.R.C.M.	Associate, Royal College of Music, London.
A.R.C.S.	Associate, Royal College of Science, London.
A.R.V.I.A.	Associate, Royal Victorian Institute of Architects.
A.S.A., Eng.	Associated Society of Accountants, England.
A.S.M.M.	Associate, School of Mines, Maryborough.
A.T.	Assistant Teacher.
A.T.C.L.	Associate, Trinity College of Music, London.
A.V.S.P.A.	Associate of the Victorian Society of Public Accountants.
B.A.	Bachelor of Arts.
B. Ag. Sc.	Bachelor of Agricultural Science.
B.C.E.	Bachelor of Civil Engineering.
B. Com.	Bachelor of Commerce.
B. Econ.	Bachelor of Economics.
B.Ed.	Bachelor of Education.
B.Sc.	Bachelor of Science.
B.T. (Bombay)	Bachelor of Teaching (Bombay)
Bot.	Certificate in Botany, Education Department.
C.A.	Chartered Accountant, Edinburgh.
Camb. (or) Cantab.	Cambridge.
C.B.	Passed the full course of the Order of the Christian Brothers.
Cert.	Certificate of Competency, Education Department.
Cert. Pianiste, T.C.L.	Certificated Pianiste, Trinity College, London.
Cert. Tr. Bd. Edn., London	Certificated Teacher, Board of Education, London.
Cert. Tr. R.A.M., Lon.	Certificated Teacher, Royal Academy of Music, London.
C.T.A.B.	Certificated Teacher, Associated Board of the Royal Academy of Music and the Royal College of Music, London.
Chem.	Certificate in Chemistry, Education Department.
1st Cl. Cert.	First Class Certificate, Education Department.
2nd Cl. Cert.	Second Class Certificate, Education Department.
2nd Cl. Cert. pendg. 1st C. Cert.	Second Class Certificate pending First Class Certificate, Education Department.
1st Cl. 1 Yr. Trg.	First Class, First Year Training, Education Department.
1st Cl. 2 Yr. Trg.	First Class, Second Year Training, Education Department.
2nd Cl. 1 Yr. Trg.	Second Class, First Year Training, Education Department.
2nd Cl. 2 Yr. Trg.	Second Class, Second Year Training, Education Department.
Coll.	College.
Co-Prin.	Co-Principal.
Dip. Assoc. Soc. Sc.	Diploma of Associate in Social Science.
Dip. Com.	Diploma of Commerce.
Dip. Dom. Econ. Ed. Dept.	Diploma of Domestic Economy, Education Department.
Dip. Educn.	Diploma of Education, Melbourne University.
Dip. Hist.	Diploma in History, London.
Dip. Mus.	Diploma in Music, Melbourne University.
Dip. Mus. Assoc.	Diploma of Musical Associate, Melbourne University.
Dip. Nat. Edn. Bd., Ireland	Diploma of the National Education Board, Ireland.
2nd Div. Comp. Ed. Dept.	Second Division of Competency, Education Department.
D.M.A.V.	Diploma, Musical Association of Victoria.
D.M.S.V.	Diploma, Musical Society of Victoria.
2 Cl. D.M.S.V.	Second Class Diploma, Musical Society of Victoria.
Dril.	Qualified to Teach Drill, Education Department.
Drg.	Licence to Teach Drawing, Education Department.
Drg. Lic.	Licence to Teach Drawing, Education Department.
Drg. Cert.	Certificate of Competency in Drawing, Education Department.
Drg. Tr's Prim. Cert.	Drawing Teacher's Primary Certificate, Education Department.
Drg. Tr's Sec. Cert.	Drawing Teacher's Secondary Certificate.
Ed. Dept.	Education Department.
Edin.	Edinburgh.
Exam. Cl. Edn.	Examination of Council of Education.
F.A.I.S.	Fellow of the Australian Institute of Secretaries.
F.C.P.A.	Fellow of the Corporation of Public Accountants.
F.C.S.	Fellow of the Chemical Society.
F.F.A.	Fellow of the Faculty of Actuaries, Scotland.
F.F.I.A.	Federal Institute of Accountants.
F.G.C.M.	Fellow of the Guild of Church Musicians, England.
F.G.S., London	Fellow of the Geological Society of London.
F.I.A.V.	Fellow of the Institute of Accountants, Victoria.
F.I.C.A.	Fellow of the Institute of Commonwealth Accountants.
F.I.C.S.T., Lon.	Fellow of the Institute of Commercial and Specialist Teachers, London.
F.L.S.	Fellow of the Linnean Society.
F.P.S.A.	Fellow of the Incorporated Phonographic Society of Australia.
F.R.C.O.	Fellow of the Royal College of Organists, England.
F.R.M.S.	Fellow of the Royal Microscopical Society.
F.S.C.T.S.	Fellow of the Society of Certificated Teachers of Shorthand.
Gym.	Qualified to Teach Gymnastics, Education Department.
H.M.	Head Master.
Head Mis.	Head Mistress.
H.T.	Head Teacher.
1st Hon. Ed. Dept.	First Class Honours, Education Department.
2nd Hon. Ed. Dept.	Second Class Honours, Education Department.
Inf. Mist.	Infant Mistress.
Insp.	Inspector.
Inter. B.Sc., Lon.	Passed Intermediate Examination, Faculty of Science, London University.
Inter. Cert.	Intermediate Certificate.

1st Cl. I.T.C.	First Class Infant Teacher's Certificate, Education Department.
2nd Cl. I.T.C.	Second Class Infant Teacher's Certificate, Education Department.
Jt. Propr.	Joint Proprietor.
J.P. Melb.	Junior Public Examination, Melbourne University.
J.T.	Junior Teacher.
Jun. Dmr.	Junior Demonstrator.
Jun. Res. M.	Junior Resident Master.
Jun. Univ.	Junior University.
K.T.	Qualified as a Kindergarten Teacher.
L.	Licence to Teach, Education Department.
L. pendg. Cert.	Licence pending Certificate of Competency, Education Department.
L.A.	Licensed Auditor, Victoria.
L.A.B.	Licentiate, Associated Board of the Royal Academy of Music and the Royal College of Music, London.
L.I.C.A.	Licentiate of Institute of Commonwealth Accountants.
L.I.I.A.V.	Licentiate, Incorporated Institute of Accountants, Victoria.
LL.A., St. Andrew's	Literate in Arts, St. Andrew's University, Scotland.
LL.B.	Bachelor of Laws.
LL.C.M.	Licentiate, London College of Music.
LL.D.	Doctor of Laws.
LL.M.	Master of Laws.
L. Mus. T.C.L.	Licentiate in Music, Trinity College, London.
L.R.A.M.	Licentiate, Royal Academy of Music, London.
LS.W.	Licensed Shorthand Writer, Victoria.
L.T.C.L.	Licentiate, Trinity College, London.
L.V.C.M.	Licentiate, Victoria College of Music, London.
Lvg. Cert.	Leaving Certificate.
Lvg. Hons.	Leaving Certificate Honors.
M.A.	Master of Arts.
Math. M.	Mathematical Master.
Matricn.	Matriculation.
M.B.	Bachelor of Medicine.
M.B., B.S.	Bachelor of Medicine, Bachelor of Surgery.
M.C.E.	Master of Civil Engineering.
M.D.	Doctor of Medicine.
Melb.	Melbourne.
M.F.I.A.	Member, Federal Institute of Accountants, Australia.
M.Inst.E.E.	Member, Institute of Electrical Engineers.
Mis. of M.	Mistress of Method.
M.R.C.O.	Member, Royal College of Organists, England.
Mus.	Licence to Teach Music, Education Department.
Mus. Assoc. Melb.	Musical Associate, Melbourne University.
Mus. Bac.	Bachelor of Music.
Mus. Cert.	Certificate of Competency in Music, Education Department.
Mus. Doc.	Doctor of Music.
O. Carm.	Member of the Carmelite Order.
Oxon.	Oxford.
Ph. C.	Pharmaceutical Chemist of Great Britain.
Ph. D.	Doctor of Philosophy.
Primy.	Primary.
Prin.	Principal.
Propr.	Proprietor.
Pupil T.	Pupil Teacher.
P.S.T.C.	Pitman's Shorthand Teacher's Certificate.
Relvg. T.	Relieving Teacher.
R.T.	Relieving Teacher.
Roy. Univ., Ireland	Royal University, Ireland.
Sci.	Science Certificate, Education Department.
2 Sci. (or) 2 Scs.	2 Science Certificates, Education Department.
S.D.A.	Seventh Day Adventist.
Secdy.	Secondary.
Sen. Com., Melb.	Senior Commercial Examination, Melbourne University.
Sloyd	Sloyd Teacher's Certificate, Education Department.
S.P., Melb.	Senior Public Examination, Melbourne University.
Sen. Res. M.	Senior Resident Master.
S.J.	Member of the Order of the Society of Jesus.
Sng.	Licence to Teach Singing, Education Department.
Sng. Cert.	Certificate of Competency in Singing, Education Department.
Sp. T.C.	Special Teacher's Certificate (Ed. Dept.)
S.S.	State School.
Stu. T.	Student Teacher.
Sub-Primy.	Sub-Primary.
Temp. T.	Temporary Teacher.
Tr.	Teacher.
Tr's. Cert. Bd. Edn., London	Teacher's Certificate, Board of Education, London.
Tr's. Cert. Mus. Melb. Univ.	Teacher's Certificate of Music, University of Melbourne.
Tr's. Cert., Edn. Dept., Punjab, India	Teacher's Certificate, Education Department, Punjab, India.
Tr's. Cert., Scotch Edn. Dept.	Teacher's Certificate, Scotch Education Department.
T.I.T.C.	Trained Infant Teacher's Certificate, Education Department.
T.P.T.C.	Trained Primary Teacher's Certificate, Education Department.
T.S.T.C.	Trained Secondary Teacher's Certificate, Education Department.
T.T.C.	Trained Teacher's Certificate, Education Department.
T.T.C. (Com. subjs.)	Trained Teacher's Certificate (Commercial subjects).
T.T. Dipl. Cam.	Trained Teacher's Diploma, Cambridge.
1st Yr. Arts	First Year Arts.
2nd Yr. Arts	Second Year Arts.
IIA Cert.	Teacher's Certificate Class IIA.
IIB Cert.	Teacher's Certificate Class IIB.
IIIA Cert.	Teacher's Certificate Class IIIA.
IIIB Cert.	Teacher's Certificate Class IIIB.
"C" Cert.	Teacher's Certificate Class "C."
"D" Cert.	Teacher's Certificate Class "D."

REGISTER OF TEACHERS.

ADDITIONS AND REVISIONS MADE DURING THE YEAR ENDED 31st DECEMBER, 1949.

Registered No.	Name.	Address.	Division in which Registered.				Subject, if in Division D.	(g) Registered by virtue of Employment before this passing of the Act.	(h) Evidence produced satisfactory to the Council of Fitness to Teach.	Qualifications.		Date of Registration.	Remarks.
			Primary.		Secondary.					(c) Literary, Academic, or other Qualifications.			
			A	B	C	D							
16573	a'Beckett, Declan (Br.)	Marist Brothers' Scholasticate, 21 Canterbury-road, Camberwell	B					Fitness to teach			27.6.49		
12452	Ackland, Hugh Lionel	Camberwell Grammar School, Mont Albert-road, Balwyn, E.8	B	C				"	B.C.E. (Melb.)		27.4.33 28.3.49	Additional registration	
16388	Agnew, Lesley Phillipa	35 Evans Court, Toorak, S.E.2	A					"	Matriculation		7.2.49		
16452	Aldag, Keith	35A Grant-street, East Brighton, S.6				D		"					
16524	Alston, Marjorie Joan	25 Edward-street, Kew, E.4			C			"	E.A., T.P.T.C.		28.11.49 26.4.49	Additional registration	
16460	Anderson, Spencer Percival	13 McGregor-street, Canterbury, E.7	B	C				"	1st C.C.		26.11.45 28.3.49	Additional registration	
16461	Archer, Enid Maude (Mrs.)	5 Henry-street, Highett	A					"	School Certificate Examination (Senior Cambridge)		14.2.49		
16548	Arnott, Florence Hunter	33 Chatham-road, Canterbury, E.7			C			"	R.A., Dip. Ed.		30.5.49		
16525	Aston, Marjory Joyce (Mrs.)	Melbourne-road, Ballarat		B				"	Trained Teacher's Certificate (S.A.)		26.4.49		
16389	Baggardge, Valma Rose	20 Hampden-road, Armadale						"	Dip from Kindergarten College of W.A.		7.2.49		
16549	Baglin, Mary (Mrs.)	12 Mangarra-road, Canterbury, E.7	A		C			"	M.A., Dip. Ed., T.T.C.		30.5.49		
16390	Baker, Jean Robertson	49 Middle-crescent, Brighton	A					"	"Specialist in Nursery School and Kindergarten Work"		7.2.49		
15877	Baldwin, Annie MacLeod	89 Sackville-street, Kew, E.4		B	C			"	B.A., T.P.T.C.		26.5.47 26.9.49	Additional registration	
15585	Ballinger, June Mary	Sacred Heart College, Ballarat East		B		D		"	Lvg. Cert.		24.6.46 27.6.49	Additional registration	
16487	Bang, Dawn Lesley (Sr. Mary June)	The Sisters of Charity, Challis-avenue, Potts Point, New South Wales	A					"			28.3.49	Additional registration	
16000	Barnbaum, Krasel	147 Fignon-street, North Carlton		B				"			30.5.49 25.7.49	Additional registration	
16653	Barnes, Lorna Priscilla	Clyde School, Woodend		B				"	London Higher Schools' Cert., Ministry of E. Teaching Cert.		28.11.49		
16391	Bartlett, Judith	17 Wilana-street, Kew	A					"	"Specialist in Nursery School and Kindergarten Work"		7.2.49		
16601	Batchelor, Jessie Veronica (Sf. Mary William)	Our Lady of the Sacred Heart Convent, Jasper-road, Bentleigh		B				"			25.7.49		
16574	Beatty, Nancy Winifred (Mrs.)	Gibbs-road, Montrose		B				"	T.P.T.C.		27.6.49		

ADDITIONS AND REVISIONS MADE DURING THE YEAR ENDED 31ST DECEMBER, 1949—continued.

Certificate No.	Name.	Address.	Division in which Registered.				Subject if in Division D.	(c) Registered by virtue of Employment before the passing of the Act.	(b) Evidence produced in support of the Certificate of Fitness to Teach.	Qualifications.		Date of Registration.	Remarks.
			Sub-Primary	Primary	Secondary	Special Subjects				(c) Literary, Academic, or other Qualifications.			
1618 8	Beckwith, Kathleen Margaret	12 Welsford-street, Shepparton ..		B				Fitness to teach	Primary Teacher's Cert (2nd Cl.)		28.3.49		
1649 0	Bellacora, Dorothy Ethel (Mrs.)	49 Orlando-street, Hampton, S.7 ..		B				"	1st C.C., Lvg. Cert.		28.3.49		
1648 9	Bendle, Valerie May ..	10 Meakin-street, East Geelong ..		C				"	B.A., Dip. Ed.		28.3.49		
1630 2	Bennett, Edna Ruby ..	33 Martin-street, Sunshine ..	A					"	Lvg. Cert., "Specialist in Nursery School and Kindergarten Work"		7.2.49		
1613 2	Bennett, John Nelson ..	Brighton Grammar School, Brighton, S.5 ..		B	C			"	J.L.B. (Addelaide)		27.4.48	} Additional registration	
1649 1	Bergson, Dora (Mrs.) ..	4 Blessington-street, St. Kilda ..		B				"	Univ. of Durham, School Cert.		28.4.49		
1657 5	Blakors, Catherine ..	78 Hotham-street, East St. Kilda ..		B	C			"	B.A., Dip. Ed.		28.3.49		
1657 6	Brogan, Valerius (Br.) ..	Marist Brothers' Scholastic, 21 Canterbury-road, Camberwell		B				"			27.6.49		
1647 4	Blomfield, Roger Marsh ..	Geelong Grammar School, Corio ..			C			"	B.A.		27.6.49		
1630 3	Blondel, Beverley ..	Box 258, Swan Hill ..	A					"	"Specialist in Nursery School and Kindergarten Work"		28.2.49		
1655 0	Bhundell, Aileen Marion ..	Main-street, Lilydale ..		B				"	T.P.T.C.		7.2.49		
1695 4	Borrack, Leo George ..	12 Hawker-street, Ivanhoe, N.21 ..			C			"	Dip. Ed.		28.11.49		
1647 5	Borroughs, Benjamin Victor (Rev.)	Ivanhoe Grammar School, Ivanhoe ..			C			"	M.A. (Durham Univ.); Dip. in Theology (Durham Univ.)		28.2.49		
1683 2	Bowen, Helen Avenel ..	10 Hambleton-street, Albert Park, S.C.6 ..		B				"	T.P.T.C.		31.10.49		
1639 4	Bradshaw, Dorothy Ellen ..	67 Rowell-avenue, Camberwell ..	A					"	"Specialist in Nursery School and Kindergarten Work"		7.2.49		
1639 5	Brown, Joy Mary ..	8 Edward-street, Kew ..	A					"	Matric.; "Specialist in Nursery School and Kindergarten Work"		7.2.49		
1662 5	Brownless, Vera Theresa ..	15 Orrong-crescent, Camberwell ..			C			"	B.Sc. (Maths.); M.A. Degree in Education; "Teacher's Diploma (London Uni.)"		26.9.49		
1639 6	Bryant, June Annette ..	20 Kingsley-parade, Ormond, S.E.9 ..	A					"	"Specialist in Nursery School and Kindergarten Work"		7.2.49		
1639 7	Buckman, Joan Ashworth ..	6 Moore-street, Hawthorn ..	A					"	"Specialist in Nursery School and Kindergarten Work"		7.2.49		
1657 7	Bungey Patricia Mary ..	Carey Baptist Grammar School, Kew ..		B				"	"C" Cert., W.A.		27.6.49		
1655 1	Burnett, Florence Eleanor (Mrs.)	55 Duke-street, Sunshine, W.20 ..	A	B				"	"C" Cert. (Educn. Dept., W.A.); "B" Cert. (Educn. Dept., W.A.)		30.5.49		

No.	Name	Address	Class	Grade	Subject	Examination	Result	Remarks
16402	Burnett, Margaret Joy	86 Lockwood-street, South Australia	B					
16398	Burton, Margaret Jean	"Karawara," Mansfield-road, Benalla	A					
16462	Byrne, Elizabeth Agnes	"Creekside," Nar Nar Goon	B					
16399	Caldler, Margaret Helen	108 Burnbank-street, Ballarat	A					
16655	Cahill, M. Michael (Sr.)	St. Joseph's Convent, Havelock-road, Haw. thorn	A					
16400	Calvert, Winifred Mary Fairfax	"Forest Home," Huonville, Tasmania	A					
16633	Cameron, Jean	324 Auburn-road, Hawthorn, E.2	B	C				
13796	Campbell, Lilian Agnes (Sr. M. Genevieve)	St. Vincent's Convent, Potts Point, Sydney	B	C				
16578	Cantwell, Mary	671 Burke-road, Camberwell, E.6	B	C				
16401	Carlson, Mary Elizabeth	Cathedral Hotel, Swanston-street, City	C					
13797	Carrall, Eileen Grace (Sr. M. Mildred)	St. Vincent's Convent, Potts Point, Sydney	B	C				
12455	Carty, Ellen Anne	1169 Hoddle-street, East Melbourne	A	B				
16634	Chaseling, Essie Roma	2 Church-street, Flemington, W.1	A					
16552	Chatfield, Heather June (Mrs.)	501 Kooyong-road, Elsternwick	C					
16656	Chippini, Marie Noelene	59 Sheffield-street, Coburg, N.13	B					
16610	Claughton, Mavis Alice	168 Canterbury-road, Middle Park	B					
3668	Clerf, Evaline Elizabeth Victoria	S.D.A. Central School, Hawthorn, E.2	A	B	C	D	Bookkeeping	
16657	Contes, Margaret Clare	30 Lansell-road, Toorak, S.E.2	B					
16526	Cochrane, Jean Crawford	Methodist Ladies' College, Kew, E.4	C					
16493	Cody, Mavis Mary	St. Michael's School, Brougham-street, North Melbourne	B					
16658	Colk, June Margaret	12 Tennyson-avenue, Caulfield	A					
16635	Colman, David Hew	Geelong Grammar School, Corio	B					
16402	Conry, Kathleen Mary (Sr. Marie Bernarde)	Presentation Novitiate, Nagle-avenue, Elsternwick	A					
16611	Considine, Monica Philomena (Sr. M. Philomena)	Star of the Sea Convent, Gardenvale	B					
16442	Cook, Dorothy Josephine (Sr. Mary St. Philip)	St. Mary's Priory, West Maitland	A					
16602	Coombes, Herbert Ealyn	Hamilton College, Hamilton	C					
16463	Cornish, Richard Burnet	Scotch College, Hawthorn, E.2	B					
16527	Craig, Alexander Sadler	366 Bond-street, Long Gully, Bendigo	B	C				
16528	Crawshaw, Nancy Bertha (Mrs.)	c/o Sir Henry Barkly Hotel, Main-road, Ballarat	B					

Lyg. Cert.

28.3.49

"Specialist in Nursery School and Kindergarten Work"

7.2.49

Second Class Cert.

14.2.49

"Specialist in Nursery School and Kindergarten Work"

7.2.49

28.11.49

"Specialist in Nursery School and Kindergarten Work"

7.2.49

T.P.T.C.; T.I.T.C.

31.10.49

B.A.

27.2.39

7.2.49

27.6.49

7.2.49

B.A.

Additional registration

B.A.

27.2.39

15.6.49

27.4.33

28.3.49

31.10.49

B.A. (Hons.); Dip. Ed.

30.5.49

28.11.49

New Zealand Government Teacher's "C" Cert.

29.8.49

27.5.18

23.2.48

22.2.38

14.2.49

28.11.49

B.A. (Melb.)

Additional registration

M.A. (Dublin University)

26.4.49

T.P.T.C.

28.3.49

28.11.49

31.10.49

7.2.49

29.8.49

7.2.49

B.Sc. (India); Dip. of Teaching (Punjab)—India

25.7.49

14.2.49

B.A., B.Ed.

26.4.49

T.P.T.C.

26.4.49

T.P.T.C.

26.4.49

ADDITIONS AND REVISIONS MADE DURING THE YEAR ENDED 31ST DECEMBER, 1949—continued.

Registered No.	Name.	Address.	Division in which Registered.				Subject, if in Division D.	(c) Registered by virtue of Employment before the passing of the Act.	(b) Evidence produced in support of the Council of Fitness to Teach.	Qualifications.		Date of Registration.	Remarks.
			Sub-Primary.	Primary.	Secondary.	Special.				(c) Literary, Academic, or other Qualifications.	(b) Evidence produced in support of the Council of Fitness to Teach.		
16579	Cruise, Everard (Br.)	Marist Brothers' Scholasticate, 21 Canterbury-road, Camberwell	B					Fitness to teach			27.6.49		
16464	Cuddihy, Marjorie Annie	8 Daley-street, Elwood	B					"	2nd Cl. Cert.		14.2.49		
16659	Curnow, Thomas Colin (Rev.)	378 Nicholson-street, North Fitzroy	B					"			28.11.49		
16529	Dallas, Margaret Cecilia (Mrs.)	17A Ascot-street, North Ballarat	B					"	Matric. (Tasmania)		26.4.49		
16660	Daly, Brigid (Mother Christiane)	Lovato Convent, St. Vincent-place, Albert Park	B					"			28.11.49		
16636	Davoren, Ursula Irene	64 Allison-street, Elsternwick				D		"	Trained Domestic Art Teacher's Certificate		31.10.49		
16403	Daws, Valma Edith	37 Fairholm-grove, Camberwell	A					"	" Specialist in Nursery School and Kindergarten Work "		7.2.49		
16661	Dawson, Elizabeth Gertrude (Mrs.)	2 Cullinane-street, Black Rock, S.9	B					"			28.11.49		
16494	Dayan, Freddy Elie	c/o Overseas Corporation (Aust.) Ltd., 375 Collins-street, Melbourne				D		"	Licence as Lettres, University of Clermont (France)		28.3.49		
16495	Dayan, Rosette Marguerite	6 Alexandra-street, Balachava				D		"	Licence as Lettres; Cambridge Certificate of Proficiency in English		28.3.49		
16580	Dean, Ernest (Bro.)	Marist Brothers' Scholasticate, 21 Canterbury-road, Camberwell	B					"			27.6.49		
16581	Delahunt, Aidan	27 Rutland-street, Clifton Hill	B					"	Lvg. Cert. (N.S.W.)		27.6.49		
16404	Dennett, Margaret Mary	Convent of Mercy, Twelfth-street, Mildura	B					"	Lvg. Certificate		7.2.49		
16637	Dickinson, Beatrice Clarissa	Clyde School, Woodend	B					"	Matric. (London Univ.)		31.10.49		
16405	Donaldson, Jean Valerie	54 Canterbury-road, Toorak	A					"	Higher School Certificates " Specialist in Nursery School and Kindergarten Work "		7.2.49		
16496	Donnelly, Diarmuid Leo (Fr.)	St. Patrick's College, East Melbourne				C		"	S. J., B.Sc. (Dublin); Dip. Ed. (Dublin)		28.3.49	} Additional registration	
16553	Donnelly, Ruth Ellen	76 Stanhope-street, Malvern	B					"			28.4.49		
16406	D'Ombrian, June Rose	Grand Hotel, Mildura	A					"			30.5.49		
16662	Doonan, Joan Margaret (Sr.)	Convent of Mercy, North Melbourne	B					"	" Specialist in Nursery School and Kindergarten Work "		7.2.49		
16638	Driscoll, Marie Catherine Therese	St. Joseph's School, Hope-street, West Brunswick	B					"	T.P.T.C.		31.10.49		
16639	Dudd, Marilyn Eileen	St. Joseph's School, Yambuk	B					"	T.P.T.C.		31.10.49		
16497	Duncan, Irene May	50 Berkeley-street, Hawthorn	A					"	Diploma at Kindergarten Training College (Adelaide)		28.3.49		
16530	Dwyer, Catherine Elizabeth	123 Flemington-road, North Melbourne	B					"	Matric.		26.4.49		
16663	Dwyer, Desmond John (Bro.)	197 Danks-street, Albert Park	B					"			28.11.49		

No.	Name	Address	Class	Subject	Examination	Registration
13980	Dwyer, John Alban (Bro.)	De La Salle House, Vaulchuse, Richmond	B		Inter. Cert. N.S.W.	30.10.39 } Additional registration
14638	East, Fred George	30 Bayles-street, Parkville, N.Z.	B	Japanese	B.A.; Dip. Ed.; Dip. Com.	26.4.49 } Additional registration 26.3.29 } 25.8.36 } 25.3.49 } 14.2.49 }
16465	Edwards, Alfred William Thomas	35 Virginia-street, Newtown, Geelong	C	Bookkeeping and Accountancy	B.A., Dip. Ed.	28.3.49
16498	Egan, John Stuart	956 Nepean-highway, Highett, S.21	C	French	B.A., B.Ed., T.S.T.C.	28.3.49
16499	Ellis, Yvonne (Sr. M. Antonita)	Our Lady of the Sacred Heart Convent, Queenstown, West Coast, Tasmania	B		Inter. and Lvg. Certs. (N.S.W.)	28.3.49
16500	Etingoff, Rachel	31 Crimes-street, St. Kilda, S.2	D	French		28.3.49
16501	Evans, Christopher	Geelong Church of England Grammar School, Geelong	B		Matriculation (Tas.)	28.3.49
16407	Every, Margery Ruth	52 Brandon-street, Burwood, E.13	A		"Specialist in Nursery School and Kindergarten Work"	7.2.49
16501A	Faulkner, Peter James	St. Patrick's College, Sturt-street, Ballarat	B		Matric. (Sydney Univ.)	28.3.49
16582	Feary, Rona Mary	Queen's C.E.G.S., Mair-street, Ballarat	B		Trained Teachers' Cert., Class "C" (N.Z.)	27.6.49
13342	Finnigan, Veronica (Sr. M. Verona)	St. Joseph's Convent, North Sydney	A		Lvg. Cert. (N.S.W.)	23.2.37 } Additional registration 28.3.49 } 26.4.49 }
16531	Fitzgerald-Macgrath, Neville Mary	c/o Mr. Bridges, Bellair-street, Kensington	B			26.4.49
16532	Fitz-Patrick, Eula Mary (Sr. Mary Sebastian)	Dominican Convent, Strathfield	B		J.P. (Melb.)	31.7.11 } Additional registration 29.3.43 } 7.2.49 }
8602	Fitzpatrick, Ross (Sr.)	Convent of Mercy, Castlemaine	B	Bookkeeping Shorthand		28.11.49
16502	Flemming, Stella Agatha (Mother)	82 St. Vincent-place Albert Park	B		Lvg. Cert.	26.4.49
16664	Foley, M. Dominic (Sr.)	St. Joseph's Convent, Havlock-road, Hawthorn	B			29.8.49
16533	Foote, Maisie Olive	Post Office, Hamilton	B			29.8.49
16612	Fontaine, Br. John Paul	Marist Brothers' College, Bendigo	B			27.6.49
16617	Fox, Edna (Mrs.)	30 Wynstay-road, Prahran, S.1	B		Matric. (Sydney)	28.3.49
16583	Fox, Myles (Bro.)	Marist Brothers' Scholasticate, 21 Canterbury-road, Camberwell	B		2nd Cl. Cert.	28.3.49
16503	Frances, George Venard (Br.)	St. Patrick's College, Sturt-street, Ballarat	B		Trained Teacher's Cert., Class "C" (N.Z.)	27.6.49
16504	Freeman, Eileen Mary (Mrs.)	52 Britannia-street, Geelong West	B		Matric.	28.11.49
16584	Gale, James Arthur	Camberwell Grammar School, 55 Mont Albert-road, Canterbury, E.7	B		Lvg. Cert. (N.S.W.)	27.6.49
16665	Gall, Kevin Owen	Christian Brothers' College, Queensberry-street, North Melbourne	B			28.2.49
16585	Gallagher, Rogatus (Br.)	Marist Brothers' Scholasticate, 21 Canterbury-road, Camberwell	B		Cambridge Higher School Cert., Bombay European Schools Teacher's Diploma	28.2.49
16476	Gandoin, Alan Augustus Walls	602 Hampton-street, East Brighton, S.5	B		Cambridge Higher School Cert.	28.3.49
16477	Gawthorne, Dorothy May Agnes (Mrs.)	69 Princess-avenue, Highett	B			
16505	Gawthorne, Eva	62 Princess-avenue, Highett	B			

ADDITIONS AND REVISIONS MADE DURING THE YEAR ENDED 31ST DECEMBER, 1949—continued.

Registered No.	Name.	Address.	Division in which Registered.				Subject, if in Division D.	(a) Registered by virtue of Employment before the passing of the Act.	(b) Evidence submitted satisfactory to the Council of Fitness to Teach.	Qualifications.		Date of Registration.	Remarks.
			Primary	Primary	Secondary	Special Subjects				(c) Literary, Academic, or other Qualifications.	(d) Additional registration		
16408	Gerraty, Gwenda Margaret	"Bracemar," Gloucester-avenue, Berwick ..	A					Fitness to teach	"Specialist in Nursery School and Kindergarten Work"		7.2.49		
13158	Gerry, Phyllis (Sr. M. Lourdes)	St. Joseph's Convent, Havebeck-road, Upper Hawthorn, E.3		B		D			Shorthand	Lyg. Cert., (N.S.W.)	28.4.36	} Additional registration	
16603	Getzler, Israel ..	259 Nicholson-street, East Brunswick			D				Hebrew		7.2.49		
16409	Gilson, Margaret Mansell ..	All Saints Rectory, 4 Meid-street, South Hobart, Tasmania	A							"Specialist in Nursery School and Kindergarten Work"	7.2.49		
16586	Goerke, Allen Reginald	St. Patrick's College, Ballarat ..		B							27.6.49		
16506	Graham, William Harold ..	6 Lorne-parade, Surrey Hills, E.10		B	C					B.A., Dip.Ed., Licentiate of Theology	28.3.49		
16640	Grant, Margaret Lyla ..	"The Hermitage," Pakington-street, Geelong				D			Domestic Science	Bachelor of Home Science (N.Z.)	31.10.49		
16410	Gray, Jocelyn Mary ..	1179 Burke-road, East Kew, E.4	A							"Specialist in Nursery School and Kindergarten Work"	7.2.49		
16411	Gray, Mavis Pearl ..	Box 14, Malvern, N.S.W. ..	A							"Specialist in Nursery School and Kindergarten Work"	7.2.49		
16534	Greaney, Michael Francis ..	1 Rex-avenue, Alphington ..		B							26.4.49		
16412	Gregory, George William ..	c/o Bank of N.S.W., 368 Collins-street, Melbourne				D			French		7.2.49		
16466	Halloran, Kathleen (Sr. M. Teresa)	Star of the Sea, Presentation Convent, Gardenvale, S.4		B							14.2.49		
16666	Hanson, John Joseph (Br.)	61 Stanhope-street, Malvern ..		B							28.11.49		
16467	Harold, Marie Therese (Sr. Marie Therese)	Star of the Sea, Presentation Convent, Gardenvale, S.4		B							14.2.49		
16587	Hart, June Athanie ..	Flat 2, 189 Whitehorse-road, Balwyn ..			C					B.Sc.	27.6.49		
16413	Hatters, Henry John ..	34 Turner-avenue, Glenhuntly, S.E.9		B						2nd Cl. Cert.	7.2.49		
16554	Hay, Ellen (Mrs.) ..	15 Emma-street, Caulfield, S.E.8		B						T.P.T.C.	30.5.49		
16535	Hayes, Patricia ..	Brigidine Convent, Malvern ..		B						T.P.T.C.	26.4.49		
16507	Heard, Ailsa Stewart ..	Private Bag, Horsham ..				D			Domestic Science	Diploma of Cookery and Institutional Management	28.3.49		
16414	Henty-Wilson, Betty Mary	33 Wellington-street, Kew, E.4	A							"Specialist in Nursery School and Kindergarten Work"	7.2.49		
16415	Hewitt, Judith Mary ..	10 Warrandyte-road, Ringwood ..	A							"Specialist in Nursery School and Kindergarten Work"	7.2.49		
16536	Hindley, Charles Hugh Philip Daniel	Church of England Grammar School, Ballarat		B	C					B.A., M.A.	26.4.49		
16537	Hindley, Elizabeth Ruth ..	Church of England Grammar School, Ballarat		B							26.4.49		

No.	Name	Address	Class	Grade	Subject	Trained Teacher's Cert.	Teacher's Cert.	Registration
16478	Hipkin, Grace Iris Noreen (Mrs.)	21 Grandview-grove, Prahran, S.1	A			Trained Infant Teacher's Cert.	28.2.49	
16667	Hollister, Margaret Cecilla (Mrs.)	Bolton-street, Eltham	B			"Specialist in Nursery School and Kindergarten Work"	28.11.49	
16418	Holmes, Judith Ann	64 Fellows-street, Kew, E.4	A			B.A. (N.Z. Univ.)	7.2.49	
16416	Holmes, Thomas Donovan	88 Toorak-road, South Yarra	C				7.2.49	
16688	Holton, Catherine Marie	3 Belmore-road, Balwyn	B				27.6.49	
16417	Horman, Beryl Margaret	2A Dryden-street, Canterbury	A			"Specialist in Nursery School and Kindergarten Work"	7.2.49	
16479	Horrobin, Mabel Doris	100 Caroline-street, South Yarra	A			Teacher's Cert. of the National Froebel Union; Board of Education Teacher's Cert.	28.2.49	
16419	Howley, Aileen Mary (St. Mary Gabriel)	Rosary Convent, Waratah	A				7.2.49	
16668	Huhs, Iris Penelope	52 Calambena-avenue, Oakleigh	A			Trained Infant Teacher's Cert.	28.11.49	
16555	Human, Shirley Egerton	St. Michael's C.E.G.S., Marlton-crescent, St. Kilda, S.2	B			B.Sc. (W.A.)	30.5.49	
16669	Hunt, John Garland	800 Hampton-street, Brighton, S.5	C			B.A., T.P.T.C.	28.11.49	
16420	Hurley, John Maurice	Christian Brothers' College, Canterbury-road, Warrambool	B			Lvg. Cert.	7.2.49	
16604	Hutton, Herbert Bernard	Geelong Grammar School, Corio	C				25.7.49	
16421	Hbbs, Aileen Estelle	5 Pyramid-crescent, Korang	A			"Specialist in Nursery School and Kindergarten Work"	7.2.49	
16670	Illingworth, Hazel	Clyde School, Woodend	D	Domestic Science		Domestic Science Diploma and Teaching Cert.	28.11.49	
16671	Isbi, Mark	414 St. Kilda-road, Melbourne	D	Hebrew			28.11.49	
16480	Isaacson, Bettine Pauline	71 Huntingtower-road, Malvern	A			"Specialist in Nursery School and Kindergarten Work"	28.2.49	
16468	Jackman, Gabrielle Lilian (St. M. Catherine)	"Star of the Sea" Presentation Convent, Gardenvale	B				14.2.49	
16556	Janetzki, Laura (Mrs.)	46 King-street, Ararat	A			T.P.T.C., I.T.C.	30.5.49	
16508	Jefferies, Daphne Ann	1150 Malvern-road, Malvern	B			Univ. of Reading and Associated Colleges Teaching Cert.	28.3.49	
16538	Johnson, Emma (Mrs.)	18 Austin-avenue, Elwood, S.3	B			D.P.T.C.	26.4.49	
16589	Johnson Leander (Br.)	Marist Brothers' Scholasticate, 21 Canterbury-road, Camberwell	B				27.6.49	
16422	Johnson, Margaret Mary (Mrs.)	18 Madden-grove, Kew	A			T.P.T.C., 1st Cl. I.T.C.	7.2.49	
16613	Johnson, Mervyn Arthur	24 Elphin-street, Darebin, N.21	B			T.P.T.C.	29.8.49	
16509	Johnston, Marjorie Stella	5 Albury-road, North Balwyn, E.9	B			Maetren.	28.3.49	
16590	Johnston, Phyllis Margaret	c/o Mrs. L. Waites, Hailes-street, Greensborough	B				27.6.49	
36423	Kelly, Joycelyn Elizabeth	102 Belford-road, Kew, E.5	A			"Specialist in Nursery School and Kindergarten Work"	7.2.49	
16424	Kerr, Fay Conway	"Aston," 27 Queen's-road, Melbourne	A			"Specialist in Nursery School and Kindergarten Work"	7.2.49	
12967	Kilmartin, Desmond Gerard	St. Kevin's College, Toorak	B	C		B.A.	25.6.35 26.4.49	Additional registration

ADDITIONS AND REVISIONS MADE DURING THE YEAR ENDED 31ST DECEMBER, 1949—continued.

Registered No.	Name.	Address.	Division in which Registered.				Subject, if in Division D.	Qualifications.			Date of Registration.	Remarks.
			Sub-Primary.	Primary.	Secondary.	Special Subjects.		(a) Registered by virtue of Employment before the passing of the Act.	(b) Evidence presented satisfactory to the Council of Fitness to Teach.	(c) Literary, Academic, or other Qualifications.		
16672	Kinsella, David Donatus ..	Christian Bros. College, Queensberry-street, North Melbourne		B						28.11.49		
16557	Kirsten, Marcia Meymott (Mrs.)	6 Harrison-crescent, Hawthorn ..			C				B.A., Diploma of Modern Language Teaching	30.5.49		
16558	Kneebone, Margaret Mary ..	4 Caloola-avenue, Oakleigh ..		B					T.P.T.C. ..	30.5.49		
16641	Knief, Gisela (Mrs.) ..	60 St. Vincent's Place, Albert Park ..		B		D	German			31.10.49		
16599	Kohn, Hermine (Mrs.) ..	101 Lee-street, North Carlton ..				D	Hebrew			27.6.49		
16642	Komesaroff, Miriam ..	102 Garton-street, North Carlton ..			C				B.A., Dip.Ed.	31.10.49		
16673	Kovacs, Martin ..	CIC, Bonegilla ..			C					28.11.49		
16674	Lacey, Mary Winifred (St. M. Ignatius)	Brigidine Convent, Malvern, S.E.4 ..		B						28.11.49		
16481	Laddis, Brenda Margaret ..	St. Catherine's School, 17 Heyington-place, Toorak			C				B.A., Dip. Ed.	28.2.49		
16539	Lanyon, Jean Dorothea ..	Tara-avenue, Blackburn ..		B						26.4.49		
16675	Lapin, Barbara ..	Willow Court, Eildon-road, St. Kilda ..		B					B.A.	28.11.49		
16676	Lee, Aileen May ..	72 Ross-street, Northcote, N.16 ..		B						28.11.49		
16510	Leopoladakis, Ruchama (Mrs.)	54 Park-street, West Brunswick ..				D	Howbrew and Yiddish			28.3.49		
16591	Lewis, Ivor Norman ..	106 Coppin-street, Richmond ..		B						27.6.49		
16614	Lewis, Minnie ..	11 Carnarvon-street, Brunswick ..		B					English Qual.—Teacher's Cert., Board of Education	29.8.49		
16540	Loutit, Thomas James ..	38 Hodder-street, East Brighton ..		B					T.P.C. ..	26.4.49		
16425	Lukies, Shirley Isobel ..	39 Dalny-road, Murrumbidgee, S.E.9 ..		A					"Specialist in Nursery School and Kindergarten Work"	7.2.49		
12528	Lynch, John H. (Br.) ..	Christian Brothers' College, North Melbourne		B	C				B.A. ..	27.6.33	Additional registration	
12515	Lynch, Mary Gertrude (Sr. M. of Good Counsel)	Sacred Heart College, Ballarat East		A					Lvg. Cert.	25.7.49	Additional registration	
16677	Lyon, Elizabeth ..	Main-road, Eltham ..		B						26.2.45		
16678	Mace, Dorothy Juanita ..	St. John's Vicarage, Toorak ..		A						28.11.49		
12639	Mackey, Haidee Beryl ..	38 Belmont-avenue, Kew, E.4 ..		B	C				B.A.	27.2.34	Additional registration	
16605	Madden, Mary Margaret ..	Sacred Heart College, Ballarat East		B						25.7.49		

ADDITIONS AND REVISIONS MADE DURING THE YEAR ENDED 31ST DECEMBER, 1949—continued.

Regis- tration No.	Name.	Address.	Division in which Registered.			Subject, if in Division D.	(e) Registered by virtue of provision of the Act.	Qualifications.			Date of Registra- tion.	Remarks.
			Sub- Primary.	Primary.	Secondary.			D	(b) Evidence produced satisfactory to the Council of Fitness to Teach.	(c) Literary, Academic, or other Qualifications.		
16561	Mulrooney, Stella Blanche	Convent Notre Dame de Sion, York-street, Sale		B				Fitness to teach	Matricul.		30.5.49	
16470	Murnane, Joyce Monica	Ouyen		B				"	2nd C.C.		14.2.49	
16542	Murphy, Mary Theresa (St. M. Winefride)	Presentation Convent, Myrtleford		B				"			26.4.49	
15793	McCabe, Mary Josephine	Convent F.C.J., "Vaucluse," Richmond		B	C	D		"	B.A.		31.3.47 28.2.49 26.7.48 7.2.49 28.3.49	Additional registration Additional registration
16256	McCall, Ruth	4 Huntingtower-road, Malvern, S.E.3		B				"				
16512	McCarthy, Francis Ireneus	St. Kevin's College, Orong-road, Toorak		B				"				
16430	McCarthy, Margaret Ellen	40 Beaconsfield-parade, Albert Park		B				"	2nd Cl. Cert.		7.2.49	
13673	McFall, Mary Agnes (St. M. St. Laurentius)	The Convent, Donald		A				"	Lvg. Cert.		28.6.38 7.2.49	Additional registration
16595	McGuane, Leonard Pachomius (Bro.)	St. Patrick's College, Ballarat		B				"	Inter. Cert., Lvg. Cert. (N.S.W.)		27.6.49	
15794	McGuigan, Mary Florence	Sacred Heart College, Ballarat East		B		D		"			31.3.47 27.6.49	Additional registration
16644	McKay, Winifred Mary (Mrs.)	4 Rae-street, Glenferrie		B				"			31.10.49	
16627	McKenzie, Margaret Ann Fraser	802 Malvern-road, Armadale				D		"	Bachelor of Home Science Degree (N.Z.)		26.9.49	
16431	McLaughlin, Aileen Joy	"Lyndale," Kent-avenue, Croydon		A				"	"Specialist in Nursery School and Kindergarten Work"		7.2.49	
16532	McLean, Raymond Clinton (Rev.)	4 Kaitiworth-grove, Glen Iris			C			"	B.A., B.D., Dep. Ed.		30.5.49	
16616	MacLish, Gladys Margaret (Mrs.)	2 Ormond College, Carlton			C			"	M.A.		29.8.49	
16685	MacLennan, Laurie Alexander	16 Lorrains-street, Essendon, W.5		B				"			28.11.49	
16432	McPherson, Sheila Elaine	"Raveloe," Brim, Victoria		A				"	"Specialist in Nursery School and Kindergarten Work"		7.2.49	
16433	McWhinney, Mary Frances	8 Vernal-avenue, Mitcham		A				"	Lvg. Cert.		7.2.49	
16563	Neil, Herbert James	261 Belmore-road, Balwyn			C			"	B.A., Dip. Ed., Dip. in Theo- logy		30.5.49	
16594	Nelson, Ethel Mary (Mrs.)	Alexandra College, Hamilton		B				"	2nd Cl. Cert.		30.5.49	
16434	Neville, Frances Hannah	13 Cairnes-grove, Bentleigh		B				"	T.P.T.C.		7.2.49	
16645	Newnam, Audrey May	"Clyde" School, Woodend		B	C			"	B.A., T.P.T.C.		31.10.49	
16435	Neylan, Margaret Joan	52 Waipole-street, Kew, E.4		A				"	"Specialist in Nursery School and Kindergarten Work"		7.2.49	

No.	Name	Address	Class	Grade	Examination	Fee	Notes
16436	North, Lesley Muriel	15 Chanak-street, East Malvern	B		Matric.	7.2.49	
16437	Nuttall, Judith	32 Epping-street, Kyneton	A		"Specialist in Nursery School and Kindergarten Work" Inter. and Lvg. Certs.	7.2.49	
16598	O'Callaghan, Thaddeus (Br.)	Marist Brothers' Sholasticate, 21 Canterbury-road, Camberwell	B		27.6.49	
16686	O'Donnell, Audrey Majella	17 Archer-avenue, Ascot Vale, W.2	A		28.11.49	
16471	Ogier, Joan Mary	75 Graham-street, Bendigo	B		Lvg. Cert.	14.2.49	
16618	O'Kane, Frances (Sr. Marie de Lourdes)	Presentation Convent, Dandenong-road, Windsor, S.1	B		20.8.49	
16687	O'Keefe, Elizabeth	Convent of Mercy, Kilmore	B		28.11.49	
16628	O'Leary, Eileen Frances	6 Raleigh-street, Windsor	C		B.A., Qual. Dip. Ed. (Melb.)	26.9.49	
16513	O'Meara, Noreen Agnes (Sr. M. Blandina)	Our Lady of the Sacred Heart Convent, Bentleigh, S.E.14	B		28.3.49	
16438	Opas, Roberta Judith	9 Jackson-street, St. Kilda	A		"Specialist in Nursery School and Kindergarten Work"	7.2.49	
16439	Osborne, Margaret Evelyn	45 Mathoura-road, Toorak	A		"Specialist in Nursery School and Kindergarten Work"	7.2.49	
16619	O'Shea, Mary Josephine (Sr. M. Bernadette)	Presentation Convent, Neerim-road, Glenhuntly	B		29.8.49	
16620	O'Sullivan, John Conan (Br. Crispin)	Assumption College, Kilmore	B		29.8.49	
16608	Painter, Shirley Valetta (Mrs.)	7 Chelsea-street, Middle Brighton	C		29.8.49	
16514	Palmer, Mavis Agnes Irene	"Firbank," Middle-creセント, North Brighton	B		B.A., Qual. Dip. Ed.	25.7.49	
16515	Peel, Nancy Lillian	50 Bryson-street, Canterbury	C		B.A., Bachelor of Teaching (Univ. of Calcutta) T.I.T.C.	28.3.49	
16440	Penhaullinack, Margaret June	28 Ranfurly-creセント, Glen Iris	A		"Specialist in Nursery School and Kindergarten Work" 2nd Cl. Cert.	7.2.49	
16565	Phelan, Ellen Agnes	St. Anthony's School, Dandenong-road, Oakleigh	B		Teacher's Cert. (Punjab Educn. Dept.) T.P.T.C.	28.3.49	
16516	Phillips, Marjorie	Maldon Hotel, Maldon	B		29.8.49	
16621	Pitt, Francis Albert	8 Railway-avenue, Brighton, S.5	B		Trained Technical Instructor's Cert.	28.3.49	
16517	Pottage, John Clifton	"Sierra," Ellesmere-avenue, Croydon	C		B.Sc., T.P.T.C.	28.3.49	
16518	Potter, Linda Margaret	32 Stanley-grove, Canterbury, E.7	C		Lvg. and Matricn. Certs. (N.S.W.)	7.2.49	
16441	Power Joseph Sergius (Br.)	Christian Brothers, 26 Barnet-street, Yarraville	B		27.1.48	Additional registration
16654	Pulver, Salomon	35 Jackson-street, St. Kilda, S.2	B		7.2.49	Additional registration
12904	Quinn, Lawrence Mark	c/o George Taylor and Staff Pty. Ltd., 306 Little Collins-street, Melbourne	B		B.Sc.	30.5.49	Additional registration
16622	Quinn, Mary Therese (Sr. M. Veronica)	Brigidine Convent, Ararat	B		Lvg. Cert.	30.4.35	Additional registration
16646	Reid, June McArthur	"The Hermitage," C.E.G.G.S., Newtown, Geelong	B		B.Sc.	25.7.49	
16647	Reid, Robert Paschal (Br.)	Christian Brothers' Residence, Park-street, South Melbourne	B		31.10.49	
16631	Reilly, Pamela Theresa	Zercho's Business College, Melbourne	D		26.9.49	
16688	Renton, Pamela Mary	4 Hermitage-road, Newtown, Geelong	A		28.11.49	

ADDITIONS AND REVISIONS MADE DURING THE YEAR ENDED 31st DECEMBER, 1949—continued.

Registered No.	Name.	Address.	Division in which Registered.			Subject, if in Division D.	(a) Registered by virtue of which the applicant has passed the Act.	(b) Evidence produced to the Council of Fitness to Teach.	Qualifications.		Date of Registration.	Remarks.
			Sub-Primary	Primary	Secondary				Subjects	(c) Literary, Academic, or other Qualifications.		
16566	Revington-Jones, Patricia	c/o Mrs. T. Cameron, 12 Turner-street, Glen Iris, S.E.6	B				Fitness to teach	Trained (N.Z.)	Teacher's Cert.	30.5.49		
16443	Richardson, Delma Aileen (Sr. Mary Leo)	St. Mary's Priory, West Maitland, N.S.W.	B				"	Lvg. Cert.	"	7.2.49		
16444	Roberts, Ann Olivia	607A Toorak-road, Toorak, S.E.2	A				"	" Specialist in Nursery School and Kindergarten Work "	Board of Educn. Teaching Cert. (England)	7.2.49		
16543	Roberts, Winifred Hannah (Mrs.)	2 Malane-street, Bentleigh East	B				"	"	"	26.4.49		
16623	Robinson, Valerie Isabel	299 Now-street, Brighton, S.5	B				"	"	"	29.8.49		
16689	Roe, Madeline	7 Gordon-grove, South Yarra	B				"	"	"	28.11.49		
16445	Rose, Hilary Dougal	51 Fairview-avenue, Newtown, Geelong	A				"	" Specialist in Nursery School and Kindergarten Work "	Matricn.	7.2.49		
16446	Rose, Kathleen Elizabeth	1 Douglas-place, Geelong	A				"	"	"	7.2.49		
11175	Russell, Bridget Helen (Sr. Genevieve)	St. Scholastica's Convent, Glebe Point, Sydney	A				"	"	Inter. Cert. (Sydney)	29.6.26 30.5.49 28.2.49	Additional registration	
16485	Ryan, Catherine	26 Page-street, Albert Park	B				"	"	"	7.2.49		
16447	Ryan, Dorothy Mae (Sr. M. Dolores)	St. Mary's Priory, West Maitland	B				"	"	Lvg. Cert.	7.2.49		
16690	Salmon, Daniel (Br.)	De La Salle College, Stanhope-street, Malvern	B				"	"	"	28.11.49		
16624	Schepisi, Cecilia June	St. Joseph's School, South Yarra	B				"	"	"	29.8.49		
16691	Schlitz, M. Clare (Sr.)	St. Joseph's Convent, Havelock-road, Hawthorn	B				"	"	Lvg. Cert.	28.11.49		
16472	Schneider, Geoffrey (Rev.)	Burke Hall, Xavier Preparatory School, Studley Park-road, Kew	B	C			"	"	S.J.	14.2.49		
16544	Schultz, Margaret (Mrs.)	"Clarendon" P.L.C., Webster-street, Ballarat	A				"	"	"	26.4.49		
16609	Seamons, Florence Fay (Mrs.)	138 Bay-street, North Brighton	B				"	"	Cl. III. Cert. (Tas.)	25.7.49		
16448	Shannon, Carmel Mary (Sr. Mary Michael)	"Star of the Sea" Presentation Convent, Gardenvale	A				"	"	Inter. Cert.	7.2.49		
16682	Shillito, Catherine Margaret	Convent of Mercy, Coburg	A				"	"	"	28.11.49		
16683	Siddle, John Vickers	63 Venice-street, Mentone	B				"	"	T.P.T.C.	28.11.49		
16094	Simm, Mario Rosalie (Sr. M. Ellis)	Brigidine Convent, Malvern, S.E.4	B				"	"	"	28.11.49		
16629	Simpson, Elsie Catherine	26 Tennyson-street, Brighton Beach	B				"	"	"C" Cert. (N.Z.)	26.9.49		
16449	Slipper, Lesley Jean	Heatherdale-road, Ringwood	A				"	"	" Specialist in Nursery School and Kindergarten Work "	7.2.49		

No.	Name	Address	Class	Grade	Language	Notes	Cl. III. Cert. (Ths.)	Date
16450	Smith, Emily Kathleen	44 Merton-street, Albert Park	B				M.A. (Glasgow Univ.)	7.2.49
16451	Smith, Jane Ferguson	Tourak College, Frankston	A				"Specialist in Nursery School and Kindergarten Work"	28.11.49
16452	Smith, Joyce Marjory	102 Doncaster-road, North Balwyn, E.9	A				B.A. (Mellb. Univ.)	7.2.49
16453	Steel, Rosemary Janet	98 Albion-road, East Malvern, S.E.5	B				Junior Public (Qld.)	7.2.49
16519	Steele, Helene Joyce (Sr. M. Kevin)	Our Lady of the Sacred Heart Convent, Elmore	B				T.P.T.C.	28.3.49
16630	Steer, Roma Mary	"Rivernook," Wurrak, Sale	B				T.P.T.C., T.L.T.C.	26.9.49
16453	Sterling, Ruth Rita (Mrs.)	Pine-avenue, Elwood, S.3	A					7.2.49
16648	Stewart, Honor Mary	Vanduse Convent F.C.J., Richmond	B					31.10.49
12119	Stewart, Margery June (Mrs.)	"Hy Brazzil," Timboon	A	B			Dip. Ed., National Board of Irish Education; Dip. Ed. National Univ. of Ireland	30.6.31 25.7.49 29.8.49
16454	Stewart, Valerie Ruth	137 Booran-road, Caulfield, S.E.9	A				"Specialist in Nursery School and Kindergarten Work"	7.2.49
16520	Storomon, Winifred Mary	10 Long-street, Plympton, S.A.	B					28.11.49
16696	Strugnell, Wilma Dawn	3 Milleva-avenue, Murrumbidgee, S.E.10	B					28.11.49
16697	Sullivan, Mary Rose	49 Piper-street, Yarravonga	A					7.2.49
16455	Swift, Mary Isobel	50 Carpenter-street, Brighton, S.5	A				Cl. III. Cert. (Ths. Ed. Dept.)	7.2.49
16456	Tabart, Gwendolyn Amos	Strahan, Tasmania	B					36.4.49
16545	Teller, Bertha (Mrs.)	311 Royal-parade, Parkville	B		French; German		T.P.T.C.	30.5.49
16456	Thompson, Cassie McDonald	218 Alma-road, East St. Kilda, S.2	B					26.4.49
16567	Thomson, Nell (Mrs.)	10 Garden-street, Hampton	B				T.P.T.C.	30.5.49
11294	Tierney, Eileen Bridget	Convent of Mercy, Bendigo	A				Inter. Cert.	29.3.27 7.2.49
16547	Tolliday, Emma May (Mrs.)	20 Rowe-street, Ballarat	B				2nd Cl. Cert.	26.4.49
16521	Truebridge, Edna Florence (Mrs.)	15 Cassell-street, Hawksburn	B				2nd Cl. Cert.	28.3.49
16698	Tuck, Kevin John (Br.)	197 Danks-street, Middle Park	B					28.11.49
16568	Tully, Samuel Hugh	168 Vere-street, Brighton, S.5	B				2nd Cl. Cert.	30.5.49
16699	Tuxen, Mary Evelyn	Temple Court, 422 Collins-street, Melbourne	B					28.11.49
16457	Tweedie, Marie Hall	52 Walpole-street, Kew, E.4	A				"Specialist in Nursery School and Kindergarten Work"	7.2.49
16597	Walker, Joyce Emily (Mrs.)	"Belmont," Best-street, Bolgrave	B				T.P.T.C.	27.6.49
16458	Walkers, Sylvia Cherril	258 Glenhuntly-road, Elwood	B					7.2.49
16569	Warfe, John Edward (Rev.)	14 Goodhall-street, Auburn, E.2	C				M.A., Dip. Ed.	30.5.49
16459	Washfold, Lilian Mavis	59 Radnor-street, Camberwell	A				Lvg. Cert.	7.2.49
16486	Waters, Sophie (Mrs.)	25 Kambia-grove, West Caulfield	B				Matricul.	28.2.49

ADDITIONS AND REVISIONS MADE DURING THE YEAR ENDED 31ST DECEMBER, 1949—continued.

Registered No.	Name.	Address.	Division in which Registered.				Subject, if in Division D.	(g) Registered by virtue of Employment Certificate or by passing of the Act.	(h) Evidence produced satisfactory to the Council of Fitness to Teach.	Qualifications.		Date of Registration.	Remarks.
			Sub-Primary	Primary	Secondary	Special Subjects				(c) Literary, Academic, or other Qualifications.	(e) Evidence produced satisfactory to the Council of Fitness to Teach.		
16701	Watts, Rowland Claude ..	62 Ford-street, Ringwood ..	A	B	C	D	Jnr. and Sr. Public Exams. (Qld.); Matric. and Inter. Arts and Sc. (London Univ.) and I.T.C.	..	28.11.49		
16570	Wells, Anne Gwenyth ..	29A Durham-road, Surrey Hills	B	30.5.49		
16649	Weilandt, Patricia Ellen ..	175 Drummond-street, Carlton	B	31.10.49		
16571	Wenzel, Geoffrey Clements ..	448 Burwood-road, Hawthorn, E.2	C	30.5.49		
16650	Wharton, Veronica (Mrs.) ..	3 Withers-street, Sunshine	B	31.10.49		
16700	Wilkinson, Ronald Geoffrey ..	Caulfield Grammar School, Glen Eira-road, East St. Kilda	B	28.11.49		
16400	Williams, Dorothy Elizabeth ..	41 Harcourt-street, Hawthorn East ..	A	7.2.49		
16473	Williams, Gerald Kevin ..	63 Ormond-road, Elwood	B	14.2.49		
16522	Williams, Herbert Lucius (Br.) ..	St. Patrick's College, Ballarat	B	28.3.49		
16572	Willis, Mary (Mrs.) ..	31 Orchard-street, North Brighton ..	A	30.5.49		
16651	Willis, Vera Mabel (Mrs.) ..	89 Barkly-street, North Fitzroy	B	31.10.49		
16598	Windred, Donatus (Br.) ..	Marist Brothers' School, St. Albans, Canterbury-road, Camberwell	B	27.6.49		
16523	Wright, Alison (Miss) ..	"The Hermitage" C.E.G.S., Geelong	B	28.3.49		

ALTERATIONS MADE DURING THE YEAR ENDED 31ST DECEMBER, 1949.

Regis-tered Number.	Name.	Address.	School or Place	Division in which Registered.				Remarks.
				Primary.		Secondary.	Special Subjects.	
				Sub-Primary.	Primary.	C	D	
16312	Bourke, Daniel Desmond	Marist Brothers' Juniorate, Macedon	Marist Brothers' Juniorate, Macedon		B		Change of address	
15409	Campbell, Myra Bernadette	St. Patrick's College, Wangaratta	St. Patrick's College, Wangaratta		B		Change of address	
15423	Coman, Kyrus Crosbie (Br.)	Marist Brothers' College, Bendigo	Marist Brothers' College, Bendigo		C		Change of address	
15706	Cumming, Heather Betha	St. Gabriel's C.E.G.G.S., Berrell-street, Waverley, Sydney	St. Gabriel's C.E.G.G.S., Berrell-street, Waverley, Sydney		B		Change of address	
14562	Day, Joyce Mary (Sr. M. Annata)	St. Dominic's School, 145 Highfield-road, Camberwell, E.6	St. Dominic's School, 145 Highfield-road, Camberwell, E.6		A		Change of address	
11514	Devine, Alice Veronica (Sr. Bernadette)	St. Augustine's School, Kyabram	St. Augustine's School, Kyabram		A		Change of address	
11516	Donohue, Francis (Br. Gilbert)	Marist Brothers' College, Bendigo	Marist Brothers' College, Bendigo		B		Change of address	
15094	Hinchey, Patricia (Sr. M. Michael)	St. Dominic's School, 145 Highfield-road, Camberwell, E.6	St. Dominic's School, 145 Highfield-road, Camberwell, E.6		A		Change of address	
16320	Jenkins, Margaret Mary (Sr. Mary Julianne)	Brigidine Convent, Ararat	Brigidine Convent, Ararat		B		Change of address	
16255	Lueke, Pauline Margaret	Flat 5, 2 Frederick-street, North Bondi			A		Change of address	
14187	Montgomerie, Nancy Evelyn	1211 Gregory-street, Ballarat			B		Change of address	
13650	McInerney, Philip Patrick (Rev.)	Navier Preparatory School, 47 South-road, Brighton Beach, S.5	Navier Preparatory School		B	C	Change of address	
14381	O'Brien, Matthew (Rev.)	St. Patrick's College, Cathedral-place, East Melbourne	St. Patrick's College, East Melbourne		B	C	Change of address	
10922	O'Meara, Agnes May (Sr. M. St. Margaret)	St. Joseph's School, Spring Vale	St. Joseph's School, Spring Vale			C	Change of address	
14605	Wilkinson, Robert Harvey	14 Silverdale-road, Ivanhoe, N.21	Carey Baptist Grammar School, Barker's-road, Kew, E.4		B		Change of address	
16310	Woulfe, Richard Maurice (Br. Marius)	Marist Brothers' College, Kyneton	Marist Brothers' College, Kyneton		B		Change of address	

REGISTER OF SCHOOLS.

SCHOOLS REGISTERED DURING THE YEAR ENDED 31st DECEMBER, 1949.

Registered Number.	Name of Person.	Proprietor or Head Teacher.	Address of Proprietor or Head Teacher.	Name of School (if any).	Address of Schoolhouse in which School is Held.	Classification.	Number of Registered Teachers.				Date of Registration.	Remarks.
							Sub-Primary.	Primary.	Secondary.	Special Subjects.		
1487	Wiebusch, Edmund Waldemar (Rev.)	Proprietor	Tabor, via Hamilton	Lake Linlithgow Lutheran School	Lake Linlithgow, Croxton East	Primary	..	1	{ 31.12.00 } 28.2.49	Re-registered New school
1488	Adrian, M. (Sr. Maureen)	H.T.	St. Joseph's Convent, Nhill	..	Leahy-street, Nhill	Primary	..	1	14.2.49	New school
1489	O'Brien, Peter Joseph..	P.	St. Mary's Presbytery, Yarra-street, Geelong	..	St. Alban's-road, East Geelong	Primary	..	1	28.2.49	New school
1490	Feiglin, Abraham	H.T.	414 St. Kilda-road, South Melbourne	Mount Scopus College	414 St. Kilda-road, South Melbourne	Sub-Primary	2	4	28.2.49	New school
1491	Anderson, Hannah B. (Miss)	P.	348 Montague-street, Albert Park	Trinity Girls' Grammar School	Sydney-road, Coburg	Primary	..	1	28.3.49	New school
1492	Harrison, Cedric Justineau	H.T.	Christian Brothers' College, 57 Queensberry-street, N.J.	St. Peter's Central School	Howard-street, West Melbourne	Primary	..	1	27.6.49	New school

SCHOOLS REMOVED FROM THE REGISTER DURING THE YEAR ENDED 31st DECEMBER, 1949.

Registered Number.	Name of Person.	Proprietor or Head Teacher.	Address of Proprietor or Head Teacher.	Name of School (if any).	Address of Schoolhouse in which School is Held.	Classification.	Remarks.
75	Ferrington, Olive M.	H.T.	..	"Lindum"	Methodist Schoolroom, Fitzroy-street, St. Kilda	Primary; Sub-Primary	Closed
1154	Wilson, Alfred J.	P. & H.T.	360 Collins-street, Melbourne	Metropolitan Business College	Place and Flinders-lane, Melbourne	Secondary (Commercial)	Closed
1341	Hill, David Clarence John	P. & H.T.	"Castleton," Arkaringa-crescent, Black Rock	"Castleton" College	Arkaringa-crescent, Black Rock	Primary; Sub-Primary	Closed
1401	Cadwallader, Alice Evelyn	H.T.	174 Napier-street, Essendon	St. Hilary's School	Napier-street, Essendon	Primary; Sub-Primary	Closed
1428	Zerebo, Frederick Wm.	P.	157 Collins-street, Melbourne	Zerebo's (Branch)	Gregory Hall, cr. Dandenong-road and Chapel-street, East St. Kilda	Secondary (Commercial)	Closed
1453	Nield, Joseph Clive	P.	Koorang School, Warrandyte	Koorang	Warrandyte	Primary	Closed

OTHER ALTERATIONS MADE DURING THE YEAR ENDED 31st DECEMBER, 1949.

Registered Number.	Name of Person.	Proprietor or Head Teacher.	Address of Proprietor or Head Teacher.	Name of School (if any).	Address of Schoolhouse in which School is Held.	Classification.	Remarks.
74	Bradshaw, Ernest Harold	P. & H.T.	Bradshaw Buildings, Bridge, Melbourne	Bradshaw's Business College	Bradshaw Buildings, Princes Chapel-street, Prahran	Secondary	New classification
1204	Muirden, William	P.	6 Redan-street, East St. Kilda	Hassett's Business College	Chapel-street, Prahran	Secondary	New classification
1483	Lee, Leah Myrtle (Mrs.)	H.T.	35 Anthony-street, Ormond	"Brookhurst"	Cr. Bambra-road, and North-cote-avenue, Caulfield	Primary	Change of name of proprietor



VICTORIA GOVERNMENT GAZETTE.

Published by Authority.

[Registered at the General Post Office, Melbourne, for transmission by post as a newspaper.]

No. 463]

THURSDAY, MAY 25.

[1950

Factories and Shops Acts.

DETERMINATION OF THE CANTEEN WORKERS BOARD.

NOTE.—This Determination applies to the whole of the State of Victoria.

IN accordance with the provisions of the Factories and Shops Acts, the Wages Board which has the power to “determine the lowest prices or rates which may be paid to any person or persons or classes of persons (other than persons subject to the jurisdiction of any Wages Board heretofore appointed) engaged in or in connexion with the supply of goods, food, drink, or meals to workers in manufacturing, trading, or commercial undertakings”, has made the following Determination, namely:—

1. That as from the beginning of the first pay period to commence in May, 1950, the last previous Determination of this Board shall be revoked and replaced by this Determination.

(a)	WAGES. Improvers.*								
	Male.		Female.						
	£ s. d.								
Under 17 years	Under 17 years
17 and under 18 years	17 and under 18 years
18 and under 19 years	18 and under 19 years
19 and under 20 years	19 and under 20 years
20 and under 21 years	20 and under 21 years

Proportion:—One improver to every three or fraction of three workers receiving not less than the minimum wage.

* The Board has determined that no apprentice shall be taken to the trade.

(b)	Adults.					
	Male.		Female.			
	£ s. d.					
Cook (Grade 1)	9 4 0	7 1 9
Cook (Grade 2)	8 4 0	5 12 3
Cook working alone	8 9 0	6 2 6
Supervisor	5 12 3
Attendant	7 15 6	4 19 6

HOURS FOR A WEEK'S WORK.

3. The number of hours to constitute an ordinary week's work shall be 40.

TIMES OF BEGINNING AND ENDING WORK.

4. Times of beginning and ending work shall be within the hours prescribed by any Award, Determination or Agreement covering the majority of employees in the industry.

OVERTIME.

5. All times worked in excess of those prescribed by Clause 3 of this Determination shall be paid for at the rate of time and a half for the first four hours and double time thereafter.

TERMS OF EMPLOYMENT.

6. (a) Employees (other than casuals) shall be engaged by the week and paid by the week.
 (b) Weekly employees to be entitled to a full week's wage shall be available, ready, and willing to perform such work as the employer shall from time to time require on the days and during the hours usually worked by the class of employee affected.
 (c) The provisions of sub-clauses (a) and (b) hereof shall not apply if there is a stoppage of work for which the employer cannot reasonably be held responsible through any strike, breakdown of machinery or other cause, proof of which shall be on the employer.
 (d) (i) Except in the case of misconduct by either employer or employee, weekly employees to terminate employment shall be entitled to or shall give one week's notice, or in lieu thereof, one week's wages shall be paid or forfeited, as the case may be.
 (ii) This shall not effect the right of the employer to dismiss any employee without notice for malingering, inefficiency or neglect of duty, and in such cases wages shall be paid up to time of dismissal only.
 (iii) If employment is terminated through any cause all monies due to the employee shall be paid on the day of termination.

CASUAL EMPLOYEES.

7. Casual employees, i.e., employees engaged by the hour shall, in the case of females, be paid at the rate of time and a third with a minimum of four hours each day up to a maximum of twenty hours per week, and for each hour thereafter in excess of twenty hours, at the ordinary wages rate, but not so as to exceed an ordinary week's wage.

MEAL BREAK.

8. A break of not less than half an hour and not more than one hour shall be allowed each day or shift for a meal which shall be provided free of cost to the employee.

ANNUAL HOLIDAYS.

9. The annual holiday shall be as prescribed by the provisions of the *Factories and Shops (Annual Holidays) Act 1946* and any amendments which may be made thereto from time to time.

SICK LEAVE.

10. Employees (including casuals) shall be entitled to sick leave to the extent as provided by any Award, Determination or Agreement for the general body of employees in the industry in connexion with which they are employed, at the rate of wage they would have received had they been working.
 Provided that the sick leave shall not exceed 40 hours of working time in any year.

UNIFORMS.

11. Uniforms shall be supplied free of cost to the employee.

GENERAL CONDITIONS.

12. Employees shall be entitled to the same terms and conditions as regards—

- Public Holidays,
- Special Rates for Saturdays, Sundays and Holidays,
- Right of Entry of Union Officials,
- Time and Wages Book, and
- Shift Work.

as those provided by any Award, Determination or Agreement for the general body of employees in the industry in connexion with which they are employed: Provided that if such Award, Determination or Agreement does not make provision for casual employees, then such casual employees shall not be entitled to payment for Public Holidays.

DEFINITIONS.

13. "Cook (Grade 1)" means a cook who is in charge of one or more cooks, and substantially directs operations in the kitchen.
 "Cook (Grade 2)" means a cook working under the supervision of a cook (Grade 1).
 "Cook working alone" means a cook working without other cooks, and substantially in charge of kitchen operations.
 "Supervisor" means a female employee who supervises the work of other employees.
 "Attendant" means an employee (whether male or female) who, except otherwise defined, is engaged in or in connexion with the supply of goods, food, drinks or meals in canteens to workers employed in manufacturing, trading or commercial undertakings.

PERIODICAL ADJUSTMENT OF WAGES.

14. The wages rates set out in clause 2 are based upon the following basic wage rates, and pursuant to the provisions of Section 21 of the *Factories and Shops Act 1934*, the Board hereby determines that such rates shall be automatically adjusted as prescribed by Clause 15. Provided that the wages of adult females and improvers shall be adjusted from time to time by increasing or decreasing the said rates in the same proportion as the amount of increase or decrease of the basic wage bears to the basic wage current immediately prior to the adjustment. Such adjustments shall be calculated to the nearest threepence, half or less than half of threepence to be disregarded.

Place.	Needs Basic Wage (Adjustable).	Loading Constant.	Total Basic Wage.	Index Number Set Assigned.
	£ s. d.	s. d.	£ s. d.	
Throughout the State	6 11 0	6 0	6 17 0	Melbourne

ADJUSTMENT OF BASIC WAGE.

- 15 (a) For the purposes of this Determination, the expression "Commonwealth Statistician's 'all items' retail price index numbers" or any like expression means the numbers stated to be such index numbers in any document purporting, and not proved to be wrongly so purporting to be printed by the Commonwealth Government Printer or to be signed by or on behalf of the Commonwealth Statistician.
 (b) Until the beginning of the first pay period to commence in August, 1950, the amounts of the Basic Wage shall be as prescribed in clause 14.
 (c) During each future successive period beginning with the first pay period to commence in an August, a November, a February, or a May, the amount of the needs basic wage shall be adjusted by the following method, namely, by multiplying the last published Commonwealth Statistician's "all items" retail price index number by the factor .087 taken to one place of decimals, the resultant whole number being the amount of the basic wage expressed in shillings, but should the decimal number reach .5 or more the basic wage shall be taken to the next higher shilling.

P. A. RANGLES, J.P., Chairman.
 J. V. WILLOX, Secretary.

Melbourne, 21st April, 1950.

By Authority: J. J. GOURLEY, Government Printer, Melbourne.



VICTORIA GOVERNMENT GAZETTE.

Published by Authority.

[Registered at the General Post Office, Melbourne, for transmission by post as a newspaper.]

No. 464]

THURSDAY, MAY 25.

[1950

Factories and Shops Acts.

DETERMINATION OF THE SOFTGOODS—WHOLESALE—BOARD.

NOTE.—This Determination applies to the whole of the State of Victoria.

IN accordance with the provisions of the Factories and Shops Acts, the Wages Board appointed to "determine the lowest prices or rates which may be paid to any persons employed selling softgoods in wholesale warehouses" has made the following Determination, namely:—

1. That as from the beginning of the first pay period to commence on or after the 1st May, 1950, the last previous Determination of this Board shall be revoked and replaced by this Determination.

2.

Apprentices or Improvers.							Other Employees.	
Wages per Week of 40 Hours.							Wages per Week of 40 Hours.	
Experience.	Commencing Age.						s. d.	
	Under 16 years.	16 years.	17 years.	18 years.	19 years.	20 years.		
<i>Males.</i>								
1st year ..	48 3	48 3	64 3	72 3	96 6	140 6		
2nd " ..	64 3	72 3	80 3	108 6	140 6	..		
3rd " ..	77 9	91 0	118 0	140 6		
4th " ..	93 9	120 9	140 6		
5th " ..	113 9	140 6		
6th " ..	140 6		
<i>Females.</i>								
1st year ..	36 0	36 0	48 3	54 3	72 3	105 6		
2nd " ..	48 3	54 3	60 3	81 6	105 6	..		
3rd " ..	58 3	68 6	88 3	105 6		
4th " ..	70 3	90 6	105 6		
5th " ..	85 3	105 6		
6th " ..	105 6		

PROPORTION (IN ANY PLACE).		
<i>Apprentices.</i>		
One apprentice to three or fraction of three workers receiving not less than the minimum wage.		
<i>Improvers.</i>		
One improver to each worker receiving not less than the minimum wage.		

HOURS OF EMPLOYMENT.		
3. The hours to be worked in any one week shall be 40.		
The normal daily periods of work shall not commence before 8.30 a.m., and shall finish not later than 5.30 p.m., Monday to Friday, and 12.30 p.m. on Saturday.		
OVERTIME.		
4. All work done outside the said normal periods, and all work done in excess of 40 hours per week within the said normal periods, shall be overtime, and shall be paid for at the rate of time and a half.		
MEAL INTERVAL.		
5. From Monday till Friday, both days inclusive, all employees shall be allowed a daily luncheon interval from 1 p.m. to 1.45 p.m.		

<i>Males.</i>	s. d.
Senior salesman, i.e., a person in immediate control of two or more employees one of whom shall be 21 years of age or over, notwithstanding such senior salesman may be under the orders of a superior who does not devote his whole time to the management of the department	200 0
Salesmen and all employees assisting in sales	189 0
<i>Females.</i>	
Females employed in Millinery, Mantles, Corsets, Under-clothing, Hosiery, Haberdashery, Ribbon, Glove, or Lace Departments—	
Senior saleswoman, i.e., a person in immediate control of two or more employees at least one of whom is 21 years of age or over, notwithstanding that such senior saleswoman may be under the orders of a superior who does not devote his or her whole time to the management of the department	150 0
Other saleswomen	141 9
Females employed in any other Departments—	
Senior saleswoman, i.e., a person in immediate control of two or more employees at least one of whom is 21 years of age or over, notwithstanding that such senior saleswoman may be under the orders of a superior who does not devote his or her whole time to the management of the department	200 0
Other saleswomen	189 0

MEAL MONEY.

6. Any employee required to work after 6.30 p.m. shall be paid not less than 4s. meal money in addition to the overtime rates as prescribed for in this Determination.

TERMINATION OF EMPLOYMENT.

7. Except where the conduct of an employee justifies instant dismissal, seven days' notice of termination of employment shall be given by either employer or employee, or one week's wages shall be paid or forfeited in lieu thereof. This provision shall only apply in the case of an employee who has been employed continuously for three months or more.

NOTICE OF INTENTION TO RATION.

8. Where an employer owing to slackness of trade desires to ration his employees, he shall give at least one clear working day's notice to each employee of his intention to ration such employee.

ANNUAL HOLIDAY.

9. The annual holiday shall be as prescribed by the provisions of the *Factories and Shops (Annual Holidays) Act 1946* No. 5111 and any amendments which may be made thereto from time to time.

SICK PAY.

10.—(a) Any employee not attending for duty who has had not less than twelve months' continuous service with the same employer shall lose his or her pay for the actual time lost unless such employee produces or forwards within 24 hours of the commencement of such absence evidence satisfactory to the employer that his or her non-attendance was due to personal ill health or accident necessitating such absence, but such employee shall not be entitled to payment for non-attendance on the grounds of personal ill health or accident for more than six days in any one calendar year.

(b) Notwithstanding the provisions of sub-clause (a) hereof, if the full period of sick leave as prescribed is not taken in any year, such portion as is not taken shall be cumulative from year to year up to a period not exceeding eighteen days, which shall be the maximum amount of leave to which an employee may be entitled in any year without deduction of pay.

For the purposes of this sub-clause service prior to 22nd April, 1946, shall be disregarded.

SPECIAL RATES FOR SUNDAYS AND HOLIDAYS.

11. The special rates for all work done on Sundays or the undermentioned public holidays shall be—

Sunday	Double time.
New Year's Day, Australia Day, Good Friday, Easter Saturday, Easter Monday, Labour Day,
King's Birthday, Christmas Day, and Boxing Day	Double time.

But if by Act of Parliament or Proclamation any other day be substituted for any of the above-named holidays, the special rate shall be payable only for work done on the day so substituted.

UNIFORMS.

12. Where any employee is required to wear any special uniform, dress, frock, overall, or dustcoat, such garment or garments shall be supplied by the employer and laundered free of cost to the employee. The garment or garments shall remain the property of the employer.

REST PERIOD.

13. A rest period of 10 minutes, at a time to be mutually arranged, shall be allowed employees during each morning.

REFERENCE.

14. An employee, on severing his or her connexion with an employer, shall be entitled to and shall receive from such employer a reference in writing, stating his or her period of service and qualifications. This provision shall apply only in the case of an employee who has been employed continuously for nine months or more.

TIME AND WAGES RECORDS.

15. An employer shall keep time and wages records showing the name of each employee, the hours worked each week by, and the wages and overtime paid to each employee.

PERIODICAL ADJUSTMENT OF WAGES.

16. The wages rates set out in clause 2 for adult males and adult females "employed in any other departments" are based upon the following basic wage rates, and pursuant to the provisions of Section 21 of the *Factories and Shops Act 1934*, the Board hereby determines that such rates shall be automatically adjusted as prescribed by Clause 7. Provided that the wages of other adult females shall be increased or decreased by 9d. for every 1s. increase or decrease in the basic wage and apprentices or improvers shall be adjusted from time to time by increasing or decreasing the said rates in the same proportion as the amount of increase or decrease of the basic wage bears to the basic wage current immediately prior to the adjustment. Such adjustments shall be calculated to the nearest threepence, half or less than half of threepence to be disregarded.

Basic Wage.

Place.	Needs Basic Wage. (Adjustable).	Loading Constant.	Total Basic Wage.	Index Number Set Assigned.
Throughout the State	£ s. d. 6 11 0	s. d. 6 0	£ s. d. 6 17 0	Melbourne

ADJUSTMENT OF BASIC WAGE.

17. (a) For the purposes of this Determination, the expression "Commonwealth Statistician's 'all items' retail price index numbers" or any like expression means the numbers stated to be such index numbers in any document purporting, and not proved to be wrongly so purporting, to be printed by the Commonwealth Government Printer or to be signed by or on behalf of the Commonwealth Statistician.

(b) Until the beginning of the first pay period to commence in August, 1950, the amounts of the Basic Wage shall be as prescribed in clause 16.

(c) During each future successive period beginning with the first pay period to commence in an August, a November, a February, or a May, the amount of the Needs Basic Wage shall be adjusted by the following method, namely, by multiplying the last published Commonwealth Statistician's "all items" retail price index number by the factor .037 taken to one place of decimals, the resultant whole number being the amount of the basic wage expressed in shillings, but should the decimal number reach .5 or more the basic wage shall be taken to the next higher shilling.

P. A. RANDELS, J.P., Chairman.

J. V. WILLOX, Secretary.

Melbourne, 3rd May, 1950.



VICTORIA GOVERNMENT GAZETTE.

Published by Authority.

[Registered at the General Post Office, Melbourne, for transmission by post as a newspaper.]

No. 465]

THURSDAY, MAY 25.

[1950

Factories and Shops Acts.

DETERMINATION OF THE BREAD TRADE BOARD.

NOTES (i).—This Determination applies to the whole of the State of Victoria as follows:—

- (a) Clauses 1 to 16 inclusive apply to the Metropolitan District as defined in the Factories and Shops Acts, and the Orders in Council thereunder, and such portion of the Shires of Doncaster and Tomplestowe (other than the township of Warrandyte) as is not included within the said District; the cities of Ballarat, Bendigo, Chelsea, Geelong, Geelong West, Mildura, Mordialloc, and Warrnambool; the town of Newtown and Chilwell; the boroughs of Eaglehawk and Sobastopol; the township of Merbein; the township of Kangaroo Flat in the Shires of Marong and of Strathfieldsaye; the township of Spring Gully, in the Shire of Strathfieldsaye; such portion of the Shire of Broadmeadows as is south of Somerton-road; the Shire of Dandenong; the Doulta Galla Riding of the Shire of Keilor, and such portion of the Maribyrnong Riding of the said Shire as is within 3 miles of the St. Albans Post Office; the Shire of Mulgrave; such portions of the Shire of South Barwon and of the Moorpanyal Riding of the Shire of Corio as are within a radius of 5 miles of the Geelong Post Office; and portions of the Shire of Werribee as are within a radius of 3 miles of the Altona Post Office and such portions of the Shire of Mildura as are within a radius of 1 mile of the Red Cliffs Post Office and the Irymple Post Office respectively.
- (b) Clause 1 and clauses 17 to 29 inclusive apply to the whole of the State *outside and excepting* those parts enumerated in the preceding paragraph.
- (ii) On 31st May, 1938, the Bread Board, the Country Bread Board, and the Provincial Bread Board were deprived of the power to "determine the lowest prices or rates of payment for bread making or baking," and such power was conferred exclusively on the Bread Trade Board.
- (iii) The Board has prescribed a form of apprenticeship indenture.
- (iv) Breadmaking and baking were proclaimed on 12th December, 1938, as Apprenticeship Trades under the *Apprenticeship Act 1928* for the Metropolitan District.
- Full particulars of the apprenticeship regulations for these trades may be obtained on application to the Secretary, Apprenticeship Commission, 103 Russell-street, Melbourne. (Price 3d.)

IN accordance with the provisions of the Factories and Shops Acts the Wages Board appointed to "determine the lowest prices or rates which may be paid to any person or persons or classes of persons employed in the trade of bread making or baking" has made the following Determination, namely:—

1. That on the 13th May, 1950, the Determination made on the 26th day of January, 1950, shall be revoked and replaced by this Determination, which shall be read as part of the Determination of this Board published in *Government Gazette* No. 145 of the 22nd day of February, 1950.

WITHIN THE AREA SET OUT IN NOTE (i) (a).

2. WAGES.—

* Apprentices.	* Improvers.	Other Employees.														
Per Week of 40 Hours. s. d.	Per Week of 40 Hours. £ s. d.	Per Hour.														
		s. d.														
1st Year—	1st six months ..	<table style="width: 100%; border-collapse: collapse;"> <tr> <td style="border: none;">Doughmakers ..</td> <td style="text-align: center;">5 0¹/₅</td> <td colspan="2" style="border: none;"></td> </tr> <tr> <td style="border: none;">Foremen or single hands ..</td> <td style="text-align: center;">5 1¹⁰/₂₀</td> <td colspan="2" style="border: none;"></td> </tr> <tr> <td style="border: none;">All others engaged in the making and/or baking of bread ..</td> <td style="text-align: center;">4 11¹/₅</td> <td colspan="2" style="border: none;"></td> </tr> </table>			Doughmakers ..	5 0 ¹ / ₅			Foremen or single hands ..	5 1 ¹⁰ / ₂₀			All others engaged in the making and/or baking of bread ..	4 11 ¹ / ₅		
Doughmakers ..	5 0 ¹ / ₅															
Foremen or single hands ..	5 1 ¹⁰ / ₂₀															
All others engaged in the making and/or baking of bread ..	4 11 ¹ / ₅															
1st six months .. 43 3	2nd				<table border="1" style="width: 100%; border-collapse: collapse;"> <tr> <th style="text-align: center;">* Ordinary Days.</th> <th style="text-align: center;">* Double Days.</th> <th style="text-align: center;">* Treble Days.</th> </tr> <tr> <td colspan="3" style="text-align: center;">Per Hour. s. d.</td> </tr> </table>			* Ordinary Days.	* Double Days.	* Treble Days.	Per Hour. s. d.					
* Ordinary Days.	* Double Days.							* Treble Days.								
Per Hour. s. d.																
2nd 44 1	3rd				<table border="1" style="width: 100%; border-collapse: collapse;"> <tr> <th style="text-align: center;">* Ordinary Days.</th> <th style="text-align: center;">* Double Days.</th> <th style="text-align: center;">* Treble Days.</th> </tr> <tr> <td colspan="3" style="text-align: center;">Per Hour. s. d.</td> </tr> </table>			* Ordinary Days.	* Double Days.	* Treble Days.	Per Hour. s. d.					
* Ordinary Days.	* Double Days.	* Treble Days.														
Per Hour. s. d.																
2nd Year—	4th	<table border="1" style="width: 100%; border-collapse: collapse;"> <tr> <th style="text-align: center;">* Ordinary Days.</th> <th style="text-align: center;">* Double Days.</th> <th style="text-align: center;">* Treble Days.</th> </tr> <tr> <td colspan="3" style="text-align: center;">Per Hour. s. d.</td> </tr> </table>			* Ordinary Days.	* Double Days.	* Treble Days.	Per Hour. s. d.								
* Ordinary Days.	* Double Days.				* Treble Days.											
Per Hour. s. d.																
1st six months .. 47 5	5th	<table border="1" style="width: 100%; border-collapse: collapse;"> <tr> <th style="text-align: center;">* Ordinary Days.</th> <th style="text-align: center;">* Double Days.</th> <th style="text-align: center;">* Treble Days.</th> </tr> <tr> <td colspan="3" style="text-align: center;">Per Hour. s. d.</td> </tr> </table>			* Ordinary Days.	* Double Days.	* Treble Days.	Per Hour. s. d.								
* Ordinary Days.	* Double Days.				* Treble Days.											
Per Hour. s. d.																
2nd 53 2	6th	<table border="1" style="width: 100%; border-collapse: collapse;"> <tr> <th style="text-align: center;">* Ordinary Days.</th> <th style="text-align: center;">* Double Days.</th> <th style="text-align: center;">* Treble Days.</th> </tr> <tr> <td colspan="3" style="text-align: center;">Per Hour. s. d.</td> </tr> </table>			* Ordinary Days.	* Double Days.	* Treble Days.	Per Hour. s. d.								
* Ordinary Days.	* Double Days.				* Treble Days.											
Per Hour. s. d.																
3rd Year—	7th	<table border="1" style="width: 100%; border-collapse: collapse;"> <tr> <th style="text-align: center;">* Ordinary Days.</th> <th style="text-align: center;">* Double Days.</th> <th style="text-align: center;">* Treble Days.</th> </tr> <tr> <td colspan="3" style="text-align: center;">Per Hour. s. d.</td> </tr> </table>			* Ordinary Days.	* Double Days.	* Treble Days.	Per Hour. s. d.								
* Ordinary Days.	* Double Days.				* Treble Days.											
Per Hour. s. d.																
1st six months .. 60 8	8th	<table border="1" style="width: 100%; border-collapse: collapse;"> <tr> <th style="text-align: center;">* Ordinary Days.</th> <th style="text-align: center;">* Double Days.</th> <th style="text-align: center;">* Treble Days.</th> </tr> <tr> <td colspan="3" style="text-align: center;">Per Hour. s. d.</td> </tr> </table>			* Ordinary Days.	* Double Days.	* Treble Days.	Per Hour. s. d.								
* Ordinary Days.	* Double Days.				* Treble Days.											
Per Hour. s. d.																
2nd 71 9	and thereafter the minimum wage.															
4th Year—	PROPORTION (within any factory or place).															
1st six months .. 83 8	One improver to every eight workers receiving not less than 197s. 4d. per week of 40 hours.															
2nd 98 0	PROPORTION (within any factory or place).															
6th Year—	One apprentice to every three or fraction of three workers receiving not less than 197s. 4d. per week of 40 hours.															
1st six months .. 115 5	PROPORTION (within any factory or place).															
2nd 134 0	One apprentice to every three or fraction of three workers receiving not less than 197s. 4d. per week of 40 hours.															
and thereafter the minimum wage.	PROPORTION (within any factory or place).															
PROPORTION (within any factory or place).	One apprentice to every three or fraction of three workers receiving not less than 197s. 4d. per week of 40 hours.															

* Except those subject to the jurisdiction of the Apprenticeship Commission.

NOTE.—The rates shown in clause 2 herein include 14d. per hour for "foremen or single hands" and "all others engaged in the making and/or baking of bread" required to work the hours and times prescribed in clause 16. Pro-rata of this amount has been included in the rates of apprentices and improvers.

WITHIN THE AREA SET OUT IN NOTE (I) (b).

17. WAGES.—		Apprentices.		Improvers.		Other Employees.	
	Per Week of 40 Hours.		Per Week of 40 Hours.				
	s. d.		£ s. d.				
1st Year—		1st year	Foremen or single hands ..	4s. 10 ¹² / ₂₀ d. per hour, or 196s. 6d. per week of 40 hours.		
1st six months ..	41 1	2nd } 8 5 1	Makers or bakers of rye bread, Vienna bread, or rolls	} 4s. 8 ¹ / ₂ d. per hour, or 187s. 4d. per week of 40 hours.		
2nd	42 2	3rd	Doughmakers			
2nd Year—		4th	Persons not provided for elsewhere in this Determination			
1st six months ..	44 7	PROPORTION (within any factory or place).					
2nd	50 8	One improver to every eight workers receiving not less than 187s. 4d. per week of 40 hours.					
3rd Year—							
1st six months ..	57 8						
2nd	67 9						
4th Year—							
1st six months ..	79 6						
2nd	92 9						
5th Year—							
1st six months ..	109 5						
2nd	127 10						
and thereafter the minimum wage.							
PROPORTION.							
One apprentice to every three or fraction of three workers receiving not less than 187s. 4d. per week of 40 hours.							

P. A. RANGLES, J.P., Chairman.
 J. V. WILLOX, Secretary.

Melbourne, 2nd May, 1950.



VICTORIA
GOVERNMENT GAZETTE.

Published by Authority.

[Registered at the General Post Office, Melbourne, for transmission by post as a newspaper.]

No. 466]

THURSDAY, MAY 25.

[1950

Factories and Shops Acts.

DETERMINATION OF A WAGES BOARD ADJUSTED PURSUANT TO SECTION 21 OF THE FACTORIES AND SHOPS ACT 1934 (No. 4275).

I, Raymond Henry Beers, Secretary for Labour, in pursuance of the powers conferred by the Factories and Shops Acts, hereby make and issue the following adjusted Determination of the Wages Board referred to hereunder showing adjusted rates and prices to operate from the beginning of the first pay period to commence in May, 1950.

Dated at Melbourne, this
23rd day of May, 1950.

RAY. H. BEERS,
Secretary for Labour.

PAINTERS BOARD.

Clause 2 of Part I. and clause 2 of Part II. of the Determination made on the 7th February, 1950, and in force as from the beginning of the first pay period to commence on or after the 8th November, 1949, shall be replaced by the following clauses:—

PART I.

1. This Part applies only in respect of the employment of persons on the construction renovation alteration repair or demolition of buildings performed on the site thereof, and in particular it shall have no application—

- (i) to employment by an employer in any industry where the work performed by the employee is subsidiary or auxiliary to the chief and principal purpose and business of such industry; or
(ii) to employment in workshops or joinery mills.

2. (i)

WAGES.

(a) Apprentices and Improvers.				(b) Other Employees.		
Apprentices Per Week of 40 hours.						
—	Adjustable Wage.	Loading.	Total Wage.	—	Per hour.	Per Week of 40 hours.
	<i>s. d.</i>	<i>s. d.</i>	<i>s. d.</i>		<i>s. d.</i>	<i>s. d.</i>
1st year's experience	39 6	2 8	42 2	All classes of work	5 4½	215 0
2nd year's experience	53 0	5 4	58 4			
3rd year's experience	72 6	8 0	80 6			
4th year's experience	103 0	10 8	113 8			
5th year's experience	134 0	13 4	147 4			
Improvers.			Per Week of 40 hours.			
			<i>s. d.</i>			
1st year's experience	50 7			
2nd year's experience	70 0			
3rd year's experience	96 7			
4th year's experience	136 5			
5th year's experience	176 10			

WAGES—continued.

(a) Apprentices and Improvers.	(b) Other Employees.						
<p>PROPORTION (BY ANY EMPLOYER). <i>Apprentices.</i></p> <p>One apprentice to every three journeymen or fraction of three journeymen employed. In cases where not more than three journeymen are employed at the trades, a second apprentice may be employed on the completion, by the first apprentice, of the second year of his apprenticeship course.</p> <p style="text-align: center;">* <i>Improvers.</i></p> <table style="width: 100%; border-collapse: collapse;"> <tr> <td style="width: 70%;">One improver to three</td> <td rowspan="4" style="width: 5%; vertical-align: middle;">}</td> <td rowspan="4" style="width: 25%; vertical-align: middle;">workers receiving not less than 215s. 0d. per week of 40 hours.</td> </tr> <tr> <td>Two improvers to six</td> </tr> <tr> <td>Three improvers to twelve and thereafter one additional improver to every twelve additional</td> </tr> <tr> <td></td> </tr> </table>	One improver to three	}	workers receiving not less than 215s. 0d. per week of 40 hours.	Two improvers to six	Three improvers to twelve and thereafter one additional improver to every twelve additional		
One improver to three	}			workers receiving not less than 215s. 0d. per week of 40 hours.			
Two improvers to six							
Three improvers to twelve and thereafter one additional improver to every twelve additional							

* Note.—The employment, within the Metropolitan District, of any improver is illegal.

(ii) An employer shall not employ any minor at work covered by this Part unless under a contract of apprenticeship, provided that any person who on or before the 1st June, 1949, was employed as an improver may continue to be so employed and paid at the rate prescribed in sub-clause (i) hereof for an improver of like experience.

(iii) Leading Hand, i.e., a tradesman who is given responsibility of direction and supervision of the work by his employer or by his employer's responsible representative of not fewer than five tradesmen shall receive in addition to his ordinary wage, allowances as follows:—

(a) If in charge of five tradesmen as aforesaid—1s. per day :

(b) If in charge of more than five tradesmen as aforesaid, 1s. per day for being in charge of the first five tradesmen, plus an additional 1s. per day for each additional five, or fraction of five tradesmen in excess of such first five tradesmen.

PART II.

1. This Part applies in respect of the employment of all persons coming within the ambit of the Determination, other than those provided for in Part I. hereof.

2.

WAGES.

(a) Apprentices and Improvers.	(b) Juvenile Workers, i.e., Persons under 21 years of Age (other than Apprentices or Improvers) engaged in producing Signs or Posters by means of Stencils, Screens, or other like methods or at any work incidental thereto.																																								
<p>Apprentices Per Week of 40 hours.</p> <table border="1" style="width: 100%; border-collapse: collapse;"> <thead> <tr> <th style="width: 20%;"></th> <th style="width: 20%; text-align: center;">Adjustable Wage.</th> <th style="width: 20%; text-align: center;">Loading.</th> <th style="width: 40%; text-align: center;">Total Wage.</th> </tr> <tr> <td></td> <td style="text-align: center;"><i>s. d.</i></td> <td style="text-align: center;"><i>s. d.</i></td> <td style="text-align: center;"><i>s. d.</i></td> </tr> </thead> <tbody> <tr> <td>1st year's experience</td> <td style="text-align: center;">39 6</td> <td style="text-align: center;">2 8</td> <td style="text-align: center;">42 2</td> </tr> <tr> <td>2nd year's experience</td> <td style="text-align: center;">53 0</td> <td style="text-align: center;">5 4</td> <td style="text-align: center;">58 4</td> </tr> <tr> <td>3rd year's experience</td> <td style="text-align: center;">72 6</td> <td style="text-align: center;">8 0</td> <td style="text-align: center;">80 6</td> </tr> <tr> <td>4th year's experience</td> <td style="text-align: center;">103 0</td> <td style="text-align: center;">10 8</td> <td style="text-align: center;">113 8</td> </tr> <tr> <td>5th year's experience</td> <td style="text-align: center;">134 0</td> <td style="text-align: center;">13 4</td> <td style="text-align: center;">147 4</td> </tr> </tbody> </table>		Adjustable Wage.	Loading.	Total Wage.		<i>s. d.</i>	<i>s. d.</i>	<i>s. d.</i>	1st year's experience	39 6	2 8	42 2	2nd year's experience	53 0	5 4	58 4	3rd year's experience	72 6	8 0	80 6	4th year's experience	103 0	10 8	113 8	5th year's experience	134 0	13 4	147 4	<p>Per Week of 40 hours.</p> <table border="1" style="width: 100%; border-collapse: collapse;"> <thead> <tr> <th style="width: 70%;"></th> <th style="width: 30%; text-align: center;"><i>s. d.</i></th> </tr> </thead> <tbody> <tr> <td>1st year's experience</td> <td style="text-align: center;">39 6</td> </tr> <tr> <td>2nd year's experience</td> <td style="text-align: center;">53 0</td> </tr> <tr> <td>3rd year's experience</td> <td style="text-align: center;">72 6</td> </tr> <tr> <td>4th year's experience</td> <td style="text-align: center;">103 0</td> </tr> <tr> <td>5th year's experience</td> <td style="text-align: center;">134 0</td> </tr> </tbody> </table>		<i>s. d.</i>	1st year's experience	39 6	2nd year's experience	53 0	3rd year's experience	72 6	4th year's experience	103 0	5th year's experience	134 0
	Adjustable Wage.	Loading.	Total Wage.																																						
	<i>s. d.</i>	<i>s. d.</i>	<i>s. d.</i>																																						
1st year's experience	39 6	2 8	42 2																																						
2nd year's experience	53 0	5 4	58 4																																						
3rd year's experience	72 6	8 0	80 6																																						
4th year's experience	103 0	10 8	113 8																																						
5th year's experience	134 0	13 4	147 4																																						
	<i>s. d.</i>																																								
1st year's experience	39 6																																								
2nd year's experience	53 0																																								
3rd year's experience	72 6																																								
4th year's experience	103 0																																								
5th year's experience	134 0																																								
<p>Improvers.</p> <table border="1" style="width: 100%; border-collapse: collapse;"> <thead> <tr> <th style="width: 70%;"></th> <th style="width: 30%; text-align: center;">Per Week of 40 hours.</th> </tr> <tr> <td></td> <td style="text-align: center;"><i>s. d.</i></td> </tr> </thead> <tbody> <tr> <td>1st year's experience</td> <td style="text-align: center;">50 7</td> </tr> <tr> <td>2nd year's experience</td> <td style="text-align: center;">70 0</td> </tr> <tr> <td>3rd year's experience</td> <td style="text-align: center;">96 7</td> </tr> <tr> <td>4th year's experience</td> <td style="text-align: center;">136 5</td> </tr> <tr> <td>5th year's experience</td> <td style="text-align: center;">176 10</td> </tr> </tbody> </table>		Per Week of 40 hours.		<i>s. d.</i>	1st year's experience	50 7	2nd year's experience	70 0	3rd year's experience	96 7	4th year's experience	136 5	5th year's experience	176 10	<p>PROPORTION.</p> <p>(i) Where one screen table is in operation— Two juvenile workers to each person receiving not less than 137s per week of 40 hours.</p> <p>(ii) Where two or more screen tables are in operation— For each two screen tables, four juvenile workers to each two fully-paid workers, provided that one of such fully-paid workers shall receive not less than 137s. per week of 40 hours.</p>																										
	Per Week of 40 hours.																																								
	<i>s. d.</i>																																								
1st year's experience	50 7																																								
2nd year's experience	70 0																																								
3rd year's experience	96 7																																								
4th year's experience	136 5																																								
5th year's experience	176 10																																								
<p>PROPORTION (BY ANY EMPLOYER). <i>Apprentices.</i></p> <p>One apprentice to every three journeymen or fraction of three journeymen employed. In cases where not more than three journeymen are employed at the trades, a second apprentice may be employed on the completion, by the first apprentice, of the second year of his apprenticeship course.</p> <p style="text-align: center;">* <i>Improvers.</i></p> <table style="width: 100%; border-collapse: collapse;"> <tr> <td style="width: 70%;">One improver to three</td> <td rowspan="4" style="width: 5%; vertical-align: middle;">}</td> <td rowspan="4" style="width: 25%; vertical-align: middle;">workers receiving not less than 208s. 6d. per week of 40 hours.</td> </tr> <tr> <td>Two improvers to six</td> </tr> <tr> <td>Three improvers to twelve and thereafter one additional improver to every twelve additional</td> </tr> <tr> <td></td> </tr> </table>	One improver to three	}	workers receiving not less than 208s. 6d. per week of 40 hours.	Two improvers to six	Three improvers to twelve and thereafter one additional improver to every twelve additional																																				
One improver to three	}			workers receiving not less than 208s. 6d. per week of 40 hours.																																					
Two improvers to six																																									
Three improvers to twelve and thereafter one additional improver to every twelve additional																																									

* Note.—The employment, within the Metropolitan District, of any improver is illegal.

(c) OTHER EMPLOYEES.

	(i) Within 20 Miles of the Principal Post Office at Elizabeth-street, Melbourne;		(ii) Within 5 Miles of the Post Office at Mildura;		(iii) Within the Gippsland District as defined herein (except within a radius of 3 Miles of the Post Office at Yallourn).		(iv) Within 10 Miles of the Principal Post Offices at Geelong and Warrnambool, respectively.		Within 3 Miles of the Post Office at Yallourn.		All Other Parts of Victoria	
	Per hour.	Per week of 40 hours.	Per hour.	Per week of 40 hours.	Per hour.	Per week of 40 hours.	Per hour.	Per week of 40 hours.	Per hour.	Per week of 40 hours.	Per hour.	Per week of 40 hours.
	<i>s. d.</i>	<i>s. d.</i>	<i>s. d.</i>	<i>s. d.</i>	<i>s. d.</i>	<i>s. d.</i>	<i>s. d.</i>	<i>s. d.</i>	<i>s. d.</i>	<i>s. d.</i>	<i>s. d.</i>	<i>s. d.</i>
(A) All classes of work, other than the production of signs or posters by means of stencils, screens, or other like methods. Persons employed at— Sign or poster writing, graining or painting, or paperhanging, or at any other work specified in (A) ..	5 3½	211 6	5 5½	218 0	5 2½	208 6						
(B) Producing signs or posters by means of stencils, screens, or other like methods, or any work incidental thereto. Persons employed at— (i) Signwriting designing forming or lettering any pictorial design, including the cutting of stencils (ii) Any other work specified in (B)	5 3½ 3 6	211 6 140 0	5 5½ 3 8	218 0 146 6	5 2½ 3 5	208 6 137 0						

Notwithstanding anything contained in clause 2 (c) (A) and (B) (i) of this Part any employee, within six months of his first employment in any place, whose employment is terminated by the employer for any cause other than misconduct or incompetence shall on such termination be entitled to be paid for such work performed by him an additional amount at the rate of 3s. 10d. per week.

(d) Leading Hand, i.e., a tradesman who is given responsibility of direction and supervision of the work by his employer or by his employer's responsible representative of not fewer than five tradesmen shall receive in addition to his ordinary wage, allowances as follows:—

(a) If in charge of five tradesmen as aforesaid—1s. per day;

(b) If in charge of more than five tradesmen as aforesaid, 1s. per day for being in charge of the first five tradesmen, plus an additional 1s. per day for each additional five, or fraction of five tradesmen in excess of such first five tradesmen.

(e) An employer shall not employ any minor at work covered by this Part, other than as a juvenile worker as defined, unless under a contract of apprenticeship, provided that any person who on or before the 1st June, 1949, was employed as an improver may continue to be so employed and paid at the rate prescribed in sub-clause (a) hereof for an improver of like experience.

Clauses, other than clause 2 of Part I. and clause 2 of Part II. of the said Determination shall remain in force.



VICTORIA GOVERNMENT GAZETTE.

Published by Authority.

[Registered at the General Post Office, Melbourne, for transmission by post as a newspaper.]

No. 467]

THURSDAY, MAY 25.

[1950

Factories and Shops Acts.

DETERMINATION OF A WAGES BOARD ADJUSTED PURSUANT TO SECTION 21 OF THE FACTORIES AND SHOPS ACT 1934 (No. 4275).

I, Raymond Henry Beers, Secretary for Labour, in pursuance of the powers conferred by the Factories and Shops Acts, hereby make and issue the following adjusted Determination of the Wages Board referred to hereunder showing adjusted rates and prices to operate from the beginning of the first pay period to commence in May, 1950.

Dated at Melbourne, this
23rd day of May, 1950.

RAY. H. BEERS,
Secretary for Labour.

ENGINEERS AND BRASSWORKERS (SKILLED) BOARD.

Clauses 2, 3, 4 and 5 of the Determination published in *Government Gazette*, No. 17, of the 13th January, 1950, shall be replaced by the following clauses:—

2.

Wages per Week of 40 Hours.

Adults.	Within 20 Miles of G.P.O., Melbourne; 10 Miles of G.P.O., Geelong; at Warrnambool and within Mildura and Gippsland Districts.	At Yallourn.	Other Parts of Victoria.
	£ s. d.	£ s. d.	£ s. d.
(a) <i>Engineering and Brassworking Section.</i>			
Angle-iron smith	9 13 6	10 0 0	9 10 6
Annealer and/or case hardener	8 19 6	9 6 0	8 16 6
Brassfinisher (tradesman)	9 9 0	9 15 6	9 6 0
Brassfinisher (2nd class)	8 14 0	9 0 6	8 11 0
Brass polisher	8 7 0	8 13 6	8 4 0
Blacksmith's machinist	8 5 0	8 11 6	8 2 0
Brass-smith, coppersmith, or other smith	9 10 6	9 17 0	9 7 6
Fitter and/or turner	9 9 0	9 15 6	9 6 0
Fitter, turbine blade	9 13 6	10 0 0	9 10 6
Forger and/or faggoter	10 7 6	10 14 0	10 4 6
Heat treater	9 13 6	10 0 0	9 10 6
Inspector	10 4 6	10 11 0	10 1 6
Key-seating machinist	8 14 0	9 0 6	8 11 0
Locksmith	9 9 0	9 15 6	9 6 0
Machine setter	9 9 0	9 15 6	9 6 0
Machinist—1st class	8 14 0	9 0 6	8 11 0
Machinist—2nd class	8 5 0	8 11 6	8 2 0
Machinist—3rd class			
Marker off (i.e., a fitter the greater part of whose time is occupied in marking off)	9 13 6	10 0 0	9 10 6
Motor cycle mechanic	9 4 6	9 11 0	9 1 6
Motor mechanic	9 9 0	9 15 6	9 6 0
Mould polisher	8 3 0	8 9 6	8 0 0
Patternmaker	10 2 0	10 8 6	9 19 0
Pipe fitter on low pressure work	8 14 0	9 0 6	8 11 0
Process worker	7 19 0	8 5 6	7 16 0
Refrigeration mechanic or serviceman	9 9 0	9 15 6	9 6 0
Safe maker and/or repairer (security work)	9 9 0	9 15 6	9 6 0
Scalemaker and/or adjuster	10 2 0	10 8 6	9 19 0
Scientific instrument maker	10 2 0	10 8 6	9 19 0
Toolmaker	9 13 6	10 0 0	9 10 6
Toolsmith			

Wages per Week of 40 Hours.—continued.

Adults.	Within 20 Miles of G.P.O., Melbourne; 10 Miles of G.P.O., Geelong; at Warrnambool and within Mildura and Gippsland Districts.	At Yallourn.	Other Parts of Victoria.
	£ s. d.	£ s. d.	£ s. d.
Wet stone grinder and glazier (tradesman) ..	9 9 0	9 15 6	9 6 0
Welder—1st class (other than when using Cutler machine)	9 13 6	10 0 0	9 10 6
Welder—1st class (using Cutler machine)	8 16 0	9 2 6	8 13 0
Welder—2nd class	8 5 0	8 11 6	8 2 0
Welder—3rd class	8 1 0	8 7 6	7 18 0
Welder—tack	8 3 0	8 9 6	8 0 0
Jobbing moulder and/or coremaker	9 9 0	9 15 6	9 6 0
Plate and machine moulder and/or coremaker—			
1st six months' experience	8 5 0	8 11 6	8 2 0
2nd six months' experience	8 8 0	8 14 6	8 5 0
3rd six months' experience	8 11 0	8 17 6	8 8 0
Thereafter	8 16 0	9 2 6	8 13 0
Experience for the purpose of calculating the rates payable to plate and machine moulders and/or coremakers shall include all experience as a moulder or coremaker, jobbing or machine, as the case may be, whether as a junior or an adult.			
Other employees with not less than three months' experience in the metal trades industry ..	7 6 0	7 12 6	7 3 0
Employee not elsewhere classified	7 0 0	7 6 6	6 17 0
<i>(b) Making or Repairing Typewriters, Book-keeping Machines, Adding Machines, Calculating Machines, Cash Registers, Duplicating Machines and Similar Machines.</i>			
Adding, calculating and book-keeping machine mechanic	9 10 6	9 17 0	9 7 6
Cash register mechanic	9 10 6	9 17 0	9 7 6
Tradesman	9 9 0	9 15 6	9 6 0
First-class mechanic	8 19 6	9 6 0	8 16 6
Second-class mechanic	8 16 0	9 2 6	8 13 0
Process worker	7 19 0	8 5 6	7 16 0
Other employees with not less than three months' experience in the metal trades industry ..	7 6 0	7 12 6	7 3 0
Employee not elsewhere classified	7 0 0	7 6 6	6 17 0

NOTE.—Employees engaged on ship repairs shall be paid the following additional margins:—

	s. d.
Tradesmen	4 6 per week.
All other labour	3 0 ..

LEADING HANDS.

Leading hands in charge of not less than three and not more than ten employees, 9s. per week extra; more than ten and not more than twenty employees, 18s. per week extra; more than twenty employees, 27s. per week extra.

Provided that an employee in an electrical supply undertaking detailed to act as leading hand in charge of two other adult employees working away from power station or workshop (one of whom is of the same classification as himself) shall be paid 6s. per week extra.

TRADESMEN IN LARGE POWER HOUSES.

Tradesmen and/or welders, and their assistants employed in large operating power houses (i.e., power houses developing more than 8,000 kilowatts), other than those not on the regular staff, engaged on new construction work, shall be paid 6s. per week extra, and other apprentices and unapprenticed juniors 3s. per week extra; such amount shall be deemed to include all special rates prescribed in clause 6.

This allowance shall continue to be payable to tradesmen attached to the staffs of such power houses while carrying out repairs or maintenance in rotary converter sub-stations which are in regular operation.

APPRENTICESHIP.

3. (Other than those covered by the Apprenticeship Commission.)

Apprenticeship Trades.

(a) An employer shall not employ minors in the following trades or occupations otherwise than under a contract of apprenticeship as hereinafter provided:—

- (i) Brassfinisher (except the making of parts by specialized processes and the assembling thereof)
- (ii) Electrical fitter and/or armature winder (except the winding of armatures by specialized processes).
- (iii) Electrical mechanic.
- (iv) Fitter and/or turner.
- (v) Locksmith—making and/or repairing locks, including those of safes and strong-room doors, but not including the making of parts by specialized processes and the assembling thereof.
- (vi) Machinist—1st and 2nd class.
- (vii) Motor mechanic.
- (viii) Moulder and/or coremaker—jobbing.
- (ix) Patternmaker.
- (x) Refrigeration mechanic or serviceman.
- (xi) Safe and strong-room maker.
- (xii) Scale maker (except the making of parts by specialized processes and the assembling thereof).
- (xiii) Scientific instrument maker.
- (xiv) Smithing—Blacksmith, copper and/or brass smith.
- (xv) Welder—1st class.
- (xvi) Window frame fitter.
- (xvii) Brass polishing.
- (xviii) Adding machine, calculating machine, book-keeping machine, cash register, or first-class mechanic.

Contract of Apprenticeship.

(b) Every contract of apprenticeship hereinafter made shall contain—

- (i) the names of the parties;
- (ii) the date of birth of the apprentice;
- (iii) a statement of the trade or trades to which the apprentice is to be bound and which he is to be taught during the course and for the purpose of the apprenticeship;
- (iv) a covenant by the master to teach and instruct or cause the apprentice to be taught or instructed in the trade to which the apprentice is bound;
- (v) the date at which the apprenticeship is to commence or from which it is to be calculated;
- (vi) all other conditions of apprenticeship.

Cancellation or Suspension of Indenture.

(c) Subject to the approval of the Secretary for Labour, but not otherwise, an indenture of apprenticeship may be suspended or cancelled—

- (i) by mutual consent;
- (ii) if through lack of orders or financial difficulties an employer is unable to find suitable employment for an apprentice and a transfer to another employer cannot be arranged;
- (iii) if, in the opinion of the Secretary for Labour, circumstances exist which render such suspension or cancellation necessary or desirable.

Any covenant in an indenture inconsistent with the provision of this clause shall be null and void and of no force or effect while this Determination remains in force and applies to the parties to the indenture.

Instruction in Welding.

(d) The training of apprentices to blacksmithing, structural steel works, fitting or fitting and turning shall include instruction in electric welding and/or oxy-acetylene welding as far as is practicable with the facilities available in the shop in which they are trained.

Proportion.

(e) (i) An employer shall not employ apprentices in excess of the proportion hereinafter prescribed. Subject to this sub-clause the proportion of apprentices who may be taken by an employer shall not exceed one apprentice to every three or fraction of three tradesmen in the trade concerned.

In the trades of—

- Welder—1st class;
- Motor mechanic; and
- Moulder and/or coremaker—jobbing;

the proportion of apprentices who may be taken by an employer shall not exceed one apprentice for every two or fraction of two tradesmen in the trade concerned.

For the purpose of ascertaining the number of apprentices, the number of tradesmen shall be deemed to be the average number working during the immediately preceding six months, and in ascertaining such proportion an employer actually working in any workshop shall be deemed to be a tradesman.

A person who is, for a term not exceeding two years, taking practical training in a workshop in continuance of a course of training for professional work shall not be taken into account in calculating the proportion of apprentices to journeymen.

(ii) Notwithstanding anything hereinbefore provided in the trades of—

- Fitter and/or turner,
- Machinist—1st and 2nd class,
- Motor mechanic, and
- Refrigeration mechanic or serviceman,

an employer may with the consent of an apprenticeship authority and upon satisfying that authority that he has the plant, equipment and staff necessary for the proper tuition of each apprentice concerned take apprentices in excess of the proportion herein prescribed. Until further order apprentices so taken shall not be counted in future calculations of the proportion of apprentices to journeymen authorized by the Determination.

Period of Apprenticeship.

(f) The periods of apprenticeship, except as to those marked (i), (xi), (xii), and (xvi), shall be as follows:—

If the apprentice, when indentured, is under the age of seventeen years—five years; if over the age of seventeen—four or five years, at the option of the contracting parties.

For the trades marked (i), (xi), (xii), and (xvi)—four or five years at the option of the contracting parties.

Adult Apprentices.

(g) Any apprentice who cannot complete his full term of apprenticeship before reaching his 22nd birthday may, by agreement with his master, serve as an apprentice until he reaches the age of 23 years.

Probationary Period.

(h) Minors may be taken on probation for three months, and if apprenticed such three months shall count as part of their period of apprenticeship. An employer shall within fourteen days of employing a probationer notify the appropriate apprenticeship authorities of the employment of such probationer to any of the trades mentioned herein.

Wages.

(i) The minimum weekly rates of wage for apprentices shall be the under-mentioned percentages of the contemporaneous needs basic wage prescribed for the area in which they are employed, and in addition thereto the constant and war loadings specified, and in all contracts of apprenticeship hereafter made, the employer shall covenant to pay wages of not less than such rates.

The total wages of apprentices and improvers shall be calculated to the nearest sixpence, any broken part of sixpence in the result not exceeding threepence to be disregarded.

(j) *Wages per Week of 40 Hours.*

	Percentage of Needs Basic Wage.	Constant Loading.	War Loading.	Total Wage Payable—		
				Within 20 Miles G.P.O., Melbourne; 10 Miles of G.P.O., Geelong; at Warrnambool and within Mildura and Gippsland Districts.	At Yallourn.	Other Parts of Victoria.
	Per Week.	Per Week.	Per Week.	£ s. d.	£ s. d.	£ s. d.
Four and five-year terms—						
1st year	29	0 0	0 9	1 18 6	2 0 6	1 18 0
2nd year	40	1 0	1 0	2 14 6	2 17 0	2 13 0
3rd year	53	1 6	1 6	3 12 6	3 16 0	3 11 0
4th year	84	2 0	2 3	5 14 6	5 19 6	5 12 0
5th year	100	2 0	3 0	7 3 0	7 9 6	7 0 0
	plus 7s.					
Four-year terms—Apprentice commencing after the age of 17 years—						
1st year	33	0 0	0 9	2 4 0	2 6 0	2 3 0
2nd year	53	1 0	1 6	3 12 0	3 15 6	3 10 6
3rd year	84	2 0	2 3	5 14 6	5 19 6	5 12 0
4th year	100	2 0	3 0	7 3 0	7 9 6	7 0 0
	plus 7s.					

The sum of 4s. per week shall be added to the above rates in the case of apprentice patternmakers.

An employee who is under 21 years of age on the expiration of his apprenticeship and thereafter works as a minor in the occupation to which he has been apprenticed shall be paid at not less than the adult rate prescribed for that classification.

Hours.

(k) The ordinary hours of employment of apprentices shall not in each workshop exceed those of the journeymen.

Overtime and Shift Work.

(l) No apprentice under the age of 18 years shall be required to work overtime or shift work unless he so desires. No apprentice shall except in an emergency work or be required to work overtime or shift work at times which would prevent his attendance at technical school as required by any statute, Determination or regulation applicable to him.

Payment by Results.

(m) An apprentice shall not work under any system of payment by results.

Lost Time.

(n) The apprentice at the end of the calendar period of any year in which he has actually given service to the master upon less than the ordinary working days prescribed in this Determination, or in which he has unlawfully absented himself without the master's consent, shall, for every day short of the said number of working days, and for every day of such absence, serve one day, and the calendar period of the succeeding year of his service shall not be deemed to begin until the said additional day or days shall have been served. Provided that in calculating the extra time to be so served the apprentice shall be credited with time which he has worked during the relevant year in excess of his ordinary hours.

Prohibition of Premiums.

(o) An employer shall not, either directly or indirectly, or by any pretence or device receive from any person or require or permit any person to pay or give any consideration in the nature of a premium or bonus for the taking or binding of any probationer or apprentice.

Attendance at Technical Schools.

(p) Apprentices attending technical colleges or schools and presenting reports of satisfactory conduct shall be reimbursed all fees paid by them.

Annual and Sick Leave.

(q) Apprentices shall be entitled to sick and annual leave in accordance with the provisions of clauses 17 and 18 hereof respectively.

IMPROVERS.

4. Improvers employed at brass polishing or in the making or repairing of typewriters, book-keeping machines, adding machines, calculating machines, cash registers, duplicating machines, and similar machines shall be paid as follows:—

Wages per Week of 40 Hours.

	Percentage of Needs Basic Wage.	Constant Loading.	War Loading.	Total Wage Payable—		
				Within 20 Miles G.P.O., Melbourne; 10 Miles of G.P.O., Geelong; at Warrnambool and within Mildura and Gippsland Districts.	At Yallourn.	Other Parts of Victoria.
	Per Week.	Per Week.	Per Week.	£ s. d.	£ s. d.	£ s. d.
1st year	25	0 0	0 9	1 13 6	1 15 0	1 12 6
2nd year	33	1 0	1 0	2 5 0	2 7 6	2 4 0
3rd year	50	1 6	1 6	3 8 6	3 11 6	3 7 0
4th year	83	2 0	2 3	5 13 0	5 18 6	5 10 6
5th year	100	2 0	3 0	7 2 0	7 8 6	6 19 0
	plus 6s.					

Notwithstanding anything elsewhere in this Determination contained, where an improver is under the age of 21 years after completion of five years at the trade of making or repairing typewriters, book-keeping machines, adding machines, calculating machines, cash registers, duplicating machines, and similar machines, he shall be paid four-fifths of the second-class mechanic's time wage until reaching the age of 21 years.

Proportion of Improvers.—In the making or repairing of typewriters, book-keeping machines, adding machines, calculating machines, cash registers, duplicating machines, and similar machines—one improver to every two or fraction of two workers employed in this section.

Brass polishing.—One improver to every two or fraction of two brass polishers receiving not less than the minimum wage.

FEMALES AND UNAPPRENTICED MALE JUNIORS.

5. (a) No junior other than an apprentice or an improver shall be employed at brass polishing or in assembling, making, or repairing typewriters, book-keeping machines, adding machines, calculating machines, cash registers, duplicating machines, and similar machines.

(b) Subject to the exception hereinafter provided, the minimum rates of wage for adult and junior females and for unapprenticed male juniors employed in occupations for which apprenticeship is not provided by this Determination shall be as follows:—

Wages per Week of 40 Hours.

	Percentage of Needs Basic Wage.	Constant Loading.	Additional Amount.	War Loading.	Total Wage Payable—		
					Within 20 Miles of G.P.O., Melbourne; 10 Miles of G.P.O., Geelong; at Warrnambool and within Mildura and Gippeland Districts.	At Yallourn.	Other Parts of Victoria.
	Per Week.	Per Week.	Per Week.	s. d.	£ s. d.	£ s. d.	£ s. d.
<i>I.—Adult Females.</i>							
Under three months' experience	65	3 0	6 0	..	4 14 0	4 18 6	4 12 0
All others ..	75	3 0	7 0	..	5 8 0	5 13 0	5 6 0
<i>II.—Junior Females.</i>							
17 years of age and under ..	40	1 0	3 6	..	2 17 0	2 19 6	2 15 6
18 years of age ..	47½	1 3	4 0	..	3 7 6	3 10 6	3 6 0
19 years of age ..	55	1 6	4 6	..	3 18 0	4 1 6	3 16 6
20 years of age ..	62½	2 0	5 0	..	4 9 0	4 13 0	4 7 0
<i>III.—Junior Males.</i>							
Under 16 years of age ..	25	0 6	2 0	..	1 15 0	1 17 0	1 14 6
16 years of age ..	35	0 9	3 0	..	2 9 6	2 12 0	2 8 6
17 years of age ..	47½	1 0	4 0	..	3 7 0	3 10 6	3 6 0
18 years of age ..	60	1 0	5 0	..	4 4 6	4 8 6	4 3 0
19 years of age ..	75	2 0	6 0	..	5 6 0	5 11 0	5 4 0
20 years of age ..	90	2 0	7 0	..	6 7 0	6 12 6	6 4 0
<p>A junior employee of eighteen years or more shall be paid 3s. per week in addition to the rates prescribed herein while he is employed as a furnaceman or assistant to a furnaceman.</p>							
<i>IV.—Junior Males (Foundries).</i>							
Under 16 years of age ..	25	0 6	2 0	1 0	1 16 0	1 18 0	1 15 6
16 years of age ..	33	0 9	2 6	1 9	2 8 0	2 10 6	2 7 0
17 years of age ..	60	1 0	5 0	3 0	4 7 6	4 11 6	4 6 0
18 years of age ..	75	2 0	6 0	4 0	5 10 0	5 15 0	5 8 0
19 years of age and over ..	90	2 6	7 0	4 6	6 12 0	6 17 6	6 9 0

Provided that the rate payable to any employee shall not excluding the constant loading be less than 20s.

The total wage shall be calculated to the nearest sixpence, any broken part of sixpence in the result not exceeding threepence to be disregarded.

(c) Except in the case of employees in foundries, the minimum rate payable to a junior female of any age or a junior male of eighteen years or more each with less than six months' experience under this Determination shall, until he or she has had six months' experience, be 10 per cent. less than the amount represented by the percentage of the needs basic wage hereby prescribed for a junior employee of his or her age and in addition thereto the constant loading prescribed for such an employee:

Provided that this sub-clause shall not operate to reduce the rates paid to any female employee as from the beginning of the first pay period to commence in August, 1942.

Prohibited Occupations.

(d) Junior employees shall not be employed:—

- (i) if under the age of 16 years—
on oil or gas burners or fires used for heating of small articles; or
using electric arc or oxy acetylene blow pipe, or
- (ii) if under 18 years of age—
die setting on power presses; or
as furnacemen or assistants to furnacemen.

Clauses, other than clauses 2, 3, 4 and 5, of the said Determination shall remain in force.



VICTORIA GOVERNMENT GAZETTE.

Published by Authority.

[Registered at the General Post Office, Melbourne, for transmission by post as a newspaper.]

No. 468]

THURSDAY, MAY 25.

[1950

Factories and Shops Acts.

DETERMINATION OF A WAGES BOARD ADJUSTED PURSUANT TO SECTION 21 OF THE FACTORIES AND SHOPS ACT 1934 (No. 4275).

I, Raymond Henry Beers, Secretary for Labour, in pursuance of the powers conferred by the Factories and Shops Acts, hereby make and issue the following adjusted Determination of the Wages Board referred to hereunder showing adjusted rates and prices to operate from the beginning of the first pay period to commence in May, 1950.

Dated at Melbourne, this
23rd day of May, 1950.

RAY H. BEERS,
Secretary for Labour.

MUSICIANS BOARD.

Clause 2 of the Determination published in *Government Gazette* No. 281 of the 14th April, 1950, shall be replaced by the following clause:—

WAGES.

(A) GRAND OPERA, GRAND BALLET, CONCERTS, OR RELIGIOUS PERFORMANCES.

Weekly Employees.

2. (A1) For the purpose of this sub-clause (A) a week's work shall be deemed to consist of seven performances, namely, six at night and one matinee, or, at the option of the employer, of any performances and/or rehearsals to the aggregate number of seven, in either case all such seven to be held within seven consecutive days and none on Sunday.

	£	s.	d.
(A2) Leaders—			
(i) Week's work	14	6	0
(ii) Each performance additional to the week's work	2	3	5
(A3) Principals—			
(i) Week's work	12	6	0
(ii) Each performance additional to the week's work	1	17	8
(A4) Week's work for other performers	10	14	0
(A5) Each performance additional to week's work	1	13	1
(A6) Pianist playing alone	12	6	0
(A7) Each performance additional to week's work	1	17	8
(A8) Pianist playing alone for voice trials or similar work (not being a member of the orchestra), 15s. 9d. per hour with a minimum payment as for two consecutive hours.			

Casual Employees.

	£	s.	d.
(A9) Leaders—each performance	2	14	6
(A10) Principals—each performance	2	4	2
(A11) Other performers—each performance	1	18	8
(A12) Pianist playing alone—each performance	2	4	2

(B) GENERAL THEATRICAL ENTERTAINMENT, INCLUSIVE OF PANTOMIME, VARIETY SHOW, VAUDEVILLE, REVUE, COMIC OPERA, MUSICAL COMEDY, DRAMA, BURLESQUE, MINSTREL SHOW, CIRCUSES, AND ALL FORMS OF EMPLOYMENT WHETHER SIMILAR TO ANY OF THE FOREGOING OR OTHERWISE, NOT ELSEWHERE PROVIDED FOR IN THIS DETERMINATION.

Weekly Employees.

(B1) For the purpose of this sub-clause B—

- (i) A week's work of six performances shall be deemed to consist of six night performances or, at the option of the employer, or any performance and/or rehearsals to the aggregate number of six, all such performances or rehearsals in either case to be held within seven consecutive days and none on a Sunday.
- (ia) A week's work of eight performances shall be deemed to consist of six night performances and two matinee performances or, at the option of the employer, of any performance and/or rehearsals to the aggregate number of eight, all such eight performances and/or rehearsals in either case to be held within seven consecutive days and none on Sunday.

(ii) A week's work of twelve performances shall be deemed to consist of two performances on each of six calendar days or, at the option of the employer, of any performance and/or rehearsals to the aggregate number of two on each of such days, all such twelve performances and/or rehearsals in either case to be held within seven consecutive days and none on Sunday.

	£	s.	d.
(B2) Week's work of six performances	8	18	6
(B3) Additional performances (each) one sixth of the six performance rate.			
(B3A) Week's work of eight performances	11	11	8
(B3B) Additional performances (each) one-eighth of the eight performance rate.			
(B4) Week's work of twelve performances	12	13	6
(B5) For the first additional performance	1	8	0
For the second additional performance	1	12	11
For the third and each succeeding additional performance	2	2	8
(B6) Pianist playing alone—six performances	10	9	6
(B7) Each performance additional to week's work	1	17	0
(B8) Pianist playing alone—twelve performances	14	4	6
(B9) For the first additional performance	1	11	3
For the second additional performance	1	16	9
For the third and each succeeding additional performance	2	10	2
(B10) Pianist or other instrumentalist being a member of the orchestra employed additionally for voice trials or similar work—8s. 7d. per hour with a minimum payment as for one hour if the call is immediately before or after a regular call, and a minimum payment as for two hours in all other cases.			
(B11) Pianist or other instrumentalist not being a member of an orchestra employed for voice trials or similar work—11s. 4d. per hour with a minimum payment as for two hours.			

Casual Employees.

(B12) Each performance other than by pianist playing alone	1	17	2
(B13) Each performance by pianist playing alone	2	3	4

(C) PICTURE SHOWS.

Weekly Employees.

(C1) For the purpose of this sub-clause C—

(i) A week's work of six performances shall be deemed to consist of six night performances or, at the option of the employer, of any performances and/or rehearsals at the aggregate number of six, all such six performances and/or rehearsals in either case to be held within seven consecutive days and none on Sunday.

(ii) A week's work of twelve performances shall be deemed to consist of two performances on each of six calendar days or, at the option of the employer, of any performances and/or rehearsals to the aggregate number of two on each of such days, all such twelve performances and/or rehearsals in either case to be held within seven consecutive days and none on Sunday.

	£	s.	d.
(C2) Week's work of six performances	8	4	0
(C3) Each performance additional to week's work	1	9	5
(C4) Week's work of twelve performances	11	7	6
(C5) For the first additional performance	1	5	4
For the second additional performance	1	9	8
For the third and each succeeding additional performance	1	18	4
(C6) Pianist playing alone for six performances	9	15	0
(C7) Each performance additional to week's work	1	14	7
(C8) Pianist playing alone for twelve performances	12	18	6
(C9) For the first additional performance	1	8	8
For the second additional performance	1	13	8
For the third and each succeeding additional performance	2	4	9
(C10) Pianist or other instrumentalist being a member of the orchestra, employed additionally for voice trials or similar work—8s. per hour with a minimum payment as for one hour if the call is immediately before or after a regular call, and a minimum payment as for two hours in all other cases.			
(C11) Pianist or other instrumentalist not being a member of the orchestra, employed on voice trials or similar work—10s. 4d. per hour with a minimum payment as for two consecutive hours.			

Casual Employees.

(C12) Each performance	1	14	3
--------------------------------	---	----	---

(D) STAGE BANDS.

Weekly Employees.

(D1) For the purpose of this sub-clause D—

A week's work shall be deemed to consist of six night performances or, at the option of the employer, of performances and/or rehearsals to the aggregate number of six, in either case all such six performances and/or rehearsals to be held within seven consecutive days and none on Sunday.

	£	s.	d.
(D2) Week's work of six performances not to exceed 18 hours	6	19	0
(D3) Each performance additional to week's work	1	5	3
(D4) Week's work of six performances not to exceed 12 hours	4	15	7
(D5) Each performance additional to week's work	0	15	6
<i>Casual Employees.</i>			
(D6) Each performance of three hours	1	9	3
(D7) Each performance of two hours	0	18	2

(E) BRASS AND REED BANDS.

Casual Employees.

	£	s.	d.
(E1) Each performance not to exceed three consecutive hours	1	5	3

(F) CAFES, HOTELS, RESTAURANTS, AND SIMILAR PLACES.

Weekly Employees.

	£	s.	d.
(F1) For a week's work of six performances each not exceeding two consecutive hours and terminating before 7.30 p.m.	5	10	7
(F2) Each performance additional to week's work	0	18	0
(F3) For week's work of twelve performances each not exceeding two consecutive hours and terminating before 8 p.m.	8	4	0
(F4) Each performance additional to week's work	0	14	3
(F5) For a week's work of six performances not exceeding three consecutive hours terminating at or before 7.30 p.m.	7	19	0
(F6) Each performance additional to week's work	1	8	7
(F7) Work commencing after 7.30 p.m. shall be paid for at the rates for general theatrical entertainment or for dancing, as the case may be.			
(F8) If any floor show or any entertainment is provided or dancing is indulged in during any of the above performances each employee shall be paid at the rates for general theatrical entertainment or for dancing, as the case may be, in lieu of the above rates.			
(F9) Pianist or other instrumentalist playing alone shall be paid the appropriate rate in accordance with the foregoing sub-clauses (F1) to (F5) inclusive, together with an additional 18 per cent.			

Casual Employees.

(F10) An employee employed under (F1) not exceeding two hours shall be paid ..	1	1	2
(F11) An employee employed for two performances each day under (F3) not exceeding two hours shall be paid	1	14	3
(F12) An employee employed under (F5) not exceeding three hours shall be paid ..	1	13	3

(G) PUBLIC BALLROOMS, CABARETS, BALLS, DANCING, AND DANCING CLASSES.

Weekly Employees.

(G1) For the purpose of this sub-clause G—
A week's work of six performances shall be deemed to consist of one performance not to exceed three consecutive hours on each of six calendar days, all to be given within seven consecutive days, and none on Sunday: Provided that such three hours may, without payment for overtime, be between 8 p.m. and 11.15 p.m.

	£	s.	d.
(G2) Week's work other than by pianist playing alone	8	11	0
(G3) Each performance additional to week's work	1	10	7
(G4) Week's work—pianist or other instrumentalist playing alone	9	13	0
(G5) Each performance additional to week's work	1	14	3

Casual Employees.

(G6) Each performance	1	15	8
(G7) Each performance—pianist or other instrumentalist playing alone	2	0	1

REGULAR WEEKLY PART-TIME EMPLOYEES.

(G8) For the purpose of items (G9) and (G10)
A week's work shall consist of two, three, four or five performances as the case may be, each performance not to exceed three consecutive hours on each of two, three, four or five calendar days, such performances to be given within seven days, and none on Sunday.
Provided that such three hours may, without payment for overtime, be between 8 p.m. and 11.15 p.m.

(G9) Week's work of two performances	3	5	0
Week's work of three performances	4	19	11
Week's work of four performances	6	11	6
Week's work of five performances	7	19	7
(G10) Pianist or other instrumentalist playing alone.			
Week's work of two performances	3	15	4
Week's work of three performances	5	12	1
Week's work of four performances	7	7	8
Week's work of five performances	8	10	10

(H) CABARETS AND BALLROOMS.

Weekly Employees.

(H1) Week's work of six performances done between 9 p.m. and 2 a.m.	15	11	0
(H2) Week's work of six performances done between 9 p.m. and 1 a.m.	12	1	6

Casual Employees.

(H3) Each performance not to exceed five hours	3	7	2
(H4) Each performance not to exceed four hours	2	13	3
(H5) All work performed before 9 p.m. under item (H1) hereof shall be paid for at the rate of 3s. 4d. for each fifteen minutes or portion thereof.			
(H6) All work performed before 9 p.m. under item (H2) hereof shall be paid for at the rate of 3s. 2d. for each fifteen minutes or portion thereof.			

(I) COFFEE LOUNGES.

Weekly Employees.

(I1) Week's work of seven performances done on Monday to Friday between 9.30 p.m. and 12 midnight, Saturday between 9.30 p.m. and 1 a.m., Sunday between 8.30 p.m. and 11.30 p.m.	11	3	6
(I2) Week's work of six performances done on Monday to Friday between 9.30 p.m. and 12 midnight, Saturday between 9.30 p.m. and 1 a.m., Sunday between 8.30 p.m. and 11.30 p.m., where the coffee lounge is closed on one regular night, which shall not be changed without reasonable notice, between Monday and Friday	10	18	2

Casual Employees.

(I3) Each performance not to exceed three hours	2	5	0
---	---	---	---

(J) SKATING RINKS.
Weekly Employees.

(J1) For the purpose of this sub-clause J—	£ s. d.
(i) A week's work of six performances shall be deemed to consist of one on each of six days, each performance not to exceed three consecutive hours in duration, all to be held within seven consecutive days, and none on Sunday.	
(ii) A week's work of twelve long performances shall be deemed to consist of two performances on each of six calendar days, each performance not to exceed three consecutive hours in duration, all twelve to be held within seven consecutive days, and none on a Sunday.	
(iii) A week's work of twelve short performances shall be deemed to consist of two performances on each of six calendar days, each performance not to exceed two consecutive hours in duration, all twelve to be held within seven consecutive days, and none on a Sunday.	
(J2) Week's work of six performances	8 4 0
(J3) Each performance additional to week's work and not to exceed three consecutive hours	1 9 5
(J4) Week's work of twelve long performances	11 7 6
(J5) For the first additional performance	1 5 4
For the second additional performance	1 9 8
For the third and each succeeding additional performance	1 18 4
(J6) Week's work of twelve short performances to be held between 2.45 p.m. and 5 p.m., and between 8 p.m. and 10.45 p.m.	9 4 0
(J7) Each performance additional to week's work and not to exceed two consecutive hours	0 15 11
Casual Employees.	
(J8) Each performance	1 14 3

(K) CASUAL EMPLOYEES GENERALLY.

- (i) Casual rates shall be ascertained by dividing the weekly rate by six or seven as the case may be, but not by more than seven where the number of performances exceeds seven, with the additional loading of 20 per cent.
- (ii) Casual rates shall be adjustable.

(L) ORGANISTS.

- (i) Organists shall be paid the rate for a member of the orchestra in the type of entertainment in which he is employed, with the addition of 20 per cent.
- (ii) In picture theatres an organist shall be restricted to three hours' actual playing time each day, worked within a daily spread of 10½ hours, and shall be released after the commencement of the second feature of the afternoon performance, and shall not be called upon to resume duty until the finish of the intermediate session.

(M) ADDITION TO PRESCRIBED RATE IF EMPLOYEE PLAYS ONE OR MORE EXTRA INSTRUMENTS.

(M1) If any extra instrument supplied by employee, each performance during week of employment—

	£ s. d.
(i) If three performances or less	extra 0 5 2
(ii) If four	extra 0 4 6
(iii) If five	extra 0 3 11
(iv) If six or more	extra 0 3 3
(v) If six or more—picture shows	extra 0 3 0

(M2) If no extra instrument supplied by employee, each performance during week of employment—

	£ s. d.
(i) If three performances or less	extra 0 3 2
(ii) If four	extra 0 2 9
(iii) If five	extra 0 2 5
(iv) If six or more	extra 0 2 0
(v) If six or more—picture shows	extra 0 1 9

(M3) If a percussionist is required to double on tympani, xylophone or vibraphone, each performance during week of employment—

	£ s. d.
(i) If three performances or less	extra 0 3 6
(ii) If four	extra 0 3 0
(iii) If five	extra 0 2 6
(iv) If six or more	extra 0 2 0

(M4) The flute and piccolo are not extra to each other, nor are other instruments extra to each other which the Union, by its authorized representative, and the employer agree are not to be considered extra, or which the Wages Board, subject to clause 17, determines not to be extra.

(N) ADDITION TO PRESCRIBED RATES FOR PERFORMING, OUTSIDE ORCHESTRA PIT OR WELL, SOLOS IN ORCHESTRA.

(N1) Where orchestra is required to perform on the stage in view of the audience—

	£ s. d.
(i) For each musician, per performance	extra 0 3 3
(ii) Picture shows—for each musician per performance	extra 0 2 6

(N2) Where a musician, other than in picture shows, is required to play in view of the audience either solo or as one of a duet, trio or otherwise than in the ordinary way as part of a complete orchestra—

	£ s. d.
(i) For such musician, per performance	extra 0 3 11
(ii) Picture shows—for such musician, per performance	extra 0 3 0

(O) REHEARSALS NOT INCLUDED BY OPTION OF EMPLOYER IN A WEEK'S WORK IN LIEU OF A PERFORMANCE.

(All weekly or casual employees intended to be employed in a performance for which the rehearsal is held, including conductor-leaders, leaders and principals.)

	£ s. d.
(O1) In Grand Opera and other work comprised in sub-clause A of this clause—	
(i) Commencing before 3 p.m., not to exceed two hours	0 15 2
(ii) Commencing before 3 p.m., not to exceed three hours	1 1 8
(iii) Commencing at or after 3 p.m., not to exceed two hours	0 18 5
(iv) Commencing at or after 3 p.m., not to exceed three hours	1 9 7
(O2) In any other work—	
(i) Commencing before 3 p.m., not to exceed two hours	0 11 11
(ii) Commencing before 3 p.m., not to exceed three hours	0 15 2
(iii) Commencing at or after 3 p.m., not to exceed two hours	0 15 2
(iv) Commencing at or after 3 p.m., not to exceed three hours	1 1 8
(O3) In the case of weekly employees the foregoing rates prescribed in this sub-clause are in addition to the rates prescribed for a week's work.	

Other Employees.

	£	s.	d.
(O4) Pianists employed only for rehearsals with company or artists in grand opera or any other work comprised in sub-clause (A) hereof—			
(i) Weekly employee, for 30 hours in a week, excluding Sunday	12	6	0
(ii) Weekly employee, for each hour over 30 in the week	0	8	4
(iii) Casual employee, for each hour on a week day, with a minimum payment as for three hours	0	10	0
(O5) Pianist employed only for rehearsals with company or artists in any general theatrical or other work comprised in sub-clause (B) hereof—			
(i) Weekly employee, for 30 hours in a week, excluding Sunday	10	9	6
(ii) Weekly employee, for each hour over 30 in the week	0	7	2
(iii) Casual employee, for each hour on a week day, with a minimum payment as for three hours	0	8	4

(P) ADDITION TO PRESCRIBED RATES WHERE EMPLOYEE SUPPLIES MUSIC.

Weekly Employees.

	£	s.	d.
(P1) Employee required to supply music extra	0	15	0

Casual Employees.

(P2) Employee so required—per performance extra	0	5	0
---	---	---	---

(Q) RELAYING.

Where musicians are engaged in any performance in a place of entertainment and such performance or any part thereof is relayed within the State or to other States, each such musician shall be paid additional rates as follows:—

Broadcasts from a Place of Entertainment.

	£	s.	d.
(i) Broadcast in one State only—per performance extra	0	5	0
(ii) Relayed to one other State—per performance extra	0	9	5
(iii) Relayed to two other States—per performance extra	0	13	4
(iv) Relayed to three other States—per performance extra	0	16	6
(v) Relayed to four other States—per performance extra	0	19	2
(vi) Relayed to five other States—per performance extra	1	1	3

(R) CONDUCTOR-LEADERS.

A conductor-leader shall be paid the appropriate rate for a member of the orchestra with an addition of 35 per cent. of such rate.

(S) LEADERS.

Where there is a conductor in an orchestra (not being an orchestra to which sub-clause (A) of this Determination applies) the leader in such orchestra shall be paid the appropriate rate for a member of the orchestra with the addition of 20 per cent. of such rate.

(T) HIGHER DUTIES.

If a musician engaged to do certain work is required to do in lieu thereof other work for which a higher rate is prescribed, he shall be paid for such other work at the higher rate with a minimum as for one performance or as for three hours on each occasion on which he is so required.

(For the purpose of this sub-clause, conducting or leading in the playing of the National Anthem, and playing out the audience, shall not be regarded as higher duties.)

(U) LOWER RATES MAY BE AGREED TO.

Where the Federal Council or Federal Executive of the Musicians Union of Australia agrees with any employer that for special reasons rates and/or conditions different from those prescribed herein should be accepted by an employee, lower rates or altered conditions may be agreed upon between the said Union and Employer.

A written copy of any such agreement, signed by the Secretary of the Union and the Employer concerned, shall be lodged with the Wages Board Branch.

Clauses, other than clause 2, of the said Determination shall remain in force.

