

TIMES OF BEGINNING AND ENDING WORK.

2. That the times of beginning and ending work for all persons (other than stable workers) shall be :—

Time of Beginning.	Time of Ending.
7 a.m.	5 p.m. on ordinary days, provided that the carting and/or delivering of bread before 8 a.m. is prohibited other than to established depots for the loading of carts.
5 a.m.	6 p.m. on days during which bread for more than one day's consumption is delivered, provided that the delivering of bread before 6 a.m. is prohibited.

DELIVERY OF BREAD.

3. The delivery of bread shall be confined to the days Monday to Friday inclusive of each week and no bread shall be delivered on any Sunday or Saturday except a Saturday which is within a period of more than two successive days upon which the carting and delivering of bread would, apart from this provision, be prohibited.

OVERTIME.

4. (a) For stable workers—
In excess of 40 hours in any week Time and one third for the first 2 hours and thereafter time and a half.
- (b) For any other person—
Within the hours fixed, in excess of the number of hours fixed as the week's work Time and one third for the first 2 hours and thereafter time and a half.

ALLOWANCE.

5. Any employee who is required to wear clean, washable outer garments shall be paid 4s. per week in addition to ordinary rates, irrespective of whether or not he supplies the garments.

SPECIAL RATES FOR SUNDAYS AND HOLIDAYS.

6. Double time shall be the rate payable for all work done on Sunday, New Year's Day, Australia Day, Good Friday, Easter Monday, Labour Day, Queen's Birthday, Show Day (in such localities mentioned in the Sixth Schedule to the *Public Service Act 1946* as are within the area to which this Section applies), Christmas Day, or Boxing Day; but if any other day be by Act of Parliament or Proclamation substituted for any of the above-mentioned holidays, the special rate shall be payable only for work done on the day so substituted.

Any employee who absents himself from work on the working day preceding or the working day following a holiday or holidays shall not be entitled to payment for the working days he absents himself from work and/or the holiday or holidays unless he produces or forwards evidence satisfactory to his employer that his absence was due to a good and satisfactory cause.

6A. In connexion with the visit to Australia of Her Majesty Queen Elizabeth II., where a public holiday or public half-holiday is proclaimed by Order in Council throughout any municipality or part thereof, or within any defined area, such public holiday or public half-holiday shall, so far as such municipality or part thereof, or such defined area is concerned, be deemed to be included in the list of holidays prescribed in clause 6 hereof.

Provided that an employee who fails to attend for work on the working day before and/or after such public holiday or public half-holiday without reasonable excuse shall not be entitled to be paid for such public holiday or public half-holiday.

SPECIAL RATE FOR SATURDAYS.

7. All employees (other than stable workers) shall be paid double time for all work done on a Saturday.

MEAL TIME.

8. Not more than one hour per day shall be deducted for meals.

TIME RATE.

9. Any person employed on time wages for less than the number of hours fixed for an ordinary week's work shall be paid, for time worked up to 20 hours, at the ordinary rate with an addition of 33 per centum.

For the time worked beyond the 20 hours aforesaid, he shall be paid the ordinary wages rate up to but not exceeding the rate prescribed by this Section for an ordinary week's work, together with any overtime rate which is applicable.

SICK LEAVE.

10. (a) Any employee who, having had at least three months' service with the same employer, is absent from duty as a result of personal ill health or accident shall be entitled to sick pay as follows :—

(i) During the first year—3½ hours' ordinary pay for each complete month of service.

(ii) During any subsequent year of service—40 hours' ordinary pay.

Provided that, in either case such employee produces or forwards within 48 hours of the commencement of such absence evidence satisfactory to the employer that his non-attendance was due to personal ill health or accident necessitating such absence.

(b) If the full period of sick leave as prescribed above is not taken in any year such portion as is not taken shall, provided an employee remains in the service of the one employer, or any successor of such employer, be cumulative from year to year. For the purposes of this sub-clause service prior to the 1st June, 1949, shall be disregarded.

DAY AND LATEST HOUR FOR PAYMENT OF WAGES.

11. Thursday, at 5.30 p.m., shall be the day and the latest hour for payment of wages.

TERMINATION OF EMPLOYMENT.

12. Except in the case of misconduct by an employee, seven days' notice of termination of employment shall be given by either employer or employee, or one week's wages shall be paid or forfeited, as the case may be, in lieu thereof.

ANNUAL HOLIDAY.

13. (a) The annual holiday shall be as prescribed by the provisions of the *Factories and Shops (Annual Holidays) Act 1946*, No. 5111, and any amendments which may be made thereto from time to time.

(b) Where a public holiday mentioned in clause 6 occurs during any period of an annual holiday taken by an employee, the period of the holiday shall be increased by one day in respect of that public holiday.

UNION REPRESENTATIVE.

14. The State Secretary of the Bread Carters' Industrial Federation or the State organizer of such Federation shall be permitted by the employer of any person whose wages are subject to this Section to inspect the entries in the time-book required to be kept under the provisions of the Factories and Shops Acts.

DEFINITION.

15. The expression "Mildura District," wherever occurring herein, shall be deemed to mean—

- (a) the City of Mildura, and
- (b) the Township of Merbein in the Shire of Mildura and such portions of the said Shire as are within a radius of 1 mile of the Red Cliffs Post Office and the Irymple Post Office respectively.

PART 2.

This Part applies to :—

- (a) The City of Hamilton, the town of Colac, the boroughs of Echuca and Wonthaggi,
- (b) the Shires or portions of the Shires (if any) set forth below in the column opposite the name of the Shire :—

Name of Shire.	Shire or Portion of the Shire within which Determination shall be Operative.
Colac	Such portions as are within a radius of 2 miles of the Colac Post Office
Frankston and Hastings	The Seaford Riding and Township of Frankston
Hampden	Such portions as are within a radius of 2 miles of the Camperdown Post Office

1.		Other Employees.	
* Improvers.		Wages per Week of 40 Hours.	
		s. d.	
Under 16 years of age	136 0	Stable Workers	271 0
16 years of age	166 0		
17 years of age	194 6		
18 years of age	221 9		
19 years of age	251 9		
20 years of age	266 9	All Others	283 0

PROPORTIONS—Wherever this Section applies.
(In any place.)
One improver to every four or fraction of four workers receiving not less than the minimum wage.

* The Board has determined that no person shall be taken on as an apprentice.

TIMES OF BEGINNING AND ENDING WORK.

2. The times of beginning and ending work for all persons (other than stable workers) shall be—

Time of Beginning.	Time of Ending.
5 a.m.	6 p.m. on ordinary days.
5 a.m.	7 p.m. on days during which bread for more than one day's consumption is delivered.

BREAD CARTERS' HOLIDAY.

3. Every baker shall permit every person employed by him in delivering bread to have and take a holiday for the whole of :—

- (a) each public holiday, other than Easter Tuesday and the day after Good Friday; and
- (b) (excepting in the case of the township of Frankston and the Seaford Riding in the Shire of Frankston and Hastings) and the shire of Hampden (such portions as are within a radius of 2 miles of the Camperdown Post Office) every Wednesday in each month, other than any such Wednesday which occurs in any week in which any public holiday occurs on some other day or days.
- (c) In the case of the township of Frankston and the Seaford Riding in the Shire of Frankston and Hastings, and the shire of Hampden (such portions as are within a radius of 2 miles of the Camperdown Post Office) every Saturday, other than any Saturday which is within a period of more than two successive days upon which the carting and delivery of bread would apart from this provision be prohibited.

OVERTIME.

- 4. (a) For stable workers—
In excess of the number of hours fixed for a week's work Time and one third for the first 2 hours and thereafter time and a half.
- (b) For any other person—
Within the hours fixed, in excess of the number of hours fixed as the week's work Time and one third for the first 2 hours and thereafter time and a half.

ALLOWANCE.

5. Any employee who is required to wear clean washable outer garments shall be paid 4s. per week in addition to ordinary rates, irrespective of whether or not he supplies the garments.

SPECIAL RATES.

6. Double time shall be the rate payable for all work done on Sunday, New Year's Day, Australia Day, Good Friday, Easter Monday, Labour Day, Queen's Birthday, Show Day (in such localities mentioned in the Sixth Schedule to the *Public Service Act 1946* as are within the area to which this Section applies), Christmas Day, or Boxing Day; but if any other day be by Act of Parliament or Proclamation substituted for any of the above-mentioned holidays, the special rate shall be payable only for work done on the day so substituted.

Any employee who absents himself from work on the working day preceding or the working day following a holiday or holidays shall not be entitled to payment for the working days he absents himself from work and/or the holiday or holidays unless he produces or forwards evidence satisfactory to his employer that his absence was due to a good and satisfactory cause.

6A. In connexion with the visit to Australia of Her Majesty Queen Elizabeth II., where a public holiday or public half-holiday is proclaimed by Order in Council throughout any municipality or part thereof, or within any defined area, such public holiday or public half-holiday shall, so far as such municipality or part thereof, or such defined area is concerned, be deemed to be included in the list of holidays prescribed in clause 6 hereof.

Provided that an employee who fails to attend for work on the working day before and/or after such public holiday or public half-holiday without reasonable excuse shall not be entitled to be paid for such public holiday or public half-holiday.

MEAL TIME.

7. Not more than one hour per day shall be deducted for meals.

TIME RATE.

8. Any person employed on time wages for less than the number of hours fixed for an ordinary week's work shall be paid, for time worked up to one-half the number of hours fixed for an ordinary week's work, at the ordinary rate with an addition of 33 per centum.

For the time worked beyond the one-half hours aforesaid, he shall be paid the ordinary wages rate up to but not exceeding the rate prescribed by this Section for an ordinary week's work, together with any overtime rate which is applicable.

SICK LEAVE.

9. (a) Any employee who, having had at least three months' service with the same employer, is absent from duty as a result of personal ill health or accident shall be entitled to sick pay as follows:—

(i) During the first year—3½ hours' ordinary pay for each complete month of service.

(ii) During any subsequent year of service—40 hours' ordinary pay.

Provided that, in either case such employee produces or forwards within 48 hours of the commencement of such absence evidence satisfactory to the employer that his non-attendance was due to personal ill health or accident necessitating such absence.

(b) If the full period of sick leave as prescribed above is not taken in any year such portion as is not taken shall, provided an employee remains in the service of the one employer, or any successor of such employer, be cumulative from year to year. For the purposes of this sub-clause service prior to the 1st June, 1949, shall be disregarded.

DAY AND LATEST HOUR FOR PAYMENT OF WAGES.

10. Thursday, at 5.30 p.m., shall be the day and the latest hour for payment of wages.

TERMINATION OF EMPLOYMENT.

11. Except in the case of misconduct by an employee, seven days' notice of termination of employment shall be given by either employer or employee or one week's wages shall be paid or forfeited, as the case may be, in lieu thereof.

ANNUAL HOLIDAY.

12. (a) The annual holiday shall be as prescribed by the provisions of the *Factories and Shops (Annual Holidays) Act 1946*, No. 5111, and any amendments which may be made thereto from time to time.

(b) Where a public holiday mentioned in clause 6 occurs during any period of an annual holiday taken by an employee, the period of the holiday shall be increased by one day in respect of that public holiday.

UNION REPRESENTATIVE.

13. The State Secretary of the Bread Carters' Industrial Federation or the State organizer of such Federation shall be permitted by the employer of any person whose wages are subject to this Section to inspect the entries in the time-book required to be kept under the provisions of the *Factories and Shops Acts*.

PART 3.

This Part applies to the cities of Ararat, Horsham, Shepparton and Sale; the towns of Castlemaine, Portland, St. Arnaud and Terang; the townships of Cobden, Derrinalum, Lake Bolac, Lismore, Mooroopna, Mortlake, Noorat, Timboon, and Shepparton East; the boroughs of Clunes, Daylesford, Inglewood, Koroit, Maryborough, Port Fairy, Queenscliff, Stawell, Swan Hill and Wangaratta.

1.

* Improvers.				Other Employees.		
				Wages per Week of 40 Hours.		
				s. d.	Wages per Week of 40 Hours.	
Under 16 years of age	118	9	
16 years of age	145	6	
17 years of age	179	0	
18 years of age	206	6	
19 years of age	236	6	
20 years of age	262	6	
Proportion.—Wherever this section applies:— One Improver to every four or fraction of four workers receiving not less than the minimum wage.					s. d.	
				Stable workers
					255	6
* The Board has determined that no apprentice shall be taken to this Section.				All others
					265	6

TIMES OF BEGINNING AND ENDING WORK.

2. The times of beginning and ending work for all persons (other than stable workers) shall be—

Time of Beginning.	Time of Ending.
5 a.m.	7 p.m.

BREAD CARTERS' HOLIDAY.

3. Every baker shall permit every person employed by him in delivering bread to have and take a holiday for the whole of:—

- (a) each public holiday, other than Easter Tuesday and the day after Good Friday; and
- (b) (excepting in the case of the cities of Ararat, Horsham, and Shepparton; the town of Terang; the townships of Cobden, Derrinallum, Lake Bolac, Lismore, Mooroopna, Mortlake, Noorat, Timboon and Shepparton East) every Wednesday in each month, other than any such Wednesday which occurs in any week in which any public holiday occurs on some other day or days.
- (c) In the case of the cities of Ararat, Horsham, and Shepparton; the town of Terang; the townships of Cobden, Derrinallum, Lake Bolac, Lismore, Mooroopna, Mortlake, Noorat, Timboon, and Shepparton East. Every Saturday, other than any Saturday which is within a period of more than two successive days upon which the carting and delivery of bread would apart from this provision be prohibited.

OVERTIME.

4. (a) For stable workers—

In excess of the number of hours fixed for an ordinary week's work Time and one third for the first 2 hours and thereafter time and a half.

(b) For any other person—

Within the hours fixed, in excess of the number of hours fixed as the week's work Time and one third for the first 2 hours and thereafter time and a half.

ALLOWANCE.

5. Any employee who is required to wear clean washable outer garments shall be paid 4s. per week in addition to ordinary rates, irrespective of whether or not he supplies the garments.

SPECIAL RATES.

6. Double time shall be the rate payable for all work done on Sunday, New Year's Day, Australia Day, Good Friday, Easter Monday, Labour Day, Queen's Birthday, Show Day (in such localities mentioned in the Sixth Schedule to the *Public Service Act 1946* as are within the area to which this Section applies), Christmas Day, or Boxing Day; but if any other day be by Act of Parliament or Proclamation substituted for any of the above-mentioned holidays, the special rate shall be payable only for work done on the day so substituted.

Any employee who absents himself from work on the working day preceding or the working day following a holiday or holidays shall not be entitled to payment for the working days he absents himself from work and/or the holiday or holidays unless he produces or forwards evidence satisfactory to his employer that his absence was due to a good and satisfactory cause.

6A. In connexion with the visit to Australia of Her Majesty Queen Elizabeth II., where a public holiday or public half-holiday is proclaimed by Order in Council throughout any municipality or part thereof, or within any defined area, such public holiday or public half-holiday shall, so far as such municipality or part thereof, or such defined area is concerned, be deemed to be included in the list of holidays prescribed in clause 6 hereof.

Provided that an employee who fails to attend for work on the working day before and/or after such public holiday or public half-holiday without reasonable excuse shall not be entitled to be paid for such public holiday or public half-holiday.

MEAL TIME.

7. Not more than one hour per day shall be deducted for meals.

SICK LEAVE.

8. (a) Any employee who, having had at least three months' service with the same employer, is absent from duty as a result of personal ill health or accident shall be entitled to sick pay as follows:—

- (i) During the first year— $3\frac{1}{2}$ hours' ordinary pay for each complete month of service.
- (ii) During any subsequent year of service—40 hours' ordinary pay.

Provided that, in either case such employee produces or forwards within 48 hours of the commencement of such absence evidence satisfactory to the employer that his non-attendance was due to personal ill health or accident necessitating such absence.

(b) If the full period of sick leave as prescribed above is not taken in any year such portion as is not taken shall, provided an employee remains in the service of the one employer, or any successor of such employer, be cumulative from year to year. For the purposes of this sub-clause service prior to the 1st June, 1949, shall be disregarded.

DAY AND LATEST HOUR FOR PAYMENT OF WAGES.

9. Thursday, at 5.30, p.m. shall be the day and latest hour for payment of wages.

TERMINATION OF EMPLOYMENT.

10. Except in the case of misconduct by an employee, seven days' notice of termination of employment shall be given by either employer or employee, or one week's wages shall be paid or forfeited, as the case may be, in lieu thereof.

ANNUAL HOLIDAY.

11. (a) The annual holiday shall be as prescribed by the provisions of the *Factories and Shops (Annual Holidays) Act 1946* No. 5111, and any amendments which may be made thereto from time to time.

(b) Where a public holiday mentioned in clause 6 occurs during any period of an annual holiday taken by an employee the period of the holiday shall be increased by one day in respect of that public holiday.

UNION REPRESENTATIVE.

12. The State Secretary of the Bread Carters' Industrial Federation or the State organizer of such Federation shall be permitted by the employer of any person whose wages are subject to this Determination to inspect the entries in the time-book required to be kept under the provisions of the *Factories and Shops Acts*.

PART 4.

This Part applies to all other parts of the State not covered by Parts 1, 2, or 3.

1.

* Improvers.		Other Employees.	
		Wages per Week of 40 Hours.	
		s. d.	
Under 16 years of age	118 9		
16 years of age	145 6		
17 years of age	179 0		
18 years of age	206 6		
19 years of age	236 6		
20 years of age	252 6		
Proportion.—Wherever this section applies :— One Improver to every four or fraction of four workers receiving not less than the minimum wage.		Stable workers	255 6
* The Board has determined that no apprentice shall be taken to this Section.		All others	265 6

TIMES OF BEGINNING AND ENDING WORK.

2. The times of beginning and ending work for all persons (other than stable workers) shall be—

Time of Beginning.	Time of Ending.
5 a.m.	7 p.m.

OVERTIME.

3. (a) For stable workers—
In excess of 40 hours in any week Time and one third for the first 2 hours and thereafter time and a half.
- (b) For any other person—
Within the hours fixed, in excess of the number of hours fixed as the week's work Time and one third for the first 2 hours and thereafter time and a half.

ALLOWANCE.

4. An employee who is required to wear clean washable outer garments shall be paid 4s. per week in addition to ordinary rates, irrespective of whether or not he supplies the garments.

SPECIAL RATES.

5. Double time shall be the rate payable for all work done on Sunday, New Year's Day, Australia Day, Good Friday, Easter Monday, Labour Day, Queen's Birthday, Show Day (in such localities mentioned in the Sixth Schedule to the *Public Service Act 1946* as are within the area to which this Section applies), Christmas Day, or Boxing Day; but if any other day be by Act of Parliament or Proclamation substituted for any of the above-mentioned holidays, the special rate shall be payable only for work done on the day so substituted.

Any employee who absents himself from work on the working day preceding or the working day following a holiday or holidays shall not be entitled to payment for the working days he absents himself from work and/or the holiday or holidays unless he produces or forwards evidence satisfactory to his employer that his absence was due to a good and satisfactory cause.

5A. In connexion with the visit to Australia of Her Majesty Queen Elizabeth II., where a public holiday or public half-holiday is proclaimed by Order in Council throughout any municipality or part thereof, or within any defined area, such public holiday or public half-holiday shall, so far as such municipality or part thereof or such defined area is concerned, be deemed to be included in the list of holidays prescribed in clause 5 hereof.

Provided that an employee who fails to attend for work on the working day before and/or after such public holiday or public half-holiday without reasonable excuse shall not be entitled to be paid for such public holiday or public half-holiday.

MEAL TIME.

6. Not more than one hour per day shall be deducted for meals.

7. (a) Any employee who, having had at least three months' service with the same employer, is absent from duty as a result of personal ill health or accident shall be entitled to sick pay as follows :—

- (i) During the first year— $3\frac{1}{2}$ hours' ordinary pay for each complete month of service.
- (ii) During any subsequent year of service—40 hours' ordinary pay.

Provided that, in either case such employee produces or forwards within 48 hours of the commencement of such absence evidence satisfactory to the employer that his non-attendance was due to personal ill health or accident necessitating such absence.

(b) If the full period of sick leave as prescribed above is not taken in any year such portion as is not taken shall, provided an employee remains in the service of the one employer, or any successor of such employer, be cumulative from year to year. For the purposes of this sub-clause service prior to the 1st June, 1949, shall be disregarded.

DAY AND LATEST HOUR FOR PAYMENT OF WAGES.

8. Thursday, at 5.30 p.m., shall be the day and latest hour for payment of wages.

TERMINATION OF EMPLOYMENT.

9. Except in the case of misconduct by an employee, seven days' notice of termination of employment shall be given by either employer or employee, or one week's wages shall be paid or forfeited, as the case may be, in lieu thereof.

ANNUAL HOLIDAY.

10. (a) The annual holiday shall be as prescribed by the provisions of the *Factories and Shops (Annual Holidays) Act 1946*, No. 5111, and any amendments which may be made thereto from time to time.

(b) Where a public holiday mentioned in clause 5 occurs during any period of an annual holiday taken by an employee, the period of the holiday shall be increased by one day in respect of that holiday.

WEEKLY HOLIDAY.

11. The employer shall grant to each carter coming under this Part a half-holiday each week. The day of such half-holiday is not to be changed by the employer unless he gives to his carters one month's previous notice of such change.

UNION REPRESENTATIVE.

12. The State Secretary of the Bread Carters' Industrial Federation or the State organizer of such Federation shall be permitted by the employer of any person whose wages are subject to this Determination to inspect the entries in the time-book required to be kept under the provisions of the *Factories and Shops Acts*.

PART 5.

All Persons to whom this Determination Applies.

PERIODICAL ADJUSTMENT OF WAGES.

1. The wages rates for adults set out in clause 1 of Parts 1, 2, 3, and 4 are based upon the following basic wage rates, and, pursuant to the provisions of Section 21 of the *Factories and Shops Act 1934*, the Board hereby determines that such rates shall be automatically adjusted as prescribed by clause 2 of this Part. Provided that the wages of improvers, set out in clause 1 of Parts 1, 2, 3, and 4, shall be adjusted from time to time by increasing or decreasing the said rates in the same proportion as the amount of increase or decrease of the basic wage bears to the basic wage current immediately prior to the adjustment. Such adjustments shall be calculated to the nearest threepence, half or less than half of threepence to be disregarded.

BASIC WAGE.

Place.	Basic Wage (Adjustable).	Index Number Set Assigned.
	£ s. d.	
Throughout the State	11 18 0	Five Towns Victoria.

ADJUSTMENT OF BASIC WAGE.

2. (a) For the purposes of this Determination, the expression "Commonwealth Statistician's 'all items' retail price index numbers" or any like expression means the numbers stated to be such index numbers in any document purporting, and not proved to be wrongly so purporting, to be printed by the Commonwealth Government Printer or to be signed by or on behalf of the Commonwealth Statistician.

(b) Until the beginning of the first pay period to commence in May, 1954, the amount of the basic wage shall be as prescribed in clause 1 of this Part.

(c) During each future successive period beginning with the first pay period to commence in a May, an August, a November, or a February, the amount of the basic wage shall be adjusted by the following method, namely, by multiplying the last published Commonwealth Statistician's "all items" retail price index number by the factor .103 taken to one place of decimals, the resultant whole number being the amount of the basic wage expressed in shillings, but should the decimal number reach .5 or more the basic wage shall be taken to the next higher shilling.

P. A. RANGLES, J.P., Chairman.

J. V. WILLOX, Secretary.

Melbourne, 23rd March, 1954.





VICTORIA GOVERNMENT GAZETTE

Published by Authority.

[Registered at the General Post Office, Melbourne, for transmission by post as a newspaper.]

No. 649]

WEDNESDAY, JULY 7.

[1954

PUBLIC HOLIDAYS.

PROCLAMATION

By His Excellency the Governor of the State of Victoria and its Dependencies in the Commonwealth of Australia, &c., &c., &c.

IN pursuance of the provisions contained in Part III. of the *Public Service Act 1946*, I, the Governor of the State of Victoria, in the Commonwealth of Australia, by and with the advice of the Executive Council of the said State, do by this my Proclamation appoint the days and dates hereunder mentioned to be observed as Public Holidays or Public Half-Holidays (as the case may be) at the places respectively specified, viz.:-

Public Holiday:--

WEDNESDAY, 4TH AUGUST, 1954, throughout the Shire of Tungamah.

Public Half-Holiday from the Hour of Twelve o'clock noon:--

WEDNESDAY, 21ST JULY, 1954, throughout the City of Ararat.

Given under my Hand and the Seal of the State of Victoria aforesaid, at Melbourne, this sixth day of July, in the year of our Lord One thousand nine hundred and fifty-four, and in the third year of the reign of Her Majesty Queen Elizabeth II.

(L.S.) DALLAS BROOKS.

By His Excellency's Command,
L. W. GALVIN,
Chief Secretary.

GOD SAVE THE QUEEN!

PUBLIC HIGHWAYS.—SHIRE OF AVOCA.

PROCLAMATION

By His Excellency the Governor of the State of Victoria and its Dependencies in the Commonwealth of Australia, &c., &c., &c.

WHEREAS by the *Local Government Act 1946* (No. 5203), section 518, it is amongst other things enacted that it shall be lawful for the Governor in Council at any time, and from time to time, upon the request of the council of any municipality, by notice in the *Government Gazette*, to declare any land reserved, used or by purchase or exchange acquired for a street, road, highway, thoroughfare, bridge, square, court, alley or right-of-way to be a public highway, and that such land shall thereupon and

thenceforth from the date of such Proclamation become and be absolutely dedicated to the public as a public highway within the meaning of any law then or thereafter in force:

And whereas the Council of the Shire of Avoca has requested that the lands hereinafter mentioned, which have been acquired for streets within the said shire, be so declared to be public highways:

Now, therefore, I, the Governor of the State of Victoria, in the Commonwealth of Australia, by and with the advice of the Executive Council of the said State, do, by this Proclamation, declare that all those pieces of land acquired for streets and described hereunder shall be public highways within the meaning of the said Act:—

Firstly: All that piece of land, being part of Crown allotments 1B, 1C, 15, 16 and 17, section G, Parish of Redbank, County of Kara Kara: commencing at the north-west corner of Crown allotment 1C; thence by lines bearing respectively 85 deg. 8 min. 2,000 links, 175 deg. 8 min. 50 links, 85 deg. 8 min. 3,075 links, 175 deg. 8 min. 75 links, 265 deg. 8 min. 3,075 links, 268 deg. 43 min. 2,004 links to the point of commencement.

Secondly: All that piece of land, being part of Crown allotments 12, 14 and 21, section G, Parish of Redbank, County of Kara Kara: commencing at the north-west corner of Crown allotment 21; thence by lines bearing respectively 85 deg. 8 min. 867 links, 68 deg. 12 min. 492 links, 114 deg. 44 min. 624 links, 124 deg. 51 min. 610 links, 214 deg. 51 min. 75 links, 304 deg. 51 min. 243.8 links, 295 deg. 30 min. 552 links, 275 deg. 11 min. 560.6 links, 265 deg. 50 min. 464.4 links, 265 deg. 8 min. 621 links, 355 deg. 8 min. 75 links to the point of commencement.

Thirdly: All that piece of land being part of Crown allotment 1A, section G, Parish of Redbank, County of Kara Kara: commencing at the north corner of Crown allotment 1A; thence by lines bearing respectively 144 deg. 2 min. 380.2 links, 304 deg. 51 min. 359.7 links, 35 deg. 6 min. 125 links to the point of commencement.

Given under my Hand and the Seal of the State of Victoria aforesaid, at Melbourne, this twenty-ninth day of June, in the year of our Lord One thousand nine hundred and fifty-four, and in the third year of the reign of Her Majesty Queen Elizabeth II.

(L.S.) DALLAS BROOKS.

By His Excellency's Command,
S. MERRIFIELD,
Commissioner of Public Works.

GOD SAVE THE QUEEN!

Soldier Settlement Act 1946 (No. 5179).

ROADS CLOSED.

PROCLAMATION

By His Excellency the Governor of the State of Victoria and its Dependencies in the Commonwealth of Australia, &c., &c., &c.

WHEREAS section 6 (1) of the *Soldier Settlement Act 1946* (No. 5179) prescribes that where any road (whether used or unused and whether formed or unformed) forms part of or intersects any estate and the Soldier Settlement Commission, after consultation with the council or councils of the municipality or municipalities concerned, certifies that the said road is unsuited to the proper subdivision of the estate:

And whereas the Soldier Settlement Commission, after consultation with the councils of the municipalities concerned, has so certified:

Now therefore, I, the Governor of the State of Victoria, in the Commonwealth of Australia, by and with the advice of the Executive Council of the said State, and in pursuance of section 6 of the *Soldier Settlement Act 1946* (No. 5179), do by this my Proclamation direct that the roads, as described hereunder, be closed, that is to say:—

Parish of Brewster, Counties of Ripon and Grenville, being the roads indicated by hachure on plan hereunder.—(B.433^(*)) (D.21103).

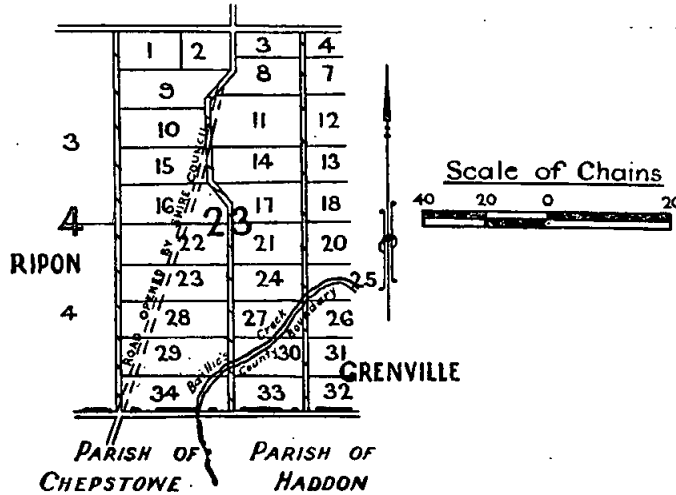

Parishes of Chepstowe and Haddon, Counties of Ripon and Grenville, being the roads indicated by hachure on plan hereunder.—(C.226⁽²⁾) (H.2⁽³⁾) (D.21103).

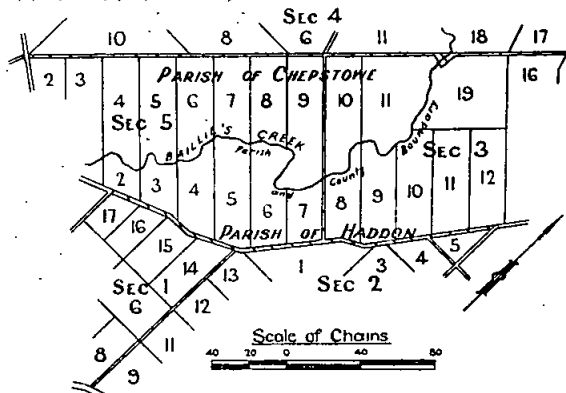

Parish of Chepstowe, County of Ripon, being the road between allotments 7, 6, 5, 4, section 4, Parish of Brewster, and allotments 1, 2, section 4, Parish of Chepstowe.—(C.226⁽²⁾) (B.433^(*)) (D.21103).

Parishes of Chepstowe and Haddon, Counties of Ripon and Grenville, being the road between allotments 34, 33, 32, section 23, Parish of Brewster, and allotment 12, section 5, Parish of Chepstowe, allotments 18, 17, section 3, Parish of Haddon.—(C.226⁽²⁾) (H.2⁽³⁾) (B.433^(*)) (D.21103).

Parish of Pircarra, County of Hampden, being the road indicated by hachure on plan hereunder.—(P.122⁽²⁾) (D.19999).

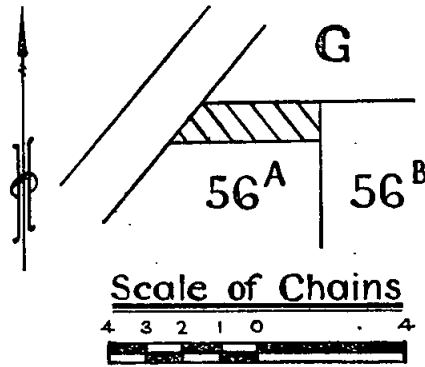

Parishes of Kalymna and Merrymbuela, County of Ripon, being the portions of road indicated by hachure on plan hereunder.—(K.99⁽²⁾) (M.404⁽²⁾) (D.1325).

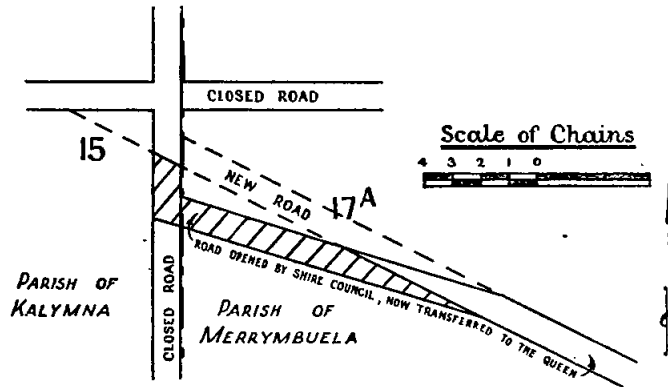

Parish of Merino, County of Normanby, being the road indicated by hachure on plan hereunder.—(M.248⁽²⁾) (D.1311).

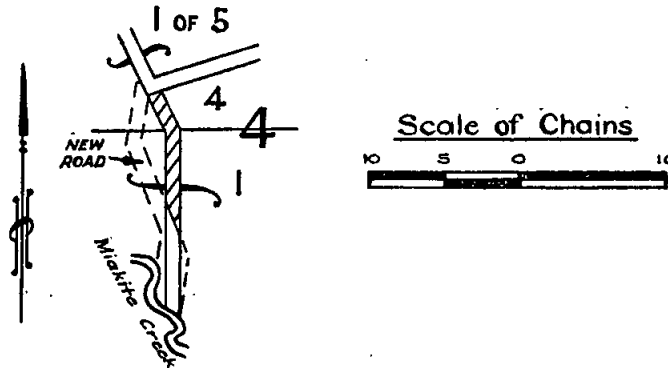

Parish of Enucl, County of Ripon, being the portion of road indicated by hachure on plan hereunder.—(E.90(A¹)) (D.13130).

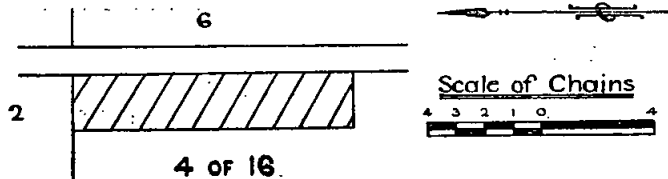

Parish of Willenabrina, County of Borung, being the road indicated by hachure on plan hereunder.—(W.352⁽⁴⁾) (D.13098).

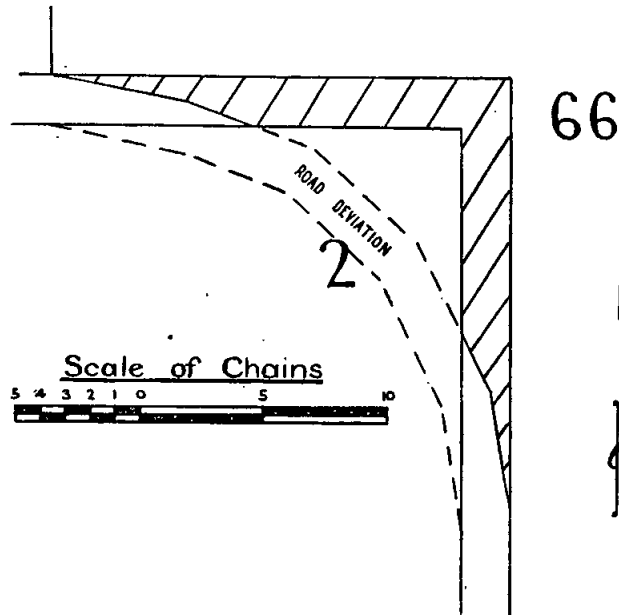

Parish of Strathmerton, County of Moira, being the roads indicated by hachure on plan hereunder.—(S.446^(A1)) (S.466^(A2)) (G.M.6/3).

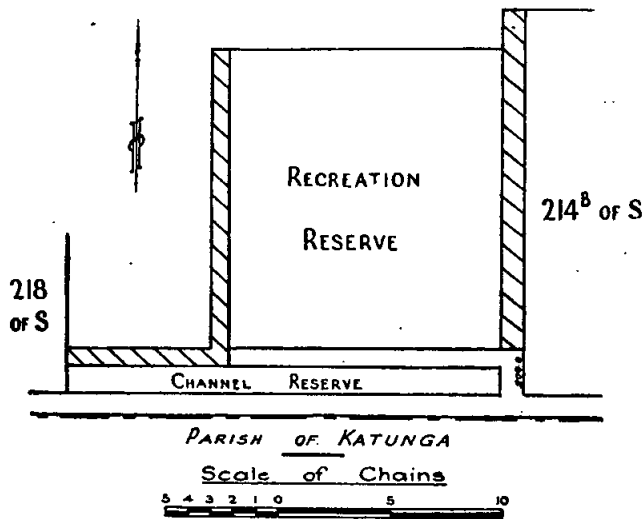

Given under my Hand and the Seal of the State of Victoria aforesaid, at Melbourne, the sixth day of July, in the year of our Lord One thousand nine hundred and fifty-four, and in the third year of the reign of Her Majesty Queen Elizabeth II.

(L.S.)

DALLAS BROOKS.

By His Excellency's Command,

J. H. SMITH,
Commissioner of Crown Lands and Survey.

GOD SAVE THE QUEEN!

Health Acts.
EXTENSION OF CASTLEMAINE MEAT AREA.

PROCLAMATION

By His Excellency the Governor of the State of Victoria and its Dependencies in the Commonwealth of Australia, &c., &c., &c.

BY virtue of the powers conferred by the Health Acts, I, the Governor of the State of Victoria, in the Commonwealth of Australia, on the recommendation of the Commission of Public Health, and by and with the advice of the Executive Council of the said State, do by this my Proclamation extend the Castlemaine Meat Area by the addition thereto of such part of the Shire of Metcalfe as is not already included in the said meat area.

This Proclamation shall take effect from the date of its publication in the *Government Gazette*.

Given under my Hand and the Seal of the State of Victoria aforesaid, at Melbourne, this twenty-ninth day of June, in the year of our Lord One thousand nine hundred and fifty-four, and in the third year of the reign of Her Majesty Queen Elizabeth II.

(L.S.) DALLAS BROOKS.

By His Excellency's Command,
WM. BARRY,
Minister of Health.

GOD SAVE THE QUEEN!

Health Acts.

DEFINING CERTAIN LOCALITIES IN WHICH IT SHALL NOT BE LAWFUL TO ESTABLISH OR AFTER A PERIOD OF DISUSE TO CARRY ON CERTAIN OFFENSIVE TRADES.

PROCLAMATION

By His Excellency the Governor of the State of Victoria and its Dependencies in the Commonwealth of Australia, &c., &c., &c.

BY virtue of the powers conferred by the Health Acts, I, the Governor of the State of Victoria, in the Commonwealth of Australia, on the recommendation of the Commission of Public Health, and by and with the advice of the Executive Council of the said State, do by this my Proclamation, define certain localities in which it shall not be lawful hereafter to establish, or after a period of disuse to carry on—

- (a) any of the offensive trades specified in the Second Schedule to the *Health Act 1928* as amended by any Act;
- (b) any of the trades specified in the Proclamation, dated the fifth day of October, 1942, and published in the *Government Gazette* of the seventh day of October, 1942, on page 3457, in connexion with the reception and disposal of nightsoil;
- (c) the trades usually carried on in connexion with fish-curing establishments.

The localities defined in this Proclamation are:

1. Essendon: The whole of the municipal district of the City of Essendon.
2. Footscray: The whole of the municipal district of the City of Footscray.
3. Sunshine: The whole of the River, Central and Southern Wards of the City of Sunshine and that portion of the Western Ward commencing at the intersection of Wright-street and Kororoit Creek and bounded thence by a line westerly along Wright-street to Fairbairn-road; thence southerly along Fairbairn-road to Canoon-street; thence westerly by Canoon-street, and continuing further westerly by the southern boundaries of Crown allotments 9 and 8, section 10, and Crown allotments 4 and 3, section 11, Parish of Derrimut, to Station-road; thence northerly along Station-road to the Ballarat railway line; thence north-westerly along the Ballarat railway line to the western boundary of Crown allotment 7, section 21; thence northerly along the western boundaries of allotments 7 and 4B to the Ballarat-road (Western Highway); thence north-westerly by the same highway to the western boundary of allotment 3A, section 21, Parish of Maribyrnong; thence northerly along the western boundary of allotment 3A, section 21, Parish of Maribyrnong, to the Kororoit Creek; thence north-easterly and

easterly along the northern boundaries of allotments 46, 47 and 48, section C, Parish of Maribyrnong, to Station-road; thence northerly along Station-road to Main-road west; thence easterly along Main-road west and Main-road east to McIntyre-road; thence following the eastern boundary of the Western Ward by a southerly, westerly and south-easterly direction to the commencing point.

4. Williamstown: The whole of the municipal district of the City of Williamstown.
5. Werribee: The whole of the Altona Riding of the Shire of Werribee.

This Proclamation shall take effect from the date of its publication in the *Government Gazette*.

Given under my Hand and the Seal of the State of Victoria aforesaid, at Melbourne, this twenty-ninth day of June, in the year of our Lord One thousand nine hundred and fifty-four, and in the third year of the reign of Her Majesty Queen Elizabeth II.

(L.S.) DALLAS BROOKS.

By His Excellency's Command,
WM. BARRY,
Minister of Health.

GOD SAVE THE QUEEN!

HOSPITALS AND CHARITIES COMMISSION.

APPLICATIONS are invited for the following positions:—

ACCOUNTS OFFICER.

Salary Range.—£754-£806 per annum, plus cost of living adjustment (£390 per annum at present).

Duties.—Under the direction of the Accountant, to carry out a critical analysis of the final accounts of institutions registered with the Commission, to examine budgets, and carry out where necessary financial investigations at institutions.

Qualifications.—To be a certificated accountant with experience in financial investigations. Knowledge of hospital accounting desirable.

ASSISTANT ACCOUNTS OFFICER.

Salary Range.—£520-£624 per annum, plus cost of living adjustment (£390 per annum at present).

Duties.—To assist in the critical analysis of the final accounts of institutions and examination of budgets, and to assist in the preparation of the Commission's Annual Report.

Qualifications.—To be a certificated or near certificated accountant. Knowledge of hospital accounting desirable.

Applications close with the Chief Administrative Officer, 61 Spring-street, on Monday, 12th July, 1954.

F. W. CREMEAN,
Chief Administrative Officer.

DEPARTMENT OF TRANSPORT.

APPOINTMENTS.—MELBOURNE AND METROPOLITAN TRAMWAYS BOARD.

HIS Excellency the Governor of the State of Victoria, by and with the advice of the Executive Council thereof, and in pursuance of the provisions of the Melbourne and Metropolitan Tramways Acts, has, by Orders made on the 25th day of May, 1954, and the 29th day of June, 1954, respectively, appointed—

ROBERT JOSEPH HENRY RISSON,
GERALD FRANCIS WRAITH, and
KIERAN JOSEPH BRENNAN

to be Members of the Melbourne and Metropolitan Tramways Board for a period of five (5) years, as from and inclusive of the 1st day of July, 1954, the said Robert Joseph Henry Risson to be Chairman of the Board, the said Gerald Francis Wraith to be Deputy Chairman of the Board, and the said Kieran Joseph Brennan to be the Member representing the employees of the Board.

A. MAHLSTEDT,
Clerk of the Executive Council.

(Published in lieu of appointments appearing on page 3677 of *Government Gazette*, dated 2nd June, 1954.)

APPOINTMENTS.

HIS Excellency the Governor of the State of Victoria, by and with the advice of the Executive Council thereof, has, by Orders made on the 29th day of June, 1954, been pleased to make the under-mentioned appointments, viz.:—

CHIEF SECRETARY'S DEPARTMENT.

Visiting Justice of Pentridge.

HENRY RICHARD PYVIS, S.M.,
pursuant to the provisions of section 18 of the *Gaols Act* 1928, to be Visiting Justice of Her Majesty's Gaol, Pentridge, *vice* Alex Robert Hill, S.M., transferred.

DEPARTMENT OF HEALTH.

Medical Officers.

ELIZABETH MAY ROGERS, M.B., B.S., and
NAN PATON BELL, M.B., B.S.,
to be Medical Officers of the Mental Hygiene Branch, Department of Health, pursuant to the provisions of section 18 of the *Mental Hygiene Authority Act* 1950 (No. 5519).

Government Representative on Hospital Committee.

WALTER BRUCE MACARTHUR
to be Government Representative on the Committee of Management of the Manangatang and District Hospital, pursuant to the provisions of section 48 of the *Hospitals and Charities Act* 1948 (No. 5300), for a term of three years, *vice* S. W. Ward, resigned.

Trustees of Public Cemeteries.

LEONARD JOHN YOUNGER
to be a Trustee of the Greta Public Cemetery, *vice* H. N. Davenport, resigned;
WILLIAM GEORGE SEERS,
COLIN STANLEY GORDON,
FRANCIS THOMAS WILSON,
JOHN DANIEL SULLIVAN, and
JAMES PERCIVAL TRUDGEON,
to be Trustees of the Welshman's Reef Public Cemetery;
ROY REGINALD BURRIS,
HENRY OSCAR ROGERS,
GLASGOW BRUCE MCCLURE,
LEWIS JAMES MCCLURE, and
THOMAS HENRY LIGHT,
to be Trustees of the Toon Public Cemetery;
STANLEY LEVI DORRINGTON,
IAN HOWARD ROEDIGER, and
THOMAS GEORGE MARSHALL,
to be Trustees of the Lorquon Public Cemetery;
WILLIAM GRIFFEN JOSEPH O'NEILL
to be a Trustee of the Euroa Public Cemetery, *vice* J. McCormack, deceased;
SYLVESTER ROBINSON
to be a Trustee of the Williamstown Public Cemetery, *vice* J. Seymour, resigned;
PHILIP DAVIES GAY
to be a Trustee of the Lalbert Public Cemetery, *vice* J. B. Gay, resigned;
ANDREW FRANCIS BALDWIN
to be a Trustee of the Foster Public Cemetery, *vice* P. Devlin, resigned;
JOHN LOUIS DARBYSHIRE
to be a Trustee of the St. Kilda General Cemetery, *vice* W. O. J. Phillips, resigned; and
JOHN GILMOUR
to be a Trustee of the St. Arnaud Public Cemetery, *vice* K. McDonald, deceased.

Public Vaccinator.

PETER MILLAR DOW, M.B., B.S.,
to be Public Vaccinator of the Shire of Bairnsdale.

LAW DEPARTMENT.

Chairman of General Sessions.

FRANCIS ROBERT NELSON, Q.C., LL.B., a Barrister at Law of Victoria who has practised for a longer period than five years,
to be a Chairman of General Sessions, pursuant to the provisions of the *Justices Act* 1928, to take effect from the date of commencement of duty and until the 31st July, 1954.

Magistrates.

ROBERT JOHN WHITE, 46 Parkside-street, Elsternwick,
GEOFFREY NELSON-INGHAM, care of The Craftsman Press Pty. Ltd., 510-516 Latrobe-street, Melbourne,
and
CHARLES WILLIAM BIRD, 133 Gertrude-street, Fitzroy,
to Keep the Peace in the Central Bailiwick of the State of Victoria; and

FRANCIS WILLIAM LIDGERWOOD, Devenish,
to Keep the Peace in the Northern Bailiwick of the State of Victoria.

Commissioners for Taking Declarations, &c.

CLARENCE FITZROY HAILBON HARRISON, 14 Studley-avenue, Kew,
ALLAN JOHN HARRISON, 62 Bamfield-street, Sandringham,
JAMES HAROLD STANLEY, 191 Victoria-street, Ballarat,
and
ALEXANDER RICHARD LANG, 69 New-street, Brighton,
to be Commissioners for taking Declarations and Affidavits, pursuant to the provisions of the *Evidence Act* 1928, to resign upon removing from the neighbourhood of the addresses stated.

Clerk of the Peace, &c.

KEVIN ALOYSIUS McDONALD
to be Clerk of the Peace for the Eastern Bailiwick, Registrar of the County Court, Clerk of the Court of Mines, Clerk of Petty Sessions, and Clerk of the Children's Court at Bairnsdale and Clerk of Petty Sessions and Clerk of the Children's Court at Bendoc, Bruthen, Cann River, Lakes Entrance, Lake Tyers, and Orbost, *vice* M. L. Killeen, deceased, to take effect from the date of commencement of duty.

Sheriff's Substitute.

KEVIN ALOYSIUS McDONALD
as Clerk of the Peace and Registrar of the County Court at Bairnsdale, and by virtue of section 92 of the *Juries Act* 1928 to do and perform with respect to the Courts at that place, in the place and stead of the Sheriff, all such acts and things as the Sheriff is, by the said Act, authorized or required to do or perform, *vice* M. L. Killeen, deceased, to take effect from the date of commencement of duty.

Clerks of Children's Courts.

DESMOND BRUCE SCULLY
to be Clerk of the Children's Court at Ouyen, Murrayville, and Woomelang, during the absence on annual leave of V. G. Stafford, to take effect from the date of commencement of duty; and
RICHARD JOHN CANNING
to be Clerk of the Children's Court at Tallangatta, Corryong, Mitta Mitta, and Walwa, during the absence on annual leave of T. R. Dunlop, to take effect from the date of commencement of duty.

Sheriff's Bailiff.

JOHN CHARLES HENRY QUILL, Sergeant of Police, Red Cliffs,
to be also a Sheriff's Bailiff, *vice* A. L. Bell, resigned, with fees, to take effect from the date of commencement of duty.

DEPARTMENT OF PUBLIC WORKS.

Member of the Town and Country Planning Board.

ARTHUR CHARLES COLLINS
to be a Member of the Town and Country Planning Board for a term of three years from and inclusive of the 27th day of June, 1954.

DEPARTMENT OF THE TREASURER.

Receiver of Revenue.

KEVIN ALOYSIUS McDONALD
to be a Receiver of Revenue, Bairnsdale, *vice* W. J. Johnson.

A. MAHLSTEDT,
Clerk of the Executive Council.

At the Executive Council Chamber,
Melbourne, 29th June, 1954.

RESIGNATIONS.

HIS Excellency the Governor of the State of Victoria, by and with the advice of the Executive Council thereof, has, by Orders made on the 29th day of June, 1954, accepted the resignations of the persons named hereunder of the offices mentioned, viz.:—

LAW DEPARTMENT.

WILLIAM THOMPSON HARGREAVES, as a Deputy Coroner at and in the vicinity of Willaura.
ARTHUR LESLIE BELL, as a Sheriff's Bailiff at Red Cliffs.

A. MAHLSTEDT,
Clerk of the Executive Council.

At the Executive Council Chamber,
Melbourne, 29th June, 1954.

CONTRACTS ACCEPTED.—(Series 1953-54.)**PUBLIC WORKS.**

4754. Alberton, State School No. 1, (1) repairs to school and residence, £375 10s.—A. K. McCrabb.
4755. Brighton, Melbourne Teachers' College Hostel, (1) supply and installation of stainless steel benches, &c., £591.—L. J. Morgan Pty. Ltd.
4756. Box Hill South, State School No. 4138, (1) repairs and replacements to boundary fencing—provision of No. 3 gateways, £256.—J. W. Wood.
4757. Ballarat, Girls' Secondary School, (3) external painting, minor repairs, &c., £752.—J. D. Wattie.
4758. Ballarat, Guncotton Factory, (3) painting and renovations, £2,000.—Stansfield and Smith Pty. Ltd.
4759. Beechworth, Mental Hospital, (1) new fibrous plaster ceilings, £1,695.—E. H. Wallace.
4760. Callignee South, State School No. 3673, (3) external and internal repairs and renovations, £475 7s. 6d.—A. G. Rowley.
4761. Devon Meadows, State School No. 3924, (3) new additions and renovations, £2,071 7s.—Collyer and Brown.
4762. Essendon North, State School No. 4015, (4) external repairs and painting, £1,164.—E. J. Lewis.
4763. Fairfield, Exotic Diseases Hospital, (3) external repairs and painting to four buildings, £1,795.—E. H. Hefford.
4764. Glenormiston, Agriculture Department, (1) renovations to residence No. 8, £257.—Pyers Bros.
4765. Glenormiston, Estate, (1) repairs and renovations to No. 9 residence, £663.—Pyers Bros.
4766. Glen Iris, State School No. 1148, (2) erection of picket and pipe rail fencing, £282.—Sargent Welding and Co.
4767. Goroke, Consolidated School, (1) electrical installation, £957.—R. J. Wilson.
4768. Heathmont, State School No. 4688, (1) erection of two shelter sheds, £938.—J. N. Cheek.
4769. Hawthorn, Moorakynne Children's Hostel, (2) renewal of electrical installation, £386.—K. H. Frank.
4770. Hughesdale, State School No. 4176, (9) additional out-offices, £2,095.—H. and A. Tinsley.
4771. Bendigo, School of Mines, (6) repairs and renovations to Civil Engineer's room, £149 7s.—P. E. Hutchings.
4772. Royal Park, Mental Hospital, (1) electrical installation, wiring, £142 3s.—H. Butcher.
4773. Footscray, Technical School, (1) electrical installation, £128 15s.—J. F. Veall.
4774. Footscray, High School, (1) construction of water main, £317 8s. 6d.—Melbourne and Metropolitan Board of Works.
4775. Dennington, State School No. 182, (5) external painting school and two shelter sheds, £208 10s.—Harris and Dalton.
4776. Strathmore, State School No. 1462, (1) new sewer connexion, £153 15s. 3d.—Melbourne and Metropolitan Board of Works.
4777. Horsham, Fisheries and Game Department, (2) minor repairs and external painting, residence, £157 10s.—J. T. Isbel.
4778. Kew, Mental Hospital, (1) provision of 3,000 gallon storage tank as temporary measure to improve water supply to laundry, £221.—Kirsten and Wigg.
4779. Footscray, Technical School, (2) electrical equipment for Electronics Laboratory, £174 17s.—J. F. Veall.
4780. Melbourne, Botanic Gardens, (1) recovering roofing of William Tell Shelter, £122 5s.—Wunderlich Ltd.
4781. Kooyongkoot, State School No. 9693, (1) cartage of prefabricated parts, £126 17s. 6d.—Thomas Warr and Co. Pty. Ltd.
4782. Bacchus Marsh, High School, (1) boundary fencing, £123 5s.—E. Brocklehurst.
4783. Murrumbena, State School No. 3449, (1) installation of additional light outlets, £175 11s. 7d.—L. E. Bienvenu.
4784. Malvern, State School, No. 2586, (2) re-wiring existing electrical installation, £208 5s.—E. C. Lewin.
4785. Kinglake, State School No. 2188, (1) repairs and painting shelter shed and re-erection of flagpole, £194 10s.—P. H. White.
4786. Ballarat, Mental Hospital, (1) installation of one twin rapid press and one air compressor receiver, £161 15s.—Robert Bryce and Co. Pty. Ltd.
4787. Moorabbin, State School No. 4687, (1) new sewer connexion and branch, £885 5s.—Melbourne and Metropolitan Board of Works.
4788. Creswick North, State School No. 2041, (1) installation of septic tank and alterations to out-offices, £697 10s.—Shire of Creswick.
- S. MERRIFIELD, Commissioner of Public Works. 28.6.54.
4789. South Melbourne, P.W.D. Storeyard, (1) supply of galvanized piping, £750.—Stewarts and Lloyds (Aust.) Pty. Ltd.
4790. Dandenong, Technical School, (1) supply of guilotine squaring shears, £169.—McPherson's Limited.
4791. Coburg, Penal Establishment, Pentridge, (1) supply of J and Salt Bars and galvanizing tank, £129 10s.—Chapple Bros. Engineers Pty. Ltd.
4792. South Melbourne, P.W.D. Storeyard, (1) supply of 30 only rotary clothes hoists, £258.—J. and W. Cooper.
4793. Various, Mental Hospitals, (1) supply of stainless steel containers, complete with lemon squeezers and nickel silver bowls, £375.—L. J. Morgan Pty. Ltd.
4794. Williamstown, Jetty Lights, (1) supply of acetylene, £171 0s. 9d.—C.I.G. (Victoria) Pty. Ltd.
4795. Box Hill, Technical School, (1) supply of Bain Marie hot press, £282.—K. G. Luke (Australasia) Ltd.
4796. South Melbourne, P.W.D. Storeyard, (1) supply of redgum, £128 4s. 10d.—H. Beecham and Co. Ltd.
4797. Brighton, Technical School, (1) supply of Bain Marie hot press, £282.—K. G. Luke (Australasia) Ltd.
4798. Carlton, Teachers' College Hostel, (1) supply of bench and drainer, £158.—L. J. Morgan Pty. Ltd.
4799. Collingwood, Technical School, (1) supply of grinding machine, £1,240.—Demco Machinery Co. Pty. Ltd.
4800. Mont Park, Mental Hospital, (1) supply of sashes and beading, £354 7s.—W. S. Neelands Pty. Ltd.
4801. Various, Technical Schools, (1) supply of seven only lathes, £9,248 5s.—McPherson's Limited.
4802. South Melbourne, P.W.D. Storeyard, (1) supply of galvanized piping, £2,650.—Stewarts and Lloyds (Australia) Pty. Ltd.
4803. Merlynston, State School, (1) supply of screenings and crushed rock, £134 8s.—Reid Bros. and Reid Pty. Ltd.
4804. Coburg, Penal Establishment, Pentridge, (1) supply of shaping machine, £649.—Norman N. Benson and Co. Pty. Ltd.
4805. Melbourne, State Offices Cafeteria, (1) supply of stainless steel benches and cupboards, £494 15s. 6d.—M. F. Ahearn and Co. Pty. Ltd.
4806. Kew, Mental Hospital, (1) supply of refrigeration cabinet, £1,133.—M. F. Ahearn and Co. Pty. Ltd.
4807. Swinburne, Technical College, (1) supply of refrigerator, £201.—Kelvinator Australia Ltd.
4808. Box Hill, Technical School, (1) supply of refrigerator, £298.—Kelvinator Australia Ltd.
4809. Sunshine, Technical School, (1) supply of cooker, £299.—Levin and Co. Ltd.
4810. Brighton, Technical School, (1) supply of cooker, £299.—Levin and Co. Ltd.
4811. Sunshine, Technical School, (1) supply of refrigerator, £201.—Kelvinator Australia Ltd.
4812. Box Hill, Technical School, (1) supply of cooker, £299.—Levin and Co. Ltd.
4813. Larundel, Mental Hospital, (1) supply of screwing machine dies and vyces, £682 8s. 6d.—McPherson's Limited.
4814. Castlemaine, Technical School, (1) supply of 7-in. lathe, complete with electrical equipment, £1,307 15s.—McPherson's Limited.
4815. Larundel, Mental Hospital, (1) supply of hack saw machine and screw cutting lathe, £234.—McPherson's Limited.
4816. Port Melbourne, P.W.D. Depot, (1) supply of screenings, £119 14s.—Albion Quarrying Co. Pty. Ltd.
4817. Port Melbourne, P.W.D. Depot, (1) supply of toppings, £141 12s.—Albion Quarrying Co. Pty. Ltd.
4818. Swinburne, Technical College, (1) supply of fire extinguishers, £215 11s.—Wormald Bros. (South) Ltd.
4819. Sunbury, Mental Hospital, (1) supply of refrigerator, £115.—Kelvinator Australia Ltd.
4820. Sunbury, Mental Hospital, (1) supply of six only washing machines, £613 10s.—Lightburn and Co. Ltd.
4821. Queenscliff, South Pier, (1) supply of redgum piles, £1,839 0s. 1d.—Wm. Haughton and Co. Ltd.
4822. Queenscliff, New Harbor, (1) supply of spalls, £1,547 12s. 6d.—Barwonside Quarries.
4823. Apollo Bay, Breakwater, (1) supply of spalls, £598 8s. 7d.—Cordon Bros.
4824. Queenscliff, Harbor Works, (1) supply of messmate piles, £434 2s. 8d.—Alex. Sturrock and Sons Pty. Ltd.
4825. Hastings, Slipway, (1) supply of messmate piles, £457 0s. 2d.—Alex. Sturrock and Sons Pty. Ltd.
4826. Port Melbourne, P.W.D. Depot, (1) plant equipment, industrial road broom, £289.—British Farm Equipment Pty. Ltd.
4827. Queenscliff, South Pier, (1) supply of sawn hardwood, £419 18s. 5d.—N. F. Gordon Pty. Ltd.
4828. Mont Park, Mental Hospital, (1) supply of timber, £170 11s.—W. S. Neelands Pty. Ltd.
4829. Ararat, Mental Hospital, (1) supply of rip saw bench, complete with boring table and blades, £265 9s. 6d.—McPherson's Limited.
4830. Caulfield, Technical College, (1) supply of one power grinding machine, £2,652.—N. N. Benson and Co. Pty. Ltd.

4831. Brunswick, Technical School, (1) supply of one 6-in. lathe, £580.—H. Osborne Pty. Ltd.
4832. Ballarat, Mental Hospital, (1) supply of three washing machines and one ironing machine, £6,978 14s.—Roy Burton and Co. Pty. Ltd.
4833. Brighton, Harbor Works, (2) supply of stone, £2,112 10s.—James Starbuck.
4834. Wangaratta, State Offices, (1) supply of 20 tons of coke, £220.—Colonial Gas Association Ltd.
4835. Langi Kal Kal, Training Centre, (1) supply of chaffcutter complete, £324 14s. 3d.—Cliff and Bunting Pty. Ltd.
4836. Kaniva, Consolidated School, (1) supply of one only water softener unit, £329.—John Thompson (Australia) Pty. Ltd.
4837. South Yarra, Weights and Measures, (1) supply of two pairs of doors, £115.—David Provan and Sons Pty. Ltd.
4838. South Melbourne, P.W.D. Storeyard, (1) supply of hardwood, £353 16s.—Albert R. Weisselberg Timber Trading Company.
4839. Sunbury, Mental Hospital, (1) supply of three only refrigerators, £380 5s.—British General Electric Co. Pty. Ltd.
4840. Sunshine, Technical School, (1) supply of one only washing machine, £102 5s.—Lightburn and Co. Ltd.
4841. South Melbourne, P.W.D. Storeyard, (1) supply of 40 only stainless steel sinks, £460.—L. J. Morgan Pty. Ltd.
4842. Travancore, Developmental Centre, (1) supply of stainless steel bench, £152.—L. J. Morgan Pty. Ltd.
4843. Penal Establishment, Pentridge, (1) supply of roll dividing and moulding machine, complete with electric motor, £730.—Small and Shattall Pty. Ltd.
4844. South Melbourne, P.W.D. Storeyard, (1) supply of hardwood timber, £356 6s. 2d.—A. R. Weisselberg Timber Trading Co.
4845. Geelong, Gordon Institute of Technology, (1) supply of two only 7-in. lathes, £2,615 10s.—McPherson's Limited.
4846. Collingwood, Technical School, (1) supply of one lathe, £1,307 15s.—McPherson's Limited.
4847. Ballarat, School of Mines, (1) supply of one centrifuge outfit and one microscopic theodolite, complete with tripod, £296 6s.—Thomas Optical and Scientific Co. Pty. Ltd.
4848. Ballarat, Technical School, (1) supply of two lathes, £2,615 10s.—McPherson's Limited.
4849. Caulfield, Technical School, (1) supply of one lathe, £1,307 15s.—McPherson's Limited.
4850. Prahran, Technical School, (1) supply of one bench lathe, £138 5s.—McPherson's Limited.
4851. Bendigo, School of Mines, (1) supply of one shaping machine, £628.—N. N. Benson and Co. Pty. Ltd.
4852. Ballarat, School of Mines, (1) supply of one surface grinder, £1,266 10s.—N. N. Benson and Co. Pty. Ltd.
4853. Glenferrie, Swinburne Technical College, (1) supply of one shaping machine, £649.—N. N. Benson and Co. Pty. Ltd.
4854. Hamilton, State School No. 295, (3) alterations to lavatory and cloak room, £1,522.—J. Wilkinson.
4855. Janefield, Mental Hospital, (5) supply and installation of new steam pipe-line, £1,580.—G. H. Curtis and Son.
4856. Janefield, Mental Colony, (3) cloak room and store to Boys' Ward at Farm Block, £1,884 10s.—Sargent Weeding and Co.
4857. Kew, Glendonald School for Deaf Children, (5) electrical installation in three classroom light timber building, £313 19s. 10d.—L. E. Bienvenu.
4858. Kew, Mental Hospital, (4) erection of new Occupational Therapy Centre at the Children's Cottages, £14,300.—G. A. Winwood Pty. Ltd.
4859. Kew East, State School No. 3161, (6) painting and repairs, £1,370.—J. A. Watkins.
4860. Kilsyth, State School No. 3645, (6) new out-offices, £742.—R. M. Swift.
4861. Kingsville, State School No. 3988, (4) electrical installation—prefabricated classrooms, £665.—G. Wilkie Elect. Co.
4862. Kyneton, High School, (2) addition of four brick out-office units, £1,018 5s.—Martyn and Johnson.
4863. Kerang, Inspector of Fisheries and Game Department, (4) erection of timber residence, out-building, and garage, £4,630.—R. L. Symons.
4864. Mont Albert, State School No. 3943, (3) additions to electrical installation, £440.—K. H. Frank.
4865. Mont Park, Mental Hospital, (4) alterations and additions to provide ablution block at boiler house, £1,210.—H. W. Willis.
4866. Melbourne, Technical School, (5) completion of new chemistry school, £64,446.—Costello and Marr.
4867. Melbourne Technical College, (1) installation of heating in Kermot Engineering School, £820.—Mideco Pty. Ltd.
4868. Ouyen, High School, (2) removal of school building from Welshman's Plains State School and re-erection, £285 10s.—M. F. O'Callaghan.
4869. Royal Park, Mental Hospital, (1) supply and installation of stainless steel benches, &c., for new staff kitchen, £1,830.—L. J. Morgan Pty. Ltd.
4870. Truganina, Explosives Reserve, (1) repairs and painting to No. 2 residences, £1,287.—H. F. Lobb.
4871. Warracknabeal, State School No. 1334, (1) renewal of south, east, and west boundary fences (non-party) £527 10s.—J. E. Cray.
4872. Werribee, Research Farm, (1) alterations and new layout in Preparation Room of Bacteriological Laboratory of Technology School, £326.—J. W. Wood.
4873. Footscray, Technical School, (1) supply of one steam generator, £1,475.—Weststeels Industries Ltd.
4874. Melbourne, Technical College, (1) supply of one bomb calorimeter outfit, £257 10s.—H. B. Selby and Co. Pty. Ltd.
4875. Glenferrie, Swinburne Technical College, (1) supply of one metallurgical microscope, complete, £225 3s. 6d.—Stanford X-ray Co. Pty. Ltd.
4876. Footscray, Technical School, (1) supply of one slotting machine, £505.—McPherson's Limited.
4877. Ballarat, School of Mines, (1) supply of one Abbe refractometer, £110.—A. E. Selby and Co. Pty. Ltd.
4878. Richmond, Technical School, (1) supply of one automotive electrical test bench, £312 15s.—Replacement Parts Pty. Ltd.
4879. Footscray, Technical School, (1) supply of two analytical balances, £130.—H. B. Selby and Co. Pty. Ltd.
4880. Heatherton, Sanatorium, (1) supply of salamander, £155 8s.—Albion Quarrying Co. Pty. Ltd.
4881. Newhaven, Jetty, (1) supply of timber, £177 14s. 5d.—Mount Alfred Timber Mills.
4882. Welshpool, Jetty, (1) supply of timber, £346 11s. 1d.—Mount Alfred Timber Mills.
4883. Various, Jetties, Newhaven and Welshpool, (1) supply of timber, £159 5s. 8d.—Mount Alfred Timber Mills.
4884. Sunbury, Mental Hospital, (1) water supply—supply of high-pressure socketted pipes, £153 4s. 5d.—James Hardie and Co. Pty. Ltd.
4885. Port Melbourne, P.W.D. Depot, (1) supply of toppings, £115 1s.—Albion Quarrying Co. Pty. Ltd.
4886. Moorabbin, Technical School, (1) supply of reinforced concrete pipes, £197 6s. 3d.—Rocla Pipes Limited.
4887. Upwey, State School No. 4530, (1) supply of spalls, sand, and gravel, &c., £111.—R. T. Sims.
4888. Scoresby, Horticultural Research Station, (1) supply of 10,000 agricultural pipes, £250.—Lilydale Brick and Pipe Works.
4889. Scoresby Horticultural Research Station, (1) supply of agricultural pipes, £277 10s.—James Hicks Pty. Ltd.
4890. Scoresby Horticultural Research Station, (1) supply of 20,000 concrete agricultural pipes, £541 13s. 4d.—E. P. M. Concrete Pty. Ltd.
4891. Nunawading, Children's Welfare Department, (1) supply of insulwool, £283 6s. 8d.—Insulwool Products Pty. Ltd.
4892. Preston, Pleasant View Mental Hospital, (1) supply of metal and toppings, £112 4s. 10d.—Albion Quarrying Co. Pty. Ltd.
4893. Lakes Entrance, Foreshore, (1) supply of building slabs and posts, £165 8s. 11d.—Monier Pipe Co. (Vic.) Pty. Ltd.
4894. Highett, State School No. 4677, (1) supply of honeycomb spalls, £132 14s. 9d.—Standard Quarries Pty. Ltd.
4895. Various, Pier, Portsea, and Harbor Works, Stony Point, (1) supply of timber, £180 8s. 9d.—Mount Alfred Timber Mills.
4896. Various, Jetty, Rye, and Pier, Portsea, (1) supply of timber, £181 14s.—Mount Alfred Timber Mills.
4897. Melbourne, Cancer Institute, (1) supply of household refrigerator, £132 17s. 6d.—Kelvinator Australia Limited.
4898. Port Melbourne, P.W.D. Depot, (1) reconditioning two Hippo differentials, fitting new parts, and labour, £351 7s. 6d.—Leyland Motors Ltd.
4899. Welshpool, Slipway, (1) supply of slip rollers, £184 16s.—A. H. Ryan and Irving Pty. Ltd.
4900. Port Melbourne, P.W.D. Depot, (1) supply of one crawler tractor, £6,676.—Victorian Industrial Sales and Service Pty. Ltd.
4901. Royal Park, Mental Hospital, (1) supply of hand basins, flushometers, &c., £155 2s. 8d.—Shanks and Co. Pty. Ltd.

ORDERS IN COUNCIL.—(Series 1953-54.)**STATE ELECTRICITY COMMISSION.**

4902. The supply of oxygen and acetylene for a period of twelve months, to specification No. 53-54/131, at Schedule rates.—C.I.G. (Vic.) Pty. Ltd.

4903. The alterations and additions to Administrative Offices, 22-32 William-street, Melbourne, for new passenger-goods lift, to Specification No. 53-54/111, £23,215.—Garrett Constructions Pty. Ltd.

4904. The supply and mounting on truck chassis of eight winches, for use as mobile pole derricks, to Quotation No. 2817, £6,496.—Martin and King Pty. Ltd.

4905. The supply, erection, and maintenance of passenger-goods lift, Administrative Offices, 22-32 William-street, Melbourne, to Specification No. 53-54/110, £13,369.—Otis Elevator Co. Pty. Ltd.

4906. The supply of 5,000 porcelain insulators, to Specification No. 53-54/90, £7,000.—Australian Porcelain Sales and Trading Pty. Ltd.

4907. The supply of 80,000 porcelain insulators, to Specification No. 53-54/90, £36,987.—Dulmison (Aust.) Pty. Ltd.

4908. The supply of 5,000 porcelain insulators, to Specification No. 53-54/90, £7,000.—Sunshine Porcelain Potteries Pty. Ltd.

4909. The supply of 400 transformers for distribution substations, to Specification No. 53-54/74, £36,860.—A.S.E.A. Electric (Aust.) Pty. Ltd.

4910. The supply of 50 transformers for distribution substations, to Specification No. 53-54/74, £6,000.—Standard Waygood Ltd.

4911. The supply of 325 transformers for distribution substations, to Specification No. 53-54/74, £29,361 15s.—Tyree Electrical Co. Pty. Ltd.

4912. The supply of 425 transformers for distribution substations, to Specification No. 53-54/74, £56,525.—Wilson Electric Transformer Co. Pty. Ltd.

Approved by the Governor in Council, 22nd June, 1954.—N. G. WISHART, Acting Clerk of the Executive Council.

ORDERS IN COUNCIL.—(Series 1954-55.)**EDUCATION DEPARTMENT.**

23. One set P.V.E. E.49 slip gauges, £70; one only P.V.E. screw diameter measuring machine complete with cylinders and prisms, £167 4s. 6d.; one only P.G. projectorscope complete, £240, for Footscray Technical School.—McPherson's Pty. Ltd., 546 Collins-street, Melbourne.

24. One only Watts Universal workshop microscope, £182 10s.; one only Hilger angle Dekker T.A.100 complete with stand T.84, £179 13s., for Footscray Technical School.—Adams William and Co. Ltd., 521 Collins-street, Melbourne.

25. One only small hole honing outfit, complete with hones, £128 16s. 3d. (less 10 per cent.), £115 18s. 8d., for Wangaratta Technical School.—Recco Ltd., 618 Elizabeth-street, Melbourne.

26. One only Izod type impact testing machine, £402, for Wangaratta Technical School.—W. and T. Avery (Aust.) Pty. Ltd., 255 William-street, Melbourne.

Approved by the Governor in Council, 29th June, 1954.—A. MAHLSTEDT, Clerk of the Executive Council.

Workers Compensation Act 1951.**LIST OF APPROVED "INSURERS," 1954-55.**

African Guarantee and Indemnity Company Limited.
 Ajax Insurance Company Limited.
 Alliance Assurance Company Limited.
 Argyll General Insurance Company Limited.
 Assurance and Thrift Association Limited.
 Atlas Assurance Company Limited.
 Australian Alliance Assurance Company.
 Australian and Eastern Insurance Company Limited.
 Australian and International Insurances Limited.
 Australian and Overseas Insurance Company Limited.
 Australian General Insurance Company Limited.
 Australian Mutual Fire Insurance Society Limited.
 Australian Natives' Association Insurance Company Limited.
 Bankers and Traders' Insurance Company Limited.
 Caledonian Insurance Company.
 Commercial of Australia Insurance Company Limited.
 Commercial Union Assurance Company Limited.
 Commonwealth General Assurance Corporation Limited.
 Cornhill Insurance Company Limited.
 Eagle Star Insurance Company Limited.
 Economic Insurance Company Limited.
 General Accident Fire and Life Assurance Corporation Limited.
 Gresham Fire and Accident Insurance Society Limited.
 Guardian Assurance Company Limited.

Hartford Fire Insurance Company.
 Insurance Company of North America.
 Interstate Steamship Insurance Company Proprietary Limited.

Law Union and Rock Insurance Company Limited.
 Legal and General Assurance Society Limited.
 Lombard Insurance Company Limited.
 London Guarantee and Accident Company Limited.
 Melbourne Fire Office Limited.

Mercantile Mutual Insurance Company Limited.
 National Employers' Mutual General Insurance Association Limited.

Neptune Insurance Company Proprietary Limited.
 North British and Mercantile Insurance Company Limited.
 North Queensland Accident Insurance Company Limited.
 Norwich Union Fire Insurance Society Limited.

Nottingham (Workers Compensation Insurances) Proprietary Limited.
 Overseas Shipping Insurance Company Proprietary Limited.

Palatine Insurance Company Limited.
 Pearl Assurance Company Limited.
 Perpetual General Insurance and Guarantee Company Limited.

Phoenix Assurance Company Limited.
 Provincial Insurance Company Limited.
 Queensland Insurance Company Limited.

Royal Exchange Assurance of London.
 Royal Insurance Company Limited.
 Scottish Insurance Corporation Limited.

Scottish Union and National Insurance Company.
 South Australian Insurance Company Limited.
 Southern Pacific Insurance Company Limited.

Sun Insurance Office Limited.
 Switzerland General Insurance Company Limited.
 The Australian National Assurance Company Limited.

The Automobile Fire and General Insurance Company of Australia Limited.
 The British General Insurance Company Limited.

The Central Insurance Company Limited.
 The Century Insurance Company Limited.
 The Chamber of Manufactures Insurance Limited.

The Colonial Mutual Fire Insurance Company Limited.
 The Co-operative Insurance Company of Australia Limited.
 The Derwent and Tamar Insurance Company Limited.

The Employers' Liability Assurance Corporation Limited.
 The Farmers and Settlers Co-operative Insurance Company of Aust. Limited.

The Federal Mutual Insurance Company of Australia Limited.
 The Federation Insurance Limited.

The Guildhall Insurance Company Limited.
 The Insurance Corporation of Ireland Limited.
 The Insurance Office of Australia Limited.

The Lancashire Insurance Company.
 The Licenses and General Insurance Company Limited.
 The Liverpool and London and Globe Insurance Company Limited.

The London Assurance.
 The London and Lancashire Insurance Company Limited.
 The Masters Builders' Insurance Company Limited.

The National Insurance Company of New Zealand Limited.
 The New Zealand Insurance Company Limited.
 The Northern Assurance Company Limited.

The Ocean Accident and Guarantee Corporation Limited.
 The Orion Insurance Company Limited.
 The Pacific Insurance Company Limited.

The Patriotic Assurance Company Limited.
 The Prudential Assurance Company Limited.
 The South African Fire and Accident Insurance Company Limited.

The South British Insurance Company Limited.
 The Southern Union Insurance Company of Australia Limited.

The Standard Insurance Company Limited.
 The State Assurance Company Limited.
 The Steadfast Insurance Company Limited.

The United Insurance Company Limited.
 The Victoria Insurance Company Limited.
 The Western Australian Insurance Company Limited.

The World Auxiliary Insurance Corporation Limited.
 The Yorkshire Insurance Company Limited.
 Transport and General Insurance Company Limited.

Triton Insurance Company Limited.
 Union Assurance Society Limited.
 Union Insurance Society of Canton Limited.

Vanguard Insurance Company Limited.
 Victoria Racing Club.
 Victorian Automobile Chamber of Commerce Insurance Company Limited.

Victorian Wheatgrowers' Corporation Limited.
 Western Assurance Company.

Approved by the Governor in Council, 29th June, 1954.—A. MAHLSTEDT, Clerk of the Executive Council.

Transport Regulation Acts.

TRANSPORT REGULATION BOARD.

NOTICES OF PUBLIC HEARINGS.

NOTICE is hereby given that the applications made by the persons named below for licences to operate commercial goods vehicles, on the route or routes or in the manner set out opposite their names, will be heard at a time and place to be communicated to the parties concerned:—

Name and Address; Nature of Application.

ADAMS, L. E., La Fayette, Traralgon; 2 commercial goods vehicles (120 cwt. each) to operate—(a) within a radius of 20 miles of Traralgon—general goods, (b) from pits in the Longford area to cement works at Traralgon—lime.

BERRI CO-OPERATIVE PACKING UNION LTD., Box 227, Berri, South Australia; 3 commercial goods vehicles (200 cwt. each) to operate in the course of business as "fruit and juice packers and canners, cordial manufacturers, produce and hardware merchants"—(a) from the South Australian/Victorian border, *en route* from Berri, to Mildura—fresh fruit, citrus, dried fruit and tinned juices, and fruit, (b) from Mildura to the Victorian/South Australian border, *en route* to Berri—own goods and supplies.

BRIEN, L. R., Green-street, Healesville; 1 commercial goods vehicle (90 cwt.) to operate between Melbourne and Healesville—general goods. (This is an application to replace licence No. D.5610, formerly held by D. W. Brien, and now cancelled.)

DERITE FIBROUS PLASTER CO. PTY. LTD., Ingles-street, Port Melbourne; 4 commercial goods vehicles (99, 90, 80, and 90 cwt.) to operate throughout the State of Victoria in the course of business as "fibrous plaster sheet manufacturers"—fibro-plaster sheets, mouldings, battens, sisal, nails, scaffolding, and sufficient plaster to complete own contracts.

DIMET PTY. LTD., 160 Adderley-street, West Melbourne; 2 commercial goods vehicles (68 and 15 cwt.) to operate throughout the State of Victoria in the course of business as "specialists in the protective treatment of metals"—material and appliances such as compressors, sand-blast machines, hoses, sand, spray equipment, and baking equipment for use on own contracts.

EDMUNDS, A. F., Halsey-road, North Essendon; 1 commercial goods vehicle (91 cwt.) to operate throughout the State of Victoria in the course of business as "manufacturers of prefabricated steel farm buildings"—prefabricated structures, in sections, for erection at site with tools incidental to such erection.

FISHER'S (KORUMBURRA) PTY. LTD., Bridge-street, Korumburra; application to vary the terms of existing licence No. D.A.8754 by the addition of ability to carry posts from Neerim South to Korumburra.

MASSEY, W. J. (trading as Heidelberg Forge and Engineering Co.), 31 Burgundy-street, Heidelberg; 1 commercial goods vehicle (104 cwt.) to operate throughout the State of Victoria in the course of business as "general engineer and manufacturers" for the purpose of supplying and installing passenger bus shelters, automatic farm gates, hay sheds, farm spraying equipment, and trailers, all of which have been manufactured by the applicant.

MANUFACTURERS' BOTTLE CO. OF VICTORIA PTY. LTD., 31 Queen-street, Melbourne; 1 commercial goods vehicle (15 cwt.) to operate throughout the State of Victoria for the purpose of servicing and maintaining own fleet of vehicles—tools, spare parts, and material incidental to such servicing and maintenance.

PARKER, L. N., McKenzie-street, Broadford; 1 commercial goods vehicle (12 cwt.) to operate as follows:—From and to Broadford to and from Hazeldene, via Flowerdale, for the carriage of mail, under contract to the P.M.G., newspapers, small parcels, and one passenger.

SUNBEAM CORPORATION LTD., Sloane-street, Maribyrnong; 2 commercial goods vehicles (8 and 7 cwt.) to operate throughout the State of Victoria in the course of business as "manufacturers of electrical and farm appliances"—appliances for installation and demonstration purposes, with tools, spare parts, and material incidental to servicing and maintaining such appliances.

ST. CLAIR TIMBER CO. PTY. LTD., 60 Market-street, Melbourne; 1 commercial goods vehicle (190 cwt.) to operate from St. Clair Timber Co. Pty. Ltd. sawmill at Wesburn for the carriage of sawn timber to—(a) the railway stations at Warburton and/or Yarra Junction, (b) to any customers if delivered within a radius of 20 miles of Warburton and/or Yarra Junction Railway Stations, (c) to any merchant or builder if delivered to a timber yard, or direct on to a building site, which is located within a radius of 25 miles of Melbourne.

TEMPLETON, A. H., & R. H. PLUNKETT (trading as Templeton and Plunkett), Willaura; 1 commercial goods vehicle (142 cwt.) to operate—(a) within a radius of 20 miles of Willaura—general goods, (b) within a radius of 50 miles of Willaura—livestock, (c) from and to Willaura to and from Ballarat—livestock.

TERRETT, F. H. & D. E., 175 Bridge-street, Benalla; 1 commercial goods vehicle (161 cwt.) to operate from J. A. Terrett and Co. Pty. Ltd. sawmill at Benalla within a radius of 20 miles of Benalla and to consignees at Kyabram, Tatura, Shepparton, Numurkah, and Cobram—sawn timber.

WATERS, S. H., & Co. PTY. LTD., 514 Little Collins-street, Melbourne; 1 commercial goods vehicle (42 cwt.) to operate within a radius of 50 miles of Wangaratta in the course of business as "wool, hide, and skin merchants"—own goods.

NOTICE is hereby given that the applications made by the persons named below for renewal of licences to operate the commercial goods vehicles on the route or routes or in the manner set out opposite their names, will be heard at a time and place to be communicated to the parties concerned:—

Name and Address; Present Franchise; Licence No.; Date of Expiry.

CLISSOLD, C. R., Deans Marsh; between Geelong and persons other than carriers who reside or carry on business on or adjacent to the road, between Geelong and Deans Marsh, via Moriac, Modewarre, Wurdie Boluc, Wonsleydale, Yan Yan Gurt, and Bambra, for the carriage of goods as follows:—(i) From Geelong—any goods for use or sale by any such persons, (ii) to Geelong—any goods produced or used by such persons; D.6355; 16th October, 1954.

EATON, H. E., Newmerella, via Orbost; (a) within a radius of 20 miles from the post office at Newmerella—general goods, (b) within the limits of the Shire of Orbost—road contracting plant and materials; D.6299; 16th October, 1954.

HANCOCK, C. F., Box 137, Lakes Entrance; (a) from fishermen's residences or premises situate at the Township of Lakes Entrance to the City of Melbourne—fish and fishermen's gear for repair, (b) from the City of Melbourne to registered fishermen's or members of any fishermen's association residing in Township of Lakes Entrance—supplies for use in fishing or the processing of fish only, (c) from the City of Melbourne to the Township of Lakes Entrance—those goods only which are specified in the Third Schedule of the *Transport Regulation Act 1933*, (d) from and to fishermen's residences or premises situate at the Township of Lakes Entrance to where the Princes Highway crosses the Victorian-New South Wales border, *en route* to and from Sydney, New South Wales—fish and fishermen's gear for repair and empty fish boxes; D.6379, D.6380; 16th October, 1954.

KEOGH, P., 303 Ascot Vale-road, Moonee Ponds; throughout the State of Victoria in the course of business as "erection engineer"—boilers, steel chimney stacks, flues, boiler parts, scaffolding, derrick poles, gear equipment, and material incidental to trade; T.D.2679; 31st August, 1954.

MILDREN, F. J., 24 Brockley-street, Wodonga; (a) within a radius of 25 miles from Corryong—general goods, (b) from and to the Township of Wodonga; *en route* to and from Albury, New South Wales, to and from the Township of Corryong and places situate within a radius of 25 miles from the post office at Corryong, but excluding places situate on the Murray Valley Highway between the Townships of Wodonga and Walma—general goods; D.6306; 16th October, 1954.

WILLIAMS BROS. CONTRACTORS PTY. LTD., 14 Hunter-road, Camberwell; (a) within a radius of 25 miles from Melbourne—general goods, (b) within a radius of 50 miles from Melbourne—road contracting plant and materials; D.6326; 30th October, 1954.

NOTICE is hereby given that the applications made by the persons named below for renewal of temporary licences for a period of twelve months to operate the commercial goods vehicles, on the route or routes or in the manner set out opposite their names, will be heard at a time and place to be communicated to the parties concerned:—

Name and Address; Present Franchise; Licence No.; Date of Expiry.

ADAMS, W. H., Three Bridges; (a) logs from forest landings at Cotters Plain area to Saxton's Sawmill at Licola, (b) sawn timber from Saxton's Sawmill at Licola to the Heyfield Railway Station; T.T.D.1612; 14th December, 1954.

BRENDA, J. F., Nicholas-street, Lilydale; (1) logs from any forest landing in the Niagaroon and Upper Yarra forestry districts and the North Big River area—(a) to the railway station at Healesville and to any mill or dump which is located within a radius of 20 miles of such landing or of the railway station at Healesville, (b) to any mill or yard situated within a radius of 25 miles of the G.P.O., Melbourne, (2) sawn timber from C. J. Row, Webb and Anderson's Sawmill at Thornton and Maryville—(a) to the railway station at Healesville, (b) to any customer if delivered within a radius of 20 miles of the Healesville Railway Station, (c) to any merchant or builder if delivered to a timber yard or direct on to building sites which are situated within a radius of 25 miles of the G.P.O., Melbourne; T.T.D.1615; 21st December, 1954.

BYRDEN, P., 2 Dalston-road, Oakleigh; logs from any forest landing in the Niagaroon and Upper Yarra forestry districts and the North Big River area—(a) to the railway stations at Warburton and/or Yarra Junction and to any mill or dump which is located within a radius of 20 miles of such landing or of the railway stations at Warburton and/or Yarra Junction, (b) to any mill or yard situated within a radius of 25 miles of the G.P.O., Melbourne, under the direction of an officer of the Forests Commission; T.T.D.1465; 18th December, 1954.

CAMBARVILLE SAWMILLING Co., Cambarville, via Marysville; (1) logs from any forest landing in the Niagaroon and Upper Yarra forestry districts and the North Big River area—(a) to the railway station at Healesville and to any mill or dump which is located within a radius of 20 miles of such landing or of the railway station at Healesville, (b) to any mill situated within a radius of 25 miles of the G.P.O., Melbourne, (2) sawn timber from holder's own sawmill at Cambarville—(a) to the railway station at Healesville, (b) to any customer if delivered within a radius of 20 miles of the Healesville Railway Station, (c) to any merchant or builder if delivered to a timber yard or direct on to a building site which is located within a radius of 25 miles of the G.P.O., Melbourne; T.T.D.1215; 18th December, 1954.

FROST, A. W., & W. R. MCKINLEY, Millgrove; (1) logs from any forest landing in the Niagaroon and Upper Yarra forestry districts and the North Big River area—(a) to the railway stations at Warburton and/or Yarra Junction and to any mill or dump which is located within a radius of 20 miles of such landing or of the railway stations at Warburton and/or Yarra Junction, (b) to any mill or yard situated within a radius of 25 miles of the G.P.O., Melbourne, (2) sawn timber from the Alpine Timber and Trading Co. Pty. Ltd. Sawmill at Millgrove—(a) to the railway stations at Yarra Junction and/or Warburton, (b) to any customer if delivered within a radius of 20 miles of the Yarra Junction and/or Warburton Railway Stations, (c) to any merchant or builder if delivered to a timber yard or direct on to a building site which is located within a radius of 25 miles of the G.P.O., Melbourne; T.T.D.1528; 3rd December, 1954.

JOHNSON, K. T., 33 McLean-street, Maffra; logs from forest landings in the Licola area to sawmills at Heyfield; T.T.D.1613; 14th December, 1954.

LARTER, R. K., Douglas-road, Mt. Macedon; (1) mill logs from private properties in the Mt. Macedon area to the Glenbervie Timber Co. Yards at Essendon and to Johnson and Reilly's Yards at Keilor and to sawmills in the metropolitan area, (2) case pine logs from Forests Commission plantation at Mt. Macedon to the Northern Timber Co. Sawmills at Stuart-street, Brunswick; T.T.D.1617; 21st December, 1954.

MCCONNELL, M., care of G. H. Bell and Son, Tolmie, via Mansfield; (1) logs from forest landings in the Tolmie area to Bell's Sawmill at Tolmie and to consignees at Mansfield and Benalla, (2) sawn timber from Bell's Sawmill at Tolmie to consignees at Mansfield, Yarrawonga, Benalla, Wangaratta, Albury, Shepparton, Numurkah, Tatura, and Kyabram; T.T.D.1558; 1st December, 1954.

MATTHEWS, J. C., Woods Point; sawn timber from Charles Bros. Pty. Ltd. Sawmill at Woods Point, via Warburton or Eildon Weir route, to the Dry Kiln Seasoning Co.'s Yards at Port Melbourne; T.T.D.1611; 21st December, 1954.

PEARSE, F., Forrest; sawn timber from Frizon and Sons Sawmill at Forrest to timber yards and building sites at Geelong; T.T.D.1559; 1st December, 1954.

PULPWOOD PROCUREMENT PTY. LTD., 70 Bridge-road, Richmond; pulpwood billets from the Upper Thompson and Bairnsdale areas to the A.P.M. Ltd. at Maryvale; T.T.D.1622; 14th December, 1954.

PULHAM, K. E., "Hillcrest," Symon-street, Healesville; (1) logs from any forest landing in the Niagaroon and Upper Yarra forestry districts and the North Big River area—(a) to the railway station at Healesville and to any mill or dump which is located within a radius of 20 miles of such landing or of the railway station at Healesville, (2) sawn timber from K. E. Pulham's Sawmill at Healesville—(a) to the railway station at Healesville, (b) to any customer if delivered within a radius of 20 miles of the Healesville Railway Station, (c) to any merchant or builder if delivered to a timber yard or direct on to building site south of the Yarra River within a radius of 25 miles but not within 8 miles of the G.P.O., Melbourne; T.T.D.1633; 14th December, 1954.

ROBERTS, N. G., St. Leonards-road, Healesville; (1) logs from any forest landing in the Niagaroon and Upper Yarra forestry districts and the North Big River area—(a) to the railway station at Healesville and to any mill or dump which is located within a radius of 20 miles of such landing or of the railway station at Healesville, (b) to any mill or yard situated within a radius of 25 miles of the G.P.O., Melbourne, (2) sawn timber from C. Rouch's Sawmill at Healesville—(a) to the railway station at Healesville, (b) to any customer if delivered within a radius of 20 miles of the railway station at Healesville, (c) to any merchant or builder if delivered to a timber yard or direct on to a building site which is located within a radius of 25 miles of the G.P.O., Melbourne, (d) to C. Rouch's own timber yards at Heidelberg; T.T.D.1614; 21st December, 1954.

SAXTON TIMBER & TRADING Co. PTY. LTD., Box 37, 26 Albert-street, Moe; (a) sawn timber from the Saxton Timber and Trading Co. Pty. Ltd. Sawmill at Licola to Saxton Timber and Trading Co. Pty. Ltd. Timber Yards at Moe, (b) sawmilling equipment from Saxton Timber and Trading Co. Pty. Ltd. Timber Yards at Moe to Saxton Timber and Trading Co. Pty. Ltd. Sawmill at Licola, (c) building materials from Saxton Timber and Trading Co. Pty. Ltd. Timber Yards at Moe to consignees at Traralgon and to consignees en route to Licola, (d) pre-cut timber from Saxton Timber and Trading Co. Pty. Ltd. Timber Yards at Moe to Saxton Timber and Trading Co. Pty. Ltd. employees' housing project at Licola; T.T.D.1629; 14th December, 1954.

TRUSCOTT, C. T., Pakenham East; (1) logs from any forest landings in the Balook, Neerim, and Erica areas to C. T. Truscott's Sawmill at Pakenham East, (2) sawn timber from C. T. Truscott's Sawmill at Pakenham East to consignees on the Mornington Peninsula and to Melbourne suburban areas direct (only) to building sites in the metropolitan area, also to Beech Timber Co.'s Timber Yards at Mentone; T.T.D.1618; 14th December, 1954.

WALKER, A. R., 27 Haig-street, Box Hill; (1) logs from any forest landing in the Niagaroon and Upper Yarra forestry districts—(a) to the railway stations at Warburton and/or Yarra Junction and to any mill or dump which is located within a radius of 20 miles of such landing or of the railway stations at Warburton and/or Yarra Junction, (b) to any mill or timber yards situated within a radius of 25 miles of the G.P.O., Melbourne, (2) sawn timber from Baird and Inverarity's Sawmill at Millgrove—(a) to the railway stations at Warburton and/or Yarra Junction, (b) to any customer if delivered within a radius of 20 miles of the Warburton and/or Yarra Junction Railway Stations, (c) to any merchant or builder if delivered to a timber yard or direct on to a building site which is located within a radius of 25 miles of the G.P.O., Melbourne; T.T.D.1349; 4th December, 1954.

NOTICE is hereby given that the applications made by the persons named below for licences to operate commercial passenger vehicles on the route or routes, or in the manner set out opposite their names, will be heard at a time and place to be communicated to the parties:—

Name and Address; Nature of Application.

BEACH TRANSPORT SERVICE PTY. LTD., 273 Beach-road, Mentone; application for renewal of licence No. C.O.65 (expiring 4th December, 1954) authorizing operations as follows:—(a) As a stage omnibus on Route 200A, between the Mordialloc Railway Station and the Chelsea Railway Station, via Nepean Highway, (b) as a country special service omnibus, pursuant to Regulations 1 and 5 of Division II. of Part III. of the Transport Consolidated Regulations, within a radius of fifty (50) miles from the post office at Mordialloc, subject to the condition that every journey undertaken shall commence within a radius of three (3) miles from the said post office.

SMITH, G. L., 2 Bridge-street, Elsternwick; application for variation of licence No. M.H.327 to delete present operational address, 771 Glenhuntly-road, Glenhuntly, and instead to include the ability to operate as follows:—(a) To be bespoken from the depot of McKinnon-Highett Private Hire Service situate at corner of Jasper and North roads, Ormond, (b) under composite conditions in Zone "B," radio controlled from the base station situate at corner of Jasper and North roads, Ormond.

MC ELVOGUE, B. C. (executor of the estate of the late P. McElvogue), 151 Victoria-avenue, Chatswood, Sydney, New South Wales; 1 commercial passenger vehicle, with seating capacity for 5 persons, to operate as a metropolitan taxi cab, subject to the cancellation of licence No. M.T.1077, at present in the name of the late P. McElvogue.

APPLICATIONS for metropolitan taxi cab licences in respect of commercial passenger vehicles, each with seating capacity for 5 persons, have been made by the persons listed hereunder:—

APPLICATIONS RECEIVED SUBSEQUENT TO THE
17TH MARCH, 1954.

ARCHER, L. F., 12 Seymour-road, Box Hill; 1 taxi cab.
ALFASY, J., 33 Castle-street, Heidelberg; 1 taxi cab.
BASTON, K. R., 29 James-street, Northcote; 1 taxi cab.
BEDFORD, W. S., 1A Thomas-street, Mitcham; 1 taxi cab.
BOWER, W. E., 7 Carroll-street, Reservoir; 1 taxi cab.
BRIGGS, H. G., Flat 1, 103 Tennyson-street, Elwood; 1 taxi cab.
BRIGGS, P., 4 Lyons-street, Footscray; 1 taxi cab.
BUTLER, B. P., 20 Yawla-street, Bentleigh; 1 taxi cab.
CACCCHETTO, P. B., 7 Moor-street, Fitzroy; 1 taxi cab.
YORKE, R. C., 21 Durham-street, Heidelberg; 1 taxi cab.
CORLEY, E. J., 17 Drummond-street, Carlton; 1 taxi cab.
COSHAM, G. G., 123 Lord-street, Richmond; 1 taxi cab.
CUNNINGHAM, C. M., 250 Balcombe-road, Mentone; 1 taxi cab.
CURTIS, W. C., 31 Murphy-street, Richmond; 1 taxi cab.
DEVLIN, O. O., 6 Filbert-street, South Caulfield; 1 taxi cab.
DUNN, G. F., 320 St. Kilda-street, Brighton; 1 taxi cab.
EAGLES, C., 9 Alwyn-street, Mitcham; 1 taxi cab.
GEMPERLE, R. C., 385 Coventry-street, South Melbourne; 1 taxi cab.
GILBERT, R., 28 Hobart-road, Murrumbeena; 1 taxi cab.
GIORGI, U., 30 Wrights-street, Prahran; 1 taxi cab.
GUTTERIDGE, E. T., 4 Halley-street, Bentleigh; 1 taxi cab.
HEATH, R. J., 5 Preston-road, Hughesdale; 1 taxi cab.
HODKINSON, R. J., Steven-street, Hurstbridge; 1 taxi cab.
HOWSON, A. T., 66 Huddle-street, Abbotsford; 1 taxi cab.
HUME, C. J. D., 12 Stuart-street, Armadale; 1 taxi cab.
HUNT, E. W., 12 Suffolk-street, Reservoir; 1 taxi cab.
KALIK, M., Flat 5, 600 Station-street, North Carlton; 1 taxi cab.
LAWLESS, W. P., 22 Goodwood-street, Richmond; 1 taxi cab.
LEGGO, S. D., Flat 8, 1 Portal-street, Ascot Vale; 1 taxi cab.
MCCASKER, S. L., 13 Balcombe-road, Black Rock; 1 taxi cab.
MCGREGOR, F. C., 12 Park-avenue, Glenhuntly; 1 taxi cab.
MARTIN, V. L., 6 Alexandra-street, East St. Kilda; 1 taxi cab.
MC LAUGHLIN, A. M., 34 Innellan-road, Murrumbeena; 1 taxi cab.
MOORE, C. F., 3 Kelleth-street, Northcote; 1 taxi cab.
MORGAN, H. W., 214 Williams-road, Hawksburn; 1 taxi cab.
MURPHY, G. P., 6 Rosedale-avenue, Glenhuntly; 1 taxi cab.
O'MARA, P. G., 104 Ford-street, Ivanhoe; 1 taxi cab.
O'REILLY, J. F., 8 Albion-street, East Brunswick; 1 taxi cab.
POWELL, F. J., 25 Ovens-street, West Brunswick; 1 taxi cab.
POWER, T. E. J., 14 Mary-avenue, Werribee; 1 taxi cab.
RAWLINGS, H. S., 2-14 Jackson-street, St. Kilda; 1 taxi cab.
ROBERTSON, J. R., 11 Hood-street, Mont Albert; 1 taxi cab.

ROWLEY, R. W., 19 Alexander-avenue, North Coburg; 1 taxi cab.

RYAN, D., 57 Graham-street, Sunshine; 1 taxi cab.
SCHULZ, T. W., 67 Reed-street, Albert Park; 1 taxi cab.
SEIKIS, A., 55 Patterson-street, East Coburg; 1 taxi cab.
SKINNER, W. J., 38 Nisbett-street, East Preston; 1 taxi cab.
SMITH, W. R., 64 Bardsley-street, Sunshine; 1 taxi cab.
STEVENSON, G., 35 Allan-street, Essendon; 1 taxi cab.
SULLIVAN, W. R., 176 Rathdown-street, Carlton; 1 taxi cab.
TINKER, G. J., 40 Prentice-street, Elsternwick; 1 taxi cab.
TUDOR, J. R., 14 Cantala-street, Pascoe Vale South; 1 taxi cab.

WALLACE, J. A., 132 Lord-street, Richmond; 1 taxi cab.
WARD, A. L., 8 Denver-crescent, Elsternwick; 1 taxi cab.
WATKINS, E., 22 Athol-street, Prahran; 1 taxi cab.
WATSON, K. J., 4 Pakington-street, St. Kilda; 1 taxi cab.
WILLIAMSON, V. M., 8 Wilson-grove, Camberwell; 1 taxi cab.
WINNETT, M. J., Flat 5, 21A Broadway, Elwood; 1 taxi cab.
WOOD, L. C., 41 Upton-road, Windsor; 1 taxi cab.
WOODHEAD, G. H., 15 Wright-street, Reservoir; 1 taxi cab.

APPLICATIONS for metropolitan taxi cab licences in respect of commercial passenger vehicles, each with seating capacity for 5 persons, have been made by the persons listed hereunder:—

APPLICATIONS RECEIVED PRIOR TO AND INCLUDING
17TH MARCH, 1954.

CARROLL, H. D., care of A. Alexander, 477 Upper Heidelberg-road, Heidelberg; 1 taxi cab.

NIEDERBERGER, E., 47 Miller-street, West Melbourne; 1 taxi cab.

APPLICATION for metropolitan taxi cab licence, or private hire licence, in respect of a commercial passenger vehicle, with seating capacity for 5 persons, has been made by the person listed hereunder:—

APPLICATION RECEIVED PRIOR TO AND INCLUDING
17TH MARCH, 1954.

REDDOCH, W. A., 10 Claremont-street, East Coburg; 1 taxi cab or 1 private hire licence.

APPLICATIONS for metropolitan taxi cab licences in respect of commercial passenger vehicles, each with seating capacity for 5 persons, subject to the cancellation of a metropolitan private hire car licence, at present held by the applicant, have been made by the persons listed hereunder:—

APPLICATIONS RECEIVED SUBSEQUENT TO THE
17TH MARCH, 1954.

ALLSOP, S., 61 Chadstone-road, Chadstone; 1 taxi cab licence, subject to the cancellation of licence No. M.H.245.

COLSON, B. A., 195 Murray-road, Preston; 3 taxi cab licences, subject to the cancellation of licence Nos. M.H.464, M.H.469, and M.H.590.

ILLMAN, G., 102 Bruce-street, West Coburg; 1 taxi cab licence, subject to the cancellation of licence No. M.H.1203.

MEARNS, J. F., 9 Beaver-street, Essendon; 1 taxi cab licence, subject to the cancellation of licence No. M.H.1235.

MEISELS, V., 7 Reaburn-crescent, West Brunswick; 1 taxi cab licence, subject to the cancellation of licence No. M.H.1283.

UTTING, T. E., 231 Heidelberg-road, Northcote; 9 taxi cab licences, subject to the cancellation of licence Nos. M.H.1, M.H.2, M.H.3, M.H.4, M.H.5, M.H.6, M.H.700, M.H.701, and M.H.801.

WOODMAN, W. H., Flat 6, 123 Williams-road, Prahran; 1 taxi cab licence, subject to the cancellation of licence No. M.H.786.

APPLICATION for metropolitan hire car licence in respect of a commercial passenger vehicle, with seating capacity for 5 persons, subject to the cancellation of country taxi licence, at present held by the applicant, has been made by the person listed hereunder:—

APPLICATION RECEIVED SUBSEQUENT TO THE
17TH MARCH, 1954.

WITHAM, J. R., 174 Spring-street, Reservoir; 1 metropolitan private hire licence, subject to the cancellation of licence No. C.T.367.

APPPLICATIONS for metropolitan private hire car licences in respect of commercial passenger vehicles, each with seating capacity for 5 persons, to be bespoken from the addresses shown with each application, have been made by the persons listed hereunder:—

APPLICATIONS RECEIVED SUBSEQUENT TO THE
17TH MARCH, 1954.

AMOTT, R. H., 81 Union-street, East Brighton; 1 private hire, Astoria Taxi Depot, 522 Swanston-street, Melbourne.

ANDERSON, C. C., 77 Southampton-street, West Footscray; 1 private hire, Morderne Taxis Ltd., 56 Hopkins-street, Footscray.

ANDERSON, F., 77 The Grove, East Coburg; 1 private hire, 77 The Grove, East Coburg.

BOTSMAN, T. J., 69 Stawell-street, Burnley, E.1; 1 private hire, Melbourne Taxis, Bridge-road, Richmond.

BROWN, K. S., 29 Midlothian-street, Chadstone; 1 private hire, 20 Midlothian-street, Chadstone.

CAREY, J., 125 Hammer-street, Williamstown; 1 private hire, Moderne Taxis, 56 Hopkins-street, Footscray.

DWYER, E. J., 16 Railway-crescent, Williamstown; 1 private hire, Moderne Taxis, 56 Hopkins-street, Footscray.

ELLWOOD, A. H., 46 Fehon-street, Yarraville; 1 private hire, Moderne Taxis, 56 Hopkins-street, Footscray.

ETCHELL, V. G., 11 Warner-avenue, Ashburton; 1 private hire, South Suburban Radio Cars, 771 Glenhuntingly-road, Glenhuntingly.

FERGUSON, D. R., 10 Sylvan-grove, Pascoe Vale; 1 private hire, Coburg Taxis, 314 Sydney-road, Coburg.

HANCOX, C. A., 12A Scots-street, Canterbury; 1 private hire, 12A Scots-street, Canterbury.

HODSON, W. F., 23 Hargreave-street, East Oakleigh; 1 private hire, McKinnon-Highett Taxi Service, Jasper-road, Highett.

LINEHAN, H. E., 18 Robbs-road, Footscray; 1 private hire, 18 Robbs-road, Footscray.

MCCARTLEY, F., 61 Fehan-street, Yarraville; 1 private hire, Moderne Taxis, 56 Hopkins-street, Footscray.

MOORE, J. K., 16 Bishop-street, West Footscray; 1 private hire, Moderne Taxis, 56 Hopkins-street, Footscray.

PHILLIPS, J., 13 Hotham-street, Preston; 1 private hire, Gem Taxis, 477 Upper Heidelberg-road, Heidelberg.

PINKEY, V. T., 40 Griffiths-street, Heidelberg; 1 private hire, Gem Taxis, 477 Upper Heidelberg-road, Heidelberg.

POWELL, W. J., 116 Francis-street, Yarraville; 1 private hire, Moderne Taxis, 56 Hopkins-street, Footscray.

PRESTON, J. T., 4 Trunan-street, Kingsville; 1 private hire, 4 Trunan-street, Kingsville.

REES, J. C., 771 Glenhuntingly-road, Glenhuntingly; 1 private hire, 771 Glenhuntingly-road, Glenhuntingly.

ROWE, T. A., 8 Roach-avenue, Essendon; 1 private hire, 8 Roach-avenue, Essendon.

SCHAFFER, C. B., 16 Coppins-street, Hawthorn; 1 private hire, Melbourne Radio Taxis, Bridge-road, Richmond.

SMYTHE, K. L., 70 Gipps-street, East Melbourne; 1 private hire, 70 Gipps-street, East Melbourne.

THOMAS, H. A., 18 Derrimutt-street, Sunshine; 1 private hire, Moderne Taxis, 56 Hopkins-street, Footscray.

TRYTELL, S., 57 Glenhuntingly-road, Elwood; 1 private hire, 57 Glenhuntingly-road, Elwood.

WARREN, M. A., 1 Newell-street, Footscray; 1 private hire, 1 Newell-street, Footscray.

FENWICK, J. P., 28 Outer-crescent, Brighton; 1 commercial passenger vehicle, with seating capacity for 5 persons, to operate as a metropolitan taxi cab, subject to the cancellation of licence No. M.T.1130, at present held by F. Chandler, 76 Buckingham-street, Richmond.

PARKER, D. J. P., Eton-road, Belmont, Geelong; 1 commercial passenger vehicle, with seating capacity for 5 persons, to be purchased, to operate as an urban private hire car, to be bespoken from Eton-road, Belmont, Geelong.

BUTTERS, H. P., 200 White Mills-road, Bendigo; 1 commercial passenger vehicle, to be purchased, with seating capacity for 5 persons, to operate as an urban private hire car, to be bespoken from 200 White Mills-road, Bendigo, and Radio Cabs, Bridge-street, Bendigo.

KENNEDY, P. M., 22 Ormond-street, Clayton; 2 commercial passenger vehicles, to be purchased, to operate as metropolitan route omnibuses on the following route:—Commencing at the Oakleigh Railway Station, via Houghton-road, Warrigal-road, Barkly-street, Hotham-street, Ellendale-street, Poath-road, Dalny-road, Murrumbena-road, North-road, East Boundary-road, South-road to a stand to be appointed at the Moorabbin Railway Station.

EDWARD, L., 10 Vera-street, Williamstown; 1 commercial passenger vehicle, with seating capacity for 25 persons, to operate under contract to the Commonwealth Oil Refineries Ltd., to carry employees only of C.O.R. between Williamstown and the refinery at Laverton.

NOTICE is hereby given that the applications made by the persons named below for licences to operate commercial passenger vehicles on the route or routes, or in the manner set out opposite their names, will be heard at a time and place to be communicated to the parties:—

Name and Address; Nature of Application.

ADAMS, R. W., corner of York and Swansea roads, Lilydale; 1 commercial passenger vehicle, with seating capacity for 5 persons, to operate as follows:—(a) At separate and distinct fares within a radius of two (2) miles of Mt. Evelyn Post Office, (b) under private hire conditions within a radius of fifty (50) miles of Mt. Evelyn Post Office, (c) on all stage routes operated by the applicant, in lieu of large seating capacity vehicles, only on such times when loading is light, and subject to time-tables and fares as authorized on the particular route.

DEVEREUX, J. O. R., Swan Hill; 1 commercial passenger vehicle, with seating capacity for 5 persons, to operate as follows:—(a) At separate and distinct fares within a radius of five (5) miles of Swan Hill Post Office, (b) under private hire conditions within a radius of fifty (50) miles of Swan Hill Post Office. Subject to the cancellation of licence No. C.T.50, at present in the name of H. W. Brown, Swan Hill.

MATHEWS, R., J. R. FRASER, and F. MALONEY (trading as Double Eight Taxis), 347 Murray-street, Colac; application for renewal of licence No. C.T.33 (expiring 3rd December, 1954), authorizing operations as follows:—(a) At separate and distinct fares for each passenger within a radius of five (5) miles from the post office at Colac, (b) under private hire conditions within a radius of fifty (50) miles of the post office at Colac.

FERGUSON, S. V., 151 Raymond-street, Sale; application for renewal of licence No. C.O.1023 (expiring 4th December, 1954), authorizing operations as follows:—

1. As a stage omnibus on the following routes:—
 - (a) Between Briagolong and the Sale High and Technical Schools, via Boisdale and Maffra, under contract to the Education Department.
 - (b) Between Maffra and the Sale High and Technical Schools, via Stratford, under contract to the Education Department.
 - (c) Between Heyfield and the Sale High and Technical Schools, via Nambrook, under contract to the Education Department.
 - (d) Between Upper Maffra West and the Sale High and Technical Schools, via Newry, Tinamba, and Maffra, under contract to the Education Department.
 - (e) Between Maffra and the Sale High and Technical Schools, via Boisdale and Maffra, under contract to the Education Department.
 - (f) Between Maffra and the Sale High and Technical Schools, via the Sale-Maffra road, under contract to the Education Department.
 - (g) Between Newry and Sale, via Tinamba and Maffra, thence via either Stratford or Bundalguah. Passengers may be carried at a separate and distinct fare for each passenger to or from any place along the route.
 - (h) Between Sale and Lakes Entrance, via Stratford and the Princes Highway East. Passengers may be carried at a separate and distinct fare for each passenger on the route defined in Part (h) of routes above, subject to the condition that on all journeys from Sale to Lakes Entrance passengers may be set down at any place *en route*, but shall be taken up only between and including Sale and Stratford, and on all journeys from Lakes Entrance to Sale passengers may be taken up anywhere *en route*, but shall be set down only between and including Stratford and Sale. (On any Sunday occurring between the first day of September in any one year and the thirtieth day of April, and not otherwise.)
 - (i) Between Maffra and Lakes Entrance, via Stratford and the Princes Highway East. Passengers may be carried at a separate and distinct fare for each passenger on this route, subject to the condition that on all journeys from Maffra to Lakes Entrance passengers may be set down at and place, *en route*, but shall be taken up anywhere *en route*, but shall be set down only between and including Stratford and Maffra. (On any Sunday occurring between the first day of September in any one year and the thirtieth day of April, and not otherwise.)

(j) Between Maffra and the Traralgon Speed Coursing Ground, via Sale and the Princes Highway East. (The vehicle may be operated to any speed coursing ground as required on days only when a public coursing fixture is being held at such speed coursing ground. This condition applies to Routes (j), (k), and (l) specified herein.)

(k) Between Briagolong and the Sale Speed Coursing Ground.

(l) Between Sale and the Sale Speed Coursing Ground.

(m) Between Sale and the Sale Racecourse. The vehicle may be operated to either of the racecourses specified in the routes defined in Parts (m) and (n), as required on days only when a public horse-racing fixture is being held at such racecourses.

(n) Between Sale and the Stratford Racecourse.

(o) Between Sale and the Sale Showgrounds, as required on days only when an agricultural show or other public fixture is being held at such showgrounds, and not otherwise.

(p) Between Sale and the East Sale Aerodrome as required, subject to the condition that no regular service shall be inaugurated or operated along this route, unless a time-table is first approved by the Transport Regulation Board.

2. As a country special service omnibus, pursuant to Regulations 1 and 5 of Division II. of Part III. of the Transport Consolidated Regulations, within a radius of fifty (50) miles from the respective post offices at Maffra, Sale, Rosedale, and Stratford, subject to the condition that all journeys undertaken shall commence within a radius of ten (10) miles from the said post office at Maffra, Sale, Rosedale, and Stratford.

3. Under special traffic conditions, pursuant to Regulation 2 of Division II. of Part III. of the Transport Consolidated Regulations, within a radius of thirty (30) miles of the respective post offices at Maffra, Sale, Rosedale, and Stratford, subject to the condition that every journey undertaken shall commence within a radius of ten (10) miles from the said post offices at Maffra, Sale, Rosedale, and Stratford.

MURRAY, H. E., and D. C. FRANKCOMBE, Wattle-avenue, Werribee; 1 commercial passenger vehicle, with seating capacity for 5 persons, to operate as follows:—(a) At separate and distinct fares within a radius of five (5) miles of Werribee Post Office, (b) under private hire conditions within a radius of fifty (50) miles of Werribee Post Office. Subject to the cancellation of licence No. C.T.117, at present in the name of Point Cook-Werribee Passenger Service.

MYLON, J. P., High-street, Wodonga; application for renewal of licence No. C.O.15 (expiring 14th November, 1954), authorizing operations as follows:—

1. As a stage omnibus on the following routes:—(a) Between Hume Weir and the border of New South Wales, *en route* to and from Albury, New South Wales, via Bonegilla, Bandianna, and Wodonga, (b) school service between Wodonga and Wodonga West State School, under contract to the Education Department.

2. The vehicle licensed as aforesaid shall be operated along the route defined in Part (a) of routes above, in conjunction with vehicles owned, and also operated along the said route by Eastern Roadlines Pty. Ltd.

3. The vehicle may also be operated as a touring omnibus within the State of Victoria, that is to say, on a round tour only on the routes set out below, and subject to the following conditions:—(i) All passengers carried on such round tour shall be carried for the whole of such round tour, and shall at the end of the tour be returned to the place from which the tour commenced, (ii) where the round tour commences at Albury or from a point outside the State of Victoria, such passengers shall be carried over the complete portion of the tour, which is within the State of Victoria, other than for the purpose of normal stops for sight-seeing or meals *en route*.

Routes to be Followed.

From Albury to Mt. Buffalo and/or Mt. Hotham, via Yackandandah to Beechworth, Myrtleford, and Bright, and return via the same route.

4. The vehicle may also be operated as a country special service omnibus, pursuant to Regulations 1 and 5 of Division II. of Part III. of the Transport

Consolidated Regulations, within a radius of fifty (50) miles from the post office at Wodonga, and also within a radius of fifty (50) miles from a point on the Victorian-New South Wales border nearest to Albury, New South Wales, subject to the condition that not more than four (4) of the vehicles hereby licensed may be so operated as special service omnibuses as aforesaid at any one time, and subject to the further condition that every journey undertaken shall commence within a radius of ten (10) miles from the said post office at Wodonga on the said point on the Victorian-New South Wales border nearest to Albury, New South Wales.

5. Under special traffic conditions, pursuant to Regulation 2 of Division II. of Part III. of the Transport Consolidated Regulations, within a radius of thirty (30) miles from the point on the Victorian-New South Wales border nearest to Albury, New South Wales, subject to the condition that every journey undertaken shall commence within a radius of ten (10) miles from the said point on the Victorian-New South Wales border nearest to Albury, New South Wales.

O'CONNELL, P. D., Tallangatta; application for renewal of licence No. C.T.46 (expiring 11th December, 1954), authorizing operations as follows:—(a) At separate and distinct fares within a radius of five (5) miles of Tallangatta, (b) under private hire conditions within a radius of fifty (50) miles of Tallangatta, (c) to operate as a stage omnibus for the carriage of passengers, mails, newspapers, and parcels on the following routes:—(i) Tallangatta-Mitta Mitta, via Tallandoon, Eskdale, Mitta Mitta North, and return to Tallangatta via Noorongoon (daily), (ii) Wodonga-Tallangatta, on Tuesdays, Thursdays, Fridays, and Saturdays, subject that not more than three passengers are carried at any one time.

PEARSON, R., 13 Ocean Grove, Warrnambool; application for renewal of licence No. C.T.60 (expiring 18th December, 1954), authorizing operations as follows:—(a) At separate and distinct fares for each passenger within a radius of six (6) miles from the post office at Warrnambool, (b) under private hire conditions within a radius of fifty (50) miles from the post office at Warrnambool.

SUTCLIFFE, B. C. (trading as Inverloch Taxis), Uilly Service Station, Inverloch; 1 commercial passenger vehicle, with seating capacity for 5 persons, to be purchased, to operate as follows:—(a) At separate and distinct fares within a radius of five (5) miles of Inverloch Railway Station, (b) under private hire conditions within a radius of seventy-five (75) miles of Inverloch Railway Station.

SUTHERLAND, A. J., 19 Pickett-street, Dandenong; 1 commercial passenger vehicle, with seating capacity for 5 persons, to be purchased, to operate for the carriage of passengers otherwise than at separate and distinct fares for each passenger throughout Victoria from 19 Pickett-street, Dandenong.

LANG, J., Bright; application for variation of licence No. C.T.67, to include the following day tour and half-day tour:—(1) Day tour—between Bright and Omeo, via Mt. Hotham; fare, 45s., including lunch, (2) half-day tour—between Bright-Porepunkah; fare, 12s. 6d., including afternoon tea.

PRESTON, R. W., & A. L. HILL (trading as Preston Taxi Service), Station-street, Lower Ferntree Gully; 1 commercial passenger vehicle, with seating capacity for 5 persons, to operate for the carriage of passengers otherwise than at separate and distinct fares for each passenger throughout Victoria from Station-street, Lower Ferntree Gully.

LANG, J., Bright; application for variation of licence No. T.O.56, to include the ability to operate as follows:—(a) To increase the seating capacity from 5 to approximately 30 persons, (b) as a stage omnibus between Bright and Mt. Hotham, as and when required, for conveyance of skiers and tourists. Fare—Bright to St. Bernard, £2; Bright to Mt. Hotham, £2 10s., (c) as a stage omnibus between Bright and Howman's Gap via Mt. Beauty, as and when required, for conveyance of skiers and tourists. Fare—£1 10s., (d) as a special service omnibus, subject to all Regulations appertaining to such operations, and subject that journeys undertaken commence within a radius of 10 miles of Bright Post Office, (e) under special traffic conditions, subject to all Regulations appertaining to such operations, and subject that journeys undertaken commence within a radius of 10 miles of Bright Post Office.

HARRISON, I. J. & G. G. (trading as Echuca Bus Service), Echuca; 2 commercial passenger vehicles, each with a seating capacity for 29 persons, to operate as follows:—
 (a) For the carriage of school children only between Kotta-Lockington and the Echuca High and Technical Schools, under contract to the Education Department,
 (b) between Echuca Post Office and Echuca Hospital, via Anstruther, High, Tyler, Hopwood, Eyre, and Haverfield streets, Boundary-road, and Francis-street, and return, (c) between Echuca Post Office and Echuca Ball-bearing Works, via Hare-street, Pakenham-street, Sturt-street, and Darling-road, (d) between Echuca Post Office and the border of New South Wales *en route* to and from Moama, New South Wales, via Hare-street and Percy-street, (e) between Echuca Post Office and Echuca Park, via Hare, Heygarth, High, and Dickson streets, (f) between Echuca Post Office and Bower's Bend, via Hare and Pakenham streets, (g) between Echuca Post Office and Echuca Racecourse, via Hare-street and the Murray Valley Highway, (h) between Echuca Post Office and the border of New South Wales *en route* to and from the Moama Racecourse, New South Wales, via Hare and Percy streets, River Murray Bridge, Deniliquin Highway, and Wamboota-road, (i) between Echuca Post Office and proposed showgrounds and trotting track in Echuca South, via Hare-street, Murray Valley Highway, and Government Hill, (j) as touring omnibuses on the following day tours:—(1) From Echuca to Shepparton, via Rochester, Corop, Colbinabbin, Rushworth, Waranga Basin, Tatura, and return via Wyuna. Fare—£1 10s., including lunch, (2) from Echuca to Bendigo, via Kyabram, Waranga Basin, Rushworth, Colbinabbin, and Goornong, and return via the Northern Highway. Fare—£1 10s., including lunch, (3) from Echuca to Turrumberry Loch, via Murray Valley Highway, and return via the same route. Fare—6s., (k) as a special service omnibus, subject to all Regulations appertaining to such operations, and subject that journeys undertaken commence within a radius of 10 miles of Echuca Post Office, (l) under special traffic conditions, subject to all Regulations appertaining to such operations, and subject that journeys undertaken commence within a radius of 10 miles of Echuca Post Office, and from Echuca to any of the following places, viz.:—Shepparton, Tatura, Cohuna, Nathalia, Rushworth, Numurkah, and the border of New South Wales *en route* to Deniliquin, New South Wales. Subject to the cancellation of licence Nos. T.S.6 and C.O.112, at present in the name of A. H. Shorthouse, Echuca, and subject further that the Education Department authorize the applicant to operate the school service as set out in paragraph (a).

CHRISTIE, D. W., 81 Sherwood-avenue, Chelsea; 1 commercial passenger vehicle, with seating capacity for 5 persons, to operate as follows:—(a) At separate and distinct fares from or to the Chelsea Railway Station to and from places within a radius of 5 miles of Chelsea Railway Station, (b) under private hire conditions within a radius of 50 miles of Chelsea Railway Station. Subject to the cancellation of licence No. C.T.513, at present in the name of W. Murray of Chelsea.

HOY'S PASSENGER SERVICE PTY. LTD., Mackay-street, Wangaratta; 1 commercial passenger vehicle, with seating capacity for 31 persons, to operate under the same terms and conditions of licence No. C.O.924, at present in the name of the applicant, and subject to the cancellation of such licence. (The purpose of application is to have licence granted to expire on 23rd October, 1956, the expiry date of all other licences held by the applicant company.)

FLOOD, T. R., Arnold-street, Bendigo; application for variation of licence No. T.S.352, to delete charter rights from Toolleen, and instead to include the ability to operate as an urban special service omnibus, subject to all Regulations appertaining to such operations; and subject that journeys undertaken commence within the urban area of Bendigo.

Notice of any objection should be forwarded to reach the Secretary to the Board not later than Wednesday, 20th July, 1954.

E. V. FIELD,
Secretary.

Exhibition Buildings, Rathdown-street, Carlton, N.3, 7th July, 1954.

Pounds Act 1928.

SHIRE OF WYCHEPROOF.

TABLE of Rates to be charged for the Trespass of Cattle and their sustenance while impounded, in the Nandaly Pound fixed by the Council of the Shire of Wycheproof.

Description of Cattle Trespassing.	Trespass Rates.		Sustenance Fees
	Upon Land other than Tillage Land Enclosed by a Substantial Fence.	Upon Tillage Land Enclosed by a Substantial Fence.	Amount to be Charged Daily for Sustenance while Impounded.
	s. d.	s. d.	s. d.
For every sheep ..	0 1	1 0	0 6
For every goat ..	0 3	10 0	3 0
For every pig ..	0 3	10 0	5 0
For every head of other cattle ..	5 0	10 0	7 0

By order of the Council,

A. SAYERS,
Shire Secretary.

Approved by the Governor in Council,
29th June, 1954.

A. MAHLSTEDT,
Clerk of the Executive Council.

Marriage Act 1928.

MINISTERS OF RELIGION REGISTERED TO CELEBRATE MARRIAGES IN VICTORIA.

It is hereby notified that, in pursuance of the provisions of the Marriage Act 1928, 19 Geo. V., No. 3726, Sec. 11, the under-mentioned Officiating Ministers of Religion have been registered at this Office for the celebration of marriages in Victoria:—

Number in Register.	Name.	Designation.	Denomination.	Residence.	Date of Registration.
10997	Kircher, Geoffrey Wm. ..	Priest ..	Church of England ..	St. Mary's, North Melbourne ..	1.5.54
10998	Munn, Sydney Morris ..	Minister ..	Congregational ..	34 Olinda-street, Bendigo ..	10.5.54
10999	Eldridge-Doyle, Claude James ..	Priest ..	Church of England ..	Mission to Seaman, Port Melbourne ..	12.5.54
11000	Girvan, Henry Hugh ..	Priest ..	Church of England ..	188 Hotham-street, East Melbourne ..	17.5.54
11001	Frost, Lindsay John ..	Pastor ..	Baptist ..	Barraport ..	14.5.54
11002	McDowell, William Walter ..	Preacher ..	Church of Christ ..	Warragul ..	19.5.54
11003	Howells, Thomas Boase ..	Minister ..	Presbyterian ..	Penahurst ..	12.5.54
11004	Fomitshevskiy Gregor ..	Priest ..	Ukranian Auto. Orthod. ..	Mooroolbool-street, Geelong ..	13.5.54
11005	Mueller, Paul Albert ..	Pastor ..	Evan. Luth. ..	Trinity Church, Newborough ..	31.5.54

Office of the Government Statist,
Melbourne, C.1, 28th June, 1954.

O. GAWLER,
Government Statist.

NOTICE.

ADMINISTRATION of the estate of each of the under-mentioned deceased persons has been granted to the Public Trustee, and creditors, next of kin, and all others having claims against the estate of any of the persons so mentioned are required to send particulars of their claims to the Public Trustee, No. 412 Collins-street, Melbourne, on or before the 9th September, 1954, or they will be excluded from the distribution of the estate when the assets are being distributed:—

*ALDERSON, VIOLET CONSTANCE, formerly of "Te-Aro," 11 Murray-street, Moonee Ponds, Victoria, and 19 East Esplanade, Manly, New South Wales, but late of Gladsville, New South Wales, spinster, died 4th February, 1953.

ARNALL, HAROLD VICTOR, late of 159 Hearne-street, Colac, painter, died 20th December, 1952.

†AUSTIN, CHARLES VICTOR, formerly of 203 Oxide-street, Broken Hill, New South Wales, but late of 36 Dorothy-avenue, Glenhuntly, Victoria, printer, died 28th January, 1954.

BENBOW, CHARLES JOHN, late of Shepparton, pensioner, died 26th September, 1953, intestate.

BLAIR, FRANCIS ALEXANDER, also known as Francis Alexander Avice, late of Ararat, pensioner, died 1st March, 1954, intestate.

CHEESE, ARTHUR REGINALD, formerly of King Island, but late of 22 Trafalgar-road, Camberwell, retired grazier, died 26th February, 1954, intestate.

DAY, WILLIAM GEORGE, late of 72 O'Heas-street, Coburg, pensioner, died 26th April, 1954, intestate.

*DONAHOO, JOANNA, late of 52 Park-street, St. Kilda, widow, died 17th March, 1954.

†EAVES, GEORGE TERENCE, also known as Terence George Eaves, formerly of 36 Rosemont-avenue, Caulfield, but late of Mont Park, clerk, died 30th December, 1953.

EHRNHOLM, IRENE, also known as Irene Frances Ehrnholm, formerly of 19 Threadneedle-street, Balwyn, but late of 38 Arthur-street, South Yarra, widow, died 3rd May, 1954, intestate.

FIRTH, WILLIAM, late of 109 Albert-street, East Melbourne, advertising executive, died 22nd April, 1954, intestate.

GILBERT, PEARL ELLEN, formerly of 241 Punt-road, Richmond, but late of 7 Stortford-avenue, West Ivanhoe, married woman, died 18th July, 1952, intestate.

*GOOCH, HARRY PERCY, formerly of 5 Mathoura-road, Toorak, but late of Kew, retired traveller, died 20th December, 1953.

*GOULDEN, MINNIE, late of 7 Craine-street, South Melbourne, seamstress, died 1st March, 1954.

GRILLS, NELLIE ATKINSON, also known as Nellie Atkinson Grylls, late of 61 Barkly-avenue, Armadale, married woman, died 11th February, 1954, intestate.

*HILL, ALFRED JOHN, late of Dunsandel, New Zealand, labourer, died 2nd March, 1954.

LEWANDZIEWSKI, CZESLAW, late of lot 257 Collins-street, St. Albans, labourer, died 14th January, 1953, intestate.

*MACK, ROBERTA ELIZABETH, late of 37 Thanet-street, Malvern, married woman, died 31st March, 1954.

PARKER, IGNATIUS CHARLES, formerly of Chiltern, but late of Ovens and Murray Home, Beechworth, pensioner, died 23rd November, 1953, intestate.

PELL, WILLIAM FOSTER, late of Mountain Highway, Bayswater, pensioner, died 12th August, 1953, intestate.

ROCHE, LAURENCE, late of 18 Agnew-street, Brighton, retired postal employee, died 21st May, 1954, intestate.

*SPEERS, JOHN ALEXANDER, late of 51 Brougham-street, Kew, pensioner, died 2nd May, 1954.

†STANISLAUS, ARTHUR ERNST BARTHULT, also known as Arthur Stanislaus, late of St. Arnaud, labourer, died 14th August, 1952.

†STANISLAUS, ELLA MARIE IDA, also known as Ella Stanislaus, late of St. Arnaud, spinster, died 14th December, 1952.

*STANLEY, SYDNEY GORDON, late of 44 Dalmor-avenue, Ormond, salesman, died 18th April, 1954.

*STUART, LESLIE, also known as Leslie Lincoln Stuart, late of 17 Milverton-street, Moonee Ponds, barman, died 24th March, 1954.

†TAYLOR, ERNEST RAYMOND, late of Bundoora, labourer, died 2nd April, 1954.

WEBB, WILLIAM, late of Melbourne Home and Hospital for Aged, Cheltenham, pensioner, died 3rd April, 1954, intestate.

* With the will annexed.

† According to the provisions of the will.

C. J. GARDNER,
Public Trustee.

Melbourne, 30th June, 1954.

4 GEORGE VI. No. 4755, SECTION 6.

I HEREBY give notice that on the 24th June, 1954, I filed elections to administer the following deceased persons' estates, in accordance with section 6 of the *Public Trustee Act 1940*:—

DAY, WILLIAM GEORGE, late of 72 O'Heas-street, Coburg, pensioner, died 26th April, 1954, intestate.

EHRNHOLM, IRENE, also known as Irene Frances Ehrnholm, formerly of 19 Threadneedle-street, Balwyn, but late of 38 Arthur-street, South Yarra, widow, died 3rd May, 1954, intestate.

GRILLS, NELLIE ATKINSON, also known as Nellie Atkinson Grylls, late of 61 Barkly-avenue, Armadale, married woman, died 11th February, 1954, intestate.

PARKER, IGNATIUS CHARLES, formerly of Chiltern, but late of Ovens and Murray Home, Beechworth, pensioner, died 23rd November, 1953, intestate.

PELL, WILLIAM FOSTER, late of Mountain Highway, Bayswater, pensioner, died 12th August, 1953, intestate.

ROCHE, LAURENCE, late of 18 Agnew-street, Brighton, retired postal employee, died 21st May, 1954, intestate.

I HEREBY give notice that on the 25th June, 1954, I filed elections to administer the following deceased persons' estates, in accordance with section 6 of the *Public Trustee Act 1940*:—

*AUSTIN, CHARLES VICTOR, formerly of 203 Oxide-street, Broken Hill, New South Wales, but late of 36 Dorothy-avenue, Glenhuntly, Victoria, printer, died 28th January, 1954.

BENBOW, CHARLES JOHN, late of Shepparton, pensioner, died 26th September, 1953, intestate.

BLAIR, FRANCIS ALEXANDER, also known as Francis Alexander Avice, late of Ararat, pensioner, died 1st March, 1954, intestate.

*EAVES, GEORGE TERENCE, also known as Terence George Eaves, formerly of 36 Rosemont-avenue, Caulfield, but late of Mont Park, clerk, died 30th December, 1953.

*STANISLAUS, ARTHUR ERNST BARTHULT, also known as Arthur Stanislaus, late of St. Arnaud, labourer, died 14th August, 1952.

*STANISLAUS, ELLA MARIE IDA, also known as Ella Stanislaus, late of St. Arnaud, spinster, died 14th December, 1952.

WEBB, WILLIAM, late of Melbourne Home and Hospital for Aged, Cheltenham, pensioner, died 3rd April, 1954, intestate.

* According to the provisions of the will.

I HEREBY give notice that on the 28th June, 1954, I filed an election to administer the following deceased person's estate, in accordance with section 6 of the *Public Trustee Act 1940*:—

*TAYLOR, ERNEST RAYMOND, late of Bundoora, labourer, died 2nd April, 1954.

* According to the provisions of the will.

C. J. GARDNER,
Public Trustee.

412 Collins-street, Melbourne, C.1, 30th June, 1954.

NOTICE TO MARINERS.

[No. 10 of 1954.]

AUSTRALIA.—VICTORIA.

THE following Notice to Mariners, which has been received from the Harbor Master, Geelong, is published for general information.

D. S. STEVENSON,
Port Officer.

Ports and Harbors Branch,
Department of Public Works,
Melbourne, C.2, 2nd July, 1954.

GEELONG HARBOR TRUST COMMISSIONERS.

PORT OF GEELONG.

Information about Dredging.

Former Notice No. 5 of 1954 (1) hereby cancelled.

Details.—Dredging operations in the Wilson Spit Channel have been completed and the dredge withdrawn to resume dredging operations in the Corio Quay area.

Caution.—When approaching and passing dredge all vessels must reduce speed to a minimum.

Local Government Acts.
CITY OF HEIDELBERG.

ORDER, CONFIRMED.

THE Minister of the Crown administering the *Local Government Act 1946*, on the 28th day of June, 1954, confirmed the Order hereinafter referred to in pursuance of section 513 of the said Act, viz.:—

An Order of the Council of the City of Heidelberg, made on the 12th April, 1954, for the purpose of widening Lower Plenty-road, Rosanna, the opening of a new street off Lower Plenty-road through lot 4, increasing the width of rights-of-way at the rear of Lower Plenty-road and Beetham-parade, and the closing of approximately 171 feet of right-of-way off Beetham-parade between lots 1 and 5, and the closing of portion of right-of-way at the rear of lots 6, 7, 8, and 9, Lower Plenty-road, and for acquiring for such purposes all those pieces of land in the municipal district of the City of Heidelberg described hereunder:—

- (a) All those pieces of land, being lots 1, 2, 3, 4, and 11 on plan of subdivision No. 9752, lodged in the Office of Titles, and being parts of Crown portion 5, Parish of Keelbundora, County of Bourke, being more particularly described in certificate of title, volume 6065, folio 1212970, in the name of Bellereive Estates Pty. Ltd., as registered proprietor.
- (b) All that piece of land, being lot 8 on plan of subdivision No. 10221, lodged in the Office of Titles, and being part of Crown portion 5, Parish of Keelbundora, County of Bourke, being more particularly described in certificate of title, volume 4494, folio 898726, in the names of James Hamilton and James Thomas Hamilton as joint registered proprietors and Catherine Laidlaw Hancock as rated owner.
- (c) All that piece of land, being lot 11 on plan of subdivision No. 10221, lodged in the Office of Titles, and being part of Crown portion 5, Parish of Keelbundora, County of Bourke, being more particularly described in certificate of title, volume 5644, folio 1128735, in the name of Norman Walter Cameron Curtis as registered proprietor.
- (d) All that piece of land commencing at the north-west corner of lot 4 and proceeding at a bearing of 46 deg. 36 min. for a distance of 10 feet; thence at a bearing of 136 deg. 36 min. for a distance of 18 ft. 2½ in.; thence at a bearing of 226 deg. 36 min. for a distance of 10 feet; thence to the commencing point at a bearing of 316 deg. 36 min. for a distance of 18 ft. 2½ in., and being part of lot 4 on plan of subdivision No. 10221, lodged in the Office of Titles, and being part of Crown portion 5, Parish of Keelbundora, County of Bourke, being more particularly described in certificate of title, volume 4919, folio 983629, in the name of Rowland Herbert Bailey, deceased, as registered proprietor.
- (e) All that piece of land commencing at the north-west corner of lot 6 and proceeding at a bearing of 46 deg. 36 min. for a distance of 10 feet; thence at a bearing of 136 deg. 36 min. for a distance of 18 feet; thence at a bearing of 226 deg. 36 min. for a distance of 10 feet; thence to the commencing point at a bearing of 316 deg. 36 min. for a distance of 18 feet, and being part of lot 6 on plan of subdivision No. 10221, lodged in the Office of Titles, and being part of Crown portion 5, Parish of Keelbundora, County of Bourke, being more particularly described in certificate of title, volume 6516, folio 1303152, in the name of Charles Burton Holland as registered proprietor.

S. MERRIFIELD,

Commissioner of Public Works.

Department of Public Works,
Local Government Branch,
Melbourne.

MOTOR CAR REGULATIONS 1952.

APPROVAL OF PORTABLE WARNING LAMPS.

NOTICE is hereby given that, for the purposes of clause 118 of the Motor Car Regulations 1952, approval has been granted for the use, as a portable warning lamp, of any lamp which is of the hurricane type and is capable of producing a clear red warning light visible at a distance of 600 feet from such lamp.

ALEX. M. DUNCAN,
Chief Commissioner of Police.

No. 649.—6521/54.—2

LAW DEPARTMENT.—ATTORNEY-GENERAL.
HAWKERS' AND PEDLERS' LICENCES.

HIS Excellency the Governor of the State of Victoria, by and with the advice of the Executive Council thereof, and in pursuance of the provisions of section 6 of the *Hawkers and Pedlers Act 1928*, doth hereby appoint every Tuesday for holding General Meetings of Justices for the special purpose of taking into consideration applications for hawkers' and pedlers' licences at the Court House at Bendigo, within the Loddon Police District, in lieu of the days heretofore appointed, to take effect as from and inclusive of the 20th July, 1954.

A. MAHLSTEDT,
Clerk of the Executive Council.

At the Executive Council Chamber,
Melbourne, 29th June, 1954.

LAW DEPARTMENT.—ATTORNEY-GENERAL.

CHILDREN'S COURT, BENDIGO.—DAYS AND HOUR APPOINTED.

HIS Excellency the Governor of the State of Victoria, by and with the advice of the Executive Council thereof, and pursuant to the provisions of the *Children's Court Act 1928*, doth hereby appoint every Monday, Wednesday, and Friday at Two o'clock p.m. as the days and hour for the holding of the Children's Court at Bendigo, in lieu of the day and hour heretofore appointed, to take effect as on and after the 19th July, 1954.

A. MAHLSTEDT,
Clerk of the Executive Council.

At the Executive Council Chamber,
Melbourne, 29th June, 1954.

CITY OF SOUTH MELBOURNE.

DECISION OF MINISTER AND COUNCIL THAT A CERTAIN RIGHT-OF-WAY IN SOUTH MELBOURNE IS NOT REQUIRED FOR PUBLIC TRAFFIC.

WHEREAS a certain right-of-way, part of right-of-way No. 202, all that portion of land being part of Crown allotments 2 and 8, section 29, City of South Melbourne, Parish of Melbourne South, County of Bourke, from a point on the south-easterly building line of City-road, distant 122 feet south-westerly from Cecil-street; thence by a line bearing 124 deg. 21 min. for a distance of 90 feet on the easterly side of gazetted right-of-way (No. 202); thence by a line bearing 151 deg. 2 min. for a distance of 65 feet still on the easterly side of gazetted right-of-way (No. 202), such point being commencing point. Commencing from this point thence by a line bearing 151 deg. 2 min. for a distance of 35 ft. 3 in.; thence by a line bearing 241 deg. 2 min. for a distance of 9 ft. 7 in.; thence by a line bearing 331 deg. 2 min. for a distance of 35 ft. 3 in.; thence by a line bearing 61 deg. 2 min. for a distance of 9 ft. 7 in. to commencing point, is situated within the Municipal District of the City of South Melbourne and was declared a public highway by notice published in the *Government Gazette* of the 23rd September, 1908:

And whereas it is alleged that the said right-of-way is no longer required for public traffic, and the question whether the said right-of-way is or is not required for public traffic has been referred to the Council of the said City of South Melbourne, and to the Honorable Samuel Merrifield in his capacity as the responsible Minister of the Crown for the time being, administering section 552 of the *Local Government Act 1946*:

Now therefore the said Council and the said Samuel Merrifield, as such Minister as aforesaid, having taken the said question into their consideration, do, under the powers vested in them by this present instrument under the common seal of the City of South Melbourne, and the hand and seal of the said Samuel Merrifield, as such Minister aforesaid, hereby decide that the said right-of-way is not required for public traffic.

Dated the 5th day of February, in the year of our Lord One thousand nine hundred and fifty-four.

The common seal of the City of South Melbourne was hereunder affixed in the presence of—

(SEAL) J. J. STRICKLAND, Mayor.
WILLIAM E. WELLS, Councillor.
H. ALEXANDER, Town Clerk.

Signed, sealed, and delivered by the said Samuel Merrifield, in the presence of C. C. GALE.

(SEAL) S. MERRIFIELD.

MELBOURNE AND METROPOLITAN BOARD OF WORKS.

NOTICE TO THE OWNERS OF TENEMENTS IN THE UNDERMENTIONED STREETS AND THE PRIVATE STREETS, LANES, COURTS, AND ALLEYS OPENING THERETO.

THE main pipe in the said streets being laid down, the owners of all tenements situated as under are hereby required, on or before 9th August, 1954, to cause a proper pipe and stock-cocks to be laid, so as to supply water within such tenements from the main pipe.

C. F. TRATHAN,
Secretary.

29th June, 1954.

STREET AND POSITION.

Brighton.

Denton-street, from Dumaresq-street westwards 3½ chains.

Broadmeadows.

Hood-street, from Napier-street to Pascoe Vale-road.
Vernon-street, from Hood-street northwards 2½ chains.
Golf Links-road, from Plumpton-avenue eastwards 8 chains.

Albert-street, from George-road to Nerissa-grove.
Nerissa-grove, from Edith-street northwards 9½ chains.
Snell-grove, from Watt-avenue westwards 16 chains.
Snell-grove, from Watt-avenue to Perrin-street.
Watt-avenue, from Callender-road to Snell-grove.
George-road, from Olive-street to Snell-grove.
Malcolm-street, from George-road to Watt-avenue.
Watt-avenue, from 5 chains south of Callender-road to Arndt-road.

Arndt-road, from Watt-avenue to Quick-street.
Quick-street, from Callender-road southwards 4½ chains.
Winifred-road, from Quick-street to Watt-avenue.
Devon-road, from Austin-crescent eastwards 5½ chains.

Brunswick.

Galtes-crescent, from Moreland-road to Southam-street.
Southam-street, from Moreland-road to Galtes-crescent.

Footscray.

Angliss-street, from Francis-street to Adeney-street.

Heidelberg.

McEwan-road, from Outhwaite-road to Collins-street.
Terry-street, from McEwan-road to Bamfield-road.

Moorabbin.

Barrington-street, from Mackie-road westwards 40½ chains.
Tambet-street, from North-road southwards 29½ chains.
Argyle-street, from Mackie-road to Tambet-street.
Melva-street, from Argyle-street northwards 6½ chains.
Poath-road, from Argyle-street northwards 6½ chains.
Gardiners-road, from Centre-road northwards 35½ chains.
Quinn's road, from Gardiners-road to East Boundary-road.
St. Georges-avenue, from Centre-road, northwards 10½ chains.

Longview-avenue, from Gardiners-road, eastwards 10 chains.

Langslow-street, from Gardiners-road to Stratford-avenue.
Fraser-street, from Gardiners-road to Stratford-avenue.
Stockdale-avenue from Gardiners-road eastwards 10 chains.

Castlewood-street, from Gardiners-road, eastwards 10 chains.

Stratford-avenue, from Longview-avenue to Stockdale-avenue.

Mulgrave.

Madeleine-street, from 2½ chains north of Margaret-street, northwards 2½ chains.

Quaintance-street, from Essex-road eastwards 17 chains.
Carinish-road from Lillian-street south-eastwards 11½ chains.

Colonel-street, from 4½ chains west of Madeleine-street to Flora-grove.

Flora-grove, from Colonel-street northwards 4½ chains.
Murray-street, from Clayton-road eastwards 10 chains.
Dixon-street, from Clayton-road eastwards 10 chains.
George-street, from Warrigal-road eastwards 22½ chains.
May Park-avenue, from Queen's-avenue westwards 6½ chains.

Oakleigh.

Flora-grove, from Colonel-street northwards 4½ chains.

Preston.

Allenby-avenue, from Hobbs-crescent to Gellibrand-crescent.

Gellibrand-crescent, from Allenby-avenue to Rodman-street.

Rodman-street, from Gellibrand-crescent north-westwards 6½ chains.

Sturdee-street, from Rodman-street to Jackson-street.
Jackson-street, from Sturdee-street north-westwards 1½ chains.

Gellibrand-crescent, from McCay-street to Allenby-avenue.
McCay-street, from Hobbs-crescent north-westwards 10½ chains.

Grimwade-street, from Gellibrand-crescent north-westwards 10½ chains.

Pickett-street, from Hickford-street north-eastwards 5 chains.

Pickett-street, from Mack-street eastwards 4½ chains.

Hickford-street, from Cheddar-road East eastwards 10½ chains.

Cheddar-road East, from Hickford-street to St. Vigeons-road.

Cheddar-road West, from Hickford-street north-eastwards 9½ chains.

Hickford-street, from 4½ chains north-west of Mack-street to Smith-street.

Smith-street, from Hickford-street to Harmer-street.
Harmer-street, from Smith-street eastwards 13½ chains.

Lambassa-grove, from Lloyd-street southwards 3 chains.
Lloyd-street, from 2 chains west of Falk-avenue to Johnson-street.

Johnson-street, from Lloyd-avenue northwards 7½ chains.
Liston-street, from Johnson-street eastwards 2½ chains.

Sandringham.

Hillcroft-avenue, from David-street northwards 3½ chains.

Melbourne and Metropolitan Board of Works Acts.
MELBOURNE AND METROPOLITAN BOARD OF WORKS.

NOTICE DECLARING THAT AN EXISTING DRAIN WITHIN THE CITY OF BRIGHTON AND WITHIN THE METROPOLIS SHALL BE AND BE DEEMED TO BE A MAIN DRAIN. (DRAIN No. 4960.)

MELBOURNE AND METROPOLITAN BOARD OF WORKS, under the powers conferred upon it by the Melbourne and Metropolitan Board of Works Acts, and otherwise, doth by this notice declare that the existing drain (or portion thereof) within the metropolis, as the same is defined and described hereunder, shall be a main drain under and for the purposes of the Melbourne and Metropolitan Board of Works Acts.

EXISTING DRAIN ABOVE REFERRED TO.

The following is a description of the course of and a specification of the points of commencement and termination of the said existing drain, that is to say:—

Commencing at the termination of the main drain as described in *Victoria Government Gazette* No. 1219, dated 31st December, 1948, page 7616; thence by an open drain and an underground drain on the north side of Outer-crescent to St. Andrew-street, easterly and south-easterly across St. Andrew-street, and along the north side of Durrant-street to and terminating at a point in line with the west building line of that portion of Carpenter-street which is north of Durrant-street.

Dated this fifteenth day of June, 1954.

The common seal of the Melbourne and Metropolitan Board of Works was affixed hereto, in the presence of—

(SEAL) J. C. JESSOP, Chairman.
CHAS. F. ROOKS, Member.
C. TRATHAN, Secretary.

SHIRE OF DANDENONG.

ORDER CONFIRMED.

THE Minister of the Crown administering the *Local Government Act* 1946, on the 21st day of June, 1954, confirmed the Order hereinafter referred to, in pursuance of section 513 of the said Act, viz.:—

An Order of the Council of the Shire of Dandenong, made on the 25th January, 1954, for the purpose of providing a place of recreation and children's playground, and for acquiring for such purpose all that piece of land in the municipal district of the Shire of Dandenong being lot 44, block C, on plan of subdivision No. 1239, lodged in the Office of Titles, and being part of Crown allotment 2, section 12, at Springvale, Parish of Mordialloc, County of Bourke, and being the land more particularly described in certificate of title, volume 3968, folio 793539.

S. MERRIFIELD,
Commissioner of Public Works.

SHIRE OF WOORAYL.—ROAD DEVIATION.

ORDER IN COUNCIL.

IN pursuance of the powers conferred by sections 521 and 525 of the *Local Government Act 1946*, the Council of the Shire of Woorayl, doth hereby order that the lands next hereinafter described shall be a public highway from the date of the publication of this Order in the *Government Gazette*, that is to say:—

All that piece of land being part of Crown allotment 42A, Parish of Allambee, County of Buln Buln, commencing at the eastern-most corner of allotment 42B, Parish of Allambee, County of Buln Buln; thence N. 61 deg. 57 min. E. 2,683.0 links; thence N. 2 deg. 25 min. W. 401.2 links, to the point of commencement. Thence N. 57 deg. 50 min. W. 38.0 links; thence S. 64 deg. 21 min. W. 256.0 links; thence N. 71 deg. 52 min. W. 178.0 links; thence S. 39 deg. 5 min. W. 141.4 links; thence S. 27 deg. 28 min. W. 178.5 links; thence N. 62 deg. 32 min. W. 184.0 links; thence N. 2 deg. 43 min. E. 407.6 links; thence N. 17 deg. 54 min. W. 276.0 links; thence N. 20 deg. 21 min. E. 381.0 links; thence N. 76 deg. 6 min. W. 170.8 links; thence N. 87 deg. 26 min. W. 270.0 links; thence N. 9 deg. 6 min. W. 390.5 links; thence N. 12 deg. 38 min. E. 147.0 links; thence N. 14 deg. 32 min. W. 167.0 links; thence N. 14 deg. 20 min. E. 287.0 links; thence N. 63 deg. 38 min. E. 327.0 links; thence N. 41 deg. 59 min. E. 195.0 links; thence N. 16 deg. 3 min. E. 175.5 links; thence N. 35 deg. 30 min. E. 45.5 links; thence N. 11 deg. 45 min. W. 326.1 links; thence S. 24 deg. 20 min. E. 365.7 links; thence S. 16 deg. 3 min. W. 251.4 links; thence S. 41 deg. 59 min. W. 237.1 links; thence S. 63 deg. 38 min. W. 300.2 links; thence S. 14 deg. 20 min. W. 215.1 links; thence S. 14 deg. 32 min. E. 165.2 links; thence S. 12 deg. 38 min. W. 152.0 links; thence S. 9 deg. 6 min. E. 289.8 links; thence S. 87 deg. 26 min. E. 198.5 links; thence S. 76 deg. 6 min. E. 292.7 links; thence S. 20 deg. 21 min. W. 458.4 links; thence S. 17 deg. 54 min. E. 259.7 links; thence S. 2 deg. 43 min. W. 275.5 links; thence S. 62 deg. 32 min. E. 54.0 links; thence N. 39 deg. 5 min. E. 231.0 links; thence S. 71 deg. 52 min. E. 206.5 links; thence N. 64 deg. 21 min. E. 271.0 links; thence S. 57 deg. 50 min. E. 121.0 links; thence S. 64 deg. 35 min. W. 86.5 links; thence S. 2 deg. 25 min. E. 32.8 links to the point of commencement: And the said Council doth hereby declare that the lands above described shall from the said date of publication in the *Government Gazette* be a public highway, in lieu of the land hereinafter described, that is to say:—

All that piece of land being part of Crown allotment 42A, Parish of Allambee, County of Buln Buln, commencing at the northern-most angle of allotment 42B, Parish of Allambee, County of Buln Buln; thence S. 28 deg. 5 min. E. 174.0 links to the point of commencement. Thence S. 28 deg. 5 min. E. 243.0 links; thence N. 17 deg. 39 min. E. 23.8 links; thence N. 6 deg. 14 min. W. 253.7 links; thence N. 18 deg. 56 min. E. 438.0 links; thence S. 76 deg. 47 min. E. 159.7 links; thence N. 79 deg. 14 min. E. 353.0 links; thence S. 74 deg. 59 min. E. 618.3 links; thence N. 46 deg. 59 min. E. 189.3 links; thence N. 29 deg. 35 min. E. 310.2 links; thence N. 3 deg. 14 min. E. 353.2 links; thence N. 36 deg. 50 min. E. 553.5 links; thence N. 66 deg. 41 min. E. 590.2 links; thence N. 35 deg. 30 min. E. 323.9 links; thence N. 16 deg. 3 min. E. 16.0 links; thence N. 24 deg. 20 min. W. 351.7 links; thence S. 11 deg. 45 min. E. 282.2 links; thence S. 35 deg. 30 min. W. 297.8 links; thence S. 66 deg. 41 min. W. 589 links; thence S. 36 deg. 50 min. W. 610.4 links; thence S. 3 deg. 14 min. W. 360.0 links; thence S. 29 deg. 35 min. W. 271.5 links; thence S. 46 deg. 59 min. W. 118.5 links; thence N. 74 deg. 59 min. W. 585.7 links; thence S. 79 deg. 14 min. W. 354.7 links; thence N. 76 deg. 47 min. W. 229 links; thence S. 18 deg. 56 min. W. 550.8 links; thence S. 6 deg. 14 min. E. 72.3 links to the point of commencement.

Dated the 2nd day of April, 1954.

The corporate seal of the President, Councillors, and Ratepayers of the Shire of Woorayl was hereunto affixed, in the presence of—

(SEAL) C. A. BOND, President.
A. J. SLOAN, Councillor.
W. G. HOLT, Councillor.
C. H. LYON, Secretary.

Approved by the Governor in Council,
29th June, 1954.

A. MAHLSTEDT,
Clerk of the Executive Council.

BARLEY MARKETING ACTS.

I. CLIVE PHILLIP STONEHAM, Minister of Agriculture, do hereby appoint Wednesday, the 18th day of August, 1954, as the day for the holding of an Election of a Representative of Growers of Barley in Victoria on the Australian Barley Board, and do further appoint Wednesday, the 21st day of July, 1954, as the day for nominations to be lodged with the Returning Officer, Mr. F. E. Cahill (the Chief Electoral Officer for State of Victoria), Old Treasury Building, Spring-street, Melbourne. Nominations will close at noon on nomination day. Dated this 5th day of July, 1954.

C. P. STONEHAM,
Minister of Agriculture.

State Electricity Commission Acts.

AGREEMENT RELATING TO THE EXTENSION OF TRANSMITTED SUPPLY TO BEAUFORT AND THE ACQUISITION BY THE STATE ELECTRICITY COMMISSION OF VICTORIA OF AN ELECTRICITY SUPPLY UNDERTAKING OPERATED BY THE SHIRE OF RIPON.

HIS Excellency the Governor of the State of Victoria, by and with the advice of the Executive Council thereof, doth, by Order made on the 6th day of July, 1954, approve the terms of an agreement between the State Electricity Commission of Victoria and the Shire of Ripon relating to the extension of transmitted supply to Beaufort and the acquisition by the Commission of the Beaufort Electricity Supply Undertaking operated by the Shire of Ripon, as authorized by the Shire of Ripon (Beaufort) Electric Lighting Order No. 199—1927.

A. MAHLSTEDT,
Clerk of the Executive Council.

At the Executive Council Chamber,
Melbourne, 6th July, 1954.

Housing Acts.

NOTICE OF RESOLUTION UNDER SECTION 40 (4) OF ACT No. 4568.

NOTICE is hereby given that Housing Commission, on the 15th day of June, 1954, resolved as follows:—

Whereas Housing Commission, in respect of the lands described in the Schedule hereto, has published a general notice under sub-section (3) of section 40 of the *Slum Reclamation and Housing Act 1938*, Housing Commission hereby resolves that the lands described in the Schedule hereto are finally appropriated for the purposes of the Housing Acts.

SCHEDULE.

All those pieces of land within the municipality of the City of Fitzroy described hereunder, namely:—

First.—All of the land more particularly described in a deed of conveyance memorialized in the Office of the Registrar-General, and numbered therein 958 of Book 497.

Secondly.—All of the land more particularly described in a deed of conveyance memorialized in the Office of the Registrar-General, and numbered therein 23 of Book 570.

Thirdly.—All of the land more particularly described in a deed of conveyance memorialized in the Office of the Registrar-General, and numbered therein 178 of Book 145.

Fourthly.—All of the land more particularly described in a deed of conveyance memorialized in the Office of the Registrar-General, and numbered therein 406 of Book 599.

Fifthly.—All of the land more particularly described in a deed of conveyance memorialized in the Office of the Registrar-General, and numbered therein 847 of Book 592.

Sixthly.—All of the land more particularly described in a deed of conveyance memorialized in the Office of the Registrar-General, and numbered therein 681 of Book 610.

Seventhly.—All of the land more particularly described in a deed of conveyance memorialized in the Office of the Registrar-General, and numbered therein 52 of Book 418.

R. J. THOMSON,
Secretary.

Stock Diseases Act 1928 (No. 3779).

QUARANTINE DISTRICTS UNDER REGULATION 37.

THE quarantine restrictions imposed on the following properties have been removed:—

Name; Address.

Forrest, P. B. & J. J.; Barjarg Station, Barjarg.
Riley, J. A.; Rutherglen.

R. J. DE C. TALBOT,
Chief Inspector of Stock.

Town and Country Planning Acts.

CITY OF BRUNSWICK PLANNING SCHEME No. 3, 1953.

NOTICE OF APPROVAL.

IN pursuance of the powers conferred by the Town and Country Planning Acts, the Governor of the State of Victoria, by and with the advice of the Executive Council thereof, having taken into consideration reports of the Melbourne and Metropolitan Board of Works and of the Town and Country Planning Board to the Minister thereon, on the 16th day of June, 1954, approved of a scheme submitted by the Council of the Municipality of the City of Brunswick, pursuant to the said Acts, entitled *The City of Brunswick Planning Scheme, No. 3, 1953*, with modifications.

A copy of such scheme may be inspected at the Town Hall, Brunswick.

A. MAHLSTEDT,
Clerk of the Executive Council.

(This notice is in lieu of that published in the *Government Gazette* of the 23rd June, 1954.)

STATE RELIEF COMMITTEE ACT 1940.

At the Executive Council Chamber, Melbourne, the twenty-ninth day of June, 1954.

PRESENT:

His Excellency the Governor of Victoria.
Mr. Shepherd | Mr. Galbally.

APPOINTMENT OF A MEMBER OF THE STATE RELIEF COMMITTEE.

IN pursuance of the powers conferred by the *State Relief Committee Act 1940*, His Excellency the Governor of the State of Victoria, by and with the advice of the Executive Council thereof, doth hereby appoint—

MRS. BERYL ASCHE,
being the person nominated by the body known as the Melbourne Benevolent Society to be a Member of the State Relief Committee until the 10th day of December, 1954, *vice* Mrs. Gertrude Zichy Woinarski, resigned.

And the Honorable John Cain, Her Majesty's Premier for the State of Victoria, shall give the necessary directions herein accordingly.

A. MAHLSTEDT,
Clerk of the Executive Council.

SUPERANNUATION ACTS.

At the Executive Council Chamber, Melbourne, the twenty-ninth day of June, 1954.

PRESENT:

His Excellency the Governor of Victoria.
Mr. Shepherd | Mr. Galbally.

IN accordance with the provisions of section 2 of the *Superannuation Act 1949*, (No. 5395), His Excellency the Governor of the State of Victoria, by and with the advice of the Executive Council thereof, doth by this Order declare that the provisions of the Superannuation Acts shall apply to the offices, under the Public Service Act, occupied from time to time by the persons whose names appear hereunder, so long only as such persons continue to occupy such offices:—

Addinsall, Eric John	Howell, Thomas George
Allen, Colleen Elizabeth	Hamilton
Atkinson, Raymond Ernest	Hunter, Evan Alexander
Bell, Douglas	Ince, Stanley MacFarlane
Brodie, Kevin Joseph	Jacob, Emanuel
Brown, Lesley Margaret	Jones, Leo
Bryant, Allan Leslie	Keamy, Cecil Frederick
Caley, Stanley Ronald	Logan, Audrey Agnes
Clarke, Charles Freeman	Loh, Adrian Philip
Clayton, Leonard Mel-	Mackay, Thomas Allan James
bourne	MacLeod, Elva Olwyn
Cole, Alec Watson	Milligan, John William
Collings, Gordon Frederick	Morrison, Stewart Arthur
Cook, Clara Margaret	Mottram, John Joseph
Creedon, Charles Francis	McCutcheon, Alec Bothwell
Crozier, Walter James	McDonald, Francis Edward
Culley, Francis Drake	Naylor, John Colenso
Davey, Patrick Joseph	Noble, Richard Mackley
Edwards, Aileen Dawn	Ormiston, Leonard Charles
Edwards, John Murray	Sydney
Emslie, John Alexander	Pascoe, Alfred Francis
Farmer, Jack	Pretlove, Keith
Fisher, Hector Alexander	Punton, Kingsley James
Fogarty, Leslie John	Quigley, Sydney John
Fordyce, Robert Bruce	Wallace
Fraser, William Ernest	Ratcliff, Percy
Frazer, Clive Eglinton	Saxton, Richard Clive
Garland, John Gerald	Stuart, Alan Joseph
Gentle, Charles William	Tippett, Jack Lindsay
Gibson, Douglas James	Tulloch, Arthur Robert
Harry, Cuthbert Oswald	Vincent, Colin
Hill, Frank Baridon	Vowles, Maurice George
	White, Wilfred Seymour

And the Honorable John Cain, Her Majesty's Treasurer for the State of Victoria, shall give the necessary directions herein accordingly.

A. MAHLSTEDT,
Clerk of the Executive Council.

FORESTS COMMISSION OF VICTORIA.

At the Executive Council Chamber, Melbourne, the twenty-ninth day of June, 1954.

PRESENT:

His Excellency the Governor of Victoria.
Mr. Shepherd | Mr. Galbally.

DEDICATION OF UNOCCUPIED CROWN LANDS AS PERMANENT FOREST IN THE PARISHES OF JANCOURT AND CARPENDEIT, COUNTY OF HEYTESBURY.

IN pursuance of the provisions of section 52 (1) of the *Forests Act 1928*, His Excellency the Governor of the State of Victoria, by and with the advice of the Executive Council thereof, doth hereby order that the areas of unoccupied Crown lands described in the accompanying Schedule No. 142 be dedicated as Permanent Forest.

THE SCHEDULE ABOVE REFERRED TO.

DEDICATION SCHEDULE No. 142.

Area to be Dedicated as Permanent Forest.

9,000 acres, more or less, of unoccupied Crown lands in the Parishes of Jancourt and Carpendeit, County of Heytesbury, being the whole of the unoccupied Crown lands within the areas shown by diagonal hatched lines on Diagram No. 711 on the accompanying plan (Correspondence Nos. 44/1662—J.22264).

DEDICATION SCHEDULE N^o142

CARPENDUIT & JANCOURT

County of Heytesbury
Chairs

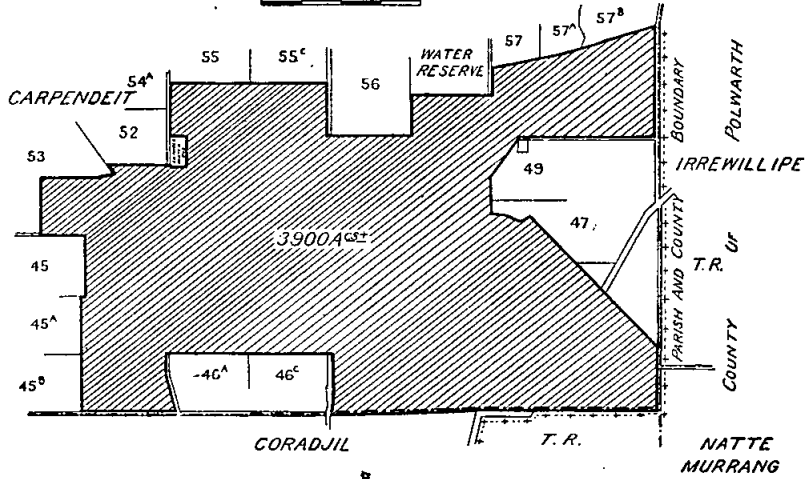

TOTAL AREA 3000 Acres ±

Subject to Survey

44/1662
FLP C²²20
J22264

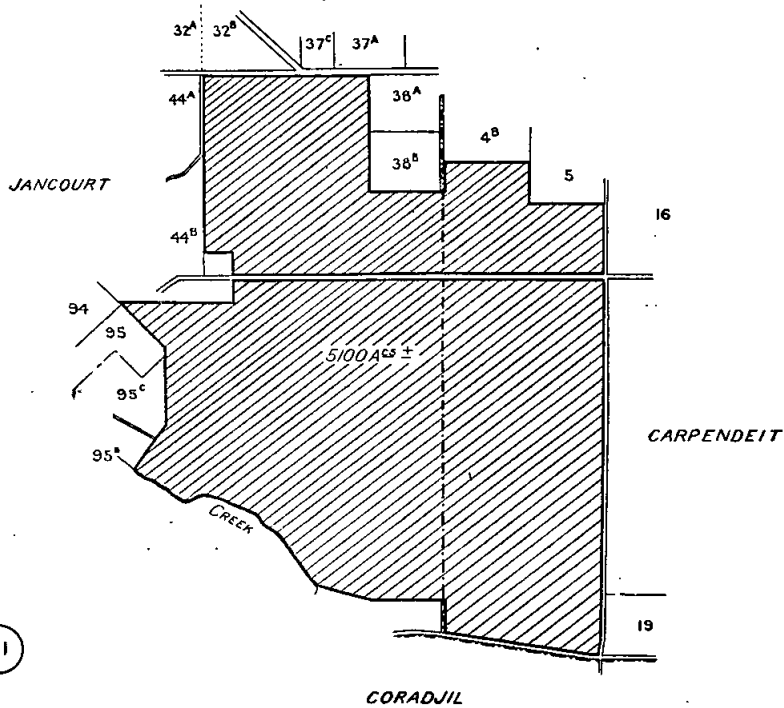

711

And the Honorable John William Galbally, Her Majesty's Minister of Forests for the State of Victoria, shall give the necessary directions herein accordingly.

A. MAHLSTEDT,
Clerk of the Executive Council.

FORESTS ACT 1928 (No. 3685).

At the Executive Council Chamber, Melbourne, the twenty-ninth day of June, 1954.

PRESENT :

His Excellency the Governor of Victoria
Mr. Shepherd | Mr. Galbally.

AMENDMENT OF REGULATION.

WHEREAS by Order made on the 15th day of January, 1946, as amended by Orders made on the 19th day of February, 1946, and the 26th day of May, 1954, Regulations were made by the Governor of the State of Victoria relating to the furnishing of monthly information and particulars by the owner of every sawmill in respect of the output of timber from such sawmill.

Now therefore His Excellency the Governor of the said State of Victoria, by and with the advice of the Executive Council of the said State and in pursuance of the powers conferred by the Forests Act doth by this Order hereby further amend the Schedule annexed to the said Order made on the 15th day of January, 1946, to read :—

SCHEDULE.

Form 599.

Pro forma.

FORESTS COMMISSION OF VICTORIA.

SAWMILLER'S RETURN.

(in duplicate.)

Return of Log Intake and Sawn Timber Output during the month of _____ 19 at _____ (name of mill)
mill situated at _____ of _____ and operated by _____
owned by _____

(1) LOGS AND SPLIT BILLETS.

Volume of logs and split billets obtained from Victorian sources.

	Hardwood.		Softwood.	
	Crown Land.	Private Property.	Crown Land.	Private Property.
Logs				
Split Billets				

(2) SAWN TIMBER.

(Not including output obtained by resawing of sawn timber such as fitches not originally produced at above mill.)

Classification.	From Logs or Split Billets Obtained from Victoria.		From Logs Imported from Other States or from Overseas.	
	Species.	Super Feet.	Species.	Super Feet.
HARDWOOD—				
(a) Seasoning Quality—				
Select				
Merchantable				
(b) Scantlings				
(c) Case Timber				
(d) Other (specify)				
Total				
SOFTWOOD—				
(a) Boards				
(b) Scantlings				
(c) Case Timber				
(d) Other (specify)				
Total				
GRAND TOTAL				

(3) ANY OTHER PRODUCE (RESULTING FROM CONVERSION OF LOGS SHOWN IN (1)).

(e.g., Pulpwood, Firewood, &c.)

Particulars.	Quantity (State Units).

I CERTIFY that the particulars which have been entered in this form are true and correct.

Witness to Signature
Address
Date

Signature of Mill Owner
or his Representative.
Date

This statement must be forwarded to Forests Commission of Victoria, State Public Offices, Melbourne, C.2, within seven days after the end of the month to which it relates.

And the Honorable John William Galbally, Her Majesty's Minister of Forests for the State of Victoria shall give the necessary directions herein accordingly.

A. MAHLSTEDT.
Clerk of the Executive Council.

RULES UNDER THE JUSTICES ACTS.

At the Executive Council Chamber, Melbourne, the
twenty-ninth day of June, 1954.

PRESENT:

His Excellency the Governor of Victoria.

Mr. Shepherd

Mr. Galbally.

UNDER and by virtue of the powers and authorities conferred by the *Justices Act 1928* (No. 3708) the *Acts Interpretation Act 1928* (No. 3630), and the *Labour and Industry Act 1953* (No. 5771), His Excellency the Governor of the State of Victoria, by and with the advice of the Executive Council thereof, doth hereby amend the *Justices Act Rules 1936* (No. 1) as follows:—

1. After Rule 58, there shall be inserted the following rule:—

“59. Every application under section 157 of the *Labour and Industry Act 1953* to a court of petty sessions shall be made by complaint and summons, and may be in the appropriate form prescribed in the Schedule hereto, or to the like effect.”

2. In the Schedule thereto, after Form 13, there shall be inserted the following forms:—

“Form 14A.	<i>Labour and Industry Act 1953</i> and <i>Justices Act 1928.</i>	Rule 59.
------------	---	----------

SUMMONS UPON COMPLAINT NOT BEING A COMPLAINT FOR AN OFFENCE.

IN THE METROPOLITAN INDUSTRIAL COURT AT RUSSELL-STREET, MELBOURNE,
IN THE CENTRAL BAILLIWICK

(Or IN THE COURT OF PETTY SESSIONS AT
IN THE BAILLIWICK).

Complainant.
Defendant.

To
of
the Defendant.

Whereas a complaint has this day been laid before the undersigned, one of Her Majesty's Justices of the Peace in and for the said Bailiwick (or: the Clerk of Petty Sessions at) that a dispute has arisen between you and the complainant as to whether (or: when) the complainant is or has become entitled to long-service leave (or: payment in lieu of long-service leave) under the provisions of the *Labour and Industry Act 1953* (or: as to the rate of ordinary pay of the complainant for the purposes of Division 4 of Part VIII. of that Act) (or: as to whether the complainant as the personal representative of A.B. late of deceased has become entitled to payment in lieu of long-service leave) (or: as to the rate of ordinary pay of the deceased for the purposes of Division 4 of Part VIII. of that Act), and that your last known place of residence (or: of business) is

These are therefore to command you in Her Majesty's name to be and appear on the day of 19 at o'clock in the noon at in the said State of Victoria before the said Metropolitan Industrial Court (or: said Court of Petty Sessions) when the said dispute will be heard and determined.

The complainant's address for service is to which or at which all notices may be posted or left.

Dated at the day of 19

Justice of the Peace.

Clerk of Petty Sessions.

Form 14b.

Labour and Industry Act 1953
and
Justices Act 1928.

Rule 59.

SUMMONS UPON A COMPLAINT NOT BEING A COMPLAINT FOR AN OFFENCE.

IN THE METROPOLITAN INDUSTRIAL COURT AT RUSSELL-STREET, MELBOURNE,
IN THE CENTRAL BAILLIWICK

(Or IN THE COURT OF PETTY SESSIONS AT
IN THE BAILLIWICK).

Complainant.
Defendant.

To
of
the Defendant.

Whereas a complaint has this day been laid before the undersigned, one of Her Majesty's Justices of the Peace in and for the said Bailiwick (or: the Clerk of Petty Sessions at) that you on the day of 19 were indebted to the said complainant in the sum of being the full amount of the payment which during the period commencing on the day of 19 and ending on the day of 19 became due to the complainant (add: where necessary, as the personal representative of AB late of deceased) under Division 4 of Part VIII. of the Labour and Industry Act 1953, and that your last known place of residence (or: of business) is

These are therefore to command you in Her Majesty's name to be and appear on the day of 19 at o'clock in the noon at in the said State of Victoria before the said Metropolitan Industrial Court (or: Court of Petty Sessions) to answer to the said complaint and to be further dealt with according to law.

The complainant's address for service is to which or at which all notices may be posted or left.

Dated at the day of 19

Justice of the Peace.
Clerk of Petty Sessions."

And the Honorable William Slater, Her Majesty's Attorney-General for the State of Victoria, shall give the necessary directions herein accordingly.

A. MAHLSTEDT,
Clerk of the Executive Council.

COUNTRY ROADS BOARD.

At the Executive Council Chamber, Melbourne, the twenty-ninth day of June, 1954.

PRESENT:

His Excellency the Governor of Victoria.
Mr. Shepherd | Mr. Galbally.

DECLARATION OF THE NEW COLERAINE-BALMORAL ROAD IN THE SHIRE OF WANNON:

WHEREAS by section 21 of the Country Roads Act 1928 (No. 3662) it is amongst other things enacted that when the Country Roads Board under the provisions of the Country Roads Act has taken the land necessary for constructing a road or deviation it shall as soon as it thinks such road or deviation is fit to be used as a public highway by Resolution declare the road or deviation to be a main road or part thereof and that upon publication in the Government Gazette of the Order of the Governor in Council confirming such Resolution such road or deviation shall thereupon be a main road or part thereof within the meaning of the said Act; And whereas the said Board has by Resolution declared the road on the land described in the Schedule to such Resolution to be part of a main road: Now therefore His Excellency the Governor of the State of Victoria by and with the advice of the Executive Council thereof doth hereby confirm the said Resolution.

Resolution for Declaration of a New Main Road under the Country Roads Act.

Whereas the land the site the road the course of which is below set out was taken by the Board under the provisions of the Country Roads Act for the purpose of constructing such new road which new road has now been laid out and formed on the same: And whereas the said Board (being the Country Roads Board incorporated under the said Act) thinks that the road aforesaid

is fit to be used as part of a public highway such Board at a meeting now holden doth by this Resolution hereby declare the said new road the course of which is described in the Schedule hereto with the commencing and terminating points thereof respectively specified to be part of a main road within the meaning and for the purposes of the Country Roads Act.

SCHEDULE.

Shire of Wannon.

7. Coleraine-Balmoral road (17607).—All that piece of land in the Parish of Konong Wootong, the boundaries of which are as follow:—Commencing at a point on the eastern boundary of lot 6 on plan of subdivision numbered 4561, lodged in the Office of Titles, and being part of allotment 7, section 15 of the said parish, the said point being distant 213 deg. 12 min. 491 links, 242 deg. 46 min. 1,507.6 links, and 228 deg. 52 min. 607.8 links from the north-eastern angle of the said lot; thence by lines bearing respectively 228 deg. 52 min. 200 links, 272 deg. 15 min. 160 links, and 68 deg. 1 min. 335 links to the point of commencement—which said piece of land is particularly delineated and shown coloured red on survey plan numbered 5411, lodged in the office of the Country Roads Board.

The common seal of the Country Roads Board was hereto affixed, at Melbourne, this twenty-first day of June, One thousand nine hundred and fifty-four, in the presence of—

(SEAL) D. V. DARWIN, Chairman.
F. M. CORRIGAN, Member.
W. H. NEVILLE, Secretary.

And the Honorable Samuel Merrifield, Her Majesty's Commissioner of Public Works for the State of Victoria, shall give the necessary directions herein accordingly.

A. MAHLSTEDT,
Clerk of the Executive Council.

COUNTRY ROADS BOARD.

At the Executive Council Chamber, Melbourne, the
twenty-ninth day of June, 1954.

PRESENT:

His Excellency the Governor of Victoria.
Mr. Shepherd | Mr. Galbally.

ORDER APPROVING OF A NEW STATE HIGHWAY IN
THE SHIRE OF CORIO.

WHEREAS the Country Roads Board constituted under the *Country Roads Act 1928* (No. 3662) has represented to His Excellency the Governor in Council that it appears to it desirable that the new Princes Highway in the Shire of Corio should be made by the said Board: And whereas the said Board in accordance with the requirements of section 19 of the said cited Act has caused to be prepared a map plan and estimate showing the points between which and on and through what land the said new highway is proposed to be made and the cost of acquiring the land and constructing the said new highway: And whereas on an inspection of the said map and plan and a consideration of the said estimate His Excellency the Governor in Council is satisfied that there are funds legally available for acquiring the land and constructing the said new highway: Now therefore be it known by this present Order that His Excellency the Governor of the State of Victoria with the advice of the Executive Council thereof doth hereby approve of the said highway being made, that is to say:—

All that piece of land in the Parish of Murtcaim, the boundaries of which are as follow:—Commencing at the north-eastern angle of lot 43A on plan of subdivision numbered 7173, lodged in the Office of Titles, and being part of Crown section 20A of the said parish; thence by lines bearing respectively 180 deg. 11 min. 94.1 links, 231 deg. 34½ min. 4,508.9 links, 355 deg. 33 min. 88.6 links, and 51 deg. 34½ min. 4,518 links to the point of commencement— which said piece of land is particularly delineated and shown coloured red on survey plan numbered 5915, lodged in the office of the Country Roads Board.

And the Honorable Samuel Merrifield, Her Majesty's Commissioner of Public Works for the State of Victoria, shall give the necessary directions herein accordingly.

A. MAHLSTEDT,
Clerk of the Executive Council.

COUNTRY ROADS BOARD.

At the Executive Council Chamber, Melbourne, the
twenty-ninth day of June, 1954.

PRESENT:

His Excellency the Governor of Victoria.
Mr. Shepherd | Mr. Galbally.

ORDER APPROVING OF WIDENING AN EXISTING
STATE HIGHWAY IN THE SHIRE OF FRANKSTON
AND HASTINGS.

WHEREAS the Country Roads Board constituted under the *Country Roads Act 1928* (hereinafter called "the principal Act") has, in exercise of its powers under the *Country Roads Act 1948* for the purpose of widening Nepean Highway in the Shire of Frankston and Hastings (declared to be a State highway under the principal Act, which declaration was confirmed by an Order in Council published in the *Government Gazette* of the 29th October, 1947, on pages 5573-5), by Resolution dated the fifteenth day of March One thousand nine hundred and fifty-four, fixed a new alignment for the west side of the said highway: And whereas by sub-section (3) of section 2 of the *Country Roads Act 1948* it is provided (*inter alia*) that the widening of any State highway pursuant to such Act shall for all purposes be deemed to be the making of such State highway pursuant to the principal Act: And whereas by sub-section (2) of section 2 of the *Country Roads Act 1948* it is provided (*inter alia*) that no State highway shall be widened pursuant to that Act unless the Governor in Council has by Order published in the *Government Gazette* approved of such widening: And whereas the said Board in accordance with the requirements of section 19 of the principal Act has caused to be prepared a map plan and estimate showing the points between which and on and through what land the said highway is proposed to be made and the cost of acquiring

the land and constructing the said highway: And whereas on an inspection of the said map and plan and a consideration of the said estimate His Excellency the Governor in Council is satisfied that there are funds legally available for acquiring the land which it is necessary to acquire for the purpose and constructing the said highway: Now therefore be it known by this present Order that His Excellency the Governor of the State of Victoria with the advice of the Executive Council thereof doth hereby, for the purposes of the *Country Roads Act 1948*, approve of the said highway being widened so as to include therein the land described in the Schedule hereto and doth hereby for the purposes of the principal Act, approve of the said highway being made over the land described in the said Schedule.

SCHEDULE.

All that piece of land in the Parish of Frankston, the boundaries of which are as follow:—Commencing at a point on the southern boundary of lot 12 on plan of subdivision numbered 9987, lodged in the Office of Titles, and being part of Davey's Crown pre-emptive right, section A in the said parish, the said point being distant 118 deg. 10 min. 100 feet from the south-western angle of the said lot; thence by lines bearing respectively 39 deg. 3 min. 163 ft. 3 in., 30 deg. 36 min. 52 ft. 8½ in., 31 deg. 51 min. 161 ft. 9½ in., 24 deg. 17 min. 240 feet, 118 deg. 10 min. 51 ft. 7½ in., 197 deg. 32 min. 154 ft. 5½ in., 213 deg. 12 min. 332 ft. 1 in., 228 deg. 57 min. 69 ft. 9 in., 298 deg. 10 min. 13 ft. 4 in., 208 deg. 10 min. 35 ft. 2 in., 228 deg. 57 min. 33 feet, and 298 deg. 10 min. 28 ft. 5½ in. to the point of commencement—which said piece of land is particularly delineated and shown coloured red and blue on survey plan numbered 5872, lodged in the office of the Country Roads Board.

And the Honorable Samuel Merrifield, Her Majesty's Commissioner of Public Works for the State of Victoria, shall give the necessary directions herein accordingly.

A. MAHLSTEDT,
Clerk of the Executive Council.

COUNTRY ROADS BOARD.

At the Executive Council Chamber, Melbourne, the
twenty-ninth day of June, 1954.

PRESENT:

His Excellency the Governor of Victoria.
Mr. Shepherd | Mr. Galbally.

ORDER APPROVING OF A DEVIATION FROM A MAIN
ROAD IN THE SHIRE OF HAMPDEN.

WHEREAS the Country Roads Board constituted under the *Country Roads Act 1928* (No. 3662) has represented to His Excellency the Governor in Council that it appears to it desirable that the deviation hereinafter referred to from the existing Ayresford-road in the Shire of Hampden (declared to be a main road under the said Act which declaration was confirmed by the Order in Council published in the *Government Gazette* of the 5th October, 1938, on page 3009) should be made by the said Board: And whereas the said Board in accordance with the requirements of section 19 of the said cited Act has caused to be prepared a map plan and estimate showing the points between which and on and through what land the said deviation is proposed to be made and the cost of acquiring the land and constructing the said deviation: And whereas on an inspection of the said map and plan and a consideration of the said estimate His Excellency the Governor in Council is satisfied that there are funds legally available for acquiring the land and constructing the said deviation: Now therefore be it known by this present Order that His Excellency the Governor of the State of Victoria with the advice of the Executive Council thereof doth hereby approve of the said road being made, that is to say:—

All those pieces of land in the Parish of Terang, the boundaries of which are as follow:—

- (a) Commencing at a point on the eastern boundary of allotment 5, section 34 of the said parish, distant 180 deg. 5 min. 1,166.4 links from the north-eastern angle of the said allotment; thence by lines bearing respectively 180 deg. 5 min. 142.8 links, 225 deg. 6½ min. 513.3 links, 270 deg. 5 min. 142.2 links, and 45 deg. 4½ min. 714.8 links to the point of commencement.

(b) Commencing at a point on the northern boundary of allotment 2, section 33 of the said parish, distant 90 deg. 5 min. 506.4 links from the north-western angle of the said allotment; thence by lines bearing respectively 270 deg. 5 min. 142.1 links, 225 deg. 6½ min. 917.2 links, 0 deg. 7 min. 141.5 links, and 45 deg. 4½ min. 716.6 links to the point of commencement— which said pieces of land are particularly delineated and shown coloured red and blue on survey plan numbered 5846, lodged in the office of the Country Roads Board.

And the Honorable Samuel Merrifield, Her Majesty's Commissioner of Public Works for the State of Victoria, shall give the necessary directions herein accordingly.

A. MAHLSTEDT,
Clerk of the Executive Council.

DEPARTMENT OF CROWN LANDS AND SURVEY.

At the Executive Council Chamber, Melbourne, the twenty-ninth day of June, 1954.

PRESENT:

His Excellency the Governor of Victoria.
Mr. Shepherd | Mr. Galbally.

REVOCATION OF TEMPORARY RESERVATION OF LAND (AS TO PORTION).

HIS Excellency the Governor of the State of Victoria, by and with the advice of the Executive Council thereof, doth hereby, in pursuance of the provisions of the Land Act 1928, revoke portion of the temporary reservation of land by Order in Council hereinafter referred to, viz.:

LORNE.—Order in Council of 28th September, 1942, of 3 roods 5 perches of land in the Township of Lorne, as a site for Cricket and other purposes of Public Recreation, so far only as regards the portion thereof comprised within the boundaries published in the Government Gazette of the 9th June, 1954, and containing 32 perches.

And the Honorable Joseph Henry Smith, Her Majesty's Commissioner of Crown Lands and Survey for the State of Victoria, shall give the necessary directions herein accordingly.

A. MAHLSTEDT,
Clerk of the Executive Council.

DEPARTMENT OF CROWN LANDS AND SURVEY.

At the Executive Council Chamber, Melbourne, the twenty-ninth day of June, 1954.

PRESENT:

His Excellency the Governor of Victoria.
Mr. Shepherd | Mr. Galbally.

UNUSED AND UNMADE ROAD CLOSED.

HIS Excellency the Governor of the State of Victoria, by and with the advice of the Executive Council thereof, doth hereby direct that, in pursuance of the provisions of section 304 of the Land Act 1928, the unused and unmade road referred to hereunder be closed, viz.:

Parish of Paywit, County of Grant, being the road indicated by hachure on plan hereunder.—(P.17⁽¹⁰⁾ (J.28322).

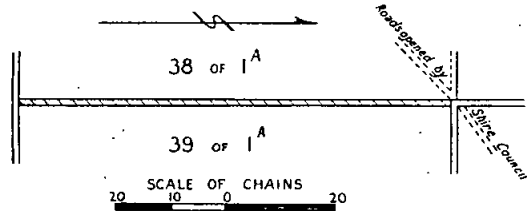

And the Honorable Joseph Henry Smith, Her Majesty's Commissioner of Crown Lands and Survey for the State of Victoria, shall give the necessary directions herein accordingly.

A. MAHLSTEDT,
Clerk of the Executive Council.

HOSPITALS AND CHARITIES ACT 1948 (No. 5300).—
SECTION SIXTY-FIVE.

At the Executive Council Chamber, Melbourne, the twenty-ninth day of June, 1954.

PRESENT:

His Excellency the Governor of Victoria.
Mr. Shepherd | Mr. Galbally.

AUTHORITY FOR THE SALE OF PROPERTY BY
FRANKSTON COMMUNITY HOSPITAL.

WHEREAS the Frankston Community Hospital, an incorporated institution within the meaning of the Hospitals and Charities Act 1948, is the owner of the property described in the Schedule hereto;

And whereas of the purchase price of £2,633, the sum of £1,300 was provided from Government Building Trust Funds;

And whereas the said property is no longer required for the purpose of the said hospital;

And whereas Mrs. Ruby Mabel Kitchin has offered to purchase the said property for the sum of £3,600;

And whereas the Hospitals and Charities Commission has made inquiry into the matter and has reported recommending the acceptance of such offer:

Now therefore, the Governor of the State of Victoria, by and with the advice of the Executive Council thereof, being satisfied that in the hereinbefore recited circumstances it would be advantageous for the said hospital to accept the said offer and in exercise of the powers conferred upon him by section sixty-five of the Hospitals and Charities Act 1948, hereby authorizes the sale by the Frankston Community Hospital of the said property for the sum of £3,600 and directs that of the last-mentioned sum, the sum of £1,300 shall be paid to the credit of the said hospital's Governmental Building Trust Fund and released only as directed by the Hospitals and Charities Commission.

SCHEDULE.

Description of Property.—Lot 25 and part of lot 24 on plan of subdivision 1059, being part of Crown allotment 5, section B, Township and Parish of Frankston, County of Mornington, being the whole of the land described in certificate of title 7477, folio 024.

And the Honorable William Peter Barry, Her Majesty's Minister of Health for the State of Victoria, shall give the necessary directions herein accordingly.

A. MAHLSTEDT,
Clerk of the Executive Council.

THE CONSTITUTION ACT AMENDMENT ACT 1928.—
SECTION 189.

At the Executive Council Chamber, Melbourne, the sixth day of July, 1954.

PRESENT:

His Excellency the Governor of Victoria.
Mr. Smith | Mr. Gladman.

OFFICE OF RETURNING OFFICER FOR THE
MELBOURNE NORTH PROVINCE.

WHEREAS William Carter Cook, Returning Officer for the Melbourne North Province, for which an election is about to be held, is absent from Victoria, and therefore unable to carry out the duties of such office:

Now therefore His Excellency the Governor of the State of Victoria, by and with the advice of the Executive Council thereof, and in pursuance of the powers conferred by section 189 of The Constitution Act Amendment Act 1928, doth by this Order:—

1. Remove the said William Carter Cook from the office of Returning Officer for the Melbourne North Province; and
2. Appoint Charles Alexander Boyle to be the Returning Officer for the said Melbourne North Province.

And the Honorable Leslie William Galvin, Her Majesty's Chief Secretary for the State of Victoria, shall give the necessary directions herein accordingly.

A. MAHLSTEDT,
Clerk of the Executive Council.

LANDLORD AND TENANT ACTS.

At the Executive Council Chamber, Melbourne, the sixth day of July, 1954.

PRESENT:

His Excellency the Governor of Victoria.
Mr. Smith | Mr. Gladman.

ORDER EXTENDING APPLICATION OF THE LANDLORD AND TENANT ACT 1948 TO CERTAIN PREMISES.

WHEREAS by an Order published in the *Government Gazette* of the 18th April, 1951, at page 2792, the five-roomed weatherboard premises situated at the south-west corner of the intersection of Cathcart and Palmerston streets, Buninyong, were excluded from the operation of the Parts III. and V. of the *Landlord and Tenant Act 1948*: And whereas it is expedient that those Parts should again extend to such premises: Now therefore, in pursuance of the powers conferred upon him by the *Landlord and Tenant Act 1948*, His Excellency the Governor of Victoria, by and with the advice of the Executive Council thereof, doth hereby declare that the application of the whole of the *Landlord and Tenant Act 1948* shall extend to such premises.

And the Honorable William Slater, Her Majesty's Attorney-General in and for the State of Victoria, shall give the necessary directions herein accordingly.

A. MAHLSTEDT,
Clerk of the Executive Council.

LANDLORD AND TENANT ACTS.

At the Executive Council Chamber, Melbourne, the sixth day of July, 1954.

PRESENT:

His Excellency the Governor of Victoria.
Mr. Smith | Mr. Gladman.

ORDER EXCLUDING CERTAIN PREMISES FROM THE OPERATION OF CERTAIN PROVISIONS OF THE LANDLORD AND TENANT ACT 1948.

IN pursuance of the powers conferred upon him by the *Landlord and Tenant Act 1948*, His Excellency the Governor of the State of Victoria, by and with the advice of the Executive Council thereof, doth hereby declare—

- (a) that the premises known as No. 25 Hawthorn-grove, Hawthorn, shall be excluded from the operation of the whole of the provisions contained in Parts II., III., and V. of that Act;
- (b) that the premises known as No. 117 Cape-street, Heidelberg, shall be excluded from the provisions of Parts III. and V. of that Act.

And the Honorable William Slater, Her Majesty's Attorney-General in and for the State of Victoria, shall give the necessary directions herein accordingly.

A. MAHLSTEDT,
Clerk of the Executive Council.

STATE ELECTRICITY COMMISSION ACTS.

At the Executive Council Chamber, Melbourne, the sixth day of July, 1954.

PRESENT:

His Excellency the Governor of Victoria.
Mr. Smith | Mr. Gladman.

WHEREAS, pursuant to the provisions of the *Electricity Commissioners' Act 1918* (No. 2936), the Governor in Council, on the 30th day of January, 1923, approved of

the State Electricity Commission of Victoria undertaking a scheme as proposed in a report entitled Report on Sugarloaf Rubicon Scheme and dated the 6th day of September, 1922, for the generation of electricity at and in the neighbourhood of the Sugarloaf Reservoir, and also of the State Electricity Commission of Victoria undertaking the supply of electricity therefrom and/or from any other source of supply available to the State Electricity Commission of Victoria in bulk or otherwise, in accordance with the provisions of the State Electricity Commission Acts, to persons and bodies of persons (including if the case so require undertakers and public statutory corporations) in the Northern and North-Eastern Districts of Victoria as referred to in the said report.

And whereas the State Rivers and Water Supply Commission of the State of Victoria is constructing, pursuant to the Waters Act, a larger dam of earth and rock fill construction immediately south of the said Sugarloaf Reservoir and suitable to contain approximately 2,750,000 acre-feet of water, and also appurtenant works including a weir to form a detention pond of approximately 4,000 acre-feet effective capacity at a place on the Goulburn River about 2½ miles downstream of the new dam.

Now therefore, pursuant to section 14 of the *State Electricity Commission Act 1928* (No. 3776), the Governor in Council for the State of Victoria doth approve of the State Electricity Commission of Victoria constructing at the dam so constructed a new hydro-electric power station and installing therein generating plant of a total capacity of 120,000 kW in addition to the existing power station plant which is to be removed from the site where it has been installed and installed in the new power station thus making the total capacity of the generating plant to be installed in the new power station at the Eildon Dam to be 135,000 kW, and of the operation and maintenance of the said power station and the supply of electricity therefrom as part of the main electricity supply system of the State Electricity Commission of Victoria.

And the Honorable John William Galbally, Her Majesty's Minister in Charge of Electrical Undertakings for the State of Victoria, shall give the necessary directions herein accordingly.

A. MAHLSTEDT,
Clerk of the Executive Council.

STATE ELECTRICITY COMMISSION ACTS.

At the Executive Council Chamber, Melbourne, the sixth day of July, 1954.

PRESENT:

His Excellency the Governor of Victoria.
Mr. Smith | Mr. Gladman.

AUTHORITY TO SUPPLY ELECTRICITY WITHIN THE CENTRAL HIGHLANDS REGION.

WHEREAS by the *State Electricity Commission (Ballarat and Bendigo Purchase) Act 1929* (No. 3826) and Orders in Council approved by the Governor in Council on the 3rd day of August, 1936, and the 16th day of January, 1940, and published respectively in the *Victoria Government Gazette* on the 12th day of August, 1936, and the 17th day of January, 1940, the State Electricity Commission of Victoria was authorized to supply electricity to certain persons and bodies of persons in certain portions of the Central Highlands area of Victoria: Now therefore His Excellency the Governor of the State of Victoria, by and with the advice of the Executive Council thereof, doth hereby approve the supply of electricity by the State Electricity Commission of Victoria in bulk or otherwise in accordance with the provisions of the State Electricity Commission Acts, to persons and bodies of persons in the whole of the Central Highlands Region, as shown on Maps "A" and "B" in the report of the State Regional Boundaries Committee on "Regional Boundaries", dated 27th December, 1944.

And the Honorable John William Galbally, Her Majesty's Minister in Charge of Electrical Undertakings for the State of Victoria, shall give the necessary directions herein accordingly.

A. MAHLSTEDT,
Clerk of the Executive Council.

POLICE REGULATION ACTS.

At the Executive Council Chamber, Melbourne, the sixth day of July, 1954.

PRESENT:

His Excellency the Governor of the State of Victoria.

Mr. Smith | Mr. Gladman.

REGULATIONS.—AMENDMENT No. 6.

HIS Excellency the Governor of the State of Victoria, by and with the advice of the Executive Council thereof, and in pursuance of the powers conferred by the Police Regulation Acts, doth hereby amend as follows the Police Regulations 1951 (that is to say):—

In sub-clause (2) of clause twenty-six of Chapter 7 of the Police Regulations 1951 for the words—

“One pound per day”

there shall be substituted the words—

“One pound fifteen shillings per day”.

And the Honorable Leslie William Galvin, Her Majesty's Chief Secretary for the State of Victoria, shall give the necessary directions herein accordingly.

A. MAHLSTEDT,
Clerk of the Executive Council.

LABOUR AND INDUSTRY ACT 1953 (No. 5771).

At the Executive Council Chamber, Melbourne, the sixth day of July, 1954.

PRESENT:

His Excellency the Governor of the State of Victoria.

Mr. Smith | Mr. Gladman.

REGULATIONS.

IN pursuance of the powers conferred by the *Labour and Industry Act* 1953, His Excellency the Governor of the State of Victoria, by and with the advice of the Executive Council thereof, doth hereby amend the Regulations made by the Governor in Council on the first day of June, 1954, under the provisions of the *Labour and Industry Act* 1953, and published in the Government Gazette on the eighth day of June, 1954, as follows:—

1. For the words “but does not include the premises of an outside worker who is licensed under this Act” appearing in the definition of a “Factory” in Regulation 5 there shall be substituted the words “but does not include any part of a poultry farm where poultry are not dressed for trade or sale by wholesale or the premises of an outside worker who is licensed under this Act”.

2. For the words “Rate of Ordinary Pay at Date of Employment” appearing in the last column of the form of Long-service Leave record prescribed by Regulation 13, there shall be substituted the words “Rate of Ordinary Pay at Date of Termination of Employment”.

And the Honorable John William Galbally, Her Majesty's Minister of Labour and Industry for the State of Victoria, shall give the necessary directions herein accordingly.

A. MAHLSTEDT,
Clerk of the Executive Council.

APPROACHING LAND SALES.

SALES of Crown lands, in fee-simple, will be held at the under-mentioned places and dates. viz.:—

	No. of Gazette.
Ararat.—Thursday, 29th July, 1954 ..	634
Beechworth.—Thursday, 8th July, 1954 ..	439
Benalla.—Tuesday, 13th July, 1954 ..	439
Camperdown.—Wednesday, 7th July, 1954 ..	428
Goroke.—Tuesday, 13th July, 1954 ..	439
Melbourne.—Wednesday, 4th August, 1954 ..	634
Melbourne.—Wednesday, 28th July, 1954 ..	634
Murrayville.—Tuesday, 10th August, 1954 ..	649
Nhill.—Tuesday, 20th July, 1954 ..	439
Ouyen.—Tuesday, 10th August, 1954 ..	649
St. Arnaud.—Thursday, 29th July, 1954 ..	634
Wangaratta.—Friday, 9th July, 1954 ..	439

SALE OF CROWN LANDS BY AUCTION.

The lands will be sold in fee-simple, and subject to the covenants, conditions, exceptions, and reservations directed by the Governor in Council by an Order in Council dated the 5th August, 1930, and published in the *Government Gazette* of the 8th August, 1930, varied as herein.

A deposit of at least twelve and a half per centum of the price at which each lot is sold must be paid by the purchaser at the time of sale, and all such payments shall be made in coin, bank notes or cheques approved by the officer conducting the sale, and the residue of such price will be payable in equal instalments, in accordance with the scale hereunder, on the last day of each successive period of six months from the time of sale, or, if the purchaser choose, at any earlier time or times; and such residue of the purchase money shall bear interest at the rate of Five pounds per centum per annum, to be computed with respect to each instalment for the period which has elapsed between the time of sale and the time of the payment of such instalment. If the residue of the price be paid within thirty days after the time of the sale no interest will be payable thereon.

The Governor in Council may allow a transfer of the purchaser's interest to an approved person at any time before the final payment of the purchase money is made. The fee for transfer shall be One pound and such transfer will be subject to payment of stamp duty.

SCALE OF PAYMENTS OF RESIDUE.

£20 and under, 6 instalments.
Over £20, and not exceeding £50, 8 instalments.
Over £50, and not exceeding £100, 10 instalments.
Over £100, and not exceeding £200, 12 instalments.
Over £200, and not exceeding £300, 14 instalments.
Over £300, and not exceeding £400, 16 instalments.
Over £400, and not exceeding £500, 18 instalments.
Over £500, 20 instalments.

FEES, ETC.

The amount payable for Assurance Fund (One halfpenny for each £1 of purchase price) and Crown grant fee must be paid with the balance of purchase money. The following is the scale of fees for Crown grants:—

50 acres and under, £1 10s.
Over 50 acres, £2.

Where the purchase money does not exceed £5, the grant fee is £1.

Valuations of improvements (if not purchased by the owner thereof), and charges for survey, must also be paid at the time of sale.

J. H. SMITH,
Commissioner of Crown Lands and Survey.
Office of Crown Lands and Survey,
Melbourne, 5th July, 1954.

MURRAYVILLE.—Sale (No. 11091) of Crown lands, in fee-simple, by auction, will be held at the PUBLIC HALL, MURRAYVILLE, on TUESDAY, the 10th AUGUST, 1954, at half-past TWO o'clock p.m. To be conducted by H. H. DODD, Land Officer, Red Cliffs.

MURRAYVILLE, PARISH OF DANYO, COUNTY OF WEEAH.
In the East of the Township.
Upset price £25 per lot. Charge for survey £5 10s. per lot.

Lot 1. Area 1r. 10 9/10p., allotment 9 of section 4. Valuation of improvements to be announced at sale.
Lot 2. Area 1r. 3 1/10p., allotment 10 of section 4. Valuation of improvements to be announced at sale.
Lot 3. Area 1r. 16 8/10p., allotment 11 of section 4. Valuation of improvements to be announced at sale.

Ouyen.—A sale, by auction, of the under-mentioned land, for and on behalf of the Minister of Education, will be held at the LAND INSPECTOR'S OFFICE, OUYEN, on TUESDAY, the 10th of AUGUST, 1954, at TEN o'clock a.m. To be conducted by H. H. DODD, Land Officer, Red Cliffs.

PARISH OF TIMBEROO, COUNTY OF KARKAROOC.

In the East of the Parish.

Upset price £7 5s. the lot.

Lot 1. Area 2a. 3r. 24p., allotment 12a, and being the land described in Crown grant, volume 6224, folio 1244733. Sale of lot 1 is subject to the following conditions:—

- The purchaser shall pay the purchase money in full at the sale;
- the preparation and registration of the transfer under the Transfer of Land Act shall be attended to by the purchaser or his solicitor, and all costs relating thereto shall be borne by the purchaser.

CLOSER SETTLEMENT ACT 1938.

MURRAYVILLE.—A sale of the under-mentioned land, in fee-simple, by auction, will be held at the PUBLIC HALL, MURRAYVILLE, on TUESDAY, the 10th AUGUST, 1954, at a quarter-past TWO o'clock p.m. To be conducted by H. H. DODD, Land Officer, Red Cliffs.

PARISH OF GUNAMALARY, COUNTY OF WEEAH.

In the North-west of the Parish.

Lot 1. Area 770a. 1r. 8p., allotment 8. Temporarily leased to C. G. Thurlow. Date of possession, 1st March, 1955. One month from 1st March, 1955, allowed for removal of improvements.

TERMS AND CONDITIONS.

Minimum deposit to be paid at the sale, 20 per cent. of the purchase price. Balance of purchase money payable by ten equal yearly instalments, together with interest computed at the rate of 4½ per cent. per annum on the unpaid balance.

Purchaser may pay balance and fees at any time prior to the due date.

Crown grant will be prepared and issued as soon as practicable after payment of purchase money in full.

Improvements to be maintained and insured with the Board of Land and Works.

The Board of Land and Works may allow a transfer of the purchaser's interests to an approved person at any time before the final payment is made (fee, £1). The registration of the transfer may be subject to payment of such further sum as the Board may require in reduction of the outstanding balance.

The fee payable for Crown grant (£2) and assurance (One halfpenny for each £1 of purchase price) must be paid with the balance of purchase money.

J. H. SMITH,
Commissioner of Crown Lands and Survey.
Office of Crown Lands and Survey,
Melbourne, 5th July, 1954.

PROPOSED REVOCATIONS OF TEMPORARY RESERVATIONS OF LANDS BY ORDERS IN COUNCIL.

IN pursuance of the provisions of the *Land Act 1928*, notice is hereby given that it is the intention of the Governor in Council to revoke the temporary reservations of lands by Orders in Council hereunder referred to, viz.:—

The following Notices were published 1st on the 23rd June, 1954, pursuant to Orders of the 19th May, 1954.

COLONGULAC.—The temporary reservation, by Order in Council of the 16th February, 1874, of 26 acres 1 rood 2 perches of land in the Parish of Colongulac, being allotments 9, 10, 11, 12, and 13, section 23, as a site for Watering and Camping purposes, is about to be revoked.—(C.294(2) (J.13386).

COLONGULAC.—The temporary reservation, by Order in Council of the 17th January, 1888, of 3 acres 2 roods 1 perch of land in the Parish of Colongulac as a site for a Manure Depot, is about to be revoked.—(C.294(2) (J.13386).

CARLYLE.—The temporary reservation, by Order in Council of the 27th September, 1886, of 56 acres 1 rood 38 perches of land in the Parish of Carlyle as a site for Water Supply purposes, revoked as to part by Order of the 4th November, 1940, is about to be revoked so far only as the portion containing 32 perches, more or less, indicated by hachure on plan hereunder, is concerned.—(C.187(*) (Rs.5122).

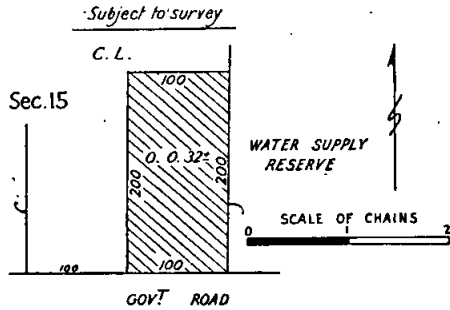

CUT-PAW-PAW.—The temporary reservation, by Order in Council of the 26th November, 1929, of 12 acres of land in the Parish of Cut-paw-paw as a site for Recreation and Public purposes, is about to be revoked so far only as the portion containing 3 perches, indicated by hachure on plan hereunder, is concerned.—(C.345(16) (Rs.3934).

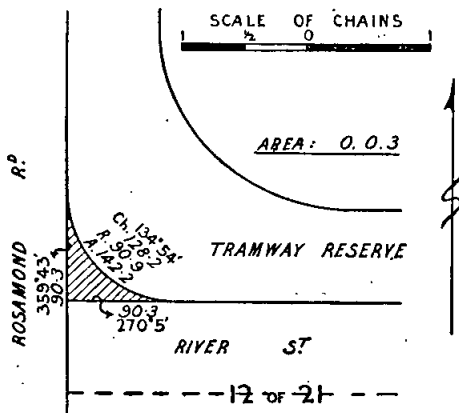

KILNOORAT.—The temporary reservation, by Order in Council of the 11th December, 1865 (see *Government Gazette* of the 19th December, 1865, page 2964), of 8 acres of land in the Parish of Kilnoorat as a site for a Cemetery, revoked as to part by Order of the 1st July, 1952, is about to be revoked so far only as the portion containing 1 acre 2 roods 2 perches, indicated by hachure on plan hereunder, is concerned.—(K.53(2) (C.92734).

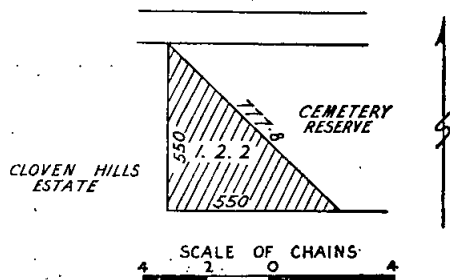

J. H. SMITH,
Commissioner of Crown Lands and Survey.

PROPOSED REVOCATIONS OF TEMPORARY RESERVATIONS OF LANDS BY ORDERS IN COUNCIL.

IN pursuance of the provisions of the *Land Act* 1928, notice is hereby given that it is the intention of the Governor in Council to revoke the temporary reservations of lands by Orders in Council hereunder referred to, viz.:

The following Notices were published 1° on the 30th June, 1954, pursuant to Orders of the 22nd June, 1954.

KOO-WEE-RUP EAST.—The temporary reservation, by Order in Council of the 12th July, 1910, of 3 roods 24 perches of land in the Parish of Koo-wee-Rup East as a site for Supply of Gravel, is about to be revoked.—(K.118(*) (Misc. 2657).

YAUGHER.—The temporary reservation, by Order in Council of the 17th August, 1927, of 20 acres 3 roods 17 perches of land in the Parish of Yaugher as a site for Public Recreation, is about to be revoked so far only as the portion containing 1 rood 4 perches, indicated by hachure on plan hereunder, is concerned.—(Y.115(?) (Rs.3543).

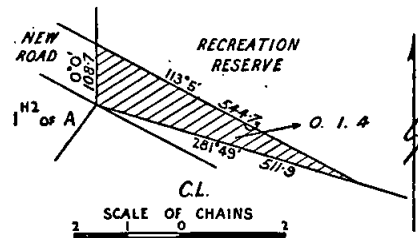

YUONGA.—The temporary reservation, by Order in Council of the 22nd August, 1887, of 5 acres of land in the Parish of Yuonga as a site for a State School, is about to be revoked so far only as the portion containing 1 rood 23 perches, more or less, indicated by hachure on plan hereunder, is concerned.—(Y.118(2) (C.95145).

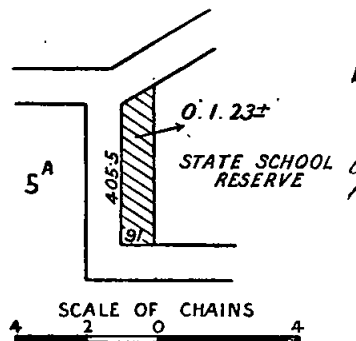

J. H. SMITH,
Commissioner of Crown Lands and Survey.

PROPOSED REVOCATIONS OF TEMPORARY RESERVATIONS OF LANDS BY ORDERS IN COUNCIL.

IN pursuance of the provisions of the *Land Act* 1928, notice is hereby given that it is the intention of the Governor in Council to revoke the temporary reservations of lands by Orders in Council hereunder referred to, viz.:

The following Notices were published 1° on the 7th July, 1954, pursuant to Orders of the 29th June, 1954.

RHEOLA.—The temporary reservation, by Order in Council of the 17th December, 1901, of 30 perches of land in the Township of Rheola, being allotment 39 of section 1, as a site for Water Supply purposes, is about to be revoked.—(R.79(*) (C.15924).

WARRAQUIL (BAKER).—The temporary reservation, by Order in Council of the 31st July, 1923, of 11 acres 3 roods 37 perches of land in the Parish of Warraquil as a site for

Recreation purposes, is about to be revoked so far only as the portion containing 2 roods 18 perches, indicated by hachure on plan hereunder, is concerned.—(W.318(A) (Rs.2790).

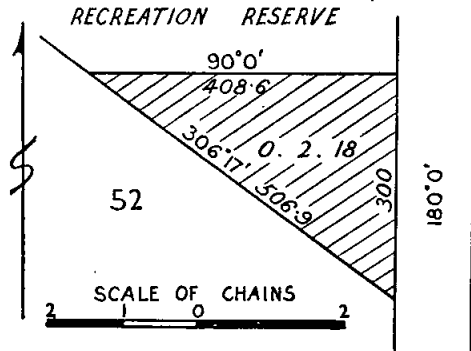

J. H. SMITH,
Commissioner of Crown Lands and Survey.

MERBEIN.—The temporary reservation, by Order in Council of the 14th May, 1946, of 8 acres 1 rood 15 perches of land in the Township of Merbein, as a site for State School purposes, is about to be revoked so far only as the portion containing 4 acres 35 perches, indicated by hachure on plan hereunder, is concerned.—(M.572(A) (Rs.5796).

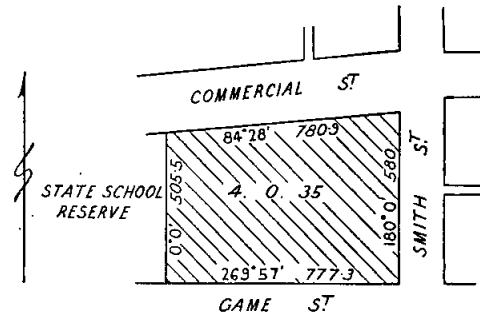

SCALE OF CHAINS

PROPOSED REVOCATIONS OF TEMPORARY RESERVATIONS OF LANDS BY ORDERS IN COUNCIL.

IN pursuance of the provisions of the Land Act 1928, notice is hereby given that it is the intention of the Governor in Council to revoke the temporary reservations of lands by Orders in Council hereunder referred to, viz.:

The following Notices were published 1° on the 16th June, 1954, pursuant to Orders of the 8th June, 1954.

GEELONG (THOMSON).—The temporary reservation, by Order in Council of the 13th April, 1954, of 15 acres 2 roods, more or less, of land in the City of Geelong as a site for a Public Hall and for Public Recreation, is about to be revoked.—(G.25(w1) (Rs.7240).

NUMURKAH.—The temporary reservation, by Order in Council of the 22nd December, 1902, of 9 acres 1 rood 1 perch of land in the Township of Numurkah as a site for Water Supply purposes, is about to be revoked so far only as the portion containing 4 acres 1 rood 1 perch, indicated by hachure on plan hereunder, is concerned.—(N.119(s) (Rs.5667).

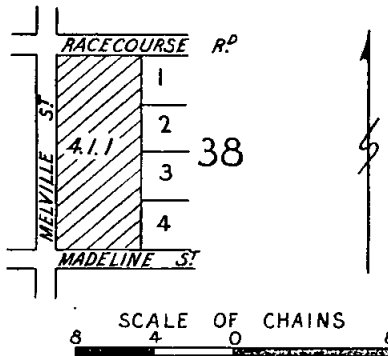

J. H. SMITH,
Commissioner of Crown Lands and Survey.

KILCUNDA.—The temporary reservation, by Order in Council of the 15th March, 1887, of 5 acres of land in the Parish of Woolamai (now in the Township of Kilcunda), as a site for a State School, is about to be revoked so far only as the portion containing 1 perch, indicated by hachure on plan hereunder, is concerned.—(K.186(1) (Rs.7246).

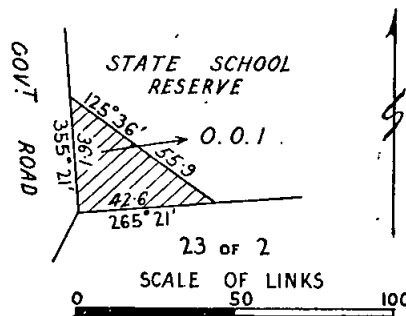

J. H. SMITH,
Commissioner of Crown Lands and Survey.

PROPOSED REVOCATIONS OF TEMPORARY RESERVATIONS AND THE WITHHOLDING FROM SALE, LEASING, AND LICENSING, OF CERTAIN LANDS BY ORDERS IN COUNCIL.

IN pursuance of the provisions of the Land Act 1928, notice is hereby given that it is the intention of the Governor in Council to revoke the temporary reservations and the withholding from sale, leasing, and licensing, of certain lands by Orders in Council hereinafter referred to:

The following Notices were published 1° on the 7th July, 1954, pursuant to Orders of the 29th June, 1954.

RHEOLA.—The temporary reservation as a site for a Mechanics' Institute and the withholding from sale, leasing, and licensing, by Order in Council of the 29th January, 1877, of 1 rood of land in the Village of Rheola, being allotment 38 of section 1, is about to be revoked.—(R.79(s) (C.69655).

GRITJURK.—The temporary reservation as a site for Public purposes (State school) and the withholding from sale, leasing, and licensing, by Order in Council of the 17th January, 1884, of 2 acres 2 roods 19 perches of land in section 10 in the Parish of Gritjurk, is about to be revoked.—(G.147(s) (C.95521).

J. H. SMITH,
Commissioner of Crown Lands and Survey.

PROPOSED REVOCATIONS OF TEMPORARY RESERVATIONS OF LANDS BY ORDERS IN COUNCIL.

IN pursuance of the provisions of the Land Act 1928, notice is hereby given that it is the intention of the Governor in Council to revoke the temporary reservations of lands by Orders in Council hereunder referred to, viz.:

The following Notices were published 1° on the 23rd June, 1954, pursuant to Orders of the 16th June, 1954.

BOOTAHPOL.—The temporary reservation, by Order in Council of the 14th March, 1870, of 21 acres 0 roods 16 perches of land in the Parish of Bootahpool, being part of allotment 2, section D, as a site for Watering purposes, is about to be revoked.—(B.580(A1) (Z.35065).

LIST OF CROWN LANDS AVAILABLE.

THE under-mentioned areas are available for application as provided by various sections of the *Land Act 1928*, and all applications received on or before Wednesday, 4th August, 1954, will be deemed to have been made simultaneously, but any application lodged after such date may be considered if received in time for inclusion in the advertisement of the cases to be heard at the Local Land Board. Applications on proper form, accompanied by 5s. duty stamp uncancelled (registration fee), may be delivered or forwarded by post to the Local Land Officer or to any Crown Lands Office in Victoria. Applicants may obtain from Local Land Officers, of the Crown Lands Department, Melbourne, a certificate authorizing the issue by the Railway Department of a return ticket at concession fares to enable them to inspect available areas or to attend Local Land Boards.

Subject to the approval of the Secretary for Lands, when the survey fee exceeds £25 but does not exceed £50, a deposit of £25 may be paid, and when the fee exceeds £50, a deposit of 50 per cent. of the fee, the balance in either case being payable over six years in half-yearly instalments.

Marked plans of any particular area, application forms, and any further information may be obtained from the Crown Lands Department, Melbourne, and Land Officers, Alexandra, Hamilton, Horsham, Red Cliffs, and Stawell.

Department of Crown Lands and Survey,
Melbourne, 7th July, 1954.

J. H. SMITH,
Commissioner of Crown Lands and Survey.

* Improvements may be subject to re-valuation after land has been granted to an applicant.

Local Land Office.	County.	Parish.	Allotment.	Section.	Area.	How Available.		Survey Fee.	Valuation of Improvements (if any).	Location of Land, &c.	Nearest Railway Station or Township and Distance in miles therefrom.	How Accessible.	Water Supply.	General Description of Land—Soil, Timber, Suitability (Grazing, &c.).	
						Classification.	Value per Acre.								
						£	s.	d.							
Hamilton (a)	Lowan	Bogalra	24A	B	±53 2 35	3rd	1 10 0	17 2 6	To be valued	In north-east corner of parish	Edenhope, 15 miles	By road	To be conserved	Undulating; grey sandy loam; red gum, stringybark, ti-tree, and bracken fern; suitable for grazing and cultivation. (01374/121)	
" (a)	Follett	"	32	A	±53 0 0	3rd	1 0 0	17 2 6	Nil	In north of parish	Dergholm, 20 miles	"	"	Slightly undulating; light sandy soil; stringybark, fraxo, and bracken fern; suitable for grazing and cultivation. (Z-30834)	
" (a)	Normanby	Bessiebelle	54	"	319 2 28	3rd	1 0 0	33 17 6	To be valued	In centre of parish	Heywood, 14 miles	"	"	Undulating; grey sandy loam with buckshot gravel subsoil; small and medium gum, ti-tree, and banksia; suitable for grazing. (0705/121)	

AGRICULTURAL AND GRAZING LANDS—SELECTION PURCHASE ALLOTMENTS.

DIVISION 4, PART I., LAND ACT 1928.

Local Land Office.	County.	Parish.	Allotment.	Section.	Area.	How Available.	Annual rental to be fixed		To be valued	Fronting street	Walker.	By road	To be conserved	General Description of Land—Soil, Timber, Suitability (Grazing, &c.).
							£	s.						
Stawell (a)	Borong	Stawell	17	116	±0 1 0	"	5 5 0	0	To be valued	Fronting street	Walker.	By road	To be conserved	Suitable for a dwelling. (Z-29304)
Alexandra (a)	Wonnangatta	Changeue	21	A	1 0 0	"	7 0 0	0	Nil	Fronting Mount Buller C.R.B. road	Mansfield R.S., 18 miles, and Mirimbah, 2 miles	"	"	Residence and garden. (H.023316)
Hamilton (a)	Lowan	Town of Harrow	5	5	±1 0 32	"	7 0 0	0	"	In north-east of town	About 1 mile from centre of town	"	"	Suitable for a dwelling. (Z-30301)

AVAILABLE UNDER SECTION 129, LAND ACT 1928.

LIST OF CROWN LANDS AVAILABLE—continued.
 * Improvements may be subject to re-valuation after land has been granted to an applicant.

Local Land Office.	County.	Parish.	Allotment.	Section.	Area.	How Available.		Valuation of Improvements (if any).	Location of Land, &c.	Nearest Railway Station or Township and Distance in miles therefrom.	How Accessible.	Water Supply.	General Description of Land—Soil, Timber, Suitability (Grazing, &c.).		
						Classification.	Value per Acre.								
				A. E. P.		f. s. d.		f. s. d.							
Horsham ..	Borung ..	Nulken Township of Minyip	5 6 7 8	28	0 0 36	Annual rental to be fixed	Fronting Wimmers-street in the north-west of township	R.S., ½ mile ..	By road	To be conserved	Suitable for a dwelling. (2.33214)		
														5 5 0	5 5 0
														5 5 0	5 5 0
Red Cliffs ..	Karkaroo	Merbein ..	4x	G	2 3 12	Annual rental 1 0 0	In north of parish ..	Merbein R.S., 4 miles	"	"	Suitable for residence and garden. (O10303/129)		
														5 12 6	One month to remove
Red Cliffs (b)	"	"	4x	G	2 3 12	Annual rental 1 0 0	In north of parish ..	Merbein R.S., 4 miles	"	"	Suitable for residence and garden. (O10304/129)		
								5 12 6							

(a) Subject to survey.—(b) Subject to drainage easement.

Land Act 1928.

LICENCES UNDER THE LAND ACTS 1915 AND 1928 DECLARED VOID.

NOTICE is hereby given that the Licences mentioned in the Schedule hereunder have been declared void by the Governor in Council for the reason specified in each case.

District.	Corr. No.	Name of Lessee.	Section of Land Act under which Leased.	Parish.	Allotment.	Area.	Class.	Annual Rental.	Reasons for Voiding.
						A. R. P.		£ s. d.	
Mallee ..	010303 /129	H. A. Bennett ..	Dwelling and garden	Merbein ..	4M section G	2 3 12	..	1 0 0	Non-compliance with conditions
Mallee ..	010304 /129	M. F. O'Sullivan ..	Dwelling and garden	Merbein ..	4N section G	2 3 12	..	1 0 0	Non-compliance with conditions

Department of Crown Lands and Survey,
Melbourne, 22nd June, 1954.

J. H. SMITH,
Commissioner of Crown Lands and Survey.

Land Act 1928.

LEASE SURRENDERED.

NOTICE is hereby given that the Governor in Council has accepted the surrender of the Lease mentioned in the Schedule hereunder for the reason specified.

District.	Corr. No.	Name.	Section of Land Act under which Leased.	Parish.	Allotment.	Area.	Class.	Reason.
						A. R. P.		
Bairnsdale ..	61/44.81.49	M. L. Johnson	44, L.A. 1928	Jilwain ..	Part of 53F	0 0 14	..	Are acquired for road purposes

Department of Crown Lands and Survey,
Melbourne, 22nd June, 1954.

J. H. SMITH,
Commissioner of Crown Lands and Survey.

TENDERS.—PUBLIC WORKS DEPARTMENT.

TENDERS will be received at this office until **TEN A.M.** on the days and for the purposes under mentioned. Particulars may be learnt at this Office and also at places shown in parenthesis.

W.O. means Inspector of Works Office; P.S.—Police Station; T.S.—Technical School; H.E.S.—Higher Elementary School; S.S.—State School; H.S.—High School.

The Board of Land and Works will not necessarily accept the lowest or any tender.

NOTE.—No preliminary deposits are to be lodged with tenders, but a deposit, in accordance with the following Schedule, will be required from the successful tenderer:—

For contract amounts not exceeding £200 ..	£ 2
For contract amounts exceeding £200 and not exceeding £500 ..	5
For contract amounts exceeding £500 and not exceeding £1,000 ..	10
For contract amounts exceeding £1,000—1 per cent. of tender ..	500
	(maximum deposit)

13th July, 1954.

Alvie.—Supply, delivery, installation, and testing of central heating and hot-water installations, Consolidated School. (P.S., Alvie; W.O., Camperdown, Warrnambool.)

Bairnsdale.—Electrical installation new "Bristol" M.A. and D.A. Blocks and existing buildings, H.S. (H.S., Bairnsdale; W.O., Bairnsdale.)

Ballarat.—Supply and delivery of food trolleys, plate warmers, and racks for Ward F.10, Mental Hospital.

Barwon Heads.—Replacements, repairs, and painting to interior of the Quarters, P.S. (W.O., Geelong; P.S., Barwon Heads.)

Box Hill.—Supply, delivery, installation, and testing of alterations in boiler-room and additional heating, H.S. (H.S., Box Hill.)

Cabbage Tree.—Erection of timber residence and out-buildings, S.S. No. 3812. (W.O., Bairnsdale; P.S., Orbost; S.S., Cabbage Tree.)

Camperdown.—Supply and installation of electric food hoist, H.S. (W.O., Camperdown.)

Carlton.—New fireproof doors, Exhibition Buildings, County Roads Board.

Dandenong.—New folding partition to class-room, S.S. No. 1403. (S.S., Dandenong.)

Echuca.—Renovations to residence, 64 Anstruther-street, H.S. (W.O., Shepparton; H.S., Echuca.)

Echuca West.—Repairs and renovations to residence, S.S. No. 3916. (W.O., Shepparton; S.S., Echuca West.)

Fitzroy.—Repairs and painting, Girls' school. (Girls' School, Fitzroy.)

Heatherton.—Additions to laundry, Sanatorium.

Kew.—Erection of a new storage shed, Mental Hospital.

Kew.—Supply and installation of warm-air ventilation system in the Occupational Therapy Building, Mental Hospital.

Kerang.—Renovations to Manual Training Block, H.S. (W.O., Swan Hill; H.S., Kerang.)

Kyneton.—Electrical installation, Nurses Home, District Hospital. (W.O., Kyneton.) (Amended specification.)

Mallacoota.—Erection of timber residence and out-buildings, S.S. No. 3515. (W.O., Bairnsdale; S.S., Mallacoota.)

Melbourne.—Attention to steel windows, Centenary Hall, State Rivers and Water Supply Commission.

Melbourne.—Attention to roof gutters, County and Court II., Law Courts.

Melbourne.—Additions to Male Staff Room, University High School. (University High School, Melbourne.)

North Melbourne.—Erection of new building, Melbourne Printing Trades School. (Quantities available.)

Orbost.—Painting and repairs, &c., H.S. (W.O., Bairnsdale; H.S., Orbost.)

Ouyen.—Conversion of school building from Welshman's Plains into Cafeteria, H.S. (H.S., Ouyen; W.O., Mildura.)

Port Melbourne.—Purchase of condemned batteries at P.W.D. Depot, Salmon-street.

South Melbourne.—Erection of a new Caretaker's Cottage on the flat roof, MacRobertson Girls' High School. (MacRobertson Girls' High School, South Melbourne.)

St. Arnaud.—Repairs and painting to residence, office, and out-office, P.S. (W.O., Maryborough; P.S., St. Arnaud.)

Werribee.—Installation of septic tanks and laying of drains and water supply to staff residences, Research Station. (Research Station, Werribee.)

20th July, 1954.

Albion.—New school (first and second sections), H.S.

Albion.—Electrical installation, H.S.

Albion.—Mechanical services, H.S.

Camberwell South.—Painting ceilings, S.S. No. 4170. (S.S., Camberwell South.)

Camperdown.—Converting residence, 3 Hopetoun-street, into two self-contained flats, H.S. (W.O., Camperdown, Warrnambool.)

Carlton.—Additions to caretaker's quarters, State Office Annexe.

Cudgewa.—Additions, repairs, and painting to school, repairs and internal painting of residence, S.S. No. 1956. (W.O., Wangaratta; S.S., Cudgewa.)

Edgecombe.—Purchase and removal of out-offices, woodshed, and shelter shed, S.S. No. 277. (W.O., Kyneton; P.S., Castlemaine.)

Fitzroy North.—Repairs and painting to school, residence, shelter sheds, and woodsheds, S.S. No. 1490. (S.S., Fitzroy North.)

Footscray.—Exhaust system for woodworking shop, Ballarat-road, Carpentry Department, T.S. (T.S., Footscray.)

Gardiner.—New skylight and shelter pavilion extensions, S.S. No. 3888. (S.S., Gardiner.)

Greenvale.—Purchase and removal of men's quarters, annexe, hut, boiler-room, out-office, and X-ray room, &c., Sanatorium.

Kaniva.—Supply, installation, and testing of hard fuel hot-water service, teachers' flats. (P.S., Kaniva.)

Kew.—Electrical installation for Occupational Therapy Block, Mental Hospital.

Koo-Wee-Rup.—Supply and delivery of 4,000 cubic yards of sandy loam, Higher Elementary School.

Manifold Heights.—Repairs and painting, S.S. No. 4224. (W.O., Geelong; S.S., Manifold Heights.)

Maryborough East.—Removal of teacher's residence from Percydale and remodelling—renovation after re-erection, S.S. No. 2828. (W.O., Maryborough, Bendigo; S.S., Maryborough East.) (Amended specification.)

Newmerella.—Erection of new timber residence, out-building, fencing, paths, &c., S.S. No. 2930. (W.O., Bairnsdale; S.S., Newmerella.) (Amended specification.)

Nunawading.—Supply of joinery, "Winlaton," Children's Welfare Department, Springvale-road.

Port Fairy.—Internal and external painting and renovations, new fibro plaster ceilings, repairs, &c., Court House. (W.O., Warrnambool; P.S., Port Fairy.)

Port Melbourne.—Purchase and removal of No. 8 disused Army huts, Lorimer-street.

Richmond.—Asphalt repairs, S.S. No. 1396.

Royal Park.—Electrical installation, Male Convalescent Ward, Mental Hospital.

Seymour.—New water service, H.S. (W.O., Alexandra; H.S., Seymour.)

Shepparton South.—Conversion of residence into two teachers' flats, S.S. No. 4666. (W.O., Shepparton, Bendigo; S.S., Shepparton South.)

Stawell.—Supply and installation of a mechanical exhaust system for woodworking machines, T.S. (T.S., Stawell; W.O., Ararat.)

Tawonga.—Additional out-office accommodation, S.S. No. 2282. (W.O., Benalla; S.S., Tawonga.)

Wangaratta.—Erection of the first section of a timber-framed school building, H.S. (W.O., Wangaratta.)

Wangaratta.—Electrical installation in section 1, H.S. (W.O., Wangaratta.)

Wangaratta.—Supply, delivery, installation, and testing of a warm-air heating/ventilation system, stage 1, H.S. (W.O., Wangaratta.)

27th July, 1954.

Ararat.—New toilets, Administration Block, Mental Hospital. (Mental Hospital, Ararat; W.O., Ararat.)

Ballarat.—Erection of sub-station and switchroom, Mental Hospital. (W.O., Ballarat; Mental Hospital, Ballarat.)

Ballarat.—Sound insulation in Plumbers' Shop, School of Mines. (W.O., Ballarat; School of Mines, Ballarat.) (Amended specification.)

Belmont.—Erection of first section in light timber construction, H.S. (W.O., Geelong.)

Belmont.—Electrical installation in stage 1, H.S. (W.O., Geelong.)

Belmont.—Supply, delivery, installation, and testing of a warm-air heating/ventilation system, stage 1, H.S. (W.O., Geelong.)

Bentleigh West.—Purchase and removal of old house and garage (situated on school site), S.S. No. 4318. (S.S., Bentleigh West.)

Brighton Beach.—Provision of additional out-office accommodation, S.S. No. 2048. (S.S., Brighton Beach.)

Casterton.—Additional office and repairs to residence, P.S. (W.O., Hamilton; P.S., Casterton.)

Glen Iris.—Additional lavatory accommodation, S.S. No. 1148. (S.S., Glen Iris.)

Greenvale.—Alterations to nurses old quarters, Sanatorium.

Heidelberg West.—Erection of No. 1 30 ft. x 15 ft. timber shelter pavilion, S.S. No. 4267. (S.S., Heidelberg West.)

Mont Albert.—Additional out-office accommodation in brick, S.S. No. 3943. (S.S., Mont Albert.) (Amended specification.)

Preston East.—Replacement of dangerous ceilings, S.S. No. 4316. (S.S., Preston East.)

Strathmerton.—Removal of old school to new site, re-erection, repairs, and renewals, S.S. No. 2790. (W.O., Shepparton; S.S., Strathmerton.)

Sunbury.—Replacement of boundary fence on Wards M.1, F.1, F.2, and dividing fence between F.1 and F.2, Mental Hospital.

Syndal.—Provision of No. 2 30 ft. x 15 ft. shelter pavilions, S.S. No. 4714. (S.S., Syndal.)

Valencia.—Residence roof repairs, S.S. No. 1622. (W.O., Bairnsdale; S.S., Valencia.)

Warracknabeal.—Erection of storage shed, Store Shed. (W.O., Warracknabeal.)

3rd August, 1954.

Mentone.—Erection of timber framed school buildings, Girls' High School.

Tenders to be addressed to the Honorable the Commissioner of Public Works, and envelope containing tender marked "Tender for _____ due _____"

S. MERRIFIELD,
Commissioner of Public Works.

Public Works Department,
Melbourne, C.2, 6th July, 1954.

PUBLIC SERVICE NOTICES.

PUBLIC SERVICE (PUBLIC SERVICE BOARD) REGULATION 39.—VACANCIES.

THE Permanent Heads of the Departments shown have recommended the officers named hereunder for appointment to the under-mentioned vacancies.

Office and Classification.	Duties.	Qualifications.	Officer Recommended for Appointment.		
			Name.	Classification.	Date of Classification.
ADMINISTRATIVE DIVISION.					
DEPARTMENT OF EDUCATION.					
Clerk, Class "C1" (three offices)	To deal with the checking and adjustment of permanent staffing in primary schools and to arrange for the advertisement of vacancies in the <i>Education Gazette</i> ; to conduct correspondence in connexion with these matters	A sound knowledge of the regulations regarding staffing of primary schools, and of the conditions concerning the filling of vacancies in primary schools	Minter, J. T. . .	Clerk, Class "C"	28.8.50
	To act as Cashier; to be responsible for the proper keeping of the Revenue and Suspense Accounts; to prepare revenue statements; to act as paying officer to the administrative staff	Experience in the handling and control of large sums of money and in banking procedure; a sound knowledge of the regulations respecting public accounts, of the relevant portions of the Education Act and the regulations thereunder, of machine accounting, and the Department's organization	Byrne, M. L. . .	Clerk, Class "C"	18.9.50
	To assist the officer in charge of the ledger and miscellaneous accounts section and to take charge in his absence; to control all ledger postings, the dissection of revenue and expenditure vouchers and advance account reconciliations; to assist the Accountant in the preparation of the statistical and financial portion of the annual report and to conduct special investigations as required	To have a sound knowledge of the regulations respecting public accounts, the relevant portions of the Education Acts and the Public Service and Teaching Service Regulations, machine accounting, and Departmental and treasury procedure regarding accounts	Colbert, N. . .	Clerk, Class "C"	1.11.50
PROFESSIONAL DIVISION.					
DEPARTMENT OF TREASURER.					
<i>Taxation (Land Tax) Office.</i>					
Senior Valuer, Class "B1"	To possess a specialized knowledge of Real Estate values; to be competent to conduct discussions relating to the value of land and improvements, and to possess a thorough knowledge of the Land Tax Act and Regulations and Office procedure; to be an Associate of the Commonwealth Institute of Valuers	Clough, A. A. . .	Valuer, "B" Class	20.2.49

Appeals against such recommendations should be lodged with the Secretary to the Public Service Board not later than Saturday, the 17th July, 1954.

Office of the Public Service Board,
Melbourne, 6th July, 1954.

By order,
E. F. FITZGIBBON,
Secretary.

PUBLIC SERVICE OF VICTORIA.—VACANCIES.

APPLICATIONS will be received by the Public Service Board, up to Wednesday, the 21st July, 1954, from persons employed in the Public Service of Victoria, who are eligible and qualified, for employment in the under-mentioned positions:—

ADMINISTRATIVE DIVISION.

Clerk, Class "C," Audit Office, Department of Premier. (Four vacancies.)

Yearly Salary.—£520, minimum; £624, maximum.

Positions Nos. 1, 2, and 3.

Duties.—To act as an Assistant Inspector of Audit and to carry out such audits and investigations as the Auditor-General may direct.

Qualifications.—To have a thorough knowledge of the Audit Act and the General Regulations respecting Public Accounts, and a knowledge of the various activities which the Auditor-General is required by law to audit. Country work throughout Victoria is essential.

Position No. 4.

Duties.—To assist in the examination of Special Accounts, and to assist in the preparation of the Auditor-General's Annual Report to Parliament.

Qualifications.—To have a thorough knowledge of the Audit Act and the General Regulations respecting Public Accounts, and a knowledge of financial statistics relating to the various activities which the Auditor-General is required by law to audit. Experience in the preparation of Loan Schemes for municipalities and other semi-Government bodies is also desirable.

Clerk, Class "C," Crown Law Offices, Department of Law.

Yearly Salary.—£520, minimum; £624, maximum.

Duties.—To assist in the preparation of salary sheets and the keeping of salary records, and, as occasion requires, record accounts in the Register of Accounts.

Qualifications.—To be experienced in the duties particularly with relation to salary sheets which are mechanically prepared. To have a sound knowledge of the Public Service Act and Regulations, the Superannuation Acts, and the Regulations respecting Public Accounts.

PROFESSIONAL DIVISION.

Court Reporter (Female), Classes "C"—"CI," Courts Branch, Department of Law.

Yearly Salary.—£520, minimum; £720, maximum.

Duties.—To report cases in the Supreme and General Sessions, &c., Courts as required; to take notes for the Judges and of deputations, and to perform such other departmental shorthand reporting work as may be required.

Qualifications.—To be a licensed shorthand writer under the provisions of the *Evidence Act 1928*, with sufficient experience in the duties of the kind mentioned.

TECHNICAL AND GENERAL DIVISION.

Engineering Assessor, State Motor Car Insurance Office, Department of Chief Secretary.

Yearly Salary.—£560, minimum; £612, maximum.

Duties.—To act as Motor Car Claims Assessor.

Qualifications.—To be an automotive engineer possessing an "A" grade certificate; to be capable of assessing motor car loss and damage claims and of compiling reports in connexion therewith. A general knowledge of motor car insurance is desirable.

Chiropodist, Kew Mental Hospital, Department of Health.

Yearly Salary.—£455, minimum; £494, maximum.

Duties.—Treatment of corns, bunions, ulcers, chilblains, fallen arches, and similar conditions of patients. Under medical direction, to treat infections, give ray treatment and massage.

Qualifications.—To hold a diploma of an approved Association or Institute of Chiropodists.

Warder, Penal and Gaols Branch, Department of Chief Secretary. (Thirty-nine vacancies.)

Yearly Salary.—£339, minimum; £430, maximum.

Duties.—To control and to supervise male prisoners, and to perform other duties as required.

Qualifications.—As required by Regulation 31 of the Public Service (Public Service Board) Regulations.

Assistant Reservoir Keeper (Torrumbarry Weir), Department of Water Supply.

Yearly Salary.—£383, minimum; £422, maximum.

Duties.—To carry out, under the supervision of the Reservoir Keeper, maintenance or construction work on the embankments, and to supervise workmen engaged on work of this nature.

Qualifications.—To have a thorough knowledge of earthwork, concrete and stone work, and experience in the use of wire ropes and steam winches; to be in good health, able to swim, and familiar with river work; to be capable of carrying out the necessary clerical work in connexion with the making of reports, preparation of wages sheets, and recording of stores.

Note.—A house will be available for a successful married applicant at a charge of 10 per cent. of salary, plus £11 8s. a year.

Engineer Mechanic, Buchan Caves, Department of Crown Lands and Survey.

Yearly Salary.—£377, minimum; £403, maximum.

Duties.—To be responsible for the operation of a diesel generating plant (D.C.) and the maintenance of electrical reticulation and wiring in the Caves; to carry out other duties required by the officer in charge.

Qualifications.—To possess an "A" Grade Electrical Mechanic's Licence issued by the State Electricity Commission of Victoria; to have had good general experience in maintenance of electric light and power installation and the operation of diesel generating plant.

Note.—A house is available in the Reserve for a married man at a yearly charge of 10 per cent. of above salary, plus £11 8s. a year.

Gardener, Grade I, Kew Mental Hospital, Department of Health.

Yearly Salary.—£377, minimum; £403, maximum.

Duties.—To have charge of vegetable garden and direct operations of attendants and patients placed at his disposal.

Qualifications.—A thorough knowledge of gardening work and ability to handle staff and patients.

Crier, Sheriff's Office, Department of Law.

Yearly Salary.—£325, minimum; £390, maximum.

Duties.—To attend in Court; to have a knowledge of the different oaths used in connexion with the business of the Court, and to administer same; to clean the Courts, and to carry out the instructions of the presiding Judge.

Cook (Male), Grade II, Mental Hygiene Branch, Department of Health.

(Kew Mental Hospital—two vacancies.)

(Royal Park Mental Hospital—one vacancy.)

Yearly Salary.—£367, minimum; £380, maximum.

Duties.—To assist in preparation, cooking, and serving of meals for patients and staff, and in maintenance and cleanliness of kitchen.

Qualifications.—A knowledge of and experience in large-quantity cooking.

Shoemaker, Grade II, Mont Park Mental Hospital, Department of Health.

Yearly Salary.—£364, minimum; £377, maximum.

Duties.—Manufacture and repair of boots and shoes, and, in the absence of the Shoemaker, Grade I, to take charge of the staff and the patients working there.

Qualifications.—To be a fully-qualified shoemaker and repairer, and to be able to make footwear for patients with abnormal feet.

Shorthand Writer and Typist (Female), Grade III, Office of Titles, Department of Law.

Yearly Salary.—£351, minimum; £364, maximum.

Duties.—To have charge of the keeping of records and indexing of all dealings in the Survey Branch. To supply all relevant information to the public. To carry out any secretarial duties required and supervise general typing.

Qualifications.—To be an experienced typist and stenographer capable of writing shorthand at the rate of 120 words a minute, with a knowledge of filing and recording—accuracy is essential. To be able to control a small staff.

Gardener, Grade II, Royal Park Mental Hospital, Department of Health.

Yearly Salary.—Junior—at 19 years, £202; at 20 years, £241. Adult—£325, minimum; £364, maximum.

Duties.—To assist the Gardener, Grade I, and, in his absence, to take charge of the vegetable garden and to direct operations of patients placed at his disposal.

Qualifications.—A good knowledge of gardening work and ability to handle staff.

General Assistant, Ballarat Mental Hospital, Department of Health.

Yearly Salary.—£312, minimum; £338, maximum.

Duties.—To act as assistant to the different artisans, usually the Engineer.

Qualifications.—Ability to carry out general labouring work, and preferably to be a semi-skilled worker.

Laundress, Grade II, Larundel Mental Hospital, Department of Health.

Yearly Salary.—Junior—at 18 years, £171; at 19 years, £197; at 20 years, £236. Adult—£275, minimum; £288, maximum.

Duties.—To assist in Laundry.

Qualifications.—Ability to operate laundry machinery.

Seamstress, Grade II, Janefield Colony, Mental Hygiene Branch, Department of Health.

Yearly Salary.—£275, minimum; £288, maximum.

Duties.—To make up and repair clothing and bedding, and to supervise patients working in the sewing room.

Qualifications.—To be a competent needlewoman and machinist.

NOTE.—In addition to the salary rates quoted, a cost of living adjustment (£390 a year for adult males, £293 a year for adult females, and juniors according to age), which varies in accordance with the rise or fall in the index number of the cost of living, is payable.

By order,

E. F. FITZGIBBON,
Secretary.

Office of the Public Service Board,
Melbourne, 6th July, 1954.

PUBLIC SERVICE OF VICTORIA.—VACANCY.

(TEMPORARY APPOINTMENT.)

APPLICATIONS will be received by the Public Service Board, up to Wednesday, the 21st July, 1954, from persons who are qualified, for appointment to the under-mentioned position:—

Storeman, Burnley Gardens, Department of Agriculture.

Yearly Salary.—£299, minimum; £325, maximum.

Qualifications.—Experience in the receipt, recording, custody, issue, and despatch of stores. Ability to drive a motor vehicle is desirable.

NOTE.—In addition to the salary rates quoted, a cost of living adjustment (£390 a year for adult males), which varies in accordance with the rise or fall in the index number of the cost of living, is payable.

By order,

E. F. FITZGIBBON,
Secretary.

Office of the Public Service Board,
Melbourne, 6th July, 1954.

Serial No. 74.

PUBLIC SERVICE ACT 1946.

THE Public Service Board, in pursuance of the powers conferred by the *Public Service Act 1946*, hereby amends the Public Service (Public Service Board) Regulations as follows:—

PART III.—SALARIES, INCREMENTS AND ALLOWANCES.

OVERTIME ALLOWANCES.

Regulation 78.

In sub-regulation (3) add the words "The hours of overtime for which payment shall be made may be restricted to such hours as the Board may determine in any particular case."

In sub-regulation (5) substitute "£1,050" for "£1,150."
Delete sub-regulation (7).

This Regulation shall have effect as on and from the 1st July, 1954.

D. D. PAINE, Chairman.
E. F. FITZGIBBON, Secretary.

Office of the Public Service Board,
Melbourne, 5th July, 1954.

No. 73.

Public Service Act 1946, Section 39.

REGULATIONS—PART III.—SALARIES, INCREMENTS, AND ALLOWANCES.

THE Public Service Board, in pursuance of the powers conferred by the *Public Service Act 1946*, hereby amends its Regulations as shown below:—

FIRST SCHEDULE.

PROFESSIONAL DIVISION.

Offices and Rates of Salaries.

Office.	Yearly Rate of Salary.	
	Minimum.	Maximum.
DEPARTMENT OF HEALTH.		
GENERAL HEALTH BRANCH.		
CLASS "A1."		
<i>Delete—</i>		
Chief Engineer	1,445	1,595
Chief Industrial Hygiene Officer	1,550	1,650
Health Officer (Venereal Diseases)	1,550	1,650
Medical Supervisor, Poliomyelitis	1,550	1,650
<i>Add—</i>		
Chief Engineer	1,550	1,700
Chief Industrial Hygiene Officer	1,610	1,760
Health Officer (Venereal Diseases)	1,610	1,760
Medical Supervisor, Poliomyelitis	1,610	1,760
MATERNAL AND CHILD HYGIENE BRANCH.		
CLASS "A1."		
<i>Delete—</i>		
Chief School Medical Inspector (Female)	1,390	1,540
Director of Maternal, Infant, and Pre-School Welfare (Female)	1,390	1,540
<i>Add—</i>		
Chief School Medical Inspector (Female)	1,490	1,640
Director of Maternal, Infant, and Pre-School Welfare (Female)	1,490	1,640

This Regulation shall have effect as on and from the 1st July, 1954.

D. D. PAINE, Chairman.
E. F. FITZGIBBON, Secretary.

Office of the Public Service Board,
Melbourne, 2nd July, 1954.

No. 71.

Public Service Act 1946, Section 39.

REGULATIONS—PART III.—SALARIES, INCREMENTS, AND ALLOWANCES.

THE Public Service Board, in pursuance of the powers conferred by the *Public Service Act 1946*, hereby amends its Regulations as shown below:—

FIRST SCHEDULE.

PROFESSIONAL DIVISION.

Offices and Rates of Salaries.

Office.	Yearly Rate of Salary.	
	Minimum.	Maximum.
DEPARTMENT OF CHIEF SECRETARY.		
CLASS "A."		
<i>Add—</i>		
Education and Training Officer, Penal and Gaols	1,100	1,265

D. D. PAINE, Chairman.
E. F. FITZGIBBON, Secretary.

Office of the Public Service Board,
Melbourne, 2nd July, 1954.

No. 66.

Public Service Act 1946, Section 39.

REGULATIONS—PART III.—SALARIES, INCREMENTS,
AND ALLOWANCES.

THE Public Service Board, in pursuance of the powers conferred by the *Public Service Act 1946*, hereby amends its Regulations as shown below:—

FIRST SCHEDULE.
PROFESSIONAL DIVISION.
Offices and Rates of Salaries.

Office.	Yearly Rate of Salary.	
	Minimum.	Maximum.
DEPARTMENT OF AGRICULTURE. CLASS "C."	£	£
<i>Add—</i> Science Master, Agricultural College ..	520	624

D. D. PAINE, Chairman.
E. F. FITZGIBBON, Secretary.

Office of the Public Service Board,
Melbourne, 24th June, 1954.

No. 69.

Public Service Act 1946, Section 50.

REGULATIONS—PART III.—SALARIES, INCREMENTS,
AND ALLOWANCES.

THE Public Service Board, in pursuance of the powers conferred by the *Public Service Act 1946*, hereby amends its Regulations as shown below:—

SECOND SCHEDULE.
TECHNICAL AND GENERAL DIVISION.
Offices and Rates of Salaries.

Department and Office.	Yearly Rate of Salary.		Increments (Annual).
	Minimum.	Maximum.	
DEPARTMENT OF CHIEF SECRETARY.	£	£	
<i>Add—</i> Engineering Assessor, State Motor Car Insurance Office	560	612	2 of £26

D. D. PAINE, Chairman.
E. F. FITZGIBBON, Secretary.

Office of the Public Service Board,
Melbourne, 30th June, 1954.

No. 67.

Public Service Act 1946, Section 39.

REGULATIONS—PART III.—SALARIES, INCREMENTS,
AND ALLOWANCES.

THE Public Service Board, in pursuance of the powers conferred by the *Public Service Act 1946*, hereby amends its Regulations as shown below:—

FIRST SCHEDULE.
PROFESSIONAL DIVISION.
Offices and Rates of Salaries.

Office.	Yearly Rate of Salary.	
	Minimum.	Maximum.
DEPARTMENT OF PUBLIC WORKS. CLASS "C2."	£	£
<i>Add—</i> Quantity Surveyor	754	806

D. D. PAINE, Chairman.
E. F. FITZGIBBON, Secretary.

Office of the Public Service Board,
Melbourne, 24th June, 1954.

No. 72.

Public Service Act 1946, Section 39.

REGULATIONS—PART III.—SALARIES, INCREMENTS,
AND ALLOWANCES.

THE Public Service Board, in pursuance of the powers conferred by the *Public Service Act 1946*, hereby amends its Regulations as shown below:—

FIRST SCHEDULE.
PROFESSIONAL DIVISION.
Offices and Rates of Salaries.

Office.	Yearly Rate of Salary.	
	Minimum.	Maximum.
DEPARTMENT OF LAW. CLASSES "A" AND "A1."	£	£
<i>Add—</i> Officer in Charge, Common Law, Crown Solicitor's Office	1,175	1,375
Officer in Charge, Conveyancing other than Railways, Crown Solicitor's Office	1,175	1,375
CLASS "A."		
<i>Delete—</i> Officer in Charge, Common Law, Crown Solicitor's Office	1,105	1,155
Officer in Charge, Conveyancing other than Railways, Crown Solicitor's Office	1,105	1,155

This Regulation shall have effect as on and from the 1st July, 1954.

D. D. PAINE, Chairman.
E. F. FITZGIBBON, Secretary.

Office of the Public Service Board,
Melbourne, 30th June, 1954.

No. 70.

Public Service Act 1946, Section 50.

REGULATIONS—PART III.—SALARIES, INCREMENTS,
AND ALLOWANCES.

THE Public Service Board, in pursuance of the powers conferred by the *Public Service Act 1946*, hereby amends its Regulations as shown below:—

SIXTH SCHEDULE.
TEMPORARY EMPLOYEES.
Designations of Positions and Rates of Salaries.

Department and Designation of Position.	Yearly Rate of Salary.		Increments (Annual).
	Minimum.	Maximum.	
DEPARTMENT OF CROWN LANDS AND SURVEY.	£	£	
<i>Add—</i> Purchasing Officer	475	501	1 of £26

This Regulation shall have effect as on and from the 1st July, 1954.

D. D. PAINE, Chairman.
E. F. FITZGIBBON, Secretary.

Office of the Public Service Board,
Melbourne, 30th June, 1954.

No. 68.

Public Service Act 1946, Section 39.

REGULATIONS—PART III.—SALARIES, INCREMENTS, AND ALLOWANCES.

THE Public Service Board, in pursuance of the powers conferred by the *Public Service Act 1946*, hereby amends its Regulations as shown below:—

FIRST SCHEDULE.

PROFESSIONAL DIVISION.
Offices and Rates of Salaries.

Office.	Yearly Rate of Salary.	
	Minimum.	Maximum.
DEPARTMENT OF PREMIER.	£	£
CLASS "C2."		
Add— Soil Physicist, Soil Conservation Authority	754	806

This Regulation shall have effect as on and from the 1st July, 1954.

D. D. PAINE, Chairman.
E. F. FITZGIBBON, Secretary.

Office of the Public Service Board,
Melbourne, 30th June, 1954.

PUBLIC SERVICE OF VICTORIA.

RESULTS of examination held on 5th June, 1954, to enable male employees to qualify for appointment to the Technical and General Division as Assistants.

Order of Merit.	Name.	Total Marks.
1	McDonald, Ronald	175
2	Negline, Denis Bede	169
3	Buchanan, Ronald Frederick	168
4	Elias, Frederic	159
5	Ellis, Walter James	156
6	Cummins, Thomas Joseph	156
7	Lewenberg, Henry	152
8	Hoefman, Albertus	149
9	Eppinger, Richard Otto	149
10	Rutherford, Harold Joseph Memory	149
11	Batt, William Kenneth Charles	149
12	Haining, William Gilbert	148
13	Imberger, Walter Joschim	145
14	Burstein, Harry	145
15	Evans, John Glyndwr	145
16	South, Bruce	142
17	Crollin, Claude Mansfield	138
18	Ryan, Joseph Thomas	127
19	Lovass, Stephen	126
20	Robertson, Percy William	116
21	Mackay, James Clarke	115
22	Jackman, Ernest Alfred	114
23	Doherty, Anthony Louis	113
24	Felsing, Ulrich Karl	105
25	Kearle, Victor Charles	103
26	Robertson, Benjamin Lawrence	102
27	Renton, John Arthur Harry	101

By order,

E. F. FITZGIBBON, Secretary.

Office of the Public Service Board,
Melbourne, 5th July, 1954.

PRIVATE ADVERTISEMENTS.

CITY OF BRIGHTON.

By-Law No. 123.

NOTICE is hereby given that the above By-law was approved by the Governor in Council on the 8th day of June, 1954, and the said By-law is published hereunder, in accordance with the provisions of section 207 of the *Local Government Act 1946*.

By-law No. 123.

A By-law of the City of Brighton made under the provisions of the Local Government Acts and every other power thereunto it enabling and numbered 123 for altering and amending By-law No. 111 of the City of Brighton.

In pursuance of the powers conferred by the Local Government Acts and every other power in that behalf enabling it the Mayor, Councillors, and Citizens of the City of Brighton, with the approval of the Governor in Council order as follows:—

1. That on and after the coming into force of this By-law it shall form part of and be read as one with By-law No. 111.

2. By-law 111 is hereby amended as follows:—

(a) By adding the following clause after clause 2 thereof:—

"2A. Within the portions of such Residential area set forth and described in the Third Schedule hereto the use of any land or the erection (including adaptation for use) or the use of any buildings for the purposes of all classes of trades industries manufactures businesses or public amusements except the trade or business of a laundry is hereby prohibited."

(b) By adding in clause 3 of the said By-law 111 after the words and figure "Subject to clause 2" the words and figure "and 2A."

(c) By adding to the Second Schedule thereto after the words "Church-street—south side," the following words and figures:—From 55 feet south-easterly of St. Andrews-street to 131 feet south-easterly of St. Andrews-street.

(d) By adding to the Second Schedule thereto after the words "West side" where referring to Hawthorn-road the following words and figures:— "From 55 feet north of Northern-avenue to Northern-avenue."

(e) By adding the following words and figures after the Second Schedule:—

THIRD SCHEDULE.

New-street.—East side having a frontage of 77 ft. 10 in. between points 117 ft. 2 in. northerly and 195 feet northerly of the north-east corner of the intersection of Bay and New streets with a depth of 148 feet along the north and south boundaries of the said land and with a width of 77 ft. 4 in. on the rear boundary abutting on a road to the east of the said land.

The Resolution for making and passing this By-law was agreed to by the Council at its meeting on the 20th day of April, 1953, and confirmed the 18th day of May, 1953.

The common seal of the Mayor, Councillors, and Citizens of the City of Brighton was hereto affixed, in the presence of—

(SEAL) R. E. TRICKEY, Mayor.
D. GRANTER, Councillor.
H. C. FERGUSON, Town Clerk.

Approved by the Governor in Council, the eighth day of June, 1954.—A. MAHLSTEDT, Clerk of the Executive Council. 9826

CITY OF MELBOURNE.

By-Law No. 338.

A By-law of the City of Melbourne made under Part VII of the Local Government Acts and numbered 338 to amend By-law No. 251 and to prescribe business areas and for other purposes.

THE Council of the City of Melbourne doth hereby in pursuance of the powers conferred by the Local Government Acts and by every other Act or power enabling it in that behalf order as follows:—

1. This By-law shall from and after the date of the same coming into operation be read and construed as one with By-law No. 324 intitled "A By-law of the City of Melbourne made under Part VII Division 1 of the Local Government Acts and numbered 324 to amend By-law No. 251 and to prescribe certain areas within the Municipal District as business areas and to prohibit within those areas the use of any land or the erection (including adaptation for use) or the use of any building or portion of a building for the purposes of such classes of trades industries manufactures businesses or public amusements as are specified and for other purposes" and any By-laws amending the same.

2. From and after the date of coming into operation of this By-law—

- (i) each of those parts of the City of Melbourne more particularly described in the Schedule hereto—
 - (a) shall cease to be a residential area within the meaning of By-law No. 251
 - (b) shall be deemed to be excised from the area more particularly described in the Second Schedule to By-law No. 251 in which it is included
- (ii) each of those parts of the City of Melbourne more particularly described in Parts 1, 2, 3 and 4 of the Schedule hereto
 - (a) is hereby prescribed as a business area within the meaning of By-law No. 324
 - (b) for the purposes of clause 3 of By-law No. 324 is hereby declared to be a limited business area
- (iii) the provisions of the said By-law No. 324 shall apply to that part of the City of Melbourne more particularly described in Part 1 of the Schedule hereto
- (iv) the provisions of the said By-law No. 324 shall apply to that part of the City of Melbourne more particularly described in Part 2 of the Schedule hereto save that for the purposes of this By-law there shall be deemed to be added to the list of trades industries manufactures and businesses in clause 3 in the said By-law No. 324 the trade or business of preparing cutting and wrapping of meats.
- (v) the provisions of the said By-law No. 324 shall apply to that part of the City of Melbourne more particularly described in Part 3 of the Schedule hereto save that for the purposes of this By-law there shall be deemed to be added to the list of trades industries manufactures and businesses in clause 3 in the said By-law No. 324 the trade or business of store for general goods
- (vi) the provisions of the said By-law No. 324 shall apply to that part of the City of Melbourne more particularly described in Part 4 of the Schedule hereto save that for the purposes of this By-law there shall be deemed to be added to the list of trades industries manufactures and businesses in clause 3 in the said By-law No. 324 the trade or business of motor show rooms and offices

THE SCHEDULE.

Part 1.

All that piece or parcel of land being part of Crown allotments 18 and 19, section 55 at West Melbourne, Parish of Melbourne North, County of Bourke. Commencing at the intersection of the north-eastern boundary of Spencer-street and the south-eastern boundary of Hawke-street; thence north-easterly along the south-eastern boundary of Hawke-street 45 ft. 8 in.; thence south-easterly 120 ft. 11 in. to a road or way reserved out of the said section 55; thence south-westerly along the north-western boundary of the said road or way 43 ft. 8½ in. to the north-eastern boundary of Spencer-street; thence north-westerly along the north-eastern boundary of Spencer-street 118 ft. 6 in. to the commencing point, and being the whole of the land more particularly described in certificates of title, volume 3342, folio 668369, volume 3342, folio 668368, and volume 3819, folio 763863.

Part 2.

All that piece or parcel of land being part of Crown allotment 49, portion 16, Parish of Doutta Galla, County of Bourke. Commencing at a point on the western boundary of Rankins-road distant 102 feet from the intersection of the western boundary of Rankins-road and the southern boundary of Racecourse-road; thence further south along the western boundary of Rankins-road 84 ft. 9 in.; thence westerly 93 feet to a road or way 12 feet wide reserved out of the said Crown allotment 16; thence northerly along the eastern boundary of the said road or way 83 ft. 3 in. to another road or way 12 feet wide reserved out of the said Crown allotment 16; thence easterly along the southern boundary of the said road or way 93 feet to the commencing point, and being the whole of the land more particularly described in certificates of title, volume 4659, folio 931735, and volume 4659, folio 931736.

Part 3.

All that piece or parcel of land being part of Crown allotment 3, section 4 at North Melbourne, Parish of Jika Jika, County of Bourke. Commencing at a point on the

northern boundary of Moss-place distant 89 ft. 9½ in. from the western boundary of Howard-street; thence further west along the northern boundary of Moss-place 35 ft. 2½ in.; thence northerly 50 ft. 6½ in., easterly 35 ft. 8 in. and southerly 50 ft. 10 in. to the commencing point, and being part of the land more particularly described in certificate of title, volume 5706, folio 1141126.

Part 4.

All that piece of land being part of Crown allotments 8, 9, 10, 11, section 11 at North Melbourne, Parish of Jika Jika, County of Bourke. Commencing at the intersection of the south-west building line of Flemington-road and the south-east building line of Wreckyn-street; thence along the south-west building line of Flemington-road to the intersection of the south-west building line of Flemington-road and the north-west building line of Blackwood-street; thence south-westerly along the north-west building line of Blackwood-street 100 feet; thence by a line parallel to the south-west building line of Flemington-road to the south-eastern building line of Wreckyn-street; thence north-easterly along the south-eastern building line of Wreckyn-street 100 feet to the commencing point.

Part 5.

All that piece or parcel of land being lots 11, 12, 13 on plan of subdivision No. 310, lodged in the Office of Titles, and being part of Crown allotment 48, portion 16, Parish of Doutta Galla, County of Bourke. Commencing at the intersection of the southern boundary of Racecourse-road and the eastern boundary of Nottingham-street; thence easterly along the southern boundary of Racecourse-road 100 feet to a road or way 10 feet wide reserved out of the said Crown allotment 48; thence southerly along the western boundary of the said road or way 99 ft. 3 in. to the northern boundary of another road or way 10 feet wide reserved out of the said Crown allotment 48; thence westerly along the northern boundary of the said road or way 100 feet to the eastern boundary of Nottingham-street; thence northerly along the eastern boundary of Nottingham-street 99 ft. 3 in. to the commencing point.

Part 6.

All that piece or parcel of land being part of Crown allotment 17, section 13 at North Melbourne, Parish of Jika Jika, County of Bourke. Commencing at a point on the south-west boundary of Crown allotment 17 bearing 126 deg. 5 min. 85 ft. 1½ in. from its intersection with the south-east boundary of Harcourt-street, such intersection bearing 36 deg. 20 min. 132 feet from the intersection of the south-east boundary of Harcourt-street and the north-east boundary of Courtney-street; thence bounded by lines bearing 36 deg. 29 min. 24 ft. 6½ in., 81 deg. 35 min. 3 ft. 11½ in., 36 deg. 35 min. 38 ft. 7½ in., 126 deg. 5 min. 11 ft. 10 in., 216 deg. 20 min. 66 feet, and 306 deg. 20 min. 14 ft. 10½ in. to the commencing point.

Resolution for passing this By-law was agreed to by the Council of the City of Melbourne the twenty-first day of April One thousand nine hundred and fifty four and confirmed the seventeenth day of May One thousand nine hundred and fifty-four.

R. H. SOLLY, Lord Mayor.

H. S. WOOTTON, Town Clerk.

Approved by the Governor in Council, the 8th day of June, 1954.—A. MAHLSTEDT, Clerk of the Executive Council. 9849

CITY OF MELBOURNE.

By-LAW No. 339.

A By-law of the City of Melbourne made under Part VII Division 1 of the Local Government Acts and numbered 339 to amend By-law No. 251 and to prescribe a business area and to apply thereto the provisions of By-law No. 324.

THE Council of the City of Melbourne doth hereby in pursuance of the powers conferred by the Local Government Acts and by every other Act or power enabling it in that behalf order as follows:—

1. This By-law shall from and after the date of the same coming into operation be read and construed as one with By-law No. 324 intituled "A By-law of the City of Melbourne made under Part VII Division 1 of the Local Government Acts and numbered 324 to amend By-law No. 251 and to prescribe certain areas within the Municipal District as business areas and to prohibit within those areas the use of any land or the erection (including adaptation for use) or the use of any building or portion of a building for the purposes of such classes of trades

industries manufactures businesses or public amusements as are specified and for other purposes" and any By-laws amending the same.

2. From and after the date of the coming into operation of this By-law—

- (i) that part of the City of Melbourne more particularly described in the Schedule hereto—
 - (a) shall cease to be a residential area within the meaning of By-law No. 251;
 - (b) shall be deemed to be excised from Residential Area "D" more particularly described in the Second Schedule to By-law No. 251;
 - (c) is hereby prescribed as a business area;
 - (d) for the purposes of clause 3 of By-law No. 324, is hereby declared to be a limited business area;
- (ii) the provisions of the said By-law No. 324 shall apply to the said part of the City of Melbourne more particularly described in the Schedule hereto.

THE SCHEDULE.

All that piece or parcel of land being part of Crown allotment 10 section 52 at Carlton Parish of Jika Jika County of Bourke. Commencing at a point bearing northerly 166 ft. 4 in. and westerly 93 ft. 9 in. from the intersection of the western boundary line of Canning-street and the northern boundary line of Carlton-street thence further westerly 58 ft. 11½ in., north-easterly 40 ft. 5 in., south-easterly 8 ft. 11 in., north-easterly 20 ft. 3½ in. and south-easterly 32 ft. 11½ in. to the commencing point.

Resolution for passing this By-law agreed to by the Council of the City of Melbourne the twenty-first day of April One thousand nine hundred and fifty four and confirmed the seventeenth day of May One thousand nine hundred and fifty-four.

R. H. SOLLY, Lord Mayor.
H. S. WOOTTON, Town Clerk.

Approved by the Governor in Council this 8th day of June, 1954.—A. MAHLSTEDT, Clerk of the Executive Council. 9850

CITY OF MOORABBIN.

NOTICE OF PREPARATION OF A PLANNING SCHEME.

City of Moorabbin Planning Scheme, 1952.—Amendment 4.

NOTICE is hereby given that the Council of the City of Moorabbin, in pursuance of its powers under the Town and Country Planning Acts, has prepared a Planning Scheme for the area described hereunder:—

Commencing on the south street alignment of North-road at a point 175 ft. 1 in. west of the west street alignment of Warrigal-road; thence southerly on a bearing of 179 deg. 37 min. for a distance of 149 feet; thence westerly on a bearing of 269 deg. 45 min. for a distance of 61 feet; thence northerly on a bearing of 359 deg. 37 min. for a distance of 149 feet to the south street alignment of North-road; thence easterly along the south street alignment of North-road on a bearing of 89 deg. 45 min. for a distance of 61 feet back to the commencing point;

for the purpose of regulating development and re-planning the aforesaid portion of the municipality.

All maps, plans, descriptions, and other data fully setting out and explaining the planning scheme have been deposited at the offices of the Council, situate the Nepean Highway, Moorabbin, and at the offices of the Town and Country Planning Board, 107 Russell-street, Melbourne, and will be open for inspection without payment of any fee by all persons affected, between the hours of 9 a.m. and 5 p.m. on all days of the week except Saturdays, Sundays and public holidays, until the 14th day of August, 1954.

All persons affected by the planning scheme are required to set forth, in writing, all objections they may have, addressed to Mr. Wilson B. Thomas, Town Clerk, Municipal Offices, Nepean Highway, Moorabbin, S.20, on or before the 14th day of August, 1954.

At the next ordinary meeting of the responsible authority to be held in the Council Chamber, Municipal Buildings, Moorabbin, on Monday, 16th day of August, 1954, it will consider any objections to the planning scheme.

At this meeting any person affected by the scheme, or any person acting on his behalf, may appear before the responsible authority in support of any written objections, or may submit any other objections to the scheme.

WILSON B. THOMAS, Town Clerk.

Dated this 1st day of July, 1954.

NOTE.—It is important that a full statement should be made giving the grounds for any objection to the planning scheme. 9830

CITY OF PRAHRAN.

BY-LAW No. 217.

Residential Areas.

A By-law of the City of Prahran, made under the provisions of the Local Government Act 1946, and numbered 217, for the purposes of altering By-law No. 196.

IN pursuance of the powers conferred by the Local Government Act 1946, and every other power it thereunto enabling, the Mayor, Councillors, and Citizens of the City of Prahran order as follows:—

1. From and after the coming into operation of this By-law, By-law No. 196, made and passed by the Council on the 21st day of March, 1938, confirmed on the 9th day of May, 1938, and approved by the Governor in Council on the 16th day of August, 1938, as altered by By-law No. 208, made and passed by the Council on the 19th day of February, 1951, confirmed on the 19th day of March, 1951, and approved by the Governor in Council on the 26th day of June, 1951, and by By-law No. 209 made and passed by the Council on the 6th day of March, 1950, confirmed on the 3rd day of April, 1950, and approved by the Governor in Council on the 8th day of August, 1950, is hereby altered as follows, and to the extent that any part or parts thereof respectively which is, or are, inconsistent with or repugnant to this By-law, are hereby expressly repealed:—

In clause 27 (iv) for the word and symbols "house"—there shall be substituted the words "house; or

(f) private hospital duly registered under the Health Acts for the accommodation of chronic convalescent or senile cases but no other cases."

Resolution for making and passing this By-law agreed to by the Council of the City of Prahran, this 29th day of March, 1954.

Confirmed this 3rd day of May, 1954.

The common seal of the Mayor, Councillors, and Citizens of the City of Prahran was hereunto affixed, in the presence of—

CHARLES S. GAWITH, Mayor.

(SEAL) G. E. FURNELL, Councillor.

HENRY T. JONES, Town Clerk.

Approved by the Governor in Council, the 8th day of June, 1954.—A. MAHLSTEDT, Clerk of the Executive Council. 9812

CITY OF PRESTON.

LOAN No. 33.

NOTICE is hereby given, that the Council of the City of Preston intends to borrow, on the credit of the Mayor, Councillors, and Citizens of the said City, the sum of £25,000, such sum to be raised by the issue of debentures, in accordance with the provisions of the Local Government Act.

The rate of interest to be named in the debentures shall be 4 17s. 6d. per centum per annum.

The money borrowed will be repayable, together with and including interest, at the Bank of New South Wales, Melbourne, or at the Council's bankers for the time being in the City of Melbourne, in half-yearly sums of £985 9s., on the 1st day of April and the 1st day of October in each year, the loan to have a currency of twenty years. The first instalment shall be payable on the 1st day of April, 1955.

The purposes for which the loan is to be applied shall be as follows:—

Electricity Department:

Transmission lines	£6,700
Sub-stations	6,900
Meters	5,900
Services	5,500

£25,000

The loan is to be liquidated by provision out of the Municipal Fund of the sum of £985 9s., including interest, in each half-year during the currency of the loan.

The plans, specifications, and estimate of the cost of the works referred to above and a statement showing the proposed expenditure of the money to be borrowed, are open for inspection at the Municipal Offices, High-street, Preston.

Dated this 29th day of June, 1954.

9811 J. C. DONATH, Town Clerk.

SHIRE OF AVOCA.

LOAN No. 11.

Notice of Intention to Borrow the Sum of £5,500 for Permanent Works and Undertakings.

NOTICE is hereby given that the Council of the Shire of Avoca proposes to borrow the sum of Five thousand five hundred pounds, on the credit of the municipal revenues of the President, Councillors, and Ratepayers of the said Shire, such sum to be raised by the issue of debentures, in accordance with the provisions of the Local Government Acts.

1. The maximum rate of interest that may be paid is 4½ per cent. per annum.

2. The purpose for which the loan is to be applied is:—
Purchase of plant—diesel grader.

3. The period of the loan shall be ten years.

4. The moneys borrowed shall be repayable by providing out of the municipal fund twenty half-yearly instalments of approximately £350 14s. 6d. each, including principal and interest, on the 1st day of April and the 1st day of October during the currency of the loan. The first instalment shall be payable on the 1st day of April, 1955.

5. Such moneys shall be repayable at the Commercial Banking Company of Sydney Limited, or at the Council's bankers for the time being in Melbourne.

The plans and specifications and the estimate of the cost of the proposed works, and a statement showing the proposed expenditure of the moneys to be borrowed, are open for inspection at the Shire Office, Avoca.

Dated 5th July, 1954.

9829 J. I. GRENFELL, Shire Secretary.

SHIRE OF BRIGHT.

BY-LAW No. 17.

A By-law of the Shire of Bright made under the provisions of the *Local Government Act 1946*, and the *Police Offences Act 1928*, and numbered 17 for the purpose of having the provisions of Part 1 of the *Police Offences Act 1928*, other than section 6 of such Part, apply to and have operation within the Municipal District of the Shire of Bright.

IN pursuance of the provisions of the *Local Government Act 1946* and the *Police Offences Act 1928*, the President, Councillors, and Ratepayers of the Shire of Bright order as follows:—

(a) That Part 1 of the *Police Offences Act 1928*, with the exception of section 6 of such Part apply to and have operation within the Municipal District of the Shire of Bright.

(b) That this By-law shall apply to and have operation throughout the whole of the Municipal District of the Shire of Bright.

Resolution for passing this By-law was agreed to by the Council of the Shire of Bright, on the 11th day of March, 1954, and confirmed at a meeting of the Council held on the 13th day of May, 1954.

The common seal of the President, Councillors, and Ratepayers of the Shire of Bright was hereunto affixed on the 13th day of May, 1954.

(SEAL) J. WALLACE, President.
H. HARGREAVES, Councillor.
9813 H. G. HAYMES, Shire Secretary.

SHIRE OF CORIO.

NOTICE is hereby given that the Council of the Shire of Corio has, under the provisions of the *Local Government Act 1949*, altered the name of the street within the municipality, as set forth in the subjoined Schedule.

SCHEDULE.

New name.—Hendy-street.

Old name.—Grandjean-parade.

Situation.—Extending northerly from south-east corner of C.A. 73, Parish of Moranghurk (Purnell-road), to the north-east corner of C.A. 71, Parish of Moranghurk (Plantation-road).

9828 W. H. MYERS, Acting Shire Secretary.

SHIRE OF ELTHAM.

LOAN No. 23.

Notice of Intention to Borrow the Sum of £5,000 for Permanent Works and Undertakings.

NOTICE is hereby given that the Council of the Shire of Eltham proposes to borrow the sum of Five thousand pounds, on the credit of the municipal revenues of the President, Councillors, and Ratepayers of the said Shire, such sum to be raised by the issue of debentures, in accordance with the provisions of the Local Government Acts.

1. The maximum rate of interest that may be paid is 4½ 17s. 6d. per cent. per annum.

2. The purpose for which the loan is to be applied is:—
Reconstruction of part of Rattray-road and part of Mountain View-road, Montmorency—£5,000.

3. The period of the loan shall be fifteen years.

4. The moneys borrowed shall be repayable by providing out of the municipal fund 30 half-yearly instalments of approximately £236 18s. each, including principal and interest, on the 30th day of September and the 31st day of March during the currency of the loan. The first instalment shall be payable on the 31st day of March, 1955.

5. Such moneys shall be repayable at The Commercial Bank of Australia Limited, Melbourne, or at the Council's bankers for the time being in Melbourne.

6. The plans and specifications and the estimate of the cost of the proposed works, and a statement showing the proposed expenditure of the moneys to be borrowed, are open for inspection at the Shire Office, Eltham.

9847 R. J. HAM, Shire Secretary.

SHIRE OF ROCHESTER.

BY-LAW No. 26.

NOTICE is hereby given that the Council of the Shire of Rochester has made the above-mentioned By-law No. 26; a summary of such By-law is as follows:—

All former By-laws so far as they relate to the matters or things provided for in this By-law are repealed.

The By-law shall come into operation on the day after the publication of this notice in the *Government Gazette* and in the *Rochester Irrigator* and *Riverine Herald* newspapers.

The By-law provides for appointing the tolls and dues to be demanded, received, and had by the Council of the Shire of Rochester, and from every person exposing or offering for sale or selling any cattle in the cattle market of the said shire situate at Rochester, and in any yards or premises within the municipal district of the said shire and outside the said cattle market, save and except that portion of the Township of Gunbower which is situated within the said shire, for regulating the said cattle market and the buildings, stalls, pens, and standings therein, and for preventing nuisances or obstructions therein or in the immediate approaches thereto, and for fixing the days and the hours during each day in which the market shall be held, and for other purposes detailed in the By-law.

Resolution for the passing of By-law No. 26 was passed by the Council on the 3rd June, 1954, and confirmed on the 1st July, 1954.

A true copy of By-law No. 26 is deposited at the office of the Council, Mackay-street, Rochester, and is available and open for inspection by any person during office hours, free of charge.

9848 H. R. WESTCOTT, F.I.M.A., Shire Secretary.

SHIRE OF RUTHERGLEN.

BY-LAW No. 12.

A By-law of the Shire of Rutherglen, made under section 193 of the *Local Government Act 1946*, and numbered 12 for regulating, restricting, restraining or prohibiting the erection, construction, &c., of buildings or erections.

IN pursuance of the powers conferred by the *Local Government Act 1946*, the President, Councillors, and Ratepayers of the Shire of Rutherglen order as follows:—

1. By-laws No. 2 and No. 10, regulating and restraining the erection of buildings, &c., are hereby repealed.

2. The operation of the Uniform Building Regulations, Victoria, having been extended to the Municipal District of the Shire, the minimum area, depth, and width of frontage specified in column 3 of Table 803 of the said Regulations, are hereby adopted as the minimum area, depth, and width of frontage on which a building shall be constructed throughout the whole of the Municipal District.

3. No person shall erect, build or construct or cause to be erected, built or constructed any building or structure the external walls of which shall be other than brick, stone or concrete on land abutting on and having a depth of 120 feet from that portion of Main-street, Rutherglen, between the intersection of Murphy-street, and the point of and opposite the north-west angle of Crown allotment 1, section H, Township of Rutherglen, Parish of Carlyle.

4. This By-law shall come into operation on the day after its publication in the *Government Gazette*.

The Resolution for passing this By-law was agreed to by the Council on the ninth day of October, 1953, and confirmed on the sixth day of November, 1953.

(SEAL) C. T. G. MORRIS, President.
J. R. RILEY, Councillor.
W. JASPER, Councillor.
C. A. RICKETTS, Shire Secretary.

Approved by the Governor in Council, the 16th day of March, 1954.—A. MAHLSTEDT, Clerk of the Executive Council. 9814

NOTICE is hereby given that The Nightingale Supply Company (Victoria) Limited, has applied for a lease, under section 125 of the Land Acts for a term of 25 years, from 28th August, 1954, of allotment 7, section 63A, City of Port Melbourne, containing 3 roods, as a site for stores, warehouses, and factories. 9817

NOTICE OF INTENTION TO APPLY FOR A LICENCE TO DIVERT WATER AND CUT RACES FROM THE MURRAY RIVER AT LIPAROO.

I HEREBY give notice that I intend to apply for a licence empowering me to divert water for a term of fifteen years to the extent of 600 acre-feet per annum at a maximum rate of 3 acre-feet per day of 24 hours for irrigation of 200 acres, being part of allotment 3A, Parish of Liparoo, and to occupy certain Crown lands for works of storage and diversion, and to cut a race thereon.

Any objection to such application must be forwarded, in writing, to the State Rivers and Water Supply Commission, Melbourne, within 30 days of the date hereof.

LEO EDWARD ENGLEFIELD.

Liparoo, via Annuello, 21st June, 1954. 9818

NOTICE OF INTENTION TO APPLY FOR A LICENCE TO DIVERT WATER AND CUT RACES FROM THE LITTLE MURRAY RIVER (WEIR), PENTAL ISLAND.

WE hereby give notice that we intend to apply for a licence empowering us to divert water for a term of fifteen years to the extent of 200 acre-feet per annum at a maximum rate of 10 acre-feet per day of 24 hours for irrigation of 212 acres, being part of allotment 6, lots 2 and 3, Parish of Pental Island, and to occupy certain Crown lands for works of storage and diversion, and to cut a race thereon.

Any objection to such application must be forwarded, in writing, to the State Rivers and Water Supply Commission, Melbourne, within 30 days of the date hereof.

JOHN TEAGUE.
JAMES E. TEAGUE.

Wilson-street, Swan Hill, 26th June, 1954. 9844

NOTICE OF INTENTION TO APPLY FOR A LICENCE TO DIVERT WATER AND CUT RACES FROM THE TORGANNAH LAGOON AT KOONOOMOO.

I HEREBY give notice that I intend to apply for a licence empowering me to divert water for a term of fifteen years to the extent of 20 acre-feet per annum at a maximum rate of 2 acre-feet per day of 24 hours for irrigation of 10 acres, being part of allotment 31c, section D, and Parish of Yarroweyah, and to occupy certain Crown lands for works of storage and diversion, and to cut a race thereon.

Any objection to such application must be forwarded, in writing, to the State Rivers and Water Supply Commission, Melbourne, within 30 days of the date hereof.

CHARLES WILLIAM GARDNER.

Yarroweyah North, 28th June, 1954. 9845

NOTICE OF INTENTION TO APPLY FOR A LICENCE TO DIVERT WATER AND CUT RACES FROM THE MURRAY RIVER, LITTLE MURRAY WEIR, AT SWAN HILL.

I HEREBY give notice that I intend to apply for a licence empowering me to divert water for a term of fifteen years to the extent of 200 acre-feet per annum at a maximum rate of 10 acre-feet per day of 24 hours for irrigation of 189 acres, being allotments 4a and 4c, Parish of Pental Island, and to occupy certain Crown lands for works of storage and diversion, and to cut a race thereon.

Any objection to such application must be forwarded, in writing, to the State Rivers and Water Supply Commission, Melbourne, within 30 days of the date hereof.

M. V. DALTON.

C/o Alec M. Hayes, solicitor, Swan Hill, 30th June, 1954.
Alec M. Hayes, of 113 Campbell-street, Swan Hill, solicitor for the applicant. 9852

NOTICE OF INTENTION TO APPLY FOR A LICENCE TO DIVERT WATER AND CUT RACES FROM THE LITTLE MURRAY RIVER AT PENTAL ISLAND.

WE hereby give notice that we intend to apply for a licence empowering us to divert water for a term of fifteen years to the extent of 200 acre-feet per annum at a maximum rate of 10 acre-feet per day of 24 hours for irrigation of 339 acres, being allotments 1A, 5, 5A, and 6A, Parish of Pental Island, and to occupy certain Crown lands for works of storage and diversion, and to cut a race thereon.

Any objection to such application must be forwarded, in writing, to the State Rivers and Water Supply Commission, Melbourne, within 30 days of the date hereof.

ERNEST JOHN WILLIAM BAIL.
GARNET ERNEST VICTOR BAIL.

Swan Hill, 28th June, 1954.
Alec M. Hayes, solicitor, 113 Campbell-street, Swan Hill. 9851

NOTICE OF INTENTION TO APPLY FOR A LICENCE TO DIVERT WATER AND CUT RACES FROM THE MURRAY RIVER AT PENTAL ISLAND.

I HEREBY give notice that I intend to apply for a licence empowering me to divert water for a term of fifteen years to the extent of 200 acre-feet per annum at a maximum rate of 10 acre-feet per day of 24 hours for irrigation of 328 acres, being part of allotments 38A and 39A, Parish of Pental Island, and to occupy certain Crown lands for works of storage and diversion, and to cut a race thereon.

Any objection to such application must be forwarded, in writing, to the State Rivers and Water Supply Commission, Melbourne, within 30 days of the date hereof.

HAROLD REX BROOKE.

Benjeroop, 28th June, 1954.
J. Malcolm McKee, LL.M., solicitor, 54 Wellington-street, Kerang. 9853

NOTICE OF INTENTION TO APPLY FOR A LICENCE TO DIVERT WATER AND CUT RACES FROM THE NARCOOYIA CREEK AT TWO POINTS, ONE IN ALLOTMENT 9c, PARISH OF NENANDIE, APPROXIMATELY 30 CHAINS FROM ITS WESTERN BOUNDARY, THE OTHER IN ALLOTMENT 1c, PARISH OF YUNGERA, APPROXIMATELY 10 CHAINS FROM THE JUNCTION OF THE CREEK WITH THE RIVER MURRAY.

I, ROY DEERING ZERBST, of Sunnysdale, via Piangil, horticulturist, hereby give notice that I intend to apply for a licence empowering me to divert water for a term of fifteen years to the extent of 300 acre-feet per annum at a maximum rate of 10 acre-feet per day of 24 hours for irrigation of 100 acres, being parts of Crown allotments 9c and 9b, Parish of Nenandie, and 1c and 1b, Parish of Yungera, and to occupy certain Crown lands for works of storage and diversion, and to cut a race thereon.

Any objection to such application must be forwarded, in writing, to the State Rivers and Water Supply Commission, Melbourne, within 30 days of the date hereof.

ROY ZERBST.

Sunnysdale, via Piangil, 5th July, 1954. 9888

NOTICE OF INTENTION TO APPLY FOR A LICENCE TO DIVERT WATER AND CUT RACES FROM THE SHEEPWASH CREEK AT MYWEE.

I HEREBY give notice that I intend to apply for a licence empowering me to divert water for a term of fifteen years to the extent of 100 acre-feet per annum at a maximum rate of 6 acre-feet per day of 24 hours for irrigation

of 50 acres, being part of allotments 61 and 62, section B, and Parish of Strahmerton, and to occupy certain Crown lands for works of storage and diversion, and to cut a race thereon.

Any objection to such application must be forwarded, in writing, to the State Rivers and Water Supply Commission, Melbourne, within 30 days of the date hereof.

JACK MACDONALD FARRALL.

Mywee, 28th June, 1954. 9846

NOTICE is hereby given that the partnership heretofore subsisting between William Henry Jones, of 25 Oxford-street, Burwood, and Douglas Thomas Kellalea, of 18 Harrison-avenue, Burwood, carrying on business as builders under the name of W. H. Jones and D. T. Kellalea, has been dissolved as from the 24th day of June, 1954. All accounts owing by the partnership should be sent to the partners, care of 25 Oxford-street, Burwood.

Dated this 28th day of June, 1954.

D. T. KELLALEA.

Witness—G. P. BURR, solicitor, Melbourne.

Sewell and Sewell, solicitors for the said Douglas Thomas Kellalea. 9842

NOTICE is hereby given that the partnership heretofore existing between Hendericus Reker and Aart De Gier, carrying on business as Holland Transport, at 48 Ercildoune-street, Caulfield, has been dissolved by mutual consent as from the 30th day of June, 1954. All debts due to and owing by the said firm will be received and paid for and on behalf of the said partners by Hendericus Reker, who will continue the business at 8 Wenden-grove, East St. Kilda.

Dated the 30th day of June, 1954.

H. REKER.
A. DE GIER.

Witness to both signatures—V. J. THOMPSON, J.P. 9840

NOTICE is hereby given that the partnership heretofore subsisting between Charles Churchill Palmer and Henry Churchill Palmer, carrying on business as solicitors at Nhill, in Victoria, under the style or firm of Trumble and Palmer, has been dissolved by mutual consent, as from the 30th day of June, 1954. And that all debts due to and owing by the said late firm will be received and paid by the said Henry Churchill Palmer, who will continue to carry on the said business under the same firm name.

Dated this 1st day of July, 1954.

CHARLES C. PALMER.
H. C. PALMER.

9864

NOTICE OF DISSOLUTION OF PARTNERSHIP.

ARTHUR HENRY BENTICK and Linton Chamberlain, confectionery manufacturers, at 865 High-street, Thornbury, under trade name of "Lynton Confectionery Co.," dissolved 30th day of June, 1954. Linton Chamberlain retires from the business, which will be carried on by Arthur Henry Bentick, who will pay all liabilities, and is entitled to all monies owing to the said partnership.

Dated this 1st day of July, 1954.

L. CHAMBERLAIN.
H. BENTICK.

Roy L. Yelland, of 37 Swanston-street, Melbourne, solicitor. 9839

NOTICE OF DISSOLUTION OF PARTNERSHIP.

NOTICE is hereby given that the partnership heretofore subsisting between the undersigned, Ernest John Holloway, of Dederang, in the State of Victoria, store-keeper, and Mladen Prvan, of Wodonga, in the said State, wireless expert, carrying on business as radio salesmen, at the Dederang General Store, and at 174 High-street, Wodonga, under the name of "The Wodonga and Dederang Radio and Refrigeration Sales and Service," has been dissolved by mutual consent, as from the 25th day of June, 1954.

All debts due to and owing by the said late firm shall be received and paid by Mladen Prvan, who will continue to carry on the business at 174 High-street, Wodonga.

Dated, 25th day of June, 1954.

ERNEST J. HOLLOWAY.
MLADEN PRVAN.

Witness—J. S. N. HARRIS, solicitor, Wodonga. 9821

NOTICE is hereby given that the partnership which subsisted between Arthur Spence Wilkinson, John Cowan Lowry, and William Myles Wilson, carrying on the practice of solicitors under the name of Home, Wilkinson, and Lowry, at 401 Collins-street, Melbourne, and at High-street, Thornbury, and High-street, Preston, has been dissolved by mutual consent as from the 30th day of June, 1954, the said Arthur Spence Wilkinson, retiring from the said practice. All debts due to and owing by the said partnership will be received and paid by the said John Cowan Lowry and William Myles Wilson, who will continue to carry on the said practice under the same name and at the same places.

Dated at Melbourne this 30th day of June, 1954.

J. C. LOWRY.

W. M. WILSON.

Witness to all signatures—M. BLAIR. 9901

NOTICE IS hereby given that the partnership heretofore subsisting between Arthur James Henry and John Stanley Laurens, carrying on the business of cleaning contractors under the trade or firm name of Henry's General Cleaning Service, of 18A Park-road, Surrey Hills, was dissolved by mutual consent as from the 30th day of June, 1954. The said business will continue to be conducted at the said address, under the said firm name by the said Arthur James Henry, who will pay and discharge all liabilities thereof as from the said date.

Dated the 30th day of June, 1954.

ARTHUR JAMES HENRY.
JOHN STANLEY LAURENS.

Best, Hooper, Rintoul, and Shallard, solicitors, 100 Queen-street, Melbourne. 9896

NOTICE IS hereby given that the partnership heretofore subsisting between Robert Leonard Williams and Robert Noel Beetham, carrying on at 310 Whitehorse-road, Balwyn, the business of retailers of soft furnishings under the firm name of "Williams and Beetham," has been dissolved by mutual consent as from the 15th day of May, 1954. The said business will be carried on by the said Robert Leonard Williams, at the same address and all debts due and owing by the said partnership will be received and paid by him.

Dated the 24th day of June, 1954.

ROBERT L. WILLIAMS.
R. N. BEETHAM.

Orr and Gibson. 9906

In the Supreme Court of Victoria.—In the matter of the *Companies Act 1938*, Part (1), and in the matter of the *LONG ISLAND ESTATES PROPRIETARY LIMITED*.—Petition for winding up the company.

NOTICE is hereby given that a petition for the winding up of the above-named company by the Supreme Court, was on the 1st day of July, 1954, presented to the said court, and that the said petition is directed to be heard before the Court sitting at the Law Courts, Melbourne, on the 2nd day of August, 1954, and any creditor or contributory of the said company desirous to support or oppose the making of an order on the said petition, may appear at the time of the hearing by himself or his counsel for that purpose, and a copy of the petition will be furnished to any creditor or contributory of the company requiring the same by the undersigned, on payment of the regulated charge for the same.

The petitioner is William Alexander Todd, whose address is 73 Dickens-street, St. Kilda.

The petitioner's solicitors are Alfred L. Abrahams and Co., 379 Collins-street, Melbourne.

ALFRED L. ABRAHAMS & CO.,
Solicitors for the Petitioner.

NOTE.—Any person who intends to appear on the hearing of the said petition must serve on or send by post to the above-named, notice, in writing, of his intention so to do. The notice must state the name and address of the person, or, if a firm, the name and address of the firm, and must be signed by the person or firm, or his or their solicitor (if any) and must be served or, if posted, must be sent by post in sufficient time to reach the above-named not later than 12 noon of the 31st day of July, 1954. 9895

Companies Act 1938.

NOTICE is hereby given that the Final Meeting of shareholders in Flaxbourne Pty. Ltd. (in voluntary liquidation) will be held in the office of the liquidator, T. and G. Building, Geelong, on Thursday, 12th August, 1954, at Two-thirty p.m.

9832

P. NEILSON, Liquidator.

SERVEX INDUSTRIES LIMITED.

(In Voluntary Liquidation.)

REGISTER of Unclaimed Money held by Servex Industries Limited (in voluntary liquidation).

Name of Owner on Books.	Total Amount Due to Owner.	Description of Unclaimed Money.	Date of Last Claim.
	£ s. d.		
Foster, Florence (Mrs.), 24 Shamrock-street, West Brunswick	1 5 0	First Dividend on 50 5 per cent. cumulative Preference Shares in Servex Industries Ltd.	30.3.48

9880

A. D. G. PROPRIETARY LIMITED.

AT an Extraordinary General Meeting the above-named company duly convened and held at the registered office of the company, 230 Collins-street, Melbourne, on Wednesday, the 30th day of June, 1954, the following Resolution was duly passed as a Special Resolution:

RESOLUTION.

"That the company be wound up voluntarily."

Dated this 1st day of July, 1954.

C. A. STEWART, Liquidator.

Young and Outhwaite, 368 Collins-street, Melbourne, C.I.
9902

THE WESTERN STAR PRODUCTS PROPRIETARY LIMITED.

PURSUANT TO SECTION 226.

AT an Extraordinary General Meeting the above-named company duly convened and held at 14-20 King-street, Melbourne, on Thursday, the first day of July, 1954, the following Resolution was duly passed as a Special Resolution:—

"That the company be wound up voluntarily."

And at such last-mentioned meeting John Maurice McCutcheon, of 34 Queen-street, Melbourne, was duly appointed liquidator for the purposes of the winding up.

Dated the first day of July, 1954.

9904 SINTON R. DENNEY, Chairman.

AUSTRALIAN SUNNY SOUTH SERVICE PROPRIETARY LIMITED.

PURSUANT TO SECTION 226.

AT an Extraordinary General Meeting the above-named company duly convened and held at 51 William-street, Melbourne, on Thursday, the first day of July, 1954, the following Resolution was duly passed as a Special Resolution:—

"That the company be wound up voluntarily."

And at such last-mentioned meeting John Maurice McCutcheon, of 34 Queen-street, Melbourne, was duly appointed liquidator for the purposes of the winding up.

Dated the first day of July, 1954.

9905 JOHN LOVE, Chairman.

ADAMSON INVESTMENTS PROPRIETARY LIMITED (IN LIQUIDATION).

NOTICE TO CREDITORS.

NOTICE is hereby given that all persons having any claims against the above company are required, on or before the 30th day of July, 1954, to send their names and addresses and particulars of their debts or claims to Mr. Edward Holmes, the liquidator of the above company at the offices of Messrs. Holmes and McCrindle, chartered accountants (Aust.), 339 Collins-street, Melbourne, and if so required by notice in writing from the said liquidator, are personally or by their solicitors, to come in and prove their said debts or claims at such time and place as shall be specified in such notice, or in default thereof they will be excluded from the benefit of any distribution made before such debts or claims are so lodged or proved.

Dated at Melbourne this 5th day of July, 1954.

9900 EDWARD HOLMES, Liquidator.

Companies Act 1938.

METROPOLITAN OMNIBUS PROPRIETORS' ASSOCIATION.

NOTICE is hereby given, in pursuance of section 236 of the Companies Act 1938, that a General Meeting of the members of the above-named company will be held at the Shell Theatre, 532-544 Bourke-street, Melbourne, on Monday, the 9th day of August, 1954, at Eight o'clock in the afternoon, for the purpose of having an account laid before them, showing the manner in which the winding up has been conducted and the property of the company disposed of, and of hearing any explanation that may be given by the liquidator.

Dated the 5th day of July, 1954.

L. C. FREEMAN, Liquidator.

140 Queen-street, Melbourne, C.I.

9843

ESPLANADE HOTELS PROPRIETARY LIMITED (IN LIQUIDATION).

NOTICE is hereby given, in pursuance of section 236 of the Companies Act 1938, that a General Meeting of the members of the above-named company will be held at the office of Kevin Donald Courtney, 422 Collins-street, Melbourne, on Monday, 2nd August, 1954, at Three o'clock in the afternoon, for the purpose of receiving the liquidator's account, showing how the winding up has been conducted and the company's property disposed of; also, to pass an extraordinary resolution to determine the method of disposing the books, accounts, and documents of the company.

Dated this 30th day of June, 1954.

9841

K. D. COURTNEY, Liquidator.

Companies Act 1928.

HARGREAVES HIRE SERVICE PROPRIETARY LIMITED.

NOTICE CONVENING FINAL MEETING.

NOTICE is hereby given, in pursuance of section 236 of the Companies Act 1938, that a General Meeting of the members of the above-named company will be held at the office of Alfred James Day, public accountant, 96 Ryrie-street, Geelong, the liquidator, on Wednesday, the 11th day of August, 1954, at Ten o'clock in the forenoon, for the purpose of having an account laid before them showing the manner in which the winding up has been conducted and the property disposed of, and of hearing any explanation that may be given by the liquidator and also of determining by Extraordinary Resolution the manner in which the books, accounts, and documents of the company and of the liquidator thereof shall be disposed of.

Dated at Geelong, this 2nd day of July, 1954.

9833

A. J. DAY, Liquidator.

APEX TYRE & RUBBER COMPANY PTY. LTD. (IN LIQUIDATION).

NOTICE is hereby given that it is intended to declare a Second and Final Dividend in this matter. Creditors who have not proved their debts by 21st July, 1954, will be excluded therefrom.

F. Y. RATTRAY, chartered accountant (Aust.), liquidator, 24 Jeffcott-street, Melbourne. 9834

KEAYANG PASTORAL COMPANY PROPRIETARY LIMITED (IN VOLUNTARY LIQUIDATION).

PURSUANT to section 226 of the Companies Act 1938, this company hereby gives notice that, at an Extraordinary Meeting of shareholders, held at 83 William-street, Melbourne, on Wednesday, 30th June, at 11.30 a.m., the following Special Resolution was duly passed:—

"That the company be wound up voluntarily."

9819

R. C. DUNN, Secretary.

METWOOD PROPRIETARY LIMITED.

AT an Extraordinary General Meeting of the members of the above-named company, duly convened and held at 74 Fletcher-street, Essendon, on Saturday, the 3rd day of July, 1954, the following Extraordinary Resolution was duly passed:—

"That it has been proved to the satisfaction of this meeting that the company cannot, by reason of its liabilities, continue its business, and that it is advisable to wind up the same, and accordingly that the company be wound up voluntarily."

Dated the 6th day of July, 1954.

9877

J. J. CLIFT, Chairman.

Company No. 27716.

Companies Act 1938.

DE LUXE MATTRESS PRODUCTS PROPRIETARY LIMITED.

NOTICE OF SPECIAL RESOLUTION TO WIND UP, PURSUANT TO SECTION 226.

AT an Extraordinary General Meeting of the above-named company duly convened and held on the 28th day of June, 1954, the following Resolution was passed as a Special Resolution:—

"That the company be wound up voluntarily."

And at such last-mentioned meeting Mr. H. J. Ekins, care of Messrs. Charlton and Rule, 473 Bourke-street, Melbourne, was appointed liquidator for the purposes of the winding up.

Dated this 2nd day of July, 1954.

9879

M. LISTER, Chairman.

Companies Act 1938.

CUMMINGS-WRIGHT ADVERTISING PTY. LTD.

AT a General Meeting of the members of the company duly convened and held at 368 Collins-street, Melbourne, on the 29th day of June, 1954, the following Special Resolution was duly passed:—

"That the company be wound up voluntarily and that Frederick Allan Hartley, chartered accountant (Aust.), be appointed liquidator of the company."

Dated the 3rd day of July, 1954.

9886 E. CUMMINGS-WRIGHT, Chairman of Directors.

Companies Act 1938.

SERVEX INDUSTRIES LIMITED (IN VOLUNTARY LIQUIDATION).

PURSUANT TO SECTION 236 (2).

NOTICE is hereby given that an Extraordinary General Meeting of the company will be held at the Board Room, 126 Grant-street, South Melbourne, on 16th August, 1954, at Ten o'clock in the forenoon, for the purpose of laying before it the accounts showing how the winding up of the company has been conducted and the property of the company disposed of.

Dated this 6th day of July, 1954.

9879

L. P. WHITE, Liquidator.

Companies Act 1938.

TRALEE DAIRY FARM PROPRIETARY LIMITED.

PURSUANT TO SECTION 226.

AT an Extraordinary General Meeting of the above-named company, duly convened and held at 480 Bourke-street, Melbourne, on Wednesday, the 30th day of June, 1954, the following Resolution was duly passed as a Special Resolution:—

"That the company be wound up voluntarily, and that Hugh Royston Mirams, of 360 Collins-street, Melbourne, be appointed the liquidator for the purposes of such winding up."

Dated the 30th day of June, 1954.

9874

NOEL V. G. NICOLSON, Chairman.

CREDITORS, next of kin, and others having claims in respect of the estate of Alicia Georgiana White, late of 55 Howitt-road, Caulfield, widow, deceased (who died on 10th December, 1953), are to send particulars of their claims to The Union Trustee Company of Australia Limited, of 333 Collins-street, Melbourne, by the 8th September, 1954, after which date it will distribute the assets, having regard only to the claims of which it then has notice.

McKEAN & PARK, solicitors, 84 William-street, Melbourne. 9878

CREDITORS, next of kin, and others having claims in respect of the estate of George John Vagg, formerly of Barongarook, but late of Colac, retired farmer, deceased (who died on the 20th April, 1954), are to send particulars of their claims to the National Trustees, Executors, and Agency Company of Australasia Limited, whose registered office is at 95 Queen-street, Melbourne, by the 6th day of September, 1954, after which date it will distribute the assets, having regard only to the claims of which it then has notice.

Dated the 2nd July, 1954.

CUNNINGHAM & LARKINS, solicitors, Murray-street, Colac. 9875

CREDITORS, next of kin, and all others having claims in respect of the estate of Letitia Jane Beechey, late of Cobden, in the State of Victoria, spinster, deceased, intestate (who died on the 19th day of February, 1954), are required to send particulars of their claims to The Fidelity Trustee Company Limited, whose registered office is 101 Lydiard-street north, Ballarat, in the State of Victoria, at their Geelong office, at 8 Malop-street, Geelong, in the State of Victoria, the administrators of the said estate, by the 15th day of September, 1954, after which date it will convey and distribute the assets of the said estate, having regard only to the claims of which it then has notice.

Dated this 28th day of June, 1954.

ARTHUR E. GEORGE & SONS, of Cobden, solicitors for the said administrator. 9816

ELIZA SARAH PRICTOR (also known as Eliza Prictor), late of Willaura, spinster, DECEASED, intestate.

CREDITORS, next of kin, and others having claims in respect of the estate of the deceased (who died on the 14th October, 1953), are required by the personal representative, The Fidelity Trustee Company Limited, of 101 Lydiard-street north, Ballarat, to send particulars to it by the 8th September, 1954, after which date the personal representative may convey or distribute the assets, having regard only to the claims of which it then has notice.

Dated the 29th June, 1954.

ST. JOHN CLARKE & BARWOOD, solicitors, Colac. 9815

JEREMIAH MELBOURNE, late of Avenel, grazier.

CREDITORS, next of kin, and others having claims in respect of the estate of the deceased (who died on the 7th day of January, 1954), are required by the personal representatives, John Sawyer Melbourne, and Arnold Vaudrey Elliott, both of Avenel, graziers, to send particulars to them, care of the undersigned, by the 1st day of September, 1954, after which date the personal representatives may convey or distribute the assets, having regard only to the claims of which they then have notice.

Dated this 23rd day of June, 1954.

W. J. OSBORNE, LL.B., solicitor, Seymour. 9824

CREDITORS, next of kin, and others having claims in respect of the estate of Elizabeth Whelan, formerly of Redbank, but late of Landsborough, spinster, deceased (who died on the 31st day of March, 1954), are to send the particulars of their claims to The Trustees Executors and Agency Company Limited, of No. 401 Collins-street, Melbourne, and Thomas Browne, of Landsborough, parish priest, care of the said company, on or before the 7th day of September, 1954, after which date they will distribute the assets, having regard only to the claims of which they then have notice.

HERRING & BATHURST, solicitors, Maryborough. 9823

ROBERT GORDON RAMSAY, late of Seymour, chemist.

CREDITORS, next of kin, and others having claims in respect of the estate of the deceased (who died on the 21st day of January, 1954), are required by the personal representatives, Gertrude Ramsay, Herbert Charles Stephens, both of Seymour, widow, and Shell Company employee, respectively, and Jack Heywood McRoberts, of 342 Flinders-lane, Melbourne, managing director, to send particulars to them, care of the undersigned, by the 1st day of September, 1954, after which date the personal representatives may convey or distribute the assets, having regard only to the claims of which they then have notice.

Dated this 23rd day of June, 1954.

W. J. OSBORNE, LL.B., solicitor, Seymour. 9825

JOHN VICTOR TINDALE PYM, late of Flat 10, "Mayfield," 44 Murphy-street, South Yarra, retired manager, DECEASED.

CREDITORS, next of kin, and others having claims in respect of the estate of the deceased (who died on the 5th May, 1954), are required by his personal representative, John Paterson Adam, of 459 Chancery-lane, Melbourne, solicitor, to send particulars to him, by the 9th September, 1954, after which date the personal representative may convey or distribute the assets, having regard only to the claims of which he then has notice.

WEIGALL & CROWTHER, solicitors, 459 Chancery-lane, Melbourne. 9883

PURSUANT to the *Trustee Act* 1928, all persons having claims against the property or estate of Albert Edward Connor, late of High-street, Kangaroo Flat, retired mine manager, deceased (who died on the 27th day of March, 1954, and letters of administration with whose will annexed, were granted by the Supreme Court of Victoria, on the 21st day of June, 1954, to Sandhurst and Northern District Trustees, Executors, and Agency Company Limited, of View-street, Bendigo, on the authority of the executor named therein), are hereby required to send particulars of such claims to the said company at such address, on or before the 10th day of September, 1954, after the expiration of which time the said company will proceed to distribute the assets of the said deceased amongst the persons entitled thereto, having regard only to the claims of which it shall have had notice.

Dated this 29th day of June, 1954.

TACHELL, DUNLOP, SMALLEY, & BALMER, solicitors, 290 Williamson-street, Bendigo. 9820

EMMA MEULEMAN, formerly of 22 Hood-street, Yarraville, but late of 25 Browning-street, Seddon, widow, DECEASED.

CREDITORS, next of kin, and others having claims in respect of the estate of deceased (who died on the 2nd March, 1954), are required by the trustee, Ferdinand Charles Meuleman, of 57 Nicholson-street, Footscray, engineer, to send particulars to him by the 26th August, 1954, after which date the trustee may convey or distribute the assets, having regard only to the claims of which he then has notice.

JOHN GINNANE, solicitor, of 422 Collins-street, Melbourne. 9887

WILLIAM HOOD, late of 1 Banchory-street, Essendon, in the State of Victoria, gentleman, DECEASED.

CREDITORS, next of kin, and others having claims against the above-named William Hood, deceased (who died on the 27th day of March, 1953, and probate of whose will was granted by the Supreme Court of Victoria on the 7th day of September, 1953, to Francis McNab, Finlay McNab, and Colin Edward McNab, all of 422 Collins-street, Melbourne, solicitors, the executors named in the said will), are to send particulars of their claims to Finlay McNab and Colin Edward McNab, survivors of the said executors, care of the undersigned solicitors, on or before the 8th day of October, 1954, after which date they will distribute the assets of the said deceased among the persons entitled thereto, having regard only to the claims of which they shall then have notice, and they will not be liable to any person of whose claims they have not then received notice.

McNAB & McNAB, solicitors, 422 Collins-street, Melbourne. 9885

CREDITORS, next of kin, and others having claims in respect of the estate of Charles Edward Howard, late of 12 Stanley-street, Kew, formerly pastoral accountant, but late retired pastoral accountant (who died on the 27th March, 1954), are required by The Trustees, Executors, and Agency Company Limited, of 401 Collins-street, Melbourne, and Montagu Edward Howard, of 15 Uvadale-road, Kew, director, the executors to whom probate of the will of the said deceased was granted by the Supreme Court of Victoria, to send particulars of such claims to the executors, care of the said The Trustees, Executors, and Agency Company Limited by the 12th September, 1954, after which date they will distribute the assets, having regard only to the claims of which they then have notice.

E. A. ATKYNS & TOOP, 422 Little Collins-street, Melbourne. 9884

CREDITORS, next of kin, and others having claims in respect of the estate of Reinhold John Kurtze, late of Portland, farmer, deceased (who died on the 24th day of June, 1953), are to send particulars of their claims to The Fidelity Trustee Company Limited, of 101 Lydiard-street north, Ballarat, in the State of Victoria, and Henry Ivan Kurtze, of 501 Great East Highway, Redcliffe, in the State of Western Australia, the executors named in the will of the deceased, at the address of the above-named company, by the 7th day of September, 1954, after which date they will distribute the assets, having regard only to the claims of which they then have notice.

Dated the 22nd day of June, 1954.

HARRIS & WILLIAMSON, solicitors for the executors. 9861

JOHN ROBERTS, late of Lake Boga, Victoria, farmer, DECEASED.

CREDITORS, next of kin, and others having claims in respect of the estate of the deceased (who died on the 24th day of June, 1953), are required by Morris Herbert Roberts, of Lake Boga aforesaid, farmer, and Edna Gwen Shepherd, of Swan Hill, in the said State, married woman, the executor and executrix to whom probate of the will of the said deceased was granted by the Supreme Court of Victoria in its probate jurisdiction, on the 27th day of May, 1954, to send particulars to them, in the care of the undersigned solicitor, by the 9th day of September, 1954, after which date the executor and executrix may convey or distribute the assets of the said deceased, having regard only to the claims of which they then have notice.

Dated this 28th day of June, 1954.

ALEC M. HAYES, of 113 Campbell-street, Swan Hill, solicitor for the estate. 9860

ALBERT ERNEST ROBINSON, late of Swan Hill, Victoria, retired manager, formerly steward, DECEASED.

CREDITORS, next of kin, and others having claims in respect of the estate of the deceased (who died on the 4th day of December, 1953), are required by Elsie Violet Robinson, of Gummow-street, Swan Hill aforesaid, widow, the executrix to whom probate of the will of the said deceased was granted by the Supreme Court of Victoria in its probate jurisdiction, on the 9th day of June, 1954, to send particulars to her, in the care of the undersigned solicitor, by the 9th day of September, 1954, after which date the executrix may convey or distribute the assets of the said deceased, having regard only to the claims of which she then has notice.

Dated this 28th day of June, 1954.

ALEC M. HAYES, of 113 Campbell-street, Swan Hill, solicitor for the estate. 9859

MATTHEW GASKELL NALDER, formerly of Meath, Victoria, but late of 69 Beveridge-street, Swan Hill, Victoria, retired farmer and grazier, DECEASED.

CREDITORS, next of kin, and others having claims in respect of the estate of the deceased (who died on the 30th day of April, 1953), are required by Muriel May Lewis, of Ultima, Victoria, married woman, the executrix to whom probate of the will of the said deceased was granted by the Supreme Court of Victoria in its probate jurisdiction, on the 30th day of October, 1953, to send particulars to her, in the care of the undersigned solicitor, by the 9th day of September, 1954, after which date the executrix may convey or distribute the assets of the said deceased, having regard only to the claims of which she then has notice.

Dated this 28th day of June, 1954.

ALEC M. HAYES, of 113 Campbell-street, Swan Hill, solicitor for the estate. 9858

CREDITORS, next of kin, and others having claims in respect of the estate of Sara Elizabeth Mayer, formerly of Springvale-road, Springvale, married woman, but late of 5 Packer-street, Murrumbidgee, widow, deceased (who died on the 31st December, 1953), are to send particulars of their claims to Dorothy Phyllis Robbins and Olive Elizabeth Gibson, care of the undersigned, by the 9th September, 1954, after which date they will distribute the assets, having regard only to the claims of which they then have notice.

JOHN I. SULLIVAN, solicitor, 221 Balaclava-road, Caulfield. 9856

CREDITORS, next of kin, and others having claims in respect of the estate of Josephine Johanna Kisby, late of 135 Cotham-road, Kew, widow, deceased (who died on the 13th day of October, 1953), are to send particulars of their claims to Mary Gertrude Kisby, of 135 Cotham-road, Kew, on or before the 9th day of September, 1954, after which date she will distribute the assets, having regard only to the claims of which she then has notice.

JOHN I. SULLIVAN, solicitor, Caulfield. 9855

CREDITORS, next of kin, and others having claims in respect of the estate of Charles Watt, late of Convalescent Hospital, Kooyong-road, Caulfield, pensioner, deceased (who died on the 9th day of February, 1954), are to send particulars of their claims to James Phillip McQueen, of 103 Ludstone-street, Hampton, on or before the 9th day of September, 1954, after which date he will distribute the assets, having regard only to the claims of which he then has notice.

JOHN I. SULLIVAN, solicitor, Caulfield. 9854

JOHN WILLIAM WRIGHT, late of Elmore, in the State of Victoria, stock and station agent, DECEASED (who died on the 23rd day of July, 1953).

CREDITORS, next of kin, and all other persons having claims against the estate of the said deceased, are required by Farmers and Citizens Trustees Company, Bendigo, Limited, of Charing Cross, Bendigo, the executor to whom probate of the will of the said deceased has been granted, to send particulars of such claims to it, on or before the 10th day of September, 1954, after which date it will distribute the assets, having regard only to the claims of which it then has notice.

ARTHUR J. ROGERS, solicitor, Elmore. 9857

CREDITORS, next of kin, and others having claims in respect of the estate of Ellis Raymond Boardman, late of Lyons, retired grazier, deceased, intestate (who died on the 16th day of January, 1954), are to send particulars of their claims to The Fidelity Trustee Company Limited, of 101 Lydiard-street north, Ballarat, in the State of Victoria, the administrator of the estate of the above-named deceased, at the address of the above-named company, by the 7th day of September, 1954, after which date it will distribute the assets, having regard only to the claims of which it then has notice.

Dated this 22nd day of June, 1954.

HARRIS & WILLIAMSON, solicitors for the administrator. 9862

CREDITORS, next of kin, and others having claims against the estate of Amy Prince, late of 16 Hillside-parade, Strathmore, widow, deceased (who died on the 19th February, 1954), are requested to send particulars of their claims to the executor, The Trustees, Executors, and Agency Company Limited, of 401 Collins-street, Melbourne, on or before the 3rd day of September, 1954, after which the said executor will proceed to distribute the assets of the said deceased, having regard only to the claims of which it shall then have had notice.

W. E. PEARCEY & IVEY, solicitors, 443 Little Collins-street, Melbourne. 9882

CHRISTOPHER JOSEPH ROSEINGRAVE (also known as Rosegrave), formerly of 6 Craine-street, South Melbourne, in the State of Victoria, rubber worker, but late of Loughwood Crusheen, in the County of Clare, Eire, of no occupation, DECEASED, intestate.

CREDITORS, next of kin, and others having claims in respect of the estate of the deceased (who died on the 26th day of February, 1952), are required by the personal representative, Michael Joseph Mornane, of 95 Queen-street, Melbourne, solicitor, to send particulars to him, at the foresaid address, by the 9th September, 1954, after which date the personal representative may convey or distribute the assets, having regard only to the claims of which he then has notice.

Dated the 7th July, 1954.

M. MORNANE, 95 Queen-street, Melbourne, solicitor. 9881

CREDITORS, next of kin, and others having claims in respect of the estate of William Hendry Blake-Rae, formerly of 21 Sandham-street, Elsternwick, in the State of Victoria, but late of Darwin, Northern Territory, senior supervisor in the Australian Broadcasting Commission, deceased (who died on the 24th day of November, 1953), are to send the particulars of their claims to The Trustees Executors and Agency Company Limited, of No. 401 Collins-street, Melbourne, on or before the 30th day of September, 1954, after which date they will distribute the assets, having regard only to the claims of which they then have notice.

NEWTON J. FRANCIS, solicitor, 465 Collins-street, Melbourne. 9898

CREDITORS, next of kin, and others having claims in respect of the estate of William Laurence Walsh, late of 849 High-street, Armadale, in the State of Victoria, retired bank officer, deceased (who died on the 3rd day of May, 1954), are to send particulars of their claims to National Trustees, Executors, and Agency Company Limited, whose registered office is situate at 95 Queen-street, Melbourne, in the said State, by the 17th day of September, 1954, after which date the executors will distribute the assets of the deceased, having regard only to the claims of which they then have notice.

Dated the 28th day of June, 1954.

GILLOTT, MOIR, & AHERN, of 95 Queen-street, Melbourne, solicitors for the applicant. 9899

No. 649.—6521/54.—4

NOTICE TO CREDITORS.—ERICH KUTTNER, late of 47 Collins-place, Melbourne, in the State of Victoria, actor, DECEASED.

CREDITORS, next of kin, and others having claims in respect of the estate of the deceased (who died on the 29th day of January, 1954), are required by the trustee, Wolfgang Sievers, of 12 Sargood-street, Toorak, photographer, to send particulars to him, care of the undersigned, by the 15th day of September, 1954, after which date the trustee may convey or distribute the assets, having regard only to the claims of which he then has notice.

Dated the 9th day of June, 1954.

R. E. KAHN & CLAHR, of 340 Collins-street, Melbourne, solicitors for the said trustee. 9903

JOSEPH EMANUEL MARTIN, formerly of Toole-street, Hopetoun, but late of 59 Victoria-street, Footscray, in the State of Victoria, gentleman, DECEASED (who died on 24th June, 1952).

CREDITORS, next of kin, and all other persons having claims against the estate of the above-named deceased, are required by the executrix, Emma May Willmet, of 59 Victoria-street, Footscray, in the said State, married woman, to send particulars of such claims to her, care of the undersigned, on or before the 9th day of September, 1954, after which date she will distribute the assets, having regard only to the claims of which they have then had notice.

JONES & KENNEDY, solicitors; 213 Nicholson-street, Footscray. 9891

EMILY GIBSON, late of 235 Gordon-street, Footscray, in the State of Victoria, widow, DECEASED (who died on 20th December, 1953).

CREDITORS, next of kin, and all other persons having claims against the estate of the above-named deceased, are required by the executor, Alfred George Leech, of 42 Gordon-street, Maidstone, in the said State, storeman, to send particulars of such claims to him, care of the undersigned, on or before the 9th day of September, 1954, after which date he will distribute the assets, having regard only to the claims of which they have then had notice.

JONES & KENNEDY, solicitors, 213 Nicholson-street, Footscray. 9892

MABEL ANNIE EMILY HEDGES, late of 31 Moore-street, Footscray, in the State of Victoria, widow, DECEASED (who died on the 3rd December, 1953).

CREDITORS, next of kin, and all other persons having claims against the estate of the above-named deceased, are required by the executor, George Mason Hedges, of the above address, printing estimator, to send particulars of such claims to him, care of the undersigned, on or before the 9th day of September, 1954, after which date he will distribute the assets, having regard only to the claims of which they have then had notice.

JONES & KENNEDY, solicitors, 213 Nicholson-street, Footscray. 9893

PURTAPA SINGH, late of 35 Tyne-street, Carlton, Indian hawker, DECEASED.

CREDITORS, next of kin, and others having claims in respect of the estate of the deceased (who died on the 10th January, 1954), are required by the executor, Ivan Thomas McNabb, of Irrewillipe East, to send particulars to him, care of the undersigned, by the 30th day of September, 1954, after which date he may transfer or distribute the assets, having regard only to the claims of which he then has notice.

Dated the 2nd July, 1954.

CUNNINGHAM & LARKINS, solicitors, Murray-street, Colac. 9876

CREDITORS, next of kin, and others having claims in respect of the estate of Florence Essilmont Cheyne, late of 49 Banksia-street, Heidelberg, spinster, deceased (who died on the 6th day of April, 1954), are required by the executors of the estate, National Trustees, Executors, and Agency Company of Australasia Limited, to send particulars of their claims to the executor at its address, 95 Queen-street, Melbourne, before the 10th day of September, 1954, after which date it will distribute the assets, having regard only to the claims of which it has then had notice.

C. J. McFARLANE & DOUGALL, solicitors, 430 Little Collins-street, Melbourne. 9873

JOHN CHARLES SEWELL, late of 21 Salisbury-street, North Essendon, in the State of Victoria, foreman, DECEASED, intestate.

CREDITORS, next of kin, and others having claims in respect of the estate of the deceased (who died on the 25th day of April, 1953), are required by the administratrix, Betty Sewell, of 21 Salisbury-street, North Essendon, in the said State, widow of the deceased, to send particulars to her, care of Sewell and Sewell, solicitors, 422 Collins-street, Melbourne, by the 15th day of September, 1954, after which date the administratrix may convey or distribute the assets, having regard only to the claims of which she then has notice.

Dated this 2nd day of July, 1954.

SEWELL & SEWELL, 422 Collins-street, Melbourne, solicitors for the administratrix. 9835

JOHN IRVING BIRNIE, late of 4 Burnham Flats, corner of Skene-street and Latrobe-terrace, Geelong, in the State of Victoria, wool auctioneer, DECEASED.

CREDITORS, next of kin, and others having claims in respect of the estate of the deceased (who died on the 2nd day of May, 1954), are required by the applicant for grant of administration, The Fidelity Trustee Company Limited, of 101 Lydiard-street north, Ballarat, in the State of Victoria, to send particulars to it, care of its office at Malop-street, Geelong, in the said State, by the 9th day of September, 1954, after which date the applicant for grant of administration may convey or distribute the assets, having regard only to the claims of which it then has notice.

WHYTE, JUST, & MOORE, solicitors, 27 Malop-street, Geelong. 9831

CREDITORS, next of kin, and others having claims in respect of the estate of Charles Myers, late of 2 Birdwood-street, Deepdene, and of 456 Little Collins-street, Melbourne, in the State of Victoria, real estate agent, and investor, deceased (who died on the 25th day of November, 1953, and probate of whose will was granted to The Equity Trustees, Executors, and Agency Company Limited, of 472 Bourke-street, Melbourne, and Thelma Lillian Myers, of 2 Birdwood-street, Deepdene aforesaid, widow), are to send particulars of their claims to the said executors, by the 6th day of September, 1954, after which date they will distribute the assets, having regard only to the claims of which they then have notice.

Dated the 2nd day of July, 1954.

GAVIN LAVER, 456 Little Collins-street, Melbourne, solicitor. 9836

ALL persons having claims against the estate of Agnes Sabina Delany, late of Nazareth House, Cornell-street, East Camberwell, in the State of Victoria, spinster, deceased (who died on the 31st day of March, 1954, and probate of whose will was duly granted to The Equity Trustees, Executors, and Agency Company Limited, of 472 Bourke-street, Melbourne, in the said State, and Vincent Harry Gill, of 11 Dominic-street, East Camberwell, aforesaid public accountant, the executors named therein), are hereby required to send particulars of such claims to the said executors, at 472 Bourke-street, Melbourne, aforesaid, on or before the 10th day of September, 1954, after which date the said executors will proceed to distribute the estate of the said deceased to the persons entitled thereto, having regard only to the claims of which they shall then have had notice.

W. A. PRENDERGAST & ROBINSON, solicitors, 17 Queen-street, Melbourne. 9838

NOTICE TO CREDITORS.—HARRIE EDWARD PEARCE, formerly of Sturt-street, but late of 5 Martin-avenue, Ballarat, in the State of Victoria, medical practitioner, DECEASED.

PURSUANT to the *Trustee Act* 1928, creditors, next of kin, and all other persons having claims against the estate of the above-named deceased (who died on the 23rd day of May, 1954), are required by the executor, Hugh Russell Coldham, of 32 Lydiard-street south, Ballarat, and 123 William-street, Melbourne, in the said State, solicitor to whom probate of deceased's will has been granted, to send particulars of such claims to the executor, care of the undersigned Lawson and Jardine, on or before the 9th day of September, 1954, after which date the executor will distribute the assets of the deceased, having regard only to the claims of which they have then had notice.

LAWSON & JARDINE, solicitors, 123 William-street, Melbourne. 9837

Trustee Act 1928.

NOTICE TO CLAIMANTS.

PURSUANT to the *Trustee Act* 1928, creditors, next of kin, and all others having claims against the estate of the deceased person named below are required to send particulars to the legal personal representatives, at the address stated, on or before the date stated, after which date the representative will distribute the assets, having regard only to the claims of which notice has been received:—

Mary Ann Sheahan, late of Rockbank, married woman, deceased, died 27th March, 1954.—Claims to the executors, Joseph Leonard Sheahan, farmer, and Ellen Teresa Sheahan, spinster, both of Rockbank, care of John F. Carroll, solicitor, 4 Paisley-street, Footscray, by 10th September, 1954. John F. Carroll, LL.B., solicitor, 4 Paisley-street, Footscray. 9872

ESTHER ISABELLA WRIGGLESWORTH, late of "Avon Park," Stratford, spinster (who died 10th November, 1953).

CREDITORS, next of kin, and all other persons having claims against the estate of the deceased are required by the executors of the will, Arthur Henry Boucher, grazier, Ethel May Boucher, married woman, and William Alfred Wrigglesworth, grazier, all of Stratford, to send particulars to them, care of the undersigned, on or before 31st August, 1954, after which date they will distribute the assets, having regard only to the claims of which they then have notice.

R. M. ROLLAND, solicitor, 57c Raymond-street, Sale. 9865

CREDITORS, next of kin, and others having claims in respect of the estate of Martha Eveline King (also known as Martha Evelina King), late of Hamilton, gentlewoman, deceased (who died on the 24th day of January, 1954), are to send particulars of their claims to The Fidelity Trustee Company, of 101 Lydiard-street north, Ballarat, in the State of Victoria, the administrator of the estate of the said deceased, at the address of the above-named company, by the 7th day of September, 1954, after which date it will distribute the assets, having regard only to the claims of which it then has notice.

Dated this 22nd day of June, 1954.

HARRIS & WILLIAMSON, solicitors for the administrator. 9863

In the Supreme Court of the State of Victoria.—*Fi. Fa.*

NOTICE is hereby given that, under and by virtue of certain process issued out of the Supreme Court of the State of Victoria and directed to the Sheriff requiring him to levy certain moneys of the real and personal estate of Milos Misanovic, of Medowra-avenue, Wangaratta, textile worker, the said Sheriff will, on Wednesday, the 11th day of August, 1954, at the hour of Two o'clock in the afternoon, cause to be sold at the Police Station, Wangaratta (unless the said process shall have been previously satisfied or the said Sheriff be otherwise stayed):—

All the right, title, estate, and interest (if any) of the said Milos Misanovic, in and to all that piece of land being lot 5 on plan of subdivision No. 26122, lodged in the Office of Titles, and being part of Crown allotment 14, section 5, at Wangaratta, Parish of Wangaratta North, County of Moira, and being the whole of the land comprised in certificate of title, volume 7973, folio 146.

N.B.—Terms: Cash. No cheques taken.

Dated at Wangaratta, this 29th day of June, 1954.

9822 W. R. FARRELL, Sheriff's Officer.

MINING NOTICES.

NORTHERN MINES DEVELOPMENT NO LIABILITY.

NOTICE is hereby given that a Call (the 2nd) of One shilling (1s.) per share on all issued contributing shares in the capital of the company (making such shares paid to 4s. each) has been made due and payable to the legal manager at the registered office of the company, 450 Collins-street, Melbourne, on Wednesday, the 14th day of July, 1954.

By order of the Board,

H. B. GEMMELL, Legal Manager.
450 Collins-street, Melbourne, C.1. 9894

NORTHERN STAR GOLD MINES NO LIABILITY.

NOTICE is hereby given that a Call (the 63rd) of Three pence per share has been made upon all the shares in the company, due and payable to the manager, at the registered office, 140 Queen-street, Melbourne, on Wednesday, 14th July, 1954.

By order of the Board,
F. L. SMYTH, Manager.

9890

NORTHERN STAR GOLD MINES NO LIABILITY.

NOTICE is hereby given that all shares forfeited for non-payment of the 62nd (June) Call of Three pence per share, will be sold by public auction at the Stock Exchange Hall, 428 Little Collins-street, Melbourne, on Thursday, 15th July, 1954, at Twelve o'clock noon, unless the shares be previously redeemed.

F. L. SMYTH,
Registered office: 140 Queen-street, Melbourne. 9889

IMPOUNDINGS.

CARISBROOK.—Impounded in Carisbrook Pound.

1 yellow heifer, no visible brand
If not claimed and expenses paid, to be sold in fourteen days.

G. W. SCOTT,
Poundkeeper. 9909—8/

EPPING.—Impounded in Epping Pound, by Ranger.

1 red roan mare, small star, hog-maned, no visible brand
If not claimed and expenses paid, to be sold on 22nd July, 1954.

J. HERD,
Poundkeeper. 9866—8/

FERNTREE GULLY.—Impounded in Ferntree Gully Pound, by Shire Ranger.

1 sheep; wether, no visible brand
If not claimed and expenses paid, to be sold on 22nd July, 1954.

A. DINSDALE,
Poundkeeper. 9870—9/4

KEILOR.—Impounded in Keilor Pound.

1 bay gelding, white spot, hind feet white, no visible brand
1 bay gelding, near hind foot white, no visible brand
If not claimed and expenses paid, to be sold on 22nd July, 1954.

D. PASCOE,
Poundkeeper. 9868—9/4

LANCEFIELD.—Impounded in Lancefield Pound, by Shire Ranger.

1 chestnut gelding, aged, white blaze on face, white stocking off hind leg, no visible brand
If not claimed and expenses paid, to be sold on 16th July, 1954.

J. PATTERSON,
Shire Secretary. 9809—10/8

MACLEOD.—Impounded in Macleod Pound.

1 dark-bay gelding, white nose, white star on forehead, no visible brand
If not claimed and expenses paid, to be sold on 21st July, 1954.

C. P. LOCKLEY,
Poundkeeper. 9907—9/4

MAFFRA.—Impounded in Maffra Pound, by Ranger.

1 brindle baldy cow, full ears, no visible brand
If not claimed and expenses paid, to be sold on 23rd July, 1954.

I. GIESCHEN,
Poundkeeper. 9808—8/

MORTLAKE.—Impounded in Mortlake Pound, on 29th June, 1954.

1 aged Jersey cow, small swallow bottom off ear, indescribable brand off rump
If not claimed and expenses paid, to be sold on 22nd July, 1954.

GEO. ROBERTSON,
Poundkeeper. 9871—10/8

NATHALIA.—Impounded in Nathalia Pound, on 29th June, 1954.

1 black gelding hack, near hind foot white, JW near shoulder
If not claimed and expenses paid, to be sold on 22nd July, 1954.

R. C. HALDEN,
Poundkeeper. 9827—10/8

ORBOST.—Impounded in Orbost Shire Pound, by Shire Herdsman.

1 Jersey heifer, no visible brand or mark
If not claimed and expenses paid, to be sold after fourteen days.

H. DOMINEY,
Poundkeeper. 9810—9/4

SUNSHINE.—Impounded in Sunshine Pound.

1 bay mare, no visible brand
1 black and white gelding, no visible brand
If not claimed and expenses paid, to be sold on 24th July, 1954.

T. W. DEUTSCHMANN,
Acting Poundkeeper. 9908—9/4

WINSLOW.—Impounded in Winslow Pound, by Shire Ranger.

1 yellow Jersey heifer, tip off ear, no visible brand
If not claimed and expenses paid within fourteen days, to be sold.

D. M. PIMBLETT,
Poundkeeper. 9869—9/4

YINNAR.—Impounded in Yinnar Pound, on 2nd July, 1954.

3 brown Jersey heifers, two years old, poley, deep notch point off ear, no visible brand
1 yellow baldy cross heifer, two years old, with horns, hole off ear, no visible brand
1 black Freisian Cross heifer, two years old, with horns, deep notch point off ear, no visible brand
1 brown Jersey heifer, two years old, with horns, deep notch point off ear, no visible brand

If not claimed and expenses paid, to be sold on 22nd July, 1954.

A. CONWAY,
Poundkeeper. 9867—18/8

A copy of the *Gazette* filed at each place for public reference.

SUBSCRIPTIONS.—The subscription, including postage, is £2 5s. per annum, £1 2s. 6d. half-yearly, or 11s. 3d. per quarter, payable in advance.

Subscriptions are required to commence and terminate with a month.

A lesser period than three months cannot be subscribed for.

Subscribers do not receive the Acts of Parliament with the *GAZETTE*.

ADVERTISEMENTS are charged at the rate of 1s. 4d. per line single column, and 2s. 8d. per line double column.

The title (£5 Reward, Dissolution of Partnerships, &c.) forms one or more lines as a heading.

On an average, ten words make a line.

Every signature must likewise be counted as a line.

The final words of a paragraph, though only portion of a line, must be counted as one line.

SIGNATURES (in particular) and proper names must be written very plainly in the text; ONE SIDE ONLY of each slip of paper should be WRITTEN UPON.

ALL COMMUNICATIONS should be addressed to "The Government Printer, Melbourne."

ALL DOCUMENTS illegibly written will be returned unpublished, and, where brands occur unprovided for by the ordinary letters of the alphabet, a worded explanatory description must be furnished.

THE VICTORIA GOVERNMENT GAZETTE is published on WEDNESDAY EVENING in each week, and Notices for insertion will be received by the Government Printer at or before Two p.m. at ordinary rates, and late advertisements between Two p.m. and FIVE p.m. at double rates on the day preceding the day of publication.

Single copies of the VICTORIA GOVERNMENT GAZETTE are Nine pence, posted One shilling, each.

No GAZETTES prior to January, 1942, in stock.

***ALL PAYMENTS ARE REQUIRED IN ADVANCE.—Remittances should be made by postal note, money order, or draft in favour of the Government Printer. Advertisements unaccompanied by a remittance sufficient to cover the cost of insertion will be returned unpublished.

THE "VICTORIA GOVERNMENT GAZETTE."

ATTENTION is invited to the following procedure in relation to the publication of official matter in the *Government Gazette*:—

1. Matter submitted to the Executive Council.
Matter submitted to the Executive Council which requires gazettal will normally be published in the issue of the following week.

Where urgent gazettal is required, special arrangements should be made with the *Gazette* Officer.

Publication will be facilitated by the submission of carbon copies for the use of the *Gazette* Officer.

2. Other matter.

(a) All other matter duly certified by a responsible officer for publication should be lodged with the *Gazette* Officer not later than half-past Ten a.m. on Tuesday.

(b) Lengthy or involved notices should be forwarded several days before publication.

(c) Proofs, which will be supplied only when specifically requested, or at the direction of the *Gazette* Officer, should be returned promptly to avoid delay in publication.

(d) No additions or amendments to matter for publication will be accepted by telephone.

AGENTS FOR THE "VICTORIA GOVERNMENT GAZETTE."

THE following have been appointed agents to receive Advertisements and Subscriptions for the *Victoria Government Gazette*:—

ARMSTRONG'S AGENCY, 143 Queen-street, Melbourne.

ARMSTRONG BROS., Kyneton.

MESSRS. ARNALL & JACKSON, 115 Barkly-street, West Brunswick.

MR. M. R. BADE, Tobacconist, Sturt-street, Ballarat.

MR. WM. DAVIS, Mildura.

A. J. DIGBY (B. S. and N. W. CASH), Main-street, Bairnsdale.

EDGAR'S NEWS AGENCY, Hargreaves-street, Bendigo.

MESSRS. HENRY FRANKS & CO., Booksellers and Stationers, Market-square, Geelong.

MESSRS. GORDON & GÖTCH, News Agents, 511 Little Collins-street, Melbourne; and corner Barrack and Clarence streets, Sydney.

A. C. HAMPTON, 243 Mitchell-street, Bendigo.

MESSRS. HARSTON, PARTRIDGE, & CO., 455 Little Collins-street, Melbourne.

MR. C. F. LATIMER, News Agent, Casterton.

MCARTHUR'S AUTHORIZED NEWSAGENCY, 345 Wyndham-street, Shepparton.

MESSRS. H. PAYNE & R. N. LOWE, 4 View Point, Bendigo.

MESSRS. R. H. & W. M. PETTY, News Agent, Wangaratta.

J. PURDIE & CO., 138 Moorabool-street, Geelong.

F. W. RASHLEIGH & SON, Nunn-street, Benalla.

MESSRS. A. S. RICHARDSON and T. C. GARDNER, trading as The Mercantile Exchange, 380 Collins-street, Melbourne.

ROBERTSON & MULLINS LTD., Elizabeth-street, Melbourne.

SALE AUTHORIZED NEWS AGENTS, Sale.

MESSRS. SMITH & DUNNON, Hamilton.

F. D. & J. R. TRAINOR, 246 Wyndham-street, Shepparton.

E. W. B. WELSH, Hogan-street, Tatura.

CONTENTS.

	PAGE
Appointments	4680
Contracts	4681
Country Roads Board	4698
Courts	4691
Estates of Deceased Persons	4690
Government Notices	4679
Impoundings	4725
Lands	4703
Melbourne and Metropolitan Board of Works— Notices	4692
Mining	4725
Ministers of Religion Registered to Celebrate Marriages in Victoria	4689
Notice to Mariners	4690
Orders in Council	4694
Private Advertisements	4714
Proclamations	4675
Public Holidays	4675
Public Service Notices	4710
Resignations	4680
Tenders	4708
Transport Regulation Board—Public Hearings	4684