



# VICTORIA GOVERNMENT GAZETTE

Published by Authority

[Registered at the General Post Office, Melbourne, for transmission by post as a newspaper.]

No. 197]

WEDNESDAY, JULY 3

[1957

## COAL MINING INDUSTRY (LONG SERVICE LEAVE) ACT 1950.

### PROCLAMATION

By His Excellency the Lieutenant-Governor of the State of Victoria and its Dependencies in the Commonwealth of Australia, &c., &c., &c.

WHEREAS by sub-section (1) of section 2 of the *Coal Mining Industry (Long Service Leave) Act 1950*, it is provided that the interpretation of "Awards" shall, *inter alia*, be deemed to include such variations, new awards, orders and interpretations made after the first day of July, One thousand nine hundred and fifty-one, as are declared to be so included by Proclamation of the Governor in Council published in the *Government Gazette*:

Now therefore I, the Lieutenant-Governor of the State of Victoria, in the Commonwealth of Australia, by and with the advice of the Executive Council of the said State, do by this my Proclamation declare the following orders and interpretations made by the Coal Industry Tribunal to be so included:—

Coal Report No. 1139 dated 15th December, 1955.  
Coal Report No. 1140 dated 21st December, 1955  
Coal Report No. 1146 dated 12th March, 1956.  
Coal Report No. 1147 dated 20th March, 1956.  
Coal Report No. 1177 dated 28th June, 1956.  
Coal Report No. 1195 dated 5th November, 1956.  
Coal Report No. 1198 dated 4th December, 1956.  
Coal Report No. 1199 dated 4th December, 1956.  
Coal Report No. 1200 dated 4th December, 1956.

Given under my Hand and the Seal of the State of Victoria aforesaid, at Melbourne, this second day of July, in the year of our Lord One thousand nine hundred and fifty-seven, and in the sixth year of the reign of Her Majesty Queen Elizabeth II.

(L.S.)

E. F. HERRING.

By His Excellency's Command,

W. J. MIBUS,  
Minister of Mines.

GOD SAVE THE QUEEN!

## ROAD PROCLAIMED.

### PROCLAMATION

By His Excellency the Lieutenant-Governor of the State of Victoria and its Dependencies in the Commonwealth of Australia, &c., &c., &c.

IN pursuance of the provisions of section 25 of the *Land Act 1928*, I, the Lieutenant-Governor of the State of Victoria, by and with advice of the Executive Council of the said State, do hereby proclaim as a road the land in the Township and Parish of Korumburra, County of Buln Buln, as indicated by hachure on plan hereunder.

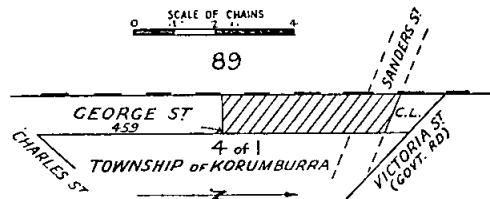

Given under my Hand and the Seal of the State of Victoria aforesaid, at Melbourne, this twenty-fifth day of June, in the year of our Lord One thousand nine hundred and fifty-seven, and in the sixth year of the reign of Her Majesty Queen Elizabeth II.

(L.S.)

E. F. HERRING.

By His Excellency's Command,

KEITH TURNBULL,  
Commissioner of Crown Lands and Survey.

GOD SAVE THE QUEEN!

RACING ACT 1957, No. 6070.  
DATE OF COMING INTO OPERATION.

PROCLAMATION

By His Excellency the Lieutenant-Governor of the State of Victoria and its Dependencies in the Commonwealth of Australia, &c., &c., &c.

WHEREAS by an Act of Parliament of the State of Victoria passed in the sixth year of the reign of Her Majesty Queen Elizabeth II., intitled the *Racing Act 1957* (No. 6070), it is amongst other things enacted that the said Act shall come into operation on a day to be fixed by Proclamation of the Governor in Council published in the *Government Gazette*:

Now therefore I, the Lieutenant-Governor of the State of Victoria, in the Commonwealth of Australia, by and with the advice of the Executive Council of the said State, do by this my Proclamation fix Wednesday, the third day of July, One thousand nine hundred and fifty-seven, as the day on which the said *Racing Act 1957* shall come into operation.

Given under my Hand and the Seal of the State of Victoria aforesaid, at Melbourne, this second day of July, in the year of our Lord One thousand nine hundred and fifty-seven, and in the sixth year of the reign of Her Majesty Queen Elizabeth II.

(L.S.) E. F. HERRING.

By His Excellency's Command,  
A. G. RYLAH,  
Chief Secretary.  
GOD SAVE THE QUEEN!

PUBLIC HOLIDAYS.

PROCLAMATION

By His Excellency the Lieutenant-Governor of the State of Victoria and its Dependencies in the Commonwealth of Australia, &c., &c., &c.

IN pursuance of the provisions contained in Part III. of the *Public Service Act 1946*, I, the Lieutenant-Governor of the State of Victoria, in the Commonwealth of Australia, by and with the advice of the Executive Council of the said State, do by this my Proclamation appoint the days and dates hereunder mentioned to be observed as Public Holidays or Public Half-Holidays (as the case may be) at the places respectively specified, viz.:

Public Holiday:—

THURSDAY, THE 18TH JULY, 1957, throughout the Shire of Stawell.

Public Half-Holiday from the Hour of Twelve o'clock noon:—

\*THURSDAY, THE 3RD OCTOBER, 1957, throughout the Shire of Wimmera.

\* Agricultural Show.

Given under my Hand and the Seal of the State of Victoria aforesaid, at Melbourne, this second day of July, in the year of our Lord One thousand nine hundred and fifty-seven, and in the sixth year of the reign of Her Majesty Queen Elizabeth II.

(L.S.) E. F. HERRING.

By His Excellency's Command,  
A. G. RYLAH,  
Chief Secretary.  
GOD SAVE THE QUEEN!

DEPARTMENT OF MINES.

MINING LEASE DECLARED VOID.

11285. Bendigo; New Monument Gold Mining Company N. L.; 1a. 1r. 22p., Parish of Sandhurst.

J. B. TILLEY,  
Secretary for Mines.

LAW DEPARTMENT.

CONSENT TO USE OF THE WORD  
"COMMONWEALTH."

HIS Excellency the Lieutenant-Governor of the State of Victoria, by and with the advice of the Executive Council thereof, doth by Order made on the 25th day of June, 1957, consent in terms of section 17 of the *Companies Act 1938*, to the use of the word "Commonwealth" in the name of the Company to be known as

"COMMONWEALTH ALUMINIUM CORPORATION PTY. LTD.",  
and which it is desired shall be registered in that name.

A. MAHLSTEDT,  
Clerk of the Executive Council.

At the Executive Council Chamber,  
Melbourne, 25th June, 1957.

Health Act 1956.

NOTIFICATION OF CONVICTION OF AN  
OFFENCE AGAINST PART XIV.

IN pursuance of the provisions of section 294 of the *Health Act 1956*, notification is hereby given that Smorgon's Preserving Company Proprietary Limited, trading as Morr Meats, 14 Bridge-road, Richmond, was at the Richmond Court on the 19th June, 1957, convicted of the offence of selling adulterated minced steak, and was fined Seventy-five pounds.

G. V. STAFFORD, Secretary,  
Commission of Public Health.

Water Acts.

STATE RIVERS AND WATER SUPPLY COMMISSION.  
DANDENONG-SPRINGVALE AND PAKENHAM URBAN DISTRICTS.

NOTICE to owners of tenements in the under-mentioned streets in the above-mentioned Urban Districts and the private streets, lanes, courts, and alleys opening thereto:—

DANDENONG-SPRINGVALE URBAN DISTRICT.

Dandenong.

Claredale-street, from Princes Highway to a point opposite lot 149, about 3 chains northerly, and from Park-street to a point opposite lot 53, about 1 chain southerly from Windale-street.

Linley-street, from Princes Highway to a point opposite lot 134, about 4½ chains northerly.

Park-street.

Plunkett-street.

Quinn-street, from Princes Highway to a point opposite lot 10, about 2½ chains north-easterly.

Windale-street, from Plunkett-street to a point opposite lot 32, about 3½ chains easterly and from Claredale-street to a point opposite lot 22, about 2½ chains westerly.

Noble Park.

Barnett-grove, from end of existing main (opposite lot 14) to Callander-road.

Burrapike-avenue.

Cadore-court.

Gunther-avenue, from View-road to a point opposite lot 2a, about 5 chains easterly.

Holloway-court.

James-street, from Heatherton-road to George-street.

Lucas-court.

Springvale.

Boonah-street, from Springvale-road to The Crescent.  
Buckingham-avenue, from Boonah-street to a point opposite lot 22, about 3½ chains northerly.

Moncur-avenue, from end of existing main (opposite lot 45) to Heatherton-road.

Regent-avenue, from St. James-avenue to a point opposite lot 20, about 9½ chains southerly.

St. James-avenue, from Regent-avenue to Princes-avenue.

PAKENHAM URBAN DISTRICT.

Henry-street.

Stephenson-street.

The main pipe in the said streets being laid down, the owners of all tenements situated as above are hereby required, on or before the 5th day of August next, to cause proper pipes and stop cocks to be laid, so as to supply water within such tenements from the main pipe.

E. BROWN, Secretary,  
State Rivers and Water Supply Commission.  
Melbourne, 28th June, 1957.

STATE RIVERS AND WATER SUPPLY COMMISSION.

LICENCES TO DIVERT WATER AND CUT RACES, PURSUANT TO THE PROVISIONS OF THE WATER ACTS.

LICENCES as detailed hereunder for the term of years from the date specified in each case have been granted by the Governor in Council to the persons named in the following Schedule:—

SCHEDULE.

Licence No.	Term of Licence and Commencing Date.	Name and Address of Person to Whom Licence is to be Granted.	Source of Supply.	Area Authorized to be Irrigated Per Annum.	Volume of Water Authorized to be Diverted Per Annum.
				acres.	ac. ft.
307	Fifteen years from 1.7.57 ..	Esther Cornelia Ashwell, Patho ..	Gunbower Creek (Splatt's Lagoon)	80	160
1118	Fifteen years from 1.7.57 ..	Colin W. Scott, Omeo ..	Mitta Mitta River and Livingstone Creek	200	400
1119	Fifteen years from 1.7.57 ..	Michelangelo and Sebastiano Pisasale, Robinvale	River Murray ..	31	93

Office of the State Rivers and Water Supply Commission, Melbourne, 25th June, 1957.

E. BROWN, Secretary.  
State Rivers and Water Supply Commission.

AUCTION SALES ACT 1928.

LIST of Persons to whom Auctioneers' Licences have been issued during the month of May, 1957.

Name.	Address.	Date of Issue.
Barnett, J. A. .. .. .	7 Centre-road, Clayton .. .. .	14.5.57
Chatham, P. .. .. .	Ascot .. .. .	1.5.57
Cook, A. A. .. .. .	24 Kensington-road, South Yarra .. .. .	10.5.57
Dawnay-Mould, Wm. R. .. .. .	161 Abbott-street, Sandringham .. .. .	21.5.57
Fitzpatrick, R. G. .. .. .	7 O'Brien-street, Warracknabeal .. .. .	28.5.57
Gardner, C. C. .. .. .	c/o Goldsbrough Mort and Co., 526 Bourke-street, Melbourne	22.5.57
Gardyne, J. .. .. .	26 Young-street, Brighton .. .. .	8.5.57
Jackson, K. L. .. .. .	c/o Elder Smith and Co., Geelong .. .. .	10.5.57
Kelly, J. M. .. .. .	c/o E. Weber, 325 Collins-street, Melbourne	21.5.57
McKinley, J. H. .. .. .	Hallam-road, Narro Warren North .. .. .	9.5.57
Neely, S. N. .. .. .	Merrigum .. .. .	10.5.57
Pond, A. .. .. .	37 Green-street, Ivanhoe .. .. .	1.5.57
Purdy, P. G. .. .. .	2 Harrison-street, Ringwood .. .. .	14.5.57
Saville, G. A. .. .. .	Dorset-road, Boronia .. .. .	8.5.57
Schlicht, P. .. .. .	Beaufort .. .. .	27.5.57
Vawdrey, J. G. .. .. .	119 Burnbank-street, Ballarat .. .. .	1.5.57
White, C. M. .. .. .	9 Martin-avenue, Ballarat .. .. .	1.5.57
Williams, C. K. .. .. .	557 Hargreaves-street, Bendigo .. .. .	1.5.57

The Treasury,  
Melbourne, C.2, 27th June, 1957.

A. T. SMITHERS,  
Director of Finance.

MONEY LENDERS ACT 1938.

IN accordance with the provisions of the above-mentioned Act, the following is published for general information:—

List of Persons to whom Money Lenders' Licences have been issued for the year ending 30th June, 1957.

Name.	Authorized Name.	Authorized Address.	Date of Issue.
*Geo. Adams Pty. Ltd. (F. W. Brown, appointee)	Geo. Adams Pty. Ltd. .. .. .	37 Swanston-street, Melbourne ..	11.6.57
*Adam Smith Pty. Ltd. (C. J. Smith, appointee)	Adam Smith Pty. Ltd. .. .. .	37 Swanston-street, Melbourne ..	11.6.57
*Field, K. E. .. .. .	K. E. Field, carrying on business as The Star Cash Order and Finance Co.	409 Sydney-road, Brunswick ..	10.6.57
*Travel Investments Pty. Ltd. (R. M. Jennings, appointee)	Travel Investments Pty. Ltd. .. .. .	495 Collins-street, Melbourne ..	11.6.57

\* Change of authorized address.

State Treasury,  
Melbourne, C.2, 27th June, 1957.

M. A. R. SYNNOT,  
Registrar.

## Transport Regulation Acts.

## TRANSPORT REGULATION BOARD.

## NOTICES OF PUBLIC HEARINGS.

NOTICE is hereby given that the applications made by the persons named below for licences to operate commercial passenger vehicles on the route or routes, or in the manner set out opposite their names, will be heard at a time and place to be communicated to the parties:—

*Name and Address; Nature of Application.*

- ROLFE, L. M., 73 Nepean Highway, Seaford; 1 commercial passenger vehicle, to be purchased, with seating capacity for five persons, to operate under the same terms and conditions as existing taxi-cabs at Seaford.
- WATSON, R. M., 359 Lucia-street, Springvale; 1 commercial passenger vehicle, to be purchased, with seating capacity for five persons, to operate as follows:—  
(a) At separate and distinct fares within a radius of five (5) miles of Springvale Railway Station, (b) under private hire conditions throughout Victoria from Lucia-street, Springvale.
- MURRAY, F. D., 5 Lisgoold-street, Heathmont; 1 commercial passenger vehicle, to be purchased, with seating capacity for five persons, to operate as follows:—(a) At separate and distinct fares within a radius of five (5) miles of Heathmont Railway Station, (b) under private hire conditions throughout Victoria from Heathmont.
- SMITH, W. R. (trading as Smith's Taxi Service), 1 Arnold-street, Horsham; 1 commercial passenger vehicle, to be purchased, with seating capacity for five persons, to operate as follows:—(a) At separate and distinct fares within a radius of five (5) miles of Horsham Post Office, (b) under private hire conditions throughout Victoria from Horsham.
- SMITH, H. E. (trading as Smith's Taxi Service), 1 Arnold-street, Horsham; 1 commercial passenger vehicle, with seating capacity for five persons, to operate as follows:—(a) At separate and distinct fares within a radius of five (5) miles of Horsham Post Office, (b) under private hire conditions throughout Victoria from Horsham.
- NEWTON, M. K., 39 Swanston-street, West Heidelberg; 1 commercial passenger vehicle, to be purchased, with seating capacity for five persons, to operate as follows:—(a) At separate and distinct fares within a radius of five (5) miles of Montmorency Railway Station, (b) under private hire conditions throughout Victoria from Montmorency.
- KENNEDY, A. E., 57 Dougharty-road, West Heidelberg; 1 commercial passenger vehicle, to be purchased, with seating capacity for five persons, to operate as follows:—(a) At separate and distinct fares within a radius of five (5) miles of Montmorency Railway Station, (b) under private hire conditions throughout Victoria from Montmorency.
- PORTSEA PASSENGER SERVICE LTD., Station-street, Frankston; application for renewal of licence No. C.O.974, expiring 24th October, 1957, authorizing operations as a stage omnibus under the same terms and conditions.
- GRIFFITH, J. W., 17 Roper-street, Mount Beauty; 1 commercial passenger vehicle, with seating capacity for eight persons, to operate as an additional stage omnibus under the same terms and conditions as licence No. C.O.511, at present in the name of the applicant.
- MCKNIGHT, A. G., Barr-street, Tungamah; 1 commercial passenger vehicle, with seating capacity for five persons, to operate for the carriage of passengers otherwise than at separate and distinct fares for each passenger throughout Victoria from Barr-street, Tungamah.
- HANSEN, W. A., 79 Park-crescent, Williamstown; application for full term metropolitan taxi-cab licence in renewal of metropolitan taxi-cab licence No. M.T.2761, which expires on 25th September, 1957, authorizing operations as a metropolitan taxi-cab.
- ST. KILDA-BRIGHTON BUS SERVICE PTY. LTD., 96-100 McKinnon-road, Bentleigh; application for one commercial passenger vehicle, with seating capacity for 37 persons, to operate as a substitute metropolitan omnibus on Route 140A (St. Kilda-Brighton).
- NOTICE is hereby given that the applications made by the persons named below for renewal of licences to operate the commercial goods vehicles on the route or routes, or in the manner set out hereunder opposite their names, will be heard at a time and place to be communicated to the persons concerned:—
- Name and Address; Present Franchise; Licence No.; Date of Expiry.*
- CAHILL, J. D., Lockington; 1 commercial goods vehicle (80 cwt.) to operate throughout the State of Victoria in the course of business as "boring contractor"—towing plant, tools of trade, equipment, steel casings, fittings, and materials incidental to own contracts; D.7935; 10th August, 1957.
- COUTTS, T. J. PTY. LTD., 711 Sturt-street, Ballarat; 1 commercial goods vehicle (8 cwt.) to operate throughout the State of Victoria as "electrical contractor"—tools of trade, equipment, spare parts and materials incidental to installation and servicing of electrical equipment and used solely for own contracts; D.7981; 21st September, 1957.
- GILBERT & BARKER MFG. CO. (AUST.) PTY. LTD., 11 Anderson-road, Thornbury; 1 commercial goods vehicle (12 cwt.) to operate throughout the State of Victoria for the installation and maintenance of petrol pumps, tanks, bowsers, fittings, tools of trade and equipment incidental to such installations and maintenance; D.8004; 21st September, 1957.
- GREEN, J. R., P.O. Box 68, Swan Hill; 1 commercial goods vehicle (7 cwt.) to operate from and to the premises of the holder of this licence at the Township of Swan Hill to clients throughout the State of Victoria—  
(a) for the purpose of servicing and maintaining sewing machines on behalf of the Singer Sewing Machine Co.—tools, tools of trade, and spare parts and machines for temporary replacement, (b) new sewing machines for display and sale, (c) second-hand sewing machines for repair, returning with repaired machines; D.5474; 27th June, 1957.
- HARCOURT FRUIT SUPPLY SOCIETY LTD., Harcourt; 1 commercial goods vehicle (97 cwt.) to operate—(a) within a radius of 20 miles from the post office at Harcourt—own goods, (b) within a radius of 50 miles from the post office at Harcourt and from the Merrigum and Rheola districts to own store at Harcourt—fresh fruit; D.8013; 21st September, 1957.
- HARRIS, P., 6 Burgoyne-street, Kerang; 1 commercial goods vehicle (20 cwt.) to operate—(a) within a radius of 20 miles from the post office at Kerang—general goods, (b) within a radius of 50 miles from the post office at Kerang in the course of business as "marine dealer"—marine stores and old metals; D.5588; 15th August, 1957.
- HOWARD, J. L., PTY. LTD., 174-6 Mitchell-street, Bendigo; 1 commercial goods vehicle (7 cwt.) to operate throughout the State of Victoria from the City of Bendigo in the course of business as "electrical contractors"—tools of trade, spare parts, fittings, and material incidental to the execution of own contracts; D.7908; 10th August, 1957.
- JOHNS, R. A., 149 Inglewood-road, Golden Square; 1 commercial goods vehicle (12 cwt.) to operate throughout the State of Victoria from own premises, at Golden Square in the course of business as "electrical contractor"—tools of trade, materials and equipment incidental to own contracts; D.8071; 10th August, 1957.
- JOHNSON, W. A., Station-street, Koo-Wee-Rup; 1 commercial goods vehicle (53 cwt.) to operate within a radius of 50 miles from the post office at Koo-Wee-Rup for the purpose of towing or repairing disabled or wrecked vehicles—tools of trade, spare parts and materials incidental to trade; D.7905; 10th August, 1957.
- THE KIWI POLISH CO. PTY. LTD., 188 Burnley-street, Richmond; 1 commercial goods vehicle (6 cwt.) to operate throughout the State of Victoria in the course of business as "manufacturers of boot and floor polishes" for the purpose of displaying samples with the ability to deliver small quantities of urgent orders; D.8000; 21st September, 1957.
- MCDONALD, L., 2 Barkly-street, Sale; 1 commercial goods vehicle (101 cwt.) to operate—(a) within a radius of 20 miles from the post office at Sale—general goods, (b) from and to places situate within the radius as defined in paragraph (a) above, to and from places situate within a 50-mile radius of the aforesaid post office—household furniture; D.7938; 10th August, 1957.
- JAMES, MCKAY & SONS PTY. LTD., 120 Lydiard-street, Ballarat; 1 commercial goods vehicle (120 cwt.) to operate within a radius of 50 miles from the chief post office situate in the City of Ballarat and to and

- from the Townships of Navarre and Landsborough in the course of business as "wholesale grocers, manufacturers and wine and spirit merchants"—own manufactured products; D.8003; 28th September, 1957.
- PETERS ICE CREAM (Vic.) LTD., 183 Burnley-street, Richmond; 1 commercial goods vehicle (50 cwt.) to operate throughout the State of Victoria for the purpose of installing and servicing refrigerators—refrigerators for installation, also tools of trade, spare parts and materials required in connexion with such installations and servicing; D.5647; 12th September, 1957.
- PETERSON, R., 13 Ligar-street, Bairnsdale; 1 commercial goods vehicle to operate—(a) within a radius of 20 miles from the post office at Bairnsdale—general goods, (b) within the State of Victoria east of a north/south line drawn through the Township of Rosedale under contract to the Country Roads Board—road-contracting plant and materials; D.7912; 10th August, 1957.
- VACUUM OIL Co. PTY. LTD., 29 Market-street, Melbourne; 1 commercial goods vehicle (124 cwt.) to operate for the carriage of own goods in the course of trade as "marketers of petroleum products"—petroleum products and accessories—(a) within a radius of 50 miles from own depot situated in the City of Geelong, (b) from and to the depot described in paragraph (a) above and from the Lismore district; D.7967; 17th August, 1957.
- VACUUM OIL Co. PTY. LTD., 29 Market-street, Melbourne; 1 commercial goods vehicle (197 cwt.) to operate for the carriage of own goods in the course of trade as "marketers of petroleum products"—petroleum products and accessories, (a) within a radius of 50 miles from own depot situated in the City of Bendigo, (b) from and to own depot described in paragraph (a) above and from the Boort, Charlton, and Gredgwin districts; D.7968; 17th August, 1957.
- VACUUM OIL Co. PTY. LTD., 29 Market-street, Melbourne; 1 commercial goods vehicle (114 cwt.) to operate for the carriage of own goods in the course of trade as "marketers of petroleum products"—petroleum products and accessories, (a) within a radius of 50 miles from own depot situated in the City of Hamilton, (b) from and to own depot described in paragraph (a) above, and from the Edenhope, Douglas, and Toolondo districts; D.7969; 17th August, 1957.
- R. WERNER & Co. PTY. LTD., 54-86 Burnley-street, Richmond; 1 commercial goods vehicle (15 cwt.) to operate throughout the State of Victoria for the purpose of installing and servicing refrigeration plants—spare parts, tools of trade, and equipment required in connexion with the aforesaid servicing and installation work; D.5653; 12th September, 1957.
- GRUMMISCH, C. H., Bass; 1 commercial goods vehicle (200 cwt.) to operate—(a) within a radius of 20 miles from the post office at The Gurdies—general goods, (b) from and to places situate within the radius as defined in paragraph (a) above and from the Township of Dandenong—livestock, (c) from and to the City of Melbourne and from the Township of The Gurdies—petroleum products in prescribed types of containers and empty containers; D.A.26319/1; 11th April, 1957.
- NOTICE** is hereby given that the applications made by the persons named below for licences to operate commercial goods vehicles, on the route or routes or in the manner set out opposite their names, will be heard at a time and place to be communicated to the persons concerned:—
- Name and Address; Nature of Application.*
- THE BALLARAT BREWING Co. LTD., 309 Dana-street, Ballarat; application to vary the terms of existing licence No. D.A.586/13 by the deletion of present conditions and adding in lieu the ability to operate within a radius of 50 miles of Ballarat in the course of business as "brewers of alcoholic beverages"—own brewed products and empty returns. (Load capacity 100 cwt.)
- BERRY, J., 12 Smith-street, Ballarat; 1 commercial goods vehicle (18 cwt.) to operate throughout the State of Victoria in the course of business as "hawker"—own clothing and drapery.
- BUBB, W. A., Anglesea; 1 commercial goods vehicle (96 cwt.) to operate within the Geelong Division of the C.R.B.—road-contracting plant and materials.
- BURNSIDE, M. O., Balmattum East; 1 commercial goods vehicle (58 cwt.) to operate—(a) within a radius of 20 miles of Euroa—general goods, (b) within a radius of 20 miles of the premises of the Benalla Dairy Co. at Benalla, and to and from Kobyboyn, Habbies Howe, and Highlands—milk, cream, empty cans, and goods the property of the aforesaid company.
- CAMBARVILLE SAWMILLING Co., 171 Doncaster-road, North Balwyn; 1 commercial goods vehicle (241 cwt.) to operate for the carriage of sawn timber from Cambarville Sawmilling Co. at Cambarville—(a) to the railway station at Healesville, (b) to any customer if delivered within a radius of 20 miles of the Healesville Railway Station, (c) to any merchant or builder if delivered to a timber yard or direct on to a building site which is situated within a radius of 25 miles of the G.P.O., Melbourne.
- CHRISTIE, A. McD., 32 John-street, Horsham; 1 commercial goods vehicle (7 cwt.) to operate—(a) between Horsham and Harrow—parcels, (b) from Noradjuha to Harrow, via Clear Lake and Douglas, and return—mails and parcels.
- DEIPENAU, H. E., PTY. LTD., 233 Victoria-street, East Brunswick; 1 commercial goods vehicle (255 cwt.) to operate from Geelong to the premises of Wunderlich Pty. Ltd. at Sunshine—cement in bulk tanker.
- DOOLAN, H. A., 15 Grace-street, Malvern; application to vary the terms of existing licence No. D.A.991/1 by the deletion of present conditions and adding in lieu the ability to operate within a radius of 70 miles of Fritsch Holzer and Co. at Hawthorn—bricks on behalf of the said company.
- FLEETWAYS TRANSPORT & AGENCY PTY. LTD., 88 Normanby-road, South Melbourne; 2 commercial goods vehicles (173 and 114 cwt.) to operate throughout the State of Victoria from the premises of distributors and dealers direct to consignees—complete motor vehicles.
- GARDNER, J. A., & L. A. FREGON, Box 9, Oakleigh; 1 commercial goods vehicle (109 cwt.) to operate within a radius of 70 miles of the premises of the New Gamble Brick Co. Pty. Ltd. at Oakleigh—bricks on behalf of the said company.
- GILLATT, B. S., 27 Mihil-street, Preston; 1 commercial goods vehicle (104 cwt.) to operate within a radius of 70 miles of the premises of the Clifton Brick Co. Pty. Ltd. at Preston—bricks on behalf of the said company.
- GOULD, J. L., Falls-road, Marysville; application to vary the terms of existing licence No. T.T.D.1387 by the addition of the ability to operate from Taylor's saw-mill at Marysville to consignees in the metropolitan area—sawn timber.
- GRAY, G. E., Bald Hills P.O.; 1 commercial goods vehicle (60 cwt.) to operate throughout the State of Victoria in the course of business as "marine dealer"—marine stores and old metals.
- HILL, R., 20 Redesdale-road, Darebin; 1 commercial goods vehicle (7 cwt.) to operate within a radius of 50 miles of the premises of H. Wells, 104 Wellington-parade, East Melbourne—knitwear and ladies' hosiery solely on behalf of H. Wells.
- HORTICULTURAL INDUSTRIES PTY. LTD., Plummer-street, Port Melbourne; 1 commercial goods vehicle (84 cwt.) to operate within a radius of 50 miles of own premises at Port Melbourne in the course of business as "manufacturers of agricultural and horticultural supplies"—own goods.
- HOWARD, J. T. A., Whittington, via Geelong; 1 commercial goods vehicle (65 cwt.) to operate within the Geelong Division of the C.R.B.—road-contracting plant and materials.
- KENT, GEORGE, (Vic.) PTY. LTD., 563 Victoria-street, Abbotsford; 2 commercial goods vehicles (100 cwt. each) to operate—(a) within a radius of 50 miles from the City of Melbourne in the course of business as "engineers"—own goods, (b) throughout the State of Victoria for the purpose of servicing and installation of industrial instruments, metering equipment, flowing meters, and temperature recorders—tools of trade, spare parts incidental to the aforementioned servicing, and installation.
- LOBB, B., 5 Burlington-street, Oakleigh; application to vary the terms of existing licence No. D.A.12543 by the deletion of paragraph (b) and adding in lieu the ability to operate within a radius of 70 miles of the G.P.O., Melbourne—bricks.
- LOVE, R. K. & S. E., Day-avenue, Omeo; 1 commercial goods vehicle (approximately 100 cwt.), to be purchased, to operate—(a) between Bairnsdale and own store at Omeo in the course of business as "general merchants"—own goods, (b) within a radius of 20 miles of Omeo—own goods, (c) from Bairnsdale to consignees within a radius of 20 miles of Omeo—petroleum products in prescribed types of containers and empty returns.
- MELBOURNE WASTE INDUSTRIES PTY. LTD., Railway Siding, Oakleigh; 1 commercial goods vehicle (17 cwt.) to operate throughout the State of Victoria in the course of business as "waste collectors on behalf of charitable organizations"—old clothing and rag.

MITCHELL & Co. Pty. Ltd., 12-36 Cross-street, West Footscray; 1 commercial goods vehicle (9 cwt.) to operate throughout the State of Victoria for the purpose of servicing and maintaining agricultural machinery—tools of trade, spare parts, and materials incidental to such work.

MITCHELL, A. R., & Sons, Watchupga; 1 commercial goods vehicle (196 cwt.) to operate—(a) within a radius of 20 miles from the post office at Watchupga—general goods, (b) from Caltex Oil Depot at Warracknabeal to consignees within a radius of 20 miles from the post office at Watchupga—petroleum products in prescribed types of containers and empty containers, (c) from and to places within the radius described in paragraph (a) above and from places within a radius of 50 miles from the post office at Watchupga—livestock, (d) from Arbutnott's mill at Koondrook to consignees at Ouyen, Watchupga, Warracknabeal—sawn redgum timber.

MONAGHAN, P. T., Oke-street, Ouyen; 1 commercial goods vehicle (90 cwt.) to operate—(a) within a radius of 20 miles of Ouyen—general goods, (b) throughout the Shires of Walpeup, Swan Hill, Wycheproof, and Mildura—road-contracting plant and materials.

MURRAY, W. A., care of C.R.B., Benalla; 1 commercial goods vehicle (81 cwt.) to operate within the Benalla Division of the C.R.B.—road-contracting plant and materials.

NEW ZEALAND LOAN & MERCANTILE AGENCY Co. LTD., Grey-street, Hamilton; 1 commercial goods vehicle (8 cwt.) to operate within a radius of 50 miles of own premises at Hamilton in the course of business as "general merchants and agents"—own goods.

PLISCH, K. J., 8 Healey-street, Moorabbin; 2 commercial goods vehicles (16 and 8 cwt.) to operate throughout the State of Victoria in the course of business as "wholesale cake distributor"—12-oz. and 16-oz. cakes and shortbreads.

SAGASSER, F. O., Box 224, Red Cliffs; 1 commercial goods vehicle (87 cwt.) to operate—(a) within a radius of 20 miles of Red Cliffs—general goods, (b) throughout the Shires of Mildura, Swan Hill, Walpeup, Karkarook, and Wycheproof—road-contracting plant and materials.

SLATER, H., 33 Fortuna-avenue, Croydon; 1 commercial goods vehicle (90 cwt.) to operate—(a) within a radius of 25 miles of the G.P.O., Melbourne—general goods, (b) throughout the State of Victoria solely on behalf of E. Hassett and Sons of Ringwood—agricultural machinery for demonstration purposes at shows and farms and return to Ringwood.

SUNBEAM CORPORATION LTD., Sloane-street, Maribyrnong; 1 commercial goods vehicle (7 cwt.) to operate throughout the State of Victoria—electrical and farm appliances for installation and demonstration purposes with tools, spare parts, and materials incidental to servicing and maintaining such appliances.

STELLINI, M., 452 Victoria-street, North Melbourne; 1 commercial goods vehicle (92 cwt.) to operate from Bacchus Marsh to Melbourne and Ballarat—brown coal.

WINTER, W. J., Main-street, Gordon; 1 commercial goods vehicle (72 cwt.) to operate—(a) within a radius of 20 miles of Gordon—general goods, (b) from and to places in paragraph (a) to and from places within a radius of 50 miles of Gordon—livestock.

ZABALDANO, R. & R., 7 Hotham-street, Seddon; 1 commercial goods vehicle (145 cwt.) to operate from North Melbourne, Geelong, and Traralgon to Barro's Paving Co. at Ringwood—cement in bulk tanker.

Notice of any objection should be forwarded to reach the Secretary of the Board not later than Wednesday, 17th July, 1957.

E. V. FIELD,  
Secretary.

Exhibition Buildings, Rathdown-street, Carlton, N.3,  
1st July, 1957.

Country Fire Authority.

PERMISSION TO HOLD FIRE BRIGADE  
DEMONSTRATION.

IN pursuance with the provisions of section 79 (1) and (2) of the *Country Fire Authority Act 1944*, the Country Fire Authority has granted permission for the holding of a fire brigades demonstration as under:—

URBAN FIRE BRIGADES.

At Beechworth, on Monday, 27th January, 1958.

G. G. SINCLAIR,  
Secretary.

27th June, 1957.

Country Fire Authority.

PERMISSION TO HOLD FIRE BRIGADE  
DEMONSTRATION.

IN pursuance with the provisions of section 79 (1) and (2) of the *Country Fire Authority Act 1944*, the Country Fire Authority has granted permission for the holding of a fire brigade demonstration as under:—

URBAN FIRE BRIGADES.

At Mildura, on Tuesday 4th, Wednesday 5th, Thursday, 6th March, 1958.

G. G. SINCLAIR,  
Secretary.

27th June, 1957.

STATE FORESTS DEPARTMENT.

APPOINTMENT OF MEMBERS OF COMMITTEE OF  
MANAGEMENT OF THE SHERBROOKE FOREST  
AREA.

WHEREAS by section 56 of the *Forests Act 1928* it is provided that the Minister of Forests may, on the recommendation of the Forests Commission, appoint any number of persons, not less than three, to be a Committee of Management of land forming part of any reserved forest, such land being a place of natural beauty or interest or health resort, and may remove any such persons: Now therefore I, Gordon Stewart McArthur, Her Majesty's Minister of Forests in the State of Victoria, on the recommendation of the Forests Commission, do hereby appoint—

Group-Captain JAMES CLEMENT FODEN, C.B.E., A.F.C.,  
of Kallista,

FREDERICK GEORGE KOLLOSCH, of Belgrave,

ALEC BROOKE CASHMORE, B.Ag.Sc., M.Sc., of Sherbrooke,

Councillor ALISTER IAN GILLIES, of Tecoma,

Dr. LEONARD HART SMITH, M.Sc., D.Phil. (Oxon), of Kew,

DENNIS O'DONOHUE, of Kallista, and

JAMES CAMPBELL WESTCOTT, A.Dip.For. (Cres.), of Kallista,

as Members of the Committee of Management for a period of three years from the third day of July, 1957, of the land forming part of the reserved forest in the Parish of Monbulk, County of Mornington, known as the Sherbrooke Forest Area, such land being a place of natural beauty and interest.

Dated at Melbourne, the 2nd day of July, 1957.

G. S. MCARTHUR,  
Minister of Forests.

STATE FORESTS DEPARTMENT.

APPOINTMENT OF COMMITTEE OF MANAGEMENT  
OF McDONALD PARK.

WHEREAS by section 56 of the *Forests Act 1928*, it is provided that the Minister of Forests, on the recommendation of the Forests Commission, may appoint any number of persons, not less than three, to be a Committee of Management of any land forming part of any reserved forest, such land being a place of natural beauty or interest or a health resort, and may remove any such persons: Now therefore I, Gordon Stewart McArthur, Her Majesty's Minister of Forests in the State of Victoria, on the recommendation of the Forests Commission, do hereby appoint—

H. J. BLACKIE, Ararat,

E. A. LEEKE, Ararat, and

LORNA BANFIELD (MISS), Ararat,

as Members of the Committee of Management, for a period of three years, from the 11th day of July, 1957, of the land forming part of the reserved forest in the Parish of Ararat, known as "McDonald Park," and more particularly described in Order in Council dated the 10th day of July, 1936, such land being a place of natural beauty.

Dated at Melbourne the 25th day of June, 1957.

G. S. MCARTHUR,  
Minister of Forests.

**CONTRACTS ACCEPTED.—(Series 1956-57.)****VICTORIAN RAILWAYS.**

159. Roofing Milk Dock, Flinders-street, for £1,078 4s. 5d. (Contract 61148).—George Ward Pty. Ltd. 160. Cast steel freight bogies, at £301 3s. per set (Contract 61162).—Bradford, Kendall Ltd. 161. Transferring goods at Colac, at rates (Contract 61203).—C. J. Welsh.

By order of the Victorian Railways Commissioners.

A. GILMORE, Acting Secretary for Railways. 28.6.57.

**CONTRACTS ACCEPTED.—(Series 1956-57.)****PUBLIC WORKS.**

6637. Melbourne, additional State Offices, (1) supply of thermostat, £144 15s. 9d.—Rubanit Roofing and Paper Products Ltd.

6638. Hampton, State School No. 3754, (1) supply of Billite units, £107 5s.—British General Electric Co. Pty. Ltd.

6639. Norlane, State School No. 4734, (1) supply of incinerator, £126 19s. 6d.—Earle Griffiths (Vic.) Pty. Ltd.

6640. Foster, High School, (1) supply of road gravel and rock, £195.—Williams Bros.

6641. Port Melbourne, Public Works Department Depot, (1) supply of screenings and toppings, £411 12s. 3d.—Willis Quarries.

6642. Burwood, High School, (1) supply of electric gravity feed slicer, £165.—Brice Scale and Slicer Co. Pty. Ltd.

6643. Port Melbourne, Public Works Department Depot, (1) supply of Ferrocart hydraulic crane, £200.—Electronic Industries Imports Pty. Ltd.

6644. Kew, Mental Hospital, (1) supply of Scair Ozone air generator, £135.—Ozone Air Generator Co.

6645. Robinvale, Consolidated School, (1) supply of incinerator, £154 10s.—J. D. MacDonald Engineering Co. Pty. Ltd.

6646. Royal Park, Mental Hospital, (1) supply of tiles, £349 0s. 1d.—Australian Tesselated Tile Co. Pty. Ltd.

6647. Port Melbourne, Public Works Department Depot, (1) supply of flexible shaft heads and wood borers, £227 5s. 6d.—Speed Tools and Equipment Co.

6648. St. Kilda, Breakwater, (1) supply of quarried stone, £903 8s.—Wyndham Quarries Pty. Ltd.

6649. Ferntree Gully, Tourist Resort, (1) supply of crushed rock and toppings, £134 2s.—F. G. Kerr.

6650. Heidelberg West, State School No. 4267, (1) supply of premix screenings and toppings, £442 19s.—Albion Quarrying Co. Pty. Ltd.

6651. Yarrunga, State School No. 4761, (1) supply of air circulators, £350.—British General Electric Co. Pty. Ltd.

6652. Kew, Mental Hospital, (1) supply of seven refrigerators, £917.—R. R. Wickers Pty. Ltd.

6653. Yallourn, Technical School, (1) supply of incinerator, £188.—J. D. MacDonald Engineering Co. Pty. Ltd.

6654. Ballarat, High School, (1) supply of Univectair unit with motors, £137 7s. 6d.—G. R. Gayfer and Co. (Vic.) Pty. Ltd.

6655. South Melbourne, Public Works Department Storeyard, (1) supply of earthenware pipes, bends, &c., £403.—Melody's Pottery Pty. Ltd.

6656. Queenscliff, Ports and Harbors, (1) supply of gas buoys, £2,385.—Winstanley Bell and Co. Ltd.

6657. Collingwood, State School No. 2462, (1) supply and delivery of crushed rock, £138 12s.—D. Germano and Son.

6658. Brunswick, State School No. 1213, (1) supply of screenings and toppings, £184 14s.—Albion Quarrying Co. Pty. Ltd.

6659. Fairfield, State School No. 2711, (1) supply of toppings and screenings, £300.—Albion Quarrying Co. Pty. Ltd.

6660. Melbourne, Public Works Department, (1) supply of water level recorder and strip charts, £253 10s.—A. G. Barker and Associates Pty. Ltd.

6661. Ferntree Gully, Technical School, (1) supply of box culvert and concrete pipes, &c., £300 19s. 4d.—Rocla Pipes Ltd.

6662. Coburg, Pentridge Gaol, (1) supply of Calorifier, £276 18s.—Orm Smith and Co. Pty. Ltd.

6663. Drouin, High School, (1) supply of sewage distributor, £220.—Tuke and Bell (Aust.).

6664. Lakes Entrance, Western Entrance, (1) cartage of stone, £197 7s. 6d.—J. C. Varney.

6665. Camberwell, Girls' Secondary School, (1) supply of Kelvinator refrigerator, £112 0s. 6d.—Robert Taylor Pty. Ltd.

6666. Royal Park, Mental Hospital, (1) supply of refrigerator, £106 7s. 7d.—Warburton, Franki (Melbourne) Ltd.

6667. Malvern, "Stonington", (1) supply of skylights, £113 7s. 6d.—Geo. Davis.

6668. Kew, Mental Hospital, (1) supply of Frigidaire, £131.—R. R. Wickers Pty. Ltd.

6669. Brighton, High School, (1) supply of lathes and trays, £537.—McPherson's Ltd.

6670. Kyneton, High School, (1) supply of Parken saw bench and Hyco wood lathe with accessories, £202 8s. 4d.—Frank Vial and Sons Pty. Ltd.

6671. South Melbourne, Public Works Department Storeyard, (1) supply of masonite, £282 9s. 1d.—Masonite Corporation (Aust.) Pty. Ltd.

6672. Ferntree Gully, Technical School, (1) supply of workshop equipment, £195 9s. 10d.—James McEwan and Co. Pty. Ltd.

6673. Sunbury, Mental Hospital, (1) supply of shoe-making machinery, £108 10s.—Michaelis Hallenstein and Co. Pty. Ltd.

6674. Various, Horsham State School No. 298, Horsham Technical School, and Horsham West State School No. 4697, (1) supply of washed concrete sand, £168 15s.—R. Freeland.

6675. Coburg, Pentridge Gaol, (1) supply of extension to existing Aga cooker, £895.—Levin and Co. Ltd.

6676. Williamstown, Dredging Depot, (1) supply of steel castings, £140.—Thompson's (Castlemaine) Ltd.

6677. North Melbourne, Melbourne Printing Trades School, (1) supply of fans, £135.—W. G. Crossie and Co. Pty. Ltd.

6678. Burwood, Teachers' Training College Hostel, (1) supply of timber, £226 9s. 1d.—Gibbs, Bright and Co.

6679. Dooen, Longerenong Agricultural College, (1) supply of iron tank stand, £155 10s.—Tubewrights (A'sia.) Ltd.

6680. Mont Park, Mental Hospital, (1) supply of stainless steel cabinet complete with ice-making evaporator and remote Frigidaire equipment, £968 10s.—M. F. Ahearn and Co. Pty. Ltd.

6681. Mont Park, Mental Hospital, (1) supply of packing flannel and cotton-press padding, £317 9s. 4d.—Robert Bryce and Co. Ltd.

6682. Glenormiston South, Glenormiston Estate, (1) supply of plain fencing wire, £133 16s. 2d.—Briscoe and Co. Ltd.

6683. Various, Dandenong North State School No. 4723 and Springvale High School, (1) supply of filling, £362 6s. 9d.—D. Fregon and Son.

6684. Lakes Entrance, Western Entrance, (1) cartage of stone, £270 5s. 8d.—J. C. Varney.

6685. Blackburn, High School, (1) supply and delivery of crushed rock, £217 10s.—D. Germano and Son.

6686. Port Melbourne, Public Works Department Depot, (1) supply of screenings, £160 16s.—G. H. Reid and Sons.

6687. Pakenham, Consolidated School, (1) supply and spreading filling, £292 10s.—R. T. Sims.

6688. Brighton, Breakwater, (1) supply of spalls, £954 19s. 7d.—J. Starbuck and Sons.

6689. Coburg, Pentridge Gaol, (1) supply of galvanized water pipe, £103 9s. 1d.—H. A. Barnard Pty. Ltd.

6690. Kyneton, District Hospital, (1) supply of cooker, £739 5s.—Levin and Co. Ltd.

6691. Warrnambool, Mental Hospital, (1) supply of two floor polishers, £107 10s.—H. M. Day and Co. Pty. Ltd.

6692. Burwood, Teachers' Training College Hostel, (1) supply of sisalkraft, £100 10s.—Sisalkraft Distributors Co. Pty. Ltd.

6693. Yallourn, Technical School, (7) mechanical services for stages 2 and 3, £4,562.—Frederick W. Nielsen Pty. Ltd.

6694. Eastern Victoria, West Gippsland and Mornington Peninsula, Various Schools, (3) maintenance of mechanical services for twelve months, £360.—T. J. Tait.

6695. Ballarat, Mental Hospital, (1) rewiring of wards F.3 and F.5, £1,170.—T. J. Coutts Pty. Ltd.

6696. Ballarat, Mental Hospital, (7) supply and installation of the new steam reticulation and modifications to existing boiler-rooms, £21,324.—G. W. T. Hall Pty. Ltd.

6697. Ballarat, Mental Hospital, (5) external sewerage to four new wards, £3,348 15s. 8d.—Industrial Plumbing Services Pty. Ltd.

6698. Ballarat, Mental Hospital, (8) supply and installation of the steam reticulation to the new standard wards, £4,548.—G. W. T. Hall Pty. Ltd.

6699. Ballarat, Teachers' College, (6) erection of Teachers' Training College in L.T.C., £118,256.—S. C. Ludbrook and Son.

6700. Ballarat, Teachers' Training College, (6) electrical installation in new college buildings, £8,340.—H. W. Sarah.

6701. Bendigo and District, Various Schools, (2) maintenance of air filters, fans, and oil burners, &c., for twelve months, £363 18s.—D. J. Osborn Plumbing Service.

6702. Bendigo North, State School No. 1267, (7) external repairs and painting, £953.—J. J. Blandthorn.

6703. Boronia, High School, (7) septic tank installation, laying of sewer and stormwater drains, &c., £7,478 19s. 11d.—Industrial Plumbing Services Pty. Ltd.

6704. Box Hill, Boys' Technical School, (2) repairs to main roof and parapet walls, £2,094.—Flat Top Roofing Co. (Don Campbell) Pty. Ltd.

6705. Box Hill, Technical School, (2) resurfacing of stairs and corridors, £335.—C. Thomas.

6706. Brighton, State School No. 1542, (10) electrical installation in infants' school, £559 12s.—R. F. Smith.

6707. Coburg, High School, (3) provision of shelter shed, bicycle shed, and fencing, £454.—A. H. Philip.

6708. Coburg, Pentridge Gaol, (3) supply and erection of security fence, £15,645.—Cyclone Company of Australia Ltd.

6709. Dunkeld, Consolidated School, (1) supply, delivery, installation, and testing of extension to heating and hot-water system, £1,276.—J. H. Gabriel.

6710. Ellinbank, Dairy Research Station, (5) erection of staff residence, £4,750.—R. J. Ireland.

6711. Elwood, State School No. 3942 (infants' school), (3) supply and fixing plaster sheeting to office, staff-room; plastering section of store, entrance hall, and toilet, &c., £528.—F. T. Pulling and Sons Pty. Ltd.

6712. French Island, McLeod Training Centre, (5) electrical installation in laundry, garage, &c., £387.—Lane and Roux.

6713. Glenroy, Technical School, (7) electrical installation in stages 2 and 3, £3,848.—H. H. Rowell.

6714. Gormandale East, State School No. 2877, (7) repairs and painting, £651 1s. 6d.—E. Vogt and E. W. Gravett.

6715. Hamilton, Court House, (4) internal painting, £765.—Mills and Taylor.

6716. Heatherton, Sanatorium, (2) supply and installation of 140 Beco No. 20 bed lights, &c., £683 8s.—L. E. Bienvenu.

6717. Hoddles Creek, State School No. 2541, (5) repairs and painting and provision of water tank, £474 15s.—R. J. Levis.

6718. Kallista, State School No. 3993, (5) erection of a new 20-ft. x 16-ft. shelter pavilion, £340.—J. W. Yates.

6719. Kenmare, State School No. 3221, (2) stripping and replastering walls, £256.—G. B. Dellar.

6720. Kew, Mental Hospital, (2) provision of flywire window screens to two nurses' homes, £621 12s.—Delpet Pty. Ltd.

6721. Kilmore East, State School No. 1495, (4) internal and external repairs and painting, school and residence, £929.—J. Komar.

6722. Kyneton, District Hospital, (1) electrical installation, £630 12s.—W. R. Parker.

6723. Leongatha, State School No. 2981, (7) erection of a new shelter pavilion, £475.—J. B. Thompson and N. E. Wynne.

6724. Macarthur, State School No. 1571, (3) provision of additional tanks and stands, drinking facilities, and drainage, £574 16s.—J. J. McLaren Pty. Ltd.

6725. Maffra, State School No. 861, (3) erection of new out-office, laying of sewer drains, and connexion to sewer at residence, 22 McMillan-street, £347.—K. B. Medew.

6726. Melbourne, State Immigration Office, 436 Queen-street, (8) cleaning 1st June, 1957 to 31st May, 1958, £350.—R. R. Regnier.

6727. Merlynston, State School No. 4328, (7) roof and down-pipe repairs, spouting renewal at school and residence, £323 10s.—Bull and Murphy.

6728. Melbourne, City Court, Russell-street, (3) alterations and fittings to room 9, corridor, and Sixth Court room, £1,231.—F. T. Pulling and Sons Pty. Ltd.

6729. Melbourne, New Treasury Buildings, caretaker's residence and gardener's shop, &c., (7) overhaul of electrical installation, £530.—H. T. Wheeler and Co. Pty. Ltd.

6730. Melbourne, former caretaker's residence, Crown Law Offices, (5) electrical installation, £636.—H. T. Wheeler and Co. Pty. Ltd.

6731. Mont Park, Gresswell Sanatorium, (3) repairs, &c., to floors, &c., wards 3 and 4, 7 and 8, £550 10s.—P. C. Brewer.

6732. Mont Park, Gresswell Sanatorium, (12) exterior painting and repairs to cottages A, B, and C, £380.—C. K. Hardy.

6733. Mont Park, Mental Hospital, (3) structural modifications to boiler-house, £545.—H. L. Wood.

6734. Mont Park, Plenty Mental Hospital, (7) supply and installation of two (2) package boiler units, £12,600.—Orr and Sembower (Aust.) Pty. Ltd.

6735. Mont Park, Larundel Mental Hospital, (7) alterations and additions to electrical installations at laundry building, £2,535.—K. H. Frank.

6736. Moonee Ponds, Court House, (4) new brick interview room, £1,782 15s.—A. E. Allen.

6737. Morwell, State School No. 4655, (9) erection of a new shelter pavilion, 32 ft. x 16 ft., £558 10s.—L. M. Lovel.

6738. Morwell, High School, (5) completion of mechanical services, stage 1, £3,240.—Kippe Industries Pty. Ltd.

6739. Mount Waverley, State School No. 3432, (5) electrical installation, £258.—R. F. Smith.

6740. Mt. Macedon, Memorial Cross Reserve, (2) erection of memorial entrance gates, £316 10s.—C. W. A. Scott.

6741. Myrtleford, State School No. 955, (2) additional out-office accommodation, £1,533 2s. 10d.—Southwell and Anderson.

6742. Newtown, State School No. 1887, (7) repairs and painting of caretaker's residence, £484.—E. R. Slaven.

6743. Pascoe Vale, Melbourne Textile School, (6) sanitary plumbing and water supply, stormwater drains, &c., £570.—M. Wellington.

T. K. MALTBY, Commissioner of Public Works. 24.6.57.

6744. Sunbury, Mental Hospital, kitchen, (4) repairs to roof, £170.—B. Motton.

6745. Sunbury, Mental Hospital, (3) painting of iron roofs, £198.—W. J. Joy.

6746. Canterbury, State School No. 3572, (3) replacement of seats in out-offices, £120.—F. T. Pulling and Sons Pty. Ltd.

6747. Newborough East, State School No. 4670, (3) installation of Warmray heaters in classrooms, £220.—W. and S. A. Gray.

6748. Blackburn South, State School No. 4035, (1) provision of new sewer branch, £402 19s. 4d.—M. and M.B.W.

6749. Yarrunga, State School No. 4761, (3) installation of electric light and power, £204 19s. 6d.—A. E. Webster.

6750. Merino, Consolidated School, teacher's residence, (2) installation of electric hot-water service, £193 18s. 2d.—J. Stapleton.

6751. Geelong, Hawthorne Teachers' Hostel, (1) alterations to position of stove, supply and installation of sink, &c., £268.—W. C. Freeman Pty. Ltd.

6752. Toorak, Teachers' College, (2) alterations and extensions to hot-water service, £242.—S. O. Cochran.

6753. Ballarat, Gun Cotton Area, Paper Mills, (2) renewal of spouting and painting, £217 15s.—W. T. Bedson.

6754. Box Hill South, State School No. 4138, (2) electrical installation, £167 12s.—W.A.D. Electrics.

6755. Jamieson, Police Station, (2) provision of septic closet, &c., £108 3s. 6d.—Jackson and Lawrie Bros.

6756. Wedderburn, State School No. 794, (1) renewal of fence, £176 14s.—E. E. and A. J. Hargreaves.

6757. Sunbury, Mental Hospital, (1) replacement of spouting, £185.—Griffiths Bros.

6758. Pascoe Vale South, State School No. 4704, (8) additional out-office, drinking and washing facilities, £674.—B. Motton.

6759. Preston, Technical School, (6) conversion of boiler to oil-firing and modification to heating system in workshop block, £1,187 3s.—Frederick W. Nielsen Pty. Ltd.

6760. Red Cliffs, State School No. 4057, (2) additional out-offices and drinking facilities, £1,715.—S. Sandor.

6761. Richmond, Police Station, (7) alterations and renovations to single-storey brick building, 3 Harvey-street, and dividing fence, £334 10s.—W. M. Hosie.

6762. Riverslea, State School No. 3667, (7) erection of shelter pavilion, £318.—K. F. and P. McMahon.

6763. Robinvale, Police Station, (5) erection of timber police station and residence, £6,912.—Hawkes Constructions Pty. Ltd.

6764. Royal Park, "Turana" Kindergarten, Children's Welfare Department, (6) electrical installation, £865.—W. S. Heard.

6765. Royal Park, Mental Hospital, (13) external painting and repairs to superintendent's residence, 214 Park-street, West Brunswick, £840.—A. McDermott.

6766. Shepparton, Technical School, (6) electrical installation, stage 1, £4,497.—V. W. Jones.

6767. Snake Valley, State School No. 574, (3) internal and external painting, &c., £320.—R. W. Sherritt.

6768. South Melbourne, Court House, (5) renovations and painting, £437.—S. O. Cochran.

6769. Stawell, Court House, (2) rewiring of electrical installation, £675.—Beckwith Electrics.

6770. Stratford, Court House, (5) general repairs, internal and external painting, £655.—W. G. Weaver.

6771. Harrow, Police Station, (1) installation of slow-combustion stove, £163 10s.—R. T. Smith.

6772. Carlton, State Film Centre, Victoria-street, (1) maintenance cleaning from 26th March, 1957, to 30th June, 1958, £300.—Essential Cleaning Service.

6773. Benalla East, State School No. 2256, (1) supply of filling and bulldozing, £1,571.—Borough of Benalla.

6774. Larundel, Mental Hospital, farm assistant's residence, (1) supply and installation of electric hot-water service, £135.—W. R. Davis.

6775. Malvern, "Stonnington" Teachers' Hostel, (1) clearing sewer blockage, &c., £394.—S. O. Cochran.

6776. Nathalia, Higher Elementary School, (1) conversion of kerosene hot-water service to electric, £118.—J. G. Hibberd Pty. Ltd.



6777. Lyndale, State School No. 4771, (6) sanding and plasticizing of floors, £297 10s.—J. J. Cotter and Son Pty. Ltd.

6778. Royal Park, Mental Hospital, (1) laying wall tiles, £375.—Wallace and Crisp.

6779. Melbourne, Cancer Institute, (1) transfer of 6 C.L. fan and motor, £341.—Mideco Pty. Ltd.

6780. Melbourne, Domestic Arts Teachers' Hostel, 470 St. Kilda-road, (1) internal renovations, &c., £183 10s.—S. O. Cochran.

6781. Nhill, High School, (1) site works, excavation, &c., £289 10s.—F. W. Pannowitz.

6782. Sunbury, Mental Hospital, (1) supply, lay, level, and roll ½-in. graded premix aggregate, £2,855.—Albion Quarrying Co. Pty. Ltd.

6783. Sunbury, Mental Hospital, (3) provision of chain wire fences and gates, £299.—W. and R. W. Lee.

6784. Sunbury, Mental Hospital, (3) re-erection of briquette and wood storage shed for front wards at M.3, £345.—B. Motton.

6785. Tottenham, State School No. 4707, (5) additional out-offices and stainless steel sink, £889 15s.—Rex Porter.

6786. Traralgon, Court House and Public Works Department Office, (3) connexion to sewerage main of Court House and Public Works Department Office, &c., £615.—H. Bodin.

6787. Wesburn, State School No. 3466, (2) additional out-office accommodation for boys and girls and resting of present boys' unit, £435.—R. M. Swift.

6788. Wodonga, High School, (2) electrical installation in additional L.T.C. classrooms, &c., £365.—J. Catterall.

6789. Wodonga, Court House, (4) repairs and painting, £487 12s. 8d.—S. Grant and R. F. Smith.

6790. Woomelang, State School No. 3373, (1) restoration of existing buildings and new corridor, £2,128 10s.—T. Purdie.

6791. Yallourn, Technical School, (8) electrical installation in stages 2 and 3, £3,506.—W. T. Waterfall and Sons Pty. Ltd.

6792. Yarrunga, State School No. 4761, (1) external painting to existing buildings (school) and shelter sheds, in two (2) coat work, £405.—A. Richardson.

T. K. MALTBY, Commissioner of Public Works. 27.6.57.

#### ORDERS IN COUNCIL.—(Series 1956-57.)

##### FORESTS COMMISSION.

Loan Fund Act No. 6040, Item 1—

6793. To the purchase of allotment 40, Parish of Barwongmoong, County of Polwarth, comprising 198 acres 2 rods 18 perches, for forest purposes, £1.—Keith King Sawmills Pty. Ltd., 41-47 Princes Highway, Oakleigh.

Approved by the Governor in Council, 7th May, 1957.—A. MAHLSTEDT, Clerk of the Executive Council.

##### STATE ELECTRICITY COMMISSION.

6794. The construction of reinforced concrete floors, roofs, and ancillary works, Wet Section No. 1 and Press and Middle House Annexe, Morwell Briquette Factory No. 1, to Specification No. 56-57/158, £35,900.—E. S. Clementson (Vic.) Pty. Ltd.

6795. The sheeting, glazing, concreting, and brickwork for raw coal conveyor, from Supply Terminal to Bunker and Wet Section to Boiler House, Morwell Project, to Specification No. 56-57/152, £22,920.—John Holland and Co. Pty. Ltd.

6796. The supply of 1,200 expulsion tube type lightning arrestors for protection of distribution sub-stations, to Specification No. 56-57/140, £6,900.—Stanger and Co. Ltd.

6797. The supply of 7,800 yards of armoured 250-volt cable and associated terminating glands for No. 6 Dredger, Yallourn, to Quotation No. 3002, £6,568 19s. 7d.—Wandleside Cable Works Ltd.

Approved by the Governor in Council, 19th June, 1957.—A. MAHLSTEDT, Clerk of the Executive Council.

#### ORDERS IN COUNCIL.—(Series 1957-58.)

##### EDUCATION DEPARTMENT.

15. Three 6-in. all-gear head, sliding, surfacing, screw-cutting lathes, for Footscray Technical School (£715 each, less 5 per cent.), £2,037 15s.—Herbert Osborne Pty. Ltd.

16. One only Colchester 6-in. x 24-in. student lathe, complete with built-in electric motor, indexing square turret, three-jaw and four-jaw chucks, for Swinburne Technical College, £675.—Herbert Osborne Pty. Ltd.

Approved by the Governor in Council, 25th June, 1957.—A. MAHLSTEDT, Clerk of the Executive Council.

#### Land Surveyors Act 1942.

##### SURVEYORS' BOARD OF VICTORIA.

THE Surveyors' Board of Victoria hereby gives notice that the following gentlemen have been granted licences to practice as surveyors in Victoria, and have been duly registered:—

Neil Joseph Crichton,  
Brian Christopher Van Baer,  
Richard Walter Hopkins,  
John David Fisher,  
Gregory Erroll Tulloch,  
Richard Lewis Gray,  
Geoffrey Howard Vernon Thomson,  
Rex Charlton Downes,  
Kevin Anthony Gissing, and  
Albert James Lynn Miller,

on the qualification of the Board's "Certificate of Competency"; and

John Perger,  
Denis Francis Weingarh, and  
Mervyn John Smith,

on "Letters of Recommendation" from the Survey Board of New South Wales.

By order,

J. B. M. KENNEDY,  
Secretary.

Office of the Surveyors' Board,  
Department of Crown Lands and Survey,  
Melbourne, C.2.

#### Land Surveyors Act 1942.

##### SURVEYORS' BOARD OF VICTORIA.

THE Surveyors' Board hereby gives notice that the next examination for the Board's Certificate of Competency will be held in the Engineering School, Melbourne University, from Monday, 19th August, 1957, to Monday, 26th August, 1957.

Application for entry to this examination must reach the Secretary to the Board not later than Friday, 26th July, 1957.

All applications must be accompanied by the appropriate fee.

J. B. M. KENNEDY,  
Secretary.

Office of the Surveyors' Board,  
Department of Crown Lands and Survey,  
Melbourne, C.2.

#### Dairy Products Acts.

##### QUOTAS FOR BUTTER AND CHEESE.

###### BUTTER QUOTA.

I, GILBERT LAWRENCE CHANDLER, Minister of Agriculture in the State of Victoria, after consultation with the Victorian Dairy Products Board, and after ascertaining that the supply and distribution of butter at reasonable prices to consumers thereof in Victoria will be ensured, hereby determine a quota for butter as follows:—

The proportion shall be eight-eight point six four per cent.

The period for which this quota is to operate shall be the month of July, 1957.

###### CHEESE QUOTA.

I, GILBERT LAWRENCE CHANDLER, Minister of Agriculture in the State of Victoria, after consultation with the Victorian Dairy Products Board, and after ascertaining that the supply and distribution of cheese at reasonable prices to consumers thereof in Victoria will be ensured, hereby determine a quota for cheese as follows:—

The proportion shall be eighty-six point three six per cent.

The period for which this quota is to operate shall be the month of July, 1957.

G. L. CHANDLER,  
Minister of Agriculture.

24th June, 1957.

## MELBOURNE AND METROPOLITAN BOARD OF WORKS.

## GENERAL NOTICE.

**T**HE Melbourne and Metropolitan Board of Works, having made sewers for carrying off the sewage from each and every property which, or any part of which, abuts on the streets or parts of streets in which such sewers are laid, and which are included within the sewerage areas hereinafter described, doth hereby declare that on and after the 3rd August, 1957, each and every property which, or any part of which, abuts on the said streets or parts of streets, shall be deemed to be a sewerer property within the meaning of the *Melbourne and Metropolitan Board of Works Act 1928*.

The sewerage areas hereinbefore referred to are:—

*Sewerage Area No. 1513.*

*City of Preston.*—Commencing at the junction of Tyler-street and Darebin Creek, thence generally south-westerly along Darebin Creek, westerly along Wood-street, northerly along the western boundaries of lots 20 Wood-street, 19 to 4 Laurel-street and 3 Tyler-street, easterly along Tyler-street to the commencing point.

*Sewerage Area No. 1514.*

*City of Mordialloc.*—Commencing at the junction of Nepean Highway and Keith-street, thence easterly along Keith-street, southerly along Davey-street, easterly along Morris-street, southerly along the eastern boundaries of lots 86 to 90, 128 to 132 and 170 to 174 Davey-street, easterly along Elliott-street, southerly along the eastern boundaries of lots 206 Elliott-street and 222 Cedric-street, easterly along Cedric-street, south-easterly along the north-eastern boundaries of lots 244 Cedric-street, 268 and 277 Kershaw-street and 311 White-street, westerly along White-street, northerly along the western boundary of lot 304 White-street, westerly along the southern boundaries of lots 283 to 287 Kershaw-street, northerly along the western boundary of the said lot 287, westerly along Kershaw-street, northerly along the western boundaries of lots 258 Kershaw-street and 252 Cedric-street, westerly along Cedric-street, northerly along Davey-street, westerly along Carrier-avenue, northerly along Eva-street, westerly along Booth-street, north-westerly along Nepean Highway to the commencing point.

*Sewerage Area No. 1515.*

*City of Footscray.*—Commencing at the junction of Charlotte-street and Roberts-street, thence southerly along Roberts-street, easterly along Drew-street, northerly along Bromyard-street, easterly and south-easterly along Kendall-street, north-easterly along the north-western boundaries of lots 163 to 167 Drew-street and a line in continuation to Stony Creek, generally north-westerly along Stony Creek, westerly along Charlotte-street to the commencing point.

*Sewerage Area No. 1516.*

*City of Caulfield.*—Commencing at the junction of North-road and Crosbie-road, thence north-westerly along Crosbie-road, easterly along Kinlock-avenue, southerly along Brett-street, westerly along North-road to the commencing point.

*Sewerage Area No. 1517.*

*City of Box Hill.*—Commencing at the junction of Halsey-street and Beaver-street, thence southerly along Beaver-street, westerly along Prince-street to the boundary of Sewerage Area No. 975, southerly and westerly following Sewerage Area No. 975 to its junction with Sewerage Area No. 1492 in Haig-street, generally southerly and easterly following Sewerage Area No. 1492 to Gardiner's Creek, generally north-easterly along Gardiner's Creek to the eastern extremity of Foch-street, northerly along the eastern boundaries of lots 151 to 125 Beaver-street, westerly along Halsey-street to the commencing point.

*Sewerage Area No. 1518.*

*City of Malvern.*—Commencing at the junction of Midlothian-street and Durward-road, thence northerly along Durward-road, easterly along the northern boundaries of lots 295 to 304 Midlothian-street, southerly along Rowena-road, easterly along Midlothian-street, southerly along the eastern boundary of lot 407 Midlothian-street, westerly along the southern boundaries of the said lot 407 and lots 406 to 380 Midlothian-street, northerly along the western boundary of the said lot 380, easterly along Midlothian-street to the commencing point.

*Sewerage Area No. 1519.*

*City of Moorabbin.*—Commencing at the junction of North-road and Dromana-avenue, thence southerly, south-easterly and southerly along Dromana-avenue, westerly

along the southern boundary of lot 110 Dromana-avenue and a line in continuation to the boundary of land occupied by British Australasian Tobacco Company Proprietary Limited, southerly and westerly along the eastern and southern boundaries of the said land to East Boundary-road, northerly along East Boundary-road, westerly along George-street, northerly along Murrong-avenue, easterly along North-road to the commencing point.

*Sewerage Area No. 1520.*

*City of Caulfield.*—Commencing at a point in Ellimatta-road about 50 feet south of the south side of Leila-road, thence easterly along the northern boundaries of lots 10 Ellimatta-road and 13 Hunter-street, southerly along Hunter-street, westerly along the southern boundaries of lots 32 Hunter-street and 39 Ellimatta-road, northerly along Ellimatta-road to the commencing point.

*Sewerage Area No. 1521.*

*City of Heidelberg.*—Commencing at the junction of Dougharty-road and Liberty-parade on the boundary of Sewerage Area No. 1470, thence generally southerly, south-westerly, and southerly following Sewerage Areas Nos. 1470 and 1433 to the intersection of Liberty-parade and Southern-road, westerly by a line to Darebin Creek, generally northerly and generally north-easterly along Darebin Creek, easterly along the production of Dougharty-road to the commencing point.

*Sewerage Area No. 1522.*

*City of Box Hill.*—Commencing at the junction of Shannon-street and Grenville-street, thence southerly along Grenville-street, westerly along Willow-street, northerly along the western boundaries of lots 4 Willow-street and 19 Shannon-street, easterly along Shannon-street to the commencing point.

*Sewerage Area No. 1523.*

*City of Preston.*—Commencing at the junction of Gilbert-road and Kingsley-road, thence westerly along Kingsley-road, northerly along the western boundaries of lots 87 Kingsley-road and 123 and 146 Kia Ora-road, westerly along portion of the southern boundary of lot 12 Bonview-street, northerly along Bonview-street, easterly along View-street, southerly along Gilbert-road to the commencing point.

*Sewerage Area No. 1524.*

*City of Preston.*—Commencing at the junction of Strathmerton-street and Evans-crescent, thence north-easterly and easterly along Evans-crescent, northerly along the eastern boundary of lot 104 Evans-crescent, westerly along the northern boundaries of the said lot 104 and lots 105 to 108 Evans-crescent, south-westerly along the north-western boundaries of lots 109 to 115 Evans-crescent, south-easterly along portion of the south-western boundary of the said lot 115, south-westerly along the north-western boundary of lot 116 Strathmerton-street, south-easterly along Strathmerton-street to the commencing point.

Further particulars regarding the streets or parts of streets in which sewers have been laid may be ascertained on inquiry at the Board's office.

By order of the Board,

C. F. TRATHAN,

Secretary.

110 Spencer-street, Melbourne, C.1, 2nd July, 1957.

## MELBOURNE AND METROPOLITAN BOARD OF WORKS.

**N**OTICE is hereby given that after the publication of this advertisement in four consecutive ordinary numbers of the *Government Gazette* and four numbers of one of the daily newspapers published in the metropolis the Melbourne and Metropolitan Board of Works will proceed to compulsorily take (unless the same is in the meantime acquired by the Board from the owner or owners or other persons interested by mutual agreement) the land mentioned and described below.

The nature of the works for which the land is proposed to be acquired is for the disposal of night-soil, as more fully appears on the plans of the proposed works, which will be open for inspection at the offices of the Board, 110 Spencer-street, Melbourne, until the 25th day of July, 1957.

The consent of the Governor in Council, under section 51 of the *Health Act 1956* (No. 6024), was duly obtained on the 11th day of June, 1957, and under section 206 of the *Melbourne and Metropolitan Board of Works Act 1928* (No. 3731) on the 19th day of June, 1957.

## PARTICULARS OF LAND.

All that piece of land at East Burwood bounded on the west by Mahoney's-road, on the south by Burwood-road, and on the east by Springvale-road, containing 36 acres 2 roods 7 perches, or thereabouts, being part of Crown portion 101, Parish of Nunawading, and being part of the land described in conveyances registered in book 391, Nos. 683 and 684.

Dated this 28th day of June, 1957.

C. TRATHAN,  
Secretary.

*Sheep (Foot Rot) Act 1956.*

## APPOINTMENT OF INSPECTORS.

NOTICE is hereby given that, in exercise of its powers, the Public Service Board has issued a Certificate dated the 14th June, 1957, appointing

PETER JOHN CUMMING and  
JOHN GREENING,

Field Officers, Live Stock, Department of Agriculture, as Inspectors, under the provisions of section 3 of the *Sheep (Foot Rot) Act 1956*, without additional salary, from and inclusive of the 1st April, 1957.

P. RYAN,  
Director of Agriculture.  
Melbourne, 24th June, 1957.

## Town and Country Planning Acts.

## TALLANGATTA PLANNING SCHEME.

NOTICE THAT A PLANNING SCHEME HAS BEEN PREPARED AND IS AVAILABLE FOR INSPECTION.

NOTICE is hereby given that the Town and Country Planning Board, in pursuance of its powers under the Town and Country Planning Acts, has prepared a Planning Scheme for the Township of Tallangatta and adjacent lands for the purpose of regulating development within such areas.

All maps, plans, descriptions, and other data fully setting out and explaining the Planning Scheme have been deposited at the office of the Council of the Shire of Towong, at Tallangatta, and at the office of the Town and Country Planning Board, 107 Russell-street, Melbourne, and will be open for inspection without payment of any fee by all persons affected, between the hours of 9 a.m. and 5 p.m. on all days of the week, except Saturdays, Sundays, and public holidays, until and including the 4th day of October, 1957.

Any persons affected by the Planning Scheme are required to set forth, in writing, all objections they may have, addressed to the Secretary, Town and Country Planning Board, 107 Russell-street, Melbourne, on or before the 4th day of October, 1957.

NOEL L. LYNEHAM,  
Secretary, Town and Country Planning Board.

## 4 GEORGE VI. No. 4755, SECTION 6.

I HEREBY give notice that on the 19th June, 1957, the Public Trustee filed elections to administer the following deceased persons' estates, in accordance with section 6 of the *Public Trustee Act 1940*:—

FARQUHAR, JOHN GEORGE SINCLAIR, also known as John George Farquhar, late of 50 John-street, Moe, labourer, died 23rd November, 1956, intestate.

\* REED, DOROTHY FENWICK, late of 1262 Malvern-road, Malvern, spinster, died 14th December, 1956.

\* REINELT, MINNIE SYBIL HALLILEY, also known as Minnie Sybil Reinelt, formerly of 25 Wridgway-avenue, Kew, but late of "Mundirum," Morris-road, Upwey, married woman, died 10th April, 1957.

\* According to the provisions of the will.

I HEREBY give notice that on the 20th June, 1957, the Public Trustee filed elections to administer the following deceased persons' estates, in accordance with section 6 of the *Public Trustee Act 1940*:—

SCHUTT, HAZELTINE SYLVESTER WILLIAM, also known as William Hazeltine Sylvester Schutt and as Harold Sylvester Schutt, formerly of 8 Guava-street, Red Cliffs, but late of Repatriation General Hospital, Heidelberg, cabinet maker, died 4th April, 1957, intestate.

WESTON, ERNEST VICTOR, late of 24 Welwyn-parade, Deer Park, civil servant, died 14th March, 1957, intestate.

I HEREBY give notice that on the 21st June, 1957, the Public Trustee filed elections to administer the following deceased persons' estates, in accordance with section 6 of the *Public Trustee Act 1940*:—

\* ANDERSON, IDA MAY, formerly of 229 Cotham-road, Kew, but late of Benevolent Home, Castlemaine, spinster, died 17th September, 1955.

COCHRANE, LAURENCE VICTOR, also known as Henry Bertram Victor Cochrane, late of Gordon House, Little Bourke-street, Melbourne, wharf labourer, died 9th August, 1956, intestate.

COLEMAN, ELLEN FRANCES, formerly of 250 Holden-street, North Fitzroy, but late of Melbourne Home and Hospital for the Aged, Cheltenham, pensioner, died 28th March, 1957, intestate.

WALLIS, ALICE, late of Panton Hill, widow, died 1st October, 1956, intestate.

\* According to the provisions of the will.

H. C. CHIPMAN,  
Public Trustee.

412 Collins-street, Melbourne, C.1, 26th June, 1957.

## NOTICE.

ADMINISTRATION of the estate of each of the under-mentioned deceased persons has been granted to the Public Trustee, and creditors, next of kin, and all others having claims against the estate of any of the persons so mentioned are required to send particulars of their claims to the Public Trustee, No. 412 Collins-street, Melbourne, on or before the 6th September, 1957, or they will be excluded from the distribution of the estate when the assets are being distributed:—

\* ADAMS, ELEANOR, late of 3 Thorn-street, Camberwell, widow, died 5th December, 1956.

† ANDERSON, IDA MAY, formerly of 229 Cotham-road, Kew, but late of Benevolent Home, Castlemaine, spinster, died 17th September, 1955.

COCHRANE, LAURENCE VICTOR, also known as Henry Bertram Victor Cochrane, late of Gordon House, Little Bourke-street, Melbourne, wharf labourer, died 9th August, 1956, intestate.

COLEMAN, ELLEN FRANCES, formerly of 250 Holden-street, North Fitzroy, but late of Melbourne Home and Hospital for the Aged, Cheltenham, pensioner, died 28th March, 1957, intestate.

FARQUHAR, JOHN GEORGE SINCLAIR, also known as John George Farquhar, late of 50 John-street, Moe, labourer, died 23rd November, 1956, intestate.

\* GOUGH, JESSIE DAINTY, formerly of Stewart-street, Williamstown, but late of 73 Melbourne-road, Williamstown, widow, died 6th March, 1957.

HARRISON, TRILBY GLADYS MARJORY, formerly of 5 Hoptoun-grove, Ivanhoe, but late of Mont Park, spinster, died 23rd November, 1956, intestate.

PAINO, VINCENT, late of 21 Phoenix-street, South Yarra, plasterer, died 8th January, 1957, intestate.

† REED, DOROTHY FENWICK, late of 1262 Malvern-road, Malvern, spinster, died 14th December, 1956.

† REINELT, MINNIE SYBIL HALLILEY, also known as Minnie Sybil Reinelt, formerly of 25 Wridgway-avenue, Kew, but late of "Mundirum," Morris-road, Upwey, married woman, died 10th April, 1957.

SCHUTT, HAZELTINE SYLVESTER WILLIAM, also known as William Hazeltine Sylvester Schutt and as Harold Sylvester Schutt, formerly of 8 Guava-street, Red Cliffs, but late of Repatriation General Hospital, Heidelberg, cabinet maker, died 4th April, 1957, intestate.

WALLIS, ALICE, late of Panton Hill, widow, died 1st October, 1956, intestate.

WESTON, ERNEST VICTOR, late of 24 Welwyn-parade, Deer Park, civil servant, died 14th March, 1957, intestate.

\* WILSON, JOHN CECIL, late of 4 Malleson-street, Richmond, gentleman, died 24th November, 1955.

\* With the will annexed.

† According to the provisions of the will.

H. C. CHIPMAN,  
Public Trustee.

Melbourne, 26th June, 1957.

## APPOINTMENTS.

HIS Excellency the Lieutenant-Governor of the State of Victoria, by and with the advice of the Executive Council thereof, has, by Orders made on the 25th day of June, 1957, been pleased to make the under-mentioned appointments, viz.:

CHIEF SECRETARY'S DEPARTMENT.  
*Director of Penal Services.*

ALEXANDER RUSSEL WHATMORE, B.Com., pursuant to the provisions of section 11 of the *Gaols Act 1928*, to be Director of Penal Services, from and inclusive of the 1st July, 1957.

*Deputy Director of Penal Services.*

ERIC VINCENT STADE, pursuant to the provisions of section 15 of the *Gaols Act 1928*, to be Deputy Director of Penal Services, from and inclusive of the 1st July, 1957.

## DEPARTMENT OF HEALTH.

*Deputy Superintendent of Mental Hospital.*

DAVID WILLIAM MCINTOSH, M.B., B.S., to be Deputy Superintendent of the Repatriation Mental Hospital, Bundoora, pursuant to the provisions of section 35 of the *Mental Hygiene Act 1928*, as from the 22nd May, 1957, vice Dr. J. Allison-Levick, resigned.

*Medical Officer.*

MICHAEL DRAKE, M.B., B.S., to be Medical Officer, Mental Hygiene Branch, Department of Health, pursuant to the provisions of section 18 (2) of the *Mental Hygiene Authority Act 1950*.

## LAW DEPARTMENT.

*Acting Chairman of General Sessions.*

HUBERT DALLAS WISEMAN, LL.M., a Barrister at Law of Victoria who has practised for a longer period than five years, to be an Acting Chairman of General Sessions for the period from the 1st July, 1957, to the 31st July, 1957, both dates inclusive.

*Magistrates.*

JAMES EDWARD CONNLEY, Omeo, and FREDERICK JOHN TOMKINS, Benambra, to Keep the Peace in the Eastern Bailiwick of the State of Victoria;

CHARLES MANGAN, Meringur, via Red Cliffs, and JOHN LEON ARMITAGE, 100 Splatt-street, Swan Hill, to Keep the Peace in the Midland Bailiwick of the State of Victoria; and

ALBERT WALTER ALEXANDER BURRELL, 9 Burton-crescent, East Ivanhoe, and

ALBERT LIONEL SCHMIDT, 44 Grace-street, Springvale North,

to Keep the Peace in the Central Bailiwick of the State of Victoria.

*Commissioners for Taking Declarations, &c.*

ROBERT EDWIN HULLS, Inspector of Works, Department of Public Works, Ballarat, to be a Commissioner for taking Declarations and Affidavits, pursuant to the provisions of the *Evidence Act 1928*, to refrain from charging fees and to resign upon ceasing to occupy his present position; and

FLORENCE MACHIN, 52 Khartoum-street, West Footscray, and

FRANK DANN, 48 Simcock-avenue, Spotswood, to be Commissioners for taking Declarations and Affidavits, pursuant to the provisions of the *Evidence Act 1928*, to resign upon removing from the neighbourhood of the addresses stated.

*Clerks of Children's Courts.*

GEOFFREY STEPHEN HOARE to be Clerk of the Children's Court at St. Arnaud, Birchip, and Donald, during the absence of R. W. Smith on annual leave, to take effect from the date of commencement of duty; and

## ALEXANDER KNOX BROWN

to be Clerk of the Children's Court at Dandenong, Berwick, Cranbourne, and Pakenham, during the absence of C. F. Lewis on annual leave, to take effect from the date of commencement of duty.

*Probation Officers of Children's Courts.*

RUSSELL WILLIAM CHAMPION, 3 Howard-street, Box Hill, to be a Probation Officer for the Children's Court at Box Hill, pursuant to the provisions of the *Children's Court Act 1956*;

LEO FRANCIS AYERS, Collingwood Citizens and Police Youth Club, Stanton-street, Abbotsford, to be a Probation Officer for the Children's Court at Collingwood, pursuant to the provisions of the *Children's Court Act 1956*;

ROBERT LAWRENCE CLIFFORD HUNT, 4 Mercer-parade, Newtown, Geelong, to be a Probation Officer for the Children's Court at Geelong, pursuant to the provisions of the *Children's Court Act 1956*;

PHILLIP REVETT COOKE, 45 Lower Plenty-road, Rosanna, to be a Probation Officer for the Children's Court at Heidelberg, pursuant to the provisions of the *Children's Court Act 1956*;

DONALD CHAPMAN, 11 Helenslea-road, Caulfield, and ROY ALFRED NUTTING, 19 Manor-grove, Caulfield, to be Probation Officers for the Children's Court at Melbourne, pursuant to the provisions of the *Children's Court Act 1956*;

JOHN MURPHY, 12th-street, Mildura, to be a Probation Officer for the Children's Court at Mildura, pursuant to the provisions of the *Children's Court Act 1956*;

PROSPER DE MESTRE PICKBURN, St. Mary's Rectory, Latrobe-road, Morwell, to be a Probation Officer for the Children's Court at Morwell, pursuant to the provisions of the *Children's Court Act 1956*; and

GENE RAYNOR, 10 Dumblane-street, Hughesdale, to be a Probation Officer for the Children's Court at Oakleigh, pursuant to the provisions of the *Children's Court Act 1956*.

## MINES DEPARTMENT.

*Member of Board of Reference.*

GEOFFREY DAVID O'DONNELL, pursuant to the provisions of the Boiler Inspection Acts, to be a Member of the Board of Reference constituted under the said Acts, to represent the Institution of Engineers, Australia.

## DEPARTMENT OF PUBLIC WORKS.

*Acting Member of the Country Roads Board.*

JOHN MATHIESON, pursuant to the provisions of the Country Roads Acts, to be Acting Member of the Country Roads Board for such period as Caleb Grafton Roberts is absent through illness, but not extending beyond the 31st December, 1957.

## A. MAHLSTEDT,

Clerk of the Executive Council.

At the Executive Council Chamber,  
Melbourne, 25th June, 1957.

## RESIGNATIONS.

HIS Excellency the Lieutenant-Governor of the State of Victoria, by and with the advice of the Executive Council thereof, has, by Orders made on the 25th day of June, 1957, accepted the resignations of the persons named hereunder of the offices mentioned, viz.:

## LAW DEPARTMENT.

ARTHUR MORTON HAYTON, as a Commissioner for taking Declarations and Affidavits, pursuant to the provisions of the *Evidence Act 1928*.

THOMAS BERNARD HARVEY, as a Probation Officer, pursuant to the provisions of the *Children's Court Act 1956*, for the Children's Court at North Melbourne.

MYLES DILLON O'CALLAGHAN, as a Probation Officer, pursuant to the provisions of the *Children's Court Act 1956*, for the Children's Court at Malvern.

IRENE LILLIAN SYMINGTON, as a Probation Officer, pursuant to the provisions of the *Children's Court Act 1956*, for the Children's Court at Malvern.

FLORENCE LUCY THOMSON, as a Probation Officer, pursuant to the provisions of the *Children's Court Act 1956*, for the Children's Court at Camberwell.

HUGH MULLIN, as a Probation Officer, pursuant to the provisions of the *Children's Court Act 1956*, for the Children's Court at Brunswick.

HEINRICH JOHANNES NOACK, as a Probation Officer, pursuant to the provisions of the *Children's Court Act 1956*, for the Children's Court at Ballarat.

## A. MAHLSTEDT,

Clerk of the Executive Council.

At the Executive Council Chamber,  
Melbourne, 25th June, 1957.

DEPARTMENT OF CROWN LANDS AND SURVEY.

At the Executive Council Chamber, Melbourne, the twenty-fifth day of June, 1957.

PRESENT:

His Excellency the Lieutenant-Governor of Victoria.  
Mr. Turnbull | Mr. McArthur.

LANDS TEMPORARILY RESERVED AS SITES.

**H**IS Excellency the Lieutenant-Governor of the State of Victoria, by and with the advice of the Executive Council thereof, doth hereby, in pursuance of the provisions of the *Land Act 1928*, reserve, temporarily, and also except from occupation for mining purposes under any miner's right, the lands hereinafter described:—

**ANGLESEA.**—Site for State School purposes, 2 acres 1 rood 7 perches, Township of Anglesea, Parish of Jan Juc, County of Grant, as indicated by hachure on plan hereunder.—(A.183(2) (Rs.7583).

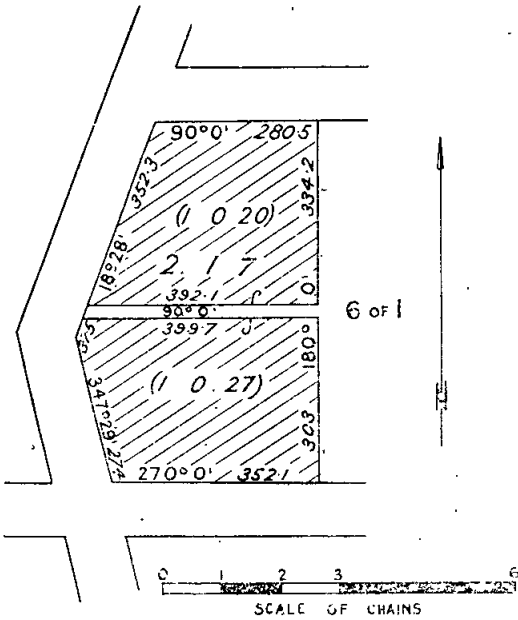

**GRAYTOWN.**—Site for the purposes of the Forests Act, 14 acres, more or less, Township of Graytown, Parish of Moormbool East, County of Dalhousie, as indicated by hachure on plan hereunder.—(G.192(8) (Rs.7592).

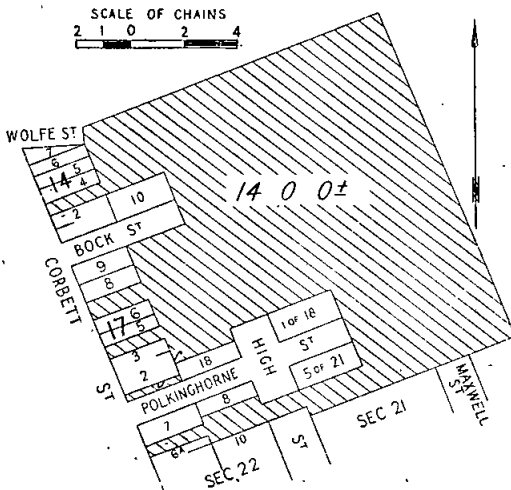

**JEETHO.**—Site for Public purposes, 15 acres 1 rood 30 perches, more or less, Parish of Jeetho, County of Mornington, as indicated by hachure on plan hereunder.—(J.41(7) (Rs.7585).

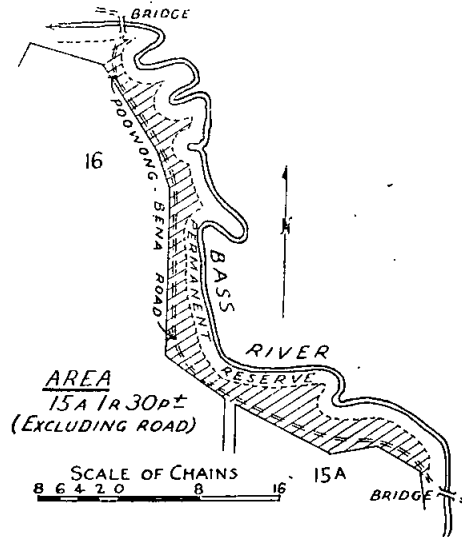

**STREATHAM.**—Site for Comfort Station, 1 rood, more or less, Township of Streatham, Parish of Streatham, County of Ripon, as indicated by hachure on plan hereunder.—(S.330(B) (Rs.7581).

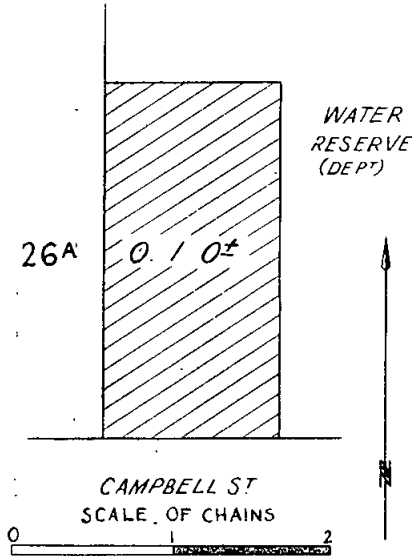

**LYNDHURST.**—Site for Public purposes, 2 roods 4 perches, more or less, Parish of Lyndhurst, County of Mornington, as indicated by hachure on plan hereunder.—(L.101(6) (Rs.5000).

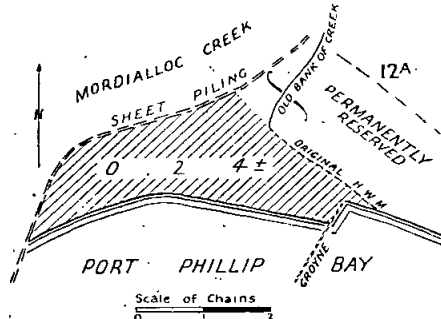



PARWAN.—Site for a Cemetery, 13 acres 1 rood 30 perches, more or less, Parish of Parwan, County of Grant, as indicated by hachure on plan hereunder.—(P.8(\*) (Rs.7610).

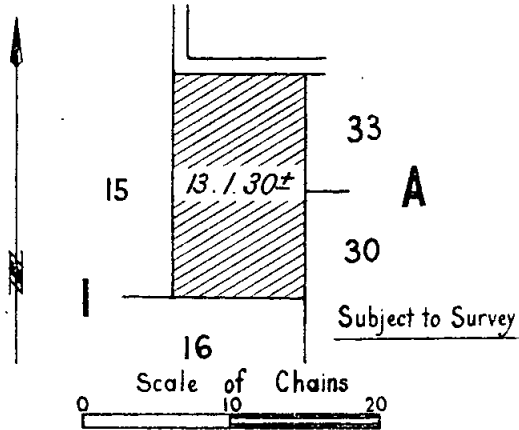

RAGLAN.—Site for the purposes of the Forests Act, 1 acre 2 roods, more or less, Township of Raglan, Parish of Raglan, County of Ripon, as indicated by hachure on plan hereunder.—(R.3(\*) (Rs.7606).

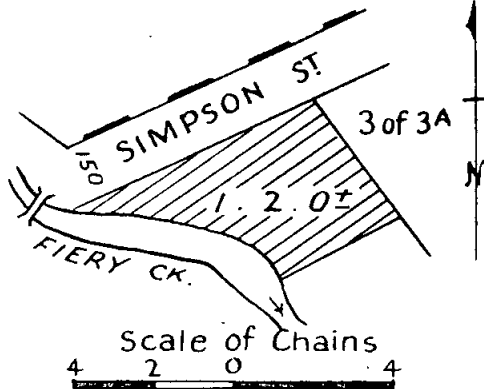

TOOMBULLUP.—Site for the purposes of the Forests Act, 3 acres, Parish of Toombullup, County of Delatite, as indicated by hachure on plan hereunder.—(T.258(\*) (Rs.7589).

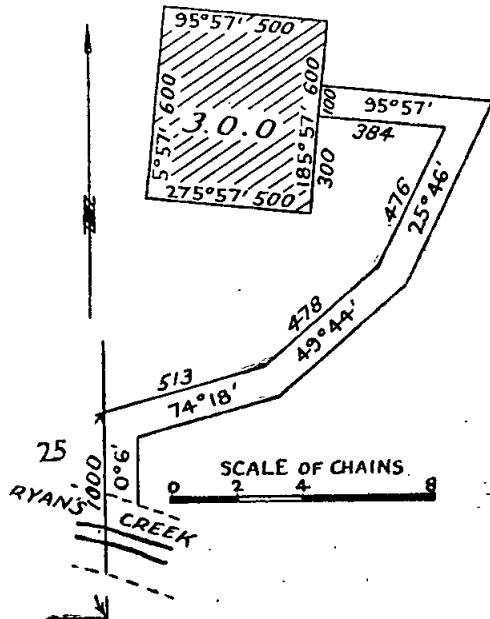

BOROONDARA (at CAMBERWELL).—Site for Town Hall and other Municipal purposes, in addition to and adjoining the site temporarily reserved therefor by Order in Council of 16th August, 1949, 1 acre 2 roods, more or less, Parish of Boroondara, County of Bourke, as indicated by hachure on plan hereunder.—(B.415(\*) (Rs.5850).

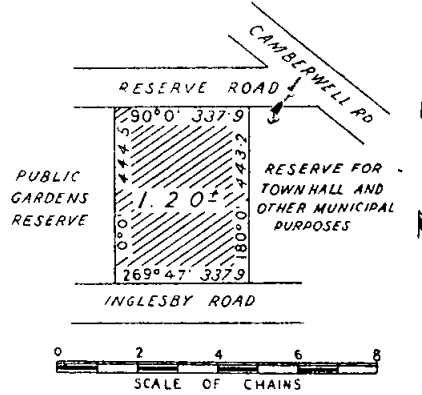

BOROONDARA (at BURWOOD).—Site for Public Park and Children's Playground, in addition to and adjoining the site temporarily reserved therefor by Order in Council of the 16th August, 1949, 3 acres 3 roods 16 6/10 perches, Parish of Boroondara, County of Bourke, as indicated by hachure on plan hereunder.—(B.415(\*) (Rs.6367).

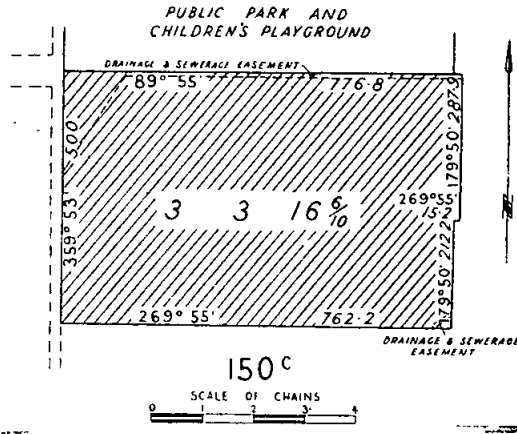

And the Honorable Keith Hector Turnbull, Her Majesty's Commissioner of Crown Lands and Survey for the State of Victoria, shall give the necessary directions herein accordingly.

A. MAHLSTEDT,  
Clerk of the Executive Council.

DEPARTMENT OF CROWN LANDS AND SURVEY.

At the Executive Council Chamber, Melbourne, the twenty-fifth day of June, 1957.

PRESENT:

His Excellency the Lieutenant-Governor of Victoria.  
Mr. Turnbull | Mr. McArthur.

UNUSED ROADS CLOSED.

HIS Excellency the Lieutenant-Governor of the State of Victoria, by and with the advice of the Executive Council thereof, doth hereby direct that, in pursuance of the provisions of section 304 of the Land Act 1928, the unused roads referred to hereunder be closed, viz.:-

Parish of Yowang, County of Grant, being the road between allotment 2 and allotment 37.—(Y.69(\*) (Misc. 2883.).

Parish of Cut-paw-paw, County of Bourke, being the road indicated by hachure on plan hereunder.—(C.345(18) (Misc. 2886).

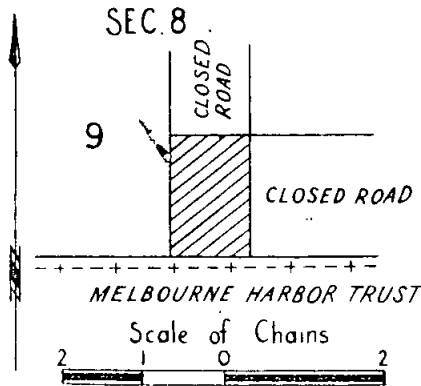

Parish of Nerrena, County of Buln Buln, being the road indicated by hachure on plan hereunder.—(N.146(4) (Misc. 2888).

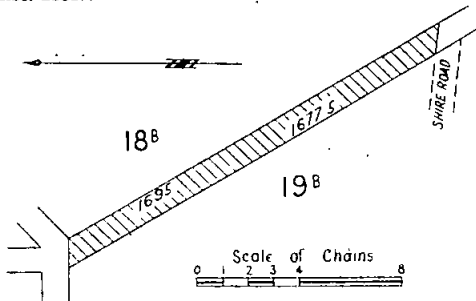

Township of Berrybank, Parish of Poliah North, County of Grenville, being the road as indicated by hachure on plan hereunder.—(B.777(2) (J.28566).

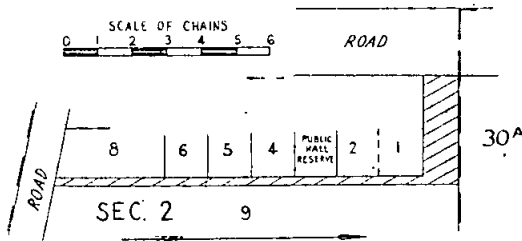

Parish of Timboon, County of Heytesbury, being the road as indicated by hachure on plan hereunder.—(T.182(7) (J.27976).

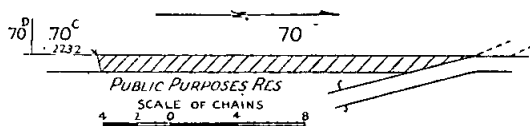

And the Honorable Keith Hector Turnbull, Her Majesty's Commissioner of Crown Lands and Survey for the State of Victoria, shall give the necessary directions herein accordingly:

A. MAHLSTEDT,  
Clerk of the Executive Council.

DEPARTMENT OF CROWN LANDS AND SURVEY.

At the Executive Council Chamber, Melbourne, the twenty-fifth day of June, 1957.

PRESENT:

His Excellency the Lieutenant-Governor of Victoria.  
Mr. Turnbull | Mr. McArthur.

REVOCATIONS OF TEMPORARY RESERVATIONS OF LANDS BY ORDERS IN COUNCIL.

HIS Excellency the Lieutenant-Governor of the State of Victoria, by and with the advice of the Executive Council thereof, doth hereby, in pursuance of the provisions of the *Land Act 1928*, revoke the temporary reservations of lands by Orders in Council hereinafter referred to, viz:—

LAYARD.—Order in Council of 3rd June, 1889, of 2 acres 3 roods 2 perches of land in the Town of Layard, as a site for Railway purposes.—(Rs. 5972.)

SHEPPARTON.—Orders in Council of 24th December, 1895, and 2nd June, 1924, of 84 acres 35 roods of land in the Parish of Shepparton, as a site for Public Park.—(Rs.2651.)

And the Honorable Keith Hector Turnbull, Her Majesty's Commissioner of Crown Lands and Survey for the State of Victoria, shall give the necessary directions herein accordingly.

A. MAHLSTEDT,  
Clerk of the Executive Council.

DEPARTMENT OF CROWN LANDS AND SURVEY.

At the Executive Council Chamber, Melbourne, the twenty-fifth day of June, 1957.

PRESENT:

His Excellency the Lieutenant-Governor of Victoria.  
Mr. Turnbull | Mr. McArthur.

REVOCATION OF ORDER IN COUNCIL WITHHOLDING CERTAIN LAND FROM SALE, LEASING, AND LICENSING.

HIS Excellency the Lieutenant-Governor of the State of Victoria, by and with the advice of the Executive Council thereof, doth hereby, in pursuance of the provisions of the *Land Act 1928*, revoke the withholding from sale, leasing, and licensing of the land mentioned hereunder:—

HARRIETVILLE.—The withholding from sale, leasing, and licensing, by Order in Council of the 13th October, 1879, of 1 acre 0 roods 39 perches of land in the Township of Harrietteville.—(H.125(6) (Rs.5520).

And the Honorable Keith Hector Turnbull, Her Majesty's Commissioner of Crown Lands and Survey for the State of Victoria, shall give the necessary directions herein accordingly.

A. MAHLSTEDT,  
Clerk of the Executive Council.

COUNTRY ROADS BOARD.

At the Executive Council Chamber, Melbourne, the twenty-fifth day of June, 1957.

PRESENT:

His Excellency the Lieutenant-Governor of Victoria.  
Mr. Turnbull | Mr. McArthur.

ORDER APPROVING OF WIDENING AN EXISTING STATE HIGHWAY IN THE SHIRE OF BALLARAT.

WHEREAS the Country Roads Board constituted under the *Country Roads Act 1928* (No. 3662) has represented to His Excellency the Governor in Council that it appears to it desirable that the existing Western Highway in the Shire of Ballarat (declared to be a State highway under the said Act which declaration was confirmed by the Order in Council published in the *Government-Gazette*



of the 8th July, 1925, on pages 2371-2373) should be widened by the said Board: And whereas the said Board in accordance with the requirements of section 19 of the said cited Act has caused to be prepared a map plan and estimate showing the points between which and on and through what land the said widening is proposed to be made: And whereas on an inspection of the said map and plan and a consideration of the said estimate His Excellency the Governor in Council is satisfied that there are funds legally available for acquiring the land: Now therefore be it known by this present Order that His Excellency the Lieutenant-Governor of the State of Victoria with the advice of the Executive Council thereof doth hereby approve of the said road being widened, that is to say:—

All that piece of land in the Parish of Burrumbeet, the boundaries of which are as follow:—Commencing at the southern angle of allotment 134A of the said parish; thence by lines bearing respectively 180 deg. 0 min. 1,738.6 links, 306 deg. 11 min. 51 links, 360 deg. 0 min. 1,500 links, 2 deg. 14½ min. 1,050.7 links and 360 deg. 0 min. 4,290.6 links; thence north-easterly by the arc of a circle of radius 1,275 links a distance of 376 links; thence by lines bearing respectively 180 deg. 0 min. 289 links, 193 deg. 18 min. 392 links, 180 deg. 0 min. 3,929 links, and 183 deg. 56 min. 877 links to the point of commencement—which said piece of land is particularly delineated and shown coloured red and yellow on survey plan numbered 6516, lodged in the office of the Country Roads Board.

And the Honorable Sir Thomas Karran Maltby, Her Majesty's Commissioner of Public Works for the State of Victoria, shall give the necessary directions herein accordingly.

A. MAHLSTEDT,  
Clerk of the Executive Council.

#### COUNTRY ROADS BOARD.

*At the Executive Council Chamber, Melbourne, the twenty-fifth day of June, 1957.*

PRESENT:

His Excellency the Lieutenant-Governor of Victoria.  
Mr. Turnbull | Mr. McArthur.

#### ORDER APPROVING OF WIDENING AN EXISTING STATE HIGHWAY IN THE SHIRE OF MILDURA.

WHEREAS the Country Roads Board constituted under the *Country Roads Act 1928* (No. 3662) has represented to His Excellency the Governor in Council that it appears to it desirable that the existing Calder Highway in the Shire of Mildura (declared to be a State highway under the said Act which declaration was confirmed by the Order in Council published in the *Government Gazette* of the 6th December, 1944, on page 2948) should be widened by the said Board: And whereas the said Board in accordance with the requirements of section 19 of the said cited Act has caused to be prepared a map plan and estimate showing the points between which and on and through what land the said widening is proposed to be made: And whereas on an inspection of the said map and plan and a consideration of the said estimate His Excellency the Governor in Council is satisfied that there are funds legally available for acquiring the land: Now therefore be it known by this present Order that His Excellency the Lieutenant-Governor of the State of Victoria with the advice of the Executive Council thereof doth hereby approve of the said road being widened, that is to say:—

All that piece of land in the Parish of Mildura, the boundaries of which are as follow:—Commencing at the north-eastern angle of the Station Ground, Township of Red Cliffs, in the said parish; thence by lines bearing respectively 180 deg. 0 min. 2,502 ft. 2 in., 193 deg. 24 min. 56 ft. 1 in., 360 deg. 0 min. 2,563 ft. 5½ in., and 117 deg. 26 min. 14 ft. 8 in. to the point of commencement—which said piece of land is particularly delineated and shown coloured red on survey plan numbered 6601, lodged in the office of the Country Roads Board.

And the Honorable Sir Thomas Karran Maltby, Her Majesty's Commissioner of Public Works for the State of Victoria, shall give the necessary directions herein accordingly.

A. MAHLSTEDT,  
Clerk of the Executive Council.

#### COUNTRY ROADS BOARD.

*At the Executive Council Chamber, Melbourne, the twenty-fifth day of June, 1957.*

PRESENT:

His Excellency the Lieutenant-Governor of Victoria.  
Mr. Turnbull | Mr. McArthur.

#### ORDER APPROVING OF A DEVIATION FROM A MAIN ROAD IN THE CITY OF PRESTON.

WHEREAS the Country Roads Board constituted under the *Country Roads Act 1928* (No. 3662) has represented to His Excellency the Governor in Council that it appears to it desirable that the deviation hereinafter referred to from the existing Whittlesea-road in the City of Preston (declared to be a main road under the said Act which declaration was confirmed by the Order in Council published in the *Government Gazette* of the 6th October, 1915, on page 3677) should be made by the said Board: And whereas the said Board in accordance with the requirements of section 19 of the said cited Act has caused to be prepared a map plan and estimate showing the points between which and on and through what land the said deviation is proposed to be made and the cost of acquiring the land: And whereas on an inspection of the said map and plan and a consideration of the said estimate His Excellency the Governor in Council is satisfied that there are funds legally available for acquiring the land: Now therefore be it known by this present Order that His Excellency the Lieutenant-Governor of the State of Victoria with the advice of the Executive Council thereof doth hereby approve of the said road being made, that is to say:—

All that piece of land in the Parish of Keelbundora, the boundaries of which are as follow:—Commencing at the western angle of the Preston Cemetery Reserve in portion 10 of the said parish; thence by lines bearing respectively 148 deg. 22 min. 50 links, 236 deg. 21 min. 3,073.2 links, 233 deg. 29 min. 489.7 links, 227 deg. 26 min. 489.7 links, 314 deg. 23 min. 50 links, 44 deg. 23 min. 972.1 links, and 56 deg. 21 min. 1,471.8 links to the western bank of the Darebin Creek; thence northerly by the said bank to a point distant 0 deg. 56 min. 158.5 links; thence by lines bearing respectively 79 deg. 48 min. 40.5 links, 79 deg. 18 min. 550 links and 56 deg. 21 min. 1,162 links to the point of commencement—which said piece of land is particularly delineated and shown coloured red and yellow on survey plan numbered 6590, lodged in the office of the Country Roads Board.

And the Honorable Sir Thomas Karran Maltby, Her Majesty's Commissioner of Public Works for the State of Victoria, shall give the necessary directions herein accordingly.

A. MAHLSTEDT,  
Clerk of the Executive Council.

#### CEMETERIES ACTS.

*At the Executive Council Chamber, Melbourne, the twenty-fifth day of June, 1957.*

PRESENT:

His Excellency the Lieutenant-Governor of Victoria.  
Mr. Turnbull | Mr. McArthur.

#### CONSENT TO BORROW GIVEN TO THE TRUSTEES OF THE NECROPOLIS, SPRINGVALE.

UNDER the powers conferred by section 2 of the *Cemeteries Act 1931* (No. 4006), as amended by the *Cemeteries (Financial) Act 1957* (No. 6076), His Excellency the Lieutenant-Governor of the State of Victoria, by and with the advice of the Executive Council thereof, doth hereby consent to the Trustees of the Necropolis, Springvale, borrowing, by way of bank overdraft, an amount not exceeding Forty thousand pounds (£40,000) to enable the said Trustees to carry out and perform the powers and authorities and duties vested in them under the *Cemeteries Acts*.

And the Honorable Ewen Paul Cameron, Her Majesty's Minister of Health for the State of Victoria, shall give the necessary directions herein accordingly.

A. MAHLSTEDT,  
Clerk of the Executive Council.

## TEACHING SERVICE ACT 1946.

*At the Executive Council Chamber, Melbourne, the  
twenty-fifth day of June, 1957.*

## PRESENT:

His Excellency the Lieutenant-Governor of Victoria.  
Mr. Turnbull | Mr. McArthur.

## REGULATIONS.

**I**N pursuance of the powers conferred by the *Teaching Service Act* 1946, His Excellency the Lieutenant-Governor of the State of Victoria, by and with the advice of the Executive Council thereof, doth hereby amend the Teaching Service (Governor in Council) Regulations, with effect from and inclusive of the 1st July, 1957, in the manner following, that is to say:—

## REGULATION 4.

LEAVE OF ABSENCE: SICK LEAVE AND SPECIAL LEAVE.

After paragraph (g) of clause 1, add the following paragraph:—

“(h) Notwithstanding anything contained in this Regulation, where a member has exhausted his sick leave credits on full pay he may, in the event of continued or further illness, elect in writing to have the whole or any portion of the leave on half pay standing to his credit converted into leave on full pay, such conversion to be made on the basis that each credit of two days on half pay shall be deemed to be a credit of one day on full pay.”

And the Honorable John Stoughton Bloomfield, Her Majesty's Minister of Education for the State of Victoria, shall give the necessary directions herein accordingly.

A. MAHLSTEDT,  
Clerk of the Executive Council.

## HOME FINANCE ACTS.

*At the Executive Council Chamber, Melbourne, the  
second day of July, 1957.*

## PRESENT:

His Excellency the Lieutenant-Governor of Victoria.  
Mr. Cameron | Mr. McArthur.  
Mr. Porter |

## HOME FINANCE (TRUST) REGULATIONS No. 3.

**P**URSUANT to the powers conferred by the Home Finance Acts and the *Acts Interpretation Act* 1928, His Excellency the Lieutenant-Governor of the State of Victoria, by and with the advice of the Executive Council thereof, doth make the following Regulations, that is to say:—

## CITATION.

1. These Regulations may be cited as the Home Finance (Trust) Regulations No. 3, and shall come into operation upon the publication thereof in the Government Gazette.

## AMENDMENT.

2. The Home Finance (Trust) Regulations are amended as follows:—

- (1) In sub-regulation (1) of regulation 3, for the expression “Officer of the Treasury nominated from time to time by the Treasurer of Victoria:—Two hundred pounds per annum” there shall be substituted the expression “Officer of the Treasury nominated from time to time by the Treasurer of Victoria:—Four hundred pounds per annum.”
- (2) In regulation 4, for the expression “£1,122” there shall be substituted the expression “£1,750”.

And the Honorable Henry Edward Bolte, Her Majesty's Treasurer for the State of Victoria, shall give the necessary directions herein accordingly.

A. MAHLSTEDT,  
Clerk of the Executive Council.

## POLICE REGULATION ACTS.

*At the Executive Council Chamber, Melbourne, the second day of July, 1957.*

## PRESENT:

His Excellency the Lieutenant-Governor of Victoria.

Mr. Cameron		Mr. McArthur.
Mr. Porter		

## REGULATIONS.

**H**IS Excellency the Lieutenant-Governor of the State of Victoria, in the Commonwealth of Australia, by and with the advice of the Executive Council of the said State, and in pursuance of the powers conferred by the Police Regulation Acts, doth hereby further amend the Police Regulations 1951, as follows (that is to say) :—

1. In paragraph (b) of sub-clause (2) of clause 5 of chapter 9 the words "compensatory allowances" are hereby deleted.
2. This amendment shall operate from the thirteenth day of March, 1955.

And the Honorable Murray Victor Porter, for and on behalf of Her Majesty's Chief Secretary for the State of Victoria, shall give the necessary directions herein accordingly.

A. MAHLSTEDT,  
Clerk of the Executive Council.

## RIVER IMPROVEMENT ACT 1948.

*At the Executive Council Chamber, Melbourne, the second day of July, 1957.*

## PRESENT:

His Excellency the Lieutenant-Governor of Victoria.

Mr. Cameron	...	Mr. McArthur.
Mr. Porter		

All of the boundaries set forth in the foregoing Schedule are shown on a plan approved by the Governor in Council and deposited in the office of the State Rivers and Water Supply Commission, Melbourne.—(Corres. 57/8467.)

A. MAHLSTEDT,  
Clerk of the Executive Council.

PENTAL ISLAND RIVER IMPROVEMENT TRUST  
CONSTITUTED.

**U**NDER the powers conferred by the *River Improvement Act 1948*, and all other powers enabling him in that behalf, His Excellency the Lieutenant-Governor of the State of Victoria, by and with the advice of the Executive Council of the said State, doth hereby order and direct as follows:—

1. That the area included within the boundaries defined in the Schedule hereto shall be and the same is hereby constituted a river improvement district to be known as the Pental Island River Improvement District, under the jurisdiction and control of a river improvement trust to be known as the Pental Island River Improvement Trust, and as on and from the date of this Order such District and Trust shall be deemed to be so constituted.
2. That the proposed works of the said Trust shall comprise river improvement works within the said District.
3. That the said Trust shall be comprised of nine Commissioners, of whom one shall be appointed by the Governor in Council, one shall be elected by the Council of the Shire of Swan Hill, and seven shall be elected by the ratepayers of the said District.

## SCHEDULE.

Commencing at a point on the left bank of the Little Murray River in line with the eastern boundary of allotment 24, Parish of Pental Island; thence generally westerly by the left bank of the Little Murray River to its western junction with the River Murray; thence generally easterly by the left bank of the River Murray to the eastern junction of the Little Murray River with the River Murray; and thence generally westerly by the left bank of the Little Murray River to the point of commencement.

## LABOUR AND INDUSTRY ACTS.

*At the Executive Council Chamber, Melbourne, the second day of July, 1957.*

## PRESENT:

His Excellency the Lieutenant-Governor of Victoria.

Mr. Cameron		Mr. McArthur.
Mr. Porter		

APPOINTMENT TO PANEL OF CHAIRMEN OF  
WAGES BOARDS.

**I**N pursuance of the powers conferred by the Labour and Industry Acts, His Excellency the Lieutenant-Governor of the State of Victoria, by and with the advice of the Executive Council thereof, doth by this Order appoint—

AUBREY VERNON BARNES and  
PETER ALPHONSUS RANGLES

to be members of a panel of Chairmen of Wages Boards for a period of five years from and including the tenth day of August, 1957, and doth further by this Order determine that the salary to be paid to each of the said members shall be Two thousand five hundred pounds per annum.

And the Honorable George Oswald Reid, Her Majesty's Minister of Labour and Industry for the State of Victoria, shall give the necessary directions herein accordingly.

A. MAHLSTEDT,  
Clerk of the Executive Council.

MILK BOARD ACTS.

At the Executive Council Chamber, Melbourne, the second day of July, 1957.

PRESENT:

His Excellency the Lieutenant-Governor of Victoria.

Mr. Cameron | Mr. McArthur.  
Mr. Porter

IN pursuance of the powers conferred by the Milk Board Acts and all other powers enabling him in that behalf, His Excellency the Lieutenant-Governor of Victoria, by and with the advice of the Executive Council thereof, doth hereby approve of the following Determination of milk prices by the Milk Board, such Determination to take effect from the 5th day of July, 1957:—

DETERMINATION.

1. The prices which shall be paid by the Board to dairy farmers for milk for sale or distribution in milk districts shall be as follow:—

- (a) For milk supplied to the Board's authorized agent named in Schedule I. hereto—3s. 2½d. per gallon.
- (b) For milk supplied to the Board's authorized agent named in Schedule II. hereto—3s. 1½d. per gallon.
- (c) For milk supplied to the Board's authorized agent named in Schedule III. hereto—3s. 1½d. per gallon.
- (d) For milk supplied to the Board's authorized agent named in Schedule IV. hereto—3s. per gallon.
- (e) For milk supplied to any of the Board's authorized agents other than those named in the Schedules hereto—3s. 4½d. per gallon.

Provided that, for milk supplied to the Board's authorized agents other than the authorized agents named in Schedules I., II., III., and IV. hereto, the Board shall be entitled to deduct from the said price such sum per gallon as may be determined by the Board from time to time in respect of the transport of such milk.

2. The minimum prices payable per gallon to dairymen (in the case of sales other than sales by retail) for milk of the kinds and quantities as described hereunder for sale or distribution in a Milk District shall be the prices as shown in the column hereto headed with the name of that Milk District.

	Metropolitan Milk District.	Dandenong Ranges Milk District.	Bendigo Milk District.	Lalrobo Valley Milk District.
(i) By dairymen (other than the owners of milk shops and owners of house trade dairies)—	<i>s. d.</i>	<i>s. d.</i>	<i>s. d.</i>	<i>s. d.</i>
(a) For bottled milk (at the dairy premises of the vendor)—				
Half-pints..	4 6½	4 6½	4 7½	4 3½
Pints ..	4 2½	4 2½	4 3½	4 0
(b) For bottled milk (delivered to the premises of the purchaser)—				
Half-pints..	4 6½	4 6½	4 7½	4 4
Pints ..	4 3½	4 3½	4 4½	4 0½
(c) For bulk milk ..	3 10½	3 10½	3 11½	3 8
(ii) By prescribed charitable institutions—				
(a) For bottled milk delivered—				
Half-pints..	5 2	5 2	5 4½	4 11½
Pints ..	4 10½	4 10½	5 1	4 7½
(b) For bulk milk delivered ..	4 6½	4 6½	4 9½	4 4
(iii) By owners of milk shops and owners of house-trade dairies—				
(a) For bottled milk delivered—				
Half-pints..	5 6	5 6	5 8½	5 5
Pints ..	5 2½	5 4½	5 4½	5 0½
(b) For bulk milk delivered ..	4 8½	4 10½	4 11½	4 7
(iv) By any other persons—				
(a) For bottled milk delivered—				
Half-pints..	5 8	5 8	5 10½	5 7
Pints ..	5 2½	5 4½	5 4½	5 0½
(b) For bulk milk ..	4 8½	4 10½	4 11½	4 7

3. The maximum prices at which milk of the kinds and quantities as described hereunder may be sold by retail in a Milk District shall be the prices as shown in the column hereto headed with the name of that Milk District.

	Metropolitan Milk District.	Dandenong Ranges Milk District.	Bendigo Milk District.	Latrobe Valley Milk District.
	<i>s. d.</i>	<i>s. d.</i>	<i>s. d.</i>	<i>s. d.</i>
(a) In sealed bottles—				
Half pint per half pint	0 5½	0 5½	0 5½	0 5½
One pint per pint	0 9½	0 10	0 10	0 9½
One quart or more in pint bottles—per quart	1 6½	1 7½	1 7½	1 6½
(b) Bulk—For sales of—				
Half pint per half pint	0 5	0 5	0 5	0 5
One pint per pint	0 9	0 9½	0 9½	0 9
One quart or more—per quart	1 5½	1 6½	1 6½	1 5½

Provided that the charge for milk supplied to persons having bulk milk delivered to them regularly in retail quantities of 1 quart or more per day shall be computed on a weekly basis by multiplying the total quartage delivered during such week by the price per quart; and provided further that the charge for milk supplied to persons having milk delivered to them regularly in sealed pint bottles in retail quantities of 1 quart or more per day shall be computed on a weekly basis by multiplying the total quartage delivered during such week, in such bottles, by the price per quart.

Provided also that the maximum retail price at which milk delivered in sealed ½-pint bottles in quantities not exceeding 3 pints a week to a purchaser elsewhere than at a dairy or milk shop within that part of the Metropolitan Milk District bounded by Spencer, Victoria, Spring and Flinders streets in the municipal district of Melbourne may be sold shall be Six pence a ½ pint.

#### SCHEDULE I.

Producers' Dairying Co. Ltd., Werribee.

#### SCHEDULE II.

Burnside Dairies, Yan Yean.

#### SCHEDULE III.

Moe Co-operative Dairying Co. Ltd., Moe.

#### SCHEDULE IV.

South-Eastern Milk Products Ltd. (Traralgon Factory), Traralgon.

M. H. RANKIN, Chairman of Milk Board.

E. G. FINCH, Member of Milk Board.

G. C. WEBBER, Member of Milk Board.

R. W. ANDERSON, Secretary of Milk Board.

And the Honorable Gilbert Lawrence Chandler, Her Majesty's Minister of Agriculture for the State of Victoria, shall give the necessary directions herein accordingly.

A. MAHLSTEDT,  
Clerk of the Executive Council.

## MARYBOROUGH SEWERAGE AUTHORITY.

At the Executive Council Chamber, Melbourne, the  
second day of July, 1957.

## PRESENT:

His Excellency the Lieutenant-Governor of Victoria.  
Mr. Cameron | Mr. McArthur.  
Mr. Porter |

## EXTENT OF SEWERAGE DISTRICT INCREASED.

UNDER the powers conferred by the Sewerage Districts Acts and all other powers enabling him in that behalf, His Excellency the Lieutenant-Governor of the State of Victoria, by and with the advice of the Executive Council of the said State, doth hereby declare, order, and direct as follows:—

That the extent of the Sewerage District of the Maryborough Sewerage Authority be increased by adding to the same the lands comprised within the boundaries described in the Schedule hereto, and as on and from the date hereof the extent of such district shall be deemed to be increased accordingly.

## SCHEDULE.

## Portion I.

Commencing at the south-eastern angle of Crown allotment A, section XXII., Parish of Maryborough, County of Talbot, being a point on the northern boundary of the existing Sewerage District and being a point on the western boundary of Park-road; thence northerly along the said western boundary of Park-road to a point in line with the northern boundary of lot 15 on lodged plan of subdivision numbered 25064; thence easterly by a line across a road to the most northerly angle of the said lot 15 and along its northern boundary and by a line being a continuation thereof through the Maryborough-Mildura railway reserve to a point on its centre-line; thence northerly along the said centre-line of a railway reserve to a point in line with the south-western boundary of Crown allotment 30b, section 1; thence south-easterly by a line through the aforesaid railway reserve and across a road to the most westerly angle of the said Crown allotment 30b, and along its south-western boundary to its most southerly angle; thence south-easterly by a line across a road to the north-eastern angle of Crown allotment 4, section XXII.; thence generally south-easterly along the eastern boundaries of the said Crown allotment 4 to its south-eastern angle; thence southerly by a line across a road to the north-eastern angle of Crown allotment 4, section XXV.; thence generally westerly along the northern boundaries of the said Crown allotment 4 and of Crown allotment 3 and by a line being a continuation thereof across a road and through the afore-mentioned Maryborough-Mildura railway reserve to a point on its centre-line; thence southerly along the said centre-line of a railway reserve to a point in line with the southern boundary of Crown allotment 1, being a point on the boundary of the existing Sewerage District; thence westerly along the northern boundary of the existing Sewerage District to the point of commencement.

## Portion II.

Commencing at a point on the centre-line of the Maryborough-Castlemaine railway reserve being a point in line with the western boundary of Crown allotment 2, section 77, Parish of Maryborough, County of Talbot, and being a north-easterly angle on the boundary of the existing Sewerage District; thence generally easterly along the said centre-line of a railway reserve to a point in line with the eastern boundary of Crown allotment 1; thence southerly by a line through the said railway reserve and to the north-eastern angle of the aforesaid Crown allotment 1 and along its eastern boundary and by a line being a continuation thereof across a road to a point on the western boundary of a State forest reserve; thence south-westerly along the western boundary of the said reserve to its south-western angle being a point on the northern boundary of Sutton-road; thence easterly along the said northern boundary of Sutton-road to a point in line with the eastern boundary of Crown allotment 10, section III.; thence southerly by a line across a road to the north-eastern angle of the said Crown allotment 10 and along its eastern boundary to the most northerly angle of Crown allotment 12; thence north-westerly by a line across the aforesaid Crown allotment 10 to the most easterly angle of Crown allotment 27A and along its northern boundary to its north-western angle; thence southerly along its western boundary to its south-western angle; thence southerly by a line across a drainage reserve to the most northerly angle of Crown allotment 28 and along its western boundary and by a line being a continuation thereof across Waterloo-road to a point on its southern boundary; thence north-westerly

along the said southern boundary of Waterloo-road to the most northerly angle of a water reserve, being a point on the boundary of the existing Sewerage District; thence generally northerly along the western boundary of the existing Sewerage District to the point of commencement.

## Portion III.

Commencing at a point on the south-western boundary of an Education Department reserve such point being on a line parallel to and distant 100 links south-easterly from the north-western boundary of Crown allotment 16, section V., Parish of Maryborough, County of Talbot, and being an angle on the eastern boundary of the existing Sewerage District; thence south-easterly along the south-western boundary of the said reserve to a point on a line parallel to and distant 100 links south-easterly from the north-western boundary of Crown allotment 15; thence south-westerly by the said line parallel to and distant 100 links south-easterly from the north-western boundary of Crown allotment 15 across a road and the said Crown allotment 15 to a point on its south-western boundary, being an angle on the boundary of the existing Sewerage District; thence north-westerly and north-easterly along the eastern boundary of the existing Sewerage District to the point of commencement.

## Portion IV.

Commencing at a point on the north-western boundary of Crown allotment 1, section V., Parish of Maryborough, County of Talbot, such point being in line with the north-eastern boundary of Crown allotment 27A and being an angle on the boundary of the existing Sewerage District; thence south-easterly by a line parallel to the south-western boundary of the aforesaid Crown allotment 1, across the said Crown allotment 1 and Crown allotments 2, 3, 4, 5, 6, and Victory-street to a point on the north-western boundary of Crown allotment 5, section VI.; thence south-westerly along the said north-western boundary of Crown allotment 5 to its most westerly angle; thence south-westerly by a line across a road to the most easterly angle of Crown allotment 6A, section X.; thence south-westerly along the south-eastern boundary of the said Crown allotment 6A to its most southerly angle; thence north-westerly along the said south-western boundaries of the said Crown allotment 6A and of Crown allotments 6, 5, 4, 3 to the most westerly angle of the said Crown allotment 3; thence south-westerly by a line across Crown allotment 7A to the most easterly angle of Crown allotment 7B; thence south-westerly along the south-eastern boundary of the said Crown allotment 7B to its most southerly angle; thence north-westerly along its south-western boundary to its most westerly angle; thence north-westerly by a line across a road to the most southerly angle of Crown allotment 5A, section XI.; thence north-westerly and north-easterly along the south-western and north-western boundaries of the said Crown allotment 5A to its most northerly angle, being a point on the boundary of the existing Sewerage District; thence south-easterly, north-easterly, north-westerly, and north-easterly along the south-eastern boundaries of the existing Sewerage District to the point of commencement.

## Portion V.

Commencing at the most northerly angle of Crown allotment 18, section XXIII.A., Parish of Maryborough, County of Talbot, being a point on the south-western boundary of the existing Sewerage District; thence southerly along the eastern boundaries of Crown allotments 12, 13, 14 to the south-eastern angle of the said Crown allotment 14; thence southerly by a line, across a road, a railway reserve, a road and Crown land to the north-eastern angle of Crown allotment 1A; thence generally southerly along the eastern boundaries of the said Crown allotment 1A and of Crown allotments 2A, 3A, 4A, 5A, 6A, 7A, 8A, 9A, 10A, and 11A to the most easterly angle of the said Crown allotment 11A; thence south-westerly along the south-eastern boundary of the said Crown allotment 11A to its most southerly angle; thence south-westerly by a line across a road to the most easterly angle of Crown allotment 10, section XIII.A.; thence south-westerly along the south-eastern boundaries of the said Crown allotment 10 and of Crown allotment 8A and by a line being a continuation thereof across a drainage reserve to a point on its western boundary; thence generally northerly along the said western boundary of a drainage reserve and by a line being a continuation thereof across a road and through the Maryborough-Ararat railway reserve to a point on its centre-line; thence northerly by a line through the said railway reserve and across a road to the south-eastern angle of Crown allotment 14, section XIII.A.; thence northerly along the eastern boundary of the said Crown allotment 14 to a point in line with the north-eastern boundary of Crown allotment 8, section XIII.; thence north-westerly by a line across the aforesaid Crown allotment 14 and a road

to the most easterly angle of the afore-mentioned Crown allotment 8 and along the north-eastern boundaries of the said Crown allotment 8 and of Crown allotments 3, 2, and 1 to a point in line with the north-western boundary of Crown allotment 20, section XII.; thence north-easterly by a line across a road to the most westerly angle of the said Crown allotment 20 and along its north-western boundary to its most northerly angle; thence north-easterly along the north-western boundary of Crown allotment 13 and by a line being a continuation thereof across a road to a point in line with the north-eastern boundary of Crown allotment 12, being a point on the boundary of the existing Sewerage District; thence south-easterly along the south-western boundary of the existing Sewerage District to the point of commencement.

*Portion VI.*

Commencing at a point on the south-eastern boundary of Gladstone-street distant 275 links south-westerly from the most northerly angle of section 39A, Town of Maryborough, County of Talbot, being a point on the western boundary of the existing Sewerage District; thence south-westerly along the said south-eastern boundary of Gladstone-street to a point in line with the south-eastern boundary of Balaclava-road; thence south-westerly by a line across Gladstone-street and along the said south-eastern boundary of Balaclava-road to a point in line with the south-western boundary of McLennan-street; thence north-westerly by a line across Balaclava-road and along the said south-western boundary of McLennan-street to the most easterly angle of a powder magazine reserve; thence north-easterly by a line to the most southerly angle of Crown allotment 43, section XXIA., Parish of Maryborough; thence north-easterly and generally north-westerly along the south-eastern and north-eastern boundaries of the said Crown allotment 43 to its most northerly angle; thence north-westerly by a line across Brassey-street to the intersection of the south-western boundary of Pekin-street with the north-western boundary of the said Brassey-street; thence generally north-easterly along the said north-western boundary of Brassey-street to the most southerly angle of Crown allotment 20, section XXIA.; thence north-westerly along the south-western boundary of the said Crown allotment 20 to the most northerly angle of Crown allotment 26; thence north-easterly by a line parallel to the south-eastern boundary of the aforesaid Crown allotment 20, across Crown allotment 20, and a road to a point on the south-western boundary of Crown allotment 18, section IIIA.; thence south-easterly and generally north-easterly along the south-western and south-eastern boundaries of the said Crown allotment 18 to its most easterly angle; thence north-easterly by a line across a road to the most southerly angle of Crown allotment 18, section IA., and along its south-eastern boundary to the most southerly angle of Crown allotment 24; thence south-easterly by a line across a road to the most westerly angle of Crown allotment 17 and along its south-western boundary to its most southerly angle; thence easterly by a line across a road to an angle on the south-western boundary of Crown allotment 14 distant 36 links southerly from its north-western angle; thence south-easterly along its south-western boundary to a point on the northern boundary of a drainage reserve, being a point on the boundary of the existing Sewerage District; thence generally south-westerly along the north-western boundary of the existing Sewerage District to the point of commencement.

*Portion VII.*

Commencing at a point on the western boundary of Crown allotment 17, section 72, Town of Maryborough, County of Talbot, such point being in line with the northern boundary of a drainage reserve through Crown allotment 14, section 1A, Parish of Maryborough, and being a point on the northern boundary of the existing Sewerage District; thence south-easterly by a line across a drainage reserve and Crown allotment 16, section 72, Town of Maryborough, to the most northerly angle of Crown allotment 1, being a point on the boundary of the existing Sewerage District; thence south-westerly and northerly along the northern boundary of the existing Sewerage District to the point of commencement.

All of which boundaries are shown on a plan approved by the Governor in Council and deposited in the office of the State Rivers and Water Supply Commission, Melbourne.—(Corres. 57/7735.)

And the Honorable Wilfred John Mibus, Her Majesty's Minister of Water Supply for the State of Victoria, shall give the necessary directions herein accordingly.

A. MAHLSTEDT,  
Clerk of the Executive Council.

GEELONG WATERWORKS AND SEWERAGE TRUST.

*At the Executive Council Chamber, Melbourne, the second day of July, 1957.*

PRESENT:

His Excellency the Lieutenant-Governor of Victoria.

Mr. Cameron	Mr. McArthur.
Mr. Porter	

CONSENT TO BORROWING £50,000.

UNDER the powers conferred by the Geelong Waterworks and Sewerage Acts and all other powers enabling him in that behalf, His Excellency the Lieutenant-Governor of the State of Victoria, by and with the advice of the Executive Council of the said State, doth hereby consent to the Geelong Waterworks and Sewerage Trust borrowing at interest, subject to the Geelong Waterworks and Sewerage Acts, the sum of Fifty thousand pounds (£50,000) to meet the cost of water supply works.

And the Honorable Wilfred John Mibus, Her Majesty's Minister of Water Supply for the State of Victoria, shall give the necessary directions herein accordingly.

A. MAHLSTEDT,  
Clerk of the Executive Council.

TALLANGATTA SEWERAGE AUTHORITY.

*At the Executive Council Chamber, Melbourne, the second day of July, 1957.*

PRESENT:

His Excellency the Lieutenant-Governor of Victoria.

Mr. Cameron	Mr. McArthur.
Mr. Porter	

AMENDMENT OF ORDER.

UNDER the powers conferred by the Sewerage Districts Acts and all other powers enabling him in that behalf, His Excellency the Lieutenant-Governor of the State of Victoria, by and with the advice of the Executive Council of the said State, doth hereby amend as follows the Order in Council proclaiming the Sewerage District and constituting the Tallangatta Sewerage Authority made the 15th December, 1953, and published in the *Victoria Government Gazette* dated the 23rd December, 1953:—

In clause (a) for the expression "Two thousand pounds (£2,000)" there shall be substituted the expression "Three thousand pounds (£3,000)."

And the Honorable Wilfred John Mibus, Her Majesty's Minister of Water Supply for the State of Victoria, shall give the necessary directions herein accordingly.

A. MAHLSTEDT,  
Clerk of the Executive Council.

PENAL REFORM ACT 1956.

*At the Executive Council Chamber, Melbourne, the second day of July, 1957.*

PRESENT:

His Excellency the Lieutenant-Governor of Victoria.

Mr. Cameron	Mr. McArthur.
Mr. Porter	

HIS Excellency the Lieutenant-Governor of the State of Victoria, in the Commonwealth of Australia, by and with the advice of the Executive Council of the said State, in pursuance of the powers in that behalf conferred by the *Penal Reform Act 1956*, and all other powers him thereunto enabling, and prior to appointment of members of the Parole Board, doth hereby determine that three years shall be the period for which persons appointed as members of the Parole Board shall hold office.

And the Honorable Arthur Gordon Rylah, Her Majesty's Chief Secretary for the State of Victoria, shall give the necessary directions herein accordingly.

A. MAHLSTEDT,  
Clerk of the Executive Council.

## PENAL REFORM ACT 1956.

At the Executive Council Chamber, Melbourne, the second day of July, 1957.

## PRESENT:

His Excellency the Lieutenant-Governor of Victoria.  
Mr. Cameron | Mr. McArthur.  
Mr. Porter

IN pursuance of the powers conferred by the *Penal Reform Act 1956* and all other powers him thereunto enabling, His Excellency the Lieutenant-Governor of the State of Victoria, in the Commonwealth of Australia, by and with the advice of the Executive Council of the said State, doth by this Order fix as follows the remuneration for their services and the travelling expenses which shall be payable to members of the Parole Board (that is to say):—

1. The Chairman shall be entitled to a fee at the rate of Five hundred pounds per annum.
2. Every male member, other than the Chairman, shall be entitled to a fee at the rate of Three hundred and fifty pounds per annum.
3. Every female member shall be entitled to an attendance fee of Five pounds five shillings in respect of each meeting attended.
4. The Chairman shall receive within Victoria the expenses for the time being payable as a Judge of the Supreme Court and when sitting or travelling in another State, such sum as is fixed by the Minister.
5. Every member, other than the Chairman, shall be entitled to travelling expenses in accordance with the conditions and at the rates provided from time to time in Part VI. of the Public Service (Public Service Board) Regulations as far as they relate to Permanent Heads.

And the Honorable Arthur Gordon Rylah, Her Majesty's Chief Secretary for the State of Victoria, shall give the necessary directions herein accordingly.

A. MAHLSTEDT,  
Clerk of the Executive Council.

*Penal Reform Act 1956.*

## MEMBER AND CHAIRMAN OF THE PAROLE BOARD.

NOTICE is hereby given that the Honorable John Vincent Barry, a Judge of the Supreme Court, has been nominated with his consent by the Honorable the Chief Justice, to be a member of the Parole Board constituted by section 17 of the *Penal Reform Act 1956*, and that in accordance with the provisions of section 19 of the said Act, the said John Vincent Barry shall be Chairman of the said Board.

A. G. RYLAH,  
Chief Secretary.

Chief Secretary's Office,  
Melbourne, 2nd July, 1957.

## APPOINTMENTS.

HIS Excellency the Lieutenant-Governor of the State of Victoria, by and with the advice of the Executive Council thereof, has, by Orders made on the 2nd day of July, 1957, been pleased to make the under-mentioned appointments, viz.:—

## CHIEF SECRETARY'S DEPARTMENT.

*Members of the Parole Board.*

CHARLES MCLEAN, C.B.E.,  
LESLIE LEIDER WEBSTER, and  
RICHARD GORDON INCE,

pursuant to section 17 of the *Penal Reform Act 1956*, to be members of the Parole Board where any general matter or any matter affecting any male prisoner is to be dealt with; and

MARIE FREDA BREEN,  
PHYLLIS IRENE FROST, and  
PHYLLIS HILLGROVE,

pursuant to section 17 of the *Penal Reform Act 1956*, to be members of the Parole Board where any matter affecting any female prisoner is to be dealt with.

*Chief Parole Officer.*

HAMISH CONNOLLY MATHEW,  
pursuant to the provisions of the *Penal Reform Act 1956*, to be Chief Parole Officer.

*Senior Parole Officer.*

ERIC BENJAMIN,  
pursuant to the provisions of the *Penal Reform Act 1956*, to be Senior Parole Officer.

*Parole Officers.*

DAVID HUNDLEY,  
FRANCIS GREGORY HYLAND,  
JOHN DEAKIN KEATING,  
DAVID EDWARD LORD,  
RUDOLF MIKLOSVARY,  
ANDREW CLARK STEVENSON, and  
JOAN MARIE SCRATTON (Mrs.),  
pursuant to the provisions of the *Penal Reform Act 1956*, to be Parole Officers.

*Chief Probation Officer.*

HAMISH CONNOLLY MATHEW,  
pursuant to the provisions of the *Penal Reform Act 1956*, to be Chief Probation Officer.

*Senior Probation Officer.*

ERIC BENJAMIN,  
pursuant to the provisions of the *Penal Reform Act 1956*, to be Senior Probation Officer.

*Probation Officers.*

DAVID HUNDLEY,  
FRANCIS GREGORY HYLAND,  
JOHN DEAKIN KEATING,  
DAVID EDWARD LORD,  
RUDOLF MIKLOSVARY,  
ANDREW CLARK STEVENSON, and  
JOAN MARIE SCRATTON (Mrs.),  
pursuant to the provisions of the *Penal Reform Act 1956*, to be Probation Officers.

*Secretary of the Parole Board.*

DAVID THOMAS JONES,  
pursuant to the provisions of the *Penal Reform Act 1956*, to be Secretary of the Parole Board.

A. MAHLSTEDT,  
Clerk of the Executive Council.

At the Executive Council Chamber,  
Melbourne, 2nd July, 1957.

## APPROACHING LAND SALES.

SALES of Crown lands, in fee-simple, will be held at the under-mentioned places and dates, viz.:—

	No. of Gazette.
Bendigo.—Thursday, 11th July, 1957	184
Mallacoota.—Thursday, 4th July, 1957	184
Shepparton.—Thursday, 4th July, 1957	184

## CLOSER SETTLEMENT ACT 1938.

Red Cliffs.—Thursday, 11th July, 1957	184
Shepparton.—Thursday, 4th July, 1957	184

## HEARING OF REASONS AGAINST THE FORFEITURE OF CERTAIN LICENCES AND LEASES BY A PERSON APPOINTED UNDER 34TH SECTION OF THE LAND ACT 1928.

NOTICE is hereby given that reasons against the forfeiture of the licences and leases in the Schedule hereto, which are deemed liable to forfeiture under the provisions of the Land Acts, will be publicly heard by the person appointed by me, the responsible Minister of the Crown administering the said Acts, to hear the same and report thereon in writing to me, when the persons in the said Schedule mentioned as holders of such licences and leases will be allowed to show cause against the same at the places and on the dates mentioned in the Schedule hereto.

KEITH TURNBULL,  
Commissioner of Crown Lands and Survey.

Department of Crown Lands and Survey,  
Melbourne, 3rd July, 1957.

## SCHEDULE.

CROWN LANDS DEPARTMENT, MELBOURNE, Wednesday, 17th July, 1957, at 2 p.m., C. E. Rice—

1952/44, Augusto Negrello, 47a. Or. 10p., Kinglake;  
1974/44, Jack William Martin, 100 acres, Fumina.



**PROPOSED REVOCATIONS OF PORTIONS OF TEMPORARY RESERVATIONS OF LANDS BY ORDERS IN COUNCIL.**

IN pursuance of the provisions of the *Land Act 1928*, notice is hereby given that it is the intention of the Governor in Council to revoke portions of the temporary reservations of lands by the Orders in Council hereunder referred to, viz.:-

The following Notices were published 1° on the 19th June, 1957, pursuant to Orders of the 14th May, 1957.

**NELSON.**—The temporary reservation, by Order in Council of the 12th October, 1937, of 3 acres 3 roods 12 perches of land in the Township of Nelson, as a site for Public purposes, so far only as the portion containing 20 perches, more or less, indicated by hachure on plan hereunder, is concerned.—(N.51<sup>(3)</sup>) (Rs.4731).

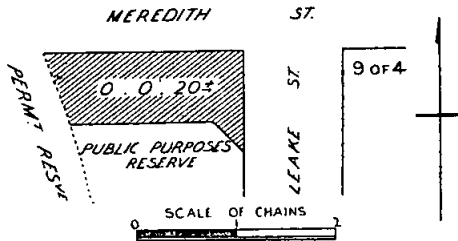

**WONGA WONGA SOUTH.**—The temporary reservation, by Order in Council of the 20th February, 1902 (see *Government Gazette* of the 26th February, 1902, page 930), of 9 acres 2 roods 20 perches of land in the Parish of Wonga Wonga South, as a site for Supply of Gravel, revoked as to part by Order of the 14th February, 1939, so far only as the portion containing 1 acre 2 roods, more or less, indicated by hachure on plan hereunder, is concerned.—(W.353<sup>(6)</sup>) (C.96938).

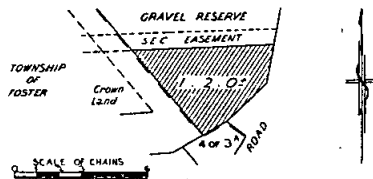

KEITH TURNBULL,  
Commissioner of Crown Lands and Survey.

(Published in lieu of Notices which appear in *Government Gazettes* dated the 22nd and the 29th May, 1957, and the 3th June, 1957, respectively.)

**PROPOSED REVOCATIONS OF TEMPORARY RESERVATIONS OF LANDS BY ORDERS IN COUNCIL.**

IN pursuance of the provisions of the *Land Act 1928*, notice is hereby given that it is the intention of the Governor in Council to revoke the temporary reservations of lands by the Orders in Council hereunder referred to, viz.:-

The following Notices were published 1° on the 12th June, 1957, pursuant to Orders of the 4th June, 1957.

**BRUARONG.**—The temporary reservation, by Orders in Council of the 6th July, 1885, and the 2nd September, 1913, of 2 acres 2 roods of land in the Parish of Bruarong as a site for a State School, is about to be revoked.—(B.639<sup>(8)</sup>) (H.023361).

**LARA.**—The temporary reservation, by Order in Council of the 19th August, 1872, of 36 acres, more or less, of land in the Township of Lara as a site for Watering purposes, is about to be revoked.—(M.205<sup>(8)</sup>) (W.203<sup>(2)</sup>) (Rs.2512).

**ROWSLEY.**—The temporary reservation, by Order in Council of the 14th November, 1892, of 1 rood of land in the Township of Rowsley as a site for a Mechanics' Institute, is about to be revoked.—(R.23<sup>(1)</sup>) (Rs.1826).

**UPOTIPTOPON.**—The temporary reservation as a site for Public purposes (State School) and the withholding from sale, leasing, and licensing, by Order in Council of the 16th June, 1884, of 5 acres of land in the Parish of Upotipotpon, are about to be revoked.—(U.53<sup>(8)</sup>) (C.96577).

**RICHMOND.**—The temporary reservation, by Order in Council of the 4th July, 1906, of 1 acre 1 rood 10 perches of land in the City of Richmond as a site for Public

Park and Recreation, is about to be revoked so far only as the portion containing 1 rood 5 perches, more or less, indicated by hachure on plan hereunder, is concerned.—(R.19<sup>(8)</sup>) (Rs.152).

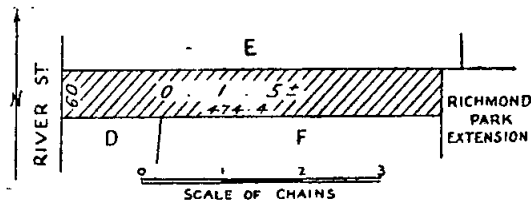

KEITH TURNBULL,  
Commissioner of Crown Lands and Survey.

**PROPOSED REVOCATIONS OF TEMPORARY RESERVATIONS OF LANDS BY ORDERS IN COUNCIL.**

IN pursuance of the provisions of the *Land Act 1928*, notice is hereby given that it is the intention of the Governor in Council to revoke the temporary reservations of lands by Orders in Council hereunder referred to, viz.:-

The following Notices were published 1° on the 19th June, 1957, pursuant to Orders of the 11th June, 1957.

**OAKLEIGH.**—The temporary reservation, by Order in Council of the 22nd November, 1921, of 1 rood 2 perches of land in the Township of Oakleigh as a site for a Public Hall, is about to be revoked.—(O.1<sup>(2)</sup>) (Rs.2382).

**TELANGATUK.**—The temporary reservation as a site for Public purposes (State School) and the withholding from sale, leasing and licensing, by Order in Council of the 20th September, 1881, of 5 acres 0 roods 3 perches of land in the Parish of Telangatuk, are about to be revoked.—(T.195<sup>(4)</sup>) (M.37685).

KEITH TURNBULL,  
Commissioner of Crown Lands and Survey.

**PROPOSED REVOCATIONS OF TEMPORARY RESERVATIONS OF LANDS BY ORDERS IN COUNCIL.**

IN pursuance of the provisions of the *Land Act 1928*, notice is hereby given that it is the intention of the Governor in Council to revoke the temporary reservations of lands by Orders in Council hereunder referred to, viz.:-

The following Notices were published 1° on the 26th June, 1957, pursuant to Orders of the 19th June, 1957.

**BAULKAMAUGH.**—The temporary reservation as a site for Public purposes (State School) and the withholding from sale, leasing, and licensing, by Order in Council of the 25th May, 1880, of 2 acres of land in the Parish of Baulkamaugh, situate in section C.—(B.718<sup>(2)</sup>) (C.97037).

**COOLUNGOOLUN.**—The temporary reservation as a site for Public purposes (State School) and the withholding from sale, leasing, and licensing, by Order in Council of the 11th November, 1879, of 5 acres of land in the Parish of Coolungoolun.—(C.422<sup>(8)</sup>) (H.021436).

**COPE COPE.**—The temporary reservation as a site for Weighbridge, and the withholding from sale, leasing, and licensing, by Order in Council of the 14th August, 1882, of 1 acre of land in the Township of Cope Cope.—(C.425<sup>(2)</sup>) (W.67961).

**GRETA.**—The temporary reservation, by Order in Council of the 31st January, 1951, of 2 roods 32 perches of land in the Township of Greta, as a site for Public Hall and Public Recreation.—(G.131<sup>(8)</sup>) (Rs.1299).

**MANSFIELD.**—The temporary reservation, by Order in Council of the 13th November, 1934, of 1 acre, more or less, of land in the Parish of Mansfield, as a site for Public purposes (Swimming Pool).—(M.35<sup>(8)</sup>) (Rs.4414).

**MERINO.**—The temporary reservation, by Order in Council of the 16th February, 1874, of 2 acres of land in the Township of Merino, as a site for State School purposes.—(M.248<sup>(4)</sup>) (Rs.6325).

**MOOROOLBARK.**—The temporary reservation, by Order in Council of the 27th October, 1910, of 1 acre 2 roods 25 perches of land in the Parish of Mooroolbark, as a site for a Mechanics' Institute.—(M.152<sup>(8)</sup>) (Rs.2190).

KEITH TURNBULL,  
Commissioner of Crown Lands and Survey.

PROPOSED REVOCATIONS OF TEMPORARY  
RESERVATIONS OF LANDS BY ORDERS IN  
COUNCIL.

IN pursuance of the provisions of the *Land Act 1928*, notice is hereby given that it is the intention of the Governor in Council to revoke the temporary reservations of lands by the Orders in Council hereunder referred to, viz.:—

The following Notices were published 1<sup>o</sup> on the 3rd July, 1957, pursuant to Orders of the 25th June, 1957.

**HARRIETVILLE.**—The temporary reservation, by Orders in Council of the 13th October, 1879, and the 18th October, 1886, of 3 acres 1 rood 39 perches of land in the Township of Harrietville, as a site for the use of the Police Department.—(H.125<sup>(a)</sup>) (Rs.5520).

**LINLITHGOW.**—The temporary reservation, by Order in Council of the 14th May, 1889, of 1 rood 13 perches, more or less, of land in the Parish of Linlithgow, as a site for Railway purposes.—(L.78<sup>(a)</sup>) (Rs.7092).

**MURRABIT.**—The temporary reservation, by Order in Council of the 30th May, 1892 (see *Government Gazette* of the 3rd June, 1892, page 2238) of 136 acres 1 rood 14 perches of land in the Parish of Murrabit, as a site for Watering purposes and for supply of Timber, so far only as the portion containing 26 acres, more or less, indicated by hachure on plan hereunder, is concerned.—(M.474<sup>(c)</sup>) (W.70436).

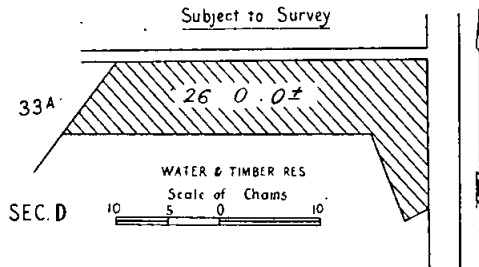

KEITH TURNBULL,  
Commissioner of Crown Lands and Survey.

PUBLIC HEARINGS BY A PERSON APPOINTED  
UNDER THE 34TH SECTION OF THE LAND ACT 1928.

NOTICE is hereby given that at the time and place mentioned in the Schedule hereunder, applications for leases and licences under the Land Acts, objections to such applications, objections to proposed proclamations, alterations, additions, diminutions, revocations, or unions of commons, and reasons against forfeiture of any leases or licences under the Land Acts deemed liable to forfeiture, will be publicly heard by the person whose name is set opposite such place in such Schedule, being the person appointed by me, the responsible Minister of the Crown administering the Land Acts, to hear the same and report thereon in writing to me.

KEITH TURNBULL,  
Commissioner of Crown Lands and Survey, and  
President of the Board of Land and Works.

Department of Crown Lands and Survey,  
Melbourne, 3rd July, 1957.

SCHEDULE.

LAND OFFICE, BENDIGO, Thursday, 18th July, 1957,  
at 10 a.m.—H. J. Henkel, Land Officer, Bendigo.

PARLIAMENT LIBRARY.—VICTORIA.

APPLICATIONS are invited for the position of—  
ASSISTANT LIBRARIAN.

Salary range £1,762–£1,862 per annum.

State age and qualifications.

Sound knowledge of cataloguing and Dewey system of Classification essential.

Applications received until July 31 by the Chairman of the Joint Library Committee, Parliament House, Melbourne.

PUBLIC SERVICE NOTICES

PUBLIC SERVICE OF VICTORIA.—VACANCIES.

APPLICATIONS will be received by the Public Service Board up to Wednesday, the 17th July, 1957, from persons employed in the Public Service of Victoria, who are eligible and qualified, for appointment to the under-mentioned positions:—

ADMINISTRATIVE DIVISION.

Clerk, Class "C1," Office of the Government Statist, Department of Chief Secretary.

Yearly Salary.—£785, minimum; £875, maximum.

Duties.—To have charge of and supervise the staff engaged in the work of preparing and maintaining the indexes to the registers of births, deaths, and marriages.

Qualifications.—To possess a good knowledge of the Registration of Births, Deaths, and Marriages Acts; to possess a knowledge of the index system of the Registration Branch and to be capable of compiling, revising and maintaining the indexes.

Clerk, Class "C1," Local Government Branch, Department of Public Works.

Yearly Salary.—£785, minimum; £875, maximum.

Duties.—To act as Secretary to the various Boards and Committees appointed under the Local Government Acts and to the Tourists Resorts Committee; to supervise examinations as required and to assist generally in the work of the Local Government Branch.

Qualifications.—To be experienced and competent in correspondence work and to have a knowledge of secretarial practice.

Clerk, Class "C," Department of Education.

Yearly Salary.—£598, minimum; £728, maximum.

Duties.—To pass teachers' salaries for payment, including the computation of increments, and allowances payable under the Teaching Service Regulations; to deal with correspondence and enquiries relating to salaries.

Qualifications.—A sound knowledge of the relevant portions of the Public Service and Teaching Service Acts and the regulations thereunder; a good knowledge of machine accounting.

PROFESSIONAL DIVISION.

Assistant Chief Inspector of Boilers, Class "C2," Department of Mines.

Yearly Salary.—£940, minimum; £1,030, maximum.

Duties.—To assist the Chief Inspector of Boilers, especially with regard to the checking of plans and specifications submitted to the Branch for survey, check and approval; to advise engineers and manufacturers in relation to design and manufacture of steam boilers and pressure vessels, and to undertake other duties as required.

Qualifications.—To have had at least ten years' satisfactory experience as an Inspector of Boilers; to possess a thorough knowledge of the design and manufacture of boilers and pressure vessels; to have had extensive experience in examination of welding practice and industrial radiology; to be experienced in dealing with the public and controlling staff.

Soils Officer, Classes "C–C2," Department of Agriculture.

Yearly Salary.—£683, minimum; £1,030, maximum—  
Agricultural Science Graduate.

£638, minimum; £1,030, maximum—  
Science Graduate or Chemistry  
Diplomate.

(Commencing salary in accordance  
with experience.)

Duties.—Under direction to carry out soil surveying in the field and analyses of soils in the laboratory.

Qualifications.—To hold a University degree in Agricultural Science or in Science with chemistry as a major subject, or an approved diploma in Chemistry.

TECHNICAL AND GENERAL DIVISION.

Assistant Maintenance Officer, Office of the Housing Commission, Department of Treasurer.

Yearly Salary.—£728, minimum; £754, maximum.

Duties.—To assist the Maintenance Officer in the technical determination, specification, and supervision of structural and painting maintenance on the Commission's metropolitan housing estates.

Qualifications.—Considerable experience as an operative builder or senior tradesman, preferably with responsibility for control of large scale maintenance works. Ability to prepare works programmes, reports and correspondence and to negotiate and supervise repainting and major repair contracts is essential. The successful applicant will be required to hold a current driver's licence.

Works Inspector, Senior, Department of Water Supply.

Yearly Salary.—£617, minimum; £669, maximum.

Duties.—To supervise and control the construction and maintenance of water supply and drainage works with particular reference to welding operations; to control labour, materials and equipment used in district works and to be responsible for necessary field records.

Qualifications.—To be capable of supervising and directing gangers and workmen employed on construction and maintenance works; to have had experience in all classes of welding work and in the setting out of works generally from plans and in laying and repairing all types of pipe mains, channels and structures; to have a good knowledge of the distribution of water in urban and irrigation districts.

Mechanical Supervisor, Robinvale Pumping Station, Department of Water Supply.

Yearly Salary.—£542, minimum; £620, maximum.

Duties.—Responsible to the Engineer in Charge for the repair and maintenance of steam boilers, steam and diesel engine driven pumps, and auxiliary mechanical plant at the Robinvale pumping station, and the supervision of persons employed on the operation and maintenance of such plant.

Qualifications.—To have served an apprenticeship as a fitter and turner, with not less than 10 years' subsequent experience in the repair and maintenance of steam and diesel engines and associated plant.

Labourer, Office of the Chief Commissioner of Police, Department of Chief Secretary. (Two vacancies.)

Yearly Salary.—£286, minimum; £299, maximum.

NOTE.—The salary rates quoted above do not include the additional amounts which are payable under Regulation 77A of the Board's Regulations.

By order,

V. P. SCULLY,  
Secretary.

Office of the Public Service Board,  
Melbourne, 2nd July, 1957.

PUBLIC SERVICE OF VICTORIA.—VACANCIES.

DEPARTMENT OF HEALTH.

MENTAL HYGIENE BRANCH.

TECHNICAL AND GENERAL DIVISION.

APPLICATIONS will be received by the Public Service Board up to Wednesday, the 24th July, 1957, from persons employed in the Public Service of Victoria, who are eligible and qualified, for appointment to the under-mentioned positions:—

Chiropodist (Male), Ballarat Mental Hospital.

Yearly Salary.—£528, minimum; £580, maximum.

Duties.—Treatment of corns, bunions, ulcers, chilblains, fallen arches, and similar conditions of patients. Under medical direction, to treat infections, give ray treatment and massage.

Qualifications.—To hold a diploma of an approved Association or Institute of Chiropodists.

Nurse, Senior (Male), or Sister (Female), Neuro-Surgical Unit, Mont Park Mental Hospital. (Two vacancies.)

Yearly Salary.—Male—£520, minimum; £559, maximum.

Female—£452, minimum; £491, maximum.

Duties.—To carry out Surgical Nursing and operating theatre techniques.

Qualifications.—To be a general trained registered nurse with surgical and theatre experience.

Deputy Charge Nurse (Male), Bendigo Training Centre. (Two vacancies.)

Yearly Salary.—£468, minimum; £494, maximum.

Duties.—To be second in charge of a ward and to relieve the Charge Nurse.

Qualifications.—To possess the Mental Hygiene Nursing Certificate and to have had experience as a Deputy Charge Nurse in a Mental Hospital; to be a registered Mental Nurse.

NOTE.—The salary rates quoted above do not include the additional amounts which are payable under Regulation 77A of the Board's Regulations.

By order,

V. P. SCULLY,  
Secretary.

Office of the Public Service Board,  
Melbourne, 2nd July, 1957.

No. 619.

Public Service Act 1946, Section 50.

REGULATIONS.—PART III.—SALARIES, INCREMENTS, AND ALLOWANCES.

THE Public Service Board, in pursuance of the powers conferred by the Public Service Act 1946, hereby amends its Regulations as shown below:—

SIXTH SCHEDULE.

TEMPORARY EMPLOYEES.

Designations of Positions and Rates of Salaries.

Department and Designation of Position.	Yearly Rate of Salary.		Increments (Annual).
	Minimum.	Maximum.	
DEPARTMENT OF CHIEF SECRETARY.	£	£	
FISHERIES AND GAME.			
Add— Information Officer (Female)	..	680	..

A. GARRAN, Chairman.  
V. P. SCULLY, Secretary.

Office of the Public Service Board,  
Melbourne, 20th June, 1957.

No. 625.

Public Service Act 1946, Section 50.

REGULATIONS—PART III.—SALARIES, INCREMENTS, AND ALLOWANCES.

THE Public Service Board, in pursuance of the powers conferred by the Public Service Act 1946, hereby amends its Regulations as shown below:—

SECOND SCHEDULE.

TECHNICAL AND GENERAL DIVISION.

Offices and Rates of Salaries.

Department and Office.	Yearly Rate of Salary.		Increments (Annual).
	Minimum.	Maximum.	
DEPARTMENT OF MINES.	£	£	
Add— Drill Foreman, Senior	..	795	..

A. GARRAN, Chairman.  
V. P. SCULLY, Secretary.

Office of the Public Service Board,  
Melbourne, 18th June, 1957.

627.

Public Service Act 1946, Section 50.

REGULATIONS—PART III.—SALARIES, INCREMENTS, AND ALLOWANCES.

Public Service Board, in pursuance of the powers conferred by the Public Service Act 1946, hereby amends its Regulations shown below:—

SECOND SCHEDULE.

TECHNICAL AND GENERAL DIVISION.

Offices and Rates of Salaries.

Department and Office.	Yearly Rate of Salary.		Increments (Annual).
	Minimum.	Maximum.	
DEPARTMENT OF CHIEF SECRETARY.	£	£	
OFFICE OF THE CHIEF COMMISSIONER OF POLICE.			
Attendant (Female), City Watchhouse ..	312	325	..
Matron, Police Hospital ..	..	598	..
DEPARTMENT OF TREASURER.			
HOUSING COMMISSION.			
Curator, Ascot Housing Estate	455	494	1 of £26 and 1 of £13
DEPARTMENT OF EDUCATION.			
Compositor, Leading Hand, Visual Education Centre..	527	579	*
Housekeeper, Grade II. . .	371	397	..
* Subject to satisfactory service, incremental progression shall be by increments, each of £13, payable after the completion of one, three, five, and seven years' adult service, respectively			
DEPARTMENT OF PUBLIC WORKS.			
French Polisher ..	..	470	..
Garden Labourer ..	286	299	..
DEPARTMENT OF HEALTH.			
AND CHILD HYGIENE.			
Storeman, Grade I. . .	390	429	1 of £26 and 1 of £13
DEPARTMENT OF AGRICULTURE.			
Butter Maker, Assistant, School of Dairy Technology ..	..	435	..
Camera Man ..	..	631	..
Carpenter, Senior, Dookie Agricultural College ..	..	515	..
Carpenter, Longerenong Agricultural College ..	450	489	1 of £26 and 1 of £13
Cook, Longerenong Agricultural College ..	455	481	1 of £26
Laboratory Attendant ..	..	338	..
Motion Picture Engineer, Assistant ..	..	739	..
Painter, Longerenong Agricultural College ..	450	489	1 of £26 and 1 of £13
Steward, Longerenong Agricultural College ..	299	312	..

SECOND SCHEDULE—continued.

Department and Office.	Yearly Rate of Salary.		Increments (Annual).
	Minimum.	Maximum.	
DEPARTMENT OF LABOUR AND INDUSTRY.	£	£	
Add—Shop Trading Investigator..	..	416	..
DEPARTMENT OF WATER SUPPLY.			
Add—Mechanical Plant Operator..	..	450	..

A. GARRAN, Chairman.  
V. P. SCULLY, Secretary.

Office of the Public Service Board,  
Melbourne, 1st July, 1957.

No. 626.

Public Service Act 1946, Section 50.

REGULATIONS—PART III.—SALARIES, INCREMENTS, AND ALLOWANCES.

Public Service Board, in pursuance of the powers conferred by the Public Service Act 1946, hereby amends its Regulations as shown below:—

SIXTH SCHEDULE.

TEMPORARY EMPLOYEES.

Designations of Positions and Rates of Salaries.

Department and Designation of Position.	Yearly Rate of Salary.		Increments (Annual).
	Minimum.	Maximum.	
DEPARTMENT OF TREASURER.	£	£	
HOUSING COMMISSION.			
Delete—Curator, Ascot Housing Estate	455	494	1 of £26 and 1 of £13
DEPARTMENT OF EDUCATION.			
Delete—Compositor, Leading Hand, Visual Education Centre..	527	553	§
§ Subject to satisfactory service, incremental progression shall be by two increments each of £13 payable after the completion of one and three years' service, respectively.			
DEPARTMENT OF AGRICULTURE.			
DOOKIE AGRICULTURAL COLLEGE.			
Delete—Carpenter, Senior ..	..	515	..

A. GARRAN, Chairman.  
V. P. SCULLY, Secretary.

Office of the Public Service Board,  
Melbourne, 1st July, 1957.

No. 620.

Public Service Act 1946, Section 50.

REGULATIONS.—PART III.—SALARIES, INCREMENTS, AND ALLOWANCES.

THE Public Service Board, in pursuance of the powers conferred by the Public Service Act 1946, hereby amends its Regulations as shown below :—

SECOND SCHEDULE.

TECHNICAL AND GENERAL DIVISION.

Offices and Rates of Salaries.

Department and Office.	Yearly Rate of Salary.		Increments (Annual).
	Minimum.	Maximum.	
	£	£	
DEPARTMENT OF TREASURER.			
HOUSING COMMISSION.			
<i>Delete—</i> Maintenance Supervisor ..	871	923	2 of £26
<i>Add—</i> Maintenance Officer ..	923	988	£1 of £39 and 1 of £26

A. GARRAN, Chairman.  
V. P. SCULLY, Secretary.

Office of the Public Service Board,  
Melbourne, 24th June, 1957.

No. 622.

Public Service Act 1946, Section 39.

REGULATIONS.—PART III.—SALARIES, INCREMENTS, AND ALLOWANCES.

THE Public Service Board, in pursuance of the powers conferred by the Public Service Act 1946, hereby amends its Regulations as shown below :—

FIRST SCHEDULE.

PROFESSIONAL DIVISION.

Offices and Rates of Salaries.

Office.	Yearly Rate of Salary.	
	Minimum.	Maximum.
	£	£
DEPARTMENT OF AGRICULTURE.		
CLASS "B".		
<i>Add—</i> District Agrostologist .. .. .	1,100	1,200
Live Stock Research Officer .. .. .	1,100	1,200
Manager, Mallee Research Station .. .. .	1,100	1,200
Manager, State Potato Research Station, Toolangi .. .. .	1,100	1,200
CLASS "C2".		
<i>Delete—</i> Live Stock Research Officer .. .. .	940	1,030
Manager, Mallee Research Station .. .. .	940	1,030
DEPARTMENT OF WATER SUPPLY.		
CLASS "A".		
<i>Add—</i> Manager, Bendigo Depot .. .. .	1,550	
CLASS "B1".		
<i>Delete—</i> Manager, Bendigo Depot .. .. .	1,300	1,400

A. GARRAN, Chairman.  
V. P. SCULLY, Secretary.

Office of the Public Service Board,  
Melbourne, 24th June, 1957.

No. 624.

PUBLIC SERVICE ACT 1946.

THE Public Service Board, in pursuance of the powers conferred by the Public Service Act 1946, hereby amends the Public Service (Public Service Board) Regulations as follows :—

PART VI.—TRAVELLING EXPENSES.

DIVISION III.—REIMBURSEMENT FOR USE OF MOTOR CAR, MOTOR CYCLE, OR BICYCLE.

Regulation 105.

Sub-regulation (1).

Immediately after the words "Officers who" the words "are authorized in the course of their duty to" are inserted.

The scale of rates in clause (b) is deleted, and the following scale is inserted in lieu thereof :—

	For the First 5,000 Miles in a Financial Year.	Mileage Over 5,000 Miles in a Financial Year.
	a mile.	a mile.
	d.	d.
Motor Cars—		
Over 24 h.p. .. .. .	13-9	9-5
Over 12 h.p. and up to 24 h.p. .. .. .	11-5	8-3
12 h.p. and under .. .. .	10-3	7-4
Motor Cycles, with side cars .. .. .	5-2	3-7
Motor Cycles .. .. .	4-4	3-2
Bicycles .. .. .	1s. 6d. a mile irrespective of mileage	

DIVISION IV.—GENERAL.

Regulation 111.

Sub-regulation (1) is revoked and the following sub-regulation is substituted therefor :—

"(1) Officers possessing motor cars may use them for transport on removal from one station to another or, where authorized by the Permanent Head, for a specific official journey, in which case they shall be reimbursed at the rate of 5-7d. a mile in respect of the distance travelled by them."

This Regulation shall have effect as on and from the 1st July, 1957.

A. GARRAN, Chairman.  
V. P. SCULLY, Secretary.

Office of the Public Service Board,  
Melbourne, 18th June, 1957.

No. 628.

Public Service Act 1946, Section 50.

REGULATIONS.—PART III.—SALARIES, INCREMENTS, AND ALLOWANCES.

THE Public Service Board, in pursuance of the powers conferred by the Public Service Act 1946, hereby amends its Regulations as shown below :—

SECOND SCHEDULE.

TECHNICAL AND GENERAL DIVISION.

Offices and Rates of Salaries.

Department and Office.	Yearly Rate of Salary.		Increments (Annual).
	Minimum.	Maximum.	
	£	£	
DEPARTMENT OF TREASURER.			
<i>Delete—</i> Customs Officer, Tender Board Office .. .. .	570	661	3 of £26 and 1 of £13
<i>Add—</i> Customs Officer, Tender Board Office .. .. .	635	726	3 of £26 and 1 of £13

This Regulation shall have effect as on and from the 18th June, 1957.

A. GARRAN, Chairman.  
V. P. SCULLY, Secretary.

Office of the Public Service Board,  
21st June, 1957.

No. 616.

Public Service Act 1946.

REGULATIONS.—PART III.—SALARIES, INCREMENTS, AND ALLOWANCES.

THE Public Service Board, in pursuance of the powers conferred by the Public Service Act 1946, hereby amends its Regulations as shown below:—

FOURTH SCHEDULE.

ADMINISTRATIVE DIVISION.

Amount or Range of Salary Assigned to Offices in Class "A1", Classes "A" and "A1", and Class "A".

Office.	Yearly Rate of Salary.	
	Minimum.	Maximum.
DEPARTMENT OF STATE FORESTS.		
CLASS "A".		
Delete— Chief Clerk .. .. .	1,550	1,750
Add— Assistant Secretary .. .. .	1,550	1,750

A. GARRAN, Chairman.  
V. P. SCULLY, Secretary.

Office of the Public Service Board,  
Melbourne, 13th June, 1957.

No. 623.

Public Service Act 1946, Section 50.

REGULATIONS.—PART III.—SALARIES, INCREMENTS, AND ALLOWANCES.

THE Public Service Board, in pursuance of the powers conferred by the Public Service Act 1946, hereby amends its Regulations as shown below:—

SIXTH SCHEDULE.

TEMPORARY EMPLOYEES.

Designations of Positions and Rates of Salaries.

Department and Designation of Position.	Yearly Rate of Salary.		Increments (Annual).
	Minimum.	Maximum.	
DEPARTMENT OF MINES.			
Add— Drill Sub-Foreman, Senior .. .. .	..	665	..

A. GARRAN, Chairman.  
V. P. SCULLY, Secretary.

Office of the Public Service Board,  
Melbourne, 18th June, 1957.

No. 630.

Public Service Act 1946.

REGULATIONS.—PART III.—SALARIES, INCREMENTS, AND ALLOWANCES.

THE Public Service Board, in pursuance of the powers conferred by the Public Service Act 1946, hereby amends its Regulations as shown below:—

FOURTH SCHEDULE.

ADMINISTRATIVE DIVISION.

Amount or Range of Salary Assigned to Offices in Class "A1", Classes "A" and "A1", and Class "A".

Office.	Yearly Rate of Salary.	
	Minimum.	Maximum.
DEPARTMENT OF CHIEF SECRETARY.		
CLASS "A."		
Delete— Registrar, Licensing Court .. .. .	..	1,550

A. GARRAN, Chairman.  
V. P. SCULLY, Secretary.

Office of the Public Service Board,  
Melbourne, 27th June, 1957.

No. 617.

Public Service Act 1946, Section 50.

REGULATIONS.—PART III.—SALARIES, INCREMENTS, AND ALLOWANCES.

THE Public Service Board, in pursuance of the powers conferred by the Public Service Act 1946, hereby amends its Regulations as shown below:—

SECOND SCHEDULE.

TECHNICAL AND GENERAL DIVISION.

Offices and Rates of Salaries.

Department and Office.	Yearly Rate of Salary.		Increments (Annual).
	Minimum.	Maximum.	
DEPARTMENT OF STATE FORESTS.			
Delete— Supervisor, Brookwood Workshop .. .. .	709	761	2 of £26
Add— Supervisor, Brookwood Workshop .. .. .	748	800	2 of £26

This Regulation shall have effect as on and from the 16th June, 1957.

A. GARRAN, Chairman.  
V. P. SCULLY, Secretary.

Office of the Public Service Board,  
Melbourne, 18th June, 1957.

No. 615.

Public Service Act 1946, Section 50.

REGULATIONS.—PART III.—SALARIES, INCREMENTS, AND ALLOWANCES.

THE Public Service Board, in pursuance of the powers conferred by the Public Service Act 1946, hereby amends its Regulations as shown below:—

SIXTH SCHEDULE.

TEMPORARY EMPLOYEES.

Designations of Positions and Rates of Salaries.

Department and Designation of Position.	Yearly Rate of Salary.		Increments (Annual).
	Minimum.	Maximum.	
DEPARTMENT OF CHIEF SECRETARY.			
CHILDREN'S WELFARE.			
Add— Cottage Mother .. .. .	..	541 <sup>φ</sup>	..

<sup>φ</sup> Includes payment for all incidents of employment, including overtime, work at night and work on Saturdays, Sundays, and Public Holidays.

A. GARRAN, Chairman.  
V. P. SCULLY, Secretary.

Office of the Public Service Board,  
Melbourne, 10th June, 1957.

No. 618.

## PUBLIC SERVICE ACT 1946.

THE Public Service Board, in pursuance of the powers conferred by the *Public Service Act 1946*, hereby amends the Public Service (Public Service Board) Regulations as follows:—

## PART III.—SALARIES, INCREMENTS, AND ALLOWANCES.

ROSTERED TIME OF ORDINARY DUTY PERFORMED BY OFFICERS OF THE TECHNICAL AND GENERAL DIVISION DURING WEEK-ENDS OR ON PUBLIC HOLIDAYS.

*Regulation 80.*

The amount "£911" is substituted for the amount "£768."

*This Regulation shall have effect as on and from the 1st July, 1957.*

A. GARRAN, Chairman.  
V. P. SCULLY, Secretary.

Office of the Public Service Board,  
Melbourne, 18th June, 1957.

No. 614.

## PUBLIC SERVICE ACT 1946.

THE Public Service Board, in pursuance of the powers conferred by the *Public Service Act 1946*, hereby amends the Public Service (Public Service Board) Regulations as follows:—

## PART II.—PROMOTIONS AND TRANSFERS.

## PROFESSIONAL DIVISION.

DEPARTMENT OF PREMIER—SOIL CONSERVATION AUTHORITY.

*Regulation 43.*

Sub-regulation (2) is revoked.

Sub-regulation (5) is revoked and the following sub-regulation substituted therefor:—

" (5) Any officer or employee who—

(a) on the 6th November, 1950, was in the employ of the Soil Conservation Authority and had completed not less than three years' practical experience as a Field Officer of such Authority, or

(b) has passed a soil conservation examination considered by the Board to be equivalent to the examination prescribed under this Regulation and who has completed not less than three years' practical experience in soil conservation approved by the Board on the recommendation of the Board of Examiners—

shall be deemed to have passed the Preliminary Examination."

Sub-regulation (7) is revoked and the following sub-regulation substituted therefor:—

" (7) Subject to the provisions of sub-regulation (5) of this Regulation, a candidate shall not be deemed to have passed the Preliminary Examination or the Final Examination, as the case may be, unless, either as an officer or employee of the Soil Conservation Authority or as a person in the employ of any other Authority deemed by the Board to be performing similar functions, he has completed the appropriate period of practical experience in soil conservation as prescribed hereunder:—

Preliminary Examination—not less than one year;

Final Examination—not less than three years."

*This Regulation shall have effect as on and from the 31st July, 1957.*

A. GARRAN, Chairman.  
V. P. SCULLY, Secretary.

Office of the Public Service Board,  
Melbourne, 26th June, 1957.

No. 621.

## PUBLIC SERVICE ACT 1946.

THE Public Service Board, in pursuance of the powers conferred by the *Public Service Act 1946*, hereby amends the Public Service (Public Service Board) Regulations as follows:—

## PART I.—APPOINTMENTS TO THE ADMINISTRATIVE, PROFESSIONAL, AND TECHNICAL AND GENERAL DIVISIONS.

TECHNICAL AND GENERAL DIVISION.

DEPARTMENT OF AGRICULTURE.

*Regulation 35.*

Sub-regulation (1).

Sub-clauses (i), (ii), and (iii) of clause (h) are deleted and the following sub-clauses are inserted:—

" (i) Vegetable Garden Management—including soils and soil preparation, cultivation, irrigation, drainage, and establishment of vegetable gardens.

(ii) Vegetable Production—including varieties and planting times, sowing and transplanting methods, spacing distances, fertilising, pruning, harvesting, curing and storage.

(iii) Vegetable Seed Production—including planting methods, isolation distances to prevent cross-pollination, harvesting and seed-cleaning methods, germination and purity requirements.

(iv) Marketing—including packing and presentation for market, size of bunches and packages, and marketing systems.

(v) Plant Pathology—life histories of the principal fungous diseases attacking vegetable crops and vegetable seed crops and methods of control.

(vi) Entomology—life histories of the principal insect pests attacking vegetable crops and vegetable seed-crops and methods of control.

(vii) Acts and Regulations—including the Seeds Act and the Vegetable Seed Certification Regulations, Vegetation and Vine Diseases Act and Regulations thereunder, and the Fruit and Vegetable Acts and Regulations thereunder."

A. GARRAN, Chairman.  
V. P. SCULLY, Secretary.

Office of the Public Service Board,  
Melbourne, 18th June, 1957.

No. 629.

## PUBLIC SERVICE ACT 1946.

THE Public Service Board, in pursuance of the powers conferred by the *Public Service Act 1946*, hereby amends the Public Service (Public Service Board) Regulations as follows:—

## PART I.—APPOINTMENTS TO THE ADMINISTRATIVE, PROFESSIONAL, AND TECHNICAL AND GENERAL DIVISIONS.

PROFESSIONAL DIVISION.

*Regulation 23.*

Sub-clause (i) of clause (a) is deleted and the following sub-clause is inserted in lieu thereof:—

" (i) the School Leaving Examination including the subject English and any two of the following subjects:—

Mathematics A,  
Mathematics I,  
Mathematics II; or "

In clause (b) the words "University or Technical School" are deleted and the word "approved" is inserted in lieu thereof.

A. GARRAN, Chairman.  
V. P. SCULLY, Secretary.

Office of the Public Service Board,  
Melbourne, 21st June, 1957.

## PUBLIC SERVICE (PUBLIC SERVICE BOARD) REGULATION 39—RECLASSIFICATIONS.

THE Public Service Board has raised the classification of the under-mentioned offices as shown, and the Permanent Heads of the Departments have recommended the officers named for appointment.

Office and Present Classification.	Revised Classification.	Duties.	Qualifications.	Officer Recommended for Appointment.		
				Name.	Classification.	Date of Classification.
<b>ADMINISTRATIVE DIVISION.</b>						
<b>DEPARTMENT OF PREMIER.</b>						
<i>Office of the Public Service Board.</i>						
Secretary to the Public Service Board, Class "A" (£1,550-£1,750)	Classes "A" and "A1" (£1,550-£2,000)	To act as Secretary to, and Executive Officer of, the Public Service Board and to be responsible for the administration of the Board's office	To possess an intimate knowledge of the Public Service Acts and the regulations thereunder, a wide knowledge of the organization and functions of the various departments, and administrative experience and organizing ability	Scully, V. P.	Secretary to the Public Service Board, Class "A" (£1,550-£1,750)	18.7.56
<b>DEPARTMENT OF LABOUR AND INDUSTRY.</b>						
Inspector of Factories and Shops (Male), Grade I. (Technical and General Division)	Inspector of Factories and Shops (Male), Class "C" (Administrative Division)	To visit and inspect factories, shops, and other places subject to the Department of Labour and Industry, for the purpose of advising upon and enforcing the provisions of the Labour and Industry Acts and other Acts administered by the Department, particularly in relation to wages, working conditions, and dangerous machinery in factories, and generally in relation to the health, safety, and convenience of all the workers	To possess a School Intermediate Certificate or an approved equivalent qualification; to have had at least five years' experience as an Inspector of Factories and Shops and to have passed the prescribed examination for promotion; to be capable of conducting investigations efficiently	Tuohill, E. J.	Inspector of Factories and Shops (Male), Grade I. (Technical and General Division)	28.11.56
<b>PROFESSIONAL DIVISION.</b>						
<b>DEPARTMENT OF CHIEF SECRETARY.</b>						
<i>Weights and Measures Branch.</i>						
Scientific Officer, Class "C1"	Deputy Superintendent of Weights and Measures, Class "C2"	To assist the Superintendent of Weights and Measures in administrative and technical work arising from the Weights and Measures Acts including the maintenance of standards, the design of equipment, and the examination of weighing and measuring appliances	A Degree or Diploma in Science or Engineering, including at least second year Physics, or other equivalent qualification; administrative, laboratory, and mechanical experience; a knowledge of the construction and methods of operation and testing of weighing and measuring equipment is desirable	Kellett, C. W. M.	Scientific Officer, Class "C1"	6.5.56
<b>DEPARTMENT OF AGRICULTURE.</b>						
Cerealist, Class "B1"	Senior Cereal Research Officer, Class "A" (£1,550-£1,600)	Under the Agricultural Superintendent, to plan the cereal research work conducted by the Department of Agriculture in Victoria, and other agronomic research projects in the cereal districts; to assist and deputize for the Senior Agronomist as required	Degree in Agricultural Science, Melbourne University, or its equivalent; proved capacity in the design and conduct of cereal and agronomic research work, and in the interpretation of results; experience in cereal cropping methods and practices	Sims, H. J.	Cerealist, Class "B1"	10.12.51
Science Master, Dookie Agricultural College, Class "C2"	Lecturer in Animal Husbandry, Class "B"	Under the Principal to lecture to students in one or more aspects of Animal Husbandry and teach science subjects related to Animal Husbandry; to be responsible to the Principal for the organization and supervision of demonstrations to students in all aspects of Animal Husbandry; to advise the Principal on modern techniques in the breeding and feeding of farm animals; to share house duties and perform such other duties as may be required	To possess a University degree in Agricultural Science or Science and to have had sound training and experience in teaching; to have sound training in, and knowledge of, the breeding, care, and general management of livestock	McMillan, I. S.	Science Master, Dookie Agricultural College, Class "C2"	8.6.56



PUBLIC SERVICE (PUBLIC SERVICE BOARD) REGULATION 39.—RECLASSIFICATIONS—*continued.*

Office and Present Classification.	Revised Classification.	Duties.	Qualifications.	Officer Recommended for Appointment.		
				Name.	Classification.	Date of Classification.

## TECHNICAL AND GENERAL DIVISION.

## DEPARTMENT OF CHIEF SECRETARY.

*Office of the Government Statist.*

Attendant ..	Photographer, Grade II. (£488—£568)	To carry out photographic work, particularly on registers of births, deaths and marriages; to have charge of the operation of the Photostat machine, including processing and printing	To be a competent photographer with a thorough knowledge of all branches of photography; to have experience of the various Schedules under the Registration of Births, Deaths and Marriages Act	Dodds, J. A.	Attendant ..	5.6.55
--------------	-------------------------------------	--	---	--------------	--------------	--------

Appeals against such recommendations should be lodged with the Secretary to the Public Service Board not later than Saturday, the 13th July, 1957.

By order,

V. P. SCULLY,

Secretary.

Office of the Public Service Board,  
Melbourne, 2nd July, 1957.

## PUBLIC SERVICE (PUBLIC SERVICE BOARD) REGULATION 39.—VACANCIES.

THE Permanent Heads of the Departments shown have recommended the officers named hereunder for appointment to the under-mentioned vacancies.

Office and Classification.	Duties.	Qualifications.	Officer Recommended for Appointment.		
			Name.	Classification.	Date of Classification.

## PROFESSIONAL DIVISION.

## DEPARTMENT OF HEALTH.

## TUBERCULOSIS BRANCH.

*Heatherton Sanatorium.*

Senior Medical Officer (Sanatoria), Class "A1" (£1,900—£2,150)	Subject to the Medical Superintendent of the Sanatorium to undertake the medical care and treatment of Tuberculosis patients; to act as Deputy Superintendent; to perform such other medical duties as the Director of Tuberculosis may from time to time direct	To be a legally qualified medical practitioner with at least one year's post graduate hospital experience; to be experienced in the treatment of persons suffering from pulmonary tuberculosis	Milne, R. C. ..	Medical Officer, (Male.) Classes "A" and "A1" (£1,550—£1,900)	18.5.55
--	--	--	-----------------	---	---------

## TECHNICAL AND GENERAL DIVISION.

## DEPARTMENT OF TREASURER.

*Office of the Housing Commission.*

Construction Superintendent (£754—£808)	Under the direction of the Chief Architect to be responsible for the control of field supervision and for the effective employment, allocation and technical instruction of Clerks of Works engaged in the supervision of housing construction contracts	To have wide experience in the construction of all classes of residential buildings, and to possess ability to prepare operational and technical directives and reports; to possess a current motor car driver's licence	Kemp, H. L. W. P.	Construction Inspector	20.2.53
---	--	--	-------------------	------------------------	---------

Appeals against such recommendations should be lodged with the Secretary to the Public Service Board not later than Saturday, the 13th July, 1957.

By order,

V. P. SCULLY,

Secretary.

Office of the Public Service Board,  
Melbourne, 2nd July, 1957.

**TENDERS—PUBLIC WORKS DEPARTMENT**

**TENDERS** will be received at this office until **TEN a.m.** on the days and for the purposes under mentioned.

Particulars may be learnt at this Office and also at places shown in parenthesis.

W.O. means Inspector of Works Office; P.S.—Police Station; T.S.—Technical School; H.E.S.—Higher Elementary School; S.S.—State School; H.S.—High School.

The Board of Land and Works will not necessarily accept the lowest or any tender.

**NOTE.**—No preliminary deposits are to be lodged with tenders, but a deposit, in accordance with the following Schedule, will be required from the successful tenderer:—

	£
For contract amounts exceeding £200 and not exceeding £500	5
For contract amounts exceeding £500 and not exceeding £1,000	10
For contract amounts exceeding £1,000—1 per cent. of tender	500
	(maximum deposit)

All tenders should be on a "firm tender" basis.

In preparing tenders, regard should be had to the decision of the Commonwealth Court of Conciliation and Arbitration and the resultant effects in respect of wages and materials.

9th July, 1957.

Aberfeldie.—Relaying section of sewerage drain, S.S. No. 4220. (S.S., Aberfeldie.)

Benalla.—Erection of Public Offices. (W.O., Benalla; Wangaratta.)

Blackburn East.—Erection of six-classroom primary school building, S.S. No. 4800.

Blackburn East.—Electrical installation, new six (6) classrooms, &c., L.T.C., S.S. No. 4800.

Blackburn East.—Heating/ventilation system in new six-classroom primary school building, S.S. No. 4800.

Cheltenham.—Construction of new out-office block and connecting same to sewer, &c., S.S. No. 84. (S.S., Cheltenham.)

Dandenong.—Central heating to existing buildings, High School. (H.S., Dandenong.)

Dingley.—Septic tank installation and laying of sewer drains, &c., S.S. No. 4257. (S.S., Dingley.)

Ellinbank.—Supply and installation of milking machinery and mechanical services in the No. 3 Dairy, Dairy Research Station. (Dairy Research Station, Ellinbank.)

Erica.—Installation of hot-water service, Police Station. (P.S., Erica.)

Flemington.—Renewal of chalkboards with cupboards under, S.S. 250. (S.S., Flemington.)

Glengarry West.—Repairs and painting to the school and residence, S.S. No. 4426. (W.O., Traralgon; S.S., Glengarry West.)

Heatherton.—Removal of small building and extensions to same, Sanatorium.

Heatherton.—Supply and delivery of steam-heated bain marie and hot press, nurses' dining-room, Sanatorium.

Horsham.—Repairs and painting to residence, corner Alexandra-avenue and Wavell-street, Lands Department. (W.O., Horsham.)

Kew.—Supply and delivery and placing in position on site new hot press and bain marie for male staff mess, Mental Hospital.

Lakes Entrance.—Additional out-offices, drinking facilities, &c., S.S. No. 2672. (W.O., Bairnsdale; P.S., Lakes Entrance.)

Manangatang.—Erection of new shelter pavilion, conversion of existing to storeroom, Consolidated and Higher Elementary School. (W.O., Swan Hill; Consolidated School, and Higher Elementary School, Manangatang.)

Melbourne.—Repairs to steel window frames, Taxation Office.

Mitcham.—Additional out-offices, drinking and washing facilities, S.S. No. 2904. (S.S., Mitcham.)

Rushworth.—Rewiring of and additions to electrical installation, Higher Elementary and S.S. No. 1057. (W.O., Bendigo, Shepparton; H.E. and S.S., Rushworth.)

Seaford.—Erection of a shelter pavilion, 32 ft. x 16 ft., and additional lavatories, S.S. No. 3835. (S.S., Seaford.)

Shepparton.—Electrical installation, old primary school at Technical School. (W.O., Shepparton; T.S., Shepparton.)

South Melbourne.—Soundproofing between offices and classrooms, Technical School. (T.S., South Melbourne.)

Sunshine East.—Supply and erection of chain wire mesh and pipe-rail fencing, including gates (New Infants' School), S.S. No. 4645. (S.S., Sunshine East.)

Templestowe.—Additional out-office accommodation, drinking and washing facilities, S.S. No. 1395. (S.S., Templestowe.)

Warragul North.—Fencing of school site in pipe rail and chain mesh, and post and wire, S.S. No. 4695. (W.O., Traralgon; S.S., Warragul North.)

Watsonia.—Electrical installation in stage 1, Technical School.

Watsonia.—Mechanical services for stage 1, Technical School.

Watsonia.—Erection of first section in L.T.C., Technical School.

16th July, 1957.

Ballarat.—Conversion of the existing steam generators to heavy oil burning, and the supply and installation of new steam header and relevant pipework and fittings, &c., in the boiler house, Mental Hospital. (W.O., Ballarat.)

Carlton.—Various minor works, Teachers' College Hostel, Drummond-street.

Caulfield.—Rewiring and additions to electrical installation, S.S. No. 773. (S.S., Caulfield.)

Caulfield North.—Installation of two sinks and sewerage drains, S.S. No. 3820.

Drouin.—Erection of pipe and chain mesh fence on street frontage (943 feet non-party), High School. (W.O., Traralgon; H.S., Drouin.)

Drouin.—Internal renovations, S.S. No. 1924. (W.O., Traralgon; S.S., Drouin.)

Eastmoor.—Installation of sump pump in septic tank, S.S. No. 4790.

Geelong North.—Repairs and renewal of fencing, party and non-party, S.S. No. 1889. (W.O., Geelong; S.S., Geelong North.)

Glenrowan.—Purchase and removal of residence, S.S. No. 1742. (W.O., Benalla.)

Grass Flat.—Repairs and renovations, S.S. No. 3192. (W.O., Horsham; S.S., Grass Flat.)

Hawthorn.—Erection of timber crossover, Swinburne Technical College. (Swinburne Technical College, Hawthorn.)

Heatherton.—Alterations and additions to medical superintendent's brick residence at Sanatorium.

Heatherton.—Repairs and painting, S.S. No. 938. (S.S., Heatherton.)

Hughesdale.—Renewal of chalkboards and two drinking troughs, S.S. No. 4176. (S.S., Hughesdale.)

Lavers Hill.—Erection of four-unit teachers' flats, Consolidated School. (W.O., Warrnambool, Camperdown.)

Malvern.—External painting and roof repairs, infant school building, S.S. No. 1604. (S.S., Malvern.)

Melbourne.—External painting and repairs, Government Statist's Office.

Melbourne.—Supply and installation of room air-conditioning unit and water cooling unit in Photographic Laboratory, Scientific Section, Police Headquarters, Russell-street.

Melbourne and Suburbs.—Chimney sweeping, 1st July, 1957, to 30th June, 1958, Public Buildings.

Moe.—Erection of shelter pavilion, S.S. No. 2142. (W.O., Traralgon; S.S., Moe.)

Mordialloc-Chelsea.—Erection of No. 2 shelter pavilions, 32 ft. x 16 ft., High School. (H.S., Mordialloc-Chelsea.)

Myrtleford.—Installation of slow-combustion stoves and hot-water services in two residences, Tobacco Research Station. (W.O., Wangaratta; Tobacco Research Station, Myrtleford.)

Nambrook West.—Erection of timber residence, garage, fencing, &c., S.S. No. 3648. (W.O., Traralgon; S.S., Nambrook West.)

Nambrook West.—Supply and installation of electric hot-water service, teacher's residence, S.S. No. 3648. (S.S., Nambrook West.)

Newcomb.—Erection of six-classroom primary school in L.T.C., S.S. No. 4776. (W.O., Geelong.)

Prospect Estate.—Repairs and painting, S.S. No. 4324. (W.O., Bairnsdale; S.S., Prospect Estate.)

Shepparton.—Supply and installation of air-conditioning system, Supreme Court. (W.O., Shepparton.)

South Melbourne.—Additional toilets for policewomen, Police Depot, St. Kilda-road.

South Yarra.—Installation of sanitary fittings, alterations to sewer drains, water supply, &c., "Park Mansions," 19 Park-street, T.B. Convalescent Hospital.

Strathmore.—Supply, delivery, installation, and testing of the mechanical services for stages 1 and 2 of building programme, High School.

Warrnambool.—Internal and external repairs and painting to residence, 38 Princess-street, S.S. No. 1743. (W.O., Warrnambool; S.S., Warrnambool.)

Yinnar.—Renovations to school and residence, new out-offices, S.S. No. 2419. (W.O., Traralgon; S.S., Yinnar.) (Amended specification.)

23rd July, 1957.

Birchip.—Electrical installation, High School. (W.O., Warracknabeal.)

Caramut.—Repairs, external and internal painting to residence, S.S. No. 728. (W.O., Warrnambool; S.S., Caramut.)

Carlton.—Electrical installations, school and caretaker's residence, S.S. No. 2605. (S.S., Carlton.)

Charlton.—Additions to electrical installations in higher elementary school and cookery school, S.S. No. 1480. (W.O., Bendigo, Swan Hill; S.S., Charlton.)

Dandenong.—Erection of first and second sections of concrete veneer and timber-framed Girls' Secondary School.

Dandenong.—Electrical services in first and second sections, Girls' Secondary School.

Dandenong.—Mechanical services for stages 1 and 2, Girls' Secondary School. (P.S., Dandenong.)

Elwood.—Supply, delivery, installation, and testing of the mechanical services for stage 2 of the building programme, High School.

Footscray.—Internal and external painting and repairs to electrical trades building, Technical School. (T.S., Footscray.)

Horsham East.—Shelter shed, woodshed, and out-offices, tank stand, &c., S.S. No. 4799. (W.O., Horsham; P.S., Nhill; S.S., Horsham East.)

Kew.—Additions to electrical installation in main school and infants' school, S.S. No. 1075. (S.S., Kew.)

Kiewa Valley.—Internal and external repairs and painting, Consolidated School, Kiewa Valley. (W.O., Wangaratta; Consolidated School, Kiewa Valley.)

Lake Hindmarsh.—New out-offices and woodshed, water supply, drainage, &c., S.S. No. 2879. (W.O., Warracknabeal; P.S., Nhill, Dimboola; S.S., Lake Hindmarsh.)

Merton.—Repairs and painting to school and residence, S.S. No. 1532. (W.O., Alexandra; S.S., Merton.)

Mt. Wallace.—New out-office block, shelter shed, and drinking facilities, S.S. No. 1018. (W.O., Ballarat; S.S., Mt. Wallace.)

Murtoa.—Completion of services to two new L.T.C. classrooms, High School. (W.O., Warracknabeal, Horsham; H.S., Murtoa.)

Natte Yallock.—Provision of chalkboards and water storage, S.S. No. 1347. (W.O., Maryborough; S.S., Natte Yallock.)

Pearcedale.—Installation of septic closets, S.S. No. 2061. (W.O., Korumburra; S.S., Pearcedale.)

Seymour.—Roof repairs, main school building, S.S. No. 547. (W.O., Alexandra, Shepparton; P.S., Seymour; S.S., Seymour.)

St. Arnaud.—Laying of sewer drains, installation of sanitary fittings, &c., S.S. No. 1646. (W.O., Maryborough; S.S., St. Arnaud.)

Sunbury.—New offices for charge nurses, wards F.4 and F.6, Mental Hospital.

Sunshine North.—Supply and erection of wire mesh and pipe rail fencing, including gates, S.S. No. 4745. (S.S., Sunshine North.)

All tenders should be on a "firm tender" basis.

In preparing tenders, regard should be had to the decision of the Commonwealth Court of Conciliation and Arbitration and the resultant effects in respect of wages and materials.

Tenders to be addressed to the Honorable the Commissioner of Public Works, and envelope containing tender marked "Tender for \_\_\_\_\_ due \_\_\_\_\_"

T. K. MALTYBY,  
Commissioner of Public Works.

Public Works Department,  
Melbourne, 2nd July, 1957.

### PRIVATE ADVERTISEMENTS

NOTICE OF INTENTION TO APPLY FOR A LICENCE TO DIVERT WATER AND CUT RACE FROM THE MURRAY RIVER, AT YARRAWONGA.

I HEREBY give notice that I intend to apply for a licence empowering me to divert water for a term of fifteen years to the extent of 300 acre-feet per annum at a maximum rate of 10 acre-feet per day of 24 hours for the irrigation of 150 acres, being part of allotments 57, 58, 59, and 62, Parish of Yarrowonga, and to occupy certain Crown lands for works of diversion, and to cut a race thereon.

Any objection to such application must be forwarded, in writing, to the State Rivers and Water Supply Commission, Melbourne, within 30 days of the date hereof.

CLARENCE ROBERT DAVIS.  
Yarrowonga. 1491

NOTICE OF INTENTION TO APPLY FOR A LICENCE TO DIVERT WATER AND CUT RACE FROM THE GUNBOWER CREEK, AT GUNBOWER.

WE hereby give notice that we intend to apply for a licence empowering us to divert water for a term of fifteen years to the extent of 150 acre-feet per annum at a maximum rate of 5 acre-feet per day of 24 hours for the irrigation of 75 acres, being part of allotments 68, 69, and 53B, sections E and 7, Parishes of Patho and Gunbower, and to occupy certain Crown lands for works of diversion, and to cut a race thereon.

Any objection to such application must be forwarded, in writing, to the State Rivers and Water Supply Commission, Melbourne, within 30 days of the date hereof.

J. D. ROWLANDS.  
D. L. ROWLANDS.  
Gunbower. 1490

NOTICE OF INTENTION TO APPLY FOR A LICENCE TO DIVERT WATER AND CUT RACE FROM THE MURRAY RIVER, AT YARRAWONGA.

WE hereby give notice that we intend to apply for a licence empowering us to divert water for a term of fifteen years to the extent of 400 acre-feet per annum at a maximum rate of 10 acre-feet per day of 24 hours for the irrigation of 200 acres, being part of allotment 73, Parish of Yarrowonga, and to occupy certain Crown lands for works of diversion, and to cut a race thereon.

Any objection to such application must be forwarded, in writing, to the State Rivers and Water Supply Commission, Melbourne, within 30 days of the date hereof.

JAMES REILLY.  
LEO REILLY.  
Yarrowonga. 1492

NOTICE OF INTENTION TO APPLY FOR A LICENCE TO DIVERT WATER AND CUT RACE FROM THE MURRAY RIVER, AT YARRAWONGA.

I HEREBY give notice that I intend to apply for a licence empowering me to divert water for a term of fifteen years to the extent of 300 acre-feet per annum at a maximum rate of 10 acre-feet per day of 24 hours for the irrigation of 150 acres, being part of allotments 70, 71, 72, and 74A, Parish of Yarrowonga, and to occupy certain Crown lands for works of diversion, and to cut a race thereon.

Any objection to such application must be forwarded, in writing, to the State Rivers and Water Supply Commission, Melbourne, within 30 days of the date hereof.

JAMES REILLY.  
Yarrowonga. 1493

NOTICE OF INTENTION TO APPLY FOR A LICENCE TO DIVERT WATER AND CUT RACE FROM THE GUNBOWER CREEK, AT GUNBOWER ISLAND.

I HEREBY give notice that I intend to apply for a licence empowering me to divert water for a term of fifteen years to the extent of 150 acre-feet per annum at a maximum rate of 5 acre-feet per day of 24 hours for the irrigation of 100 acres, being part of allotments 21, 22, and 21A, section 8, Parish of Gunbower, and to occupy certain Crown lands for works of diversion, and to cut a race thereon.

Any objection to such application must be forwarded, in writing, to the State Rivers and Water Supply Commission, Melbourne, within 30 days of the date hereof.

JOHN ERIC KEOGH.  
Burke's Bridge, via Cohuna. 1504

NOTICE OF INTENTION TO APPLY FOR A LICENCE TO DIVERT WATER AND CUT RACE FROM THE GUNBOWER CREEK, CHENNALS LAGOON, AT TORRUMBARRY.

I HEREBY give notice that I intend to apply for a licence empowering me to divert water for a term of fifteen years to the extent of 100 acre-feet per annum at a maximum rate of 5 acre-feet per day of 24 hours for the irrigation of 50 acres, being part of allotment 23, section D, Parish of Patho, and to occupy certain Crown lands for works of diversion, and to cut a race thereon.

Any objection to such application must be forwarded, in writing, to the State Rivers and Water Supply Commission, Melbourne, within 30 days of the date hereof.

JOHN THOMAS WILLIAMS.  
Torrumbarry. 1503

NOTICE OF INTENTION TO APPLY FOR A WATER EASEMENT LICENCE.

WE, the undersigned, hereby give notice as hereunder of our respective and individual intentions to apply for licences authorizing us to construct and use a race and pipe line upon the undermentioned land. Any objection to these applications must be forwarded in writing to the State Rivers and Water Supply Commission, Melbourne, within thirty days of the date thereof.

Names and Addresses of Applicants.	Particulars of Land upon or through which Easement Desired.		Nature and Purposes of Easement.	Term for which Licence Required.
	Situation of Land.	Name and Address of Owner.		
Clarence Robert Davis, Yarrowonga .. .. .	Crown Allotment 13A, Parish of Bundalong	William Albert Bott, Yarrowonga	Race and pipe line for irrigation, pasture, stock, and domestic purposes	Fifteen years
James Reilly, Yarrowonga .. .. .	" " "	" " "	" " "	Fifteen years
Francis Joseph Keenan, Boomahnoomoonah .. .	" " "	" " "	" " "	Fifteen years
James Reilly and Leo Reilly, Yarrowonga .. .	" " "	" " "	" " "	Fifteen years
Walter Leo Ryan and William Joseph Ryan, Yarrowonga	" " "	" " "	" " "	Fifteen years

Dated at Yarrowonga this 27th day of June, 1957.

Signatures of Applicants:—

Clarence Robert Davis, Yarrowonga, farmer. Francis Joseph Keenan, Boomahnoomoonah, farmer. Walter Leo Ryan, Yarrowonga, farmer. James Reilly, Yarrowonga, farmer. Leo Reilly, Yarrowonga, farmer.  
1494 William Joseph Ryan, Yarrowonga, farmer.

NOTICE OF INTENTION TO APPLY FOR A LICENCE TO DIVERT WATER AND CUT RACE FROM THE GUNBOWER CREEK, AT GUNBOWER.

I HEREBY give notice that I intend to apply for a licence empowering me to divert water for a term of fifteen years to the extent of 150 acre-feet per annum at a maximum rate of 8 acre-feet per day of 24 hours for the irrigation of 75 acres, being part of allotments 81, 84, and 85, section E, Parish of Patho, and to occupy certain Crown lands for works of diversion, and to cut a race thereon.

Any objection to such application must be forwarded, in writing, to the State Rivers and Water Supply Commission, Melbourne, within 30 days of the date hereof.

ALEXANDER ANGUS McINNES.

Gunbower. 1470

NOTICE OF INTENTION TO APPLY FOR A LICENCE TO DIVERT WATER AND CUT RACE FROM THE GUNBOWER CREEK, AT COHUNA.

I HEREBY give notice that I intend to apply for a licence empowering me to divert water for a term of fifteen years to the extent of 150 acre-feet per annum at a maximum rate of 6 acre-feet per day of 24 hours for the irrigation of 75 acres, being part of allotments 39, 45, and 45A, section 8, Parish of Gunbower West, and to occupy certain Crown lands for works of diversion, and to cut a race thereon.

Any objection to such application must be forwarded, in writing, to the State Rivers and Water Supply Commission, Melbourne, within 30 days of the date hereof.

JOSEPH HEAP.

Box 127, Cohuna. 1464

MEENIYAN WATERWORKS TRUST.

NOTICE to owners of tenements in the under-mentioned streets, and the private streets, lanes, courts, and alleys opening thereto:—

- McLaine-street, to the junction of Morgans-road.
- Morgans-road.
- Whitelaw-street, from the junction of Morgans-road eastward to Greaves-street.
- Ross-street, from Whitelaw-street to McKitterick-street.
- McKitterick-street, from the western boundary of allotment 22, section 5, to Geale-street.
- Geale-street, south-east from the railway crossing to the eastern boundary of allotment 34, section 4.
- Hanily-street, from the railway crossing to the water district boundary.
- McDonald-street.
- Maloneys-lane, from Royston-street to the western boundary of allotment 16, section 2.
- Scholes-street, from Hanily-street to a point 6 chains westward.
- Royston-street, from Maloneys-lane to Odgers-lane.

The main pipe in the said streets being laid down, the owners of all tenements situated as above are hereby required, on or before the 7th day of August, 1957, to cause proper pipes and stop-cocks to be laid so as to supply water within such tenements from the main pipe.

1502 J. R. THOMPSON, Secretary.

BENDIGO SEWERAGE AUTHORITY.

THE Bendigo Sewerage Authority having made provision for carrying off the sewage from each and every property which or any part of which is within the boundaries of the Sewerage Areas hereinafter defined, doth hereby declare that on and after the first day of July, 1957, each and every property which or any part of which is within the said Sewerage Areas shall be deemed to be a seweraged property within the meaning of the Sewerage Districts Acts. The Sewerage Areas referred to are bounded as follows, viz.:—

Sewerage Area No. 130.

Commencing at a point on the boundary of Sewerage Area No. 105 on the centre line of Keck-street 2½ chains east of the east side of Neale-street; thence southerly by a line parallel with and 2½ chains east of the east side of Neale-street to the south side of Dreschler-street; thence easterly along the south side of Dreschler-street, to a point 4 chains east of the east side of Neale-street; thence southerly by a line parallel with and 4 chains east of the east side of Neale-street to the centre line of a race reserve; thence generally southerly and easterly along the centre line of the said race reserve to the prolongation of the south-eastern boundary of Crown allotment 532, section H, Parish of Sandhurst; thence south-westerly by a line across the race reserve and along the south-eastern boundary of the said Crown allotment 532 and its prolongation to the centre line of Osborne-street; thence north-westerly along the centre line of Osborne-street to its junction with the centre line of Neale-street; thence northerly generally westerly, northerly and generally easterly along the boundaries of Sewerage Areas Nos. 126, 70, 51, 91, 125, 91 and 105 to the point of commencement.

Sewerage Area No. 131.

Commencing at the south-eastern corner of Sewerage Area No. 127; thence by a line to a point 2½ chains east of the east side of MacDougall-road and 2½ chains south of the south side of Collins-street; thence generally northerly by an irregular line through Crown lands being the rear boundaries of sundry freehold allotments and residence areas fronting MacDougall-road to a point on the south-western side of Belle Vue-road; thence north-easterly by an irregular line across Belle Vue-road, through Crown lands and along the rear boundaries of properties fronting Breen-street to the west side of Sullivan-street; thence by a line across Sullivan-street to the southern most corner of Sewerage Area No. 121; thence in an anti-clockwise direction along the boundaries of Sewerage Areas Nos. 121, 47, and 127 to the point of commencement.

Sewerage Area No. 132.

Commencing at the most western corner of Crown allotment 139, section C, City of Bendigo; thence south-easterly along the south-western boundaries of the said allotment to its most southerly corner; thence southerly by a line parallel with Young-street a distance of 4½ chains; thence easterly by a line at right angles thereto to the boundary of Sewerage Area No. 127; thence in an anti-clockwise direction along the boundaries of Sewerage Area No. 127 to the point of commencement.

## Sewerage Area No. 133.

Commencing at the most eastern point on the boundary of Sewerage Area No. 109; thence south-easterly along the north-eastern boundary of Crown allotment 522, section H, Parish of Sandhurst, and its continuation through Crown allotments Nos. 96 and 95, no section, to the south-eastern boundary of Crown allotment No. 95; thence north-easterly along the said south-eastern boundary and its continuation across Strathfieldsaye-road to the boundary of Sewerage Area No. 111; thence in an anti-clockwise direction along the boundaries of Sewerage Areas Nos. 111, 90, 66, 76, 86 and 109 to the point of commencement.

By order of the Bendigo Sewerage Authority,

1475 H. W. SNELL, Chairman.  
H. A. MOORS, Secretary.

## CITY OF COLLINGWOOD.

## BY-LAW No. 88.

## Regulation of Traffic.

A By-law of the City of Collingwood, made under Part VII., Division 1, of the *Local Government Act 1946*, and numbered 88, for regulating traffic in Gordon-street, Clifton Hill, and Myrtle-street, Clifton Hill, and further for prohibiting the leaving of vehicles in Smith-street, Collingwood, in the said City of Collingwood.

IN pursuance of the powers contained in the *Local Government Act 1946*, the Mayor, Councillors and Citizens of the City of Collingwood order as follows:—

1. In this By-law "vehicle" means any conveyance drawn or propelled by human, animal, mechanical or other power and includes a "motor car" within the meaning of the *Motor Car Act 1951*.
2. No vehicle shall be driven and no animal shall be ridden or driven at any time in a northerly direction along Gordon-street, Clifton Hill, or in a southerly direction along Myrtle-street, Clifton Hill, and no vehicle shall proceed at any time or in any direction along either the said Gordon-street, or the said Myrtle-street, if the weight of the said vehicle together with the weight of the load being carried thereon exceed 5 tons.
3. Every person who is in charge of any vehicle which is at any time upon either Gordon-street, or Myrtle-street, Clifton Hill, shall upon drawing up any such vehicle in such street cause the same to be drawn up (unless the same is so drawn up for the purpose of loading or unloading the same) at the eastern guttering of Gordon-street or the western guttering of Myrtle-street, as the case may be.
4. No person shall cause or permit any vehicle of which he or she may be in charge to remain stationary at any time or at any place in Smith-street, in the City of Collingwood, for a period of time exceeding two hours.
5. Every person who is guilty of an offence against any clause or any part thereof of this By-law shall be guilty of an offence and liable on conviction to a penalty not exceeding Ten pounds.

The resolution for passing this By-law was agreed to by the Council on the 30th day of July, 1956, and confirmed on the 27th day of August, 1956.

The common seal of the Mayor, Councillors and Citizens of the City of Collingwood was hereto affixed by order of the Council on the 3rd day of September, 1956, in the presence of—

(SEAL) H. F. DUMMETT, Mayor.  
G. TUNALEY, Councillor.  
G. J. BROWN, Town Clerk.

Approved by the Governor in Council on the 11th June, 1957, in so far as such approval is required pursuant to the provisions of Section 197, *Local Government Act 1946*.  
—A. MAHLSTEDT, Clerk of the Executive Council. 1473

## CITY OF FOOTSCRAY.

## REGULATION No. 219.

NOTICE is hereby given that the Council of the City of Footscray has made a Regulation numbered 219, under the provisions of the *Local Government Act 1946*, for regulating any meeting or gathering in the Municipal Hall Buildings in Empire-street, Footscray.

The following is a summary of the provisions of the above-mentioned Regulation:—

1. Rules for preserving good order and decency in the Municipal Hall Buildings in Empire-street, Footscray, and preventing damage to such buildings and to the furniture and fittings thereof.

2. Conditions of letting.

3. The Schedule of Charges for the hire of the Buildings.

A copy of the regulation may be inspected free of charge at the Town Hall, Footscray, during office hours.

Resolution agreed to on the 27th May, 1957, and confirmed on the 24th June, 1957.

1483

E. J. SMITH, Town Clerk.

## CITY OF HEIDELBERG.

## LOAN No. 80.

NOTICE is hereby given that the Council of the City of Heidelberg proposes to borrow the sum of £25,000 on the credit of the Mayor, Councillors and Citizens of the City of Heidelberg in accordance with the provisions of the *Local Government Act 1946*, and amendments.

The rate of interest to be paid shall be £5 10s. per centum per annum.

The said loan shall be liquidated by thirty half-yearly repayments of the principal thereof on the first day of April and the first day of October in each year during the currency of the loan, together with interest from time to time accruing on so much of the total amount of the said loan as is unpaid.

Such monies shall be repayable at the Commonwealth Trading Bank of Australia, Melbourne, or at the Council's bankers for the time being in the City of Melbourne.

The purposes for which the said loan shall be applied are as follows:—

Purchase of grader .. .. .	£9,800
Construction of Olympic swimming pool (part cost only) .. .. .	£15,200
	<u>£25,000</u>

The plans, specifications and estimate of cost of the work referred to above and a statement showing the proposed expenditure are open for inspection at the office of the Council, Town Hall, Ivanhoe, on all days and between the hours the said office is appointed to be open.

Dated this 2nd day of July, 1957.

1484

F. PHILLIPS, Town Clerk.

## TOWN OF COLAC.

## BY-LAW No. 28.

*Prohibiting the Leaving of Motor Cars and Other Vehicles Standing in Streets, &c.*

A By-law of the Town of Colac, made under the provisions of section 197 of the *Local Government Act 1946*, and every other power enabling it in that behalf, and numbered 28, for the purpose of prohibiting the leaving (whether unattended or not) of motor cars and other vehicles standing in the street or road or part thereof specified in the By-law, and for suppressing nuisances.

THE Mayor, Councillors, and Burgesses of the Town of Colac, in pursuance of the powers conferred by the *Local Government Act*, order as follows:—

1. In this By-law—

"Motor car" means a motor car within the meaning of paragraph (c) of sub-section 3 of section 197 of the *Local Government Act 1946* the overall length of which exceeds 20 feet and the weight of which when unladen exceeds 2 tons.

"Overall length" shall have the same meaning as the definition of overall length in section 3 of the *Motor Car Act 1951*.

2. No person shall leave (whether unattended or not) any motor car standing in such streets or roads or parts thereof as are specified in the Schedule hereto between the hours of midnight and 6 o'clock in the morning.

3. Any person committing any breach of the provisions of this By-law shall be liable on conviction for a first offence to a penalty not exceeding Five pounds (£5), and for any second or subsequent offence to a penalty not exceeding Twenty pounds (£20).

## THE SCHEDULE.

The whole of Murray-street; that portion of Jennings-street east of Cants-road; the whole of Armstrong, Bromfield, Calvert, Campbell, Chapel, Church, Connor, Corangamite, Dennis, Gellibrand, Grant, Gravesend, Hart, Hearn, Hesse, Hewitt, Ligar, Manifold, Marks, McLaughlin, Miller, Moore, Nelson, Pollack, Queen, Sinclair, Skene, Wallace, and Wilson streets; Johnstones-lane, Murray-street east, and White-avenue.

Resolution for passing this By-law agreed to by the Council of the Town of Colac on the 19th day of December, 1956, and confirmed by the said Council on the 23rd day of January, 1957.

The common seal of the Mayor, Councillors, and Burgesses of the Town of Colac was hereunto affixed this 23rd day of January, 1957, in the presence of—

(SEAL) D. C. STALKER, Mayor.  
J. C. McLENNAN, Councillor.  
F. M. KELLY, Town Clerk.

Approved by the Governor in Council on the 11th day of June, 1957.—A. MAHLSTEUT, Clerk of the Executive Council. 1513

## BOROUGH OF CAMPERDOWN.

## BY-LAW No. 6.

A By-law of the Borough of Camperdown, made under the *Health Act 1928*, and numbered 6, for or with respect to—

- (a) prescribing the conditions on which animals may be received into or removed from the Camperdown Municipal Abattoirs;
- (b) requiring persons engaged in tending and slaughtering animals and in dressing carcasses at the said Abattoirs to be licensed and prescribing the conditions of licence;
- (c) fixing the rates of fees and dues payable to the Council of the Borough of Camperdown, under Part XIII. of the said Act;
- (d) prescribing the times for slaughtering animals at the said Abattoirs;
- (e) the feeding, watering, and tending, and the preventing of cruelty to and overcrowding of animals in the said Abattoirs and the milking of milch animals at the said Abattoirs.

IN pursuance of the powers conferred by the *Health Act 1928*, and the *Local Government Act 1928*, and the amendments thereof, and every other power enabling them in this behalf, the Mayor, Councillors, and Burgesses of the Borough of Camperdown order as follows:—

1. This By-law shall come into operation on the day after the day of the publication hereof in the *Victoria Government Gazette* and is divided into Parts as follows:—

- Part I.—Introductory.  
Part II.—Conditions on which Animals may be Received into or Removed from the Abattoirs.  
Part III.—Licensing of Slaughtermen and others.  
Part IV.—Fees and Dues.  
Part V.—Times for Slaughtering Animals at the Abattoirs.  
Part VI.—Opening Chilling Chambers and Cleaning Tripes.  
Part VII.—Care of Animals at the Abattoirs.  
Part VIII.—Duties and Conduct of Slaughtermen and Other Persons.  
Part IX.—Penalties.

## PART I.—INTRODUCTORY.

2. In this By-law, unless inconsistent with the context or subject matter:—

“The Abattoirs” means the Camperdown Municipal Abattoirs carried on, maintained, and controlled, and managed as Municipal Abattoirs by the Borough of Camperdown, and includes all the lands and premises used or occupied with and forming part of the Abattoirs establishment.

“The Council” means the Council of the Borough of Camperdown.

“The Superintendent” means the Superintendent for the time being of the Abattoirs appointed by the Council and includes an Acting or Deputy Superintendent and also any officer or employee of the Council actually in charge of the Abattoirs during the temporary absence of the Superintendent.

“Slaughterman's Licence” means a licence granted to a person in accordance with the provisions of Part III. of this By-law and authorizing the licensee to tend and slaughter animals and dress carcasses at the Abattoirs.

“Meat Inspector” means Meat Inspector appointed under Part XIII. of the *Health Act 1928*, or any corresponding enactment for the time being in force.

## PART II.—CONDITIONS ON WHICH ANIMALS MAY BE RECEIVED INTO OR REMOVED FROM THE ABATTOIRS.

3. Every person who shall pay the fees and dues hereinafter fixed shall be entitled to the use for a reasonable time of such portion of the Abattoirs as shall be available and be assigned to him by the Superintendent. No person shall use any portion of the Abattoirs, except for such purpose and at or for such time as the Superintendent shall approve.

4. Every person who shall bring any animals to the Abattoirs shall forthwith inform the Superintendent of the number and description thereof, together with the name and address of the owner thereof and locality or district from which the same were brought, and the Superintendent shall thereupon cause such particulars to be entered in a Record Book to be kept at the Abattoirs, and every such person shall place such animals in such portion of the Abattoirs as the Superintendent directs, and in no case shall any animals once brought into the Abattoirs be removed without the consent of the Superintendent.

5. No person shall without the previous consent of the Superintendent bring into the Abattoirs any animal known or reasonably suspected by him to be or visibly affected with any infectious or contagious disease.

6. (1) The owner of an animal brought to the Abattoirs for slaughter shall:—

- (a) slaughter the animal or cause it to be slaughtered within 48 hours after it has been brought to the Abattoirs; and
- (b) remove or cause to be removed the carcass and every part thereof (except the inedible offal therefrom) from the Abattoirs within 48 hours after the carcass has been placed in the chilling chamber; and
- (c) remove or cause to be removed the said inedible offal from the Abattoirs not later than 4.30 p.m. in the afternoon of the same day upon which such animal was slaughtered.

(2) If the owner shall fail to remove the inedible offal within the time aforesaid, the Council may forthwith remove the same from the Abattoirs and dispose of it in such manner as the Council or the Superintendent may decide. The costs and expenses of such removal and disposal shall forthwith be paid to the Council by the owner, but if the said inedible offal is disposed of for a monetary consideration, the Council may apply such consideration, if and when received, in or towards repayment of the costs and expenses of such removal and disposal, and the balance, if any, of the consideration, shall be then paid by the Council to the owner.

If no monetary consideration, or a monetary consideration less than the costs and expenses of such removal and disposal, is received by the Council, then the whole, or the balance (as the case may be) of such costs and expenses, shall be recoverable by the Council from the owner.

(3) Nothing herein contained shall impose or be deemed to impose on the Council any duty to seek or obtain a monetary consideration for any such inedible offal not removed by the owner in accordance with paragraph (c) of sub-section (1) of this section, and disposed of by the Council under sub-section (2) of this section.

7. The Council shall have a lien on all animals, carcasses, skins, hides, fat, and offal for the time being in the Abattoirs and owned by any person indebted to the Council, and if such person shall make default for seven days in payment of any fees or dues payable by him to the Council under this By-law the Council (without making any demand or giving any notice) may sell by public auction or private contract all or any part of such animals, carcasses, skins, hides, fat, and offal, and after deducting all such fees and dues so payable to the Council and the expenses of sale, shall pay the proceeds of such sale to the owner of the animals, carcasses, skins, hides, fat, or offal sold.

8. The Council will take all reasonable care of animals brought to the Abattoirs for slaughter, but will not be responsible for any injury to or for the death or escape of any animal brought to the Abattoirs for slaughter or inspection.

9. The Council will take all reasonable care of carcasses, skins, hides, and edible and inedible offal while in the Abattoirs, but will not be responsible for any loss thereof or any damage thereto, and in particular will not be responsible for bone-taint or any other condition which may occur in carcass meat in the chilling chambers or for any break-down or failure in the chilling system, any part of the mechanical electrical or other technical installations of the Abattoirs.

10. No person shall remove from the Abattoirs the carcass of any animal slaughtered thereat until the same has been examined by a Meat Inspector and passed by him as fit for human consumption and branded by him with the regulation brand.

11. Any person using the Abattoirs who shall do or cause any breakage, injury, damage, or destruction thereto or to any of the plant or appliances used in connexion therewith, whether accidentally or otherwise, shall make good the same to the satisfaction of the Superintendent, and if he shall wilfully do or cause any such breakage, injury, damage, or destruction he shall be guilty also of an offence against this By-law.

PART III.—LICENSING OF SLAUGHTERMEN AND OTHERS.

12. After the expiration of 21 clear days from the day on which this By-law comes into operation no person shall tend or slaughter any animal or dress any carcass at the Abattoirs, unless he is the holder of a current Slaughterman's Licence issued to him in accordance with the provisions hereinafter contained.

13. Every person who desires to obtain a Slaughterman's Licence shall make application to the Council for such licence in the form in the First Schedule hereto. All such applications shall be lodged with the Superintendent of the Abattoirs.

14. The Council may in its discretion grant or refuse the application. Every licence granted shall be in the form contained in the Second Schedule hereto, and may be signed for the Council by the Superintendent.

15. A Slaughterman's Licence shall continue in operation until the 31st day of December next after the granting or renewal thereof and no longer. Every application for the renewal of a licence shall be in the form in the Third Schedule hereto and shall be lodged with the Superintendent of the Abattoirs not later than the 7th day of December in the year of expiry thereof, and the Council may in its discretion grant or refuse the application. On renewal of a licence a new licence shall be issued to the licensee and shall be dated and be effective on and from the 1st day of January next following the expiry of the previous licence.

16. A Slaughterman's Licence is not transferable by the licensee to another person.

17. (1) Where the Superintendent has reason to believe that the holder of a Slaughterman's Licence has been guilty of an offence against the By-laws of the Borough of Camperdown relating to the Abattoirs or has been guilty at the Abattoirs of an offence against the Health Acts or any Regulation now or hereafter made thereunder, the Superintendent may suspend the licence of such person and shall forthwith submit to the Council a statement in writing setting out the grounds of the suspension.

(2) On receipt of any statement in pursuance of the last preceding sub-clause the Council shall make a thorough examination of the grounds of suspension set out in the statement, and shall afford the licensee an opportunity of appearing before it in person and showing cause why the suspension of his licence should be removed.

(3) The Council may either remove the suspension of the licence or confirm such suspension and cancel the licence and shall give notice in writing of its decision to the Superintendent and to the licensee concerned.

(4) During the period of suspension of a Slaughterman's Licence the licensee therein named shall not tend or slaughter any animal or dress any carcass at the Abattoirs.

18. (1) The operation of this part of this By-law may at any time be suspended by Resolutions passed by the Council and in that case the time at which such suspension shall be effective shall be notified by advertisement inserted by the Council in a newspaper published in Camperdown.

(2) If the operation of this Part is so suspended this Part may again be brought into operation by Resolutions passed by the Council and the time at which this Part shall again come into operation shall be notified by advertisement inserted by the Council in a newspaper published in Camperdown.

PART IV.—FEES AND DUES.

19. The fees and dues payable to the Council under Part XIII. of the Health Act 1928 shall be as follows:—

Kind.	For Use of Abattoir.		Examining any Animal.		Examining and Branding.		Slaughtering and Dressing.		Chilling any Carcass.		Total Charge.			
	s.	d.	s.	d.	s.	d.	£	s.	d.	£		s.	d.	
Cattle ..	3	0	1	6	4	0	1	2	0	4	6	1	16	0
Goat, kid, lamb, sheep ..	1	0	1	0	1	0	0	2	0	1	0	0	6	0
Bobby calf (not exceeding 80 lb.) ..	0	6	0	6	1	0	0	2	0			0	4	0
Calves over 80 lb. but not exceeding 250 lb. (skinned) ..	2	0	2	0	2	0	0	6	0	1	0	0	13	0
Swine ..	2	0	2	0	2	0	0	5	0	1	0	0	12	0

s. d.

For any certificate as to an examination made by a meat inspector .. 4 0

Provided that the fees and dues payable for or in respect of the matters mentioned in the above table shall in the case of animals slaughtered at the Abattoirs on Saturday, Sunday or any public holiday be one hundred and fifty per centum of the fees and due hereinbefore prescribed but so that such fees and dues payable under this paragraph shall not in any case exceed the maximum fees and dues for the time being prescribed by or under section 284 of the Health Act 1928, or the corresponding enactments for the time being in force.

PART V.—TIMES FOR SLAUGHTERING ANIMALS AT THE ABATTOIRS.

20. (1) The days for slaughtering animals at the Abattoirs shall be Monday to Friday (both inclusive) in each week (Public Holidays excepted) and the times on those days for slaughtering animals at the Abattoirs shall be as follows:—

- (a) Between the hours of 7.30 o'clock and 9.45 o'clock in the morning;
- (b) between the hours of 10 o'clock in the morning and 12 o'clock midday;
- (c) between the hours of 1 o'clock and 3 o'clock in the afternoon; and
- (d) between the hours of 3.15 o'clock and 4 o'clock in the afternoon.

(2) Except with the consent of the Superintendent previously obtained no person shall slaughter any animal at the Abattoirs except on the days and between the hours prescribed by sub-clause (1) of this clause.

PART VI.—OPENING CHILLING CHAMBERS AND CLEANING TRIPES.

21. (1) The chilling chambers at the Abattoirs shall be open on Mondays to Fridays (both days inclusive) in each week (Public Holidays excepted) during the following hours:—

- (a) Between 7 o'clock and 8 o'clock in the morning
- (b) between 1 o'clock and 1.30 o'clock in the afternoon; and
- (c) between 4 o'clock and 4.30 o'clock in the afternoon.

(2) No person except the Superintendent or an officer or employee of the Council or other person authorized by the Superintendent shall open or close any chilling chamber at the Abattoirs.

(3) If any person desires any chilling chamber to be opened on any day or at any time except on the days and between the hours prescribed by sub-clause (1) of this clause he shall make special application to the Superintendent for that purpose and the Superintendent may in his discretion grant or refuse the application and if the application is granted the applicant shall pay to the Superintendent on behalf of the Council an opening fee of Five shillings.

22. No person shall clean any tripe or tripes at the Abattoirs except with the previous consent of the Superintendent and the Superintendent may refuse such consent unless such person or his employer or principal has entered into an agreement with the Council to pay them the sum of Six pence for each tripe cleaned by him or his employees or contractors at the Abattoirs.

PART VII.—CARE OF ANIMALS AT THE ABATTOIRS.

23. No person shall ill-treat or unnecessarily frighten or irritate any animal at the Abattoirs or use any unnecessary or preventible cruelty in slaughtering any animal at the Abattoirs.

24. (1) The owner of any animal received into the Abattoirs shall:—

- (a) Provide the same with good and sufficient food at least once every twenty-four hours and with water when necessary; and
- (b) in the case of a milch animal milk the same once or twice daily, as may be proper.

(2) If the owner of any such animal shall fail or neglect to comply with any of the provisions of sub-clause (1) of this clause the Superintendent may comply with such provisions on his behalf and such owner shall forthwith pay to the Council all expenses incurred by the Superintendent in complying with such provisions on behalf of the owner.

PART VIII.—DUTIES AND CONDUCT OF SLAUGHTERMEN AND OTHER PERSONS.

25. Immediately any animal slaughtered is discovered to be diseased the slaughterman in charge shall stop the work of dressing the carcass thereof and shall report the fact to the Superintendent or Meat Inspector on duty at the time and shall not proceed further with such dressing until authorized to do so by the Superintendent or a Meat Inspector.

26. No slaughterman or other person shall—

- (1) Mix the organs from a diseased carcass with the organs from healthy carcasses; or
- (2) write on soil or disfigure any of the walls, floors, ceilings, fittings, or fixtures of the Abattoirs or remove, deface, or disfigure any signboard or written or printed matter or notice on or in the Abattoirs; or
- (3) except with the permission of the Superintendent interfere in any way (save in the course of normal and proper authorized user) with the electric switches, motors, fans, ventilation arrangements or the steam or water pipes or any other plant or appliances whatsoever in the Abattoirs.

27. Every slaughterman and every other person having meals at the Abattoirs shall for that purpose use the mess-room provided and shall not eat any meal or snack in any other portion of the Abattoirs.

28. (1) No person shall bring any dog other than a cattle or sheep dog into or allow any such dog to remain in the Abattoirs.

(2) Every person who has brought any sheep or cattle dog into the Abattoirs shall keep such dog when not in use securely tied up in such place as is assigned for that purpose by the Superintendent.

(3) If there shall in relation to any dog be any contravention of the foregoing provisions of this clause the Superintendent or any person authorized by him may seize and destroy such dog whether or not it is in charge of any person.

29. (1) No slaughterman or other person shall slaughter any animal or load or handle any meat in the Abattoirs unless he is wearing clean and suitable clothing.

(2) No slaughterman shall leave the Abattoirs wearing his slaughtering clothes.

(3) Every slaughterman shall keep his slaughtering clothes when not in use in such part of the Abattoirs as shall have been assigned to him by the Superintendent for that purpose.

30. (1) When the work of slaughtering and dressing the carcass or carcasses of any animal or animals has been completed the slaughterman in charge shall immediately:—

- (a) Clean the portions of the Abattoirs in which such slaughtering or dressing operations have been carried out and leave the same in a proper and tidy condition; and
- (b) deposit the offal, hides, skins, and waste or refuse matter from such animal or animals in such manner and in such pits, bins or receptacles as the Superintendent shall by any general or special direction have directed.

(2) No person shall deposit or cause to be deposited any blood, offal, filth, or waste or refuse matter upon any portion of the Abattoirs or on any road or land abutting thereon except in the pits, bins, or receptacles provided and directed for that purpose.

31. No person shall without the consent of the Superintendent place any insoluble or germicidal or other foreign matter in any urinal or water-closet at the Abattoirs. Every person using any such urinal or water-closet shall use only the sanitary paper provided therein by the Council and shall, before leaving such convenience use the flushing water provided for the removal of the excrement deposited in such convenience.

32. No person unless having lawful business to transact at the Abattoirs shall enter or remain therein and if any such person shall not leave the Abattoirs immediately upon being requested to do so by the Superintendent such person shall be guilty of an offence against this By-law and may also be forcibly removed from the Abattoirs by the Superintendent or by any person authorized by him.

33. Any slaughterman or other person who shall in the Abattoirs:

- (a) Be under the influence of intoxicating liquor; or
- (b) behave in a riotous indecent offensive threatening or insulting manner; or
- (c) use any profane indecent obscene threatening abusive or insulting words; or
- (d) create any disturbance; or
- (e) obstruct in the execution of his duty the Superintendent or any Meat Inspector or any other officer or person appointed by the Council to aid in the conduct management or maintenance of the Abattoirs; or
- (f) neglect or refuse to comply with any lawful request of any such Superintendent, Meat Inspector, officer, or person

shall be guilty of an offence against this By-law and may also be forcibly removed from the Abattoirs by the manager or by any person authorized by him.

PART X.—PENALTIES.

34. Every person who is guilty of any wilful act or default contrary to this By-law or is otherwise guilty of an offence against this By-law shall be liable to a penalty not exceeding Twenty pounds.

FIRST SCHEDULE.

Application No. ....  
(to be filled in by the Superintendent of the Abattoirs)

BOROUGH OF CAMPERDOWN.  
CAMPERDOWN MUNICIPAL ABATTOIRS.

Application for Slaughterman's Licence.

To the Camperdown Borough Council:

I, the undersigned, hereby apply for a licence for the year ending on 31st December, 19 , authorizing me to tend and slaughter animals and dress carcasses at the Camperdown Municipal Abattoirs.

Dated this                    day of                    19 .  
Surname of applicant (in block letters)  
Christian names of applicant  
Occupant of applicant  
Address of applicant

Signature of applicant

SECOND SCHEDULE.

BOROUGH OF CAMPERDOWN.  
CAMPERDOWN MUNICIPAL ABATTOIRS.

Slaughterman's Licence.

No.                     
\* New  
\* Renewal

\* Strike out whichever is unnecessary.

Pursuant to the provisions of By-law No.                    of Camperdown                    Borough of Camperdown is hereby licensed for the period from the date hereof until the 31st day of December, 19 , to tend and slaughter animals and dress carcasses at the Camperdown Municipal Abattoirs subject to the conditions hereunder set out:—

CONDITIONS.

1. This licence is granted subject to the provisions of the Health Acts and of all Regulations and By-laws now or hereafter made under the said Acts.

2. If the Superintendent of the Abattoirs has reason to believe that the holder of this licence has been guilty of an offence against the By-laws of the Borough of Camperdown relating to the Abattoirs or has been guilty at the Abattoirs of any offence against the Health Acts or any Regulation now or hereafter made thereunder the Superintendent may suspend this licence and in that case he will report the grounds of suspension to the Borough Council, which may either remove the suspension or confirm the suspension and cancel this licence.

Dated this                    day of                    19

For the Borough of Camperdown,  
Superintendent.



**NOTE.**—Application for the renewal of this licence must be lodged with the Superintendent of the Abattoirs not later than the 7th December in the year of expiry of this licence. The form of application for renewal may be obtained from the Superintendent.

## THIRD SCHEDULE.

## BOROUGH OF CAMPERDOWN.

## CAMPERDOWN MUNICIPAL ABATTOIRS.

*Application for Renewal of Slaughterman's Licence.*  
To the Camperdown Borough Council:

I, the undersigned, being the holder of a Slaughterman's Licence No. \_\_\_\_\_ for the Camperdown Municipal Abattoirs which expires on the 31st December, 19\_\_\_\_. Hereby apply for renewal of such licence for the year ending 31st December, 19\_\_\_\_.

Dated this \_\_\_\_\_ day of \_\_\_\_\_ 19\_\_\_\_.

Signature \_\_\_\_\_

Resolution for passing this By-law agreed to by the Council on the 24th day of October, 1956, and confirmed on the 28th day of November, 1956.

The common seal of the Mayor, Councillors, and Burgesses of the Borough of Camperdown was hereto affixed by order of the Council, in the presence of—

(SEAL) C. W. BUERCKNER, Mayor.  
F. A. ROBERTSON, Councillor.  
R. J. LORD, Town Clerk.

Submitted to the Commission of Public Health on the 8th day of January, 1957.—G. V. STAFFORD, Secretary to the Commission.

Approved by the Governor in Council on the 5th day of March, 1957.—A. MAHLSTEDT, Clerk of the Executive Council. 1480

## BOROUGH OF ECHUCA.

## BY-LAW No. 49.

**NOTICE** is hereby given that the Council of the Borough of Echuca has under the provisions of the Local Government Act, made by special Order the by-law numbered 49, for regulating the municipal saleyards of the Borough of Echuca and the buildings, stalls, pens and standing therein, and for preventing nuisances or obstructions therein and for fixing the days and hours during each day in which the market shall be held.

A copy of this by-law is open for inspection free of charge during office hours at the Town Hall, Echuca.

1471 K. F. McCARTNEY, Town Clerk.

## BOROUGH OF ECHUCA.

## PUBLIC HIGHWAY.

**THE** Council of the Borough of Echuca doth hereby declare pursuant to sub-section 3 of Section 585 of the Local Government Act, that the private street described hereunder is dedicated to the public as a public highway:—

"All that piece of land being part of Crown allotment 5A, Town of Echuca, Parish of Echuca North, County of Rodney, commencing at a point 104 feet south 11 deg. east of the north-eastern corner of the said allotment 5A; thence south-westerly 31 ft. 5 in. in an arc of a circle with centre lying 20 feet north-westerly; thence by the southern boundaries of lots 1, 2, 3, 4, 5, 6, 7, 8 and part of 9 of plan of subdivision No. 26159, bearing south 79 deg. west 425 feet; thence by line bearing south 11 deg. east 70 feet; thence north-easterly 31 ft. 5 in. in an arc of a circle with centre lying 20 feet south-easterly; thence by the northern boundaries of lots 21, 20, 19, 18, 17, 16 and 15 of the said plan of subdivision No. 26159, bearing north 79 deg. east 405 feet; thence south-easterly 31 ft. 5 in. in an arc of a circle with centre lying 20 feet south-westerly; thence by a line bearing north 11 deg. west 90 feet to the point of commencement."

The common seal of the Council of the Borough of Echuca was hereto affixed on the 25th June, 1957, in the presence of—

(SEAL) R. S. L. McDONALD, Mayor.  
F. C. McCARTNEY, Councillor.  
K. F. McCARTNEY, Town Clerk. 1497

## SHIRE OF CORIO.

**NOTICE** is hereby given that First Constable Thomas Basford Meikle, No. 8428, has been appointed Prosecuting Officer for the Shire of Corio. 1501

## SHIRE OF CHILTERN.

## LOAN No. 5.

*Notice of Intention to Borrow the Sum of £1,000 for Permanent Works and Undertakings.*

**NOTICE** is hereby given that the Council of the Shire of Chiltern proposes to borrow the sum of £1,000 on the credit of the municipal revenues of the President, Councillors and Ratepayers of the said shire, such sum to be raised by the issue of debentures, in accordance with the provisions of the Local Government Acts.

1. The maximum rate of interest that may be paid is 5½ per cent. per annum.

2. The purpose for which the loan is to be applied is for the erection of conveniences in the children's playground and tourist amenities block, both of which are situated in the Chiltern Park.

3. The period of the loan shall be ten years.

4. The moneys borrowed shall be repayable by providing out of the municipal fund twenty half-yearly instalments of approximately £65 13s. 6d. each, including principal and interest on the first day of February and the first day of August during the currency of the loan. The first instalment shall be payable on the first day of February, 1958.

5. Such moneys shall be repayable at the Bank of New South Wales, Melbourne, or at the Council's bankers for the time being in Melbourne.

The plans and specifications and the estimate of the cost of the proposed works, and a statement showing the proposed expenditure of the moneys to be borrowed, are open for inspection at the Shire Office, Chiltern.

J. THOMAS SULLIVAN, Shire Secretary.

19th June, 1957.

1462

## SHIRE OF FERN TREE GULLY.

## DOG ACTS.—SHOPPING AREAS.

**TAKE** notice that on the 12th day of June, 1957, the Council of the Shire of Fern Tree Gully passed an order specifying the roads set out in the Schedule hereunder to be shopping areas under the provisions of section 4 of the *Dog Act* 1936, as amended by section 2 of the *Dog Act* 1939.

## SCHEDULE OF STREETS REFERRED TO.

*Bayswater.*

All that portion of the Main Wantirna-Sassafras road, between Highmoor-avenue and the Fern Tree Gully railway line crossing.  
Station-street throughout.

*Belgrave.*

Main Fern Tree Gully-road, between Wattle-avenue and Terry-avenue.

Monbulk-road, between Terry-avenue and Leslie-street, and between the Clematis Creek and the State forest boundary.

Bayview-road and Main Belgrave-Emerald road, between "Heathermont" Guest House and the Main Fern Tree Gully-road.

*Boronia.*

Dorset-road, between Cypress-avenue and William-street.  
Boronia-road, between Park-crescent and Floriston-road.

*Clematis.*

Belgrave-Emerald road, for a distance of 20 chains east and west of its junction with Wellington-road.

*Emerald.*

Main Belgrave-Emerald road, between the Gembrook railway crossing north-west of Emerald Railway Station and the Church of Christ in the Emerald township.

Main Belgrave-Emerald-Cockatoo road, for a distance of 10 chains south-west and 5 chains north-east from its intersection with the Emerald-Monbulk road.

*Lower Fern Tree Gully.*

Station-street, between Selman-avenue and The Avenue.  
Frances-crescent, between The Avenue and Bambury-place.  
Alpine-street and The Avenue, between Forest-road and View-street.

Forest-road, between the railway line and Underwood-road.

Underwood-road, from Forest-road to the right-of-way at the north-western corner of lot 30 on plan of subdivision numbered 10374 and lodged in the Office of Titles.

Main Fern Tree Gully-road, between Burwood-road and Kevin-avenue, and between the Fern Tree Gully Post Office and Forest-road.

*Upper Fern Tree Gully.*

Main Fern Tree Gully-road, between Hilltop-road and the Gembrook railway line.

*Ferny Creek.*

Olinda-road, between the Ferny Creek-Belgrave road and a point distant 275 feet northerly from the Sherbrooke-road.

*Kallista.*

Monbulk-road, between The Patch-road and Gleghorn-road.

*Belgrave Heights-Belgrave South.*

Belgrave-Hallam road and Old Belgrave-Hallam road, between The Crescent and Mount Morton-road.

Avonside and Glen roads, between The Crescent and Lower Mount Morton-road.

*Menzies Creek.*

Belgrave-Emerald road, between the Church of England and Aura Station-road.

Old Government-road, from Aura Station-road easterly 10 chains.

*Monbulk.*

Olinda-Monbulk road, Monbulk-road, and Boundary-road, between Hunter-street and Victoria-avenue.

*Olinda.*

Olinda-road, for a distance of 20 chains east of its junction with the main road in the Olinda Township.

*Sassafras.*

Olinda-road, for a distance of 20 chains north and south of the Main Wantirna-Sassafras road.

*Selby*

Belgrave-Emerald road, between Selby Station-road and Selby Aura-road.

*Tecoma.*

Main Fern Tree Gully-road, between Sophia-grove and Rockleigh-avenue.

*The Basin.*

Main Wantirna-Sassafras road, between Augusta-road and Church-street.

Forest-road, between Main Wantirna-Sassafras road and Church-street.

Church-street throughout.

*Upwey.*

Main Fern Tree Gully-road, between Hughes-street and Irvine-street.

1472 N. M. SIMMONS, Shire Secretary.

SHIRE OF WARRAGUL.

By-LAW No. 56.

*Cantilever Verandahs.*

A By-law of the Shire of Warragul, made under Part VII., Divisions 1 and 7, of the *Local Government Act 1946*, and numbered 56, for—

(a) prohibiting on, from, and after a date specified herein the erection or placing against or in front of any house or building abutting upon any public footway in any street, or part thereof, specified herein of any verandah over or across such footway, unless such verandah is supported by cantilevers, brackets, or projecting supports, and not otherwise;

(b) requiring the pulling down and removal before a date specified herein of all verandahs before the first-mentioned date erected or placed against or in front of any house or building abutting upon any such public footway, which verandahs are upon, over, or across such footway and are supported otherwise than by cantilevers, brackets, or projecting supports.

IN pursuance of the powers conferred by the *Local Government Act 1946*, the President, Councillors, and Ratepayers of the Shire of Warragul order as follows:—

1. In this By-law, unless the context otherwise requires, "verandah" shall be construed as having the meaning contained in the definition of "verandah" in the Uniform Building Regulations.

2. By-law No. 20 to the extent to which it adopts paragraphs 2, 3, and 6, under heading (1) ("Porticoes, projections, &c.") of Part 1 of the Thirteenth Schedule of the *Local Government Act 1903*, is hereby repealed.

3. From and after the 1st day of July, 1957, no verandah shall be erected or placed against or in front of any house or building abutting upon any public footway in any street, or part thereof, within the Shire of Warragul, or over and across such footway, unless such verandah is supported by cantilevers, brackets, or projecting supports, and not otherwise.

4. The owner of any verandah erected or placed against or in front of any house or building abutting upon any public footway of any street in the Shire of Warragul, which verandah is upon, over, or across such footway, and is supported otherwise than by cantilevers, brackets, or projecting supports, shall pull down and remove such verandah before the 1st day of July, 1967.

5. Any person committing any breach of any of the provisions of this By-law shall, on conviction, be liable to a penalty not exceeding £20.

Resolutions for passing this By-law agreed to by the Council on the 12th day of February, 1957, and confirmed on the 12th day of March, 1957.

The common seal of the President, Councillors, and Ratepayers of the Shire of Warragul was hereunto affixed, in the presence of—

(SEAL) MAC. STEWARD, President.  
E. H. BAKER, Councillor.  
L. A. HEMLEY, Secretary.

Approved by the Governor in Council, 11th June, 1957.—  
A. MAHLSTEDT, Clerk of the Executive Council. 1476

SHIRE OF WODONGA.

THE Shire of Wodonga has applied for a lease under section 125, *Land Act 1928*, as a site for offices, shops, and hall.

1500

H. MCK. SILKE, Shire Secretary.

I, OLGA GOSTINOPOLSKY, of 92 Marlborough-street, East Bentleigh, in the State of Victoria, heretofore called and known by the name of Olga Gostinopolsky, hereby give public notice that by a deed poll dated the 24th day of June, 1957, duly executed and attested and deposited with the Registrar-General of the said State on the 24th day of June, 1957, I formally and absolutely renounced and abandoned the said surname of Gostinopolsky, and declared that I had assumed and adopted and intended thenceforth upon all occasions whatsoever to use and subscribe the surname of Gostin instead of the said surname of Gostinopolsky, and so as to be at all time thereafter called, known and described by the said surname of Gostin.

Dated 15th June, 1957.

1474

OLGA GOSTIN.

NOTICE is hereby given that Claude Irvine, of Tawonga, farmer, has retired from the partnership carrying on the business known as the Tawonga Baling Company and that Walter John Edward Ryder, of Tawonga, farmer, has been admitted as a partner to the said firm, which will continue to carry on business at Tawonga with the undersigned as members of the partnership.

Dated at Tawonga the 9th day of April, 1957.

JAMES C. YOUNG.  
STEPHEN YOUNG.  
J. E. DAMM.  
J. H. RYDER.  
W. J. E. RYDER.

Joseph E. Dally, LL.B., solicitor, Myrtleford. 1468

NOTICE OF DISSOLUTION OF PARTNERSHIP.

NOTICE is hereby given that the partnership heretofore subsisting between the undersigned George Kamaretsos, of 114 Leith-street, Ballarat, and Keith Brien Ball, of 912 Sherrard-street, Ballarat, carrying on business as pie and pastry manufacturers, at 101-103 Sturt-street, Ballarat, under the name of Keith's Pies and Pasties, has been dissolved by mutual consent as from the 31st day of May, 1957. All debts due to and owing by the said late firm will be received and paid by the said Keith Brien Ball, who will continue to carry on the business at the same place.

Dated the 25th day of June, 1957.

GEORGE KAMARETSOS.  
KEITH BALL.

1499

## DISSOLUTION OF PARTNERSHIP.

**WE**, Edwin Walter Lewis, gentleman, and Grant Lewis, farmer, both of Lurg, hereby give notice that the partnership hitherto subsisting between the said parties has been dissolved by mutual consent as from the date hereof. Any accounts owing by or to the partnership must be forwarded to Edwin Walter Lewis before the 1st day of July, 1957.

Dated the 24th day of June, 1957.

WALTER LEWIS.  
GRANT LEWIS.

Hamilton, Clarke and Clarke, solicitors for the parties.  
1482

**NOTICE** is hereby given that the partnership heretofore subsisting between the undersigned, Henry Alfred Smith and Alexander Reginald Victor Watson, carrying on business as hardware merchants and builders at Myrtleford, under the name of "Smith and Watson," has been dissolved by mutual consent as from the 1st day of June, 1957. All debts due and owing by the said late firm will be received and paid by Reg. Watson Pty. Ltd., which will continue to carry on the business at the same place.

Dated at Myrtleford the 21st day of June, 1957.

H. A. SMITH.  
A. R. V. WATSON.

Joseph E. Daly, LL.B., solicitor, Clyde-street, Myrtleford.  
1505

**NOTICE** is hereby given that the partnership heretofore subsisting between the undersigned, Arthur Clive Hawkins and Walter Grey Hawkins, carrying on business as graziers at Seaspray-road, via Sale, under the name of "A. C. and W. G. Hawkins," has been dissolved by mutual consent as from the 30th day of June, 1957. All debts due to and owing by the said late firm will be received by Walter Grey Hawkins, who will continue to carry on the business at the same place.

Dated at Sale the 26th day of June, 1957.

A. C. HAWKINS.  
W. G. HAWKINS.

Witness to both signatures—R. W. ROLLAND, solicitor, Sale.  
1515

**NOTICE** is hereby given that the partnership heretofore subsisting between the undersigned, George Hedley Cohen and Adam Ronald Paterson, carrying on a business of motor body repairers at 457 Victoria-street, Abbotsford, under the style of "Paterson and Cohen," has been dissolved by mutual consent as from the 1st day of July, 1957. All debts due to and owing by the said late firm will be received and paid by the said Adam Ronald Paterson, who will continue to carry on the business at the same place under the style of "Paterson and Cohen."

Dated at Melbourne the 1st day of July, 1957.

GEORGE H. COHEN.  
A. R. PATERSON.

Witness—ARTHUR J. DOWNING.

F. J. Oramas and Downing, solicitors, 84 William-street, Melbourne.  
1529

**NOTICE** is hereby given that the partnership heretofore carried on between Christabel Ruth Hardy and Walter Geoffrey Groves, carrying on business at Finlay-ailey, at the rear of 262 Queen-street, Melbourne, under the name of "Prompt Die Cutting Service," has been dissolved by mutual consent as from the 30th day of June, 1957. All debts due to and owing by the late firm will be received and paid by Christabel Ruth Hardy, who will continue to carry on the business at the same place.

Dated this 1st day of July, 1957.

R. C. HARDY.  
W. G. GROVES.

J. Allan Anderson and Son, solicitors, 472 Bourke-street, Melbourne.  
1545

## NOTICE OF DISSOLUTION OF PARTNERSHIP.

**THE** partnership hitherto subsisting between Clarence Robert Hughan and Robert Keith Hughan, both of Tatong, farmers, carried on by them at Tatong, under the name of C. H. Hughan and Son, has been dissolved by mutual consent as from the first day of July, 1957. All accounts outstanding are to be forwarded to Robert Keith Hughan, which will be paid and satisfied by him.

Dated this 21st day of June, 1957.

C. R. HUGHAN.  
R. K. HUGHAN.

Hamilton, Clarke and Clarke, solicitors for the parties.  
1481

**NOTICE** is hereby given that the partnership heretofore subsisting between Ena Helen Batkin, Maisie Irene Rye, and Desmon Thomas Batkin and Maisie Irene Rye as executor and executrix respectively of the will of Maude Louise Batkin, deceased, carrying on business as selling agents and distributors at 26-30 Dow-street, South Melbourne, under the style or firm of B.R.J. Sales Co., has been dissolved as from the 31st day of December, 1956.

Dated this 20th day of June, 1957.

E. H. BATKIN.  
M. I. RYE.

D. T. BATKIN,  
M. I. RYE,

executor and executrix respectively of the will of Maude Louise Batkin, deceased.  
1518

**NOTICE** is hereby given that the partnership heretofore subsisting between the undersigned Geoffrey Ernest Fethers and John Derry Arnott, carrying on business as veterinary surgeons and veterinary practitioners at 443 Mont Albert-road, Mont Albert, under the style of "Geof. Fethers and J. D. Arnott," has been dissolved by mutual consent as from the first day of July, 1957. All debts due to and owing by the said late firm will be received and paid by the said John Derry Arnott, who will continue to carry on the business at the same address.

G. FETHERS.  
JOHN D. ARNOTT.

Witness to both signatures—M. WHITTAM.

Abbott, Stillman and Wilson, of 422 Little Collins-street, Melbourne, solicitors for both parties.  
1496

**NOTICE** is hereby given that the partnership heretofore subsisting between Edward Harold Ernest Grinter and Lawrence Leonard Grinter, carrying on business as farmers at Whittington, under the style or firm of Grinter Bros., has been dissolved as from the 30th day of June, 1957.

Dated this first day of July, 1957.

E. H. E. GRINTER.  
L. L. GRINTER.

Wighton and McDonald, solicitors, 189-191 Moorabool-street, Geelong.  
1479

*Companies Act 1938.*

STEWARTS TANJIL REEF PROPRIETARY LIMITED.  
MEMBERS VOLUNTARY WINDING UP.

**NOTICE** is hereby given that at an Extraordinary General Meeting of members held at 44 Elizabeth-street, Melbourne, on 28th June, 1957, a Special Resolution was passed, placing the company in voluntary liquidation under the provisions of sections 230-236 of the *Companies Act 1938*. And at such meeting Frederick Ernest Wilson, 44 Elizabeth-street, Melbourne, public accountant, was appointed liquidator for the purposes of the winding up.

Dated the 28th day of June, 1957.

1487

E. C. CANDY, Secretary.

*Companies Act 1938.*

BAY COTTAGE TEA ROOMS PROPRIETARY LIMITED.

**AT** an Extraordinary General Meeting of the members of the above-named company, duly convened and held at 26 Warleigh-grove, North Brighton, on the 21st day of June, 1957, the following Special Resolution was duly passed—

"That the company be wound up voluntarily by a members' voluntary winding up, and that John Patrick Chaundy be appointed liquidator for the purposes of such winding up."

Dated this 22nd day of June, 1957.

1457

A. TARANTO, Director.

D. C. W. PROPRIETARY LIMITED (IN VOLUNTARY LIQUIDATION).

PURSUANT TO SECTION 236 (3) OF VICTORIAN COMPANIES ACT 1938.

**NOTICE** is hereby given that the Final Meeting of the shareholders of D. C. W. Proprietary Limited (in Voluntary Liquidation) will be held at the offices of C. W. Stirling and Co., 420 St. Kilda-road, Melbourne, S.C.2, on the 9th day of August, 1957, at 9.15 a.m., for the purpose of having an account laid before it showing how the winding up of the company has been conducted and the property of the company has been disposed of.

1534

W. A. REID, Liquidator.  
N. W. GLUCK, Liquidator.

*The Companies Act 1938.*

In the matter of **STEWART WARNER INDUSTRIES (AUSTRALIA) PROPRIETARY LIMITED.**

**NOTICE** is hereby given that at an Extraordinary Meeting of the members of the above-named company, held on Wednesday, the 26th June, 1957, it was resolved that the company be wound up voluntarily, and at a meeting of creditors held on the same day, pursuant to section 238, it was resolved that for such purpose, Edward Ronald Smail, of 31 Queen-street, Melbourne, chartered accountant (Aust.), be appointed liquidator.

Notice is also given that after 21 days from this date I shall proceed to distribute the assets. All creditors having any claims against the company should furnish particulars of same by that date, otherwise I shall proceed to distribute the assets without regard to their claim.

Dated this 1st day of July, 1957.

E. R. SMAIL, Liquidator.

Kennedy, Smail, and Middlemiss, 31 Queen-street, Melbourne. 1528

*Companies Act 1938.*

**NOTICE OF INTENTION TO APPLY TO ATTORNEY-GENERAL FOR LICENCE, PURSUANT TO SECTION 18 (1).**

**I CEDRIC CUTHBERT RALPH**, of 317 Collins-street, Melbourne, solicitor, on behalf of Health Publicity Council of Australia, about to be formed for the purposes of fostering research on diet and health and publicizing the same within Australia, hereby give notice of intention to apply to the Attorney-General for a licence directing that the association be registered as a company with limited liability without the addition of the word "Limited" to its name.

Dated this 1st day of July, 1957.

**CEDRIC RALPH**, 317 Collins-street, Melbourne, solicitor for the said association. 1543

*A. W. APPLETON PTY. LTD.*

**NOTICE** is hereby given that as the above-mentioned company ceased trading operations on 1st July, 1957, no responsibility or liability will be accepted by it for any goods or services delivered or rendered to it unless authorized in writing by the Secretary.

By order of the Board,

K. J. BROWNE, Secretary.

1-3 Palmerston-crescent, South Melbourne, S.C.5. 1540

*C. F. F. PROPRIETARY LIMITED (IN VOLUNTARY LIQUIDATION).*

**PURSUANT TO SECTION 236 (3) OF VICTORIAN COMPANIES ACT 1938.**

**NOTICE** is hereby given that the Final Meeting of the shareholders of C. F. F. Proprietary Limited (in Voluntary Liquidation) will be held at the offices of C. W. Stirling and Co., 420 St. Kilda-road, Melbourne, S.C.2, on the 9th day of August, 1957, at 9.30 a.m., for the purpose of having an account laid before it showing how the winding up of the company has been conducted and the property of the company has been disposed of.

1533 W. A. REID, Liquidator.  
N. W. GLUCK, Liquidator.

*LUDLOW BUILDINGS PROPRIETARY LIMITED (IN VOLUNTARY LIQUIDATION).*

**NOTICE CONVENING FINAL MEETING, PURSUANT TO SECTION 236.**

**NOTICE** is hereby given, in pursuance of section 236 of the *Companies Act 1938*, that a General Meeting of the members of the above-named company will be held at 98 Collins-street, Melbourne, on Wednesday, the 7th day of August, 1957, at Three o'clock in the afternoon, for the purpose of having an account laid before them showing the manner in which the winding up has been conducted and the property of the company disposed of, and of hearing any explanation that may be given by the liquidator.

1531 R. A. CHAPPELL, Liquidator.

*The Companies Act 1938.—In the matter of SOUTHERN CAN CO. (AUST.) PTY. LTD.*

**NOTICE** is hereby given that at an Extraordinary General Meeting of the above-named company, held on Monday, the 1st July, 1957, it was resolved by special resolution that the company be wound up voluntarily, and that for such purpose William D. J. Higgins, of 20 Queen-street, Melbourne, be appointed liquidator.

Dated this 1st day of July, 1957.

1530 W. D. HIGGINS, Liquidator.

*A. H. SCHULZ & SONS PROPRIETARY LIMITED.*

**AT** an Extraordinary General Meeting of the above-named company, duly convened and held at 1 Lincoln-street, Richmond, on Friday, the 28th day of June, 1957, the following Extraordinary Resolution was duly passed:—

"That it has been proved to the satisfaction of this meeting that the company cannot by reason of its liabilities continue its business, and that it is advisable to wind up the same, and accordingly that the company be wound up voluntarily."

Dated the 1st day of July, 1957.

1526 A. H. SCHULZ, Chairman.

**CREDITORS**, next of kin, and all others having claims against the estate of Ormond Wallace Davies, late of 102 Pleasant-street south, Ballarat, gentleman, deceased (who died on 1st January, 1957), are required to send particulars of their claims to the executor, The Fidelity Trustee Company Limited, at its address, 101 Lydiard-street north, Ballarat, by the 27th August, 1957, after which date the said executor will distribute the assets, having regard only to the claims of which it then has notice.

1459 BAIRD & BAIRD, solicitors, Ballarat.

**CREDITORS**, next of kin, and all others having claims against the estate of Wilfred George Earles, formerly of 46 Queen-street, Ararat, but late of 17 Inkerman-street, Ballarat, railway employee, deceased (who died on 22nd February, 1957), are required to send particulars of their claims to the executor, The Fidelity Trustee Company Limited, at its address, 101 Lydiard-street north, Ballarat, by the 4th September, 1957, after which date the said executor will distribute the assets, having regard only to the claims of which it then has notice.

1498 BAIRD & BAIRD, solicitors, Ballarat.

**ALFRED JAMES JAGER**, late of Swan Hill, in the State of Victoria, farmer, DECEASED (who died on the 22nd day of March, 1957).

**CREDITORS**, next of kin, and all other persons having claims against the estate of the deceased, are required by the executors of the will, George William Jager, of Indented Head, in the said State, farmer, and Kenneth Alfred Jager, of "Thule," Barham, in the State of New South Wales, farmer, to send particulars to them, care of the undersigned, on or before the 21st day of September, 1957, after which date they will distribute the assets, having regard only to the claims of which they then have notice.

Dated the 21st day of June, 1957.

GARDEN & GREEN, solicitors, McCallum-street, Swan Hill. 1467

**JAMES HEGARTY**, late of Sago Hill, retired dairyman (who died on the 28th July, 1955).

**CREDITORS**, next of kin, and all persons having claims against the estate of the deceased, are required to send particulars to the administrator, The Fidelity Trustee Company Limited, of 101 Lydiard-street north, Ballarat, care of its address above given, on or before the 30th day of August, 1957, after which date it will distribute the assets, having regard only to the claims of which it shall then have notice.

HEINZ & GORDON, solicitors, 22 Lydiard-street south, Ballarat. 1461

**PURSUANT** to the Trustees Acts, all persons having claims against the property or estate of Gladys Jeane Pettit (also known as Jeane Gladys Pettit), late of Portland, in the State of Victoria, married woman, deceased (who died on the 16th day of December, 1956, and probate of whose will was granted by the Supreme Court of Victoria on the 2nd day of May, 1957, to The Fidelity Trustee Company Limited, whose registered office is situate at 101 Lydiard-street north, Ballarat, in the said State, the executor appointed by the said will), are hereby required to send particulars of such claims to the said company, on or before the 21st day of September, 1957, after the expiration of which time the said executor will proceed to distribute the assets of the said deceased amongst the persons entitled thereto, having regard only to the claims of which the said company shall have had notice.

Dated the 21st day of June, 1957.

HARRIS & WILLIAMSON, 43A Percy-street, Portland, solicitors for the applicant. 1465

ELLEN GRAHAM, late of 74 Margaret-street, Moonee Ponds, widow, DECEASED.

ALL creditors and other persons, including the children of sisters of the above-named, having claims in respect to the will and estate of the said Ellen Graham, deceased, are required to send particulars of their claims to Mary Agnes Smyth (the present trustee of the estate), care of Hoad and Bonella, 101 Queen-street, Melbourne, on or before the 6th day of September, 1957, after which date the said trustee will distribute the assets of the said deceased, having regard only to the claims of which she shall have had notice.

HOAD & BONELLA, solicitors, 101 Queen-street, Melbourne. 1541

CREDITORS, next of kin, and others having claims in respect of the estate of Doris Maud Martin, late of 13 Toolangi-road, Alphington, in the State of Victoria, widow, deceased (who died on the 15th day of May, 1956), are to send the particulars of their claims to National Trustees, Executors, and Agency Company of Australasia Limited, whose registered office is at 95 Queen-street, Melbourne, by the 5th day of September, 1957, after which date the said company will distribute the assets, having regard only to the claims of which it then has notice.

F. P. WALSH, solicitor, 452 High-street, Northcote. 1469

CREDITORS, next of kin, and others having claims in respect of the estate of Edward John Strickland, also known as Edwin John Strickland, formerly of Barkstead, in the State of Victoria, mill hand, but late of 336 Humfray-street north, Ballarat, in the said State, greengrocer, deceased (who died on the 17th day of February, 1957), are required by The Fidelity Trustee Company Ltd. (formerly The Ballarat Trustees, Executors, and Agency Co. Ltd.), of 101 Lydiard-street north, Ballarat, to send particulars to the said company, at its address given above, by the 29th day of August, 1957, after which date it will distribute the assets, having regard only to the claims of which it then has notice.

1460

MATIAS GARCIA PARRA (also known as Mathias Garcia), late of 76 Wilson-street, North Carlton, in the State of Victoria, labourer, DECEASED, intestate.

CREDITORS, next of kin, and others having claims in respect of the intestate estate of the said deceased (who died on the 8th day of November, 1955), are to send particulars of their claims to Juan Rodriguez Gonzalez and John Lancelot Hewison and John Munro Whitehead, the administrators of the said intestate estate, care of the under-mentioned solicitors, by the 12th day of September, 1957, after which date the said administrators will distribute the assets in the said intestate estate, having regard only to claims of which they then have notice.

ELLISON, HEWISON, & WHITEHEAD, solicitors, 352 Collins-street, Melbourne. 1537

MARGARET JANE STOTT, formerly of 993 Nepean Highway, Moorabbin, married woman, but late of 138 Toorak-road, Camberwell, widow, DECEASED.

CREDITORS, next of kin, and others having claims in respect of the estate of the deceased (who died on 7th February, 1957), are required by Rex Gordon Peile, of 99 Queen-street, Melbourne, solicitor, the executor of deceased's will, to send particulars to him, in care of the under-mentioned solicitors, by the 3rd day of September, 1957, after which he may convey or distribute the assets, having regard only to the claims of which he then has notice.

Dated this 1st day of July, 1957.

BARKER & PEILE, solicitors, 99 Queen-street, Melbourne. 1544

CREDITORS, next of kin, and others having claims in respect of the estate of Arthur Turner, late of 42 May-road, Toorak, retired, deceased (who died on the 27th day of April, 1956), are to send particulars of their claims to Harold Charles Moroney, care of the under-mentioned solicitors, by the 30th day of August, 1957, after which date he will distribute the assets, having regard only to the claims of which he then has notice.

JAMES P. OGDON & CO., solicitors, 165 Greville-street, Prahran. 1516

Trustee Act 1953.

NOTICE TO CLAIMANTS.

PURSUANT to the Trustee Act 1953, creditors, next of kin, and all other persons having claims in respect of the estate of any deceased person named below are required to send particulars thereof to the legal personal representative or representatives at the addresses stated below, on or before the dates stated, after which dates the representatives will distribute the assets, having regard only to the claims of which notice has been received:—

Elsie Jane Colquhoun, late of 34 Forster-street, Williamstown, married woman, deceased, died 30th day of August, 1956.—Claims to the executor, John Hamilton Colquhoun, of 34 Forster-street, Williamstown, retired blacksmith, care of John F. Carroll, solicitor, 4 Paisley-street, Footscray, by the 6th day of September, 1957. John F. Carroll, LL.B., solicitor, 4 Paisley-street, Footscray. 1517

Julya Margaret Moriarty, late of 28 Wattle-road, Hawthorn, spinster, deceased, died on the 7th day of May, 1957.—Claims to the executor, William Nicholas Murphy, care of M. Mornane, solicitor, of 95 Queen-street, Melbourne, by the 4th September, 1957. M. Mornane, solicitor. 95 Queen-street, Melbourne. 1542

Mary Shanley, late of Killarney, widow, deceased, died on 2nd December, 1956.—Claims to the executors, John Basil Shanley and Lawrence Shanley, both of Killarney, farmers, care of Conlan and Leishman, solicitors, 36 Bank-street, Port Fairy, by 31st August, 1957. 1463

Annie May McAllen, late of Port Fairy, widow, deceased, died 4th May, 1957.—Claims to the administrator, Martin Charles McAllen, of Orford, farm labourer, care of Conlan and Leishman, solicitors, 36 Bank-street, Port Fairy, by 4th September, 1957. 1466

John James Stokes, late of 37 Fyans-street, Geelong South, in the State of Victoria, gentleman, deceased, died on the 12th day of February, 1957.—Claims to The Equity Trustees, Executors, and Agency Company Limited, of 472 Bourke-street, Melbourne, by the 15th day of September, 1957. 1478

CREDITORS, next of kin, and others having claims against the estate of William Henry Ashcroft, formerly of Warragul, but late of 14 Edith-street, Dandenong, retired grazier, deceased (who died on 8th of January, 1957), are to send particulars of their claims to the personal representatives, John Walker Ashcroft and Alan Ashcroft, care of the undersigned solicitors, on or before the 21st day of August, 1957, after which date they will distribute the assets of the deceased, having regard only to the claims of which they have notice.

GRAY, FRIEND, & LONG, solicitors, Warragul. 1458

ALEXANDER MILLEDGE, late of 21 Birdwood-avenue, Elwood, importer, DECEASED (who died on the 31st day of October, 1956).

CREDITORS, next of kin, and all other persons having claims against the estate of the said deceased are required by the executors of his will and codicil, Mary Milledge and Alexander Dexter Milledge, managing director, both of 21 Birdwood-avenue, Elwood, to send particulars thereof, care of the under-mentioned solicitors, on or before the 17th day of September, 1957, after which date they may proceed to distribute the assets of the deceased, having regard only to the claims of which they then have notice.

COLTMAN, WYATT & ANDERSON, solicitors, 578 Bourke-street, Melbourne, C.1. 1522

CREDITORS, next of kin, and others having claims in respect of the estate of Gertrude Mary Sheffield Oldmeadow, late of 8 Darvall-street, Rosanna, spinster, deceased (who died on the 14th day of September, 1956), are required by her executors, James Anthony Vavau Oldmeadow, of Waterdale-road, Ivanhoe, gentleman, and Richard Frank Oldmeadow, of 32 Hopetoun-grove, Ivanhoe, estate agent, to send particulars of their claims, care of the under-mentioned solicitors, by the 6th day of September, 1957, after which date they will distribute the assets, having regard only to the claims of which they have then had notice.

Dated this 3rd day of July, 1957.

MCCRACKEN & MCCRACKEN, solicitors, 317 Collins-street, Melbourne. 1525

**CREDITORS**, next of kin, and others having claims in respect of the estate of Lillian Maude Tindal, late of Main-road, Doncaster, spinster, deceased (who died on the 30th day of December, 1956), are required to send particulars of their claims to Ivan Sanders and Keith Fagg, executors of the will of the said deceased, in care of the under-mentioned solicitors, by the 14th day of September, 1957, after which date the said executors will distribute the assets of the estate of the said deceased, having regard only to the claims of which they then have notice.

P. H. FIPPEY & EMERY, solicitors, 422 Collins-street, Melbourne. 1521

**CREDITORS**, next of kin, and others having claims in respect of the estate of Ronald Leslie Sinclair, late of 17 Ranfurly-crescent, Glen Iris, retired electrical engineer, deceased (who died on the 4th day of October, 1956), and probate of whose will has been granted to Nina Bryce Sinclair, of 17 Ranfurly-crescent, Glen Iris, widow, are to send particulars of their claims to the said executrix, care of the under-mentioned solicitors, by the 12th day of September, 1957, after which date she will distribute the assets, having regard only to the claims of which she then has notice.

PEARCE & WEBSTER, solicitors, 430 Little Collins-street, Melbourne. 1520

**CREDITORS**, next of kin, and others having claims in respect of the estate of Frederick Norman Lee, late of 430 St. George's-road, Thornbury, in the State of Victoria, pharmaceutical chemist, deceased (who died on the 26th day of January, 1957), are required by Elsie May Lee, of Riverview-terrace, Bulleen, in the said State, widow, and The Equity Trustees, Executors, and Agency Company Limited, of 472 Bourke-street, Melbourne, in the said State, the executors of the will of the said deceased, to send particulars to the said The Equity Trustees, Executors, and Agency Company Limited at its aforesaid address, by the 6th day of September, 1957, after which date the said executors may convey or distribute the assets, having regard only to claims of which the said executors then have notice.

Dated the 3rd day of July, 1957.

EGGLESTON, LEE & CLIFTON-JONES, solicitors, 578 Bourke-street, Melbourne. 1523

**CREDITORS**, next of kin, and others having claims against the estate of Hugh Martin, late of 20 Motherwell-street, Hawksburn, retired engineer, deceased (who died on the 3rd day of May, 1957), are required by the administrators of the estate, The National Trustees, Executors, and Agency Company of Australasia Limited, to send particulars of their claims to the under-mentioned solicitors by the 3rd day of September, 1957, after which date the administrators will distribute the assets of the estate, having regard only to the claims of which it has then had notice.

GODFREY STEWART, MARTIN & CO., solicitors, 20 Bank-place, Melbourne. 1519

**CREDITORS**, next of kin, and others having claims against the estate of Marie Patricia English, late of 86 Studley-road, Heidelberg, in the State of Victoria, married woman, deceased (who died on the 24th day of January, 1957), are to send particulars of their claims to the executors of the said deceased, Jean Mercy Gee, Leslie Allan Brumby and Malcolm Mansfield Brumby, c/o Messrs. Loughrey & Loughrey, solicitors, of 108 Queen-street, Melbourne, by the 6th day of September, 1957, after which date the said executors will distribute the assets of the deceased, having regard only to the claims of which they then have had notice.

Dated the 25th day of June, 1957.

LOUGHREY & LOUGHREY, solicitors, 108 Queen-street, Melbourne. 1524

EDWIN LYALL ANDERSON, late of 43 Ormond-road, East Geelong, licensed grocer, DECEASED.

**CREDITORS**, next of kin, and others having claims in respect of the estate of the said deceased (who died 6th May, 1957), are required by the applicants for grant of probate of the will, Alan Mills, of Terang, furniture retailer, and Joan Valerie Anderson, of 43 Ormond-road, East Geelong, spinster, to send particulars to them care of the undersigned solicitors, by 12th September, 1957, after which date the said applicants may convey or distribute the assets, having regard only to the claims of which they then have notice.

WIGHTON & McDONALD, solicitors, 189-191 Moora-bool-street, Geelong. 1495

CLEMENT RAVELLI, late of Mount Macedon, gardener, DECEASED.

**CREDITORS**, next of kin, and others having claims in respect of the estate of the above-named deceased (who died on the 2nd day of June, 1956), are required by his executor, Henry Bruce Stewart, of Kyneton, solicitor, to send particulars to him, care of the under-mentioned solicitors, before the 15th September, 1957, after which date he may convey or distribute the assets, having regard only to the claims of which he then has notice.

H. HURRY & SON, solicitors, Kyneton, and at Woodend and Gisborne. 1512

**CREDITORS** and all others having claims against the estate of the under-mentioned person are required to send particulars thereof to the undersigned, on or before the 4th day of August, 1957, otherwise they may be excluded when the assets are being distributed.

Name: John Muldarry.

Usual residence: 537 Wyndham-street, Shepparton.

Occupation: Builder.

Date of death of deceased: 14th May, 1956.

MORRISSY & DEANE, solicitors, Shepparton. 1514

**CREDITORS**, next of kin, and those having claims in respect of the estate of Robert Henderson, late of 110 Orrong-road, Armadale, canvasser, deceased (who died on the 14th day of October, 1954), are requested to send particulars of their claims to the administrator, National Trustees, Executors and Agency Company of Australasia Limited, of 95 Queen-street, Melbourne, by the 15th day of September, 1957, after which date the administrator will distribute the assets, having regard only to the claims of which it has notice.

KENNETH J. CLEMENTS, 29 Glenhantly-road, Elsternwick, solicitor for the administrator. 1489

**CREDITORS**, next of kin, and others having claims against the estate of Ema Velik, late of "Avalon," Woonsocket-court, St. Kilda, widow, deceased (who died on the 7th day of May, 1956), are required by the executors, Mayer Velik, medical practitioner, Essendon, and Alfred Newton Super, solicitor, Melbourne, the executors named in the said will, to send particulars of their claims to the said executors, care of their solicitor, at the address set out below, by the 5th day of September, 1957, after which date they will distribute the assets, having regard only to the claims of which they then shall have had notice.

SYLVIA ROTHSTADT, M.A., LL.B., 243 Collins-street, Melbourne. 1486

**CREDITORS**, next of kin, and others having claims against the estate of Samuel Davis, late of 7 Esperance-avenue, Middle Brighton, salesman, deceased (who died on the 16th day of June, 1956), are required by the executrix, Freda Mayta Davis, of 7 Esperance-avenue, Middle Brighton, widow, the sole executrix named in the said will, to send particulars of their claims to the said executrix, care of her solicitor, at the address set out below, by the 5th day of September, 1957, after which date she will distribute the assets, having regard only to the claims of which she then shall have had notice.

A. NEWTON SUPER, M.A., LL.B., 243 Collins-street, Melbourne. 1485

ALFRED CARL GEISLER, late of Bright, contractor.

**CREDITORS**, next of kin, and others having claims in respect of the estate of the deceased (who died on the 22nd December, 1955), are required by the trustee, Albert Francis Antonio Masciorini, of Bright, draper, to send particulars to him, care of the solicitor named hereunder by the 9th September, 1957, after which date the trustee may convey or distribute the assets, having regard only to the claims of which he then has notice.

Dated the 26th day of June, 1957.

JOSEPH E. DAILY, LL.B., solicitor, Clyde-street, Myrtleford. 1477

**CREDITORS**, next of kin, and others having claims in respect of the estate of Ellen O'Halloran, formerly of Crowlands, but late of 116 High-street, Ararat, spinster, deceased (who died on the 21st day of July, 1956), are to send particulars of their claims to The Fidelity Trustee Company Limited, of Lydiard-street, Ballarat, by the 11th day of September, 1957, after which date it will distribute the assets, having regard only to the claims of which it then has notice.

BRIGGS & O'DRISCOLL, solicitors, Ararat. 1488

MARION ESTELLE LEWIS, formerly of 35 Stephenson-street, Richmond, in the State of Victoria, but late of 26 Brighton-street, Richmond aforesaid, married woman, DECEASED, intestate.

CREDITORS, next of kin, and others having claims in respect of the intestate estate of the said deceased (who died on the 30th day of May, 1956), are to send particulars of their claims to Griffith Lewis, the administrator of the said intestate estate, care of the under-mentioned solicitors, by the 12th day of September, 1957, after which date the said administrator will distribute the assets in the said intestate estate, having regard only to claims of which he then has notice.

ELLISON, HEWISON, & WHITEHEAD, solicitors, 352 Collins-street, Melbourne. 1538

CREDITORS, next of kin, and others having claims in respect of the estate of Edward Sheldon Cunningham, late of 10 Kensington-road, South Yarra, K.B., LL.D., Honoris Causa, Glasgow University, retired journalist, are to send particulars to The Equity Trustees, Executors, and Agency Company Limited, of 472 Bourke-street, Melbourne, on or before the 10th of September, 1957, after which date it will distribute the assets, having regard only to the claims of which it then has notice.

LYNCH & MACDONALD, solicitors, 360 Collins-street, Melbourne. 1536

CREDITORS, next of kin, and others having claims in respect of the estate of Albert Victor Ashby Shorter, late of Auckland, in the Dominion of New Zealand, company manager, deceased (who died on the 24th day of October, 1956), are to send particulars of their claims to The Trustees, Executors, and Agency Company Limited, of 401 Collins-street, Melbourne, in the State of Victoria, by the 5th day of September, 1957, after which date it will distribute the assets, having regard only to the claims of which it then has notice.

MCCAY & THWAITES, solicitors, 360 Collins-street, Melbourne. 1527

ANASTASIA BARROWS PETTMAN, late of 16 Stanley-street, Pascoe Vale, widow, DECEASED.

CREDITORS, next of kin, and all other persons having claims against the estate of the above-named deceased (who died on 28th January, 1957), are required by the administrator, Edwin Hugh Pettman, of 28 Richardson-street, Essendon, clerk, to send particulars of such claims to him, care of the undersigned, on or before 4th September, 1957, after which date he will distribute the assets, having regard only to the claims of which he has then had notice.

JONES & KENNEDY, solicitors, 213 Nicholson-street, Footscray. 1532

**MINING NOTICES**

**MORNING STAR (G.M.A.) MINES NO LIABILITY.**

NOTICE is hereby given that a Call (the 4th) of One shilling (1s.) per share on all the issued contributing shares in the capital of the company (making such shares fully paid to 4s. each) has been made due and payable to the manager at the registered office of the company, 360 Collins-street, Melbourne, on Wednesday, the 10th day of July, 1957.

By order of the Board,  
F. R. MORGAN, Manager.  
360 Collins-street, Melbourne. 1539

**WESTERN TITANIUM NO LIABILITY.**

**NOTICE OF CALL.**

NOTICE is hereby given that a Call (the 1st) of Two shillings and six pence per share on all issued contributing shares in the capital of the company (making such shares paid to Three shillings each) has been made due and payable to the legal manager at the registered office of the company on Wednesday, 10th July, 1957. This call relates to new issue shares allotted this day and has been prepaid in full with application moneys.

By order of the Board,  
K. W. CRAIG, Legal Manager.  
11th Floor, 100 Collins-street, Melbourne, C.1. 1535

**FIFTEENTH SCHEDULE.—PART A.**

I the undersigned, hereby make application to register Victorian Oil No Liability as a Company under the provisions of Part II. of the Companies Act 1938.

- The name of the company is to be Victorian Oil No Liability.
- The place of intended operations is Gippsland in the State of Victoria.
- The registered office of the company will be situate at 3rd Floor, 100 Collins-street, Melbourne.
- The value of the company's property, including claim and machinery is—Nil.
- The number of shares in the company is Four hundred of five shillings each.
- The number of shares subscribed for is Four hundred being not less than 25 per centum of the entire number of shares in the company.
- The amount of subscribed capital which is paid up is Five pounds being not less than 5 per centum of the subscribed capital.
- The name of the Manager is John Joseph McFarlane.
- The names, addresses, and occupations of at least two shareholders who have subscribed for shares in the company, and the number of shares subscribed for by each of them at this date, are as follow :—

Names.	Addresses.	Occupations.	Number of Shares Subscribed for by Each.
Edmund George Barker	17 Frogmore-road, Murrumbena, Victoria	Company Director	200
Sydney Roy Hoaking	Kensington-road, Kensington, South Australia	Chartered Accountant (Aust.)	200

10. A majority in number and value of the shareholders in and the creditors (if any) of the company in writing have consented to its incorporation as a No Liability Company.

Dated the 26th day of June, 1957.

J. McFARLANE, Manager.

Witness to signature—M. KEOGH.

I, JOHN JOSEPH McFARLANE, of 100 Collins-street, Melbourne, in the State of Victoria, Manager, do solemnly and sincerely declare that—

- I am the manager of the said intended company.
- The above statement is to the best of my belief and knowledge true in every particular.

And I make this solemn declaration conscientiously believing the same to be true and by virtue of the provisions of an Act of the Parliament of Victoria rendering persons making a false declaration punishable for wilful and corrupt perjury.

J. McFARLANE.

Taken before me at Melbourne this 26th day of June, 1957.—M. Keogh, clerk to Arthur Phillips and Just, Solicitors, Melbourne.

Arthur Phillips and Just, solicitors, 472 Bourke-street, Melbourne.

NOTE.—Immediately following the incorporation of the company it is intended to increase its capital to £1,000,000 divided into 4,000,000 shares of 5s. each.

1546

**IMPOUNDINGS**

**BENDIGO.**—Impounded in Bendigo Pound.

- 1 dark-bay gelding, white near hind foot, blaze face, no visible brand
- 1 bay gelding, white off fetlock, M in half circle
- 1 skewball gelding, white blaze, no visible brand

If not claimed and expenses paid, to be sold on 18th July, 1957.

1511—13/6  
F. KIRK,  
Assistant Poundkeeper.

**FERNTREE GULLY.**—Impounded in Ferntree Gully Pound, by Shire Ranger.

- 2 black and white steers, no visible brand
- 1 red and white steer, no visible brand
- 1 Hereford heifer, no visible brand

If not claimed and expenses paid, to be sold at Dandenong Saleyards on 22nd July, 1957.

1508—13/6 A. GROGAN, Poundkeeper.

**KIEWA.**—Impounded in Kiëwa Found.

- 3 Hereford crossbred steers, top off near ear, no visible brand
- 2 Hereford crossbred heifers, top off off ear, no visible brand

If not claimed and expenses paid, to be sold on 10th July, 1957.

1509—13/6 W. J. HYNES, Poundkeeper.

**LILYDALE.**—Impounded in Lilydale Pound.

- 1 brown Jersey cow, small horns, no visible brand

If not claimed and expenses paid, to be sold on 20th July, 1957.

1507—9/ M. STEWART, Poundkeeper.

**SOUTH BARWON.**—Impounded in South Barwon Pound, by Ranger Hooper.

- 1 Ayrshire cow, dehorned, milking side earmarked, no visible brand

If not claimed and expenses paid, to be sold on 18th July, 1957.

1547—12/ P. HOOPER, Poundkeeper.

**YARRA JUNCTION.**—Impounded in Yarra Junction Pound.

- 1 Red Poll cow, white belly, white patch on rump, no visible brand
- 1 brindle cow, no visible brand
- 2 Guernsey cows, no visible brand

If not claimed and expenses paid, to be sold on 20th July, 1957.

1506—15/ M. BERUDE, Poundkeeper.

AGENTS FOR THE "VICTORIA GOVERNMENT GAZETTE."

THE following have been appointed agents to receive Advertisements and Subscriptions for the *Victoria Government Gazette*:—

- ARMSTRONG'S AGENCY, 143 Queen-street, Melbourne.
- ARMSTRONG BROS., Kyneton.
- MESSRS. ARNALL & JACKSON, 115 Barkly-street, West Brunswick.
- BERRY, ANDERSON, & CO., 207 Sturt-street, Ballarat.
- MR. WM. DAVIS, Mildura.
- A. J. DIGBY (B. S. and N. W. Cash), Main-street, Bairnsdale.
- EDGAR'S NEWS AGENCY, Hargreaves-street, Bendigo.
- MESSRS. HENRY FRANKS & CO., Booksellers and Stationers, Market-square, Geelong.
- MESSRS. GORDON & GOTCH, News Agents, 511 Little Collins-street, Melbourne; and corner Barrack and Clarence streets, Sydney.
- A. C. HAMPTON, 243 Mitchell-street, Bendigo.
- MESSRS. HARSTON, PARTRIDGE, & CO., 455 Little Collins-street, Melbourne.
- MR. C. F. LATIMER, News Agent, Casterton.
- MARTHUR'S AUTHORIZED NEWSAGENCY, 345 Wyndham-street, Shepparton.
- MESSRS. R. H. & W. M. PETTY, News Agent, Wangaratta.
- MESSRS. POWELL & DIXON, 89 Firebrace-street, Horsham.

- J. PURDIE & CO., 138 Moorabool-street, Geelong.
  - F. W. RASHLEIGH & SON, Nunn-street, Benalla.
  - ROBERTSON & MULLENS LTD., Elizabeth-street, Melbourne.
  - SALE AUTHORIZED NEWS AGENTS, Sale.
  - SKINNER'S AUTHORIZED NEWSAGENCY, 49-51 Franklin-street, Traralgon.
  - MESSRS. SMITH & DUNNON, Hamilton.
  - THE MERCANTILE EXCHANGE, 380 Collins-street, Melbourne.
  - F. D. & J. R. TRAINOR, 246 Wyndham-street, Shepparton.
  - C. F. & H. J. VERNON, 162 Bridge-road, Richmond.
  - VIEW POINT AUTHORIZED NEWSAGENCY, 4 View Point, Bendigo.
  - E. W. B. WELSH, Hogan-street, Tatura.
- A copy of the *Gazette* filed at each place for public reference.

THE "VICTORIA GOVERNMENT GAZETTE."

ATTENTION is invited to the following procedure in relation to the publication of official matter in the *Government Gazette*:—

1. *Matter submitted to the Executive Council.*

Matter submitted to the Executive Council which requires gazettal will normally be published in the issue of the following week.

Where urgent gazettal is required, special arrangements should be made with the *Gazette* Officer.

Publication will be facilitated by the submission of carbon copies for the use of the *Gazette* Officer.

2. *Other matter.*

(a) All other matter duly certified by a responsible officer for publication should be lodged with the *Gazette* Officer not later than half-past Ten a.m. on Tuesday.

(b) Lengthy or involved notices should be forwarded several days before publication.

(c) Proofs, which will be supplied only when specifically requested, or at the direction of the *Gazette* Officer, should be returned promptly to avoid delay in publication.

(d) No additions or amendments to matter for publication will be accepted by telephone.

CONTENTS

	PAGE
Appointments .. .. .	2132
Auction Sales Act .. .. .	2123
Contracts .. .. .	2127
Country Roads Board .. .. .	2136
Estates of Deceased Persons .. .. .	2131
Government Notices .. .. .	2122
Impoundings .. .. .	2167
Lands .. .. .	2144
Melbourne and Metropolitan Board of Works— Notices .. .. .	2130
Mining .. .. .	2122, 2167
Money Lenders Act 1938—Supplementary List .. .. .	2123
Orders in Council .. .. .	2133
Private Advertisements .. .. .	2155
Proclamations .. .. .	2121
Public Holidays .. .. .	2122
Public Service Notices .. .. .	2146
Resignations .. .. .	2132
State Rivers and Water Supply Commission .. .. .	2123
Tenders .. .. .	2154
Transport Regulation Board—Public Hearings .. .. .	2124