



VICTORIA
GOVERNMENT GAZETTE

Published by Authority

[Registered at the General Post Office, Melbourne, for transmission by post as a newspaper.]

No. 78]

WEDNESDAY, SEPTEMBER 2

[1959

Land Act 1958.

AREA OF LAND COMPRISED IN CERTAIN CLASSES DIMINISHED OR INCREASED.

PROCLAMATION

By His Excellency the Governor of the State of Victoria and its Dependencies in the Commonwealth of Australia, &c., &c., &c.

WHEREAS by the *Land Act 1958* it is amongst other things enacted that the Governor in Council may, by Proclamation to be published in the *Government Gazette*, at any time diminish or increase the area of land comprised in any of the classes mentioned in Part I., Division 1, Section 5, of the said *Land Act 1958*, but that the area of lands which may be sold by auction (Class 6), shall not be increased except as in certain cases in the said Act provided: Now therefore I, the Governor of the State of Victoria, in the Commonwealth of Australia, by and with the advice of the Executive Council of the said State, and in accordance with the provisions of sections 94 and 117 of the *Land Act 1958* aforesaid, do hereby diminish or increase (as the case may be) the areas of Crown lands comprised in Classes 6 and 7 of the classes mentioned in section 5 of the *Land Act 1958* aforesaid, to the extent set forth in the subjoined Schedule (that is to say):—

Schedule referred to.

CLASSES DIMINISHED OR INCREASED.

County.	Parish.	Allotment.	Section.	Area.	Diminished.	Increased.	Description.
					Class.	Class.	
				A. B. P.			
Talbot	Castlemaine	10	3B	23 0 0±	7	6	In the north of the Parish

Given under my Hand and the Seal of the State of Victoria, aforesaid, at Melbourne, this twenty-fifth day of August, in the year of our Lord One thousand nine hundred and fifty-nine, and in the eighth year of the reign of Her Majesty Queen Elizabeth II.

DALLAS BROOKS.

(L.S.)

By His Excellency's Command,

KEITH TURNBULL,
Commissioner of Crown Lands and Survey.

GOD SAVE THE QUEEN!

Land Act 1958.

UNALIENATED CROWN LAND AVAILABLE FOR SETTLEMENT UNDER IMPROVEMENT PURCHASE LEASES.

PROCLAMATION

By His Excellency the Governor of the State of Victoria and its Dependencies in the Commonwealth of Australia, &c., &c., &c. IN pursuance of the provisions of Section 153 of the Land Act 1958, I, the Governor of the State of Victoria, in the Commonwealth of Australia, by and with the advice of the Executive Council of the said State, do by this Proclamation declare the unalienated Crown lands mentioned in the subjoined Schedule, to be available for settlement under improvement purchase leases.

SCHEDULE.

County.	Parish.	Allotment.	Section.	Area.	Land Valuation.
				A. B. P.	
Polwarth	Otway	26		175 0 0±	£1 10s. per acre

Given under my Hand and the Seal of the State of Victoria aforesaid, at Melbourne, this twenty-fifth day of August, in the year of our Lord One thousand nine hundred and fifty-nine, and in the eighth year of the reign of Her Majesty Queen Elizabeth II.

DALLAS BROOKS.

(L.S.)

By His Excellency's Command,

KEITH TURNBULL,
Commissioner of Crown Lands and Survey.

GOD SAVE THE QUEEN!

PUBLIC HIGHWAY.—SHIRE OF FRANKSTON AND HASTINGS.

PROCLAMATION

By His Excellency the Governor of the State of Victoria and its Dependencies in the Commonwealth of Australia, &c., &c., &c.

WHEREAS by the Local Government Act 1958, section 519, it is amongst other things enacted that it shall be lawful for the Governor in Council at any time, and from time to time, upon the request of the council of any municipality, by notice in the Government Gazette, to declare any land reserved, used or by purchase or exchange acquired for a street, road, highway, thoroughfare, bridge, square, court, alley or right-of-way to be a public highway, and that such land shall thereupon and thenceforth from the date of such proclamation become and be absolutely dedicated to the public as a public highway within the meaning of any law then or thereafter in force:

And whereas the Council of the Shire of Frankston and Hastings has requested that the land hereinafter mentioned, which has been reserved for a street within the said Shire, be so declared to be a public highway:—

Now, therefore, I, the Governor of the State of Victoria, in the Commonwealth of Australia, by and with the advice of the Executive Council of the said State, do by this Proclamation declare that all that piece of land reserved for a street known as Boonong-avenue and being part of Crown allotments 52 and 53, section A; Parish of Frankston, and being indicated by hachure on the plan hereunder, shall be a public highway within the meaning of the said Act.

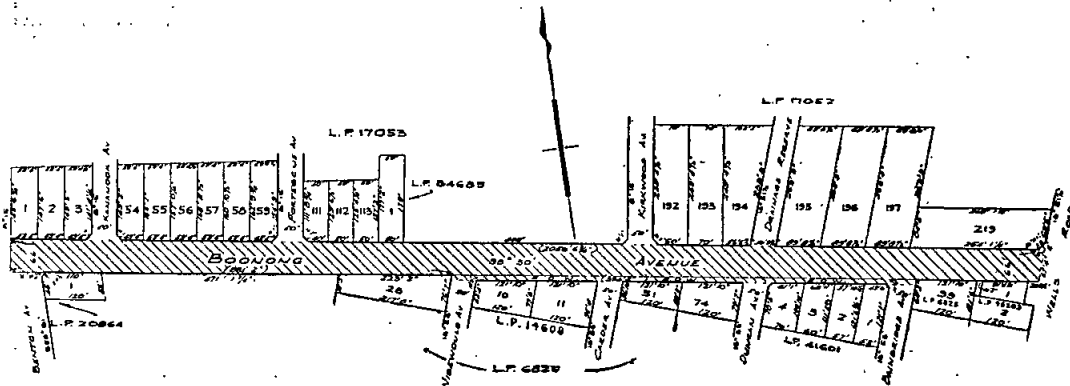

Given under my Hand and the Seal of the State of Victoria aforesaid, at Melbourne, this twenty-fifth day of August, in the year of our Lord One thousand nine hundred and fifty-nine, and in the eighth year of the reign of Her Majesty Queen Elizabeth II.

(L.S.)

DALLAS BROOKS.

By His Excellency's Command,

MURRAY PORTER,
Minister for Local Government.

GOD SAVE THE QUEEN!

LOCAL GOVERNMENT ACT.

PROCLAMATION EXTENDING THE OPERATION OF THE UNIFORM BUILDING REGULATIONS.

By His Excellency the Governor of the State of Victoria and its Dependencies in the Commonwealth of Australia, &c., &c., &c.

WHEREAS section 928 (2) of the *Local Government Act 1958* provides—*inter alia*—that the Governor in Council may, by proclamation published in the *Government Gazette*, at the request of the council of any municipality (not being a city or town) extend the operation of the Regulations made under Part XLIX. of the Act to the municipal district of such municipality or any part thereof:

And whereas the Council of the Shire of Benalla has requested that the said Regulations be extended to the municipal district of the said Shire:

Now, therefore, I, the Governor of the State of Victoria, by and with the advice of the Executive Council thereof, by this my Proclamation, do hereby extend the operation of the Regulations made under Part XLIX. of the *Local Government Act 1958* to the municipal district of the Shire of Benalla:

And doth order that the said Regulations shall come into operation in the municipal district of the Shire of Benalla on publication of this Proclamation in the *Government Gazette*, provided that Parts I. and II. of Chapter 8 thereof shall not be deemed to come into operation till the 1st December, 1959, except in so far as may be necessary to enable the Council of the said municipality to make by-laws pursuant to the powers conferred by Part III. of the said Chapter, and provided further that no such by-law shall come into operation before the 1st December, 1959.

Given under my Hand and the Seal of the State of Victoria aforesaid, at Melbourne, this twenty-fifth day of August, in the year of our Lord One thousand nine hundred and fifty-nine, and in the eighth year of the reign of Her Majesty Queen Elizabeth II.

(L.S.)

DALLAS BROOKS.

By His Excellency's Command,

MURRAY PORTER.

Minister for Local Government.

GOD SAVE THE QUEEN!

HOLIDAY—ROYAL AGRICULTURAL SHOW.

NOTICE is hereby given that on—

THURSDAY, THE 24TH SEPTEMBER, 1959,

the Public Offices in the municipalities mentioned hereunder will be closed, that day being appointed by the *Public Service Act 1958*, to be observed as a holiday in the Public Offices:—

The Cities of Box Hill, Brighton, Broadmeadows, Brunswick, Camberwell, Caulfield, Chelsea, Coburg, Collingwood, Dandenong, Essendon, Fitzroy, Footscray, Hawthorn, Heidelberg, Kew, Malvern, Melbourne, Moorabbin, Mordialloc, Northcote, Nunawading, Oakleigh, Port Melbourne, Prahran, Preston, Richmond, St. Kilda, Sandringham, South Melbourne, Sunshine and Williamstown; the Borough of Ringwood; the Shires of Altona, Bacchus Marsh, Berwick, Bulla, Cranbourne, Doncaster and Templestowe, Eltham, Fern Tree Gully, Frankston and Hastings, Gisborne, Keilor, Lillydale, Melton, Mornington, Mulgrave, Romsey, Springvale and Noble Park, Werribee and Whittlesea.

This notice relates only to the closing of the State Public Offices. All inquiries regarding holidays in other offices and in shops and industry should be directed to the Department of Labour and Industry, Old Treasury Building, Spring-street, Melbourne. (Telephone MF 0321. Extension 266 or 6382.)

A. G. RYLAH,

Chief Secretary.

Chief Secretary's Office,
Melbourne, 24th August, 1959.

Pounds Act 1958.

SHIRE OF PHILLIP ISLAND.

TABLE of Rates to be charged for the trespass of cattle and their sustenance while impounded in the Pound fixed by the Council of the Shire of Phillip Island.

Description of Cattle Trespassing.	Trespass Rates.		Sustenance Fees.
	Upon Land other than Tillage Land Enclosed by a Substantial Fence.	Upon Tillage Land Enclosed by a Substantial Fence.	Amount to be Charged Daily for Sustenance while Impounded.
	s. d.	£ s. d.	s. d.
For every sheep ..	0 3	0 2 0	2 0
For every goat ..	10 0	0 10 0	10 0
For every pig ..	10 0	0 10 0	10 0
For every head of other cattle ..	10 0	0 10 0	10 0

By order of the Council,

B. C. REES,

Shire Secretary.

Approved by the Governor in Council.

25th August, 1959.

A. MAHLSTEDT,

Clerk of the Executive Council.

COUNTY COURTS 1960.

NOTICE is hereby given that County Courts will be held during the year 1960 at the under-mentioned places, on Monday, the 1st February, 1960:—

Ararat	Maryborough
Bairnsdale	Melbourne
Ballarat	Mildura
Bendigo	Morwell
Colac	Sale
Geelong	Shepparton
Hamilton	Wangaratta
Horsham	Warragul
Kerang	Warrnambool
Korumburra	

Except at Melbourne, Courts of Insolvency and Courts of Mines will be held on the day above-mentioned, at such of the above-mentioned places, as have been appointed places for holding such Courts.

Dated at Melbourne, this 26th day of August, 1959.

By order of the Judges,

J. CAVEN,

Registrar, Melbourne.

SHIRE OF ROSEDÁLE.

PETITION UNDER THE DRAINAGE AREAS ACT.

IN pursuance of the provisions of section 6 of the *Drainage Areas Act 1958*, the substance and prayer of a petition presented to His Excellency the Governor in Council, in accordance with section 4 of the said Act, are published, viz.:—

The petitioners, the President, Councillors, and Ratepayers of the Shire of Rosedale pray that His Excellency the Governor in Council may be pleased to constitute certain land in the Parish of Giffard a drainage area within the meaning of the *Drainage Areas Act*.

A copy of such petition, together with a plan showing the proposed drainage area and a report by an engineer of the Local Government Department with regard thereto, has been lodged at the Shire Office, Rosedale, and will be open for inspection for a period of sixty (60) days from the 2nd September, 1959, until the 31st October, 1959.

A counter-petition against the proposal may be forwarded to the Minister for Local Government, pursuant to the provisions of section 5 (5) of the *Drainage Areas Act 1958*, not later than the 28th November, 1959.

M. V. PORTER,

Minister for Local Government.

Fisheries Act.

NOTICE OF INTENTION TO PROHIBIT FISHING IN CERTAIN WATERS DURING THE MURRAY FISH CLOSE SEASON.

It is hereby notified for general information that it is intended, after the expiration of one month from the date of publication of this notice in the *Government Gazette*, to move His Excellency the Governor in Council to make a Proclamation to provide as follows:—

A. Revoking the whole or portion of the Proclamations set out hereunder respecting prohibition of fishing in the waters specified therein.

Proclamations Referred to—	Date of Proclamation.	Date of Publication in the <i>Government Gazette</i> .	To be Revoked.
Prohibition of all fishing in certain streams	1.9.37	8.9.37	The portions referring to Broken, Chalka, and Gunbower Creeks, Kiewa and Loddon Rivers
Prohibition of all fishing in certain streams	28.6.39	5.7.39	The portions referring to Major's Creek and Gardiner's or Mitchell Creek
Prohibition of all fishing in Hughes Creek	11.3.41	12.3.41	The whole
Variation of Proclamation respecting fishing in the Acheron Breakaway and the Goulburn River	31.7.45	1.8.45	The whole of paragraph (3)
Prohibition of all fishing in Taylor's Lake near Horsham	19.9.50	20.9.50	The whole
Prohibition of all fishing in part of Campaspe River	27.10.53	28.10.53	The whole of paragraph (c)
Prohibition of fishing in certain waters	19.10.54	27.10.54	The portions referring to Broken, King, Mitta Mitta and Ovens River
Prohibition of fishing in Marraboor River	21.10.58	29.10.58	The whole of paragraph (b)
Alteration of Proclamation respecting fishing in the Acheron Breakaway and the Goulburn River	21.11.45	28.11.45	The whole

B. Prohibiting all fishing in or the taking of fish from the undermentioned waters and any waters which flow either directly or indirectly thereto and the waters impounded by any weir wall or dam constructed thereon during the period in each year from midnight on the last Sunday in August to the last day preceding the last Saturday in November (inclusive).

Beveridge Anabranch (also known as the Little Murray)	The whole of such water from its junction with the Murray River near Swan Hill to its junction with the Murray River near Beverford
Broken Creek	The whole of such stream from its junction with the Broken River to its junction with the Murray River
Broken River	Downstream from the bridge over such river at Swanpool
Campaspe River	Downstream from the bridge over such river on the Murray Valley Highway
Chalka Creek	Upstream from its junction with the Murray River
Deegay Ponds	See Major's Creek
Gardiner's Creek	See Mitchells Creek
Goulburn River	Downstream from the Riversdale Bridge over such river near Alexandra to its Junction with the Murray River and including the waters impounded by the Goulburn Weir but not including the tributaries of such river excepting Mitchell's Creek, Major's Creek or Deegay Ponds, Broken River and Hughes Creek listed herein.
Gunbower Creek	The whole of such Creek
Hughes Creek	Downstream from the Goulburn Valley Highway
Kiewa River	Downstream from Keegan's Bridge, also known as Keighan's Bridge, over such river at Dederang
King River	Downstream from the bridge over such river at Moyhu
Loddon River	Downstream from a point 200 yards downstream from the Laanecoorie Weir but not including the tributaries of such portion of the river except the Marraboor River listed herein
Major's Creek (or Deegay Ponds)	Upstream from its junction with the Goulburn River near Mitchellstown
Marraboor River (also known as the Little Murray)	The whole of such river downstream from its junction with the Loddon River to its junction with the Murray River
Mitchell's Creek (or Gardiner's Creek)	Upstream from its junction with Major's Creek (near Mitchellstown)
Mitta Mitta River	Downstream from the bridge over such river on the Eskdale-Mitta, Mitta North Road to the rail and road bridge at Tallangatta East and in all that portion of the Mitta Mitta Arm of the Hume Reservoir and backwaters between such two bridges
Ovens River	Downstream from the bridge over such river at Rocky Point, but not including that portion of Reedy or Youngs Creek (sometimes called Wooragee Creek) and its tributaries upstream from its junction with Spring Creek (also known as Reids Creek) in which water all fishing is prohibited from the 1st day of May to the last day preceding the first Saturday in November (both days inclusive) in each year.
Taylor's Lake (near Horsham)	The whole of such lake

A. G. RYLAH,
Chief Secretary.

A. DUNBAVIN BUTCHER,
Director of Fisheries and Game.

Transport Regulation Acts.

TRANSPORT REGULATION BOARD.

NOTICES OF PUBLIC HEARINGS.

NOTICE is hereby given that the applications made by the persons named below for licence to operate the commercial goods vehicles on the route or routes, or in the manner set out opposite their names, will be heard at a time and place to be communicated to the persons concerned:—

Name and Address; Nature of Application.

- ADAMS, JAMES S. & Co. PTY. LTD., High-street, Mornington; 1 commercial goods vehicle (11 cwt.) to operate throughout the State of Victoria for the purpose of repair and maintenance of own equipment in the course of business as "contractors"—tools of trade, spare parts and materials incidental to such work.
- ALDOUS, R. J., Francis-street, Yea; 1 commercial goods vehicle (258 cwt.) to operate—(a) from Hauser and Mahon's sawmill at Murrindindi to consignees in the Metropolitan area—sawn timber, (b) from the Kinglake area to sawmills at Lilydale—logs.
- AUSTRALIA AND NEW ZEALAND BANK LTD., 351 Collins-street, Melbourne; 1 commercial goods vehicle (38 cwt.) to operate throughout the State of Victoria as a mobile bank—own banking fixtures, stationery and advertising materials.
- BALTIC SIMPLEX MACHINERY CO. LTD., 210-220 Hall-street, Spotswood; 1 commercial goods vehicle (8 cwt.) to operate—(a) within a radius of 50 miles of own premises at Spotswood in the course of business as "farm machinery manufacturers and distributors"—own goods, (b) throughout the State of Victoria for the purpose of servicing and maintaining farm machinery—tools of trade, spare parts and materials incidental to such work, also farm implements for demonstration purposes only.
- BARHAM CONSTRUCTION Co., Box 518, Shepparton; 1 commercial goods vehicle (60 cwt.) to operate throughout the State of Victoria in the course of business as "bridge building contractors"—tools of trade and equipment incidental to own contracts.
- BEAUREPAIRE TYRE SERVICE PTY. LTD., 83-95 Franklin-street, Melbourne; 2 commercial goods vehicles (17 and 13 cwt.) to operate within a radius of 50 miles of own branch depot at Warrnambool—tires and tubes for sale and delivery, used tires for repair or retread or having been repaired or retreaded, batteries, oil and car accessories.
- BOON SPA PTY. LTD., 264 Geelong-road, West Footscray; 1 commercial goods vehicle (94 cwt.) to operate within a radius of 50 miles of own premises at Footscray, but excluding operations between Geelong and Melbourne, in the course of business as "aerated water manufacturers"—own aerated waters.
- BRUMBY, G. S., 160 Gillies-street, Fairfield; variation of licence No. D.A.33324 by deleting present conditions and adding in lieu—(a) within a radius of 25 miles of the G.P.O., Melbourne—general goods, (b) within a radius of 70 miles of the Glen Iris Brick Co. at Thornbury—bricks on behalf of the said company.
- CLAYTON TOWING SERVICE, Sarton-road, Clayton; 1 commercial goods vehicle (20 cwt.) to operate throughout the State of Victoria as a tow truck for the purpose of towing disabled or wrecked vehicles—tools of trade and equipment incidental to such work.
- DALTON, F. J., 2 Noske-street, Newtown; 1 commercial goods vehicle (100 cwt.) to operate—(a) within a radius of 25 miles of the Geelong Post Office—general goods, (b) within the Geelong Division of the C.R.B.—road-contracting plant and materials.
- D'ALTON, J. E., Hall's Gap; 1 commercial goods vehicle (8 cwt.) to operate within a radius of 50 miles of the post office at Horsham in the course of business as "builder"—own goods.
- DELANEY, J. J., Townsend-street, Mortlake; 1 commercial goods vehicle (119 cwt.) to operate—(a) within a radius of 20 miles of the post office at Mortlake—general goods, (b) within a radius of 50 miles of the post office at Mortlake—road-contracting plant and materials.
- DOBBYN, H. H. & SONS, 42 Walnut-avenue, Mildura; variation of licence No. D.A.36364 and D.A.36364/1, by the addition of the ability to carry one piano for demonstration purposes or for possible sale.
- EXCELSIOR BUTTER FACTORY PTY. LTD., 57 Little Ryrie-street, Geelong; 1 commercial goods vehicle (26 cwt.) to operate—(a) within a radius of 25 miles of the post office at Geelong in the course of business as "butter manufacturers and wholesale distributors"—own goods, (b) between Geelong and Warrnambool—own perishable smallgoods, (c) between Geelong and Warrnambool—canned hams on behalf of Mayfair Distributors Pty. Ltd., provided that not more than 1 cwt. be carried on any one trip.
- FERGUSON, B. J., Speewa P.O. via Swan Hill; 1 commercial goods vehicle (97 cwt.) to operate within the Bendigo Division of the C.R.B.—road-contracting plant and materials.
- HUNT, L. C., 182 Heatherton-road, Noble Park; variation of licence No. D.A.33713 by deleting Bendigo and adding in lieu, the Dandenong Division of the C.R.B.
- INTERNATIONAL VENDING MACHINES PTY. LTD., 540 Little Collins-street, Melbourne; 2 commercial goods vehicles (each 9 cwt.) to operate throughout the State of Victoria as "vending machine operators"—tools of trade, machines for installation or removal and small quantities of stock for replenishment if required.
- JENNINGS, A. V. CONSTRUCTION Co. PTY. LTD., Trent-street, Burwood; 1 commercial goods vehicle (138 cwt.) to operate—(a) within a radius of 25 miles of own premises at Burwood in the course of business as "building contractors"—own goods, (b) throughout the State of Victoria—own tools of trade and equipment only, (c) within a radius of 20 miles of any project currently engaged upon—own goods for the completion of such project.
- JENNINGS, A. V. CONSTRUCTION Co. PTY. LTD., Trent-street, Burwood; 1 commercial goods vehicle (9 cwt.) to operate within the State of Victoria for the purpose of supervising own building contracts—tools of trade and an odd item of material for the repair or completion of own contract.
- KENNA, A. J., Mortlake; variation of licence No. D.A.30874 by deleting present conditions and adding in lieu the ability to operate within a radius of 50 miles of the post office at Mortlake in the course of business as "earth-moving contractor"—tools of trade and equipment incidental to own contracts.
- LAW, B. T., 4 Lae-court, Ashburton; 1 commercial goods vehicle (112 cwt.) to operate within a radius of 50 miles of the Taraxale Brewing Co. Pty. Ltd. at Oakleigh, but excluding operations between Melbourne and Geelong—aerated waters on behalf of the said company.
- MALEYS LTD., 91 Leveson-street, North Melbourne; 1 commercial goods vehicle (16 cwt.) to operate—(a) within a radius of 50 miles of own premises at North Melbourne in course of business as "hardware manufacturers"—own goods, (b) throughout the State of Victoria for the purpose of servicing washing machines previously manufactured by the applicant—tools of trade and parts incidental to servicing only and washing machines for repair or having been repaired.
- MARS FREIGHT LINES, Sydney-road, Campbellfield; 1 commercial goods vehicle (244 cwt.) to operate throughout the State of Victoria in the course of business as "earth-moving, land-clearing and dam-sinking contractors"—own earth-moving plant and equipment.
- MINNS, R. G., Tylden; 2 commercial goods vehicles (100 and 87 cwt.) to operate within a radius of 75 miles of own quarry at Tylden—own road-metal screenings.
- MIRBOO SERVICE STATION PTY. LTD., Mirboo North; 1 commercial goods vehicle (108 cwt.) to operate throughout the State of Victoria as a "tow truck"—for the purpose of repairing or towing disabled or wrecked vehicles.
- MURRAY VALLEY SAWMILLS PTY. LTD., Nathalia; 1 commercial goods vehicle (108 cwt.) to operate for the carriage of—(1) sawn timber from own sawmills at Nathalia or Picola to consignees within a radius of 50 miles of each mill, (2) sawn timber from sawmills at Mansfield to consignees within a radius of 20 miles of Mansfield.
- MCKAY, JACK, 21 Scoresby-street, Hamilton; 1 commercial goods vehicle (100 cwt.) to operate within a radius of 50 miles of Hamilton—road-contracting plant and materials.
- THE NATIONAL CASH REGISTER Co. PTY. LTD., 124 Russell-street, Melbourne; 1 commercial goods vehicle (8 cwt.) to operate—(a) throughout the State of Victoria for the installation, servicing and maintenance of cash registers—tools of trade, spare parts and materials incidental to such work: Provided that no more than two cash registers for loan or temporary replacement be carried, (b) from the nearest or most convenient railway station direct to applicant's clients for installation only—new cash register machines.
- PARKES, E. S., 38 Charter-street, Ringwood; 1 commercial goods vehicle (7 cwt.) to operate throughout the State of Victoria in the course of business as "signwriter"—tools of trade and materials incidental to own contracts.

REEVES, N. H., Ripplebrook, via Drouin; 1 commercial goods vehicle (172 cwt.) to operate within a radius of 30 miles of quarries at Erica—road metal and screenings.

ROONEY MOTORS, 49 Cox-street, Port Fairy; 1 commercial goods vehicle (7 cwt.) to operate throughout the State of Victoria as a "tow truck" for the purpose of towing or repairing disabled or wrecked vehicles.

THE ROSELLA PRESERVING & MANUFACTURING CO. LTD., 64 Balmain-street, Richmond; 2 commercial goods vehicles (19 and 30 cwt.) to operate—(a) within a radius of 50 miles of own premises at Richmond in course of business as "food preservers"—own goods, (b) throughout the State of Victoria for the purpose of window dressing, advertising and sales promotion—tools of trade and advertising materials.

RYMERS, C. H., 330 Main-street, Bairnsdale; 1 commercial goods vehicle (12 cwt.) to operate east of a north-south line drawn through Dandenong in the course of business as "building contractor"—tools of trade, equipment and small quantities of materials incidental to the completion of own contracts.

STANSFIELD & SMITH PTY. LTD., 307 City-road, South Melbourne; 1 commercial goods vehicle (8 cwt.) to operate—(a) within a radius of 50 miles of own premises at South Melbourne in course of business as "glass merchants and glazing contractors"—own goods, (b) throughout the State of Victoria for the purpose of supervising own glazing contracts—tools of trade, small quantities of loose glass and materials incidental to the completion of glazing contracts.

STOTT & UNDERWOOD LTD., 411-413 Lonsdale-street, Melbourne; 3 commercial goods vehicles (8 cwt. each) to operate throughout the State of Victoria for the purpose of servicing and maintaining office equipment—tools of trade, spare parts and materials incidental thereto and office equipment for replenishment purposes only.

TURNER, A. J., 25 Millar's-road, Altona; variation of licence No. D.A.36694 by the addition of the ability to operate within a radius of 25 miles of the G.P.O., Melbourne—general goods.

WAGA, J., 4 Bruce-street, Sunshine; 1 commercial goods vehicle (219 cwt.) to operate—(a) within a radius of 25 miles of Melbourne—general goods, (b) from pits in the Cranbourne area to places in paragraph (a) above—sand, (c) from Sunshine to places within a radius of 50 miles of Sunshine—hot asphalt screenings and pre-mix screenings on behalf of Albion Quarrying Co.

ALEXANDRA FREIGHTERS, 107 Grant-street, Alexandra; 2 commercial goods vehicles (120 and 244 cwt.) to operate between Melbourne and Alexandra and places within a radius of 5 miles of Alexandra and places en route—general goods.

NOTICE is hereby given that the applications made by the persons named below for renewal of licences to operate the commercial goods vehicles on the route or routes, or in the manner set out opposite their names, will be heard at a time and place to be communicated to the persons concerned:—

Name and Address; Present Franchise; Licence No.; Date of Expiry.

ANSETT MOTORS LTD., 210 Gray-street, Hamilton; 1 commercial goods vehicle (67 cwt.) to operate throughout the State of Victoria for the purpose of repairing or towing disabled or wrecked applicant's own vehicles to or from own premises at Hamilton—tools, spare parts, and materials incidental to such repair and maintenance; D.A.23228; 21st November, 1959.

BIRCH, E. C., PTY. LTD., 165 Flindens-lane, Melbourne; 2 commercial goods vehicles (each 5 cwt.) to operate throughout the State of Victoria in course of business as "wholesale softgoods dealer"—own softgoods for display and advertising purposes, with the ability to make an urgent incidental delivery; D.A.23853, D.A.23853/1; 21st November, 1959.

BONE, S., & SON, 142 High-street, Belmont, Geelong; 1 commercial goods vehicle (96 cwt.) to operate within a radius of 50 miles from the post office at Geelong in the course of business as "fuel and produce merchants"—own goods; D.A.22951; 21st November, 1959.

Hoy, J. A., 141 McArthur-street, Sale; 1 commercial goods vehicle (100 cwt.) to operate within a radius of 50 miles from the post office at Sale in the course of business as "fuel and oil merchant"—firewood, briquettes, coal, and oil; D.A.1335; 1st August, 1959.

OWEN, R. B., Tawonga South and P.O. Box 7, Mount Beauty; 1 commercial goods vehicle (104 cwt.) to operate—(a) from and to the Township of Wodonga to and from the Township of Bogong, via the Townships of Baranduda, Osborne's Flat, Allan's Flat, Yackandandah, Dederang, and Tawonga—general goods, (b) from and to the Township of Wodonga to and from the Township of Bogong, via the Townships of Kiewa, Kergunyah, Dederang, and Tawonga—general goods, subject to the condition that no goods whatsoever shall be taken up or set down between Kiewa and Dederang, both townships inclusive, (c) from and to places situate within a radius of 20 miles from the post office at Tawonga to and from places situate within a radius of 50 miles of the aforesaid post office—livestock; D.A.15537/1; 21st November, 1959.

PAYNE, A. N., PTY. LTD., 103 Whitehorse-road, Deepdene; 1 commercial goods vehicle (19 cwt.) to operate throughout the State of Victoria in the course of business as "wholesale pastrycooks and cake manufacturers"—block, wedding, and birthday cakes; D.A.2368/2; 21st November, 1959.

NOTICE is hereby given that the applications made by the persons named below for renewal of temporary licences for a period of twelve months to operate the commercial goods vehicles on the route or routes, or in the manner set out opposite their names, will be heard at a time and place to be communicated to the parties concerned:—

Name and Address; Present Franchise; Licence No.; Date of Expiry.

ADAMS, J. H., Powelltown; 1 commercial goods vehicle (180 cwt.) to operate for the carriage of logs from Foresta's landing in the Matlock area to Foresta's Sawmill at North Fitzroy; T.T.D.1685; 6th December, 1959.

ANDREWS, A. K., Nar-Nar-Goon; 1 commercial goods vehicle (107 cwt.) to operate for the carriage of sawn timber and palings from J. McGill's Sawmill at Garfield to building sites at Oakleigh, Ringwood, Springvale, Dandenong, and Frankston; T.T.D.2106; 15th December, 1959.

BEATTIE, H., 16 Leila-street, Traralgon; 1 commercial goods vehicle (275 cwt.) to operate for the carriage of—(1) logs from forest landings in the Valencia Creek, Boola Boola, and Balook and Mullungdung areas to I. A. McPherson's Sawmill at Traralgon, (2) sawn timber from I. A. McPherson's Sawmill at Traralgon to consignees within a radius of 20 miles of the Township of Traralgon; T.T.D.2109; 15th December, 1959.

BILLS, R. P., Box 196, Bairnsdale; 1 commercial goods vehicle (303 cwt.) to operate for the carriage of—(1) sawn timber from sawmills at Cabbage Tree, Club Terrace, Cann River, and Bemm River to consignees at Orbost and to the railway station at Orbost, (2) sawn timber from the Buchan Timber Co.'s Sawmill at Buchan to the railway stations at Nowa Nowa and Bairnsdale and to consignees in Bairnsdale; T.T.D.2002; 17th December, 1959.

Box, W. G., Forrest, via Colac; 1 commercial goods vehicle (205 cwt.) to operate for the carriage of—(1) logs from forest landings at Mount Sabine and Gerangamete to Hancock Bros.' Sawmills at Barramunga and Gerangamete, (2) sawn timber from Hancock Bros.' Sawmills at Barramunga and Gerangamete to consignees at Geelong, (3) sawn timber from Hamill and Mulgrew's Sawmills at Barramunga and Hancock Bros.' Sawmills at Gerangamete, to consignees at Colac and the railway station at Birregurra; T.T.D.1888; 9th December, 1959.

BRENDA, J. F., Nicholas-street, Lilydale; 1 commercial goods vehicle (200 cwt.) to operate for the carriage of—(1) logs from any forest landing in the Niagaroon and Upper Yarra forestry districts and the North Big River area—(a) to the railway station at Healesville and to any mill or dump which is located within a radius of 20 miles of such landing or of the railway station at Healesville, (b) to any mill or timber yard situated within a radius of 25 miles of the G.P.O., Melbourne, (2) sawn timber from C. J. Row, Webb and Anderson's Sawmill at Thornton and Marysville—(a) to the railway station at Healesville, (b) to any customer if delivered within a radius of 20 miles of the Healesville Railway Station, (c) to any merchant or builder if delivered to a timber yard or direct on to building sites which are situated within a radius of 25 miles of the G.P.O., Melbourne; T.T.D.1615; 21st December, 1959.

- BUSH, R. C. & C. A., 5 Napier-street, Warragul; 1 commercial goods vehicle (218 cwt.) to operate for the carriage of—(1) logs from forest landings in the Moe South area (A.P.M. Forests Pty. Ltd.), to sawmills in the Springvale area, (2) sawn timber from A. Cannon's Sawmill at Garfield to Pearce's timber yard at Springvale, McCormack and Anderson's timber yard at Box Hill, and to Day's timber yards at Lower Fern Tree Gully; T.T.D.2104; 1st December, 1959.
- CAFFREY, M. E., Third-avenue, Heyfield; 1 commercial goods vehicle (217 cwt.) to operate for the carriage of logs from forest landings in the Licola area to sawmills at Heyfield; T.T.D.2099; 1st December, 1959.
- COLLINS, J., & BROS. PTY. LTD., Rodger-street, Yarram; 1 commercial goods vehicle (179 cwt.) to operate for the carriage of—(1) logs from forest landings within a radius of 50 miles of Yarram to own sawmills at Yarram, (2) sawn timber from own sawmills at Yarram to consignees within a radius of 50 miles of Yarram; T.T.D.2098; 1st December, 1959.
- CROWE BROS. TRANSPORT PTY. LTD., Buchan; 1 commercial goods vehicle (280 cwt.) to operate for the carriage of sawn timber from Crowe Bros. Sawmill at Buchan to the railway station at Nowa Nowa and to consignees at Bairnsdale; T.T.D.1621; 14th December, 1959.
- DUNNING, G. & D., Forest-road, Orbost; 3 commercial goods vehicles (264, 238, and 225 cwt.) to operate for the carriage of sawn timber from Errinundra Timber Co.'s Mills at Club Terrace to the Orbost Railway Station; T.T.D.1889, T.T.D.1890, T.T.D.1891; 9th December, 1959.
- GRACE, L., Dandenong-road, Clayton; 1 commercial goods vehicle (159 cwt.) to operate for the carriage of—(1) sawn timber from sawmills east of Orbost to the railway station at Orbost, (2) sawn timber from the Buchan Timber Co.'s Sawmill at Buchan to the railway station at Nowa Nowa, (3) sawn timber loaded from own yards at Clayton to consignees and building sites within a radius of 25 miles of the G.P.O., Melbourne; T.T.D.1678; 6th December, 1959.
- HAMPSHIRE, BROS., E. & C., Winchelsea; 1 commercial goods vehicle (165 cwt.) to operate for the carriage of—(1) logs from forest landings in the Benwerrin and Deans Marsh areas to own sawmill at Deans Marsh, (2) sawn timber from own sawmill at Deans Marsh to consignees at Colac and Geelong; T.T.D.2100; 1st December, 1959.
- HARRIS, W. J., Yarra Junction; 1 commercial goods vehicle (133 cwt.) to operate for the carriage of sawn timber from Parkinson Bros. and Piper's Sawmill at Hazeldene to building sites in the metropolitan area; T.T.D.2107; 15th December, 1959.
- HILDER, J. W., Gembrook; 1 commercial goods vehicle (104 cwt.) to operate for the carriage of—(1) battens, fencing rails, palings, and scantlings from J. D. Pearce, Hilder and Sons, Goodie and Atkinson, F. Fielder, and A. Briely's Sawmills at Gembrook to consignees in the metropolitan area, (2) sawn timber and palings from W. D. Hilder and Sons' Sawmill at Fumina South to own yards at Gembrook; T.T.D.1812; 17th December, 1959.
- JOHNSON, K. T., 40 McLean-street, Maffra; 1 commercial goods vehicle (263 cwt.) to operate for the carriage of logs from forest landings in the Licola area to sawmills at Heyfield; T.T.D.1613; 14th December, 1959.
- KÉITH, G. J., 12 Tambo-avenue, Reservoir; 1 commercial goods vehicle (135 cwt.) to operate for the carriage of—(1) loose paling battens (3 feet to 9 feet long, 2 inches to 4 inches wide, $\frac{3}{4}$ inch to 1 inch thick), from Jackson's Sawmill at Yea to A.P.M. yards at Fairfield, (2) loose paling battens (3 feet to 9 feet long, 2 inches to 4 inches wide, $\frac{3}{4}$ inch to 1 inch thick), from Murrindindi Sawmills at Murrindindi to the A.P.M. yards at Broadford and Fairfield, (3) general goods within a radius of 20 miles of the G.P.O., Melbourne; T.T.D.1896; 17th December, 1959.
- MAHER, J. W. C., 12 Jamieson-street, Daylesford; 1 commercial goods vehicle (100 cwt.) to operate for the carriage of sawn timber from own sawmill at Spargo Creek to building sites or timber yards at Geelong; T.T.D.1680; 6th December, 1959.
- MATTHEWS, J. C., Woods Point; 1 commercial goods vehicle (276 cwt.) to operate for the carriage of sawn timber from Charles Bros. Sawmill at Woods Point, via Warburton or Eildon Weir to Dry Kiln Seasoning Co.'s timber yards at Port Melbourne; T.T.D.1611; 21st December, 1959.
- MCCONACHY, L. D., Three Bridges; 1 commercial goods vehicle (204 cwt.) to operate for the carriage of sawn timber from own sawmill at Three Bridges to consignees in the metropolitan area; T.T.D.2101; 1st December, 1959.
- MCCONNELL, M. J., 19 Reynolds-street, Mansfield; 1 commercial goods vehicle (271 cwt.) to operate for the carriage of—(1) logs from forest landings in the Mount Buller area to Bell's Sawmill at Mansfield and sawmills at Benalla, (2) sawn timber from Bell's Sawmills at Mansfield to consignees at Benalla; T.T.D.1558; 1st December, 1959.
- OVEREND, B. S., Wallace-street, Bairnsdale; 1 commercial goods vehicle (237 cwt.) to operate for the carriage of—(1) logs from forest landings in the Bendoc area to sawmills at Bendoc and Cann River, (2) sawn timber from sawmills at Bendoc and Cann River to the railway station at Orbost and to consignees in Orbost; T.T.D.2108; 15th December, 1959.
- PILTZ, D. A., Anderson-street east, Euroa; 1 commercial goods vehicle (104 cwt.) to operate for the carriage of sawn timber from E. Bamford and Sons' and L. I. Bamford's Sawmills to consignees within a radius of 20 miles of Euroa and to consignees at Kyabram, Merrigum, Nagambie, Murchison, Shepparton, Pyalong, Numurkah, and Seymour; T.T.D.2105; 1st December, 1959.
- REDENBACH, W. & J., (trading as Redenbach Bros.), Gelantipy; 1 commercial goods vehicle (263 cwt.) to operate for the carriage of—(1) logs from forest landings in the Gelantipy and Buchan areas to sawmills at Nowa Nowa, Buchan, and Gelantipy, (2) sawn timber from sawmills at Gelantipy and Buchan to the railway stations at Nowa Nowa and Bruthen and to consignees within a radius of 20 miles of Bairnsdale; T.T.D.2103; 15th December, 1959.
- SAXTON TIMBER & TRADING CO. PTY. LTD., 26 Albert-street, Moe; 1 commercial goods vehicle (288 cwt.) to operate for the carriage of—(1) sawn timber from own sawmill at Licola to own timber yards at Moe, (2) sawmilling equipment from own timber yards at Moe to own sawmill at Licola, (3) building materials from own timber yards at Moe to consignees at Traralgon and to consignees *en route* to Licola, (4) pre-cut timber from own timber yards at Moe to own employees' housing project at Licola, (5) transport of sawmilling equipment from company's sawmill at Licola to company's engineering shop at Moe, (6) transport of equipment and timber between the company's mill at Licola and Moe and the company's pine plantations at Longford and Moondarra (Vic.); T.T.D.1629; 14th December, 1959.
- WALKER, A. R., 27 Haig-street, Box Hill; 1 commercial goods vehicle (175 cwt.) to operate for the carriage of—(1) logs from any forest landings in the Niagara and Upper Yarra forestry districts and the North Big River areas—(a) to the railway station at Warburton and/or Yarra Junction and to any mill or dump which is located within a radius of 20 miles of such landings or of the railway station at Warburton and/or Yarra Junction, (b) to any mill or timber yards situated within a radius of 25 miles of the G.P.O., Melbourne, (2) sawn timber from Baird and Inverlarty's Sawmill at Millgrove—(a) to the railway station at Warburton and/or Yarra Junction, (b) to any customer if delivered within a radius of 20 miles of the railway station at Warburton and/or Yarra Junction, (c) to any merchant or builder if delivered to timber yard or direct on to a building site which is located within a radius of 25 miles of the G.P.O., Melbourne; T.T.D.1349; 4th December, 1959.

NOTICE is hereby given that the applications made by the persons named below for licences to operate commercial passenger vehicles on the route or routes, or in the manner set out opposite their names, will be heard at a time and place to be communicated to the parties:—

Name and Address; Nature of Application.

- WALKER, R., care of R. Witham, Metung; 1 commercial passenger vehicle, with seating capacity for 31 persons, to operate as follows:—(a) For the carriage of school children only between Stratford, via Maffra and Sale, under contract to the Education Department, (b) as a special service omnibus, subject to all regulations appertaining to such operations and subject also to the condition that all journeys undertaken commence within a radius of 10 miles of Stratford Post Office, (c) under special traffic conditions, subject to all regulations appertaining to such operations and subject also to the condition that all journeys undertaken commence within a radius of 10 miles of Stratford Post Office.
- DENHAM, B. G., & H. WATCHORN (trading as Phillip Island Tourist Service), Cowes, Phillip Island; 3 commercial passenger vehicles, with seating capacity for 29, 36 and 29 persons respectively, to operate for the carriage

of passengers between Cowes, Phillip Island, and Melbourne, subject to the condition that no passengers be carried exclusively between Dandenong and Melbourne (subject also to the cancellation of licences Nos. C.O.215, C.O.776 and C.O.918 and permit authorities applying thereto).

APPPLICATIONS for renewal of licences by persons listed hereunder to operate under the same terms and conditions from the date of expiry:—

Name and Address; Licence No.; Classification; Date of Expiry.

- BOXSHALL, H. E., Scott-street, Mitcham; C.T.619; country taxi, Mitcham; 23rd August, 1959.
 LANGDON, A. W., & P. HARGREAVES (trading as Myrtleford Motors), corner of Clyde and Alice streets, Myrtleford; T.S.183; school service; 10th January, 1960.
 PYLE, T. J., Tawonga South; C.O.433; country omnibus; 30th January, 1960.
 BARNES, J. D., 19 Ainsworth-street, Sunshine; M.C.350; metropolitan charter; 22nd December, 1959.

HAYES, F. J., 128 Altona-street, Heidelberg West; 1 commercial passenger vehicle, with seating capacity for five persons, to operate as a metropolitan taxi-cab.

APPPLICATIONS for metropolitan private, hire car licences by the persons listed hereunder in respect of commercial passenger vehicles, with seating capacity for five persons, to operate under composite conditions from an approved depot in zone set out opposite their names:—

Name and Address; Zone.

- HAYES, F. J., 128 Altona-street, Heidelberg West; "O".
 HAYES, F. J., 128 Altona-street, Heidelberg West; "C".
 HAYES, F. J., 128 Altona-street, Heidelberg West; "N".
 HAYES, F. J., 128 Altona-street, Heidelberg West; "G".
 GEDLING, K. M., 14 Latrobe-street, Bulleen; "H".

- BLACK, S., 14 Everett-street, West Brunswick; "H".
 BLACK, S., 14 Everett-street, West Brunswick; "N".
 WILSON, H. J. L., 207 Spring-street, Reservoir; "N".
 RANK, R. A. W., 73 Main-road, Lower Plenty; "H".
 CLARKE, R. R., Lot 2, Edinburgh-street, South Blackburn; "H".
 CLARKE, R. R., Lot 2, Edinburgh-street, South Blackburn; "N".
 MOONEY, J. E., 25 Keith-street, Parkdale; "B".
 THOMSON, P. W. J., care of Royal Hotel, Clifton Hill; "D".
 THOMSON, P. W. J., care of Royal Hotel, Clifton Hill; "N".
 MELTON, C. J., 14 Normanby-avenue, Thornbury; "H".
 MEDWIN, K. I., 10 Dowling-street, Fawkner; "N".

JOINER, J. H., 31 Rose-street, Altona; application for one commercial passenger vehicle, with seating capacity for 36 persons, to operate as an additional metropolitan stage omnibus on route No. 141A (Altona-Footscray) under the same terms and conditions as licences already held in the name of the applicant.

AUSTRALIAN BLOCK & CHAIN CO. PTY. LTD. (L. Benini), 40-44 Robbs-road, West Footscray; application for one commercial passenger vehicle, with seating capacity for 28 persons, to operate for the carriage of employees only of the Australian Block and Chain Co. Pty. Ltd., free of charge, commencing in Moor-street, Fitzroy, thence via Grattan, Lygon, Victoria and Elizabeth streets to North Melbourne Railway Station, thence via Dynon-road, Barkly-street, Nicholson-street to the company's premises situated in Robbs-road, West Footscray:—

Time-table.

Depart Moor-street 7.15 a.m. Depart Factory 4.45 p.m.

Notice of any objection should be forwarded to reach the Secretary to the Board not later than Wednesday, 16th September, 1959.

E. V. FIELD,
Secretary.

Exhibition Buildings, Rathdown-street, Carlton, N.3, Wednesday, 2nd September, 1959.

MONEY LENDERS ACT 1958.

IN accordance with the provisions of the above-mentioned Act, the following is published for general information.

List of Persons to whom Money Lenders' Licences have been issued for the year ending 30th June, 1960.

Name.	Authorized Name.	Authorized Address.	Date of Issue.
Blakey, Martin	Martin Blakey	33 Baird-street, East Brighton	24.7.59
Confidential Investments Pty. Ltd. (W. T. MacGavin, appointee)	Confidential Investments Pty. Ltd.	157 Commercial-road, South Yarra	13.7.59
Finance Accommodation Pty. Ltd. (G. R. Orr, appointee)	Finance Accommodation Pty. Ltd.	266 Swan-street, Richmond	2.7.59
G. E. Finance Proprietary Limited (G. J. Evans, appointee)	G. E. Finance Proprietary Limited	62 Wellington-parade, East Melbourne	6.7.59
Gippsland Acceptance Limited (F. J. Ulrick, appointee)	Gippsland Acceptance Limited	Lonsdale-street, Dandenong	20.7.59
James, Jemima	Jemima James	1 Woodlawn-street, Richmond	14.7.59
* Collins Trading Company Pty. Ltd. (M. H. Joske, appointee)	Collins Trading Company Pty. Ltd.	277 Smith-street, Fitzroy	21.7.59
Paynes Properties Proprietary Limited (M. R. Ralph, appointee)	Paynes Properties Proprietary Limited	138 Bourke-street, Melbourne	6.7.59
Pivot Investment Corporation Ltd. (T. Morrow, appointee)	Pivot Investment Corporation Ltd.	75-77 Moorabool-street, Geelong	9.7.59
Reakes, Charles Alfred William	C. A. W. Reakes	327 Lydiard-street, Ballarat	2.7.59
Shepherd, John Charles	John Charles Shepherd	79 Speight-street, Thornbury	25.7.59

* Now Authorized Address.

State Treasury,
Melbourne, C.2, 24th August, 1959.

M. A. R. SYNNOT,
Registrar.

CONTRACTS ACCEPTED.—(Series 1959-60.)**PROVISIONS.**

Gazette No. 60, 6th July, 1958, Schedule No. 14, Sub-Schedule No. 2, Groceries—Ceelong District.—For "The rates to be paid under this Sub-Schedule shall be the wholesale price ruling on the day of delivery", substitute "The rates to be paid under this Sub-Schedule shall be the wholesale price ruling on the day of delivery, ex store, plus 5 per cent., if delivered", as from 1st July, 1959.

GENERAL STORES.

Gazette No. 64, 16th July, 1959, Schedule No. 29, Cordage, &c.—For the rates shown opposite the following items, substitute the rates as set out hereunder, as from 13th August, 1959:—Item No. 3, 11s. 8½d. lb. Item No. 5, 11s. 8½d. lb. Item No. 6, 10s. 2½d. lb. Item No. 7, 14-lb. coils, 6s. 6½d. lb.; 1-lb. reels, 6s. 8½d. lb. Item No. 8, 10s. 5½d. lb. Item No. 9, 7s. 5½d. lb. Item No. 10, 9s. 10½d. lb. Item No. 12, 10s. 5½d. lb. Item No. 14, 1-in. and up, 6s. 2½d. lb.; ¾-in. and ½-in., 6s. 5½d. lb.; under ¾-in., 6s. 7½d. lb. Item No. 18, 5s. 7½d. lb. Item No. 19, 5s. 1½d. lb. Item No. 20, 4s. 7½d. lb. Item No. 21, 9s. 5½d. lb. Item No. 22, 9s. 5½d. lb. Item No. 23, 9s. 5½d. lb. Item No. 24, £12 1s. per cwt. Item No. 25, £12 4s. 6d. per cwt. Item No. 26, 10s. 0½d. lb. Item No. 27, 9s. 10d. lb. Item No. 28, 12s. 3½d. lb. Item No. 29, 6s. 1½d. lb. Item No. 30, 14-lb. coils, 3s. 7½d. lb.; 1-lb. reels, 3s. 9d. per lb.

Gazette No. 64, 16th July, 1959, Schedule No. 77, White Lead, Linsed Oil, &c.—For Item Nos. 7, 8, 9, 11, 12, 13, substitute 18s. 10d., £1 3s. 4d., £1 4s. 6d., 19s., £1 3s. 6d., £1 4s. 9d. per gallon, as from 17th August, 1959.

SUPPLY OF PRISONERS' MEALS IN LOCK-UPS.

Gazette No. 53, 17th June, 1959, Prisoners' Meals, St. Kilda, Contract No. 66.—For Breakfast and Tea, substitute 2s. 9d., as from 1st July, 1959.

W. H. RUTHERFORD, Secretary to the Tender Board. 31.8.59.

VICTORIAN RAILWAYS.

25. Sawn redgum timber, at Rates (Contract 61414).—McCulloch Carrying Co. Pty. Ltd. 26. Sawn redgum timber, at Rates (Contract 61446).—Kerang Sawmills. 27. Sawn redgum timber, at Rates (Contract 61447).—Ryan and McNulty Pty. Ltd. 28. Sawn redgum timber, at Rates (Contract 61448).—Mooroopna Sawmills. 29. Sawn redgum timber, at Rates (Contract 61449).—Murray Valley Sawmills. 30. Sawn redgum timber, at Rates (Contract 61450).—Red Gum Distributors Pty. Ltd. 31. Sawn redgum timber, at Rates (Contract 61451).—Arbutnot Sawmills Pty. Ltd. 32. Sawn redgum timber, at Rates (Contract 61452).—Weral Sawmilling Co. Pty. Ltd. 33. Sawn redgum timber, at Rates (Contract 61453).—Bonum Sawmills. 34. Sawn redgum timber, at Rates (Contract 61454).—Evans Bros. 35. Sawn redgum timber, at Rates (Contract 61455).—King and Jones. 36. Sawn redgum timber, at Rates (Contract 61456).—Rutherglen Timber Co. 37. Sawn redgum timber, at Rates (Contract 61457).—D. K. Murray's Sawmills. 38. Sawn redgum timber, at Rates (Contract 61458).—Fasham's Sawmills. 39. Sawn redgum timber, at Rates (Contract 61459).—Gulpa Sawmills Pty. Ltd. 40. Sawn redgum timber, at Rates (Contract 61460).—Edwards River Sawmill Pty. Ltd. 41. Sawn redgum timber, at Rates (Contract 61461).—A. B. Rowe and Son Pty. Ltd. 42. Sawn redgum timber, at Rates (Contract 61462).—W. J. and E. M. Hartshorne. 43. Line relays, at Rates (Contract 61473).—McKenzie and Holland (Aust.) Pty. Ltd.

By order of the Victorian Railways Commissioners,
A. GILMORE, Secretary for Railways. 28.8.59.

CONTRACTS ACCEPTED.—(Series 1958-59.)**PUBLIC WORKS.**

4642. Ballarat, Mental Hospital, (1) supply of refrigerators, £418.—R. R. Wickers Pty. Ltd.

4643. Port Melbourne, P.W.D. Depot, (1) supply of metal and screenings, £373 15s. 6d.—G. H. Reid and Sons Pty. Ltd.

4644. Elwood, High School, (1) supply of lathe with equipment, £267 17s.—Industrial Hardware Pty. Ltd.

4645. Ballarat, Mental Hospital, (1) supply of paint, £317 4s.—Taubmans (Vic.) Pty. Ltd.

4646. Carlton, Migration Reception Centre, (1) supply of two hot-water units, £481 12s.—Orm Smith and Co. (Vic.) Pty. Ltd.

4647. Yarrowonga, State School No. 1819, (1) supply of nine (9) bearer floor type air circulators, £339 8s. 3d.—Warburton Franki Industries (Melb.) Pty. Ltd.

4648. Wheeler's Hill, "Hillside," Children's Welfare Department, (1) supply of refrigerator, £294.—R. R. Wickers Pty. Ltd.

4649. South Melbourne, P.W.D. Storeyard, (1) supply of tents, flies, painters drop cloths and mattress covers, £708 5s.—Thomas Evans Pty. Ltd.

4650. Sandringham, Girls' Technical School, (1) supply of dishwasher, £265.—Brice Scale and Slicer Pty. Ltd.

4651. Snob's Creek, Fish Hatchery, (1) supply of reinforced concrete pipes, £250 1s. 4d.—Rocla Pipes Ltd.

4652. North Melbourne, Government Printing Office, (1) supply of wash troughs, £680.—Weatherleys Pty. Ltd.

4653. Tongala, Consolidated School, (1) supply of air circulators, £414 16s. 9d.—Warburton Franki Industries (Melb.) Pty. Ltd.

4654. Dooen, Longerenong Agricultural College, (1) supply and delivery of precast reinforced concrete wall panels, £1,340.—E.P.M. Concrete Pty. Ltd.

4655. Kew, Mental Hospital, (1) supply and delivery of keuri timber, £264 15s. 4d.—Mordialloc Timber Co. Pty. Ltd.

4656. Williamstown, Dredges "Pioneer" and "Matthew Flinders", (1) supply of bunker coal, £2,298 1s. 6d.—Melbourne Steamship Co.

4657. Bendigo, Mental Hygiene Training Centre, (1) supply of one Sterlec G.E.C. double deck pastry oven, £437 5s.—British General Electric Co. Pty. Ltd.

4658. Larundel, Mental Hospital, (1) supply of two only Lawtrac towing units, £1,839.—Freighter Industries (Vic.) Pty. Ltd.

4659. Larundel, Mental Hospital, (1) supply of sewing machines, £480 6s. 9d.—Singer Sewing Machine Co.

4660. Beechworth, Mental Hospital, (1) supply of general purpose press with accessories, £1,041 4s.—Robert Bryce and Co. Ltd.

4661. Kew, Mental Hospital, (1) supply of dental equipment, £1,138 12s.—The Amalgamated Dental (Aust.) Pty. Ltd.

4662. Hamilton, Department of Agriculture, (1) supply of super seeder dice drill with accessories, £607 18s.—Connor, Shea, and Co. Pty. Ltd.

4663. Mont Park, Mental Hospital, (1) supply of twelve (12) Avery person weighers, £733 10s.—W. and T. Avery (Aust.) Pty. Ltd.

4664. Mont Park, Mental Hospital, (1) supply of 200 cubic yards of metal, £295.—Albion Quarrying Co. Pty. Ltd.

4665. Traralgon, Mental Hospital, (1) supply of crushed rock, £480 12s. 6d.—Manuells Bluestone Quarries.

4666. Langi Kal Kal, Prison Farm, (1) supply of electric dishwasher with three-phase motor, £295.—Brice Scale and Slicer Co. Pty. Ltd.

4667. South Yarra, Melbourne Teachers' College Hostel, (1) supply of refrigeration cabinet with ice making evaporator, £475.—M. F. Ahearn and Co. Pty. Ltd.

4668. Mont Park, Plenty Mental Hospital, (1) supply of refrigerator, £323 12s. 6d.—M. F. Ahearn and Co. Pty. Ltd.

4669. Mont Park, Mental Hospital, (1) supply of glazed tiles, £3,090 18s. 9d.—Australian Tesselated Tile Co. Pty. Ltd.

4670. Geelong, Gordon Institute of Technology, (1) supply of one evaporative cooler, £706.—Knox Schlapp Pty. Ltd.

4671. Royal Park, Mental Hospital, (1) supply of two steam jacketed tilting pans, £1,118.—Atherton Benham Pty. Ltd.

4672. Dooen, Longerenong Agricultural College, (1) supply of aluminium framed windows and aluminium sliding external doors, £4,949.—The Bronze Window Frame Co. Pty. Ltd.

4673. South Yarra, Teachers' Hostel, (1) supply of one electric food trolley with extra set of containers, £277 10s.—M. F. Ahearn and Co. Pty. Ltd.

4674. Snob's Creek, Fish Hatchery, (1) supply of 100 stainless-steel hatching baskets, £1,760.—Melbourne Wire Works Pty. Ltd.

4675. Melbourne, Old Treasury Buildings, (1) supply and delivery of sheet copper casing to cornice mould, £776.—K. S. P. Chandler Ltd.

4676. Mont Park, Plenty Mental Hospital, (1) supply of lattice trusses, £366.—Standard Steel Pty. Ltd.

MURRAY PORTER, for Commissioner of Public Works. 28.8.59.

ORDERS IN COUNCIL.—(Series 1959-60.)

PUBLIC WORKS.

579. Mont Park Mental Hospital, supply of new picture screen, £272 10s.—National Theatre Supplies (N.E.205207).

580. Government House, Melbourne, hire of marquees and chairs, £544 15s.—Miller Bros. Hirings Pty. Ltd. (M.220121).

581. State Film Centre, 110 Victoria-street, Carlton, cleaning for the period 1st July, 1959, to 30th June, 1960, £300 p.a.—Essential Cleaning Service (M.145042).

582. Crown Law Offices, Melbourne, supply and installation of steel cabinets and shelving, £303 8s.—E. T. Brown Ltd. (M.206586).

Approved by the Governor in Council, 25th August, 1959.—A MAHLSTEDT, Clerk of the Executive Council.

STATE ELECTRICITY COMMISSION.

583. The purchase of land at Yallourn, comprising approximately 118 acres 1 rood 20 perches, being Crown allotment 4A, Parish of Narracan, and being the whole of the land comprised in certificate of title, volume 7333, folio 582, together with improvements erected thereon, as site for dam for water storage, Yallourn Power Station, £14,750.—Nicolantonio Disisto.

584. The rewinding of one 38-MW generator stator, at Richmond Power Station, and supply of 12 spare stator bars, £8,480 4s. 10d.—Gibson Battle (Melb.) Pty. Ltd.

Approved by the Governor in Council, 18th August, 1959.—A MAHLSTEDT, Clerk of the Executive Council.

Local Government Act 1958.

SHIRE OF MINHAMITE.

IN pursuance of the powers conferred by sections 521 and 525 of the *Local Government Act 1958*, the Council of the Shire of Minhamite doth hereby direct that the land in the Parish of Ardonachie shown hatched on the plan annexed hereto which has been taken, purchased or acquired by it shall be a public highway from and after the date of publication of this Order in the *Government Gazette*, and doth declare that such land shall be a public highway in lieu of the land in the said parish shown cross-hatched on the said plan.

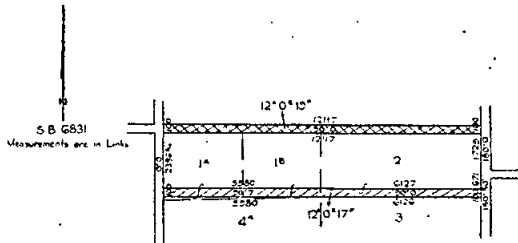

The common seal of the President, Councillors and Ratepayers of the Shire of Minhamite was hereunto affixed this sixth day of July, One thousand nine hundred and fifty-nine, in the presence of—

(SEAL) C. C. NAGORCKA, President.
F. G. GLARE, Councillor.
ALAN J. BOWES, Secretary.

Approved by the Governor in Council, 25th August, 1959.

A. MAHLSTEDT,
Clerk of the Executive Council.

Victoria.

CO-OPERATION ACT 1958.

NOTICE is hereby given, in pursuance of section 78 (7) of the *Co-operation Act 1958* and section 241 (3) of the *Companies Act 1958*, that, at the expiration of three months from the date hereof, CO-OPERATIVE WHOLESALERS OF VICTORIA LIMITED will, unless cause is shown to the contrary, be struck off the register and the society will be dissolved.

Dated this 28th day of August, 1959.

E. T. EBBELS,
Registrar of Co-operative Societies.

Victoria.

CO-OPERATION ACT 1958.

NOTICE is hereby given, in pursuance of section 78 (7) of the *Co-operation Act 1958* and section 241 (3) of the *Companies Act 1958*, that, at the expiration of three months from the date hereof, CORRYONG CO-OPERATIVE SOCIETY LIMITED will, unless cause is shown to the contrary, be struck off the register and the society will be dissolved.

Dated this 28th day of August, 1959.

E. T. EBBELS,
Registrar of Co-operative Societies.

Water Acts.

STATE RIVERS AND WATER SUPPLY COMMISSION.

DROMANA—PORTSEA, CULGOA, PIANGIL, BARWON HEADS—OCEAN GROVE, QUEENSLIFF—POINT LONSDALE, DRYSDALE, PORTARLINGTON, COHUNA AND CAMPERDOWN URBAN DISTRICTS.

NOTICE to owners of tenements in the under-mentioned streets in the above-mentioned Urban Districts and the private streets, lanes, courts, and alleys opening thereto:—

DROMANA—PORTSEA URBAN DISTRICT.

McCrae.

Beverley-street, from end of existing main (opposite lot 61) to a point opposite lot 70, about 6½ chains south-easterly.

Charles-street, from end of existing main (opposite lot 100) to a point opposite lot 116, about 14½ chains south-easterly.

CULGOA URBAN DISTRICT.

Ultima-road, from Church-street to a point about 5 chains north-westerly.

PIANGIL URBAN DISTRICT.

McGradie-street, from end of existing main (opposite right-of-way between allotments 5 and 6, section 3) to a point opposite allotment 8, about 2½ chains southerly.

BARWON HEADS—OCEAN GROVE URBAN DISTRICT.

Ocean Grove.

Madeley-street, from end of existing main (opposite lot 273) to a point opposite lot 268, about 5 chains westerly.

Presidents-avenue, from Madeley-street to Wyatt-street.
Wyatt-street, from Presidents-avenue to a point opposite lot 571, about 5½ chains westerly, and from Presidents-avenue to a point opposite lot 579, about 2½ chains easterly.

QUEENSLIFF—POINT LONSDALE URBAN DISTRICT.

Point Lonsdale.

Alexander-crescent, from Fellowes-road to a point opposite lot 9, about 4½ chains south-easterly.

Bailey-street, from Egerton-street to a point opposite lot 26, about 3½ chains north-easterly.

Fellowes-road, from end of existing main (opposite lot 53) to Alexander-crescent.

Ward-street, from end of existing main (opposite lot 22) to a point opposite lot 21, about 1 chain north-westerly.

DRYSDALE URBAN DISTRICT.

Duke-street, from Victory-avenue to a point opposite lot 9, about 2½ chains south-westerly.

Victory-avenue, from end of existing main (opposite lot 8) to Duke-street.

PORTARLINGTON URBAN DISTRICT.

Clarke-street, from end of existing main (opposite allotment 1, section 36A) to Mercer-street.

Fisher-street, from Drysdale-street to The Esplanade.

Sproat-street, from end of existing main (opposite lot 13) to a point opposite lot 11, about 1½ chain northerly.

The Esplanade, from Fairfax-street to Clarke-street and from Gellibrand-street to Fisher-street.

Valerie-avenue, from Mercer-street to a point opposite lot 39, about 5 chains easterly.

COHUNA URBAN DISTRICT.

Channel-street, from Hay-street to George-street.
George-street, from Channel-street to a point opposite lot 4, about 12½ chains south-westerly.

CAMPERDOWN URBAN DISTRICT.

Morris-street, from Scott-street to Campbell-street.

The main pipe in the said streets being laid down, the owners of all tenements situated as above are hereby required, on or before the 5th day of October next, to cause proper pipes or stopcocks to be laid, so as to supply water within such tenements from the main pipe.

E. BROWN, Secretary,
State Rivers and Water Supply Commission.
Melbourne, 28th August, 1959.

Hospitals and Charities Act 1958 (No. 6274).—Section 46.
PETITION TO INCORPORATE NATHALIA DISTRICT HOSPITAL.

IT is hereby notified, in accordance with the provisions of section 46 of Act No. 6274, that the Hospitals and Charities Commission has received a petition signed by not less than twenty-five contributors to Nathalia District Hospital praying that that institution be incorporated under the provisions of the said Act. This institution established in Nathalia will have for its objects—

- (a) To afford relief, including maintenance and the treatment or cure of, or attention to, any disease or ailment, or any injury consequent on any accident, medical and/or surgical attendance, medicine, nursing assistance, support or aid of any kind or in any form to such persons as are entitled thereto under the Act;
- (b) To provide facilities for the treatment of intermediate and private patients or either of them;
- (c) To provide facilities for the carrying out of investigations into ailments, diseases, injuries or other matters affecting the human body,

and is capable of being incorporated.

If a counter-petition signed by an equal or greater number of contributors is not lodged with the aforesaid Commission, at 1 Nicholson-street, Melbourne, within one calendar month of publication of this notice, the Governor in Council may, by Order made pursuant to Act No. 6274, declare the contributors for the time being to Nathalia District Hospital to be a body corporate by the name set forth in such Order.

E. P. CAMERON,
Minister of Health.
Department of Health, Melbourne.

MILDURA URBAN WATER TRUST.

RATING BY-LAW 1959-60.

ON the 16th day of July, 1959, in accordance with the approved estimates, the Mildura Urban Water Trust doth hereby make a rate for the supply of water for domestic purposes of One shilling and four pence (1s. 4d.) in the £1 on the municipal valuation of lands and tenements liable to be rated within its district.

Provided that in no cases shall the amount of rate payable per annum in respect of any tenement (other than on land on which there is no building) be less than 80s. (Eighty shillings), and in respect of any land on which there is no building be less than 45s. (Forty-five shillings).

The above rates are to be payable in one amount on the 30th September, 1959, and if not paid by 30th November, 1959, to bear interest at a rate of six per cent. (6%) per annum from 30th September, 1959, to date of payment.

The common seal of the Mildura Urban Water Trust was hereto affixed by the direction of the said Trust by—

D. MAXWELL, Secretary.

In the presence of—
(SEAL) J. S. SHILLIDAY, Commissioner.
W. B. BOWRING, Commissioner.

Approved by the Governor in Council,
25th August, 1959.

A. MAHLSTEDT,
Clerk of the Executive Council.

MILDURA URBAN WATER TRUST.

EXCESS BY-LAW 1959-60.

MILDURA URBAN WATER TRUST, pursuant to and in exercise and execution of the powers conferred on it by Mildura Irrigation and Water Trusts Act and the Water Acts, doth hereby make the By-law following:—

The maximum quantity of water to be supplied in any one year without further charge to any property rated by the Trust is hereby fixed at the quantity which, at a charge of One shilling and six pence per 1,000 gallons, would produce an amount equal to the amount of the rate levied on such a property for the said year.

The charge for water supplied by measure to any property rated by the Trust in excess of such maximum quantity, computed as in the last preceding clause, is hereby fixed at Eleven pence per 1,000 gallons, which shall be payable on demand.

The foregoing By-law was made and passed by the Mildura Urban Water Trust, and its common seal was hereto affixed by direction of the said Trust on 16th July, 1959, by—

D. MAXWELL, Secretary.

In the presence of—
(SEAL) J. S. SHILLIDAY, Commissioner.
W. B. BOWRING, Commissioner.

Approved by the Governor in Council,
25th August, 1959.

A. MAHLSTEDT,
Clerk of the Executive Council.

4 GEORGE VI. No. 4755, SECTION 6.

I HEREBY give notice that on the 11th August, 1959, the Public Trustee filed an election to administer the following deceased person's estate, in accordance with section 6 of the *Public Trustee Act 1940*:—

HAMILTON, MARGARET PATRICK, late of Mont Park, Victoria, spinster, died 11th May, 1959, intestate.

I HEREBY give notice that on the 19th August, 1959, the Public Trustee filed elections to administer the following deceased persons' estates, in accordance with section 6 of the *Public Trustee Act 1940*:—

BROWN, WILLIAM CULLIS, late of 20 Napier-street, Fitzroy, pensioner, died 6th July, 1959, intestate.

CONWAY, JOHN, also known as Henry John Conway, late of Ararat, pensioner, died 21st January, 1959, intestate.

*FISHER, ESTELLA GLADYS GRACE, formerly of 256 Commercial-road, Morwell, but late of Yinnar-road, Morwell, married woman, died 5th May, 1959.

*LUCAS, SYDNEY CHARLES ALBERT, late of 50 Combermere-street, Essendon, waterside worker, died 24th May, 1959.

MOREY, DENIS THOMAS, late of 314 Bank-street, South Melbourne, pensioner, died 26th March, 1959, intestate.

PLUNKETT, PETER, formerly of 217 Highfield-road, East Camberwell, but late of 16 Cornell-street, East Camberwell, pensioner, died 13th May, 1959, intestate.

REID, WILLIAM, late of 118 Moore-street, Ararat, male nurse, died 6th July, 1958, intestate.

STANSFIELD, ROBERT HENRY, late of Mount Royal, retired baker, died 25th May, 1959, intestate.

* According to the provisions of the will.

A. D. DUNCAN,
Public Trustee.

601 Little Collins-street, Melbourne, C.1, 26th August, 1959.

NOTICE.

ADMINISTRATION of the estate of each of the under-mentioned deceased persons has been granted to the Public Trustee, and creditors, next of kin, and all others having claims against the estate of any of the persons so mentioned are required to send particulars of their claims to the Public Trustee, 7th Floor, 601 Little Collins-street, Melbourne, on or before the 5th November, 1959, or they will be excluded from the distribution of the estate when the assets are being distributed:—

*BIGGS, CHARLES CLYDE, late of 2 Ralph-street, Hampton, retired soft furnishing specialist, died 26th May, 1959.

BROWN, WILLIAM CULLIS, late of 20 Napier-street, Fitzroy, pensioner, died 6th July, 1959, intestate.

CARMODY, ARTHUR DALY, late of 1 Federal-street, Mt. Waverley, pensioner, died 13th August, 1958, intestate.

COCKMAN, CATHERINE, formerly of 29 Brougham-street, Richmond, but late of 15 Clifton-street, Box Hill, widow, died 11th May, 1959, intestate.

CONWAY, JOHN, also known as Henry John Conway, late of Ararat, pensioner, died 21st January, 1959, intestate.

FIRTH, WILLIAM LAUDER, also known as William George Firth, late of 131 Grange-road, Glenhuntly, pensioner, died 3rd May, 1959, intestate.

† FISHER, ESTELLA GLADYS GRACE, formerly of 256 Commercial-road, Morwell, but late of Yinnar-road, Morwell, married woman, died 5th May, 1959.

* FORSYTH, ROBERT ROY, late of 77 McCracken-street, Essendon, engineer, died 17th May, 1959.

* GOWLETT, HERBERT SPENCER, late of 55 Devonshire-road, Watsonia, clerk, died 1st October, 1958.

HAMILTON, MARGARET PATRICK, late of Mont Park, Victoria, spinster, died 11th May, 1959, intestate.

† LUCAS, SYDNEY CHARLES ALBERT, late of 50 Combermere-street, Essendon, waterside worker, died 24th May, 1959.

MOREY, DENIS THOMAS, late of 314 Bank-street, South Melbourne, pensioner, died 26th March, 1959, intestate.

* PARKER, JAMES ROBERT, formerly of 48 Gladstone-avenue, South Perth, Western Australia, but late of 36 Davey-street, Mandurah, Western Australia, retired building contractor, died 26th September, 1958.

PLUNKETT, PETER, formerly of 217 Highfield-road, East Camberwell, but late of 16 Cornell-street, East Camberwell, pensioner, died 13th May, 1959, intestate.

REID, WILLIAM, late of 118 Moore-street, Ararat, male nurse, died 6th July, 1958, intestate.

* RODRIGUES, ERNEST MICHAEL, late of 37 Smith-street, Kensington, retired storeman, died 9th May, 1959.

* SATCHWELL, JOHN WILLIAM, late of 389 Victoria-street, West Melbourne, retired engine-driver, died 1st June, 1959.

STANSFIELD, ROBERT HENRY, late of Mount Royal, retired baker, died 25th May, 1959, intestate.

STEVENS, WILLIAM EDWIN SAMUEL, formerly of 22 Rathmines-road, Auburn, but late of 5 Queens-avenue, Hawthorn, retired fitter, died 25th May, 1959, intestate.

* THORPE, GEORGE HENRY HERBERT, late of 8 Griffiths-street, Reservoir, carpenter, died 14th April, 1959.

* With the will annexed.

† According to the provisions of the will.

A. D. DUNCAN,
Public Trustee.

Melbourne, 26th August, 1959.

NOTICE TO MARINERS.

[No. 13 of 1959.]

AUSTRALIA.—VICTORIA.

THE following Notice to Mariners, which has been received from the Harbor Master, Portland, is published for general information.

V. G. SWANSON,
Port Officer.

Ports and Harbors Branch,
Department of Public Works,
Melbourne, C.2, 24th August, 1959.

PORTLAND HARBOR TRUST COMMISSIONERS.

PORT OF PORTLAND.—MOORING BUOYS ESTABLISHED.

Positions.—(a) Red Light, Railway Pier, Lat. 38 deg. 21 min. 00 sec. S.; Long. 141 deg. 36 min. 40 sec. E. (approximately).

(b) Whaler Point Lighthouse, Lat. 38 deg. 20 min. 24 sec. S.; Long. 141 deg. 36 min. 45 sec. E. (approximately).

Position of Mooring Buoys.—

- (1) 200 feet 355 deg. from position (a) above.
- (2) 420 feet 040 deg. from position (a) above.
- (3) 5.2 cables 163 deg. from position (b) above.

Details.—Mooring buoys have been established in the above positions.

Charts Affected.—B.A. No. 1062 and inset.

Publications.—General Notice to Mariners Respecting Navigation in Victorian Waters, 1942, pages 46 and 48.

Labour and Industry Acts.

EXPLOSIVE-POWERED TOOL REGULATIONS.

IN accordance with sub-clause 5 of clause 4 of the Explosive-Powered Tool Regulations, I give notice that I did, on the 13th day of August, 1959, approve of a sample of a tool bearing the brand "Drive-it" and serial No. 825, and I specify that the manner in which such tool is to be described shall be "Drive-it Model 330G".

V. G. EMPEY,
Chief Inspector of Factories and Shops.

POLICE OFFENCES ACT 1958.

IN pursuance of the powers conferred upon the Chief Secretary by sub-section (3) of section 181 of the Police Offences Act 1958, I, Arthur Gordon Rylah, Her Majesty's Chief Secretary for the State of Victoria, do by this notice grant exemption from compliance with sub-sections (1) and (2) of section 184 of the said Act with respect to the publication "Rockets Galore", distributed by Colorgravure Publications, 26-30 Flinders-street, Melbourne.

A. G. RYLAH,
Chief Secretary.

Chief Secretary's Office,
Melbourne, 24th August, 1959.

APPOINTMENTS.

HIS Excellency the Governor of the State of Victoria, by and with the advice of the Executive Council thereof, has, by Orders made on the 25th day of August, 1959, been pleased to make the under-mentioned appointments, viz.:—

CHIEF SECRETARY'S DEPARTMENT.

Licensing Inspector.

HUGH RUPERT DONELLY, Chief Inspector of Police, pursuant to the provisions of the Licensing Act 1958, to be a Licensing Inspector for the Licensing District of Victoria, from and inclusive of the 13th August, 1959, vice Alexander Patrick Donnelly, retired.

Governor (Acting) of Gaol.

REGINALD GEORGE MATHIESON, pursuant to the provisions of the Gaols Act 1958, to be Governor (Acting) of the Sale Gaol, from the 30th August, 1959, to the 13th September, 1959, both dates inclusive, during the absence on leave of Donald Stewart Ross.

LAW DEPARTMENT.

Justices of the Peace.

EDWIN MORCOM, Ardmona, to Keep the Peace in the Midland Bailiwick of the State of Victoria;

ROBERT FRANCIS YOUNG, Woods Point, and

PATRICK MICHAEL O'BRIEN, Woods Point,

to Keep the Peace in the Northern Bailiwick of the State of Victoria; and

FRANCIS STORAN, 25 Princes Highway, Dandenong,

ROBERT HENRY CATTO, 20 Wavell-avenue, Kilsyth,

GERARD EDWARD MCCONVILL, 171 Bourke-street, Mel-

bourne,

FRANK HENRY BEDFORD, 10 Elizabeth-street, Elstern-

wick,

GEORGE GRAHAM, 654 Pascoe Vale-road, Oak Park,

RAYMOND BARRY HYND, 8 Sixth-street, Eildon,

CHARLES WILLIAM PERKINS, 36 Preston-street, West

Coburg, and

JOHN MCINTYRE PENMAN, 36 Market-street, South

Melbourne,

to Keep the Peace in the Central Bailiwick of the State of Victoria.

Commissioners for Taking Declarations, &c.

BRIAN JOHN BUTTERWORTH, Anglesea,

DAVID TEGWYN MORGAN, 76 Wellington-parade, East

Melbourne,

CHARLES CALDERWOOD, 433 Little Collins-street, Mel-

bourne,

BASIL DELLAS, 5 Balcombe-street, Sunshine,

DAVID AUSTIN CONNOR, 44 Packham-street, Box Hill

North,

CARL DOBLE MORRIS, 50 Corner-street, Brighton, and

HAROLD ALFRED DOUGLAS, 247 Warrigal-road, Oakleigh,

to be Commissioners for taking Declarations and Affidavits, pursuant to the provisions of the Evidence Act 1958, to resign upon removing from the neighbourhood of the addresses stated; and

ARTHUR CLARENDON CHARLWOOD, Officer of Unilever Australia Pty. Ltd., Ingles-street, Port Melbourne, to be a Commissioner for taking Declarations and Affidavits, pursuant to the provisions of the Evidence Act 1958, to resign upon ceasing to occupy his present position.

Probation Officer of Children's Court.

KATHLEEN ELIZABETH COLBOURN, 14 Milfay-avenue, Kew, to be a Probation Officer, pursuant to the provisions of the Children's Court Act 1958, for the Children's Court at Kew.

A. MAHLSTEDT,
Clerk of the Executive Council.

At the Executive Council Chamber,
Melbourne, 25th August, 1959.

RESIGNATIONS.

HIS Excellency the Governor of the State of Victoria, by and with the advice of the Executive Council thereof, has, by Orders made on the 25th day of August, 1959, accepted the resignations of the persons named hereunder of the offices mentioned, viz.:—

CHIEF SECRETARY'S DEPARTMENT.

ALEXANDER PATRICK DONNELLY, as a Licensing Inspector for the Licensing District of Victoria, to date from and inclusive of the 13th August, 1959.

WILLIAM STANLEY FINCHETT, as an Assistant to the Inspector of Fisheries.

GEORGE RICHARD DENYER, as a Licensing Inspector for the Licensing District of Victoria, to date from and inclusive of the 14th August, 1959.

LAW DEPARTMENT.

JOSEPH VINCENT SWEENEY, as a Commissioner for taking Declarations and Affidavits, pursuant to the provisions of the Evidence Act 1958.

A. MAHLSTEDT,
Clerk of the Executive Council.

At the Executive Council Chamber,
Melbourne, 25th August, 1959.

MILK AND DAIRY SUPERVISION ACT 1958 (PART I).

At the Executive Council Chamber, Melbourne, the twenty-fifth day of August, 1959.

PRESENT:

His Excellency the Governor of Victoria.
Mr. Chandler | Mr. Mibus.
Mr. Reid

APPOINTMENT OF MEMBERS OF THE DAIRY PRODUCE BOARD.

IN pursuance of the powers in that behalf conferred by Part I. of the Milk and Dairy Supervision Act 1958 (No. 6317), His Excellency the Governor of the State of Victoria, by and with the advice of the Executive Council thereof, doth by this Order hereby appoint the under-mentioned persons as members of the Dairy Produce Board for a period of two (2) years from and inclusive of the 4th September, 1959:—

- THOMAS MATTHEW JENSEN,
- DAVID ANDREW LANCASTER, and
- RUSSELL IAN HOWEY,
- Officers of the Department of Agriculture;
- REGINALD HOLDENSON and
- JAMES FREDERICK KITTSON,
- Representatives of Factory Owners;
- ERIC THOMAS HEARD, Representative of Factory Managers; and
- COSMO BOND GARDINER, Dairyman supplying milk or cream to a factory.

And doth hereby appoint the said THOMAS MATTHEW JENSEN to be the Chairman of the said Dairy Produce Board.

And the Honorable Gilbert Lawrence Chandler, Her Majesty's Minister of Agriculture for the State of Victoria, shall give the necessary directions herein accordingly.

A. MAHLSTEDT,
Clerk of the Executive Council.

DEPARTMENT OF CROWN LANDS AND SURVEY.

At the Executive Council Chamber, Melbourne, the twenty-fifth day of August, 1959.

PRESENT:

His Excellency the Governor of Victoria.
Mr. Chandler | Mr. Mibus.
Mr. Reid

LANDS TEMPORARILY RESERVED AS SITES.

HIS Excellency the Governor of the State of Victoria, by and with the advice of the Executive Council thereof, doth hereby, in pursuance of the provisions of the Land Act 1958, reserve, temporarily, and also except from occupation for mining purposes under any miner's right, the lands hereinafter described:—

ELPHINSTONE.—Site for Public Recreation, 10 acres, Parish of Elphinstone, County of Talbot, as indicated by hachure on plan hereunder.—(E.34(2) (Rs.412).

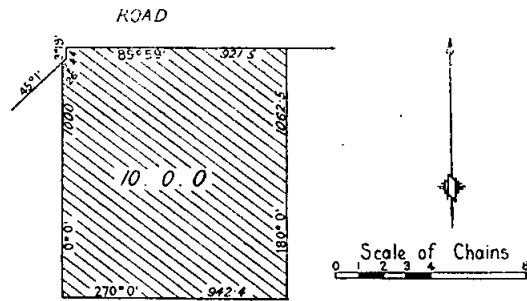

3 of 6

NORTH HAMILTON.—Site for Public Recreation, 37 acres 3 roods 19 perches, Parish of North Hamilton, County of Dundas, as indicated by hachure on plan hereunder.—(H.46(5) (Rs.7844).

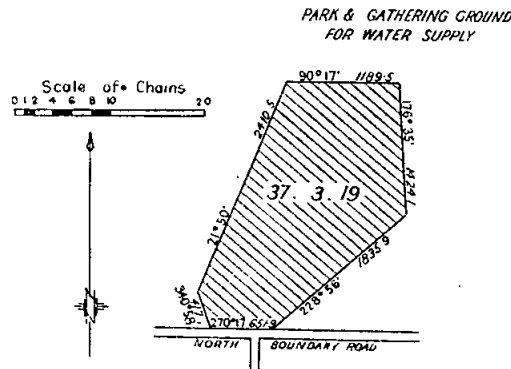

AXEDALE.—Site for Public purposes, 3 acres, more or less, Township of Axedale, Parish of Axedale, County of Bendigo, as indicated by hachure on plan hereunder.—(A.98(5) (Rs.7856).

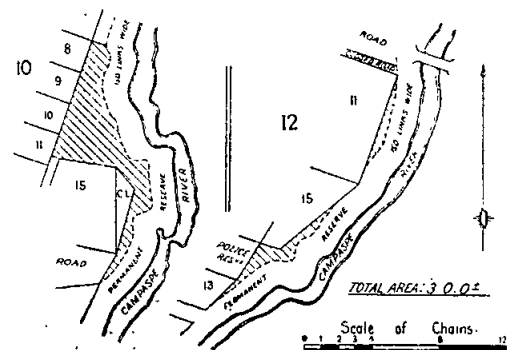

COONGULMERANG (LINDENOW).—Site for a Public Hall, 3 roods 30 perches, Parish of Coongulmerang, County of Tanjil, as indicated by hachure on plan hereunder.—(C.369(2) (Rs.7843).

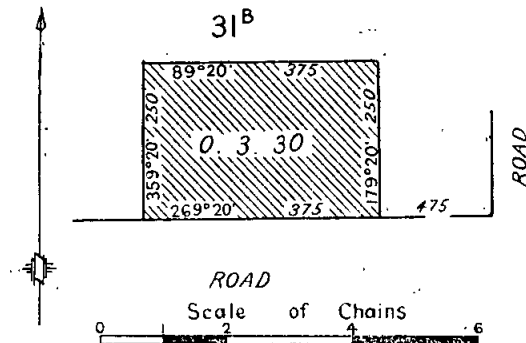

MORKALLA.—Site for a Public Hall, 2 roods 16 perches, Township of Morkalla, Parish of Morkalla, County of Millewa, as indicated by hachure on plan hereunder.—(M.595(B) (Rs.7847).

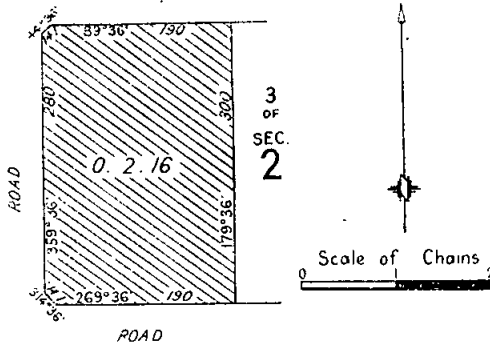

And the Honorable Keith Hector Turnbull, Her Majesty's Commissioner of Crown Lands and Survey for the State of Victoria, shall give the necessary directions herein accordingly.

A. MAHLSTEDT,
Clerk of the Executive Council.

DEPARTMENT OF CROWN LANDS AND SURVEY.

At the Executive Council Chamber, Melbourne, the twenty-fifth day of August, 1959.

PRESENT:

His Excellency the Governor of Victoria.
Mr. Chandler | Mr. Mibus.
Mr. Reid

UNUSED ROADS CLOSED.

HIS Excellency the Governor of the State of Victoria, by and with the advice of the Executive Council thereof, doth hereby direct that, in pursuance of the provisions of section 349 of the Land Act 1958, the unused roads referred to hereunder be closed, viz:—

Parish of Taminick, County of Molra, being the road between allotments 58A, 58, and Pre-emptive Section A.—(H.025198) (T.155(2)).

At Bendigo, Parish of Sandhurst, County of Bendigo, being the portion of Palmerston-street indicated by hachure on plan hereunder.—(S.372(22)) (Rs.4281).

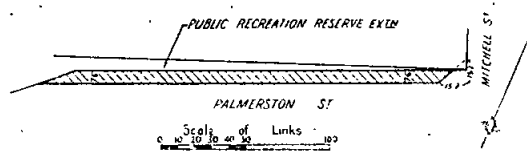

Parish of Narrewillock, County of Gladstone, being the roads indicated by hachure on plan hereunder.—(N.118(2) (W.67789).

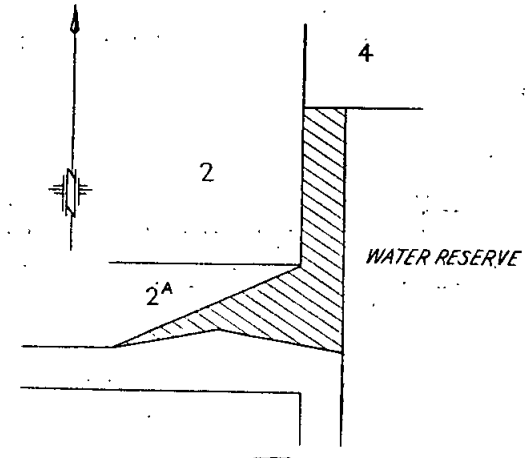
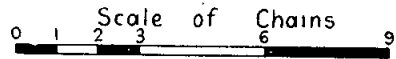

And the Honorable Keith Hector Turnbull, Her Majesty's Commissioner of Crown Lands and Survey for the State of Victoria, shall give the necessary directions herein accordingly.

A. MAHLSTEDT,
Clerk of the Executive Council.

MELBOURNE AND METROPOLITAN TRAMWAYS ACT 1958 (No. 6311).

At the Executive Council Chamber, Melbourne, the twenty-fifth day of August, 1959.

PRESENT:

His Excellency the Governor of Victoria.

Mr. Chandler | Mr. Mibus.
Mr. Reid

WHEREAS His Excellency the Governor in Council has this day consented, pursuant to the provisions of section 28 of the Melbourne and Metropolitan Tramways Act 1958, to the Melbourne and Metropolitan Tramways Board raising by way of loan an amount not exceeding Four hundred thousand pounds (£400,000): And whereas His Excellency the Governor in Council is satisfied that a sufficient proportion of the loan to be so raised will fall due and be repaid in each year during the currency of the proposed loan: Now therefore it is directed, pursuant to the provisions of section 32 of the said Act, that it shall not be necessary to provide a sinking fund in connexion with such loan.

And the Honorable Henry Edward Bolte, Her Majesty's Treasurer for the State of Victoria, shall give the necessary directions herein accordingly.

A. MAHLSTEDT,
Clerk of the Executive Council.

LABOUR AND INDUSTRY ACTS.

At the Executive Council Chamber, Melbourne, the
twenty-fifth day of August, 1959.

PRESENT:

His Excellency the Governor of Victoria.
Mr. Chandler | Mr. Mibus.
Mr. Reid |

EXPLOSIVE-POWERED TOOL REGULATIONS.—(AMENDMENT No. 2.)

IN pursuance of the powers conferred by the Labour and Industry Acts, His Excellency the Governor of the State of Victoria, by and with the advice of the Executive Council thereof, doth hereby amend the Explosive-Powered Tool Regulations as follows:—

Sub-clause (5) of clause 4 shall be rescinded and replaced by the following:—

- “(5) (a) When the Chief Inspector determines—
- (i) that any sample of a tool is manufactured in accordance with these Regulations; or
 - (ii) that it would be unnecessary because of the characteristics of any sample of a tool submitted for approval hereunder to require the owner or any other person to comply with all or any of these Regulations in respect of any tool made in accordance with such sample;

he shall grant his approval to such tool in accordance with such determination and notify the same in the *Government Gazette* and by such notice specify the manner in which such tool is to be described for the purposes of the regulations.

(b) The Chief Inspector may at any time for good cause vary or rescind any such approval.

(c) Any such variation or rescission shall be notified in the same manner as a grant of approval under this clause.

And the Honorable George Oswald Reid, Her Majesty's Minister of Labour and Industry for the State of Victoria, shall give the necessary directions herein accordingly.

A. MAHLSTEDT,
Clerk of the Executive Council.

APPROACHING LAND SALES.

SALES of Crown lands, in fee-simple, will be held at the under-mentioned places and dates, viz.:—

	No. of Gazette.
Bairnsdale.—Monday, 21st September, 1959 ..	73
Bendigo.—Thursday, 24th September, 1959 ..	75
Castlemaine.—Tuesday, 22nd September, 1959 ..	75
Horsham.—Tuesday, 15th September, 1959 ..	73
Inglewood.—Tuesday, 6th October, 1959 ..	78
Tarwin Lower.—Saturday, 3rd October, 1959 ..	69

SALE OF CROWN LANDS BY AUCTION.

The lands will be sold in fee-simple, and subject to the covenants, conditions, exceptions, and reservations directed by the Governor in Council by an Order in Council dated the 5th August, 1930, and published in the *Government Gazette* of the 8th August, 1930, varied as herein.

A deposit of at least twelve and a half per centum of the price at which each lot is sold must be paid by the purchaser at the time of sale, and all such payments shall be made in coin, bank notes or cheques approved by the officer conducting the sale, and the residue of such price will be payable in equal instalments, in accordance with the scale hereunder, on the last day of each successive period of six months from the time of sale, or, if the purchaser choose, at any earlier time or times, and such residue of the purchase money shall bear interest at the rate of Five pounds per centum per annum, to be computed with respect to each instalment for the period which has elapsed between the time of sale and the time of the

payment of such instalment. If the residue of the price be paid within thirty days after the time of the sale no interest will be payable thereon.

The Governor in Council may allow a transfer of the purchaser's interest to an approved person at any time before the final payment of the purchase money is made. The fee for transfer shall be One pound and such transfer will be subject to payment of stamp duty.

SCALE OF PAYMENTS OF RESIDUE.

£20 and under, 6 instalments.
Over £20, and not exceeding £50, 8 instalments.
Over £50, and not exceeding £100, 10 instalments.
Over £100, and not exceeding £200, 12 instalments.
Over £200, and not exceeding £300, 14 instalments.
Over £300, and not exceeding £400, 16 instalments.
Over £400, and not exceeding £500, 18 instalments.
Over £500, 20 instalments.

FEES, ETC.

The amount payable for Assurance Fund (One half-penny for each £1 of purchase price) and Crown grant fee must be paid with the balance of purchase money. The following is the scale of fees for Crown grants:—

50 acres and under, £1 10s.

Over 50 acres, £2.

Where the purchase money does not exceed £5, the grant fee is £1.

Valuations of improvements (if not purchased by the owner thereof), and charges for survey, must also be paid at the time of sale.

KEITH TURNBULL,
Commissioner of Crown Lands and Survey,
Office of Crown Lands and Survey,
Melbourne, 25th August, 1959.

LIST OF CROWN LANDS AVAILABLE.

THE under-mentioned areas are available for application as provided by various sections of the Land Act 1958, and all applications received on or before Wednesday, 30th September, 1959, will be deemed to have been made simultaneously, but any application lodged after such date may be considered if received in time for inclusion in the advertisement of the cases to be heard at the Local Land Board. Applications on proper form, accompanied by 5s. duty stamp uncancelled (registration fee), may be delivered or forwarded by post to the Local Land Officer or to any Crown Lands Office in Victoria. Subject to the approval of the Secretary for Lands, when the survey fee exceeds £25 but does not exceed £50, a deposit of £25 may be paid, and when the fee exceeds £50, a deposit of 50 per cent. of the fee, the balance in either case being payable over six years in half-yearly instalments. Marked plans of any particular area, application forms, and any further information may be obtained from the Crown Lands Department, Melbourne, Land Officers, Red Cliffs and Ballarat.

Department of Crown Lands and Survey,
Melbourne, 31st August, 1959.

KEITH TURNBULL,
Commissioner of Crown Lands and Survey.

* Improvements may be subject to re-valuation after land has been granted to an applicant.

Local Land Office.	County.	Parish.	Allotment.	Section.	Area.	How Available.		Survey Fee.	Valuation of improvements (if any)*.	Location of Land, &c.	Nearest Railway Station or Township and Distance in miles therefrom.	How Accessible.	Water Supply.	General Description of Land—Soil, Timber, Suitability (Grazing, &c.).				
						Classification.	Value per Acre.											
						A.	B.	F.										
						£	s.	d.	£	s.	d.							
AGRICULTURAL AND GRAZING LANDS—SELECTION PURCHASE ALLOTMENTS.																		
DIVISION 4, PART I, LAND ACT 1958.																		
Red Cliffs	Weeah	Tyalla	32 and 33		1,528 0 0±	4th	0 6 0	66 10 0	Nil	Four miles north of Tyalye township	Four miles north of Tyalye R.S.	By road	To be conserved. No water supply on the area, but a bore is situated on the north-east corner of allotment 33	Undulating; salty flats with Copi subsoil and some Copi rises; mallee timber scattered; suitable for grazing. (010300/121)				
Ballarat	Talbot	Tourelle	4	7	120 0 0± (subject to survey)	3rd	15 0 0	23 15 0	To be valued	In south-east corner of parish	Clunes, 4 miles	Poor along a 1-chain strip which will be henceforth shown as a Government road; adjoining the railway	Moderately sloping; chocolate volcanic soil, with some grey loam, river flat; suitable for grazing. (J.20552)					

CLOSER SETTLEMENT ACT 1938.

THE Farm Allotment mentioned in the Schedule hereunder is hereby proclaimed available for application and may be taken up under Closer Settlement Lease.

Parish.	Allotment.	Section.	Area.	Monetary Liability.	Deposit Including Lease and Registration Fees.	Term of Lease.	Remarks.
			A. B. P.	£ s. d.	£ s. d.		
Wyperfeld	14	..	985 0 8	1,349 13 6	270 18 6	36 years	Deposit 20 per cent. approximately. Yearly instalment £58 8s. 0d. Survey Fee £40 10s. Location 12 miles north of Yaapeet Railway Station.
Muldra	53	..	733 3.25	2,692 12 6	542 12 6	36 years	Deposit approximately 20 per cent. Yearly instalments £118 5s. Survey Fee £36 5s. Location 12 miles north-west of Murrayville

Office of Crown Lands and Survey,
Melbourne, 28th August, 1959.

KEITH TURNBULL,
Commissioner of Crown Lands and Survey.

Land Act 1958.

LEASES UNDER THE LAND ACTS 1915 AND 1928 DECLARED VOID.

NOTICE is hereby given that the leases mentioned in the Schedule hereunder have been Declared Void by the Governor in Council for the reason specified in each case.

District.	Corr. No.	Name of Lessee.	Section of Land Act under which Leased.	Parish.	Allotment.	Area.	Class.	Annual Rental.	Reasons for Voiding.
						A. B. P.			
Melbourne ..	0464/125	L. J. S. and W. Fink	125	Melbourne South	1 and 2	1 0 6	Lease expired. (New lease to issue) Non-compliance with conditions
Bairnsdale ..	340/50	Allan Hodge ..	50	Woongulmerang East	20	470 0 0±	

Department of Crown Lands and Survey,
Melbourne, 24th August, 1959.

KEITH TURNBULL,
Commissioner of Crown Lands and Survey.

Land Act 1958.

LICENCES UNDER THE LAND ACTS 1915, 1928 AND 1958 DECLARED VOID.

NOTICE is hereby given that the Licences in the Schedule hereunder have been Declared Void for the reason specified in each case.

District.	Corr. No.	Name of Licensee.	Section of Land Act under which Licensed.	Parish.	Allotment.	Section.	Area.	Annual Rental.	Reasons for Voiding.
							A. B. P.	£ s. d.	
St. Arnaud	0666/86	Estate of H. A. Crooks	86	Carisbrook ..	1	40A	5 3 13	..	Unauthorized tenancy
Bendigo ..	01505/129	L. W. Clow ..	129	Sandhurst ..	26H	E	0 0 19	..	Non-compliance with Residence and Improvements conditions
Bendigo ..	01554/129	Estate of M. J. Connally	129	Redcastle	0 2 22	..	Non-compliance with conditions
Mallee ..	08747/129	H. I. and A. V. Attwood	129	Mildura ..	2	6	3 0 0	..	Licence surrendered

Department of Crown Lands and Survey,
Melbourne, 31st August, 1959.

KEITH TURNBULL,
Commissioner of Crown Lands and Survey.

COMMON ABOUT TO BE DIMINISHED.

IN pursuance of the provisions contained in the *Land Act 1958*, notice is hereby given that it is the intention of the Governor in Council to diminish the common hereinafter mentioned, viz:—

The following Notice was published 1° on the 19th August, 1959, pursuant to Order of the 11th August, 1959.

The Maldon Shire Common, proclaimed as such by the Governor in Council on the 2nd April, 1889, and altered by Order in Council of the 23rd April, 1912, is about to be diminished by the excision therefrom of allotments 11, 13 and 22, section 3e, containing 1 acre 3 roods 9 perches.—(Rs.353.)

KEITH TURNBULL,
Commissioner of Crown Lands and Survey.

LAND AVAILABLE UNDER THE SOLDIER SETTLEMENT ACTS.

NOTIFICATION is hereby given in accordance with Section 50 of the *Soldier Settlement Act 1958* that the undermentioned holdings are available for settlement.

Any discharged serviceman who has applied to the Commission on or before the 2nd September, 1959, for classification in the required class or classes of primary production for which the holdings are made available and whose application has been accepted but now necessarily finalized, or any discharged serviceman who has been classified as suitable in such class or classes of primary production, may apply on the prescribed form for settlement on the holdings.

The prescribed application forms, plans and further particulars may be obtained from the Enquiry Branch, Soldier Settlement Commission, State Public Offices, Melbourne. The closing date for the receipt of completed applications for settlement on these holdings is the 21st September, 1959, such applications to be in the hands of the Secretary, Soldier Settlement Commission, on or before that date.

I. K. MORTON,
Secretary.

Soldier Settlement Commission,
Melbourne, 28th August, 1959.

SCHEDULE OF ALLOTMENTS.

PORTION OF MURRAY VALLEY IRRIGATION SETTLEMENT AREA.

PARISH OF KATUNGA, COUNTY OF MOIRA.

Suitable for Dairying under Irrigation and a limited amount of Canned Fruit Production.

Lot No. on plan of Subdivision.	Section.	Approximate area in Acres (subject to survey).
35	E	176

PORTION OF "RETREAT" ESTATE.

PARISH OF BARNOOLUT, COUNTY OF NORMANBY.

Suitable for Dairying.

Lot No. on Plan of Subdivision.	Approximate area in Acres (subject to Survey).
5	172

TENDERS—PUBLIC WORKS DEPARTMENT

TENDERS will be received at this Department until **TEN a.m.** on the Tuesdays, and for the purposes, under mentioned.

Particulars may be learnt at the Department and also at places shown in parenthesis.

W.O. means Inspector of Works Office; P.S.—Police Station; T.S.—Technical School; H.E.S.—Higher Elementary School; S.S.—State School; H.S.—High School; C.S.—Consolidated School.

Tenders should be submitted on the Department's printed Tender Form. All tenders must be on a "Firm Tender" basis. The Board of Land and Works will not necessarily accept the lowest or any tender.

Tenders to be addressed to the Commissioner of Public Works, and envelope containing tender to be marked "Tender for closing Tuesday,"

NOTE—No preliminary deposit is to be lodged with any tender, but a deposit in accordance with the following Schedule, will be required from each successful tenderer:—

For contract amounts exceeding £200 and not exceeding £500	£ 5
For contract amounts exceeding £500 and not exceeding £1,000	10
For contract amounts exceeding £1,000—1 per cent. of tender	500 (maximum deposit)

8th September, 1959.

Aspendale.—Supply and installation of sawdust extraction system, Technical School.

Aspendale.—Joinery, consisting of benches and shelving, Technical School.

Cheltenham.—Erection of new High School.
Cheltenham.—Erection of new office, and residence, Police Station. (P.S., Cheltenham.)

Cheltenham.—Electrical installation, Police Station and Residence. (P.S., Cheltenham.)

Cheltenham.—Supply and installation of gas-heating and hot-water service, Police Station. (P.S., Cheltenham.)

Cheltenham.—Supply, delivery, installation, and testing of mechanical services for stages 1 and 2, High School.

Echuca.—Renewal of water supply, S.S. No. 208. (W.O., Shepparton; S.S., Echuca.)

Fitzroy.—Renewal of chalkboards, &c., High School.

Geelong West.—Erection of second and third sections, Girls' Technical School. (W.O., Geelong; Girls' Technical School, Geelong West.)

Geelong West.—Electrical installation in stages two and three, Girls' Technical School. (W.O., Geelong; Girls' Technical School, Geelong West.)

Geelong West.—Supply, delivery, installation, and testing of the mechanical services for stages two and three, Girls' Technical School. (W.O., Geelong; Girls' Technical School, Geelong West.)

Glen Waverley Heights.—Erection of a new eight (8) class-room primary school, S.S. No. 4836.

Glen Waverley Heights.—Electrical installation in eight (8) L.T.C. class-rooms, S.S. No. 4836.

Glen Waverley Heights.—Warm-air heating/ventilation system in the new primary school, S.S. No. 4836.

Heidelberg.—Erection of non-party fencing to school site, S.S. No. 294. (S.S., Heidelberg.)

Kew.—Supply and delivery of equipment for meal service unit, Ward 2/4, Children's Cottages, Mental Hospital.

Kew.—Supply of equipment for meal service unit, Ward M.3, Children's Cottages, Mental Hospital.

Kilmore.—Roof and general repairs, Court House. (W.O., Alexandra; P.S., Kilmore.) (Amended specification.)

Koondrook.—Demolition of, removal of, and purchase of materials from Wharf, Public Works Department. (W.O., Swan Hill; P.S., Koondrook, Cohuna, Kerang.)

Malvern.—Supply and fixing fibrous plaster and acoustic tiles, Industrial Therapy Clinic, Mental Hygiene Clinic, 321 Glenferrie-road.

Malvern.—Supply of joinery at Industrial Therapy Clinic, Mental Hygiene Clinic, 321 Glenferrie-road.

Melbourne.—Supply and installation of car-hoist and accessories and amendment to existing drains, Fisheries and Game Offices, 605 Flinders-street.

Melbourne.—Supply, delivery, installation and testing of mechanical services, Children's Court and Clinic, Batman-avenue.

Melbourne.—Treatment to stair treads and landings in Art School, Royal Melbourne Technical College, Latrobe-street.

Merri.—Renewal of water service, S.S. No. 3110.

Mont Park.—Supply and delivery of heavy duty electric range, Bundoora Mental Hospital.

Mount Macedon.—Extension to kiosk and kitchen to caretaker's quarters, Memorial Cross. (W.O., Kyneton; Memorial Cross Kiosk, Mount Macedon.)

Murrabit.—Installation of septic tank system at school and residence, S.S. No. 3859. (W.O., Swan Hill; S.S., Murrabit.)

Nunawading South.—Erection of five (5) additional class-rooms, S.S. No. 4808. (S.S., Nunawading South.)

Nunawading South.—Electrical installation in five (5) additional L.T.C. class-rooms, &c., S.S. No. 4808. (S.S., Nunawading South.)

Nunawading South.—Extension of heating to five (5) additional class-rooms, S.S. No. 4808. (S.S., Nunawading South.)

Portland.—Supply of three (3) lathes, High School.

St. Arnaud.—Provision of new fittings to laundry and kitchen in Cooking Centre, High School. (W.O., Maryborough; H.S., St. Arnaud.)

Syndal.—Erection of two (2) 32-ft. x 16-ft. shelter sheds, Technical School.

Tottenham.—Supply of lathes and shaping machine, Technical School.

Trafalgar.—Erection of a new brick veneer Police Station and Residence. (W.O., Warragul and Traralgon.)

Traralgon.—Supply and installation of science benches, High School. (W.O., Traralgon; H.S., Traralgon.)

Warracknabeal.—Erection of thirteen (13) class-room concrete-veneer timber-framed primary school, S.S. No. 1334. (W.O., Warracknabeal.)

Warracknabeal.—Electrical installation, S.S. No. 1334. (W.O., Warracknabeal and Horsham.)

Warracknabeal.—Supply and installation of warm-air ventilation system, S.S. No. 1334. (W.O., Warracknabeal.)

Werribee.—Supply and install Warmray heaters, S.S. No. 649. (S.S., Werribee.)

15th September, 1959.

Ararat.—Toilet block for Housecraft Training Centre, Mental Hospital. (W.O., Ararat; Mental Hospital, Ararat.)

Ballarat.—Supply and delivery of two (2) packaged boilers and the installation of one (1) boiler, Mental Hospital. (W.O., Ballarat; Mental Hospital, Ballarat.)

Ballarat.—External renovations to Receiving Home, Mental Hospital. (W.O., Ballarat; Mental Hospital, Ballarat.)

Camperdown.—Installation of sanitary fittings, septic tank, sewer drains, &c., High School. (W.O., Camperdown; H.S., Camperdown.)

Carlton.—Conversion of Room 101 to Science Room, University High School.

Flemington.—Re-slating of roofs and external repairs and renovations, Court House.

French Island.—Supply and delivery of select grade special construction hardwood (unseasoned), Training Prison. (W.O., Bairnsdale.)

Geelong East.—Erection of two (2) 40-ft. x 20-ft. shelter pavilions, Technical School. (W.O., Geelong.)

Hawthorn.—External and internal repairs and painting, Police Station.

Heatherton.—Exterior painting to five (5) residences, Sanatorium. (Sanatorium, Heatherton.)

Keon Park.—Electrical installation in stages two and three, Technical School. (T.S., Keon Park.)

Keon Park.—Supply, delivery, installation, and testing of the mechanical services for stages two and three, Technical School. (T.S., Keon Park.)

Melbourne.—Supply, delivery, installation, and testing of conversion of three (3) boilers to oil firing and the replacement of heating pump, Central T.B. Clinic, 364 Little Lonsdale-street.

Melbourne.—Rewiring and modifications to passenger lift, Crown Law Department, 459 Lonsdale-street.

Melbourne.—Provision of brick coke bin, &c., Royal Melbourne Technical College.

Mont Park.—Supply and installation of mechanical services to Central Ward and main kitchen, Mental Hospital. (Mental Hospital, Mont Park.)

Mount Waverley.—Erection of a new toilet block, S.S. No. 3432.

Murchison.—Septic tank installation, sanitary plumbing, S.S. No. 1126. (W.O., Shepparton; S.S., Murchison.)

Niddrie.—Erection of two (2) 32-ft. x 16-ft. shelter pavilions, High School.

Port Melbourne.—Supply and delivery to Salmon-street of three (3) six ton petrol motor trucks, each with 14 ft. x 7 ft. 6 in. approximately tray body, all-steel welded frame with 1½-in. T. & C. H.W. floor and about 12-in. drop sides, two-speed rear axle, seven tires, complete with standard equipment, Storeyard, Public Works Department. (Specifications to be submitted with tender.)

Port Melbourne.—Supply and delivery to Salmon-street of one (1) Ford V-8, 154-in. wheelbase, chassis and cab, 6-ton capacity, two-speed rear axle, spare tire, 6-ton hydraulic hoist and 5 cubic yard all-steel tipping body, Storeyard, Public Works Department. (Specifications to be submitted with tender.)

South Yarra.—Renewal of water service (completion), Melbourne High School.

South Yarra.—Window cleaning, period 1st October, 1959, to 30th September, 1960, Department of Health, 19 Park-street.

Sunshine.—Additional toilets and washroom in brickwork, Technical School. (T.S., Sunshine.)

Tongala.—Purchase and removal of residence and out-buildings, Consolidated School. (W.O., Shepparton.)

Torquay.—Erection of new residence and office, Police Station. (W.O., Geelong; P.S., Torquay.)

West Melbourne.—Supply and fixing of corrugated asbestos roofing to new storeroom, South Raft, Government Cool Stores.

Woorak.—Purchase and removal of old class-room and outbuildings, S.S. No. 2246. (W.O., Horsham; S.S., Woorak.)

22nd September, 1959.

Albury.—Renovations and painting, Transport Regulation Board Residence, 62 Short-street. (W.O., Wangarratta; P.S., Wodonga.)

Bendigo.—Alterations and renovations to the Assembly Hall, School of Mines. (W.O., Bendigo; School of Mines, Bendigo.)

Blackburn.—Erection of first section, Technical School.

Blackburn.—Electrical installation for stage one, Technical School.

Blackburn.—Mechanical services for stage one, Technical School.

Carlton.—Repairs to flat roofing over Gymnasium, Melbourne Teachers' College, Grattan-street.

Cheltenham.—Electrical installation in stages one and two, High School.

Hawthorn.—New bathroom and porch to resident Supervisor's Flat, Burwood Teachers' College Hostel, 11 Patterson-street.

Melbourne.—Stainless steel benchwork, cupboards, &c., Secondary Teachers' College Hostel, 481 St. Kilda-road.

Melbourne.—Supply of twenty-four (24) 16-in. oscillating electric fans, Public Trustee's Office, 601 Little Collins-street. (Specifications to be submitted with tender.)

Mitcham.—Fencing, S.S. No. 2904. (S.S., Mitcham.)

Pira.—Erection of two (2) out-offices with septic closets, S.S., No. 4278. (W.O., Swan Hill; S.S., Pira.)

Shepparton.—Erection of second and third sections, Technical School. (W.O., Shepparton; T.S., Shepparton.)

Stawell.—Supply, delivery, and installation of auxiliary equipment, pipework, and condensate reticulation in the Boiler House, Pleasant Creek Special School. (W.O., Bendigo, Warrnambool; Pleasant Creek Special School, Stawell.)

Sunbury.—Conversion of old Tailoress' Room to Hair-dressing Salon, Mental Hospital. (Mental Hospital, Sunbury.)

Various.—Erection of fifteen (15) additional class-rooms to various standard concrete-veneer and timber Primary Schools.

Various.—Erection of extended third section to four (4) concrete-veneer timber-framed High Schools.

29th September, 1959.

Melbourne.—Provision of Building Technology Laboratory, Royal Melbourne Technical College.

T. K. MALTBY,
Commissioner of Public Works.

Public Works Department,
Melbourne, 1st September, 1959.

PUBLIC SERVICE NOTICES

PUBLIC SERVICE (PUBLIC SERVICE BOARD) REGULATION 39.—RECLASSIFICATIONS.

THE Public Service Board has raised the classification of the under-mentioned offices as shown, and the Permanent Heads of the Departments have recommended the officers named for appointment.

Office and Present Classification.	Revised Classification.	Duties.	Qualifications.	Officer Recommended for Appointment.		
				Name.	Classification.	Date of Classification.

ADMINISTRATIVE DIVISION.

DEPARTMENT OF PREMIER.

Tourist Development Authority.

Class "D"	Class "C"	To check classification sheets from the Branches of the Victorian Government Tourist Bureaux; to prepare payments to Hotels and Guest Houses, Airways, Shipping, and Road Motor Companies, &c., and to act as ledgerkeeper for the Tourist Development Authority	To have a knowledge of the Public Accounts and Stores Regulations 1958, and the operation of the non-rail booking sections of the Victorian Government Tourist Bureaux; to be conversant with machine accounting and the accounting system employed in the Victorian Government Tourist Bureaux	Wenn, A. J.	Class "D"	*31.5.59
-----------	-----------	--	---	-------------	-----------	----------

* Date of transfer to Public Service pursuant to *Tourist (Amendment) Act 1958.*

DEPARTMENT OF PUBLIC WORKS.

General Administration Branch.

Class "B"	Class "B1"	To assist in the provision of accommodation, and to prepare recommendations and negotiate for the purchase of properties, for State Departments; to negotiate rental of buildings, &c., and prepare leasing agreements; to submit recommendations for the establishment of Public Offices in Country Districts, to maintain records of Government buildings and furniture and fittings therein; to examine claims for <i>ex gratia</i> payments in lieu of rates on Government property, and to be a member of the Fire Insurance Committee	To have organizing ability and to be competent to conduct negotiations for the purchase and leasing of properties on behalf of State Departments; to have a knowledge of the relevant provisions of the Local Government Act, Landlord and Tenant Act, Town and Country Planning Act, Transfer of Land Act, and the Public Works Act; to be familiar with the principles of valuation and current property values and rentals	Ward, F. H.	Class "B"	17.9.56
-----------	------------	---	---	-------------	-----------	---------

DEPARTMENT OF HEALTH.

Maternal and Child Hygiene Branch (School Dental Services).

School Dental Officer, Class "A1" (£2,200) (four offices)	Senior Dental Officer, Class "A1" (£2,300) (four offices)	Under the respective Superintendents, to co-ordinate the activities of mobile units operating in country districts, to examine and assess the dental needs of children and to perform other duties as directed	To have a thorough knowledge of the dental treatment of children, to have had charge of mobile dental units and experience in the work of a dental centre	Chapman, K. R.	School Dental Officer, Class "A1" (£2,200)	} 29.6.58
				Davis, D. E.		
		Jago, J. D.				
		Wilson, D. N. L. M.				
School Dental Officer, Class "A1" (£2,143)	Senior Dental Officer, Class "A1" (£2,243)			Campbell, Janet M.	School Dental Officer, Class "A1" (£2,143)	18.8.58

DEPARTMENT OF AGRICULTURE.

Poultry Expert, Class "B1"	Class "A"	Under the Superintendent of Live Stock, to administer the Poultry Branch of the Live Stock Division, to advise poultry farmers on all phases of poultry husbandry; to supervise the Random Sample Laying Test and chicken sexing examinations; to participate as required in all phases of the Department's extension and investigational work in the poultry industry	An expert knowledge of the principles of breeding and selection; commercial poultry keeping; preparation for market, and the marketing of poultry and poultry produce	Hall, M. D.	Poultry Expert, Class "B1"	25.10.54
----------------------------	-----------	--	---	-------------	----------------------------	----------

PUBLIC SERVICE (PUBLIC SERVICE BOARD) REGULATION 39.—RECLASSIFICATIONS—continued.

Office and Present Classification.	Revised Classification.	Duties.	Qualifications.	Officer Recommended for Appointment.		
				Name.	Classification.	Date of Classification.
TECHNICAL AND GENERAL DIVISION. DEPARTMENT OF CHIEF SECRETARY. OFFICE OF THE CHIEF COMMISSIONER OF POLICE. <i>Motor Registration Branch.</i>						
Assistant (Female), Grade IV., Grades 17-19 inclusive	Assistant (Female), Senior, Grades 23-26 inclusive	To check and sort applications for searches from the records and for duplicate Owners' and Registration Certificates; to deal with applications for registration received without fees or with irregular remittances; and to answer correspondence relating to such applications	To be a competent typist, to possess a good knowledge of the procedure of the Inwards Mail Assessment Section, to be conversant with the Motor Car Acts and Regulations	Murphy, Bernadette M.	Assistant (Female), Grade IV., Grades 17-19 inclusive	6.8.51
DEPARTMENT OF EDUCATION.						
Machinist (Female), Grade III., Grades 19-21 inclusive	Machinist (Female), Senior, Grades 24-26 inclusive	To assist in the preparation of teachers' salary payrolls and other statistical records as may be required, and to supervise the work of other machinists	To be a competent operator of Mercedes or Remington dual cross accounting machines	Hartridge-Young, Mildred P.	Machinist (Female), Grade III., Grades 19-21 inclusive	29.5.51
DEPARTMENT OF AGRICULTURE.						
Assistant (Female), Grade I., Grades 9-10 inclusive	Assistant (Female), Grade II., Grades 11-12 inclusive	To maintain the mailing list and to attend to various routine matters in connexion with the publication of the Dairy Farming Digest; to record and file all correspondence and library references in the Dairy Husbandry Branch, to keep records of field projects	To have had experience in general office work, the recording and filing of correspondence; to have a knowledge of the office routine and activities of the Dairying Division	Baylis, Catherine D.	Assistant (Female), Grade I., Grades 9-10 inclusive	24.3.58

Appeals against such recommendations should be lodged with the Secretary to the Public Service Board not later than Saturday, 12th September, 1959.

Office of the Public Service Board,
Melbourne, 1st September, 1959.

By Order,
V. P. SCULLY,
Secretary.

PUBLIC SERVICE (PUBLIC SERVICE BOARD) REGULATION 39.—VACANCY.

THE Permanent Head of the Department shown has recommended the officer named hereunder for appointment to the under-mentioned vacancy.

Office and Classification.	Duties.	Qualifications.	Officer Recommended for Appointment.		
			Name.	Classification.	Date of Classification.
TECHNICAL AND GENERAL DIVISION. DEPARTMENT OF CHIEF SECRETARY. <i>Penal and Gaols Branch.</i>					
Penal Officer, Senior, Grades 33-35 inclusive	To assist in the control of a division, and in the absence of the Chief Penal Officer to act as Chief Penal Officer and to perform other such duties as directed including those of storekeeper, where allotted to country institutions, and as Officer in Charge for night watches and for court escorts; applicants should be prepared to take up duty in country institutions as directed by the Director	To have passed the prescribed examination for promotion; to have a satisfactory record of service, the qualities of leadership required of a senior officer in the management of staff and prisoners, and the experience and ability to assume responsibility, including storekeeping when required	Tumath, W. T.	Penal Officer, Grades 18-23 inclusive	17.4.57

Appeals against such recommendation should be lodged with the Secretary to the Public Service Board not later than Saturday the 12th September, 1959.

Office of the Public Service Board,
Melbourne, 1st September, 1959.

By order,
V. P. SCULLY,
Secretary.

No. 968.

Public Service Act 1958, Section 39.

REGULATIONS.—PART III.—SALARIES, INCREMENTS, AND ALLOWANCES.

THE Public Service Board, in pursuance of the powers conferred by the Public Service Act 1958, hereby amends its Regulations as shown below:—

FIRST SCHEDULE.
PROFESSIONAL DIVISION.

Amount of Salary Assigned to Offices in Class "A1".

Office.	Yearly Rate of Salary.
DEPARTMENT OF CHIEF SECRETARY.	
£	
<i>Delete</i> — Director of Fisheries and Game	2,200
<i>Add</i> — Director of Fisheries and Game	2,400

A. GARRAN, Chairman.
V. P. SCULLY, Secretary.

Office of the Public Service Board,
Melbourne, 17th August, 1959.

No. 969.

Public Service Act 1958, Section 39.

REGULATIONS.—PART III.—SALARIES, INCREMENTS, AND ALLOWANCES.

THE Public Service Board, in pursuance of the powers conferred by the Public Service Act 1958, hereby amends its Regulations as shown below:—

SIXTH SCHEDULE.
TEMPORARY EMPLOYEES.

Designations of Positions and Rates of Salaries.

Department and Designation of Position.	Yearly Rate of Salary.		Increments (Annual).
	Minimum.	Maximum.	
DEPARTMENT OF TREASURER:			
HOUSING COMMISSION.			
<i>Delete</i> — Manager, Holmesglen Concrete House Factory	£	£	2,200
<i>Add</i> — Manager, Holmesglen Concrete House Factory			2,600

A. GARRAN, Chairman.
V. P. SCULLY, Secretary.

Office of the Public Service Board,
Melbourne, 13th August, 1959.

PUBLIC SERVICE OF VICTORIA.—VACANCIES.

APPLICATIONS will be received by the Public Service Board up to Wednesday, the 16th September, 1959, from persons employed in the Public Service of Victoria, who are eligible and qualified, for appointment to the under-mentioned positions:—

ADMINISTRATIVE DIVISION.

Deputy Registrar-General and Assistant Registrar of Titles, Class "A1", Office of Titles, Department of Law.
Yearly Salary.—£2,050.

Duties.—To supervise the staff and work of the Office of the Registrar-General and the Office of Titles; to act as Registrar-General and Registrar of Titles during the absence of that officer and to advise the staff, Solicitors and the public on the practice of the Office relating to dealings lodged under the various Acts administered in the office.

Qualifications.—A good knowledge of the Transfer of Land Act and all other Acts dealing with real property and of the practice of the Office of Titles and a knowledge of the several Acts administered by the Registrar-General.

Class "B1", Department of Education.

Yearly Salary.—£1,390, minimum; £1,500, maximum.

Duties.—To have charge of the Teachers Branch, and to act as Secretary to the Committee of Classifiers for the Primary Schools Division.

Qualifications.—To possess ability to control and direct a staff, good organizing ability, a sound knowledge of the Public Service, Teaching Service, and Education Acts and of the regulations thereunder; and a good knowledge of the Department.

Class "B1", Department of Water Supply.

Yearly Salary.—£1,390, minimum; £1,500, maximum.

Duties.—To advise and direct the Commission's District Accounting Officers on all rating matters; to sign rate certificates; to examine and make recommendations for the settlement of difficult rating cases; to negotiate settlements where estates of deceased persons, bankruptcy, &c., are involved; to prepare estimates of District Revenue and expenditure for rating purposes; to examine and report on District Balance Sheets with particular reference to adjustment of capital liabilities and the sufficiency of revenue to meet costs of operation.

Qualifications.—To be a qualified Accountant with extensive experience of the Commission's accounting procedure; to possess a good knowledge of the Water Acts and the activities of the Commission, together with understanding of the rating procedure as laid down in the Local Government Act.

Class "B", Victorian Licensing Court, Department of Chief Secretary.

Yearly Salary.—£1,180, minimum; £1,280, maximum.

Duties.—Under the direction of the Supervisor of Licensed Premises to have charge of the branch recording system; to prepare reports and orders relating to matters to be brought before the Victorian Licensing Court; to co-ordinate the work of assistant supervisors, to conduct the correspondence and clerical work of the branch. In the absence of the Supervisor, to carry out such duties.

Qualifications.—To have a thorough knowledge of the Licensing Acts and Regulations thereunder and the procedure of the Victorian Licensing Court; to have had experience in dealing with plans and specifications of Licensed premises in relation to the requirements under the Licensing Acts, to have had experience in the preparation of reports and orders under the Licensing Acts and to be familiar with details of the licensed trade generally.

Classes "C2"—"B", Office of the Public Trustee, Department of Law.

Yearly Salary.—£1,000, minimum; £1,280, maximum.

Duties.—To act as Trust Officer dealing with the estates of mental patients and infirm persons.

Qualifications.—A good knowledge of the Public Trustee Act and the regulations thereunder particularly in their relation to mental patients and infirm persons and of the Mental Hygiene Act; experience in the management and conduct of estates and businesses and a knowledge of real estate values.

Class "C2", Office of Titles, Department of Law.

Yearly Salary.—£1,000, minimum; £1,100, maximum.

Duties.—To advise Counter Clerks and public on various documents filed under the Companies Act and Instrument Act, to supervise the entering of such documents and to institute proceedings against Company officers making default in filing returns.

Qualifications.—A good knowledge of the Companies Act, Instrument Act, Industrial and Provident Societies Act and Printers and Newspapers Act.

Class "C1", Audit Office, Department of Premier.

Yearly Salary.—£830, minimum; £920, maximum.

Duties.—To conduct audits throughout Victoria as directed by the Auditor-General.

Qualifications.—To be a qualified Accountant and to have had experience in the practice of governmental and public auditing.

Class "C1", Office of Titles, Department of Law.*Yearly Salary.*—£830, minimum; £920, maximum.*Duties.*—To have charge of receipt of dealings lodged for registration; to supervise entries made in the Lodging Book and to deal with correspondence in respect of orders entered therein; to advise the public on correct presentation of documents.*Qualifications.*—To have a good knowledge of the Transfer of Land Act and cognate Acts and of the practice of the Office of Titles.**Class "C", Audit Office, Department of Premier.***Yearly Salary.*—£624, minimum; £759, maximum.*Duties.*—To assist in the audit and examination of accounts as required by the Auditor-General.*Qualifications.*—To have a knowledge of the Audit Act and the Regulations thereunder and to have entered on a course of study in accountancy.**Class "C", Motor Registration Branch, Office of the Chief Commissioner of Police, Department of Chief Secretary.***Yearly Salary.*—£624, minimum; £759, maximum.*Duties.*—To be Deputy Officer in Charge of the Mechanization Section; to deal with all applications for Common Expiry Registrations and to compute fees payable thereon.*Qualifications.*—To have had experience in the operation of Powers Samas machines used for punch card systems; to have a knowledge of the Motor Car Acts and Regulations thereunder, and to possess ability to control staff.**Class "C", Stamp Duties Office, Department of Treasurer.***Yearly Salary.*—£624, minimum; £759, maximum.*Duties.*—To perform the duties of Relieving Officer in all the branches of the office, to attend the public counters and advise the public and to assist in those branches as required.*Qualifications.*—To be familiar with the Stamps Act and the Regulations thereunder and to have had experience in different sections of the office.**Class "C", Office of the Housing Commission, Department of Treasurer. (Two vacancies.)***Yearly Salary.*—£624, minimum; £759, maximum.**POSITION No. 1.***Duties.*—Under the direction of the Chief Architect to assist with drafting of correspondence relating to tenders; to assist with compilation of the weekly agenda, and with the general clerical work of the Administrative Section of the Branch.*Qualifications.*—To possess initiative and organizing ability, and a knowledge of building terms and contracts; to be capable of preparing draft correspondence and précis.**POSITION No. 2.***Duties.*—Under the Housing Standards Officer to supervise administrative staff of the Branch, conduct correspondence and interviews with the public and arrange for Titles Office searches.*Qualifications.*—A general knowledge of office procedure, ability to supervise staff, conduct interviews and correspondence. A knowledge of Titles Office procedure would be an advantage.**PROFESSIONAL DIVISION.****Building Surveyor, Class "B", General Health Branch, Department of Health.***Yearly Salary.*—£1,180, minimum; £1,280, maximum.*Duties.*—To examine plans and specifications of public and other buildings; to make and check structural calculations for steel, reinforced concrete, and other buildings; to prepare plans and sketches and to inspect and report on buildings.*Qualifications.*—To be a qualified architect, or to hold a recognised diploma in building surveying or its equivalent, and to have had suitable experience.**Food Technologist (Chemist), Classes "C"—"C2", General Health Branch, Department of Health.***Yearly Salary.*—£759, minimum; £1,100, maximum. (Commencing salary according to experience.)*Duties.*—Under the direction of the Chief Health Officer to advise on food processing problems and on standards for processed foods; to conduct investigations into food processing procedures in relation to public health; to assist in inspection and sampling of processed foods and to perform such other duties as may be directed.*Qualifications.*—A University degree in science with chemistry or biochemistry as a major subject or an approved diploma in chemistry.*NOTE.*—The successful applicant will be required to undertake a twelve months' post-graduate course in food technology at the New South Wales University of Technology and prior to undertaking such course, to enter into an agreement to remain in the Public Service of Victoria for a certain period after completion of the course.**Assistant Entomologist, Classes "C"—"C2", Department of Agriculture.***Yearly Salary.*—Agricultural Science Graduate—£830, minimum; £1,100 maximum; Science Graduate—£759, minimum; £1,100, maximum.

(Commencing salary will be determined within this initial career range according to experience, but advancement is not limited to the maximum quoted.)

Duties.—Under the Chief Biologist, to investigate the biology and control of Victorian insect pests, particularly those of fruit, and to perform other duties in entomology as required.*Qualifications.*—To possess the degree of Bachelor of Agricultural Science or Bachelor of Science with a sound training in Entomology, capacity to lecture and to conduct laboratory and field experiments and to prepare suitable scientific reports.*NOTE.*—The successful applicant will be located at the Horticultural Research Station, Tatura, after a preliminary training at the Plant Research Laboratory, Burnley.**Chemist, Classes "C"—"C2", Department of Agriculture. (Two vacancies.)***Yearly Salary.*—£759, minimum; £1,100, maximum.

(Commencing salary will be determined within this initial career range according to experience, but advancement is not limited to the maximum quoted.)

POSITION No. 1.*Duties.*—Under general direction to carry out analyses of a range of agricultural products and materials.*Qualifications.*—To hold a science degree or approved diploma with chemistry as the major subject with some experience in the analysis of agricultural materials.**POSITION No. 2.***Duties.*—To carry out analyses of a range of agricultural products and materials.*Qualifications.*—To hold a science degree or approved diploma with chemistry as a major subject, with preferably some experience in the analysis of agricultural materials.**Archivist, Class "C", Public Library, Department of Chief Secretary.***Yearly Salary.*—£624, minimum; £759, maximum.*Duties.*—To inspect records in Government Departments, and to determine which of these have archival value and are worthy of permanent preservation; to arrange and describe the archives already deposited within the Public Library of Victoria; to assist in the collection and arrangement of non-Government records and private documents of historical value.*Qualifications.*—To have a University degree in Arts, with History, including Australian History as a major subject, and to have proved capacity for undertaking advanced historical research. Some knowledge of the history of administration within the Victorian Government would be advantageous.**TECHNICAL AND GENERAL DIVISION.****Draughting Assistant, Grade I., Department of Crown Lands and Survey.***Yearly Salary.*—£689, minimum; £728, maximum.*Duties.*—To assist with stereo-triangulation and the preparation of topographical maps from aerial photographs using first order Stereo-Plotting equipment.*Qualifications.*—To have a thorough knowledge of the use of aerial photographs for topographical mapping and be conversant with the principles of the A.5 Autograph.

Dairy Supervisor, Department of Agriculture.

Yearly Salary.—£650, minimum; £728, maximum.

Duties.—Subject to the Superintendent of Dairying, to undertake inspections of dairy farms and dairies as required. To advise and instruct on sanitation and dairy farm practice. To examine cows for notifiable disease, and to assist generally in the administration of the Milk and Dairy Supervision Acts in the field.

Qualifications.—To possess a Dairy Supervisor's Certificate issued under the Milk and Dairy Supervision Acts.

Draughting Assistant, Grade II., Department of Crown Lands and Survey.

Yearly Salary.—£598, minimum; £650, maximum.

Duties.—To assist in the preparation of topographical maps from aerial photographs using second order Stereo-Plotting equipment.

Qualifications.—To have a sound knowledge of the use of aerial photographs for topographical mapping and be conversant with the principles of A.6 Stereo-Plotting and Multiplex equipment.

Shorthand Writer and Typist (Female), Senior, Correspondence School, Department of Education.

Yearly Salary.—£494, minimum; £520, maximum.

Duties.—To act as senior typist and stenographer at the Correspondence School, Napier-street, Fitzroy.

Qualifications.—To be a competent typist and capable of writing shorthand at the rate of 120 words a minute; to be sufficiently experienced to be able to allocate and supervise the work of the typing staff.

Senior Water Bailiff (Tongala), Department of Water Supply.

Yearly Salary.—£481.

Duties.—To control a section of the main channel and subsidiary channels and to regulate supplies between Water Bailiffs; to supervise water distribution repairs, and maintenance of channels within the Section.

Qualifications.—To be experienced in the regulation and distribution of water required by each Bailiff for his section; to possess an intimate knowledge of water requirements for orchards, crops, pastures, and grasses grown under irrigation in the district; to have had experience in channel and drain construction and maintenance.

NOTE.—A residence is available for the successful applicant, if married, for which rental of 10 per cent. of standard salary, plus £16 per annum, will be charged. Particulars available from the Department of Water Supply.

Water Bailiff (Swan Hill), Department of Water Supply.

Yearly Salary.—£390, minimum; £442, maximum.

Qualifications.—Ability to control and regulate the supply of water to irrigators, keep the necessary records, and make arithmetical computations in connexion therewith; a knowledge of water requirements for crops and grasses and vines and citrus plantings grown under irrigation, the methods of preparation of land for same, and methods of channel and drain construction and maintenance.

Assistant (Female), Grade II., Stamp Duties Office, Department of Treasurer.

Yearly Salary.—£325, minimum; £338, maximum.

Duties.—To emboss cheques, promissory notes, receipts, and other material submitted for stamping, and keep accurate records of all material dealt with.

Qualifications.—To be competent to operate a power embossing machine, and have ability to set up for stamping special types of forms.

Labourer, Office of the Chief Commissioner of Police, Department of Chief Secretary.

Yearly Salary.—£286, minimum; £299, maximum.

NOTE.—The salary rates quoted above do not include the additional amounts which are payable under Regulation 77A of the Board's Regulations.

By order,

V. P. SCULLY,

Office of the Public Service Board,
Melbourne, 1st September, 1959.

PUBLIC SERVICE OF VICTORIA.—VACANCIES.**DEPARTMENT OF HEALTH.****MENTAL HYGIENE BRANCH.****TECHNICAL AND GENERAL DIVISION.**

APPPLICATIONS will be received by the Public Service Board up to Wednesday, the 23rd September, 1959, from persons employed in the Public Service of Victoria, who are eligible and qualified, for appointment to the under-mentioned positions:—

Charge Nurse (Male), Bundoora Repatriation Mental Hospital. (Two vacancies.)

Yearly Salary.—£533, minimum; £572, maximum.

Duties.—To take charge or sub-charge of a ward in a Mental Hospital.

Qualifications.—To possess the Mental Hygiene Nursing Certificate and to have had experience as a Deputy Charge Nurse in a Mental Hospital; to possess a current practising Certificate as issued by the Victorian Nursing Council.

NOTE.—The salary rates quoted above do not include the additional amounts which are payable under Regulation 77A of the Board's Regulations.

By order,

V. P. SCULLY,

Secretary.

Office of the Public Service Board,
Melbourne, 1st September, 1959.

PUBLIC SERVICE OF VICTORIA.—VACANCIES.**TEMPORARY APPOINTMENTS.**

APPPLICATIONS will be received by the Public Service Board up to Wednesday, the 16th September, 1959, from persons who are qualified for appointment to the under-mentioned positions:—

Examiner, Embossing, Assistant, Stamp Duties Office, Department of Treasurer.

Yearly Salary.—£377, minimum; £455, maximum.

Duties.—To assist in the inspection of stamp duty embossed on instruments and material; to check the value of the stamp duty impressed on material against payments on requisitions; to pack stamped material for transport, and to assist with the embossing of stamp duty on legal documents.

Works Inspector, Wonthaggi District, Department of Water Supply.

Yearly Salary.—£572, minimum; £598, maximum.

Duties.—To supervise and inspect the installation of water supply works by licensed plumbers and to carry out maintenance of pipelines; to regulate the supply of water to the high and low level systems; to carry out water treatment as required and to supervise labour.

Qualifications.—To be capable of supervising the installation of water supply works by licensed plumbers and to be able to operate electrically driven centrifugal pumps and water treatment plant. A knowledge of the repair, maintenance and installation of cast iron and wood stave mains and asbestos cement reticulation pipes is essential. Familiarity with the operation of the Lance Creek Reservoir, the Lance Creek-Wonthaggi pipeline and of both the high and low level systems is required.

NOTE.—The salary rates quoted above do not include the additional amounts which are payable under Regulation 77A of the Board's Regulations.

By order,

V. P. SCULLY,

Secretary.

Office of the Public Service Board,
Melbourne, 1st September, 1959.

PRIVATE ADVERTISEMENTS

Local Government Act 1958.

CITY OF COBURG.

WHEREAS the Council of the City of Coburg deems it expedient to execute a work or undertaking which the said Council is authorized by the *Local Government Act 1958* to execute, namely the widening of portion of Marion-street, Coburg:

And whereas in the opinion of the said Council it is necessary or desirable to take compulsorily the land described in the Schedule hereto for the purposes of such work or undertaking:

And whereas the said Council has caused to be prepared maps and plans showing such land and the names of the owners or reputed owners, lessees or reputed lessees, and the occupiers thereof as far as such names can be ascertained by the said Council:

And whereas such maps and plans are deposited at the office of the said Council and are and shall be open for inspection by all persons interested at all reasonable hours for the space of 40 clear days after the publication of this notice in the *Government Gazette*:

Now notice is hereby given to all persons affected by the proposed work or undertaking and they are hereby called upon to set forth in writing, addressed to the said Council or the Town Clerk of the City of Coburg within 40 clear days from the publication of this notice in the *Government Gazette*, all objections which they may have to the said work or undertaking.

SCHEDULE HEREINBEFORE REFERRED TO.

All that piece of land, being part of Crown portion 149 at Coburg, Parish of Jika Jika, County of Bourke, commencing at a point being the north-eastern angle of lot 10 shown on lodged plan of subdivision No. 7528; and bounded thence by lines bearing respectively north 0 deg. 8½ min. west 5 ft. 2½ in., north 89 deg. 30½ min. east 166 ft. 5½ in., south 4 ft. 11 in., and south 89 deg. 25 min. west 166 ft. 5½ in. to the commencing point.

Dated this 31st day of August, 1959.

6951

G. A. BRIDGES, Town Clerk.

CITY OF MELBOURNE.

AUTHORITY TO BORROW LOAN MONEYS.

NOTICE is hereby given, in accordance with the provisions of section 13 of Act 53, Victoria, 1055, that it is the intention of the Council to borrow the sum of Eight hundred and thirty-two thousand pounds, for the purpose of carrying into effect the provisions of the several Acts of Parliament relating to the City of Melbourne, and to provide funds for permanent works and undertakings during the year from 1st July, 1959, to 30th June, 1960.

6930

F. H. ROGAN, Town Clerk.

TOWN OF PORTLAND.

BY-LAW No. 62.

IN pursuance of the powers conferred by the above By-law, the Council of the Town of Portland hereby resolves—

1. That the following streets within the municipality hitherto unnamed shall be named as indicated:—

New road continuing Julia-street westerly from Cameron-street to the West Boundary-road	Julia-street.
New road running northerly from Julia-street on the west side of Harbor Railway	Anderson-street.
Street bounding the western boundaries of sections 38, 41B and 42B	Tipping-street.
New road continuing the southern portion of Finn-street northerly to Otway-street (previously the Bridgewater-road)	Finn-street.
Street connecting Francis-street with Fern-street on south of railway line	Hedditch-street.

2. That the following streets shall be renamed as indicated:—

Old Name.	Situation.	New Name.
Beverly-street	Throughout	Beverley-street.
Bridgewater-road	From Blair-street to West Boundary-road	Otway-street.
Finn-street	From Otway-street to Harbor Railway	Frost-court.
Fredericks-lane	Throughout	Fredericks-court.
Henry-street	Throughout	Henry-place.
Henty-street west	From Tipping-street to Harbor Railway	Henty-court.
Hughes-street	Throughout	Edgar-street.
Jones-street	Throughout	Jones-court.
Julia-street west	From Anderson-street to West Boundary-road	William-street.
Lighthouse-avenue	Throughout	Lighthouse-court.
Manca-street	Throughout	Manca-court.
Market-street	Throughout	Market-court.
Moorhouse-street	Throughout	Moorhouse-court.
Nelson-road	Throughout	Cape Nelson-road.
Otway-street	From Bentinck-street to Portland-Hamilton Railway	Otway-court.
Perry-street	Throughout	Perry-court.
Portland-street	Throughout	Portland-court.
Ross-street	Between Browning-street and Harbor Railway	Kennedy-court.
Ross-street	Between Fitzgerald-street and Harbor Railway	Ross-court.
Rossdell-street	South of Island View-parade	Rossdell-court.
Scott-street	Between Browning-street and Harbor Railway	Oswald-court.
Scott-street	Between Fitzgerald-street and Harbor Railway	Scott-court.
South Boundary-road	Throughout	Derril-road.
Stuchbery-street	Throughout	Stuchbery-court.
Sutton-avenue	Throughout	Sutton-court.
Tanner-street	Throughout	Tanner-court.
The Esplanade	From Wade-street to Starkey-street	Clifton-court.
Thornton-street	Throughout	Thornton-court.
Wade-street	Between Browning-street and Portland-Hamilton Railway	Marriott-court.
Whaler-crescent	Throughout	Whaler-court.

In witness whereof the common seal of the Town of Portland was hereunto attached this 18th day of August, 1959, in the presence of—

(SEAL)

ARTHUR J. THOMAS, Councillor.
A. H. LANGLEY, Councillor.
E. NOEL T. HENRY, Town Clerk.

Local Government Act 1958.

TOWN OF COLAC.

DECLARATION OF PRIVATE STREETS AS PUBLIC HIGHWAYS.

IN pursuance of the power conferred by section 587 (3) of the *Local Government Act 1958* the Council of the Town of Colac on the application of the owners of so many of the premises as in rateable value are the greater part of all the premises fronting on the streets herein-after mentioned, being private streets within the municipal district of the Town of Colac more than 15 feet in width constructed to the satisfaction of the Council, but not constructed pursuant to Division 10 of Part XIX. or Part XLII. of the *Local Government Act 1958* or any corresponding previous enactment, hereby declares such streets to be dedicated to the public as public highways.

The streets in respect of which this declaration is made are—

McKenzie-street, full length.
Dunoon-street, full length.
Robertson-street, from McKenzie-street to Bartlett-street.
Richmond-street, from McKenzie-street southerly for 6½ chains.
Richard-street, full length.
Churchill-square, full length.

In witness whereof the common seal of the Mayor, Councillors and Citizens of the Town of Colac was hereto affixed this 26th day of August, 1959, in the presence of—

(SEAL) G. W. MALINS, Mayor.
L. C. LEE, Councillor.
F. M. KELLY, Town Clerk.

6936

BOROUGH OF WONTHAGGI.

APPOINTMENT OF RANGER.

NOTICE is hereby given that the Council of the Borough of Wonthaggi has appointed Stanley Harold Brown as Ranger in place of Raymond Charles Street.

6939

A. BEANLAND, Town Clerk.

SHIRE OF BERWICK.

ALTERATION OF STREET NAMES.

NOTICE is hereby given that the Council of the Shire of Berwick has altered, under the provisions of the *Local Government Act*, the names of the streets shown hereunder:—

Old Name; New Name; Location.

Normanby-street and Brown-street; Langmore-lane; running continuously from Berwick-Cranbourne road on the west to Princes Highway on the east in the Township and Parish of Berwick.

Unnamed; McNabb-street; commencing at the south corner of Crown allotment 2, Town and Parish of Berwick, and continuing north along the western boundary of the said allotment for a distance of 8 chains or thereabouts.

Little Yannathan-road; Fallon-road; commencing at the junction of the main Koo-Wee-Rup-Longwarry road at the south-east corner of Crown allotment 154, section O, and continuing west to the north-west corner of Crown allotment 177a, section O, Parish of Koo-Wee-Rup East.

Unnamed; Gardiner-street; commencing at the junction with the Berwick-Harkaway road at the north-west corner of Crown allotment 4 and continuing east to the north-east corner of Crown allotment 5, Town and Parish of Berwick.

George-street; Anderson-street; shown on lodged plan No. 3022 and situated between Henry-street and John-street, Pakenham East.

6932

BEATRICE THOMAS, Shire Secretary.

SHIRE OF BERWICK.

NOTICE is hereby given that the Council of the Shire of Berwick has specified for the purposes of subsection (1) of section 4 of the *Dog Act 1936*, as amended by section 2 of the *Dog Act 1939*, the shopping centre Autumn-place, Doveton (between Powers-road and Hawthorn-road).

The owner of any dog (other than a dog being used in the droving of stock) which is found in the above-mentioned shopping centre, and which dog is not under the control of some person by means of a chain or cord

or leash, shall be liable for a first offence to a penalty of not more than Two pounds, and for a second or subsequent offence to a penalty of not more than Five pounds.

By order,

BEATRICE THOMAS, Shire Secretary.

Shire Hall, Pakenham East, 24th August, 1959. 6931

SHIRE OF HEALESVILLE.

RESULT OF POLL.

PROPOSAL that Part XI. (Rating on Unimproved Values) of the *Local Government Act 1958* be adopted in the Shire of Healesville, and that rates shall be made and levied in respect of rateable property on the basis of the unimproved capital value thereof.

Number of valid votes recorded for the proposal—1,372.

Number of valid votes recorded against the proposal—1,447.

Number of votes for which voters are inscribed on the municipal roll—5,477.

I declare the proposal to be rejected.

6952

W. M. OLIVER, Returning Officer.

SHIRE OF MALDON.

BY-LAW No. 14.

A By-law of the Shire of Maldon, made under the provisions of the *Local Government Acts*, and numbered 14, for the purpose of—

- (a) Prohibiting or regulating the use of private property situate at the junction of streets or roads for the growing of trees, shrubs, or hedges abutting on any such street or road or within 10 feet therefrom, or within a distance of 30 feet from such junction.
- (b) Requiring the removal and lopping of trees, shrubs, or hedges (whether planted before or after the commencement of the *Local Government Act 1946*) from or on private property so situate.
- (c) Requiring the reduction to a height not exceeding 3 ft. 6 in. of any portion of a fence within 30 feet of such junction.
- (d) Authorizing the Council of the said Shire at the expense of the owner (the amount of which expense may be recovered by the Council in a Court of Petty Sessions as a civil debt recoverable summarily)—
 - (1) To remove or lop trees, shrubs, or hedges growing or being on private property so situate which are not removed or lopped as required by or under any By-law made under paragraph (b) hereof.
 - (2) To reduce in height any portion of a fence which is not reduced in height as required by or under any By-law made under paragraph (c) hereof.

IN pursuance of the powers conferred by the *Local Government Acts* and of any and every other power it thereunto enabling it in that behalf, the President, Councillors, and Ratepayers of the Shire of Maldon order as follows:—

1. No person shall use any private property situate at the junction of any streets or roads for the growing of trees, shrubs, or hedges abutting on any such street or road or within 10 feet therefrom, or within a distance of 30 feet from the junction of any streets or roads, unless each part of any such tree, shrub, or hedge be kept at a height not greater than 3 ft. 6 in. above the surface level of the street or road nearest to such tree, shrub, or hedge.

2. The owner or occupier of any private property situate at the junction of any streets or roads upon which property any trees, shrubs, or hedges are growing abutting on such streets or roads or within a distance of 10 feet therefrom or within a distance of 30 feet from such junction shall, if any such trees, shrubs, or hedges, or any part or parts thereof, be of a height greater than 3 ft. 6 in. above the surface level of the street or road nearest to any such trees, shrubs, or hedges, upon receipt of notice in writing under the hand of the Municipal Clerk of the said Shire and within the time specified in such notice, remove or lop or cause to be removed or lopped any tree, shrub, or hedge (whether planted before or after the commencement of the *Local Government Act*

1946) to such extent as may be necessary to bring the same into conformity with the requirements of clause 1 of this By-law.

3. Upon default being made by any owner or occupier of private property situate at the junction of any streets or roads in complying with any notice served under clause 2 of this By-law, the said Council may, notwithstanding the imposition or recovery of any penalty, by its engineer or authorized officer enter upon such private property with a sufficient number of workmen and may remove or lop such trees, shrubs, or hedges growing or being thereon which have not been removed or lopped as required by the said notice, and the expenses incurred by the said Council in so doing shall be forthwith paid by the owner of such private property to the said Council, and in the default of such payment may be recovered by the said Council as a civil debt recoverable summarily.

4. The owner of any private property situate at the junction of any streets or roads upon which private property there is a fence within 30 feet from the junction of such streets or roads shall, if such fence be of a height greater than 3 ft. 6 in. from the surface level of the street or road nearest to such fence, upon receipt of notice in writing under the hand of the Municipal Clerk of the said Shire and within the time therein specified cause to be reduced to a height not exceeding 3 ft. 6 in. above the surface level of the street or road nearest such fence any portion of such fence within 30 feet of the junction of such street or road.

5. Upon default by the owner or occupier of any private property situate at the junction of any streets or roads in complying with any notice served under clause 4 of this By-law, the said Council may, notwithstanding the imposition or recovery of any penalty, by its engineer or other authorized officer, enter upon such private property with a sufficient number of workmen and may reduce in height any portion of a fence which has not been reduced in height as required by such notice and the expense incurred by the said Council in so doing shall be forthwith paid by the owner of such private property to the said Council, and in default of such payment may be recovered by the said Council as a civil debt recoverable summarily.

6. For the purposes of this By-law—

(1) The word "junction" shall mean the point at which the building line of a street or road meets the building line of another street or road, and in cases where the corner has been rounded off or splayed the word "junction" shall mean and include the point of intersection of the building lines if continued along the front and side boundaries of the property.

(2) The words "surface level" shall mean—

(a) Where the footway on that side of the street or road which abuts on the private property in question is paved, the level of that part of the paved portion of such footway nearest to the private property in question.

(b) If such footway is not paved and the level of the street or road abutting on such private property has been fixed in accordance with the provisions of Division 9 of Part XIX. of the *Local Government Act 1946*, or any previous or subsequent Act of Parliament of a like nature, the level as so fixed of that part of such street or road nearest to the private property in question.

(c) Otherwise the actual level of that part of such street or road nearest to the private property in question.

7. This By-law shall apply to and have operation throughout the whole of the municipal district of the Shire of Maldon.

8. Any person who by wilful act or default shall offend against any of the provisions of this By-law shall be liable to a penalty not exceeding Twenty pounds.

Resolution for passing this By-law was agreed to by the Council of the Shire of Maldon on the 2nd day of July, 1959, and confirmed on the 6th day of August, 1959.

The common seal of the President, Councillors, and Ratepayers of the Shire of Maldon was affixed hereto, in the presence of—

(SEAL) J. P. EDWARDS, President.
T. H. GRIGG, Councillor.
S. R. BEACH, Shire Secretary.

6918

SHIRE OF MORWELL.

APPOINTMENT OF POUNDKEEPER.

Morwell Pound.

NOTICE is hereby given that William George Newton has been appointed Poundkeeper at the Morwell Pound.
6937

W. K. MATHISON, Shire Secretary.

SHIRE OF NEWSTEAD.

LOAN No. 1.

Notice of Intention to Borrow the Sum of £3,500 for Permanent Works and Undertakings.

NOTICE is hereby given that the Council of the Shire of Newstead proposes to borrow the sum of Three thousand five hundred pounds, on the credit of the municipal revenues of the President, Councillors, and Ratepayers of the said Shire, such sum to be raised by the issue of debentures, in accordance with the *Local Government Act 1958*.

1. The maximum rate of interest which may be paid is 5½ per cent. per annum.

2. The purpose for which the loan is to be applied is the erection of a brick-veneer residence.

3. The period of the loan shall be for ten years.

4. The moneys borrowed shall be repaid by providing out of the municipal fund twenty half-yearly instalments of Two hundred and twenty-nine pounds seventeen shillings, including interest on the reducing balance, during the currency of the loan.

5. Such moneys shall be repayable at The National Bank of Australasia Limited, Melbourne, or at the Council's bankers for the time being in Melbourne.

The plans and specifications and the estimate of the cost of the proposed works, and a statement showing the proposed expenditure of the moneys to be borrowed, are open for inspection at the Shire Office, Newstead.

Dated this 2nd day of September, 1959.

6984 W. T. HUTCHESON, Shire Secretary.

SHIRE OF TRARALGON.

DEDICATION TO THE PUBLIC AS PUBLIC HIGHWAYS OF STREETS CONSTRUCTED TO THE SATISFACTION OF THE COUNCIL.

PURSUANT to an application dated 30th April, 1959, by Australian Paper Manufacturers Ltd., the Council of the Shire of Traralgon hereby declares that the under-mentioned streets have been constructed to the satisfaction of the Council and shall hereafter be dedicated to the public as public highways, pursuant to section 583 (3) of the *Local Government Act 1958*, viz:—

Catterick-crescent—full length.

Mermod-court—full length.

McCallum-court—full length.

Stagg-street—full length.

Davis-court—full length.

Armstrong-court—full length.

6927 E. F. TAYLOR, Shire Secretary.

SHIRE OF WERRIBEE.

LOAN No. 44.

Special Order to Borrow the Sum of £15,000.

NOTICE is hereby given that at an Ordinary Meeting of the Council of the Shire of Werribee, held on the 28th August, 1959, the said Council did agree to the following Resolution, that is to say:—

"That the Council do by Special Order and it does hereby resolve to borrow the sum of Fifteen thousand (£15,000) pounds on the credit of the President, Councillors and Ratepayers of the Shire of Werribee, such sum to be raised by the granting of a mortgage, in accordance with the provisions of the *Local Government Act 1958*.

1. The rate of interest to be paid shall be 5½ per cent. per annum.

2. The moneys borrowed shall be repayable at the State Savings Bank of Victoria, Melbourne, by twenty half-yearly instalments of approximately £985 1s. 6d., commencing on the 1st day of May, 1960.

3. The purpose for which the loan is to be applied is private street construction, in accordance with the provisions of Division 10, Part XIX. of the *Local Government Act*.

4. The period of the loan shall be ten years.

5. The loan shall be liquidated from the receipt of moneys payable by property owners under schemes adopted pursuant to the aforesaid Division.

Notice is hereby further given that the said Resolution will be submitted for confirmation at a Meeting of the said Council to be held on Thursday, 10th September, 1959, at half-past Ten a.m., in the Shire Offices, Werribee.
6948 N. G. MINNS, Shire Secretary.

THE BALLARAT SEWERAGE AUTHORITY.

GENERAL NOTICE.

THE above-mentioned Sewerage Authority, having made provision for carrying off the sewage from each and every property which, or any part of which, is within the sewerage area hereinafter described, doth hereby declare that on and after the 1st day of October, 1959, each and every property which, or any part of which, is within the said sewerage area shall be deemed to be a seweraged property within the meaning of the *Sewerage Districts Act 1928*.

The boundaries of the Sewerage Area hereinbefore referred to are:—

Sewerage Area No. 181.

City of Ballarat.—Commencing at a point on the prolongation of the northern boundary of No. 42 Princes-street (formerly numbered 38 Princes-street) and situate about 225 feet east of Princes-street and being a point on the boundary of Sewerage Area No. 48; thence easterly about 460 feet to a point on the prolongation of the east building line of King-street and being about 119 feet north of Webb-avenue, north-easterly along the northern boundaries of properties on the north side of Webb-avenue to a point on the west building line of Newman-street about 102 feet from the north-west corner of Newman-street and Webb-avenue, southerly along the west building line of Newman-street to the south-west corner of Newman and Morris streets; thence westerly and northerly along the boundary of Sewerage Area No. 48 to the point of commencement.

Further particulars regarding the streets or parts of streets in which sewers have been laid may be ascertained on inquiry at the Authority's office.

By order of the said Sewerage Authority,

6953 A. W. NICHOLSON, Chairman.
C. H. CLAMP, Secretary.

SPRINGVALE AND NOBLE PARK SEWERAGE AUTHORITY.

GENERAL NOTICE.

THE above-mentioned Sewerage Authority, having made provision for carrying off the sewage from each and every property which, or any part of which, is within the sewerage areas hereinafter described, doth hereby declare that on and after the 1st day of October, 1959, each and every property which, or any part of which, is within the said sewerage areas shall be deemed to be a seweraged property within the meaning of the *Sewerage Districts Act 1958*.

The boundaries of the sewerage areas hereinbefore referred to are:—

Sewerage Area No. 1—Noble Park.

Commencing at a point being the intersection of the western side of Ian-street and the north-eastern side of Mons-parade; thence north-westerly along the north-eastern side of Mons-parade to its intersection with the southern side of Heatherton-road; thence northerly across Heatherton-road to a point being the intersection of the northern side of Heatherton-road and the eastern side of Rosslyn-street; thence northerly and north-westerly along the eastern and north-eastern sides respectively of Rosslyn-street to a point being the intersection of the north-eastern side of Rosslyn-street and the south-eastern side of Lyle-street; thence north-easterly along the south-eastern side of Lyle-street to its intersection with the south-western bank of Mile Creek; thence south-easterly along the south-western bank of Mile Creek to its intersection with the northern side of Heatherton-road; thence westerly along the northern side of Heatherton-road to its intersection with the western side of Jasper-street; thence southerly across Heatherton-road to a point being the intersection of the southern side of Heatherton-road and the western side of Ian-street; thence southerly along the western side of Ian-street to the point of commencement.

Sewerage Area No. 2—Noble Park.

Commencing at a point being the intersection of the north-eastern side of Mons-parade and the south-eastern side of Pau-street; thence north-easterly along the south-eastern side of Pau-street to its intersection with the south-western bank of Mile Creek; thence south-easterly

along the south-western bank of Mile Creek to its intersection with the north-western side of Callaghan-street; thence south-westerly along the north-western side of Callaghan-street to its intersection with the north-eastern side of Mons-parade; thence north-westerly along the north-eastern side of Mons-parade to the point of commencement.

Sewerage Area No. 3—Noble Park.

Commencing at a point being the intersection of the northern side of Noble-street and the eastern side of Buckley-street; thence westerly across Buckley-street and along the northern side of Noble-street to its intersection with the eastern side of Allan-street; thence northerly along the eastern side of Allan-street and the northerly production of the eastern side of Allan-street to its intersection with the northern side of Joy-parade; thence westerly along the northern side of Joy-parade to its intersection with the eastern side of Corrigan-road; thence northerly along the eastern side of Corrigan-road to a point distant 600 feet north or thereabouts from the intersection of the northern side of Heatherton-road and the eastern side of Corrigan-road; thence easterly by a line parallel to Heatherton-road to a point on the south-eastern side of James-street; thence north-easterly along the south-eastern side of James-street to its intersection with the south-western side of Lightwood-road; thence south-easterly along the south-western side of Lightwood-road to its intersection with the northern side of Heatherton-road; thence southerly across Heatherton-road to a point being the intersection of the southern side of Heatherton-road and the south-western side of Douglas-street; thence south-easterly along the south-western side of Douglas-street to a point on the south-western side of Douglas-street distant 290 feet south-east or thereabouts from the intersection of the south-western side of Douglas-street and the eastern side of Leonard-avenue; thence southerly by a line parallel to Leonard-avenue a distance of 170 feet or thereabouts; thence westerly by a line parallel to Noble-street to a point on the western side of Leonard-avenue; thence southerly along the western side of Leonard-avenue to a point distant 500 feet south or thereabouts from the southern side of Noble-street; thence westerly by a line parallel to Noble-street to a point on the eastern side of Buckley-street; thence northerly along the eastern side of Buckley-street to the point of commencement.

Sewerage Area No. 4—Noble Park.

Commencing at a point being the south-western angle of lot 12 on lodged plan No. 11206; thence northerly along the eastern side of Arnold-street to the north-western angle of lot 9 on the said lodged plan; thence easterly along the northern boundary of the said lot 9 to its north-eastern angle; thence southerly along the eastern boundaries of the said lot 9 and lots 10, 11 and 12 on the said lodged plan to the south-eastern angle of the said lot 12; thence westerly along the southern boundary of the said lot 12 to the point of commencement.

Sewerage Area No. 5—Springvale.

Commencing at a point being the intersection of the western side of Kelvin-grove and the north-eastern side of Sandown-road west; thence north-westerly along the north-eastern side of Sandown-road west to its intersection with the eastern side of Springvale-road; thence northerly along the eastern side of Springvale-road to a point being the intersection of the eastern side of Springvale-road and the easterly prolongation of the northern side of Boulton-street; thence westerly across Springvale-road and along the northern side of Boulton-street to its intersection with the eastern side of Parsons-avenue; thence northerly along the eastern side of Parsons-avenue to its intersection with the southern side of Watt-street; thence easterly along the southern side of Watt-street to its intersection with the southerly prolongation of the eastern side of Bessemer-street; thence northerly across Watt-street and along the eastern side of Bessemer-street to its intersection with the southern side of Trevethic-road; thence easterly along the southern side of Trevethic-road to its intersection with the western side of Springvale-road; thence southerly along the western side of Springvale-road to its intersection with the westerly prolongation of the northern side of Rosalie-street; thence easterly across Springvale-road and along the northern side of Rosalie-street to its intersection with the northerly prolongation of the western side of Wales-street; thence southerly across Rosalie-street and along the western side of Wales-street to its intersection with the northern side of Virginia-street; thence westerly along the northern side of Virginia-street to its intersection with the eastern side of Prince-street; thence southerly along the southerly prolongation of the eastern side of Prince-street a distance

of 150 feet or thereabouts; thence westerly by a line parallel to Virginia-street to a point on the western side of Kelvin-grove; thence southerly along the western side of Kelvin-grove to the point of commencement.

For the purposes of the description the streets herein described shall be taken as those similarly designated on the official plans of the Springvale and Noble Park Sewerage Authority.

By order of the Springvale and Noble Park Sewerage Authority.

6947 ANDREW A. ERICKSEN, Chairman.
HOLMAN L. WILLIAMS, Secretary.

LANCEFIELD WATERWORKS TRUST.

EIGHTH SCHEDULE.

Notice to the Owners of Tenements in Baynton-road West of Park-street to the Boundary of the Trusts Water Area at the Mill Corner, a Distance of 29 Chains, and Private Streets, Lanes, and Alleys Opening Thereto.

THE main pipe in the said road being laid down, the owners of all tenements situated as above, are hereby required on or before the 1st day of October, 1959, to cause a proper pipe and stock cocks to be laid, so as to supply water within such tenements from the main pipe.

6977 OWEN MALONE, Secretary.

NOTICE is hereby given that Charlesworth Rubber Proprietary Limited has applied for a lease under section 134 of the *Land Act* 1958, for a term of 25 years from 6th November, 1959, of allotment 13, section 59, City of Port Melbourne, Parish of Melbourne South, containing 1 acre and 17 perches, as a site for latex and hardware manufacture.

6917

NOTICE OF INTENTION TO APPLY FOR A LICENCE TO DIVERT WATER AND CUT RACE FROM THE LODDON RIVER, AT EDDINGTON.

I HEREBY give notice that I intend to apply for a licence empowering me to divert water for a term of fifteen years to the extent of 30 acre-feet per annum at a maximum rate of 6 acre-feet per day of 24 hours for the irrigation of 15 acres, being part of allotments 1, 3-12 and 2-7, 22-31, sections 1 and 2 respectively, Parish of Eddington, and to occupy certain Crown lands for works of diversion, and to cut a race thereon.

Any objection to such application must be forwarded, in writing, to reach the State Rivers and Water Supply Commission, Melbourne, before 26th September, 1959, being 30 days from the first publication of this notice.

JOYCE MARY TAYLOR.
Eddington. 6919

NOTICE OF INTENTION TO APPLY FOR A LICENCE TO DIVERT WATER AND CUT RACE FROM THE TULLAROOP CREEK, NEAR EDDINGTON.

WE hereby give notice that we intend to apply for a licence empowering us to divert water for a term of fifteen years to the extent of 80 acre-feet per annum at a maximum rate of 8 acre-feet per day of 24 hours for the irrigation of up to 700 acres of land, being part of allotments 13c, 15A1, 15A2, 15A3, 15B, 16A and 16B, section 1, Parish of Eddington, and to occupy certain Crown lands for works of diversion, and to cut a race thereon.

Any objection to such application must be forwarded in writing to reach the State Rivers and Water Supply Commission, Melbourne, before 7th October, 1959, being 30 days from the first publication of this notice.

THE FIDELITY TRUSTEE CO. LTD.,
executor of Charles Michael Mullins, deceased.
101 Lydiard-street north, Ballarat. 6929

NOTICE OF INTENTION TO APPLY FOR A LICENCE TO DIVERT WATER AND CUT RACE FROM THE TUTCHEWOP OUTFALL CHANNEL, AT WINLATON.

I HEREBY give notice that I intend to apply for a licence empowering me to divert water for a term of fifteen years to the extent of 80 acre-feet per annum at a maximum rate of 5 acre-feet per day of 24 hours for the irrigation of 40 acres, being part of allotments 24B, 24c, 24d, 24E, 24F and 25, section 1, Parish of Benjeroop, for works of diversion, and to cut a race thereon.

Any objection to such application must be forwarded, in writing, to the State Rivers and Water Supply Commission, Melbourne, within 30 days of the date hereof.

GEORGE HEPBURN.
Private Bag, Tresco. 6942

NOTICE OF INTENTION TO APPLY FOR A LICENCE TO DIVERT WATER FROM THE THOMSON RIVER, AT HEYFIELD.

I HEREBY give notice that I intend to apply for a licence empowering me to divert water for a term of fifteen years to the extent of 36 acre-feet per annum at a maximum rate of 3 acre-feet per day of 24 hours for irrigation of 18 acres, being part of allotment 2A1, Parish of Glenmaggie.

Any objection to such application must be forwarded, in writing, to reach the State Rivers and Water Supply Commission, Melbourne, before 14th September, 1959, being 30 days from the first publication of this notice.

ROBERT WILLIAM STONLEY CHESTER.
Heyfield. 6945

NOTICE is hereby given that the partnership heretofore subsisting between the undersigned Edward Marsham Hughes, John Oswald Baker, and John Henry McMullen, carrying on business as motor mechanics at 232 Malop-street, Geelong, under the firm name of Malop Motors, has been dissolved by mutual consent as from the 22nd day of July, 1959. All debts owing to and by the partnership will be received and paid by the said Edward Marsham Hughes, John Oswald Baker, and Harold Henry Joseph Allen, who will continue to carry on the said business in partnership under the firm name of Malop Motors.

Dated this 26th day of August, 1959.

EDWARD M. HUGHES.
J. O. BAKER.
J. H. MCMULLEN.
H. J. ALLEN.

Harwood and Pincott, solicitors, 77 Moorabool-street, Geelong. 6928

NOTICE is hereby given that the partnership heretofore subsisting between Norman George Hollingworth and William Allen Street, carrying on business as farmers at Koondrook, under the style or firm of "Hollingworth and Street", has been dissolved by mutual consent as from the 1st day of August, 1959, and all debts due to and owing by the said firm will be received and paid respectively by William Allen Street, who will continue to carry on the said business.

Dated the 1st day of August, 1959.

N. G. HOLLINGWORTH.
W. A. STREET.

Francis Lynch, solicitor, 54 Wellington-street, Kerang. 6920

NOTICE is hereby given that the partnership heretofore subsisting between the undersigned, Claude Victor Newton, Hazel Amelia Rose Burge and Ivy Winifred Newton, carrying on business at 322 Moray-street, South Melbourne, under the name of Burton Service Co. has been dissolved by mutual consent, as from the 30th day of June, 1959. All debts due to and owing by the said late firm will be received and paid by Hazel Amelia Rose Burge, and Ivy Winifred Newton, who will continue to carry on the business at 6 Union-street, South Melbourne.

Dated at Melbourne the 20th day of August, 1959.

C. V. NEWTON.
HAZEL BURGE.
IVY W. NEWTON.

Henderson and Ball, solicitors, 430 Little Collins-street, Melbourne. 6978

NOTICE is hereby given that the partnership heretofore subsisting between Alan Richard Turner Greenwood, Frank Rowland Johnson and Alton Stanley Jackson, as dental practitioners at T. & G. Buildings, corner of Collins and Russell streets, Melbourne, under the firm name of Greenwood, Johnson & Jackson, has been dissolved as from the 8th day of June, 1959. Dr. A. R. T. Greenwood is continuing practice at T. & G. Buildings, corner of Collins and Russell streets, Melbourne, Mr. F. R. Johnson is continuing practice at T. & G. Buildings, corner of Collins and Russell streets, Melbourne. Dr. A. S. Jackson is practising at 110 Collins-street, Melbourne.

Dated this 27th day of August, 1959.

ALAN R. T. GREENWOOD.
F. R. JOHNSON.
ALTON S. JACKSON.

6983

The *Companies Act 1958*.—In the matter of SELOTTA SHOES PROPRIETARY LIMITED (in Voluntary Liquidation).

NOTICE is hereby given that a First Dividend is intended to be declared in this matter and that creditors who have not lodged proof of debt by 24th September, 1959, will be excluded from the benefit of such distribution.

K. C. KEOWN, Liquidator.

Dated this 28th day of August, 1959.

Fuller, King and Co., 83 William-street, Melbourne, C.1.
6966

In the matter of J. W. CLIFFORD PTY. LTD. (in Liquidation).

BY Order of the Court dated 26th August, 1959, Guy Newton Moore, the liquidator of the said company, was granted his release as such liquidator.

GUY N. MOORE, Liquidator.

108 Queen-street, Melbourne. 6963

THE AMATEUR RACE CLUBS PROPRIETARY LIMITED.

NOTICE CONVENING FINAL MEETING, PURSUANT TO SECTION 210.

NOTICE is hereby given, in pursuance of section 210 of the *Companies Act 1958*, that a General Meeting of the members of the above-named company will be held at 418 St. Kilda-road, Melbourne, on Wednesday, the 30th day of September, 1959, at 4 p.m. o'clock in the afternoon, for the purpose of having an account laid before them showing the manner in which the winding up has been conducted and the property of the company disposed of, and of hearing any explanation that may be given by the liquidator.

6964

H. R. WAY, Liquidator.

FORBCO INDUSTRIES PTY. LTD. (IN LIQUIDATION).

NOTICE is hereby given in pursuance of section 236 of the *Companies Act 1958*, that a General Meeting of the members of the above-named company will be held at the office of Kennedy and Courtney, 353 Lonsdale-street, Melbourne, on the 16th day of September, 1959, at 10.30 a.m. in the forenoon, for the purpose of receiving the liquidator's account showing how the winding up has been conducted and the company's property disposed of, also to pass an extraordinary resolution to determine the method of disposing the books, accounts and documents of the company.

Dated this 26th day of August, 1959.

6982

J. J. COURTNEY, Liquidator.

The *Companies Act 1958*.—In the matter of PARKSIDE SHOE COMPANY PROPRIETARY LIMITED (in Voluntary Liquidation).—NOTICE OF FINAL MEETING.

NOTICE is hereby given that pursuant to section 236 of the *Companies Act 1958* a General Meeting of the members of the above-named company will be held at the offices of Fuller, King and Co., at 83 William-street, Melbourne, on Thursday, 1st October, 1959, at 4.30 p.m. in the afternoon, for the purpose of having an account laid before them, showing the manner in which the winding up has been conducted and the property of the company disposed of, and of hearing any explanation that may be given by the liquidator.

Dated this 25th day of August, 1959.

6972

K. C. KEOWN, Liquidator.

Companies Act 1958.

JARMAN FURNISHING COMPANY PROPRIETARY LIMITED.

AT an Extraordinary General Meeting of the above-named company duly convened and held at 11 Turner-street, Pascoe Vale, on the 24th day of August, 1959, the following Special Resolution was duly passed:—

"That the company be wound up voluntarily".

Dated this 24th day of August, 1959.

6971

A. W. JARMAN, Secretary.

The Companies Act 1958.

WYTEX PROPRIETARY LIMITED (IN LIQUIDATION).

NOTICE is hereby given in pursuance of section 210 of the *Companies Act 1958*, that a General Meeting of members of the company will be held at the office of the liquidator on 28th September, 1959, at 12 noon, for the purpose of having an account laid before them. Creditors

were advised by circular of 14th September, 1955, that Crown claims would absorb all proceeds above expenses and apart from Taxation Office there would be no distributions to creditors, therefore, there will be no return to shareholders.

J. WALLACE ROSS, Liquidator.

105 Queen-street, Melbourne.

6969

Companies Act 1958.

PREMIER MOTORS PROPRIETARY LIMITED.

AT a General Meeting of the members of Premier Motors Proprietary Limited, duly held at 50 Market-street, Melbourne, on the 27th August, 1959, the following Special Resolution was duly passed:—

That the company be wound up voluntarily by its members.

Dated 27th August, 1959.

W. R. GRAY, Liquidator.

Care of The Fidelity Trustee Company Limited, 50 Market-street, Melbourne. 6967

The *Companies Act 1958*.—In the matter of FOOTSCRAY ICE WORKS PTY. LTD.—NOTICE OF FINAL MEETING.

NOTICE is hereby given that, pursuant to section 210 of the *Companies Act 1958*, a General Meeting of the members of the above-named company will be held at 211 Geelong-road, West Footscray, on Wednesday, the seventh day of October, 1959, at 9.30 o'clock in the forenoon, for the purpose of having an account laid before them showing the manner in which the winding-up has been conducted and the property of the company disposed of, and of hearing any explanation that may be given by the liquidator.

Dated the 22nd day of August, 1959.

6924

W. P. LEE, Liquidator.

Companies Act 1958.

ST. KILDA TAXI TRUCK SERVICE PTY. LTD. (IN LIQUIDATION).

NOTICE is hereby given that a General Meeting of members of the above-named company, pursuant to section 210 of the *Companies Act 1958*, will be held at the office of the liquidators, Suite 10, 545 St. Kilda-road, Melbourne, on Monday, 5th October, 1959, at 9.30 a.m., for the purpose of having an account laid before it showing how the property of the company has been disposed of and how the winding-up of the company has been conducted.

Dated this 26th day of August, 1959.

6916

M. B. GREEN, Liquidator.

B. STERNFELD, Liquidator.

CREDITORS, next of kin, and others having claims in respect of the estate of Elizabeth Mabel Brownlie, late of 16 Epsom-road, Ascot Vale, in the State of Victoria, widow, deceased (who died on the 25th day of February, 1959), are to send particulars of their claims to the executor, Francis Alexander Murphy, care of the under-mentioned solicitor, on or before the 6th day of November, 1959, after which date the said executor will distribute the assets, having regard only to the claims of which he then has notice.

VALDA J. WRAITH, LL.B., solicitor, 1 Tibrockney-street, Highett. 6981

CREDITORS, next of kin, and others having claims against the estate of William George Lees, formerly of Spencer-street, Ballarat East, in the State of Victoria, but late of 16 East-street, Ballarat, in the said State, pensioner, deceased (who died on the 7th day of August, 1959), are to send particulars of their claims to the executor, The Fidelity Trustee Company Limited, of 101 Lydiard-street north, Ballarat, in the said State, by the 8th day of November, 1959, after which date it will distribute the assets, having regard only to the claims of which it then has notice. 6922

CREDITORS, next of kin, and others having claims against the estate of Amy Aileen Noack, late of Buninyong, in the State of Victoria, married woman, deceased (who died on the 5th day of June, 1959), are to send particulars of their claims to the executor, The Fidelity Trustee Company Limited, of 101 Lydiard-street north, Ballarat, in the said State by the 8th day of November, 1959, after which date it will distribute the assets, having regard only to the claims of which it then has notice. 6921

CHARLOTTE FANNY AMELIA McMINN, late of 40 Canberra-road, Toorak, widow, DECEASED.

CREDITORS, next of kin, and others having claims in respect of the estate of the deceased (who died on the 27th March, 1959), are required by the executor, Keith Hercules, of 443 Little Collins-street, Melbourne, solicitor, to send particulars to him, by the 12th day of November, 1959, after which date the executor may convey or distribute the assets, having regard only to the claims of which he then has notice.

KEITH HERCULES, LL.B., solicitor, of 443 Little Collins-street, Melbourne. 6980

CHARLES KEITH HARRISON, late of "Spindrift", Bembridge-avenue, Frankston, gentleman, DECEASED.

CREDITORS, next of kin, and others having claims in respect of the estate of the deceased (who died on 15th June, 1959), are required by the executor, Lloyd Pym Goode, of the address below, to send particulars to him, by the 3rd November, 1959, after which date he may convey or distribute the assets, having regard only to the claims of which he then has notice.

LLOYD P. GOODE & CO., solicitors, 475 Bourke-street, Melbourne. 6974

WALTER ALBERT WARREN, late of 222 Stanley-street, West Melbourne, retired, DECEASED (who died on the 13th day of July, 1959).

CREDITORS, next of kin, and all other persons having claims against the estate of the deceased, are required by the executor of his will, Arthur Frederick Parker, of Warrandyte, minister of religion, to send particulars thereof to him, care of the under-mentioned solicitors, on or before the 11th day of November, 1959, after which date he may proceed to distribute the assets of the deceased, having regard only to the claims of which he then has notice.

COLTMAN, WYATT & ANDERSON, solicitors, 578 Bourke-street, Melbourne. 6955

CREDITORS, next of kin, and others having claims against the estate of James David Elder, late of Auckland, New Zealand, clerk, deceased (who died on 9th March, 1957), are to send particulars of their claims to The Union Trustee Company of Australia Limited, the registered office of which is situate at 333 Collins-street, Melbourne, in the State of Victoria, by the 4th November, 1959, after which date it will distribute the assets, having regard only to the claims of which it then has notice.

BLAKE & RIGGALL, solicitors, 120 William-street, Melbourne. 6958

CREDITORS, next of kin, and others having claims in respect of the estate of Ellen Jane Stammers, late of Traralgon, in the State of Victoria, widow, deceased (who died on the 29th day of March, 1959, and probate of whose will was granted by the Supreme Court of Victoria on the 21st day of August, 1959, to Louis Grosvenor Hay Bell, of Traralgon, in the said State, agent, George Angus Downie, of Traralgon aforesaid, railway employee, and Thomas Geoffrey Littleton, of Traralgon aforesaid, solicitor, the executors named in said will), are to send particulars of their claims to the said executors, care of the below-mentioned solicitors, by the 14th day of November, 1959, after which date they will distribute the assets of the said deceased, having regard only to the claims of which they then have notice.

Dated this 24th day of August, 1959.

BRUCE & LITTLETON, of Traralgon, solicitors to the said executors. 6957

PURSUANT to the *Trustee Act 1928*, all persons having claims against the property or estate of William Campbell, late of South Melbourne, public servant, deceased (who died on the 14th June, 1888, and letters of administration of whose will and unadministered estate were granted by the Supreme Court of Victoria on the 30th day of July, 1959, to Reuben Stanley Thompson, formerly of 11 St. Georges-road, Elsternwick, but now of 3 St. Georges-road, Elsternwick, valuer), are hereby required to send particulars of such claims to the said administrator, addressed to the care of Messrs. Hodgson and Finlayson, solicitors, 360 Collins-street, Melbourne, on or before the 18th day of November, 1959, after the expiration of which time the said administrator will proceed to distribute the assets of the said deceased amongst the persons entitled thereto, having regard only to the claims of which he shall have had notice.

Dated the 31st day of August, 1959.

HODGSON & FINLAYSON, 360 Collins-street, Melbourne, solicitors for the administrator. 6968

CREDITORS, next of kin, and others having claims in respect of the estate of Charles William John Patterson, late of 37 Balwyn-road, Canterbury, superintendent, deceased (who died on 25th March, 1959), are to send particulars of their claims to The Equity Trustees, Executors and Agency Company Limited, of 472 Bourke-street, Melbourne, by 7th November, 1959, after which date it will distribute the assets, having regard only to the claims of which it then has notice.

R. C. H. BEATTIE, solicitor, 422 Little Collins-street, Melbourne. 6954

CHARLES THOMAS STRONG, late of 458 Victoria-parade, East Melbourne, retired accountant, DECEASED.

CREDITORS, next of kin, and others having claims in respect of the estate of the deceased (who died on or about the 15th day of May, 1959), are required by The Trustees, Executors and Agency Company Limited, of 401 Collins-street, Melbourne, and Edward Joseph Lever, of 4 Kendall-street, Elwood, secretary, the executors of the will of the deceased, who have applied for a grant of probate thereof, to send particulars to them at the address of the said company by the 5th day of November, 1959, after which date the said executors may convey or distribute the assets, having regard only to the claims of which they then have notice.

Dated the 25th day of August, 1959.

J. M. SMITH & EMMERTON, 480 Bourke-street, Melbourne, solicitors for the executors. 6949

EUGENE GALLIGAN, late of Kepler-street, Warrnambool, Catholic priest, DECEASED.

CREDITORS, next of kin, and others having claims in respect of the estate of the above-named deceased (who died on the 28th day of January, 1959), are required to send particulars of their claims to William McCunnie, of Sturt-street, Ballarat, Catholic priest, the executor of the will of the said deceased, care of Desmond Dunne and Dwyer, solicitors, 95 Kepler-street, Warrnambool, on or before the 2nd day of November, 1959, after which date he will distribute the assets, having regard only to the claims of which he has notice.

DESMOND DUNNE & DWYER, solicitors, 95 Kepler-street, Warrnambool. 6946

STANLEY WILLIAM TOURNIER, late of Sydenham-avenue, Geelong West, labourer, DECEASED.

CREDITORS, next of kin, and others having claims in respect of the estate of the deceased (who died on the 26th day of February, 1959), are required by the personal representatives, Esther Elizabeth Tournier, of Sydenham-avenue, Geelong West, widow, and Neil Lindsay Davidson, of Malop-street, Geelong, solicitor, to send particulars to them, care of the under-mentioned solicitors, by the 4th day of November, after which date the personal representatives may convey or distribute the assets, having regard only to the claims of which they then have notice.

WHYTE, JUST & MOORE, solicitors, 27 Malop-street, Geelong. 6938

RAMON ALFRED BROOK, late of 15 Laurie-street, Newport, in the State of Victoria, garage proprietor, DECEASED.

CREDITORS, next of kin, and all other persons having claims against the estate of the above-named deceased, are required by Allan Raymond Brook, of 15 Laurie-street, Newport, in the said State, garage employee, to send particulars of such claims to him, care of the undersigned, on or before 2nd November, 1959, after which date he will distribute the assets, having regard only to the claims of which he has then had notice.

JONES & KENNEDY, solicitors, 213 Nicholson-street, Footscray. 6975

THE NATIONAL TRUSTEES, EXECUTORS AND AGENCY COMPANY OF AUSTRALASIA LIMITED, of 95 Queen-street, Melbourne, in the State of Victoria, the executor of the will of Ada Caroline Hill, late of Eva-street, Clayton, widow, deceased (who died on the 28th day of December, 1959), require all creditors, next of kin, and others having claims against the property or estate of the said deceased, to send to the said executor, on or before the 11th day of November, 1959, particulars, in writing, of such claims after which date the said executor intends to convey or distribute such property or estate to or among the persons entitled thereto, having regard only to the claims of which they shall have had notice.

FREDERICK W. COX & SON, solicitors, 452 Lonsdale-street, Melbourne. 6976

ELEANOR ELIZA FOWLER, late of DeCarle-street, Coburg, married woman, DECEASED, intestate.

CREDITORS, next of kin, and others having claims in respect of the estate of the deceased (who died on the 20th day of February, 1912), are required by Ruby Lucinda Nicholls, of 36 Willow-grove, Coburg, married woman, the applicant for a grant of administration *de bonis non*, to send particulars by addressing the same to her, care of the office of Dall and Allaway, 89 Queen-street, Melbourne, solicitors, by the 3rd day of November, 1959, after which date the said Ruby Lucinda Nicholls may convey or distribute the assets, having regard only to the claims of which she then has notice.

Dated this 2nd day of September, 1959.

DALL & ALLAWAY, 89 Queen-street, Melbourne, solicitors for the applicant. 6925

ALFRED POPPLE, late of Seymour, farmer, DECEASED.

CREDITORS, next of kin, and other having claims in respect of the estate of the deceased (who died on the 13th day of May, 1959), are required by the executors, Jane Popple, Lawrence Milne Parker and Harold Thomas Popple, to send particulars to the undersigned solicitors by the 17th day of November, 1959, after which date the executors may convey or distribute the assets, having regard only to the claims of which they then have had notice.

WILFRID J. OSBORNE & OSBORNE, solicitors, Seymour. 6926

CREDITORS, next of kin, and others having claims in respect of the estate of Philip Cohen, late of 603 Dandenong-road, Malvern, retired police magistrate, deceased (who died on the 13th day of December, 1958), are requested to send particulars of their claims to the executor, Dr. Basil Walter Cohen, of 8 Webb-street, Brighton, care of the undermentioned solicitor, by the 15th day of November, 1959, after which date the executor will distribute the assets, having regard only to the claims of which he has notice.

KENNETH J. CLEMENTS, solicitor, 29 Glenhuntly-road, Elsternwick. 6943

ALL persons having claims against the estate of Rupert Glendon Weeks, late of 4 Holroyd-court, East St. Kilda, in the State of Victoria, gentleman, deceased (who died on the 30th day of April, 1959, the application for probate of his will dated 25th day of September, 1957, having been approved), are hereby required to send particulars of such claims to The Trustees, Executors and Agency Company Limited, at its office at 401 Collins-street, Melbourne, on or before the 6th day of November, 1959, after which date the said company may convey or distribute the assets, having regard only to the claims of which it shall have then had notice.

MALLESON, STEWART & CO., solicitors, 105 King-street, Melbourne. 6970

ALL persons having claims against the estate of Emma Toutcher, late of "The Wattles", Barkly-avenue, Mornington, widow (who died on the 5th day of April, 1959, and probate of whose will has been applied for by The Fidelity Trustee Company Limited, of 101 Lydiard-street north, Ballarat), are hereby required to send particulars, in writing, of such claims to that company, at its Melbourne office, 50 Market-street, Melbourne, by the 4th day of October, 1959, after which date the said company may proceed to distribute the assets of the said Emma Toutcher, deceased, having regard only to the claims of which it shall then have had notice.

Dated this 27th day of August, 1959.

G. B. FROST & HUNT, solicitors, 10 Main-street, Mornington. 6944

GEORGE CROMBIE DICKSON, late of 6 Labert-crescent, Armadale, director, DECEASED.

CREDITORS, next of kin, and others having claims in respect of the estate of the deceased (who died on the 15th July, 1955), are required by the personal representatives, Thomas Edgar Inglis, of 399 Little Collins-street, Melbourne, manager, Stanley George Young, of 55 William-street, Melbourne, accountant, and Hector Morris Pemberton, of Terrace-road, Vermont, engineer, to send particulars to them by the 6th December, 1959, after which date the personal representatives may convey or distribute the assets, having regard only to the claims of which they then have notice.

Dated the 28th August, 1959.

NORRIS, COATES & HEARLE, solicitors, 422 Collins-street, Melbourne. 6965

CREDITORS, next of kin, and others having claims in respect of the estate of Auburn Marfleet, late of Ararat, grazier, deceased (who died on the 3rd day of March, 1959), are to send particulars of their claims to the executor, The Fidelity Trustee Company Limited, of 101 Lydiard-street north, Ballarat, by the 10th day of November, 1959, after which date it will distribute the assets, having regard only to the claims of which it then has notice.

BRIGGS & O'DRISCOLL, solicitors, Ararat. 6941

FREDERICK WILLIAM CRAIG, late of Ferny Creek, confectioner, DECEASED.

CREDITORS, next of kin, and others having claims in respect of the estate of the deceased (who died on the 27th March, 1955), are required by the executors, Thelma Jean Hedley, of Ferny Creek, housewife, and Keith Hercules, of 443 Little Collins-street, Melbourne, solicitor, to send particulars to them, care of Keith Hercules, of 443 Little Collins-street, Melbourne, by the 12th day of November, 1959, after which date the executors may convey or distribute the assets, having regard only to the claims of which they then have notice.

KEITH HERCULES, LL.B., solicitor, 443 Little Collins-street, Melbourne. 6979

CREDITORS, next of kin, and others having claims in respect of the estate of George Henry Worrall, late of 15 Shafton-avenue, Huntingdale, in the State of Victoria, truck driver, deceased (who died on the 14th day of June, 1959), are required by the executrix, Dorothy Elsie Worrall, of 15 Shafton-avenue, Huntingdale, in the said State, widow, to send particulars of their claims to her, care of Rogers and Gaylard, solicitors, of 281 Collins-street, Melbourne, by the 11th day of November, 1959, after which date the said executrix will distribute the assets of the deceased, having regard only to the claims of which she then shall have had notice.

ROGERS & GAYLARD, solicitors, 281 Collins-street, Melbourne. 6959

CREDITORS, next of kin, and others having claims in respect of the estate of Eileen Bina Weymouth, late of 2 Burston-place, Brighton, in the State of Victoria, married woman, deceased (who died on the 28th day of October, 1958), are required by her Executor, William George Weymouth, of 2 Burston-place, Brighton, aforesaid builder, to send particulars of their claims to him, care of Rogers and Gaylard, solicitors, of 281 Collins-street, Melbourne, by the 11th day of November, 1959, after which date the said executor will distribute the assets of the deceased, having regard only to the claims of which he then shall have had notice.

ROGERS & GAYLARD, solicitors, 281 Collins-street, Melbourne. 6960

CREDITORS, next of kin, and others having claims in respect of the estate of Angus Oswald Hugo, formerly of Stratford, bank officer, but late of Eastbourne, Wellington, in the Dominion of New Zealand, retired, deceased (who died on or about the 21st October, 1958), are to send particulars of their claims to The Union Trustee Company of Australia Limited, of 333 Collins-street, Melbourne, the duly constituted Attorney of Elizabeth Cecilia Beatson Hugo, of Eastbourne, Wellington, in the said Dominion, widow, and The Guardian Trust and Executors Company of New Zealand Limited, of Shortland-street, Auckland, in the said Dominion, the executors of the estate of the deceased, by 2nd day of November, 1959, after which date the said The Union Trustee Company of Australia Limited will distribute the assets, having regard only to the claims of which it then has notice.

FREDERICK OWEN & ASSOCIATES, solicitors, 84 William-street, Melbourne. 6961

CHRISTINA SCOTT, formerly of 30 Forrest-street, Sunshine, but late of Leighton Private Hospital, Bulleen, in the State of Victoria, widow, DECEASED.

CREDITORS, next of kin, and others having claims in respect of the estate of the deceased (who died on the 2nd day of June, 1959), are required by the personal representative, Stanley Henry Burridge, of 33 Fortuna-avenue, North Balwyn, in the said State, missioner, to send particulars to him by the 5th day of November, 1959, after which date the personal representative may convey or distribute the assets, having regard only to the claims of which he then has notice.

Dated the 1st day of September, 1959.

RIGBY & FIELDING, solicitors, 90 William-street, Melbourne. 6962

In the Supreme Court of the State of Victoria.

SALE BY THE SHERIFF.

ON Friday, the 2nd day of October, 1959, at Eleven o'clock, at the Police Station, 1003 Nepean Highway, Moorabbin (unless process be stayed or satisfied):

All the estate and interest (if any) of Keith Reginald Murray, of Shed H, Victoria Market, Melbourne, storeholder, as proprietor of an estate, in fee-simple, in the land described in certificate of title, volume 8022, folio 173, upon which is erected a single-story weatherboard villa. The land has a frontage of 52 feet, plus splayed corner to east side of Celia-street, by a depth of 149 ft. 1 in., plus splayed corner to the north side of Schulz-street, and is known as lot 57, Celia-street, East Bentleigh.

Registered mortgage No. A495699 affects the said estate and interest.

Terms: Cash only.

DAVID J. JOHNSTON, Sheriff's Officer.

18th August, 1959.

6950

MINING NOTICE

RAVENSTHORPE COPPER MINES NO LIABILITY.

NOTICE is hereby given that a Call (the Fifth) of One shilling per share, on all issued contributing shares in the capital of the company, making such shares paid to Eight shillings each, has been made due and payable to the Secretary, at the Registered Office of the company, 11th Floor, 100 Collins-street, Melbourne, on Wednesday, the 9th day of September, 1959.

By order of the Board.

C. R. PARISH, Deputy Secretary.

11th Floor, 100 Collins-street, Melbourne, C.I. Victoria.

6973

IMPOUNDINGS

OXLEY.—Impounded in Oxley Pound, from Oxley, by Herdsman.

1 bay gelding, white hind feet, white star on forehead, white snip on nose, long tail, no visible brand

If not claimed and expenses paid, to be sold on 17th September, 1959.

6985—12/ M. J. WARREN, Poundkeeper.

TALLANGATTA EAST.—Impounded in Tallangatta East Pound.

1 black steer, shorthorned, about 2 years old, notched ears, no visible brand

1 black steer, polled, about 2 years old, notched ears, no visible brand

If not claimed and expenses paid, to be sold on 11th September, 1959.

6935—15/ THOS. J. KIRK, Poundkeeper.

WARRANTYTE.—Impounded in Warrantyte Pound.

1 ram, no visible brand

If not claimed and expenses paid, to be sold on 20th September, 1959.

6933—9/ J. W. THOMSON, Shire Secretary.

WARRNAMBOOL.—Impounded in Warrnambool Pound.

1 draught bay horse, bald head and two white hind fetlocks, no visible brand

If not claimed and expenses paid, to be sold on 15th September, 1959.

6940—10/6 V. MCKAY, Poundkeeper.

STATE ACTS, 1958.

COPIES of the following Acts of Parliament of Victoria may be obtained at the Government Printing Office, or from any bookseller, at the price set opposite to each:—

No.	Price.
	s. d.
6171. Milk Board (Members)	0 6
6172. Consolidated Revenue	0 6
6173. Footscray (Lawson-street) Land	0 6
6174. Railways (Contracts)	0 6
6175. Game (Destruction)	0 6
6176. Western Metropolitan Market (Amendment)	0 6
6177. Local Government (Portland)	0 6
6178. Melbourne (Flinders-street) Land	0 6
6179. Public Account Advances (Home Builders' Account)	0 6
6180. Snowy Mountains Hydro-electric Agreements	2 6
6181. Gas and Fuel Corporation (Bendigo Undertaking)	1 0
6182. Acts Interpretation	0 6
6183. Railways (Employés)	0 6
6184. Monash University	1 9
6185. University (Council)	0 6
6186. Marriage (Amendment)	0 6
6187. Consolidated Revenue	0 6
6188. to Consolidated Acts 1958.	
6421. Amendments Incorporation	0 6
6422. Police Offences (Trespass to Farms)	0 6
6423. Fern Tree Gully and Gembrook Railway (Reconstruction) Amendment	0 6
6424. Kew and Heidelberg Lands	0 6
6425. Gas and Fuel Corporation (Maryborough Undertaking)	0 6
6426. Local Government (Dandenong)	0 6
6427. Responsible Ministers	0 6
6428. Supreme Court and County Court (Judges)	0 6
6429. Melbourne and Metropolitan Board of Works (Borrowing Powers and Debentures)	0 6
6430. Consolidated Revenue	0 6
6431. Fences (Amendment)	0 6
6432. Contracts of Sale (Payments)	0 6
6433. Metropolitan Fire Brigades (Board)	0 6
6434. Process Servers and Inquiry Agents (Repossessions)	0 6
6435. Housing (Broadmeadows Land)	0 6
6436. Consolidated Revenue	0 6
6437. Instruments (Bills of Sale)	0 6
6438. Churches of Christ, Scientist Incorporation	0 9
6439. Wheat Industry Stabilization	1 0
6440. Dog (Guides for the Blind)	0 6
6441. Monash University (Acquisition of Land)	0 6
6442. Soldier Settlement (Loan)	0 6
6443. Home Finance (Amendment)	0 6
6444. Friendly Societies (Amendment)	0 6
6445. Co-operative Housing Societies (Guarantees)	0 6
6446. Land Tax (Exemptions and Rates)	0 6
6447. River Murray Waters	0 9
6448. Victorian Inland Meat Authority (Advances)	0 6
6449. Stamps (Amendment)	1 3
6450. Superannuation (Amendment)	0 6
6451. Grain Elevators (Amendment)	0 6
6452. Geelong Harbor Trust Lands	1 0
6453. Melbourne Cricket Club (Guarantee)	0 6
6454. Companies	15 0
6455. Local Government (City of Oakleigh)	0 6
6456. Co-operative Housing Societies (Residential Flats)	0 6
6457. Transport Regulation (Fund)	0 6
6458. Railways (Standardization Agreement)	1 0
6459. Water Supply Loan Application	1 3
6460. Co-operative Housing Societies (Insurance)	0 6
6461. Racing (Amendment)	0 6
6462. Motor Car (Third-party Insurance)	0 6
6463. Firearms (Amendment)	0 6
6464. Hawthorn and Kew Railway (Dismantling)	0 6
6465. Juries (Amendment)	0 9
6466. Tourist (Amendment)	0 6
6467. Filled Milk	0 9
6468. St. Kilda and Brighton Electric Street Railway (Dismantling)	0 6
6469. Judges Salaries	0 6
6470. Public Officers Salaries and Allowances	0 6
6471. Ballarat Railway Land	0 6
6472. Game (Licences)	0 6
6473. Geelong Waterworks and Sewerage (Amendment)	0 6
6474. Coal Mine Workers Pensions (Early Retirement)	0 6
6475. Revenue Deficit Funding	0 6
6476. Railway Loan Application	1 3
6477. Administration and Probate (Amendment)	0 9

STATE ACTS, 1958—continued.

No.		Price.
		s. d.
6479.	Local Government Department	0 6
6480.	Police Offences (Gaming)	0 6
6481.	Marine (Amendment)	0 6
6482.	Public Works Loan Application	0 9
6483.	Motor Car (Amendment)	0 6
6484.	Appropriation of Revenue, 1957-58	6 9
6485.	Water (Valuations)	0 6
6486.	Police Regulation (Amendment)	0 6
6487.	State Forests Loan Application	0 6
6488.	Police Offences (Trap Shooting)	0 6
6489.	Sessional Acts Revision	1 3

A. C. BROOKS,
Government Printer.

STATE ACTS, 1959.

COPIES of the following Acts of Parliament of Victoria may be obtained at the Government Printing Office, or from any bookseller, at the price set opposite to each:—

No.		Price.
		s. d.
6490.	Water (Contracts)	0 6
6491.	Property Law (Amendment)	0 6
6492.	Agricultural Education (Amendment)	0 6
6493.	Swan Hill Railway Land	0 6
6494.	Stamps (Amendment)	0 6
6495.	Justices (Amendment)	0 6
6496.	Consolidated Revenue	0 6
6497.	State Electricity Commission (Tourist Areas)	0 6
6498.	Aborigines (Houses)	0 6
6499.	Superannuation (Amendment)	0 6
6500.	Country Roads (Amendment)	0 6
6501.	Bendigo Land	0 6
6502.	University (Honorary Degrees)	0 6
6503.	Melbourne and Metropolitan Board of Works (Reconstitution)	0 9
6504.	Land (Charges)	0 6
6505.	Statute Law Revision	1 0
6506.	Legal Profession Practice (Amendment)	0 6
6507.	Health	0 9
6508.	Fisheries (Amendment)	0 6
6509.	Water (Irrigation Districts)	0 6
6510.	Broadmeadows (Rating on Unimproved Values)	0 6
6511.	Trustee (Amendment)	0 6
6512.	Nurses	0 6
6513.	Hairdressers Registration (Amendment)	0 6
6514.	Labour and Industry (Retail Trading Hours)	0 6
6515.	Milk Board (Amendment)	0 6
6516.	Stock Diseases (Amendment)	0 9
6517.	Hepburn Springs Land	0 9
6518.	Vermin and Noxious Weeds	1 0
6519.	The Constitution Act Amendment (Parliamentary Salaries)	0 9
6520.	Public Works Committee (Amendment)	0 6
6521.	Land (Plantation Areas)	0 6
6522.	National Art Gallery and Cultural Centre (Amendment)	0 6
6523.	Portland Harbor Trust (Amendment)	0 6
6524.	Revocation and Excision of Crown Reservations	1 9
6525.	Tourist (Amendment)	0 6
6526.	Town and Country Planning (Amendment)	0 6
6527.	Vegetation and Vine Diseases (Amendment)	0 6
6528.	Medical	0 9
6529.	Bread Industry	1 0
6530.	Cemeteries	0 9
6531.	Hire-Purchase	2 3
6532.	Motor Car (Amendment)	0 9
6533.	Motor Car (Hours of Driving)	0 6
6534.	Land Settlement	1 9
6535.	Local Government (Amendment)	1 6
6536.	Melbourne and Metropolitan Board of Works (Amendment)	1 3

Table of Acts and Enactments passed, date of operation, &c. 0 6

A. C. BROOKS,
Government Printer.

THE VICTORIA GOVERNMENT GAZETTE is published on WEDNESDAY EVENING in each week, and Notices for insertion will be received by the Government Printer at or before Two p.m. at ordinary rates, and late advertisements between Two p.m. and Five p.m. at double rates on the day preceding the day of publication.

Single copies of the VICTORIA GOVERNMENT GAZETTE are One shilling, posted One shilling and three pence.

No GAZETTES prior to January, 1950, in stock.

***ALL PAYMENTS ARE REQUIRED IN ADVANCE.—Remittances should be made by postal note, money order, or draft in favour of the Government Printer. Advertisements unaccompanied by a remittance sufficient to cover the cost of insertion will be returned unpublished.

SUBSCRIPTIONS.—The subscription, including postage, is £2 15s. per annum, £1 7s. 6d. half-yearly, or 13s. 9d. per quarter, payable in advance.

Subscriptions are required to commence and terminate with a month.

A lesser period than three months cannot be subscribed for.

Subscribers do not receive the Acts of Parliament with the GAZETTE.

ADVERTISEMENTS are charged at the rate of 1s. 6d. per line single column, and 3s. per line double column.

The title (£5 Reward, Dissolution of Partnerships, &c.) forms one or more lines as a heading.

On an average, ten words make a line.

Every signature must likewise be counted as a line.

The final words of a paragraph, though only portion of a line, must be counted as one line.

SIGNATURES (in particular) and proper names must be written very plainly in the text; ONE SIDE ONLY of each slip of paper should be WRITTEN UPON.

ALL COMMUNICATIONS should be addressed to "The Government Printer, Melbourne".

ALL DOCUMENTS illegibly written will be returned unpublished, and where brands occur unprovided for by the ordinary letters of the alphabet, a worded explanatory description must be furnished.

THE "VICTORIA GOVERNMENT GAZETTE".

ATTENTION is invited to the following procedure in relation to the publication of official matter in the Government Gazette:—

1. Matter submitted to the Executive Council.

Matter submitted to the Executive Council which requires gazettal will normally be published in the issue of the following week.

Where urgent gazettal is required, special arrangements should be made with the Gazette Officer.

Publication will be facilitated by the submission of carbon copies for the use of the Gazette Officer.

2. Other matter.

(a) All other matter duly certified by a responsible officer for publication should be lodged with the Gazette Officer not later than half-past Ten a.m. on Tuesday.

(b) Lengthy or involved notices should be forwarded several days before publication.

(c) Proofs, which will be supplied only when specifically requested, or at the direction of the Gazette Officer, should be returned promptly to avoid delay in publication.

(d) No additions or amendments to matter for publication will be accepted by telephone.

AGENTS FOR THE "VICTORIA GOVERNMENT GAZETTE".

THE following have been appointed agents to receive Advertisements and Subscriptions for the Victoria Government Gazette:—

ARMSTRONG'S AGENCY, 143 Queen-street, Melbourne.

ARMSTRONG BROS., Kyneton.

MESSRS. ARNALL & JACKSON, 115 Barkly-street, West Brunswick.

MR. WM. DAVIS, Mildura.

A. J. DIGBY (B. S. and N. W. Cash), Main-street, Bairnsdale.

EDGAR'S NEWS AGENCY, Hargreaves-street, Bendigo.

MESSRS. HENRY FRANKS & CO., Booksellers and Stationers, Market-square, Geelong.

MESSRS. GORDON & GOTCH, News Agents, 511 Little Collins-street, Melbourne; and corner Barrack and Clarence streets, Sydney.

GULLAN'S NEWSAGENCY, 88 Bridge-street, Ballarat.

A. C. HAMPTON, 243 Mitchell-street, Bendigo.

MESSRS. HARSTON, PARTRIDGE, & CO., 455 Little Collins-street, Melbourne.

MR. C. F. LATIMER, News Agent, Casterton.

McARTHUR'S AUTHORIZED NEWSAGENCY, 345 Wyndham-street, Shepparton.

MESSRS. R. H. & W. M. PETTY, News Agent, Wangaratta.

MESSRS. POWELL & DIXON, 89 Firebrace-street, Horsham.

J. PURDIE & CO., 138 Moorabool-street, Geelong.

F. W. RASHLEIGH & SON, Nunn-street, Benalla.

SALE AUTHORIZED NEWSAGENCY, 142 Raymond-street, Sale.

SKINNER'S AUTHORIZED NEWSAGENCY, 49-51 Franklin-street, Traralgon.

MESSRS. SMITH & DUNNON, Hamilton.

THE MERCANTILE EXCHANGE, 380 Collins-street, Melbourne.

TUFF'S SHEPPARTON NEWSAGENCY, 246 Wyndham-street, Shepparton.

C. F. & H. J. VERNON, 162 Bridge-road, Richmond.

VIEW POINT AUTHORIZED NEWSAGENCY, 4 View Point, Bendigo.

E. W. B. WELSH, Hogan-street, Tatura.

A copy of the *Gazette* filed at each place for public reference.

CONTENTS

	PAGE
Acts of Parliament on sale at the Government Printing Office	2694
Appointments	2672
Contracts	2669
Courts	2663
Estates of Deceased Persons	2671
Government Notices	2663
Holiday—Royal Agricultural Show	2663
Impoundings	2694
Lands	2675
Mining	2694
Money Lenders Act 1958—Supplementary List	2668
Notice to Mariners	2672
Orders in Council	2673
Private Advertisements	2686
Proclamations	2661
Public Service Notices	2681
Resignations	2673
State Rivers and Water Supply Commission	2670
Tenders	2679
Transport Regulation Board—Public Hearings	2665
Waterworks Trusts	2671