

[1729]



VICTORIA
GOVERNMENT GAZETTE

Published by Authority

[Registered at the General Post Office, Melbourne, for transmission by post as a newspaper.]

No. 371

TUESDAY, JUNE 1

[1965

SUPPLEMENT NUMBER 5

ADDITIONS TO AND AMENDMENTS

of the

REGISTER OF PROPRIETARY MEDICINES

SUPPLEMENT NUMBER 5.

Health Act 1958.

ADDITIONS TO AND AMENDMENTS OF, THE REGISTER OF PROPRIETARY MEDICINES.

Published in accordance with the provisions of the Health Act 1958, Section 265 (3).

Department of Health,
Melbourne, 18th May, 1965.

KEVIN BRENNAN,
Chief Health Officer.

The following are ADDITIONS to the Register of Proprietary Medicines.

Distinctive Name of Proprietary Medicine.	Social Number.	Date of Registration.	Name and Address of Applicant.	Purposes for which the Medicine may be sold.
Acetophos (Codeine Co. N.H.S.) ..	11080	18.5.65	H. F. Harvey Pty. Ltd., 231 Elizabeth-street, Croydon, N.S.W.	As an analgesic and antipyretic
Achtion 10 mg. ..	10955	18.5.65	W. Angliss and Co. (Aust.) Pty. Ltd., 255 George-street, Sydney, N.S.W.	*For use in the treatment of thrombophlebitis, pulmonary embolism and coronary thrombosis
Achtion 50 mg. ..	10956	18.5.65	W. Angliss and Co. (Aust.) Pty. Ltd., 255 George-street, Sydney, N.S.W.	*For use in the treatment of thrombophlebitis, pulmonary embolism and coronary thrombosis
Alupent Metered Aerosol ..	10927	18.5.65	Boehringer Ingelheim Pty. Ltd., 504 Pacific Highway, St. Leonards, N.S.W.	Treatment by inhalation in bronchial asthma, bronchitis with emphysema, and spastic bronchitis of other aetiology
Alupent Tablets 20 mg. ..	10974	18.5.65	Boehringer Ingelheim Pty. Ltd., 504 Pacific Highway, St. Leonards, N.S.W.	For the symptomatic treatment of bronchial asthma
Ambravein 100 mg. ..	10957	18.5.65	Lepetit (Pharmaceuticals) Pty. Ltd., 65 Queens-road, Melbourne	For intravenous tetracycline therapy
Amical Senega and Ammonia Mixture ..	10953	18.5.65	Allied Master Chemists of Aust. Ltd., 408 Punt-road, South Yarra	For the relief of the coughs of colds and bronchitis
Aminopt Eye Drops ..	10941	18.5.65	Sigma Co. Ltd., 589 Collins-street, Melbourne	For use in the treatment of eye infections due to gram-positive or gram-negative organisms
Antisol	11119	18.5.65	R. D. Toppin and Sons Pty. Ltd., (pro J. Frydman) 326 Racecourse-road, Newmarket	For use as an antiseptic and germicide
Appetrol	10963	18.5.65	E. Griffiths Hughes Pty. Ltd., 699 Warrigal-road, Chadstone	For appetite control
Appetrol S.R.	10982	18.5.65	E. Griffiths Hughes Pty. Ltd., 699 Warrigal-road, Chadstone	For appetite control
Aquacillin 1.5 megs. ..	10938	18.5.65	F. H. Fauting and Co. Ltd., 123 Lonsdale-street, Melbourne	For use in the treatment of diseases due to penicillin sensitive organisms
Aramine Injection	11040	18.5.65	Merck Sharp and Dohme (Australia) Pty. Ltd., 62 Ferndell-street, South Granville, N.S.W.	*As a vasopressor agent to counteract the acute hypotension associated with various types of shock
Asamar Capsules	11035	18.5.65	Dista Products (Australia) Pty. Ltd., 1 Campbell-street, Artarmon, N.S.W.	For the symptomatic relief of bronchospasm in asthma and bronchitis
Ascorbic Acid Flavoured Tablets 50 mg. ..	10975	18.5.65	Knoll Laboratories (Australia) Pty. Ltd., 176 Princes Highway, Arncliffe, N.S.W.	For use in the treatment of vitamin C deficiency
Ascorbic Acid Flavoured Tablets 250 mg. ..	10976	18.5.65	Knoll Laboratories (Australia) Pty. Ltd., 176 Princes Highway, Arncliffe, N.S.W.	For use in the treatment of vitamin C deficiency
Ascotin Tablets	10988	18.5.65	F. H. Fauting and Co. Ltd., 123 Lonsdale-street, Melbourne	For the relief of the pain of influenza, migraine, headache, neuralgia, neuritis, and after teeth extractions. (In lieu of Serial No. 1613 of 20th February, 1962)
Admin Tablets	10989	18.5.65	Knoll Laboratories (Australia) Pty. Ltd., 176 Princes Highway, Arncliffe, N.S.W.	For relief of the spasm of asthma and the discomfort of hay fever and chronic bronchitis
Aspirin and Caffeine Mixture ..	11011	18.5.65	Sanax Pty. Ltd., 223 Bay-road, Sandringham	For the relief of headache and pain and the discomfort of colds
A.R.H. Teething Mixture	10964	18.5.65	A. R. Hibberd, 771 Station-street, Box Hill	For the relief of bouts of teething discomforts in babies
A. R. Tabs	11124	18.5.65	H. W. Woods Pty. Ltd., 10 Clifford-street, Huntingdale ..	For the relief of the pain of rheumatism, arthritis, fibrositis, sciatica, neuritis and lumbago, periodic, joint and muscular pains and the aches and pains of influenza and neuralgia. (In lieu of Serial No. 4987 of 25th October, 1961)
Ascorbic Acid 50 mg.	11104	18.5.65	Marin and Pleasance, (pro A.A. Health Food Pty. Ltd.), 20 Crewe-road, Oakleigh	For use in the treatment of vitamin C deficiencies
Astopen	10973	18.5.65	Union Distributors Pty. Ltd., 384 Punt-road, South Yarra ..	For the relief of asthma spasm
Astopen Forte	11098	18.5.65	Union Distributors Pty. Ltd., 384 Punt-road, South Yarra ..	For the relief of asthma spasm

Banacol Junior Tablets	11109	18.5.65	Martin and Pleasance, (pro Sanitarium Health Food Co.), 164 Burwood-road, Hawthorn	*To help ensure vascular permeability and integrity and in the treatment of vitamin A, C and D deficiency
Banacol Tablets	11108	18.5.65	Martin and Pleasance, (pro Sanitarium Health Food Co.), 164 Burwood-road, Hawthorn	*To help vascular permeability and integrity and in the treatment of vitamins A, C and Bioflavonoid deficiencies
Barrier Cream	10919	18.5.65	F. H. Faulding and Co. Ltd., 123 Lonsdale-street, Melbourne	For use as an emollient and protective cream. (In lieu of Serial No. 1379 of 25th July, 1951)
B-Ease	10936	18.5.65	R. D. Toppin and Sons Pty. Ltd., (pro S. A. Hirsch), 268 Broadway, Reservoir	For relief of the symptoms of asthma, bronchitis and hay fever
Bellarine Medicated Room Spray	11145	18.5.65	Esigen Laboratories Pty. Ltd., 1 Union-street, Brunswick	For the relief of the coughs of colds
Betacel Soluble Injection	10911	18.5.65	Cinco-Allenburys (Aust.) Pty. Ltd., 23 Villiers-street, North Melbourne	For use in the treatment of conditions responsive to corticosteroid therapy
Bicillin-V Oral Suspension	10985	18.5.65	Wyeth Pharmaceuticals Pty. Ltd., Gregory Place, Parramatta, N.S.W.	For infections due to penicillin sensitive organisms
Bilax	10946	18.5.65	Fulford Williams Pty. Ltd., 33 Collego-street, Gladstoneville, N.S.W.	As a laxative. Recommended for relief of biliousness, sick headache and indigestion when due to constipation. (In lieu of Serial No. 545 of 3rd March, 1948)
Bile Beans	11140	18.5.65	C. E. Fulford (Australasia) Ltd., Nielson and Devonshire streets, Sydney, N.S.W.	As a laxative. (In lieu of Serial No. 2341 of 13th May, 1953)
Binecia Tablets	11127	18.5.65	F. H. Faulding and Co. Ltd., 123 Lonsdale-street, Melbourne	*For the relief of indigestion due to gastric hyperacidity and as an adjunctive therapy in the treatment of peptic ulcer. (In lieu of Serial No. 5194 of 13th June, 1956)
Bionycetin Capsules 250 mgm.	11128	18.5.65	George Morgan and Co. Pty. Ltd., 209 Clarence-street, Sydney, N.S.W.	For use in the treatment of infections due to organisms sensitive to chloramphenicol
Bionycetin Ear Drops	11129	18.5.65	George Morgan and Co. Pty. Ltd., 209 Clarence-street, Sydney, N.S.W.	For use in the treatment of eye infections due to organisms sensitive to chloramphenicol
Biomyccetin Ophthalmic Solution	11130	18.5.65	George Morgan and Co. Pty. Ltd., 209 Clarence-street, Sydney, N.S.W.	For use in the treatment of eye infections due to organisms sensitive to chloramphenicol
Biomyccetin Syrup	11131	18.5.65	George Morgan and Co. Pty. Ltd., 209 Clarence-street, Sydney, N.S.W.	For use in the treatment of infections due to organisms sensitive to chloramphenicol
Bonington's Spray 8 Medicated Aerosol	10909	18.5.65	Bonington and Co. Pty. Ltd., 179 Harris-street, Pyrmont, N.S.W.	For the relief of the coughs of colds
B. Flex Tablets	11106	18.5.65	Martin and Pleasance, (pro A.A. Health Foods Pty. Ltd.), 20 Grove-road, Oakleigh	For use in the treatment of vitamin B complex deficiencies
Brietal Sodium 664 Ampoules	11068	18.5.65	Eli Lilly (Aust.) Pty. Ltd., Wharf-road, West Ryde, N.S.W.	A short acting anaesthetic
Burcosol Soluble Compound	10937	18.5.65	Burroughs Wellcome and Co. (Australia) Ltd., Cressy-street, Rosbery, N.S.W.	For the relief of nervous and muscular pain. (In lieu of Serial No. 8715 of 29th June, 1960)
Burney's Cherry Linctus	11138	18.5.65	Sykes' Pharmacies, 523 High-street, Croyton	For relief of irritating cough
Burney's Corn Remover	11139	18.5.65	Sykes' Pharmacies, 523 High-street, Croyton	For the removal of corns
Burney's Cough Mixture	11137	18.5.65	Sykes' Pharmacies, 523 High-street, Croyton	For the relief of the coughs of colds
Butazolidin Ampoules	11039	18.5.65	Gely (Australasia) Pty. Ltd., 178 Pacific Highway, St. Leonards, N.S.W.	*An analgesic, anti-inflammatory and anti-pyretic agent indicated for the treatment of musculoskeletal disorders and gout. (In lieu of Serial No. 6743 of 22nd January, 1958)
Calcium Gluconate Tablets	11103	18.5.65	Martin and Pleasance, (pro A.A. Health Foods Pty. Ltd.), 20 Grove-road, Oakleigh	For use in the treatment of calcium deficiency
Calcium-Sandoz Effervescent Tablets	11097	18.5.65	Sandoz Australia Pty. Ltd., 620 Harris-street, Ultimo, N.S.W.	For use in all calcium deficiency disorders. (In lieu of Serial No. 7058, of 22nd January, 1958)
Capla	11037	18.5.65	E. Griffiths Hughes Pty. Ltd., 56 Buffalo-road, Gladstoneville, N.S.W.	*For use in the treatment of hypertension
Carisoma	11100	18.5.65	E. Griffiths Hughes Pty. Ltd., 56 Buffalo-road, Gladstoneville, N.S.W.	As a muscle relaxant
Ceetamol Tablets	11054	18.5.65	Protea Pharmaceuticals Pty. Ltd., 107 Kent-street, Sydney, N.S.W.	As an analgesic
Cetal	11129	18.5.65	Orapharm Producta, 489 Chapel-street, South Yarra	For use as a pre-operative and pre-injection preparation of skin
Chloramol Capsules 250 mg.	11055	18.5.65	Protea Pharmaceuticals Pty. Ltd., 107 Kent-street, Sydney, N.S.W.	For use in the treatment of infections amenable to oral chloramphenicol therapy
Chlotride	11041	18.5.65	Merck Sharp and Dohme (Australia) Pty. Ltd., 62 Ferndell-street, South Granville, N.S.W.	*As an oral diuretic and anti-hypertensive agent
Codelprone	11042	18.5.65	Merck Sharp and Dohme (Australia) Pty. Ltd., 62 Ferndell-street, South Granville, N.S.W.	*For adrenocortical steroid therapy associated with tension and anxiety
Cogentin Injection	11043	18.5.65	Merck Sharp and Dohme (Australia) Pty. Ltd., 62 Ferndell-street, South Granville, N.S.W.	*For use in the treatment of acute dystonic reactions due to high dosage of phenothiazine tranquilizers and reserpine

* Denotes that product is subject to the labelling provisions of Victorian Food and Drug Standards Regulation No. 74.

REGISTER OF PROPRIETARY MEDICINES—continued.

Distinctive Name of Proprietary Medicine.	Serial Number.	Date of Registration.	Name and Address of Applicant.	Purposes for which the Medicine may be sold.
Cogentin Tablets 0.5 mg.	11044	18.5.65	Merck Sharp and Dohme (Australia) Pty. Ltd., 62 Fernhill-street, South Granville, N.S.W.	*Parkinsonism of idiopathic arteriosclerotic or postencephalitic origin
Cogentin Tablets 2 mg.	11045	18.5.65	Merck Sharp and Dohme (Australia) Pty. Ltd., 62 Fernhill-street, South Granville, N.S.W.	*Parkinsonism of idiopathic arteriosclerotic or postencephalitic origin
Congestaid	10908	18.5.65	Colgate-Palmolive Pty. Ltd., 22 Colgate-avenue, Balmain, N.S.W.	For the relief of the coughs of colds
Coscopin Capsules	11123	18.5.65	Evan's Medical Australia (Pty.) Ltd., 214 Graham-street, Port Melbourne	For the relief of coughs
Cromomyein Suspension	10912	18.5.65	Merck Sharp and Dohme (Australia) Pty. Ltd., 62 Fernhill-street, South Granville, N.S.W.	For the symptomatic relief of diarrhoea
Dal-E Cream (Non-Greasy)	11033	18.5.65	Dal-Vita Products Pty. Ltd., 12 Mount-street, North Sydney, N.S.W.	A topical application for use in the treatment of cuts, wounds, abrasions, itching rashes, external ulcers and burns. (In lieu of Serial No. 9386 of 25th October, 1961)
Daramide Tablets	11046	18.5.65	Merck Sharp and Dohme (Australia) Pty. Ltd., 62 Fernhill-street, South Granville, N.S.W.	*For the treatment of glaucoma and chronic respiratory insufficiency
Decadron Eye/Ear Solution	11048	18.5.65	Merck Sharp and Dohme (Australia) Pty. Ltd., 62 Fernhill-street, South Granville, N.S.W.	For the treatment of inflammatory and allergic conditions or infections of the eye and ear
Decadron Injection	11047	18.5.65	Merck Sharp and Dohme (Australia) Pty. Ltd., 62 Fernhill-street, South Granville, N.S.W.	*For use in the treatment of arthritic, allergic and inflammatory conditions where adrenocortical hormone therapy is required
Decrin	10968	18.5.65	Nicholas Pty. Ltd., 699 Warrigal-road, Chadstone	For relief of headaches, neuralgia, pain of rheumatism, muscular pains, toothache, period pains, the discomfort of colds, influenza and feverish conditions, and as a general sedative
Delph Peak-in Glow Shampoo—Medicated	11142	18.5.65	Adams National Industries (Aust.) Pty. Ltd., 122 Old Pittwater-road, Brookvale, N.S.W.	For the removal of dandruff
Depron	10961	18.5.65	E. Griffiths Hughes Pty. Ltd., 699 Warrigal-road, Chadstone N.S.W.	*For use in the treatment of depression accompanied by tension and agitation or where insomnia is a problem
Diamagna	11080	18.5.65	Wyoth Pharmaceuticals Pty. Ltd., Gregory-place, Parramatta, N.S.W.	A non-antibiotic preparation for relief of simple diarrhoea
Diamox Sustets	10921	18.5.65	Cyanamid D.H.A. Pty. Ltd., Cherry-lane, Brooklyn	*For use as an oral diuretic
Diarrhoea Mixture	11140	18.5.65	Sykes' Pharmacies, 523 High-street, Croxton	For relief of diarrhoea
Diet 90	10929	18.5.65	K. D. Toppin and Sons Pty. Ltd., (pro W. Sharp), 881 Sydney-road, Brunswick	For the temporary reduction of the sensations of hunger
Dijene Tablets	10990	18.5.65	Boots Pure Drug Company (Australia) Pty. Ltd., 33 Stewart-street, Richmond	For the relief of symptoms associated with gastric hyperacidity and dyspepsia
Doloxene Anonules No. 702	11091	18.5.65	Eli Lilly (Australia) Pty. Ltd., Wharf-road, West Ryde, N.S.W.	For use as an analgesic
Doloxene and Amytal Pulvules No. 372	11066	18.5.65	Eli Lilly (Australia) Pty. Ltd., Wharf-road, West Ryde, N.S.W.	As a combined analgesic sedative
Drenison 85 Ointment	11009	18.5.65	Eli Lilly (Australia) Pty. Ltd., Wharf-road, West Ryde, N.S.W.	A cortico-steroid for topical application
Drenison-N Ointment 80	11010	18.5.65	Eli Lilly (Australia) Pty. Ltd., Wharf-road, West Ryde, N.S.W.	A cortico-steroid for topical application where infection is present
Duosan Injections 6 x 1 c.c.	10971	18.5.65	Gamayrod Pty. Ltd., 169 Lygon-street, Carlton	For the relief of indigestion when due to acidity
Durophlet M. Capsules, 12½ mg.	11064	18.5.65	Riker Laboratories Australia Pty. Ltd., 68 Alexander-street, Crows Nest, N.S.W.	As an appetite suppressant
Durophlet M. Capsules 20 mg.	11065	18.5.65	Riker Laboratories Australia Pty. Ltd., 68 Alexander-street, Crows Nest, N.S.W.	As an appetite suppressant
Dux Rx Shampoo—Medicated	11120	18.5.65	Dux Drug Co. Pty. Ltd., 624 Burke-road, Camberwell	For use in the removal of dandruff
Dytac Capsules	10926	18.5.65	Smith, Kline and French Laboratories (Aust.) Ltd., Warringah-road, French's Forest, N.S.W.	*For use in the treatment of oedema associated with congestive heart failure, cirrhosis of the liver, the nephrotic syndrome; also in idiopathic and drug induced oedema
Efal Tablets	11063	18.5.65	Knoll Laboratories (Australia) Pty. Ltd., 176 Princes Highway, Arncliffe, N.S.W.	For relief of the spasms of asthma and hay fever. (In lieu of Serial No. 9593 of 21st October, 1961)
Efferdex	10902	18.5.65	Sanex Pty. Ltd., 223 Bay-road, Sandringham	For the symptomatic relief of minor gastric discomforts
Euclyptus Oil Woolworths Ltd. (Aust. and N.Z.)	10547	18.5.65	W. K. Burnside Pty. Ltd., 34 Joffcott-street, West Melbourne	As an inhalation for the relief of coughs and colds and as an embrocation for the relief of sprains and other muscular disorders

Entonyl Tablets 10 mg.	11143	18.5.65	Albott Laboratories Pty. Ltd., Captain Cook-drive, Kurnell, N.S.W.	*For use in the treatment of some types of primary (essential) and secondary hypertension
Entonyl Tablets 25 mg.	11144	18.5.65	Albott Laboratories Pty. Ltd., Captain Cook-drive, Kurnell, N.S.W.	*For use in the treatment of some types of primary (essential) and secondary hypertension
Femadone Tablets	11080	18.5.65	Lepetit (Pharmaceuticals) Pty. Ltd., 65 Queens-road, Melbourne	As an analgesic and sedative/hypnotic
Ferro-Mandate Tablets	10930	18.5.65	Cyanamid D.H.A. Pty. Ltd., Cherry-lane, Brooklynn	For use in the prevention or treatment of iron deficiency anaemias
Fruonic	10914	18.5.65	Lohn-Corden Ltd., 389 Macaulay-road, Kensington	For use as a mild laxative
Fucidin Leo Suspension	11067	18.5.65	Andrews Laboratories Pty. Ltd., 12 Primrose-avenue, Rosebery, N.S.W.	For mild and severe staphylococcal infections
Fungizone Lotion 30 cc.	11094	18.5.65	E. R. Squibb and Sons (Pty.) Ltd., 126 Franklin-street, Melbourne	For use in the treatment of cutaneous and/or mucocutaneous Candida infections amenable to topical amphotericin treatment
Gastronyein	10951	18.5.65	Drug Houses of Australia Ltd., Cherry-lane, Brooklynn	For use in the treatment of infantile gastroenteritis, dysentery and bacterial diarrhoeas in which neomycin-susceptible organisms are present
Germicidal Dax Rx Detergent	11121	18.5.65	Dux Drug Co. Pty. Ltd., 624 Burke-road, Camberwell	For use as a germicide and detergent
Haemopan Tablets 10 mg.	11056	18.5.65	Protea Pharmaceuticals Pty. Ltd., 107 Kent-street, Sydney, N.S.W.	*As an anticoagulant of wide clinical application
Haemopan Tablets 50 mg.	11057	18.5.65	Protea Pharmaceuticals Pty. Ltd., 107 Kent-street, Sydney, N.S.W.	*For use in the treatment of delirium tremens grand mal epilepsy, acute mania and for general narcosis in elderly patients
Hemineurin Injection	10972	18.5.65	Rochele East, Queensland	*For relief of anxiety states and as a hypnotic
Hemineurin Tablets	10981	18.5.65	Astra Pharmaceuticals (Australia) Pty. Ltd., Evans-road, Rocklea East, Queensland	
Herbal Ointment	10918	18.5.65	O.M.L. Products, 429 Bay-street, Brighton	An emollient ointment for the relief of minor irritations of the skin
Heizenroeder Kron Essenz or Altona Drops	10922	18.5.65	H. A. Brauer, Tannunda, South Australia	For use as a laxative and bitter to improve appetite
Hexa-Jels	11122	18.5.65	Dux Drug Co. Pty. Ltd., 624 Burke-road, Camberwell	For the relief of mouth and throat infection
Histryl Liquid	11078	18.5.65	Smith Kline and French Laboratories (Australia) Ltd., Warringah-road, French's Forest, N.S.W.	For use in the treatment of paediatric allergic reactions, accompanied by the release of histamine
Huds	10992	18.5.65	Drug Houses of Australia Ltd., Cherry Lane, Brooklynn	For the relief of coughs of colds and throat irritation
Hydrocortisyl Skin Cream B.P.C.	11001	18.5.65	Roussel Pharmaceuticals (Pty.) Ltd., 403 Pacific Highway, Artarmon, N.S.W.	For use in the treatment of non-infective dermatoses
Hydrocortisyl Skin Cream, B.P.C. 4%	11002	18.5.65	Roussel Pharmaceuticals (Pty.) Ltd., 403 Pacific Highway, Artarmon, N.S.W.	For use in the treatment of non-infective dermatoses
Hydrocortisyl Skin Cream B.P.C. 2 1/2%	11003	18.5.65	Roussel Pharmaceuticals (Pty.) Ltd., 403 Pacific Highway, Artarmon, N.S.W.	For use in the treatment of non-infective dermatoses
Ibesone Tablets	11077	18.5.65	Eli Lilly (Australia) Pty. Ltd., Wharf-road, West Ryde, N.S.W.	For use in the treatment of diseases caused by erythromycin-sensitive organisms
Insusade	11028	18.5.65	Evans Medical Australia (Pty.) Ltd., 214 Graham-street, Port Melbourne	*For use in the treatment of tuberculosis
Influenza Mixture	11141	18.5.65	Seltes' Pharmacies, 523 High-street, Croxton	For relief of discomfort of colds and influenza
Isosal-T.D. Capsules	10967	18.5.65	William R. Warner and Co. Pty. Ltd., 10 Bilscho-street, Villawood, N.S.W.	*For oral treatment of diabetes
Janus Juniper and Celery Mineral Spring Salts	11090	18.5.65	Redmount-Puss, 657 George-street, Haymarket, N.S.W.	For use as an aperient
Kemifetine 1% Ophthalmic Ointment	11134	18.5.65	Andrews Laboratories Pty. Ltd., 12 Primrose-avenue, Rosebery, N.S.W.	For use in the treatment of eye infections due to chloramphenicol-sensitive organisms
Kemifetine Otolgic Solution	11136	18.5.65	Andrew Laboratories Pty. Ltd., 12 Primrose-avenue, Rosebery, N.S.W.	For acute and chronic otitis, suppuration in cavities from old radical operations, refractory otorrhoea, when due to chloramphenicol-sensitive organisms, and for post-operative medication after antro-ticootomy
Kemifetine Succinato Vials	11135	18.5.65	Andrews Laboratories Pty. Ltd., 12 Primrose-avenue, Rosebery, N.S.W.	For use in the treatment of infections due to chloramphenicol-sensitive organisms
Kirocid Syrup	11069	18.5.65	Schering Pty. Ltd., 620 Harris-street, Ultimo, N.S.W.	For use in the treatment of all infections due to sulphonomide sensitive organisms
Kirocid Tablets	11068	18.5.65	Schering Pty. Ltd., 620 Harris-street, Ultimo, N.S.W.	For use in the treatment of all infections due to sulphonomide sensitive organisms
Komin	10969	18.5.65	Sigma Company Ltd., 589 Collins-street, Melbourne	For the treatment of bacterial diarrhoeas in which neomycin susceptible organisms are present
Lacredosin Ampoules	11023	18.5.65	Calmie Limited, 3 Bibby-street, Chiswick, N.S.W.	*As an adjunct in the treatment of angina pectoris and cardiac insufficiency
Lacredosin Acetamide Eye and Ear Ointment with Neomycin 0.1%	11132	18.5.65	Cyanamid D.H.A. Pty. Ltd., Cherry-lane, Brooklynn	A corticosteroid therapy and for infections due to neomycin-sensitive organisms
Ley's Cough Mixture	11147	18.5.65	Ley's Pharmacy, 86 Charman-road, Mentone	For the relief of the coughs of colds. (In lieu of Serial No. 6722 of 22nd January, 1958)
Lift	11090	18.5.65	Nicholls Pty. Ltd., 699 Warrigal-road, Chadstone	To alleviate fatigue and lassitude
Liqua-Dent Tablets	11089	18.5.65	H. F. Harvey Pty. Ltd., 231 Elizabeth-street, Croydon, N.S.W.	To assist in the prevention of dental caries

* Denotes that product is subject to the labelling provisions of Victorian Food and Drug Standards Regulation No. 74.

REGISTER OF PROPRIETARY MEDICINES—continued.

Distinctive Name of Proprietary Medicine.	Serial Number.	Date of Registration.	Name and Address of Applicant.	Purposes for which the Medicine may be sold.
Lomofil Liquid	11061	18.5.65	Drug Houses of Australia Ltd., Cherry-lane, Brooklyn	For use in the treatment of acute and chronic diarrhoeas and (in rhucoen associated with ileostomies and colostomies
Lomofil Tablets	11062	18.5.65	Drug Houses of Australia Ltd., Cherry-lane, Brooklyn	For use in the treatment of acute and chronic diarrhoeas and diarrhoea associated with ileostomies and colostomies
Lotherington's Pain Tablets	10923	18.5.65	R. D. Toppin and Sons Pty. Ltd., (pro H. M. Rocklum), 397 Sydney-road, Brunswick	For use as an analgesic and sedative
Medic Medicated Vapour	10910	18.5.65	Samuel Taylor Pty. Ltd., 239 Pacific Highway, Artarmon, N.S.W.	For the relief of the coughs of colds
Medihaler-Duo	11149	18.5.65	Riker Laboratories Aust. Pty. Ltd., 68 Alexander-street, Crows Nest, N.S.W.	For the relief of the spasm of asthma
Mellert Retard Sandoz Tablets	10984	18.5.65	Sandoz Australia Pty. Ltd., 620 Harris-street, Ultimo, N.S.W.	*For use as a tranquilliser
Mesulfon	10945	18.5.65	Ayers Laboratories Pty. Ltd., Gregory-place, Parramatta, N.S.W.	As an antihacterial for urinary tract infections such as pyelonephritis, pyelitis, cystitis and urethritis
Meticocilin Tablets 0.95 gr.	10904	18.5.65	Camprod Pty. Ltd., 169 Lygon-street, Carlton	*For use as an adjunct in the treatment of certain hepatic conditions
Mevastine Tablets 2.5 mg.	11053	18.5.65	Merek Sharp and Dohme (Australia) Pty. Ltd., 62 Fernfield-street, South Granville, N.S.W.	*An anti-hypertensive agent
Milk of Magnesia—Sweetened	10907	18.5.65	Alfred Lawrence and Co. Pty. Ltd., (pro Victor Pharmacy), 4 Victoria-street, North Melbourne	As an antacid and mild laxative
Millicaine Dental Cartridges	10905	18.5.65	Difrex (Aust.) Laboratories Pty. Ltd., 321 Pitt-street, Sydney, N.S.W.	For local and regional anaesthesia
Millicaine with Noradrenalin Dental Cartridges	10906	18.5.65	Difrex (Aust.) Laboratories Pty. Ltd., 321 Pitt-street, Sydney, N.S.W.	For local and regional anaesthesia
Millicaine Dental with Noradrenalin 0.6%	10935	18.5.65	Difrex (Aust.) Laboratories Pty. Ltd., 321 Pitt-street, Sydney, N.S.W.	For local and regional anaesthesia
Millicaine Dental Plain 0.6%	10934	18.5.65	Difrex (Aust.) Laboratories Pty. Ltd., 321 Pitt-street, Sydney, N.S.W.	For local and regional anaesthesia
Milturate	10962	18.5.65	E. Griffiths Hughes Pty. Ltd., 699 Warrigal-road, Chadstone	*For coronary artery vasodilatation and control of anxiety
Multi-vitamin Tablets	11107	18.5.65	Martin and Pleasance, (pro A.A. Health Foods Pty. Ltd.), 20 Crowe-road, Oakleigh	*For use in the treatment of vitamin deficiencies
Narin Nasal Spray	11026	18.5.65	Sienn Company Ltd., 589 Collins-street, Melbourne	For relief of allergic and infectious conditions of the nose and ear
Natural Vitamin E Capsules 50 mg.	11111	18.5.65	Martin and Pleasance (pro Sanitarium Health Food Co.), 164 Burwood-road, Hawthorn	For use as a vitamin E supplement
Natural Vitamin E Capsules 50 mg.	11117	18.5.65	Martin and Pleasance, 358 Swan-street, Richmond	For use as a vitamin E supplement
Natural Vitamin E Tablets 50 mg.	11115	18.5.65	Martin and Pleasance, 358 Swan-street, Richmond	For use as a vitamin E supplement
Natural Vitamin E Tablets 50 mg.	11112	18.5.65	Martin and Pleasance, (pro Sanitarium Health Food Co.), 164 Burwood-road, Hawthorn	For use as a vitamin E supplement
Natural Vitamin E Capsules 100 mg.	11110	18.5.65	Martin and Pleasance, (pro Sanitarium Health Food Co.), 164 Burwood-road, Hawthorn	For use as a vitamin E supplement
Natural Vitamin E Capsules 100 mg.	11116	18.5.65	Martin and Pleasance, 358 Swan-street, Richmond	For use as a vitamin E supplement
Natural Vitamin E Tablets 100 mg.	11113	18.5.65	Martin and Pleasance, (pro Sanitarium Health Food Co.), 164 Burwood-road, Hawthorn	For use as a vitamin E supplement
Natural Vitamin E Tablets 100 mg.	11114	18.5.65	Martin and Pleasance, 358 Swan-street, Richmond	For use as a vitamin E supplement
Neo-Hyor	11027	18.5.65	Sigma Co. Ltd., 589 Collins-street, Melbourne	*For infected and inflammatory conditions of the eye when due to neomycin susceptible organisms
Neomagna	11032	18.5.65	Wyeth Pharmaceuticals Pty. Ltd., Gregory-place, Parramatta, N.S.W.	For the symptomatic treatment of diarrhoeas and for specific therapy in bacterial diarrhoeas due to neomycin-susceptible organisms
Neosporin-H brand Ointment	10938	18.5.65	Burroughs Wellcome and Co. (Australia) Ltd., Cressy-street, Rosebery, N.S.W.	To reduce inflammation and infection. (In lieu of Serial No. 6387 of 14th August, 1957)

Nephrid Tablets 1 mg.	10998	18.5.65	Pfizer Corporation, Wharf-road, West Ryde, N.S.W.	*As an oral, non-mercurial diuretic, saluretic and anti-hypertensive agent
Nephrid Tablets 2 mg.	10999	18.5.65	Pfizer Corporation, Wharf-road, West Ryde, N.S.W.	*As an oral, non-mercurial diuretic, saluretic and anti-hypertensive agent
Neutradonna Sed. Powder	11049	18.5.65	British Schering Ltd., Pacific Highway, St. Leonards, N.S.W.	*For the treatment of dyspepsia, gastric ulcer, duodenal ulcer, gastritis, nausea of pregnancy, nervous dyspepsia and oesophagitis
Neutradonna Sed. Tablets	11050	18.5.65	British Schering Ltd., Pacific Highway, St. Leonards, N.S.W.	*For the treatment of dyspepsia, gastric ulcer, duodenal ulcer, gastritis, nausea of pregnancy, nervous dyspepsia, oesophagitis
Norlestrin	11118	18.5.65	Parke, Davis and Co., 32 Cawarra-road North, Caringbah, N.S.W.	*For menstrual irregularities and dysmenorrhoea
Nusulate Tablets	11079	18.5.65	H. F. Harvey Pty. Ltd., 231 Elizabeth-street, Croydon, N.S.W.	As an analgesic and anti-pyretic
Nyal Pepsamol	10947	18.5.65	Sterling Pharmaceuticals Pty. Ltd., 75 Atkins-road, Ermington, N.S.W.	For the relief of indigestion, flatulence, dyspepsia and heartburn when due to acidity
Olex	10986	18.5.65	Tromax Pty. Ltd., (pro Miller and Maund Pty. Ltd.), 16 Watchorn-street, Hobart, Tasmania	For relief of the irritation of eczema, chafing and as an adjunct in the treatment of facial blemishes
O.M.I. Effervescent Salts	10917	18.5.65	O.M.I. Products, 429 Bay-street, Brighton	For use as a mild aperient
Optimyxin Polymyxin Eye Drops	10939	18.5.65	Burroughs Wellcome and Co. (Australia) Ltd., Cressy-street, Rosebery, N.S.W.	For infections of the eye sensitive to polymyxin. (In lieu of Serial No. 9043 of 26th October 1961)
Optocort Eye Ointment	11058	18.5.65	Protea Pharmaceuticals Pty. Ltd., 107 Kent-street, Sydney, N.S.W.	For the treatment of non-specific non-infective inflammation of the anterior segment of the eye
Optone Eye Drops	10965	18.5.65	Sainond and Spragon (Aust.) Pty. Ltd., 198 Toorongs-road, East Hawthorn	For the relief of irritation of the eyes. (In lieu of Serial No. 5015 of 11th April, 1956)
Orbenin Capsules 250 mg.	10949	18.5.65	Beecham Research Pty. Ltd., Chesterville-road, Moorabbin	For the treatment of penicillin sensitive infections
Orbenin Vials 250 mg.	10950	18.5.65	Beecham Research Pty. Ltd., Chesterville-road, Moorabbin	For the treatment of penicillin sensitive infections
Orenzyme Tablets	10903	18.5.65	Wm. S. Merrell Pty. Ltd., 104 Mount-street, North Sydney, N.S.W.	As an adjunct in the treatment of inflammatory conditions
Otopol Polymyxin Ear Drops A.P.F.	10940	18.5.65	Burroughs Wellcome and Co. (Australia) Ltd., Cressy-street, Rosebery, N.S.W.	For infections of the ear sensitive to polymyxin. (In lieu of Serial No. 9044 of 26th October, 1961)
Fabreix Diarrhoea Mixture	11093	18.5.65	R. D. Toppin and Sons Pty. Ltd., (pro Rexall Drug Company), R. 21 Mount-street, Glen Waverley	For the relief of diarrhoea due to infectious organisms
Faineze Tablets	10924	18.5.65	R. D. Toppin and Sons Pty. Ltd., (pro St. Kilda Community Chemist), enr. Jackson and Fitzroy streets, St. Kilda	For use as an analgesic and sedative. (In lieu of Serial No. 8264 of 24th February, 1960)
Painstiller	10983	18.5.65	D. Kortekaas, 178 Blyth-street, Altona	For relief of pain and for relief of the discomfort of colds and influenza
Panalamine 1000	11036	18.5.65	Protea Pharmaceuticals Pty. Ltd., 107 Kent-street, Sydney, N.S.W.	For use in the treatment of pernicious anaemias
Parstelin S2	10996	18.5.65	Smith, Kline and French Laboratories, Warringah-road, French's Forest, N.S.W.	*For use in mild mental and emotional disturbances associated with depression
Passade	11029	18.5.65	Evans Medical Australia (Pty.) Ltd., 214 Graham-street, Port Melbourne	*For use in the treatment of tuberculosis
Penicillin V.K. Suspension (Banana Flavoured)	10977	18.5.65	Knoll Laboratories (Australia) Pty. Ltd., 176 Princes Highway, Arncliffe, N.S.W.	For use in the treatment of infections due to penicillin sensitive organisms
Pergalen Ointment	11025	18.5.65	Hoechst Pharmaceuticals Pty. Ltd., 505 St. Kilda-road, Melbourne	For use in the treatment of haematomata, contusions, inflammatory infiltrations, tenosynovitis and bursitis
Persomnia	10931	18.5.65	E. Griffiths Hughes Pty. Ltd., 699 Warrigal-road, Chadstone	As a mild sedative. (In lieu of Serial No. 6753 of 22nd January, 1958)
Phensedyl Cough Capsules	10952	18.5.65	May and Baker (Australia) Pty. Ltd., Paramount-road, West Footscray	For the relief of coughs
Phiacort Cream 0.5%	10994	18.5.65	Phial (Aust.) Pty. Ltd., 160 Pacific Highway, North Sydney, N.S.W.	For use as an anti-pruritic, anti-allergic and anti-inflammatory agent in non-infective conditions
Phiacort Cream 1%	11099	18.5.65	Phial (Aust.) Pty. Ltd., 160 Pacific Highway, North Sydney, N.S.W.	As an anti-pruritic, anti-allergic and anti-inflammatory agent in non-infective conditions
Phthazol (Phthalyl-Sulphathiazole) 0.5 gm.	11088	18.5.65	Knoll Laboratories (Australia) Pty. Ltd., 176 Princes Highway, Arncliffe, N.S.W.	For use in the treatment of bacillary dysentery due to sulphamide-sensitive organisms
Pholocolin Linctus	10960	18.5.65	Drug Houses of Australia Ltd., Cherry-lane, Brooklyn	For use as a cough linctus
Pil-Aloe-X	10959	18.5.65	R. D. Toppin and Sons Pty. Ltd., (pro Olsen Pharmaceuticals), 21 Olsen-place, Broadmeadows	As a laxative
Pilopt Eye Drops 2%	10042	18.5.65	Sigma Co. Ltd., 589 Collins-street, Melbourne	As a miotic
Pilopt Eye Drops 3%	10043	18.5.65	Sigma Co. Ltd., 589 Collins-street, Melbourne	As a miotic
Pilopt Eye Drops 4%	10044	18.5.65	Sigma Co. Ltd., 589 Collins-street, Melbourne	For the relief of headaches, upset stomach, flatulence, dyspepsia, wind, indigestion, pain and fatigue. (In lieu of Serial No. 7795 of 6th May, 1959)
Pixup Hangover Special	11085	18.5.65	A. Krentz, 18 Collins-street, Melbourne	

* Denotes that product is subject to the labelling provisions of Victorian Food and Drug Standards Regulation No. 74.

REGISTER OF PROPRIETARY MEDICINES—continued.

Distinctive Name of Proprietary Medicine.	Serial Number.	Date of Registration.	Name and Address of Applicant.	Purposes for which the Medicine may be sold.
Pluraxin-Winthrop	10933	18.5.65	Sterling Pharmaceuticals Pty. Ltd., 75 Atkins-road, Ermington, N.S.W.	For use as a multi-vitamin supplement
Pluryl Leo	11034	18.5.65	Andrus Laboratories Pty. Ltd., 12 Primrose-avenue, Rosebery, N.S.W.	*A diuretic and saluretic
Polytraclin-N Eye Drops	10995	18.5.65	Glaxo-Allenburys (Australia) Pty. Ltd., 23 Villiers-street, North Melbourne	For use in the treatment of bacterial infections of the eye. (In lieu of Serial No. 9541 of 25th October, 1961)
Prevision	11084	18.5.65	Roussea Pharmaceuticals (Pty.) Ltd., 403 Pacific Highway Artarmon, N.S.W.	*For menstrual irregularities and dysmenorrhoea
Primobolan Depot	11070	18.5.65	Schering Pty. Ltd., 620 Harris-street, Ultimo, N.S.W.	For use in the treatment of all conditions which require an increased synthesis of protein
Primobolan Tablets 1 mg.	11072	18.5.65	Schering Pty. Ltd., 620 Harris-street, Ultimo, N.S.W.	For convalescence, cachexia, wasting disease
Primobolan Tablets 5 mg.	11071	18.5.65	Schering Pty. Ltd., 620 Harris-street, Ultimo, N.S.W.	For convalescence, cachexia, wasting disease
Prodigox Tablets	11039	18.5.65	Protea Pharmaceuticals Pty. Ltd., 107 Kent-street, Sydney, N.S.W.	*For use where digitalis therapy is indicated
Protasmas Capsules	11060	18.5.65	Protea Pharmaceuticals Pty. Ltd., 107 Kent-street, Sydney, N.S.W.	For the relief of the spasm of asthma
Pulvules 389 Aventyl	10928	18.5.65	Eli Lilly (Australia) Pty. Ltd., Wharf-road, West Ryde, N.S.W.	*As an anti-depressive drug and psycho stimulation
Redisol—H1000 neg./ml.	10913	18.5.65	Merck Sharp and Dohme (Aust.) Pty. Ltd., 62 Fernndell-street, South Granville, N.S.W.	*For use in the treatment of pernicious anaemia
Rema Vitamin Tonic	11133	18.5.65	R. D. Toppin and Sons Pty. Ltd., (pro Aronson's Pharmacy), 296 Little Collins-street, Melbourne	For use as a vitamin tonic
Rexall Tiny Tot Diarrhoea Mixture	11092	18.5.65	R. D. Toppin and Sons Pty. Ltd., (pro Rexall Drug Company), 21 Mount-street, Glen Waverley	For the relief of diarrhoea due to infectious organisms
Roberts A.P.A. Tablets	10991	18.5.65	Phillip's Southern Trading Pty. Ltd., (pro F. G. Roberts), 289 Malvern-road, South Yarra	For relief of the discomfort of colds and influenza
Roberts B12 Tablets	10993	18.5.65	Phillip's Southern Trading Pty. Ltd., (pro F. G. Roberts), 289 Malvern-road, South Yarra	For use as a vitamin B12 supplement
Roberts Vitamin and Mineral Supplement	10987	18.5.65	Phillip's Southern Trading Pty. Ltd., (pro F. G. Roberts), 289 Malvern-road, South Yarra	For use as a vitamin and mineral supplement
Rovamyacin Oral Syrup	11125	18.5.65	May and Baker (Australia) Pty. Ltd., Paramount-road, West Footscray	For use in the treatment of infections due to organisms sensitive to spiramycin
Rumadol Balm	10979	18.5.65	R. D. Toppin and Sons Pty. Ltd., (pro Ferrotin Pharmaceuticals), 229 Victoria-street, West Melbourne	A non-greasy cream for the relief of nerve and muscular pain
Rumadol Liniment	10980	18.5.65	R. D. Toppin and Sons Pty. Ltd., (pro Ferrotin Pharmaceuticals), 229 Victoria-street, West Melbourne	For relief of rheumatic pains, lumbago, fibrositis, sprains and muscular pains
Sanax A.P.C. Tablets	11012	18.5.65	Sanax Pty. Ltd., 223 Bay-road, Sandringham	For the relief of headache and for the pain of rheumatism, lumbago, sciatica and period pains
Sanax Aspirin Tablets 5 gr.	11013	18.5.65	Sanax Pty. Ltd., 223 Bay-road, Sandringham	For the relief of nerve pains, headache, neuralgia and the discomfort of colds and influenza
Sanax Bicarbonate of Soda BP	10915	18.5.65	Sanax Pty. Ltd., 223 Bay-road, Sandringham	As a neutralizer for acids
Sanax Boracic Acid	11014	18.5.65	Sanax Pty. Ltd., 223 Bay-road, Sandringham	A dusting powder for minor wounds
Sanax Calamine Lotion	11015	18.5.65	Sanax Pty. Ltd., 223 Bay-road, Sandringham	A soothing and drying lotion for minor skin irritations
Sanax Castor Oil	11016	18.5.65	Sanax Pty. Ltd., 223 Bay-road, Sandringham	A soothing application for eye irritations and minor burns and as a laxative
Sanax Chlorodyne	11006	18.5.65	Sanax Pty. Ltd., 223 Bay-road, Sandringham	For the relief of coughs and for diarrhoea
Sanax Eucalyptus Oil	11017	18.5.65	Sanax Pty. Ltd., 223 Bay-road, Sandringham	As an inhalation for relief of the coughs of colds and as an embrocation for the relief of minor muscular disorders
Sanax Hydrogen Peroxide	10916	18.5.65	Sanax Pty. Ltd., 223 Bay-road, Sandringham	As a mild antiseptic
Sanax Lysol	11018	18.5.65	Sanax Pty. Ltd., 223 Bay-road, Sandringham	As an antiseptic and germicide
Sanax Nasal Drops	11019	18.5.65	Sanax Pty. Ltd., 223 Bay-road, Sandringham	For the relief of nasal irritation when due to colds, catarrh or hay fever
Sanax Pure Liquid Paraffin	11020	18.5.65	Sanax Pty. Ltd., 223 Bay-road, Sandringham	As an intestinal lubricant and mild laxative
Sanax Salt Tablets 5 gr.	11021	18.5.65	Sanax Pty. Ltd., 223 Bay-road, Sandringham	For the treatment of salt depletion
Sanax Sal Volatile	11024	18.5.65	Sanax Pty. Ltd., 223 Bay-road, Sandringham	As a stimulant for fainting or as a mild smelling salts

Sanax Tincture of Iodine 2 1/2% Tablets	11021	18.5.65	Sanax Pty. Ltd., 223 Bay-road, Sandringham	As a mild antiseptic
Sanax Vitamin B Group Forte	11022	18.5.65	Sanax Pty. Ltd., 223 Bay-road, Sandringham	As a vitamin B group supplement
Sarcosylinum	11038	18.5.65	Malco Agency, 9 Valentine-street, Sydney, N.S.W.	*For use in the treatment of testicle seminoma and its metastases, reticulosarcoma, and malignant angioendothelioma, and bone tumours
Saroten	11073	18.5.65	Nicholas Pty. Ltd., 699 Warrigal-road, Chadstone	*An anti-depressant and tranquilizer
Savlon Nasal Spray	10901	18.5.65	Imperial Chemical Industries of Australia and New Zealand Ltd., 1 Nicholson-street, Melbourne	For the relief of nasal congestion associated with head colds, catarrh and hay fever
Seb-A-Clen	10948	18.5.65	Pharmacia Pty. Ltd., 692 Botany-road, Alexandria, N.S.W.	For use in the treatment of seborrhoea of the scalp and dandruff
Senpolin	11081	18.5.65	Evans Medical Australia (Pty.) Ltd., 214 Graham-street, Port Melbourne	For the relief of painful conditions associated with muscular rheumatism, lumbago, sciatica, neuritis, sprains and stiffness
Signetur Polyco	10966	18.5.65	Sigma Co. Ltd., 589 Collins-street, Melbourne	*For use in the treatment of topical infections due to gram-positive and gram-negative organisms
Sofradex Eye/Ear Drops 3 cc.	11005	18.5.65	Roussel Pharmaceuticals (Pty.) Ltd., 403 Pacific Highway, Artarmon, N.S.W.	For use in the treatment of external inflammatory conditions of the eye and ear. (In lieu of Serial No. 9711 of 5th June, 1963)
Sofradex Eye/Ear Ointment 3g.	11004	18.5.65	Roussel Pharmaceuticals (Pty.) Ltd., 403 Pacific Highway, Artarmon, N.S.W.	For use in the treatment of external inflammatory conditions of the eye and ear. (In lieu of Serial No. 9712 of 5th June, 1963)
Somilan	10978	18.5.65	The British Drug Houses (Australia Pty.) Ltd., 250 Pitt-street, Sydney, N.S.W.	As a sedative and hypnotic
Somnital Capsules gr. 1 1/2	10954	18.5.65	Prosana Laboratories Pty. Ltd., 22 Daisy-street, Revesby, N.S.W.	As a sedative and hypnotic
Sterilex	10970	18.5.65	World Agencies Pty. Ltd., 82 Sussex-street, Sydney, N.S.W.	For the relief of discomfort of sore throat and mouth ulcers
Sulfauridine Suspension	10932	18.5.65	Merck Sharp and Dohme (Australia) Pty. Ltd., 62 Fern-dell-street, South Granville, N.S.W.	For use as an adjunct in the treatment of specific and non-specific diarrhoea
The Gargle	11000	18.5.65	R. D. Toppin and Sons Pty. Ltd., (pro H. S. Pickering) 673 Newspan Highway, East Brighton	For the relief of the irritation of sore throat
Tocosamine	11148	18.5.65	Drug Houses of Australia Ltd., Cherry-lane, Brooklyn	*For the induction of labor and stimulation of all forms of desultory labor and uterine inertia
Tryptano Injection	11051	18.5.65	Merck Sharp and Dohme (Australia) Pty. Ltd., 62 Fern-dell-street, South Granville, N.S.W.	*As an anti-depressant agent
Ungvita Fort.	10925	18.5.65	Nicholas Pty. Ltd., 699 Warrigal-road, Chadstone	For use as an antiseptic dressing for wounds and other skin lesions
Urozol (Sulphamethizole) 0.1 gm.	11074	18.5.65	Knoll Laboratories (Australia) Pty. Ltd., 176 Princes Highway, Arncliffe, N.S.W.	For use in the treatment of cystitis, urethritis, pyelitis, pyelonephritis, ureteritis and prostatitis due to bacterial infection amenable to sulfonamide therapy
Urozol (Sulphamethizole) 0.25 gm.	11075	18.5.65	Knoll Laboratories (Australia) Pty. Ltd., 176 Princes Highway, Arncliffe, N.S.W.	For use in the treatment of cystitis, urethritis, pyelitis, pyelonephritis, ureteritis and prostatitis due to bacterial infection amenable to sulfonamide therapy
Urozol (Sulphamethizole) 0.50 gm.	11076	18.5.65	Knoll Laboratories (Australia) Pty. Ltd., 176 Princes Highway, Arncliffe, N.S.W.	For use in the treatment of cystitis, urethritis, pyelitis, pyelonephritis, ureteritis and prostatitis due to bacterial infection amenable to sulfonamide therapy
Valium Roche Tablets 2 mg.	11081	18.5.65	Roche Products Pty. Ltd., 1 Barrack-street, Sydney, N.S.W.	*As a tranquilizer
Valium Roche Tablets 5 mg.	11082	18.5.65	Roche Products Pty. Ltd., 1 Barrack-street, Sydney, N.S.W.	*As a tranquilizer
Valium Roche Tablets 10 mg.	11083	18.5.65	Roche Products Pty. Ltd., 1 Barrack-street, Sydney, N.S.W.	*As a tranquilizer
Valium Roche Ampoules 10 mg./2 ml.	11052	18.5.65	Roche Products Pty. Ltd., 1 Barrack-street, Sydney, N.S.W.	*As a tranquilizer
Vardase Oral Tablets	10920	18.5.65	Cyanamid D.H.A. Pty. Ltd., Cherry-lane, Brooklyn	For use as an adjunct in the treatment of oedema associated with infections or trauma
Vicarex Tablets	10907	18.5.65	Difrex (Aust.) Laboratories Pty. Ltd., 321 Pitt-street, Sydney, N.S.W.	For use as a vitamin and mineral supplement
Victor's Raspberry Cough Linctus	11095	18.5.65	R. D. Toppin and Sons Pty. Ltd., (pro C. Victor), 91 Holmes-road, East Brunswick	For the relief of the coughs of colds
Vitamin A Tablets	11101	18.5.65	Martin and Pleasance, (pro A.A. Health Foods Pty. Ltd.), 20 Crewe-road, Oakleigh	For use in the treatment of vitamin A deficiencies
Vitamin B1 Tablets 10 mg.	11105	18.5.65	Martin and Pleasance, (pro A.A. Health Foods Pty. Ltd.), 20 Crewe-road, Oakleigh	For use as a vitamin B1 supplement
Vitamin E Tablets 50 mg.	11102	18.5.65	Martin and Pleasance, (pro A.A. Health Foods Pty. Ltd.), 20 Crewe-road, Oakleigh	For use as a vitamin E supplement
Wyovin Tablets	11087	18.5.65	Wesph. Pharmaceuticals Pty. Ltd., Gregory-place, Parramatta, N.S.W.	*An anticholinergic agent for use in the treatment of peptic ulcer and the control of pain associated with smooth muscle spasm in the gastro-intestinal and genito-urinary tracts

* Denotes that product is subject to the labelling provisions of Victorian Food and Drug Standards Regulation No. 74.

The following are AMENDMENTS of the Register of Proprietary Medicines.

Distinctive Name of Proprietary Medicine.	Serial Number	Nature of Amendment.
Cystex	7121	Registration restored as at 26th March, 1958. Entry inadvertently published in list of omissions in <i>Government Gazette</i> of 20th November, 1964
Distaquaine G	10766	Registration transferred to Dista Products (Australia) Pty. Limited, 1 Campbell-street, Artarmon, N.S.W.
Distolyt Tablets	10800	Registration transferred to Dista Products (Australia) Pty. Limited, 1 Campbell-street, Artarmon, N.S.W.
Streptaquaine 1 in 4	10767	Registration transferred to Dista Products (Australia) Pty. Limited, 1 Campbell-street, Artarmon, N.S.W.
Sedasco Tablets	10013	Distinctive name of preparation shown incorrectly in <i>Government Gazette</i> of 4th June, 1964

[1739]



VICTORIA GOVERNMENT GAZETTE

Published by Authority

[Registered at the General Post Office, Melbourne, for transmission by post as a newspaper.]

No. 381

WEDNESDAY, JUNE 2

1965

Government House,
Melbourne.

LEVEE AT PARLIAMENT HOUSE, MELBOURNE.

In honour of the Birthday of Her Majesty the Queen, His Excellency the Governor of Victoria, Major-General Sir Rohan Delacombe, K.C.M.G., K.B.E., C.B., D.S.O., K.St.J., will hold a Levee at Parliament House, Spring-street, Melbourne, at 9.45 a.m. on Saturday, 12th June, 1965.

On the occasion of the celebration of The Queen's Birthday, His Excellency is anxious to receive as many citizens as possible.

In accordance with previous custom, there will be no precedence in the order of presentation, but it is requested that members of services and all public bodies group themselves together for presentation, as far as possible.

It is requested that those entitled to wear uniform or official dress will do so on this occasion, but His Excellency will be pleased to receive those not entitled to wear uniform or official dress in morning suit or lounge suit.

For the guidance of those attending the Levee, it will be appropriate, for those who wish to do so, to wear Honours, Decorations and Awards.

Private Entree Cards will admit recipients to the South Door of the Spring-street Entrance at Parliament House at 9.30 a.m. All other citizens are requested to enter by the North Door of the Spring-street Entrance at 10.15 a.m.

It is particularly desired that gentlemen attending the Levee should provide themselves with a card on which should be printed or typed in capitals, or written in block letters, their styles of address for presentation in order to facilitate announcement to His Excellency.

By His Excellency's Command,

P. P. JEFFREYS, Major,
Private Secretary and Comptroller.

Land Act 1958.

UNALIENATED CROWN LAND AVAILABLE FOR SETTLEMENT UNDER IMPROVEMENT PURCHASE LEASES.

PROCLAMATION.

By His Excellency the Governor of the State of Victoria and its Dependencies in the Commonwealth of Australia, &c., &c., &c.
IN pursuance of the provisions of section 153 of the *Land Act 1958*, I, the Governor of the State of Victoria in the Commonwealth of Australia, by and with the advice of the Executive Council of the said State, do by this Proclamation declare the unalienated Crown lands mentioned in the subjoined Schedule, to be available for settlement under improvement purchase leases.

SCHEDULE.

County.	Parish.	Allotment.	Section.	Area.	Land Valuation.
				A. R. P.	
Ripon	Beaufort	32	E1	53 1 38	£7 per acre
Ripon	Beaufort	34	E1	56 2 38	£6 per acre

Given under my Hand and the Seal of the State of Victoria aforesaid, at Melbourne, this twenty-fifth day of May, in the year of our Lord One thousand nine hundred and sixty-five, and in the fourteenth year of the reign of Her Majesty Queen Elizabeth II.

ROHAN DELACOMBE.

(L.S.)

By His Excellency's Command,

JIM BALFOUR,
 Minister of Lands.

GOD SAVE THE QUEEN !

ACTS OF PARLIAMENT.

PROCLAMATION

By His Excellency the Governor of the State of Victoria and its Dependencies in the Commonwealth of Australia, &c., &c., &c.

I, THE Governor of the State of Victoria, in the Commonwealth of Australia, do hereby declare that I have this day assented, in Her Majesty's name, to the Bills passed by the Parliament of the said State, the titles whereof are hereunder set forth, together with the short titles, that is to say:—

- No. 7272. "An Act to amend the *Sale of Land Act 1962*, the *Local Government Act 1958* and the *Transfer of Land Act 1958*, and for other purposes." (*Sale of Land Act 1965*.)
- No. 7273. "An Act to amend the *Labour and Industry Act 1958*." (*Labour and Industry (Amendment) Act 1965*.)
- No. 7274. "An Act to consolidate and amend the Law relating to the Sale of Farm Produce." (*Farm Produce Merchants and Commission Agents Act 1965*.)
- No. 7275. "An Act to authorize the Surrender to the Crown of certain Lands held upon certain Trusts and the Reservation thereof as a Site for a National Park, to amend the *National Parks Act 1958*, and for other purposes." (*National Parks (Amendment) Act 1965*.)
- No. 7276. "An Act to make Better Provision for Appeals against Valuations of Land, and for other purposes." (*Valuation of Land (Appeals) Act 1965*.)
- No. 7277. "An Act to amend the *Medical Act 1958* with respect to Foreign Practitioners." (*Medical (Foreign Practitioners) Act 1965*.)
- No. 7278. "An Act to amend the *Soldier Settlement Act 1958* and the *Land Settlement Act 1959*." (*Rural Finance and Settlement Commission Act 1965*.)
- No. 7279. "An Act to amend the *Home Finance Act 1962*." (*Home Finance (Amendment) Act 1965*.)
- No. 7280. "An Act to make Provision with respect to the Imposition and Collection of Penalties for Traffic Offences, and for other purposes." (*Road Traffic (Infringements) Act 1965*.)
- No. 7281. "An Act to amend the *Companies Act 1961*." (*Companies (Amendment) Act 1965*.)
- No. 7282. "An Act to amend the *Health Act 1958* and the *Pesticides Act 1958* with respect to Household Insecticides, and for other purposes." (*Health (Household Insecticides) Act 1965*.)

No. 7283. "An Act to amend Section Thirty-eight of the *Country Roads Act 1958*, to amend the *Motor Car Act 1958*, to make Provision for the Establishment of a Fund to be applied to Special Road Projects, to amend the *Stamps Act 1958*, and for other purposes." (*Roads (Special Projects) Act 1965*.)

No. 7284. "An Act to apply out of the Consolidated Revenue the sum of Forty-three million eight hundred and seventy-seven thousand eight hundred and forty pounds to the service of the year One thousand nine hundred and sixty-five and One thousand nine hundred and sixty-six."

No. 7285. "An Act to apply out of the Consolidated Revenue the sum of One million seven hundred and seventy-seven thousand five hundred and four pounds to the service of the year One thousand nine hundred and sixty-four and One thousand nine hundred and sixty-five."

Given under my Hand and the Seal of the State of Victoria, aforesaid, at Melbourne, this first day of June, in the year of our Lord One thousand nine hundred and sixty-five, and in the fourteenth year of the reign of Her Majesty Queen Elizabeth II.

(L.S.)

ROHAN DELACOMBE.

By His Excellency's Command,

HENRY E. BOLTON

GOD SAVE THE QUEEN!

ACTS ENUMERATION AND REVISION ACT 1958.

PROCLAMATION

By His Excellency the Governor of the State of Victoria and its Dependencies in the Commonwealth of Australia, &c., &c., &c.

WHEREAS the *Public Works Loan and Application Act 1946* (No. 2) and the *Public Works Loan and Application Act 1947* were at the commencement of the *Acts Enumeration and Revision Act 1958* enactments in force in Victoria: And whereas those enactments were inadvertently not set out in the Second Schedule to the *Acts Enumeration and Revision Act 1958* and were accordingly repealed by virtue of that Act: And whereas section 10 of the *Acts Enumeration and Revision Act 1958* provides that the Governor in Council may by proclamation published in the *Government Gazette* indicate enactments as enactments which are to be added to those mentioned in the Second Schedule to that Act, and that thereupon the enactments shall be deemed to have been mentioned in that Schedule and the effect shall be the same as if that Schedule had

at the time of passing of that Act included those enactments: Now therefore I, the Governor of the State of Victoria, acting by and with the advice of the Executive Council of that State, do by this my Proclamation indicate the *Public Works Loan and Application Act 1946* (No. 2) (No. 5199) and the *Public Works Loan and Application Act 1947* (No. 5240) as enactments which are to be added to those mentioned in the Second Schedule to the *Acts Enumeration and Revision Act 1958*.

Given under my Hand and the Seal of the State of Victoria aforesaid at Melbourne this first day of June in the year of Our Lord One thousand nine hundred and sixty-five and in the fourteenth year of the reign of Her Majesty Queen Elizabeth II.

(L.S.) ROHAN DELACOMBE.

By His Excellency's Command,

V. F. WILCOX,
Acting Attorney-General.

GOD SAVE THE QUEEN!

HEALTH (CHILD MINDING) ACT 1964 (No. 7122).
DATE OF COMING INTO OPERATION.

PROCLAMATION

By His Excellency the Governor of the State of Victoria and its Dependencies in the Commonwealth of Australia, &c., &c., &c.

WHEREAS by sub-section (3) of section 1 of the *Health (Child Minding) Act 1964* (No. 7122) it is provided that the said Act shall come into operation on a day to be fixed by proclamation of the Governor in Council published in the *Government Gazette*:

NOW THEREFORE I, the Governor of the State of Victoria, in the Commonwealth of Australia, by and with the advice of the Executive Council of the said State, do by this my Proclamation fix Thursday the first day of July, One thousand nine hundred and sixty-five, as the day on which the said *Health (Child Minding) Act 1964* (No. 7122) shall come into operation.

Given under my Hand and the Seal of the State of Victoria aforesaid, at Melbourne, this twenty-fifth day of May, in the year of our Lord, One thousand nine hundred and sixty-five, and in the fourteenth year of the reign of Her Majesty Queen Elizabeth II.

(L.S.) ROHAN DELACOMBE.

By His Excellency's Command,

J. ROSSITER,
Acting Minister of Health.

GOD SAVE THE QUEEN!

PUBLIC HOLIDAYS.

PROCLAMATION

By His Excellency the Governor of the State of Victoria and its Dependencies in the Commonwealth of Australia, &c., &c., &c.

IN pursuance of the provisions contained in Part III. of the *Public Service Act 1958*, I, the Governor of the State of Victoria, in the Commonwealth of Australia, by and with the advice of the Executive Council of the said State, do by this my Proclamation appoint the days and dates hereunder mentioned to be observed as Public Half-Holidays at the places respectively specified, viz.:—

Public Half-Holidays from the Hour of Twelve o'clock noon:—

WEDNESDAY, THE 17TH NOVEMBER, 1965, throughout the City of Hamilton.

* THURSDAY, THE 18TH NOVEMBER, 1965, throughout the City of Hamilton.

* Agricultural Show.

Given under my Hand and the Seal of the State of Victoria aforesaid, at Melbourne, this twenty-fifth day of May, in the year of our Lord One thousand nine hundred and sixty-five, and in the fourteenth year of the reign of Her Majesty Queen Elizabeth II.

(L.S.) ROHAN DELACOMBE.

By His Excellency's Command,

V. F. WILCOX,
Acting Chief Secretary.

GOD SAVE THE QUEEN!

BANK HOLIDAY.

PROCLAMATION

By His Excellency the Governor of the State of Victoria and its Dependencies in the Commonwealth of Australia, &c., &c., &c.

IN pursuance of the provisions of the *Bank Holidays Act 1958*, I the Governor of the State of Victoria, in the Commonwealth of Australia, do by this my Proclamation appoint the day and date named hereunder a special day to be observed as a Bank Half-Holiday at the place mentioned, that is to say:—

Bank Half-Holiday from the Hour of Eleven o'clock a.m.:—
THURSDAY, THE 10TH JUNE, 1965, at Stratford.

Given under my Hand and the Seal of the State of Victoria aforesaid, at Melbourne, this first day of June, in the year of our Lord One thousand nine hundred and sixty-five, and in the fourteenth year of the reign of Her Majesty Queen Elizabeth II.

(L.S.) ROHAN DELACOMBE.

By His Excellency's Command,

V. F. WILCOX,
Acting Chief Secretary.

GOD SAVE THE QUEEN!

PUBLIC HOLIDAY.—QUEEN'S BIRTHDAY.

IT is hereby notified that on—

MONDAY, THE 14TH JUNE, 1965,

the Public Offices will be closed, such day having been appointed by the *Public Service Act 1958* to be observed as a holiday in the Public Offices throughout the State of Victoria.

This notice relates only to the closing of the State Public Offices. All inquiries regarding the holiday in other offices and in shops and industry, should be directed to the Department of Labour and Industry, 110 Exhibition-street, Melbourne, C.1 (Telephone 63 0321, Extension 6158 or 6721).

A. G. RYLAH,
Chief Secretary.

Chief Secretary's Office,
Melbourne, C.1, 12th May, 1965.

(The Proclamation appears in the *Government Gazette* dated 12th February, 1964.)

Town and Country Planning Act 1961.

CITY OF MOORABBIN PLANNING SCHEME 1952.

AMENDMENT No. 16, 1964.

Notice of Approval.

IN pursuance of the powers conferred by the *Town and Country Planning Act 1961*, the Governor in Council on the 1st June, 1965, approved a planning scheme entitled the City of Moorabbin Planning Scheme 1952, Amendment No. 16, 1964, in respect of part of the municipal district of the City of Moorabbin.

A copy of the planning scheme as approved may be inspected, during office hours, at the office of the Town and Country Planning Board, 179 Queen-street, Melbourne; at the office of the Moorabbin City Council at Moorabbin, and when available, at the Office of Titles, Melbourne, and at the Central Plan Office of the Department of Crown Lands and Survey, Melbourne.

W. H. CRAIG, Secretary,
Town and Country Planning Board.

MILK BOARD ACT 1958.

IN accordance with the provisions of section 4A of the *Milk Board Act 1958*, the Milk Board hereby exempts from the provisions of the said Act, from the date of publication of this notice until 30th June, 1968, all milk intended for use by the under-mentioned companies in the manufacture of yoghurt:—

Irrewarra Pty. Ltd., 85 City-road, South Melbourne.
Peters (Vic.) Yarragon Dairy Co. Pty. Ltd., Yarragon.
Keren Dairy Products Pty. Ltd., 720 Heidelberg-road, Alphonston.

W. DOBINSON,
Secretary.

Process Servers and Inquiry Agents Act 1958.

APPLICATION FOR LICENCES LODGED WITH CLERKS OF COURTS.

BY direction of the Chief Secretary, the subjoined lists of "new" applications for process servers and inquiry agents licences are published for general information.

Applicant.	Address.	Court.	Tentative Date of Hearing of Application.
<i>Inquiry Agents Licences.</i>			
Barallon, Allen Robert	58 Victoria-avenue, Albert Park	South Melbourne	15.6.65
Black, Margaret May	Monash Hotel, Dandenong-road, Clayton	Oakleigh	25.6.65
Fodor, Steven	17 Hopetoun-street, Elsternwick	Elsternwick	22.6.65
Frost, George Derek	Blackwood-avenue, Belgrave	Fern Tree Gully	21.6.65
Mallo-Alonso, Elesban	83 Fortuna-avenue, North Balwyn	Kew	17.6.65
<i>Process Servers Licences.</i>			
Black, Margaret May	Monash Hotel, Dandenong-road, Clayton	Oakleigh	25.6.65
Digman, Henry Stephenson	Room 4, 128A Commercial-road, Prahran	Prahran	10.6.65
Edwards, Leo Royden	3 Crosbie-road, Murrumbena	Oakleigh	4.6.65
Fodor, Steven	17 Hopetoun-street, Elsternwick	Elsternwick	22.6.65
Frost, George Derek	Blackwood-avenue, Belgrave	Fern Tree Gully	21.6.65
Mallo-Alonso, Elesban	83 Fortuna-avenue, North Balwyn	Kew	17.6.65

Attention is directed to the provisions of the above Act and regulations thereunder relating to the lodgement of objections to applications.

Chief Secretary's Office,
Melbourne, 31st May, 1965.

C. W. PHILLIPS, Registrar,
Process Servers and Inquiry Agents.

AUCTION SALES ACT.

LIST of Persons to whom Auctioneer's Licences have been issued during the month of April, 1965, and prior months:—

Name.	Address.	Date of Issue.
Backman, John Charles	35 Bowen-street, Warragul	1.4.65
Earl, Geoffrey Enos	72 Fairview-avenue, Geelong	15.4.65
Geddes, Ian John	30 Clarke-street, Hamilton	23.4.65
Glanville, Francis William	11 Pritchard-street, Swan Hill	1.1.65
Gray, John Noel	110 Curlewis-street, Swan Hill	1.1.65
*Keleher, Gerald David	132 Station-street, Aspendale	26.4.65
McMahon, Thomas David	89 McCallum-street, Swan Hill	1.1.65
Martin, James Patrick	10 Newman's-road, Templestowe	28.4.65
Meldrum, Ian Douglas	65 Broadway-street, Camberwell	30.4.65
Salton, Allan Arthur John	51 Belgravia-avenue, Box Hill North	26.4.65
Stagg, Charles Alexander	Knight-street, Maffra	19.1.65
Taylor, James Alister	Duke-street, Rosedale	19.1.65
Warren, William Alexander	22 Trafalgar-street, Mont Albert	26.4.65
White, Marshall	26 Sunlight-crescent, East Brighton	29.4.65

* By Transfer from A. W. Sims.

The Treasury,
Melbourne, C.2, 26th May, 1965.

E. W. COATES,
Director of Finance.

THE LICENSING ACT.

WHEREAS the victualler's licence for the licensed premises known as the Sarsfield Hotel, situate at Sarsfield, in the licensing area of Bairnsdale, has been surrendered as from the thirty-first day of December, 1964, notice is hereby given that the amount of compensation payable to the owners and occupier of such premises, pursuant to the provisions of the *Licensing Act 1958*, is as under:—

Owners, £500; occupier, £100.

Dated at Melbourne, this twenty-first day of May, 1965.

W. E. McALLISTER,
Registrar of the Victorian Licensing Court.

THE LICENSING ACT.

WHEREAS the victualler's licence for the licensed premises known as the Railway Hotel, situate at Casterton, in the licensing area of Hamilton, has been surrendered as from the first day of March, 1965, notice is hereby given that the amount of compensation payable to the owner of such premises, pursuant to the provisions of the *Licensing Act 1958*, is as under:—

Owner, £1,555.

Dated at Melbourne, this twenty-first day of May, 1965.

W. E. McALLISTER,
Registrar of the Victorian Licensing Court.

DEPARTMENT OF MINES.

SUBJECT to any necessary excisions, &c., it is proposed to grant the following mining lease:—

8209, Mineral; Leon Jerome Le Grand; 11a. 0r. 5p., Parish of Holey Plains.

CONSENT GRANTED TO TRANSFER MINING LEASES.

5599, Gippsland; from Samuel Phillip Macumber to Glen Wills Goldfields No Liability.

5606, Gippsland; from Samuel Phillip Macumber to Glen Wills Goldfields No Liability.

7222, Mineral; from Wedderburn Brick and Pipe Works Pty. Ltd., to Angelo Buffon.

MINERAL SEARCH LICENCE EXPIRED.

536, Mineral Search Licence; Hilary Fynes-Clinton Nevill and Howard Jarvis; 480 acres, Parish of Dorchap.

T. A. DARCY,
Minister of Mines.

TAILINGS LICENCE DECLARED VOID.

3239, Tailings Licence; Reginald David Rewell; 22a. 3r. 34p., Parish of Maldon.

E. CONDON,
Secretary for Mines.

Transport Regulation Act.
TRANSPORT REGULATION BOARD.

HEARING OF APPLICATIONS.

NOTICE is hereby given that the following applications will be considered by the Transport Regulation Board at its offices at Rathdown-street, Carlton, at 10.15 a.m., on Wednesday, 23rd June, 1965.

BERBERICK, R. (MRS.) (trading as Clayton Nursery, Kindergarten and Creche), 1 Adaleigh-court, Clayton. One commercial passenger vehicle (S/C. 4) to operate free of charge for the carriage of kindergarten children to and from the creche and to the children's home addresses situated in Clayton, Springvale, Huntingdale and Oakleigh.

CROYDON AND DISTRICTS RETARDED AND SPASTIC CHILDREN'S WELFARE ASSOCIATION, 4 Alto-avenue, Croydon. One commercial passenger vehicle (S/C. 11) to operate free of charge for the carriage of retarded and spastic children to and from their home addresses in the Bayswater and Croydon areas and the Associations Day Centre at Croydon.

FINLAY, W. F., 92 Dorking-road, Box Hill. One commercial passenger vehicle to be purchased with large seating capacity to operate as a country stage omnibus on the following route:—Mount Waverley—Sadie-street: Commencing from Mount Waverley Railway Station via Stephenson's-road, Virginia-street, Woodstock-road, William-street, Dallas-street, Athol-street, Heany-street, Paynes-road, Oakern-street, Lewton-road to Sadie-street.

Sections on Route:

(a) Mount Waverley—corner Athol and Heany streets.

(b) Corner Athol and Heany streets—Sadie-street.

Time-tables to be operated and fares to be charged may be obtained on request to the Board.

FINLAY, W. F., 92 Dorking-road, Box Hill. One commercial passenger vehicle to be purchased with large seating capacity to operate as a country stage omnibus on the following route:—Mount Waverley—Pinewood: Commencing from Mount Waverley Railway Station via Stephenson's-road, The Highway, Mt. Pleasant-drive, Forster-road, Wilga-street, Tooroodun-street, Toombah-street, Pinewood-drive to shops at Blackburn-road, with extension along Forster-road to Fern Tree Gully-road during peak periods.

Sections on Route:

(a) Mount Waverley Railway Station—French-street (1 mile).

(b) Waverley-road—Blackburn-road (1.25 mile).

Sections overlap along Forster-road between Waverley-road and French-street.

Time-tables to be operated and fares to be charged may be obtained on request to the Board.

FINLAY, W. F., 92 Dorking-road, Box Hill. One commercial passenger vehicle to be purchased with large seating capacity to operate as a country stage omnibus on the following route:—Mount Waverley—Gordon-road: Commencing from Mount Waverley Railway Station via Stephenson's-road, Waimarie-drive, Wills-avenue, Lawrence-road, High Street-road, Josephine-avenue to Gordon-road.

Sections on Route:

(a) Mount Waverley Railway Station—Prince-street.

(b) Prince-street—Gordon-road.

Time-tables to be operated and fares to be charged may be obtained on request to the Board.

HORTICULTURAL INDUSTRIES PTY. LTD., 327 Plummer-street, Port Melbourne. One commercial passenger vehicle (S/C. 10) to operate free of charge for the carriage of employees from South Gate to company premises, Port Melbourne via Riverside-avenue, Yarra Bank-road, Normanby-road, Williamstown-road, Smith-road and Plummer-street.

Time-table:

Depart South Gate: 7.45 a.m.; 8.35 a.m.

Depart Port Melbourne: 4.35 p.m.; 5.5 p.m.

McHARRY, N. J. & A. M., 43 The Esplanade, Drumcondra, Geelong. One commercial passenger vehicle (S/C. 39) to operate under the same terms and conditions as existing "U.O." licences in the name of the applicants.

PINCINI, E. J. & L., PTY. LTD., Baths-road, Mirboo North. One commercial passenger vehicle (S/C. 41) to operate as follows:—(a) For the carriage of school children only between Limonite and Mirboo North under contract to the Education Department. (b) As a country special service omnibus from Boolarra.

POINT COOK—WERRIBEE PASSENGER SERVICE PTY. LTD., Railway-avenue, Laverton. Application for permit authority to operate any "M.C." licensed vehicle at separate and distinct fares from the Footscray Railway Station via Geelong-road to the Brooklyn Speedway.

Fare: 3s. single.

Time-table: (Sundays only): Depart Footscray 11.30 a.m.; Depart Speedway 5.30 p.m.

POINT COOK—WERRIBEE PASSENGER SERVICE PTY. LTD., Railway-avenue, Laverton. Application for permit authority to operate any "C.O." licensed vehicle at separate and distinct fares from Werribee to the Brooklyn Speedway.

Fare: 3s. Single.

Time-table: (Sundays only): As required to carry traffic offering.

RUSSELL, V. E. (MRS.), 656 Bell-street, Pascoe Vale. One commercial passenger vehicle (S/C. 6) to operate free of charge for the carriage of children to and from their home addresses in Pascoe Vale, Glenroy, Broadmeadows, Campbellfield, Fawkner, Brunswick, Coburg and Reservoir and the applicants child minding centre at 97 Bell-street, Pascoe Vale and or 656 Bell-street, Pascoe Vale.

SCORAH, J. F. & M. M., Woodend-road, Lancefield. One commercial passenger vehicle (S/C. 7) to operate under the same terms and conditions as existing C.O. licences in the name of the applicants.

DYSON'S, L. C., BUS SERVICES PTY. LTD., 753 Plenty-road, Reservoir. Application to operate the Nathalia to Melbourne stage omnibus service as at present operated by the applicant company under licences numbered C.O.166 and C.O.320 with the following amendment:—To vary existing condition on area to be served, Monday to Saturday, to include places on route between Lady's Pass and a point 1 mile south of Kilmore. Application submitted in view of intention by the Victorian Railway Commissioners to discontinue the existing passenger rail service between Heathcote and Heathcote Junction.

N.B.—Conditions of licence permits area to be served on Sundays from Nathalia to Wallan.

HARRISON, G. J., F. & M. (trading as Harrison's Coaches), 1 Francis-street, Echuca. Application to operate the Lockington to Melbourne stage omnibus service as at present operated by the applicants under licences numbered C.O.135 and C.O.153 with the following amendment:—To vary existing condition on area to be served, Monday to Saturday, to include places on route between Lady's Pass and a point 1 mile south of Kilmore. Application submitted in view of intention by the Victorian Railway Commissioners to discontinue the existing passenger rail service between Heathcote and Heathcote Junction.

N.B.—Conditions of licence permits area to be served on Sundays from Lockington to Wallan.

SEYMOUR PASSENGER SERVICE PTY. LTD., 7 Wallis-street, Seymour. Application to operate under the same terms and conditions as authorized under country omnibus licences held by the applicant company with the following amendment:—To operate a stage omnibus service on school days only between Broadford and Kilmore via Hume Highway, departing Broadford at 8.50 a.m. and Kilmore at 3.55 p.m.

Fares:

Adults, 3s. single; Children, 1s. 6d. single.

SEYMOUR PASSENGER SERVICE PTY. LTD., 7 Wallis-street, Seymour. Application to operate under the same terms and conditions as authorized under country omnibus licences held by the applicant company with the following amendment:—To operate a stage omnibus service between Kilmore and Kilmore East Railway Station on the following time-table:—

Depart Kilmore—

7.05 a.m. Monday to Saturday.

8.50 a.m. School days only.

3.30 p.m. School days only.

6.50 p.m. Monday to Friday.

1.55 p.m. Saturday.

Depart Kilmore East—

7.22 a.m. Monday to Saturday.

9.05 a.m. School days only.

3.45 p.m. School days only.

7.05 p.m. Monday to Friday.

2.10 p.m. Saturdays.

Fares—

Adults 1s. 6d. Single.

Children 9d. Single.

Application submitted in view of intention of the Victorian Railways Commissioners to discontinue the existing passenger rail service between Heathcote and Heathcote Junction, to provide a service connecting

with rail service from Kilmore East to Melbourne and to meet the need of transport requirements for schools in Kilmore.

APPPLICATION for renewal of licences as shown, by persons listed hereunder to operate under the same terms and conditions:—

BANKS-SMITH, R., 76 Marshall-avenue, North Clayton; C.T.457.
 BOX HILL & DISTRICT RETARDED & SPASTIC CHILDREN'S ASSOCIATION, 37 Thurston-street, Box Hill; T.P.55.
 COON, L. J., Waubra; T.P.5.
 CURRAN, H. W. & N. E. J. (trading as Curran and Sons), 12 Barkly-street, West Ararat; C.T.530.
 DAWSON, L. A., (Mrs.) 11 Huntingdon-road, East Bentleigh; T.P.17.
 DIXON, R. M., & Sons, Swann-street, Brim; T.P.104.
 GANGEMI, V., 3 Mowat-street, West Geelong; T.P.233.
 GEELONG & DISTRICT ASSOCIATION FOR WELFARE OF DEAF CHILDREN, Pakington-street, West Geelong; T.P.19, T.P.80.
 GENERAL MOTORS-HOLDEN'S PTY. LTD., Salmon-street, Port Melbourne; T.P.21.
 MOON, F. H., King-street, Flinders; T.S.218.
 MCKENZIE, C. F., Shoreham; T.S.554.
 ORGANS BUS SERVICE PTY. LTD., 32 Yaldwin-street, West Kyneton; T.S.219.
 ROBERTSON, K. M., 9 Quarry-road, Mitcham; C.T.61.
 SMALE, G. V., 120 Kars-street, Frankston; C.T.644.

Notice of any objection should be forwarded to reach the Secretary of the Board not later than Wednesday, 16th June, 1965.

Applicants as above are advised that it will not be necessary to appear on the hearing date specified unless advised in writing by the Board.

B. P. KAY,
 Secretary.

Exhibition Buildings, Rathdown-street, Carlton, N.3,
 Wednesday, 2nd June, 1965.

Commercial Goods Vehicles Act.
 TRANSPORT REGULATION BOARD.

HEARING OF APPLICATIONS.

NOTICE is hereby given that the following applications will be considered by the Transport Regulation Board at its offices at Rathdown-street, Carlton, at 10.15 a.m. on Wednesday, 23rd June, 1965.

ASCOT PTY. LTD., 171 Fitzroy-street, St. Kilda. Application to vary the conditions of licence No. D.A.34589/31 (L/C. 194 cwt.) by deleting from the existing conditions "paragraph (a)" and adding in lieu as paragraph (a) "within a 25-mile radius of the G.P.O. Melbourne—own goods".
 ASCOT PTY. LTD., 171 Fitzroy-street, St. Kilda. Application to vary the conditions of licence No. D.A.34589/22 (L/C. 23 cwt.) by deleting the existing conditions and adding in lieu "To operate in the course of business as 'Structural Engineers'—(a) Within a 50-mile radius from the G.P.O. Melbourne—own goods but excluding the carriage of goods from the City of Geelong. (b) Throughout the State of Victoria—tools of trade and equipment only. (c) Within a 20-mile radius from the site of any project currently engaged upon or from the railway station nearest thereto—materials for use on such project".
 ATHANASIADIS, J., 25 Mason-street, Traralgon. One commercial goods vehicle (L/C. 135 cwt.) to operate within 25 miles of the A.P.M. at Maryvale—pulpwood.
 AUSTRALIAN COMBUSTION INDUSTRY, 81 Bell-street, West Heidelberg. One commercial goods vehicle (7 cwt.) to operate throughout the State of Victoria in the course of business as "Slow Combustion Fitters"—slow combustion stoves, oil heaters, appliances, tools of trade and small quantity of materials incidental to the installation and repair of such units.
 BEAUREPAIRE TYRE SERVICE PTY. LTD., 102 Victoria-street, Carlton. One commercial goods vehicle (11 cwt.) to operate within a 50-mile radius of own premises at Burwood in the course of business as "Tire Retreaders and Distributors"—tires and tubes for sale and delivery, used tires and tubes for repair or retreading or having been repaired or retreaded, batteries, oil and motor car accessories.
 BEAUREPAIRE TYRE SERVICE PTY. LTD., 102 Victoria-street, Carlton. One commercial goods vehicle (11 cwt.) to operate within a 50-mile radius of own premises at Flemington in the course of business as "Tire Retreaders and Distributors"—tires and tubes for sale and delivery, used tires for repair or retreading or having been repaired or retreaded, batteries, oil and car accessories.

BLACKNEY, C. A. (trading as Blackney's Fish Supply), 119 Ryrie-street, Geelong. One commercial goods vehicle (23 cwt.) to operate in the course of business as "Frozen Food Supplied": (a) Within a 50-mile radius from the chief post office in the City of Geelong—processed frozen vegetables and frozen fish. (b) From own premises in the City of Geelong frozen processed food products and frozen fish to the City of Warrnambool and places en route via the Princes Highway.

BLANKSBY, L. J., Post Office, Tremont. One commercial goods vehicle (8 cwt.) to operate within a 50-mile radius of Wunderlich Ltd. at South Melbourne as a serviceman engaged on aluminium window and door installations—tools of trade, spare parts and windows and doors for repair or fitting.

BRANSON, R. A. & G. T. KICK (trading as Branson and Kick), 263 Beveridge-street, Swan Hill. One commercial goods vehicle (9 cwt.) to operate: (a) Within a 20-mile radius of post office at Swan Hill—general goods. (b) Within a 50-mile radius of post office at Swan Hill—fresh fruit and vegetables.

BRUMNIACH, M. & C., 204 Separation-street, Bell Park. One commercial goods vehicle (202 cwt.) to operate within a 50-mile radius from the chief post office in the City of Geelong solely on behalf of Geelong—Premixed Concrete Pty. Ltd.—premixed concrete in a specially constructed agitator vehicle.

CAMBARVILLE TRANSPORT CO., 171 Doncaster-road, North Balwyn. Application to vary the conditions of licence No. T.T.D.157 (245 cwt.) by adding to the existing conditions as an additional paragraph "from Ringwood to own sawmill at Cambarville—petroleum products in prescribed types of containers and empty return containers to be used at the said mill."

CARINYA PTY. LTD., Woolsthorpe. Application to vary the conditions of licence No. D.A.15269 (L/C. 17 cwt.) by deleting from the existing conditions "paragraph (a)" and adding in lieu "From places within the area defined in paragraph (c) to consignees in Portland—wool".

CERAMIC TRANSPORT PTY. LTD., 125 Springvale-road, Springvale. Two commercial goods vehicles (280 and 140 cwt.) to operate: (a) Within a 20-mile radius of post office at Springvale—general goods. (b) Within a 70-mile radius of the premises of Brick Industries Ltd. at Burwood—bricks on behalf of the said company.

CLARKE, W. D., P.O. Bag 17, Warrnambool. One commercial goods vehicle (120 cwt.) to operate: (a) Within a 20-mile radius of the post office at Hawkesdale—general goods. (b) From and to places as defined in paragraph (a) above to and from places situate within a 50-mile radius of the post office at Hawkesdale—likestock. (c) Within a 50-mile radius from the post office at Hawkesdale in the course of business as a "Primary Producer"—own goods.

CROCKFORD & ROBERTSON PTY. LTD., 15 Abbott-street, Fairfield. Two commercial goods vehicles (16 cwt. each) to operate throughout the State of Victoria in the course of business as "Air Control Engineers"—tools of trade, spare parts and materials incidental to the servicing and installation of heating and air conditioning systems.

DAVIS, C. E., P.O. Box 64, Euroa. One commercial goods vehicle (8 cwt.) to operate: (a) Within a 20-mile radius of the Euroa Post Office—general goods. (b) Within a 20-mile radius from the premises of the Benalla Dairy Co. and to and from Kobyboyn, Habbies Howe and Highlands—milk, cream, empty cans and goods the property of Benalla Dairy Co.

FAGG, KEITH, PTY. LTD., 628 Canterbury-road, Vermont. Two commercial goods vehicles (142 and 141 cwt.) to operate: (a) Within a 25-mile radius of Melbourne in course of business as "Sand, Screenings, Stone and Hardware Suppliers"—own goods. (b) From Bacchus Marsh and Balliang to places within paragraph (a) sand, gravel and stone.

FELT & TEXTILES OF AUSTRALIA LTD. (trading as Goodchild Shoes), 73 Cromwell-street, Collingwood. Three commercial goods vehicles (60, 58 and 51 cwt.) to operate: (a) Within a 50-mile radius of own premises at Collingwood in course of business as footwear manufacturers—own goods. (b) From Melbourne to own premises at Maldon—raw materials and partly manufactured articles, returning with manufactured articles.

GREY, G., 12 McFarlane-street, Stratford. One commercial goods vehicle (340 cwt.) to operate within a 50-mile radius of own premises at Stratford in the course of business as "Timber Contractor" own bulldozer, tools of trade and equipment.

- HAUSER, N., 29 Tallangatta-road, Wodonga. One commercial goods vehicle (101 cwt.) to operate: (a) From forest landings within a 50-mile radius of post office at Red Bluff to own mill at Red Bluff—logs. (b) From own mill at Red Bluff to consignees within a 50-mile radius thereof—sawn timber.
- INDUSTRIAL TRACTOR & EARTHMOVING EQUIPMENT PTY. LTD., cnr. Dougharty and Kyla roads, West Heidelberg. One commercial goods vehicle (12 cwt.) to operate throughout the State of Victoria in the course of business as "Industrial Tractor Sales and Service"—tools of trade and spare parts incidental to the servicing of industrial machinery.
- KENNEDY, K. T., 53 Wawunna-road, Horsham. One commercial goods vehicle (100 cwt.) to operate: (a) Within a 20-mile radius of post office at Horsham—general goods. (b) Within a 50-mile radius of post office at Horsham—petroleum products in prescribed types of containers and empty return containers solely on behalf of Neptune Oil Co. Pty. Ltd.
- KOETSVELD, A. I. & B. J., Nar-Nar-Goon. Two commercial goods vehicles (137 and 127 cwt.) to operate: (a) Within a 50-mile radius of Nar-Nar-Goon Post Office—general goods. (b) Throughout the State of Victoria livestock.
- LECHTE, G. R. & V. F., 11 Hunter-street, Murrumbidgee. One commercial goods vehicle (171 cwt.) to operate within a 50-mile radius of the Plant of Bayview Quarries Pty. Ltd. at Springvale—premixed concrete in a specially constructed agitator vehicle solely on behalf of the said company.
- LINDTON, L. E., 11 Textile-avenue, Wangaratta. One commercial goods vehicle (8 cwt.) to operate throughout the State of Victoria in the course of business as "Signwriter"—tools of trade and equipment and small quantity of materials incidental to the completion of own contracts.
- MENDOLA, G. N., 789 Nicholson-street, North Carlton. One commercial goods vehicle (25 cwt.) to operate within a 100-mile radius of Melbourne in course of business as "Marine Dealer and Scrap Metal Collector"—marine goods and scrap metals.
- MYER (BALLARAT) PTY. LTD., 301 Sturt-street, Ballarat. One commercial goods vehicle (15 cwt.) to operate: (a) Within a 50-mile radius from the chief post office in the City of Ballarat—own goods. (b) Within that part of the State of Victoria bounded by and including the Cities of Warrambool, Horsham, Bendigo and Geelong for the purpose of installing and repairing television receivers, refrigerators and washing machines—appliances for installation, for repair or having been repaired and for return, tools of trade, spare parts and materials incidental thereto.
- MYER (BALLARAT) PTY. LTD., 301 Sturt-street, Ballarat. Application to vary the conditions of licence No. D.A.31084/5 (16 cwt.) by adding to existing conditions as an additional paragraph for delivery of new furniture to customers within the area as defined in paragraph (b) above.
- MCDONALD, J. W. & W. W. (trading as J. & W. McDonald), 2 Kokoda-avenue, Hamilton. Application to vary the conditions of licence No. D.A.48931 (273 cwt.) by adding to the existing conditions as an additional paragraph "the carriage of raw materials to Nagorcka and Yuill, approved decentralized secondary industry, manufacturers of builders joinery, Hamilton".
- MCDONALD, W. W., 2 Kokoda-avenue, Hamilton. Application to vary the conditions of licence No. T.T.D.723 (324 cwt.) by adding to the existing conditions as an additional paragraph "the carriage of raw materials to Nagorcka and Yuill, approved decentralized secondary industry, manufacturers of builders joinery, Hamilton".
- NESCI, T., Station-street, Yarram. Application to vary the conditions of licence Nos. D.A.50678, D.A.50678/1, D.A.50678/2 and D.A.50678/3 (120, 246, 120 and 240 cwt.) by adding to the existing conditions as an additional paragraph "From Breweries in Melbourne direct to farms within a 30-mile radius of Yarram—wet brewers grains in bulk".
- PERRIS, N. L. & Y. F., 12 Mathoura-street, Horsham. One commercial goods vehicle (116 cwt.) to operate: (a) Within a 20-mile radius from the Horsham Post Office general goods. (b) Within a 50-mile radius from Ampol Petroleum (Vic.) Pty. Ltd., depot at Horsham and from Horsham to Beulah—petroleum products in prescribed types of containers and empty return containers. (c) Within a 50-mile radius from the Horsham Post Office—empty bulk tanks on behalf of Ampol Petroleum (Vic.) Pty. Ltd.
- PORTER, G. E., PTY. LTD., 15 Queen's-parade, Clifton Hill. One commercial goods vehicle (207 cwt.) to operate (a) Within a 25-mile radius of Melbourne—general goods. (b) From the South Dynon railway terminal to consignees in the Geelong area—hard coke in bulk.
- PORTER, G. E., PTY. LTD., 15 Queen's-parade, Clifton Hill. Application to vary the conditions of licence No. D.A.54561 (176 cwt.) by deleting the present conditions and adding in lieu "(a) Within a 25-mile radius of Melbourne—general goods. (b) From the South Dynon railway terminal to consignees in the Geelong area—hard coke in bulk".
- PRE-MIXED CONCRETE (BALLARAT) PTY. LTD., 11 Lydiard-street south, Ballarat. One commercial goods vehicle (184 cwt.) to operate within a 50-mile radius from own premises at Ballarat in the course of business as "Suppliers of Premixed Concrete" in a specially constructed bulk agitator vehicle—own ready mixed concrete.
- RUBIN, J., 15 Morgan-street, Carnegie. One commercial goods vehicle (146 cwt.) to operate: (a) Within a 35-mile radius of the premises of Bayview Quarries Pty. Ltd., at Montrose—screenings and stone dust on behalf of the said company. (b) From pits within the above radius to the said premises—sand.
- RUMBLE, K. L., 126 Park-street west, Ballarat. One commercial goods vehicle (78 cwt.) to operate throughout the State of Victoria in the course of business as "Marine Collector"—marine goods as designated in the *Marine Stores and Old Metals Act 1958* (No. 6303) but excluding the carriage of any such goods to wharves, docks or ships for shipment or export purposes.
- RUSCHMEYER, W. E., 15 Mahon-avenue, Bendigo. One commercial goods vehicle (18 cwt.) to operate throughout the State of Victoria in the course of business as "Marine Collector"—marine goods as designated in the *Marine Stores and Old Metals Act 1958* (No. 6303), but excluding the carriage of any such goods to wharves, docks or ships for shipment or export purposes.
- SMITH, F. G., 118 Colac-road, Camperdown. One commercial goods vehicle (10 cwt.) to operate within a 50-mile radius of own premises at Camperdown in the course of business as a "Plumber"—own goods, plumbing appliances for repair or having been repaired, tools of trade and equipment incidental thereto.
- STONEHAM, S. R. (trading as W. J. Stoneham), 49 Mostyn-street, Castlemaine. One commercial goods vehicle (112 cwt.) to operate within a 50-mile radius of the Castlemaine Post Office in the course of business as "General Merchants"—own goods.
- SVANOSIO, N. L. & J. A., 83 Neale-street, Bendigo. One commercial goods vehicle (131 cwt.) to operate: (a) Within a 95-mile radius of the post office at Cohuna and within a 100-mile radius of the post office at Merbein (Bendigo Division of the C.R.B.) as a "Road Contractor"—road-making plant and materials. (b) Within a 25-mile radius of the post office at Bendigo—general goods.
- TRARALGON MIXED CONCRETE PTY. LTD., P.O. Box 194, Liddiards-road, Traralgon. One commercial goods vehicle (184 cwt.) to operate within a 50-mile radius of own premises at Traralgon in the course of business as "Premixed Concrete Manufacturers"—own premixed concrete in a specially constructed agitator vehicle.
- TREGENZA, D. G., Post Office, Karawinna. One commercial goods vehicle (68 cwt.) to operate: (a) Within a 20-mile radius of the post office at Karawinna—general goods. (b) From depots at Mildura to places situate within a 20-mile radius of post office at Karawinna—petroleum products in prescribed types of containers and empty return containers.
- TYRESOLES (GEELONG) PTY. LTD., 158 Melbourne-road, North Geelong. One commercial goods vehicle (19 cwt.) to operate from and to own premises at North Geelong to and from the Townships of Werribee, Bacchus Marsh, Meredith, Lismore, Camperdown, Port Campbell, Apollo Bay and Lorne in the course of business as "Tire Retreaders and Distributors"—tires and tubes for sale and delivery, used tires for repair or retreading and having been repaired or retreaded, batteries, oil, motor car accessories and polythene piping.
- WISE, E. J. & R. G. (trading as J. & R. Wise), Blake-street, Skipton. One commercial goods vehicle (154 cwt.) to operate: (a) Within a 20-mile radius from the post office at Skipton—general goods. (b) From and to places situate within the radius as described in paragraph (a) above and from places situate within a 50-mile radius from the post office at Skipton—livestock.
- WOODS, T. H., 12 Albert-street, Richmond. Application to vary the conditions of licence No. D.A.51507 (L/C. 183 cwt.) by deleting from the present conditions "Ready Mixed Concrete (Vic.) Pty. Ltd. at Nunawading" and adding in lieu "Pioneer Concrete (Vic.) Pty. Ltd. at Preston".

TOW TRUCKS.

- ANDERSON, K. L., PTY. LTD., South Gippsland Highway, Tooradin. One commercial goods vehicle (54 cwt.) to operate as a "Tow Truck" throughout the State of Victoria for the purpose of lifting and carrying or towing and/or repairing wrecked or disabled vehicles—tools of trade, spare parts and materials incidental thereto.
- MARTIN, W. S. & W. D. (trading as Watsonia Garage), 349-359 Greensborough-road, Watsonia. One commercial goods vehicle (63 cwt.) to operate as a "Tow Truck" throughout the State of Victoria for the purpose of lifting and carrying or towing and/or repairing wrecked or disabled vehicles—tools of trade, spare parts and materials incidental thereto.
- WOLFENDEN, W. K. & T. L. PRIMMER, 24 Brown-street, East Geelong. Application to vary the conditions of licence No. D.A.46985 (105 cwt.) by deleting "within a 50-mile radius of Geelong" and adding in lieu "to operate throughout the State of Victoria."

APPPLICATION for renewal of licence as shown by persons listed hereunder to operate under the same terms and conditions from the date of expiry shown in each case.

- AINGER, J. W., Burwood-road, Wantirna South; D.A.43991/1; 7th August, 1965; 52 cwt.
- ASCOM PTY. LTD., 171 Fitzroy-street, St. Kilda; D.A.34589/6; 1st August, 1965; 68 cwt.
- ASCOM PTY. LTD., 171 Fitzroy-street, St. Kilda; D.A.34589/7; 1st August, 1965; 57 cwt.; D.A.34589/8; 1st August, 1965; 118 cwt.; D.A.34589/9; 7th August, 1965; 237 cwt.
- CHAMBERS, H. M., 36 Ross-street, Tatura; D.A.6306; 10th August, 1965; 8 cwt.
- DELAHEY, R. D., 17 William-street, Bacchus Marsh; D.A.3378/1; 31st August, 1965; 227 cwt.
- ELMER, L. G. & R. H., Victoria-road, Beechworth; D.A.42398/2; 1st August, 1965; 145 cwt.
- GENERAL MOTORS-HOLDEN'S PTY. LTD., Princes Highway, Dandenong; D.A.27925/42; 1st August, 1965; 10 cwt.
- GRUMMISCH, C. H., Bass; D.A.26319/2; 26th August, 1965; 19 cwt.
- HARRISON, E. H. & L. G., 33 Wellman-street, Box Hill; D.A.42027/1; 14th August, 1965; 74 cwt.
- JORDAN, R. A., PTY. LTD., 16 Levanswell-road, Moorabbin; D.A.44035/1; 14th August, 1965; 8 cwt.; D.A.44035/2; 14th August, 1965; 11 cwt.; D.A.44035/3; 14th August, 1965; 11 cwt.; D.A.44035/4; 14th August, 1965; 10 cwt.
- MILLS, B. G. & R. L., Fernshaw-road, Healesville; D.A.32607/2; 3rd July, 1965; 142 cwt.
- MCDONALD, W. L., Whitfield; D.A.1671/1; 2nd June, 1965; 118 cwt.
- ROCHE, H. C. J., 33 Wade-street, Portland; D.A.44183/1; 21st August, 1965; 105 cwt.
- VEAL, H. J., PTY. LTD., 120 King-street, Melbourne; D.A.2201; 1st August, 1965; 194 cwt.
- YARRA VALLEY TYRE CO. PTY. LTD., 50 Maroondah Highway, Ringwood; D.A.43328/2; 13th June, 1965; 11 cwt.

Notice of any objection should be forwarded to reach the Secretary of the Board not later than Wednesday, 16th June, 1965.

Applicants are advised that it will not be necessary to appear on the hearing date specified above, unless advised in writing by the Board.

B. P. KAY,
Secretary.

Exhibition Buildings, Rathdown-street, Carlton, N.3, 2nd June, 1965.

Transport Regulation Act.
TRANSPORT REGULATION BOARD.
NOTICE No. 66.

*Hiring Rates and Fares Specified for Metropolitan
Taxi-cabs and Private Hire Cars.*

TAKE notice that, pursuant to powers conferred on the Board by the provisions of Regulation 45 of Part III. of the Transport Consolidated Regulations 1960, the Board hereby specifies, in accordance with the provisions of Regulation 5 of Part I. of the said Regulations, amendments to Notice No. 57 notified in *Victoria Government Gazette* No. 72 dated 27th July, 1960, as stated hereunder:

PART (D) FARES.

Sub-paragraph (a) is amended as follows:—

- (i) By substituting for the expression "sub-paragraphs (b) and (c) hereof" in (i) thereof the expression "sub-paragraph (b) hereof".
- (ii) By deleting from (iii) thereof the expression "and in sub-paragraph (c) hereof".

Sub-paragraph (b) is amended as follows:—

- (i) By inserting after the words "Such fares shall relate to" the words "and shall be the only fares charged for".
- (ii) By adding under the heading "From Loading Stands in the City of Melbourne (excluding Newmarket)" the expression "To Sandown Park Racecourse (horse race-meetings only)—0 12 0".
- (iii) By adding under the heading "From Loading Stands in the City of Camberwell" the expression "To Sandown Park Racecourse (horse race-meetings only)—0 9 0".
- (iv) By adding under the heading "From Loading Stands in the City of St. Kilda" the expression "To Sandown Park Racecourse (horse race-meetings only)—0 9 0".
- (v) By adding under the heading "From Loading Stand in Gordon-street, Elsternwick, City of Caulfield" the expression "To Sandown Park Racecourse (horse race-meetings only)—0 8 0".
- (vi) By substituting for the expression "(a)" in the concluding paragraph the expression "(b)".

By order of the Transport Regulation Board.

B. P. KAY,
Secretary.

Children's Welfare Act 1958.

DECLARATION OF INSTITUTION AS AN APPROVED
CHILDREN'S HOME.

IN accordance with the provisions of Regulation 42 of Division 1 of the Social Welfare Regulations 1962, notice is hereby given that on the twentieth day of May, 1965, acting in pursuance of the powers conferred by sub-section (1) of section 14 of the *Children's Welfare Act 1958*, I declared The Menzies Homes for Children, 2 Wise-avenue, Seaford, as an approved children's home for the purposes of the said Act.

V. F. WILCOX,
Acting Chief Secretary.

Chief Secretary's Office,
Melbourne, 20th May, 1965.

Children's Welfare Act 1958.

DECLARATION OF INSTITUTION AS AN APPROVED
CHILDREN'S HOME.

IN accordance with the provisions of Regulation 42 of Division 1 of the Social Welfare Regulations 1962, notice is hereby given that on the twentieth day of May, 1965, acting in pursuance of the powers conferred by sub-section (1) of section 14 of the *Children's Welfare Act 1958*, I declared The Menzies Homes for Children, 14 Namur-street, Noble Park, as an approved children's home for the purposes of the said Act.

V. F. WILCOX,
Acting Chief Secretary.

Chief Secretary's Office,
Melbourne, 20th May, 1965.

Children's Welfare Act 1958.

DECLARATION OF INSTITUTION AS AN APPROVED
CHILDREN'S HOME.

IN accordance with the provisions of Regulation 42 of Division 1 of the Social Welfare Regulations 1962, notice is hereby given that on the twentieth day of May, 1965, acting in pursuance of the powers conferred by sub-section (1) of section 14 of the *Children's Welfare Act 1958*, I declared The Menzies Homes for Children, 469 Heatherton-road, Dandenong, as an approved children's home for the purposes of the said Act.

V. F. WILCOX,
Acting Chief Secretary.

Chief Secretary's Office,
Melbourne, 20th May, 1965.

CONTRACTS ACCEPTED.—(Series 1964-65.)**VICTORIAN RAILWAYS.**

115. Demolition and removal of Locomotive Maintenance Shed, water tank tower and workshops building at North Melbourne, for £698 15s. 6d. (Contract 62701).—H. Myska and A. Liebreuz. 116. Design, manufacture, supply, delivery and installation of flashing light signals at eleven country locations, for £38,875 (Contract 62742).—McKenzie & Holland (Aust.) Pty. Ltd. 117. Supply and delivery of axle boxes at £46 2s. each (Contract 62745).—The S.K.F. Ball Bearing Co. (Australia) Pty. Ltd. 118. Manufacture, supply and delivery of a control console and track diagram (illuminated) for Flinders-street, for £7,597 15s. (Contract 62797).—McKenzie & Holland (Aust.) Pty. Ltd.

By order of the Victorian Railways Commissioners,
W. WALKER, Secretary. 28.5.65.

PRISONERS' MEALS IN LOCK-UPS.**CONTRACT CANCELLED.**

Gazette No. 63, 15th July, 1964, Prisoners' Meals—Shepparton. Contract No. 283, is hereby cancelled.

CONTRACT ACCEPTED.

3852. For the supply of Prisoners' Meals at Shepparton, from 19th May, 1965, to 30th June, 1965, Breakfast and Tea, 3s.; Hot Dinner, 3s. 6d.—Reid & Kelson, Shepparton Hotel, Shepparton.

GENERAL STORES.

Gazette No. 62, 9th July, 1964, Schedule No. 29, Cordage, Lines, &c.—For the rates shown opposite the following items, substitute the rates as set out hereunder:—Item No. 1, 2s. 6d. per lb.; Item No. 2, 2s. 10½d. per lb.; Item No. 16, 1½-in. and up, 3s. 0½d. per lb.; 1½-in. and 1¼-in., 3s. 1½d. per lb.; 1¼-in., 3s. 1½d. per lb.; 1-in., 3s. 1½d. per lb.; ¾-in. 3s. 2½d. per lb.; ½-in. 3s. 3½d. per lb.; ¼-in., 3s. 6½d. per lb.; ¼-in., 3s. 11d. per lb.; Trawl Twine, 3s. 5½d. per lb., as from 7th May, 1965.

Gazette No. 62, 9th July, 1964, Schedule No. 53, Leather.—For Item No. 13, substitute 11s. 10d. each, as from 1st February, 1965.

Gazette No. 62, 9th July, 1964, Schedule No. 54, Metals.—For Item No. 10, substitute £190 1s. per ton, as from 12th May, 1965.

Gazette No. 19, 24th March, 1965, Schedule No. 56, Motor Spirit, &c.—Rates for Item Nos. 2 and 3 have been reduced by ¼d. per gallon, as from 12th May, 1965.

Gazette No. 29, 31st March, 1965, Schedule No. 52, Tools (General).—For rates shown opposite the following items, substitute the rates as set out hereunder:—Item No. 21, 11s. per gross, as from 10th April, 1965; Item No. 47, £7 14s. 10d. per dozen, as from 1st April, 1965; Item No. 179, £2 8s. per gross, as from 1st April, 1965.

Supplies under Item Nos. 48 to 50 and 290 are to be purchased under clause 109 of the Regulations.

H. COUTTS, Secretary to the Tender Board. 31.5.65.

PUBLIC WORKS.

3853. Ararat, Social Welfare Department, Gaol, erection of a new prison, £388,957.—McDougall-Ireland Pty. Ltd.

3854. Camperdown, State School No. 114, erection of class-rooms, &c., £55,329.—A. V. Jennings Industries (Aust.) Ltd.

3855. Clayton, Monash University, Secondary Teachers' College, supply and installation of plenum heating, exhaust ventilation and hot-water system, £28,064.—Belsair Pty. Ltd.

3856. Mt. Waverley, High School, 1st and 2nd sections of concrete block veneer timber-framed school buildings, £118,333.—J. P. Wolbers.

3857. Mt. Waverley, High School, supply and installation of mechanical services, Stages 1 and 2, £12,780.—Thermic Heating & Ventilation.

3858. Niddrie, Police Station, erection of brick Police Station and Residence, &c., £27,575.—Riviera Homes Pty. Ltd.

3859. Plenty, Mental Hospital, supply and installation of steam, condensate, hot-water and heating services for three Geriatric Wards, £37,243.—Supertherm Industries Pty. Ltd.

3860. Ringwood, Technical School, asphalt paving, concrete paving, retaining walls, drainage and associated works, £20,499 11s.—Sheffield Paving & Construction Co.

3861. Stony Point, Public Works Department, Jetty Construction, 200-ft. extension to jetty, £46,698 18s. 7d.—M. R. Hornbrook (N.S.W.) Pty. Ltd.

3862. Various, Primary Schools, additions to six (6) timber-framed Primary Schools at Frankston Forest, Dandenong South, Sunshine Heights, Overport, Heather-hill and Bon Beach, £84,594.—D. B. Tincknell Pty. Ltd.

3863. Warrnambool, Mental Hospital, provision of additional facilities for kitchen and store, £17,196 18s.—R. F. Bishop.

3864. Yallourn, High School, extensions and remodelling, £78,359.—A. V. Jennings Industries (Aust.) Ltd.

3865. Yallourn, High School, supply and installation of mechanical services, £17,340.—Ford-Swinton Industries Pty. Ltd.

3866. Ararat, State School No. 800, construction of class-rooms, library and storerooms, &c., £4,429.—A. V. Jennings Industries (Aust.) Ltd.

3867. Ararat, Mental Hospital, supply and installation of a new main switchboard, £804.—R. Lonsdale.

3868. Ballarat, Mental Hospital, electrical installation for new Engineers Workshop and Garage, £775.—R. Lonsdale.

3869. Bon Beach, State School No. 4798, extension of plenum heating to four (4) class-rooms, £1,969.—Chadstone Air Conditioning Services.

3870. Brunswick North, State School No. 3585, additional drinking and washing facilities, &c., £786 10s.—Kilkenny Bros.

3871. Brunswick East, State School No. 3179, replacement of urinal, pedestal pans and additional drinking and washing facilities, £1,599.—G. & J. Little.

3872. Brunswick North-West, State School No. 4399, additional drinking and washing facilities, &c., £719 10s.—Kilkenny Bros.

3873. Carlton, State School No. 2605, additional toilet accommodation, £2,010.—Egeberg Building & Plumbing Service.

3874. Caulfield, Technical College, internal repairs and painting, £1,940.—N. Borazio.

3875. Clifton Hill, State School No. 3146, provision of sheds and fencing, £399.—R. G. Dew.

3876. Dandenong South, State School No. 4810, extension of plenum heating to four (4) class-rooms, £2,100.—Chadstone Air Conditioning Services.

3877. Dookie, Agricultural College, erection of a residence, £5,340 5s. 6d.—W. Phelan & Sons Pty. Ltd.

3878. Fairfield, Infectious Diseases Hospital, supply installation and testing of paging system, £2,640.—Watson Victor Ltd.

3879. Forrest, State School No. 2708 and Residence, renovations, out-offices, septic tank installation, £3,450.—K. H. Helstrup.

3880. Geelong West, State School No. 1492, general repairs, painting and renewal of roofs, £19,000.—N. Peshut.

3881. Glenburn, State School No. 3344 and Residence, internal and external repairs and painting, £1,400.—A. & A. Kortum.

3882. Golden Square, High School, electrical installation in extended stage three, £3,905.—W. R. Parker.

3883. Horsham, High School, provision and erection of two additional class-rooms, etc., £4,598 10s.—A. V. Jennings Industries (Aust.) Ltd.

3884. Kew, Mental Hospital, electrical installation for Maintenance Workshop, £510.—G. W. Weatherill.

3885. Kew, Mental Health Authority, Childrens Cottages, construction of two porous Tennis Courts, £1,410 15s. 6d.—"Weatherproof" Constructions.

3886. Lara, "Serendip" Fisheries and Wildlife Reserve, erection of animal house, £9,985.—C. Van Meurs.

3887. East Malvern, Police Station, renovations to Sergeant's residence, £1,694.—P.R.P. Trio Builders.

3888. Merlynston, State School No. 4328, asphalt repairs, drainage and associated works, £4,499 11s. 6d.—Roy Senior & Son Pty. Ltd.

3889. Melbourne, 632 Bourke-street, Licensing Court, maintenance cleaning, 1st March, 1965, to 28th February, 1966, £1,248.—Aladdin Cleaning Service.

3890. Mitcham, Special School No. 4871, asphalt paving, drainage, retaining walls and associated works, £6,596 7s. 6d.—Sheffield Paving & Construction Co.

3891. Mont Park, Mental Hospital, improved ventilation in L.T.C. building used as ironing and mending room, £601 18s.—W. P. Tresise & Co. Pty. Ltd.

3892. Murrumbidgee, State School No. 4119, new toilet block and septic tank installation, £980.—H. Richards.

3893. Newborough, Yallourn Technical School, supply, delivery and placing in position on site of a packaged steam boiler, £4,050.—George & George Pty. Ltd.

3894. Ouyen, High School, new tanks, repairs and painting, £6,500.—K. H. Helstrup.

3895. Port Melbourne, Mines Department Store, Cook-street, supply and erection of structural steel frame work, £655.—R. G. Dew.

3896. Royal Park, Psychiatric Hospital, alterations and extensions to male convalescent ward for office accommodation, £3,480.—A. La Rovere.

- 3897. Scoresby, Horticultural Research Station, erection of storage shed, £1,977.—R. L. & P. P. Baldwin.
- 3898. Stacey's Bridge, State School No. 3355, erection of out-offices and installation of septic tank, £1,202.—H. A. Wilson.
- 3899. Thomastown East, State School No. 4827, new light duty asphalt, concrete and drainage works, graveling earthworks and beautification, £5,469 15s. 4d.—B. Richards.
- 3900. Wedderburn, Police Station and Court House, septic tank installation, £652.—W. Chalmers.
- 3901. Werribee, Research Station, supply, delivery and installation of air conditioning units in wheat improvement wing, £730 10s.—Kelvinator Australia Ltd.
- 3902. Wodonga, Fisheries and Wildlife Department, residence, 74 William-street, external painting and extensions, provision and installation of S.C. heater, £1,066 10s.—H. Scherf.

JIM BALFOUR, Acting Minister of Public Works.
1.6.65.

ORDERS IN COUNCIL.—(Series 1964-65.)
PUBLIC WORKS.

- 3842. Ballarat, Mental Hospital, renewal of floor tiles in kitchens, Wards 25 and 26, £893.—A. & B. Oswald Pty. Ltd.—(W.267188.)
 - 3843. French Island, Prison Farm, repairs to diesel engine, £810 12s.—Southern Cross Machinery Pty. Ltd.—(S.E.286906.)
 - 3844. Melbourne, Health Department, X-ray Division, Flinders-lane, supply of six (6) 70-mm. Film Filing 8-drawer cabinets, £519 18s.—Melbourne Cine Supplies Pty. Ltd.—(M.56335.)
 - 3845. Merrilands, State School No. 4826, special grant authorized by Education Department towards cost of erection of a canteen building, £807.—Merrilands State School No. 4826 School Committee.—(N.W.55727.)
 - 3846. Wodonga, Technical School, drainage works, £5,317.—Shire of Wodonga.—(N.E.279256.)
- Approved by the Governor in Council, 25th May, 1965.—
J. COLQUHOUN, Clerk of the Executive Council.

EDUCATION DEPARTMENT.

- 3847. One only Vander graph generator with accessories (£52 15s.), one only spectrometer (Griffin model) (£71 11s. 6d.), one only power source for Cathode Ray oscilloscope (£51 10s.) and one only set sectional models steam engines—turbines and diesels (£78 19s.), for Hamilton Technical School, £254 15s. 6d.—Townson & Mercer.
- Approved by the Governor in Council, 25th May, 1965.—
J. COLQUHOUN, Clerk of the Executive Council.

STATE ELECTRICITY COMMISSION.

- 3848. For the supply of 26,000 lbs. of cotton-covered annealed copper strip for transformer manufacture, to Quotation No. 3670, £10,497 10s.—Cablemakers (A.C.T.) Pty. Ltd.
 - 3849. For the supply of 155 amp. active or neutral junction boxes for consumer services for a period of two years, to Specification No. 64165/111, at Schedule rates.—Mahlco Plastics Pty. Ltd.
 - 3850. For the supply of 74 transformer differential relays for system protection, to Specification No. 64-65/211, £16,800.—A. Reyrolle & Co. Ltd.
 - 3851. For the erection of capacitor banks and switch-yard extensions at Metropolitan sub-stations and terminal stations, to Specification No. 64-65/256, £10,900 plus items at Schedule rates.—Switchgear Pty. Ltd.
- Approved by the Governor in Council, 27th April, 1965.—
J. COLQUHOUN, Clerk of the Executive Council.

ROAD TRAFFIC REGULATIONS, 1962.
APPROVAL OF PORTABLE WARNING SIGNAL.

Notice is hereby given that the undermentioned Portable Warning Signal has been approved by me as complying with Regulation 1204 of the Road Traffic Regulations 1962.

Designation Mark.	Submitted by.	Type.	Approval No.
A.E. and S.S.—S.A.A. E.38.	Advance Engineering and Safety Signs Pty. Ltd., rear 20 Vine-street, Blackburn	Triangular—Cataphote beads on both sides	W.19

R. H. ARNOLD,
Chief Commissioner of Police.

Melbourne and Metropolitan
BOARD OF WORKS.

NOTICE is hereby given that after the publication of this advertisement in the *Government Gazette* and once in not less than two daily newspapers published in the metropolis, the Melbourne and Metropolitan Board of Works will proceed to compulsorily take (unless the same is in the meantime acquired by the Board from the owner or owners or other person interested by mutual agreement) the land mentioned and described in the Schedule hereto.

The nature of the works in respect of which the land is proposed to be taken is for the purpose of carrying out sewerage construction works on the South-eastern Trunk Sewer.

A plan of the proposed works will be open for inspection at the offices of the Board, 110 Spencer-street, Melbourne, from the date hereof until the 18th June, 1965, during office hours.

The quantity of land which the Board requires for the purpose of such works and other particulars are set forth below.

The consent of the Governor in Council was duly obtained in terms of the Board's principal Act (No. 6310) on the 11th May, 1965.

SCHEDULE.

All that piece of land being part of Crown allotment 1, section 19, Parish of Mordialloc, commencing at a point in the southern boundary of Centre Dandenong-road 675 feet east of Boundary-road; thence southerly by a line bearing 180 degrees for 150 feet; thence easterly by a line bearing 90 degrees for 127 feet; thence northerly by a line bearing 360 degrees for 150 feet to the southern boundary of Centre Dandenong-road; thence westerly by the last-mentioned boundary for 127 feet to the commencing point and containing 1 rood 30 perches.

Dated the 27th day of May, 1965.

H. J. SNADDEN,
Secretary.

Melbourne and Metropolitan
BOARD OF WORKS.

NOTICE is hereby given that after the publication of this advertisement in the *Government Gazette*, and once in not less than two daily newspapers published in the metropolis, the Melbourne and Metropolitan Board of Works will proceed to compulsorily take (unless the same is in the meantime acquired by the Board from the owner or owners or other person interested by mutual agreement) the land mentioned and described in the Schedule hereto.

The nature of the works in respect of which the land is proposed to be taken is for the purposes in connexion with a drainage retarding basin on Moonee Ponds Creek.

A plan of the proposed works will be open for inspection at the offices of the Board, 110 Spencer-street, Melbourne, from the date hereof until the 18th June, 1965, during office hours.

The quantity of land which the Board requires for the purpose of such works and other particulars are set forth below.

The consent of the Governor in Council was duly obtained in terms of the Board's principal Act (No. 6310), on the 11th May, 1965.

SCHEDULE.

All that piece of land being part of Crown allotments 1 and 2, portion 4, Parish of Tullamarine, commencing at a point bearing 89 deg. 47 min. for 6,276 ft. 3¼ in., 311 deg. 30¼ min. for 131 ft. 10 in. and 273 deg. 44 min. for 235 ft. 4¼ in. from the south-western corner of the land in certificate of title, volume 8418, folio 785; thence northerly by a line bearing 351 deg. 56¼ min. for 582 ft. 10¼ in.; thence southerly by lines bearing 135 deg. 55¼ min. for 232 ft. 2½ in. and 160 deg. 24¼ min. for 299 ft. 7 in.; thence westerly by a line bearing 244 deg. 37¼ min. for 221 ft. 2 in. to the commencing point and containing 1 acre 2 roods 23 3/10 perches.

Dated the 27th day of May, 1965.

H. J. SNADDEN,
Secretary.

Melbourne and Metropolitan
BOARD OF WORKS:

NOTICE TO THE OWNERS OF TENEMENTS IN THE UNDERMENTIONED STREETS, AND THE PRIVATE STREETS, LANES, COURTS AND ALLEYS OPENING THERETO.

THE main pipe in the said streets being laid down, the owners of all tenements situated as under are hereby required, on or before the 5th July, 1965, to cause a proper pipe and stop cocks to be laid so as to supply water within such tenements from the main pipe.

H. J. SNADDEN,
Secretary.

25th May, 1965.

STREET AND POSITION.
Box Hill.

Somers-street, from Banksia-street northwards 2½ chains.
Tudor-street, from Lytton-street eastwards 3½ chains.

Broadmeadows.

Walter-street, from Dickinson-street eastwards 7 chains.

Doncaster and Templestowe.

Tristania-street, from Leeds-road to Lawrence-street.
Howitt-drive, from Caroline-drive to Mirang-avenue.
Bilby-street, from Thompson-road eastwards 5½ chains.
Mirang-avenue, from Bilby-street to Bryson-grove.
Finn-court, from Mirang-avenue south-westwards 5½ chains.
Bryson-grove, from Howitt-drive to Mirang-avenue.
Macedon-road, from Waratah-drive southwards 8½ chains.
Waratah-drive, from Macedon-road eastwards 2½ chains.
Kitson-crescent, from Macedon-road westwards 7 chains.

Hawthorn.

Camberwell-grove, from 3½ chains north of Burke-avenue northwards 1 chain.

Moorabbin.

Druitt-street, from Old Dandenong-road to Glennie-avenue.
Abercrombie-street, from Old Dandenong-road to Axford-crescent.
Axford-crescent, from Old Dandenong-road to Druitt-street.
Teton-court, from Wickham-road southwards 21½ chains.
Gladesville-drive, from 7½ chains east of Bignell-road eastwards, southwards and westwards 12½ chains.
Gardenia-grove, from Centre Dandenong-road south-eastwards 13 chains.
Camelia-grove, from Gardenia-grove southwards and south-eastwards 19 chains.
Ash-court, from Gardenia-grove north-eastwards 3 chains.
Seagull-street, from Camelia-grove southwards 5 chains.

Nunawading.

Burwood-road, from 5 chains east of Blackburn-road eastwards 2½ chains.

Oakleigh.

Haughton-road, from Prince Charles-street to McGregor-street.
Coombs-street, from Huntingdale-road to Alvina-street.
Talbot-avenue, from Coombs-street southwards 7 chains.
Nova-street, from Coombs-street southwards 5½ chains.
Jason-street, from Coombs-street northwards 2½ chains.

Ringwood.

Aurum-crescent, from Glenvale-road north-eastwards 8 chains.

Springvale.

Princes Highway, from Browns-road south-eastwards 7½ chains.
Browns-road, from Princes Highway north-eastwards 19 chains.

Sunshine.

Tudor-road, from Berkshire-road southwards 11 chains.
Ferndale-road, from Tudor-road eastwards 4 chains.

Waverley.

William-street, from 3 chains west of Park-lane to Beverley-grove.
Beverley-grove, from William-street northwards 3 chains.
Woodstock-road, from William-street northwards 3 chains.
Cranleigh-grove, from William-street northwards 2½ chains.
Vasey-avenue, from Wingate-avenue to Taroona-avenue.
Taroona-avenue, from Lawrence-road to Vasey-avenue.
Flame-street, from Nethercote-drive westwards 3 chains.
Nethercote-drive, from 2½ chains south of Birch-street southwards 11 chains.

Whittlesea.

Heyington-avenue, from Marjory-street to Lansell-court.
Lansell-court, from Heyington-avenue northwards and eastwards 11 chains.

Local Government Act 1958.

ROAD DECLARED A PRIVATE STREET.

IN pursuance of the powers conferred by sub-section 3A of section 575 of the Local Government Act 1958, I, James Charles Murray Balfour, Her Majesty's Minister of Lands in the State of Victoria hereby declare that the road set out in Crown land in the Parish of Castlemaine, County of Talbot, as delineated and indicated by hachure on the plan hereunder, be a private street within the meaning of and for the purposes of Division 10, Part XIX. of the said Act.—(C.100(38A).)

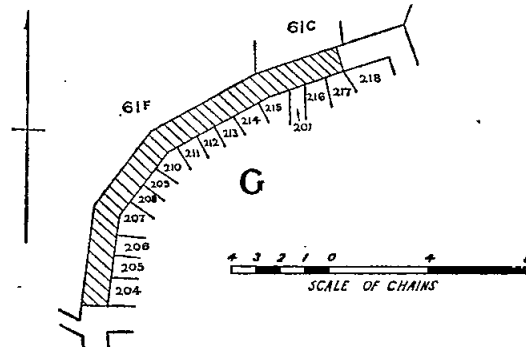

Dated at Melbourne this 19th day of May, 1965.

JIM BALFOUR,
Minister of Lands.

Corres. No. W.68466.

LOCAL GOVERNMENT DEPARTMENT.

ORDER CONFIRMED.—SHIRE OF MORNINGTON.

THE Minister of the Crown administering the Local Government Act 1958, as amended, on the 27th day of May, 1965, confirmed the Order hereinafter referred to, in pursuance of section 514 of the said Act, namely:—

An Order of the Council of the Shire of Mornington made on the 28th April, 1965, directing the compulsory taking of the land described hereunder for the purpose of providing a car park.

All that piece of land being part of Crown allotment 29, section 22, Parish of Moorooduc commencing at a point on the western alignment of Octavia-street distant 151 ft. 4½ in. from the northern alignment of Barkly-street; thence by lines bearing respectively 243 deg. 59 min. for 193 ft. 7 in., 347 deg. 20 min. for 167 ft. 9 in., 62 deg. 8 min. for 143 ft. 1½ in. and 149 deg. 58 min. for 168 ft. 3 in. to the commencing point.

R. J. HAMER,
Minister for Local Government.

Local Government Department,
Melbourne.

LOCAL GOVERNMENT DEPARTMENT.

ORDER CONFIRMED.—SHIRE OF GISBORNE.

THE Minister of the Crown administering the Local Government Act 1958, as amended, on the 24th day of May, 1965, confirmed the Order hereinafter referred to in pursuance of section 514 of the said Act, namely:

An Order of the Council of the Shire of Gisborne made on the 3rd May, 1965, directing the compulsory taking of the lands described hereunder for the purpose of establishing a Shire Depot:

- (a) All that part of Crown allotment 8, section 6, Township of Gisborne, commencing at the north-eastern corner of the said allotment; thence easterly by the northern boundary of the said allotment for 250 links, south-westerly on a bearing of 225 deg. 13 min. for 141.4 links, westerly by the southern boundary of the said allotment a distance of 150 links to the south-western corner thereof and northerly by the western boundary thereof a distance of 100 links to the point of commencement.
- (b) All those parts of Crown allotments 16 and 17, section 6, Township of Gisborne, commencing at the north-eastern corner of allotment 17; thence bearing south 200 links, west 200 links, north 200 links and east 200 links to the point of commencement.

(c) All those parts of Crown allotments 10, and 12, section 6, Township of Gisborne, commencing at the north-eastern corner of allotment 10; thence bearing east 125 links, southerly by a line bearing 184 deg. 45 min. for a distance of 301 links to Fisher-street, west 100 links and thence north by the western boundaries of allotments 12 and 10 for a distance of 300 links to the point of commencement.

R. J. HAMER,
Minister for Local Government.
Local Government Department,
Melbourne.

PUBLIC TRUSTEE ACT 1958 (No. 6350), SECTION 17.

I HEREBY give notice that on the 12th May, 1965, the Public Trustee filed elections to administer the following deceased persons' estates, in accordance with section 17 of the *Public Trustee Act 1958*:—

- DELBURN, LENA RUBY SINCLAIR, also known as Helena Delburn and Lee Delburn, late of 31 Sinclair-avenue, Gardiner, widow, died 11th February, 1965.
- GAY, SAMUEL EDWARD, late of 3 Eurythmic-street, Mordialloc, retired lift driver, died 30th November, 1964.
- GILMORE, JAMES, late of 50 Blyth-street, Brunswick, old-age pensioner, died 26th December, 1964.
- HODGES, EMILY MARY, late of 1 Lewisham-road, Windsor, spinster, died 21st March, 1965.
- SHEEHAN, KATHERINE, late of Queen Elizabeth Home, Ballarat, pensioner, died 6th February, 1965.
- STUART, FRANK KELVIN, late of 33 Thomas-street, Mitcham, retired builder, died 22nd February, 1965.
- SWINDLE, MARY, also known as Mary Swindell, late of 37 O'Farrell-street, Yarraville, spinster, died 8th December, 1964.

A. D. DUNCAN,
Public Trustee.
256 Flinders-street, Melbourne, C.1, 26th May, 1965.

NOTICE.

CREDITORS, next of kin and others having claims against the estate of any of the under-mentioned deceased persons are required to send particulars of their claims to the Public Trustee, 256 Flinders-street, Melbourne, the personal representative, on or before the 3rd August, 1965, after which date the Public Trustee may convey or distribute the assets, having regard only to the claims of which the Public Trustee then has notice:—

- AMEER, ELSIE MAY, late of 14 Nelson-road, Camberwell, widow, died 21st March, 1965.
- APPLEBY, HENRY, formerly of Smithtown, N.S.W., and 25 Calais-road, Scarborough, Western Australia, but late of 17 Drew-street, Wembley, Western Australia, retired factory manager, died 28th August, 1964.
- BURVILL, HAZEL, late of Ararat, widow, died 11th October, 1964.
- CHARLES, WILLIAM JAMES, late of "Hughesden", 4 Hughes-street, Tecoma, retired public servant, died 20th May, 1964.
- DELBURN, LENA RUBY SINCLAIR, also known as Helena Delburn and Lee Delburn, late of 31 Sinclair-avenue, Gardiner, widow, died 11th February, 1965.
- EDWARDS, REBECCA, late of 11 Arthur-street, Preston, widow, died 23rd February, 1965.
- FAULKNER, ETHEL ALICE, late of 5 Bridges-street, Glen Iris, home duties, died 1st December, 1964.
- FREEMAN, FREDERICK HARRY, also known as Fredrick Harry Freeman, late of 7 Kerwan-street, Strathmore, aircraft ground engineer, died 15th February, 1965.
- GAY, SAMUEL EDWARD, late of 3 Eurythmic-street, Mordialloc, retired lift driver, died 30th November, 1964.
- GILMORE, JAMES, late of 50 Blyth-street, Brunswick, old-age pensioner, died 26th December, 1964.
- GLOVER, CHRISTINA ELIZA, late of "Urara", Lismore, Victoria, home duties, died 23rd January, 1965.
- GODDARD, JEANNETTE, also known as Janet Goddard and Jeanette Goddard, late of 50 Wentworth-avenue, Canterbury, widow, died 23rd November, 1964.
- HARRIS, LEILA FLORIS, late of 22 Hamilton-street, West Brunswick, spinster, died 15th February, 1965.
- HEWITT, JOHN, late of 27 Stella-avenue, Noble Park, war pensioner, died 17th October, 1964.
- HODGES, EMILY MARY, late of 1 Lewisham-road, Windsor, spinster, died 21st March, 1965.
- KUZNECOVS, PAULS, late of Hospital H.G., Bonegilla, storeman, died 13th May, 1964.
- PAFF, ADOLF ALFRED HERMAN FRITZ (in the will called Adolf Pfaff), late of 65 Princess-street, Kew, translator, died 27th January, 1965.
- RAISBECK, CHARLES JOSEPH, formerly of 14 Knowles-street, Westgarth, but late of Mount Royal, Parkville, retired boilermaker, died 4th March, 1965.

- SHEEHAN, KATHERINE, late of Queen Elizabeth Home, Ballarat, pensioner, died 6th February, 1965.
- STACK, CATHERINE MARY, late of 1 York-street, Bonbeach, widow, died 14th February, 1965.
- STUART, FRANK KELVIN, late of 33 Thomas-street, Mitcham, retired builder, died 22nd February, 1965.
- SWINDLE, MARY, also known as Mary Swindell, late of 37 O'Farrell-street, Yarraville, spinster, died 8th December, 1964.
- WHEAT, WILLIAM ERNEST, also known as William Earnest Wheat, formerly of 29 Leopold-crescent, Mont Albert, late of 18 Olympiad-crescent, Box Hill, retired telephone technician, died 15th February, 1965.

A. D. DUNCAN,
Public Trustee.

Soil Conservation and Land Utilization Act 1958.

KILMORE WATER SUPPLY CATCHMENT.

Proclaimed 25th May, 1963, *Victoria Government Gazette* No. 41, dated 29th May, 1963, pursuant to section 22 of the *Soil Conservation and Land Utilization Act 1958* (No. 6372).

NOTICE OF DETERMINATION OF LAND-USE.

IN pursuance of the provisions of section 23, sub-section (1) of the *Soil Conservation and Land Utilization Act 1958* (No. 6372), the Soil Conservation Authority has determined the land-use for all that area of land in the Parish of Clonbinane within the boundaries of the Kilmore Water Supply Catchment, delineated and marked on plan No. 1633, the original of which is lodged at the Head Office of the Soil Conservation Authority. All land within this area shall be used in accordance with the provisions of the particular category of land-use to which each area has been assigned.

The provisions of each of the land-use categories are set out hereunder.

Category 1.
Land which shall remain as permanent forest and shall not be disturbed in any way except for the minimum requirements for protective forest maintenance under conditions made or approved by the Soil Conservation Authority. This covers areas within a minimum distance of 1, 2 or 3 chains from the banks of streams as specified on Plan No. 1633.

Category 2.
Land which shall be used for permanent forest, where forestry operations may be carried out only in accordance with conditions made or approved by the Soil Conservation Authority.

PLAN No. 1633.

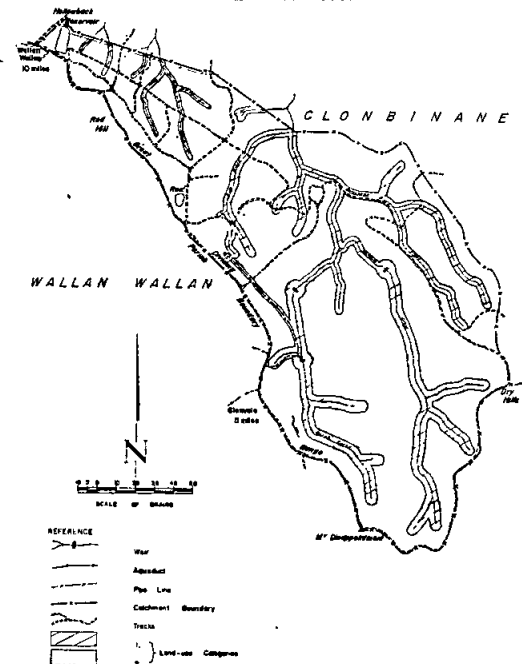

R. D. HALL, Secretary,
Soil Conservation Authority.

BUNGAREE AND WALLACE WATERWORKS TRUST.

FIXING THE LIMIT OF A BANK OVERDRAFT.

HIS Excellency the Governor of the State of Victoria, by and with the advice of the Executive Council thereof, doth, by Order made on the 25th day of May, 1965, in pursuance of the provisions of section 288 of the Water Act 1958 (No. 6413), fix the limit of the overdraft to be obtained by the Bungaree and Wallace Waterworks Trust from the English, Scottish and Australian Bank Limited, Ballarat, at an amount not to exceed at any one time the sum of Eight thousand pounds (£8,000).

J. COLQUHOUN,
Clerk of the Executive Council.

At the Executive Council Chamber,
Melbourne, 25th May, 1965.

SHEPPARTON URBAN WATERWORKS TRUST.

AUTHORITY TO OBTAIN BANK OVERDRAFT.

HIS Excellency the Governor of the State of Victoria, by and with the advice of the Executive Council thereof, doth, by Order made on the 25th day of May, 1965, authorize the Shepparton Urban Waterworks Trust to obtain, in pursuance of the provisions of section 286 of the Water Act 1958 (No. 6413), an advance or advances during the year 1965 from the Australia and New Zealand Bank Limited, Shepparton, by overdraft of the Trust's current account thereat, such overdraft not to exceed at any one time the sum of Ten thousand pounds (£10,000).

J. COLQUHOUN,
Clerk of the Executive Council.

At the Executive Council Chamber,
Melbourne, 25th May, 1965.

SHIRE OF KOWREE WATERWORKS TRUST.

AUTHORITY TO OBTAIN BANK OVERDRAFT.

HIS Excellency the Governor of the State of Victoria, by and with the advice of the Executive Council thereof, doth, by Order made on the 25th day of May, 1965, authorize the Shire of Kowree Waterworks Trust to obtain, in pursuance of the provisions of section 286 of the Water Act 1958 (No. 6413), an advance or advances during the year 1965 from the National Bank of Australasia Limited, Edenhope, by overdraft of the Trust's current account thereat, such overdraft not to exceed at any one time the sum of Three thousand pounds (£3,000).

J. COLQUHOUN,
Clerk of the Executive Council.

At the Executive Council Chamber,
Melbourne, 25th May, 1965.

CANN RIVER IMPROVEMENT TRUST.

BY-LAW No. 2.

THE Cann River Improvement Trust, in pursuance and exercise of the powers conferred by the River Improvement Act 1958, doth hereby make the By-law following:—

1. The following rate, to be called the "Cann River Improvement District River Improvement Rate", is hereby made and shall be levied upon the occupiers or owners of all the properties within the Cann River Improvement District which are rateable to any municipality, a rate of Nine pence in the £1 on the net annual municipal value of such properties. Provided that the sum of One shilling shall be the minimum amount of rate in respect of any property liable to be rated in the said district.

2. Such rate is made and shall be levied for the year beginning with the 1st day of January, 1965, and ending with the 31st day of December, 1965, and shall be payable on the 15th day of June, 1965, at the office of the Cann River Improvement Trust, Noorinbee.

3. Such person or persons as the Cann River Improvement Trust may from time to time appoint for that purpose shall be or is or are hereby authorized to demand, receive, collect, and recover the said rate.

The foregoing By-law was made by the Cann River Improvement Trust on the 23rd day of April, 1965, and the common seal of the said Trust was hereunto affixed on the 23rd day of April, 1965.

(SEAL) GEORGE E. CAMERON, Chairman.
S. T. FILMER, Commissioner.
D. S. BROOME, Secretary.

Approved by the Governor in Council, 25th May, 1965.—
J. COLQUHOUN, Clerk of the Executive Council.

SHEPPARTON URBAN WATERWORKS TRUST.

RATING BY-LAW FOR THE YEAR 1965.

THE Shepparton Urban Waterworks Trust, in pursuance and exercise of the powers conferred by the Water Acts, doth hereby make a rate for the supply of water for domestic purposes of Ten pence in the pound of the annual municipal valuation of lands and tenements liable to be rated within the Shepparton Urban District.

Provided that in no case shall the amount of rate payable per annum in respect of any tenement (other than land on which there is no building) be less than Sixty shillings, and in respect of any land on which there is no building less than Thirty shillings.

Such rates are made and shall be levied upon the occupiers or owners of the said lands and tenements for the year commencing on the 1st day of January, 1965, and shall be payable on the 4th day of June, 1965, at the office of the said Trust.

The maximum quantity of water to be supplied in any one year without further charge to any property rated by the Trust is hereby fixed at the quantity which, at a charge of One shilling and three pence per 1,000 gallons, would produce an amount equal to the amount of the rate levied on such property for the said year.

The charge for water supplied by measure to any property rated by the Trust in excess of such maximum quantity, computed as in the last preceding clause, is hereby fixed at One shilling and three pence per 1,000 gallons.

The charge for water supplied by measure to any property not rated by the Trust is hereby fixed at One shilling and three pence per 1,000 gallons, and the minimum quantity of water to be charged for in cases where water is so supplied is fixed at 40,000 gallons.

The charge for water supplied by measure shall be payable, on demand, at the office of the Trust.

Passed this 11th day of May, 1965.

(SEAL) A. G. ROSS, Chairman.
N. P. HAYMES, Secretary.

Approved, 24th May, 1965.—T. A. DARCY, Minister of Water Supply.

LANG LANG WATERWORKS TRUST.

RATING BY-LAW FOR THE PERIOD 1ST JANUARY TO 31ST DECEMBER, 1965.

THE Lang Lang Waterworks Trust, in pursuance and exercise of the powers conferred by the Water Acts, doth hereby make a rate for the supply of water for domestic purposes of One shilling and seven pence in the pound of the annual municipal valuation of lands and tenements liable to be rated within the Lang Lang Urban District.

Provided that in no case shall the amount of rate payable per annum in respect of any tenement (other than land on which there is no building) be less than Three pounds, and in respect of lands on which there is no building less than Two pounds.

Such rates are made and shall be levied upon the occupiers or owners of the said lands and tenements for the year commencing the 1st day of January, 1965, and ending the 31st day of December, 1965, and shall be payable on the 2nd day of June, 1965, at the office of the said Trust.

The maximum quantity of water to be supplied in any one year, without further charge to any property rated by the Trust, is hereby fixed at the quantity which, at a charge of Two shillings per 1,000 gallons, would produce an amount equal to the amount of the rate levied on such property for the said year.

The charge for water supplied by measure to any property rated by the Trust in excess of such maximum quantity, computed as in the last preceding clause, is hereby fixed at Two shillings and six pence per 1,000 gallons.

The charge for water supplied by measure to any property not rated by the Trust is hereby fixed at Two shillings per 1,000 gallons and the minimum quantity of water to be charged for in cases where water is so supplied is hereby fixed at 70,000 gallons.

The charge for water supplied by measure shall be payable, on demand, at the office of the Trust.

Passed this 6th day of May, 1965.

(SEAL) MAURICE SUPER, Chairman.
ERNEST R. LLOYD, Secretary.

Approved, 24th May, 1965.—T. A. DARCY, Minister of Water Supply.

APPOINTMENT OF A DEPUTY TO A MEMBER OF THE
PUBLIC SERVICE BOARD.

WHEREAS in the manner prescribed by the Regulations and at an election held in conjunction with the election of Frederick Charles McArdle as the public service representative on the Public Service Board, Kevin John Tutty was elected to be his deputy in the case of his suspension, illness or absence:

And whereas the said Frederick Charles McArdle is unable by reason of illness to attend meetings of the Board during the period from the 2nd June, 1965, to the 4th June, 1965, both dates inclusive:

Now therefore, at the request of the said Frederick Charles McArdle, and in pursuance of the powers conferred by section 15 (2A) of the *Public Service Act 1958*, I do hereby appoint the said Kevin John Tutty, to be the deputy of Frederick Charles McArdle, during the above-mentioned period.

Given under my hand at Melbourne this first day of June, 1965.

A. GARRAN,
Chairman.

Motor Car Act 1958, Section 41.

EFFECTIVE DATE OF WITHDRAWAL BY AUTHORIZED
INSURER.

WHEREAS by notice, in writing, dated the twenty-fourth day of May, 1965, the following authorized insurer under Part V. of the *Motor Car Act 1958*, namely—

WESTERN AUSTRALIAN INSURANCE COMPANY (CANBERRA)
LIMITED.

has withdrawn from insurance business in terms of the aforesaid Part:

Now therefore, I, Her Majesty's Acting Chief Secretary for the State of Victoria, in pursuance of section 41 of the said Act, do hereby specify the first day of August, 1965, as the date upon which such withdrawal shall have effect.

V. F. WILCOX,
Acting Chief Secretary.

Chief Secretary's Office,
Melbourne, 27th May, 1965.

APPOINTMENTS.

HIS Excellency the Governor of the State of Victoria, by and with the advice of the Executive Council thereof, has, by Orders made on the 25th day of May, 1965, been pleased to make the under-mentioned appointments, viz.:—

CHIEF SECRETARY'S DEPARTMENT.

Electoral Registrars (Acting).

RAE STOXLAY McDOWELL

to be Electoral Registrar (Acting) for the Armadale and Prahran Subdivisions of the Electoral District of Prahran; and for the South Yarra and Toorak Subdivisions of the Electoral District of Toorak, to take effect on and from the 12th May, 1965, during the absence, on leave, of John Joseph Ireland; and

PATRICK JOSEPH McNAMARA

to be Electoral Registrar (Acting) for the Caulfield West, Elsterwick North, Ripponlea and St. Kilda North Subdivisions of the Electoral District of Ripponlea; and for the St. Kilda, St. Kilda Park and St. Kilda West Subdivisions of the Electoral District of St. Kilda, to take effect on and from the 12th May, 1965, during the absence, on leave, of Rae Stoxlay McDowell.

Licensing Inspector.

ALFRED WILLIAM JOHN SIMMONS, Superintendent of Police, Grade II,
to be a Licensing Inspector for the purposes of the *Licensing Act 1958*, vice George William McCulloch, resigned.

Public Auditor.

COLIN RICHARD PROWSE,
pursuant to the provisions of the *Friendly Societies Act 1958*, to be a Public Auditor for the purposes of the said Act.

MINISTRY OF HEALTH.

Members of Committees of Management of Hospitals.

GERALD MAXWELL ANDERSON
to be a Member of Committee of Management of the Coryong and District Hospital, pursuant to proviso (a) of section 48 (1) of the *Hospitals and Charities Act 1958* for a further period of three years expiring on the 12th June, 1968;

WILLIAM FRANCIS RASHLEIGH

to be a Member of Committee of Management of the Royal Talbot Centre, pursuant to proviso (a) of section 48 (1) of the *Hospitals and Charities Act 1958* for a further period of three years expiring on the 11th June, 1968;

REGINALD FREDERICK JOHN MAY

to be a Member of the Committee of Management of Eildon and District Community Hospital, pursuant to proviso (a) to section 48 (1) of the *Hospitals and Charities Act 1958* for a period of three years, vice H. M. Ford, resigned; and

EUSTACE ALWYNNE ROWLANDS, M.B., B.S., F.R.C.S.,
to be a Member of the Committee of Management of the Dental Hospital of Melbourne, pursuant to proviso (c) to section 48 (1) of the *Hospitals and Charities Act 1958*, on the nomination of the University of Melbourne, for a period of three years.

LAW DEPARTMENT.

Clerk of Petty Sessions, &c.

IAN JAMES BENNETT

to be also Clerk of Petty Sessions and Clerk of the Children's Court at Warburton during the absence of I. M. Griffiths, on annual leave, to take effect from the date of commencement of duty.

Commissioners for Taking Declarations, &c.

BRUCE IAN MACKAY, 27 The Avenue, Windsor,
RONALD JAMES HILL, 8 Cromwell-street, Glenroy,
JOHN PATRICK GREEN, Reservoir-road, Bendigo,
JOHN HENRY PATON, 79 Vine-street, Moonee Ponds,
JOHN ANGUS HOWES, 213 Smith-street, Thornbury,
DONALD SOUTHWOOD PHELTS, 128 The Avenue, Spotswood, and

VERDON PATRICK HEHR, 18 Belmont-street, Belmont, Geelong,

to be Commissioners for taking Declarations and Affidavits, pursuant to the provisions of the *Evidence Act 1958*, to resign upon removing from the neighbourhood of the addresses stated; and

BARRY ALBERT HARDMAN, care of Tour Finance Limited, 83 William-street, Melbourne,

ALBERT LYTTLETON MCFARLANE, care of State Savings Bank of Victoria, 177 Barkly-street, Footscray,

VERNON ARCHIBALD MORETON PARTRIDGE, care of Utah Construction and Engineering Pty. Limited, 505 St. Kilda-road, Melbourne, and

IAN CRAWFORD SMITH, care of Town Hall, Castlemaine,
to be Commissioners for taking Declarations and Affidavits, pursuant to the provisions of the *Evidence Act 1958*, to resign upon ceasing to occupy their present positions.

Judge of the Supreme Court.

EDWARD HAMILTON-ESLER BARBER, who has been a practising barrister of the Supreme Court of the State of Victoria of not less than eight years standing,

to be a Puisne Judge of the Supreme Court of the State of Victoria, pursuant to the provisions of section 7 of the *Supreme Court Act 1958*, vice the Honorable Sir Arthur Dean, retired.

Justices of the Peace.

EDWARD GEORGE SMITH, 77 The Avenue, Spotswood, and

JOHN ESMOND MARTIN SPELLMAN, 440 Burke-road, Camberwell,

to Keep the Peace in the Central Bailiwick of the State of Victoria;

JAMES RICHARD McCANN, 1 Widdicombe-street, Casterton, and

OWEN RICHARD EDWARDS, corner of Church and Lochiel streets, Dimboola,

to Keep the Peace in the Western Bailiwick of the State of Victoria; and

PETER LAWRENCE, Youth Training Centre, Malmesbury,
to Keep the Peace in the Midland Bailiwick of the State of Victoria.

Special Magistrates.

WILLIAM JOHN CUTHILL, and

CHARLES EDGAR ELVISH,

Stipendiary Magistrates, City Court, Melbourne,
to be also Special Magistrates to exercise the jurisdiction of the Metropolitan Industrial Court, to take effect from the date of commencement of duty.

LOCAL GOVERNMENT DEPARTMENT.
Member of Municipal Engineers Board.

NEIL STANLEY GUERIN
to be a Member of the Municipal Engineers Board, pursuant to section 168 of the *Local Government Act 1958*, with effect on and from the 1st day of July, 1965, vice Caleb Grafton Roberts.

DEPARTMENT OF WATER SUPPLY.
Member of Sewerage Authority.

CARLYLE MCQUEEN
to be a Member of the Springvale and Noble Park Sewerage Authority for a period of four years from the date hereof, subject to the provisions of the *Sewerage Districts Act*.

J. COLQUHOUN,
Clerk of the Executive Council.

At the Executive Council Chamber,
Melbourne, 25th May, 1965.

APPOINTMENTS.

HIS Excellency the Governor of the State of Victoria, by and with the advice of the Executive Council thereof, has, by Orders made on the 28th day of May, 1965, been pleased to make the under-mentioned appointments, viz.:—

LAW DEPARTMENT.

Acting Judge of the Supreme Court.

MURRAY VINCENT MCINERNEY, M.A., LL.M., Q.C., a barrister of the Supreme Court of the State of Victoria of not less than eight years standing, to be an Acting Judge of the Supreme Court of the State of Victoria pursuant to the provisions of section 7 of the *Supreme Court Act 1958* during the absence of the Honourable Alexander Duncan Grant Adam on approved leave, to take effect from the date of commencement of duty.

Associate.

WILLIAM HARKNESS McLORINAN
to be Associate to His Honour Mr. Acting Justice McInerney, to take effect from the date of commencement of duty.

J. COLQUHOUN,
Clerk of the Executive Council.

At the Executive Council Chamber,
Melbourne, 28th May, 1965.

APPOINTMENTS.

HIS Excellency the Governor of the State of Victoria, by and with the advice of the Executive Council thereof, has, by Orders made on the 1st day of June, 1965, been pleased to make the under-mentioned appointments, viz.:—

CHIEF SECRETARY'S DEPARTMENT.

Commissioners for Redivision of Victoria into Electoral Districts, &c.

FRANK ERNEST CAHILL, the Chief Electoral Officer,
CHARLES JAMES ALLOTT LACK, the Commonwealth Electoral Officer for the State of Victoria, and
FRANK WILLIAM ARTER, the Surveyor-General,
pursuant to the provisions of section 4 of the *Electoral Provinces and Districts Act 1965* (No. 7270), to be Commissioners for the purposes of the redivision of the State of Victoria into electoral districts and of the southern area into electoral provinces in accordance with the said Act.

DEPARTMENT OF CROWN LANDS AND SURVEY.
Committee of Management.

The Honorable PATRICK LESLIE COLEMAN, C.B.E.,
JOHN XAVIER O'DRISCOLL, Q.C., O.B.E.,
STANDISH MICHAEL KEON,
PERCY PEMBROKE PAGE,
LEWIS LUXTON, C.B.E.,
SIR KENNETH GEORGE LUKE, C.M.G.,
SIR MAURICE ARNOLD NATHAN, K.B.E.,
GEORGE FURNER LANGLEY,
WILLIAM TREVOR LONG, and
HILAIRE GERARD CANTWELL,
for a period of three (3) years ending the 31st May, 1968, and
Councillor EDWARD LEO CURTIS,
for so long as he continues to be a Councillor and the elect of the Council of the City of Melbourne, but nevertheless for no longer than the 31st May, 1968,

pursuant to section 221 of the *Land Act 1958*, to be a Committee of Management of the Land temporarily reserved on the 24th August, 1909, as a site for the Recreation, Convenience and Amusement of the People and for a Children's Playground in the City of Melbourne and known as "Olympic Park."

J. COLQUHOUN,
Clerk of the Executive Council.

At the Executive Council Chamber,
Melbourne, 1st June, 1965.

RESIGNATIONS.

HIS Excellency the Governor of the State of Victoria, by and with the advice of the Executive Council thereof, has, by Orders made on the 25th day of May, 1965, accepted the resignations of the persons named hereunder of the offices mentioned, viz.:—

CHIEF SECRETARY'S DEPARTMENT.

MICHAEL FRANCIS SHARKEY, as a Licensing Inspector for the purposes of the *Licensing Act 1958*, to date from and inclusive of the 10th May, 1965.

LAW DEPARTMENT.

The Honorable EDWARD HAMILTON ESLEER BARBER, as an Acting Judge of the Supreme Court of the State of Victoria during the absence of the Honorable Alexander Duncan Grant Adam, on approved leave, to take effect from midnight on the 24th May, 1965.

His Honour Judge EDWARD HAMILTON ESLEER BARBER, as a Judge of the County Court and Chairman of General Sessions, to take effect from midnight on the 24th May, 1965.

JOHN ATCHISON STAVELY from the Commission of the Peace for the Eastern Bailiwick of the State of Victoria.

SILVESTER LAWRENCE KILBY from the Commission of the Peace for the Central Bailiwick of the State of Victoria.

J. COLQUHOUN,
Clerk of the Executive Council.

At the Executive Council Chamber,
Melbourne, 25th May, 1965.

MONASH UNIVERSITY ACT 1958.

At the Executive Council Chamber, Melbourne, the
twenty-fifth day of May, 1965.

PRESENT:

His Excellency the Governor of Victoria.
Mr. Bloomfield | Mr. Reid
Mr. Balfour | Mr. Darcy
Mr. Rossiter | Mr. Wilcox.

APPOINTMENT OF MEMBERS OF THE COUNCIL OF
THE MONASH UNIVERSITY.

HIS Excellency the Governor of the State of Victoria, by and with the advice of the Executive Council thereof and in pursuance of the powers conferred by the *Monash University Act 1958*, doth by this Order hereby appoint the under-named persons as members of the Council of the Monash University for a period of four years from and including the dates indicated:—

- (i) Sir ROBERT RUTHERFORD BLACKWOOD, M.C.E., B.E.E., A.M.I.E. (Aust.), from 3rd July, 1965; and
Sir MICHAEL CHAMBERLIN, from 3rd July, 1965 (as representing industrial and commercial interests).
- (ii) GEORGE PRITCHARD HARVEY WILSON, Esq., from 3rd July, 1965 (as representing agricultural interests).
- (iii) The Honorable PERCY VICTOR FELTHAM, M.B.E., M.L.C., from 2nd August, 1965;
Dr. HENRY ALFRED JENKINS, M.L.A., from 2nd August, 1965; and
The Honorable JOHN FREDERICK ROSSITER, M.L.A., from 2nd August, 1965.
(Members of the Parliament of Victoria.)

And the Honorable John Stoughton Bloomfield, Her Majesty's Minister of Education for the State of Victoria, shall give the necessary directions herein accordingly.

J. COLQUHOUN,
Clerk of the Executive Council.

DEPARTMENT OF CROWN LANDS AND SURVEY.

At the Executive Council Chamber, Melbourne, the twenty-fifth day of May, 1965.

PRESENT:

His Excellency the Governor of Victoria.

Mr. Bloomfield	Mr. Reid
Mr. Balfour	Mr. Darcy
Mr. Rossiter	Mr. Wilcox.

LANDS TEMPORARILY RESERVED AS SITES.

HIS Excellency the Governor of the State of Victoria, by and with the advice of the Executive Council thereof, doth hereby, in pursuance of the provisions of the Land Act 1958, reserve, temporarily, and also except from occupation for mining purposes under any miner's right, the lands hereinafter described:—

DURDIDWARRAH.—Site for Public purposes (Supply of Gravel) 13 acres 0 roods 16 perches, Parish of Durdidwarrah, County of Grant, as indicated by hachure on plan hereunder.—(D.135(4) (Rs.8450).

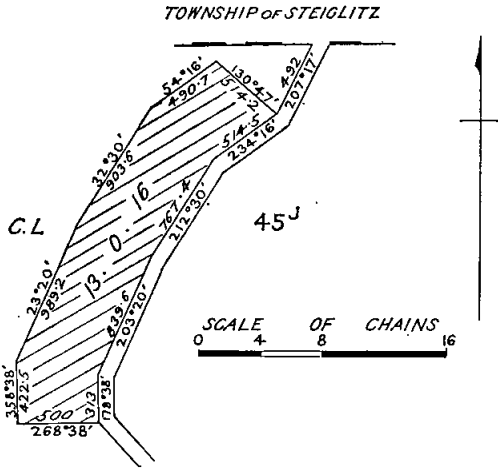

EUROA.—Site for Public purposes (Showground) 1 acre 1 rood 30 perches, Township of Euroa, Parish of Euroa, County of Moira, as indicated by hachure on plan hereunder.—(E.81(3) (Rs.8447).

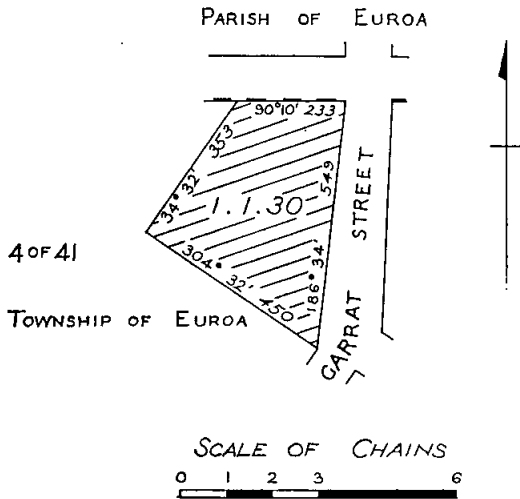

KRAMBRUK (APOLLO BAY).—Site for Public purposes 2 acres 2 roods, more or less, Parish of Krambruk, County of Polwarth, as indicated by hachure on plan hereunder.—(K.149(12) (Rs.4917).

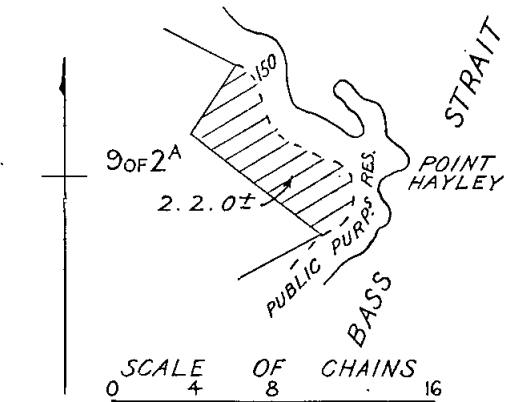

MAJORCA.—Site for Public purposes (Public Hall) 21 perches, Township of Majorca, Parish of Craigie, County of Talbot, as indicated by hachure on plan hereunder.—(M.425(7) (Rs.8423).

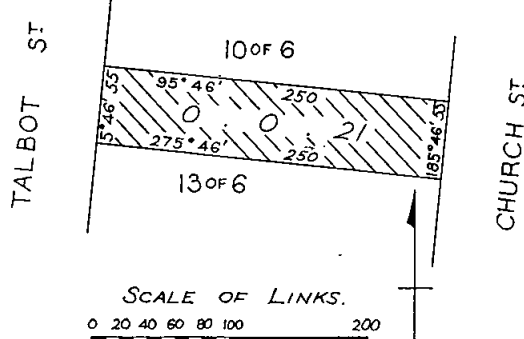

MILDURA (RED CLIFFS).—Site for Public purposes (Sewerage purposes) 30 acres, Parish of Mildura, County of Karkaroc, as indicated by hachure on plan hereunder.—(M.593(P3) (Rs.8448).

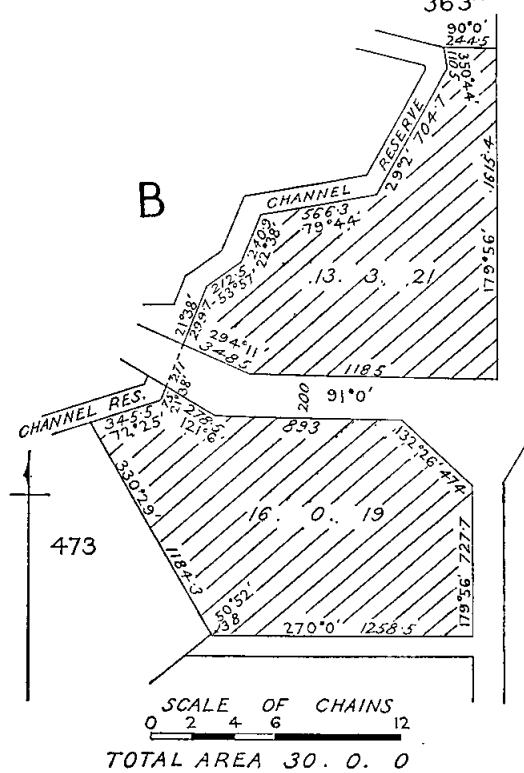

NATTEYALLOCK.—Site for Public Recreation and Play-ground purposes 2 acres 0 roods 33 perches, Parish of Natteyallock, County of Gladstone, as indicated by hachure on plan hereunder.—(N.36⁽³⁾) (Rs.8438).

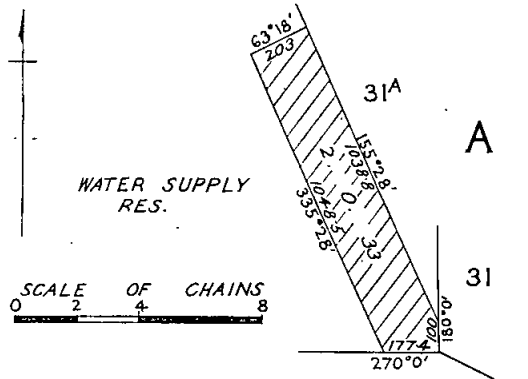

YAN YAN GURT.—Site for Public purposes (Sanitary Depot) 10 acres, Parish of Yan Yan Gurt, County of Polwarth, as indicated by hachure on plan hereunder.—(Y.49⁽³⁾) (Rs.8455).

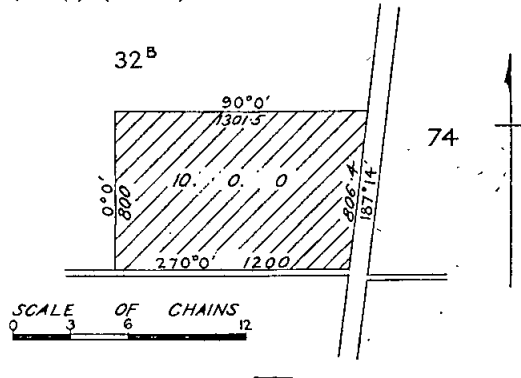

WARBURTON (WESBURN).—Site for Public Park and Recreation in addition to and adjoining the site temporarily reserved therefor by Orders in Council of the 30th August, 1886, and the 29th July, 1889, 2 roods 10 perches, Parish of Warburton, County of Evelyn, as indicated by hachure on plan hereunder.—(W.348⁽¹⁴⁾) (Rs.2136).

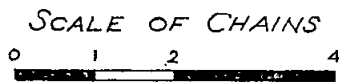
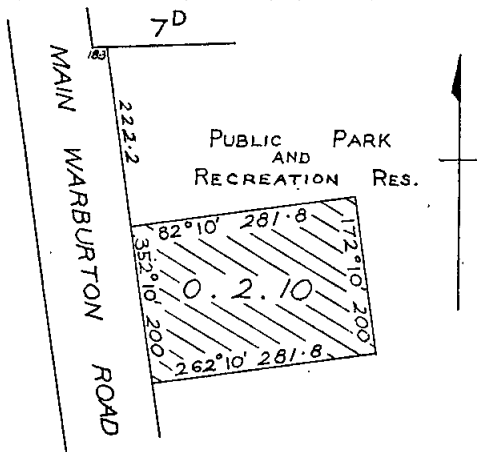

WURRUK.—Site for Public purposes (Public Hall) 32 perches, more or less, Township of Wurruk, Parish of Wurruk Wurruk, County of Tanjil, as indicated by hachure on plan hereunder.—(W.225⁽³⁾) (Rs.8449).

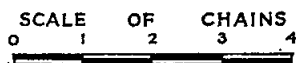
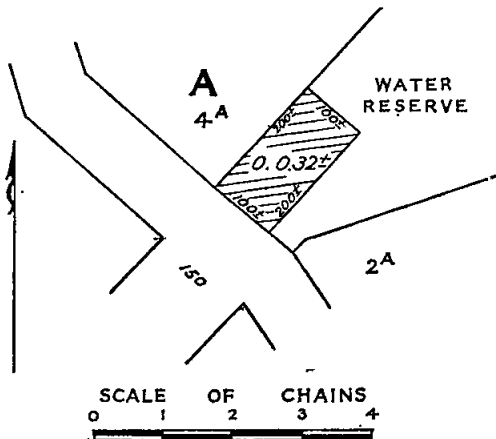

And the Honorable James Charles Murray Balfour, Her Majesty's Minister of Lands for the State of Victoria, shall give the necessary directions herein accordingly.

J. COLQUHOUN,
Clerk of the Executive Council.

DEPARTMENT OF CROWN LANDS AND SURVEY.

At the Executive Council Chamber, Melbourne, the twenty-fifth day of May, 1965.

PRESENT:

His Excellency the Governor of Victoria.
Mr. Bloomfield Mr. Reid
Mr. Balfour Mr. Darcy
Mr. Rossiter Mr. Wilcox.

UNUSED ROADS CLOSED.

HIS Excellency the Governor of the State of Victoria, by and with the advice of the Executive Council thereof, doth hereby direct that, in pursuance of the provisions of section 349 of the Land Act 1958, the unused roads referred to hereunder be closed, viz.:

Parish of Salisbury West, County of Gladstone, being the road indicated by hachure on plan hereunder.—(S.441⁽³⁾) (W.81637).

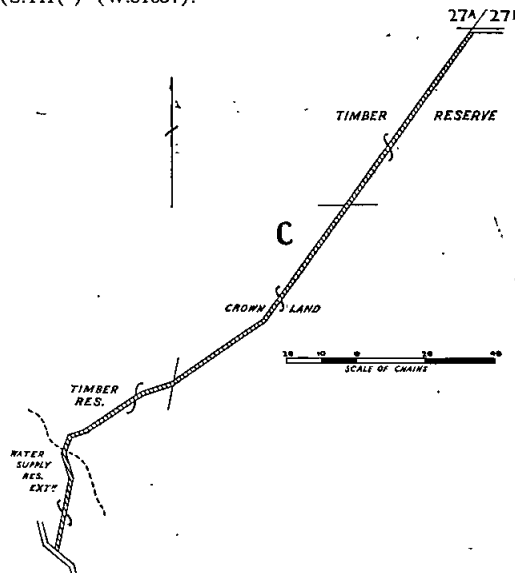

Township of Culgoa, Parish of Kaneira, County of Tatchera, being the portion of the width of the road indicated by hachure on plan hereunder.—(C.485⁽²⁾) (M.41638).

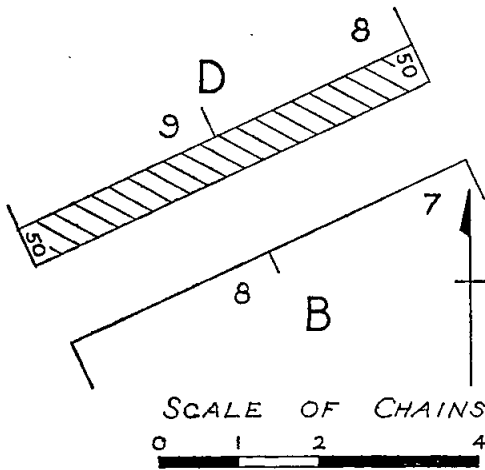

At Bendigo, Parish of Sandhurst, County of Bendigo, being the portion of the width of the road indicated by hachure on plan hereunder.—(S.372⁽¹²³⁾) (W.86596).

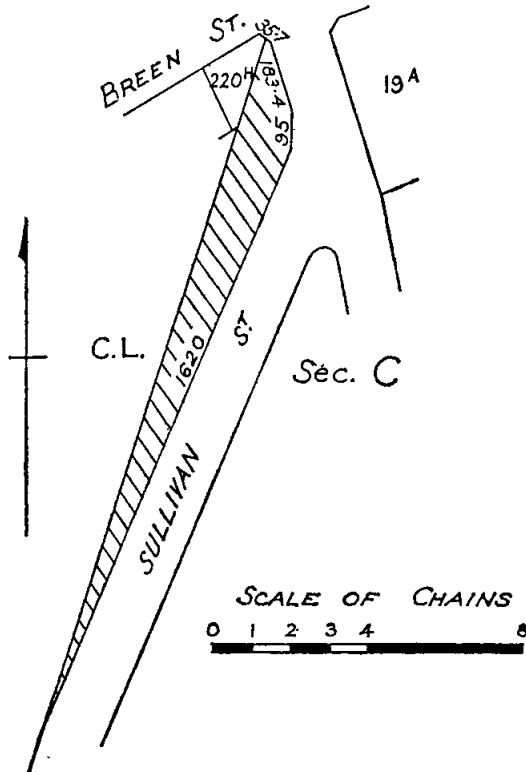

Parish of Kinypanial, County of Gladstone, being the road indicated by hachure on plan hereunder.—(K.56⁽⁷⁾) (W.81060).

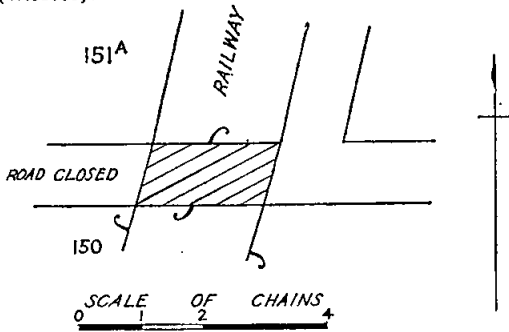

Parish of Pental Island, County of Tatchera, being the road between allotment 43 and allotment 44.—(P.144⁽¹⁾) (W.85690).

And the Honorable James Charles Murray Balfour, Her Majesty's Minister of Lands for the State of Victoria, shall give the necessary directions herein accordingly.

J. COLQUHOUN,
Clerk of the Executive Council.

COUNTRY ROADS BOARD.

At the Executive Council Chamber, Melbourne, the twenty-fifth day of May, 1965.

PRESENT:

His Excellency the Governor of Victoria.	
Mr. Bloomfield	Mr. Reid
Mr. Balfour	Mr. Darcy
Mr. Rossiter	Mr. Wilcox.

DECLARATION OF A DEVIATION FROM THE PRINCES HIGHWAY IN THE SHIRE OF ORBOST.

WHEREAS by sections 74 and 58 of the *Country Roads Act 1958* (No. 6229) it is amongst other things enacted that when the Country Roads Board under the provisions of the *Country Roads Act* has by Resolution declared a deviation to be a State highway the said Board may also declare that such deviation shall be in lieu of any existing highway or part thereof named in such Resolution and that on publication in the *Government Gazette* of the Order confirming such Resolution the existing highway or part thereof shall cease to be a State highway or be discontinued as provided in the Resolution: And whereas the said Board has by Resolution declared the deviation on the land described in the First Schedule to such Resolution to be a State highway and has also declared that such deviation shall be in lieu of the part of the existing highway being the land described in the Second Schedule to the said Resolution and that such part of the said existing highway shall be discontinued: Now therefore His Excellency the Governor of the State of Victoria by and with the advice of the Executive Council thereof doth hereby confirm the said Resolution.

Resolution for Declaration of a Deviation of a State Highway under the Country Roads Act.

Whereas the land the site of the highway the course of which is below set out was taken by the Board under the provisions of the *Country Roads Act 1958* for the purpose of constructing such highway deviation which highway deviation has now been laid out and formed on the same: And whereas the said Board (being the Country Roads Board incorporated under the said Act) thinks that the highway aforesaid is fit to be used as a public highway such Board at a meeting now holden acting under the authority conferred upon it by sections 74 and 58 of the said Act doth by this present Resolution hereby declare the said highway deviation the course of which is described in the First Schedule hereto with the commencing and terminating points thereof respectively specified to be part of a State highway within the meaning and for the purposes of the *Country Roads Act 1958*; And the said Board doth also declare that such deviation shall be in lieu of the existing highway or part thereof described in the Second Schedule hereto and that such part of the said existing highway shall be discontinued.

FIRST SCHEDULE.

Shire of Orbost.

1. *Princes Highway*.—All that piece of land in the Parish of Maramingo, the boundaries of which are as follow:—Commencing at a point on the south-western boundary of allotment 2, section A, of the said parish, distant 154 deg. 23 min. 867 links from the western angle of the said allotment; thence by lines bearing respectively 334 deg. 23 min. 1,276.9 links, 258 deg. 9½ min. 154.4 links, 154 deg. 23 min. 236.5 links, 325 deg. 12 min. 335 links, 333 deg. 35 min. 764.1 links, 335 deg. 18 min. 1,123.4 links, 7 deg. 15 min. 1,137 links, 18 deg. 2 min. 599.6 links, 28 deg. 2 min. 582.2 links, 29 deg. 41 min. 1,656 links, 43 deg. 19 min. 508.3 links, 45 deg. 19 min. 271.5 links, 66 deg. 22 min. 278.8 links, 78 deg. 7 min. 514.8 links, 64 deg. 28 min. 442.2 links, 91 deg. 56 min. 210 links, 120 deg. 59 min. 1,445.3 links, 109 deg. 29 min. 953.6 links, 270

deg. 43 min. 377.2 links, 265 deg. 42 min. 435.5 links, 289 deg. 29 min. 1,247.9 links, 287 deg. 10 min. 359.5 links, 275 deg. 1 min. 366.8 links, 258 deg. 34 min. 439.3 links, 240 deg. 37 min. 439.4 links, 224 deg. 10 min. 425.7 links, 209 deg. 41 min. 1,613.6 links, 208 deg. 2 min. 551.6 links, 198 deg. 2 min. 545 links, 187 deg. 15 min. 506.8 links, 174 deg. 28½ min. 645.7 links, 158 deg. 18 min. 1,668 links, 153 deg. 21 min. 1,546.9 links and 311 deg. 49 min. 194.6 links to the point of commencement—which said piece of land is particularly delineated and shown coloured red, yellow and green on survey plans numbered 8902, 8903 and 8904 lodged in the office of the Country Roads Board.

SECOND SCHEDULE.

Shire of Orbost.

1. *Princes Highway*.—All those pieces of land in the Parish of Maramingo the boundaries of which are as follow:—

- (b) Commencing at a point on the eastern boundary of allotment 1A, section A, Parish of Maramingo, distant 334 deg. 23 min. 943.5 links from the south-eastern angle of the said allotment; thence by lines bearing respectively 302 deg. 52 min. 396 links, 313 deg. 56 min. 155.5 links, 343 deg. 6 min. 55.5 links, 1 deg. 15 min. 423.2 links, 153 deg. 35 min. 237.4 links, 178 deg. 36 min. 207.5 links, 124 deg. 46 min. 182 links and 145 deg. 12 min. 335 links to the point of commencement.
- (b) Commencing at a point in allotment 1A, section A of the said parish, distant 334 deg. 23 min. 943.5 links, 325 deg. 12 min. 335 links and 333 deg. 35 min. 599.5 links from the south-eastern angle of the said allotment; thence by lines bearing respectively 296 deg. 11 min. 387.9 links, 358 deg. 7 min. 618.4 links, 155 deg. 18 min. 257.9 links, 178 deg. 7 min. 320.7 links, 116 deg. 11 min. 197.2 links and 153 deg. 35 min. 164.6 links to the point of commencement.
- (c) Commencing at a point on the northern boundary of allotment 1A, section A, of the said parish, distant 271 deg. 56 min. 431.1 links from the north-eastern angle of the said allotment; thence by lines bearing respectively 171 deg. 17 min. 32 links, 208 deg. 24 min. 209.9 links, 354 deg. 28½ min. 179.2 links, 28 deg. 24 min. 27.6 links, 351 deg. 17 min. 17.2 links, 351 deg. 29 min. 161 links, 310 deg. 11 min. 8.1 links, 354 deg. 28½ min. 142.8 links, 130 deg. 11 min. 147.6 links and 171 deg. 29 min. 217 links to the point of commencement.
- (d) Commencing at a point on the eastern boundary of allotment 17, section A, of the said parish, distant 351 deg. 29 min. 161 links and 310 deg. 11 min. 434 links from the more southerly of the south-eastern angles of the said allotment; thence by lines bearing respectively 310 deg. 11 min. 106 links, 2 deg. 7 min. 530 links, 59 deg. 34 min. 210.3 links, 198 deg. 2 min. 159.9 links, 238 deg. 44 min. 38.2 links, 182 deg. 18 min. 346.8 links and 187 deg. 15 min. 187.6 links to the point of commencement.
- (e) Commencing at the more easterly of the south-eastern angles of allotment 17, section A, of the said parish; thence by lines bearing respectively 182 deg. 3 min. 100 links, 272 deg. 23 min. 169 links, 304 deg. 2 min. 409.7 links, 18 deg. 2 min. 105.5 links, 124 deg. 14 min. 410.5 links, and 92 deg. 23 min. 140 links to the point of commencement—

which said pieces of land are particularly delineated and shown coloured blue and blue hatched on survey plans numbered 8902 and 8903, lodged in the office of the Country Roads Board.

The common seal of the Country Roads Board was hereto affixed at Kew, this seventeenth day of May, One thousand nine hundred and sixty-five, in the presence of—

I. J. O'DONNELL, Chairman.
(SEAL) F. WEST, Member.
N. L. ALLANSON, Secretary.

And the Honorable Murray Victor Porter, Her Majesty's Minister of Public Works for the State of Victoria, shall give the necessary directions herein accordingly.

J. COLQUHOUN,
Clerk of the Executive Council.

COUNTRY ROADS BOARD.

At the Executive Council Chamber, Melbourne, the twenty-fifth day of May, 1965.

PRESENT:

His Excellency the Governor of Victoria.
Mr. Bloomfield | Mr. Reid
Mr. Balfour | Mr. Darcy
Mr. Rossiter | Mr. Wilcox.

DECLARATION OF A DEVIATION FROM THE MIDLAND HIGHWAY IN THE SHIRE OF NEWSTEAD.

WHEREAS by sections 74 and 58 of the *Country Roads Act 1958* (No. 6229) it is amongst other things enacted that when the Country Roads Board under the provisions of the Country Roads Act has by Resolution declared a deviation to be a State highway the said Board may also declare that such deviation shall be in lieu of any existing highway or part thereof named in such Resolution and that on publication in the *Government Gazette* of the Order confirming such Resolution the existing highway or part thereof shall cease to be a State highway or be discontinued as provided in the Resolution; And whereas the said Board has by Resolution declared the deviation on the land described in the First Schedule to such Resolution to be a State highway and has also declared that such deviation shall be in lieu of the part of the existing highway being the land described in the Second Schedule to the said Resolution and that such part of the said existing highway shall be discontinued: Now therefore His Excellency the Governor of the State of Victoria by and with the advice of the Executive Council thereof doth hereby confirm the said Resolution.

Resolution for Declaration of a Deviation of a State Highway under the Country Roads Act.

Whereas the land the site of the highway the course of which is below set out was taken by the Board under the provisions of the *Country Roads Act 1958* for the purpose of constructing such highway deviation which highway deviation has now been laid out and formed on the same; And whereas the said Board (being the Country Roads Board incorporated under the said Act) thinks that the highway aforesaid is fit to be used as a public highway such Board at a meeting now holden acting under the authority conferred upon it by sections 74 and 58 of the said Act doth by this present Resolution hereby declare the said highway deviation the course of which is described in the First Schedule hereto with the commencing and terminating points thereof respectively specified to be part of a State highway within the meaning and for the purposes of the *Country Roads Act 1958*; And the said Board doth also declare that such deviation shall be in lieu of the existing highway or part thereof described in the Second Schedule hereto and that such part of the said existing highway shall be discontinued.

FIRST SCHEDULE.

Shire of Newstead.

9. *Midland Highway*.—All those pieces of land in the Parish of Guildford, the boundaries of which are as follow:—

- (a) Commencing at the south-eastern angle of allotment 23, section 5, of the said parish; thence by lines bearing respectively 283 deg. 45 min. 41.5 links, 11 deg. 53 min. 836.9 links and 189 deg. 3 min. 839.3 links to the point of commencement.
- (b) Commencing at the north-western angle of allotment 17A, section 4, of the said parish; thence by lines bearing respectively 90 deg. 18 min. 36.5 links, 205 deg. 9 min. 1,318.9 links, 199 deg. 24 min. 642 links, 9 deg. 3 min. 260.7 links and 24 deg. 18 min. 1,692 links to the point of commencement.
- (c) Commencing at the south-western angle of allotment 15, section 4, of the said parish; thence by lines bearing respectively 12 deg. 30 min. 600 links, 41 deg. 33 min. 1,411.8 links, 215 deg. 21 min. 1,113 links, 206 deg. 5 min. 818.2 links and 270 deg. 18 min. 62.6 links to the point of commencement.

Also all that piece of land in the Parishes of Guildford and Castlemaine, the boundaries of which are as follow:—

Commencing at the north-eastern angle of allotment 1B, section 5, of the said parish; thence by lines bearing respectively 237 deg. 3 min. 659.2 links, 53

deg. 20 min. 643.6 links, 0 deg. 18 min. 45.5 links, 53 deg. 17½ min. 1,008 links, 49 deg. 56 min. 310.5 links, 193 deg. 14 min. 387.3 links, 241 deg. 3 min. 174.4 links, 335 deg. 59 min. 40 links, 233 deg. 58 min. 310.7 links, 180 deg. 18 min. 108.5 links, 259 deg. 52 min. 360 links and 237 deg. 3 min. 173 links to the point of commencement.

Also, all those pieces of land in the Parish of Castlemaine the boundaries of which are as follow:—

(a) Commencing at the north-western angle of allotment 44, section 3A of the said parish; thence by lines bearing respectively 63 deg. 12 min. 180 links, 227 deg. 48 min. 243 links and 13 deg. 14 min. 84.2 links to the point of commencement.

(b) Commencing at the eastern angle of allotment 128, section 3A, of the said parish; thence by lines bearing respectively 211 deg. 37 min. 549.2 links, 196 deg. 5 min. 173.9 links, 210 deg. 3 min. 501 links, 243 deg. 12 min. 505.7 links, 49 deg. 56 min. 474.5 links and 34 deg. 16 min. 1,199.3 links to the point of commencement—

which said pieces of land are particularly delineated and shown coloured red and yellow on survey plans numbered 8167 and 8168, lodged in the office of the Country Roads Board.

SECOND SCHEDULE.

Shire of Newstead.

9. *Midland Highway*.—All those pieces of land in the Parish of Castlemaine, the boundaries of which are as follow:—

(a) Commencing at the western angle of allotment 85A, section 3A, of the said parish; thence by lines bearing respectively 196 deg. 5 min. 275.1 links, 270 deg. 18 min. 59.7 links and 27 deg. 14 min. 296.9 links to the point of commencement.

(b) Commencing at the north-western angle of allotment 43, section 3A, of the said parish; thence by lines bearing respectively 210 deg. 3 min. 378 links, 243 deg. 12 min. 360 links, 49 deg. 8 min. 305.7 links, 34 deg. 13 min. 350.6 links and 90 deg. 18 min. 82.2 links to the point of commencement.

(c) Commencing at the south-western angle of allotment 46B, section 3A, of the said parish; thence by lines bearing respectively 63 deg. 12 min. 130 links, 229 deg. 56 min. 267.7 links, 13 deg. 14 min. 80.2 links and 63 deg. 12 min. 79 links to the point of commencement.

(d) Commencing at a point on the western boundary of allotment 44, section 3A, of the said parish, distant 193 deg. 14 min. 84.2 links from the north-western angle of the said allotment; thence by lines bearing respectively 193 deg. 14 min. 322.3 links, 225 deg. 33 min. 374 links, 13 deg. 14 min. 348 links and 47 deg. 48 min. 352.5 links to the point of commencement.

Also all that piece of land in the Parish of Guildford, the boundaries of which are as follow:—

Commencing at the north-western angle of allotment 23, section 5, of the said parish; thence by lines bearing respectively 23 deg. 42 min. 530 links, 46 deg. 24 min. 68.1 links, 204 deg. 7 min. 510.1 links, 197 deg. 59 min. 275.3 links and 9 deg. 3 min. 197.7 links to the point of commencement—

which said pieces of land are particularly delineated and shown coloured blue on survey plans numbered 8167 and 8168 lodged in the office of the Country Roads Board.

The common seal of the Country Roads Board was hereto affixed at Kew, this seventeenth day of May, One thousand nine hundred and sixty-five, in the presence of—

(SEAL) I. J. O'DONNELL, Chairman.
F. WEST, Member.
N. L. ALLANSON, Secretary.

And the Honorable Murray Victor Porter, Her Majesty's Minister of Public Works for the State of Victoria, shall give the necessary directions herein accordingly.

J. COLQUHOUN,
Clerk of the Executive Council.

COUNTRY ROADS BOARD.

At the Executive Council Chamber, Melbourne, the twenty-fifth day of May, 1965.

PRESENT:

His Excellency the Governor of Victoria.
Mr. Bloomfield | Mr. Reid
Mr. Balfour | Mr. Darcy
Mr. Rossiter | Mr. Wilcox.

DECLARATION OF A DEVIATION FROM THE YABBA-ROAD IN THE SHIRE OF TOWONG.

WHEREAS by sections 21 and 58 of the *Country Roads Act 1958* (No. 6229) it is amongst other things enacted that when the Country Roads Board under the provisions of the Country Roads Act has by Resolution declared a deviation to be a main road the said Board may also declare that such deviation shall be in lieu of any existing road or part thereof named in such Resolution and that on publication in the *Government Gazette* of the Order Resolution confirming such Resolution the existing road or part thereof shall cease to be a main road or be discontinued as provided in the Resolution: And whereas the said Board has by Resolution declared the deviation on the land described in the First Schedule to such Resolution to be a main road and has also declared that such deviation shall be in lieu of the part of the existing road being the land described in the Second Schedule to the said Resolution and that such part of the said existing road shall be discontinued: Now therefore His Excellency the Governor of the State of Victoria by and with the advice of the Executive Council thereof doth hereby confirm the said Resolution.

Resolution for Declaration of a Deviation of a Main Road under the Country Roads Act.

Whereas the land the site of the road the course of which is below set out was taken by the Board under the provisions of the *Country Roads Act 1958* for the purpose of constructing such road deviation which road deviation has now been laid out and formed on the same: And whereas the said Board (being the Country Roads Board incorporated under the said Act) thinks that the road aforesaid is fit to be used as a public highway such Board at a meeting now holden acting under the authority conferred upon it by sections 21 and 58 of the said Act doth by this present Resolution hereby declare the said road deviation the course of which is described in the First Schedule hereto with the commencing and terminating points thereof respectively specified to be part of a main road within the meaning and for the purposes of the *Country Roads Act 1958*: And the said Board doth also declare that such deviation shall be in lieu of the existing road or part thereof described in the Second Schedule hereto and that such part of the said existing road shall be discontinued.

FIRST SCHEDULE.

Shire of Towong.

9. *Yabba-road* (16309).—All those pieces of land in the Parish of Wagra, the boundaries of which are as follow:—

(a) Commencing at a point on the southern boundary of allotment 5, section 21, of the said parish, distant 267 deg. 24 min. 1,746 links from the south-eastern angle of the said allotment; thence by lines bearing respectively 295 deg. 44 min. 496 links, 321 deg. 20 min. 545 links and 129 deg. 9 min. 1,015.2 links to the point of commencement.

(b) Commencing at a point on the western boundary of allotment 11, section 21, of the said parish, distant 138 deg. 43 min. 363 links from the north-western angle of the said allotment; thence by lines bearing respectively 193 deg. 37 min. 249.6 links, 188 deg. 37 min. 611.5 links, 155 deg. 37 min. 447.7 links, 128 deg. 42 min. 703.5 links, 99 deg. 19 min. 826.5 links, 113 deg. 15 min. 839.8 links, 263 deg. 33 min. 403.7 links, 293 deg. 15 min. 464.8 links, 279 deg. 19 min. 854.5 links, 308 deg. 42 min. 803.8 links, 335 deg. 37 min. 554.8 links, 8 deg. 37 min. 670.8 links, 295 deg. 26 min. 600.5 links, 87 deg. 28 min. 403 links, 121 deg. 2 min. 264 links and 66 deg. 46 min. 185 links to the point of commencement—

which said pieces of land are particularly delineated and shown coloured red on survey plan numbered 9606A, lodged in the office of the Country Roads Board.

SECOND SCHEDULE.

Shire of Towong.

9. *Yabba-road* (16309).—All that piece of land in the Parish of Wagra, the boundaries of which are as follow:—Commencing at the north-western angle of allotment 9, section 21, in the said parish; thence by lines bearing respectively 87 deg. 28 min. 792 links, 246 deg. 3 min. 864.5 links, 248 deg. 55 min. 519.4 links, 239 deg. 28 min. 480.5 links, 230 deg. 32 min. 696 links, 144 deg. 32 min. 810 links, 113 deg. 51 min. 546.7 links, 89 deg. 20 min. 301 links, 137 deg. 11 min. 372 links, 104 deg. 34 min. 153 links, 73 deg. 18 min. 746 links, 64 deg. 49 min. 422.5 links, 100 deg. 18 min. 402 links, 135 deg. 13 min. 269.4 links, 98 deg. 10 min. 513.6 links, 83 deg. 33 min. 936.7 links, 113 deg. 15 min. 302.7 links, 263 deg. 33 min. 1,218.9 links, 278 deg. 10 min. 583 links, 315 deg. 13 min. 272.5 links, 280 deg. 18 min. 307 links, 244 deg. 49 min. 385.6 links, 253 deg. 18 min. 799 links, 284 deg. 34 min. 239 links, 317 deg. 11 min. 349.5 links, 269 deg. 20 min. 267 links, 293 deg. 51 min. 620.3 links, 324 deg. 32 min. 991 links, 50 deg. 32 min. 847.5 links, 59 deg. 28 min. 504.6 links, 68 deg. 55 min. 589 links and 359 deg. 47 min. 155.5 links to the point of commencement—
which said piece of land is particularly delineated and shown coloured blue on survey plan numbered 9606A, lodged in the office of the Country Roads Board.

The common seal of the Country Roads Board was hereto affixed, at Kew, this seventeenth day of May, One thousand nine hundred and sixty-five, in the presence of—

I. J. O'DONNELL, Chairman.
F. WEST, Member.
N. L. ALLANSON, Secretary.

And the Honorable Murray Victor Porter, Her Majesty's Minister of Public Works for the State of Victoria, shall give the necessary directions herein accordingly.

J. COLQUHOUN,
Clerk of the Executive Council.

COUNTRY ROADS BOARD.

At the Executive Council Chamber, Melbourne, the twenty-fifth day of May, 1965.

PRESENT:

His Excellency the Governor of Victoria.
Mr. Bloomfield | Mr. Reid
Mr. Balfour | Mr. Darcy
Mr. Rossiter | Mr. Wilcox.

ORDER APPROVING OF WIDENING AN EXISTING MAIN ROAD IN THE BOROUGH OF SEBASTOPOL.

WHEREAS the Country Roads Board constituted under the *Country Roads Act 1958* (No. 6229) has represented to His Excellency the Governor in Council that it appears to it desirable that the existing Sebastopol-Smythesdale road in the Borough of Sebastopol (declared to be a main road under the said Act which declaration was confirmed by the Order in Council published in the *Government Gazette* of the 18th June, 1947, on pages 2949-51) should be widened by the said Board: And whereas the said Board in accordance with the requirements of section 19 of the said Act has caused to be prepared a map plan and estimate showing the points between which and on and through what land the said widening is proposed to be made and the cost of acquiring the land: And whereas on an inspection of the said map and plan and a consideration of the said estimate His Excellency the Governor in Council is satisfied that there are funds legally available for acquiring the land: Now therefore be it known by this present Order that His Excellency the Governor of the State of Victoria with the advice of the Executive Council thereof doth hereby approve of the said widening being made, that is to say:—

All that piece of land in the Township of Sebastopol, Parish of Ballarat, the boundaries of which are as follow:—Commencing at the south-western angle of allotment 3, section 27, of the said township; thence by lines bearing respectively 0 deg. 5 min. 44.4 links, 45 deg. 58 min. 295.5 links, 90 deg. 45 min. 26.3 links and 223 deg. 45 min. 345.3 links to the point of commencement—which said

piece of land is particularly delineated and shown coloured red on survey plan numbered 10010, lodged in the office of the Country Roads Board.

And the Honorable Murray Victor Porter, Her Majesty's Minister of Public Works for the State of Victoria, shall give the necessary directions herein accordingly.

J. COLQUHOUN,
Clerk of the Executive Council.

LOCAL GOVERNMENT DEPARTMENT.

At the Executive Council Chamber, Melbourne, the twenty-fifth day of May, 1965.

PRESENT:

His Excellency the Governor of Victoria.
Mr. Bloomfield | Mr. Reid
Mr. Balfour | Mr. Darcy
Mr. Rossiter | Mr. Wilcox.

CONFIRMATION OF SEPARATE RATE—CITY OF NUNAWADING.

IN pursuance of the provisions of section 287 of the *Local Government Act 1958*, as amended, His Excellency the Governor of the State of Victoria, by and with the advice of the Executive Council thereof, hereby confirms a separate rate of nine pence (9d.) in the pound and six pence (6d.) in the pound on the unimproved capital value of certain properties described hereunder, which rate was made by the Council of the City of Nunawading on the 30th March, 1965, for the purpose of providing off-street parking facilities for use in connexion with the Blackburn Shopping Centre:

PROPERTIES TO BE RATED AT 9D. IN THE POUND.

Main-street.

East side—Numbers 1 to 3A inclusive.
West side—Numbers 2 to 6A inclusive.

South-parade.

South side—Numbers 68 to 132 inclusive.

PROPERTIES TO BE RATED AT 6D. IN THE POUND.

Blackburn-road.

West side—Numbers 20, 20A, 20B, and 20C.

And the Honorable Rupert James Hamer, Her Majesty's Minister for Local Government for the State of Victoria, shall give the necessary directions herein accordingly.

J. COLQUHOUN,
Clerk of the Executive Council.

LOCAL GOVERNMENT DEPARTMENT.

At the Executive Council Chamber, Melbourne, the twenty-fifth day of May, 1965.

PRESENT:

His Excellency the Governor of Victoria.
Mr. Bloomfield | Mr. Reid
Mr. Balfour | Mr. Darcy
Mr. Rossiter | Mr. Wilcox.

ROAD DISCONTINUED—CITY OF BRIGHTON.

WHEREAS it is provided in section 528 (2) of the *Local Government Act*, as amended, that where a road (whether or not a public highway but not being a road set out on land of the Crown) or any part thereof is not required for public use the Governor in Council on the request of the Council of the municipality in which such road is situated made not less than one month after publishing in a newspaper generally circulating in the district and posting to the registered proprietor (if any) of the land and any person known to have an interest in the land notice of intention to make such a request may by Order published in the *Government Gazette* direct that such road or part shall be discontinued and thereupon such road or part shall be discontinued accordingly.

And whereas the Council of the City of Brighton has requested that the Governor in Council direct that portion of a right-of-way, off Well-street, be discontinued and not less than one month previously has published in a newspaper generally circulating in the district and posted to the registered proprietor of the land in the road and to all persons known to have an interest in the said road notice of intention to make such request.

Now therefore His Excellency the Governor of the State of Victoria, by and with the advice of the Executive Council thereof, hereby directs:

- (a) That the portion of the said road, which is shown by hachure on the plan hereunder, shall be discontinued;
- (b) that notwithstanding such discontinuance the Melbourne and Metropolitan Board of Works shall continue to have and possess the same right title power authority or interest in or in relation to the whole of the land in the portion of the said road as it had or possessed prior to such discontinuance with respect to or in connexion with any sewers or drains laid or erected in on or over such land for the purpose of sewerage or drainage;
- (c) that, subject to any such right title power authority or interest, the land in the portion of the said road may be sold by the Council of the City of Brighton by agreement.

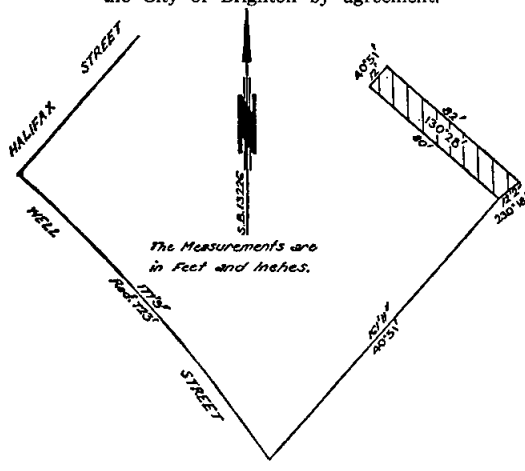

And the Honorable Rupert James Hamer, Her Majesty's Minister for Local Government for the State of Victoria, shall give the necessary directions herein accordingly.

J. COLQUHOUN,
Clerk of the Executive Council.

MOOROOPNA SEWERAGE AUTHORITY.

At the Executive Council Chamber, Melbourne, the twenty-fifth day of May, 1965.

PRESENT:

His Excellency the Governor of Victoria.	
Mr. Bloomfield	Mr. Reid
Mr. Balfour	Mr. Darcy
Mr. Rossiter	Mr. Wilcox.

EXTENT OF SEWERAGE DISTRICT INCREASED.

UNDER the powers conferred by the Sewerage Districts Act and all other powers enabling him in that behalf, His Excellency the Governor of the State of Victoria, by and with the advice of the Executive Council of the said State, doth hereby declare, order and direct as follows:—

That the extent of the Sewerage District of the Mooroopna Sewerage Authority be increased by adding to the same the land comprised within the boundaries described in the Schedule hereto and as on and from the date hereof the extent of such District shall be deemed to be increased accordingly.

SCHEDULE.

Commencing at the south-western angle of the lands shown on lodged plan of subdivision No. 22162, Parish of Toolamba, County of Rodney, being a point on the western boundary of the existing Sewerage District; thence westerly by a line across a drainage reserve to the south-eastern angle of the lands shown on lodged plan of subdivision No. 56994; thence westerly and generally northerly along the southern and western boundaries of the lands shown on the said lodged plan to the north-western angle of the said lands being a point on the southern boundary of the Midland Highway; thence easterly along the said southern

boundary of the Midland Highway to a point on the boundary of the existing Sewerage District; thence southerly, easterly and southerly along the boundary of the existing Sewerage District to the point of commencement.

All of which boundaries are shown on a plan approved by the Governor in Council and deposited in the office of the State Rivers and Water Supply Commission, Melbourne.—(Corr. 59/4644/163.)

And the Honorable Thomas Anthony Darcy, Her Majesty's Minister of Water Supply for the State of Victoria, shall give the necessary directions herein accordingly.

J. COLQUHOUN,
Clerk of the Executive Council.

DANDENONG VALLEY AUTHORITY ACT 1963.

At the Executive Council Chamber, Melbourne, the twenty-fifth day of May, 1965.

PRESENT:

His Excellency the Governor of Victoria.	
Mr. Bloomfield	Mr. Reid
Mr. Balfour	Mr. Darcy
Mr. Rossiter	Mr. Wilcox.

CONSENT TO DEVIATE THE COURSE OF DANDENONG CREEK IN THE PARISHES OF SCORESBY AND NUNAWADING.

WHEREAS the Dandenong Valley Authority desires to deviate part of the course of Dandenong Creek in Crown allotments 22 and 23, Parish of Scoresby and Crown allotments 122G and 123, Parish of Nunawading: And whereas the Dandenong Valley Authority by notice published in the *Victoria Government Gazette*, No. 23, dated 31st March, 1965, declared the Dandenong Creek to be an arterial drain: And whereas, in pursuance of the provisions of section 22 (3) (a) of the *Dandenong Valley Authority Act 1963* the Authority may, with the consent of the Governor in Council, declare the course of an arterial drain to be deviated and amend the first-mentioned notice accordingly:

Now, therefore, His Excellency the Governor of Victoria, acting by and with the advice of the Executive Council thereof, and in pursuance of the said Act and all other powers thereunto him enabling, hereby consents to the deviation of part of the course of Dandenong Creek in Crown allotments 22 and 23, Parish of Scoresby, and Crown allotments 122G and 123, Parish of Nunawading, in accordance with the plan marked "Dandenong Valley Authority, River Gauging Station at Boronia-road" and approved by the Governor in Council and deposited in the office of the State Rivers and Water Supply Commission, Melbourne.—(Corres. 64/1454.)

And the Honorable Thomas Anthony Darcy, Her Majesty's Minister of Water Supply for the State of Victoria, shall give the necessary directions herein accordingly.

J. COLQUHOUN,
Clerk of the Executive Council.

GEELONG WATERWORKS AND SEWERAGE TRUST.

At the Executive Council Chamber, Melbourne, the twenty-fifth day of May, 1965.

PRESENT:

His Excellency the Governor of Victoria.	
Mr. Bloomfield	Mr. Reid
Mr. Balfour	Mr. Darcy
Mr. Rossiter	Mr. Wilcox.

CONSENT TO BORROWING £100,000.

UNDER the powers conferred by the Geelong Waterworks and Sewerage Act and all other powers enabling him in that behalf, His Excellency the Governor of the State of Victoria, by and with the advice of the Executive Council of the said State, doth hereby consent to the Geelong Waterworks and Sewerage Trust borrowing at interest, subject to the Geelong Waterworks and Sewerage Act the sum of One hundred thousand pounds (£100,000) to meet the cost of water supply works.

And the Honorable Thomas Anthony Darcy, Her Majesty's Minister of Water Supply for the State of Victoria, shall give the necessary directions herein accordingly.

J. COLQUHOUN,
Clerk of the Executive Council.

STAWELL SEWERAGE AUTHORITY.

At the Executive Council Chamber, Melbourne, the
twenty-fifth day of May, 1965.

PRESENT:

His Excellency the Governor of Victoria.	
Mr. Bloomfield	Mr. Reid
Mr. Balfour	Mr. Darcy
Mr. Rossiter	Mr. Wilcox.

CONSENT TO BORROWING £16,000.

UNDER the powers conferred by the Sewerage Districts Act and all other powers enabling him in that behalf, His Excellency the Governor of the State of Victoria, by and with the advice of the Executive Council of the said State, doth hereby consent to the Stawell Sewerage Authority borrowing by the assignment of the General Fund the sum of Sixteen thousand pounds (£16,000) for the conversion of Loan No. 4.

And the Honorable Thomas Anthony Darcy, Her Majesty's Minister of Water Supply for the State of Victoria, shall give the necessary directions herein accordingly.

J. COLQUHOUN,
Clerk of the Executive Council.

TALLANGATTA SEWERAGE AUTHORITY.

At the Executive Council Chamber, Melbourne, the
twenty-fifth day of May, 1965.

PRESENT:

His Excellency the Governor of Victoria.	
Mr. Bloomfield	Mr. Reid
Mr. Balfour	Mr. Darcy
Mr. Rossiter	Mr. Wilcox.

CONSENT TO BORROWING £2,200.

UNDER the powers conferred by the Sewerage Districts Act and all other powers enabling him in that behalf, His Excellency the Governor of the State of Victoria, by and with the advice of the Executive Council of the said State, doth hereby consent to the Tallangatta Sewerage Authority borrowing by the assignment of the General Fund the sum of Two thousand two hundred pounds (£2,200) to meet the cost of sewerage works as set forth in the detailed statement bearing date the 21st May, 1965.

And the Honorable Thomas Anthony Darcy, Her Majesty's Minister of Water Supply for the State of Victoria, shall give the necessary directions herein accordingly.

J. COLQUHOUN,
Clerk of the Executive Council.

HEALTH ACT 1958 (No. 6270), SECTION 94.

At the Executive Council Chamber, Melbourne, the
twenty-fifth day of May, 1965.

PRESENT:

His Excellency the Governor of Victoria.	
Mr. Bloomfield	Mr. Reid
Mr. Balfour	Mr. Darcy
Mr. Rossiter	Mr. Wilcox.

DIVISION I. OF PART V. OF THE HEALTH ACT 1958 (No. 6270), RELATING TO PIGGERIES, EXTENDED TO CERTAIN PORTIONS OF THE MUNICIPAL DISTRICT OF THE SHIRE OF ROCHESTER.

UNDER the powers conferred by the Health Act 1958 (No. 6270), His Excellency the Governor of the State of Victoria, by and with the advice of the Executive Council thereof, on the request of the Council of the Shire of Rochester, and on the recommendation of the Commission of Public Health, doth hereby order that the

provisions of Division I. of Part V. of the said Act, so far as those provisions are applicable to piggeries, shall be extended to the four portions of the municipal district of the Shire of Rochester contained within the boundaries as set out hereunder, namely:—

(a) *Echuca Area*.—Commencing at a point being the south-eastern corner of Crown allotment 11, section A, Parish of Millewa; thence westerly by the southern boundary of allotment 11, a line across the Northern Highway, the southern boundaries of Crown allotments 12A, 13A, and 15, a line across a road and the southern boundaries of Crown allotments 16A, 17, 18, 19, 20A and 20 to the south-eastern corner of allotment 20; thence northerly by the western boundaries of Crown allotments 20 and 1, a line across a road, the western boundary of Crown allotment 54 Parish of Millewa, the western boundaries of Crown allotments 76B, 76A, and 77 Parish of Wharparilla, a line across a road, the western boundaries of a water reserve, a line across a road and the western boundaries of Crown allotments 78A, 78, 79, a line across the Echuca-Serpentine main road, the western boundaries of Crown allotments 80A, 80B, 80A1 and 81, a line across a road, the western boundaries of Crown allotments 82 and 83B, a line across the Murray Valley Highway, the western boundaries of Crown allotments 127, 128 and 131, a line across a road, the western boundaries of Crown allotments 132, 135, 135A and 136 to the north-western corner of Crown allotment 136, Parish of Wharparilla; thence northerly by a line being the prolongation of the western boundary of the said Crown allotment 136 to the intersection of the said line with the left-hand bank of the River Murray; thence generally easterly and southerly by the left-hand bank of the River Murray to its intersection with a line being the common north-south boundary between the Shire of Rochester and the Borough of Echuca; thence southerly and easterly by the common municipal boundary to its intersection with the left-hand bank of the Campaspe River; thence southerly, easterly and southerly by the left-hand bank of the Campaspe River to the south-eastern corner of Crown allotment 11, section A, Parish of Millewa, being the point of commencement.

(b) *Gunbower Area*.—Commencing at a point being the north-eastern corner of Crown allotment 7c, section C, Parish of Gunbower; thence westerly along the northern boundaries of Crown allotments 7c and 7d to the north-western corner of Crown allotment 7d; thence southerly across a railway and along the eastern boundary of Crown allotment 7E to the south-western corner of Crown allotment 7E; thence easterly along the southern boundaries of Crown allotments 7E and 7C, across a road and further easterly in a straight line across allotment 9 of C a road, a railway reserve and a rifle range to the south-western corner of Crown allotment 5, section A, Township of Gunbower; thence easterly along the southern boundaries of Crown allotments 5 and 4 to the south-eastern corner of Crown allotment 4; thence northerly along the eastern boundaries of Crown allotments 4 and 3 and across a reserve to the left bank of the Gunbower Creek; thence generally westerly along the left bank of the Gunbower Creek to the junction of the Gunbower Creek with Taylor's Creek; thence south-westerly along the left bank of Taylor's Creek to the boundary of Crown allotment 9 of C; thence north-westerly along the boundary of Crown allotment 9 of C, to the corner of that Crown allotment; thence westerly across a road to the point of commencement.

(c) *Lockington Area*.—Commencing at a point being the north-western corner of Crown allotment 29, section A, Parish of Pannooabamawm; thence southerly and easterly along the boundary of Crown allotment 29 to the north-western corner of Crown allotment 29B; thence southerly along the western boundary of Crown allotment 29B, and across a road to the northern boundary of Crown allotment 127, Parish of Pannooabamawm; thence easterly and southerly along the boundary of Crown allotment 127 to the south-eastern corner of Crown allotment 127; thence easterly along the southern boundary of Crown allotment 126B to the south-western corner of Crown allotment 175B, Parish of Bamawm; thence easterly along the southern boundary of Crown allotment 175B across a road; thence easterly along the southern boundaries of Crown allotments 173, 172, 170B to the south-eastern corner of Crown allotment 169B; thence northerly along the western boundaries of Crown allotments 22 and 20, section A, Bamawm Estate, across a road, and along the western boundaries of Crown allotments 14 and 12 to the north-western corner of Crown allotment 12; thence westerly along the northern boundaries of Crown allotments 10, 9 and 9A; thence across a road to the north-eastern corner of Crown allotment 112, Parish of Bamawm; thence westerly along the northern boundary of Crown allotment 112, to the north-eastern corner of Crown allotment 124A; thence westerly along the southern boundary

of Crown allotment 124A, Parish of Pannooabamawm, and Crown allotment 29, section A, Parish of Pannooabamawm, to the point of commencement.

(d) *Rochester Area*.—Commencing at a point being the north-western corner of Crown allotment E1, no section, Parish of Rochester West; thence easterly by the northern boundaries of Crown allotments E1, E2, and 59, a line across the Northern Highway, and the northern boundaries of Crown allotments 8, 9, 10, and 11 to the north-eastern corner of Crown allotment 11, Parish of Rochester West; thence by a line bearing south-easterly across the Campaspe River to the north-western corner of Crown allotment 2, no section, Parish of Rochester; thence easterly by the northern boundary of the said Crown allotment 2, a line across a road, and the northern boundaries of Crown allotments 12, 7, 8, and 9, section B, to the north-eastern corner of Crown allotment 9, section B; thence southerly by the eastern boundary of Crown allotment 9, section B, and the eastern boundaries of Crown allotments 42, and 43, no section, a line across a road, the eastern boundaries of Crown allotments 53, 54, 57 and 58, no section, a line across a road, the eastern boundaries of Crown allotments 61, 62, 65 and 66, no section, a line across a road, and the eastern boundaries of Crown allotments 72 and 73, no section, to the south-eastern corner of Crown allotment 73, no section, Parish of Rochester; thence westerly by the southern boundaries of Crown allotments 73 and 74, no section, a line across a road, the southern boundaries of Crown allotments 75 and 77, no section, a line across a road, and the southern boundary of Crown allotment 21, no section, to the south-western corner of Crown allotment 21, no section, Parish of Rochester; thence by a line bearing south-westerly across the Campaspe River to the south-eastern corner of Crown allotment 94, no section, Parish of Rochester West; thence generally southerly along the left-hand bank of the Campaspe River to its intersection with the south-western boundary of Crown allotment 55, Parish of Diggora; thence north-westerly along the south-western boundary of Crown allotment 55 to the eastern boundary of the Northern Highway reserve; thence northerly by a line across the said Highway reserve, the Northern Railway reserve and a road to the south-eastern corner of allotment 4, Restdown Estate, Parish of Diggora; thence westerly along the southern boundaries of allotments 4 and 2 and northerly along the western boundary of allotment 2 to the north-western corner of allotment 2, Restdown Estate; thence north-easterly by a line across a road, to the south-western corner of Crown allotment 81, no section, Parish of Rochester West; thence northerly along the western boundaries of Crown allotments 81, 80, a line across a road, the western boundaries of Crown allotments 72, 71, a line across a road, and the western boundary of Crown allotment E1, no section, to the north-western corner of Crown allotment E1, no section, Parish of Rochester West being the point of commencement.

And the Honorable Ronald William Mack, Her Majesty's Minister of Health for the State of Victoria, shall give the necessary directions herein accordingly.

J. COLQUHOUN,
Clerk of the Executive Council.

Water Act 1958.

STATE RIVERS AND WATER SUPPLY COMMISSION.

At the Executive Council Chamber, Melbourne, the twenty-fifth day of May, 1965.

PRESENT:

His Excellency the Governor of Victoria.	
Mr. Bloomfield	Mr. Reid
Mr. Balfour	Mr. Darcy
Mr. Rossiter	Mr. Wilcox.

GOULBURN-MURRAY IRRIGATION DISTRICT—PORTIONS EXCISED.—RODNEY IRRIGATION AREA—BOUNDARIES VARIED.

UNDER the powers conferred by the *Water Act 1958* and all other powers enabling him in that behalf, His Excellency the Governor of the State of Victoria, with the advice of the Executive Council of the said State, on the recommendation of the State Rivers and Water Supply Commission, doth hereby declare, order, and direct as follows:—

That there shall be excised from the Goulburn-Murray Irrigation District those portions of the same set out and described in the Schedule hereto and that the boundaries

of the Rodney Irrigation Area shall be varied to excise from the said Area the aforesaid portions, which portions shall be deemed to be excised from the said Irrigation District and Irrigation Area as from the 30th day of June, 1965.

SCHEDULE.

Portion 1.—The whole of lots 12, 13 and 14 on lodged plan of subdivision No. 5248, being part of Crown allotment 50, Parish of Toolamba West, County of Rodney.

Portion 2.—Commencing at the south-western angle of lot 15 on lodged plan of subdivision No. 4765, being part of Crown allotment 103, Parish of Toolamba West, County of Rodney; thence northerly and easterly by the western and northern boundaries of the said lot to its north-eastern angle; thence southerly by the eastern boundaries of lots 15 and 8 and westerly by the southern boundary of said lot 8 to a point in line with the eastern boundary of lot 9; thence northerly by a line and the eastern boundaries of lots 9 to 14 inclusive and westerly by the southern boundary of lot 15 aforesaid to the point of commencement.

The lands set out and described in the foregoing Schedule are shown on a plan approved by the Governor in Council and deposited in the office of the State Rivers and Water Supply Commission, Melbourne.—(Corr. Nos. 63/5989, 62/5924.)

And the Honorable Thomas Anthony Darcy, Her Majesty's Minister of Water Supply for the State of Victoria, shall give the necessary directions herein accordingly.

J. COLQUHOUN,
Clerk of the Executive Council.

WATER ACT 1958.

At the Executive Council Chamber, Melbourne, the twenty-fifth day of May, 1965.

PRESENT:

His Excellency the Governor of Victoria.	
Mr. Bloomfield	Mr. Reid
Mr. Balfour	Mr. Darcy
Mr. Rossiter	Mr. Wilcox.

TATURA WATERWORKS TRUST—EXTENT OF DISTRICT INCREASED.

UNDER the powers conferred by the *Water Act 1958* and all other powers enabling him in that behalf, His Excellency the Governor of the State of Victoria, with the advice of the Executive Council of the said State, doth hereby declare, order, and direct as follows:—

That the extent of the Waterworks District of the Tatura Waterworks Trust be increased by adding to the same the lands set out and described in the Schedule hereto, and as on and from the 1st day of July, 1965, such district shall be deemed to be increased accordingly.

SCHEDULE.

1. The whole of lots 12, 13 and 14 on lodged plan of subdivision No. 5248, being part of Crown allotment 50, Parish of Toolamba West, County of Rodney.

2. Commencing at the south-western angle of lot 15 on lodged plan of subdivision No. 4765, being part of Crown allotment 103, Parish of Toolamba West, County of Rodney; thence northerly and easterly by the western and northern boundaries of the said lot to its north-eastern angle; thence southerly by the eastern boundaries of lots 15 and 8 and westerly by the southern boundary of said lot 8 to a point in line with the eastern boundary of lot 9; thence northerly by a line and the eastern boundaries of lots 9 to 14 inclusive and westerly by the southern boundary of lot 15 aforesaid to the point of commencement.

The lands set out and described in the foregoing Schedule are shown on a plan approved by the Governor in Council and deposited in the office of the State Rivers and Water Supply Commission, Melbourne.—(Corr. 63/5989, 62/5924.)

And the Honorable Thomas Anthony Darcy, Her Majesty's Minister of Water Supply for the State of Victoria, shall give the necessary directions herein accordingly.

J. COLQUHOUN,
Clerk of the Executive Council.

THE DECENTRALIZATION ADVISORY COMMITTEE
ACT 1964 (No. 7232).

At the Executive Council Chamber, Melbourne, the
twenty-fifth day of May, 1965.

PRESENT:

His Excellency the Governor of Victoria.	
Mr. Bloomfield	Mr. Reid
Mr. Balfour	Mr. Darcy
Mr. Rossiter	Mr. Wilcox.

APPOINTMENT OF THE DECENTRALIZATION
ADVISORY COMMITTEE.

IN pursuance of the powers conferred by section 3 of *The Decentralization Advisory Committee Act 1964*, His Excellency the Governor of the State of Victoria, by and with the advice of the Executive Council thereof doth by this Order:

(i) Appoint the following persons who are members of organizations in the community the principal objects of which include the development of areas outside the metropolitan area within the meaning of the *Town and Country Planning Act 1961*, to be members of the Decentralization Advisory Committee for a period of three years as from the 1st July, 1965:

BERNARD FRANCIS LORD.
WILLIAM OGDEN.
JOHN GERARD QUINN.
MAURICE OLIVER WILLIAMS.

(ii) Appoint the following persons who have had experience in commercial development in country areas to be members of the Decentralization Advisory Committee for a period of three years as from the 1st July, 1965:

JOHN DOUGLAS ANDREWS, M.Sc., Dip.Ed., F.R.A.C.I.
JOHN MARK DUNN, F.A.S.A., F.C.I.S.
ALBERT VICTOR JENNINGS, F.A.I.B.

And the Honorable Vance Oakley Dickie, Her Majesty's Minister of State Development for the State of Victoria, shall give the necessary directions herein accordingly.

J. COLQUHOUN,
Clerk of the Executive Council.

WODONGA WATERWORKS TRUST.

At the Executive Council Chamber, Melbourne, the
first day of June, 1965.

PRESENT:

His Excellency the Governor of Victoria.	
Mr. Darcy	Mr. Wilcox.
Mr. Dickie	

EXTENT OF WATERWORKS DISTRICT INCREASED.

UNDER the powers conferred by the Water Act and all other powers enabling him in that behalf, His Excellency the Governor of the State of Victoria, by and with the advice of the Executive Council of the said State, doth hereby declare, order and direct as follows:—

That the extent of the Waterworks District of the Wodonga Waterworks Trust be increased by adding to the same the land comprised within the boundaries described in the Schedule hereto and as on and from the date hereof the extent of such District shall be deemed to be increased accordingly:

SCHEDULE.

Commencing at a point on the eastern boundary of Crown allotment 7, section XV., Parish of Wodonga, Country of Bogong, being a point on a line parallel to and distant 500 links south-westerly from the north-eastern boundary of allotment 1, section N^o, Town of Wodonga, Parish of Wodonga, and being a point on the boundary of the existing Waterworks District; thence southerly along the eastern boundary of the aforesaid Crown allotment 7, and of Crown allotment 12, section XV., and by a line across a road to the north-eastern angle of Crown allotment 2A, section XIV.; thence easterly by a line across a road to the north-western angle of Crown allotment 1, section M2, Town of Wodonga, Parish

of Wodonga; thence easterly along the northern boundary of the said Crown allotment 1 to its north-eastern angle; thence southerly along the eastern boundary of the said Crown allotment 1 to the south-western angle of Crown allotment 2; thence easterly along the southern boundary of the said Crown allotment 2 and by a line being a continuation thereof across House Creek to a point on its right bank being a point on the boundary of the existing Waterworks District; thence generally northerly, westerly and north-westerly along the boundary of the existing Waterworks District to the point of commencement.

All of which boundaries are shown on a plan approved by the Governor in Council and deposited in the office of the State Rivers and Water Supply Commission, Melbourne.—(Corr. 59/1136/167.)

And the Honorable Thomas Anthony Darcy, Her Majesty's Minister of Water Supply for the State of Victoria, shall give the necessary directions herein accordingly.

J. COLQUHOUN,
Clerk of the Executive Council.

CHELSEA SEWERAGE AUTHORITY.

At the Executive Council Chamber, Melbourne, the
first day of June, 1965.

PRESENT:

His Excellency the Governor of Victoria.	
Mr. Darcy	Mr. Wilcox.
Mr. Dickie	

CONSENT TO BORROWING £50,000.

UNDER the powers conferred by the Sewerage Districts Act and all other powers enabling him in that behalf, His Excellency the Governor of the State of Victoria, by and with the advice of the Executive Council of the said State, doth hereby consent to the Chelsea Sewerage Authority borrowing a sum of Fifty thousand pounds (£50,000) by the assignment of the General Fund to meet the cost of sewerage works as set forth in the detailed statement bearing date the 28th May, 1965.

And the Honorable Thomas Anthony Darcy, Her Majesty's Minister of Water Supply for the State of Victoria, shall give the necessary directions herein accordingly.

J. COLQUHOUN,
Clerk of the Executive Council.

LANDLORD AND TENANT ACT 1958.

At the Executive Council Chamber, Melbourne, the
first day of June, 1965.

PRESENT:

His Excellency the Governor of Victoria.	
Mr. Darcy	Mr. Wilcox.
Mr. Dickie	

ORDER EXTENDING APPLICATION OF PART V. OF THE
LANDLORD AND TENANT ACT 1958 TO CERTAIN
PREMISES.

IN pursuance of the powers conferred by section 44 of the *Landlord and Tenant Act 1958*, His Excellency the Governor of Victoria, by and with the advice of the Executive Council thereof, doth hereby declare that the application of Part V. of the *Landlord and Tenant Act 1958* shall extend to the following premises:—

1. The premises known as No. 1 Lucas-court, Noble Park.
2. The premises known as No. 76 Stubbs-street, Kensington.

And the Honorable Vernon Francis Wilcox, Her Majesty's Acting Attorney-General for the State of Victoria, shall give the necessary directions herein accordingly.

J. COLQUHOUN,
Clerk of the Executive Council.

APPROACHING LAND SALES.

SALES of Crown lands, in fee-simple, will be held at the under-mentioned places and dates, viz.:—

	No. of Gazette.
Castlemaine.—Tuesday, 6th July, 1965 ..	38
Maryborough.—Friday, 25th June, 1965 ..	34
St. Arnaud.—Thursday, 24th June, 1965 ..	34

SALE OF CROWN LAND BY AUCTION.

The land will be offered for sale in fee-simple, and subject to the provisions of the Land Act and Regulations thereunder.

The upset price is the sum at which bidding will start, and no bid below that sum can be accepted. The highest bidder at or above that sum shall be the purchaser, subject to signature of contract and any necessary payment.

TERMS:—

A deposit of at least 12½% of the purchase price must be paid at the sale, either in cash or by cheque.

The residue is payable in half-yearly instalments, in accordance with the following scale, or may be paid off at any earlier time.

£20 and under, 6 instalments.	Over £20, and not exceeding £50, 8 instalments.
Over £50, and not exceeding £100, 10 instalments.	Over £100, and not exceeding £200, 12 instalments.
Over £200, and not exceeding £300, 14 instalments.	Over £300, and not exceeding £400, 16 instalments.
Over £400, and not exceeding £500, 18 instalments.	Over £500, 20 instalments.

Interest at the rate of 5% per annum is payable with all payments of residue, and is computed for each instalment from the date of sale to the date of such payment. Additional interest is charged if any instalment is not paid on or before the due date.

If paid off within 30 days of sale, no interest is payable.

FEES, ETC.:

Also payable at the sale, in addition to the deposit, are the survey fee and, if applicable, the valuation of improvements (if purchaser be not the owner thereof).

Payable with balance of purchase money—

Crown Grant fee—50 acres and under ..	£1 10s.
Over 50 acres ..	£2
Purchase money £5 or under	£1

Assurance Fund contribution—One halfpenny for each £1 of purchase price. (This is a fund established to guarantee the validity of freehold titles.)

Transfer of interest prior to completion of payment may be allowed on payment of £1 fee and subject to stamp duty.

If unable to attend personally, a prospective purchaser may arrange for another person to bid as his agent.

Attention is drawn to section 95, Land Act 1958, which provides that the purchaser shall be deemed to be the owner for the purposes of other Acts; also to an amendment to the Local Government Act providing for Government roads, in certain circumstances, to be declared "private streets", thus making the purchaser liable to contribute to the cost of street construction.

J. C. M. BALFOUR,

Commissioner of Crown Lands and Survey.

Office of Crown Lands and Survey,
Melbourne, 2nd June, 1965.

CASTLEMAINE.—Sale (No. 11780) of Crown land in fee-simple, by auction, will be held at the LAND INSPECTOR'S OFFICE, LITTLETON-STREET, CASTLEMAINE, on TUESDAY, the 6th day of JULY, 1965, at half-past TWO o'clock p.m. To be conducted by G. E. HARPIN, Land Officer, Bendigo.

TOWNSHIP OF CASTLEMAINE, PARISH OF CASTLEMAINE,
COUNTY OF TALBOT.

Lot 1.

Fronting the north side of Campbell-street about 2 chains west of Fletcher-street.

Upset price £50 the lot. Survey fee £6 12s. 6d.

Area 0a. 2r. 18p., allotment 15 of section 52. One month allowed for removal of improvements. Subject to drainage easement and sewerage easement each 10 links wide.—(W.85447.)

Lot 2.

Fronting north side of Berkeley-street about 2 chains west of Fletcher-street.

Upset price £50 the lot. Survey fee £6.

Area 0a. 2r. 1p., allotment 15 of section 54. Subject to easement 10 links wide.—(W.85123.)

NOTE.—In respect to both lots 1 and 2 it is understood that the Castlemaine Town Council will not issue a building permit until certain drainage works are completed.

Lot 3.

At the south-western corner of Saint and Preshaw streets.

Upset price £25 the lot. Survey fee £6 10s.

Area 0a. 2r. 22p., subject to survey, allotment 11 of section 140.

Lot 4.

At the north-western corner of Preshaw and Britton streets.

Upset price £25 the lot. Survey fee £6.

Area 28 perches, subject to survey, allotment 13 of section 140.—(W.87079.)

PARISH OF CASTLEMAINE, COUNTY OF TALBOT.

Lot 5.

Fronting the east side of Eureka-road about 20 chains south of the Melbourne to Bendigo railway.

Upset price £60 the lot. Survey fee £7 7s. 6d.

Area 2a. 0r. 11p., allotment 54 of section B1. Subject to S.E.C. easement 82 links wide and race easement 10 links wide. Valuation of improvements £65 (pens, fencing and dam) (Crown).—(W.86150.)

Lot 6.

In the south of the Parish about ¼ mile south-east of the Campbell Railway Station.

Upset price £40 the lot. Survey fee £8.

Area 6a. 0r. 27p., allotment 7 of section 12A. Subject to race easement 10 links wide.—(W.67745.)

Lot 7.

PARISH OF CHEWTON, COUNTY OF TALBOT.

Fronting east side of a Government road and about 30 chains north of the Park-road-Calder Highway intersection.

Upset price £100 the lot. Survey fee £8 2s. 6d.

Area 20a. 0r. 24p., allotment 225B of section E.—(W.87315.)

TOWNSHIP OF MALDON, PARISH OF MALDON,
COUNTY OF TALBOT.

Lot 8.

A corner allotment in the south of the Township and about 2 chains south of the C.R.B. main road.

Upset price £60 the lot. Survey fee £6 12s. 6d.

Area 0a. 3r. 25p., allotment 11 of section 4c.—(W.81747.)

Lot 9.

PARISH OF MALDON, COUNTY OF TALBOT.

About 2 chains north-west of the Maldon—Castlemaine road about 2 miles south-east of Maldon.

Upset price £10 the lot. Survey fee £5 17s. 6d.

Area 1a. 0r. 20p., allotment 14 of section 1b.—(W.70179.)

Lot 10.

PARISH OF TARREGOWER, COUNTY OF TALBOT.

Being former State school and residence site at Welshman's Reef.

Upset price £45 the lot. Survey fee £8 10s.

Area 2a. 1r. 0p., subject to survey, allotment 24 of section C. Valuations of improvements £18 (Education Department) (fencing).

NOTE.—Allotment as now offered comprises land hitherto shown on Departmental plans as allotments 24 and 25.—(W.87200.)

Lot 11.

TOWNSHIP OF FRYERSTOWN, PARISH OF FRYERS,
COUNTY OF TALBOT.

Fronting the north side of Market-street about 8 chains west of Landseer-street.

Upset price £10 the lot. Survey fee £7 10s.

Area 0a. 2r. 31p., allotment 13 of section 1. One month allowed for removal of improvements.—(W.85111.)

PROPOSED REVOCATION OF TEMPORARY RESERVATION, AND THE WITHHOLDING FROM SALE, LEASING, AND LICENSING, OF LAND BY ORDER IN COUNCIL.

IN pursuance of the provisions of the *Land Act 1958*, notice is hereby given that it is the intention of the Governor in Council to revoke the temporary reservation, and the withholding from sale, leasing, and licensing, of land by Order in Council hereunder referred to, viz.:—

The following Notice was published 1° on the 26th May, 1965, pursuant to Order of the 18th May, 1965.

GLENROWEN.—The temporary reservation as a site for Mechanics' Institute and the withholding from sale, leasing and licensing by Order in Council of the 18th December, 1883, of 1 rood 24 perches of land in the Township of Glenrowen.—(G.92⁽⁸⁾) (Rs.7044).

J. C. M. BALFOUR,
Minister of Lands.

PROPOSED PERMANENT RESERVATIONS OF LANDS AS SITES.

IN pursuance of the provisions of the *Land Act 1958*, notice is hereby given that it is the intention of the Governor in Council to permanently reserve as sites, and also except from occupation for mining purposes under any miner's right, the lands hereunder referred to:—

The following Notices were published 1° on the 26th May, 1965, pursuant to Orders of the 18th May, 1965.

ELTHAM.—Land proposed to be permanently reserved as a site for Public Recreation, 57 acres 3 roods 32 perches, Township of Eltham, Parish of Nillumbik, County of Evelyn, being the site temporarily reserved therefor by Order in Council of the 28th May, 1913, and known as the Eltham Park Reserve.—(E.41⁽¹⁾) (Rs.932).

HAWKESDALE.—Land proposed to be permanently reserved as a site for a Racecourse and Public Recreation, 146 acres 0 roods 21 perches, Township of Hawkesdale, Parish of Kangertong, County of Villiers, being the site temporarily reserved therefor by Orders in Council of the 20th December, 1887, and the 26th February, 1957, and known as the Hawkesdale Racecourse and Recreation Reserve.—(H.54⁽³⁾) (Rs.1634).

J. C. M. BALFOUR,
Minister of Lands.

PROPOSED REVOCATIONS OF TEMPORARY RESERVATIONS OF LANDS BY ORDERS IN COUNCIL.

IN pursuance of the provisions of the *Land Act 1958*, notice is hereby given that it is the intention of the Governor in Council to revoke the temporary reservations of lands by Orders in Council hereunder referred to, viz.:—

The following Notices were published 1° on the 26th May, 1965, pursuant to Orders of the 18th May, 1965.

BALLARAT EAST.—The temporary reservation, by Order in Council of the 27th June, 1870, of 18½ perches of land in the Township of Ballarat East as a site for a Place of Public Worship in connexion with the Presbyterian Denomination.—(B.128⁽⁴⁰⁾) (C.91802).

CARWARP.—The temporary reservation, by Order in Council of the 6th November, 1947, of 15 acres of land in the Parish of Carwarp as a site for Public Recreation.—(C.473⁽⁶⁾) (Rs.3288).

COLVINSBY and WARRAK.—The temporary reservation, by Order in Council of the 7th May, 1877 (see *Government Gazette* of the 11th May, 1877, page 864) of 148 acres 2 roods 28 perches of land in the Parishes of Colvinsby and Warrak as a site for Victorian Water Supply purposes.—(C.367⁽⁵⁾) (C.99359).

COSTERFIELD.—The temporary reservation, by Order in Council of the 11th January, 1887, of 2 roods 1 perch of land in the Township of Costerfield as a site for Mechanics' Institute, revoked as to part by Order of the 27th February, 1940, is about to be revoked so far as the balance thereof containing 1 rood 15 perches is concerned.—(C.370^(c2)) (Rs.1514).

MOHICAN (BUXTON).—The temporary reservation, by Order in Council of the 13th April, 1965, of 148 acres 2 roods, more or less, of land in the Parish of Mohican as a site for Public purposes (Social Welfare Branch Adventure Camp) is about to be revoked so far only

as the portion containing 1 acre 3 roods, more or less, indicated by hachure on plan hereunder, is concerned.—(M.553⁽³⁾) (Rs.8436).

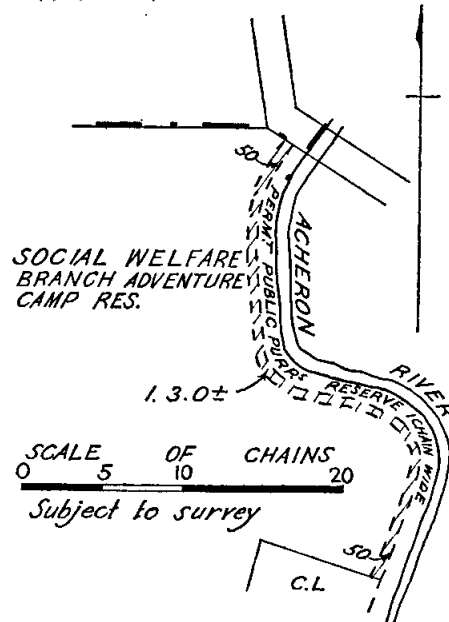

SANDHURST (KENNINGTON).—The temporary reservation, by Order in Council of the 24th September, 1912, of 5 acres 1 rood 9 perches of land in the Parish of Sandhurst as a site for Public Gardens, revoked as to part by Order of the 12th March, 1918, is about to be revoked so far only as the portion containing 1 rood 13 perches, more or less, indicated by hachure on plan hereunder, is concerned.—(S.371⁽²⁰⁾) (Rs.782).

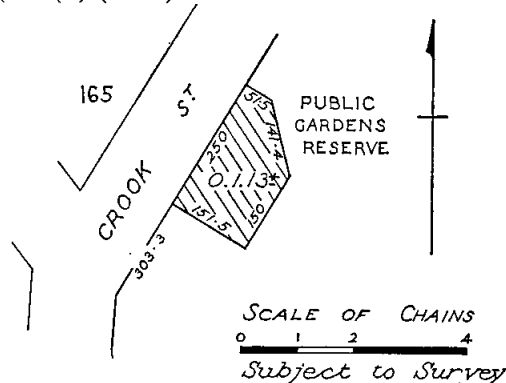

STUARTMILL.—The temporary reservation, by Order in Council of the 29th April, 1921, of 1 acre 2 roods 33 perches of land in the Township of Stuartmill as a site for State School purposes.—(S.355⁽²⁾) (Rs.2126).

WERRAP.—The temporary reservation, by Order in Council of the 27th January, 1920, of 4 acres of land in the Parish of Werrap as a site for State School purposes.—(W.386⁽³⁾) (Rs.2097).

J. C. M. BALFOUR,
Minister of Lands.

COMMON ABOUT TO BE DIMINISHED.

IN pursuance of the provisions contained in the *Land Act 1958*, notice is hereby given that it is the intention of the Governor in Council to diminish the common hereinafter mentioned, viz.:—

The following Notice was published 1° on the 26th May, 1965, pursuant to Order of the 18th May, 1965.

The United Municipal and Goldfield Common of Clunes, proclaimed as such on the 14th September, 1863, is about to be diminished by the excision therefrom of allotment 12, section 21, Township of Clunes, and containing 1 rood 32 perches.—(Rs.398.)

J. C. M. BALFOUR,
Minister of Lands.

PROPOSED REVOCATIONS OF TEMPORARY RESERVATIONS OF LANDS BY ORDERS IN COUNCIL.

IN pursuance of the provisions of the *Land Act 1958*, notice is hereby given that it is the intention of the Governor in Council to revoke the temporary reservations of lands by Orders in Council hereunder referred to, viz.:—
The following Notices were published 1^o on the 2nd June, 1965, pursuant to Orders of the 25th May, 1965.

COHUNA.—The temporary reservation, by Order in Council of the 7th October, 1958, of 2 roods of land in the Township of Cohuna, as a site for the purposes of the Forests Act.—(C.424^(*)) (Rs.7620).

DOUITA GALLA (ESSENDON).—The temporary reservation, by Order in Council of the 4th May, 1909, of 3 acres 2 roods 4 perches of land at Essendon, in the Parish of Douita Galla, as a site for a Public Park and other purposes of Public Recreation, revoked as to part by Order of the 14th January, 1958, is about to be revoked so far only as the portion containing 1 acre 0 roods 34 perches, indicated by hachure on plan hereunder, is concerned.—(E.68(c)) (Rs.2793).

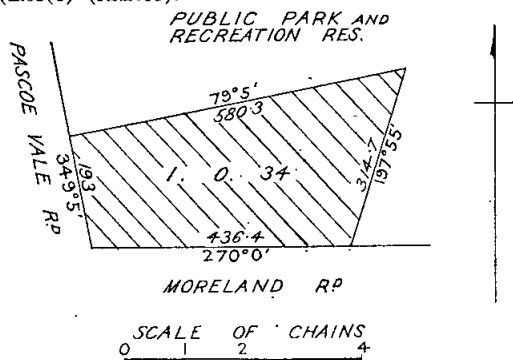

ESKDALE.—The temporary reservation, by Order in Council of the 18th May, 1937, of 1 rood 31 perches of land in the Township of Eskdale, as a site for Camping and Watering purposes.—(E.112^(*)) (Rs.4198).

GEELONG.—The temporary reservation, by Order in Council of the 3rd August, 1954, of 15 acres 1 rood 10 perches, more or less, of land in the City of Geelong, as a site for Public Recreation, is about to be revoked so far only as the portion containing 20 perches, more or less, indicated by hachure on plan hereunder, is concerned.—(G.25^(*)) (Rs.7240).

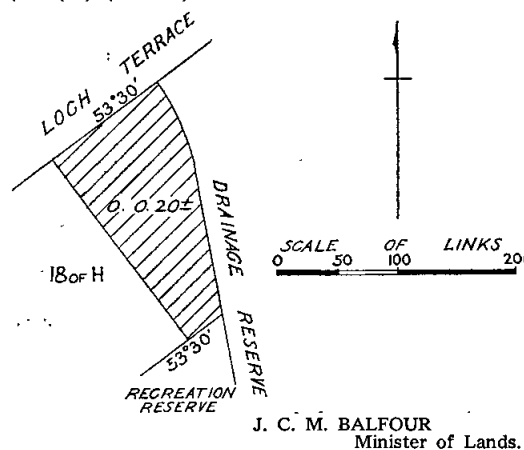

COMMITTEES OF MANAGEMENT OF RESERVES. APPOINTMENTS.

NOTICE is hereby given that, in pursuance of section 221 of the *Land Act 1958*, the following appointments of Committees of Management of reserved Crown lands have been made by the Minister of Lands:—

PORTIONS OF THE WATER SUPPLY PURPOSES RESERVES (2) AND THE MUNICIPAL AND RAILWAY WATER SUPPLY PURPOSES RESERVE IN THE PARISH OF BARAMBOGIE.

The Chiltern Waterworks Trust as the Committee of Management of such portions of Crown lands in the Parish

of Barambogie reserved as sites for Water Supply purposes and Municipal and Railway Water Supply purposes as are indicated by red, blue and yellow colours on plan B/21.5.65 attached to Lands Department correspondence Rs.6486.—(Corres. Rs.6486.)

"BENDIGO PUBLIC PURPOSES (PRE-SCHOOL CENTRE) RESERVE."

The Council of the City of Bendigo as a Committee of Management of the land in the Parish of Sandhurst at Bendigo temporarily reserved by Order in Council of the 16th March, 1965, as a site for Public purposes (Pre-school Centre).—(Corres. Rs.8429.)

"BIRCHIP RECREATION AND SHOWGROUNDS RESERVE."

Colin Foster Russell, Francis Robert Bolden, Anthony John Ruyg, James Ryan Sheridan, James Joseph Ryan, Mathias Vincent O'Keefe, Robert John Reid, William Mathew Crosbie, Alphonso Maurice Connelly, Maxwell Harold Bolden, Francis John Thomas King, Vernon Aloysius Connelly, George Felix Cartwright and Norman Ernest Haslam as a Committee of Management for a period of three (3) years of the remaining portion of the lands in the Township of Birchip reserved by Orders in Council of the 29th August, 1905, and the 25th September, 1909, as a site for a Public Park and other purposes of Public Recreation and of the lands in the Township of Birchip, reserved by Orders in Council of the 25th August, 1890, and 29th November, 1894, as a site for Show Yards and known as the "Birchip Recreation and Showgrounds Reserve".—(Corres. Rs.1922, Rs.1923.)

"DUNBULBALANE PUBLIC RECREATION RESERVE."

Charles Robert Barnbrook, Kevin Joseph Malane, George Robert Kellas, Neil Felmingham, Peter James Hall, James Norman McLeod, Ronald Keith Harrower, Cyril Edward Valentine and Lancel John Delmenico as a Committee of Management for a period of three (3) years of the land in the Parish of Dunbulbalane temporarily reserved by Order in Council dated the 23rd March, 1965, as a site for Public Recreation.—(Corres. Rs.8426.)

"FITZROY RIVER PUBLIC PURPOSES RESERVE."

George Norman Nunn, Clive Alexander Mitchell, James Benjamin Saunders, Kenneth John Harris, Leonard Raymond Arnott, John James William Papley and David Frost as a Committee of Management for a period of three (3) years of the reserved Crown land in the Parish of Tarragal as shown in red colour on plan A/1st August, 1958, attached to Lands Department correspondence Rs.7758, and known as the "Fitzroy River Public Purposes Reserve".—(Corres. Rs.7758.)

"FLAGGY CREEK PUBLIC HALL RESERVE."

Edward Wolfe Smith, Emily Perrin, Alfred John Perrin, William Ian Williams, Leonie Williams, John Thomas Saunders and Rinaldo Lanteri as a Committee of Management for a period of three (3) years of the land temporarily reserved by Order in Council dated the 2nd November, 1949, as a site for a Public Hall in the Parish of Wuk Wuk, and known as the "Flaggy Creek Public Hall Reserve".—(Corres. Rs.6453.)

"HEATHCOTE SHOWGROUNDS RESERVE."

William Arthur Cary, Edwin Alfred Kemp, James Louis Tranter, Robert Hagan Perry and Keith Thomas Wilkie as a Committee of Management for a period of three (3) years of the remaining portion of the land in the Township of Heathcote, Parish of Heathcote temporarily reserved by Orders in Council, dated the 4th January, 1883, and the 28th January, 1905, as a site for Show Yards, and known as the "Heathcote Showgrounds Reserve".—(Corres. Rs.662.)

"MOLIAGUL FREE LIBRARY RESERVE."

William Edward Shay, Kenneth Joseph McClelland, Cyril Shay, George Mervyn Carless, Cyril James Snow, Edward Ernest Shay, Raymond Stanley Shay and James William Mason as a Committee of Management for a period of three (3) years of the land temporarily reserved by Order in Council dated 29th May, 1888, as a site for a Free Library in the Township of Moliagul, and known as the "Moliagul Free Library Reserve".—(Corres. Rs.421.)

"MURRAY RIVER FRONTAGE PARK," MILDURA.

The Council of the City of Mildura as a Committee of Management of the reserved Crown land shown by green colour on plan M/18.12.1950, on Lands Department correspondence C.74988, being portion of the "Murray River Frontage Park", Mildura.—(Corres. C.74988.)

"PAARATTE RECREATION RESERVE."

George Basil Wilson, William Joseph White, Arthur Edward Schild, Alexander Hendeson Collins Graham, Isabell Graham, Rodney Sissons, Leslie Davison, Ian Maxwell Baglin, Michael Laurence Dwyer and Alfred Ernest Cooknell as a Committee of Management for a period of three (3) years of the land temporarily reserved by Order in Council dated the 20th November, 1934, as a site for Public Recreation in the Parish of Paaratte and known as the "Paaratte Recreation Reserve".—(Corres. Rs.4416.)

"PHILLIP ISLAND KOALA RESERVE."

Richard Thomas Martin Pescott, Alfred Dunbavin Butcher, Archibald Westoby Shillinglaw, William George Papworth, Alexander Ernest Wilkie, Herbert Eric Grayden, Jack Robinson Oswin, Joshua Wickett Gliddon, Vernon Thompson and Donald Gray Hopkins as a Committee of Management of the land in the Parish of Phillip Island, temporarily reserved by Order in Council dated the 27th January, 1965, as a site for the Preservation of Koalas.—(Corres. Rs.8401.)

"QUEENSLIFF BOWLING, TENNIS AND CROQUET RESERVE SITE."

James William Warren, Robert George Stevenson, Alexander Laker and John William Page as a Committee of Management for a period of three (3) years of the land containing 2 acres 0 roods 18 5/10 perches permanently reserved by Order in Council dated the 30th March, 1931, as a site for the Recreation of the People in the Township of Queenscliff and known as the "Queenscliff Bowling, Tennis and Croquet Reserve".—(Corres. Rs.4109.)

"SWIFT'S CREEK CAMPING RESERVE."

John Sutter Reid, Stanley H. Fitzpatrick, John O'Brien, Thomas McLarty and John George Barker as a Committee of Management for a period of three (3) years of the land in the Parish of Tongio-Munjie East temporarily reserved as a site for Public purposes by Order in Council of the 27th April, 1955, also the permanent reserve abutting, and together known as the "Swift's Creek Camping Reserve".—(Corres. Rs.7361.)

"TAHARA RECREATION RESERVE."

Alfred William John Pepper, Peter Dohle, Norman Lawrence Rhook, John Nolte, Thomas Leslie Hay, Murdoch McLennan Aylmer and Ewen William Nolte as a Committee of Management for a period of three (3) years of the areas in the Township of Tahara temporarily reserved by Orders in Council dated 10th March, 1914, and 12th December, 1950, as sites for Public Recreation, such areas being together known as the "Tahara Recreation Reserve".—(Corres. Rs.832.)

"THOM'S BRIDGE PICNIC AND CAMPING RESERVE."

Gordon Hall, Anthony Derham, Stanley Cook, Clarence Oliver Murray, Patrick Turvey, John Derham and Reginald Brinsmead as a Committee of Management for a period of three (3) years of that portion of the land permanently reserved for public purposes along the Latrobe River, in the Parish of Tanjil East, as is indicated in red colour on the plan marked T/3.6.49 attached to Lands Department correspondence No. Rs.6376, and known as "Thom's Bridge Picnic and Camping Reserve".—(Corres. Rs.6376.)

"TOOLANGI RECREATION AND CAMPING RESERVE."

Frederick Lee, Wayne Fenner, Charles Cherry, Allen Bunt, Edward Cherry, Alec Demby, Robert Pockett and John Priestley as a Committee of Management for a period of three (3) years of the land in the Township of Toolangi temporarily reserved by Order in Council dated the 27th February, 1913, as a site for Public Recreation and Order in Council dated the 30th June, 1936, as a site for Camping purposes known as the "Toolangi Recreation and Camping Reserve".—(Corres. Rs.42, Rs.4586.)

"WHITFIELD TOURIST CAMPING RESERVE."

Philip G. Cooper, L. Toohey, John F. Dickson, J. Skinns, L. McDonald, Brian E. Sheppard, L. Morgan, Bill Chong, A. E. Neate and H. Whitty as a Committee of Management for a period of three (3) years of the land in the Parishes of Whitfield and Edi temporarily reserved by Order in Council dated 11th January, 1949, as a site for Tourist Camping purposes together with that portion of the permanent reserve along the King River abutting the aforementioned land, and known as the "Whitfield Tourist Camping Reserve".—(Corres. Rs.6313.)

"YACKANDANDAH RACECOURSE AND RECREATION RESERVE."

Mervin Mahon, Peter Schuppan, John Adams, Alexander McKibbin, Ernest Britton, Hugh Mason and David Montgomery as a Committee of Management for a period of three (3) years of the lands temporarily reserved as a site for a Racecourse and other purposes of Public Recreation in the Parish and Township of Yackandandah and known as the "Yackandandah Racecourse and Recreation Reserve".—(Corres. Rs.2746.)

ALAN J. HOLT,
Secretary for Lands.

24th May, 1965.

Land Act 1958.

LICENCE UNDER THE LAND ACTS 1928 AND 1958 DECLARED VOID.

NOTICE is hereby given that the Licence in the Schedule hereunder has been Declared Void for the reason specified.

District.	Corr. No.	Name of Licensee.	Section of Land Act under which Licensed.	Parish.	Allotment.	Section.	Area.	Annual Rental	Reasons for Voiding.
Northern..	0234-138	Margaret Esther Ashcroft	138	Inglewood	13	1A	A. R. P. 0 3 32	£ s. d. 1 0 0	Licence surrendered

Department of Crown Lands and Survey,
Melbourne, 31st May, 1965.

J. C. M. BALFOUR,
Minister of Lands.

TENDERS—PUBLIC WORKS DEPARTMENT

TENDERS will be received at the Head Office of the Public Works Department, Treasury-place, Melbourne, until **TEN** a.m. on the dates shown and for the purposes mentioned hereunder.

Particulars and tender forms may be obtained at the Contracts Office, Room 7, Building Division, Parliament-place, and at the places indicated in brackets after certain items.

The abbreviations shown in the brackets mean the following:—W.O.—Inspector of Works Office; P.S.—Police Station; C.S.—Consolidated School; H.E.S.—Higher Elementary School; H.S.—High School; S.S.—State School; T.S.—Technical School.

Tenders should be submitted on the Department's printed Tender Form and will not be received by telephone. All tenders must be on a "Firm Tender" basis. The lowest or any tender will not necessarily be accepted.

Tenders are to be addressed to the Minister of Public Works, and the envelopes containing the tender is to be clearly marked "Tender for _____, closing Tuesday, _____".

No preliminary deposit is to be lodged with any tender, but a successful tenderer will be required to pay a deposit for any accepted tender of the value of £1,500 or over.

Tuesday, 8th June, 1965.

Building, Electrical and Mechanical Works.

Ararat.—Erection of new Dormitory, Ward M.6, and renovations to existing Cottage, Mental Hospital. (W.O., Ararat and Ballarat.) (Bill of quantities available.)

Ascot Vale.—External and internal renovations, Police Station.

Bass.—Erection of out-offices and installation of septic tank, S.S. 847 and Residence. (W.O., Korumburra; S.S., Bass.)

Burnley Gardens.—Supply and installation of evaporative cooling equipment in Twin Glasshouse, Agriculture Department.

Burwood.—Supply and installation of heating and hot-water services in additional class-rooms and toilet areas, Social Welfare Department, "Allambie".

Clifton Creek.—New out-offices and septic tank installation, S.S. 3684. (W.O., Bairnsdale; S.S., Clifton Creek.)

Coburg.—Supply, delivery and erection of steel roof trusses for store building, Pentridge.

Collingwood.—New toilet block, store and hopper stand, &c., Technical School.

Corinella.—New toilets and septic tank, S.S. 1392. (W.O., Korumburra; S.S., Corinella.)

Ellinbank.—Supply and installation of central heating, hot-water, exhaust and L.P. gas services in new Laboratory Block, Research Station. (W.O., Warragul and Traralgon.)

Everton Upper.—Re-siting out-offices, new woodshed and septic tank installation, S.S. 1198. (W.O., Wangaratta; S.S., Everton Upper.)

Flemington.—Supply and installation of plenum heating, exhaust ventilation and hot-water service, High School.

Lara.—Erection of Service Block, Fisheries and Wildlife Reserve. (W.O., Geelong.)

Malvern.—Erection of shelter shed and store including other minor works, S.S. 2586.

Minyip.—Repairs and painting, Police Station and Residence. (W.O., Warracknabeal; P.S., Minyip.)

Mt. Evelyn.—Repairs and painting, Police Station and Residence.

Piangil.—New tank, repairs and painting, Police Station and Residence. (W.O., Swan Hill; P.S., Piangil.)

Point Wilson.—Erection of field laboratory, two sampling shelters and five magazines, Explosives Area. (W.O., Geelong.)

Point Wilson.—Electrical installation, Field Laboratory and Explosives Magazines, Explosives Area.

Royal Park.—Supply, delivery and installation of heating system in Research Institute, Mental Hospital.

Scoresby.—New porch and alterations to laboratory, new bench in fruit receiving room, Research Station. (Scoresby Research Station.)

Shepparton.—New porch, repairs and painting, Police Station Residence. (W.O., Shepparton.)

Stawell West.—Plenum heating to four class-rooms, S.S. 4934. (W.O., Ararat and Ballarat.)

Terang.—Toilet and change room block, sewerage existing school buildings, High School. (W.O., Camperdown; H.S., Terang.)

Toorak.—Supply and installation of new boiler equipment and extension of heating system, Technical Teachers' College.

Tottenham.—Supply and installation of extensions to heating and hot-water systems, Technical School.

Traralgon.—Electrical installation, additional L.T.C. class-rooms, &c., High School. (W.O., Traralgon.)

Warrandyte.—Repairs and painting to residence, Police Station.

Werribee.—Supply, delivery and installation of extensions to existing hot-water service to new Dormitory Block, Research Farm. (W.O., Geelong.)

Furniture and Furnishings.

Heidelberg.—Supply of school furniture, Technical School.

Site Works.

Burwood.—Construction of a playground for the Kindergarten including footpaths and landscaping, Social Welfare Department, "Allambie" Reception Centre.

Hihett.—New light duty asphalt, asphalt repairs, drainage works, retaining wall and gravelling, S.S. 4677.

Middle Park.—New light duty asphalt, asphalt repairs and concreting, S.S. 2815.

Miscellaneous.

Maryborough.—Supply of Engineering Laboratory equipment, Technical College.

Traralgon.—Supply and delivery of kitchen equipment for the Kiosk, Hobson Park Hospital.

Warrambool.—Supply and delivery of kitchen equipment for the new Main Kitchen, Mental Hospital.

Werribee.—Supply and delivery of kitchen equipment for the new Main Kitchen, Research Farm.

Williamstown.—Supply and delivery of 8-in. rubber suction hose, Ports and Harbors, Dredging Depot.

Williamstown.—Supply and delivery of two (2) petrol-engined double drum friction winches, 3-ton capacity, Public Works Department, Dredging Depot.

Tuesday, 15th June, 1965.

Building, Electrical and Mechanical Works.

Bendigo.—Electrical installation, New Wing, and alterations to existing buildings, High School. (W.O., Bendigo.)

Box Hill.—Electrical installation, re-wiring and improved lighting in main building, Boys' Technical School.

Brunswick.—Renewal of water supply, Technical School. Brunswick South.—Staff toilet and additional troughs, S.S. 2743 and residence.

Cannum.—Repairs and painting and erection of shelter pavilion, S.S. 1867. (W.O., Warracknabeal and Horsham; S.S., Cannum.)

Canterbury.—New toilet, roof to Bristol Prefab., repairs and painting, S.S. 3572.

Castlemaine.—New toilet facilities, Gaol. (W.O., Bendigo; Gaol, Castlemaine.)

Coburg West.—Installation of two stainless-steel drinking troughs and replacement of concrete drinking troughs, S.S. 3941.

Eddington.—New out-offices and septic tank installation, S.S. 793 and Residence. (W.O., Maryborough; S.S., Eddington.)

Elsternwick.—Additional washing and drinking troughs, S.S. 2870.

Fitzroy.—Demolition and removal of buildings, &c., Section "B", High School.

Footscray.—New steel fire escape stairs, S.S. 1912.

Hallston.—New out-offices and septic tank installation, S.S. 2825. (W.O., Korumburra; S.S., Hallston.)

Jacana.—Connexion of sewerage, S.S. 4839.

Kilmore.—Repairs and painting, Court House. (W.O., Alexandra; Court House, Kilmore.)

Kyneton.—Erection of toilet block and woodshed, S.S. 343. (W.O., Kyneton; S.S., Kyneton.)

Lara.—Supply and installation of air-conditioning units in Animal House, "Serendip", Fisheries and Wildlife Reserve. (W.O., Geelong.)

Loddon East.—Supply and installation of extensions to central heating, Consolidated School. (W.O., Bendigo.)

Malvern.—Renewal of external ramp (brick and concrete), S.S. 1604 (Infants).

Manningham.—New Primary School of ten class-rooms, plus library, S.S. 4940.

Manningham.—Electrical installation in new school of twelve L.T.C. class-rooms, &c., S.S. 4940.

Manningham.—Plenum heating to new ten class-room school, S.S. 4940.

Melbourne.—Renewal of roof and gutters and external painting and sewerage plumbing, Health Department, Milton House. (Amended Specification.)

Mont Park.—Remodelling Wards F.7, 8, 9 and 10, Mental Hospital. (Bills of Quantities available.)

Pennyroyal.—External and internal painting and repairs to white ant damage, S.S. 1204. (W.O., Geelong; S.S., Pennyroyal.)

Richmond.—Erection of additional toilet and washing facilities, Technical School.

Royal Park.—Conversion of existing hot-water system to 105° F. system and supply of a new 180° F. system in Male and Female Receiving Wards, Mental Hospital.

Somers.—Replacement of urinals, provision of showers, &c., School Camp, S.S. 4647. (S.S., Somers.)

St. Kilda.—Supply and installation of central heating extension and boiler room modification, S.S. 1479.

Toolangi.—Alterations and renovations to Blue Range Barn, Research Station.

Toongabbie.—Provision of septic tanks, bore hole, &c., S.S. 856 and Residence. (W.O., Traralgon; S.S., Toongabbie.)

Various.—Electrical installation in additional Science Wings, Mentone Girls', McKinnon, Waverley and Murrumbena High Schools.

Various.—Supply and installation of mechanical services in new Science Blocks, High Schools, Oakleigh, Bentleigh, Highett and Huntingdale.

Various.—Addition of Science Wings to four timber-framed High Schools at Balwyn, McLeod, Ashwood and Croydon.

Various.—Supply and installation of mechanical services in Science Wings at Balwyn, McLeod, Ashwood and Croydon High Schools.

Various.—Electrical installation in additional Science Wings, Strathmore, Glenroy, Maribyrnong and St. Albans High Schools.

Williamstown.—External repairs and painting, Court House.

Willow Grove.—Conversion of septic closet to tank, S.S. 2520 and Residence. (W.O., Warragul; S.S., Willow Grove.)

Woodend.—Erection of laundry, W.C., and repairs, Police Station, Residence. (W.O., Kyneton; Police Station, Woodend.)

Furniture and Furnishings.

Warrnambool.—Supply of timber benches, &c., Technical College.

Site Works.

Balwyn.—Asphalt repairs, drainage works and graveling, S.S. 1026.

Beaumaris.—New light duty asphalt, drainage works, concreting, gravelling and earthworks, High School.

Blackburn.—Asphalting, concreting, gravelling, drainage, maintenance and associated works, High School.

Doncaster East.—Earthworks, asphalting, concreting, drainage and associated works, S.S. 2096.

Glen Waverley Heights.—Asphalting, concreting, drainage, retaining walls and associated works, S.S. 4836.

Upper Fern Tree Gully.—Site works, earthworks, drainage (surface and underground) and paving for new school, S.S. 3926.

Miscellaneous.

Melbourne.—Supply of incinerators and spare parts from 1st July, 1965, to 30th June, 1966, Public Works Department.

Sebastopol.—Supply of grinding and drilling machines, Technical School.

Various.—Chimney sweeping, 1st July, 1965, to 30th June, 1966, Government Buildings, Melbourne and Suburbs.

Tuesday, 22nd June, 1965.

Building, Electrical and Mechanical Works.

Arawata.—Conversion to septic tank, S.S. 2970. (W.O., Korumburra; S.S., Arawata.)

Ellinbank.—Erection of brick veneer residence and garage, Dairy Research Station. (W.O., Warragul and Traralgon.)

Hawthorn.—Re-organization of Engineering Laboratories, Swinburne Technical College.

Hawthorn.—Alterations and additions electrical installations, Applied Mechanics, Thermodynamics and Internal Combustion Laboratories, Swinburne Technical College.

Hawthorn.—Supply, installation and testing of Cooling Water, ventilation and exhaust systems and hot-water service for Mechanical Engineering Laboratories, Swinburne Technical College.

Heatherton.—New aluminium glazing to north and south blocks, Sanatorium.

Noradjuha.—New toilet block and install septic tanks, S.S. 1930 and Residence. (W.O., Horsham; S.S., Noradjuha).

Prahran.—Erection of new High School (Three Storey). (Specified Bills of Quantities.)

Prahran.—Supply and installation of plenum heating, exhaust ventilation and hot-water system, High School.

Preston.—Erection of boiler house, Pleasant View Psychiatric Hospital.

Stawell.—Erection of two Dependent Patients Wards, Pleasant Creek Special School. (W.O., Ararat and Ballarat.) (Bills of Quantities Available.)

Stawell.—Electrical installation for two Dependent Patients Wards, Pleasant Creek Special School. (W.O., Ararat.)

Stawell.—Supply and installation of steam and condensate mains, low and high temperature hot-water systems, plenum and floor heating to two new Dependent Wards, Pleasant Creek Special School. (W.O., Ballarat.)

Warrnambool West.—New Primary School of eight class-rooms, S.S. 4899. (W.O., Warrnambool.)

Warrnambool West.—Electrical installation, new school of eight L.T.C. class-rooms, &c., S.S. 4899. (W.O., Warrnambool.)

Warrnambool West.—Plenum heating to new eight class-room school, S.S. 4899. (W.O., Warrnambool.)

Werribee.—Erection of residence and garage, Research Farm. (W.O., Geelong.)

Werribee.—Electrical installation in new Dormitory for 27 students, Research Farm.

Furniture and Furnishings.

Melbourne.—Supply of drawing and painting easels, Royal Melbourne Institute of Technology.

Wangaratta.—Supply of benches and display boards, Visual Education Centre, High School. (W.O., Wangaratta.)

Site Works.

Boronia West.—Surface and minor underground drainage, paving (mainly asphalt, some concrete and gravel), and sundry work, S.S. 4908.

St. Albans.—New light-duty asphalt, asphalt repairs, drainage works, concreting and gravelling, S.S. 2969.

Wodonga.—Pre-grading of site for proposed Technical School. (W.O., Benalla and Wangaratta; Police Station, Wodonga.)

J. C. M. BALFOUR,
Acting Minister of Public Works.

Public Works Department,
Melbourne, C.2, 31st May, 1965.

PUBLIC SERVICE NOTICES

No. 1490.

Public Service Act 1958, Section 50.

REGULATIONS.—PART IV.—SALARIES AND INCREMENTS.

THE Public Service Board, in pursuance of the powers conferred by the *Public Service Act 1958*, hereby amends its Regulations as shown below :—

SIXTH SCHEDULE.

TEMPORARY EMPLOYEES.

Designations of Positions and Rates of Salaries.

Department and Designation of Position.	Yearly Rate of Salary.		Increments (Annual).
	Minimum.	Maximum.	
GENERAL.	£	£	
<i>Delete—</i> Surveyor, Licensed	1,448	1,558	1 of £110
<i>Add—</i> Surveyor	1,448	2,293	1 of £165, 1 of £175, 3 of £120 and 1 of £145

A. GARRAN, Chairman.
V. P. SCULLY, Secretary.

Office of the Public Service Board,
Melbourne, 4th May, 1965.

No. 1489.

Public Service Act 1958, Section 39.

REGULATIONS.—PART IV.—SALARIES AND INCREMENTS.

THE Public Service Board, in pursuance of the powers conferred by the *Public Service Act 1958*, hereby amends its Regulations as shown below :—

FIRST SCHEDULE.

PROFESSIONAL DIVISION.

Amount of Salary Assigned to Offices in Class "A1".

Office.	Yearly Rate of Salary.
CHIEF SECRETARY'S DEPARTMENT.	£
<i>Add—</i> Deputy Director, Forensic Science Laboratory, Office of the Chief Commissioner of Police ..	3,035

A. GARRAN, Chairman.
V. P. SCULLY, Secretary.

Office of the Public Service Board,
Melbourne, 21st May, 1965.

PUBLIC SERVICE OF VICTORIA.—VACANCIES.

APPLICATIONS will be received by the Public Service Board up to Wednesday, the 16th June, 1965, from persons employed in the Public Service of Victoria, who are eligible and qualified for appointment to the under-mentioned positions:—

ADMINISTRATIVE DIVISION.

Assistant Budget Officer (Works Programme), Class "A", Treasury.

Yearly Salary.—£2,613, minimum; £2,763, maximum.

Duties.—Detailed preparation and administration of Government and semi-Government works programmes; continuous review of planning and progress of works programmes in conjunction with Departments; to investigate and report on proposed works projects; to represent the State Co-ordinator of Works as required.

Qualifications.—A degree in Commerce or Economics or accountancy qualifications. Proved experience in research and investigation work.

Class "B1", Treasury.

Yearly Salary.—£2,293, minimum; £2,443, maximum.

Duties.—To act as Budget Inspector; investigations and preparation of material required for Treasury Budget control; special duties as directed.

Qualifications.—A degree in Commerce or Economics or accountancy qualifications. Experience in research and investigation work. A good knowledge of Government budgetting and accounting procedures.

Class "B1", Treasury.

Yearly Salary.—£2,293, minimum; £2,443, maximum.

Duties.—To be responsible under the Executive Officer for the administration of the Correspondence Branch and to act as Training and Methods Officer.

Qualifications.—A knowledge of the administration and functions of the Treasury and its Branches and ability to control and direct staff.

Class "C2", Education Department.

Yearly Salary.—£1,788, minimum; £1,908, maximum.

Duties.—To assist in the arrangements for the establishment and conduct of school bus services and to assist generally in the work of the Branch.

Qualifications.—A good knowledge of the Victorian Education system; capable of conducting negotiations with bus contractors.

Class "C1", Treasury.

Yearly Salary.—£1,558, minimum; £1,668, maximum.

Duties.—Assist in the preparation of material for budget purposes and the detailed administration of borrowings by semi-Government and Local Government bodies in accordance with statutory and Loan Council requirements.

Qualifications.—Progress towards a degree in Commerce or Economics or towards accountancy qualifications.

Class "C1", Office of the Housing Commission, Treasury.

Yearly Salary.—£1,558, minimum; £1,668, maximum.

Duties.—To be responsible to the Chief Architect for assembly of plans and contract documents; advertising of contracts; checking and comparing tenders, capabilities and standing of contractors; signing of contracts; and liaison with the Melbourne and Metropolitan Board of Works for procurement of sewer house connexion plans.

Qualifications.—General administrative experience; preferably, experience in administrative aspects of contract letting particularly in relation to building contracts.

Class "C", Department of Health.

Yearly Salary.—£1,283, minimum; £1,448, maximum.

Duties.—To be Secretary of the Medical Board of Victoria and to assist the Personnel Officer.

Qualifications.—A good knowledge of the Medical Act, Part I, of the Public Service Act and Regulations and of the Public Accounts and Stores Regulations. A knowledge of the organization of the Department is desirable.

Class "C", Office of the Public Service Board, Premier's Department.

Yearly Salary.—£1,283, minimum; £1,448, maximum.

Duties.—To assist generally in the correspondence registry.

Qualifications.—A knowledge of records management, preferably with practical experience.

PROFESSIONAL DIVISION.

Medical Officer (Male), Classes "A-A1", General Health Branch, Department of Health.

Yearly Salary.—£2,613, minimum; £3,360, maximum.

Qualifications.—A legally qualified medical practitioner of Victoria.

Designing Engineer, Class 3, Water Supply Department.

Yearly Salary.—£2,917, minimum; £3,283, maximum.

Duties.—To be responsible for the critical review of town water supply and sewerage proposals, designs (including hydrological aspects) and tenders and to supervise engineers engaged thereon; to advise on special construction problems; and to confer with Engineers of local Water Supply and Sewerage Authorities.

Qualifications.—A degree or diploma in Civil Engineering and qualified as an Engineer of Water Supply under the Water Act. Experience in the investigation, design and construction of water supply works and in the preparation of reports, estimates, plans and specifications. Experience in sewerage practice would be an advantage.

Senior Irrigation Officer, Class "B1", Department of Agriculture.

Yearly Salary.—£2,293, minimum; £2,443, maximum.

Duties.—To initiate and supervise investigations associated with irrigation of Victorian horticultural crops; to give demonstrations of irrigation practices; and to prepare reports, articles and lectures on horticultural irrigation.

Qualifications.—A degree in Agricultural Science from an Australian University, or its equivalent; a good general knowledge of the production of horticultural crops under irrigation, and a detailed knowledge of modern irrigation practice, the classification of soil types and the determination of soil properties; capacity for research and instruction work in this field.

Hydrographer, Class "C1", Water Supply Department.

Yearly Salary.—£1,558, minimum; £1,668, maximum.

Duties.—To take charge of a hydrographic survey party in a survey zone; to carry out the gauging of all streams and channels and to record the necessary data within that survey zone.

Qualifications.—To have had extensive experience in hydrographic survey work.

NOTE.—The successful applicant may be located at one of the Commission's hydrographic centres.

Librarian (Male or Female), Class "C", State Library, Chief Secretary's Department. (Two vacancies.)**Yearly Salary.—**

Male—£1,283, minimum; £1,448, maximum.
 Female—£1,096, minimum; £1,261, maximum.

Position No. 1.

Duties.—To undertake such duties as the Chief Librarian may require, and be prepared to work in any State Departmental library which is staffed by an officer of the State Library of Victoria.

Qualifications.—To be eligible to matriculate; to have passed the Preliminary Certificate or the first three subjects of the Registration Certificate of the Library Association of Australia; to have approved library experience or a Degree of an Australian University; a good knowledge of cataloguing rules and practices.

Position No. 2.

Duties.—Under the general direction of the Senior Cataloguer to be responsible for the Lending Library and Travelling Libraries Catalogues, to perform other professional duties as required.

Qualifications.—To be eligible to matriculate; to have passed the Preliminary Certificate or the first three subjects of the Registration Certificate of the Library Association of Australia; to have approved library experience; or to hold the Degree of an Australian University; to have a good knowledge of cataloguing rules and practices.

NOTE.—Separate applications must be submitted for these positions.

Librarian (Male or Female), Classes "E"-"D", State Library, Chief Secretary's Department.**Yearly Salary.—**

	Male.	Female.
At 16 years of age ..	£467	£437
at 17 years of age ..	£549	£472
at 18 years of age ..	£646	£530
at 19 years of age ..	£743	£614
at 20 years of age ..	£858	£699

Adult—£972, minimum; £1,178, maximum—Male.
 £785, minimum; £991, maximum—Female.

Duties.—To assist in the professional work of the State Library or in any State Departmental library served by the State Library staff.

Qualifications.—To be under 30 years of age, eligible to matriculate and preferably to have passed the first three subjects of the Registration Certificate of the Library Association of Australia; a good knowledge of books and current affairs.

NOTE.—Applicants will be submitted to a suitable test to prove their qualifications and aptitude for library work. For successful candidates eligible to matriculate or holding higher educational qualifications special salary loadings will apply.

TECHNICAL AND GENERAL DIVISION.**Superintendent (Female), "Illoura", Children's Home, Balwyn, Family Welfare Division, Social Welfare Branch, Chief Secretary's Department.**

Yearly Salary.—£1,187, minimum; £1,275, maximum.

Duties.—To have charge of a home for 36 adolescent school girls; to organize and supervise arrangements for their care, custody and activities.

Qualifications.—A sound education with experience in, and a capacity for, the conduct of an establishment for adolescent girls; ability to control adolescent girls and to supervise staff; to be skilled in modern child-care methods.

NOTE.—Quarters and rations provided at £166 a year. Successful applicant will be required to reside at the Home.

Examiner, Embossing, Stamp Duties Office, Treasury.

Yearly Salary.—£1,187, minimum; £1,223, maximum.

Duties.—To examine and supervise the work of the staff employed in the stamping of cheques and receipts with impressed duty; to pack stamped material for transport; to assist with the impressing of stamp duty on legal documents.

Qualifications.—Capacity to operate embossing and "Cash Register" impressing machines; to be accurate and quick at figures and of good physique; familiarity with the several types of dutiable documents is desirable.

Stores Inwards Officer, Government Printing Office, Treasury.

Yearly Salary.—£1,115, minimum; £1,205, maximum.

Duties.—To receive and inspect all goods delivered to the Government Printing Office; to distribute accepted goods throughout the organization; to keep all necessary records; other duties as required.

Qualifications.—Clerical ability; preferably a sound knowledge of the Public Accounts and Stores Regulations 1958.

Carpenter and Shipwright, Ports and Harbours Branch, Public Works Department. (Three vacancies.)

Yearly Salary.—£1,097 minimum; £1,205 maximum. (Plus an allowance of £50 a year for ship repair and "dirty" work).

Duties.—To carry out Shipwright and Carpenter's duties, including repairs to departmental vessels.

Qualifications.—To have served an apprenticeship as a Shipwright and worked as a journeyman for at least one year at the building and repairing of vessels and general ship work.

Prison Officer (Male), Prisons Division, Social Welfare Branch, Chief Secretary's Department.

Yearly Salary.—£1,079 minimum; £1,187 maximum.

Duties.—To control and supervise male prisoners; other duties as required.

Qualifications.—As required by Regulation 34 (5) of the Public Service (Public Service Board) Regulations.

Attendant, Public Offices Reserve, Public Works Department.

Yearly Salary.—£1,007 minimum; £1,061 maximum.

Duties.—To assist in control of parking of motor vehicles in the Public Offices Reserve, and to direct the public as to location of the various Government Departments.

Qualifications.—To be of good address and tactful in dealing with the public.

Chauffeur, Departmental, Youth Welfare Division, Social Welfare Branch, Chief Secretary's Department.

Yearly Salary.—£972 minimum; £1,043 maximum.

Duties.—To act as Chauffeur at "Turana" Youth Training Centre and to perform other duties as directed; to ensure that the vehicle is maintained in a safe and serviceable condition.

Qualifications.—A licenced and experienced driver with a good mechanical knowledge of motor cars.

Garage Attendant, Senior, Office of the Chief Commissioner of Police, Chief Secretary's Department.

Yearly Salary.—£989 minimum; £1,025 maximum.

Duties.—To train and supervise Garage Attendants engaged in lubricating departmental motor vehicles; to check for defects in and authorize replacement of tires.

Qualifications.—Experience in lubricating vehicles in use in the Police Department; ability to train and supervise a small staff.

Attendant, Grade I, National Gallery, National Museum and Institute of Applied Science, Chief Secretary's Department. (Two vacancies.)

Yearly Salary.—£972 minimum; £1,025 maximum.

Duties.—To clean and prepare galleries prior to and supervise them after admission of the public; other duties as directed.

Qualifications.—Physically fit and of good address. Museum or similar experience would be an advantage.

NOTE.—The successful applicants may be required to undertake shift duties.

Superintendent (Female), Assistant, "Illoura", Children's Home, Balwyn, Family Welfare Division, Social Welfare Branch, Chief Secretary's Department.

Yearly Salary.—£989.

Duties.—To be Assistant Superintendent of a home for 36 adolescent girls; to relieve the Superintendent in her absence.

Qualifications.—A sound education; experience in the care of adolescent girls, including girls with behaviour problems; ability to assist in the management of a home; to be competent in supervising staff and to possess personal flexibility and an interest in learning modern methods of child care.

NOTE.—Quarters and rations provided at £166 a year. Successful applicant will be required to reside at the Home.

Machinist (Female), Grade II., Taxation (Land Tax) Office, Treasury.

Yearly Salary.—£863 minimum; £881 maximum.

Duties.—To operate an Accounting Machine for the preparation of Land Tax Assessment Notices and Debit Registers and for Statistical work; other duties as required.

Qualifications.—Competent in the operation of both "National" and "Burroughs" Accounting Machines. A knowledge of procedure adopted in the issue of Land Tax Assessment Notices is desirable.

The salary rates quoted above do not include the additional amount which is payable under Regulation 74 of the Board's Regulations.

By order,
V. P. SCULLY,
Secretary.

Office of the Public Service Board,
Melbourne, 1st June, 1965.

PUBLIC SERVICE OF VICTORIA.—VACANCIES.
(TEMPORARY APPOINTMENTS.)

APPPLICATIONS will be received by the Public Service Board up to Wednesday, the 16th June, 1965, from persons who are qualified for appointment to the under-mentioned positions:—

Dairy Supervisor, Department of Agriculture.

Yearly Salary.—£1,295, minimum; £1,383, maximum.

Duties.—To inspect dairy farms and dairies as required; to advise and instruct on sanitation and dairy farm practice; to examine cows for notifiable disease and to assist generally in the administration of the Milk and Dairy Supervision Act in the field; to carry out other duties as required.

Qualifications.—A dairy Supervisor's Certificate issued under the Milk and Dairy Supervision Act.

NOTE.—Prior to appointment to a dairy supervision district, the successful applicant will be required to carry out herd test sampling duties for a period with Melbourne as his centre.

Trade Instructor (Female), (Arts and Crafts), Winlaton Girls Training Centre, Nunawading, Youth Welfare Division, Social Welfare Branch, Chief Secretary's Department.

Yearly Salary.—£1,223, minimum; £1,327, maximum.

Duties.—To give demonstrations and to conduct classes in arts and crafts work.

Qualifications.—A trained Secondary Teachers' Certificate (Arts and Crafts) or a Diploma of Arts. Trained Technical Teachers' Certificate or equivalent is desirable.

Trade Instructor (Female) (Cookery and Home Management), Youth Welfare Division, Social Welfare Branch, Chief Secretary's Department.

Yearly Salary.—£1,223, minimum; £1,327, maximum.

Duties.—To give demonstrations and conduct practical classes in cookery and home management.

Qualifications.—A Diploma of Food and Food Services or a Diploma of Nutrition and Food Services. Trained Technical Teachers' Certificate or equivalent is desirable.

Fruit Preserving Expert (Female), Assistant, Department of Agriculture.

Yearly Salary.—

At 18 years of age, £517;
at 19 years of age, £601;
at 20 years of age, £686.

Adult.—£810, minimum; £845, maximum.

Duties.—To advise on problems of fruit and vegetable preservation; to deliver lectures and demonstrations and to prepare exhibits for Agricultural Shows and articles for publication.

Qualifications.—A general knowledge of the preparation of jams, bottled fruits and vegetables, jellies, pickles, sauces, crystallised fruits, fruit butters, pulps and juices and ability to lecture and demonstrate.

NOTE.—The salary rates quoted above do not include the additional amount which is payable under Regulation 74 of the Board's Regulations.

By order,
V. P. SCULLY,
Secretary.

Office of the Public Service Board,
Melbourne, 1st June, 1965.

PUBLIC SERVICE OF VICTORIA.—VACANCIES.**DEPARTMENT OF HEALTH.****MENTAL HYGIENE BRANCH.****TECHNICAL AND GENERAL DIVISION.**

APPPLICATIONS will be received by the Public Service Board up to Wednesday, the 23rd June, 1965, from persons employed in the Public Service of Victoria, who are eligible and qualified for appointment to the under-mentioned positions:—

Supervisor (Male), Rehabilitation and Training Workshop, Caulfield.

Yearly Salary.—£1,295, minimum; £1,487, maximum.

Duties.—Supervision of a workshop for training and rehabilitation in which light assembly and bench-tool work will be undertaken.

Qualifications.—Approved qualification preferably as a toolmaker; familiarity with work methods and supervision under factory conditions; interest in social welfare and the problems associated with psychiatric illness and the intellectually handicapped is desirable.

Assistant Head Nurse (Female), St. Nicholas Hospital, Carlton.

Yearly Salary.—£1,187, minimum; £1,275, maximum.

Duties.—To assist Head Nurse in the management of female division and to prepare leave sheets and other records as directed; to relieve Head Nurse as required, and to give lectures to Student Nurses and others.

Qualifications.—A current practising certificate for Mental Deficiency Nursing. Ability to direct and control staff and patients and to keep records.

NOTE.—Applications from temporary employees who are not eligible for appointment to the Technical and General Division will be accepted.

Nurse, Senior (Male), Surgical Unit, Mont Park.

Yearly Salary.—£1,223.

Qualifications.—A registered general trained Nurse with surgical and theatre experience.

Carpenter, Grade II., Bundoora.

Yearly Salary.—£1,061, minimum; £1,187, maximum.

Duties.—To assist in all carpentering work.

Qualifications.—A competent and experienced carpenter.

Cook (Male), Grade I., Warrnambool.

Yearly Salary.—£1,025, minimum; £1,079, maximum.

Duties.—To assist in preparation, cooking and serving of meals for patients and staff, and cleanliness of kitchen.

Qualifications.—A knowledge of and experience in large quantity cooking.

Charge Nurse (Female) (Two vacancies).

Yearly Salary.—£1,007, minimum; £1,079, maximum.

One vacancy—Traralgon.

Duties.—To take charge or sub-charge of a ward in a Mental Hospital.

Qualifications.—A current practising Certificate for Mental Nursing.

NOTE.—Successful applicant will be required to work an eight-hour roster.

One vacancy—Janefield Colony.

Duties.—To take charge or sub-charge of a ward in a Mental Hospital and to assist in the training of Student Nurses and others.

Qualifications.—A current practising Certificate for Mental Deficiency Nursing and approved experience.

NOTE.—Separate applications must be submitted for these positions.

Seamstress, Grade I., St. Nicholas Hospital, Carlton.

Yearly Salary.—£776, minimum; £827, maximum.

Duties.—To make up and repair clothing and bedding.

Qualifications.—A competent needlewoman and machinist.

The salary rates quoted above do not include the additional amount which is payable under Regulation 74 of the Board's Regulations.

By order,
V. P. SCULLY,
Secretary.

Office of the Public Service Board,
Melbourne, 2nd June, 1965.

PUBLIC SERVICE OF VICTORIA.—RECLASSIFICATIONS.

THE Public Service Board has raised the classification of the under-mentioned offices as shown, and appointed thereto the respective officers named hereunder.

Office and Former Classification.	Revised Classification.	Duties.	Qualifications.	Officer Appointed.
ADMINISTRATIVE DIVISION.				
PUBLIC WORKS DEPARTMENT.				
Class "E"	Class "D" (With right of progression to Class "C")	Subject to the Officer in Charge, Procurement Section to arrange purchase of stores, builders materials and furniture and to assist in supervising work and personnel of the Section	Practical experience in the purchase of stores, builders materials and furniture; organising ability and capable of supervising staff; knowledge of Stores and Accounts Regulations	Jordan, N. L.
PROFESSIONAL DIVISION.				
DEPARTMENT OF AGRICULTURE.				
Field Officer, Grades 32-37 inclusive, Technical and General Division	Farm Survey Research Officer, Classes "C1" "C2", Professional Division	To undertake research in farm management economics in Victorian rural industries with particular reference to the development of farm record systems and methods of farm business analysis. To take part in extension activity in these fields	A degree in Commerce with appropriate training in basic agriculture and in the techniques of farm management	Shoobridge, R. G.
TECHNICAL AND GENERAL DIVISION.				
PUBLIC WORKS DEPARTMENT.				
Draughting Assistant, Grade IV., Grades 35-36 inclusive	Grade V., Grades 38-40 inclusive	Preparations of plans and specifications for major maintenance works and for major alterations and extensions to Government buildings; to direct draughtsmen engaged in similar work as required	A suitably qualified architectural draughtsman with extensive knowledge of architectural work and maintenance requirements for all types of Government buildings, together with experience in the preparation of plans and specifications for that type of work	Landells, G. W.
Assistant Draughtswoman, Grade II., Grades F22-F26, inclusive	Grade III., Grades F28-F30, inclusive	To prepare sketch plans, working drawings, specifications and details for court-houses and similar buildings; to carry out inspections, and prepare reports and estimates	To have had considerable experience of architectural draughting	Mountford, Eleonara R.
Assistant Draughtswoman, Grade II., Grades F22-F26, inclusive	Grade III., Grades F28-F30, inclusive	To prepare schemes and estimates for the furnishing of public buildings, and to provide specifications, designs and working drawings	Experience in design and construction of all types of furniture; a capable draughtswoman; to have made substantial progress in the Diploma course of Interior Design	Currie, Mavis J.

Office of the Public Service Board,
Melbourne, 1st June, 1965.

By order,
V. P. SCULLY,
Secretary.

PRIVATE ADVERTISEMENTS

CITY OF MELBOURNE.

BY-LAW No. 451.

A By-law of the City of Melbourne made under Part VII Division 1 and Part XLIX of the *Local Government Act 1958* and Clause 815 (i) of the Uniform Building Regulations, Victoria, and numbered 451 for prescribing areas within the municipal district in which buildings of Class II. Occupancy shall not be required to comply with the provisions of Clauses 804 to 808 inclusive of the Uniform Building Regulations, Victoria.

IN pursuance of the powers conferred by the *Local Government Act 1958*, the Uniform Building Regulations, Victoria, and of every other Act or power enabling it in that behalf the Council of the City of Melbourne DOTH ORDER as follows:—

1. This By-law may be cited as the "City of Melbourne Flats in Business Areas By-law 1964".

2. In this By-law, unless the context otherwise requires—

"Class II. Occupancy", "depth" and "width of frontage" shall have the meanings ascribed to those expressions by the Uniform Building Regulations, Victoria;

"Schedule" means schedule to this By-law.

3. The areas more particularly described in the First Schedule save and except such parts as are described in the Second Schedule are hereby prescribed as areas in which buildings of Class II. Occupancy shall not be required to comply with the provisions of Clauses 804 to 808 inclusive of the Uniform Building Regulations, Victoria, provided that, subject to the provisions of section 452 of the *Health Act 1958*, the site of any such building shall abut on a street not less than 30 feet in width and shall have an area of not less than 3,300 square feet, a width of frontage of not less than 33 feet, and a depth of not less than 60 feet.

FIRST SCHEDULE.

All that piece of land commencing at the intersection of the southern boundary of Dudley Street and the eastern boundary of Spencer Street and bounded by the said southern boundary of Dudley Street and its prolongation bearing north-easterly to the eastern boundary of Peel Street, thence by the said eastern boundary of Peel Street bearing northerly to Victoria Street, thence by the southern boundary of Victoria Street bearing easterly to Spring Street, thence by the western boundary of Spring Street and its prolongation bearing south-easterly to the northern bank of the Yarra River, thence by the said northern bank of the Yarra River bearing generally

westerly to Spencer Street and thence by the eastern boundary of Spencer Street bearing north-westerly to the commencing point; together with all those pieces of land the respective title deeds of which show or describe each of such pieces of land as having an abuttal to the northern boundary of Dudley Street between King Street and William Street.

SECOND SCHEDULE.

A. All that piece of land commencing at the intersection of the eastern boundary of Elizabeth Street and the northern boundary of Collins Street and bounded by the said eastern boundary of Elizabeth Street bearing north-westerly to Lonsdale Street, thence by the southern boundary of Lonsdale Street bearing north-easterly to Swanston Street, thence by the western boundary of Swanston Street bearing south-easterly to Collins Street and thence by the northern boundary of Collins Street bearing south-westerly to the commencing point.

B. All that piece of land abutting on the eastern boundary of Swanston Street between Little Collins Street and Little Bourke Street and having a depth of 70 feet from Swanston Street.

C. All those pieces of land abutting on the northern and the southern boundaries of Bourke Street between Swanston Street and Russell Street and having depths of 75 feet from Bourke Street.

RESOLUTION for passing this By-law agreed to by the Council of the City of Melbourne the twenty-eighth day of September One thousand nine hundred and sixty-four and confirmed the twenty-sixth day of October One thousand nine hundred and sixty-four.

E. L. CURTIS, Lord Mayor.
F. H. ROGAN, Town Clerk.

Approved by the Governor in Council, 11th May, 1965.
—J. COLQUHOUN, Clerk of the Executive Council.

(This publication of City of Melbourne By-law No. 451 supersedes that of 11th November, 1964, in Gazette No. 90 at page 3467.) 6276

CITY OF NUNAWADING.

No. 935.

LOAN No. 86.

Notice of Intention to Borrow the Sum of £34,500 for Permanent Works and Undertakings.

NOTICE is hereby given that the Council of the City of Nunawading proposes to borrow the principal sum of Thirty-four thousand five hundred pounds on the credit of the municipal revenues of the Mayor, Councillors and Citizens of the said City, such sum to be raised by the grant of a mortgage in accordance with the provisions of the *Local Government Act 1958*.

1. The maximum rate of interest that may be paid is £5 12s. 6d. per cent. per annum.

2. The purposes for which the loan is to be applied are:

- (a) Construction of Burwood-road from Middleborough-road to M.M.B.W. Pipe Track (Part Council's proportion of cost) £24,950
- (b) Construction of the following footpaths: £9,550
 - (i) Highbury-road, north side, east of Blackburn-road, adjacent to school.
 - (ii) Springfield-road, north side, from Springvale-road to Mitcham-road.
 - (iii) Mitcham-road, west side, from end of existing path north of Andover-avenue to Hedge End-road.
 - (iv) Boronia-road, north side, from Lusk-drive to Centre-road.
 - (v) Holland-road, east and west sides, south of Fulton-road to Eley-road (Part cost).
 - (vi) Rooks-road, east and west sides, north of Canterbury-road.
 - (vii) Edward-street, east side.
 - (viii) Fellowes-street, east side.
 - (ix) Blackburn-road, west side, from Canterbury-road to Hawthorn-road.
 - (x) Springfield-road, north side, from Blackburn North State School to Koonung-road.
 - (xi) Burwood-road, south side, west of Blackburn-road.

3. The period of the loan shall be ten years.

4. The moneys borrowed shall be repayable by providing out of the municipal fund twenty half-yearly instalments of approximately £2,278 18s. 7d. each, including

principal and interest, on the 1st day of February and the 1st day of August during the currency of the loan. The first instalment shall be payable on the 1st day of February, 1966.

5. Such moneys shall be repayable to the Commissioners of the State Savings Bank of Victoria, at the office of the said Commissioners, 139-165 Elizabeth-street, Melbourne.

The plans and specifications and the estimate of the cost of the proposed works and a statement showing the proposed expenditure of the moneys to be borrowed are open for inspection at the office of the Council of the City of Nunawading at White Horse-road, Nunawading.

Dated 28th May, 1965.

6282

J. H. BROWN, Town Clerk.

CITY OF SWAN HILL.

LOAN No. 37.

Notice of Intention to Borrow the Sum of £58,000 for Permanent Works and Undertakings.

NOTICE is hereby given that the Council of the City of Swan Hill proposes to borrow the sum of Fifty-eight thousand pounds on the credit of the municipal revenues of the Mayor, Councillors and Citizens of the said City, such sum to be raised by the grant of a mortgage, in accordance with the provisions of the *Local Government Act 1958*.

1. The maximum rate of interest that may be paid is £5 15s. per centum per annum.

2. The interest is to be payable half-yearly during the currency of the loan.

3. The period of the loan shall be 40 years.

4. The moneys borrowed shall be repayable at the National Bank of Australasia Limited, Western Branch, 460 Collins-street, Melbourne.

5. The loan is to be liquidated by the creation of a sinking fund pursuant to section 428A of the *Local Government Act 1958*.

6. The purposes for which the loan is to be applied are road and drainage works and swimming pool improvements.

The plans and specifications and the estimate of the cost of the proposed works, and a statement showing the proposed expenditure of the moneys to be borrowed, are open for inspection at the Town Hall, Swan Hill, during office hours.

Dated 28th May, 1965.

6280

R. J. PUGSLEY, Town Clerk.

CITY OF WARRNAMBOOL.

LOAN No. 65.

Notice of Intention to Borrow the Sum of £40,000 for Permanent Works and Undertakings.

NOTICE is hereby given that the Council of the City of Warrnambool proposes to borrow the sum of Forty thousand pounds on the credit of the municipal revenues of the Mayor, Councillors and Citizens of the said City, the sum to be raised by the grant of a mortgage in accordance with the provisions of the *Local Government Act 1958*.

1. The maximum rate of interest that may be paid is £5 12s. 6d. per cent. per annum.

2. The purpose for which the loan is to be applied is construction of private streets—£40,000.

3. The period of the loan shall be ten years.

4. The moneys borrowed shall be repayable by providing out of the municipal fund twenty half-yearly instalments of £2,642 4s. 9d. each, including principal and interest on the 1st day of August and the 1st day of February during the currency of the loan. The first instalment shall be payable on the 1st day of February, 1966.

5. Such moneys shall be payable at the C.B.C. Savings Bank Limited, Melbourne.

6. A statement showing the proposed expenditure of the moneys to be borrowed is open for inspection at the Municipal Office, Timor-street, Warrnambool.

6281

K. L. ARNEL, Town Clerk.

TOWN OF ST. ARNAUD.

LOAN No. 29.

Notice of Intention to Borrow the Sum of £3,000 for Permanent Works and Undertakings.

NOTICE is hereby given that the Council of the Town of St. Arnaud proposes to borrow the sum of Three thousand pounds (£3,000), on the credit of the municipal

revenues of the Mayor, Councillors and Burgesses of the said Town, such sum to be raised by the grant of a mortgage, in accordance with the provisions of the *Local Government Act 1958*.

1. The maximum rate of interest that may be paid is 5½ per annum.

2. The purpose for which the loan is to be applied is—

Town Hall seating	£800
Saleyards alterations	750
Plant (tip trailer)	400
Footpath kerb and channel construction, McMahon-street, Mill-street, Silvermines- road and North Western-road	£1,050

3. The period of the loan shall be ten years.

4. The moneys borrowed shall be repayable by providing out of the municipal fund twenty half-yearly instalments of approximately £198 3s. 4d. each, including principal and interest, on the 1st day of March and the 1st day of September during the currency of the loan. The first instalment shall be payable on the 1st day of March, 1966.

5. Such moneys shall be repayable to the Commissioners of the State Savings Bank of Victoria at the office of the said Commissioners, 139-165 Elizabeth-street, Melbourne.

The plans and specifications and the estimate of cost of the proposed works and a statement showing the proposed expenditure of the moneys to be borrowed, are open for inspection at the office of the Council of the Town of St. Arnaud, at Town Hall, St. Arnaud.

Dated 24th May, 1965.

6258 PAUL JAMES, Town Clerk.

BOROUGH OF KYABRAM.

LOAN NO. 12.

Notice of Intention to Borrow the Sum of £10,775 for Permanent Works and Undertakings.

NOTICE is hereby given that the Council of the Borough of Kyabram proposes to borrow the sum of Ten thousand seven hundred and seventy-five pounds on the credit of the municipal revenue of the Mayor, Councillors and Burgesses of the said Borough, such sum to be raised by the grant of a mortgage in accordance with the provisions of the *Local Government Acts*.

1. The maximum rate of interest that may be paid is £5 12s. 6d. per cent. per annum.

2. The purpose for which the loan is to be applied is the purchase of a road grader.

3. The period of the loan shall be ten (10) years.

4. The moneys borrowed shall be repayable by providing out of the municipal fund twenty half-yearly instalments of £711 15s. 1d. each, including principal and interest, on the 1st day of August and the 1st day of February, during the currency of the loan. The first instalment shall be repayable on the 1st day of February, 1966.

5. Such moneys shall be repayable at the Commonwealth Savings Bank of Australia, in Melbourne.

6264 J. A. CLAREY, Town Clerk.

SHIRE OF BARRABOOL.

LOAN NO. 17.

Notice of Intention to Borrow the Sum of £6,500 for Permanent Works and Undertakings.

NOTICE is hereby given that the Council of the Shire of Barrabool proposes to borrow the principal sum of Six thousand five hundred pounds on the credit of the municipal revenues of the President, Councillors and Ratepayers of the said Shire, such sum to be raised by the grant of a mortgage in accordance with the provisions of the *Local Government Act 1958*.

1. The maximum rate of interest that may be paid is £5 12s. 6d. per centum per annum.

2. The purpose for which the loan is to be applied is—
Purchase of Anglesea Memorial Hall and land—
£6,500.

3. The period of the loan shall be ten years.

4. The moneys borrowed shall be repayable by providing out of the municipal fund twenty half-yearly instalments of approximately £429 7s. 3d. each, including principal and interest, on the 1st day of March and 1st day of September during the currency of the loan. The first instalment shall be payable on the 1st day of March, 1966.

5. Such moneys shall be repayable at the Australia and New Zealand Bank Limited, 2 Malop-street, Geelong, or at the Council's bankers for the time being in Melbourne.

The plans and specifications and the estimate of the cost of the proposed works, and a statement showing the proposed expenditure of the moneys to be borrowed, are open for inspection at the office of the Council of the Shire of Barrabool, 441 Moorabool-street, South Geelong.

Dated 19th May, 1965.

6279 G. L. PEARCE, Shire Secretary.

SHIRE OF BIRCHIP.

LOAN NO. 26.

Notice of Intention to Borrow the Sum of £9,000 for Permanent Works and Undertakings.

NOTICE is hereby given that the Council of the Shire of Birchip proposes to borrow the principal sum of Nine thousand pounds (£9,000), on the credit of the municipal revenues of the President, Councillors and Ratepayers of the Shire of Birchip, such loan to be raised by grant of a mortgage, in accordance with the provisions of the *Local Government Act 1958*.

1. The maximum rate of interest that may be paid is £5 11s. 3d. (5 9/16) per cent. per annum.

2. The period of the loan shall be nine (9) years.

3. The purposes for which the loan is to be applied are:—

(a) Construction of kerb, channel and foot- paths, Town of Birchip	£5,000
(b) Purchase of two (2) residences and im- provements thereto	£4,000

4. The moneys borrowed shall be repayable by providing out of the municipal fund eighteen (18) half-yearly instalments of £642 6s. 10d. each, including principal and interest.

5. Such moneys shall be repayable at the Commercial Savings Bank of Australia Ltd., Birchip, or at such other place or places as the lender from time to time may require.

The plans and specifications and the estimate of the cost of the proposed works and a statement showing the proposed expenditure of the moneys to be borrowed, are open for inspection at the Shire Office, Birchip.

6327 WALTER J. McQUILLEN, Shire Secretary.

SHIRE OF BULN BULN.

NOTICE is hereby given that the Council of the Shire of Buln Buln did at its meeting, on Wednesday, 21st April, 1965, appoint Senior Constable Peter Razga, No. 10532, Police Station, Drouin, in lieu of Senior Constable Lindsay James Evans, No. 10461, transferred, to be Prosecuting Officer of the Shire of Buln Buln.

6326 K. A. PRETTY, Shire Secretary.

SHIRE OF HEALESVILLE.

LOAN NO. 38.

Notice of Intention to Borrow the Sum of £25,000 for Permanent Works and Undertakings.

NOTICE is hereby given that the Council of the Shire of Healesville proposes to borrow the principal sum of £25,000 on the credit of the municipal revenues of the President, Councillors and Ratepayers of the said Shire, such sum to be raised by the grant of a mortgage, in accordance with the provisions of the *Local Government Act 1958*.

1. The maximum rate of interest that may be paid is 5½ per cent. per annum.

2. The purpose for which the loan is to be applied is construction and providing of municipal offices.

3. The period of the loan is to be twenty (20) years.

4. The moneys borrowed shall be repayable by providing out of the municipal fund 40 half-yearly instalments of approximately £1,059 16s. 3d. each, including principal and interest, on the 1st day of March and the 1st day of September during the currency of the loan. The first instalment shall be payable on the 1st day of March, 1966.

5. Such moneys shall be repayable to the National Bank of Australasia, 271 Collins-street, Melbourne.

The plans and specifications and the estimate of the cost of the proposed works and a statement showing the proposed expenditure of the moneys to be borrowed, are open for inspection at the office of the Council of the Shire of Healesville, at the Shire Office, Healesville.

Dated 26th May, 1965.

6266 W. M. OLIVER, Shire Secretary.

SHIRE OF HEYTESBURY.

PUBLIC HIGHWAY.

IN pursuance of the powers conferred by section 522 of the Local Government Act 1958, the Council of the Shire of Heytesbury doth hereby direct that the land in the Parish of Timboon shown hatched on the plan hereunder which has been taken, purchased or acquired by it shall be a public highway from and after the date of publication of this Order in the Government Gazette.

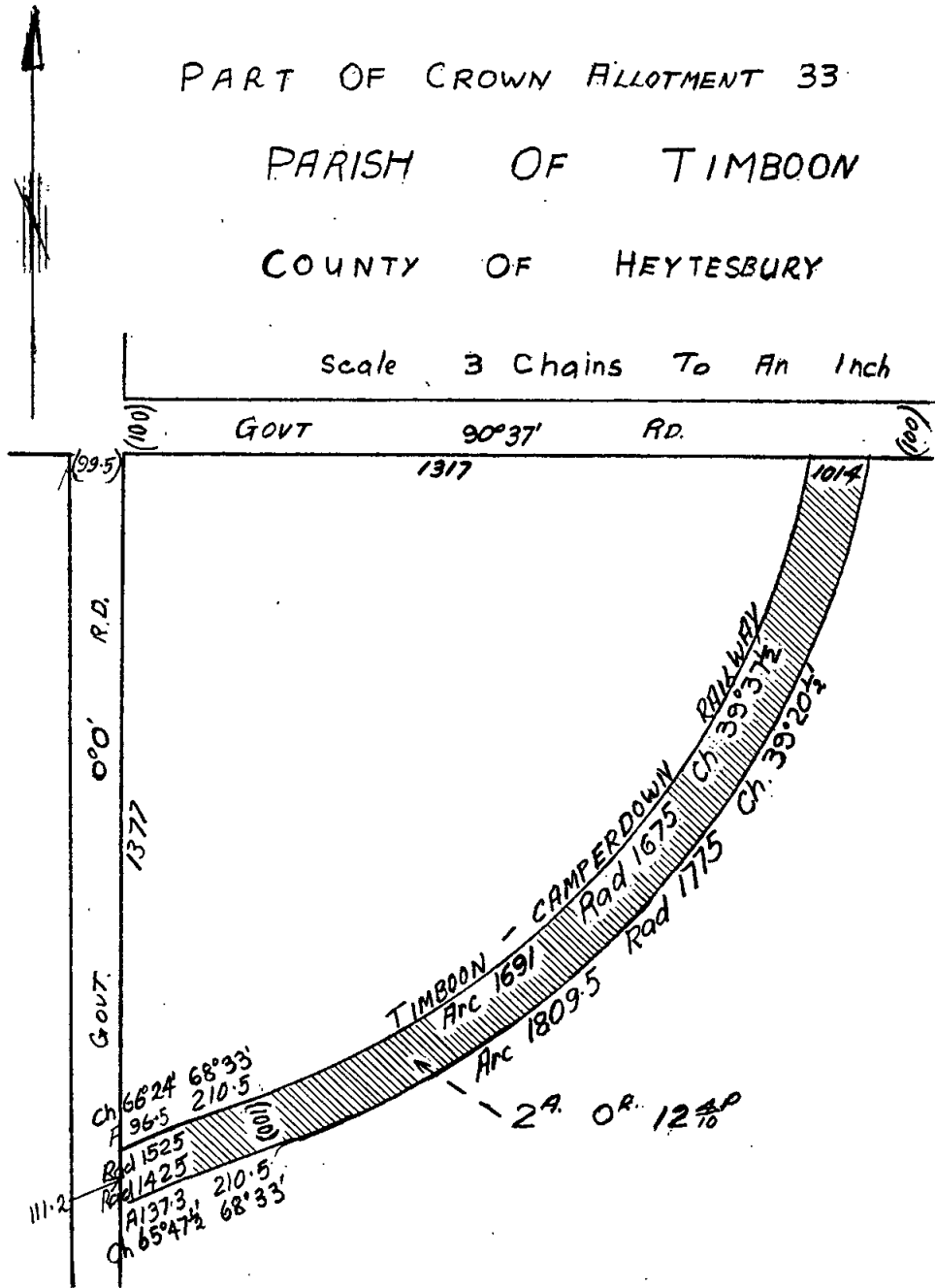

The common seal of the President, Councillors and Ratepayers of the Shire of Heytesbury was hereunto affixed this 13th day of May, 1965, in the presence of—

L. J. HOWARTH, President.

(SEAL)

A. J. BAILEY, Councillor.

W. J. HOLTON, Shire Secretary.

SHIRE OF KYNETON.

LOAN No. 33.

Notice of Intention to Borrow the Sum of £1,500 for Permanent Works and Undertakings.

NOTICE is hereby given that the Council of the Shire of Kyneton proposes to borrow the sum of One thousand five hundred pounds on the credit of the municipal revenues of the President, Councillors and Ratepayers of the said Shire, such sum to be raised by the grant of a mortgage, in accordance with the provisions of the *Local Government Act 1958*.

1. The maximum rate of interest that may be paid is £5 10s. per centum per annum.
2. The purpose for which the loan is to be applied is—
Construction of kerb and channel, Trentham—£1,500.
3. The period of the loan shall be five years.
4. The moneys borrowed shall be repayable by providing out of the municipal fund ten half-yearly instalments of £173 12s. 3d. including principal and interest, on the 1st day of March and the 1st day of September during the currency of the loan. The first instalment shall be repayable on the 1st day of March, 1966.

5. Such moneys shall be repayable at the C.B.C. Savings Bank Limited, Melbourne.

The plans and specifications, and the estimate of the proposed works and a statement showing the proposed expenditure of the money to be borrowed, are open for inspection at the Shire Office, Kyneton.

Dated the 31st day of May, 1965.

6328 S. G. PORTER, Shire Secretary.

SHIRE OF SOUTH BARWON.

NOTICE OF CHANGE OF STREET NAMES.

NOTICE is hereby given that in pursuance of the powers conferred by the *Local Government Act*, the Council of the Shire of South Barwon has made the following alterations in street names:—

Old Name; New Name; Location.

- Anne-street; Murray-street; west off Marcus-street, Highton, on lodged plan No. 31913.
Dyson-avenue; Bruthen-road; west off Cara-road, Highton, on lodged plans Nos. 63018 and 58494.
Spring-street; Curtis-street; south side of lodged plan No. 9530 between Bailey-street and Barwon Heads-road, Belmont.
Hutt-street; Woodley-court; west off Adelaide-street, Highton, on lodged plans Nos. 34393 and 65451.
Ocean-parade; Stephens-parade; on plan of subdivision No. 11362, Township of Barwon Heads.

E. T. CORNISH, Shire Secretary.

Shire Hall, Belmont. 6265

SHIRE OF UPPER YARRA.

LOAN No. 25.

Notice of Intention to Borrow the Sum of £6,000 for Permanent Works and Undertakings.

NOTICE is hereby given that the Council of the Shire of Upper Yarra proposes to borrow the principal sum of Six thousand pounds on the credit of the municipal revenues of the President, Councillors and Ratepayers of the said Shire, such sum to be raised by the grant of a mortgage in accordance with the provisions of the *Local Government Act 1958*.

1. The maximum rate of interest that may be paid is £5 12s. 6d. per cent. per annum.
2. The purpose for which the loan is to be applied is:—

Part cost of filtration plant at Yarra Junction swimming pool	£1,100
Footpath construction, Main-street, Wesburn and Main street, Yarra Junction	2,150
Half cost of sealing Gibson-parade, Warburton Road construction, Yarra-street, Yarra Junction	850
Pipe culvert construction, Park-lane, Yarra Junction	1,400
	500
	£6,000

3. The period of the loan shall be ten years.

4. The moneys borrowed shall be repayable by providing out of the municipal fund twenty half-yearly instalments of approximately £396 6s. 9d. each, including principal and interest, on the 1st day of March and the

1st day of September, during the currency of the loan. The first instalment shall be payable on the 1st day of March, 1966.

5. Such moneys shall be repayable to the Commissioners of the State Savings Bank of Victoria at the office of the said Commissioners, 139-165 Elizabeth-street, Melbourne.

The plans and specifications and the estimate of the cost of the proposed works and a statement showing the proposed expenditure of the moneys to be borrowed, are open for inspection at the office of the Council of the Shire of Upper Yarra, at Yarra Junction.

Dated Wednesday, 22nd June, 1965.

6272 J. N. EDDY, Shire Secretary.

SHIRE OF WERRIBEE.

ORDER CHANGING NAMES OF STREETS.

NOTICE is hereby given that in accordance with the provisions of clause 8 of Part I. of the Fifteenth Schedule of the *Local Government Act 1958*, the following change of street names has been ordered by the Council of the Shire of Werribee.

Old Name; New Name; Location.

- Black Swamp-road; McGrath-road; between Bulban and Ballan roads.
Ballan, sometimes known as Boundary-road; Greens-road; north-east corner of allotment 19, section 18, and north-west corner of allotment 2, section 20, Parish of Mambourin.

Such Order to take effect from the date of publication in the *Victoria Government Gazette*.

6259 N. G. MINNS, Shire Secretary.

THE BALLARAT SEWERAGE AUTHORITY.

GENERAL NOTICE.

THE above-mentioned Sewerage Authority having made provision for carrying off the sewage from each and every property which or any part of which is within the Sewerage Areas hereinafter described doth hereby declare that on and after the 1st day of July, 1965, each and every property which or any part of which is within the said Sewerage Areas shall be deemed to be a seweraged property within the meaning of the *Sewerage Districts Act 1958*.

The boundaries of the Sewerage Areas hereinbefore referred to are:—

Sewerage Area No. 255.

City of Ballarat:—Commencing at the south-west corner of No. 68 Kline-street being a point on the boundary of Sewerage Area No. 191; thence southerly about 57 feet to a point about 140 feet north of Wilson-street and being a south-east corner of vacant allotment No. 31 Lovenear-grove, westerly about 336 feet to the south-west corner of vacant allotment No. 37 Lovenear-grove, northerly along the western boundary of the said No. 37 to the north-west corner of the said No. 37, north-easterly across Lovenear-grove to the south-west corner of No. 12 Lovenear-grove being a point on the boundary of Sewerage Area No. 217; thence easterly, northerly, north-easterly, easterly, southerly, easterly, southerly, westerly and southerly along the boundaries of Sewerage Areas Nos. 217 and 191 to the point of commencement.

Sewerage Area No. 256.

City of Ballarat:—Commencing at the north-east corner of King-street and a right-of-way such corner being the south-west corner of No. 88 Eureka-street and on the boundaries of Sewerage Areas Nos. 77 and 158; thence easterly, south-easterly, south-westerly and north-westerly along the boundaries of Sewerage Areas Nos. 77, 98 and 158 to the point of commencement.

Further particulars regarding the streets or parts of streets in which sewers have been laid may be ascertained on inquiry at the Authority's Office.

By order of the said Sewerage Authority,

6277 A. W. NICHOLSON, Chairman.
CHAS. H. CLAMP, Secretary.

BENDIGO SEWERAGE AUTHORITY.

THE Bendigo Sewerage Authority, having made provision for carrying off the sewage from each and every property which or any part of which is within the Sewerage Areas hereinafter described, doth hereby declare that on and after the 1st day of June, 1965, each and every

property which or any part of which is within the said Sewerage Areas, shall be deemed to be a sewered property within the meaning of the Sewerage Districts Acts.

The boundaries of the Sewerage Areas hereinbefore referred to are:—

Sewerage Area No. 234.

Commencing on the boundary of Sewerage Area No. 71, at the southernmost corner of Crown allotment 425, section E, at Bendigo, Parish of Sandhurst; thence north-westerly and northerly along the south-western and western boundaries of the said Crown allotment and along Knight-street to the boundary of Sewerage Area No. 211; thence south-easterly and south-westerly along the boundaries of Sewerage Areas Nos. 211 and 71 to the point of commencement.

Sewerage Area No. 235.

Commencing on the boundary of Sewerage Area No. 195 at the intersection of Prouses-road and De Gille-street; thence generally easterly along De Gille-street to the westernmost corner of Crown allotment 42A, section I, Parish of Sandhurst; thence generally easterly along the northern boundaries of Crown allotments 42A, 42D and 38 to Dick-street; thence southerly along Dick-street to Holdsworth-road; thence easterly along Holdsworth-road to the western boundary of Crown allotment 7, section I, Parish of Sandhurst; thence northerly along the said western boundary; thence easterly along the northern boundaries of the said Crown allotment 7 and of Crown allotments 6 and 5 and across John-street and along the northern boundaries of Crown allotments 8 and 1; thence southerly along the eastern boundary of Crown allotment 1 and its prolongation across Holdsworth-road; thence easterly along Holdsworth-road to the eastern boundary of Crown allotment 55L; thence southerly along the said eastern boundary; thence westerly along the southern boundaries of Crown allotments 55L, 55K, 55J, 55H, 55G, 55F and 55B and across Finn-street and along the southern boundaries of Crown allotments 30, 29, 28, 27, 26, 25, 24, 23, 22 and 51A; thence northerly along the western boundary of Crown allotment 51 to Holdsworth-road; thence generally westerly along Holdsworth-road and northerly along Prouses-road to the point of commencement.

Sewerage Area No. 236.

Commencing on the boundary of Sewerage Area No. 210 in Cornish-street; thence north-easterly along Cornish-street to Anderson-street and north-westerly along Anderson-street to Prouses-road (Buckley-street); thence south-westerly along Buckley-street to the south-eastern corner of Crown allotment 239Q, Parish of Sandhurst; thence northerly along the eastern boundary of the said Crown allotment; thence south-westerly along the north-western boundaries of Crown allotments 239Q, 239P and 239N and northerly along the eastern boundaries of Crown allotments 239R, 239S and 239T and south-westerly along the north-western boundary of Crown allotment 239T to the boundary of Sewerage Area No. 224; thence generally southerly along the boundaries of Sewerage Areas Nos. 224 and 210 to the point of commencement.

Sewerage Area No. 237.

Commencing at the south-eastern corner of Crown allotment 162B, section C, at Bendigo, Parish of Sandhurst; thence westerly along the southern boundary of Crown allotment 162B and northerly along the western boundaries of Crown allotments 162B, 162A and 162; thence easterly along Rowe-street to Woodward-road; thence northerly along Woodward-road to the south-eastern corner of Crown allotment 167D; thence easterly along the southern boundaries of Crown allotments 167D and 167C; thence northerly along the western boundary of Crown allotment 167C and across Belle Vue-road to the continuation of the north-eastern boundary of Crown allotment 220D; thence south-easterly by a line through Crown land and along the north-eastern boundary of Crown allotment 220D to Sullivan-street; thence southerly along Sullivan-street and across Belle Vue-road to the eastern corner of Crown allotment 2; thence generally southerly along the eastern boundaries of Crown allotments 234, 24, 25 and 26 and through Crown land and along the eastern boundaries of Crown allotments 32, 31A, 31, 28, 29 and 30 and across and along Porter-street and along the eastern boundaries of Crown allotments 135M, 135N and 135O; thence westerly and southerly along the northern and western boundaries of Crown allotment 135P; thence easterly along the northern boundary of Crown allotment 135B; thence southerly along the eastern boundaries of Crown allotments 135B and 135Q and Residence Area No. 978; thence westerly along the southern boundary of the said Residence Area to Woodward-road and northerly along Woodward-road to the point of commencement.

Sewerage Area No. 238.

Commencing at the northernmost corner of Sewerage Area No. 158; thence northerly along the western boundary of the Recreation Reserve Extension and of Crown allotments 7 and 6, section 18, Township of Kangaroo Flat; thence easterly along the northern boundary of Crown allotment 6 and across Neil-street to its eastern side; thence northerly along Neil-street to the north-western corner of Crown allotment 2, section 8; thence easterly along the northern boundary and southerly along the eastern boundary of the said Crown allotment 2 and easterly along the northern boundary of Crown allotment 2A and of Residence Area No. 7145 to the eastern boundary of the said Residence Area and across Lansell-street to the boundary of Sewerage Area No. 190; thence generally westerly along the boundaries of Sewerage Areas 190 and 158 to the point of commencement.

Sewerage Area No. 239.

Commencing at the south-western corner of Sewerage Area No. 182; thence southerly, easterly and northerly along the western, southern and eastern boundaries of lot 9 of plan of subdivision of Crown allotment 75B, section D, Parish of Mandurang; thence westerly along the southern boundary of Sewerage Area No. 182 to the point of commencement.

By order of the Bendigo Sewerage Authority.

6267 T. R. FLOOD, Chairman.
H. A. MOORS, Secretary.

Sewerage Districts Acts.

ALEXANDRA WATERWORKS TRUST.

PROPOSED SEWERAGE AUTHORITY.

NOTICE is hereby given that the Alexandra Waterworks Trust has made application to the Honorable the Minister of Water Supply for the constitution of a Sewerage Authority and for the proclamation of a Sewerage District at Alexandra and for the construction, maintenance and continuance of sewerage works within that district under the provisions of the Sewerage Districts Acts.

A general plan and description of the proposed works have been submitted with the application and copies of same may be seen at the offices of the Trust, Shire Hall, Alexandra.

Dated at Alexandra, the 20th day of May, 1965.

6173 R. G. HATFIELD, Secretary.

NOTICE OF INTENTION TO APPLY FOR A LICENCE TO DIVERT WATER AND CUT RACE (RE-ISSUE) FROM THE RIVER MURRAY, AT COLIGNAN.

WE hereby give notice that we intend to apply for a licence empowering us to divert water for a term of five years to the extent of 81 acre-feet per annum at a maximum rate of $\frac{1}{2}$ acre-foot per day of 24 hours for the irrigation of 27 acres, being part of allotments 1 and 2, section B, Parish of Colignan, and to occupy certain Crown lands for works of diversion, and to cut a race thereon.

Any objection to such application must be forwarded, in writing, to reach the State Rivers and Water Supply Commission, Melbourne, before 27th June, 1965, being 30 days from the first publication of this notice.

DOROTHY PATRICIA WILLIAMS.
DONALD JAMES WILLIAMS.

Colignan, Victoria. 6261

NOTICE OF INTENTION TO APPLY FOR A LICENCE TO DIVERT WATER AND CUT RACE (RE-ISSUE) FROM THE OVENS RIVER, AT EVERTON.

WE hereby give notice that we intend to apply for a licence empowering us to divert water for a term of eight years to the extent of 20 acre-feet per annum at a maximum rate of $1\frac{1}{2}$ acre-feet per day of 24 hours for the irrigation of pasture, being part of allotments L3, L4, L6, L7 and L, no section, Parish of Everton, and to occupy certain Crown lands for works of diversion, and to cut a race thereon.

Any objection to such application must be forwarded, in writing, to reach the State Rivers and Water Supply Commission, Melbourne, before 2nd July, 1965, being 30 days from the first publication of this notice.

CARL LAMONT WRAITH.
FRANCIS VICTOR WRAITH.
BEATRICE MURIEL WRAITH.
JESSIE MAY WRAITH.

Box 37, P.O., Wangaratta. 6329

NOTICE OF INTENTION TO APPLY FOR LICENCES TO DIVERT WATER AND CUT RACES FROM THE RIVER MURRAY.

EACH of the persons named in the Schedule hereunder gives notice that he or she intends to apply for a Licence empowering him or her to divert water for irrigation purposes for a term of five years in accordance with the particulars shown opposite his or her name in the Schedule set out hereunder, and to occupy certain Crown lands for works of diversion and to cut races thereon.

Any objection to an application must be forwarded, in writing, to the State Rivers and Water Supply Commission, Melbourne before 2nd July, 1965, being 30 days from the first publication of this notice.

Name.	Address.	Volume.		Area to be Irrigated.	Location.	
		Per Annum.	Maximum Rate per Day.		Allotment.	Parish.
		ac. ft.	ac. ft.	Acres.		
Murray Adams	P.O. Box 16, Swan Hill	32	3	16	12	Pental Island
Thomas and Ernest Thomas Bright	Pental Island	100	10	50	26	" "
Thomas and Ernest Thomas Bright	Pental Island	400	20	200	26 and A	" "
Harold Rex Brooke	Benjeroop	400	20	200	38 and 38A	" "
David Phillip Bryan	Box 69, Swan Hill	50	5	25	Part 3	" "
Joseph Francis Crowe, Joseph Bruce Crowe, John Timothy Crowe	Tyntynder South	400	20	200	23	" "
John Harold Dunstan	Box 113, Lake Boga	400	20	200	22	" "
William Leonard Ingram, Shirley Joseph Ingram	Pental Island	282	20	141	19A	" "
Keith Allingham Greenham	Pental Island	400	20	200	21	" "
William Leonard Ingram	Pental Island	394	20	197	20	" "
Estate of the late Alice Jane Jackson	Pental Island	400	20	200	32 and 33	" "
George Patrick O'Brien, Kevin William O'Brien, Ronald George O'Brien	358 Beveridge-street, Swan Hill	400	20	200	18	" "
George Sinclair Moar	Box 139, Swan Hill	100	10	50	35 and 36	" "
Keith William Teague, Patricia Joan Teague	Mystic Park	400	20	200	19	" "
Archibald Wearne	Pental Island	70	7	35	37 and 40	" "
Harold Stowell Brooke	Benjeroop	500	20	250	39 and 39A	" "

6334

NOTICE OF INTENTION TO APPLY FOR LICENCES TO DIVERT WATER AND CUT RACES FROM THE LITTLE RIVER MURRAY.

EACH of the persons named in the Schedule hereunder gives notice that, he or she intends to apply for a Licence empowering him or her to divert water for irrigation purposes for a term of five years in accordance with the particulars shown opposite his or her name in the Schedule set out hereunder, and to occupy certain Crown lands for works of diversion and to cut races thereon.

Any objection to an application must be forwarded, in writing, to the State Rivers and Water Supply Commission, Melbourne, before 2nd July, 1965, being 30 days from the first publication of this notice.

Name.	Address.	Volume.		Area to be Irrigated.	Location.	
		Per Annum.	Maximum Rate per Day.		Allotment.	Parish.
		ac. ft.	ac. ft.	Acres.		
Edgar Alfred Abbott, and Amy Abbott	Fish Point	200	20	100	45	Pental Island
John P. Baker, and Patrick C. Baker	Swan Hill	100	10	50	40A and 41	" "
David Phillip Bryan	Box 69, Swan Hill	200	20	100	Part 3	" "
David Ian Chisholm	Box 79, Swan Hill	162	16	81	8	" "
Estate of the late Thomas Chisholm	Box 79, Swan Hill	172	8	86	9	" "
Mervyn Victor Dalton	Swan Hill	200	20	100	4A	" "
Mervyn Victor Dalton	Swan Hill	200	20	100	4B and 4C	" "
John Harold Dunstan, Hedley William Dunstan, and Keith Clifford Dunstan	Box 113, Lake Boga	200	20	100	27 and 48	" "
Peter Alexander Greenham	Swan Hill	200	20	100	7	" "
John Francis Hill	Pental Island	82	8	41	1A and 5	" "
Keith Leslie James	Box 154, Swan Hill	200	20	100	13	" "
Estate of the late Arthur George Jenkins	Box 301, Swan Hill	150	15	75	14	" "
Oscar Leonard Keller	Pental Island	200	20	100	24 and 25	" "
Kenneth Tremaine Waldie McLean	5 Gray-street, Swan Hill	200	20	100	10A	" "
Henry Llewellyn Naylor	Swan Hill	130	13	65	42	" "
Jeffrey James Prater, and Robert Raymond Prater	Swan Hill	200	20	100	16A	" "
Keith Leys Smith, and Grace Adelaide Smith	Swan Hill	120	12	60	16B	" "
William Murray Smith	Swan Hill	200	20	100	15	" "
George Harold Willox	4 Everingham-street, Swan Hill	118	11	59	5A, 5B, and 6A	" "

6335

NOTICE OF INTENTION TO APPLY FOR A LICENCE
TO DIVERT WATER AND CUT RACE FROM THE
OVENS RIVER, AT EVERTON.

I HEREBY give notice that I intend to apply for a licence empowering me to divert water for a term of eight years to the extent of 22½ acre-feet per annum at a maximum rate of 1½ acre-feet per day of 24 hours for the irrigation of 15 acres of tobacco or pastures, being part of allotments A27, A27A, A27B, A27C and A27D, no section, Parish of Everton, and to occupy certain Crown lands for works of diversion, and to cut a race thereon.

Any objection to such application must be forwarded, in writing, to reach the State Rivers and Water Supply Commission, Melbourne, before 6th June, 1965, being 30 days from the first publication of this notice.

HAROLD HENRY WILLIAMS.

Everton. 6322

NOTICE OF INTENTION TO APPLY FOR A LICENCE
TO DIVERT WATER AND CUT RACE FROM THE
OVENS RIVER, AT WANGARATTA.

I HEREBY give notice that I intend to apply for a licence empowering me to divert water for a term of eight years to the extent of 200 acre-feet per annum at a maximum rate of 1 acre-foot per day of 24 hours for the watering of greens, tees and fairways, being part of allotment 6, section 16, Parish of Wangaratta South, and to occupy certain Crown lands for works of diversion, and to cut a race thereon.

Any objection to such application must be forwarded, in writing, to reach the State Rivers and Water Supply Commission, Melbourne, before 29th June, 1965, being 30 days from the first publication of this notice.

ROBERT CLIFFORD JUGGINS.

Secretary, Wangaratta Golf Club (Waldara). 6330

NOTICE OF INTENTION TO APPLY FOR A LICENCE
TO DIVERT WATER AND CUT RACE FROM THE
OVENS RIVER, AT EUROBIN.

I HEREBY give notice that I intend to apply for a licence empowering me to divert water for a term of eight years to the extent of 19½ acre-feet per annum at a maximum rate of 2 acre-feet per day of 24 hours for the irrigation of 13 acres of tobacco, being part of allotments B15 and B3, no section, and 7H, section 25, Parish of Barwidgee, and to occupy certain Crown lands for works of diversion, and to cut a race thereon.

Any objection to such application must be forwarded, in writing, to reach the State Rivers and Water Supply Commission, Melbourne, before 2nd July, 1965, being 30 days from the first publication of this notice.

EDWARD GEORGE WALKEAR.

Eurobin. 6332

NOTICE OF INTENTION TO APPLY FOR A LICENCE
TO DIVERT WATER AND CUT RACE (RE-ISSUE)
FROM THE RIVER MURRAY, AT KARADOC.

I HEREBY give notice that I intend to apply for a licence empowering me to divert water for a term of five years to the extent of 111 acre-feet per annum at a maximum rate of 3 acre-feet per day of 24 hours for the purpose of irrigating 37 acres of vines, citrus orchard and market garden, being part of allotment A, no section, Parish of Karadoc, and to occupy certain Crown lands for works of diversion, and to cut a race thereon.

Any objection to such application must be forwarded, in writing, to reach the State Rivers and Water Supply Commission, Melbourne, before 30th June, 1965, being 30 days from the first publication of this notice.

CHARLES COTTRELL.

Box 1, Gol Gol, via Mildura. 6321

NOTICE OF INTENTION TO APPLY FOR A LICENCE
TO DIVERT WATER AND CUT RACE (RE-ISSUE)
FROM THE RIVER MURRAY, AT MERBEIN.

I HEREBY give notice that I intend to apply for a licence empowering me to divert water for a term of five years to the extent of 108 acre-feet per annum at a maximum rate of 2½ acre-feet per day of 24 hours for the purpose of irrigating 24 acres, being part of allotment 2, section H, Parish of Merbein, and to occupy certain Crown lands for works of diversion, and to cut a race thereon.

Any objection to such application must be forwarded, in writing, to reach the State Rivers and Water Supply Commission, Melbourne, before 29th June, 1965, being 30 days from the first publication of this notice.

ALFRED LYAL SMITH.

Box 263, Merbein, Vic. 6333

NOTICE OF INTENTION TO APPLY FOR A LICENCE
TO DIVERT WATER AND CUT RACE (RE-ISSUE)
FROM THE RIVER MURRAY, AT TOL TOL, VIA
ROBINVALE.

I HEREBY give notice that I intend to apply for a licence empowering me to divert water for a term of five years to the extent of 750 acre-feet per annum at a maximum rate of 15 acre-feet per day of 24 hours for the irrigation of 250 acres, being part of allotment 7, Parish of Tol Tol, and to occupy certain Crown lands for works of diversion, and to cut a race thereon.

Any objection to such application must be forwarded, in writing, to reach the State Rivers and Water Supply Commission, Melbourne, before 27th June, 1965, being 30 days from the first publication of this notice.

ROYSTON SIDDONS.

Murray Groves, Tol Tol, Robinvale. 6255

NOTICE OF INTENTION TO APPLY FOR A LICENCE
TO DIVERT WATER AND CUT RACE (RE-ISSUE)
FROM THE RIVER MURRAY, AT NANGILOC.

I HEREBY give notice that I intend to apply for a licence empowering me to divert water for a term of five years to the extent of 210 acre-feet per annum at a maximum rate of 6 acre-feet per day of 24 hours for the irrigation of 70 acres of citrus, being part of allotment 19, lot 1, lodged plan 31214, Parish of Carwarp, and to occupy certain Crown lands for works of diversion, and to cut a race thereon.

Any objection to such application must be forwarded, in writing, to reach the State Rivers and Water Supply Commission, Melbourne, before 25th June, 1965, being 30 days from the first publication of this notice.

IVAN LAURENCE THOMAS WIFFEN.

Box 103 Red Cliffs. 6269

NOTICE OF INTENTION TO APPLY FOR A LICENCE
TO DIVERT WATER AND CUT RACE FROM THE
OVENS RIVER, AT PEECHELBA EAST.

I HEREBY give notice that I intend to apply for a licence empowering me to divert water for a term of eight years to the extent of 100 acre-feet per annum at a maximum rate of 2 acre-feet per day of 24 hours for the irrigation of 10 acres of currie cocksfoot and 40 acres of sub. and rye, being part of allotment 155A, Parish of Boorhaman, and to occupy certain Crown lands for works of diversion, and to cut a race thereon.

Any objection to such application must be forwarded, in writing, to reach the State Rivers and Water Supply Commission, Melbourne, before 28th May, 1965, being 30 days from the first publication of this notice.

GEOFFREY WILSON SALTER.

Peechelba East. 6270

NOTICE OF INTENTION TO APPLY FOR A LICENCE
TO DIVERT WATER AND CUT RACE FROM THE
OVENS RIVER (YARRAWONGA WEIR BACK-
WATER), AT BOORHAMAN NORTH.

I HEREBY give notice that I intend to apply for a licence empowering me to divert water for a term of five years to the extent of 80 acre-feet per annum at a maximum rate of ½ acre-foot per day of 24 hours for the irrigation of 80 acres, being parts of allotments 1b1, 1b, 2a and 2b, Parish of Boorhaman.

Any objection to such application must be forwarded, in writing, to reach the State Rivers and Water Supply Commission, Melbourne, before 21st June, 1965, being 30 days from the first publication of this notice.

PHILIP LESLIE LORD.

Murray Valley Highway, via Yarrowonga. 6271

NOTICE OF INTENTION TO APPLY FOR A LICENCE
TO DIVERT WATER AND CUT RACE (RE-ISSUE)
FROM THE OVENS RIVER, AT WANGARATTA.

I HEREBY give notice that I intend to apply for a licence empowering me to divert water for a term of eight years to the extent of 15 acre-feet per annum at a maximum rate of 1½ acre-feet per day of 24 hours for the irrigation of 10 acres of tobacco, being part of allotments 3 and 4, section 14, Parish of Wangaratta North, and to occupy certain Crown lands for works of diversion, and to cut a race thereon.

Any objection to such application must be forwarded, in writing, to reach the State Rivers and Water Supply Commission, Melbourne, before 19th June, 1965, being 30 days from the first publication of this notice.

LUIGI PERUZZO.

Box 164, P.O., Wangaratta. 6254

NOTICE OF INTENTION TO APPLY FOR A LICENCE TO DIVERT WATER AND CUT RACE (RE-ISSUE) FROM THE RIVER MURRAY, AT MILDURA.

WE hereby give notice that we intend to apply for a licence empowering us to divert water for a term of five years to the extent of 105 acre-feet per annum at a maximum rate of 5 acre-feet per day of 24 hours for the purpose of irrigating 35 acres of pastures, being part of recreation reserve (Sandalong Park), section F, Parish of Mildura, and to occupy certain Crown lands for works of diversion, and to cut a race thereon.

Any objection to such application must be forwarded, in writing, to reach the State Rivers and Water Supply Commission, Melbourne, before 26th June, 1965, being 30 days from the first publication of this notice.

TREVOR GLYN LEWIS.
VALDA SHIRLEY LEWIS.

P.O. Box 716, Mildura.

6331

NOTICE OF DISSOLUTION OF PARTNERSHIP.

NOTICE is hereby given that the partnership heretofore subsisting between Jeffrey Russell Jones, of Highbury-road, Tally Ho, Peter Edward A'Vard and David Ross, carrying on business as J. A. R. Plant Hire, at 30 Stephenson-road, Mount Waverley, has been dissolved by mutual consent as from the 15th day of January, 1965, and the said business shall be carried on by the said Peter Edward A'Vard and the said David Ross as and from that date. All debts due to and owing by the said partnership will be received and paid by the said Peter Edward A'Vard and David Ross, who will continue to carry on the business at the same place.

Dated this 20th day of May, 1965.

JEFF. R. JONES.
P. A'VARD.
D. ROSS.

6310

Witness—M. WESCOTT.

In the matter of the Companies Act; and in the matter of DWYERS SERVICE STATION PROPRIETARY LIMITED (Receiver and Manager appointed).

NOTICE is hereby given that at an Extraordinary General Meeting of the above-named company duly convened and held at Benalla, at 10 o'clock in the forenoon, on the 26th day of May, 1965, the following Special Resolution was duly passed, viz.:—

That the company Dwyers Service Station Proprietary Limited be wound up voluntarily pursuant to the provisions of Part X. of the Companies Act 1961.

6324

M. J. DWYER, Chairman.

AT a General Meeting of the members of Suitall Clothing Co. Pty. Limited duly convened and held at the office of Sackville, Wilks & Co., 100 Collins-street, Melbourne, on the 28th May, 1965, it was resolved that the company be wound up voluntarily and that Ronald J. Siree be appointed liquidator.

6325

The Companies Act 1961.

GOLDSTRAW INDUSTRIES PROPRIETARY LIMITED.

NOTICE PURSUANT TO SECTION 254 (2) (b).

AT an Extraordinary General Meeting of Goldstraw Industries Proprietary Limited held at "Astor House", 161-173 Sturt-street, South Melbourne, on the 27th May, 1965, the following Resolution was passed as a Special Resolution.

"That the company be wound up voluntarily and that Robert William Fotheringham be appointed liquidator for the purposes of the winding up."

Dated this 27th day of May, 1965.

6323

L. P. WHITE, Secretary.

DENNING RISE PROPRIETARY LIMITED.

SPECIAL RESOLUTION TO WIND UP, PURSUANT TO SECTION 254 OF THE COMPANIES ACT 1961.

AT an Extraordinary General Meeting of the above-named company, duly convened and held at "Moora", 132 Wattle-street, Bendigo, on the 24th day of May, 1965, the following Resolution was duly passed as a Special Resolution:—

"That the company be wound up voluntarily."

And at such last-mentioned meeting, William George Giles, of "Moora", 132 Wattle-street, Bendigo, was appointed liquidator for the purpose of the winding up.

Dated this 24th day of May, 1965.

6257

W. G. GILES, Liquidator.

Companies Act 1961.

SEASIDE TAXIS LIMITED.

NOTICE OF RESOLUTION.

AT an Extraordinary General Meeting of the above-named company, duly convened and held at the office of Black Cabs Co-operative Society Ltd., 100 McKinnon-road, McKinnon, on the 27th May, 1965, the following Special Resolution was duly passed:—

"That the company be wound up voluntarily and that John Joseph Courtney, chartered accountant, be appointed liquidator for the purpose of such winding up, and that at the said meeting the following further Resolution was duly passed by unanimous vote of all the members of the said company entitled to vote, namely: "That the time for giving notice of such General Meeting as aforesaid be abridged from twenty-one days to seven days".

Dated this 27th day of May, 1965.

6315

A. WEIGHT, Chairman.

The Companies Act 1961.—In the matter of S. A. ARMISTEAD PROPRIETARY LIMITED (in Voluntary Liquidation) Creditors' Winding Up.

NOTICE is hereby given that at an Extraordinary General Meeting of the above company, duly convened and held at 44 Queen-street, Melbourne, on the 28th day of May, 1965, the following Resolution was proposed and passed as a Special Resolution:—

"That the company be wound up voluntarily and that Ernest Harding Niemann, of 1 Kingston-street, East Malvern, chartered accountant, be nominated as liquidator for the purpose of the winding up."

Dated the 28th day of May, 1965.

6284

W. KIRKHOPE, Director.

The Companies Act 1961.—In the matter of ELLIS SAW-MILLING COMPANY PROPRIETARY LIMITED (in Voluntary Liquidation) Creditors' Winding Up.

NOTICE is hereby given that at an Extraordinary General Meeting of the above company, duly convened and held at 44 Queen-street, Melbourne, on the 28th day of May, 1965, the following Resolution was proposed and passed as a Special Resolution:—

"That the company be wound up voluntarily and that Ernest Harding Niemann, of 1 Kingston-street, East Malvern, chartered accountant, be nominated as liquidator for the purpose of the winding up."

Dated the 28th day of May, 1965.

6285

W. KIRKHOPE, Director.

The Companies Act 1961.—In the matter of TRAFALGAR TIMBERS PROPRIETARY LIMITED (in Voluntary Liquidation) Creditors' Winding Up.

NOTICE is hereby given that at an Extraordinary General Meeting of the above company, duly convened and held at 44 Queen-street, Melbourne, on the 28th day of May, 1965, the following Resolution was proposed and passed as a Special Resolution:—

"That the company be wound up voluntarily and that Ernest Harding Niemann, of 1 Kingston-street, East Malvern, chartered accountant, be nominated as liquidator for the purpose of the winding up."

Dated the 28th day of May, 1965.

6286

W. KIRKHOPE, Director.

Companies Act 1961.

R. & R. READ PROPRIETARY LIMITED (IN LIQUIDATION).

NOTICE is hereby given that a Ninth and Final Dividend is intended to be declared in the above matter.

Creditors who have not proved their debts by the 15th day of June, 1965, will be excluded therefrom.

Dated this 16th day of May, 1965.

6348

R. D. WIDDOWS, Liquidator.

The Companies Act 1961, Section 254 (2b).

RE CARNEGIE (VIC.) PTY. LTD.

AT a General Meeting of the members of Carnegie (Vic.) Pty. Ltd., duly convened and held at Vere-street, Richmond, on the 26th day of May, 1965, the following Special Resolution was duly passed:—

"That the company be wound up voluntarily and that Jack Henry be appointed liquidator for that purpose."

Dated this 26th day of May, 1965.

6274

J. HENRY, Liquidator.

Unclaimed Moneys Act 1962.

REGISTER of Unclaimed Moneys held by the—

Name of Owner on Books and Last Known Address.	Total Amount Due to Owner.	Description of Unclaimed Moneys.	Date when Amount first became Payable.
	£ s. d.		
SINGER AUSTRALIA PTY. LIMITED.			
Eaglen, Eric Harold, Lot 38, Plenty-avenue, Greensborough ..	15 3 9	Security Deposit	11.8.62
Croft, Richard, South Gippsland Highway	7 6 4	" "	2.1.61
Pruce, John Samuel, 30 Marshall-avenue, Clayton	5 14 6	" "	24.12.61
Grellett, Roy, 10 Jay-street, Norlane	9 4 1	" "	18.4.63
Knight, Arthur Edward, 11 Knight-avenue, Herne Hill	14 17 11	" "	27.9.62
Cameron, Hugh, 34 Karong-road, Bendigo	8 6 9	" "	5.7.63
6336			
CLIFTON BRICK HOLDINGS.			
Natross Investments Pty. Ltd. 14 Woorigoleen-road, Toorak S.E.2 {	9 7 6	Unclaimed dividend	30.4.62
	9 7 6	" "	10.4.63
MacKintosh, Gillian N. J. (Miss) Flat 4, Coolullah-avenue, South Yarra	18 15 0	" "	22.10.62
MacKintosh, Lillian M. I. (Miss) Flat 4, Coolullah-avenue, South Yarra	18 15 0	" "	10.4.63
Penrose, Dorothy (Miss) 72 Queen-street, Bendigo	6 5 0	" "	22.10.62
6337			

The Companies Act 1961.

APEX HOLDINGS LIMITED (IN LIQUIDATION).

NOTICE is hereby given that a Meeting of creditors in the above-named matter will be held at the offices of A. L. Royce and Warne-Smith, 440 Collins-street, Melbourne, on Monday, 19th day of July, 1965, at 9 a.m.

Dated this 26th day of May, 1965.

P. W. HARVEY, Official Liquidator.

A. L. Royce and Warne-Smith, 440 Collins-street, Melbourne. 6294

The Companies Act 1961.

FAIRLANE HOMES PROPRIETARY LIMITED (IN LIQUIDATION).

NOTICE is hereby given that a Meeting of creditors in the above-named matter will be held at the offices of A. L. Royce and Warne-Smith, 440 Collins-street, Melbourne, on Monday, 19th day of July, 1965, at 10 a.m.

Dated this 27th day of May, 1965.

P. W. HARVEY, Official Liquidator.

A. L. Royce and Warne-Smith, 440 Collins-street, Melbourne. 6303

Companies Act 1961.

RE: A. E. GATES PTY. LTD. (IN VOLUNTARY LIQUIDATION).

AT a Meeting of shareholders held on Tuesday, 25th May, 1965, at 10 a.m., it was resolved that the company be wound up voluntarily pursuant to section 260 to the above Act, and for that purpose John Phillip Hyman, public accountant, of 792 Elizabeth-street, Melbourne, be and is appointed liquidator.

Dated this 25th day of May, 1965.

6308 A. E. GATES, Director.

Notice of Winding-Up Order.—In the matter of HIGH CREST HOMES PROPRIETARY LIMITED.

WINDING-UP Order made 26th May, 1965.

Name and address of official liquidator: John Charles Couzens, 527 Collins-street, Melbourne.

JAMES CANNY, Deputy Commissioner of Taxation of the Commonwealth of Australia, petitioner. 6309

The Companies Act 1961.—In the matter of GLEN MAGGIE TIMBER MILLS PTY. LTD. (in Voluntary Liquidation) Creditors' Winding Up.

NOTICE is hereby given that at an Extraordinary General Meeting of the above company, duly convened and held at 44 Queen-street, Melbourne, on the 28th day of May, 1965, the following Resolution was proposed and passed as a Special Resolution:—

"That the company be wound up voluntarily and that Ernest Harding Niemann, of 1 Kingston-street, East Malvern, chartered accountant, be nominated as liquidator for the purpose of the winding up."

Dated the 28th day of May, 1965.

6283 W. KIRKHOPE, Director.

CITY AND SOUTHERN DECORATING PTY. LTD.

AT a Meeting of creditors of this company, held at 24 Jeffcott-street, Melbourne, on 25th May, 1965, at 2.30 p.m., the following Special Resolution was passed:—

"That the company be wound up voluntarily and that William Arthur Browne, chartered accountant, of 24 Jeffcott-street, Melbourne, be appointed liquidator for the purpose of winding up."

Dated 25th May, 1965.

6318 W. A. BROWNE, Liquidator.

T. N. CHUCK PTY. LTD.

THE following Special Resolution was passed at an Extraordinary General Meeting of the members of the above-named company, held on the 18th of May, 1965, at 93 City-road, South Melbourne:—

"That the company be placed in voluntary liquidation and that P. D. George, of Edwin V. Nixon & Partners, be appointed liquidator."

Dated this 26th day of May, 1965.

6311 P. D. GEORGE, Liquidator.

The Companies Act 1961.—In the matter of ELECTRIX (Vic.) PTY. LTD.—Notice to Creditors of Meeting, Pursuant to Section 260.

NOTICE is hereby given that a Meeting of creditors of the above-named company will be held at the offices of Kennedy, Small & Middlemiss, 296 Little Lonsdale-street, Melbourne, on Thursday, the 17th day of June, 1965, at 3 p.m., the company having convened a meeting of its members for the same day for the purpose of considering a Resolution that the company be wound up voluntarily.

Dated this 26th day of May, 1965.

D. A. RYAN, Director.
Kennedy, Small & Middlemiss, 296 Little Lonsdale-street, Melbourne. 6293

The Companies Act 1961.—In the matter of ROBERTS BROS. ELECTRICAL PTY. LTD. (in Liquidation).

NOTICE is hereby given that a First Dividend is intended to be declared in this matter. Creditors who have not proved their debts by the 21st day of June, 1965, will be excluded from the dividend.

Dated this 31st day of May, 1965.

A. M. HORSBURGH, Liquidator.
Kennedy, Small & Middlemiss, 296-300 Little Lonsdale-street, Melbourne. 6306

The Companies Act 1958.—In the matter of J. & V. NICHOLLS PTY. LTD. (in Liquidation).

NOTICE is hereby given that a Fourth Dividend is intended to be declared in this matter. Creditors who have not proved their debts by the 21st day of June, 1965, will be excluded from the dividend.

Dated this 31st day of May, 1965.

E. R. SMAIL, Liquidator.
Kennedy, Small & Middlemiss, 296-300 Little Lonsdale-street, Melbourne, C.1. 6307

The Companies Act 1961.—In the matter of ELECTRIX HOLDINGS PTY. LTD.—Notice to Creditors of Meeting Pursuant to Section 260.

NOTICE is hereby given that a Meeting of creditors of the above-named company will be held at the offices of Kennedy, Smail & Middlemiss, 296 Little Lonsdale-street, Melbourne, on Thursday, the 17th day of June, 1965, at 11 a.m., the company having convened a meeting of its members for the same day for the purpose of considering a Resolution that the company be wound up voluntarily.

Dated this 26th day of May, 1965.

D. A. RYAN, Director.

Kennedy, Smail & Middlemiss, 296 Little Lonsdale-street, Melbourne. 6297

The Companies Act 1961.—In the matter of C. & S. PROPRIETARY LIMITED.—Notice to Creditors of Meeting Pursuant to Section 260.

NOTICE is hereby given that a Meeting of creditors of the above-named company will be held at the offices of Kennedy, Smail & Middlemiss, 296 Little Lonsdale-street, Melbourne, on Friday, the 18th day of June, 1965, at 10.45 a.m., the company having convened a meeting of its members for the same day for the purpose of considering a Resolution that the company be wound up voluntarily.

Dated this 26th day of May, 1965.

D. A. RYAN, Director.

Kennedy, Smail & Middlemiss, 296 Little Lonsdale-street, Melbourne. 6296

The Companies Act 1961.—In the matter of VICTORIAN MEAT PACKING COMPANY PROPRIETARY LIMITED.

NOTICE is hereby given that at an Extraordinary General Meeting of members of the above-named company held on the 26th day of May, 1965, it was resolved that the company be wound up voluntarily, and at a meeting of creditors held on the same day pursuant to section 260, it was resolved that for such purpose, Norman Eric Stretton, of 296 Little Lonsdale-street, Melbourne, accountant be appointed liquidator.

Notice is also given that after 21 days from this date I shall proceed to distribute the assets. All creditors having any claims against the company should furnish particulars of same by that date, otherwise I shall proceed to distribute the assets without regard to their claim.

Dated this 28th day of May, 1965.

N. E. STRETTON, Liquidator.

Kennedy, Smail & Middlemiss, 296 Little Lonsdale-street, Melbourne. 6304

The Companies Act 1961.—In the matter of ROBERTS BROS. ELECTRICAL PROPRIETARY LIMITED.

NOTICE is hereby given that at an Extraordinary General Meeting of members of the above-named company held on the 25th day of May, 1965, it was resolved that the company be wound up voluntarily, and at a meeting of creditors held on the same day pursuant to section 260, it was resolved that for such purposes, Alan Murray Horsburgh, of 296 Little Lonsdale-street, Melbourne, accountant, be appointed liquidator.

Notice is also given that after 21 days from this date I shall proceed to distribute the assets. All creditors having any claims against the company should furnish particulars of same by that date, otherwise I shall proceed to distribute the assets without regard to their claim.

Dated this 28th day of May, 1965.

A. M. HORSBURGH, Liquidator.

Kennedy, Smail & Middlemiss, 296 Little Lonsdale-street, Melbourne. 6305

The Companies Act 1961.—In the matter of ELECTRIX (WHOLESALE) PTY. LTD.—Notice to Creditors of Meeting Pursuant to Section 260.

NOTICE is hereby given that a Meeting of creditors of the above-named company will be held at the offices of Kennedy, Smail & Middlemiss, 296 Little Lonsdale-street, Melbourne, on Friday, the 18th day of June, 1965, at 10.15 a.m., the company having convened a meeting of its members for the same day for the purpose of considering a Resolution that the company be wound up voluntarily.

Dated this 26th day of May, 1965.

D. A. RYAN, Director.

Kennedy, Smail & Middlemiss, 296 Little Lonsdale-street, Melbourne. 6295

Companies Act 1961.

NOTICE OF MEETING OF CREDITORS, PURSUANT TO SECTION 260 (1).

W. R. SPEAKMAN & SONS PROPRIETARY LIMITED.

NOTICE is hereby given that a meeting of the creditors of W. R. Speakman & Sons Proprietary Limited will be held in the board room of the Institute of Chartered Accountants in Australia, 23 McKillop-street, Melbourne, on the 11th day of June, 1965, at 11.30 a.m., the company having convened a meeting of its members for the same day for the purpose of considering a resolution that the company be wound up voluntarily.

No person shall be entitled to vote as a creditor at the meeting unless he has lodged with the chairman of the meeting a proof of the debt which he claims to be due to him from the company.

Dated this 31st day of May, 1965.

6350

J. McINTOSH, Secretary.

In the Supreme Court of Victoria.—1965, C.O.7037.—In the matter of the Companies Act 1961 and in the matter of ALAN L. JOHNSON PROPRIETARY LIMITED.

NOTICE is hereby given that a petition for the winding up of the above-named company by the Supreme Court was on the 31st day of May, 1965, presented by James Canny, Deputy Commissioner of Taxation for the Commonwealth of Australia. And that the said petition is directed to be heard before the Court, sitting at the Fourteenth Court, Law Courts, William-street, Melbourne, at the hour of 10.30 o'clock in the forenoon, on the 9th day of July, 1965, and any creditor or contributory of the said company desiring to support or oppose the making of an order on the said petition may appear at the time of hearing by himself or his counsel for that purpose; and a copy of the said petition will be furnished to any creditor or contributory of the said company requiring the same by the undersigned on payment of the regulated charge for the same.

The petitioner's official address is 436 Lonsdale-street, Melbourne.

The petitioner's solicitor is Harold Edward Renfree, Crown Solicitor for the Commonwealth, of 440 Little Collins-street, Melbourne.

H. E. RENFREE.

NOTE.—Any person who intends to appear on the hearing of the said petition must serve on or send by post to the above-named H. E. Renfree, notice in writing of his intention so to do. The notice must state the name and address of the person, or, if a firm, the name and address of the firm, and must be signed by the person or firm, or his or their solicitor (if any), and must be served or, if posted, must be sent by post in sufficient time to reach the above named not later than 4 o'clock in the afternoon on the 8th day of July, 1965.

6359

In the Supreme Court of Victoria.—1965, C.O.7035.—In the matter of the Companies Act 1961 and in the matter of CREDITO ITALO-AUSTRALIANO PROPRIETARY LIMITED.

NOTICE is hereby given that a petition for the winding up of the above-named company by the Supreme Court was on the 31st day of May, 1965, presented by James Canny, Deputy Commissioner of Taxation for the Commonwealth of Australia. And that the said petition is directed to be heard before the Court, sitting at the Fourteenth Court, Law Courts, William-street, Melbourne, at the hour of 10.30 o'clock in the forenoon on the 2nd day of July, 1965, and any creditor or contributory of the said company desiring to support or oppose the making of an order on the said petition may appear at the time of hearing by himself or his counsel for that purpose; and a copy of the said petition will be furnished to any creditor or contributory of the said company requiring the same by the undersigned on payment of the regulated charge for the same.

The petitioner's official address is 436 Lonsdale-street, Melbourne.

The petitioner's solicitor is Harold Edward Renfree, Crown Solicitor for the Commonwealth, of 440 Little Collins-street, Melbourne.

H. E. RENFREE.

NOTE.—Any person who intends to appear on the hearing of the said petition must serve on or send by post to the above-named H. E. Renfree, notice in writing of his intention so to do. The notice must state the name and address of the person, or, if a firm, the name and address of the firm, and must be signed by the person or firm, or his or their solicitor (if any), and must be served or, if posted, must be sent by post in sufficient time to reach the above named not later than 4 o'clock in the afternoon on the 1st day of July, 1965.

6360

In the Supreme Court of Victoria.—1965, C.O.7036.—In the matter of the *Companies Act 1961* and in the matter of **MINSAN PROPRIETARY LIMITED.**

NOTICE is hereby given that a petition for the winding up of the above-named company by the Supreme Court was on the 31st day of May, 1965, presented by James Canny, Deputy Commissioner of Taxation for the Commonwealth of Australia. And that the said petition is directed to be heard before the Court, sitting at the Fourteenth Court, Law Courts, William-street, Melbourne, at the hour of 10.30 o'clock in the forenoon on the 2nd day of July, 1965, and any creditor or contributory of the said company desiring to support or oppose the making of an order on the said petition may appear at the time of hearing by himself or his counsel for that purpose; and a copy of the said petition will be furnished to any creditor or contributory of the said company requiring the same by the undersigned on payment of the regulated charge for the same.

The petitioner's official address is 436 Lonsdale-street, Melbourne.

The petitioner's solicitor is Harold Edward Renfree, Crown Solicitor for the Commonwealth, of 440 Little Collins-street, Melbourne.

H. E. RENFREE.

NOTE.—Any person who intends to appear on the hearing of the said petition must serve on or send by post to the above-named H. E. Renfree, notice in writing of his intention so to do. The notice must state the name and address of the person, or, if a firm, the name and address of the firm, and must be signed by the person or firm, or his or their solicitor (if any), and must be served or, if posted, must be sent by post in sufficient time to reach the above named not later than 4 o'clock in the afternoon on the 1st day of July, 1965.

The *Companies Act 1961.*

AUSTIN KILPATRICK & CO. PROPRIETARY LIMITED.

AT a General Meeting of the members of Austin Kilpatrick & Co. Proprietary Limited duly convened and held at Castlereagh-street, Sydney, New South Wales, on the 27th day of May, 1965, it was resolved that the company be wound up voluntarily and that John McKenzie Hilliard, chartered accountant, of 447 Collins-street, Melbourne, be appointed liquidator.

Dated this 1st day of June, 1965.

6351 J. M. HILLIARD, Liquidator.

The *Companies Act 1961.*

NOYES AUSTRALIA PROPRIETARY LIMITED.

AT a General Meeting of the members of Noyes Australia Proprietary Limited duly convened and held at Frederick-street, St. Leonards, New South Wales, on the 26th day of May, 1965, it was resolved that the company be wound up voluntarily and that James Manson Poulton, chartered accountant, of 447 Collins-street, Melbourne be appointed liquidator.

Dated this 1st day of June, 1965.

6352 J. M. POULTON, Liquidator.

The *Companies Act 1961.*—In the matter of **COASTAL HOTELS PTY. LTD.**—Notice re Meeting of Creditors, Pursuant to section 260.

NOTICE is hereby given that a meeting of creditors of the above-named company will be held at the Burwood Memorial Hall, 502 Toorak-road, Burwood, on Friday, 11th June, 1965, at 10 a.m., the company having convened a meeting of its members for the same day for the purpose of considering a Resolution that the company be wound up voluntarily.

Dated this 1st day of June, 1965.

R. DAVIS, Director.

Gee and O'Keefe, public accountants, 325 Warrigal-road, Burwood. 6349

CREDITORS, next of kin and others having claims in respect of the estate of Benjamin Zivin, deceased, late of 36 Kingsley-street, Elwood, Melbourne, retired shopkeeper (who died on the 17th March, 1964), are to send particulars of their claims to the Executrices Betty Mavis Henry and Isobel Stern care of the under-mentioned solicitors, by the 9th of August, 1965, after which date they will distribute the estate, having regard only to the claims of which they then have notice.

W. A. PRENDERGAST & ROBINSON, solicitors, 406 Lonsdale-street, Melbourne. 6320

Trustee Act 1958.

NOTICE TO CLAIMANTS.

PURSUANT to the *Trustee Act 1958*, creditors, next of kin and all other persons having claims in respect of the estate of the deceased persons named below are required to send particulars to the legal personal representative or representatives at the addresses stated, after which date the representative or representatives will distribute the assets, having regard only to the claims of which notice has been received:—

George Thomas Stuart, late of 8 Hosking-street, Williamstown, pensioner, deceased, died on the 1st day of February, 1965.—Claims to the executrix, Dorothy Gladys Doig of 19 Hosking-street, Williamstown, married woman, care of John F. Carroll of 4 Paisley-street, Footscray, solicitor, by the 11th day of August, 1965. John F. Carroll, LL.B., solicitor, 4 Paisley-street, Footscray. 6342

Raymond Tomas Bult, late of 25 Pridham-street, Maidstone, electrical foreman, deceased, died on the 5th day of November, 1964.—Claims to the executrix, Olivena Nellie Bult of 25 Pridham-street, Maidstone, widow, care of John F. Carroll, of 4 Paisley-street, Footscray, solicitor, by the 11th day of August, 1965. John F. Carroll, LL.B., solicitor, 4 Paisley-street, Footscray. 6343

Frederick Thomas Jenkin, late of Tragowel, farmer, who died 4th December, 1964.—Claims to the administratrix, Alice Jessie Jenkin, care of Willen and McKenzie, solicitors, Kerang, by 4th August, 1965. 6268

Elizabeth Page Crocket, late of 5 Park-street, Parkville, Victoria, spinster, deceased intestate, who died on the 24th January, 1959.—Claims to The Equity Trustees Executors and Agency Company Limited, of 472 Bourke-street, Melbourne, Victoria, the administrator of the estate of the said deceased, by the 11th August, 1965. T. A. Kennedy, LL.B., solicitor, 509 Collins-street, Melbourne. 6290

THE TRUSTEES, EXECUTORS AND AGENCY COMPANY LIMITED, of 401 Collins-street, Melbourne, the executor of the will of John Henry Hammond, formerly of 12 Hoyt-street, Hampton, but late of The Majestic Hotel, Fitzroy-street, St. Kilda, gentleman, deceased (who died on the 22nd day of March, 1965), require all creditors next of kin and others having claims against the property or the estate of the said deceased, to send to it, the said executor at its aforementioned address, on or before the 9th day of August, 1965, particulars in writing of such claims, after which date the said executor intends to convey or distribute such property or estate to or among the persons entitled thereto, having regard only to the claims of which it shall have had notice.

DARVALL & HAMBLETON, solicitors, 7th Floor, T. & G. Building, 147 Collins-street, Melbourne. 6355

ALL persons having claims against the estate of William Lloyd Brill, late of 16 Getting-crescent, Campbell, in the Australian Capital Territory, air force officer, deceased (who died on the 12th October, 1964), and probate of whose will was on the 8th December, 1964, granted by the Supreme Court of the Australian Capital Territory to Perpetual Trustee Company (Canberra) Limited and application to the Supreme Court of Victoria (Probate Jurisdiction) by The Perpetual Executors and Trustees Association of Australia Limited to seal such probate (having been granted on the 25th May, 1965), are hereby required to send particulars of such claims to The Perpetual Executors and Trustees Association of Australia Limited at its registered office at 100-104 Queen-street, Melbourne, on or before 3rd August, 1965, after which date the said company will proceed to transfer, convey or distribute the said estate to or among the persons entitled thereto, having regard only to the claims of which it shall then have had notice and will not be liable for the assets so transferred, conveyed or distributed to any persons of whose claim it shall not then have had notice.

WEIGALL AND CROWTHER, solicitors, 83 William-street Melbourne. 6291

ALL persons having claims against the estate of Austin Morris Bisley, late of Hamilton, in the Dominion of New Zealand, merchant, deceased (who died on 27th June, 1964), and probate of whose will was on the 7th August, 1964, granted by the Supreme Court of New Zealand to The Guardian Trust and Executors Company of New Zealand Limited, Austin Francis Shirer Bisley, David Shirer Bisley, and Robin Shirer Bisley, and application to the Supreme Court of Victoria (Probate Jurisdiction) by The Perpetual Executors and Trustees Association of Australia Limited to seal such probate (having been granted on the 26th May, 1965), are hereby required to send particulars of such claims to The Perpetual Executors and Trustees Association of Australia Limited at its registered office at 100-104 Queen-street, Melbourne, on or before 3rd August, 1965, after which date the said company will proceed to transfer, convey or distribute the said estate to or among the persons entitled thereto, having regard only to the claims of which it shall then have had notice and will not be liable for the assets so transferred conveyed or distributed to any persons of which claim it shall not then have had notice.

RYLAH & RYLAH, solicitors, 349 Collins-street, Melbourne. 6300

PERCY ERNEST EVANS, late of "Flowing Vale", Lima East, in the State of Victoria, farmer and grazier, DECEASED (who died on the 25th August, 1964).

CREDITORS, next of kin and all other persons having claims against the estate of the deceased are required by the executors of the will, The Trustees Executors and Agency Company Limited, 401 Collins-street, Melbourne, to send particulars to it, on or before the 21st day of August, 1965, after which date they will distribute the assets, having regard only to the claims of which they have notice.

HAMILTON CLARKE & CLARKE, solicitors, 55 Nunn-street, Benalla. 6253

ELLEN GARD, late of 20 Martin-road, South Camberwell, in the State of Victoria, married woman, DECEASED.

CREDITORS, next of kin and others having claims in respect of the estate of the deceased (who died on the 9th day of May, 1960), are required to send particulars thereof to The Equity Trustees Executors and Agency Company, of 476 Bourke-street, Melbourne, by the 9th day of August, 1965, after which date the said company will distribute the assets, having regard only to the claims of which it then has notice.

CEDRIC RALPH, solicitor, 480 Bourke-street, Melbourne. 6256

IDA MATHILDA HASLER, late of Laurel Bank-parade, Newtown, Geelong, married woman, DECEASED.

CREDITORS, next of kin and others having claims in respect of the estate of the deceased (who died on the 26th day of May, 1964), are required by the personal representative, Francis Pelham Just, of Malop-street, Geelong, solicitor, to send particulars to him, care of the under-mentioned solicitors, by the 11th day of August, 1965, after which date the personal representative may convey or distribute the assets, having regard only to the claims of which he then has notice.

WHYTE, JUST & MOORE, solicitors, 27 Malop-street, Geelong. 6273

CREDITORS, next of kin and others having claims in respect of the estate of Alan Jack McLeod, late of 149 Patterson-road, Moorabbin, in the State of Victoria, billiard saloon proprietor, deceased (who died on the 8th day of August, 1964), are requested to send particulars of their claims to National Trustees, Executors and Agency Company of Australasia Limited, of 95 Queen-street, Melbourne, the duly authorized administrator of the estate of the said deceased, by the 15th day of August, 1965, after which date the administrator will distribute the assets, having regard only to the claims of which it has notice.

KENNETH J. CLEMENTS, 255 Glenhantly-road, Elsternwick, solicitor for the administrator. 6260

CREDITORS, next of kin and others having claims in respect of the estate of John Henderson, late of Korumburra, dealer, deceased (who died on the 28th June, 1963), are to send particulars of their claims to John Lyons, care of the undersigned, by the 2nd day of August, 1965, after which date he will distribute the assets, having regard only to the claims of which he then has notice.

BIRCH, ROSS & BARLOW, solicitors, Korumburra. 6340

CREDITORS, next of kin and others having claims in respect of the estate of Robert William Elsum McBride, late of 29 Collins-street, Thornbury, in the State of Victoria, retired Commonwealth public servant, deceased (who died on the 2nd day of March, 1965), are required to send the particulars of their claims to The Perpetual Executors and Trustees Association of Australia Limited, of 100-104 Queen-street, Melbourne, in the said State, by the 7th day of August, 1965, after which date the said company will distribute the assets, having regard only to the claims of which it then has notice.

Dated the 2nd day of June, 1965.

W. ROSS RICHARDS, solicitor, 9 Beech-street, East Malvern. 6341

RE MARIE AUGUSTE BETTS, late of "Hopevale", Tahara, grazier, DECEASED.

CREDITORS, next of kin and others having claims in respect of the estate of the above-named deceased (who died on the 3rd May, 1964), are required by the executors, Peter Dohle of "Leyton", Tahara, grazier, and John William Nash of Coleraine, solicitor, to send particulars of the same to them, in care of the undersigned, on or before the 2nd August, 1965, after which date they will convey or distribute the assets, having regard only to the claims of which they then have notice.

FITZGERALD & NASH, solicitors, Whyte-street, Coleraine. 6344

RE WILLIAM DOLMAN, late of Coleraine, auctioneer, DECEASED.

CREDITORS, next of kin and others having claims in respect of the estate of the above-named deceased (who died on the 11th August, 1964), are required by the executor, William Gray Dolman, of 98 Percy-street, Portland, butcher, to send particulars to him, in care of the undersigned, on or before the 2nd August, 1965, after which date the executor will convey or distribute assets, having regard only to the claims of which he then has notice.

FITZGERALD & NASH, solicitors, Whyte-street, Coleraine. 6345

CREDITORS, next of kin and others having claims in respect of the estate of Marion Rosalie Stanton, late of Mordialloc Hotel, 528 Main-street, Mordialloc, in the State of Victoria, widow, deceased (who died on the 11th November, 1964), are required to send particulars of their claims to the executors, Ellen May Millar, Henry Norman Stanton and Douglas Culma Allan, care of the under-mentioned solicitors before the 4th day of August, 1965, after which date the executors will distribute the assets, having regard only to the claims of which they then have notice.

BRENDAN MCGUINNESS & CO., solicitors, 118 Queen-street, Melbourne. 6317

WILLIAM HORACE CHEW, late of Nyah, in the State of Victoria, orchardist, DECEASED.

CREDITORS, next of kin and other persons having claims against the estate of the said deceased are required to send particulars of same to Victor James Wilkins, the executor of the will of the said deceased, in care of the undersigned, on or before the 6th day of August, 1965, after which date he will distribute the assets, having regard only to the claims of which he then has notice.

DELANY & DELANY, barristers & solicitors, 270 Campbell-street, Swan Hill. 6313

FRANCES COWAN, formerly of 19 Harcourt-avenue, Caulfield, in the State of Victoria, married woman, but late of 377 Alma-road, Caulfield North, in the said State, widow, DECEASED.

CREDITORS, next of kin and others having claims in respect of the estate of the deceased (who died on the 20th day of June, 1964), are required by the executor, James Wright Cowan, of 214A Wattle Valley-road, Burwood, in the said State, to send particulars to him, care of Trevaks, Havyatt & Co., solicitors, of 472 Bourke-street, Melbourne, by the 3rd day of August, 1965, after which date he will distribute the assets, having regard only to the claims of which he then has notice.

Dated the 27th day of May, 1965.

TREVAKS, HAVYATT & CO., solicitors, 472 Bourke-street, Melbourne. 6262

NOTICE TO CREDITORS of the estate of THOMAS LYNE, late of Fish Creek, in the State of Victoria, farmer, DECEASED.

CREDITORS, next of kin and others having claims in respect of the estate of the deceased (who died on the 4th day of July, 1963), are required by the trustee Leo Synan, to send particulars to him care of Bruce, Watt, Ambrose, Riches & Co., solicitors, of Morwell, by the 4th day of August, 1965, after which date the executor trustee may distribute the assets of the estate, having regard only to the claims of which he then has notice.

BRUCE, WATT, AMBROSE, RICHES & CO., solicitors,
Commonwealth Bank Chambers, Morwell. 6302

CREDITORS, next of kin and others having claims in respect of the estate of Frank Otto Edward Fishman, late of Mirboo North, garage proprietor, deceased, intestate (who died on the 8th day of May, 1964), are required by the administratrix, Ruby Myrtle Fishman, of Mirboo North, widow, to send particulars of their claims to her care of the under-mentioned solicitors, by the 31st day of July, 1965, after which date the administratrix will distribute the assets, having regard only to the claims of which she then has notice.

MARSHALL & MACKENZIE, solicitors, Leongatha.
6287

FRANCIS WILLIAM MITCHELL, late of Lalbert, in the State of Victoria, farmer, DECEASED.

CREDITORS, next of kin and others having claims in respect of the estate of the deceased (who died on the 19th day of January, 1964), are required by the Executors, Violet Hannah Mitchell, widow, and Albert Francis Mitchell, farmer, both of Lalbert aforesaid to send particulars to us care of the undersigned by the 8th day of September, 1965, after which date the executors may convey or distribute the assets having regard only to the claims of which they then shall have had notice.

ALEC M. HAYES, solicitor, 199 Campbell-street, Swan Hill. 6288

GEORGE ALFRED RONALD TUDBALL, late of 17 Webb-street, Glen Iris, retired technician, DECEASED.

CREDITORS, next of kin and others having claims in respect to the estate of the above-named deceased (who died on the 11th day of June, 1964), are required by the executrix, Elma Florence Tudball, to send particulars of their claims to her care of the under-mentioned solicitors by the 9th day of August, 1965, after which date she will distribute the assets, having regard only to the claims of which she then has notice.

UPTON & ETTELSON, solicitors, 100 Queen-street, Melbourne. 6299

GEOFFREY HAROLD BEEMER, late of 1515 Burke-road, East Kew, in the State of Victoria, taxi proprietor, DECEASED.

CREDITORS, next of kin and others having claims in respect of the estate of the above-named deceased (who died on the 6th day of April, 1965), are required by the Executrix, Joyce Jessie Beemer, of 1515 Burke-road, East Kew, widow, to send particulars to her care of the under-mentioned solicitor, by the 6th August, 1965, after which date she may convey or distribute the assets, having regard only to the claims of which she then has notice.

JAMES M. N. MCINTYRE, solicitor, 450 Little Collins-street, Melbourne. 6301

CREDITORS, next of kin and others having claims in respect of the will of Hannah Ronayne, late of 22 Wheatley-road, Bentleigh, home duties, deceased (who died on the 24th day of February, 1965), are to send particulars of their claims to the executor, Michael Joseph Mornane, of 95 Queen-street, Melbourne, solicitor, by the 5th day of August, 1965, after which date he will distribute the assets, having regard only to the claims of which he shall have had notice.

M. MORNANE, solicitors, 95 Queen-street, Melbourne.
6357

CREDITORS, next of kin and others having claims in respect of Frederick William Johnson, late of 27 Duke-street, St. Kilda, in the State of Victoria, retired, deceased (who died on 31st day of December, 1964), are required to send written particulars of their claim to George Frederick Johnson, care of the undersigned, by the 2nd day of August, 1965, after which date the executor will distribute the assets, having regard only to claims of which he then has notice.

RALPH FREADMAN, GILES & CO., of 141A Chapel-street, St. Kilda, solicitors for the executor. 6346

THOMAS SCOTT WALES, late of Whitehead's Creek, grazier, DECEASED.

CREDITORS, next of kin and others having claims in respect of the estate of the deceased (who died on the 22nd day of July, 1964), are required by the executors, Ethel Alma Wales, Archie Charles Wales and Colin Scott Wales, to send particulars to the undersigned solicitors, by the 16th day of August, 1965, after which date the executors may convey or distribute the assets, having regard only to the claims of which they then have had notice.

WILFRID J. OSBORNE & OSBORNE, solicitors, Seymour. 6263

Re WILLIAM COCKBILL, late of Rockbank, and of 43 Maribrynong-road, Ascot Vale, director, DECEASED.

CREDITORS, next of kin and others having claims in respect of the deceased (who died on the 8th day of March, 1965), are required by the Trustees, David Hedley Thomas and William Frederick Rowe, of care of David Thomas & Frenkel, solicitors, of 104 Queen-street, Melbourne, to send particulars to them by the 20th day of August, 1965, after which date the trustees may convey or distribute the assets, having regard only to the claims of which they then have notice.

DAVID THOMAS & FRENKEL, solicitors for the trustees, of 104 Queen-street, Melbourne. 6314

ALEXANDER KAYE, late of No. 386 Flinders-lane, Melbourne, manufacturers agent, DECEASED.

CREDITORS, next of kin and others having claims in respect of the estate of the deceased (who died on the 4th day of March, 1965), are required by the trustee, The Trustees, Executors and Agency Company Limited, of 401 Collins-street, Melbourne, to send particulars to it by the 2nd day of August, 1965, after which date the trustee may convey or distribute the assets, having regard only to the claims of which it then has notice.

PHILLIPS, FOX & MASEL, 450 Little Collins-street, Melbourne, solicitors for the trustee. 6353

CREDITORS, next of kin and others having claims in respect of the estate of Cora Elizabeth Louisa Richards, late of 44 Lynch-street, Footscray, spinster, deceased (who died on the 1st day of January, 1965), are to send particulars of their claims to the executors, James Henry Marvill and Clara Marvill, care of the under-mentioned solicitors, by the 3rd day of August, 1965, after which date the executors will distribute the assets, having regard only to the claims of which they then have notice.

MARTIN & MARTIN, solicitors, 37 Queen-street, Melbourne. 6354

CREDITORS, next of kin and others having claims in respect of the estate of Maude Partington, late of 24 Alice-street, West Coburg, Victoria, married woman, deceased (who died on the 2nd March, 1965), are required to send particulars of their claims to The Equity Trustees Executors and Agency Company Limited, of 472 Bourke-street, Melbourne, Victoria, the executor of the will of the said deceased, by the 9th August, 1965, after which date the said company will distribute the assets, having regard only to the claims of which it then shall have had notice.

KIDDLE, BRIGGS & WILLOX, solicitors, 400 Collins-street, Melbourne. 6356

CREDITORS, next of kin and others having claims in respect of the estate of Hubert Cecil Soden, late of 3 Harwood-street, Elwood, in the State of Victoria, retired managing director (who died on the 25th June, 1964), are to send particulars of their claims to The Equity Trustees, Executors and Agency Company Limited, of 472 Bourke-street, Melbourne, in the said State, by the 14th day of August, 1965, after which date it will distribute the assets, having regard only to the claims of which it then has notice.

CYRIL BROOKS, LL.B., 411 Collins-street, Melbourne. 6358

CREDITORS, next of kin and others having claims in respect of Christina May McCallum, late of 19 Rosemount-avenue, Caulfield, in the State of Victoria, spinster, deceased (who died on 21st day of July, 1964), are required to send written particulars of their claims to Iain Grant McCallum, care of the undersigned, by the 2nd day of August, 1965, after which date the executor will distribute the assets, having regard only to claims of which he then has notice.

RALPH FREADMAN, GILES & CO., of 141A Chapel-street, St. Kilda, solicitors for the executor. 6338

CREDITORS, next of kin and others having claims in respect of Alice Parkinson, late of Flat 1, 9 Alfriston-street, Elwood, in the State of Victoria, married woman, deceased (who died on 7th day of March, 1965), are required to send written particulars of their claim to Francis Parkinson, care of the undersigned, by the 2nd day of August, 1965, after which date the executor will distribute the assets, having regard only to the claims of which he then has notice.

RALPH FREADMAN, GILES & CO., of 141A Chapel-street, St. Kilda, solicitors for the executor. 6339

CREDITORS, next of kin and all others having claims against the estate of Alexander Anderson, late of Underbool, in the State of Victoria, farmer, deceased (who died on the 10th day of January, 1965), are requested by the executor of the will of the said deceased, The Union-Fidelity Trustee Company of Australia Limited of 101 Lydiard-street North, Ballarat, in the said State, to send particulars of their claims to the said company on or before the 28th day of August, 1965, after which date the executor will distribute the assets, having regard only to the claims of which it shall then have had notice.

DUCK, GALLAGHER & RYAN, solicitors, 75 Deakin-avenue, Mildura, Victoria. 6289

CREDITORS, next of kin and all others having claims against the estate of Anthony Farrugia, late of 46 Heyington-avenue, Thomastown, in the State of Victoria, building labourer, deceased (who died on 8th October, 1964), are required to send particulars of such claims to Grazio Farrugia of 46 Heyington-avenue, Thomastown aforesaid, the administrator of the above estate, at his address on or before the expiration of two months from the date of publication hereof, after which date the said administrator will distribute the assets, having regard only to the claims of which he shall then have had notice.

LLOYD P. GOODE & CO., solicitors, 388 Bourke-street, Melbourne. 6298

GEORGE JOHN RATH, late of 56 Chapman-avenue, North Melbourne, retired pastrycook, DECEASED (who died on 4th February, 1965).

CREDITORS, next of kin and all other persons having claims against the estate of the deceased are required by the executors of his will, Paula Rath of 56 Chapman-avenue, North Melbourne, widow, Paula Giese of 94 Bay-road Sandringham, widow, and Carl Leopold Rath of 62 Mooltan-street, Flemington, baker, to send particulars thereof to them, care of the under-mentioned solicitors before 7th August, 1965, after which date they may distribute the assets of the deceased, having regard only to the claims of which they then have notice.

COLTMAN, WYATT & ANDERSON, solicitors, 578 Bourke-street, Melbourne. 6319

CREDITORS, next of kin and others having claims against the estate of Edward Charles Brewster, late of 19 De Lacey-street, Maidstone, widower (who died on the 6th December, 1964), are required to send particulars of their claims to the executors, Matthew Haggart and Frederick Roy Marsh, care of the undernamed solicitor, on or before the 15th day of August, 1965, after which date they will distribute the assets, having regard only to the claims of which they then have notice.

JOHN GINNANE, solicitor, 153A Barkly-street, Footscray. 6312

CREDITORS, next of kin and others having claims against the estate of William Kelly, late of 63 Alexander-street, Footscray, retired (who died on the 18th August, 1963), are required to send particulars of their claims to the executors, Francis William Kelly and Ruth Isabel Kelly, care of the undernamed solicitor, by the 15th day of August, 1965, after which date they will distribute the assets, having regard only to the claims of which they then have notice.

JOHN GINNANE, solicitor, 153A Barkly-street, Footscray. 6316

In the Supreme Court of the State of Victoria.

SALE BY THE SHERIFF.

ON Friday, the 9th day of July, 1965, at 10 a.m., at the Police Station, Sunshine (unless process be stayed or satisfied):—

All the estate and interest (if any) of Jean Reilly, married woman, of 123 Suspension-street, Ardeer, as proprietor of an estate in fee-simple in the land described

in certificate of title, volume 8066, folio 068, upon which is erected a weatherboard and fibro-cement dwelling house, known as No. 29 Dumfries-street, Deer Park.

Registered mortgages Nos. 1117917 for approximately £2,052) and 1117921 (for approximately £244) affects the said estate and interest.

Terms: Cash only.

25th May, 1965. N. FROGLEY, Sheriff's Officer. 6292

IMPOUNDINGS

BRANXHOLME.—Impounded in Branhholme Pound.

1 Merino ewe, six-tooth, back notch near ear, top and back notch off ear, no visible brand

If not claimed and expenses paid, to be sold on 19th June, 1965.

V. LATHER, Poundkeeper. 6362—14/

LEONGATHA.—Impounded in Leongatha Pound by Ranger on 24th May, 1965.

1 lamb, newly shorn, hole in off ear, no visible brand.

If not claimed and expenses paid to be sold on 17th June, 1965.

G. NELSON, Poundkeeper. 6278

MORTLAKE.—Impounded in Mortlake Pound, on 27th May, 1965.

2 Dorset Horn rams, one ram has blue mark along back, no other marks or brands

1 ewe, notch top left ear, notch bottom right ear, no visible brand

If not claimed and expenses paid, to be sold on 17th June, 1965.

H. M. ROBERTSON, Poundkeeper. 6364—20/

YARRA JUNCTION.—Impounded in Yarra Junction Pound.

1 brown heifer calf, no visible brand
1 Friesian heifer calf, no visible brand

If not claimed and expenses paid, to be sold on 19th June, 1965.

M. BERUDE, Poundkeeper. 6363—16/

Subordinate Legislation Act 1962.

NOTICE OF MAKING OF STATUTORY RULES.

IN pursuance of the provisions of the *Subordinate Legislation Act 1962* and the Regulations made thereunder, notice is given of the making of the following statutory rules:—

	Price.
	<i>Stamps Act 1958.</i>
71/1965. Stamps (Mortgage) Regulations 1965 ..	0 6
	<i>Health Act 1958.</i>
72/1965. Child Minding Centres (Health Act) Regulations 1965 ..	2 0
	<i>Gas Regulation Act 1958.</i>
73/1965. Gas Testing Regulations No. 1 1965 ..	0 6
	<i>Mental Health Act 1959 (No. 6605).—</i> Section 113.
74/1965. Mental Health (Medical Positions and Salaries) Regulations 1965 ..	0 6
	<i>Fisheries Act 1958.</i>
75/1965. Proclamation Revoking the Close Season for Trout ..	0 6
	<i>Fisheries Act 1958.</i>
76/1965. Proclamation Prohibiting Fishing in Certain Waters ..	1 0

Copies of these statutory rules may be purchased at the Sale of Publications Section of the Government Printing Office, located at Macarthur-street, Melbourne, C.2. If ordered by mail, remittance should be addressed to "The Government Printer, Box 203, P.O., North Melbourne, N.1.", and should include 6d. extra for postage.

A. C. BROOKS, Government Printer.

STATE ACTS, 1964

STATE ACTS, 1964—continued.

COPIES of the following Acts of Parliament of Victoria may be obtained at the Government Printing Office, or from any accredited agents, at the price set opposite to each:—

No.	Price. s. d.
7106. Governor's Salary	0 6
7107. Gaols (Visiting Justices)	0 6
7108. Grain Elevators (Borrowing Powers)	0 6
7109. The Constitution Act Amendment (Conjoint Elections)	0 9
7110. Opticians Registration (Fees and Penalties)	0 6
7111. Railway Lands	0 9
7112. Revocation and Excision of Crown Reservations	0 9
7113. Balmoral Geelong and Balwyn Lands Exchange	1 0
7114. Transfer of Land (Service Agreements)	0 6
7115. R.S.L. Widows and Widowed Mothers' Trust Patriotic Fund	1 0
7116. Home Finance (Reconstitution of Trust)	0 9
7117. Appeal Costs Fund	1 3
7118. Maryborough Free Library and Literary Institute	0 9
7119. Wills (Formal Validity)	0 9
7120. Stamps (Exemptions)	0 9
7121. The Evangelical Lutheran Church of Australia (Victorian District) Incorporation	1 6
7122. Health (Child Minding)	0 9
7123. Wodonga Sewerage Authority (Acquisition of Land)	0 9
7124. Firearms (Interstate Transactions)	0 9
7125. Housing Advances and Loans (Improper Commissions)	0 6
7126. Process Servers and Inquiry Agents (Qualification)	0 6
7127. Supreme Court (Qualification of Judges)	0 6
7128. Monash University (Amendment)	0 6
7129. Athlone Mechanics' Institute Land	0 6
7130. Transfer of Land (Restrictive Covenants)	0 6
7131. Goods (Trading Stamps)	0 6
7132. Health (Amendment)	0 9
7133. Consolidated Revenue	0 6
7134. Estate Agents (Amendment)	0 9
7135. Public Service (Amendment)	1 0
7136. Sheep Owners Protection (Amendment)	1 0
7137. Motor Car (Indorsement of Licences)	0 6
7138. Racing (Interstate Totalizers)	0 6
7139. Police Offences (Animals)	1 0
7140. Education (Adult Education)	0 6
7141. University (Faculties)	0 6
7142. Statute Law Revision	0 9
7143. Labour and Industry (Chemists' Shops)	0 6
7144. Teaching Service (Amendment)	0 6
7145. Litter	0 9
7146. Acts Interpretation (Commencement)	0 6
7147. Adoption of Children	2 0
7148. National Parks	0 9
7149. The Constitution Act Amendment (Responsible Ministers)	0 6
7150. Consolidated Revenues	0 6
7151. Land (Special Grant)	0 6
7152. State Insurance Funds	0 6
7153. Local Government (Councillors' Declarations)	0 6
7154. Metropolitan Fire Brigades (Long Service Leave)	0 6
7155. Mildura (Rating on Unimproved Values)	0 9
7156. Country Fire Authority (Borrowing Powers)	0 6
7157. South Melbourne (Unimproved Rating Poll)	0 6
7158. Closer Settlement (Regulations)	0 6
7159. General Sessions (Pensions of Chairmen)	0 6
7160. Grain Elevators (Borrowing)	0 6
7161. Local Authorities Superannuation (Amendment)	0 6
7162. Children's Court (Amendment)	0 6
7163. Justices (Complaints and Summonses)	0 6
7164. Fisheries and Game (Reduced Licence Fees)	0 6
7165. Agricultural Colleges	1 0
7166. Motor Car (Amendment)	0 6
7167. Consolidated Revenue	0 6
7168. Administration and Probate (Small Estates)	0 9
7169. Game (Black Swans)	0 6
7170. Latrobe Valley (Amendment)	0 6
7171. Local Government (St. Kilda and Elwood Land Reclamation)	0 6
7172. State Forests Loan Application	0 6
7173. Portland Harbor Trust (Borrowing Powers)	0 6
7174. Sewerage Districts	1 0
7175. Consolidated Revenue	0 6
7176. Municipal Association (Accident Insurance)	0 6
7177. Railways (Long Service Leave)	0 6
7178. Country Roads (Amendment)	0 9

No.	Price. s. d.
7179. Revocation and Excision of Crown Reservations	1 0
7180. Railway Loan Application	1 0
7181. Disposal of Uncollected Goods (Damaged Motor Cars)	0 6
7182. Trustee Companies (Affidavits)	0 6
7183. Maintenance (Reciprocating State)	0 6
7184. Crimes (Amendment)	1 0
7185. Motor Car (Fines and Drivers' Licence Fees)	0 6
7186. Public Works Loan Application	1 0
7187. Juries (Women Jurors)	0 9
7188. Pesticides	1 0
7189. La Trobe University	1 9
7190. National Parks (Amendment)	0 6
7191. Motor Car (Carriers' Identification Marks)	0 6
7192. Swine Compensation	0 6
7193. Stamps (Motor Car)	1 0
7194. Land Tax (Rates and Exemptions)	0 9
7195. Estate Agents	0 6
7196. Tattersall Consultations (Jackpot Consultations)	0 6
7197. Labour and Industry (Fees)	0 6
7198. Water	1 6
7199. Superannuation (Time for Election)	0 6
7200. Police Offences (Betting Information)	0 6
7201. Marine (Amendment)	1 0
7202. Labour and Industry (Long Service Leave)	0 9
7203. Acquisition of Materials	1 0
7204. Stamps	2 0
7205. Forests (Amendment)	0 9
7206. Boilers Inspection (Amendment)	0 6
7207. State Electricity Commission (Contributions)	0 6
7208. Theatres (Sunday Films)	0 6
7209. Housing (Amendment)	1 0
7210. Social Welfare (Trainees)	0 9
7211. Health (Offensive Trades)	0 6
7212. Medical (Amendment)	1 0
7213. Stock Foods (Amendment)	1 0
7214. Railways (Funds)	0 6
7215. Licensing (Dining Permits)	0 6
7216. Water (Recreational Areas)	0 6
7217. Monash University (Amendment)	1 0
7218. Water Supply Loan Application	1 6
7219. Education (School Committees)	0 6
7220. Cancer (Amendment)	0 6
7221. Cadet Surveyors	0 6
7222. Marine Stores and Old Metals (Welfare and Community Organizations)	0 6
7223. Tomato Processing Industry (Uniform Agreement)	1 0
7224. Melbourne Sailors' Home	0 6
7225. Co-operative Housing Societies (Indemnities)	0 6
7226. Legal Profession Practice (Amendment)	1 9
7227. Parliamentary Salaries, Pensions and Superannuation	1 0
7228. Public Lands and Works	3 6
7229. Appropriation of Revenue	7 9
7230. Racing (Amendment)	1 0
7231. Friendly Societies (Assignment of Contracts)	0 9
7232. The Decentralization Advisory Committee	0 9
7233. Mines (Exploration Licences)	1 3
7234. Motor Car (Hours of Driving)	1 0
7235. Valuation of Land (Valuations)	1 0
7236. Shell (Corio to Williamstown) Pipelines	1 0
7237. Consumers Protection	0 9

Table of Acts and Enactments passed, date of operation, &c. 0 3

A. C. BROOKS,
Government Printer.

ACTS REPRINTED IN ACCORDANCE WITH THE AMENDMENTS INCORPORATION ACT 1958 (No. 6422), AND FOR SALE AT THE SALE OF PUBLICATIONS BRANCH OF THE GOVERNMENT PRINTING OFFICE, MACARTHUR-STREET, MELBOURNE.

No.	Price. s. d.
6189. Acts Interpretation (Incorporating amendments up to No. 7146)	1 6
6191. Administration and Probate (Second Reprint—Incorporating amendments up to No. 6920)	3 6
6209. Boiler Inspection (Incorporating amendments up to No. 7072)	1 9

ACTS REPRINTED IN ACCORDANCE WITH THE AMENDMENTS INCORPORATION ACT 1958 (No. 6422)—*continued.*

No.	Price. s. d.
6218. Children's Court (Incorporating amendments up to No. 7084)	2 0
6219. Children's Welfare (Incorporating amendments up to No. 6812)	2 6
6220. Clean Air (Incorporating amendments up to No. 6886)	1 0
6222. Commercial Goods Vehicles (Incorporating amendments up to No. 6886)	1 9
6225. Co-operation (<i>Second Reprint</i> —Incorporating amendments up to No. 7083)	4 3
6226. Co-operative Housing Societies (Incorporating amendments up to No. 7097)	4 0
6228. Country Fire Authority (Incorporating amendments up to No. 7065)	4 0
6229. Country Roads (Incorporating amendments up to No. 6943)	4 0
6231. Crimes (Incorporating amendments up to No. 6958)	13 3
6236. Dog (<i>Second Reprint</i> —Incorporating amendments up to No. 7065)	1 6
6242. Employers and Employee's (Incorporating amendments up to No. 6740)	1 9
6245. Estate Agents (<i>Second Reprint</i> —Incorporating amendments up to No. 7134)	3 9
6246. Evidence (Incorporating amendments up to No. 6758)	3 6
6249. Fences (Incorporating amendments up to No. 6550)	1 3
6251. Firearms (Incorporating amendments up to No. 6716)	2 3
6259. Gaols (Incorporating amendments up to No. 6651)	1 6
6265. Goods (<i>Second Reprint</i> —Incorporating amendments up to No. 7006)	2 6
6270. Health (Incorporating amendments up to No. 6886)	14 6
6274. Hospitals and Charities (Incorporating amendments up to No. 6716)	3 6
6279. Instruments (<i>Second Reprint</i> —Incorporating amendments up to No. 6886)	3 9
6282. Justices (Incorporating amendments up to No. 6961)	11 3
6283. Labour and Industry (<i>Second Reprint</i> —Incorporating amendments up to No. 7143)	7 6
6285. Landlord and Tenant (<i>Second Reprint</i> —Incorporating amendments up to No. 6996)	5 0
6289. Land Tax (Incorporating amendments up to No. 7099)	3 3
6291. Legal Profession Practice (Incorporating amendments up to No. 7065)	4 6
6293. Licensing (Incorporating amendments up to No. 6659)	9 3
6295. Limitation of Actions (Incorporating amendments up to No. 6845)	1 6
6298. Local Authorities Superannuation (Incorporating amendments up to No. 6894)	2 6
6299. Local Government (Incorporating amendments up to No. 7052)	35 0
5309. Medical (Incorporating amendments up to No. 6837)	3 9
6310. Melbourne and Metropolitan Board of Works Act 1958 (Incorporating amendments up to No. 7054)	8 6
6315. Metropolitan Fire Brigades (Incorporating amendments up to No. 6886)	2 9
6317. Milk and Dairy Supervision (Incorporating amendments up to No. 6964)	4 0
6318. Milk Board Act (Incorporating amendments up to No. 7093)	2 3
6324. Money Lenders (Incorporating amendments up to No. 6886)	2 6
6325. Motor Car (Incorporating amendments up to No. 6867)	6 6
6328. Nurses (Incorporating amendments up to No. 6716)	2 0
6330. Partnership	1 6
6337. Police Offences (Incorporating amendments up to No. 7145)	8 3
6338. Police Regulation (Incorporating amendments up to No. 7081)	4 6
6343. Process Servers and Inquiry Agents (Incorporating amendments up to 7126)	1 3
6344. Property Law (Incorporating amendments up to No. 6867)	9 0
6349. Public Service (Incorporating amendments up to No. 6886)	2 9
6350. Public Trustee (Incorporating amendments up to No. 6961)	3 6
6359. Road Traffic. (Incorporating amendments up to No. 6999)	1 6

ACTS REPRINTED IN ACCORDANCE WITH THE AMENDMENTS INCORPORATION ACT 1958 (No. 6422)—*continued.*

No.	Price. s. d.
6363. Second-Hand Dealers	1 3
6367. Settled Land (Incorporating amendments up to No. 6505)	4 0
6372. Soil Conservation and Land Utilization Act 1958 (Incorporating amendments up to No. 6961)	2 0
6375. Stamps (<i>Second Reprint</i> —Incorporating amendments up to No. 7142)	7 0
6377. State Electricity Commission (Incorporating amendments up to No. 7054)	5 0
6379. State Savings Bank (Incorporating amendments up to No. 6886)	4 3
6399. Transfer of Land (<i>Second Reprint</i> —Incorporating amendments up to No. 7130)	5 3
6401. Trustee (<i>Second Reprint</i> —Incorporating amendments up to No. 6963)	4 3
6419. Workers Compensation (Incorporating amendments up to No. 7063)	5 0
6577. Lifts and Cranes (Incorporating amendments up to No. 6886)	1 3
6585. Forests (Pulpwood Agreement) (Incorporating amendments up to No. 6886)	1 6
6605. Mental Health (Incorporating amendments up to No. 7135)	4 6
6651. Social Welfare (<i>Second Reprint</i> —Incorporating amendments up to No. 7084)	3 6
6653. Valuation of Land (Incorporating amendments up to No. 7019)	1 6
6832. Motor Boating (Incorporating amendments up to No. 6961)	1 6
6839. Companies (Incorporating amendments up to No. 7142)	22 6
6879. Unclaimed Moneys (Incorporating amendments up to No. 6961)	1 3
6886. Subordinate Legislation (Incorporating amendments up to No. 6961)	1 6
6889. Poisons (Incorporating amendments up to No. 7065)	3 6
6890. Probate Duty (Incorporating amendments up to No. 6970)	3 9

A. C. BROOKS,
Government Printer.

AGENTS FOR THE "VICTORIA GOVERNMENT GAZETTE".

THE following have been appointed agents to receive Advertisements and Subscriptions for the *Victoria Government Gazette*—

- ARMSTRONG'S AGENCY, 205 Queen-street, Melbourne.
- ARNALL & JACKSON, 390 Barkly-street, Brunswick, N.10.
- BAIRNSDALE AUTHORIZED NEWSAGENCY, 132 Main-street, Bairnsdale.
- COOKE, F. R. & E. M., & SONS, 69 Bridge-street, Benalla.
- DAVIES, G. & M. V., 112 Gray-street, Hamilton.
- DAVIS, WM. (MILDURA) PTY. LTD., 126 Eighth-street, Mildura.
- DIXON'S NEWSAGENCY, 89 Firebrace-street, Horsham.
- EDGAR'S NEWSAGENCY PTY. LTD., 293 Hargreaves-street, Bendigo.
- FRANKS, H., & CO., 184 Ryrie-street, Geelong.
- GORDON & GOTCH AUSTRALASIA LTD., 511 Little Collins-street, Melbourne.
- GULLAN'S NEWSAGENCY, 88 Bridge-street, Ballarat.
- HALES, D. & N., Henty-street, Casterton.
- HAMPTON, A. C., 243 Mitchell-street, Bendigo.
- HARSTON, PARTRIDGE & CO. PTY. LTD., 455 Little Collins-street, Melbourne.
- THE MERCANTILE EXCHANGE, 90 Queen-street, Melbourne.
- MCGILL'S AUTHORIZED NEWSAGENCY, 183-5 Elizabeth-street, Melbourne.
- PETTY, R. H. & W. M., 83 Murphy-street, Wangaratta.
- PURDIE, J., & CO., 138 Moorabool-street, Geelong.
- SALE AUTHORIZED NEWSAGENCY, 142 Raymond-street, Sale.
- SKINNER'S AUTHORIZED NEWSAGENCY, 49-51 Franklin-street, Traralgon.

TUFF'S SHEPPARTON NEWSAGENCY, 246 Wyndham-street, Shepparton.

VERNON, C. F. & H. J., 162 Bridge-road, Richmond.

VIEW POINT AUTHORIZED NEWSAGENCY, 4 View-Point, Bendigo.

A copy of the Gazette filed at each place for public reference.

THE "VICTORIA GOVERNMENT GAZETTE".

SUBSCRIPTIONS.—The subscription, including postage, is £2 15s. per annum, or £1 7s. 6d. per half year, payable in advance.

Subscriptions are required for whole months, and must cover at least a half year.

Single copies are One shilling, posted One shilling and six pence. Subscribers do not receive the Acts of Parliament with the GAZETTE.

GAZETTES are held in stock for five years only.

PRIVATE ADVERTISEMENTS.—The charge for insertion is 2s. per line single column, and 4s. per line double column. The title forms one or more lines as a heading. On an average ten words make a line of single column. Every signature must likewise be counted as a line. The final words of a paragraph, though only portion of a line, must be counted as one line. Signatures (in particular) and proper names must be written very plainly in the text; ONE SIDE ONLY of each sheet of paper should be WRITTEN UPON.

All documents illegibly written will be returned unpublished, and where brands occur unprovided for by the ordinary letters of the alphabet, a worded explanatory description must be furnished.

Advertisements unaccompanied by a remittance sufficient to cover the cost of the insertion will be returned unpublished.

THE VICTORIA GOVERNMENT GAZETTE is published on WEDNESDAY EVENING in each week, and Notices for insertion will be received by the Government Printer at or before ONE p.m. at ordinary rates, and late advertisements between ONE p.m. and FOUR p.m. at double rates on the day preceding the day of publication.

PAYMENTS.—All payments are required in advance and remittances should be made by cheque, postal note, or money order payable to "GOVERNMENT PRINTER".

ADDRESS.—All communications should be addressed to "The Government Printer, Box 203, P.O., North Melbourne".

PUBLICATION OF OFFICIAL MATTER.

ATTENTION is invited to the following procedure in relation to the publication of official matter in the Government Gazette:—

1. Matter submitted to the Executive Council.

Matters submitted to the Executive Council which requires gazettal will normally be published in the issue of the following week.

Where urgent gazettal is required, special arrangements should be made with the Gazette Officer, Room 9, first floor, Old Treasury Building.

Publication will be facilitated by the submission of carbon copies for the use of the Gazette Officer.

2. Other matter.

(a) All other matter duly certified by a responsible officer for publication should be lodged with the Gazette Officer not later than half-past Ten a.m. on Tuesday.

(b) Lengthy or involved notices should be forwarded several days before publication.

(c) Proofs, which will be supplied only when specifically requested or, at the direction of the Gazette Officer, should be returned promptly to avoid delay in publication.

(d) No additions or amendments to matter for publication will be accepted by telephone.

CONTENTS

	PAGE
Acts of Parliament	1740
Acts of Parliament on sale at the Government Printing Office	1788
Appointments	1752
Auction Sales Act	1742
Bank Holiday	1741
Contracts	1747
Estates of Deceased Persons	1750
Government Notices	1741
Impoundings	1787
Lands	1764
Levee at Parliament House, Melbourne	1739
Melbourne and Metropolitan Board of Works—Notices	1748
Mining	1742
Notice of Making of Statutory Rules	1787
Orders in Council—	
Acts—Monash University; Land; Country Roads; Local Government; Sewerage Districts; Dandenong Valley Authority; Geelong Waterworks and Sewerage; Health; Water; The Decentralization Advisory Committee; Sewerage Districts; Landlord and Tenant.	1753 et seq
Private Advertisements	1773
Proclamations	1740
Public Holiday—Queen's Birthday	1741
Public Holidays	1741
Public Service Notices	1769
Resignations	1753
Tenders	1768
Transport Regulation Board—Public Hearings	1743
Waterworks Trusts	1751