



VICTORIA
GOVERNMENT GAZETTE

Published by Authority

[Registered at the General Post Office, Melbourne, for transmission by post as a newspaper.]

No. 32]

WEDNESDAY, APRIL 10

1968

PROCLAMATIONS

ACTS OF PARLIAMENT.

PROCLAMATION

By His Excellency the Governor of the State of Victoria and its Dependencies in the Commonwealth of Australia, &c., &c., &c.

I, THE Governor of the State of Victoria, in the Commonwealth of Australia, do hereby declare that I have this day assented, in Her Majesty's name, to the Bills passed by the Parliament of the said State, the titles whereof are hereunder set forth, together with the short titles, that is to say:—

- No. 7661. "An Act to amend Section 120 and Section 125 of the *Melbourne Harbor Trust Act 1958*" (*Melbourne Harbor Trust (Borrowing Powers) Act 1968*.)
- No. 7662. "An Act to provide for the Revocation of the Reservation of certain Land in the Parish of Moorabbin permanently reserved as a Site for a Cemetery and for the Exchange thereof for certain other Land in the said Parish and for the Reservation of that other Land as a Site for a Cemetery." (*Cheltenham Cemetery Lands Exchange Act 1968*.)
- No. 7663. An Act to amend Part I. of the *Administration and Probate Act 1958*." (*Administration and Probate (Amendment) Act 1968*.)
- No. 7664. "An Act to amend the *Road Traffic Act 1958*." (*Road Traffic (Infringements) Act 1968*.)
- No. 7665. "An Act to amend Sections 23 and 44 of the *Transport Regulation Act 1958*." (*Transport Regulation (Amendment) Act 1968*.)
- No. 7666. "An Act to amend Section 3 of the *Commercial Goods Vehicles Act 1958*." (*Commercial Goods Vehicles (Amendment) Act 1968*.)

No. 7667. "An Act to authorize the Construction of a Line of Railway to connect the Railway from Frankston to Crib Point with Long Island, and for other purposes." (*Tyabb to Long Island Railway Construction Act 1968*.)

Given under my Hand and the Seal of the State of Victoria aforesaid, at Melbourne, this second day of April, in the year of our Lord One thousand nine hundred and sixty-eight, and in the seventeenth year of the reign of Her Majesty Queen Elizabeth II.

(L.S.) ROHAN DELACOMBE.

By His Excellency's Command,
HENRY BOLTE,
Premier.

GOD SAVE THE QUEEN !

EXTRACTIVE INDUSTRIES ACT 1966.
DATE OF COMING INTO OPERATION OF ACT.

PROCLAMATION.

By His Excellency the Governor of the State of Victoria, and its Dependencies in the Commonwealth of Australia, &c., &c., &c.

WHEREAS by an Act of the Parliament of the State of Victoria passed in the fifteenth year of the reign of Her Majesty Queen Elizabeth II intitled the *Extractive Industries Act 1966*, it is amongst other things enacted that the said Act shall come into operation on a day to be fixed by proclamation of the Governor in Council published in the *Government Gazette*:

NOW THEREFORE I, the Governor of the State of Victoria, in the Commonwealth of Australia, by and with the advice of the Executive Council of the said State, do by this my proclamation fix Wednesday the fifteenth day of May, One thousand nine hundred and sixty-eight, as the day upon which the said Act shall come into operation.

Given under my Hand and the Seal of the State of Victoria aforesaid, at Melbourne, this ninth day of April, in the year of our Lord One thousand nine hundred and sixty-eight, and in the seventeenth year of the reign of Her Majesty Queen Elizabeth II.

(L.S.) ROHAN DELACOMBE.

By His Excellency's Command,
JIM BALFOUR,
Minister of Mines.

GOD SAVE THE QUEEN!

BANK HOLIDAY.

PROCLAMATION

By His Excellency the Governor of the State of Victoria and its Dependencies in the Commonwealth of Australia, &c., &c., &c.

IN pursuance of the provisions of the *Bank Holidays Act 1958*, I, the Governor of the State of Victoria, in the Commonwealth of Australia, do by this my Proclamation appoint the day and date named hereunder a special day to be observed as a Bank Half-Holiday at the place respectively mentioned, that is to say:—

Bank Half-Holiday from the Hour of 11 a.m.:—

THURSDAY, THE 2ND MAY, 1968, at Warrnambool and Koroit.

Given under my Hand and the Seal of the State of Victoria aforesaid, at Melbourne, this 9th day of April, in the year of our Lord One thousand nine hundred and sixty-eight, and in the seventeenth year of the reign of Her Majesty Queen Elizabeth II.

(L.S.) ROHAN DELACOMBE.

By His Excellency's Command,
JAMES W. MANSON,
for Chief Secretary.

GOD SAVE THE QUEEN!

PUBLIC HOLIDAYS.

PROCLAMATION

By His Excellency the Governor of the State of Victoria and its Dependencies in the Commonwealth of Australia, &c., &c., &c.

IN pursuance of the provisions contained in Part III. of the *Public Service Act 1958*, I, the Governor of the State of Victoria, in the Commonwealth of Australia, by and with the advice of the Executive Council of the said State, do by this my Proclamation appoint the days and dates hereunder mentioned to be observed as Public Holidays or Public Half-Holidays (as the case may be) at the places respectively specified, viz.:—

Public Holiday:—

TUESDAY, THE 5TH NOVEMBER, 1968, throughout the Shire of Phillip Island.

Public Half-Holiday from the Hour of Twelve o'clock noon:—

THURSDAY, 2ND MAY, 1968, throughout the City of Warrnambool.

Given under my Hand and the Seal of the State of Victoria aforesaid, at Melbourne, this 9th day of April, in the year of our Lord One thousand nine hundred and sixty-eight, and in the seventeenth year of the reign of Her Majesty Queen Elizabeth II.

(L.S.) ROHAN DELACOMBE.

By His Excellency's Command,
A. G. RYLAH,
Chief Secretary.

GOD SAVE THE QUEEN!

ADDITIONAL PUBLIC HOLIDAY.

PROCLAMATION

By His Excellency the Governor of the State of Victoria and its Dependencies in the Commonwealth of Australia, &c., &c., &c.

WHEREAS by Section 67 of the *Public Service Act 1958* it is amongst other things enacted that the Governor in Council may, in addition to the days specified therein to be observed as holidays in the public offices, appoint any other day or days to be kept as public holidays in the whole or any part of the State of Victoria:

NOW THEREFORE I, the Governor of the State of Victoria, in the Commonwealth of Australia, by and with the advice of the Executive Council of the said State, do by this my Proclamation appoint Thursday, the 2nd day of January, 1969, to be observed as a Public Holiday throughout the State of Victoria.

Given under my Hand and the Seal of the State of Victoria aforesaid, at Melbourne, this 9th day of April, in the year of our Lord One thousand nine hundred and sixty-eight, and in the seventeenth year of the reign of Her Majesty Queen Elizabeth II.

(L.S.) ROHAN DELACOMBE.

By His Excellency's Command,
A. G. RYLAH,
Chief Secretary.

GOD SAVE THE QUEEN!

GOVERNMENT NOTICES

PUBLICATION OF THE "VICTORIA GOVERNMENT GAZETTE".

EASTER HOLIDAYS.

BECAUSE of the Easter Holidays, the *Victoria Government Gazette* will be published on—

FRIDAY, THE 19TH APRIL, 1968

instead of Wednesday, the 17th April, 1968.

All official matter for publication therein should be lodged with the *Gazette Officer*, Chief Secretary's Department (Telephone Extension 6282), not later than 9.30 a.m. on Thursday, the 18th April, 1968.

A. C. BROOKS,
Government Printer.

EASTER HOLIDAYS.

IT is hereby notified that on—

FRIDAY, THE 12TH,

SATURDAY, THE 13TH,

MONDAY, THE 15TH,

TUESDAY, THE 16TH APRIL, 1968,

the Public Offices will be closed, such days being appointed by the *Public Service Act 1958* to be observed as holidays in the Public Offices throughout Victoria.

This notice relates only to the closing of the State Public Offices. All inquiries regarding holidays in other offices and in shops and industry should be directed to the Department of Labour and Industry, 110 Exhibition-street, Melbourne, 3000. (Telephone 63 0321, Extension 6158, 6721 or 6859.)

A. G. RYLAH,
Chief Secretary.

Chief Secretary's Office,
Melbourne, 18th March, 1968.

ANZAC DAY HOLIDAY.

IT is hereby notified that on—

THURSDAY, THE 25TH APRIL, 1968,

the Public Offices will be closed, such day having been appointed by the *Public Service Act 1958*, to be observed as a holiday in the Public Offices throughout the State of Victoria.

This notice relates only to the closing of the State Public Offices. All inquiries regarding the holiday in other offices and in shops and industry should be directed to the Department of Labour and Industry, 110 Exhibition-street, Melbourne, 3000. (Telephone 63 0321, Extension 6158, 6721 or 6859.)

A. G. RYLAH,
Chief Secretary.

Chief Secretary's Office,
Melbourne, 3000, 29th March, 1968.

Transport Regulation Act.
TRANSPORT REGULATION BOARD.

HEARING OF APPLICATIONS.

NOTICE is hereby given that the following applications will be considered by the Transport Regulation Board at its offices at the corner of Lygon and Princes streets, Carlton, at 10.15 a.m., on Wednesday, 1st May, 1968.

CAMDEN BUS SERVICE PTY. LTD., 1248 Glenhuntly-road, Glenhuntly. One commercial passenger vehicle (S/C. 28) to operate as an additional metropolitan stage omnibus on Route 94A (Elsternwick—Ormond—Oakleigh—Chadstone) under the same terms and conditions as licences already held by the applicant company.

CROYDON BUS SERVICE PTY. LTD., Maroondah Highway, Croydon. One commercial passenger vehicle (S/C. 5) to operate for the carriage of Melbourne and Metropolitan Board of Works personnel between Croydon and Starvation Creek district under contract to the M.M.B.W.

FLEETWAYS HAULWAY PTY. LTD., 61 Bertie-street, Port Melbourne. One commercial passenger vehicle (S/C. 11) to convey applicant company's staff employed for driving new cars, to or from storage or delivery points of new cars within a 25-mile radius of the G.P.O., Melbourne. To be used as required for the carriage of car equipment and trade plates within the radius specified.

GEELONG ROAD BUS SERVICE PTY. LTD., 307 Geelong-road, West Footscray. Eleven commercial passenger vehicles each with large seating capacity to operate on Route 20A (Footscray—Brooklyn) under "M.O." licences presently held by the applicant company with the ability to extend service from the Guiding Star Hotel, Brooklyn, via Geelong-road, Old Geelong-road, Bladin, Wright, Thomas, Woods and Lohse streets to Maher-street, Laverton, returning, via Maher-street and Bladin-street to normal route.

Time-table.

Initially four to six return trips week-days and two return trips Saturday morning will be operated.

NIXON, W. E., D. J. & W. B. (trading as Thomsons Road-liners), 326 Bell-street, Preston. One commercial passenger vehicle (S/C. 45) to be operated as a metropolitan special service omnibus.

NIXON, W. E., D. J. & W. B. (trading as Thomsons Road-liners), 326 Bell-street, Preston. Application for permit authority to operate any one "M.C." licensed vehicle in the name of the applicants under contract to Mount Scopus College for the carriage of school children from the corner of Marylands-street and Bealiba-road, South Caulfield to Mount Scopus College, Burwood, via Bealiba, Bamba and Glenhuntly roads, Hotham-street, Balacava, Hawthorn, Dandenong, Claremont and Toorong roads, High-street, Warrigal-road and Burwood-road to the school.

Time-table.

Depart South Caulfield 8.10 a.m.
Depart Mt. Scopus College 4.15 p.m.

POINT COOK—WERRIBEE PASSENGER SERVICE PTY. LTD., Railway-avenue, Laverton. Application for authority to operate any one of the applicant's "C.O." licensed vehicles with large seating capacity on a route:—Hoppers Crossing, Werribee—Footscray Railway Station. Commencing in Heaths-road, Hoppers Crossing, via Heaths, Morris and Old Geelong roads, Princes Highway West to Laverton; thence via Aviation-road, Maher-road, Bladin-street, Old Geelong-road, Princes Highway West, Geelong-road, Barkley-street, Leeds-street and Irving-street to a stand adjacent to the Footscray Railway Station.

Time-table.

Initially four return trips week-days.

APPLICATION for renewal of licences as shown, by persons listed hereunder, to operate under the same terms and conditions.

BROWN, L. J., 45 Springfield-road, Box Hill; M.H.2246.
COLLINS, W. J., 2 Bartlett-street, Moorabbin; M.H.2238.
COWEN, A. B., 58 Fromer-street, Moorabbin; M.H.2241.
FENECH, L. J., 44 Station-street, Moorabbin; M.H.2243.
HADEN, G. W., 49 Carlingford-street, Elsternwick; M.H.2236.
HURLEY, D. R., 6 Abercrombie-street, Deepdene; M.H.2266.
KEITH, M. P., 1 Luckins-road, Moorabbin; M.H.2244.
KRUSE, G. T., Flat 3, 3 Alexandra-street, Aspendale; M.H.1901.
MILLER, K. H., 203 Morton-street, Ballarat; U.T.166.
RIGOPoulos, A., 99 Gipps-street, Collingwood; M.T.4058.
ROBERTSON, J. R., 11 Hood-street, Mont Albert; M.H.2242.
ROWE, G. R., 9 Niringa-avenue, Aspendale; M.H.2250.

ROWE, J. (estate of), 72 Wellington-street, St. Kilda; M.T.2475.

STOKES, R. A., 60 Milroy-street, Brighton East; M.H.2240.
WOOLLEY, G. D., 14 Pearce-street, Burwood; M.H.1966.

ZEIDAN, R., 51 University-street, Carlton; M.T.1651.

Notice of any objection should be forwarded to reach the Secretary of the Board not later than Wednesday, 24th April, 1968.

Applicants are advised that it will not be necessary to appear on the hearing date specified above, unless advised in writing by the Board.

B. P. KAY,
Secretary.

Corner Lygon and Princes streets, Carlton, Wednesday, 10th April, 1968.

Commercial Goods Vehicles Act.
TRANSPORT REGULATION BOARD.

HEARING OF APPLICATIONS.

NOTICE is hereby given that the following applications will be considered by the Transport Regulation Board at its offices at the corner Lygon and Princes streets, Carlton, at 10.15 a.m., on Wednesday, 1st May, 1968.

ADAMS, D. & W., & Co. PTY. LTD., 198 Chesterville-road, Moorabbin, 3189. One commercial goods vehicle (L/C. 11 cwt.) to operate throughout the State of Victoria in course of business as "Pest Control Contractors"—tools of trade, spraying equipment and materials incidental to the completion of own contracts.

BAIRNSDALE PLASTER WORKS, 198-200 McLeod-street, Bairnsdale, 3875. One commercial goods vehicle (L/C. 65 cwt. approximately) to operate throughout that part of the State of Victoria situated east of a north/south line drawn through the Township of Rosedale in course of business as "Fibrous Plaster Manufacturers"—own tools of trade and own materials incidental to the completion of own contracts.

BENTLEY, J. N. & R. M., Nar-Nar-Goon, 3812. Application to vary the conditions of licence No. D.A.53438 (L/C. 135 cwt.) by deleting the existing conditions and adding in lieu:—(a) From the premises of Albion Reid Pty. Ltd., at Berwick and Narre Warren and Rowland's Quarries Pty. Ltd., at Narre Warren to consignees situated within a 35-mile radius of the post office at Narre Warren—screenings, sand and stone dust solely on behalf of the above companies. (b) From pits situated within the radius defined in paragraph (a) above, to the said premises of Albion Reid Pty. Ltd., at Narre Warren—sand."

BICKERDIKE, W. J., 5 Turner-street, Wangaratta, 3677. One commercial goods vehicle (L/C. 302 cwt.) to operate: (a) From forest landings at Mt. Cobbler to the mill of South Wangaratta Sawmilling Co. Pty. Ltd., at Wangaratta—logs. (b) From forest landings at Jamieson to the mill of J. A. Terrett and Co. Ltd., at Benalla—logs.

BORDER AVIATION AGRICULTURISTS PTY. LTD., 706 Yambula-avenue, Albury, N.S.W., 2640. Two commercial goods vehicles (L/C. 80 cwt. approximately each) to operate in the course of business as "Aerial Agriculturists" as follows:—(a) Throughout the State of Victoria—(i) Tools of trade and equipment incidental to own contracts. (ii) Aviation fuel and chemicals not exceeding a total weight (aggregate) of ten hundred-weight (10 cwt.) at any one time. (b) Within a 20-mile radius of the site of any contract currently engaged upon or from the railway station nearest to such site—aviation fuel and chemicals for use in such contract.

BRITTAIN, W. H., 10 Hampden-street, Terang, 3264. Two commercial goods vehicles (L/C. 120 and 137 cwt.) to operate: (a) Within a 20-mile radius of the railway stations at Boorcan, Mortlake, Terang and Panmure in course of business as "Superphosphate Spreading Contractor"—superphosphate for spreading purposes providing all such superphosphate shall have been initially consigned by rail to the railway stations nearest to current contract sites. (b) Within a 50-mile radius of the post office at Terang—bulk lime provided all such lime carried on the vehicle shall have been initially consigned by rail to Terang Railway Station.

CHRISTIAN, J. D., Cottles Bridge, 3099. One commercial goods vehicle (L/C. 296 cwt.) to operate: (a) Throughout the State of Victoria in course of business as "Excavation Contractor"—own bulldozers and tools of trade and equipment incidental to the completion of own contracts. (b) Within a 25-mile radius of the post office situated at Hurstbridge—bulldozers, power shovels and earth-moving equipment on behalf

- of other contractors. (c) Within a 25-mile radius of the post office situated at Hurstbridge—general goods, provided no journey shall exceed 30 road miles in length within the said radius.
- CHRISTY, E. N., 12 Hopetoun-street, Rochester, 3561. Three commercial goods vehicles (L/C. 65 cwt. approximately, 66 and 65 cwt. approximately) to operate within the Shires of Rochester and Cohuna in course of business as "Sanitary and Garbage Collection Contractors"—tools of trade, equipment and waste for disposal.
- CLARK, NORMAN G. (AUST.), PTY. LTD., 278 Barkly-street, Brunswick, 3056. One commercial goods vehicle (L/C. 10 cwt.) to operate throughout the State of Victoria as a Service Vehicle in the course of business as "Suppliers and Lessors of Heavy Duty Transport Vehicles and Logging Tractors"—tools, equipment and spare parts incidental only to the servicing and repair in the field of vehicles sold or leased by Norman G. Clark (Aust.) Pty. Ltd.
- COX, E. N., 38 Murphy-street, Bairnsdale, 3875. Application to vary conditions of licence No. D.A.60740 (L/C. 65 cwt.) by deleting the existing conditions and adding in lieu:—(a) Within a 25-mile radius of the post office at Bairnsdale—fertilizers, wool, fencing materials, fodder and livestock. (b) Within a 25-mile radius of the post office at Bairnsdale in course of own business as a 'Primary Producer'—own goods. (c) In that part of Victoria east of a north/south line drawn through the City of Melbourne and south of an east/west line drawn through the Township of Glen Valley in course of own business as a 'Scrap metal Dealer'—scrap metal."
- ELLIN, W. J., 34 Risdon-drive, North Clayton, 3168. One commercial goods vehicle (L/C. 9 cwt.) to operate throughout the State of Victoria in the course of business as "Signwriter" for the purpose of supervising own contracts—tools of trade, ladders, scaffolding, and a small quantity of materials incidental to the completion of own contracts.
- FRESTONE AUSTRALIA PTY. LTD., 33 Lygon-street, Carlton, 3053. Two commercial goods vehicles (L/C. 11 cwt. each) to operate within a 50-mile radius of own branch premises at Hamilton in course of business as "Tyre Manufacturers and Distributors"—motor tyres, tubes, batteries, tyres and tubes for repair or having been repaired, and own manufactured rubber products, provided that all goods are initially consigned by rail from Melbourne to Hamilton.
- FLEETWAYS HAULWAY PTY. LTD., 88 Normanby-street, South Melbourne, 3205. Two commercial goods vehicles (L/C. 163 and 192 cwt.) to operate: (a) From the premises of motor vehicle distributors and dealers direct to consignees throughout the State of Victoria—complete motor vehicles. (b) Between the Cities of Melbourne, Geelong and Dandenong—motor car bodies subject to the condition that no delivery of such goods shall be made to any wharf at which rail facilities are available.
- GOODROPE, C. T., PTY. LTD., 9 Dundee-street, Reservoir, 3073. One commercial goods vehicle (L/C. 197 cwt.) to operate within a 50-mile radius of the premises of Blue Metal Quarries Pty. Ltd., at Epping, solely on behalf of the said company—premixed concrete in a specially constructed agitator vehicle.
- HALL, W. T., 37 Day-street, Bairnsdale, 3875. One commercial goods vehicle (L/C. 10 cwt.) to operate within that part of the State of Victoria east of a line drawn north and south through the Township of Rosedale in the course of business as "Electrical Contractors"—electrical appliances for installation, for repair or having been repaired, tools of trade, spare parts and materials incidental to the installation, repair and servicing of such appliances.
- HARCOMBE, D. J., 18 Fenwick-street, Portarlington, 3223. One commercial goods vehicle (L/C. 105 cwt.) to operate: (a) Within a 25-mile radius of the chief post office in the City of Geelong in course of business as "Carrier"—general goods, provided that no goods shall be carried whether by one stage or by more than one stage between places within the above radius which are more than 30 road miles apart by the nearest practicable route. (b) From and to the Townships of Portarlington and St. Leonards to and from fish markets in the City of Melbourne—scallops, fish and empty bags and cases for return.
- HOLLAND, V. E., South Gippsland Highway, Five Ways, 3977. One commercial goods vehicle (L/C. 163 cwt.) to operate: (a) Within a 35-mile radius of the premises of Victorian Quarries Ltd. at Dromana, solely on behalf of the said company—screenings, stone dust and premix. (b) From pits within a 35-mile radius of Dromana to the plant of Victorian Quarries Ltd. at Dromana—sand.
- HORSFIELD, L. N., Thorpdale, 3835. One commercial goods vehicle (L/C. 240 cwt.) to operate within a 50-mile radius of own premises at Thorpdale in the course of business as "Primary Producer, Farm Implement Manufacturer, Farm Requirements Supplier and Potato and Onion Dealer"—own goods.
- JOHNSTONE, T. W., Cobrico Wayside, Cobden, 3266. One commercial goods vehicle (L/C. 70 cwt.) to operate: (a) Within a 25-mile radius of the post office at Cobrico, provided no journey shall exceed 30 road miles in length within the said radius—general goods. (b) From and to places situated within the radius as defined in paragraph (a) above, to and from places situated within a 50-mile radius from the post office at Cobrico—livestock.
- JURACIC, J., 6 Short-street, Northcote, 3070. One commercial goods vehicle (L/C. 198 cwt.) to operate: (a) Within a 35-mile radius from the plant of Bayview Quarries Pty. Ltd. at Tullamarine—screenings, stone dust and premix on behalf of the said company. (b) From pits situated within the radius as defined in paragraph (a) above to the premises of Bayview Quarries Pty. Ltd. at Tullamarine—sand.
- KIPPING, L. R., Hoppner-street, Bruthen, 3885. One commercial goods vehicle (L/C. 300 cwt. approximately), to operate: (a) From the sawmill of Neville Smith & Co. Pty. Ltd., at Bruthen, to the Bruthen Railway Station and/or to customers within a 20-mile radius of the said sawmill—sawn timber. (b) From the railway station at Dandenong for delivery to customers and building sites situated within a 20-mile radius of the said railway station and to customers on the Mornington Peninsula—sawn timber. (c) From the railway stations situated within a 20-mile radius of the post office at the corner of Bourke and Elizabeth streets in the City of Melbourne to customers and building sites within the said radius—sawn timber.
- LEADBETTER, C., 6 Steward-street, Warragul, 3820. One commercial goods vehicle (L/C. 176 cwt.) to operate within a 50-mile radius of the post office at Warragul in the course of business as a "Scrap Metal Dealer"—special wares, scrap metals and marine goods as designated in the *Marine Stores and Old Metals Act 1958* (No. 6303), Part 1, section (3), but excluding the carriage of any such special wares, marine stores or old metals to wharves, docks or ships for shipment or export purposes, with the proviso that no trailer shall be attached to the vehicle.
- MAZZETTO, B., 819 Sydney-road, Coburg North, 3058. One commercial goods vehicle (193 cwt.) to operate within a 50-mile radius from the premises of Blue Metal Quarries Pty. Ltd. at Northcote solely on behalf of the said company—premixed concrete in a specially constructed agitator vehicle.
- MELLEN, T. A., PTY. LTD., 77 Glenhuntly-road, Elwood, 3184. Application to vary conditions of licence No. D.A.53227/1 (L/C. 36 cwt.) by deleting from the existing conditions "Within a 50-mile radius of the post office situated at the corner of Bourke and Elizabeth streets in the City of Melbourne and to the Latrobe Valley area" and by adding in lieu: "Throughout the State of Victoria".
- MORGAN, T. J., Melbourne-road, Foster, 3960. Application to vary conditions of licence No. D.A.38344/1 (L/C. 144 cwt.) by adding to the existing conditions as paragraph (c) and paragraph (d) "(c) Between the Townships of Foster and Bairnsdale—livestock. (d) Between the Township of Foster and markets situated in the metropolitan area at Dandenong and Newmarket—livestock.
- McMAHON, B. G., care of 7 Howard-street, Warrnambool, 3280. One commercial goods vehicle (L/C. 60 cwt. approximately) to operate throughout the State of Victoria—own water boring equipment and own tools of trade in course of business as "Water Drilling Contractors".
- O'CALLAGHAN, M. B., Fuller-street, Ouyen, 3490. One commercial goods vehicle (L/C. 187 cwt.) to operate throughout the State of Victoria in the course of business as "House-moving Contractor"—houses and outbuildings for removal and re-erection, tools of trade and equipment necessary for use on own contracts.
- ORR, K. R., Bullarto South, 3456. Two commercial goods vehicles (L/C. 136 and 264 cwt.) to operate from places within a 15-mile radius of the post office at Taggerty in course of business as a "Contractor"—(i) To pole treatment works at Trentham and Brooklyn. (ii) To council yards at Box Hill and Heidelberg—poles.
- PATTINSON, T. E., 1 Keck-street, Flora Hill, Bendigo, 3550. One commercial goods vehicle (L/C. 80 cwt.) to operate within a 75-mile radius of the chief post office in the City of Bendigo in course of business as

- "Fibrous Plaster Manufacturer"—plaster sheets, stopping plaster, tools of trade and equipment incidental to the completion of own contracts, but excluding operations between the City of Melbourne and the City of Bendigo.
- RODA, G. S., 18 Plane-street, Thomastown, 3074. One commercial goods vehicle (L/C. 193 cwt.) to operate within a 50-mile radius from the premises of Blue Metal Quarries Pty. Ltd. at Epping solely on behalf of the said company—premixed concrete in a specially constructed agitator vehicle.
- SEARLE, N. K. (trading as N. K. S. Signs), 32 Blake-street, Ararat, 3377. One commercial goods vehicle (L/C. 7 cwt.) to operate within a 100-mile radius of the post office at Ararat in course of trade as "Sign-writer and Window Dresser"—tools of trade, equipment, display and advertising materials and a small quantity of paint incidental to the completion of own contracts.
- SMITH, LANCE, CLAY SUPPLIES PTY. LTD., 30 Clarice-road, Box Hill South, 3128. One commercial goods vehicle (L/C. 250 cwt. approximately), to operate throughout the State of Victoria in course of business as "Excavation Contractors"—own plant, equipment and tools of trade incidental to own contracts.
- SMITH, P. J. R., Cann River, 3889. One commercial goods vehicle (L/C. 10 cwt.) to operate throughout that part of the State of Victoria situated east of a north/south line drawn through the Township of Bairnsdale in the course of business as "Marine and Industrial Engineer"—tools of trade, spare parts, motors to be repaired or having been repaired and materials incidental to the completion of own contracts.
- SOBICH, H. W., Caravan Park, Buronga, N.S.W., 2648. One commercial goods vehicle (L/C. 60 cwt.) to operate: (a) Within a 50-mile radius of the post office at Mildura in course of business as "Horse Riding School Proprietors"—own goods. (b) Within a 25-mile radius of the post office at Mildura—general goods, provided that no journey shall exceed 30 road miles in distance within the said radius.
- STEPHENSON, L., Scotts Creek, 3267. One commercial goods vehicle (L/C. 110 cwt.) to operate: (a) Within a 25-mile radius of the post office at Scotts Creek—general goods, provided that no journey shall exceed 30 road miles in length within the said radius. (b) Within a 50-mile radius of the post office at Scotts Creek in the course of trade as "Primary Producer"—own goods. (c) From and to places within a 25-mile radius of the post office at Scotts Creek to and from places outside that radius which are wholly within a 50-mile radius of the said post office—livestock.
- STEWART BAYLEY HAULAGE PTY. LTD., 54 Stevens-street, Portarlington, 3223. One commercial goods vehicle (L/C. 253 cwt.) to operate: (a) Within a 25-mile radius of the chief post office in the City of Geelong—general goods. (b) Within a 35-mile radius of own pits at the You-Yangs—crushed rock, gravel, sand and screenings.
- SVANOSIO, N. L. & J. A., 129 Creek-street, Bendigo, 3550. One commercial goods vehicle (L/C. 134 cwt.) to operate: (a) Within a 95-mile radius of the post office at Cohuna and within a 100-mile radius of the post office at Merbein as a "Road Contractor"—road-making plant and materials. (b) Within a 25-mile radius of the post office at Bendigo—general goods.
- THOMPSON EARTHMOVERS PTY. LTD., 10 Ashburn-place, Blackburn, 3130. Two commercial goods vehicles (L/C. 203 cwt. each) to operate: (a) Within a 25-mile radius of own premises at Blackburn in course of business as "Earth-moving Contractors and Plant Hirers"—own goods. (b) Throughout the State of Victoria as "Earthmoving Contractors"—own tools of trade, own plant, and own equipment. (c) Within a 25-mile radius of any contract currently engaged upon or from the nearest railway station thereto—materials for use on such contract.
- THOMPSON, R. H., 129 Southwaite-road, West Heidelberg, 3081. Application to vary conditions of licence No. D.A.60911 (L/C. 41 cwt.) by adding to the existing conditions after "Charlton", "St. Arnaud".
- WILLIAMSON, A. J. G., 21 Devon-grove, Oakleigh, 3166. Application to vary conditions of licence No. D.A.21646 (L/C. 120 cwt.) by adding to the existing conditions after "bricks" the words "and roof tiles".
- WILLS, W. D. & H. O. (AUSTRALIA) LTD., 246 East Boundary-road, East Bentleigh, 3165. Two commercial goods vehicles (L/C. 11 cwt. each) to operate throughout the State of Victoria as a "Traveller's Vehicle" for display and sales promotion of own products and agency lines in the course of business as "Manufacturers and Distributors"—samples of own products and agency lines together with display materials relating to goods for sale and also together with sufficient

quantities of stock of the various lines for sale, to enable a sample to be left with a customer when required or an interim supply of any products to be left with the retailer pending despatch of normal supplies to such retailer, also with the ability to return to Melbourne with any damaged or unsaleable stock.

WITTE CONSTRUCTIONS, 3 Shakespeare-street, Traralgon, 3844. One commercial goods vehicle (L/C. 133 cwt.) to operate: (a) Within a 50-mile radius of the post office at Traralgon in course of business as "Excavation Contractor"—own tools of trade and equipment. (b) Within a 20-mile radius of any current contract site or from the railway station nearest thereto—surplus materials for disposal and materials necessary for completion of said contracts.

TOW TRUCKS.

- COPPENS, J. H., 101 Main-street, Bacchus Marsh, 3340. One commercial goods vehicle (L/C. 25 cwt.) to operate within a 50-mile radius of the post office at Bacchus Marsh as a "Tow Truck" solely—(a) For the purpose of lifting and carrying or towing motor cars and the carriage of tools and equipment necessary for such purposes only. (b) The carriage of spare parts necessary for the repair of a disabled motor to and from the place at which such disablement has occurred.
- GOETZ, O., & P. SMITH, Cann River, 3889. One commercial goods vehicle (to be purchased) to operate within a 50-mile radius of the post office at Cann River as a "Tow Truck" solely—(a) For the purpose of lifting and carrying or towing motor cars and the carriage of tools and equipment necessary for such purpose only. (b) The carriage of spare parts necessary for the repair of a disabled motor to and from the place at which such disablement has occurred.
- SMITH, G., Dennington, 3279. Application to vary conditions of licence No. D.A.28243/2 (L/C. 31 cwt.) by deleting from the existing conditions that part commencing at "Subject to" and ending at "tow truck operator" and by adding in lieu as paragraph (b)—"(b) Within a 50-mile radius of the post office at Dennington to attend the scenes of accidents for the purpose of removing damaged vehicles".

RENEWALS.

- APPLICATIONS for renewal of licences as shown, by persons listed hereunder to operate under the same terms and conditions from the expiry shown in each case.
- A. H. AGENCIES & SALES PTY. LTD., 1122 High-street, Armadale, 3143; D.A.45101/2; 27th April, 1968; 17 cwt.
- ALLEN, A. W., SALES PTY. LTD., 51 Riverside-avenue, South Melbourne, 3205; D.A.2218/13; 31st May, 1968; 48 cwt.
- ARMOURD ESCORTS PTY. LTD., corner Arden & Lothian streets, North Melbourne, 3051; D.A.37566/1; 31st May, 1968; 17 cwt.
- BEAUREPAIRE TYRE SERVICE PTY. LTD., 102 Victoria-street, Carlton, 3053; D.A.629/17; 27th June, 1968; 22 cwt.
- BEAUREPAIRE TYRE SERVICE PTY. LTD., 102 Victoria-street, Carlton, 3053; D.A.629/48; 31st May, 1968; 18 cwt.
- BEAUREPAIRE TYRE SERVICE PTY. LTD., 102 Victoria-street, Carlton, 3053; D.A.629/49; 6th June, 1968; 18 cwt.
- BEAUREPAIRE TYRE SERVICE PTY. LTD., 102 Victoria-street, Carlton, 3053; D.A.629/97; 1st June, 1968; 11 cwt.
- BOOTS PURE DRUG CO. (AUST.) PTY. LTD., 33 Stewart-street, Richmond, 3121; D.A.36645/2; 31st May, 1968; 8 cwt.
- BUSHBY, B. P., & Co., Box 122, Dimboola, 3414; D.A.39344/1; 16th May, 1968; 7 cwt.
- CAKEBREAD CONSTRUCTION CO. PTY. LTD., Nepean Highway, Mornington, 3931; D.A.31653/1; 18th May, 1968; 138 cwt.
- CAPLE, R. G. A., Scotts-road, Korumburra, 3950; D.A.51764; 21st April, 1968; 40 cwt.
- CARLTON & UNITED BREWERIES LTD., 16 Bouverie-street, Carlton, 3053; D.A.808/11; 20th June, 1968; 10 cwt.
- CLOSTER, L. J. D., 6 Tyrell-street, Box Hill, 3128; D.A.36641/4; 9th March, 1968; 137 cwt.
- CORDIAS, T. C., Box 100, Maffra, 3860; D.A.38350/1; 27th April, 1968; 128 cwt.
- COMI, D. & O. FRASSON, 21 Lytton-street, Carlton, 3053; D.A.52123; 4th May, 1968; 196 cwt.
- CRAIGIE (CLAYS) PTY. LTD., 68 Dawson-street, Brunswick, 3056; D.A.52478; 16th June, 1968; 146 cwt.; D.A.52478/1; 16th June, 1968; 145 cwt.; D.A.52478/2; 16th June, 1968; 147 cwt.; D.A.52478/3; 16th June, 1968; 146 cwt.; D.A.52478/4; 16th June, 1968; 228 cwt.; D.A.52478/5; 16th June, 1968; 145 cwt.; D.A.52478/6; 16th June, 1968; 228 cwt.
- DURATAR PTY. LTD., 480 St. Kilda-road, Melbourne, 3004; D.A.39424; 27th June, 1968; 78 cwt.
- FREIGHTERS, A., 124 Grant-street, Alexandra, 3714; D.A.524/2; 23rd April, 1968; 225 cwt.

GENERAL PROVIDORS PTY. LTD., 51 Playne-street, Frankston, 3199; T.D.A.53767/10; 20th June, 1968; 37 cwt.
 GRAHAM ENGINEERING Co., 180 Bay-street, Port Melbourne, 3207; D.A.39490; 27th June, 1968; 38 cwt.
 HARTLEY, ERN. (WARRNAMBOOL) PTY. LTD., 223 Koroiit-street, Warrnambool, 3280; D.A.1266/1; 16th May, 1968; 75 cwt.
 HARTLEY, ERN. (WARRNAMBOOL) PTY. LTD., 223 Koroiit-street, Warrnambool, 3280; D.A.1266/3; 16th May, 1968; 74 cwt.
 HIRD BROS., P.O. Box 27, Heathcote, 3606; D.A.39370/1; 16th May, 1968; 63 cwt.
 INSTRUMENTATION LTD., 636 Swanston-street, Carlton, 3053; D.A.61015/1; 16th June, 1968; 11 cwt.
 JONES, D. W., 126 Cecil-street, Williamstown, 3016; D.A.1392/11; 27th June, 1968; 112 cwt.
 KEENAN, L. & M. M., 8 Lovelace-street, East Preston, 3072; D.A.1412; 2nd June, 1968; 10 cwt.
 LEY, G. H., Peshurst, 3289; D.A.12848; 27th April, 1968; 198 cwt.
 MANGER & O'NEILL PTY. LTD., 99-109 Annesley-street, Echuca, 3625; D.A.1550; 23rd April, 1968; 144 cwt.
 MASSEY FERGUSON (AUST.) LTD., 2 Devonshire-road, Sunshine, 3020; D.A.1252/23, D.A.1252/24; 6th June, 1968; 11 cwt.
 McDONALD, A. J., 4 Wimble-street, Seymour, 3660; D.A.39213; 9th May, 1968; 14 cwt.
 McLAUGHLIN, H. L. & F. E., Post Office, Arcadia, 3613; T.D.A.51786; 21st April, 1968; 8 cwt.
 NEWTON, L. C. & P., Tarcombe-street, Euroa, 3666; D.A.39333; 16th May, 1968; 7 cwt.
 O'BRIEN, D. W., 28 Redfern-road, East Hawthorn, 3122; D.A.52379; 3rd June, 1968; 136 cwt.
 PAINTER, L. H., 58 Webster-street, Alexandra, 3714; D.A.38787; 28th March, 1968; 117 cwt.
 PERMEWAN WRIGHT LTD., 147-179 Alexandra-parade, Abbotsford, 3067; D.A.1809/34; 21st April, 1968; 61 cwt.
 PERMEWAN WRIGHT LTD., 147-179 Alexandra-parade, Abbotsford, 3067; D.A.1809/35; 21st April, 1968; 43 cwt.
 PERMEWAN WRIGHT LTD., 147-179 Alexandra-parade, Abbotsford, 3067; D.A.1809/36; 21st April, 1968; 10 cwt.
 PERMEWAN WRIGHT LTD., 147-179 Alexandra-parade, Abbotsford, 3067; D.A.1809/37; 21st April, 1968; 6 cwt.
 PERMEWAN WRIGHT LTD., 147-179 Alexandra-parade, Abbotsford, 3067; D.A.1809/39; 27th April, 1968; 11 cwt.
 PETCH, A. S., 24 Kitchener-street, Trafalgar, 3840; D.A.39031; 27th April, 1968; 8 cwt.
 SAJJA, G., 39 Athol-street, Moonce Ponds, 3039; D.A.39723; 27th June, 1968; 138 cwt.
 SLATTERY, J. H., Brown-street, Caramut, 3274; D.A.24232/3; 18th May, 1968; 155 cwt.
 SOUTHERN PLANT HIRE Co. PTY. LTD., 34 Adelaide-street, Dandenong, 3175; D.A.39531; 31st May, 1968; 65 cwt.
 SUNBEAM CORPORATION LTD., Sloane-street, Maribyrnong, 3032; D.A.14579/32; 6th June, 1968; 8 cwt.
 SUNBEAM CORPORATION LTD., Sloane-street, Maribyrnong, 3032; D.A.14579/42; 16th June, 1968; 10 cwt.
 T.R. SERVICES PTY. LTD., 497 Queensberry-street, North Melbourne, 3051; D.A.23673/2; 18th June, 1968; 6 cwt.
 TENNANT, J. L., 759 Plenty-road, Reservoir, 3073; D.A.26547; 18th June, 1968; 125 cwt.
 TRANSVIC CONTRACTORS PTY. LTD., 185 Lygon-street, Carlton, 3053; D.A.46774/5; 16th June, 1968; 11 cwt.
 TREVOR BOILER & ENG. Co. PTY. LTD., Steel-street, North Melbourne, 3051; D.A.28850/3; 16th June, 1968; 15 cwt.
 VICTORIAN QUARRIES LTD., P.O. Box 63, Dromana, 3936; D.A.51248/4; 22nd June, 1968; 195 cwt.
 WARRNAMBOOL & DISTRICT BASE HOSPITAL, Ryot-street, Warrnambool, 3280; D.A.39179; 2nd May, 1968; 32 cwt.
 WILSON, C. D., 3 Carman-street, Dandenong, 3175; D.A.27928/2; 15th March, 1968; 217 cwt.

TOW TRUCKS.

BAIRNSDALE G.P. MOTORS PTY. LTD., 115 Main-street, Bairnsdale, 3875; T.D.A.25954; 30th April, 1968; 39 cwt.
 MCKENZIE, A. K., SERVICE STATION PTY. LTD., 255 Murray-street, Colac, 3250; D.A.39456; 24th May, 1968; 67 cwt.
 PULLIN, R. J., MOTORS PTY. LTD., High-street, Mansfield, 3722; T.D.A.46467; 13th May, 1968; 20 cwt.

Notice of any objection should be forwarded to reach the Secretary of the Board not later than Wednesday, 24th April, 1968.

Applicants are advised that it will not be necessary to appear on the hearing date specified above, unless advised in writing by the Board.

B. P. KAY,
Secretary.

Corner Lygon and Princes streets, Carlton, 3053, 10th April, 1968.

Pounds Act 1958.

SHIRE OF HASTINGS.

TABLE of Rates to be charged for the trespass of cattle and their sustenance while impounded, fixed by the Council of the Shire of Hastings.

Description of Cattle Trespassing.	Trespass Rates.		Sustenance Fees.
	Upon land other than Tillage Land Enclosed by a Substantial Fence.	Upon Tillage Land Enclosed by a Substantial Fence.	Amounts to be Charged Daily for Sustenance while Impounded.
	\$	\$	\$
For every sheep ..	0-03	0-10	0-10
For every goat ..	1-00	2-00	0-25
For every pig ..	0-50	1-00	0-50
For every head of other cattle ..	1-00	2-00	1-00
<i>Additional rates payable in respect of entire animals.</i>			
For every entire horse or bull ..	15-00	20-00	..
For every entire ram ..	5-00	10-00	..

By Order of the Council,

L. A. WALKER,
Shire Secretary.

Approved by the Governor in Council, 2nd April, 1968.—
J. ROSSITER, Clerk of the Executive Council.

NOTICE TO MARINERS.

[No. 8 of 1968]T.

AUSTRALIA.—VICTORIA.

WESTERNPORT.—HARBOR WORKS IN PROGRESS.

Position: *Hastings Jetty Light.*

Lat. 38 deg. 19 min. S. Long. 145 deg. 12 min. E. (Approx.).

MARINERS and others are advised that jetty construction, dredging, pipeline construction and other harbor works are in progress in an area within the following boundaries:—

From a position 069 deg. 4,000 feet from the above light in a 180-deg. direction for 3,800 feet; thence 090 deg. for 6,400 feet; thence 000 deg. for 7,800 feet; thence 270 deg. to the shore.

Mariners are warned to keep clear of the area described above as submerged piles and other underwater obstructions may be encountered.

A. J. WAGGLEN,
Port Officer.

Public Works Department,
Ports and Harbours Branch,
Melbourne, Vic. 3002.
4th April, 1968.

Police Regulation Act 1958, Section 122.

SALE OF UNCLAIMED MOTOR VEHICLE.

A HOLDEN sedan, registered No. GRN-283, engine No. V633018P, came into the possession of Police following a fatal accident on 21st October, 1967.

As the vehicle, which was extensively damaged in the accident, has not been claimed, it will be sold by public auction at the Police Station, Lyons-street, Newstead, at 2 p.m. on 24th April, 1968.

R. H. ARNOLD,
Chief Commissioner of Police.

POLICE OFFENCES ACT 1958.

IN pursuance of the powers conferred upon the Chief Secretary by sub-section (3) of section 184 of the *Police Offences Act 1958*, I do by this Notice, grant exemption from compliance with sub-sections (1) and (2) of section 184 of the said Act with respect to the publication "Long Way to Shiloh", distributed by Colorgrave Publications, 61 Flinders-lane, Melbourne.

JAMES W. MANSON,
for Chief Secretary.

Chief Secretary's Office,
Melbourne, 1st April, 1968.

Private Agents Act 1966.

NOTICE OF RECEIPT OF APPLICATIONS FOR LICENCES UNDER THE PROVISIONS OF THE PRIVATE AGENTS ACT 1966.

THE Clerk(s) of the Court(s) of Petty Sessions as listed hereunder hereby give notice that applications, as under, have been lodged for hearing by the said Court(s) on the date(s) specified.

Any person desiring to object to any of such applications must—

- (a) lodge with the respective Clerk of Petty Sessions a notice in the prescribed form of his objection and of the grounds thereof ;
- (b) cause a copy of such notice to be served personally or by post upon the applicant at least three days before the hearing of the application ; and
- (c) send or deliver—
 - (i) where the objection is not made by the officer in charge of the police district in which the Court is situated— a copy of the notice to such officer ; and
 - (ii) where the objection is not made by the Registrar or Deputy Registrar—a copy to the Registrar.

Full Name of Applicant or in the case of a Firm or Corporation, of the Nominee.	Place of Abode of Applicant or Nominee.	Name of Firm or Corporation.	Address for Registration.	Type of Licence.	Date of Hearing of Application.
---	---	------------------------------	---------------------------	------------------	---------------------------------

COURT OF PETTY SESSIONS, GEELONG.

Loone, Robert Gordon	Flat 8, 54 Percy-street, Newtown	H. A. Lucas (Trading as Geelong and District Investigations)	44 Western Beach, Geelong	Commercial Sub-agent	23.4.68
" " "	" "	" "	" "	Process Server	"

Dated at Geelong this 1st day of April, 1968.

J. R. AITKEN,
Clerk of Petty Sessions.

COURT OF PETTY SESSIONS, MELBOURNE.

Bebbington, Derek	Flat D1 and 2, Broadmeadows Hostel, Camp-road, Broadmeadows	Australian Watching Co. Pty. Ltd.	130 Abbotsford-street, North Melbourne	Watchman	23.4.68
Collins, Derek James Louis	Flat 2, Area 1, Broadmeadows Hostel, Camp-road, Broadmeadows	" "	" "	"	"
Cooper, Thomas	Flat 5, 36 Derby-street, Kensington	" "	" "	"	"
Gill, Benjamin Emon	Flat 1, 34 Wynnstay-road, East Prahran	" "	" "	"	"
Murray, Ernest James	236 Essex-street, Footscray	" "	" "	"	"
Nielsen, Howay Freddy	7 Watkins-street, Fawkner	" "	" "	"	"
Pesti, Gabor	13 John-street, Williamstown	" "	" "	"	"
Poole, David Cowley	391 Coventry-street, South Melbourne	Mayne Nickless Ltd.	94 York-street, South Melbourne	"	"
Vincent, Wesley Barry	69 Queen-street, Regent	Australian Watching Co. Pty. Ltd.	130 Abbotsford-street, North Melbourne	"	"
Wallis, Albert Frederick Charles	21 Electric-avenue, Glenroy	" "	" "	"	"
Williams, Noel Stanley	97 Esplanade West, Port Melbourne	Armoured Escorts Pty. Ltd.	Cnr. Arden and Lothian streets, North Melbourne	"	"
Wilson, Edward	116 Lower Dandenong-road, Mentone	Australian Watching Co. Pty. Ltd.	130 Abbotsford-street, North Melbourne	"	"

Dated at Melbourne this 2nd day of April, 1968.

G. L. WEBSTER,
Clerk of Petty Sessions.

COURT OF PETTY SESSIONS, SPRINGVALE.

Wilson, Alexander	Ballarto-road, Skye	" "	9 Bowmore-road, Noble Park	Watchman	19.4.68
-------------------	---------------------	-----	----------------------------	----------	---------

Dated at Springvale this 2nd day of April, 1968.

F. J. DUTHIE,
Clerk of Petty Sessions.

COURT OF PETTY SESSIONS, PRAHRAN.

Morgan, Cyril Alfred Murray	28 Argyll-street, Chadstone	T. J. F. Ericksen	Suite 12, 614 St. Kilda-road, Melbourne	Commercial Sub-agent	23.4.68
Reed, Ross	51 Hunter-street, Malvern	Melbourne Night Patrol Service	Suite 18, 614 St. Kilda-road, Melbourne	Watchman	"

Dated at Prahran this 2nd day of April, 1968.

J. M. DUGAN,
Clerk of Petty Sessions.

PRIVATE AGENTS—continued.

Full Name of Applicant or in the case of a Firm or Corporation, of the Nominee.	Place of Abode of Applicant or Nominee.	Name of Firm or Corporation.	Address for Registration.	Type of Licence.	Date of Hearing of Application.
COURT OF PETTY SESSIONS, MELBOURNE.					
Bugg, John Edward ..	Flat 4, 18 Barry-street, Reservoir	E. S. Englander Pty. Ltd.	533 Collins-street, Melbourne	Process Server (Individual)	18.4.68
Northby, William Allan ..	Flat 28, 23 George-street, Fitzroy	Australian Watching Co. Pty. Ltd.	130 Abbotsford-street, North Melbourne	" "	"
" " "	" "	" "	" "	Inquiry Agent (Individual)	"
Brady, William John ..	M.F.B. Station, Victoria-parade, East Melbourne	Mayne Nickless Ltd.	94 York-street, South Melbourne	Watchman	"
Clancy, Graham Bradley ..	20 Darebin-road, Thornbury	Australian Watching Co. Pty. Ltd.	130 Abbotsford-street, North Melbourne	" "	"
Comins, Michael John ..	9 Friendship Square, Cheltenham	" "	" "	" "	"
Craig, John Maxwell ..	19 Scotia-street, Moonee Ponds	" "	" "	" "	"
Dunn, Frederick Richard ..	52 Cosmos-street, Glenroy	" "	" "	" "	"
Gellert, Carl Theodor ..	12 Burnett-street, Mitcham	" "	" "	" "	"
Greig, Allan Herbert ..	29 Charlesworth-street, Laverton	" "	" "	" "	"
Harbourd, Noel Dudley Wells	6 Parnay-road, Mt. Waverley	" "	" "	" "	"
Harris, Noel Richard ..	48 Pleasant-street, Pascoe Vale	Mayne Nickless Ltd.	94 York-street, South Melbourne	" "	"
Hobeika, Shafik ..	Flat 14, 45 Robe-street, St. Kilda	Australian Watching Co. Pty. Ltd.	130 Abbotsford-street, North Melbourne	" "	"
Lyons, Lindsay Gordon ..	52 Liston-avenue, Keon Park, 3073	Mayne Nickless Ltd.	94 York-street, South Melbourne	" "	"
McNamara, Daniel Francis ..	73 North-road, Newport	Australian Watching Co. Pty. Ltd.	130 Abbotsford-street, North Melbourne	" "	"
McWilliams, James ..	79 Dallas-drive, Broadmeadows	" "	" "	" "	"
Newton, David Johnstone ..	8 Stewart-street, Braybrook	" "	" "	" "	"
Phillips, George Charles ..	1 View-street, Croydon	" "	" "	" "	"
Smith, Denis ..	Preston Hostel, Water-street, Preston	" "	" "	" "	"
Smith, George Atkinson ..	" " Milton-street, Nunawading	" "	" "	" "	"
Smithers, Colin John ..	" " Milton-street, Nunawading	" "	" "	" "	"
Stone, Adrian McCleod ..	33 Princess-street, Kew	Mayne Nickless Ltd.	94 York-street, South Melbourne	" "	"

Dated at Melbourne this 28th day of March, 1968.

G. L. WEBSTER,
Clerk of Petty Sessions.

COURT OF PETTY SESSIONS, MELBOURNE.					
Archdall, John Mervyn ..	29 Compton-street, Reservoir	Australian Watching Co. Pty. Ltd.	130 Abbotsford-street, North Melbourne	Watchman	19.4.68
Booth, Harold Edward ..	23 Monash-street, West Preston	Armoured Escorts Pty. Ltd.	Cnr. Arden and Lothian streets, North Melbourne	" "	"
Lowery, Frank Kenneth ..	113 Cheddar-road, Reservoir	Australian Watching Co. Pty. Ltd.	130 Abbotsford-street, North Melbourne	" "	"
Mifsud, Nicholas ..	536 Macaulay-road, Kensington	" "	" "	" "	"
Opie, Warren Brydon ..	16 Hilgay-street, Broadmeadows	Armoured Escorts Pty. Ltd.	Cnr. Arden and Lothian streets, North Melbourne	" "	"
Riley, Ronald Peter ..	42 Hickford-street, Reservoir	" "	" "	" "	"
Shuster, Benny ..	208 Tennyson-street, Elwood	Australian Watching Co. Pty. Ltd.	130 Abbotsford-street, North Melbourne	" "	"

Dated at Melbourne this 29th day of March, 1968.

G. L. WEBSTER,
Clerk of Petty Sessions.

COURT OF PETTY SESSIONS, SOUTH MELBOURNE.					
Brown, Lloyd George ..	Macclesfield - road, Monbulk	" "	52-54 Albert-road, South Melbourne	Commercial Sub-agent	23.4.68

Dated at South Melbourne this 29th day of March, 1968.

G. MILLER,
Clerk of Petty Sessions.

PRIVATE AGENTS—continued.

Full Name of Applicant or in the case of a Firm or Corporation, of the Nominee.	Place of Abode of Applicant or Nominee.	Name of Firm or Corporation.	Address for Registration.	Type of Licence.	Date of Hearing of Application.
COURT OF PETTY SESSIONS, SOUTH MELBOURNE.					
Beaumont, Georges Pierre ..	77 Reed-street, Albert Park	77 Reed-street, Albert Park	Inquiry Agent ..	19.4.68
Allen, Eric Glen ..	23 Sainsbury-avenue, Greensborough	101-105 Clarke-street, South Melbourne	Watchman ..	"
Bennett, Raymond ..	31 Robertson-crescent, Laverton	" "	" ..	"
Bulled, Leslie William John ..	15 Loongana-avenue, Glenroy	" "	" ..	"
Burgan, Andrew Charles ..	172 Clark-street, Port Melbourne	" "	" ..	"
Charnock, Jeffrey Trevor ..	131 Bladin-street, Laverton	" "	" ..	"
Clark, Joseph Frederick ..	26a Gibbons-street, Werribee	" "	" ..	"
Crisp, Bruce John ..	46A Glover-street, South Melbourne	" "	" ..	"
Deheer, Derrill ..	2 Henry-street, Kensington	" "	" ..	"
Dickens, James Oscroft ..	27 Steane-street, Reservoir	" "	" ..	"
Eccles, Anthony Harold Edward	7 Craddock-avenue, Caulfield	" "	" ..	"
Gibson, Ivan George ..	14 Dillon-street, Braybrook	" "	" ..	"
Gruner, Helmut ..	207 Canterbury-road, St. Kilda	" "	" ..	"
Hohmuth, Jeffrey Alan ..	Flat 10, 56 Grange-road, Carnegie	" "	" ..	"
Hopper, Frederick Raymond ..	25 Shamrock-street, West Brunswick	" "	" ..	"
King, Jonathan Charles ..	7 Studley-court, Laverton	" "	" ..	"
Kinnen, Joseph Arrell ..	65 Park-crescent, North Williamstown	" "	" ..	"
Langley, Bevan Kenneth ..	9 Cropley-crescent, Laverton	" "	" ..	"
Norris, John Thomas ..	36 Britten-street, Glen Iris	" "	" ..	"
O'Callaghan, William Michael	42 Emerald-street, Essendon	" "	" ..	"
Peterson, Colin John ..	Studley-court, Laverton	" "	" ..	"
Phillipini, Joseph Stanley ..	103 Roberts-street, Essendon	" "	" ..	"
Pretty, Wilfred Charles ..	64 Seston-street, East Reservoir	" "	" ..	"
Rogers, John W. ..	15 Wackett-street, Laverton	" "	" ..	"
Seth, Winston ..	15 Enfield-avenue, East Preston	" "	" ..	"
Smith, Peter Kenneth ..	24 Jeffrey-street, Bentleigh	" "	" ..	"
Smith, Robert William ..	9 South-avenue, Moorabbin	" "	" ..	"
Sweeney, Garrett William ..	52 Suffolk-road, Surrey Hills	" "	" ..	"
Tither, Alan ..	4 Rosedale-crescent, Broadmeadows	" "	" ..	"
Titheridge, David John ..	236 Coventry-street, South Melbourne	" "	" ..	"
Watt, Ivan Forbes ..	23 McKay-street, Mordialloc	" "	" ..	"
Williams, Richard Dewi ..	"Stonehaven Park", McCrettons - road, Healsville	" "	" ..	"
Wilson, Archie Hubert Flinders	10 May-street, East Doncaster	" "	" ..	"

Dated at South Melbourne this 29th day of March, 1968.

G. MILLER,
Clerk of Petty Sessions.

COURT OF PETTY SESSIONS, FOOTSCRAY.

Hampton, Geoffrey Keith ..	20 Trethowan-street, Broadmeadows	Mayne Nickless Ltd.	York-street, South Melbourne	Watchman ..	18.4.68
----------------------------	-----------------------------------	---------------------	------------------------------	-------------	---------

Dated at Footscray this 28th day of March, 1968.

G. S. HOARE,
Clerk of Petty Sessions.

COURT OF PETTY SESSIONS, CAMBERWELL.

White, Joy Winifred ..	32 Milton-street, Nunawading	57 High-street, Glen Iris	Process Server	18.4.68
" ..	"	" ..	Inquiry Agent ..	"

Dated at Camberwell this 26th day of March, 1968.

J. C. TOBIN,
Clerk of Petty Sessions.

PRIVATE AGENTS—continued.

Full Name of Applicant or in the case of a Firm or Corporation, of the Nominee.	Place of Abode of Applicant or Nominee.	Name of Firm or Corporation.	Address for Registration.	Type of Licence.	Date of Hearing of Application.
COURT OF PETTY SESSIONS, MELBOURNE.					
Ellingham, Freeman	41 Churchill-avenue, Ascot Vale	Armoured Escorts Pty. Ltd.	Cnr. Arden and Lothian - streets, North Melbourne	Inquiry Agent (Individual)	17.4.68
Andrews, John William	22 Cool-street, Reservoir	Australian Watching Co. Pty. Ltd.	130 Abbotsford-street, North Melbourne	Watchman	"
Ayling, Peter John	12 Glen-road, Mitcham	Armoured Escorts Pty. Ltd.	Cnr. Arden and Lothian streets, North Melbourne	"	"
Barrile, John Simon	7 Liscard-street, Elsternwick	" "	" "	"	"
Cleaver, Darrell Anthony	130 Rathmines-street, Fairfield	" "	" "	"	"
Cooke, Russell Alan	Flat 1, 32 Pearson-street, Brunswick	" "	" "	"	"
de Blaquiere, Ronald George	125 Messmate-street, Lalor	Australian Watching Co. Pty. Ltd.	130 Abbotsford-street, North Melbourne	"	"
Fry, Arnold Raymond	22 Lark-street, Altona West	" "	" "	"	"
Hickey, Kenneth John	92 Peel-street, Kew	Mayne Nickless Ltd.	94 York-street, South Melbourne	"	"
Holmes, Edgar Franklyn	42 Hotham-road, Niddrie	Armoured Escorts Pty. Ltd.	Cnr. Arden and Lothian streets, North Melbourne	"	"
Lambrick, Bryan Matthew	45 Marine-parade, St. Kilda	Australian Watching Co. Pty. Ltd.	130 Abbotsford-street, North Melbourne	"	"
Sherlock, Peter Leonard Joseph	45 Cappella-court, Glen Waverley	" "	" "	"	"
Trevithick, Brian Denis	195 Esplanade, Altona	" "	" "	"	"
Williams, Alan George James	Flat 5, cnr. Queen and Regent - avenues, Springvale	" "	" "	"	"

Dated at Melbourne this 27th day of March, 1968.

G. L. WEBSTER,
Clerk of Petty Sessions.

PUBLIC TRUSTEE ACT 1958 (No. 6350), SECTION 17.

HEREBY give notice that on the 20th March, 1968, the Public Trustee filed an election to administer the following deceased person's estate in accordance with section 17 of the Public Trustee Act 1958:—

THORNLOE, ADELAIDE, late of Flat 67, Layfield-court, Victoria-avenue, Albert Park, widow, died 9th November, 1967.

HEREBY give notice that on the 28th March, 1968, the Public Trustee filed an election to administer the following deceased person's estate in accordance with section 17 of the Public Trustee Act 1958:—

EDGAR, JOHN WILLIAM, formerly of 22 Park-avenue, Burwood, New South Wales, 599 King-street, West Melbourne, and Room 52, Mercy Hospital, Grey-street, East Melbourne, but late of Rosehill Hospital, Centre-road, Bentleigh, retired public servant, died 28th January, 1968.

A. D. DUNCAN,
Public Trustee.

256 Flinders-street, Melbourne, 3000, 3rd April, 1968.

NOTICE.

CREDITORS, next of kin and others having claims against the estate of any of the under-mentioned deceased persons are required to send particulars of their claims to the Public Trustee, 256 Flinders-street, Melbourne, the personal representative, on or before the 17th June, 1968, after which date the Public Trustee may convey or distribute the assets, having regard only to the claims of which the Public Trustee then has notice:—

BALFOUR, GORDON JOHN LEWIS, late of 817 Glenhuntingly-road, South Caulfield, planning officer, died 10th January, 1968.

BUHLER, ALFRED PERCIVAL, late of 6 Arkle-street, East Prahran, carpenter, died 3rd February, 1968.

BYRA, MICHAEL, late of Beechworth, labourer, died 6th June, 1966.

CLAYSTER, HILDA MAY, formerly of 14 Donaldson-street, Ivanhoe, but late of 97 Arthur-street, Launceston, Tasmania, widow, died 7th July, 1967.

DERRICK, COLIN PHILIP, formerly of 63 Lynch-street, Footscray, 597 St. Kilda-road, Prahran, but late of 2

Waverley-avenue, Kew, resident house master, died 30th December, 1967.

DUFF, MABEL FRANCES, late of 17 Pembroke-street, Surrey Hills, widow, died 21st October, 1966.

EDGAR, JOHN WILLIAM, formerly of 22 Park-avenue, Burwood, New South Wales, 599 King-street, West Melbourne, and Room 52, Mercy Hospital, Grey-street, East Melbourne, but late of Rosehill Hospital, Centre-road, Bentleigh, retired public servant, died 28th January, 1968.

ELLIS, FLORENCE MAIE, also known as Florence May Ellis, late of 79 Spencer-street, St. Kilda, married woman, died 17th December, 1967.

EVANS, OLIVE IRENE, late of Flat 4, 74 Union-road, Ascot Vale, widow, died 25th December, 1967.

FRANCIS, ARLEIGH AMBROSE, late of 12 The Glen, Fern Tree Gully, retired, died 31st December, 1967.

GORRINGE, FRANK HERBERT ROLLENS, late of Marton, New Zealand, retired farmer, died 30th May, 1967.

HALL, FLORENCE ANNIE, late of 2 Graylings-avenue, East St. Kilda, married woman, died 13th September, 1967.

HARRIS, LYELL ALBERT GORDON, formerly of R.A.A.F., Laverton, but late of 45 Merton-street, Albert Park, labourer, died 27th August, 1967.

HAY, HERBERT LAING, late of Invercargill, New Zealand, retired secretary, died 20th July, 1967.

HUCKERBY, AIMEE ALICE, late of 73 Brighton-street, Richmond, married woman, died 9th August, 1967.

KLAVINS, JANIS, late of 12 Gore-street, Fitzroy, labourer, died 21st July, 1967.

MORRISON, HAROLD, formerly of Homestead-road, Templestowe, but late of 139 Waterdale-road, Ivanhoe, retired orchardist, died 5th June, 1967.

NELSON, VIOLET ROSE, formerly of 46 Elm-grove, Ripponlea, but late of 40 Lyndon-street, Elsternwick, widow, died 7th December, 1967.

RUSSELL, GEORGE FREDERICK, late of 96 (in the Will called 6) Railway-parade, East Cannington, W.A. clerk, died 10th June, 1967.

THORNLOE, ADELAIDE, late of Flat 67, Layfield-court, Victoria-avenue, Albert Park, widow, died 9th November, 1967.

WAINWRIGHT, ALBERT PATRICK, formerly of 22 Como-street, Alphington, but late of 18 Edinburgh-street, East Bentleigh, retired painter, died 18th January, 1968.

A. D. DUNCAN,
Public Trustee.

Melbourne, 3rd April, 1968.

Health Act 1958.

VICTORIA—DEPARTMENT OF HEALTH.

NOTICE TO ATTEND FOR RADIOLOGICAL EXAMINATION.

To all persons aged twenty-one years and over enrolled or resident in the Subdivisions specified hereunder in the State Electoral District of Dundas.

TAKE notice that you are required to attend at a Department of Health X-ray unit sited in the public street at or as near as possible to the main entrance to the premises specified in this notice, at any time between the hours specified on one of the days specified and during the period specified in respect of those premises, and thereat to submit yourself to radiological examination of the chest for the purpose of ascertaining whether you may be suffering from pulmonary tuberculosis. If you have had a Chest X-ray within the last twelve months and for that reason do not wish to be examined now, you should attend the unit as directed and submit particulars of the previous examination.

SPECIFIED SUBDIVISIONS, PREMISES, PERIODS, DAYS AND HOURS.

Subdivision.	Premises.	Period.	Days.	Hours.
Stawell ..	Town Hall, Stawell ..	Friday, 19th April, 1968, to Tuesday, 30th April, 1968 (inclusive)	Friday, 19th April, 1968 .. All other days during the period except Saturdays, Sundays and Public Holidays	From 2 p.m. to 6 p.m. and 7.30 p.m. to 9 p.m. From 10 a.m. to 6 p.m. and 7.30 p.m. to 9 p.m.
	Mechanics' Hall, Great Western Shire Hall, Stawell West	Wednesday, 24th April, 1968 Friday, 26th April, 1968, and Monday, 29th April, 1968	Wednesday, 24th April, 1968 Friday, 26th April, 1968 .. Monday, 29th April, 1968	From 2 p.m. to 6 p.m. and 7.30 p.m. to 9 p.m. From 11 a.m. to 6 p.m. and 7.30 p.m. to 9 p.m. From 10 a.m. to 6 p.m. and 7.30 p.m. to 9 p.m.
Murtoa ..	Methodist Church, Murtoa	Wednesday, 24th April, 1968, to Monday, 29th April, 1968 (inclusive)	Wednesday, 24th April, 1968 All other days during the period except Saturday, Sunday and Public Holidays	From 11 a.m. to 6 p.m. and 7.30 p.m. to 9 p.m. From 10 a.m. to 6 p.m. and 7.30 p.m. to 9 p.m.
	Memorial Hall, Rupanyup	Tuesday, 30th April, 1968, and Wednesday, 1st May, 1968	Tuesday, 30th April, 1968 Wednesday, 1st May, 1968	From 11 a.m. to 6 p.m. and 7.30 p.m. to 9 p.m. From 10 a.m. to 6 p.m. and 7.30 p.m. to 9 p.m.
Horsham South	Memorial Hall, Haven	Tuesday, 30th April, 1968, to Thursday, 2nd May, 1968 (inclusive)	Tuesday, 30th April, 1968 All other days during the period except Public Holidays	From 2 p.m. to 6 p.m. and 7.30 p.m. to 9 p.m. From 10 a.m. to 6 p.m. and 7.30 p.m. to 9 p.m.
Goroke ..	Infant Welfare Centre, Goroke	Wednesday, 1st May, 1968, to Friday, 3rd May, 1968 (inclusive)	Wednesday, 1st May, 1968 All other days during the period except Public Holidays	From 7.30 p.m. to 9 p.m. From 10 a.m. to 6 p.m. and 7.30 p.m. to 9 p.m.
	Shire Office, Natimuk ..	Thursday, 2nd May, 1968, and Friday, 3rd May, 1968	Thursday, 2nd May, 1968 Friday, 3rd May, 1968 ..	From 2 p.m. to 6 p.m. and 7.30 p.m. to 9 p.m. From 10 a.m. to 6 p.m. and 7.30 p.m. to 9 p.m.
Harrow ..	Public Hall, Toolondo ..	Friday, 3rd May, 1968 ..	Friday, 3rd May, 1968 ..	From 11 a.m. to 6 p.m. and 7.30 p.m. to 9 p.m.
	Mechanics' Institute, Harrow	Tuesday, 7th May, 1968, and Wednesday, 8th May, 1968	Tuesday, 7th May, 1968 .. Wednesday, 8th May, 1968	From 10 a.m. to 6 p.m. and 7.30 p.m. to 9 p.m. From 10 a.m. to 6 p.m. and 7.30 p.m. to 9 p.m.
	Public Hall, Apsley ..	Tuesday, 7th May, 1968, and Wednesday, 8th May, 1968	Tuesday, 7th May, 1968 .. Wednesday, 8th May, 1968	From 10 a.m. to 6 p.m. and 7.30 p.m. to 9 p.m. From 10 a.m. to 6 p.m. and 7.30 p.m. to 9 p.m.
	Shire Hall, Edenhope ..	Tuesday, 7th May, 1968, to Thursday, 9th May, 1968 (inclusive)	Each day during the period except Public Holidays	From 10 a.m. to 6 p.m. and 7.30 p.m. to 9 p.m.
	Memorial Hall, Balmoral	Friday, 10th May, 1968, and Monday, 13th May, 1968	Friday, 10th May, 1968 .. Monday, 13th May, 1968	From 2 p.m. to 6 p.m. and 7.30 p.m. to 9 p.m. From 10 a.m. to 6 p.m. and 7.30 p.m. to 9 p.m.
Hamilton ..	Town Hall, Hamilton (2 Units)	Thursday, 9th May, 1968, to Friday, 17th May, 1968 (inclusive)	Thursday, 9th May, 1968 All other days during the period except Saturday, Sunday and Public Holidays	From 2 p.m. to 6 p.m. and 7.30 p.m. to 9 p.m. From 10 a.m. to 6 p.m. and 7.30 p.m. to 9 p.m.
	Soldiers Memorial Hall, Cavendish	Tuesday, 14th May, 1968 ..	Tuesday, 14th May, 1968	From 11 a.m. to 6 p.m. and 7.30 p.m. to 9 p.m.
	Post Office, Tarrington	Wednesday, 15th May, 1968	Wednesday, 15th May, 1968	From 11 a.m. to 6 p.m. and 7.30 p.m. to 9 p.m.

NOTE :—Any person to whom this notice applies and who without reasonable excuse fails to comply with the requirements of the notice shall be guilty of an offence, and shall be liable to a penalty of not more than forty dollars.

Dated this 1st day of April, One thousand nine hundred and sixty-eight.

R. J. FARNBACH,
Chief Health Officer.

ORDERS IN COUNCIL.—(Series 1967-68.)**EDUCATION DEPARTMENT.**

2870. Thirty-six (36) only microscopes (stereo), for Warrnambool Technical College, \$756.00.—Optical Prescriptions Spectacle Makers Pty. Ltd.

2871. One (1) only set of eight geological models, (1) only illuminated planetarium, and (2) only sets of eight geological land forms, for Warrnambool Technical College, \$324.00.—L. & S. Library Supplies.

2872. One (1) only high tension power supply, for Warrnambool Technical College, \$261.65.—B.W.D. Electronics.

2873. One (1) only A.C. ammeter, (1) only D.C. milliammeter, (1) only D.C. ammeter, and (1) only D.C. voltmeter, for Warrnambool Technical College, \$273.40.—A. J. Williams.

2874. One (1) only decade resistance (RB45), (1) only decade resistance (RB55), and (1) only standard resistance (1 ohm), for Warrnambool Technical College, \$360.00.—J. L. William.

2875. One (1) only granite surface plate, "A" Grade, 4 ft. x 2 ft. with stand, for Bendigo Institute of Technology, \$585.00.—Murray & Livermore.

2876. Various items of equipment for the home economics department, for Northcote Technical School, \$779.54.—James McEwan & Co. Pty. Ltd.

2877. Various items of equipment for the home economics department, for Northcote Technical School, \$334.42.—K. G. Luke Aust. Pty. Ltd.

2878. One (1) only forklift truck, for Melbourne School of Textiles, \$850.00.—Crown Controls Aust. Pty. Ltd.

2879. One (1) only bar tacking machine, complete with stand, motor and accessories, for Melbourne School of Textiles, \$360.00.—Henry Kliger Pty. Ltd.

2880. One (1) only felling machine, complete with stand and motor, &c., for Melbourne School of Textiles, \$259.00.—De Wolf Fletcher Pty. Ltd.

2881. Two (2) only sewing machine heads, (8) only sewing machines, complete with tables and motors, &c., (1) only buttonhole machine with stand, motor and accessories, and (1) only button sewer, complete with stand, motor and accessories, for Melbourne School of Textiles, \$2,930.00.—International Sewing Machines Pty. Ltd.

2882. One (1) only dryer and wiring, for Prahran Technical School, \$1,920.86.—L. Bienvenu Pty. Ltd.

2883. One (1) only interferometer with accessories, for Preston Technical College, \$288.75.—H. B. Selby & Co. Pty. Ltd.

2884. Six (6) only calculating machines, for Royal Melbourne Institute of Technology, \$1,500.00.—Peacock Bros. Pty. Ltd.

2885. Eight (8) electric sewing machines, for St. Albans Technical School, \$682.00.—Singer Australia Pty. Ltd.

2886. One (1) only volt ratio box, and (1) only standard four-terminal resistance, for Stawell Technical School, \$220.00.—J. L. William.

2887. One (1) only Michelson interferometer, for Warrnambool Technical College, \$254.30.—H. B. Selby & Co.

Approved by the Governor in Council, 2nd April, 1968.—J. ROSSITER, Clerk of the Executive Council.

PUBLIC WORKS.

2888. Boort, High School, supply and delivery of material for construction of sporting facilities, \$1,142.72.—Shire of Gordon.—(N.W.53186.)

2889. Coburg, Pentridge Gaol, repairs to textile milling machines, \$1,783.47.—J. Dyson & Sons Pty. Ltd.—(N.W.110574.)

2890. Fern Tree Gully, High School, supply and installation of hot-water service and extractor fans, \$2,297.73; supply and installation of hot-water heaters, pump, &c., \$1,335.00.—Thos. J. Tait Pty. Ltd.—(W.E.122643 "B".)

2891. Heatherhill, High School, erection of portable Administration Building, \$12,532.40.—Willcroft-Terrapin Pty. Ltd.—(S.E.90995 "K".)

2892. Kew East, S.S. 3161, supply of display units, \$2,904.00.—Bera Furniture Pty. Ltd.—(E.M.123823.)

2893. Malvern, Teachers' College, supply and delivery of cafeteria equipment, \$2,262.00.—Ahearn, Main & Stott Pty. Ltd.—(E.M.126622.)

2894. Melbourne, "Princes Gate", reimbursement of costs incurred in supplying special items of furniture for use in various executive offices of the Ministry of Fuel and Power and Mines Department, \$4,475.00.—Princes Gate Pty. Ltd.—(C.100154.)

2895. Mount View, S.S. 4923, erection of fencing, \$2,247.50.—R. W. Lee.—(E.M.22017 "D".)

2896. West Melbourne, Government Cool Stores, supply and delivery of lifting and locking gear for Cool Room Doors, \$2,575.00.—Charles Marshall Pty. Ltd.—(S.W.108297.)

Approved by the Governor in Council, 2nd April, 1968.—J. ROSSITER, Clerk of the Executive Council.

CONTRACTS ACCEPTED.—(Series 1967-68.)**SOIL CONSERVATION AUTHORITY.****CONTRACT No. E.682.**

2897. Hire of plant for construction of approximately 50 chains of diversion banks.—G. T. S. & I. D. Smith, Buxton John Deere (82-h.p.) tractor with 7-ft. blade, at \$5.50 an hour.

CONTRACT No. M.682.

2898. Earthworks in the Burnell and Denning Channel Projects.—J. C. & S. M. Jardine, Ouyen. Cat. D4D tractor with attachments, at \$9.25 an hour.

CONTRACT No. 6806.

2899. Mt. Korong Group Conservation Area, waterway construction and gully battering.—E. B. Mawson, Cohuna. Cat. D7 bulldozer at \$25.00 an hour; Galion 118 grader, at \$13.00 an hour.

CONTRACT No. 6803.

Parwan Valley and Brisbane Ranges Group Conservation Areas.

2900. Erection of four (4) reinforced concrete structures, \$4,040.00.—A. & G. De Bortoli, Box 165, Bacchus Marsh.

CONTRACT No. 6805.

Nine Mile and Shelbourne Hills Group Conservation Areas.

2901. Supply of 30 tons of baled straw.—J. D. & D. H. McNabb, Baringhup West, Vic., at \$16.00 per ton.

CONTRACT No. 6808.**Eppalock Catchment Project.****Chisel Seeding Programme 1968.**

Name of Successful Tenderer; (a) Tractor h.p., (b) Chisel Seeder Size; Rate Per Hour.

2902. R. D. Hagan, Tooboorac; (a) 52 h.p., (b) 10 ft. 9 tyne; \$5.50.

2903. K. N. Turner, Heathcote; (a) 55 h.p., (b) 9 ft. 9 tyne; \$5.50.

2904. A. T. Campbell, Heathcote South; (a) 52 h.p., (b) 8 ft. 8 tyne; \$5.00.

2905. T. K. McMahon, Heathcote South; (a) 62 h.p., (b) 9 ft. 9 tyne; \$5.50.

2906. D. J. Smith, Trentham; (a) 55 h.p., (b) 8 ft. 7 tyne; \$5.00.

2907. G. A. & O. M. Lewis, Bendigo; (a) 82 h.p., (b) 9 ft. 9 tyne; \$5.50.

2908. J. F. McKenzie-McHarg, Heathcote; (a) 45 h.p., (b) 6 ft. 6 tyne; \$4.80.

P. J. MCCALLUM,

Secretary.

GENERAL STORES.

Gazette No. 56, 17th July, 1967, Schedule No. 57, Nails, Rivets, &c.—Amend discount for Item No. 18 to read less 16 per cent., as from 1st April, 1968.

PRISONERS' MEALS IN LOCK-UPS.**CONTRACT CANCELLED.**

Gazette No. 54, 5th July, 1967, Prisoners' Meals, Bendigo.—Contract No. 169 is hereby cancelled.

CONTRACT ACCEPTED.

2909. For the supply of Prisoners' Meals at Bendigo, as from 6th March, 1968, Breakfast and Tea, 55 cents; Hot Dinner, 65 cents.—B. Pikoulas.

H. COUTTS, Secretary to the Tender Board. 8.4.68.

Country Fire Authority Act 1958.

VARIATION OF SUMMER PERIOD IN RESPECT OF SPECIFIED PARTS OF THE COUNTRY AREAS OF VICTORIA.

WHEREAS by Section 4 of the *Country Fire Authority Act 1958* it is enacted that the Chief Secretary of Victoria, after consultation with the Minister of Forests, may from time to time by declaration published in the *Government Gazette* declare any period to be the summer period in respect of the country area of Victoria, or any specified part or parts thereof and, without affecting the generality of the foregoing, may declare different periods to be the summer period in respect of different parts of the said country area:

And whereas by the said section it is further enacted that any declaration so published may be revoked, amended or varied by a subsequent declaration so published:

And whereas by declaration issued on the date stated in Schedule A annexed hereto, different summer periods expiring on the thirtieth day of April, 1968, were declared in respect of different parts of the country area of Victoria, including the parts of the said country area specified in Schedule B hereto:

And whereas the Chief Secretary and the Minister of Forests have consulted accordingly:

Now therefore I, the Chief Secretary of Victoria, do by this my declaration vary the aforesaid declaration by declaring that the summer period in respect of the parts of the country area of Victoria specified in Schedule B hereto shall end at midnight on the 16th April, 1968.

SCHEDULE A.

Date of Declaration; Date of Publication in "Government Gazette".

17th November, 1967; 16th November, 1967.

SCHEDULE B.

The Third Fire Control Region comprised by the municipal districts of the Cities of Geelong, Geelong West and Newtown and those portions of the municipal districts of the Shires of Barrabool, Bellarine, Corio and South Barwon not included in the Seventh Fire Control Region;

the Seventh Fire Control Region comprised by the municipal districts of the Borough of Queenscliffe and the Shires of Bannockburn, Leigh, and Winchelsea and those portions of the municipal districts of the Shires of Barrabool, Bellarine, Corio and South Barwon not included in the Third Fire Control Region;

the Twelfth Fire Control Region comprised by the municipal districts of the Shires of Alexandra, Broadford, Kilmore, McIvor, Pyalong, Seymour and Yea;

those portions of the Fourteenth Fire Control Region comprised by the municipal districts of the Shires of Bacchus Marsh and Melton and those portions of the municipal districts of the Cities of Broadmeadows, Keilor and Sunshine and the Shires of Bulla and Werribee not included in the Metropolitan Fire District;

those portions of the Twenty-third Fire Control Region comprised by the municipal district of the Shire of Oxley and those portions of the Shire of Wangaratta which lie outside the following boundaries:—

Commencing at the junction of the Ovens River and the Murray Valley Highway; thence by the northern boundary of the municipality to the North-Eastern railway line; thence generally south-westerly by the North-Eastern railway line to the Reedy Creek, Parish of Wangaratta North; thence generally westerly by the Reedy Creek and northerly by the Ovens River to the point of commencement.

A. G. RYLAH,
Chief Secretary.

Chief Secretary's Office,
Melbourne, 8th April, 1968.

Country Fire Authority Act 1958.

VARIATION OF SUMMER PERIOD IN RESPECT OF SPECIFIED PARTS OF THE COUNTRY AREAS OF VICTORIA.

WHEREAS by Section 4 of the *Country Fire Authority Act 1958* it is enacted that the Chief Secretary of Victoria, after consultation with the Minister of Forests, may from time to time by declaration published in the *Government Gazette* declare any period to be the summer period in respect of the country area of Victoria, or any specified part or parts thereof and, without affecting the

generality of the foregoing, may declare different periods to be the summer period in respect of different parts of the said country area:

And whereas by the said section it is further enacted that any declaration so published may be revoked, amended or varied by a subsequent declaration so published:

And whereas by declaration issued on the date stated in Schedule A annexed hereto, different summer periods expiring on the thirtieth day of April, 1968, were declared in respect of different parts of the country area of Victoria, including the parts of the said country area specified in Schedule B hereto:

And whereas the Chief Secretary and the Minister of Forests have consulted accordingly:

Now therefore I, the Chief Secretary of Victoria, do by this my declaration vary the aforesaid declaration by declaring that the summer period in respect of the parts of the country area of Victoria specified in Schedule B hereto shall end at midnight on the 19th April, 1968.

SCHEDULE A.

Date of Declaration; Date of Publication in "Government Gazette".

17th November, 1967; 16th November, 1967.
10th November, 1967; 8th November, 1967.

SCHEDULE B.

The Eighth Fire Control Region comprised by the municipal districts of the Borough of Wonthaggi and the Shires of Bass, Flinders, Hastings and Phillip Island and those portions of the City of Frankston and the Shires of Berwick, Cranbourne and Mornington not included in the Twenty-sixth Fire Control Region and French Island;

the Twenty-Fourth Fire Control Region comprised by the municipal districts of the Shires of Beechworth, Bright, Chiltern, Myrtleford, Towong, Upper Murray, Wodonga and Yackandandah;

the Twenty-Sixth Fire Control Region comprised by the municipal districts of the Cities of Chelsea and Dandenong and those portions of the municipal districts of the Cities of Springvale and Waverley not included in the Metropolitan Fire District and those portions of the municipal districts of the City of Frankston and the Shires of Berwick, Cranbourne and Mornington not included in the Eighth Fire Control Region and those portions of the municipal district of the Shire of Knox not included in the Thirteenth Fire Control Region.

A. G. RYLAH,
Chief Secretary.

Chief Secretary's Office,
Melbourne, 8th April, 1968.

Country Fire Authority Act 1958.

VARIATION OF SUMMER PERIOD IN RESPECT OF SPECIFIED PARTS OF THE COUNTRY AREAS OF VICTORIA.

WHEREAS by Section 4 of the *Country Fire Authority Act 1958*, it is enacted that the Chief Secretary of Victoria, after consultation with the Minister of Forests, may from time to time by declaration published in the *Government Gazette* declare any period to be the summer period in respect of the country area of Victoria, or any specified part or parts thereof and, without affecting the generality of the foregoing, may declare different periods to be the summer period in respect of different parts of the said country area:

And whereas by the said section it is further enacted that any declaration so published may be revoked, amended or varied by a subsequent declaration so published:

And whereas by declaration issued on the date stated in Schedule A annexed hereto, different summer periods expiring on the thirtieth day of April, 1968, were declared in respect of different parts of the country area of Victoria, including the parts of the said country area specified in Schedule B hereto:

And whereas the Chief Secretary and the Minister of Forests have consulted accordingly:

Now therefore I, the Chief Secretary of Victoria, do by this my declaration vary the aforesaid declaration by declaring that the summer period in respect of the parts of the country area of Victoria specified in Schedule B hereto shall end at midnight on the 10th April, 1968.

SCHEDULE A.

Date of Declaration: Date of Publication in "Government Gazette":

5th November, 1967; 1st November, 1967.

SCHEDULE B.

The Fourth Fire Control Region comprised by the municipal districts of the Town of Portland and the Shires of Glenelg, Portland and Wannan.

A. G. RYLAH,
Chief Secretary.

Chief Secretary's Office,
Melbourne, 8th April, 1968.

Country Fire Authority Act 1958.

VARIATION OF SUMMER PERIOD IN RESPECT OF SPECIFIED PARTS OF THE COUNTRY AREAS OF VICTORIA.

WHEREAS by Section 4 of the *Country Fire Authority Act 1958*, it is enacted that the Chief Secretary of Victoria, after consultation with the Minister of Forests, may from time to time by declaration published in the *Government Gazette* declare any period to be the summer period in respect of the country area of Victoria, or any specified part or parts thereof and, without affecting the generality of the foregoing, may declare different periods to be the summer period in respect of different parts of the said country area:

And whereas by the said section it is further enacted that any declaration so published may be revoked, amended or varied by a subsequent declaration so published:

And whereas by declaration issued on the date stated in Schedule A annexed hereto, different summer periods expiring on the thirtieth day of April, 1968, were declared in respect of different parts of the country area of Victoria, including the parts of the said country area specified in Schedule B hereto:

And whereas the Chief Secretary and the Minister of Forests have consulted accordingly:

Now therefore I, the Chief Secretary of Victoria, do by this my declaration vary the aforesaid declaration by declaring that the summer period in respect of the parts of the country area of Victoria specified in Schedule B hereto shall end at midnight on the 11th April, 1968.

SCHEDULE A.

Date of Declaration: Date of Publication in "Government Gazette":

17th November, 1967; 16th November, 1967.

SCHEDULE B.

Those portions of the Eleventh Fire Control Region comprised by the municipal district of the Town of Bairnsdale.

A. G. RYLAH,
Chief Secretary.

Chief Secretary's Office,
Melbourne, 8th April, 1968.

Country Fire Authority Act 1958.

VARIATION OF SUMMER PERIOD IN RESPECT OF SPECIFIED PARTS OF THE COUNTRY AREAS OF VICTORIA.

WHEREAS by Section 4 of the *Country Fire Authority Act 1958*, it is enacted that the Chief Secretary of Victoria, after consultation with the Minister of Forests, may from time to time by declaration published in the *Government Gazette* declare any period to be the summer period in respect of the country area of Victoria, or any specified part or parts thereof and, without affecting the generality of the foregoing, may declare different periods to be the summer period in respect of different parts of the said country area:

And whereas by the said section it is further enacted that any declaration so published may be revoked, amended or varied by a subsequent declaration so published:

And whereas by declaration issued on the date stated in Schedule A annexed hereto, different summer periods expiring on the thirtieth day of April, 1968, were declared in respect of different parts of the country area of Victoria, including the parts of the said country area specified in Schedule B hereto:

And whereas the Chief Secretary and the Minister of Forests have consulted accordingly:

Now therefore I, the Chief Secretary of Victoria, do by this my declaration vary the aforesaid declaration by declaring that the summer period in respect of the parts of the country area of Victoria specified in Schedule B hereto shall end at midnight on the 12th April, 1968.

SCHEDULE A.

Date of Declaration: Date of Publication in "Government Gazette":

17th November, 1967; 16th November, 1967.
24th November, 1967; 22nd November, 1967.

SCHEDULE B.

The Sixth Fire Control Region comprised by the municipal districts of the City of Colac, the Town of Camperdown and the Shires of Colac, Hampden, Heytesbury and Otway;

those portions of the Twenty-Second Fire Control Region comprised by the municipal district of the Shire of Nathalia;

those portions of the Twenty-Third Fire Control Region comprised by the municipal district of the Shire of Mansfield and those portions of the municipal district of the Shire of Benalla which lie in a southerly direction from the north-eastern railway line.

A. G. RYLAH,
Chief Secretary.

Chief Secretary's Office,
Melbourne, 8th April, 1968.

Country Fire Authority Act 1958.

VARIATION OF SUMMER PERIOD IN RESPECT OF SPECIFIED PARTS OF THE COUNTRY AREAS OF VICTORIA.

WHEREAS by Section 4 of the *Country Fire Authority Act 1958* it is enacted that the Chief Secretary of Victoria, after consultation with the Minister of Forests, may from time to time by declaration published in the *Government Gazette* declare any period to be the summer period in respect of the country area of Victoria, or any specified part or parts thereof and, without affecting the generality of the foregoing, may declare different periods to be the summer period in respect of different parts of the said country area:

And whereas by the said section it is further enacted that any declaration so published may be revoked, amended or varied by a subsequent declaration so published:

And whereas by declaration issued on the date stated in Schedule A annexed hereto, different summer periods expiring on the thirtieth day of April, 1968, were declared in respect of different parts of the country area of Victoria, including the parts of the said country area specified in Schedule B hereto:

And whereas the Chief Secretary and the Minister of Forests have consulted accordingly:

Now therefore I, the Chief Secretary of Victoria, do by this my declaration vary the aforesaid declaration by declaring that the summer period in respect of the parts of the country area of Victoria specified in Schedule B hereto shall end at midnight on the 15th April, 1968.

SCHEDULE A.

Date of Declaration; Date of Publication in "Government Gazette":

10th November, 1967; 8th November, 1967.

SCHEDULE B.

Those portions of the Eleventh Fire Control Region comprised by the municipal districts of the Shires of Bairnsdale, Tambo and Orbost.

A. G. RYLAH,
Chief Secretary.

Chief Secretary's Office,
Melbourne, 8th April, 1968.

LOCAL GOVERNMENT DEPARTMENT.

ORDER CONFIRMED.—CITY OF CAULFIELD.

THE Minister of the Crown administering the *Local Government Act 1958*, on the 4th day of April, 1968, confirmed the Order hereinafter referred to in pursuance of section 514 of the said act namely:

An Order made by the Council of the City of Caulfield on the 25th March, 1968, directing the compulsory taking of the land described hereunder for the purpose of the provision of a place of public resort and recreation.

All that piece of land being part of lot 255 on Plan of Subdivision No. 5799, commencing at a point distant 950 feet bearing 270° and 126 feet bearing 180° from the south-western corner of the intersection of Murrumbena-road and Woomack-road, thence from that commencing point bearing 180° for 104 feet 3½ inches; 270° for 50 feet; 0° 0' for 103 feet 7 inches and 90° for 50 feet to the point of commencement.

R. J. HAMER,
Minister for Local Government.

Local Government Department,
Melbourne.

Cemeteries Act 1953.

SCALE OF FEES OF THE BRIGHTON GENERAL CEMETERY.

IN pursuance of the powers conferred upon them by the *Cemeteries Act*, the trustees of the Brighton General Cemetery hereby make the following scale of fees, which shall come into operation upon publication in the *Government Gazette*, and from and after such publication every scale of fees heretofore made by the said trustees shall be and is hereby rescinded to the extent to which it conflicts with this scale.

Annual Maintenance Fee.

Grave, 4 ft. x 8 ft.	\$5.75
Grave, 8 ft. x 8 ft.	\$8.50
Grave, 12 ft. x 8 ft.	\$10.50
Grave, 16 ft. x 8 ft.	\$12.00
Bronze plaque, lawn grave	\$25.00

F. D. ALFORD, Chairman.
J. GODWIN, Trustee.
C. A. JONES, Trustee.
A. ALLEN, Secretary.

Approved by the Governor in Council, 2nd April, 1968.—
J. ROSSITER, Clerk of the Executive Council.

Cemeteries Act 1958.

SCALE OF FEES OF THE FOOTSCRAY GENERAL CEMETERY.

IN pursuance of the powers conferred upon them by the *Cemeteries Act*, the trustees of the Footscray General Cemetery hereby make the following scale of fees, which shall come into operation upon publication in the *Government Gazette*, and from and after such publication every scale of fees heretofore made by the said trustees shall be and is hereby rescinded to the extent to which it conflicts with this scale.

Lawn Section (Undenominational).

Land, 8 ft. x 4 ft.	\$40.00
-----------------------------	---------

J. W. BACON, J.P., Trustee.
THOMAS C. BENTLEY, Trustee.
OWEN G. JONES, Trustee.

Approved by the Governor in Council, 2nd April, 1968.—
J. ROSSITER, Clerk of the Executive Council.

Cemeteries Act 1958.

SCALE OF FEES OF THE WONTHAGGI PUBLIC CEMETERY.

IN pursuance of the powers conferred upon them by the *Cemeteries Act*, the trustees of the Wonthaggi Public Cemetery hereby make the following scale of fees, which shall come into operation upon publication in the *Government Gazette*, and from and after such publication the scale of fees published in the *Government Gazette*, No. 48, dated 6th July, 1966, is hereby rescinded.

Lawn Sections (Non-Denominational).

Land, 8 ft. x 4 ft.	\$60.00
First interment, at 7 feet	\$30.00
Second (final) interment in same grave	\$30.00
Certificate of right to burial	\$4.00
Bronze memorial plaque 15 in. x 11 in.	\$24.00

Other Sections—Miscellaneous Charges.

The scale of fees published in the *Government Gazette*, No. 45, dated 16th June, 1965, shall be amended by deleting therefrom the words and figures "Permission to construct a brick grave 15s.", and inserting in lieu thereof the words and figures as follows:—"Permission to construct a brick, stone, tilework or concrete grave, \$8.00".

J. R. ELKIN, Trustee.
A. G. HOWLETT, Trustee.
J. R. QUILFORD, Trustee.

Approved by the Governor in Council, 2nd April, 1968.—
J. ROSSITER, Clerk of the Executive Council.

Melbourne and Metropolitan
BOARD OF WORKS.

NOTICE TO THE OWNERS OF TENEMENTS IN THE UNDERMENTIONED STREETS AND THE PRIVATE STREETS, LANES, COURTS AND ALLEYS OPENING THERETO.

THE main pipe in the said streets being laid down, the owners of all tenements situated as under are hereby required on or before the 13th May, 1968, to cause a proper pipe and stop cocks to be laid so as to supply water within such tenements from the main pipe.

H. J. SNADDEN,
Secretary.

2nd April, 1968.

STREET AND POSITION.

Doncaster and Templestowe.

Anderson-street, from Unwin-street northwards 270 feet.
Roseland-grove, from Anarth-street eastwards 1,070 feet.
Roseland-grove, from Anarth-street westwards 1,020 feet.
Anarth-street, from Board-street to Roseland-grove.

Eltham.

Park-road, from Beard-street north-eastwards 214 feet.
Park-road, from Andrews-street south-westwards 182 feet.

Nunawading.

Eley-road, from Samuel-road eastwards 85 feet.
Eley-road, from Samuel-road westwards 325 feet.
Streeton-court, from Eley-road southwards 320 feet.

Oakleigh.

Bettina-street, from Dennis-street south-eastwards 610 feet.

Preston.

Laurie-street, from St. Vigeons-road to Purinuan-road.
Chenies-street, from Purinuan-road to Rathcown-road.
Ramleh-road, from Laurie-street to Merino-street.

Ringwood.

Nestan-drive, from Mullum-Mullum-road to Jennifer-drive.
Jeffrey-drive, from 350 feet north-east of Golden-grove north-eastwards 450 feet.
Ronald-street, from Nestan-drive south-westwards 250 feet.
Fran-court, from Nestan-drive north-eastwards 260 feet.

Waverley.

Barrington-drive, from Morton-road to High Street-road.
Nolan-court, from Barrington-drive north-westwards 230 feet.

Keat-court, from Barrington-drive south-eastwards 240 feet.
Avoca-court, from Barrington-drive eastwards 290 feet.
Crundale-street, from Morton-road to Barrington-drive.
Shelly-court, from Barrington-drive westwards 220 feet.
Brooke-court, from Barrington-drive north-westwards 210 feet.

Elizabeth-court, from Waverley-road northwards 512 feet.
Catherine-avenue, from 300 feet west of Long Beach-crescent westwards 450 feet.

Walton Heath-crescent, from Catherine-avenue to Therese-avenue.
Therese-avenue, from Walton Heath-crescent westwards 510 feet.

Therese-avenue, from Walton Heath-crescent eastwards 480 feet.
Ben Hogan-court, from Therese-avenue southwards 590 feet.
Snead-court, from Therese-avenue southwards 440 feet.
Catherine-avenue, from Chantilly-street eastwards 250 feet.
Catherine-avenue, from Chantilly-street, westwards 130 feet.
Chantilly-street, from Catherine-avenue southwards 170 feet.

Whittlesea.

Main-street, from 50 feet west of Simpson-street westwards 410 feet.

Badger-court, from Simpson-street westwards 380 feet.
Burwood-court, from Simpson-street westwards 380 feet.

Melbourne and Metropolitan
BOARD OF WORKS.

NOTICE is hereby given that after the publication of this advertisement in the *Government Gazette* and once in not less than two daily newspapers published in the metropolis, the Melbourne and Metropolitan Board of Works will proceed to compulsorily take (unless the same is in the meantime acquired by the Board from the owner or owners or other person interested by mutual agreement) the land mentioned and described in the Schedule hereto.

The nature of the works in respect of which the land is proposed to be taken is for the purpose of the construction of a Sewerage Pumping Station.

A plan of the proposed works will be open for inspection at the offices of the Board, 110 Spencer-street, Melbourne, from the date hereof until the 18th April, 1968, during office hours.

The quantity of land which the Board requires for the purpose of such works and other particulars are set forth below.

The consent of the Governor in Council was duly obtained in terms of the Board's principal Act (No. 6310) on the 19th March, 1968.

SCHEDULE.

All that piece of land being lot 8 and lot 9 on lodged plan 6266 and being part of Crown portion 57 at Caulfield Parish of Prahran East, of Elsternwick, County of Bourke and being the whole of the land described in certificates of title, volume 6753, folio 527 and volume 4034, folio 720.

Dated the 29th day of March, 1968.

H. J. SNADDEN, Secretary.

SURVEY CO-ORDINATION (PLACE NAMES) ACT
No. 7360.

PURSUANT to the powers conferred by section 32 of the above Act, the Place Names Committee hereby gives notice that it has approved of the name of the under-mentioned Post Office.

Municipality; Location; Name.

City of Preston; La Trobe University; La Trobe University.

By order of the Committee,

C. E. E. BARLOW,
Secretary.

SURVEY CO-ORDINATION (PLACE NAMES) ACT
No. 7360.

PURSUANT to the powers conferred by section 28 of the above Act, the Place Names Committee hereby gives notice of its intention to assign the following name to the subdivision mentioned hereunder.

Municipality; Location; Proposed Name.

City of Broadmeadows; That area of land generally bounded on the North and East by the Moonee Ponds Creek, and on the west by Mickleham-road; Truscott.

Any person who objects to the proposed name, may give notice of objection, in writing, to the Secretary of the Committee, stating the reasons therefor, not more than two months following the publication of this notice.

By order of the Committee,

C. E. E. BARLOW,
Secretary.

SURVEY CO-ORDINATION (PLACE NAMES) ACT
No. 7360.

PURSUANT to the powers conferred under section 29 of the above Act, the Place Names Committee gives notice of the following alteration in the name of the under-mentioned township.

Shire; Present Name; New Name.

Flinders; Red Hill (*Government Gazette*, 1922, page 2541) (generally known as Red Hill South); Red Hill South.

By order of the Committee,

C. E. E. BARLOW,
Secretary.

Town and Country Planning Act 1961
LAKE BELFIELD PLANNING SCHEME.

NOTICE OF APPROVAL.

IN pursuance of the powers conferred by the *Town and Country Planning Act 1961*, the Governor in Council, on the 9th April, 1968, approved a planning scheme entitled the Lake Belfield Planning Scheme, in respect of part of the municipal district of the Shire of Stawell and such planning scheme comes into operation on the date this notice of approval is published in the *Government Gazette*.

A copy of the planning scheme as approved may be inspected free of charge during office hours at the office of the Town and Country Planning Board, 179 Queen-street, Melbourne; at the office of the Council of the Shire of Stawell at Stawell; and when available, at the Office of Titles, Melbourne; and at the Central Plan Office of the Department of Crown Lands and Survey, Melbourne.

W. H. CRAIG, Secretary,
Town and Country Planning Board.

Town and Country Planning Act 1961.

SHIRE OF DEAKIN.

INTERIM DEVELOPMENT ORDER.

Notice of Approval.

IN pursuance of the powers conferred by the *Town and Country Planning Act 1961*, the Governor in Council, on the 9th April, 1968, approved an Interim Development Order made by the Shire of Deakin for all land within the Municipal District of the Shire of Deakin, except the Township of Tongala.

The Interim Development Order provides that the use, subdivision or development of any land within the area described or the erection, construction or carrying out of any buildings, roads or other works thereon is prohibited except that the Responsible Authority may permit such uses, subdivision, development, erection, constructions or other works as it thinks proper.

A copy of the Interim Development Order may be inspected, free of charge, at the office of the Shire of Deakin, Tongala and at the office of the Town and Country Planning Board, 179 Queen-street, Melbourne.

B. PEARL, Shire Secretary.

Town and Country Planning Act 1961.

PORTLAND PLANNING SCHEME 1957.

AMENDMENT No. 8, 1967.

(SHIRE OF PORTLAND.)

Notice of Approval.

IN pursuance of the powers conferred by the *Town and Country Planning Act 1961*, the Governor in Council on the 2nd April, 1968, approved a planning scheme entitled the Portland Planning Scheme 1957, Amendment No. 8, 1967, Shire of Portland, in respect of part of the municipal district of the Shire of Portland and such planning scheme comes into operation on the date this notice of approval is published in the *Government Gazette*.

A copy of the planning scheme as approved may be inspected free of charge during office hours at the office of the Town and Country Planning Board, 179 Queen-street, Melbourne; at the office of the Shire of Portland, at Heywood; and when available, at the Office of Titles, Melbourne; and at the Central Plan Office of the Department of Crown Lands and Survey, Melbourne.

W. H. CRAIG, Secretary,
Town and Country Planning Board.

Town and Country Planning Act 1961.

SHIRE OF KNOX PLANNING SCHEME 1965.

AMENDMENT No. 34, 1968.

Notice of Amendment.

IN pursuance of the powers conferred by sub-section 6 of section 32 of the *Town and Country Planning Act 1961*, the Governor in Council, by and with the advice of the Executive Council thereof, on the 2nd April, 1968, amended the Shire of Knox Planning Scheme 1965.

A copy of the amendment may be inspected during office hours at the office of the Town and Country Planning Board, 179 Queen-street, Melbourne; at the office of the Council of the Shire of Knox at Fern Tree Gully; and when available at the Office of Titles, Melbourne; and at the Central Plan Office of the Department of Crown Lands and Survey, Melbourne.

W. H. CRAIG, Secretary,
Town and Country Planning Board.

STATE RIVERS AND WATER SUPPLY COMMISSION.

LICENCES TO DIVERT WATER AND CUT RACES PURSUANT TO THE PROVISIONS OF SECTION 204 OF THE WATER ACT 1958 (AS AMENDED).

THE Governor in Council has approved of the granting by the State Rivers and Water Supply Commission of licences as detailed hereunder for the term of years from the date specified in each case to the persons named in the following Schedule :—

SCHEDULE.

Licence No.	Term of Licence and Commencing Date.	Name and Address of Person to whom Licence is to be Granted.	Source of Supply.	Area Authorized to be Irrigated Per Annum.	Volume of Water Authorized to be Diverted Per Annum.	Annual Fee.
				acres.	ac. ft.	\$
2320	Five years from 1.7.67	Ian William Alexander, Walpa ..	Mitchell River ..	20	40	20.00
2321	Five years from 1.7.67	Mathew Calvert, Hillside ..	Mitchell River ..	25	50	25.00
2322	Five years from 1.7.67	Ivan Leonard and John Henry Coates, Hillside	Mitchell River ..	25	50	25.00
2323	Five years from 1.7.67	Peter Charles Martin, Hillside ..	Mitchell River ..	50	100	50.00

Office of the State Rivers and Water Supply Commission,
Melbourne, 9th April, 1968.

G. W. LEWIS, Secretary,
State Rivers and Water Supply Commission.

STATE RIVERS AND WATER SUPPLY COMMISSION.

LICENCE TO DIVERT WATER AND CUT RACE PURSUANT TO THE PROVISIONS OF SECTION 204 OF THE WATER ACT 1958 (AS AMENDED).

THE Governor in Council has approved of the granting by the State Rivers and Water Supply Commission of licence as detailed hereunder for the term of years from the date specified to the persons named in the following schedule :—

SCHEDULE.

Licence No.	Term of Licence and Commencing Date.	Name and Address of Person to whom Licence is to be Granted.	Source of Supply.	Area Authorized to be Irrigated Per Annum.	Volume of Water Authorized to be Diverted Per Annum.
				acres.	ac. ft.
2324	Four years from 1.7.67 ..	William Irving and Patricia Chute Robertson, Bamawm	River Murray ..	14	28

The annual fee payable in respect of each acre-foot of water authorized to be diverted is the equivalent of one-half of the irrigation charge per acre-foot fixed in the Goulburn-Murray Irrigation District for the preceding financial year.

Office of the State Rivers and Water Supply Commission,
Melbourne, 9th April, 1968.

G. W. LEWIS, Secretary,
State Rivers and Water Supply Commission.

STATE RIVERS AND WATER SUPPLY COMMISSION.

LICENCE TO DIVERT WATER PURSUANT TO THE PROVISIONS OF SECTION 204 OF THE WATER ACT 1958 (AS AMENDED).

THE Governor in Council has approved of the granting by the State Rivers and Water Supply Commission of licence as detailed hereunder for the term of years from the date specified to the persons named in the following Schedule :—

SCHEDULE.

Licence No.	Term of Licence and Commencing Date.	Name and Address of Person to whom Licence is to be Granted.	Source of Supply.	Area Authorized to be Irrigated Per Annum.	Volume of Water Authorized to be Diverted Per Annum.	Annual Fee.
				acres.	ac. ft.	\$
2325	Five years from 1.7.67	Alfred William Stewart and Annie Muriel McDonald, Hillside	Mitchell River ..	55	110	55.00

Office of the State Rivers and Water Supply Commission,
Melbourne, 9th April, 1968.

G. W. LEWIS, Secretary,
State Rivers and Water Supply Commission.

Water Act 1958.

STATE RIVERS AND WATER SUPPLY COMMISSION.

WESTERNPORT URBAN DISTRICT.

NOTICE to owners of tenements in the under-mentioned street in the Westernport Urban District and the private streets, lanes, courts and alleys opening thereto:—

Somerville.

Sydney-street, from Jones-road to a point opposite lot 7, about 4 chains westerly.

The main pipe in the said street being laid down, the owners of all tenements situated as above are hereby required, on or before the 1st day of June next, to cause proper pipes and stop cocks to be laid, so as to supply water within such tenements from the main pipe.

G. W. LEWIS, Secretary,
State Rivers and Water Supply Commission.
Melbourne, 8th April, 1968.

DEPARTMENT OF MINES.

SUBJECT to any necessary excisions, &c., it is proposed to grant the following leases:—

8597, Mineral; Arbil Star Mining Co. Pty. Ltd., 32a. 1r. 24p., Parish of Byawatha.

8665, Mineral; Australian Gypsum Limited; 67a. Or. 15p., Parish of Woatwoara.

MINING LEASE TRANSFERRED.

11373, Bendigo; from Maurice James Steeth and Donald Douglas Mather to Maurice James Steeth and Michael Delaney.

J. C. M. BALFOUR,
Minister of Mines.

SHIRE OF KORONG.

WEDDERBURN AND KORONG VALE WATER SUPPLY DISTRICT.

By Law No. 5.

THE Council of the Shire of Korong (hereinafter referred to as "the Council") in pursuance and exercise of the powers conferred by the Water Act 1958. does hereby make the following By Law restricting the use for other than domestic purposes of water supplied by the Council within the Wedderburn and Korong Vale Water Supply District.

1. This By Law shall come into operation at such time as the Council from time to time directs by notice published in a Newspaper circulating generally within the District and cease to have operation at such time as the Council from time to time directs by a notice so published.

2. Subject to the provisions of Clauses 3 and 4 of this By Law no person shall, with water supplied by the Council—

- (a) Water any garden, lawn or other land (other than commercial market gardens, commercial nurseries or land used for the growing of green feed for commercial poultry farms) within the specified district except by means of a hose held in the hand or by means of a can or other vessel held in the hand between the hours of 6.00 P.M. and 7.00 P.M. on each day.
- (b) Fill, add to or cleanse any private swimming pool of a depth greater than one foot within the specified area.
- (c) Water any land grass lawn or ornamental garden comprising a nature strip on a road reserve within the specified area.
- (d) Wash any vehicle of any description by means of a hose.

3. No person shall with water supplied by the Council, water any market gardens, commercial nurseries or land used for the growing of green feed for commercial poultry farms within the specified district by means of fixed sprinklers except between the hours of 6.00 A.M. and 10.00 A.M. of each day or by means of a hose held in the hand or by means of a can or other vessel held in the hand.

4. No person shall with water supplied by the Council water any land comprising sports grounds, golf courses, racecourses, public and club bowling and croquet greens and public and club tennis courts within the specified district by means of fixed sprinklers except for a maximum period of fourteen hours per week at such times as are agreed to by the Council.

5. Every person who uses or permits or suffers water supplied by the Council to be used contrary to the provisions of this By Law shall be guilty of an offence and shall be liable to a penalty not exceeding One Hundred Dollars.

6. If any person supplied with water by the Council wrongfully does or causes or permits to be done anything in contravention of this By Law, the Council may (without prejudice to any remedy in respect thereof) close or cut off any of the pipes by or through which water is supplied for his house and may cease to supply him with water as provided by the Water Act 1958.

The common seal of the President, Councillors and Ratepayers of the Shire of Korong was hereby affixed to a Resolution of the Council, this 19th day of March, 1968, in the presence of—

(SEAL) HOWARD PERRYMAN, Shire President.
A. J. MITCHELL, Councillor.
R. STANLEY, Shire Secretary.

Approved by the Governor in Council, 9th April, 1968.—
J. ROSSITER, Clerk of the Executive Council.

SHIRE OF WALPEUP.

RATING BY-LAW, COWANGIE WATER SUPPLY DISTRICT.

THE Council of the Shire of Walpeup in pursuance of and in exercise of the powers conferred by the Water Act 1958 and of any and every other power it thereunto enabling doth hereby make a By-Law as follows:—

1. The Council hereby makes and levies a rate in respect of all lands and tenements within the Cowangie Water Supply District of Twenty-five cents (25c) in the dollar on the net annual value set out in the valuation at present in force of such lands and tenements for the purposes of the municipal rate of the Shire of Walpeup which is hereby adopted as the valuation of such lands and tenements respectively.

2. Such rate shall be made and levied upon the occupiers and owners of such lands and tenements for the year commencing on the 1st day of October, 1967, and shall be payable on the 10th day of April, 1968, at the Shire Office, Ouyen.

3. In no case shall the rate payable hereunder in respect of any land on which there is a building be less than Sixteen Dollars (\$16.00) and in respect of land on which there is no building be less than Four Dollars (\$4.00).

The foregoing By-Law was made on the 14th day of March, 1968, and the Common Seal of the President, Councillors and Ratepayers of the Shire of Walpeup was affixed that day in the presence of:—

(SEAL) A. J. LESTER, President.
A. N. PARKER, Councillor.
R. G. VIAL, Secretary.

Approved, 28th March, 1968.—W. BORTHWICK, Minister of Water Supply.

MOUNT MACEDON WATERWORKS TRUST.

RATING BY-LAW FOR THE YEAR 1968.

THE MOUNT MACEDON WATERWORKS TRUST, in pursuance and exercise of the powers conferred by the Water Act, doth hereby make a rate for the supply of water for domestic purposes of ten cents in the dollar of the municipal valuation of lands and tenements liable to be rated within the Mount Macedon Urban District.

Provided that in no case shall the amount of rate payable per annum in respect of any tenement (other than land on which there is no building) be less than Four dollars, and of any which there is no building Four dollars.

Such rates are made and shall be levied upon the occupiers or owners of the said lands and tenements for the year commencing the 1st day of January, 1968, and shall be payable on the 30th day of June, 1968, at the office of the said Trust.

The maximum quantity of water to be supplied in any one year without further charge to any property rated by the Trust is hereby fixed at the quantity which at a rate of Twenty cents per 1,000 gallons, would produce an amount equal to the amount of rate levied on such property for the said year.

The charge for water supplied by measure to any property rated by the Trust in excess of such maximum quantity, computed as in the preceding clause, is hereby fixed at Twenty cents per 1,000 gallons up to 300,000 gallons, and fifteen cents per 1,000 gallons in excess of this amount.

The charge for water supplied by measure shall be payable on demand at the office of the Trust.

Passed this 12th day of March, 1968.

(SEAL)

M. F. COGGER, Chairman.
M. SPECK, Commissioner.
A. D. HOWARD, Secretary.

Approved, 28th March, 1968.—W. EORTHWICK, Minister of Water Supply.

DEVENISH WATERWORKS TRUST.

RATING BY-LAW 1968.

THE Devenish Waterworks Trust, in pursuance and exercise of the powers conferred by the water Act, doth hereby make the following rates for the supply of water for domestic purposes on land and tenements liable to be rated within the Devenish Urban District.

On such lands and tenements a rate of 22 cents in the dollar on amounts of annual municipal valuations not exceeding fifty Dollars and five cents in the dollar on the amount of municipal valuations exceeding Fifty Dollars but not exceeding One hundred and fifty dollars and 2.5 cents in the dollar exceeding One Hundred and fifty Dollars.

Provided that in no case shall the amount payable per annum in respect of any tenement (other than land on which there is no building) be less than (11) eleven dollars or more than forty Dollars and in respect of any land on which there is no building be less than One Dollar.

Such rates are made and shall be levied upon the occupiers or owners of such lands and tenements for the year commencing on the 1st day of January 1968, and shall be payable on the 31st Day of August 1968 at the office of the said trust.

The maximum quantity of water to be supplied in any one year without further charge to any property rated by the Trust is hereby fixed at the quantity which, at the charge of 20 cents per 1,000 gallons would produce an amount equal to the amount of rates levied on such property for said year.

The charge for water to be supplied by measure to any property rated by the Trust in excess of such maximum quantity, computed as in the preceding clause, is hereby fixed at 20 cents per 1,000 gallons.

The charge for water supplied by measure shall be payable on demand at the office of the said Trust.

Passed this 9th day of March, 1968.

(SEAL)

P. J. LIDGERWOOD, President.
T. L. MCCALLUM, Secretary.

Approved, 28th March, 1968.—W. BORTHWICK, Minister of Water Supply.

MURRAYVILLE WATERWORKS TRUST.

RATING BY-LAW FOR YEAR 1968.

THE Murrayville Waterworks Trust in pursuance of and in exercise of the powers conferred by the Water Act 1958 and of any and every other power it thereunto enabling doth hereby make a By-Law as follows:—

1. The Trust hereby makes and levies a rate in respect of all lands and tenements within the Murrayville Urban District of Seventeen Cents (17c) in the Dollar on the net annual value set out in the valuation at present in force of such lands and tenements for the purposes of the municipal rate of the Shire of Walpeup which is hereby adopted as the valuation of such lands and tenements respectively.

2. Such rate shall be made and levied upon the occupiers and owners of such lands and tenements for the year commencing on the 1st day of January, 1968, and shall be payable on the 10th day of April, 1968, at the Office of the said Trust, Ouyen.

3. In no case shall the rate payable hereunder in respect of any land on which there is a building be less than Thirteen Dollars and Fifty Cents (\$13.50) and in respect of land on which there is no building be less than Four Dollars (\$4.00).

The foregoing By-Law was made on the 7th day of March, 1968, and the Common Seal of the Murrayville Waterworks Trust was affixed that day in the presence of—

(SEAL)

M. WILLERSDORF, Chairman.
N. R. MILDE, Commissioner.
R. G. VIAL, Secretary.

Approved, 28th March, 1968.—W. BORTHWICK, Minister of Water Supply.

UNDERBOOL WATERWORKS TRUST.

RATING BY-LAW FOR 1968.

THE UNDERBOOL WATERWORKS TRUST in pursuance of and in exercise of the powers conferred by the Water Act 1958 and of any and every other power it thereunto enabling doth hereby make a By-Law as follows:—

1. The Trust hereby makes and levies a rate in respect of all lands and tenements within the Underbool Urban District of Eighteen Cents (18c) in the dollar on the net annual value set out in the valuation at present in force of such lands and tenements for the purposes of the municipal rate of the Shire of Walpeup which is hereby adopted as the valuation of such lands and tenements respectively.

2. Such rate shall be made and levied upon the occupiers and owners of such lands and tenements for the year commencing on the 1st day of January, 1968, and shall be payable on the 10th day of April, 1968, at the Office of the said Trust, Ouyen.

3. In no case shall the rate payable hereunder in respect of any land on which there is a building be less than Fifteen Dollars (\$15.00) and in respect of land on which there is no building be less than Four Dollars (\$4.00).

The foregoing By-Law was made on the 14th day of March, 1968, and the common seal of the Underbool Waterworks Trust was affixed that day in the presence of—

(SEAL)

A. B. ELLIOTT, Chairman.
J. T. LEWIS, Commissioner.
R. G. VIAL, Secretary.

Approved, 28th March, 1968.—W. BORTHWICK, Minister of Water Supply.

FORREST WATERWORKS TRUST.

RATING BY-LAW.

THE Forrest Waterworks Trust in pursuance of and in exercise of the powers conferred by the Water Act 1958 and of any and every other power it thereunto enabling doth hereby make a By-law as follows:—

1. The Trust hereby makes and levies a rate in respect of all the lands and tenements within the Forrest Urban District of 17.5 cents in the dollar on the net annual value set out in the valuation at present in force of such lands and tenements for the purposes of the municipal rate of the Shire of Otway which is hereby adopted as the valuation of such lands and tenements respectively.

2. Such rate shall be made and levied upon the occupiers and owners of such lands and tenements for the year commencing on the 1st day of October, 1967, and shall be payable on the 1st day of June, 1968, at the office of the said Trust.

3. In no case shall the rate payable hereunder in respect of any land on which there is a building be less than Seventeen Dollars and in respect of land on which there is no building be less than Five Dollars.

Resolution for passing this By-law agreed to by the Trust, this 18th day of March, 1968.

The common seal of the Forrest Waterworks Trust was hereto affixed this 18th day of March, 1968, in the presence of—

(SEAL)

J. W. TURNER, Chairman.
A. N. DOWIE, Commissioner.
T. J. FRY, Secretary.

Approved, 28th March, 1968.—W. BORTHWICK, Minister of Water Supply.

LORNE WATERWORKS TRUST.

RATING BY-LAW No. 78.

THE Lorne Waterworks Trust in pursuance of and in exercise of the powers conferred by the Water Act 1958 and of any and every other power it thereunto enabling doth hereby make a By-Law as follows:—

1. The Trust hereby makes and levies a rate in respect of all the lands and tenements within the Lorne Waterworks Urban District of 5 cents in the dollar on the net annual value set out in the valuation at present in force of such lands and tenements for the purpose of the municipal rate of the Shire of Winchelsea which is hereby adopted as the valuation of such lands and tenements respectively.

2. Such rate shall be made and levied upon the occupiers and owners of such lands and tenements for the year commencing on the 1st day of January 1968 and shall be payable on the 1st day of May 1968 at the office of the said Trust.

3. In no case shall the rate payable hereunder in respect of any land on which there is a building be less than eight dollars and in the respect of land on which there is no building be less than four dollars.

Passed this 1st day of March, 1968.

(SEAL) L. A. ALLEN, Chairman.
J. V. HAYES, Commissioner.
W. K. MATHISON, Secretary.

Approved, 28th March, 1968.—W. BORTHWICK, Minister of Water Supply.

FORREST WATERWORKS TRUST.

BY-LAW No. 4.

THE Forrest Waterworks Trust in pursuance of and in exercise of the powers conferred by the *Water Act 1958* and of any and every other power it thereunto enabling doth hereby make a By-law as follows:—

1. The meter or meters measuring the supply of water to any land or tenement shall be read as near as practicable to twelve months from the date that it was read previously and the quantity of water so measured as having been supplied during the period between any two successive such readings (hereinafter called "the meter year") shall be the basis of the calculating of charges payable under this By-law provided always that where a meter has been installed on any land or tenement during the course of a meter year the quantity of water measured as having been supplied during the period between the date of such installation and the date of the reading shall be the basis of calculating such charges.

2. Subject as is hereinafter provided in respect of any land or tenement rated by the Trust—

(a) The maximum quantity of water to be supplied in any meter year without charge is hereby fixed as a quantity which if charged at 34 cents per thousand gallons for any meter year would give an amount equal to the amount of the rate payable in respect of the land or tenement for the financial year in which the said meter year ended.

(b) For all water supplied in any meter year in excess of the maximum quantity referred to in paragraph (a) of this clause the charge is hereby fixed at 34 cents per thousand gallons for any meter year.

3. Subject as is hereinafter provided the charge for water supplied by measure to any property not rated by the Trust is hereby fixed at 34 cents per thousand gallons.

4. The minimum charge for water supplied by measure to any property not rated by the Trust is hereby fixed at Seventeen Dollars.

5. The aforesaid charges shall be payable within seven days of demand upon the owner or occupier at the office of the Trust during normal business hours.

6. The provisions of Clauses 4, 5, and 6 of this By-law shall not apply to any land tenement or property supplied with water by the Trust under a special agreement pursuant to Section 215 of the *Water Act 1958*.

Resolution for passing this By-law agreed to by the Trust, this 18th day of March, 1968.

The common seal of the Forrest Waterworks Trust was hereto affixed this 18th day of March, 1968, in the presence of—

(SEAL) J. W. TURNER, Chairman.
A. N. DOWIE, Commissioner.
T. J. FRY, Secretary.

Approved, 28th March, 1968.—W. BORTHWICK, Minister of Water Supply.

ST. ARNAUD WATERWORKS TRUST.

BY-LAW No. 5.

THE Commissioners of the St. Arnaud Waterworks Trust, hereinafter referred to as the "Trust", in pursuance and exercise of the powers conferred by the *Water Act*, for the purpose of restricting or prohibiting the use of water for other than domestic purposes do hereby make the following By-law:

1. This By-law shall come into operation at such times as the Trust from time to time directs by notice published in a newspaper circulating generally within the

District and shall cease to have operation at such time as the Trust from time to time directs by a notice so published.

2. Subject to the provisions of Clause 3, 4 and 5 of this By-law no person shall, with water supplied by the Trust—

- (a) water any garden, lawn or other land within the specified area except by means of a hose held in the hand or by means of a can or other vessel held in the hand, between the hours of 5.30 p.m. and 6.30 p.m. of each day
- (b) wash any vehicle of any description whatsoever by means of a hose or other mechanical device
- (c) fill, add to or cleanse any private swimming pool within the specified area.

3. No person shall with water supplied by the Trust, water any land comprising sports grounds, Public and Club Bowling and Croquet Greens and Public and Club Tennis Courts within the specified area except between the hours of 7 p.m. and 9 p.m. of each day.

4. No person shall with water supplied by the Trust, water any land comprising Parks and Gardens under the control of the St. Arnaud Town Council except for a maximum period of 14 hours a week at times and under conditions to be determined by the Trust.

5. Except during the hours referred to in Clauses 2, 3 and 4 hereof no person shall attach or affix a hose or permit or suffer a hose to remain attached or affixed to any taps connected to any pipe or main used for the conveyance or supply of water by the Trust.

6. Any person who shall use or permit or suffer to be used any water supplied by the Trust contrary to the provisions of this By-law shall be guilty of an offence and shall be liable to a penalty not exceeding \$100, recoverable summarily before any Court of competent jurisdiction and in the case of a continuing offence to a further penalty not exceeding \$10 for every day after notice of the offence from the Trust.

7. If any person supplied with water by the Trust wrongfully does or causes or permits to be done anything in contravention of this By-law, the Trust may (without prejudice to any remedy in respect thereof) close or cut off any of the pipes by or through which water is supplied to him or for his use and may cease to supply him with water as provided by the *Water Act 1958*.

8. The provisions of this By-law shall have effect throughout the whole of the St. Arnaud Waterworks Trust Urban District, and shall also apply to the owners or occupiers of any premises supplied with water by the Trust, outside its urban district.

The foregoing By-law was made by the Commissioners of the St. Arnaud Waterworks Trust on the eighteenth day of March, 1968, and the common seal of the said Trust was hereto affixed the eighteenth day of March, 1968, in the presence of—

(SEAL) G. A. ANDERSON, Chairman.
JOHN S. McNALLY, Commissioner.
P. JAMES, Secretary.

Approved by the Governor in Council, 9th April, 1968.—J. ROSSITER, Clerk of the Executive Council.

APOLLO BAY WATERWORKS TRUST.

NOTICE is hereby given that the Trust, on 22nd March, 1968, made a By-law styled By-law No. 7d, which provides for restrictions on the use of water supplied by the Trust.

The By-law was approved by the Governor in Council on 9th April, 1968.

A copy of the By-law may be inspected free of charge during office hours at the office of the Trust.

T. J. FRY,
Secretary.

HEATHCOTE WATERWORKS TRUST.

BY-LAW No. 687.

Water Restrictions—Tooborac Urban District.

THE Heathcote Waterworks Trust, hereinafter referred to as "the Trust", in pursuance and exercise of the powers conferred by the *Water Acts*, do hereby make the By-law following, restricting the use for other than domestic purposes of water supplied by the said Trust within the Tooborac Urban District.

1. This By-law shall apply to and have force in the Tooborac Urban District.

2. This By-law shall come into operation on the date of its publication in the *Victoria Government Gazette*.

3. No person shall, with water supplied by the Trust:—

(a) Water any garden, lawn or other land except by means of a can or other vessel held in the hand between the hours 5 p.m. and 7 p.m. on each day;

(b) Fill, add to or cleanse any private swimming pool;

(c) Wash cars other than from a bucket or similar container.

4. Every person who uses or permits or suffers water supplied by the Trust to be used contrary to the provisions of this By-law shall be liable to a penalty not exceeding One hundred dollars recoverable summarily before any court of competent jurisdiction.

5. If any person supplied with water by the Trust wrongfully does or causes or permits to be done anything in contravention of this By-law, the Trust may (without prejudice to any remedy in respect thereof) close or cut off any of the pipes by or through which water is supplied by the Trust to him or for his use, and may cease to supply him with water as provided by the Water Acts.

The foregoing By-law was made by the Heathcote Waterworks Trust on the 5th day of March, 1968, and the common seal of the said Trust was hereunto affixed in the presence of:

(SEAL) J. L. TRANTER, Chairman.
J. A. McDONALD, Commissioner.
D. MAXWELL, Secretary.

Approved by the Governor in Council, 9th April, 1968.—
J. ROSSITER, Clerk of the Executive Council.

HEATHCOTE WATERWORKS TRUST.

BY-LAW No. 686.

Water Restrictions.

THE Heathcote Waterworks Trust, hereinafter referred to as "the Trust", in pursuance and exercise of the powers conferred by the Water Acts, doth hereby make the By-law following, that is to say:

By-law No. 685 is hereby expressly repealed in so far as it applies to the Tooborac Urban District.

The foregoing By-law was made by the Heathcote Waterworks Trust on the 5th day of March, 1968, and the common seal of the said Trust was hereunto affixed in the presence of:

(SEAL) J. L. TRANTER, Chairman.
J. A. McDONALD, Commissioner.
D. MAXWELL, Secretary.

Approved by the Governor in Council, 9th April, 1968.—
J. ROSSITER, Clerk of the Executive Council.

MALLACOOTA WATERWORKS TRUST.

FIXING THE LIMIT OF BANK OVERDRAFT.

HIS Excellency the Governor of the State of Victoria, by and with the advice of the Executive Council thereof doth by Order made on the 9th day of April, 1968, fix the limit of the overdraft to be obtained by the Malla-coota Waterworks Trust pursuant to the provisions of section 288 of the *Water Act 1958* (No. 6413) at Forty thousand dollars (\$40,000).

J. ROSSITER,
Clerk of the Executive Council.

At the Executive Council Chamber,
Melbourne, 9th April, 1968.

ANGLESEA SEWERAGE AUTHORITY.

FIXING THE LIMIT OF BANK OVERDRAFT.

HIS Excellency the Governor of the State of Victoria, by and with the advice of the Executive Council thereof, doth by Order made on the 9th day of April, 1968, fix the limit of the overdraft to be obtained by the Anglesea Sewerage Authority, pursuant to the provisions of section 79 of the *Sewerage Districts Act*, at Ten thousand dollars (\$10,000).

J. ROSSITER,
Clerk of the Executive Council.

At the Executive Council Chamber,
Melbourne, 9th April, 1968.

APOLLO BAY SEWERAGE AUTHORITY.

FIXING THE LIMIT OF BANK OVERDRAFT.

HIS Excellency the Governor of the State of Victoria, by and with the advice of the Executive Council thereof, doth by Order made on the 9th day of April, 1968, fix the limit of the bank overdraft to be obtained by the Apollo Bay Sewerage Authority, pursuant to the provisions of section 79 of the *Sewerage Districts Act*, at Two thousand dollars (\$2,000).

J. ROSSITER,
Clerk of the Executive Council.

At the Executive Council Chamber,
Melbourne, 9th April, 1968.

APPOINTMENTS AND RESIGNATIONS

APPOINTMENTS.

HIS Excellency the Governor of the State of Victoria by and with the advice of the Executive Council thereof, has, by Orders made on the 2nd day of April, 1968, been pleased to make the under-mentioned appointments, viz:—

CHIEF SECRETARY'S DEPARTMENT.

Honorary Probation Officers.

LUTHER PAUL ALTUS (The Reverend), 14 Havelock-street, Wodonga,

PETER CARL AUMANN (The Reverend), 1411 Heatherton-road, Dandenong,

ROSE ELIZABETH CHAPMAN (Mrs.), 26 Seaview-street, South Caulfield,

JOHN MCMAHON HILL, Dockers Plains,

CHRISTIAN FREDERICK CARL LESLIE, 89 Railway-street, Eureka,

PETER CONLY MATHIESON (The Reverend), 4 Woodland-street, Wodonga, and

SYLVIA MAY WIDDICOMBE, 51 Middle-street, Ascot Vale, pursuant to the provisions of section 10 (1) of the *Children's Court Act 1958*, to be Honorary Probation Officers for all Children's Courts in Victoria.

RÖLAND HENRY CARMODY, 45 Maxweld-street, Ardeer,

JOHN MCMAHON HILL, Dockers Plains,

PETER JULIAN HUMPHREYS, 13 Bolton-avenue, Hampton,

EDWARD MCINTYRE KIPPAX (The Reverend), St. Andrew's Manse, P.O. Box 71, Woodend.

ROBERT JOHN LOWELL, care of West Gippsland Hospital, P.O. Box 78, Warragul,

ALBERT GORDON SIMPSON, 24 Middleton-street, Black Rock,

ROSA ELIZABETH CHAPMAN (Mrs.), 26 Seaview-street, South Caulfield,

SYLVIA MAY WIDDICOMBE (Miss), 51 Middle-street, Ascot Vale; and

WANDA VIOLET CHAPMAN (Mrs.), 607A Howitt-street, Ballarat,

pursuant to the provisions of section 507 (2) of the *Crimes Act 1958*, to be Honorary Probation Officers for all Adult Courts in Victoria.

MINISTRY OF HEALTH.

Members of the Medical Board of Victoria.

HOWARD HADFIELD EDEY, B.Sc., M.B., B.S., F.R.C.S., F.R.A.C.S.; and

HARRY WILLIAM GARLICK, M.D., M.R.C.P., F.R.A.C.P. to be Members of the Medical Board of Victoria, pursuant to section 4 of the *Medical Act 1958*.

Members of Committees of Management of Hospitals.

EMIL LYELL MUMME

to be a Member of the Committee of Management of Mansfield District Hospital, pursuant to proviso (a) to section 48 (1) of the *Hospitals and Charities Act 1958*, for a further period of three years ending 12th April, 1971.

GEORGE ROSS SHERWOOD BARTLEY

to be a Member of the Committee of Management of Sunshine and District Community Hospital, pursuant to proviso (a) to section 48 (1) of the *Hospitals and Charities Act 1958*, for a period of three years.

Deputy Superintendent of Mental Hospital.

HORACE WELLESLEY HANNAH, M.B., B.S., D.P.M. to be a Deputy Superintendent, Mental Hospital, Mont Park, pursuant to the provision of section 26 (1) of the *Mental Health Act 1959*, as from and inclusive of 19th March, 1968, vice Dr. R. V. Lea, resigned.

Trustees of Public Cemeteries.

THOMAS JAMES SHRIMPTON
to be a Trustee of the Geelong Western Public Cemetery,
vice L. Matthews, resigned.

KEVIN SCANLON; and
JOHN KYDD
to be Trustees of the Drouin West Public Cemetery, vice
W. Mason and R. Logan, resigned.

Public Vaccinator.

BARRY BETTISON, M.B., Ch.B.
to be Public Vaccinator, Municipality of Maffra.

LAW DEPARTMENT.

Commissioners for Taking Declarations, &c.

JOHN LESLIE WATERS, 561 Bourke-street, Melbourne,
ERIC JOHN TRELOAR, 82 The Right, Eaglemont,
LEONARD GORDON INGLIS MOORE, 56 Main-street, Black-
burn; and

ORLANDO CARDAMONE, 135 Station-street, Blackburn
to be Commissioners for taking declarations and affidavits,
pursuant to the provisions of the Evidence Act 1958.
To resign upon removing from the neighbourhood of the
addresses stated.

GAVIN HENRY ELLIOTT, care of Associated Quarries Pty.
Ltd., 521 Collins-street, Melbourne,
BRIAN RAYMOND BARRY, care of Associate Securities
Limited, 52 Exhibition-street, Melbourne,
MARGARET GRAHAM, care of Ascot Pty. Ltd., 63
Queensbridge-street, South Melbourne; and
ROBERT PERCIVAL McHUTCHISON, care of Secretarial
Services, 406 Lonsdale-street, Melbourne
to be Commissioners for taking declarations and affidavits,
pursuant to the provisions of the Evidence Act 1958.
To resign upon ceasing to occupy their present positions.

PHILIP COMAN, and
HERBERT JOSEPH ELLIOT, care of Companies Registra-
tion Office, 451 Latrobe-street, Melbourne
to be Commissioners for taking declarations and affidavits,
pursuant to the provisions of the Evidence Act 1958. To
refrain from charging fees and to resign upon ceasing to
occupy their present positions.

JOHN WILLIAM FLYNN, Sergeant No. 9140,
LEONARD ALFRED SMITH, Senior Constable, No. 10751;
and
ROBERT BRUCE BAIRD, First Constable, No. 12053, care
of Coroner's Court, Flinders-street Extension,
Melbourne

to be Commissioners for taking declarations and affidavits,
pursuant to the provisions of the Evidence Act 1958. To
refrain from charging fees and to resign upon being
transferred from the address stated.

Justices of the Peace.

JOHN WILLIAM BOOTH, 18 Elgin-street, Carlton, and
ALBERT McDONALD BETHUNE, Longwarry-road, Bayles,
to keep the Peace in the Central Bailiwick of the State of
Victoria.

AILSA MAE TRAINER, 41 Ovens-street, Wangaratta
to keep the Peace in the Northern Bailiwick of the State
of Victoria

ALEX WILLIAM LARKINS, Lakes Entrance
to keep the Peace in the Eastern Bailiwick of the State
of Victoria.

HAROLD THOMAS HARDING, Halls Gap
to keep the Peace in the Western Bailiwick of the State
of Victoria.

MINES DEPARTMENT.

Mining Registrar.

DERMOTT CHARLES BEVAN
to act as Mining Registrar at Gordon for the Gordon Divi-
sion of the Ballarat Mining District, vice First Constable
Raymond John Nijam, transferred.

DEPARTMENT OF WATER SUPPLY.

Members of Sewerage Authority.

ERIC STEPHEN HOCKING
to be a Member of the Mount Beauty Sewerage Authority,
to hold office as such, for the period from the date hereof,
until 29th June, 1968, subject to the provisions of the
Sewerage Districts Act.

WILLIAM McCULLOCH
to be a Member of the Mount Beauty Sewerage Authority,
to hold office as such from the date hereof, until the date
of expiry of the present term of office, of Leslie N. Peart,

as a Councillor for the Mount Beauty Riding of the Shire
of Bright, subject to the provisions of the Sewerage
Districts Act.

Waterworks Trusts Commissioners.

ERIC STEPHEN HOCKING
to be a Commissioner of the Mount Beauty Waterworks
Trust, to hold office as such, for the period from the date
hereof until 29th June, 1968, subject to the provisions of
the Water Act.

WILLIAM McCULLOCH
to be a Commissioner of the Mount Beauty Waterworks
Trust, to hold office as such from the date hereof until
the date of expiry of the present term of office of Leslie
N. Peart, as a Councillor for the Mount Beauty Riding,
of the Shire of Bright, subject to the provisions of the
Water Act.

LESTER JOHN HUBBARD
to be a Commissioner of the Noojee Waterworks Trust,
to hold such position for a period of four years from the
date hereof, subject to the provisions of the Water Act.

J. ROSSITER,

Clerk of the Executive Council.

At the Executive Council Chamber,
Melbourne, 2nd April, 1968.

Vermin and Noxious Weeds Act 1958.

APPOINTMENT OF INSPECTOR.

IT is hereby notified that the Public Service Board, in
exercise of its powers, has appointed the under-
mentioned person as an Inspector under the provisions
of section 4 of the *Vermin and Noxious Weeds Act 1958*,
without additional salary—

FRANK ROBERT CLAYTON MORGAN.

A. J. HOLT,

Secretary for Lands.

Melbourne, 1st April, 1968.

RESIGNATIONS.

HIS Excellency the Governor of the State of Victoria,
by and with the advice of the Executive Council
thereof, has, by Orders made on the 2nd April, 1968,
accepted the resignations of the persons named hereunder,
of the offices mentioned, viz.:—

LAW DEPARTMENT.

Justices of the Peace.

The persons named in the first column of the Schedule
hereto from the Commission of the Peace for the
respective Bailiwicks of the State of Victoria, set opposite
their names in the second column of the said Schedule.

SCHEDULE.

Name.	Bailiwick.
VICTOR ROY PEARD	Northern.
VIOLET MARY WAUGH (Sister Mary Gennaro)	Central.

J. ROSSITER,

Clerk of the Executive Council.

At the Executive Council Chamber,
Melbourne, 2nd April, 1968.

ORDERS IN COUNCIL

COAL MINES ACT 1958, No. 6221.

At the Executive Council Chamber, Melbourne, the
second day of April, 1968.

PRESENT:

His Excellency the Governor of Victoria.
Mr. Thompson | Mr. Reid.
Mr. Wilcox

PURSUANT to the provisions of Section 116 of the
Coal Mines Act 1958, His Excellency the Governor
of the State of Victoria, by and with the advice of the
Executive Council, doth by this Order, re-appoint Noel
Anthony Mace as a member of the Coal Mine Workers
Pensions Tribunal for a period of five years from and
inclusive of 22nd February, 1968, to be Chairman of the
said Tribunal.

And the Honorable James Charles Murray Balfour, Her
Majesty's Minister of Mines for the State of Victoria,
shall give the necessary directions herein accordingly.

J. ROSSITER,

Clerk of the Executive Council.

DEPARTMENT OF CROWN LANDS AND SURVEY.

DEPARTMENT OF CROWN LANDS AND SURVEY:

At the Executive Council Chamber, Melbourne, the second day of April, 1968.

At the Executive Council Chamber, Melbourne, the second day of April, 1968.

PRESENT:

PRESENT:

His Excellency the Governor of Victoria.
Mr. Thompson | Mr. Reid.
Mr. Wilcox

His Excellency the Governor of Victoria.
Mr. Thompson | Mr. Reid.
Mr. Wilcox

UNUSED ROADS CLOSED.

LANDS TEMPORARILY RESERVED AS SITES.

HIS Excellency the Governor of the State of Victoria, by and with the advice of the Executive Council thereof, doth hereby direct that, in pursuance of the provisions of section 349 of the Land Act 1958, the unused roads referred to hereunder be closed, viz.:—

HIS Excellency the Governor of the State of Victoria, by and with the advice of the Executive Council thereof, doth hereby, in pursuance of section 14 of the Land Act 1958, reserve temporarily from sale, from being leased, and from having a licence granted in respect thereof, and also except from occupation for mining purposes under any miner's right, the land hereinafter described:—

Parish of Loddon, County of Gunbower, being the road indicated by hatching on plan hereunder.—(L.161⁽⁶⁾) (C.99864).

KEELBUNDORA (HEIDELBERG WEST).—Site for Public purposes (Police purposes), 26 perches, Parish of Keelbundora, County of Bourke, as indicated by hatching on plan hereunder.—(K.25⁽⁶⁾) (Rs.8414).

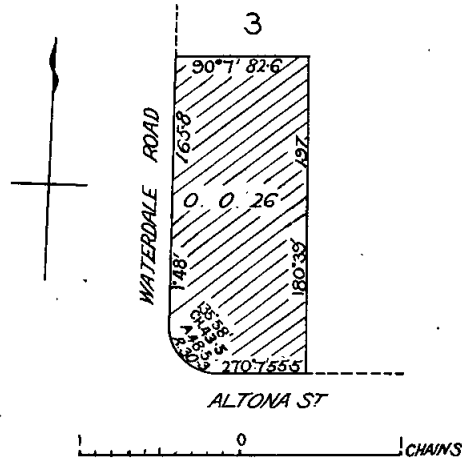
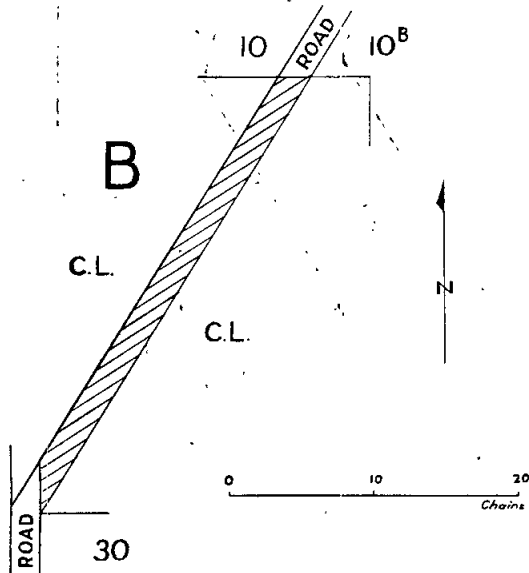

Parish of Toongabbie South, County of Tanjil, being the road indicated by hatching on plan hereunder.—(T.164⁽⁶⁾) (Rs.8964).

KILLARA.—Site for Public purposes (Public Hall), 1 acre, Parish of Killara, County of Normanby, as indicated by hatching on plan hereunder.—(K.151⁽²⁾) (Rs.8973).

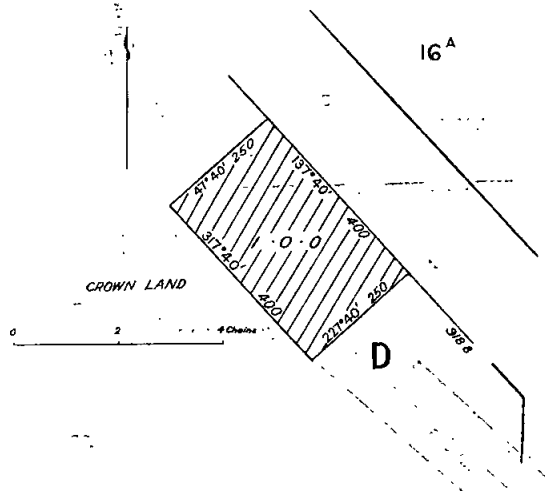
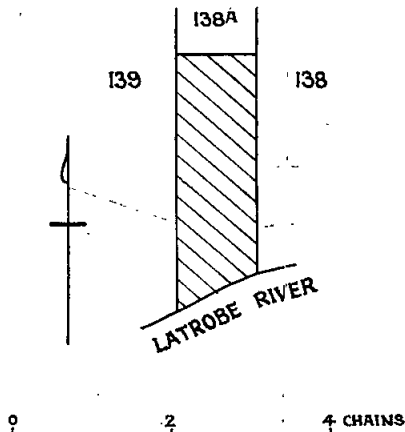

And the Honorable Sir William John Farquhar McDonald, Her Majesty's Minister of Lands for the State of Victoria, shall give the necessary directions herein accordingly.

J. ROSSITER,
Clerk of the Executive Council.

MOORNGAG.—Site for Water Supply purposes, 14 acres, more or less, Parish of Moorngag, County of Delatite, as indicated by hatching on plan hereunder.—(M.430⁽²⁾) (Rs.1200).

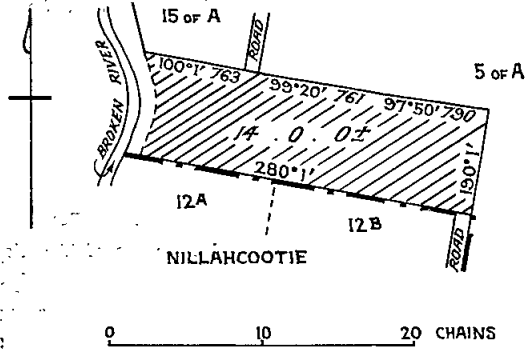

And the Honorable Sir William John Farquhar McDonald, Her Majesty's Minister of Lands for the State of Victoria, shall give the necessary directions herein accordingly.

J. ROSSITER,
Clerk of the Executive Council.

COUNTRY ROADS BOARD.

At the Executive Council Chamber, Melbourne, the second day of April, 1968.

PRESENT:

His Excellency the Governor of Victoria.
Mr. Thompson Mr. Reid.
Mr. Wilcox

ORDER CONFIRMING RESOLUTIONS OF THE COUNTRY ROADS BOARD.

HIS Excellency the Governor of the State of Victoria, by and with the advice of the Executive Council thereof, doth hereby, in pursuance of the provisions of the *Country Roads Act 1958*, confirm the resolutions of the Country Roads Board, the dates whereof and the terms of which are scheduled hereunder:—

SCHEDULE.

State highway.

Resolution dated the Twenty-fifth day of March, One Thousand Nine Hundred and Sixty-eight, made pursuant to Sections 21 and 74 of the *Country Roads Act 1958*, declaring the widening of the Princes Highway in the Shire of Colac as shown hatched on Plan numbered G.P.10593 hereunder to be part of a State highway within the meaning and for the purposes of the said Act.

STATE HIGHWAY PRINCES HIGHWAY SHIRE OF COLAC

Measurements in links

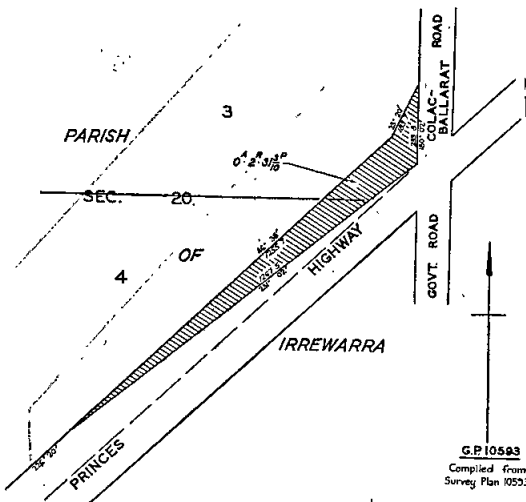

G.P.10593
Compiled from Survey Plan 10593

Main roads.

Resolution dated the Twenty-fifth day of March, One Thousand Nine Hundred and Sixty-eight, made pursuant to Section 21 of the *Country Roads Act 1958*, declaring the widening of the Bairnsdale-Dargo Road in the Shire of Bairnsdale as shown hatched on Plan numbered G.P.9861 hereunder to be part of a main road within the meaning and for the purposes of the said Act.

MAIN ROAD BAIRNSDALE-DARGO ROAD

SHIRE OF BAIRNSDALE

Measurements in links

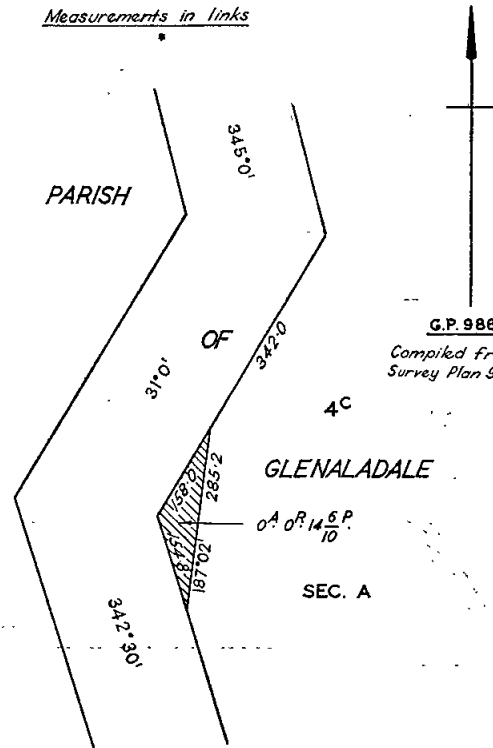

G.P.9861
Compiled from Survey Plan 9861

Resolution dated the Twenty-fifth day of March, One Thousand Nine Hundred and Sixty-eight, made pursuant to Section 21 of the *Country Roads Act 1958*, declaring the widening of the Loch-Wonthaggi Road in the Shire of Korumburra as shown hatched on Plan numbered G.P.10758 hereunder to be part of a main road within the meaning and for the purposes of the said Act.

MAIN ROAD LOCH-WONTHAGGI ROAD SHIRE OF KORUMBURRA

Measurements in links

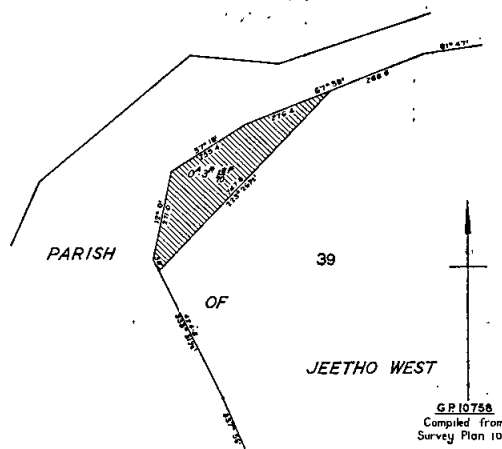

G.P.10758
Compiled from Survey Plan 10758

Resolution dated the Twenty-fifth day of March, One Thousand Nine Hundred and Sixty-eight, made pursuant to Section 21 of the *Country Roads Act 1958*, declaring the widening of the Koo Wee Rup—Longwarry Road in the Shire of Cranbourne as shown hatched on Plan numbered G.P.9007 hereunder to be part of a main road within the meaning and for the purposes of the said Act.

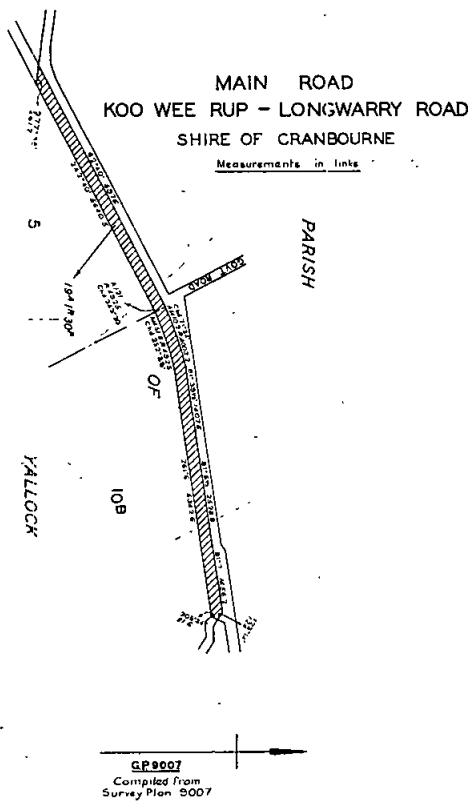

Resolution dated the Twenty-fifth day of March, One Thousand Nine Hundred and Sixty-eight, made pursuant to Section 21 of the *Country Roads Act 1958*, declaring the widening of the Mirboo—Yarragon Road in the Shire of Mirboo as shown hatched on Plan numbered G.P.10156 hereunder to be part of a main road within the meaning and for the purposes of the said Act.

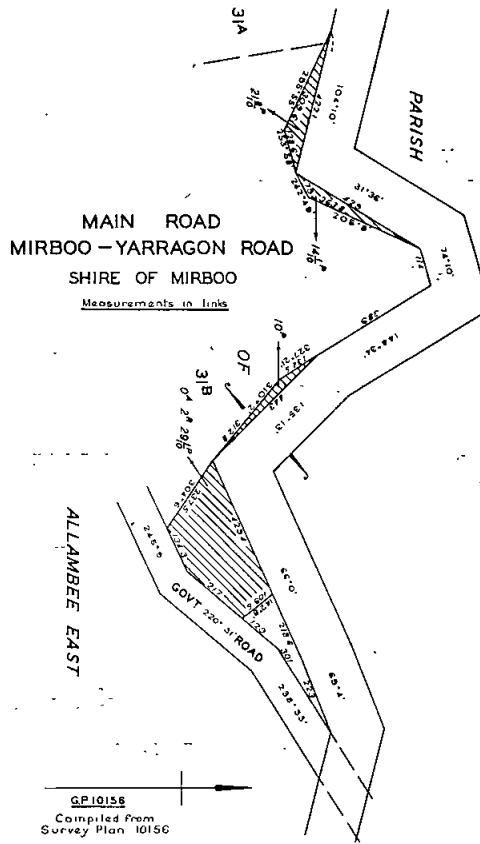

Resolution dated the Twenty-fifth day of March, One Thousand Nine Hundred and Sixty-eight, made pursuant to Section 21 of the *Country Roads Act 1958*, declaring the widening of the Tatura—Rushworth Road in the Shire of Rodney as shown hatched on Plan numbered G.P.8073 hereunder to be part of a main road within the meaning and for the purposes of the said Act.

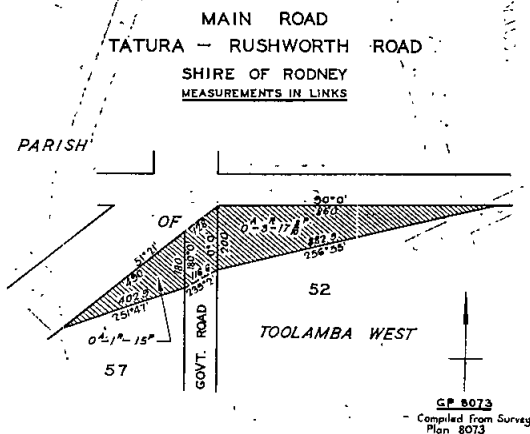

Resolution dated the Twenty-fifth day of March, One Thousand Nine Hundred and Sixty-eight, made pursuant to Section 21 of the *Country Roads Act 1958*, declaring the widening of the Shelley—Jingellic Road in the Shire of Towong as shown hatched on Plan numbered G.P.7825 hereunder to be part of a main road within the meaning and for the purposes of the said Act.

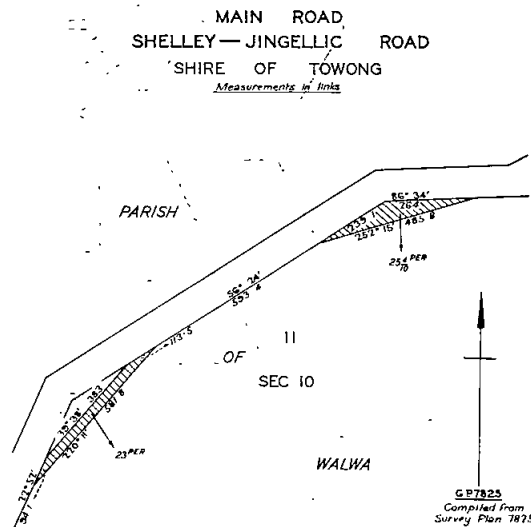

Resolution dated the Twenty-fifth day of March, One Thousand Nine Hundred and Sixty-eight, made pursuant to Sections 21 and 58 of the *Country Roads Act 1958*, declaring the deviation from Tintaldra Road in the Shire of Upper Murray as indicated by diagonal hatching on Plans numbered G.P.10801 and G.P.10802 attached to this Order to be part of a main road within the meaning and for the purposes of the said Act, and also declaring that such deviation shall be in lieu of the existing road or part thereof indicated by cross hatching on Plan numbered G.P.10801 and that such part of the said existing road shall be discontinued.

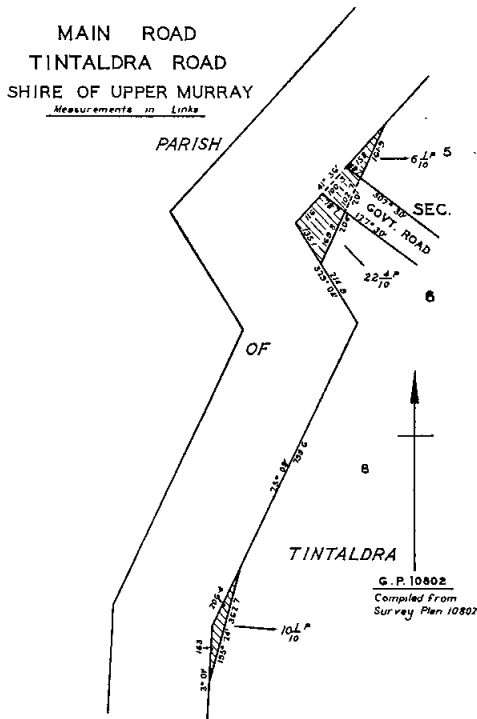
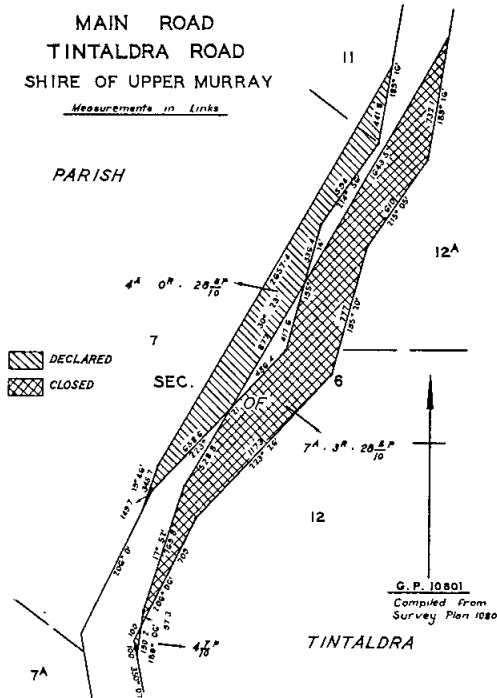

Resolution dated the Twenty-fifth day of March, One Thousand Nine Hundred and Sixty-eight, made pursuant to Section 21 of the *Country Roads Act 1958*, declaring the widening of the Yackandandah—Wodonga Road in the Shire of Yackandandah as shown hatched on plan numbered G.P.10075 hereunder to be part of a main road within the meaning and for the purposes of the said Act.

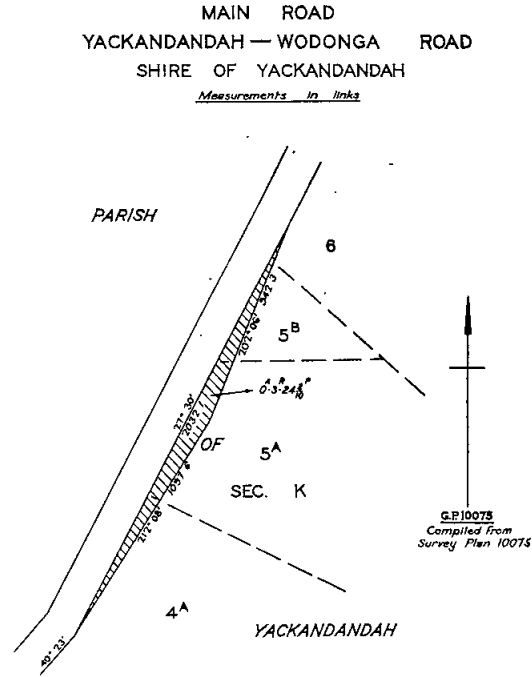

Tourists' road.
Resolution dated the Twenty-fifth day of March, One Thousand Nine Hundred and Sixty-eight, made pursuant to Sections 21, 58 and 88 of the *Country Roads Act 1958*, declaring the deviation from the Ocean Road in the Shires of Otway and Heytesbury as indicated by diagonal hatching on Plans numbered G.P.10615, G.P.10616 and G.P.10617 hereunder to be part of a tourists' road within the meaning and for the purposes of the said Act, and also declaring that such deviation shall be in lieu of the existing road or part thereof indicated by cross hatching on Plan numbered G.P.10616.

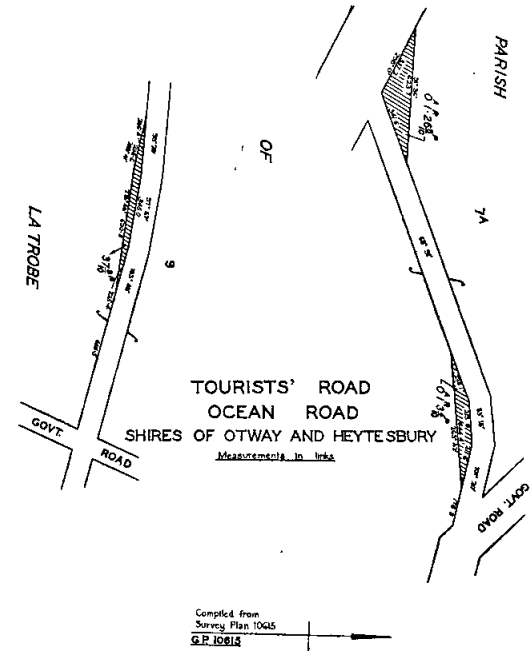

LOCAL GOVERNMENT DEPARTMENT.

At the Executive Council Chamber, Melbourne, the second day of April, 1968.

PRESENT:

His Excellency the Governor of Victoria.

Mr. Thompson | Mr. Reid.
Mr. Wilcox |

ROAD DISCONTINUED—CITY OF BRIGHTON.

WHEREAS it is provided in Section 528 (2) of the Local Government Act 1958, that where a road (whether or not a public highway but not being a road set out on land of the Crown) or any part thereof is not required for public use, the Governor-in-Council on the request of the municipality in which such road is situated made not less than one month after publishing in a newspaper generally circulating in the district and posting to the registered proprietor (if any) of the land and any person known to have an interest in the land notice of intention to make such a request may by Order published in the Government Gazette direct that such road or part shall be discontinued and thereupon such road or part shall be discontinued accordingly:

AND WHEREAS the Council of the City of Brighton has requested that a right-of-way, between Moore Street and Stone Street, Brighton be discontinued and not less than one month previously has published in a newspaper generally circulating in the district and posted to the registered proprietor of the land in the road and to all persons known to have an interest in the said road notice of intention to make such request.

NOW THEREFORE His Excellency the Governor of the State of Victoria, by and with the advice of the Executive Council thereof, hereby directs:

- (a) that the road, which is shown by hachure on the plan hereunder, shall be discontinued;
- (b) that notwithstanding such discontinuance the Melbourne and Metropolitan Board of Works shall continue to have and possess the same right title power authority or interest in or in relation to the land shown by hachure on the said plan as it had or possessed prior to such discontinuance with respect to or in connection with any sewers or drains laid or erected in on or over such land for the purposes of sewerage or drainage; and
- (c) that, subject to any such right, title power authority or interest, the land in the said road may be sold by the Council of the City of Brighton by agreement.

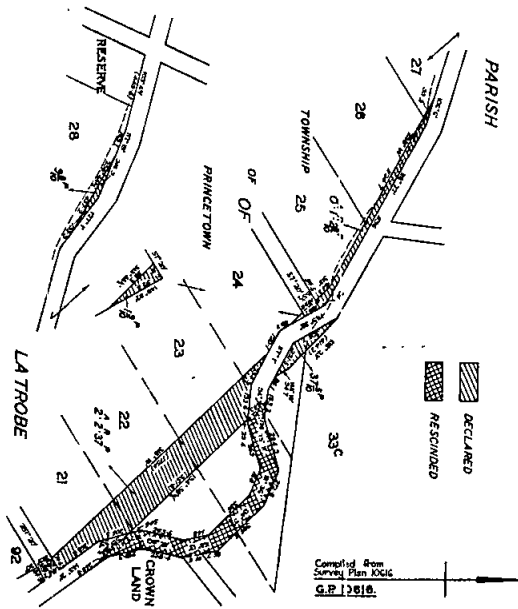

TOURISTS' ROAD
OCEAN ROAD
SHIRE OF OTWAY
Measurements in links

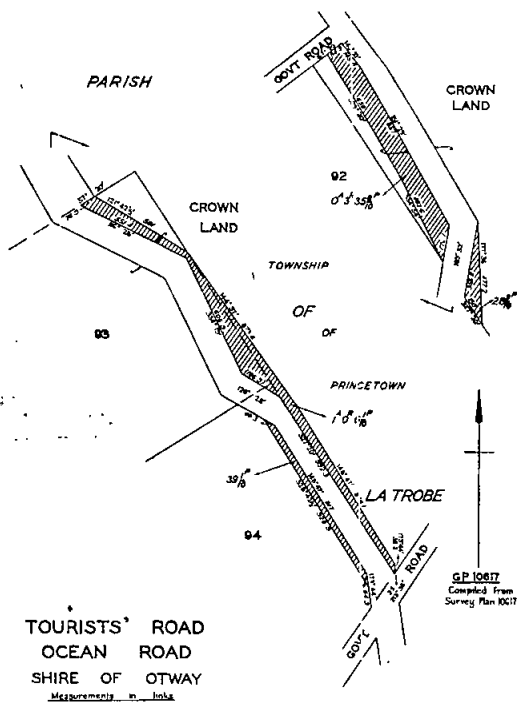

TOURISTS' ROAD
OCEAN ROAD
SHIRE OF OTWAY
Measurements in links

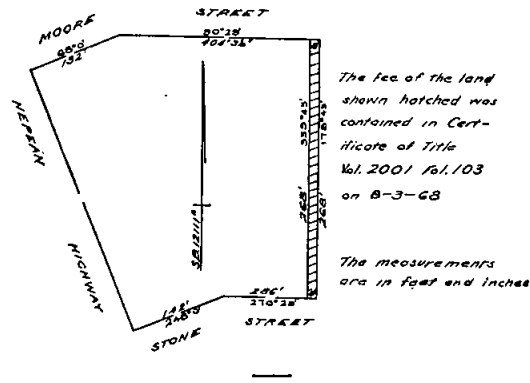

The fee of the land shown hatched was contained in Certificate of Title Vol. 2001 fol. 103 on B-3-68

The measurements are in feet and inches

And the Honorable Murray Victor Porter, Her Majesty's Minister of Public Works for the State of Victoria, shall give the necessary directions herein accordingly.

J. ROSSITER,
Clerk of the Executive Council.

And the Honorable Rupert James Hamer, Her Majesty's Minister for Local Government for the State of Victoria, shall give the necessary directions herein accordingly.

J. ROSSITER,
Clerk of the Executive Council.

SOIL CONSERVATION AND LAND UTILIZATION ACT
1958.

At the Executive Council Chamber, Melbourne, the
second day of April, 1968.

PRESENT:

His Excellency the Governor of Victoria.
Mr. Thompson | Mr. Reid.
Mr. Wilcox

DISTRICT ADVISORY COMMITTEE—GLENELG SOIL
CONSERVATION DISTRICT.

IN pursuance of the powers conferred by Section 15 of the Soil Conservation and Land Utilization Act, His Excellency the Governor of the State of Victoria by and with the advice of the Executive Council thereof doth hereby appoint the following persons to be members of the District Advisory Committee of the Glenelg Soil Conservation District for a term of three years as from 26th March, 1968.

DOUGLAS RAYMOND HEARD—being a person elected to represent grazing, agricultural and other relevant interests in the District.

ARTHUR COLIN CAMPBELL—being a person elected to represent grazing, agricultural and other relevant interests in the District.

PERCY JOHN MUNRO—being a person elected to represent grazing, agricultural and other relevant interests in the District.

ALAN HERBERT BAULCH—being a person elected to represent grazing, agricultural and other relevant interests in the District.

LESLIE GEORGE TAYLOR—being a person elected to represent grazing, agricultural and other relevant interests in the District.

STUART WARD MARGETTS—being the person representing the Department of Agriculture.

GOFFREY BERNARD EBBS—being a person representing the Soil Conservation Authority.

And the Honorable Sir William John Farquhar McDonald, Her Majesty's Minister for Conservation for the State of Victoria, shall give the necessary directions herein accordingly.

J. ROSSITER,
Clerk of the Executive Council.

HOSPITALS AND CHARITIES ACT 1958.—SECTION 52.

At the Executive Council Chamber, Melbourne, the
second day of April, 1968.

PRESENT:

His Excellency the Governor of Victoria.
Mr. Thompson | Mr. Reid.
Mr. Wilcox

VARIATION OF THE OBJECTS OR PURPOSES OF
MARYBOROUGH AND DISTRICT HOSPITAL.

WHEREAS Maryborough and District Hospital is an incorporated institution within the meaning of the *Hospitals and Charities Act 1958*;

AND WHEREAS the Committee of Management of the said institution has agreed that the objects or purposes of the said institution should be varied;

AND WHEREAS the Hospitals and Charities Commission after enquiry has recommended that the objects or purposes should be varied;

NOW THEREFORE His Excellency the Governor of the State of Victoria by and with the advice of the Executive Council of the said State, and by virtue of the powers conferred on him by Section 52 of the *Hospitals and Charities Act 1958* and all other powers enabling him in that behalf, hereby varies the objects or purposes of Maryborough and District Hospital so that such objects or purposes shall be as follows:—

- (a) To afford relief, including maintenance and the treatment or cure of, or attention to, any disease or ailment, or any injury consequent on any accident, medical and/or surgical attendance, medicine, nursing assistance,

support or aid of any kind or in any form to such persons as are entitled thereto under the Act;

- (b) To provide facilities for carrying out investigation into ailments, disease, injuries or other matters affecting the human body;
- (c) To provide facilities for the treatment of intermediate and private patients or either of them;
- (d) To provide facilities for the training of nursing aides.

And the Honorable Vance Oakley Dickie, Her Majesty's Minister of Health for the State of Victoria, shall give the necessary directions herein accordingly.

J. ROSSITER,
Clerk of the Executive Council.

HOSPITALS AND CHARITIES ACT 1958.—SECTION 52.

At the Executive Council Chamber, Melbourne, the
second day of April, 1968.

PRESENT:

His Excellency the Governor of Victoria.
Mr. Thompson | Mr. Reid.
Mr. Wilcox

VARIATION OF THE OBJECTS OR PURPOSES OF
BENDIGO HOME AND HOSPITAL FOR THE AGED.

WHEREAS Bendigo Home and Hospital for the Aged is an incorporated institution within the meaning of the *Hospitals and Charities Act 1958*;

AND WHEREAS the Committee of Management of the said institution has agreed that the objects or purposes of the said institution should be varied;

AND WHEREAS the Hospitals and Charities Commission after enquiry has recommended that the objects or purposes should be varied;

NOW THEREFORE His Excellency the Governor of the State of Victoria, by and with the advice of the Executive Council of the said State, and by virtue of the powers conferred on him by Section 52 of the *Hospitals and Charities Act 1958*, and all other powers enabling him in that behalf, hereby varies the objects or purposes of Bendigo Home and Hospital for the Aged so that such objects or purposes shall be as follows:—

- (a) To afford relief, including maintenance and the treatment or cure of, or attention to, any disease or ailment, or any injury consequent on any accident, medical and/or surgical attendance, medicine, nursing assistance, support or aid of any kind or in any form to such aged or infirm persons as are entitled thereto under the Act;
- (b) To minister to the necessities of persons admitted to the Home without regard to their race or nationality, or their religious or political beliefs;
- (c) To provide training courses for nursing staff and to provide facilities for the training of medical ancillary students and others connected with the attainment of the foregoing objects;
- (d) To provide facilities for carrying out research into the diseases of the aged and infirm;
- (e) To provide facilities for the treatment of intermediate and private patients or either of them;
- (f) To establish a home or homes, a village or housing estate for the permanent accommodation of aged persons, including the provision of premises to accommodate only aged persons within the meaning of the Aged Persons Homes Act 1954-57 of the Commonwealth of Australia and in respect of which provision a grant has been received from the Commonwealth.

And the Honorable Vance Oakley Dickie, Her Majesty's Minister of Health for the State of Victoria, shall give the necessary directions herein accordingly.

J. ROSSITER,
Clerk of the Executive Council.

STATE FORESTS DEPARTMENT.

At the Executive Council Chamber, Melbourne, the
second day of April, 1968.

PRESENT:

His Excellency the Governor of Victoria.
Mr. Thompson | Mr. Reid.
Mr. Wilcox

ALIENATED LAND ACQUIRED BY EXCHANGE, ETC.,
AND DEDICATED AS RESERVED FOREST.

WHEREAS by section 42, sub-section 8, of the Forests Act 1958, it is prescribed that the Governor in Council may acquire by exchange of land dedicated as reserved forest—

- (a) any alienated land or Crown land licensed or leased with an inchoate right of purchase; or
- (b) any land, public or private, and whether vested in trustees or otherwise,

and may by Order published in the *Government Gazette* dedicate the same as reserved forest:

Now, therefore, His Excellency the Governor of the State of Victoria, by and with the advice of the Executive Council of the said State, and in pursuance of the provisions of section 42, sub-section 8, of the Forests Act 1958, doth by this Order—

- (1) acquire the alienated land described in Schedule "A" hereto by exchange of land dedicated as reserved forest described in Schedule "B" hereto;
- (2) excise from the Reserved Forest the area described in the aforesaid Schedule "B", such excision to take effect 30 days from date hereof;
- (3) dedicate the land described in Schedule "A" aforementioned as reserved forest, such dedication to take effect 30 days from date hereof.

SCHEDULE "A"—DEDICATION SCHEDULE No. 195.

Alienated land acquired from John Gilmore Thomson and Mary Elizabeth Thomson of North Portland, being allotments 5E and 12A, Section 13, Parish of Tarragal comprising 74 acres 3 roods 15 perches.

SCHEDULE "B"—EXCISION SCHEDULE No. 158.

Land excised from Reserved Forest for John Gilmore Thomson and Mary Elizabeth Thomson of North Portland, being 115 acres 0 roods 0 perches of Reserved Forest, Section 3, Parish of Gorae, as shown on plan S-830 over 63/1563 in file of correspondence No. 63/1563 in the Forests Department.

And the Honorable Edward Raymond Meagher, Her Majesty's Minister of Forests for the State of Victoria, shall give the necessary directions herein accordingly.

J. ROSSITER,
Clerk of the Executive Council.

STATE FORESTS DEPARTMENT.

At the Executive Council Chamber, Melbourne, the
second day of April 1968.

PRESENT:

His Excellency the Governor of Victoria.
Mr. Thompson | Mr. Reid.
Mr. Wilcox

ALIENATED LAND ACQUIRED BY EXCHANGE, ETC.,
AND DEDICATED AS RESERVED FOREST.

WHEREAS by section 42, sub-section 8, of the Forests Act 1958, it is prescribed that the Governor in Council may acquire by exchange of land dedicated as reserved forest—

- (a) any alienated land or Crown land licensed or leased with an inchoate right of purchase; or
- (b) any land, public or private, and whether vested in trustees or otherwise,

and may by Order published in the *Government Gazette* dedicate the same as reserved forest:

Now, therefore, His Excellency the Governor of the State of Victoria, by and with the advice of the Executive Council of the said State, and in pursuance of the provisions of section 42, sub-section 8, of the Forests Act 1958, doth by this Order—

- (1) acquire the alienated land described in Schedule "A" hereto by exchange of land dedicated as reserved forest described in Schedule "B" hereto;
- (2) excise from the Reserved Forest the area described in the aforesaid Schedule "B", such excision to take effect 30 days from date hereof;
- (3) dedicate the land described in Schedule "A" aforementioned as reserved forest, such dedication to take effect 30 days from date hereof.

SCHEDULE "A"—DEDICATION SCHEDULE No. 196.

Alienated land acquired from Clyde William Harding of Ballarat, being allotments 129E, 129F and 129G, Parish of Yarrowee, comprising 101 acres 1 rood 35 perches.

SCHEDULE "B"—EXCISION SCHEDULE No. 159.

Land excised from Reserved Forest for Clyde William Harding of Ballarat being 12 acres 1 rood 1 perch of Reserved Forest, Section P, Parish of Ballarat, as shown on plan S-854 over 64/218 in file of correspondence No. 64/218 in the Forests Department.

And the Honorable Edward Raymond Meagher, Her Majesty's Minister of Forests for the State of Victoria, shall give the necessary directions herein accordingly.

J. ROSSITER,
Clerk of the Executive Council.

DONALD SEWERAGE AUTHORITY.

At the Executive Council Chamber, Melbourne, the
ninth day of April, 1968.

PRESENT.

His Excellency the Governor of Victoria.
Mr. Manson | Sir William McDonald.
Mr. Borthwick

APPROVAL TO SITES OF RISING MAIN AND TREATMENT WORKS AND LANDS TO BE COMPULSORILY ACQUIRED.

UNDER the powers conferred by the Sewerage Districts Act and all other powers enabling him in that behalf, His Excellency the Governor of the State of Victoria, by and with the advice of the Executive Council of the said State, doth hereby approve—

- (a) the sites for rising main and sewage treatment works on the lands described in Portions I, II, III, IV and V of the Schedule hereto, which lands are situated without the Sewerage District of the said Sewerage Authority, and
- (b) the compulsory acquisition of the lands described in Portions II, III, V, VI and VII of the said Schedule comprising the sites of pumping stations Nos. 2 and 3, rising main and treatment works.

SCHEDULE.

PORTION I.

Site of Rising Main.

The site of the Rising Main being a strip of land 50 links in width being 25 links on either side of a centreline commencing at a point on the south-eastern boundary of Camp Street distant 595.7 links south-westerly from the south-western boundary of Woods Street, Township of Donald, Parish of Banyenong, County of Kara Kara, being a point on the boundary of the existing Sewerage District; thence generally southerly through a Water Reserve and across the Richardson River to a point on its left bank.

PORTION II.

Site of Rising Main and Easement to be Compulsorily Acquired.

Commencing at a point on the southern boundary of Crown allotment 1, Section VIII A, Parish of Witchipool, County of Borung, being distant 3539.8 links easterly from the eastern boundary of a Government Road; thence through the said Crown allotment 1 by lines bearing 350°

28' a distance of 2406.0 links, bearing $11^{\circ}7'$ a distance of 395.1 links, bearing $35^{\circ}8'$ a distance of 966.5 links and bearing $30^{\circ}10\frac{1}{2}'$ to a point on the left bank of the Richardson River; thence easterly along the said left bank of the Richardson River to its intersection with a line parallel to and distant 37.9 links easterly from the said line bearing $30^{\circ}10\frac{1}{2}'$; thence through the said Crown allotment 1 by lines parallel to and distant 37.9 links easterly from the said lines bearing $30^{\circ}10\frac{1}{2}'$, $35^{\circ}8'$, $11^{\circ}7\frac{1}{2}'$ and $350^{\circ}28'$ to a point on the said southern boundary of Crown allotment 1; thence westerly along the said southern boundary of Crown allotment 1 to the point of commencement.

PORTION III.

Site of Rising Main and Easement to be Compulsorily Acquired.

Commencing at a point on the southern boundary of Crown allotment 8, Section VIII A, Parish of Witchipool, County of Borung, being distant 3533.0 links easterly from the eastern boundary of a Government Road; thence northerly by a line through the said Crown allotment 8 to a point on its northern boundary, distant 3542.8 links easterly from the said eastern boundary of a Government Road; thence easterly along the said northern boundary of Crown allotment 8 to its intersection with a line parallel to and distant 37.9 links easterly from the said line; thence southerly by the said parallel line through the said Crown allotment 8 to a point on its southern boundary; thence westerly along the said southern boundary of Crown allotment 8 to the point of commencement.

PORTION IV.

Site of Rising Main.

The site of the rising main being a strip of land 50 links in width being 25 links on either side of a centreline commencing at a point on the southern boundary of Crown allotment 8, Section VIII A, Parish of Witchipool, County of Borung being distant approximately 3550 links easterly from the eastern boundary of a Government Road; thence generally southerly by a line across Ferrier's Lane and easterly within the said Ferrier's Lane Reserve to a point opposite the site of Treatment Works as described in Portion V.

PORTION V.

Site of Treatment Works and Lands to be Compulsorily Acquired.

Commencing at the north-western angle of Crown allotment 1, Section D, Parish of Laen, County of Borung; thence easterly along the northern boundary of the said Crown allotment 1 a distance of 2954.5 links; thence through the said Crown allotment 1 by lines bearing $187^{\circ}26'$ a distance of 2045.5 links and bearing $277^{\circ}26'$ a distance of 2954.5 links to a point on the western boundary of the said Crown allotment 1; thence northerly along the said western boundary of Crown allotment 1 to the point of commencement.

PORTION VI.

Site of Pumping Station No. 3 and Lands to be Compulsorily Acquired.

Commencing at the intersection of the north-eastern boundary of Lewis Street and the north-western boundary of Napier Street, Crown allotment 7, Section 9, Township of Donald, Parish of Banyenong, County of Kara Kara; thence north-westerly along the said north-eastern boundary of Lewis Street a distance of 45.45 links; thence through the said Crown allotment 7 by lines bearing $42^{\circ}35'$ a distance of 90.91 links and bearing $132^{\circ}35'$ a distance of 45.45 links to the said north-western boundary of Napier Street; thence south-westerly along the said north-western boundary of Napier Street to the point of commencement; being an area within the existing Sewerage District.

PORTION VII.

Site of Pumping Station No. 2 and Lands to be Compulsorily Acquired.

Commencing at a point on the north-western boundary of South Street distant 250.0 links south-westerly from the south-western boundary of Woods Street, Crown allotment 2, Section 10, Township of Donald, Parish of Banyenong, County of Kara Kara; thence south-westerly along the said north-western boundary of South Street a distance of 42.4 links; thence through the said Crown allotment 2 by lines bearing $301^{\circ}10'$ a distance of 278.8 links, bearing $31^{\circ}10'$ a distance of 42.4 links and bearing $121^{\circ}10'$ a distance of 278.8 links to the point of commencement; being an area within the existing Sewerage District.

The locations and boundaries of the said sites are shown on a plan approved by the Governor in Council by and with this Order and deposited in the office of the State Rivers and Water Supply Commission, Melbourne.—(Corr. No. 67/4768/40.)

And the Honorable William Archibald Borthwick, Her Majesty's Minister of Water Supply for the State of Victoria, shall give the necessary directions herein accordingly.

J. ROSSITER,
Clerk of the Executive Council.

ALEXANDRA SEWERAGE AUTHORITY.

At the Executive Council Chamber, Melbourne, the ninth day of April, 1968.

PRESENT:

His Excellency the Governor of Victoria.
Mr. Manson | Sir William McDonald.
Mr. Borthwick

CONSENT TO BORROWING \$100,000.

UNDER the powers conferred by the Sewerage Districts Act and all other powers enabling him in that behalf, His Excellency the Governor of the State of Victoria, by and with the advice of the Executive Council of the said State, doth hereby consent to the Alexandra Sewerage Authority borrowing by mortgage of the General Fund the sum of One hundred thousand dollars (\$100,000) to meet the cost of sewerage works as set forth in the detailed statement bearing date the 4th April, 1968.

And the Honorable William Archibald Borthwick, Her Majesty's Minister of Water Supply for the State of Victoria, shall give the necessary directions herein accordingly.

J. ROSSITER,
Clerk of the Executive Council.

CHELSEA SEWERAGE AUTHORITY.

At the Executive Council Chamber, Melbourne, the ninth day of April, 1968.

PRESENT:

His Excellency the Governor of Victoria.
Mr. Manson | Sir William McDonald.
Mr. Borthwick

CONSENT TO BORROWING \$300,000.

UNDER the powers conferred by the Sewerage Districts Act and all other powers enabling him in that behalf, His Excellency the Governor of the State of Victoria, by and with the advice of the Executive Council of the said State, doth hereby consent to the Chelsea Sewerage Authority borrowing by mortgage of the General Fund the sum of Three hundred thousand dollars (\$300,000) to meet the cost of sewerage works as set forth in the detailed statement bearing date 4th April, 1968.

And the Honorable William Archibald Borthwick, Her Majesty's Minister of Water Supply for the State of Victoria, shall give the necessary directions herein accordingly.

J. ROSSITER,
Clerk of the Executive Council.

COLAC SEWERAGE AUTHORITY.

At the Executive Council Chamber, Melbourne, the ninth day of April, 1968.

PRESENT:

His Excellency the Governor of Victoria.
Mr. Manson | Sir William McDonald.
Mr. Borthwick

CONSENT TO BORROWING \$12,000.

UNDER the powers conferred by the Sewerage Districts Act and all other powers enabling him in that behalf, His Excellency the Governor of the State of Victoria, by

and with the advice of the Executive Council of the said State, doth hereby consent to the Colac Sewerage Authority borrowing by mortgage of the General Fund the sum of Twelve thousand dollars (\$12,000) for the conversion of Loan No. 9.

And the Honorable William Archibald Borthwick, Her Majesty's Minister of Water Supply for the State of Victoria, shall give the necessary directions herein accordingly.

J. ROSSITER,
Clerk of the Executive Council.

DANDENONG SEWERAGE AUTHORITY.

At the Executive Council Chamber, Melbourne, the ninth day of April, 1968.

PRESENT:

His Excellency the Governor of Victoria.
Mr. Manson | Sir William McDonald.
Mr. Borthwick |

CONSENT TO BORROWING \$19,000.

UNDER the powers conferred by the Sewerage Districts Act and all other powers enabling him in that behalf, His Excellency the Governor of the State of Victoria, by and with the advice of the Executive Council of the said State, doth hereby consent to the Dandenong Sewerage Authority borrowing at interest the sum of Nineteen thousand dollars (\$19,000) for the conversion of Loan No. 17.

And the Honorable William Archibald Borthwick, Her Majesty's Minister of Water Supply for the State of Victoria, shall give the necessary directions herein accordingly.

J. ROSSITER,
Clerk of the Executive Council.

KERANG SEWERAGE AUTHORITY.

At the Executive Council Chamber, Melbourne, the ninth day of April, 1968.

PRESENT:

His Excellency the Governor of Victoria.
Mr. Manson | Sir William McDonald.
Mr. Borthwick |

CONSENT TO BORROWING \$76,000.

UNDER the powers conferred by the Sewerage Districts Act and all other powers enabling him in that behalf, His Excellency the Governor of the State of Victoria, by and with the advice of the Executive Council of the said State, doth hereby consent to the Kerang Sewerage Authority borrowing by mortgage of the General Fund the sum of Seventy-six thousand dollars (\$76,000) to meet the cost of sewerage works as set forth in the detailed statement bearing date 4th April, 1963.

And the Honorable William Archibald Borthwick, Her Majesty's Minister of Water Supply for the State of Victoria, shall give the necessary directions herein accordingly.

J. ROSSITER,
Clerk of the Executive Council.

SHEPPARTON SEWERAGE AUTHORITY.

At the Executive Council Chamber, Melbourne, the ninth day of April, 1968.

PRESENT:

His Excellency the Governor of Victoria.
Mr. Manson | Sir William McDonald.
Mr. Borthwick |

CONSENT TO BORROWING \$100,000.

UNDER the powers conferred by the Sewerage Districts Act and all other powers enabling him in that behalf, His Excellency the Governor of the State of Victoria, by and with the advice of the Executive Council of the said State, doth hereby consent to the Shepparton Sewerage

Authority borrowing by mortgage of the General Fund the sum of One hundred thousand dollars (\$100,000) to meet the cost of sewerage works as set forth in the detailed statement bearing date the 4th April, 1968.

And the Honorable William Archibald Borthwick, Her Majesty's Minister of Water Supply for the State of Victoria, shall give the necessary directions herein accordingly.

J. ROSSITER,
Clerk of the Executive Council.

WARRACKNABEAL SEWERAGE AUTHORITY.

At the Executive Council Chamber, Melbourne, the ninth day of April, 1968.

PRESENT:

His Excellency the Governor of Victoria.
Mr. Manson | Sir William McDonald.
Mr. Borthwick |

CONSENT TO BORROWING \$19,500.

UNDER the powers conferred by the Sewerage Districts Act and all other powers enabling him in that behalf, His Excellency the Governor of the State of Victoria, by and with the advice of the Executive Council of the said State, doth hereby consent to the Warracknabeal Sewerage Authority borrowing by mortgage of the General Fund the sum of Nineteen thousand five hundred dollars (\$19,500) to meet the cost of sewerage works as set forth in the detailed statement bearing date 4th April, 1968.

And the Honorable William Archibald Borthwick, Her Majesty's Minister of Water Supply for the State of Victoria, shall give the necessary directions herein accordingly.

J. ROSSITER,
Clerk of the Executive Council.

CROYDON SEWERAGE AUTHORITY.

At the Executive Council Chamber, Melbourne, the ninth day of April, 1968.

PRESENT:

His Excellency the Governor of Victoria.
Mr. Manson | Sir William McDonald.
Mr. Borthwick |

AMENDMENT OF ORDER.

UNDER the powers conferred by the Sewerage Districts Act and all other powers enabling him in that behalf, His Excellency the Governor of the State of Victoria, by and with the advice of the Executive Council of the said State, doth hereby amend as follows the Order in Council made on the 15th day of March, 1967, and published in the *Victoria Government Gazette* No. 28 dated 22nd March, 1967, and the said Order in Council is so amended as from the date hereof.

Wherever occurring in Portions I and II of the Schedule for the words "volume 7009, folio 1401762" there shall be substituted the words "volume 4945, folio 967".

And the Honorable William Archibald Borthwick, Her Majesty's Minister of Water Supply for the State of Victoria, shall give the necessary directions herein accordingly.

J. ROSSITER,
Clerk of the Executive Council.

DANDENONG SEWERAGE AUTHORITY.

At the Executive Council Chamber, Melbourne, the ninth day of April, 1968.

PRESENT:

His Excellency the Governor of Victoria.
Mr. Manson | Sir William McDonald.
Mr. Borthwick |

AMENDMENT OF ORDER.

UNDER the powers conferred by the Sewerage Districts Act and all other powers enabling him in that behalf, His Excellency the Governor of the State of Victoria, by and with the advice of the Executive Council of the said State, doth hereby amend as follows the Order made by the Governor in Council on 26th March, 1968, and

published in the *Victoria Government Gazette* dated 27th March, 1968, consenting to the Dandenong Sewerage Authority borrowing a sum of Nineteen thousand dollars (\$19,000) for the conversion of Loan No. 15.

For the expression "Nineteen thousand dollars (\$19,000)" there shall be substituted the expression "Nine thousand dollars (\$9,000)."

And the Honorable William Archibald Borthwick, Her Majesty's Minister of Water Supply for the State of Victoria, shall give the necessary directions herein accordingly.

J. ROSSITER,
Clerk of the Executive Council.

LANDLORD AND TENANT ACT 1958.

At the Executive Council Chamber, Melbourne, the ninth day of April, 1968.

PRESENT:

His Excellency the Governor of Victoria.
Mr. Manson | Sir William McDonald.
Mr. Borthwick |

ORDER EXTENDING APPLICATION OF PART V. OF THE LANDLORD AND TENANT ACT 1958 TO CERTAIN PREMISES.

IN pursuance of the powers conferred by section 44 of the *Landlord and Tenant Act 1958*, His Excellency the Governor of Victoria, by and with the advice of the Executive Council, doth hereby declare that the application of Part V. of the *Landlord and Tenant Act 1958* shall extend to the following premises—

The premises known as Number 3 McKenzie Street, Brunswick.

And the Honorable George Oswald Reid, Her Majesty's Attorney-General in and for the State of Victoria, shall give the necessary directions herein accordingly.

J. ROSSITER,
Clerk of the Executive Council.

LANDS DEPARTMENT NOTICES

APPROACHING LAND SALES.

SALES of Crown Lands, in fee-simple, will be held at the under-mentioned places and dates, viz.:

	No. of Gazette.
Apollo Bay.—Saturday, 18th May, 1968	25
Cann River.—Wednesday, 17th April, 1968	14
Euroa.—Friday, 17th May, 1968	29
Heathcote.—Friday, 17th May, 1968	29
Mallacoota.—Wednesday, 17th April, 1968	14
Melbourne.—Wednesday, 22nd May, 1968	25
Orbost.—Thursday, 18th April, 1968	14
Robinvale.—Tuesday, 30th April, 1968	25
Rushworth.—Friday, 17th May, 1968	29
Tallangatta.—Tuesday, 7th May, 1968	29
Yackandandah.—Tuesday, 7th May, 1968	29
Yarra Junction.—Friday, 24th May, 1968	29

SALE OF FREEHOLD LAND BY AUCTION.

Apollo Bay.—Saturday 18th May, 1968 25

AUCTION OF RIGHT TO LEASE CROWN LAND.

Melbourne.—Wednesday, 22nd May, 1968 25

LOCAL LAND BOARD.

IN pursuance of the provisions of section 34 of the *Land Act 1958*, notice is hereby given that public hearings at the following place and time, will be conducted by the persons respectively mentioned, being duly appointed in that behalf.

W. J. F. McDONALD,
Minister of Lands.

Department of Crown Lands and Survey,
Melbourne.

SCHEDULE.

BENALLA LAND INSPECTOR'S OFFICE, Tuesday, 23rd April, 1968, at 11 a.m.—E. Kennedy and F. F. Holt.

PROPOSED REVOCATION OF TEMPORARY RESERVATION OF LAND BY ORDER IN COUNCIL.

IN pursuance of the provisions of the *Land Act 1958*, notice is hereby given that it is the intention of the Governor in Council to revoke the temporary reservation of land by Order in Council hereunder referred to, viz.:

The following Notice was published 1° on the 3rd April, 1968, pursuant to Orders of the 26th March, 1968.

SWAN HILL.—The temporary reservation by Order in Council of the 5th March, 1895, of 1 acre 1 rood 33 perches of land in the Township of Swan Hill (formerly Township of Castle Donnington) as a site for a Public Park and Garden is about to be revoked.—(S.464(*) (Rs.2601).

W. J. F. McDONALD,
Minister of Lands.

PROPOSED PERMANENT RESERVATION OF LANDS AS SITES.

IN pursuance of sections 14 and 21 of the *Land Act 1958*, notice is hereby given that it is the intention of the Governor in Council to reserve permanently from sale, from being leased and from having a licence granted in respect thereof the land hereinafter described:—

The following Notice was published 1° on the 27th March, 1968, pursuant to Orders of the 19th March, 1968.

OAKLEIGH.—Land proposed to be permanently reserved as a site for Public Recreation, 2 roods 1 perch, more or less, Township of Oakleigh, Parish of Mulgrave, County of Bourke, being the site temporarily reserved therefor by Order in Council of the 5th February, 1952.—(O.1(2) (Rs.470).

OAKLEIGH.—Land proposed to be permanently reserved as a site for Public Recreation, 1 acre 10 perches, Township of Oakleigh, Parish of Mulgrave, County of Bourke, being the remaining portion of the site temporarily reserved therefor by Order in Council of the 12th May, 1925.—(O.1(2) (Rs.470).

W. J. F. McDONALD,
Minister of Lands.

PROPOSED REVOCATIONS OF TEMPORARY RESERVATIONS OF LANDS BY ORDERS IN COUNCIL.

IN pursuance of the provisions of the *Land Act 1958*, notice is hereby given that it is the intention of the Governor in Council to revoke the temporary reservations of lands by Orders in Council hereunder referred to, viz.:

The following Notices were published 1° on the 27th March, 1968, pursuant to Orders of the 19th March, 1968.

BARWO.—The temporary reservation, by Order in Council of the 26th September, 1887, of 89 acres 2 roods 35 perches of land in the Parish of Barwo as a site for a Racecourse is about to be revoked.—(B.690A(*) (Rs.4890).

TALLANGATTA VALLEY.—The temporary reservation by Order in Council of the 16th December, 1941, of 3 acres 3 roods of land in the Township of Tallangatta Valley (formerly Township of Wyeboon) as a site for Camping Purposes is about to be revoked.—(W.340C2) (Rs.5305).

W. J. F. McDONALD,
Minister of Lands.

PROPOSED REVOCATIONS OF TEMPORARY RESERVATIONS OF LANDS BY ORDERS IN COUNCIL.

IN pursuance of the provisions of the *Land Act 1958*, notice is hereby given that it is the intention of the Governor in Council to revoke the temporary reservations of lands by Orders in Council hereunder referred to, viz.:

The following Notices were published 1° on the 20th March, 1968, pursuant to Orders of the 13th March, 1968.

TONIMBUK.—The temporary reservation, by Order in Council of the 20th November, 1934, of 6 acres 2 roods 3 perches of land in the Parish of Tonimbuk as a site for the Supply of Gravel is about to be revoked.—(T.280(1) (Rs.4417).

BANNOCKBURN.—The temporary reservation as a site for the use of the Police Department and the withholding from sale, leasing and licensing by Order in Council of the 9th August, 1881, of land in the Parish of Wabdallah (now in the Township of Bannockburn) are about to be revoked.—(B.35⁽¹⁾) (Rs.8869.)

KERANG.—The temporary reservation, by Order in Council of the 24th June, 1902, of 41 acres 25 perches of land in the Township of Kerang as a site for a Sewage Farm, revoked as to part by various Orders, is about to be revoked so far as the balance thereof containing 16 acres 2 roods 5 perches, more or less, is concerned.—(K.19⁽¹¹⁾) (Rs.5955.)

ECHUCA.—The temporary reservation, by Order in Council of the 30th November, 1874, of 2 acres 24 perches, more or less, of land in the Township of Echuca as a site for Drainage purposes, revoked as to part by Order of the 2nd July, 1963, is about to be revoked so far only as the portion containing 1 rood 10 perches, more or less, indicated by hatching on plan hereunder, is concerned.—(E.⁽⁸⁾) (C.76302.)

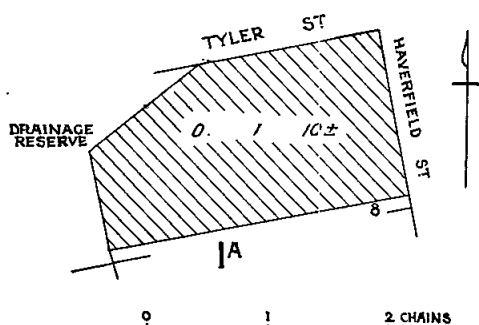

STAWELL.—The temporary reservation, by Order in Council of the 13th November, 1944, of 1 acre 1 rood 22 perches of land in the Township of Stawell (formerly Borough of Stawell) as a site for Racecourse and Public Recreation is about to be revoked.—(S.329⁽¹²⁾) (Rs.3938.)

POREPUNKAH.—The temporary reservation, by Order in Council of the 27th March, 1917, of 3 roods 16 perches of land in the Parish of Porepukah as a site for a Rubbish Depot is about to be revoked.—(P.70A⁽⁸⁾) (Rs. 1441.)

PORT WELSHPOOL.—The temporary reservation, by Order in Council of the 8th February, 1916, of 2 acres of land in the Township of Port Welshpool (formerly Township of Welshpool) as a site for a Rubbish Depot is about to be revoked.—(P.189⁽²⁾) (Rs.888.)

W. J. F. McDONALD,
Minister of Lands.

REGULATIONS FOR THE CARE, PROTECTION, AND MANAGEMENT OF THE APOLLO BAY FORESHORE.

WHEREAS by section 218 of the *Land Act 1958* the Minister of Lands is empowered to make Regulations with respect to certain land and for extending or applying all or any of those Regulations to certain other land:

Now therefore I, William John Farquhar McDonald, Her Majesty's Minister of Lands in and for the State of Victoria, do hereby make the following Regulation.

All the Regulations made on the 20th October, 1932, with respect to the portions of the Reserves for Public purposes in the Parish of Krambruk as are indicated by red colour on plan marked K/14.3.30 attached to Lands Department correspondence Rs.4917, are hereby applied to the land in the Parish of Krambruk, temporarily reserved by Order in Council dated the 25th May, 1965, as a site for Public purposes.—(Rs.4917.)

Given under my hand at Melbourne, on the 4th day of April, 1968.

W. J. F. McDONALD,
Minister of Lands.

Every person who contravenes or fails to comply with these Regulations shall, in accordance with the provisions of section 218 of the *Land Act 1958*, for each offence be liable to a penalty of not more than Fifty dollars, and

every person who contravenes or fails to comply with any such Regulations, and who, after he has been warned by any bailiff of Crown lands or by any member of the Police Force, does not desist therefrom may be forthwith apprehended by such bailiff or member of the Police Force and taken before some justice to be dealt with according to law and shall be liable to a penalty of not more than One hundred dollars.

REGULATIONS FOR THE CARE, PROTECTION, AND MANAGEMENT OF THE "NANDALY RECREATION RESERVE".

WHEREAS by section 218 of the *Land Act 1958* the Minister of Lands is empowered to make Regulations with respect to certain land and for extending or applying all or any of those Regulations to certain other land: Now therefore I, William John Farquhar McDonald, Her Majesty's Minister of Lands in and for the State of Victoria, do hereby make the following Regulation:—

All the Regulations made on the 27th August, 1928, with respect to the land in the Township of Nandaly and Parish of Bimbourie, reserved as a site for Public Recreation and Showgrounds are hereby applied to the land in the Township of Nandaly and Parish of Bimbourie, temporarily reserved by Order in Council dated the 16th January, 1968, as a site for Public Recreation and Showground.—(Rs.1334.)

Given under my hand at Melbourne, on the 4th day of April, 1968.

W. J. F. McDONALD,
Minister of Lands.

Every person who contravenes or fails to comply with these Regulations shall, in accordance with the provisions of section 218 of the *Land Act 1958*, for each offence be liable to a penalty of not more than Ten dollars, and every person who contravenes or fails to comply with any such Regulations, and who, after he has been warned by any bailiff of Crown lands or by any member of the Police Force, does not desist therefrom may be forthwith apprehended by such bailiff or member of the Police Force and taken before some justice to be dealt with according to law and shall be liable to a penalty of not more than Twenty dollars.

ADDITIONAL REGULATION FOR THE CARE, PROTECTION, AND MANAGEMENT OF THE "SHOREHAM FORESHORE RESERVE".

WHEREAS by section 218 of the *Land Act 1958*, power is given to the Minister of Lands to make Regulations in respect of the care, protection and management of any Crown land which has been reserved under the *Land Acts* for any public purpose whatsoever and which has not been conveyed to or vested in trustees, and for further purposes so enacted: Now therefore the Minister of Lands, in pursuance of the power conferred aforesaid doth hereby make the following additional Regulation in respect of certain land in the Township of Balnarring and Parishes of Balnarring and Flinders, reserved for Public purposes as are indicated by red colour on plan marked "F"/12.4.61 attached to Lands Department correspondence.—(Rs.3297.)

REGULATION.

36. No person shall bring any rubbish into the Reserve, and deposit it in the containers provided for the users of the Reserve.

Given under my hand at Melbourne, on the 4th day of April, 1968.

W. J. F. McDONALD,
Minister of Lands.

Every person who contravenes or fails to comply with these Regulations shall, in accordance with the provisions of section 218 of the *Land Act 1958*, for each offence be liable to a penalty of not more than Fifty dollars, and every person who contravenes or fails to comply with any such Regulations, and who, after he has been warned by any bailiff of Crown lands or by any member of the Police Force, does not desist therefrom may be forthwith apprehended by such bailiff or member of the Police Force and taken before some justice to be dealt with according to law and shall be liable to a penalty of not more than One hundred dollars.

REGULATIONS FOR THE CARE, PROTECTION AND MANAGEMENT OF THE CAPE SCHANCK AND OCEAN FRONTAGE RESERVE, SORRENTO FORESHORE RESERVE, RYE OCEAN PARK RESERVE, RYE FORESHORE RESERVE, ARTHUR'S SEAT PUBLIC PARK, SORRENTO OCEAN PARK RESERVE, FLINDERS FORESHORE RESERVE, KOONYA OCEAN PARK RESERVE.

WHEREAS by section 218 of the *Land Act 1958* the Minister of Lands is empowered to make Regulations as to any land which under the provisions of that Act or of any other Act relating to Crown lands has been reserved for any public purpose whatsoever and which has not been conveyed to or vested in trustees: And whereas the above-named Reserves have not been conveyed to or vested in trustees: And whereas it is expedient that Regulations for the care, protection and management of the Reserves and for other purposes connected therewith should be made: Now therefore I, William John Farquhar McDonald, Her Majesty's Minister of Lands in and for the State of Victoria, in pursuance of the powers aforesaid, do hereby make the following Regulations for or with respect to the Reserves:—

The above-named Reserves have been placed under the control of the Council of the Shire of Flinders as a Committee of Management with power and authority to enforce the following Regulations:—

REGULATIONS.

Title.

1. These Regulations may be cited as the Cape Schanck and Ocean Frontage Reserve, Sorrento Foreshore Reserve, Rye Ocean Park Reserve, Rye Foreshore Reserve, Arthur's Seat Public Park Reserve, Kings Falls Reserve, Sorrento Public Park Reserve, Sorrento Ocean Park Reserve, Koonya Ocean Park Reserve, Flinders Foreshore Reserve.

Parts.

2. These Regulations are divided into Parts as follows:—

Part I.—The Reserves Generally.

Part II.—Camping Areas.

Part III.—General.

Application.

3. Parts I. and III. of these Regulations shall apply to the whole of the Reserves and Part II. shall apply to any camping areas therein.

4. These Regulations are made in lieu of all previous Regulations which may have been applicable to the Reserves mentioned in the Title hereto and which Regulations are hereby revoked.

Definitions.

5. In these Regulations unless inconsistent with the context or subject-matter—

"Act" means the *Land Act 1958*.

"Authorized Officer" means any person appointed, in writing, by the Committee as an authorized officer for the purpose of these Regulations and (except for the purpose of receipt of any fees or the grant, variation or revocation of any permit) also includes any member of the Police Force and any bailiff of Crown Lands.

"Camp", without limiting the generality of the verb, includes—

(a) Erect, occupy or use any tent, or any temporary makeshift or similar form of accommodation; or

(b) park, occupy or use any caravan or other movable form of accommodation.

5. "Camping Area" means any part of the Reserves reserved under the Act or set apart by the Committee as a site for camping purposes.

"Committee" means the Committee of Management appointed, pursuant to the Act to manage the Reserves.

"Firearm" includes any rifle, gun, pistol, air pistol, gun or like thing using gas, cartridges, catapult, bow and arrow or cross bow and any other implement designed to discharge missiles capable of injuring or destroying animal life.

"Permit" includes any authority, approval, consent, permission, receipt, ticket or the like given, granted or issued under the Act or these Regulations.

"Vehicle" includes any motor car, motor cycle, bicycle, cart, trailer, caravan, horse drawn vehicle, trailer and water craft.

"Building" means any tent, marquee, stall, booth, shed, bathing box, boat shed, swing boat, merry-go-round, ocean wave, toilet block or other structure or erection.

"Person" means and includes a person, a group of persons, members of any Club, Society or any organization or any member thereof and any firm or corporation (where the context so permits).

For the purpose of these Regulations words purporting the singular number shall mean and include the plural and words purporting the masculine gender shall mean and include the feminine gender where the context requires or admits.

PART I.—THE RESERVES GENERALLY.

Behaviour.

6. No person shall—

(a) Enter or remain in the Reserves who may offend against decency as regards dress, language or conduct;

(b) commit or create or knowingly permit or allow to continue any public or private nuisance or any annoyance to the public or any person lawfully in the Reserves whether such nuisance or annoyance takes place in a public or private building, tent, caravan or other structure or in any enclosed or unenclosed space in the Reserves or do or suffer to be done any act which in the opinion of an authorized officer is or is likely to be to the annoyance or disturbance of any person using the Reserves;

(c) Except in an area set apart for the purpose, play any game in which a hard ball is used or engage in any game or sport likely to cause interference, disturbance or danger to other persons using the Reserves.

Shooting, &c.

7. No person shall in the Reserves except in accordance with a written permit—

(a) Shoot, trap, maim, injure, kill or destroy any bird or animal;

(b) have in his possession, carry or use any firearm, poison, trap or snare.

8. (a) Any person carrying or using any firearm, poison, trap or snare in the Reserves without a permit shall surrender the same on demand to any authorized officer who shall issue a receipt therefore.

(b) The person apparently entitled to any such article may collect it from the office of the Committee after completion of investigations and legal proceedings (if any) by the Committee or the Police in relation to any offence alleged against the person who surrendered the same.

Damage.

9. (a) No person, except with a permit issued by the Committee, shall in the Reserves, remove, cut, damage, displace, deface or interfere with any rock, timber, tree, shrub, plant, wild flower or other vegetation or any sign, notice board, seat, table, gate, post, fence, bridge, building, structure or any other thing of the like nature to any of the foregoing.

(b) No person shall without a permit from the Committee, dig or remove from or take into the Reserves any gravel, stone, shell grit, sand, soil or loam.

Missiles.

10. No person shall roll or throw any stone or other substance or missile within the Reserves.

Camping.

11. No person shall camp in any part of the Reserves except in accordance with the provisions of Part II. of these Regulations.

Refuse and Litter.

12. No person shall within the Reserves deposit or cause to be deposited (except in a receptacle provided for the purpose) any bottle, glass object, vessel or other container, broken glass, tins, waste paper, foodstuff, vegetable matter, offal or other refuse or litter.

Glass, &c.

13. No person shall intentionally break any glass, bottle or other container within the Reserves and in the event of breaking any glass, bottle or other container shall immediately gather the pieces up and place them in receptacles provided.

General.

14. No person shall in any part of the Reserves, except in accordance with and upon the terms of a permit, in writing, by the Committee—

- (a) Sell or offer for sale any article whatsoever;
- (b) give out, distribute, erect, leave, set up or display any handbills, placards, notices, pamphlets, books, papers, advertising matter or the like thing;
- (c) occupy, use or enter any building, booth, shed, stand or structure unless the same is set aside for public use or held under occupancy by the person concerned;
- (d) erect or place therein any building, booth, shed or other structure;
- (e) solicit or collect money or orders for goods or services;
- (f) take part in or advertise any entertainment for gain;
- (g) preach, declaim, harangue or deliver any address of any kind or use any amplifier, public address system, loud hailer or similar device;
- (h) let for hire any article, device or thing;
- (i) take photographs for gain or commercial purposes;
- (j) ply any vehicle for hire or carry passengers for fee or reward;
- (k) conduct any school or provide any form of instruction for gain;
- (l) advertise for sale or trade or hire any article, device, service or thing.

Dogs.

15. No person shall cause, suffer or permit any dog belonging to him or in his charge—

- (a) To be brought into or enter or remain in the Reserves unless such dog be and continue to be under proper control on a chain, cord or leash and unless such dog be effectively restrained from causing annoyance to any person and from damaging or interfering in any way with the property of the Committee;
- (b) to be brought into or enter or remain in any camping area or any portion of the Reserves prohibited to the entry of dogs and indicated by notices.

Horses.

16. No person shall ride, drive or lead any horse upon the Reserves except for the purpose of swimming or bathing the same in Port Phillip Bay and then only in the mornings before 8 a.m.

Animals Generally.

17. (a) Save as aforesaid, no person shall cause or suffer or knowingly permit any animal belonging to him or in his charge to be brought into or enter or remain in the Reserves without a permit.

(b) Any animal found in the Reserves contrary to these Regulations may be seized by an Authorized Officer and impounded or destroyed, and the owner or custodian thereof shall be liable to pay compensation for any damage done by such animal to the property of the Committee.

Enclosures.

18. No person shall, except where and upon conditions authorized by the Committee, enter any area in the Reserves which is enclosed for plantations of young trees, shrubs or grass plots or for the growth or preservation of native flora or for re-establishment of growth or reclamation of eroded areas.

Fires.

19. No person shall without a permit light a fire within the Reserves, except in a fireplace provided by the Committee for the purpose and any person who lights a fire in the Reserves shall take all reasonable and proper precautions to ensure that the fire does not escape from control, nor shall any person wilfully, carelessly or negligently do make or permit any act or omission which may result or be likely to result in damage by fire to anything growing or being thereon.

Roadways, &c.

20. No person shall unless authorized by the Committee drive, ride, push, pull, place or leave any vehicle in or on the Reserves except in or upon such roadways or areas set aside for the purpose, and no person shall allow any vehicle to remain stationary in any position obstructing the lawful passage of others.

Parking.

21. No person shall park any vehicle within the Reserves except—

- (a) In an area set apart for the purpose and clearly defined by signs; or
- (b) as and where directed or authorized by the Committee or an Authorized Officer;
- (c) upon payment of such fees (if any) as may be prescribed.

Stranded Vehicles.

22. An Authorized Officer may remove or cause to be removed or order the removal of any parked, stranded or broken down vehicle from any roadway or area within the Reserves—provided that the removal of any vehicle—

- (a) Shall be at the sole risk of the owner of the vehicle who shall be deemed to have accepted such risk as a condition of entry to the Reserves; and
- (b) may be effected in such manner as the Authorized Officer deems fit.

Abandoned Vehicles.

23. Any vehicle left unattended within the Reserves for a continuous period exceeding 48 hours may be removed by the Committee at the risk and expense of the owner.

Use of Facilities.

24. No person shall—

- (a) Use any kitchen, laundry, change room, shower, toilet or other convenience or any part thereof in the Reserves, except for its proper purpose and upon payment of such fees (if any) as may be prescribed;
- (b) enter or use or permit any child under his care or control to enter or use any place, room, convenience or structure set apart for the use of the opposite sex; provided that this Regulation shall not apply to a child under the age of six years, when accompanied by an adult of the opposite sex;
- (c) if above the age of fourteen years, use any swings or play equipment provided for children, or (save whilst in charge of a child under that age) enter any children's playground.

Boatsheds, &c.

25. (a) The Committee may set aside sites on the Reserves for bathing boxes, boatsheds and other buildings or structures.

(b) No person shall occupy any such site or erect or maintain any such structure without a written permit from the Committee.

(c) The Committee may at any time cancel the permit given in which case the bathing box, boatshed or other structure shall be removed and in the event of it not being removed by the person to whom the permit had been given for such occupation, the Committee shall cause the bathing box, boatshed or other structure to be removed from the Reserve.

(d) No bathing box, boatshed or similar structure shall be used at any time for residential purposes and in the event of the Committee being satisfied that such bathing box, boatshed or similar structure is being used contrary to this Regulation, the permit shall be cancelled.

Direction by Sign.

26. (a) The Committee may, by clear notices or signs established in such prominent position or positions as the case requires, prohibit or regulate any act, matter or thing within the Reserves or any part thereof.

(b) No person shall erect or remove any such notice or sign except with the authority of the Committee.

(c) No person shall disobey the directions indicated in any such notice or sign.

Permits.

27. (a) The holder of any permit shall observe and comply with all conditions thereof.

(b) Any person purporting to hold any permit shall produce the same on demand by an Authorized Officer and unless such permit is thereupon produced that person shall not be entitled to claim the benefit of any such permit.

Direction to Leave.

28. (a) Any Authorized Officer may direct a person who in his opinion offends any of these Regulations forthwith to leave the Reserves or any place therein.

(b) Every person who fails to comply forthwith with any such direction shall be guilty of an offence and may be removed from the Reserves or such place.

Giving of Name.

29. If, in the opinion of an Authorized Officer, any person has contravened or failed to comply with any provision of these Regulations, then such officer may demand and receive the name and address of such person and any person who refuses to furnish his name and address or who then furnishes an incorrect name and address, shall be deemed to have committed an offence.

Obstruction to Officers.

30. No person shall obstruct, hinder or interfere with an Authorized Officer or any employee of the Committee in the execution of his duty in the Reserves.

General.

31. Every person found to be under the influence of alcohol in the Reserves shall be guilty of an offence against these Regulations.

32. No person shall commit any nuisance or behave in a disorderly manner in the Reserves.

33. Every person bathing from the Reserves shall be decently attired in a bathing costume.

34. No person shall play any game or take part in any activity in or on any portion of the Reserve to the danger, inconvenience or annoyance of the public or any member of the public.

35. The Committee may set apart or enclose certain parts of the Reserves for the holding of fêtes, sports, concerts, carnivals or other amusements subject to such conditions as may be set out on such permit and on such charges as the Committee shall decide.

36. Any permits required to be issued by the Committee of the Reserves shall be issued by the Secretary of the Committee or other Authorized Officer of the Committee.

PART II.—CAMPING AREAS.

General.

37. The Committee may—

- (a) Set aside any portions of the Reserves as camping areas.
- (b) Set apart individual camp sites within any camping area.
- (c) Fix and collect such fees or other charges as it may from time to time determine for the entry, use or occupation of any camping area or of any facilities or sites therein.

Conditions.

38. (a) No person shall camp except on a site set apart as aforesaid.

(b) No person shall occupy or use any site or any facilities or amenities within any camping area except in accordance with a written permit from the Committee.

(c) Any permission issued by the Committee or its Authorized Officer to a person to use a camping area or camping site may be cancelled or withdrawn by the Committee or its authorized officer, and subject to such cancellation or withdrawal a proportionate refund of any fees or charges paid in advance may be refunded, and the Committee or its authorized officer at its or his discretion may deduct and retain from any such proportionate refund such sums as it or he determines will be necessary to clean up and put in order the site in relation to which the permission has been so cancelled or withdrawn.

(d) No person shall neglect or refuse to remove forthwith, any tent, camping structure, caravan or vehicle erected or installed on any portion of the Reserves when directed to do so by the Committee or its authorized officer.

Cleanliness.

39. Every person using or in any camping area shall—

- (a) Maintain any site used or occupied by him and all appurtenances for the time being thereon in a clean, sanitary and tidy condition;
- (b) before vacating such site, clear the same of all refuse and litter whatsoever;
- (c) observe proper standards of hygiene and tidiness in the use of the camping area generally and of facilities and amenities therein;
- (d) abide by all lawful directions given by the Committee or an authorized officer.

PART III.—GENERAL.

General Powers.

40. The Committee may—

(a) Provide and maintain conveniences, facilities and amenities of any description in any part of the Reserves; or arrange for the provision and maintenance thereof and may from time to time determine or vary the conditions of entry or use thereof;

(b) make such arrangements as it deems necessary or desirable for or in connexion with the proper and efficient management and operation of the Reserves or any portion thereof.

Permits.

41. (a) Any permit may be granted for such period and subject to such terms, conditions and fees consistent with these regulations as the Committee may from time to time determine either generally or in a particular case.

(b) No permit shall be transferable.

(c) Any permit (other than a permit granted by or pursuant to a document under seal) may be revoked or withdrawn.—(Rs.1187, Rs.1010, Rs.7713, Rs.3565, Rs.1496, Rs.229, Rs.4124, Rs.2110, Rs.3605, Rs.7224.)

Given under my hand at Melbourne, on the fourth day of April, 1968.

W. J. F. McDONALD,

Minister of Lands.

Every person who contravenes or fails to comply with these Regulations shall, in accordance with the provisions of section 218 of the *Land Act 1958*, for each offence be liable to a penalty of not more than Fifty dollars, and every person who contravenes or fails to comply with any such Regulations, and who, after he has been warned by any bailiff of Crown lands or by any member of the Police Force, does not desist therefrom may be forthwith apprehended by such bailiff or member of the Police Force and taken before some justice to be dealt with according to law and shall be liable to a penalty of not more than One hundred dollars.

REGULATIONS FOR THE CARE, PROTECTION AND MANAGEMENT OF THE "PHILLIP ISLAND KOALA RESERVES".

WHEREAS by section 218 of the *Land Act 1958* the Minister of Lands is empowered to make Regulations as to any land which under the provisions of that Act or of any other Act relating to Crown lands has been reserved for any public purpose whatsoever and which has not been conveyed to or vested in trustees: And whereas certain Crown lands in the Parish of Phillip Island were reserved as sites for a Sanctuary for Native Bears and the Preservation of Koalas: And whereas such lands (hereinafter called "the Reserve") have not been conveyed to or vested in trustees.

And whereas it is expedient that Regulations for the care, protection and management of the Reserve and for other purposes connected therewith should be made: Now therefore I, William John Farquhar McDonald, Her Majesty's Minister of Lands in and for the State of Victoria, in pursuance of the powers aforesaid, do hereby make the following Regulations for or with respect to the Reserve.

REGULATIONS.

1. No person shall enter or remain in the Reserve without the authority, in writing, of the Curator or of a member of the Committee of Management.

2. No person shall enter or remain in the Reserve who may offend against decency as regards dress, language, or conduct.

3. No person shall, without the permission, in writing, of the Committee of Management first obtained, remove, cut, damage, or deface any buildings, trees (whether alive or dead) or any shrubs, ferns, plants, or bark, fruit, seeds, roots, leaves or flowers, or seats, tables, gates, posts or fences in the Reserve, or write on or otherwise, mark any tree, seat, gate, post, table, fence, pillar, railing, building, or any other erection within or in connexion with the Reserve.

4. No person shall climb upon or jump over the fences in or around the Reserve or stick bills on the buildings, fences, gates, seats or trees, or cut or paint names, letters, or marks on the buildings, trees or seats, gates, posts or fences, or otherwise deface or write thereon without the permission, in writing, of the Committee of Management first obtained.

5. No person shall shoot, poison, trap, snare, hook, catch, or otherwise destroy or interfere with or take away any animal, including birds, of any description, or skin, egg, feathers, or nest, or carry any firearms, poison, traps, snares, or gins within the Reserve without the permission, in writing, of the Committee of Management first obtained.

6. No person shall light or maintain any fire within the Reserve without the permission, in writing, of the Committee of Management first obtained, and then only in such places as may be directed.

7. No person shall camp in the Reserve, nor erect therein any dwelling, nor any booth or other structure for any purpose whatsoever, or offer for sale therein any article without the permission, in writing, of the Committee of Management first had and obtained, and then only subject to the payment of such fees and on such conditions as the Committee of Management may determine; such written permission shall, if required, be produced at any time to any person duly authorized by the Committee of Management to demand the production of same.

8. No person shall bring into the Reserve or allow to wander therein any horse, cattle, sheep, goat, pig, or other animal without permission, in writing, of the Committee of Management first obtained, and the owner of any such animals found trespassing shall be liable to prosecution for breach of these Regulations.

9. The Committee of Management shall have full power to impound any cattle found trespassing in the Reserve, and the Committee of Management shall be taken to be the occupier of the Reserve (with all power incidental to that status) within the meaning of any law for the time being in force relating to the impounding of cattle. For the purpose of this clause, "cattle" shall mean cattle as interpreted by section 3 of the Pounds Act 1958.

10. No person shall bring into the Reserve any seed or portion of any plant without the permission, in writing, of the Committee of Management first obtained.

11. No dog shall be allowed in the Reserve, and all dogs found therein shall be liable to be destroyed, and the owners thereof to prosecution.

12. No person except those employed in the Reserve, and other persons engaged on official business, shall enter any plots therein which may be enclosed for plantations of young trees or shrubs, or for the protection of young native species naturally grown, or remove therefrom any plant or bark, fruit, seed, leaves, or flowers, or other part of any plant, without the permission, in writing, of the Committee of Management.

13. No motor delivery cart, lorry, wagon, truck, van, or other vehicle shall be allowed within the Reserve without the permission, in writing, of the Committee of Management first obtained.

14. No person shall commit a nuisance in any part of the Reserve, or in or on any part of any building in the Reserve.

15. No person shall play, practice, or engage in any game or sport within the Reserve, or at any time behave in such a way as, in the opinion of the Committee of

Management, tends to frighten or disturb the native animals and/or birds therein.

These Regulations are made in lieu of all previous regulations in respect of the said land which are hereby revoked.—(Rs.79, Rs.8401, Rs.4770 and Rs.7714.)

Given under my hand at Melbourne, on the 4th day of April, 1968.

W. J. F. McDONALD,
Minister of Lands.

Every person who contravenes or fails to comply with these Regulations shall, in accordance with the provisions of section 218 of the Land Act 1958, for each offence be liable to a penalty of not more than Fifty dollars, and every person who contravenes or fails to comply with any such Regulations, and who, after he has been warned by any bailiff of Crown lands or by any member of the Police Force, does not desist therefrom may be forthwith apprehended by such bailiff or member of the Police Force and taken before some justice to be dealt with according to law and shall be liable to a penalty of not more than One hundred dollars.

REGULATIONS FOR THE CARE, PROTECTION AND MANAGEMENT OF "AKOONAH PARK", BERWICK.

WHEREAS by section 218 of the Land Act 1958 the Minister of Lands is empowered to make Regulations with respect to certain land and for extending or applying all or any of those Regulations to certain other land: Now therefore I, William John Farquhar McDonald, Her Majesty's Minister of Lands in and for the State of Victoria, do hereby make the following Regulation:—

All the Regulations made on the 12th December, 1951, with respect to the land in the Township of Berwick, temporarily reserved by Order in Council dated the 24th April, 1951, as a site for Showgrounds and Public Recreation, are hereby applied to the land in the Township of Berwick, temporarily reserved by Order in Council dated the 6th February, 1968, as a site for Show Grounds and Public Recreation.—(Rs.6654.)

Given under my hand at Melbourne, on the fourth day of April, 1968.

W. J. F. McDONALD,
Minister of Lands.

Every person who contravenes or fails to comply with these Regulations shall, in accordance with the provisions of section 218 of the Land Act 1958, for each offence be liable to a penalty of not more than Fifty dollars, and every person who contravenes or fails to comply with any such Regulations, and who, after he has been warned by any bailiff of Crown lands or by any member of the Police Force, does not desist therefrom may be forthwith apprehended by such bailiff or member of the Police Force and taken before some justice to be dealt with according to law and shall be liable to a penalty of not more than One hundred dollars.

SALE BY AUCTION.

NOTICE is hereby given that the following Contracts of Sale have been cancelled.

Lot.	Place of Sale.	Date of Sale.	Allotment.	Section.	Township or Parish.	Area.			Purchaser.
						A.	R.	P.	
11 ..	Melbourne	15.7.59	33	J	Warneet ..	0	0	32	M. T. Anderson
2 ..	Ballarat	3.6.64	A14R	..	Dereel ..	44	0	19	H. A. Green

Department of Lands and Survey,
Melbourne, 3002, 27th March, 1968.

W. J. F. McDONALD,
Minister of Lands.

COMMITTEES OF MANAGEMENT OF RESERVES.

APPOINTMENTS.

NOTICE is hereby given that, in pursuance of section 221 of the Land Act 1958, the following appointments of Committees of Management of reserved Crown lands have been made by the Minister of Lands:—

"ANGLESEA MARINE AND RIVER FRONTAGES AND RECREATION RESERVE."

Fenton Leslie Hedley, Ralph Desmond Harrison, Ralph Myall, Max Gerlach, Kenneth Douglas Ingram, Willis John Hunt and Gerald Joseph McKnight as a Committee of Management for a period ending the 6th June, 1968, of the remainder of the reserved Crown lands in the Parishes of Jan Juc and Angahook at Anglesea, as indicated by red colour on plan marked "J/14.1.1941", attached to Lands Department correspondence C.74086, and known as the "Anglesea Marine and River Frontages and Recreation Reserve".—(Corres. C.74086.)

"BALLIANG RECREATION RESERVE."

Thomas Leslie McMahon, Mervyn Winstanley Haines, Henry David Craig, Graeme Kerr Gulline and Cecil Alexander Beggs as a Committee of Management for a period of three (3) years of the land in the Parish of Balliang, temporarily reserved by Order in Council dated the 2nd September, 1913, as a site for Public Recreation, and known as the "Balliang Recreation Reserve".—(Corres. Rs.620.)

"BLACKWOOD CRICKET AND RECREATION RESERVE", AND THE "BLACKWOOD PUBLIC PARK AND RECREATION RESERVE."

Capel Murray Healey, Maxwell Kennet Matheson, John Joseph Cann, Kenneth Matheson, Walter Henry Sweet, Gary George Matheson and Leslie Edward Armstrong as a Committee of Management for a period of three (3) years of the land in the Parish of Blackwood, permanently reserved by Order in Council dated the 10th April, 1893, as a site for Cricket and other purposes of Public Recreation, and known as the "Blackwood Cricket and Recreation Reserve", together with the reserved Crown lands indicated by red colour on plan "B/22.9.50" attached to Lands Department correspondence Rs.6591, and known as the "Blackwood Public Park and Recreation Reserve".—(Corres. Rs.484, Rs.6591.)

"BUNGAREE PUBLIC RECREATION RESERVE."

William O'Donohue, Andrew J. Prendergast, Patrick J. Mahar, Thomas P. Hanrahan, Francis M. Cullinan and Albert C. Trigg as a Committee of Management for a period of three (3) years of the land in the Parish of Warrenheip, temporarily reserved by Order in Council dated the 11th November, 1964, as a site for Public Recreation, and known as the "Bungaree Public Recreation Reserve".—(Corres. Rs.5211.)

"CORINDHAP PUBLIC PURPOSES (SUPPLY OF GRAVEL) RESERVE."

The Corporation of the Council of the Shire of Leigh as the Committee of Management of the land in the Township of Corindhap, temporarily reserved by Order in Council dated the 20th February, 1968, as a site for Public purposes (Supply of Gravel).—(Corres. Rs.8949.)

"CORYYONG RACECOURSE, SHOW YARDS AND RECREATION RESERVE."

Percy William Attrée (for so long only as he continues to be a Councillor and the elect of the Council of the Shire of Upper Murray), James Carmody, Clarence Leonard Brew, Colin Andrew Whitesed, Leo Clarence Lloyd, Thomas Bruce Harris, Gordon Corrigan Hamilton, Colin William John McClure, and Ronald John Macnamara as a Committee of Management for a period ending the 17th November, 1968, of the land in the Township of Corryyong, Parish of Towong, temporarily reserved as a site for a Racecourse and other purposes of Public Recreation and Show Yards, by Order in Council dated the 20th February, 1968, this site being an extension to the remaining portion of reserved Crown land, set aside for the same purpose by Orders in Council dated the 20th August, 1888, and 12th October, 1909.—(Corres. Rs.1930.)

"EDENHOPE PUBLIC PARK, GARDENS AND RECREATION RESERVE."

The Corporation of the Council of the Shire of Kowree as the Committee of Management of the land in the Township of Edenhope, temporarily reserved by Order in Council dated the 20th February, 1968, as a site for Public Park, Gardens and Recreation.—(Corres. Rs.8952.)

"INGLEWOOD PUBLIC PARK."

John William Appleby, George Albert Addlem, Ronald Barber, Alan Robert Cumming, William John Leitch and James Little as a Committee of Management for a period of three (3) years of the land in the Township of Inglewood, permanently reserved by Orders in Council dated the 26th March, 1884, and 30th June, 1966, as a site for a Public Park, and known as "Inglewood Public Park".—(Corres. Rs.1263.)

"INVERLOCH RECREATION RESERVE."

William McIndoe Cashin, Gottfried Nicholas Jongeblood, Ronald Bolding, William Ross McDermott, Alfred William Cuttriss, Arthur Reginald Baker, John Francis Miller, Maurice William Cargill, Jeffrey William Metherall, Allan Henry, Noel David Beaton and Patrick McGarvie as a Committee of Management for a period of three (3) years of the land in the Parish of Kirrak, temporarily reserved by Order in Council dated the 15th May, 1888, as a site for Public Recreation, and known as the "Inverloch Recreation Reserve".—(Corres. Rs.661.)

"KYABRAM RACECOURSE AND RECREATION RESERVE."

Leon Joseph Pettifer and David Athol Vickers (as representatives of the public), Arthur Steven Caldwell and George Hooper (as representatives of the Kyabram Turf Club), Gordon Alexander Fraser, Paul Herbert Easton (as representatives of the Kyabram Golf Club), Willard Alfred Robinson (for so long only as he shall continue to be a Councillor and the elect of the Borough of Kyabram) as a Committee of Management for a period of three (3) years of the land in the Parish of Kyabram East, temporarily reserved by Order in Council dated the 5th December, 1967, as a site for Racecourse and Recreation purposes, and known as the "Kyabram Racecourse and Recreation Reserve".—(Corres. Rs.1446.)

"LABERTOUCHE PUBLIC HALL RESERVE."

Brian Scandolera, Ronald Douglas Davidson, Richard Iben Hine, Henry Bernadus de Vent, Charles A. L. Muir, William Farrington Kydd, Kevin Macfarlane, Leonard W. Boreham, Lawrence M. Ryan and Walter Drayton as a Committee of Management for a period of three (3) years of the land in the Parish of Jindivick, temporarily reserved by Order in Council dated the 31st October, 1961, as a site for a Public Hall, and known as the "Labertouche Public Hall Reserve".—(Corres. Rs.8083.)

"LAKE BOGA PUBLIC PARK."

Thomas Leslie Richie, Murray Whelan, James A. Denham, James Eric Teague, Gordon Raymond Filler, Peter John Lowe, Thomas Edward Lightfoot, Maurice Codling, Ronald Potts, Ronald George Kelly and Albert Malcolm King as a Committee of Management for a period of three (3) years of the reserved Crown land in the Township of Lake Boga, Parish of Kunat Kunat, shown black on plan marked "KB/12.12.1967" attached to Lands Department correspondence Rs.2824, and known as "Lake Boga Public Park".—(Corres. Rs.2824.)

"LAKE LASCELLES PUBLIC PURPOSES RESERVE."

Thomas Henry Phillips, Peter Robert Grigg, Kenneth Graeme Healey, Michael James Hallam, Kenneth Phillip Collins, Brian Raymond Decker, Harold Leslie Healey, Kenneth William Entwistle and Reginald Christopher Crawford as a Committee of Management for a period of three (3) years of the land in the Parish of Wiall, temporarily reserved by Order in Council dated the 6th September, 1966, as a site for Public purposes, and known as "Lake Lascelles".—(Corres. Rs.8407.)

"LISMORE RECREATION RESERVE."

James Russell McCall, Christopher John Bennett, John Edward Meyer, Edward Morcom Rogers, John Henry Bustard, John Edmund Baker, Thomas Escrick Seymour, James Rowe Oman and Alexander John Brett, as a

Committee of Management for a period of three (3) years of the land in the Township of Lismore temporarily reserved for Public Recreation by Order in Council dated the 24th September, 1877, and known as the "Lismore Recreation Reserve".—(Corres. Rs.2301.)

"LONGWARRY NORTH MECHANICS INSTITUTE RESERVE."

Walter John Wade, John Clive Cocks, Frederick Lloyd Haysom, Leslie Albert Faux, Neville James North, Edward Hughes Gardner, Roy Alfred Berryman and Herbert Gardener as a Committee of Management for a period of three (3) years of the land in the Parish of Drouin West, temporarily reserved by Order in Council dated the 17th October, 1961, as a site for a Public Hall, and known as the "Longwarry North Mechanics Institute Reserve".—(Corres. Rs.8077.)

"MACARTHUR RECREATION RESERVE."

Daryl Norman Timms, Wesley Benjamin Sharrock, Peter Andrew Paton, Rodney Jacob Jacobson, Robert William Trigger, John Edward Barling and Lawrence Alfred Deckert as a Committee of Management for a period of three (3) years of the lands in the Township of Macarthur, temporarily reserved by Order in Council dated the 24th March, 1885, as a site for Public Recreation, and by Order in Council dated the 11th September, 1916, reserving the area for the additional purpose of Snowgrounds and also such portion of the Reserve for Public purposes in the Township of Macarthur as indicated by pink tint on plan marked "A" with Lands Department correspondence Rs.718, and known as the "Macarthur Recreation Reserve".—(Corres. Rs.718.)

"MAIN STREET MISSION RESERVE", BALLARAT EAST.

The Corporation of the Council of the City of Ballarat as the Committee of Management of the land in the Township of Ballarat East, temporarily reserved by Order in Council dated the 20th February, 1968, as a site for Public Recreation, and known as the "Main Street Mission Reserve".—(Corres. Rs.8948.)

"MOUNT ECKERSLEY RECREATION RESERVE."

George Edwards, Gordon Charles Solly, Robert James Marney, Hector John Field and Edgar Robert Bannam as a Committee of Management for a period ending the 2nd August, 1970, of the land in the Parish of Myamyn, temporarily reserved by Orders in Council dated the 10th August, 1954, and 27th February, 1968, as sites for Public Recreation and known as the "Mount Eckersley Recreation Reserve".—(Corres. Rs.7287.)

This appointment is made in lieu of all previous appointments which are hereby revoked.

"NAMBROK HALL AND RECREATION RESERVE."

Norman David Medew, Vernon John Bermingham, William Henry Wheeler, Henry Cull, John Joseph Killeen, John Bruce Mathieson, William John Gurling, Robert Joseph Barr Mason, Kevin Jeremiah Gray, Ronald Sydney Pieteron, Douglas Benbow Jenkin, Willi Brordus John Smits, Donald Gavin Johnston and Lowther Thomas Lees as a Committee of Management for a period ending the 7th December, 1970, of the land in the Parish of Denison, temporarily reserved by Order in Council dated the 11th February, 1958, as a site for a Public Hall and Public Recreation and known as the "Nambrok Hall and Recreation Reserve".—(Corres. Rs.7700.)

This appointment is made in lieu of the appointment made on the 8th December, 1967, which is hereby revoked.

"NUNGURNER FORESHORE RESERVE."

Raymond Duke Kleinitz, Frank Pollard Stephenson, Arthur Francis Fulford, Edith Fanny Ferguson, Peter John C. Bury, Elizabeth Hyland Fulford, and Earl Bearham as a Committee of Management for a period ending the 14th May, 1968, of the reserved Crown land in the Parishes of Colquhoun and Bumberrah and the Township of Nungurner, as indicated by red colour on plan "B/21-10-54" attached to Lands Department correspondence C.95531, and known as the "Nungurner Foreshore Reserve".—(Corres. C.95531.)

"PIANGIL MEMORIAL PARK RESERVE."

Donald William Hayden, Harold Hankinson, Leslie James Granger, Reginald Becher Hungerford, Samuel E. Gibson, Daryl H. Rodgers, Henry George Blandthorn,

Alan J. Branson, Ian J. Rodgers and Ronald Cramer as a Committee of Management for a period of three years of the land, temporarily reserved by Order in Council dated the 22nd January, 1918, as a site for Recreation purposes in the Township of Piangil, and known as the "Piangil Memorial Park Reserve".—(Corres. Rs.1728.)

"PRINCETOWN RESERVES."

Frederick Simpson Allan, Errol Cameron, James Thomas Robbins, Colin Lester Jacobs, Sydney Fordyce Duguid, Jan Van Leerdaam, Charles Haslam Gorman, William John Till, Cecil James Duro, Leslie Thorpe Lewis, James Wines, Henry Walter Shorney, William Henry Scott and Kevin John Howlett as a Committee of Management for a period of three (3) years of the reserved Crown lands in the Township of Princetown as are indicated by yellow, blue and red colours on plan marked "P/11.8.60" attached to Lands Department correspondence C.76060, and known as the "Princetown Reserves".—(Corres. C.76060.)

SITE FOR PUBLIC PURPOSES (ELDERLY PEOPLES HOMES) RESERVE, ARARAT.

Patricia Gertrude Grano, Hugh James Carruthers and Bruce Rowland Tivey, the accredited representatives of the Ararat Elderly Peoples Homes, as the Committee of Management of the land in the Township of Ararat, temporarily reserved by Order in Council dated the 5th March, 1968, as a site for Public purposes (Elderly Peoples Homes).—(Corres. Rs.8717.)

"PUBLIC PURPOSES (MUNICIPAL PURPOSES) RESERVE", ECHUCA.

The Corporation of the Council of the City of Echuca as the Committee of Management of the land in the Township of Echuca, Parish of Echuca North, temporarily reserved by Order in Council dated the 20th February, 1968, as a site for Public purposes (Municipal purposes), together with the frontage to the Campaspe River, as shown by green hachure on sketch plan "E/19.5.66" attached to Lands Department correspondence Rs.8945.—(Corres. Rs.8945.)

"PUBLIC RECREATION RESERVE" AT BENDIGO (GOLDEN SQUARE).

The Corporation of the City of Bendigo as the Committee of Management of the land in the Parish of Sandhurst at Bendigo (Golden Square), temporarily reserved by Order in Council dated the 20th February, 1968, as a site for Public Recreation.—(Corres. Rs.7267.)

PUBLIC PURPOSES (MUNICIPAL DEPOT) RESERVE, TOWNSHIP OF PORTARLINGTON.

The Corporation of the Council of the Shire of Bellarine as the Committee of Management of the land in the Township of Portarlington, temporarily reserved by Order in Council dated the 27th February, 1968, as a site for Public purposes (Municipal Depot).—(Corres. Rs.8958.)

"PUBLIC RECREATION RESERVE", SWAN HILL.

The Corporation of the Council of the City of Swan Hill as the Committee of Management of the land in the Township of Swan Hill, temporarily reserved by Order in Council dated the 27th February, 1968, as a site for Public Recreation.—(Corres. Rs.4956.)

SITE FOR A RUBBISH DEPOT, TOWNSHIP OF GOORNONG.

The Corporation of the Council of the Shire of Huntly as the Committee of Management of the land in the Township of Goornong, temporarily reserved by Order in Council dated the 7th December, 1914, as a site for a Rubbish Depot.—(Corres. Rs.386.)

"WALPEUP RECREATION RESERVE."

Lester Edmund Schubert, Kenneth Sellars Renkin, Jack Williams, Edward James Gwiel, Clifford James Ferguson, Francis John Wakefield, Donald Henry Vallance, John Henry Smith, Harold Leslie Pryse, David Jack Alger, Neil John Vallance, Richard John Corbett and Norman Kenneth McSwain as a Committee of Management for a period ending the 18th September, 1970, of the land in the Parish

of Walpeup, reserved as a site for Public Recreation, and known as the "Walpeup Recreation Reserve".—(Corres. Rs.1948.)

This appointment is made in lieu of the appointment made on the 19th September, 1967, which is hereby revoked.

—
"WANDO VALE PUBLIC HALL RESERVE."

John Patrick Neylon, Stanley Edgar Donehue, Terrence Pete Davidson, Hamilton Kitchener Cowland, Colin Arthur Munro, Eric Phillip John Pettingill, William Roy Wathen, Arthur Noel Munro, and Norman Forge Munro as a Committee of Management for a period of three (3) years of the land in the Township of Wando Vale, temporarily reserved by Orders in Council dated the 22nd July, 1902, and 22nd November, 1949, as sites for a Public Hall, and known as the "Wando Vale Public Hall Reserve".—(Corres. Rs.5839.)

—
"WATER SUPPLY PURPOSES RESERVE," MARYBOROUGH.

The Corporation of the Council of the City of Maryborough, as the Committee of Management of the land in the Parish of Maryborough, temporarily reserved by Orders in Council dated the 31st May, 1880, and 20th February, 1968, as sites for Water Supply purposes.—(Corres. Rs.6583.)

—
"WOOLAMAI RECREATION RESERVE."

Gordon Clive Hade, Francis Alexander Shackelford, Bernard Schackelford, William Alford, Arthur Henry Eden, Edward Maxwell Hade and William Robert Finlay as a Committee of Management for a period of three (3) years of the remaining portion of land in the Parish of Woolamai, temporarily reserved by Order in Council dated the 25th June, 1888, as a site for a Racecourse, and known as the "Woolamai Recreation Reserve".—(Corres. Rs.4350.)

W. J. F. McDONALD,
Minister of Lands.

Department of Crown Lands and Survey,
Melbourne, 4th April, 1968.

TENDERS

PUBLIC WORKS DEPARTMENT

TENDERS will be received at Public Works Department, Treasury-place, Melbourne, until **TWO** p.m. on dates shown and for purposes mentioned hereunder.

Particulars and tender forms available at Contracts Office, Room 7, Building Division, Parliament-place and at places indicated in brackets hereunder.

Abbreviations in brackets mean:—W.O.—Inspector of Works Office; P.S.—Police Station; C.S.—Consolidated School; H.E.S.—Higher Elementary School; H.S.—High School; S.S.—State School; T.S.—Technical School.

Tenders to be submitted on the Department's printed Tender Form and will not be received by telephone. All tenders must be on a "Firm Tender" basis. The lowest or any tender will not necessarily be accepted.

Address tenders to the Minister of Public Works, and endorse the envelope containing the tender "Tender for , closing Tuesday,

Hand delivered tenders to be placed in the Tender Box of the Public Works Department, located on the wall of the centre entrance foyer, Ground Floor, New Treasury Building, Treasury-place, Melbourne.

No preliminary deposit is required with any tender, but a successful tenderer will be required to pay a deposit for any accepted tender of \$5,000 or over.

Wednesday, 17th April, 1968.

Building, Electrical and Mechanical Works.

Alberton West.—Renovations, &c., S.S. 2140 and Residence. (W.O., Traralgon.) (Re-advertised.)

Boronia.—Erection of two new Science Rooms, High School.

Boronia.—Electrical installation, High School.

Boronia.—Mechanical services, High School.

Cooriemungle.—Additional exterior lighting, H.M. Prison Farm. (W.O., Geelong and Camperdown.)

Elliminyt.—Connexion to sewer, S.S. 2028. (W.O., Geelong.)

Fitzroy North.—Alterations and additions to toilets, S.S. 1490.

Melbourne.—Supply and installation of an Air Conditioning System, South Australian Government Tourist Bureau, Royal Arcade. (Re-advertised.)

Morwell.—Erection of Assembly Hall, Technical School. (W.O., Traralgon; T.S., Morwell.)

Morwell.—Electrical services, Technical School. (W.O., Traralgon; T.S., Morwell.)

Morwell.—Mechanical services, Technical School. (W.O., Traralgon; T.S., Morwell.)

Murtoa.—Renovations, S.S. 1549. (W.O., Warracknabeal.)

Nambrok West.—Internal and external renovations, S.S. 3648 and Residence. (W.O., Traralgon; S.S., 3648, Nambrok West.)

Various.—Erection of three brick-veneer proprietary residences, Travancore Developmental Centre, Flemington, and Children's Cottages, Kew.

Wodonga.—Additional class-rooms, High School. (W.O., Wangaratta.)

Wodonga.—Electrical installation, High School. (W.O., Wangaratta.)

Wodonga.—Mechanical services, High School. (W.O., Wangaratta.)

Site Works.

Mount Macedon.—Construction of a concrete water storage tank, Memorial Cross Reserve. (Forests Commission, Macedon.)

Mount Macedon.—Kerbing, channelling and drainage works, Memorial Cross Reserve. (Forests Commission, Macedon.)

Miscellaneous.

Ararat.—Supply of timber and hardboard, Mental Hospital.

Beechworth.—Supply of Plumbing Fittings, Mental Hospital.

St. Albans.—Supply of universal milling machine, Technical School.

Various.—Supply of woodworking machines for the period 1st July, 1968, to 30th June, 1969, schools and other Government Departments.

Various.—Supply of engineers machine tools for the period 1st July, 1968, to 30th June, 1969, schools and other Government Departments.

Various.—Supply of engineers lathes for the period 1st July, 1968, to 30th June, 1969, schools and other Government Departments.

Tuesday, 23rd April, 1968.

Building, Electrical and Mechanical Works.

Bendigo.—Mechanical services, Technical College. (W.O., Bendigo.)

Coburg.—Supply and installation of replacement furnace, H.M. Prison.

Dromana.—Erection of new court house. (W.O., Mornington.) (Re-advertised.)

Echuca.—Erection of a brick office block and cell block, Police Station. (W.O., Shepparton; P.S., Echuca.)

Echuca.—Electrical installation, Police Station. (W.O., Shepparton; P.S., Echuca.)

Echuca.—Mechanical services, Police Station. (W.O., Shepparton; P.S., Echuca.)

Hawthorn.—Erection of new building, Technical Teachers' College. (Bills of Quantities Available.)

Hawthorn.—Electrical installation, Technical Teachers' College.

Hawthorn.—Mechanical services, Technical Teachers' College.

Hawthorn.—Electric passenger lift, Technical Teachers' College.

Hawthorn West.—Additional toilet facilities, S.S. 293.

Rutherglen.—Erection of new staff Hostel, Agricultural Research Station. (W.O., Wangaratta.)

Rutherglen.—Mechanical services, Agricultural Research Station. (W.O., Wangaratta.)

Templestowe.—Connexion to sewer, High School.

Toora.—Erection of tile-roofed brick veneer office, Police Station. (W.O., Korumburra.) (Re-advertised.)

Warrnambool.—Erection of new cell, Police Station. (W.O., Warrnambool.)

Werribee.—Erection of broiler test shed, State Research Farm. (W.O., Geelong.) (Re-advertised.)

Furniture and Furnishings.

Ballarat.—Supply and fix curtains, Mental Hospital. (W.O., Ballarat, Horsham.)

Site Works.

Balwyn.—Asphalt and concrete paving, drainage, &c., "Illoura", Reception Centre, Social Welfare Department.
 Brunswick North.—Asphalt, concrete and gravel paving, &c., S.S. 3585.
 Mont Park.—Paving, drainage and roadway, Mental Hospital.
 Wellington.—Asphalting, concreting, drainage, &c., S.S. 4947.

Tuesday, 30th April, 1968.**Building, Electrical and Mechanical Works.**

Ballarat.—Alterations, Residence, Mental Hospital. (W.O., Ballarat.) (Re-advertised.)
 Balmoral.—Erection of combined kitchen and dining room, High School. (W.O., Hamilton.)
 Balmoral.—Electrical installation, High School. (W.O., Hamilton; H.S., Balmoral.)
 Balmoral.—Mechanical services, High School. (W.O., Warrnambool, Hamilton.)
 Bayswater.—External repairs and painting, High School.
 Beechworth.—External painting, High School. (W.O., Wangaratta.)
 Benalla.—Erection of new wing, High School. (Bills of Quantities available.) (W.O., Benalla, Wangaratta.)
 Benalla.—Electrical installation, High School. (W.O., Wangaratta; H.S., Benalla.)
 Benalla.—Mechanical services, High School. (W.O., Benalla, Bendigo and Wangaratta.)
 Cranbourne.—Erection of brick veneer wing, S.S. 2068.
 Cranbourne.—Electrical installation, S.S. 2068.
 Cranbourne.—Plenum heating, S.S. 2068.
 Hawthorn West.—Internal renovations and painting, S.S. 293.
 Heidelberg.—Renovations, toilet block, S.S. 294.
 Kyabram.—Renovations, Residence, S.S. 2902. (W.O., Shepparton; S.S., Kyabram.)
 Melbourne.—Internal painting, William Angliss Food Trades School.
 Merbein.—Underpinning of school building, S.S. 3687. (W.O., Mildura.)
 Myrtleford.—External renovations, Residence, Lands and Survey Department. (W.O., Benalla.)
 Niddrie.—Internal renovations, High School.
 Seaholme.—Mechanical services, S.S. 4440.

Shepparton.—Additions and alterations, Residence, Ambergere Hospital. (W.O., Shepparton.) (Re-advertised.)
 Warrandyte South.—Fire and water service installation, S.S. 3476.

Site Works.

Booroondara North.—Site works, S.S. 4960.
 Broadmeadows.—Site works, S.S. 4900.
 Burwood.—Site works, "Allambie" Reception Centre.
 Burwood.—Design and construction of swimming pool, "Allambie" Reception Centre.
 Guthridge.—Site works, S.S. 4853. (W.O., Traralgon.)
 Mentone Park.—Site works, S.S. 4955.
 Merbein.—Site works, S.S. 3687. (W.O., Mildura.)

Miscellaneous.

Kew.—Supply and delivery of one 25-lb. capacity washer extractor, John Cannon House.
 Port Melbourne.—Supply and delivery of one 6-ton truck, Public Works Department's Depot.

Tuesday, 7th May, 1968.**Building, Electrical and Mechanical Works.**

Carlton.—Alterations and additions, Collins Motors Building. (Bills of Quantities available.)
 Carlton.—Electrical installation, Collins Motors Building.
 Carlton.—Mechanical services, Collins Motors Building.
 Carlton.—Installation of passenger lift, Collins Motors Building.
 Carlton.—Supply and installation of P.A.B.X. telephone system, Collins Motors Building.
 Carlton.—Thermal fire alarm system, Collins Motors Building.
 Chiltern.—Renovations to Residence and Office, Police Station. (W.O., Wangaratta; P.S., Chiltern.)
 Mossiface.—Connexion to water main, S.S. 3176. (W.O., Bairnsdale, Orbost; S.S., Mossiface.)
 Sunbury.—Extensions and renovations to laundry building, Mental Hospital.

Furniture and Furnishings.

Bendigo.—Supply and fix stools, tables and wall fittings, Cafeteria, High School. (W.O., Bendigo.)

M. V. PORTER,
 Minister of Public Works.

Public Works Department,
 Melbourne, 3002, 8th April, 1968.

*Teaching Service Act 1958.***TEACHING SERVICE (CLASSIFICATION, SALARIES AND ALLOWANCES) REGULATIONS.****AMENDMENT No. 141.**

THE Teachers Tribunal, in pursuance of the powers conferred by the *Teaching Service Act 1958*, hereby amends the Teaching Service (Classification, Salaries and Allowances) Regulations in the manner following, that is to say:—

PART V.—PROFESSIONAL OFFICERS.

In clause 12 under the sub-heading "(d) Other Positions", for the expression "Survey and Planning Assistant" substitute the expression "Survey Officer; Statistics Officer".

LOUIS F. C. GARLICK, Chairman.

G. FENNELL, Secretary.

Office of the Teachers Tribunal,
 Melbourne, 8th April, 1968.

PUBLIC SERVICE NOTICES

No. 1825.

PUBLIC SERVICE ACT 1958.

THE Public Service Board, in pursuance of the powers conferred by the *Public Service Act 1958*, hereby amends the Public Service (Public Service Board) Regulations as shown below—

PART IV.—SALARIES AND INCREMENTS.
DIVISION IV.—TECHNICAL AND GENERAL DIVISION.
Regulation 84.

Sub-clause (b) (iv) is revoked and the following sub-clause is substituted therefor:—

“(iv) Ward Assistant Male officers who have completed six years' service may be paid two additional increments of \$72 beyond the maximum salary appropriate to their office, with one increment payable on the completion of the sixth year of service and the second increment payable on completion of the seventh year of service. Female officers who have completed six years' service may be paid one additional increment of \$72 beyond the maximum salary appropriate to their office.”

F. E. CAHILL, Chairman.
V. P. SCULLY, Secretary.

Office of the Public Service Board,
Melbourne, 19th March, 1968.

No. 1826

PUBLIC SERVICE ACT 1958.

THE Public Service Board, in pursuance of the powers conferred by the *Public Service Act 1958*, hereby amends the Public Service (Public Service Board) Regulations as follows:—

PART VI.—TRAVELLING AND OTHER EXPENSES.
DIVISION I.—REIMBURSEMENT OF PERSONAL EXPENSES.
GENERAL.
Regulation 136 (2).

The amount “\$9” is substituted for the amount “\$7.60”.

F. E. CAHILL, Chairman.
V. P. SCULLY, Secretary.

Office of the Public Service Board,
Melbourne, 1st April, 1968.

PUBLIC SERVICE OF PAPUA AND NEW GUINEA,
PRINCIPAL DENTAL COLLEGE, NEW GUINEA.

IN 1960 the only dental education available in Papua and New Guinea was a two-year course for dental nurses. To-day, some 46 students are enrolled at the Dental College of Papua and New Guinea and are graduating as qualified dentists, technicians and dental assistants at the rate of fifteen a year.

The College is located at Port Moresby. Administrative and professional control is exercised by its Principal, who personally conducts some lectures and advises the Chief of Dental Services on course content and examination pass standards.

The position of Principal is now vacant. To fill it we are looking for a dentistry graduate who has a good background in dental training work and a relevant post-graduate diploma. As director of the Territory's first dental academy, the Principal must be capable of more than routine oversight of professional activities. We are looking for someone with vision and a genuine desire to help generate a vigorous and highly skilled dental profession in the Territory.

Salary would be in the range of \$7,653–\$8,572 per annum, including allowances, and a married man would receive an additional \$360 per annum. Income tax in the Territory is currently less than half that payable in Australia and conditions generally are good. Appointment is by contract and fares and removal expenses to take up appointment will be paid for the appointee and family.

Applicants employed by a Government Authority may be considered for secondment to the Territory Service for an initial period of two years, with preservation of existing rights.

A furnished house will be provided at nominal rental for a married appointee and single accommodation is also available. Three months' leave is granted after 21 months' service, with assisted leave fares to Australia or overseas, and a further three months' leave is granted after six years, making a “long leave” of six months. Education allowances are paid for parents who send their children to secondary school in Australia.

More details and application forms are available from—
The Department of External Territories,

Hobart-place, Canberra, A.C.T.; 2601. Phone 4 0477
46 Market-street, Sydney, N.S.W., 2000. Phone 29 5151
188 Queen-street, Melbourne, Vic., 3000. Phone 67 6159
145 Eagle-street, Brisbane, Qld., 4000. Phone 33 7575

Applications should quote advertisement No. 419a.

By order of the Secretary,
DEPARTMENT OF EXTERNAL TERRITORIES,
CANBERRA, A.C.T.

PRIVATE ADVERTISEMENTS

NOTICE is hereby given that the Goroke Youth Club has applied for a lease under section 134 of the *Land Act 1958*, for a term of 21 years over an area of approximately 1 acre 2 roods, being part of an area of Crown land reserved as an extension for recreation purposes, Parish of Goroke, as a site for a Youth Club hall. 1805

ORBOST SEWERAGE AUTHORITY.

PURSUANT to section 119 (2) of the *Sewerage District Act 1958*, notice is hereby given of the intention to construct sewers in Nicholson-street, Lawson and Wolsley streets, in the Township of Orbost.

Details of the proposed works and its location are shown on plans which are available for inspection at the office of the Authority, Clarke-street, between the hours of 10 a.m. and 4 p.m., Monday to Friday.

L. SPINK, Secretary, Orbost Sewerage Authority. 2185

Sewerage Districts Acts.

PROPOSED SEWERAGE AUTHORITY.

NOTICE is hereby given that the Council of the Shire of Ripon has made application to the Honorable the Minister of Water Supply for the constitution of a Sewerage Authority and for the Proclamation of a Sewerage District at Beaufort and for the construction,

maintenance and continuance of sewerage works within that district under the provisions of the Sewerage Districts Acts.

A general plan and description of the proposed works have been submitted with the application and copies of same may be seen at the Shire Office, Beaufort.

Dated at Beaufort, the 12th day of March, 1968.

2214

F. GLARE, Secretary.

NOTICE OF INTENTION TO APPLY FOR A LICENCE TO
DIVERT WATER AND CUT RACE (RE-ISSUE) FROM
THE RIVER MURRAY AT WHARPARILLA NORTH.

I HEREBY give notice that I intend to apply for a licence empowering me to divert water for a term of four years to the extent of 200 acre-feet per annum at a maximum rate of 6 acre-feet per day of 24 hours for the irrigation of 100 acres of permanent pasture, being part of allotments 3 and 12B, section A, Parish of Torrumbarry North, and to occupy certain Crown Lands for works of diversion, and to cut a race thereon.

Any objection to such application must be forwarded, in writing, to reach the State Rivers and Water Supply Commission, Melbourne, before 28th April, 1968, being 30 days from the first publication of this notice.

THOMAS JOHN FARLEY.

Private Bag, Echuca.

2161

NOTICE OF INTENTION TO APPLY FOR A LICENCE TO DIVERT WATER AND CUT RACE (RE-ISSUE) FROM THE RIVER MURRAY AT WHARPARILLA NORTH.

I HEREBY give notice that I intend to apply for a licence empowering me to divert water for a term of four (4) years to the extent of 200 acre-feet per annum at a maximum rate of 6 acre-feet per day of 24 hours for the irrigation of 100 acres of lucerne and permanent pasture, being part of allotments 2 and 13, section A, Parish of Torrumbarry North, and to occupy certain Crown lands for works of diversion, and to cut a race thereon.

Any objection to such application must be forwarded, in writing, to reach the State Rivers and Water Supply Commission, Melbourne, before 28th April, 1968, being 30 days from the first publication of this notice.

TIMOTHY PETER FARLEY.

High-street, Heathcote, Victoria. 2162

NOTICE OF INTENTION TO APPLY FOR A LICENCE TO DIVERT WATER AND CUT RACE (RE-ISSUE) FROM THE MITCHELL RIVER AT HILLSIDE.

I HEREBY give notice that I intend to apply for a licence empowering me to divert water for a term of four years to the extent of 40 acre-feet per annum at a maximum rate of three acre-feet per day of 24 hours for the irrigation of twenty acres of lucerne, pasture and crops, being part of allotment 7A, section A, Parish of Moormung, and to occupy certain Crown lands for works of diversion, and to cut a race thereon.

Any objection to such application must be forwarded in writing to reach the State Rivers and Water Supply Commission, Melbourne, before 8th May, 1968, being 30 days from the first publication of this notice.

CHARLES EDWARD JOINER.

Hillside, 3868. 2208

NOTICE OF INTENTION TO APPLY FOR A LICENCE TO DIVERT WATER AND CUT RACE FROM THE MURRAY RIVER AT NORONG.

I HEREBY give notice that I intend to apply for a licence empowering me to divert water for a term of four years to the extent of 200 acre-feet per annum at a maximum rate of ten acre-feet per day of 24 hours for the irrigation of 100 acres of pasture and lucerne, being part of allotments 1, 2, 4, 5 and 11, section D, Parish of Norong, and to occupy certain Crown lands for works of diversion, and to cut a race thereon.

Any objection to such application must be forwarded in writing to reach the State Rivers and Water Supply Commission, Melbourne, before 4th May, 1968, being 30 days from the first publication of this notice.

DOUGLAS STANTON.

Care of Post Office, Rutherglen. 2210

NOTICE OF INTENTION TO APPLY FOR A LICENCE TO DIVERT WATER AND CUT RACE FROM THE MURRAY RIVER AT ECHUCA.

WE hereby give notice that we intend to apply for a licence empowering us to divert water for a term of fifteen years to the extent of 30 acre-feet per annum at the maximum rate of 3 acre-feet per day of 24 hours for the irrigation of 15 acres of pasture, being parts of allotments 8, 22 and 23, Parish of Echuca North, and to occupy certain Crown lands for works of diversion, and to cut a race thereon.

Any objection to such application must be forwarded in writing to reach the State Rivers and Water Supply Commission, Melbourne, before 10th May, 1968, being 30 days from the first publication of this notice.

NEIL DESMOND BROWN.

JOY AILEEN BROWN.

Box 61, Tongala. 2172

OPTICIANS REGISTRATION BOARD—VICTORIA.

PURSUANT to the *Opticians Registration Act 1958* and the *Opticians Regulations*, notice is hereby given that an election for one certified optician to be nominated by certified opticians for appointment as a member of the Opticians Registration Board to fill the vacancy caused by the retirement of Jonathan Nathan, will be held on Monday, the 13th day of May, 1968: and notice is further given that Monday, the 22nd day of April, 1968, has been fixed as the date for receiving nominations for the election.

All nominations must be in the form or to the effect of the form prescribed by the Regulations and must be lodged with the Registrar of the Board before noon on the said 22nd day of April, 1968. Nomination forms may be obtained from the Registrar.

BRIAN M. MORRIS, Registrar, Opticians Registration Board, Third Floor, 108 Queen-street, Melbourne, 3000.

2227

CITY OF ARARAT.

LOAN No. 64.

Notice of Intention to Borrow.

NOTICE is hereby given that the Council of the City of Ararat intends to borrow the sum of Twelve thousand five hundred dollars (\$12,500) secured by a charge over the general rates of the municipality, by the grant of a mortgage in accordance with the provisions of the Local Government Acts.

(a) The amount of the principal money which it is proposed to borrow is \$12,500 (Twelve thousand five hundred dollars).

(b) The maximum rate of interest that may be paid is \$5.75 per annum.

(c) The times which the moneys borrowed are to be repayable are on the 1st days of January and July during the years 1969-1978 and that the place such moneys shall be repayable is at the Bank of New South Wales, Ararat.

(d) The purpose for which the loan is to be applied is—

Construction of Kerb, Channel and Footpaths—	
Tatooon-road—Marx-crescent to Centenary Park	\$920
Bonnin-avenue—Abutting Lone Person and Darby and Joan Units	370
Kerb and Channel Construction—	
High-street Central	540
Lambert-street—near Tunnel Reserve	250
Construction Kerb and Channel and sealing pavement near Cavell Reserve	1,200
Central Surface graded seal—	
Blake-street, between Fay and Grano streets	3,500
Construction of surface graded seal—	
Benbow and Laby streets	5,720
	<u>\$12,500</u>

(e) The manner in which the loan is to be liquidated is by provision out of the municipal fund in each half year during the currency of the loan of the sum of \$830.52 which includes principal and interest.

The plans and specifications and estimate of the cost of the works and a statement showing the proposed expenditure of the moneys to be borrowed are open for inspection at the Municipal Office Building, Vincent-street, Ararat.

2164

J. I. GRENFELL, Town Clerk.

CITY OF DONCASTER AND TEMPLESTOWE.

LOAN No. 110.

Notice of Intention to Borrow the Sum of \$14,100 for Permanent Works and Undertakings.

NOTICE is hereby given that the Council of the City of Doncaster and Templestowe proposes to borrow the principal sum of Fourteen thousand one hundred dollars (\$14,100) secured by a charge over a separate rate of the municipality made on the 26th September, 1966, against rateable properties in Anderson-street and James-street, Templestowe. Such sum is to be raised by the grant of a mortgage in accordance with the provisions of the *Local Government Act 1958*.

1. The maximum rate of interest that may be paid is 5.75 per centum per annum.

2. The purpose for which the loan is to be applied is the payment of the cost of construction works for the development of off-street parking areas to service the Anderson-street Shopping Centre.

3. The period of the loan shall be ten years.

4. The moneys borrowed shall be repayable by providing out of the separate rate fund twenty half-yearly instalments of approximately \$937.38 each, including principal and interest, on the 1st day of June and the 1st day of December in each year during the currency of the loan. The first instalment shall be payable on the 1st day of December, 1968.

5. Such moneys shall be repayable to the E. S. & A. Savings Bank Limited, at Doncaster, Melbourne.

The plans and specifications and estimate of the cost of the proposed works, and a statement showing the proposed expenditure of the moneys to be borrowed, are open for inspection at the office of the Council of the City of Doncaster and Templestowe, at the Municipal Offices, Doncaster-road, Doncaster.

2168

J. W. THOMSON, Town Clerk.

CITY OF DONCASTER AND TEMPLESTOWE.

LOAN No. 111.

Notice of Intention to Borrow the Sum of \$53,700 for Permanent Works and Undertakings.

NOTICE is hereby given that the Council of the City of Doncaster and Templestowe proposes to borrow the principal sum of Fifty-three thousand seven hundred dollars (\$53,700) secured by a charge over a separate rate of the municipality made on the 19th September, 1966, against rateable properties in Macedon-road, The Mall and Manningham-road, Lower Templestowe. Such sum is to be raised by the grant of a mortgage in accordance with the provisions of the *Local Government Act 1958*.

1. The maximum rate of interest that may be paid is 5.75 per centum per annum.

2. The purpose for which the loan is to be applied is the payment of money used for the purchase of land to provide off-street car park areas at the Macedon-square Shopping Centre and for the payment of cost of construction of such car park areas.

3. The period of the loan shall be ten years.

4. The moneys borrowed shall be repayable by providing out of the separate rate fund twenty half-yearly instalments of approximately \$3,568.47 each, including principal and interest, on the 1st day of June and the 1st day of December in each year during the currency of the loan. The first instalment shall be payable on the 1st day of December, 1968.

5. Such moneys shall be repayable to the E. S. & A. Savings Bank Limited, at Doncaster, Melbourne.

The plans and specifications and estimate of the cost of the proposed works, and a statement showing the proposed expenditure of the moneys to be borrowed, are open for inspection at the office of the Council of the City of Doncaster and Templestowe, at the Municipal Offices, Doncaster-road, Doncaster.

2169

J. W. THOMSON, Town Clerk.

CITY OF HAMILTON.—HAMILTON PLANNING SCHEME.

AMENDMENT No. 1.—1968.

NOTICE is hereby given that the City of Hamilton in pursuance of its powers under the *Town and Country Planning Act 1961*, has prepared a Planning Scheme Amendment No. 1 for an area of land near the Grange Burn and east of George-street for the purpose of developing a lake and providing recreational facilities.

A copy of the scheme has been deposited at the Municipal Office, Town Hall, Brown-street, Hamilton, and at the Office of the Town and Country Planning Board, 175 Queen-street, Melbourne, and will be open for inspection during office hours by any person free of charge.

Any persons affected by the Planning Scheme are required to set forth, in writing, all objections they may have, addressed to the Town Clerk, City of Hamilton, P.O. Box 107, Hamilton, Victoria, on or before the Thirty-first day of July, 1968, and to state whether they wish to be heard in respect of their objections.

5th April, 1968.

2184

H. F. DONALD, Town Clerk.

CITY OF KEW.

LOAN No. 57.

Notice of Intention to Borrow the Sum of \$65,000 for Permanent Works and Undertakings.

NOTICE is hereby given that the Council of the City of Kew proposes to borrow the principal sum of \$65,000 secured by a charge over the general rates of the municipality, such sum to be raised by the grant of a mortgage, in accordance with the provisions of the *Local Government Acts*.

1. The maximum rate of interest that may be paid is 5½ per centum per annum.

2. The period of the loan shall be fifteen years.

3. The moneys borrowed shall be repayable by providing out of the municipal fund 30 half-yearly instalments of \$3,289.51 each, including principal and interest, on the 30th day of June and the 31st day of December during the currency of the loan. The first instalment shall be payable on the 31st day of December, 1968.

4. Such moneys shall be repayable at the National Bank of Australasia Limited, Melbourne, or at the Council's bankers for the time being in Melbourne.

5. The purposes for which the loan is to be applied are—

Elderly Citizens Club :

Provision of building, furniture and equipment .. \$30,000

Places of Public Resort and Recreation :

Swimming Pool improvements .. 15,000

Construction of Roads (C.R.B. Main) :

Princess-street (part cost) .. 5,000

Reconstruction of Streets :

High-street (part cost) .. 15,000

\$65,000

The plans and specifications and the estimate of the cost of the proposed works, and a statement showing the proposed expenditure of the moneys to be borrowed, are open for inspection at the Town Hall, Walpole-street, Kew.

Dated this 4th day of April, 1968.

2151

J. L. JOHNSON, Town Clerk.

Town and Country Planning Acts.

CITY OF MOORABBIN.—THE CITY OF MOORABBIN PLANNING SCHEME 1952.

NOTICE THAT A PLANNING SCHEME TO AMEND THE CITY OF MOORABBIN PLANNING SCHEME, 1952 HAS BEEN PREPARED AND IS AVAILABLE FOR INSPECTION.

Amendment No. 21, 1968.

NOTICE is hereby given that the Council of the City of Moorabbin in pursuance of its powers under the Town and Country Planning Acts, has prepared a Planning Scheme for that portion of the City of Moorabbin as defined by the grey border on the map comprising the First Schedule to the City of Moorabbin Planning Scheme 1952 for the purpose of zoning and regulating buildings and other works.

A copy of the scheme has been deposited at the Municipal Offices, Nepean Highway, Moorabbin, and at the office of the Town and Country Planning Board, 179 Queen-street, Melbourne, and will be open for inspection during office hours by any person free of charge.

Any persons affected by the Planning Scheme are required to set forth, in writing, all objections they may have, addressed to the Town Clerk, Moorabbin City Council, P.O. Box 21, Moorabbin, 3189, on or before the 10th day of July, 1968, and to state whether they wish to be heard in respect of their objections.

Dated this 2nd day of April, 1968.

2108

V. A. SMITH, Town Clerk.

CITY OF SOUTH MELBOURNE.

By-Law No. 427.

A by-law of the City of South Melbourne made under The Health Acts and numbered 427 for the purpose of amending By-law No. 394 of the said City.

THE Mayor, Councillors and Citizens of the City of South Melbourne in pursuance of the powers conferred by The Health Acts and of every other Act or power enabling it in that behalf doth hereby make the By-law and order as follows:—

1. That By-law No. 394 as amended by By-law No. 407 of the said City be further amended by substituting for Clauses 3 and 4 thereof the following clauses:—

"3. (1) The times for selling and for slaughtering animals and for selling carcasses or meat at the abattoirs shall be:—on Mondays Tuesdays Wednesdays Thursdays and Fridays from 7.30 a.m. to 5.0 p.m. and on Saturdays from 7.30 a.m. to 11.0 a.m., but not including Good Friday, Easter Monday, Christmas Day, Boxing Day, New Year's Day, Australia Day, Queen's Birthday, Anzac Day, Labor Day, and any other public holiday.

(2) No person shall, unless with the consent of Council, sell or slaughter any animal or sell any carcass or meat at the abattoirs except within the times herein prescribed.

4. A fee of Fifty cents shall be payable by any person to the Council under Part XV of the *Health Act 1958* for any certificate obtained by such person as to an examination made by a meat inspector."

Resolution adopting this By-law agreed to by the Council of the City of South Melbourne on the 6th day of December, 1967, and confirmed at a meeting of the said Council held on the 7th day of February, 1968.

(L.S.) PHILIP SMART, Mayor.
C. B. COLLETT, Councillor.
R. E. DARLING, Town Clerk.

Submitted to the Commission of Public Health on 27th February, 1968.—A. T. GARDNER, Secretary, Commission of Public Health.

Approved by the Governor in Council, 2nd April, 1968.—J. ROSSITER, Clerk of the Executive Council. 2217

CITY OF WILLIAMSTOWN.

NOTICE OF INTENTION TO APPLY FOR AN ORDER IN COUNCIL UNDER THE "ELECTRIC LIGHT AND POWER ACT 1958".

NOTICE is hereby given that the Mayor, Councillors and Citizens of the City of Williamstown intend to apply to the Governor in Council of the State of Victoria for an Order under section 10 of the *Electric Light and Power Act 1958*, authorizing the Council to supply electricity for public and private purposes within certain areas of land as described below:—

- (a) That area of land at West Newport within the municipal boundaries of the City of Williamstown and bounded on the north by Mason-street, on the east by Challis-street, on the south by the Geelong/Melbourne railway and on the west by Blenheim-road.
- (b) That area of land at East Altona within the municipal boundaries of the Shire of Altona and bounded on the north by Mason-street, on the east by Blenheim-road, and on the west and south by the State Electricity Commission's Fuel Depot.

The applicant at present contemplates supplying electricity in those streets within the said area of supply in which supply is now available.

The said streets are indicated upon a plan of the locality which plan is intended to be lodged with the application for Order.

There are no tramways or railways which the applicant proposes to break up or interfere with in accordance with the special power to be inserted in that behalf in the proposed Order.

Copies of the draft Order and of the Order when made can be obtained by any person at the price of One dollar each at the office of the City of Williamstown, Town Hall, Williamstown, and at the office of the State Electricity Commission of Victoria, at 15 William-street, Melbourne.

Notices of objection and other documents may be served at the office of the applicant as aforesaid.

Every council, company, person or persons desirous of bringing before the State Electricity Commission of Victoria, by whom the *Electric Light and Power Act 1958*, is administered, any objection respecting the application must do so within three months from the date of the *Government Gazette* containing this advertisement, by notice addressed to the Secretary, State Electricity Commission of Victoria, 15 William-street, Melbourne, marked on the outside of the cover enclosing it: "Electric Light and Power Act 1958". A copy of every such notice must also be forwarded to the applicant for the Order.

Dated this 1st day of April, 1968.
2170 J. E. MORLEY, Town Clerk.

BOROUGH OF PORT FAIRY.

LOAN No. 29.

Notice of Intention to Borrow.

NOTICE is hereby given that the Council of the Borough of Port Fairy proposes to borrow the sum of \$17,000 on the credit of the said Borough.

Such sum to be raised by grant of a mortgage in accordance with the *Local Government Act 1958*.

1. The maximum rate of interest that may be paid is 5½ per centum per annum.

2. The purposes for which the loan is to be applied are:—

Construction of toilets at Borough Chambers	1,000
Construction of toilets at Drill Hall	4,400
Seats and tables for Drill Hall	3,000
Plant Purchase	1,300
Development of Public Parks	3,500
Drainage works from William-street	2,800
Electrical installations at Gardens Camping Reserve	1,000
	<u>\$17,000</u>

3. The period of the loan shall be ten years.

4. The moneys borrowed shall be repayable by providing out of the municipal fund, twenty half-yearly instalments of approximately \$1,129.50 each, including principal and interest on the 15th day of July and the 15th day of January during the currency of the loan. The first instalment shall be payable on the 15th day of January, 1969.

5. Such moneys shall be repayable at the Australia and New Zealand Savings Bank Limited, Melbourne or at the Council's bankers for the time being.

Plans and specifications and estimates of cost, and statement showing the proposed expenditure of moneys to be borrowed are open for inspection at the Borough Chambers.

2175 JOHN W. PHILLIPS, Town Clerk.

SHIRE OF BERWICK.

BY-LAW No. 54.

Abattoirs By-law.

A Bylaw of the Shire of Berwick made under Section 326 of the *Health Act 1958* and Numbered 54 for:

- (a) Fixing the rates of fees or dues payable to the Council under Part XV. of the *Health Act 1958*.
- (b) Prescribing the times for slaughtering animals at public and private abattoirs.
- (c) The feeding watering and tending and the preventing of cruelty to and overcrowding of animals in abattoirs.
- (d) Stopping temporarily the manufacture of and the sale of small goods in circumstances in which danger to the consumer is apprehended owing to uncleanness or to the presence of infection on or about the premises where such manufacture or sale is carried on.

IN pursuance of the powers conferred by the *Health Act 1958* and of any and every other power it thereunto enabling the President Councillors and Ratepayers of the Shire of Berwick orders as follows:

- 1. This Bylaw shall be known as the Abattoirs Bylaw.
- 2. Bylaw No. 48 of the Shire of Berwick relating to Abattoirs is hereby repealed.

3. The fees and dues which shall be demanded and received by the Council for examining animals and examining and branding carcasses offal and meat by or under the direction of the Meat Inspector shall be as follows:—

A. For examining any:	
(i) Bull cow calf (other than a bobby calf) heifer, ox or steer	0.30c.
(ii) Bobby calf goat kid lamb or sheep	0.10c.
(iii) Head of swine	0.20c.
B. For examining and branding any carcass or side of:—	
(i) Bull cow calf (other than a bobby calf) heifer ox or steer	0.40c.
(ii) Bobby calf goat kid lamb or sheep	
for the first 400 carcasses examined in any one day	0.15c. per carcass
for the next 200 carcasses examined in any one day	0.10c. per carcass
for all carcasses over the first 600	0.5c. per carcass.
(iii) Swine	0.25c.
C. Any quantity of meat (not including offal) fresh or cured in pieces less than a side per cwt. or part thereof	
	0.10c.

D. Any offal—per piece 0.03c.

In this Bylaw "bobby calf" means a calf not more than six weeks old.

For any Certificate as to an examination made by a Meat Inspector 0.50c.

4. (a) The times for slaughtering animals at public or private abattoirs are hereby prescribed as being between the hours of 6 o'clock in the morning and 3 o'clock in the afternoon of any week day other than Saturday.

(b) No person shall slaughter any animals at any public or private abattoir at any time other than the times prescribed by this Bylaw, except where in the opinion of the Meat Inspector it is necessary immediately to slaughter any animal.

5. The proprietor or person in charge of any abattoir:

(a) Shall at all times cause to be provided for and to be available to all animals therein adequate water and food for the use of such animals.

(b) Shall not suffer any animal or animals therein to be overcrowded or treated with cruelty.

6. Any person having the control or management of any animal or animals in any abattoir:

(a) Shall at all times cause to be provided for and to be available to such animal or animals adequate water and food for the use of such animal or animals.

(b) Shall not suffer any such animal or animals to be overcrowded or treated with cruelty.

7. If the Medical Officer of Health at any time apprehends that danger to the consumer will result owing to uncleanness or to the presence of infection on or about any premises where the manufacture of or the sale of small goods is carried on such Medical Officer of Health may by notice in writing under his hand to the owner occupier or person in charge of such premises direct such owner occupier and person in charge to stop the manufacture and/or sale (as the case may be) of small goods from such premises until such time as such condition of uncleanness or such infection ceases and such owner occupier and person in charge of such premises shall comply with the terms of such notice.

8. This Bylaw shall apply to and have operation throughout the whole of the Municipal district which has been constituted a meat area by proclamation of the Governor-in-Council.

Resolution for passing this Bylaw agreed to by the Council of the Shire of Berwick on the 18th day of September, 1967, and confirmed on the 16th day of October, 1967.

The corporate seal of the President, Councillors and Ratepayers of the Shire of Berwick was hereunto affixed, in the presence of—

(SEAL) A. J. FUNSTON, President.
J. G. HOSKING, Councillor.
B. J. WALLIS, Shire Secretary.

Submitted to the Commission of Public Health on 16th January, 1968.—A. T. GARDNER, Secretary, Commission of Public Health.

Approved by the Governor in Council on the 20th day of February, 1968.—J. ROSSITER, Clerk of the Executive Council. 2216

SHIRE OF BERWICK.

BYLAW No. 55.

Registration (Health) Fees Bylaw.

A Bylaw of the Shire of Berwick made under Section 368 of the Health Act 1958 and Numbered 55 for prescribing fees for the registration and renewal and transfer of registration of certain premises.

IN pursuance of the powers conferred by the Health Act 1958 and of any and every other power it thereunto enabling the President Councillors and Ratepayers of the Shire of Berwick orders as follows:—

1. This Bylaw may be known as the Registration (Health) Fees Bylaw.

2. Bylaw No. 39 of the Shire of Berwick relating to the prescription of fees for Registration of Premises is hereby repealed.

3. The respective fees set out in the second column of Table A set out hereunder are hereby prescribed as the fees for the registration and renewal of registration of the respective premises set out in the first column of such Table A opposite the respective fees.

TABLE A.

Nature of Premises.	Fees.
Offences trades premises (being fat extracting or melting or rendering works which are conducted at premises occupied principally as a butcher's shop and at which fat is extracted melted or rendered only from materials derived from such shop)	\$5.00
Offensive trades premises (being abattoirs in meat areas or piggeries)	\$10.00
Offensive trades premises (other than those referred to above)	
(i) where not more than ten persons (including the proprietor and his family) are employed	\$10.00
(ii) where more than ten such persons but not more than twenty such persons are employed	\$15.00
(iii) where more than twenty such persons but not more than thirty such persons are employed	\$20.00
(iv) where more than thirty such persons are employed	\$30.00
Cattle Saleyards	\$10.00
Boarding Houses	\$10.00
Common Lodging Houses	\$10.00
Eating Houses	\$10.00
Apartment Houses—	
Containing not more than one apartment	\$5.00
Containing more than one apartment	\$10.00
Camping areas	\$10.00
Food premises	
(i) where not more than five persons (including the proprietor and his family) are employed	\$5.00
(ii) where more than five such persons are employed—additional for each person in excess of five	\$0.50
Provided that the maximum fee payable shall be	\$100.00
Premises at or in which eggs for sale are received or stored for the purpose of being chilled	\$5.00
Food vending machines operated by—	
(i) one or two cents a sale	\$0.50
(ii) a coin or coins in excess of two cents in value but not exceeding five cents in value a sale	\$2.00
(iii) a coin or coins in excess of five cents in value a sale	\$4.00

4. The fee prescribed for the transfer of any registration of premises is \$1 or 50% of the registration fee (whichever is the lesser amount).

5. Every application for renewal of registration of premises shall be made on or before the 15th day of November in any year. In the event of non-observance of the foregoing a fee equivalent to one half of the prescribed renewal fee shall be paid in addition to the prescribed renewal fee for such premises.

6. This Bylaw shall apply to and have operation throughout the whole of the Municipal district of the Shire of Berwick.

Resolution for passing this Bylaw agreed to by the Council of the Shire of Berwick on the 18th day of September, 1967, and confirmed on the 16th day of October, 1967.

The corporate seal of the President, Councillors and Ratepayers of the Shire of Berwick was hereunto affixed in the presence of—

(SEAL) A. J. FUNSTON, President.
J. G. HOSKING, Councillor.
B. J. WALLIS, Shire Secretary.

Approved by the Governor in Council on the 20th day of February, 1968.—J. ROSSITER, Clerk of the Executive Council.

Submitted to the Commission of Public Health on the 16th day of January, 1968.—A. T. GARDNER, Secretary, Commission of Public Health. 2215

SHIRE OF FLINDERS.

LOAN No. 61.

Construction of Private Streets.

NOTICE is hereby given that at a meeting of the Council of the Shire of Flinders, held at the Shire Office, Dromana, on 6th March, 1968, the said Council did agree to the following Resolution, that is to say:—

That this Council by Special Order does hereby resolve to borrow the sum of Twenty-five thousand dollars by the grant of a mortgage for such amount secured on the general rates of the President, Councillors and Ratepayers of the Shire of Flinders, in accordance with section 585 of the Local Government Act 1958 as amended.

The rate of interest to be paid shall be 5½ per centum per annum, and the period of the loan shall be fifteen years, and that the money borrowed shall be repayable by half-yearly instalments of \$1,265.20, including principal and interest, on the 11th day of October and 11th day of April during the currency of the loan, the first instalment being payable on 11th October, 1968, and that such money shall be repayable at the Commercial Bank of Australia Ltd., at Frankston.

The loan shall be applied for the purpose of constructing private streets within the Shire of Flinders, in pursuance of and in accordance with the provisions of Division 10 of Part XIX. of the Local Government Act 1958.

And notice is further given that at a meeting of the said Council, held at the Shire Office, Dromana, on 3rd April, 1968, the said Resolution was confirmed.

2167

S. WILLIAMS, Shire Secretary.

SHIRE OF HASTINGS.

LOAN No. 27.

Notice of Intention to Borrow the Sum of \$54,000 for Permanent Works and Undertakings.

NOTICE is hereby given that the Council of the Shire of Hastings proposes to borrow the principal sum of Fifty-four thousand dollars, secured by a charge over the general rates of the municipality such sum to be raised by the grant of a mortgage in accordance with the provisions of the Local Government Act 1958.

1. The maximum rate of interest that may be paid is 5.75 per cent. per annum.

2. The purposes for which the loan is to be applied are:—

(a) Myers-road, Bittern—construction and seal ..	\$10,000
(b) Governors-road, Crib Point—construction ..	4,000
(c) Hodgins-road, Hastings—construction ..	5,200
(d) Hodgins-road, Moorooduc—construction ..	6,000
(e) Salmon, Skinner and Mullett streets, Hastings—construction ..	3,000
(f) Edward-street, Hastings—drainage ..	800
(g) Godings-road, Moorooduc—construction and seal ..	700
(h) Paving and kerbing Salmon and Hodgins roads, Hastings ..	2,800
(i) Main drainage Hodgins-road ..	3,000
(j) Councils contribution for C.R.B. works ..	18,500
	<hr/>
	\$54,000

3. The period of the loan shall be ten years.

4. The moneys borrowed shall be repayable by providing out of the municipal fund, twenty half-yearly instalments of \$3,587.83 each including principal and interest on the 20th day of December and the 20th day of June during the currency of the loan. The first instalment to be paid on the 20th December, 1968.

5. Such moneys shall be payable to the National Bank Savings Bank Ltd., 271-285 Collins-street, Melbourne.

The plans and specifications and the estimate of the cost of the proposed works and the statement showing the proposed expenditure of the moneys to be borrowed are opened for inspection at the office of the Council of the Shire of Hastings, at Marine-parade, Hastings.

5th April, 1968.

2178

L. A. WALKER, Shire Secretary.

SHIRE OF KORUMBURRA.

NOTICE is hereby given that, in pursuance of the powers conferred by the Local Government Act, the Council of the Shire of Korumburra did at a Meeting held on 20th March, 1968, order that the following alteration be made in the name of the street as under:—

Old Name.—Korumburra-Wonthaggi road. (Shown cross hatched on the plan annexed hereto.)

New Name.—Cruickshank-road. (Shown hatched on the plan annexed hereto.)

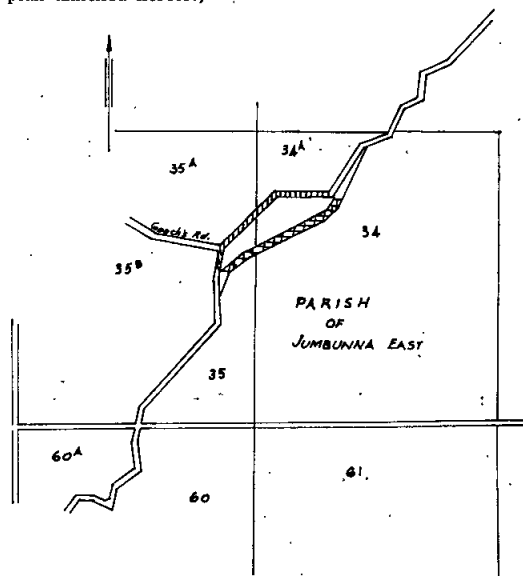

2018

W. O. CLARK, Shire Secretary.

SHIRE OF LEIGH.

NOTICE OF INTENTION TO BORROW THE SUM OF \$32,000 FOR THE ERECTION OF NEW SHIRE OFFICES.

NOTICE is hereby given that the Council of the Shire of Leigh proposes to borrow the sum of Thirty-two thousand dollars on the credit of the municipal revenues of the President, Councillors and Ratepayers of the said Shire, such sum to be raised by the grant of a mortgage in accordance with the provisions of the Local Government Act 1958.

1. The maximum rate of interest that may be paid is 5.875 dollars per centum per annum.

2. The purpose for which the loan is to be applied is the erection of shire offices at Rokewood.

3. The period of the loan shall be fifteen years.

4. The moneys borrowed shall be repayable by providing out of the municipal fund thirty half-yearly instalments of approximately \$1,620 each including principal and interest, on the 10th day of February and the 10th day of August during the currency of the loan.

The first instalment shall be payable on the 10th day of February, 1969.

5. Such moneys shall be repayable at the Commercial Bank of Australia Limited, Rokewood.

The plans and specifications and the estimate of cost of the proposed works and a statement showing the proposed expenditure of the moneys to be borrowed are open for inspection at the Shire Office, Rokewood.

1988

C. G. HALLUM, Shire Secretary.

SHIRE OF MAFFRA.

Notice of Intention to Borrow the Sum of \$17,000 for Permanent Works and Undertakings.

NOTICE is hereby given that the Council of the Shire of Maffra proposes to borrow the sum of Seventeen thousand dollars (\$17,000) secured by a charge over the general rates of the municipality, such sum to be raised by the grant of a mortgage in accordance with the provisions of the Local Government Act 1958.

1. The maximum rate of interest that may be paid is 5.750 per cent. per annum.

2. The purposes for which the loan is to be applied are:—

(i) Development of Public Reserve, Heyfield Township—Local Contribution ..	\$875
(ii) Purchase of Plant—Medium Grader ..	\$16,125
TOTAL	\$17,000

3. The period of the loan shall be ten (10) years.

4. The moneys borrowed shall be repayable by providing out of the municipal fund, twenty half-yearly instalments of approximately \$1,129.50 each, including principal and interest, on the 1st day of January and the 1st day of July, during the currency of the loan. The first instalment shall be repayable on the 1st day of January, 1969.

5. Such moneys shall be repayable at the C.B.C. Savings Bank Limited, 257 Collins-street, Melbourne.

6. The plans, specifications and estimates of cost of the proposed works and a statement showing the proposed expenditure of the money to be borrowed are open for inspection at the Shire Office, Maffra.

Dated this 5th day of April, 1968.

2179 J. RENNICK, Shire Secretary.

SHIRE OF PHILLIP ISLAND.

BY-LAW NO. 34.

A By-Law of the Shire of Phillip Island, made under the provisions of the Dog Act 1958 and numbered 34 for fixing registration fees and other fees thereunder.

IN pursuance of the powers conferred by the Dog Act 1958 and of every other power it thereunto enabling, the President, Councillors and Ratepayers of the Shire of Phillip Island, order as follows:—

1. By-Law No. 25 of the Shire of Phillip Island is hereby repealed.

2. The following fees and sums are hereby fixed, pursuant to the Dog Act 1958:—

(a) for registration, pursuant to section 6 of the Dog Act 1958 ..	2.00
(b) for particulars of any dog or for the name of the registered owner thereof or for a certified copy of the receipt mentioned in Section 12 of the Dog Act 1958 ..	0.25
(c) sum payable to the Registration Officer pursuant to Section 15 of the Dog Act 1958 ..	6.00
(d) sum payable to the Registration Officer pursuant to Section 16 of the Dog Act 1958 ..	6.00

3. This By-Law shall apply to and have operation throughout the whole of the municipal district of the Shire of Phillip Island.

Resolution for passing this By-Law agreed to by the Council of the Shire of Phillip Island, this 21st day of February, 1968, and confirmed this 20th day of March, 1968.

The common seal of the President, Councillors, and Ratepayers of the Shire of Phillip Island was hereunto affixed on this 20th day of March, 1968.

(SEAL) WILLIAM G. PAPWORTH, President.
J. W. MITCHELL, Councillor.
E. R. BOOTH, Councillor.
STAN. A. HARRIS, Municipal Clerk.

2166

SHIRE OF WERRIBEE.

LOAN NO. 68.

Notice of Intention to Borrow the Sum of \$20,000 for Permanent Works and Undertakings.

NOTICE is hereby given that the Council of the Shire of Werribee proposes to borrow the sum of Twenty thousand dollars secured by a charge over the general rates of the municipality, such sum to be raised by the grant of a mortgage in accordance with the provisions of the Local Government Act 1958.

1. The maximum rate of interest that may be paid is 5½ per centum per annum.

2. The purpose for which the loan will be applied is:—

Road Construction—Old Geelong-road (Service road), Housing Commission, Laverton ..	\$20,000
--	----------

3. The period of the loan shall be 40 years.

4. The loan is to be liquidated by the creation of a Sinking Fund pursuant to the provisions of section 428A (1) of the Local Government Act 1958.

5. The moneys borrowed shall be repayable at the office of the Housing Commission, Victoria, 179 Queen-street, Melbourne, or such other place as the Commission may require.

6. The plans and specifications and the estimate of the cost of the proposed works and a statement showing the proposed expenditure of the moneys to be borrowed are open for inspection at the municipal offices, Werribee, during office hours.

2176

N. G. MINNS, Shire Secretary.

NOTICE OF DISSOLUTION OF PARTNERSHIP.

NOTICE is hereby given that the partnership heretofore subsisting between Norman Ray Parker, farmer, and Agnes Joan Parker, married woman, of the one part, and William Harold Ackland, carpenter and Helen Josephine Ackland, married woman, of the other part, carrying on business as timber merchants and hardware retailers and builders, at Jeparit, under the style or firm of "Jeparit Timber and Hardware Company", has been dissolved as from the 20th day of January, 1968.

Dated the 20th day of March, 1968.

W. H. ACKLAND.
HELEN J. ACKLAND.
N. R. PARKER.
A. J. PARKER.

Muntz & Muntz, solicitors for all parties, Dimboola. 2205

NOTICE is hereby given that the partnership heretofore subsisting between Gyndoline May Murray and Dianne Lynette Weidemann, carrying on business as servicing, sales and hiring of television, wireless, electric and electronic goods at 63 Buena Vista-drive, Montmorency, under the style or firm name of "Diamond Valley T.V. Service", has been dissolved as from the 29th day of February, so far as concerns the said Gyndoline May Murray, of 17 Elsa-court, Eltham, who retires from the said firm. All debts due to and owing to the said firm will be received and paid respectively by Dianne Lynette Weidemann, of 63 Buena Vista-drive, Montmorency, who will continue to carry on the said business under the style or firm of "Diamond Valley T.V. Service."

Dated the 29th day of March, 1968.

G. M. MURRAY.

Signed by the said Gyndoline May Murray, in the presence of—B. C. HOLLAND. 2221

NOTICE is hereby given that the partnership existing heretofore between Eileen May Chenu, of 31 Derbyshire-road, Mount Waverley, and Valda June Morris, of 32 Prospect-street, Mount Waverley, is hereby dissolved by the retirement of Valda June Morris from the partnership.

By the solicitor for Eileen May Chenu and Valda June Morris.

JULIAN J. DOYLE, 434A Toorak-road, Toorak. 2222

NOTICE is hereby given that the partnership heretofore subsisting between the undersigned Margaret Irene Collis, of 34 Hamlyn-avenue, North Geelong, physical instructress, and Tinka Tucakovic, of 156 Garden-street, East Geelong, masseuse, carrying on business as specialists in physical culture, massage and Sauna bathing, at Karran House, 68 Yarra-street, Geelong, under the firm name of Geelong Ladies' Sauna Centre, has been dissolved by mutual consent as from the 1st day of April, 1968. All debts due to and owing by the said late firm will be received and paid by the said Margaret Irene Collis.

Dated the 1st day of April, 1968.

M. I. COLLIS.
T. TUCAKOVIC.

K. S. Cox, solicitor, T. & G. Building, Moorabool-street, Geelong. 2131

TAKE notice that the partnership hitherto carried on by Barry George Hepworth, of 18 Breeze-street, Carrum, solicitor, Bernard Paul, of 5 Horton-close, Elwood, solicitor, and Maxwell Frederick Marriott, of 5 Almond-street, North Balwyn, solicitor, under the business name of "Hepworth Paul Marriott & Co.," at 377 Little Collins-street, Melbourne, and 461 Nepean Highway, Chelsea, as barristers and solicitors, has been dissolved as from the 1st day of April, 1968. The said firm will be carried on thereafter at the above addresses by the said Bernard Paul and Maxwell Frederick Marriott.

Dated this 2nd day of April, 1968.

BARRY GEORGE HEPWORTH.
BERNARD PAUL.
MAXWELL FREDERICK MARRIOTT.

2106

NOTICE is hereby given that the partnership heretofore subsisting between the undersigned Douglas Arthur Wallace, Margaret Edna Wallace, Norman Ronald Wallace and Julie Eleynor Wallace carrying on business at 1 Nathan-place, Windsor, under the business name of "D. & N. Wallace Bros. and Co.", has been dissolved by mutual consent as from the 29th day of February, 1968. Norman Ronald Wallace and Julie Eleynor Wallace will continue to carry on D. & N. Wallace Bros. & Co.

Dated the 10th day of February, 1968.

D. WALLACE.
E. WALLACE.
N. R. WALLACE.
J. E. WALLACE.

Witness to all signatures—W. B. WALLACE.

E. K. O'Donnell, solicitor, 173 Greville-street, Prahran.
2207

The Companies Act 1961.

WIBROC (OVERSEAS) PROPRIETARY LIMITED (IN MEMBERS' VOLUNTARY LIQUIDATION).

NOTICE is hereby given that at an Extraordinary Meeting of the members of the above-named company held on Friday, the 29th day of March, 1968, it was resolved that the company be wound up voluntarily and that for such purpose Mr. Scott Maurice Nunan, chartered accountant, of Hall & Rose, 260 Queen-street, Melbourne, be appointed liquidator.

Dated this 1st day of April, 1968.

S. M. NUNAN, Liquidator.

Hall & Rose, chartered accountants, 260 Queen-street, Melbourne, Vic., 3000. 2196

The Companies Act 1961.

WIBROC (INTERSTATE) PROPRIETARY LIMITED (IN MEMBERS' VOLUNTARY LIQUIDATION).

NOTICE is hereby given that at an Extraordinary Meeting of the members of the above-named company held on Friday, the 29th day of March, 1968, it was resolved that the company be wound up voluntarily and that for such purpose Mr. Scott Maurice Nunan, chartered accountant, of Hall & Rose, 260 Queen-street, Melbourne, be appointed liquidator.

Dated this 1st day of April, 1968.

S. M. NUNAN, Liquidator.

Hall & Rose, chartered accountants, 260 Queen-street, Melbourne, Vic., 3000. 2197

The Companies Act 1961.—In the matter of PETER GREEN PTY. LTD.

NOTICE is hereby given that at an Extraordinary General Meeting of the members of the above-named company held on the 14th day of March, 1968, it was resolved that the company be wound up voluntarily and at a meeting of creditors held on the same day pursuant to section 260, it was resolved that for such purpose Norman Eric Stretton, of 296 Little Lonsdale-street, Melbourne, accountant, be appointed liquidator.

Notice is also given that after 21 days from this date I shall proceed to distribute the assets. All creditors having any claims against the company should furnish particulars of same by that date, otherwise I shall proceed to distribute the assets without regard to their claims.

Dated this 15th day of March, 1968.

N. E. STRETTON, Liquidator.

Kennedy, Small & Middlemiss, 296 Little Lonsdale-street, Melbourne. 2199

The Companies Act 1961.

NOTICE OF FINAL MEETING OF SHAREHOLDERS OF D. E. HOLDINGS PTY. LTD. (IN LIQUIDATION).

NOTICE is hereby given in pursuance of section 272 of the Companies Act 1961 that a General Meeting of the members of D. E. Holdings Pty. Ltd. (in Liquidation), will be held at the Fifth Floor, 191 Queen-street, Melbourne, on Wednesday, 15th May, 1968, at 11 o'clock in the forenoon, for the purposes of laying before the meeting an account showing how the winding up has been conducted and the property of the company has been disposed of and of giving any explanation of the account.

Dated this 2nd day of April, 1968.

2203 J. B. HUTCHINS, Liquidator.

No. 32.—3167/68.—4

The Companies Act 1966.

C.T.E. INVESTMENTS PTY. LIMITED.

AT an Extraordinary General Meeting of the above-named company duly convened and held at 105 King-street, Melbourne, on Monday, 1st April, 1968, the following Special Resolution was duly passed:—

"That the company be wound up voluntarily, that Mr. Alexander Sydney McLaughlan and Mr. Howard John Hinde, both chartered accountants, of 143 Queen-street, Melbourne, be appointed liquidators, and that either of them shall have power to act alone in the winding up for all or any purposes, and that the liquidators be directed subject to the sale of all or any part of the trading stock of the company and subject to payment of or adequate provision for the liabilities of the company to divide the assets of the company amongst the contributories in specie or kind".

Dated this 3rd day of April, 1968.

2236 A. S. McLAUGHLAN, Liquidator.

The Companies Act 1966.

V.D.H. INVESTMENTS PROPRIETARY LIMITED.

AT an Extraordinary General Meeting of the above-named company duly convened and held at 105 King-street, Melbourne, on Monday, 1st April, 1968, the following Special Resolution was duly passed:—

"That the company be wound up voluntarily, that Mr. Alexander Sydney McLaughlan and Mr. Howard John Hinde, both chartered accountants, of 143 Queen-street, Melbourne, be appointed liquidators, and that either of them shall have power to act alone in the winding up for all or any purposes, and that the liquidators be directed subject to the sale of all or any part of the trading stock of the company and subject to payment of or adequate provision for the liabilities of the company to divide the assets of the company amongst the contributories in specie or kind".

Dated this 3rd day of April, 1968.

2237 A. S. McLAUGHLAN, Liquidator.

The Companies Act 1966.

RERA INVESTMENTS (VIC.) PTY. LIMITED.

AT an Extraordinary General Meeting of the above-named company duly convened and held at 105 King-street, Melbourne, on Monday, 1st April, 1968, the following Special Resolution was duly passed:—

"That the company be wound up voluntarily, that Mr. Alexander Sydney McLaughlan and Mr. Howard John Hinde, both chartered accountants, of 143 Queen-street, Melbourne, be appointed liquidators, and that either of them shall have power to act alone in the winding up for all or any purposes, and that the liquidators be directed subject to the sale of all or any part of the trading stock of the company and subject to payment of or adequate provision for the liabilities of the company to divide the assets of the company amongst the contributories in specie or kind".

Dated this 3rd day of April, 1968.

2235 A. S. McLAUGHLAN, Liquidator.

The Companies Act 1961.

REGENT PUBLICITY PTY. LTD (IN LIQUIDATION).

NOTICE TO CREDITORS OF INTENTION TO DECLARE DIVIDEND.

A FIRST Dividend is intended to be declared in the above matter. Creditors who have not proved their debts by the 11th day of April, 1968, will be excluded from this dividend. The date of liquidation was the 2nd day of October, 1967.

Dated this 28th day of March, 1968.

LEWIS LUCKINS, F.C.A., Liquidator.

Lewis, Luckins & Co., chartered accountants, 289 Flinders-lane, Melbourne, 3000. Telephone 63 8827. 2226

Companies Act 1961, Section 254.

NOTICE is hereby given that on the 3rd April, 1968, the members of Toronto Investments Pty. Ltd., at an Extraordinary Meeting passed the following Special Resolutions:—

1. "That the company be wound up voluntarily."

2. "That Mr. Bruce Etherington be and is hereby appointed liquidator of the company."

Dated this 5th day of April, 1968.

BRUCE ETHERINGTON, liquidator of Toronto Investments Pty. Ltd. 2232

Unclaimed Moneys Act 1962.

REGISTER of Unclaimed Moneys held by the—

Name of Owner on Books and Last Known Address.	Total Amount Due to Owner.	Description of Unclaimed Moneys.	Date when Amount first become Payable
\$			
ELDER SMITH GOLDSBROUGH MORT LIMITED.			
Heath, Nancy, G. B., Lilydale	97.76	Bank N.S.W. Cheque No. 1659 Dividend No. 8 unrepresented	30.4.66
Hemsley, Marion, 32 St. James-place, London	11.83	Bank N.S.W. Cheque No. 4297 Dividend No. 8 unrepresented	30.4.66
Jemieson, Marewa A. W., Christchurch, N.Z.	139.67	Bank N.S.W. Cheque No. 4316 Dividend No. 8 unrepresented	30.4.66
Stewart, Sarah, Wellington, N.Z.	27.20	Bank N.S.W. Cheque No. 4501 Dividend No. 8 unrepresented	30.4.66
Mitchell, W. M., 68 Howitt-road, Caulfield	24.00	Bank N.S.W. Cheque No. 2391 Dividend No. 9 unrepresented	7.11.66
Nicholl, E. M. Ashfield, N.S.W.	12.00	Bank N.S.W. Cheque No. 2667 Dividend No. 9 unrepresented	7.11.66
Gilchrist, G., Te Aroha, N.Z.	15.30	Bank N.S.W. Cheque No. 4172 Dividend No. 9 unrepresented	7.11.66
Haines, C., Dimboola	15.00	National Bank Cheque No. 2470 unrepresented	25.3.66
Buffalo River Hall, Myrtleford	14.28	National Bank Melb. Cheque No. 53875 unrepresented	13.5.66
Collett, K. B. (Miss), Yak Win, Macarthur	156.36	National Bank Melb. Cheque No. 754 unrepresented proceeds Wool	8.5.66
Pastures Protection Board, Balranald	31.92	National Bank Melb. Cheque No. 40989 unrepresented	13.7.66
George Farmer Pty. Ltd., Dimboola	16.11	National Bank Melb. Cheque No. 72205 unrepresented	2.8.66
Millard, R. M., Casterton	57.77	National Bank Melb. Cheque No. 82225 unrepresented	9.9.66
Tyers, Transport, Hamilton	14.81	National Bank Melb. Cheque No. 84033 unrepresented	18.10.66
Sheppard, R.	28.25	Bank N.S.W. Melb. Cheque No. 30207 unrepresented	28.3.66
Beer, H., Mansfield-road, Sunbury	10.37	Bank N.S.W. Melb. Cheque No. 31760 unrepresented	27.7.66
Kreiger, A. F. and E. V.	86.45	Cartage National Bank Melb. Cheque No. 25038 unrepresented	22.10.66
Douglas, J. G.	30.00	Commonwealth Bank Melb. Cheque No. 65470 unrepresented	22.10.66
Hanson, I. R. and G., Fern Hill	61.02	Bank N.S.W. Melb. Cheque No. 62805 unrepresented	1.6.66
Dynon, J. J., address unknown	118.60	proceeds 6 sheep Newmarket Commonwealth Bank Melb. Cheque No. 59347 unrepresented	14.2.67
Ottrey, K., Gapsted	83.34	National Bank Melbourne Cheque No. 35917 Unrepresented, proceeds Stock	17.2.67
Christenson, W.	71.15	Bank N.S.W., Melbourne Cheque No. 53366 Unrepresented	24.2.67
Unknown	44.28	Proceeds 1 sow, Horsham ..	8.9.66
Hannah, Address Unknown	10.80	Proceeds stock ex Myrtleford..	5.9.66
Unknown	21.07	Proceeds 1 cattle, 1 sheep, Kerang	20.9.66
Unknown	66.68	Proceeds 1 cattle, Myrtleford ..	23.11.66
Unknown	49.27	Proceeds 1 cattle, Coleraine ..	15.2.67
Unknown	73.58	Proceeds 1 cow, Echuca ..	18.2.67
Unknown	10.39	Proceeds 15 sheepskins, Geelong	1.9.66
2137			
NATIONAL RELIANCE INVESTMENT COMPANY LIMITED.			
Heath, A. G., 66 Undercliff-road, Harbord, N.S.W.	54.53	Dividend	20.6.66
2138			
JASON INVESTMENT COMPANY (AUSTRALIA) LIMITED.			
Lewis, M. E. (Mrs.), 59 McLean-street, Waitara, N.Z.	27.20	Dividend	1.12.66
Caldwell, R. H., 177 West Coast Highway, Scarborough W.A.	19.68	"	28.2.67
2139			
CLONMORE INVESTMENTS (AUSTRALIA) LIMITED.			
Dunbabin, S. J. (Miss), 6 Quorn-street, Sandy Bay, Tas.	24.50	Dividend	19.12.66
2140			
BONVILLE UNDERWRITING AND DEVELOPMENT LIMITED.			
Isralzik, E. (Mrs.), 2 Carlington-street, Elsternwick, Vic.	12.50	Dividend	12.12.66
2141			
AUSTRALIAN FOUNDATION INVESTMENT COMPANY LIMITED.			
Buckley, H. G., c/o Rotoma P.O., Via Rotorua, N.Z.	10.11	Dividend	19.9.66
Fisher, D. E. (Mrs.), 5 Palm Beach-road, Newport Beach, N.S.W.	16.11	"	"
Heath, N. G. B. (Mrs.), Heatherlie, Lilydale	351.55	"	"
2142			

Unclaimed Moneys Act 1962.

REGISTER of Unclaimed Moneys held by the—

Name of Owner on Books and Last Known Address.	Total Amount Due to Owner.	Description of Unclaimed Moneys.	Date when Amount first became Payable.
S			
THE PHOSPHATE CO-OPERATIVE COMPANY OF AUSTRALIA LIMITED.			
Baumann, H., 150 Corio-street, Geelong 2010	148.10	Donations by workmates to appeal for his assistance	10.5.65
KODAK (AUSTRALASIA) STAFF SUPERANNUATION FUND.			
Windsor, Maurice, Lot 23, Ash-grove, Montrose 2011	29.52	Refund of premiums paid by member to the Kodak (Australia) Staff Superannuation Fund during period of membership	28.2.66
KODAK (AUSTRALASIA) PTY. LTD.			
Thorpe, J., Melbourne Caravan Park, East Coburg	14.50	Unclaimed wages	15.6.66
Hughes, N. J., 95 Murray-road, East Preston	21.53	" "	17.2.67
Windebank, G., 15 Dawson-street, Coburg 2012	46.19	" "	16.1.67
HENRY JONES (IXL) LIMITED.			
Barnett, M. L. (Mrs.), 17A Sterling-street, Kew	12.00	Dividend	— 6.66
Stump, E. L. and F. L., c/o His Majesty's Hotel, 835 Hay-street, Perth, W.A.	15.00	" "	" "
Poole, Bryan C. H., "Marbury", Old Northern-road, Dural, N.S.W.	21.00	" "	" "
Neville, Thos. (estate of), c/o Eric Howard and Solomon, 56 Hunter-street, Sydney, N.S.W.	12.00	" "	" "
Hudson, Joan (Mrs.), Heidelberg	18.00	" "	" "
Von-Bibra, Eric E. (estate of), 12 Manning-avenue, Sandy Bay, Tas.	18.00	" "	" "
Parkinson, Dorothy N. (Mrs.), Norman Park, Qld.	30.78	" "	" "
Blaxland, Guy H. G., Wahroonga, N.S.W.	12.60	" "	" "
Bull, William J., Sydney, N.S.W.	31.50	" "	" "
Friend, Philip O. and N. R. McDowell, Sydney, N.S.W. 2109	45.00	" "	" "
LONDON STORES LTD.			
Blackburne, Rudy F., 154 Neerim-road, Glenhuntly, 3163 2110	109.74	Dividends on Shares	28.2.67
TOPPA HOLDINGS LIMITED.			
George, M. A., 17 Ashley-street, Reservoir, Vic. 3073	37.20	Dividend	18.11.66
Dobbie, J. W., 508 Highgate, Dunedin N.W., New Zealand	17.85	" "	20.4.66
Salway, G. F., c/o The New Zealand Insurance Co. Ltd. Trust Department, Box 973, Hamilton, N.Z.	10.20	" "	" "
C.B.A. Nominees Pty. Ltd., 273 George-street, Sydney, N.S.W. 2000	44.40	" "	" "
Curnow, J. W., 14 Beaumont-avenue, Canterbury, Vic. 3126	15.20	" "	" "
Francis, A. W., Narre Warren North, Vic. 3804	18.74	" "	" "
Plastone and Co. Ltd., Western Australia 2111	94.68	" "	" "
GIBBINS FARM IMPLEMENT COMPANY LTD.			
Shaw, Richard Lionel, 88A King William-street, Adelaide, S.A.	20.00	Dividend on 250 shares	1.12.66
Rose, George (estate of), 17 Auburn-grove, Armadale	16.00	Dividend on 200 shares	" "
Worch, Theodore, 61 Stanhope-street, Malvern 2112	20.00	Dividend on 250 shares	" "
DALGETY AND NEW ZEALAND LOAN LIMITED.			
Name and address unknown	456.81	Proceeds, sheep sold at Newmarket	4.10.64
Name and address unknown	74.27	Proceeds, Finley, Oct.-Dec., 1965	" "
Lindsay Plant and Co., 120 King-street, Melbourne	43.13	Proceeds, sale 66 lb. bulk wool, sale 14	17.6.66
Stephens, G., Mollison-street, Kyneton	113.52	Purchase, 24½ pints of Phosdren, Kyneton	29.6.66
Name and address unknown	124.41	Proceeds, 1 steer, Benalla	4.10.66
Name and address unknown	10.34	Proceeds, Warragul	5.9.66
Vanderham, H., Yarra View-road	12.46	Proceeds, 1 Calf, Croydon	18.7.66
Arandt Bros., Melton South	10.86	Cartage 98 lambs, Newmarket	22.11.66
Name and address unknown	27.25	Proceeds, 1 bull, Stuarts	14.6.66
Name and address unknown	175.20	Proceeds, 2 cattle, Tatura	19.1.67
Name and address unknown	121.30	Proceeds, 1 choppers, B'dale	6.5.66
Name and address unknown	211.91	Proceeds, 2 bulls, B'dale	15.11.66
Name and address unknown	186.92	Proceeds, 2 steers, B'dale	23.9.66
Johnson, W., Marnoo	17.78	Stock proceeds, Horsham	12.11.65
Name and address unknown	33.73	Proceeds, 1 bale wool, Melb., 20.6.66. Description—Corcor Brand—Net weight 384 lb., Ardno East, B.G.	8.7.66
2115			
GOLDEN POULTRY FARMING INDUSTRIES LTD.			
Mieville, David Peter, 19 Dudley-road, Rose Bay, N.S.W.	12.50	Interim Dividend	18.3.66
Dunstan, Edwin Turner, 25 Prospect-road, Rosanna 2113	10.00	Final Dividend	24.10.66

Unclaimed Moneys Act 1962.

REGISTER of Unclaimed Moneys held by the—

Name of Owner on Books and Last Known Address.	Total Amount Due to Owner.	Description of Unclaimed Moneys.	Date when Amount first became Payable.
§			
KYABRAM PRESERVING COMPANY LIMITED.			
Norman, Ronald Lindsay, Katunga 2000	10.60	Dividend on 106 \$1 shares ..	30.9.66
PAKENHAM (No. 2) CO-OPERATIVE HOUSING SOCIETY LIMITED.			
Peebles, Ronald Frederick, Savage-street, Pakenham East ..	200.39	Balance of mortgagee sale of property financed by this society	6.5.63
BRYSON INDUSTRIES LIMITED.			
Coulson, Rita (Mrs.), Unit 62, 35A Sutherland-crescent, Darling Point, N.S.W. 2002	22.50	Dividend—ordinary ..	22.11.66
GEELONG R. S. AND S. WOOLLEN AND WORSTED CO-OPERATIVE MANUFACTURING COY. LIMITED.			
Gordon, G. (estate of), c/o J. E. Gordon "Ballangeich", Ellerslie	12.80	40th Dividend on 4 shares in this Company	18.11.66
Graham, C. A. (estate of), c/o L. A. Graham, Rupanyup ..	12.80	" " 4 "	"
Leckie, W. G. (estate of), c/o E. R. Hudson, P.O. Box 452, Broken Hill, N.S.W.	32.00	" " 10 "	"
Mowbray, Elizabeth, 2 Willow-street, Malvern ..	12.80	" " 4 "	"
Reed, R. A., 40 Prout-street, Iron Bark, Bendigo ..	12.80	" " 4 "	"
Minnett, S., 394 St. Kilda-road, Melbourne ..	19.20	" " 6 "	"
Watson, F. T. H., 31 Queensberry-street, North Melbourne ..	12.80	" " 4 "	"
GENERAL MOTORS ACCEPTANCE CORPORATION, AUSTRALIA.			
Jackson, R. H., Flat 18, 245 Williams-road, South Yarra ..	33.90	Overpayment of Hire Purchase Agreement	15.7.66
Jez, M., 122 Pilgrim-street, Footscray ..	56.00	" " " "	11.8.66
Ruehr, G., 46 Percy-street, Chilwell ..	50.10	" " " "	1.4.66
Sharam, G. R., Nicholls-lane, off Flowerdale-road, West Kinglake	17.61	" " " "	21.12.66
McPhail, J. P., Dampier, W.A. ..	14.10	" " " "	7.4.66
Zappia, C., c/o D. Preece, Toolamba ..	15.60	" " " "	14.11.66
Harris, F. and Sons, Quambatook ..	28.00	Insurance Commission ..	13.12.66
Czajkowski, S., 58 Hammond-road, Dandenong ..	158.64	Surplus funds on sale of re-possession	20.1.67
PHILIP MORRIS (AUSTRALIA) LIMITED.			
Martin, Edward and C. Maguire, c/o J. A. Hoogle and Co., 40 Wall-street, New York, U.S.A.	110.50	15th Dividend on 1000 Ordinary Shares	1.2.67
Annand, Gertrude Annie (Mrs.), 25 Dickson-terrace, Hamilton, Brisbane	13.00	" " " "	"
Atkinson, Robert David, 15 Rocklynn-place, Launceston, Tasmania	13.00	" " " "	"
Potter, Frederick Albert, 88 St. Elmo-road, Ivanhoe ..	13.00	" " " "	"
Starr, Peggie Mary (Mrs.), 43 Sussex-street, North Brighton ..	13.00	" " " "	"
WILKE AND COMPANY LIMITED.			
Begg, L. T., 133 Belford-road, Kew, 3101	13.50	Unclaimed Dividend ..	—10.66
Gardiner, E., c/o 25 Duncan-street, West End, Brisbane, Queensland, 4101	90.40	Directors' Fees ..	—6.64
Marlaise, M. M. (Christou), Lot 24, Burns-avenue, Westall	29.65	Unclaimed Wages ..	—7.65
Aldridge, E. J., 35 Lothian-street, North Melbourne, 3051	28.90	" " ..	—12.64
Belman, H. O., 180 Toorak-road, South Yarra, 3141	19.55	" " ..	—5.66
WINDSOR HOTEL LIMITED.			
Cheeseman, Edward Thomas, Bellevue Park, St. Marys, N.S.W. ..	16.25	6½% Dividend on 250 Ordinary Shares	14.9.65
Newman, Maisee Anna and Newman, Leonard Reginald, Melbourne-road, Norlane, Geelong	26.00	" " 400 "	"
Zerfas, Alfred John, 67 Wellington-street, Kew ..	65.00	" " 1,000 "	"
ANGLO-AUSTRALIAN NOMINEES PTY. LIMITED.			
Name and address unknown ..	10.00	Dividend on 400 Ansett Transport Industries Ltd. shares	2.5.66
" " " " ..	20.00	Dividend on 800 Associated Portland Cement Manufacturers Aust. Ltd. shares	—9.66
" " " " ..	12.50	Dividend on 500 Macquarie Broadcasting Holdings Ltd. shares	15.11.66
CHEETHAM SALT LIMITED.			
Salvia, Carmelo (estate of), 16 Brownbill-street, East Geelong ..	46.13	Holiday pay due ..	—7.65
Crawford, Wayne, 29 Rainsford-street, Werribee ..	16.46	Wages unpaid ..	15.3.67

Unclaimed Moneys Act 1962.

REGISTER of Unclaimed Moneys held by the—

Name of Owner on Books and Last Known Address.	Total Amount Due to Owner.	Description of Unclaimed Moneys.	Date when Amount first become Payable.
\$			
FREIGHTERS LIMITED.			
Beattie, R. G., Flat 11, 19 Mercer-road, Armadale	11.31	Dividend and Interest	20.5.66
Burdon, C. D., 9 Bulwer-avenue, Perth, W.A.	16.00	Dividend	"
Butler, G. W. H., "Wurrook", Rokewood	100.00	"	"
Carroll, E. T., 15 Railway-parade, Penhurst, N.S.W.	11.30	Dividend and Interest	"
Crudginton, E. (Mrs.), Unit 6, 23 Ormond-street, Ashfield, N.S.W.	45.40	Dividend	"
Grant, D. L., (Mrs.), 16 Black-street, Brighton	20.00	"	"
Smith, C. F., 145 Beach-road, Sandringham	10.08	"	"
Southwick, A. (Mrs.), 19 North-road, Elwood	48.00	"	"
Warne, A. M. (Mrs.), and A. J. Warne, Flat 4, 4 Irwell-street, St. Kilda ..	40.00	"	"
Belshaw, R. R., 28 Cawkwell-street, Malvern	10.80	"	28.10.66
Lyon, H. D., 23 Jervois-street, East St. Kilda	20.00	"	20.5.66
Morris, G. A., D. M. Morris, G. H. Butler and Mrs. W. M. Morris, c/o J. A. Thompson, Johnson, Arnott and Co. 10 Martin Place, Sydney, N.S.W.	30.00	"	"
McLean, M. A. (Mrs.), Anglers Hotel, 2 Raleigh-road, Maribyrnong	20.00	"	"
McArthur, E. H. and Mrs. R. E. McArthur, 11 Walsh-road, Ashburton, N.Z.	54.69	Dividend and Interest	"
Downing, L. W., (Mrs.), Flat 4, 5 Plumer-road, Rose Bay, N.S.W.	16.96	"	"
Johnstone, D. (Mrs.), and J. J. Johnston, Flat 2, 12 Carrington-street, Sydney, N.S.W.	14.00	Dividend	"
MacGowan, B. A. (Mrs.), Port Moresby, Papua, N.G.	10.00	"	"
Schwilk, I. E. (Mrs.), 5 De Landa, 95 Drumalbyn-road, Bellevue Hill N.S.W.	11.37	Dividend and Interest	"
Curwen-Walker, K. L., (Miss), 18 Fowler-street, Box Hill	37.80	Dividend	"
Symes, P. M. (Mrs.), 80 Russell-street, Westport, N.Z. ..	33.05	Dividend and Interest	"
Byrne S. W. and M. M. Boyd, 166 Queen-street, Melbourne	24.50	Interest	31.5.66
Symonds, E. H., P.O. Box 127, Pinnarco, S.A.	30.24	Dividend	28.10.66
James, M. L. (Mrs.), 21 Croydon-avenue, Montrose, Tas. . .	22.00	"	"
2114			
AUSTRALIAN FIBRE GLASS PTY. LIMITED.			
Ivachew, Anna, 21 Frederick-street, Dandenong	18.50	Wages	24.3.66
Henwood, Shiela May, 83 Box-street, Doveton	12.10	"	22.6.66
Reed, Doris, Hallam-road, Hallam	29.70	"	8.5.66
McDermott, Elizabeth, 79 Jason-crescent, Dandenong	12.50	"	31.7.66
Van Loo, Thelma, 81 Clow-street, Dandenong	20.20	"	26.7.66
Chaban, Alexandra, 35 Box-street, Doveton	17.75	"	10.8.66
Beaudouin, Joseph, 8 Belmont-street, Oakwood Park	22.50	"	2.10.66
Palmer, George, 37 Scott-street, Dandenong	27.85	"	28.12.66
2145			
AUSTRALIAN WINDOW GLASS PTY. LTD.			
Hojnacki, S., 3 Eckford-street, Dandenong	15.75	Bonus	9.3.66
Harbour, K. W., 16 Thomas-street, Noble Park	10.77	"	16.3.66
Lewis, K. O., 254 Latrobe-street, Cranbourne	15.14	"	20.4.66
			29.6.66
			6.7.66
2146			
LUSTRE JEWELLERY LIMITED.			
Chandler, Victor E., Little Yarra-road, Gladysdale	17.50	Dividend on 200 shares	30.9.66
2147			
EGG AND EGG PULP MARKETING BOARD.			
Varagannzs, P. (address unknown)	11.65	Credit Balance in Debtor's Account	30.8.65
Trenka, H., P.O., Box 3, Mitcham	18.00	"	22.2.67
Walker, L. and P. E., Sharon Downs, Geelong	56.23	Final Payment for Eggs Deliv- ered 1965-66	25.11.66
Harradine, F. C. V., Mandurang	77.33	"	25.11.66
Jolly, W., Bangalay-avenue, Frankston	14.64	Egg Purchases	16.3.66
Portogallo, V., Box 69, Kay-road, Werribee	18.64	"	15.9.66
Unknown Producer	13.22	"	13.10.66
Unknown Producer	12.54	"	22.12.66
Knight, M., Cockatoo	16.24	"	17.2.67
2148			
DENNY'S LASCELLES LIMITED.			
Hopkins, Vyvienne L. (Mrs.), 603 Dandenong-road, Malvern .. .	120.12	Dividend on shares— Cheque No. 572	25.8.66
		Cheque No. 8568	28.2.67
Olsson, Christina S. (Miss), 470 Bridge-road, Richmond .. .	60.06	Cheque No. 957	25.8.66
		Cheque No. 8945	28.2.67
Falkenberg, Ellen (estate of), Wannon	11.20	Cheque No. 8357	"
Petering, F. W., Coromby	15.55	Proceeds Stock	4.11.66
Sudholz, Gary, Natimuk	126.81	"	10.11.66
Hines, P. and B., Marnoo East	100.48	"	11.11.66
Hall, K. G., P. B., Stawell	500.00	"	9.1.67
Liersch, C. E. and M. I., Horsham	115.36	"	2.2.67
2152			

Unclaimed Moneys Act 1962.

REGISTER of Unclaimed Moneys held by the—

Name of Owner on Books and Last Known Address.	Total Amount Due to Owner.	Description of Unclaimed Moneys.	Date when Amount first become Payable.
§			
CHRYSLER AUSTRALIA LIMITED.			
Bickner, Michael Paul, 31 Alma-road, St. Kilda	19.06	Wages	1.5.66
Plessas, Ioannis, 2 Vere-street, North Richmond	12.06	"	1.5.66
Urbanic, Joseph, Flat 1, 21 Hilda-crescent, Hawthorn	10.88	"	9.5.66
Dukeson, Edison, 444 Flinders-street, Melbourne	22.71	"	23.5.66
Cauchi, Sam, 15 Fitzroy-street, St. Kilda	37.66	"	20.6.66
Niocastritis, Petros, 81 Cromwell-road, South Yarra	30.03	"	"
2149			
SIDMONS INDUSTRIES LIMITED.			
Lipscombe, Stanley, Box A 242, P.O., South Sydney, N.S.W., and 139A Bathurst-street, Sydney, N.S.W.	12.50	Sum due for 25 only Convertible Notes each 50 cents issued by Siddons Industries Limited 1960 and due for conversion to shares 30th June, 1965. Certificate not surrendered	— .6.65
2150			
WANGARATTA WOOLLEN MILLS LIMITED.			
Allan, Fanny (estate of), c/o P. Allan, 147 Ludstone-street, Hampton Auckland, Harry L., c/o T. W. Keay Royal-avenue, Springhill, Brisbane, Qld.	13.40	Dividends	30.9.66
Balcke, Augustus V. (estate of), c/o Neil Stewart, Wangaratta	24.00	"	"
McMiken, Lynton, 90 Maude-street, Shepparton	140.00	"	"
O'Neill, Violet P. (estate of), c/o A. McSwiney, Wangaratta	42.00	"	"
Wright, Phyllis, 113 Burke-street, Wangaratta	72.00	"	"
Bourke, Peter, 25 Bridge-road, Beechworth	12.65	Wages	19.7.66
	21.30	"	15.11.66
2116			
THOS. COOK AND SON (AUSTRALASIA) PTY. LTD.			
Deacon, O. W. (Dr.), address unknown	10.00	Unused sea passage money (Voucher A1/80423)	— .12.60
Sender, F. (Mr. and Mrs.), East St. Kilda	18.50	Unused sea passage money (Voucher A1/87439)	— .10.61
Smith, B. W., 123 Henry-street, Windsor	10.00	Steamship Deposit (Receipt A4/3870)	— .6.61
Parker, G., 24 Lynn-street, Williamstown	10.00	Steamship Deposit (Receipt A4/4758)	— .7.61
Boyd, K., address unknown	100.00	Deposit on Travel Booking (Receipt A7/9528)	— .5.61
Bank N.S.W., Melbourne	22.85	Deposit on Travel Booking (Receipt A7/9797)	— .2.61
Lucas, E., 27 Flinders-lane, Melbourne	29.42	Deposit of Travel Booking (Receipt A7/10338)	— .5.61
Williams and Adams (Misses), c/o A.N.Z. Bank, Melbourne	22.80	Deposit on Travel Booking (Receipt A7/12101)	— .8.61
Wilcox, A. A., 39 Queen's-parade, Burwood	26.09	Insurance premium (Policies 15657/8)	— .12.60
Weston, Misses, 80 Wartoa-road, Rosanna	11.33	Greyhound Bus Lines (Ticket 14018)	— .10.61
Pier Hotel, Glenelg, S.A.	36.00	Hotel Deposit (Receipt A10/30838)	— .11.60
Wilson, P. L. (Mr. and Mrs.), c/o Chevron Hotel, Melbourne	13.00	Hotel Deposit (Receipt A10/30911)	— .2.61
2117			
CONSOLIDATED QUARRIES LIMITED.			
Brahman, John A., Fairway House, Forest-road, Pyrford Surrey, England	10.60	Dividend	28.4.66
Hind, Shelagh (Mrs.), c/o Bank of N.S.W., 109 St. Georges-terrace, Perth, W.A.	14.00	"	28.4.66
Bain, Florence (Mrs.), Flat 10, 8 Power-street, Toorak	187.50	"	8.11.66
Jones, Olive S., (Mrs.), 62 Tucker-road, Moorabbin	11.25	"	"
Martin, Gordon G., 207 Drummond-street, South Ballarat	15.00	"	"
Morell, Timothy J., c/o G. Van Egmond, 16 Taskinny-road, Toorak	22.50	"	"
Rigutto, Oswald, 550 Nepean Highway, East Brighton	18.75	"	"
Rogers, Alice A., Hidden Springs, Leongatha	75.00	"	"
Kronhill, Julia, (Mrs.), 1 Ontario-street, Caulfield	10.50	"	"
McNicol, Frances M. (Mrs.), E.S. and A. Bank, Martin Place, Sydney, N.S.W.	52.50	"	"
2118			
CARLTON BREWERY LIMITED.			
Arnheim, Joan, 57 Currajong-street, Parks, N.S.W.	16.00	Dividend	25.3.66
Blaxland, Guy H. G., 6 Collings-street, Wahroonga, N.S.W.	44.76	"	6.10.66
Bradley, Frederick S., 11 Luxton-road, South Yarra	16.00	"	25.3.66
Holmes, Constance M., Flat 4, 16 Canfield Gardens, London, N.W.6	18.08	"	"
Philp, Josephine M., 43 Bayview-terrace, Clayfield, Queensland	36.00	"	6.10.66
Roger, June D., c/o Master's Office, 697 George-street, Sydney, N.S.W.	15.00	"	"
Ryan, James A., P.O. Box 64, Port Melbourne	67.20	"	"
Saunders, Ethel R. (estate of), c/o National Trustees, Executors and Agency Co. of Australasia Ltd., 46 Queen-street, Bendigo	60.00	"	"
Williams, Kathleen C., Bull's Creek-road, Blackwood, S.A.	85.28	"	25.3.66
2119			

Unclaimed Moneys Act 1962.

REGISTER of Unclaimed Moneys held by the—

Name of Owner on Books and Last Known Address.	Total Amount Due to Owner.	Description of Unclaimed Moneys.	Date when Amount first became Payable.
§			
FEDERATION CREDITS LTD.			
Conway, James Dargin, 17 Nenagh-street, North Manley, N.S.W.	30.00	Dividend on 1000 shares in Federation Credits Ltd.	30.9.66
Gordon, Arthur Graeme, 5 Wandeen-road, Taylor's Point, Avalon Beach, N.S.W.	12.00	400 shares	"
Jennings, William Anthony, 68 Windsor-road, Baulkham Hill, N.S.W.	12.00	400 shares	"
Leyden, Stephen Francis, c/o S. C. Ho:derm, 10 O'Connell-street, street, Sydney, N.S.W.	60.00	2000 shares	"
Pascoe Neville Keith, 24 Lansdown-road, East St. Kilda, ..	12.00	400 shares	"
Smithson, John Harold, c/o Coffs Harbour Hotel, Coffs Harbour, N.S.W.	30.00	1000 shares	"
2120			
BRUNTON'S BRIGHT STEEL COMPANY.			
Speakman, John, McCarthy's-avenue, St. Albans	35.08	Wages	— 10 65
2121			
AUSTRALIAN GLASS MANUFACTURERS COMPANY.			
Portelli, C., 191 Stanley-street, West Melbourne	62.60	Wages	20.5.66
Kalispiras, N., 1 Brockschire-street, Clifton Hill	14.70	"	24.6.66
Natoli, A., 76 Addison-street, Elwood	29.48	"	"
Hunter, J., 13 Sumner-street, East Brunswick	23.23	"	14.7.66
Scarmato, V., 11 Huxtable-avenue, North Altona	16.24	"	5.8.66
Docker, A., 12 Millers-road, Seaholme	12.57	"	24.8.66
Simic, T., 35 Buckingham-street, Footscray	20.00	"	7.9.66
Koutsogiannakis, J., 13 Evelyn-street, St. Kilda	15.33	"	21.9.66
Ward, D., 21 Fairbank-road, Moorabbin	25.20	"	26.9.66
McAleese, J., 64 Hammer-street, Williamstown	18.88	"	5.10.66
Soupourmas, C., 12 O'Grady-street, Clifton Hill	30.22	"	"
Lountzis, S., 67 Lincoln-street, Essendon	16.36	"	12.10.66
Vella, E., 94 Droop-street, Footscray	16.21	"	25.10.66
Springham, P., Flat 5, 5 Simcock-avenue, Spotswood	21.40	"	27.10.66
Batsilas, G., 262 Montague-street, South Melbourne	81.48	"	7.11.66
Stankovic, F., 335 Bank-street, South Melbourne	23.28	"	23.11.66
Clarke, R., 37 Stephenson-street, Spotswood	34.99	"	14.12.66
Georgakis, I., 1 Hotham-street, Oakleigh	39.83	"	2.2.67
Kostoulas, I., 4 Vicar-street, Hawthorn	37.90	"	22.2.67
Rose, B., 7 Webb-street, Altona	14.60	"	16.12.64
Enterprises, J. L. P., 3 Bourke-street, Brunswick	18.00	Overcharge of Account	14.12.65
Sahhar, A., 197 Douglas-parade, Newport	11.50	Wages	25.3.66
Agas, C., 51 McIlwraith-street, North Carlton	14.54	"	6.4.66
Horafaris, S., 36 Andrew-street, Windsor	40.23	"	29.4.66
2122			
LAMINEX INDUSTRIES.			
Mr. Tan, 123 Park-drive, Parkville	14.90	Wages	10.1.67
2133			
A.C.I. METAL STAMPING CO.			
Outen, K., 52 Thomas-street, Laverton	14.52	Unclaimed Wages	— 4:66
2134			
A.C.I. PLASTICS.			
Page, J., 142 Byrrell-road, East Bentleigh	37.90	Wages	6.10.65
Dano, P., 67 Orlina-road, Armadale	49.00	"	22.10.65
Murray, K., address unknown	16.10	"	4 to 5 years ago
Blanfield, H., address unknown	21.60	"	1.3.63
Black, S., 331 Beach-road, Black Rock	15.30	"	27.3.66
Holden, B., 12 Earl-crescent, Bentleigh	39.50	"	8.5.66
Torcasio, B., 147 Rowan-road, Moorabbin	14.80	"	1.5.66
Wallace, J., 1 Summit-avenue, Moorabbin	11.90	"	19.2.67
2135			
GENERAL MOTORS—HOLDEN'S PTY. LTD.			
Baack, L., Box 5384 BB. G.P.O. Melbourne	10.00	Suggestion Award	— 2.66
Braz, M. F., 94 Langhorne-street, Dandenong	35.39	Wages	— 4.66
Cvetanovski, L., 109 George-street, Fitzroy	10.52	"	— 8.66
Maw, B. G., Fishermen's Bend Hostel	43.25	"	— 1.67
Scoutas C., 20 Henry-street, Oakleigh	92.57	"	— 6.65
Steenon, W. J., 37 Carlisle-street, St. Kilda	11.00	Suggestion Award	— 9.66
2136			
GORDON AND GOTCH (AUSTRALASIA) LIMITED.			
McNeilly, J. B. (estate of), c/o F. W. Beehag, Princes Highway Rockdale, N.S.W.	93.60	Dividend	24.6.66
Armstrong, E. M. (estate of), 3 Malcolm-street, Perth, W.A.	83.20	"	{ 24.6.66 16.12.66
Begg, J. McQ., No. 4 R.D. Balclutha, N.Z.	27.20	"	{ 24.6.66 16.12.66
2144			

In the matter of the *Co-operative Housing Societies Act 1958*; and in the matter of CORIO AND MOORPANYAL CO-OPERATIVE HOUSING SOCIETY LIMITED (in Liquidation).

AT a Special General Meeting of the above-named society duly convened and held at the registered office, 16 James-street, Geelong, on Monday, 8th April, 1968, the subjoined Special Resolution was duly passed:—

That the society having successfully completed its objectives five months ahead of its expected term, be wound up voluntarily, and that Mr. Robert Graham Farrow, of 16 James-street, Geelong, be appointed liquidator for the purposes of the winding up.

Dated this 8th day of April, 1968.

2218 R. T. ESLER, Chairman of Meeting.
R. G. FARROW, Secretary.

The *Companies Act 1961*.—In the matter of BLUE MEADOWS PTY. LTD. (in Voluntary Liquidation).—Members' Winding Up.

NOTICE is hereby given that at an Extraordinary General Meeting of the above company, duly convened and held on 5th April, 1968, the following Resolution was proposed and passed as a Special Resolution.

"That the company be wound up voluntarily and that Ernest Harding Niemann, of 44 Queen-street, Melbourne, be appointed liquidator for the purpose of such winding up, and that he be authorized to draw as remuneration for his services as liquidator his normal hourly charges in respect thereto."

Dated 5th April, 1968.

2220 R. G. PITCHER, Secretary.

The *Companies Act*.

HERBERT THOMAS PTY. LTD. (IN VOLUNTARY LIQUIDATION).

NOTICE OF FINAL MEETING.

NOTICE is hereby given that, pursuant to section 272 of the *Companies Act 1961*, a General Meeting of members of Herbert Thomas Pty. Ltd. will be held at the office of Spry, Walker & Co., 339 Collins-street, Melbourne, on Friday, 10th May, 1968, at 9.30 a.m., for the purpose of laying before the meeting accounts showing how the winding up has been conducted, and the property of the company has been disposed of, and of hearing any explanation that may be given by the liquidators.

R. MOORE.
E. M. HUGGARD.

2223 Joint and Several Liquidators.

DUINO PROPRIETARY LIMITED.

AT a General Meeting of the members of the above-named company, duly convened and held at the registered office, 401 Collins-street, Melbourne, on the 3rd day of April, 1968, the Special Resolution set out below was duly passed—

1. "That the company be wound up voluntarily."
2. "That Messrs. Lance Garnsworthy and Eric Maxwell Huggard, of the firm of Spry, Walker & Co., chartered accountants, be appointed joint and several liquidators at a fee to be determined in accordance with the normal professional scale rates for the time occupied by the said liquidators and/or their staff in carrying out duties as liquidators."

Dated this 10th day of April, 1968.

2224 B. H. HOLLINGSWORTH, Secretary.

FEDERATED INVESTMENTS' PTY. LTD.

AT a General Meeting of the members of the above-named company, duly convened and held at the registered office, 401 Collins-street, Melbourne, on the 3rd day of April, 1968, the Special Resolution set out below was duly passed—

1. "That the company be wound up voluntarily."
2. "That Messrs. Lance Garnsworthy and Eric Maxwell Huggard, of the firm of Spry, Walker & Co., chartered accountants, be appointed joint and several liquidators at a fee to be determined in accordance with the normal professional scale rates for the time occupied by the said liquidators and/or their staff in carrying out duties as liquidators."

Dated this 10th day of April, 1968.

2225 B. H. HOLLINGSWORTH, Secretary.

The *Companies Act 1966*.

NUHOLCO INVESTMENTS PROPRIETARY LIMITED.

AT an Extraordinary General Meeting of the above-named company duly convened and held at 105 King-street, Melbourne, on Monday, 1st April, 1968, the following Special Resolution was duly passed:—

"That the company be wound up voluntarily, that Mr. Alexander Sydney McLaughlan and Mr. Howard John Hinde, both chartered accountants, of 143 Queen-street, Melbourne, be appointed liquidators and that either of them shall have power to act alone in the winding up for all or any purposes, and that the liquidators be directed subject to the sale of all or any part of the trading stock of the company and subject to payment of or adequate provision for the liabilities of the company to divide the assets of the company amongst the contributories in specie or kind."

Dated this 3rd day of April, 1968.

2234 A. S. McLAUGHLAN, Liquidator.

Co-operative Housing Societies Act 1958.

CENTRAL CO-OPERATIVE HOUSING SOCIETY LIMITED.

NOTICE is hereby given that at a Special General Meeting of the above-named society, duly convened and held at "Wellesley House", 126-130 Wellington-parade, East Melbourne, on the 1st day of April, 1968, at 12.30 o'clock in the afternoon, the following Special Resolution was duly passed:—

"That the society having successfully completed its objectives nine months ahead of its expected term be wound up voluntarily, and that Jack Henry, of 126-130 Wellington-parade, East Melbourne, be appointed liquidator for the purposes of the winding up."

Dated this 2nd day of April, 1968.

2107 F. G. SHARKEY, Chairman.
J. HENRY, Secretary.

S.E.C. EMPLOYEES' CO-OPERATIVE HOUSING SOCIETY LIMITED (IN LIQUIDATION).

SPECIAL RESOLUTION.

Passed 27th March, 1968.

AT a special general meeting of the above-named society, duly convened and held at the S.E.C. Recreation Centre, 252 Flinders-lane, Melbourne, on the 27th day of March, 1968, at 5.30 p.m. the subjoined special resolution was duly passed:—

That the Society having successfully completed its objectives sixteen months ahead of its expected term be wound up voluntarily, and that Mr. Cecil Humphries, of 27 Oregon-drive, Donvale, be appointed liquidator for the purposes of the winding up.

2163 E. L. STUBBS, Chairman of Meeting.
C. HUMPHRIES, Secretary.

In the matter of the *Co-operative Housing Societies Act 1958*, and the *Companies Act 1961*, and in the matter of the S.E.C. EMPLOYEES' CO-OPERATIVE HOUSING SOCIETY LIMITED (in liquidation).—Notice to Creditors.

NOTICE is hereby given that all persons having any claim against the above society are required on or before the 26th day of April, 1968, to send their names and addresses and particulars of their debts or claims to Mr. C. Humphries, 27 Oregon-drive, Donvale, the liquidator of the said society, at his office and if so required by notice, in writing, from the said liquidator are personally, or by their solicitors, to come in and prove their said debts or claims at such time and place as shall be specified in such notice; or, in default thereof, they shall be excluded from the benefit of any distribution made before such debts or claims are so lodged or proved.

Dated at Melbourne this 28th day of March, 1968.

2173 C. HUMPHRIES, Liquidator.

LUXOR FABRICS PTY. LTD. (IN VOLUNTARY LIQUIDATION).

NOTICE is hereby given that the final General Meeting of shareholders of the company will be held at 392A St. Kilda-road, Melbourne, on Wednesday, 15th May, 1968, at 11 a.m.

Agenda:—To lay before the meeting the final account of the company relating to its winding up and to give any explanation that may be required.

2180 P. A. JUNO, Liquidator.

In the matter of ARTACO PTY. LTD.

WINDING-UP Order made 28th day of March, 1968.

Name and address of liquidator, John Kenneth Hall, 260 Queen-street, Melbourne, 3000.

WEIGALL & CROWTHER, solicitors for petitioner.
2213

The Companies Act 1961.—In the matter of HILLSTAN FROZEN FOODS PTY. LTD. (in Liquidation).

NOTICE is hereby given that, pursuant to section 272 of the Companies Act, a Final Meeting of the creditors of the above company will be held at the offices of Kennedy, Smail and Middlemiss, 296 Little Lonsdale-street, Melbourne, on Wednesday, the 8th day of May, 1968, at 11 a.m.

Business: To receive the liquidator's accounts.

Dated this 3rd day of April, 1968.

EDWARD RONALD SMAIL, Liquidator.

Kennedy, Smail and Middlemiss, 296 Little Lonsdale-street, Melbourne, 3000.
2228

The Companies Act 1961.—In the matter of AUSTIN'S OF COLLINS STREET PTY. LTD. (in Liq.).

NOTICE is hereby given that, pursuant to section 272 of the Companies Act, a Final Meeting of the creditors of the above company will be held at the offices of Kennedy, Smail and Middlemiss, 296 Little Lonsdale-street, Melbourne, on Wednesday, the 8th day of May, 1968, at 10.30 a.m.

Business: To receive the liquidator's accounts.

Dated this 8th day of April, 1968.

ALAN MURRAY HORSEBURGH, Liquidator.

Kennedy, Smail and Middlemiss, 296 Little Lonsdale-street, Melbourne, 3000.
2229

The Companies Act 1961.—In the matter of ARAMALCO PROPRIETARY LIMITED (in Liquidation).

NOTICE is hereby given that, pursuant to section 272 of the Companies Act, a Final Meeting of the creditors of the above company will be held at the offices of Kennedy, Smail and Middlemiss, 296 Little Lonsdale-street, Melbourne, on Wednesday, the 8th day of May, 1968, at 10 a.m.

Business: To receive the liquidator's accounts.

Dated this 8th day of April, 1968.

N. E. STRETTON, Liquidator.

Kennedy, Smail and Middlemiss, 296 Little Lonsdale-street, Melbourne, 3000.
2230

The Companies Act 1961.—In the matter of HIGHWAY CARAVANS PROPRIETARY LIMITED (in voluntary liquidation).

NOTICE is hereby given that at an Extraordinary Meeting of the members of the above-named company, held on Friday, the 29th day of March, 1968, it was resolved that the company be wound up voluntarily and at a meeting of creditors, held on the 29th day of March, 1968, it was resolved that for such purpose Geoffrey Ormond Harrison, chartered accountant, of Hall & Rose, 260 Queen-street, Melbourne, be appointed liquidator.

Notice is also given that after 21 days from this date, I shall proceed to distribute the assets. All creditors, having any claim against the company should furnish particulars of same by that date, otherwise I shall proceed to distribute the assets without regard to their claim.

Dated this 2nd day of April, 1968.

G. O. HARRISON, Liquidator.

Hall & Rose, chartered accountants, 260 Queen-street, Melbourne, Vic. 3000.
2193

The Companies Act 1961.

WIBROC (N.S.W.) PROPRIETARY LIMITED
(IN MEMBERS' VOLUNTARY LIQUIDATION).

NOTICE is hereby given that at an Extraordinary Meeting of the members of the above-named company held on Friday, the 29th day of March, 1968, it was resolved that the company be wound up voluntarily and that for such purpose Mr. Scott Maurice Nunan, chartered accountant, of Hall & Rose, 260 Queen-street, Melbourne, be appointed liquidator.

Dated this 1st day of April, 1968.

S. M. NUNAN, Liquidator.

Hall & Rose, chartered accountants, 260 Queen-street, Melbourne, Vic. 3000.
2194

In the matter of the Companies Act, and in the matter of LEE & MCGLOIN PROPRIETARY LIMITED.

NOTICE is hereby given that at an Extraordinary General Meeting of the above-named company duly convened and held at the Registered Office on the 5th day of April, 1968, the following Special Resolution was duly passed, viz.:

"That the Company be wound up voluntarily and that Bruce Carne Candy of E. C. Candy & Co., 118 Queen-street, Melbourne, be appointed liquidator for such winding up."

2209

ARTHUR B. LEE, Chairman.

PRINCIPE SHOES PTY. LTD. (IN LIQUIDATION).

NOTICE OF GENERAL MEETING OF THE COMPANY PURSUANT TO SECTION 272 (1) OF THE VICTORIAN COMPANIES ACT 1961.

NOTICE is hereby given that a General Meeting of the members and creditors of the company will be held on Friday, 31st May, 1968, at the offices of Arthur Andersen & Co., 330 Collins-street, Melbourne, at 11 a.m. for the purpose of laying before it the liquidator's account showing how the winding up has been conducted and the property of the company disposed of.

2211

K. H. VIAL, Liquidator.

THE MIDLAND BRICK COMPANY PROPRIETARY LIMITED (IN VOLUNTARY LIQUIDATION).

NOTICE is hereby given that at an Extraordinary General Meeting of the Company held at 396 Wyndham-street, Shepparton, Victoria, on the 29th day of March, 1968, at 10 o'clock in the forenoon a Special Resolution was duly passed that the company be wound up voluntarily, and at the same meeting an ordinary resolution was duly passed that Peter Addenbrook Walker, of 357 Little Collins-street, Melbourne, Victoria, be appointed as liquidator for the purpose of such winding up.

2183

P. A. WALKER, Liquidator.

The Companies Act 1961.

A. WASSILIEFF PROPRIETARY LIMITED
(IN MEMBERS' VOLUNTARY LIQUIDATION).

NOTICE is hereby given that at an Extraordinary Meeting of the members of the above-named company held on Friday, the 29th day of March, 1968, it was resolved that the company be wound up voluntarily and that for such purpose Mr. Scott Maurice Nunan, chartered accountant, of Hall & Rose, 260 Queen-street, Melbourne, be appointed liquidator.

Dated this 1st day of April, 1968.

S. M. NUNAN, Liquidator.

Hall & Rose, chartered accountants, 260 Queen-street, Melbourne, Vic. 3000.
2195

Trustee Act 1958.

NOTICE TO CLAIMANTS.

PURSUANT to the Trustee Act 1958, creditors, next of kin and all other persons having claims in respect of the estate of the deceased persons named below are required to send particulars to the legal personal representative or representatives at the addresses stated, after which date the representative or representatives will distribute the assets, having regard only to the claims of which notice has been received.

Bridget Eileen Bowman, late of Home-street, Koroit, spinster, deceased, intestate, died on the 30th day of October, 1967.—Claims to the administrator, Robert Gratton Bowman, of Station-street, Koroit, railway employee, care of Conlan & Leishman, solicitors, 38 Bank-street, Port Fairy, by 10th June, 1968.
2181

Robert Crawford Stewart, late of 8 Grant-street, Port Fairy, pensioner, deceased, died 30th day of December, 1967.—Claims to the executrix, Marion Agnes White, of 94 Epsom-road, Ascot Vale, clerk, care of Conlan & Leishman, solicitors, 38 Bank-street, Port Fairy, by 10th June, 1968.
2182

Thomas Francis O'Brien, late of Port Fairy-road, Koroit, in the State of Victoria, farmer, deceased (died 14th October, 1967).—Claims to the executor, Peter Paul Conlan, of 38 Bank-street, Port Fairy, by 15th June, 1968.
Conlan & Leishman, solicitors, 38 Bank-street, Port Fairy.
2132

CREDITORS, next of kin and others having claims in respect of the estate of Arthur Plavins, also known as Arthurs Plavins, formerly of Milne-street, Crib Point, but late of 20 Kars-street, Frankston, in the State of Victoria, retired carpenter, deceased (who died on the 31st December, 1966), are requested to send particulars of their claims to the administratrix, Milda Hermine Reimers, c/o the under-mentioned solicitors, by the 1st day of July, 1968, after which date she will distribute the assets, having regard only as to the claims of which she then has notice.

LESTER, PEARN & FIELDEN, solicitors, 14 Haughton-road, Oakleigh. 2102

JOHN TEMPLE, late of Old Menzies Creek-road, Narre Warren East, retired farmer, DECEASED (who died on the 19th January, 1968).

CREDITORS, next of kin and all others having claims in respect of the estate of the said deceased, are requested by the executor, The Trustees, Executors and Agency Company Limited, of 401 Collins-street, Melbourne, to send particulars of such claims to the said company by the 15th June, 1968, after which date the said company will distribute the assets, having regard only to the claims of which it then has notice.

DAVIES, CAMPBELL & PIESSE, solicitors, 401 Collins-street, Melbourne. 2233

CREDITORS, next of kin and others having claims in respect of the estate of Frank Augustus Murray, late of 245 Beaconsfield-parade, Middle Park, retired (who died on the 14th day of August, 1966), are required to send particulars of their claims to the executor, Ian David Murray, care of the under-mentioned solicitors, by the 25th day of June, 1968, after which date he will distribute the assets, having regard only to the claims of which he then has notice.

TREVOR MORRIS & SON, solicitors, 108 Queen-street, Melbourne. 2231

KATHLEEN GERTRUDE O'CONNELL, late of 11 Waterloo-street, Camberwell, spinster, DECEASED.

CREDITORS, next of kin and others having claims in respect of the estate of the deceased (who died on the 20th day of November, 1967), are required by James William Fitzwalter Thomson, of 422-8 Collins-street, Melbourne, and Phyllis Clara Ward, of 11 Waterloo-street, Camberwell, to send particulars of their claims to the said James William Fitzwalter Thomson, care of Read & Read, solicitors, of 422-8 Collins-street, Melbourne, by the 14th day of June, 1968, after which date they will convey or distribute the assets, having regard only to the claims of which he then has notice.

READ & READ, solicitors, of 422 Collins-street, Melbourne. 2238

MYRA ELIZABETH LYDIA MARZETTI DAVIS (usually known as Myra Elizabeth Davis), late of 6 Kenilworth-grove, Glen Iris, widow, DECEASED.

CREDITORS, next of kin and others having claims in respect of the estate of the deceased (who died on the 4th day of November, 1967), are required by James William Fitzwalter Thomson, of 422-8 Collins-street, Melbourne, to send particulars of their claims to him by the 14th day of June, 1968, after which date he will convey or distribute the assets, having regard only to the claims of which he then has notice.

READ & READ, solicitors, of 422 Collins-street, Melbourne. 2239

JOHN ALPHONSUS BOURKE and Laurence Herbert Ledger, both of Benalla, graziers, and The Union-Fidelity Trustee Company of Australia Limited, of 100 Exhibition-street, Melbourne, executors of the will and codicil of Edward John Ginnivan, late of "Mt. Ida", Benalla, in the State of Victoria, grazier (who died on the 1st day of November, 1967), require all creditors, next of kin and others having claims against the property or estate of the said deceased to send particulars of such claims, in writing, care of Hamilton, Clarke and Clarke, 55 Nunn-street, Benalla, on or before the 1st day of July, 1968, after which date the said executors intend to convey or distribute such property or estate to or among the persons entitled thereto, having regard only to the claims of which they shall then have had notice.

Dated this 9th day of April, 1968.

HAMILTON, CLARKE & CLARKE, 55 Nunn-street, Benalla, proctors for the said executors. 2126

JAMES JOHN HIGGINS, late of 19 Gladstone-street, Warrnambool, retired, DECEASED.

CREDITORS, next of kin and others having claims in respect of the above-named deceased (who died on the 20th day of January, 1968, probate of whose will was granted to John Beynon Dwyer and James Michael Dwyer, both of 95 Kepler-street, Warrnambool, solicitors, on the 5th day of March, 1968), are requested to send particulars of their claims, in writing, to the said John Beynon Dwyer and James Michael Dwyer, care of the undersigned, on or before the 10th day of June, 1968, after which date the said John Beynon Dwyer and James Michael Dwyer will distribute the assets of the said estate, having regard only to the claims of which they then have notice as aforesaid.

DESMOND DUNNE & DWYER, solicitors, Warrnambool. 2103

CREDITORS, next of kin and others having claims in respect of the estate of Alfred Hawkins, late of 109 Oakover-road, West Preston, rate collector, deceased (who died on the 12th December, 1967), are to send their claims to Allan Moore, Esq., solicitor, of 140 Queen-street, Melbourne, by the 10th June, 1968, after which date the executrix may distribute or convey the assets, having regard only to the claims of which she then has notice.

ALLAN MOORE, LL.B., 406 Lonsdale-street, Melbourne. 2104

EARDLEY FRANCIS WILMONT TAYLOR, late of 107 Nicholson-street, Footscray, in the State of Victoria, pastrycook, DECEASED.

CREDITORS, next of kin and others having claims in respect of the estate of the deceased (who died on the 22nd day of September, 1967), are required by the applicant for grant of administration, Keith Taylor, of 67 Heidelberg-road, Clifton Hill, to send particulars to him by the 15th day of June, 1968, after which date the applicant for grant of administration may convey or distribute the assets, having regard only to claims of which he then has notice.

Dated the 27th March, 1968.

CEDRIC RALPH, solicitor, 480 Bourke-street, Melbourne. 2105

CREDITORS, next of kin and others having claims in respect of the estate of Laurence Joseph Raffaele, late of 67 Paterson-street, North Carlton, invalid pensioner, deceased, intestate (who died 13th December, 1967), are to send particulars of their claims to the administratrix, Joan O'Brien, care of the under-mentioned firm, by the 6th day of June, 1968, after which date she will distribute the assets, having regard only to the claims of which she then has notice.

O'BRIEN & GALANTE, solicitors, 44 Pascoe Vale-road, Moonee Ponds. 2125

ARTHUR SYDNEY WILLIAMS, late of 3 Inverloch-street, Wonthaggi, gentleman, DECEASED, intestate.

CREDITORS, next of kin and others having claims in respect of the estate of the deceased (who died on 11th August, 1967), are required by the administrator, Herbert Richmond Williams, to send particulars of their claims to him, care of the under-mentioned solicitor, by the 10th day of June, 1968, after which date the administrator will distribute the assets, having regard only to the claims of which he then has notice.

B. T. E. FLYNN, solicitor, of 125 Bell-street, Coburg. 2129

ERIC JOHN REDFORD, late of 37 Melinga-crescent, Chadstone, in the State of Victoria, welder, DECEASED, intestate.

CREDITORS, next of kin and others having claims in respect of the estate of the deceased (who died on the 30th day of April, 1967), are required by the administratrix, Anna Marie Redford, of 1183 Hay-street, Perth, in the State of Western Australia, to send particulars to her solicitor, Neville D. Kelly, LL.B., of 437 Centre-road, Bentleigh, in the State of Victoria, by the 21st day of June, 1968, after which date the administratrix may convey or distribute the assets, having regard only to the claims of which she then has notice.

Dated the 3rd day of April, 1968.

NEVILLE D. KELLY, LL.B., solicitor, of 437 Centre-road, Bentleigh. 2130

EMMA ROBINA ELIZABETH KINSMAN, late of Flat 6, "Lester Court", Mona-place, South Yarra, retired clerk, DECEASED.

CREDITORS, next of kin and others having claims in respect of the estate of the above-named deceased (who died on the 13th November, 1967), are required by the trustees, James Horace Rosier, of 7 Cowper-street, East Hawthorn, company representative, and Vincent Lewis Breen, of 17 McNamara-street, West Preston, retired manager, to send particulars to them, care of the undersigned, by the 12th day of June, 1968, after which date the trustees may convey or distribute the assets, having regard only to the claims of which they then have notice.

WHITING & BYRNE, 166 Queen-street, Melbourne, 2206

MARY ANN BENNETT, late of 29 Central-avenue, Black Rock, in the State of Victoria, widow, DECEASED (who died on the 16th day of November, 1967).

CREDITORS, next of kin and all other persons having claims against the estate of the deceased are required by the executors of her will Maxwell Westwood, moulder, and Kevin Westwood, aircraft maintenance engineer, both of 24 Jinghi-road, Reservoir, in the said State, to send particulars thereof to them, care of the under-mentioned solicitors, before the 10th day of June, 1968, after which date they may distribute the assets of the deceased, having regard only to the claims of which they then have notice.

COLTMAN WYATT & ANDERSON, solicitors, of 578 Bourke-street, Melbourne. 2192

EUGENIE VICTORIA BEAUMONT, late of Flat 1, 31 Orange-grove, East St. Kilda, widow, DECEASED.

CREDITORS, next of kin and others having claims in respect of the estate of the deceased (who died on the 31st day of December, 1967), are to send particulars of their claims to The Perpetual Executors and Trustees Association of Australia Limited, of 100-104 Queen-street, Melbourne, by the 15th day of June, 1968, after which date it will convey or distribute the assets, having regard only to the claims of which it then has notice.

MORRISON, TEARE & PURNELL, solicitors, of 164 Flinders-street, Melbourne. 2198

DAER CAMPBELL COOPER, late of 133 New-street, Brighton, company director, DECEASED.

CREDITORS, next of kin and others having claims in respect of the estate of the deceased (who died on the 13th day of January, 1968), are required by The Perpetual Executors and Trustees Association of Australia Limited, of 100-104 Queen-street, Melbourne, to send particulars of their claims to the said company by the 30th day of June, 1968, after which date it will convey or distribute the assets, having had regard only to the claims of which the company then has notice.

Dated the 5th day of April, 1968.

MADDEN BUTLER ELDER & GRAHAM, solicitors, 31 Queen-street, Melbourne. 2200

ELIZABETH MAUD VALENTINE BULLOCK (also known as Elizabeth Maude Bullock), late of 6 Stewart-road, North Clayton, widow, DECEASED.

CREDITORS, next of kin and others having claims in respect of the estate of the above-named deceased, (who died on 21st November, 1967), are required by the executors, John Raymond Bullock, of 16 Greenwood-avenue, Ringwood, retail grocer, and Vernon Kinross Bullock, of 6 Stewart-road, North Clayton, electrical retailer, to send particulars to them, in care of their under-mentioned solicitors, by 12th June, 1968, after which date the executors may convey or distribute the assets, having regard only to the claims of which they then have notice.

W. H. FLOOD & PERMEZEL, 388 Bourke-street, Melbourne, solicitors for the executors. 2201

ANNIE FLORENCE MOSS, late of 18 Invermay-grove, Hawthorn, spinster, DECEASED.

CREDITORS, next of kin and others having claims against the estate of the above deceased (who died on the 27th day of October, 1967), are required to send particulars of such claims to the executors, Ernest Franklin Barnard and Lance Garwood, care of the under-mentioned solicitor, by the 24th June, 1968, after which date the executors will distribute the assets, having regard only to the claims of which they then have notice.

M. JOHN KELLY, solicitor, 422 Collins-street, Melbourne. 2204

CAROLINE MAY CRAWFORD, late of Kinross Nursing Home, 9 Broughton-road, Surrey Hills, Victoria, widow, DECEASED.

CREDITORS, next of kin and others having claims in respect of the estate of the deceased (who died on the 14th day of January, 1968), are required by the applicant for a grant of administration The Perpetual Executors and Trustees Association of Australia Limited, of 100-104 Queen-street, Melbourne, to send particulars of their claims to the said company by the 14th day of June, 1968, after which date it will convey or distribute the assets, having had regard only to the claims of which the said company then has notice.

HEDDERWICK, FOOKES & ALSTON, 103 William-street, Melbourne. 2202

CREDITORS, next of kin and others having claims in respect of the estate of Percy Leonard Champness, late of Mount Moriac, grazier deceased (who died on the 13th day of September, 1967), are asked to send particulars of their claims to the executor of the will, The Equity Trustees Executors and Agency Company Limited, of 472 Bourke-street, Melbourne, by the 14th day of June, 1968, after which date the said executor may convey or distribute the assets, having regard only to the claims of which it then has notice.

F. R. APTED, solicitor, 63 Yarra-street, Geelong. 2186

CREDITORS, next of kin and others having claims in respect of the will of Clive Charles Anderson, late of Tarwin Lower, dairy farmer, deceased (who died on the 16th day of October, 1967), are to send particulars of their claims to National Trustees Executors and Agency Company of Australasia Limited, of 95 Queen-street, Melbourne, by the 19th day of June, 1968, after which date it will distribute the assets, having regard only to the claims of which it then has notice.

BIRCH, ROSS & BARLOW, solicitors, Leongatha. 2177

CREDITORS, next of kin and others having claims in respect of the estate of Winifred May O'Sullivan, formerly of Moorabbin Hotel, Point Nepean-road, Moorabbin, in the State of Victoria, married woman, but late of "Minora Lodge", Olivers Hill, Nepean Highway, Frankston, in the said State, widow, deceased (who died on the 28th day of September, 1967), are required to send particulars of their claims to the executor, National Trustees Executors and Agency Company of Australasia Limited, of 95 Queen-street, Melbourne, before the 10th day of June, 1968, after which date the executor will distribute the assets, having regard only to the claims of which it then has had notice.

BRENDAN MCGUINNESS & CO., solicitors, 118 Queen-street, Melbourne. 2188

CREDITORS, next of kin and others having claims in respect of the estate of Eileen Beatrice Sherwood, late of Deane-street, Frankston, spinster, deceased (who died on the 15th of December, 1967), are to send particulars of their claims to George Henry William Sherwood, of 8 Elsa-court, Eltham, the executor appointed by the will of the said deceased, by the 12th of June, 1968, after which date the executor will distribute the assets, having regard only to the claims of which he shall then have notice.

H. L. YUNCKEN & YUNCKEN, solicitors, 443 Little Collins-street, Melbourne, 3000. 2189

THE NATIONAL TRUSTEES EXECUTORS AND AGENCY COMPANY OF AUSTRALASIA LIMITED, of 95 Queen-street, Melbourne, the executor of the will of May Eliza Cooper, late of 36 Fitzroy-street, Fitzroy, spinster, deceased (who died on the 18th day of January, 1968), requests all creditors, next of kin and others having claims against the property or estate of the said deceased to send to it, the said executor, at its aforementioned address on or before the 8th day of May, 1968, particulars in writing of such claims, after which date the executor intends to convey or distribute such property or estate to or among the persons entitled thereto, having regard only to the claims of which it shall have had notice.

HEFFEY & BUTLER, solicitors of 358 Lonsdale-street, Melbourne. 2190

CREDITORS, next of kin and others having claims in respect of the estate of Allan Procter Brown, late of 34 Broadway, Elwood, public relations officer, deceased (who died on 22nd April, 1967), are required to send particulars of such claims to The Equity Trustees Executors and Agency Company Limited at its registered office at 472 Bourke-street, Melbourne, by 14th June, 1968, after

which date the said company will distribute the assets having, regard only to the claims of which it then has notice.

DOYLE & KERR, solicitors, 108 Queen-street, Melbourne.
2191

AILEEN MARY FALKENBERG, late of 117 Normanby-road, East Kew, in the State of Victoria, widow, DECEASED.

CREDITORS, next of kin and others having claims in respect of the estate of the deceased (who died on the 5th day of December, 1967), are required by Kevin Luke Murphy, of 422 Bourke-street, Melbourne, in the said State, solicitor, he being the surviving executor of the will of the deceased and the person to whom probate of such will has been granted by the Supreme Court of Victoria, to send particulars to him, the said Kevin Luke Murphy, at his aforementioned address, by the 20th day of June, 1968, after which date the said executor, Kevin Luke Murphy, may convey or distribute the assets, having regard only to the claims of which he then has notice.

LUKE MURPHY & CO., solicitor, 422 Bourke-street, Melbourne.
2171

IMPOUNDINGS

ARDEER.—Impounded in Ardeer Pound.

1 chestnut mare, star on forehead, off hind white sock, no visible brand
1 grey mare, no visible brand
If not claimed and expenses paid, to be sold on 27th April, 1968.

D. L. THOMPSON,
Poundkeeper.
2187—\$2

ELTHAM.—Impounded in Eltham Pound, by Ranger.

1 English Leicester ewe, no visible brand
If not claimed and expenses paid, to be sold on 27th April, 1968.

G. MATHEWS,
Poundkeeper.
2212—\$1.50

PAKENHAM.—Impounded in Pakenham Pound, from McGinnes-road, Tynong North.

1 Jersey cow, dehorned, no visible brand.
If not claimed and expenses paid to be sold on 23rd April, 1968.

H. SMITH,
Poundkeeper.
2123—\$1.75

PAKENHAM.—Impounded in Pakenham Pound, from Belgrave-Hallam road, Narre Warren North.

3 Jersey heifers, 8 months, no visible brand.
If not claimed and expenses paid to be sold on 17th April, 1968.

H. SMITH,
Poundkeeper.
2124—\$1.75

STAWELL.—Impounded in Stawell Pound, Navarre-road.

1 female goat, all white, about six months old, no visible brand
If not claimed and expenses paid, to be sold on 25th April, 1968.

W. G. DRYBURGH,
Poundkeeper.
2127—\$1.75

TATURA.—Impounded in Tatura Pound.

4 lambs, V front of right ear, blue brand on loin
1 lamb, V top out of left ear, no visible brand
If not claimed and expenses paid, to be sold on 2nd May, 1968.

J. H. MACTIER,
Poundkeeper.
2219—\$1.75

TATURA.—Impounded in Tatura Pound.

3 Jersey steers, W on right rump
6 Jersey heifers, O on left rump
1 ewe, V top of both ears, no visible brand
6 wethers, UU in left ear, no visible brand
If not claimed and expenses paid, to be sold on 25th April, 1968.

J. H. MACTIER,
Poundkeeper.
2128—\$2.25

WARRNAMBOOL.—Impounded in Warrnambool Pound, on 1st April, 1968.

1 bay gelding hack, white stripe on face, two fetlocks white, no visible brand

Impounded on 3rd April, 1968.

3 fawn Jersey heifers, no visible brands

If not claimed and expenses paid, to be sold on 24th April, 1968.

M. STONEHOUSE,
Poundkeeper.
2174—\$2.50

Subordinate Legislation Act 1962.

NOTICE OF MAKING OF STATUTORY RULES.

IN pursuance of the provisions of the *Subordinate Legislation Act 1962* and the Regulations made thereunder, notice is given of the making of the following statutory rules:—

No.	Gas Regulation Act 1958.	Price.
74/1968.	Gas (Dryness) Regulations 1968 ..	10c
	<i>Education Act 1958.</i>	
75/1968.	Adult Education Regulations (Salaries) 1968 ..	10c
	<i>Melbourne Harbor Trust Act 1958.</i>	
76/1968.	Melbourne Harbor Trust Superannuation Regulations 1957 (Amendment No. 1/68)	15c

Copies of these statutory rules may be purchased at the Sale of Publications Section of the Government Printing Office, located at Macarthur-street, Melbourne, 3002. If ordered by mail, remittance should be addressed to "The Government Printer, Box 203, P.O., North Melbourne, 3051", and should include 5c extra for postage. If a credit account is held at this office, no remittance is required with the mail order.

The annual subscription rate for Statutory Rules (including a Bound Volume) is \$15, payable in advance. The subscription year commences on 1st January.

A. C. BROOKS,
Government Printer.

STATE ACTS, 1965

COPIES of the following Acts of Parliament of Victoria may be obtained at the Government Printing Office, or from any accredited agents, at the price set opposite to each (these prices do not include postage).

No.	Price
7238.	Wills (Minors') .. \$0.05
7239.	Cattle Compensation (Amendment) .. \$0.05
7240.	Swine (Amendment) .. \$0.05
7241.	Social Welfare (Cadetships) .. \$0.05
7242.	Appeal Costs Fund (Amendment) .. \$0.05
7243.	Altona Railway Extension .. \$0.08
7244.	Transfer of Land (Removal of Caveats) .. \$0.05
7245.	Water Authorities Accident Insurance .. \$0.08
7246.	Portland Harbor Trusts (Amendment) .. \$0.10
7247.	Melbourne and Metropolitan Board of Works (Borrowing Powers) .. \$0.05
7248.	Justices (Registration) .. \$0.10
7249.	Mildura Irrigation and Water Trusts (Amendment) .. \$0.08
7250.	Health (Tuberculosis Arrangement) .. \$0.08
7251.	Children's Court (Admission to Hearings) .. \$0.05
7252.	Bendigo Land (Special Grant) .. \$0.05
7253.	Werribee Waterworks District (Abolition) .. \$0.05
7254.	Dandenong Valley Authority (Amendment) .. \$0.05
7255.	Legal Aid (Costs) .. \$0.05
7256.	Agricultural Education (Continuation) .. \$0.05
7257.	Geelong (Kardinia Park) Land .. \$0.05
7258.	Water (Amendment) .. \$0.08
7259.	Victorian Inland Meat Authority (Amendment) .. \$0.05
7260.	The Constitution Act Amendment (Subordinate Legislation Committee) .. \$0.05
7261.	Country Fire Authority .. \$0.08
7262.	Subordinate Legislation (Amendment) .. \$0.05
7263.	Crimes (Illegal Use of Motor Cars) .. \$0.08
7264.	Property Law (Loans to Minors) .. \$0.08
7265.	Soil Conservation (Water Resources) .. \$0.08
7266.	Grain Elevators (Borrowing Powers) .. \$0.05
7267.	Aborigines (Amendment) .. \$0.05
7268.	Stamps .. \$0.10
7269.	Crimes (Parole) .. \$0.05

STATE ACTS, 1965—continued.	
No.	Price.
7270.	Electoral Provinces and Districts .. \$0.12
7271.	Mordialloc Public Hall and Court House .. \$0.08
7272.	Sale of Land .. \$0.15
7273.	Labour and Industry (Amendment) .. \$0.10
7274.	Farm Produce Merchants and Commission Agents .. \$0.30
7275.	National Parks (Amendment) .. \$0.10
7276.	Valuation of Land (Appeals) .. \$0.20
7277.	Medical (Foreign Practitioners) .. \$0.05
7278.	Rural Finance and Settlement Commission .. \$0.05
7279.	Home Finance (Amendment) .. \$0.05
7280.	Road Traffic (Infringements) .. \$0.10
7281.	Companies (Amendment) .. \$0.10
7282.	Health (Household Insecticides) .. \$0.08
7283.	Roads (Special Projects) .. \$0.10
7284.	Consolidated Revenue .. \$0.05
7285.	Consolidated Revenue .. \$0.05
7286.	Local Government (Amendment) .. \$0.15
7287.	Teaching Service (Amendment) .. \$0.05
7288.	Marketing of Primary Products (Egg Marketing) .. \$0.10
7289.	Maintenance .. \$0.52
7290.	Veterinary Surgeons (Amendment) .. \$0.10
7291.	Victoria Institute of Colleges .. \$0.18
7292.	Workers Compensation (Amendment) .. \$0.18
7293.	Petroleum Products Subsidy .. \$0.10
7294.	Consolidated Revenue .. \$0.05
7295.	Acts Interpretation .. \$0.08
7296.	Administration and Probate (Surviving Actions) .. \$0.05
7297.	Mines (Regulations) .. \$0.05
7298.	Electric Light and Power (Interstate Supplies) .. \$0.05
7299.	Supreme Court (Judges) .. \$0.05
7300.	Local Government (Brighton Land Reclamation) .. \$0.08
7301.	Racing (Totalizer Percentages) .. \$0.05
7302.	Agricultural Colleges (Cadetships) .. \$0.05
7303.	State Electricity Commission (Chairman) .. \$0.08
7304.	Geelong Harbor Trust Lands .. \$0.08
7305.	San Remo—Newhaven Land .. \$0.08
7306.	Echuca Stockyards Railway Construction .. \$0.08
7307.	Metropolitan Transportation Committee (Amendment) .. \$0.05
7308.	Fuel and Power .. \$0.08
7309.	Albert Park Lands .. \$0.05
7310.	Presbyterian Trusts (Common Fund) .. \$0.08
7311.	Melbourne Harbor Trust (Amendment) .. \$0.10
7312.	Apprenticeship (Amendment) .. \$0.10
7313.	Country Roads (Collection Costs) .. \$0.05
7314.	Motor Car .. \$0.10
7315.	Decimal Currency .. \$0.20
7316.	Joint Select Committee (Drainage) .. \$0.10
7317.	Stamps (Amendment) .. \$0.08
7318.	Country Fire Authority (Service of Notices) .. \$0.05
7319.	Licensing .. \$0.15
7320.	Railway Loan Application .. \$0.10
7321.	Water Licences and Permits .. \$0.10
7322.	Railways (Amendment) .. \$0.05
7323.	Local Government (Constitution of Municipalities) .. \$0.20
7324.	Evidence (Reproductions) .. \$0.12
7325.	Milk and Dairy Supervision (Cheese Factory Licences) .. \$0.05
7326.	Water Supply Loan Application .. \$0.15
7327.	Motor Car (Driving Offence) .. \$0.08
7328.	Land Settlement and Rural Finance .. \$0.08
7329.	Committees (Amendment) .. \$0.05
7330.	Public Works Loan Application .. \$0.10
7331.	Weights and Measures (Amendment) .. \$0.12
7332.	Statute Law Revision .. \$0.15
7333.	Valuation of Land (General Amendment) .. \$0.10
7334.	Cul-de-sac Applications .. \$0.05
7335.	Tourist Resorts .. \$0.05
7336.	Gas Regulation (Amendment) .. \$0.08
7337.	Dried Fruits (Amendment) .. \$0.05
7338.	Patriotic Funds (Amendment) .. \$0.10
7339.	Flinders-lane Alignments .. \$0.08
7340.	Forests (Amendment) .. \$0.08
7341.	Poultry Levy (Collection Arrangement) .. \$0.08
7342.	Tomato Processing Industry (Amendment) .. \$0.08
7343.	Veterinary Surgeons (Further Amendment) .. \$0.05
7344.	Motor Car (Portable Speed-measuring Devices) .. \$0.05
7345.	Justices (Amendment) .. \$0.05
7346.	Judges' Salaries and Allowances .. \$0.05
7347.	Country Roads (Cadetships) .. \$0.05
7348.	St. Kilda Land .. \$0.10
7349.	Public Officers .. \$0.08
7350.	Marine (Amendment) .. \$0.08
7351.	Racing (Dog Racing) .. \$0.08
7352.	Land Tax (Rates) .. \$0.08

STATE ACTS, 1965—continued.	
No.	Price.
7353.	Collusive Practices .. \$0.12
7354.	Hospitals Superannuation .. \$0.20
7355.	Psychological Practices .. \$0.15
7356.	Public Officers Salaries and Allowances .. \$0.10
7357.	Superannuation .. \$0.10
7358.	Road Transport .. \$0.15
7359.	Stamps (Bills of Exchange) .. \$0.05
7360.	Survey Co-ordination (Place Names) .. \$0.10
7361.	Motor Car (Further Amendment) .. \$0.05
7362.	Universities (Amendment) .. \$0.10
7363.	Home Finance (Second Mortgages) .. \$0.05
7364.	Library Council of Victoria .. \$0.10
7365.	Lower Yarra Crossing Authority .. \$0.10
7366.	Evidence (Amendments) .. \$0.08
7367.	State Forests Loan Application .. \$0.05
7368.	Labour and Industry .. \$0.10
7369.	Justices (Sentencing) .. \$0.05
7370.	Consolidated Revenue .. \$0.05
7371.	Appropriation of Revenue .. \$0.85

A. C. BROOKS,
Government Printer.

STATE ACTS, 1966

COPIES of the following Acts of Parliament of Victoria may be obtained at the Government Printing Office, or from any accredited agents, at the price set opposite to each (these prices do not include postage).

The annual subscription for State Acts 1967 et seq. is \$8 payable in advance.

Bound Volumes of State Acts are also available on a subscription basis at \$15 per annum.

No.	Price.
7372.	Education (Council of Adult Education) .. \$0.05
7373.	Legal Profession Practice (Amendment) .. \$0.05
7374.	Co-operation (Amendment) .. \$0.05
7375.	Nurses (Amendment) .. \$0.05
7376.	Property Law (Loans to Minors) .. \$0.05
7377.	Audit (Amendment) .. \$0.08
7378.	Marketing of Primary Products (Tobacco Leaf Marketing Board) .. \$0.05
7379.	State Library National Gallery National Museum and Institute of Applied Science (Amendment) .. \$0.05
7380.	Reid Murray Acceptance Limited (Scheme of Arrangement) .. \$0.12
7381.	Lake Corangamite .. \$0.10
7382.	Tobacco Leaf Marketing Board (Appointment of Manager) .. \$0.05
7383.	Country Fire Authority (Borrowing Powers) .. \$0.05
7384.	Labour and Industry (Sheltered Workshops) .. \$0.05
7385.	Wombat Bonuses .. \$0.05
7386.	Country Fire Authority (Interstate Fire Brigades) .. \$0.05
7387.	Loch Public Hall Trust .. \$0.12
7388.	Co-operative Housing Societies (Amendment) .. \$0.05
7389.	Fisheries and Game (Amendment) .. \$0.08
7390.	Marine Stores and Old Metals (Collectors) .. \$0.05
7391.	Companies .. \$0.22
7392.	The Constitution Act Amendment .. \$0.05
7393.	Vagrancy .. \$0.12
7394.	Consolidated Revenue .. \$0.05
7395.	Land (Plantation Areas) .. \$0.10
7396.	Daylesford Springs Land .. \$0.05
7397.	Barley Marketing (Amendment) .. \$0.05
7398.	Sheep Dipping (Repeal) .. \$0.05
7399.	Grain Elevators (Amendment) .. \$0.05
7400.	Seymour Racecourse Land .. \$0.05
7401.	Shepparton Abattoirs .. \$0.05
7402.	Paisley-Galvin Railway Land Exchange .. \$0.08
7403.	Aerial Spraying Control .. \$0.12
7404.	Racing (Amendment) .. \$0.08
7405.	Summary Offences .. \$0.28
7406.	Friendly Societies (Amendment) .. \$0.05
7407.	Crimes (Dangerous Driving) .. \$0.05
7408.	Medical (Foreign Practitioners Qualification Committee) .. \$0.05
7409.	Opticians Registration (Amendment) .. \$0.05
7410.	Labour and Industry (Petrol Shops) .. \$0.08
7411.	Melbourne and Metropolitan Board of Works (Amendment) .. \$0.08
7412.	Carlton (Recreation Ground) Land .. \$0.08
7413.	Boilers Inspection (Amendment) .. \$0.05
7414.	Warragul and Neerim Railway Lands .. \$0.08
7415.	Victoria Institute of Colleges (Council) .. \$0.05

STATE ACTS 1966—continued.

No.	Price.
7416. Marketable Securities	\$0.18
7417. Pensions Supplementation	\$0.20
7418. Evidence (Medical Evidence)	\$0.05
7419. Water (Rating by Area)	\$0.05
7420. County Court (Common Law Jurisdiction) ..	\$0.05
7421. State Electricity Commission (Amendment) ..	\$0.05
7422. Gas and Fuel Corporation (Borrowing) ..	\$0.05
7423. Vegetation and Vine Diseases (Amendment) ..	\$0.05
7424. Motor Car	\$0.05
7425. Estate Agents (Amendment)	\$0.10
7426. Melbourne University (Chancellorship) ..	\$0.05
7427. Tobacco Leaf Industry Stabilization	\$0.15
7428. Consolidated Revenue	\$0.05
7429. Lotteries Gaming and Betting	\$0.35
7430. Stamps (Mortgages)	\$0.05
7431. Money Lenders (Exemption)	\$0.05
7432. Protection of Animals	\$0.12
7433. Marketing of Primary Products (Maize Marketing Board)	\$0.10
7434. Consolidated Revenue	\$0.10
7435. Firearms (Competition Weapons)	\$0.10
7436. Provincial Sewerage Authorities Association of Victoria	\$0.10
7437. Waterworks Trusts Association of Victoria ..	\$0.10
7438. Maffra Lands Exchange	\$0.10
7439. Trewalla Lands Exchange	\$0.10
7440. Tattersall Consultations	\$0.10
7441. Public Authorities (Contributions)	\$0.10
7442. Racing (Totalizator Percentages)	\$0.10
7443. Lower Yarra Crossing Authority (Guarantee) ..	\$0.10
7444. Stock and Share Brokers (Amendment)	\$0.15
7445. Moorpanyal Lands Exchange	\$0.10
7446. North Melbourne Lands	\$0.15
7447. Marine (Amendment)	\$0.10
7448. Mildura Irrigation and Water Trusts (Amendment)	\$0.10
7449. State Accident Insurance Office Land	\$0.10
7450. Public Account (Bona Vacantia)	\$0.10
7451. Motor Car (Hospital and Charities Contri- butions)	\$0.10
7452. Commonwealth and States Financial Agree- ment	\$0.15
7453. State Forests Loan Application	\$0.10
7454. Water (Amendment)	\$0.15
7455. Hospitals and Charities (Liability of Patients)	\$0.15
7456. Sewerage District's (Amendment)	\$0.10
7457. Limitation of Actions (Notice of Action) ..	\$0.10
7458. Long Island Country Club	\$0.10
7459. Country Roads (Level Crossings) (Amend- ment)	\$0.10
7460. Evidence (Foreign Tribunals)	\$0.10
7461. San Remo Lands	\$0.10
7462. The Constitution Act Amendment (Con- joint Elections)	\$0.10
7463. Vermin and Noxious Weeds (Financial)	\$0.10
7464. Co-operative Housing Societies (Financial) ..	\$0.10
7465. Morwell National Park	\$0.10
7466. Land Tax (Rates)	\$0.10
7467. Teaching Service (Married Women)	\$0.10
7468. Melbourne Cricket Ground (Guarantees) ..	\$0.10
7469. Gaols (Commencement of Sentences)	\$0.10
7470. Revocation and Excision of Crown Reservations	\$0.15
7471. Soil Conservation and Land Utilization (Advisory Council)	\$0.10
7472. Legal Profession Practice (Further Amend- ment)	\$0.10
7473. Forests (Wood Pulp Agreement)	\$0.15
7474. Companies (Amendment)	\$0.10
7475. Portland Harbor Trust (Railways)	\$0.10
7476. Country Fire Authority (Fire Prevention) ..	\$0.10
7477. Victorian Pipelines Commission	\$0.15
7478. Bees	\$0.15
7479. Milk Board (Amendment)	\$0.10
7480. Milk Pasteurization (Amendment)	\$0.10
7481. State Insurance (Payments into Court)	\$0.10
7482. National Gallery of Victoria	\$0.15
7483. Building Societies (Amendment)	\$0.10
7484. Firearms (Amendment)	\$0.15
7485. Geelong Waterworks and Sewerage (Amend- ment)	\$0.10
7486. Grain Elevators (Further Amendment)	\$0.10
7487. Settlement Purchase Leases	\$0.10
7488. Appeal Costs Fund (Amendment)	\$0.15
7489. Geelong Harbor Trust (Amendment)	\$0.30
7490. Health (Amendment)	\$0.15
7491. Marketing of Primary Products (Onion Marketing Board)	\$0.10
7492. State Coal Mine	\$0.10
7493. Horse Breeding (Amendment)	\$0.10
7494. Private Agents	\$0.30

STATE ACTS 1966—continued.

No.	Price.
7495. Local Government	\$0.40
7496. Wrongs (Assessment of Damages)	\$0.10
7497. Melbourne and Metropolitan Board of Works (Reconstitution)	\$0.15
7498. Port Phillip Authority	\$0.15
7499. Extractive Industries	\$0.35
7500. Stamps	\$0.25
7501. Companies (Defaulting Officers)	\$0.15
7502. Labour and Industry (Amendment)	\$0.15
7503. Juries	\$0.10
7504. Public Works Loan Application	\$0.15
7505. Commercial Goods Vehicles (Tow Trucks) ..	\$0.10
7506. Motor Car (Trailers)	\$0.15
7507. Housing (Commonwealth and State Agree- ment)	\$0.10
7508. Consolidated Revenue	\$0.10
7509. Revenue Deficits Funding	\$0.10
7510. The Constitution Act Amendment (Postal Voting)	\$0.25
7511. Railway Loan Application	\$0.15
7512. Inflammable Liquids	\$0.25
7513. Water Supply Loan Application	\$0.25
7514. Appropriation of Revenue	\$1.15

A. C. BROOKS,
Government Printer.

STATE ACTS, 1967

COPIES of the following Acts of Parliament of Victoria may be obtained at the Government Printing Office, or from any accredited agents, at the price set opposite to each (these prices do not include postage).

The annual subscription for State Acts 1967 et seq. is \$8 payable in advance.

Bound Volumes of State Acts are also available on a subscription basis at \$15 per annum.

No.	Price.
7515. New Melbourne Cemetery Lands	\$0.10
7516. Country Fire Authority (Prosecutions)	\$0.10
7517. Social Welfare (Detention)	\$0.10
7518. Zoological Gardens	\$0.15
7519. Richmond (South-Eastern Freeway) Lands ..	\$0.10
7520. The Geelong Gas Company's	\$0.10
7521. Co-operative Housing Societies (Indemnities) ..	\$0.10
7522. Supreme and County Courts (Sittings)	\$0.10
7523. Dandenong Valley Authority (Amendment) ..	\$0.15
7524. State Savings Bank (Amendment)	\$0.10
7525. Land (Surf Life Saving Association)	\$0.10
7526. Warragul (Public Park) Lands	\$0.10
7527. Tobacco Leaf Marketing Board (Appointment of Manager) (Amendment)	\$0.10
7528. Stock Artificial Breeding (Amendment)	\$0.10
7529. Second-hand Dealers (Amendment)	\$0.10
7530. Legal Aid (Amendment)	\$0.10
7531. Weights and Measures (Amendment)	\$0.25
7532. The Constitution Act Amendment (Electoral) ..	\$0.10
7533. Education and Teaching Service (Amend- ment)	\$0.15
7534. Public Officers Salaries and Allowances	\$0.10
7535. Railways (State Coal Mine Officers)	\$0.10
7536. Public Officers (Long Service Leave)	\$0.15
7537. Pipelines (Submerged Lands)	\$0.30
7538. Police Regulation (Pensions)	\$0.10
7539. Legal Profession Practice (Victoria Law Foundation)	\$0.10
7540. Petroleum (Barracouta and Marlin Fields Agreement)	\$0.25
7541. Pipelines	\$0.25
7542. Local Government (Amendment)	\$0.15
7543. Stamps (Amendment)	\$0.10
7544. Police Offences (Obscene Publications)	\$0.10
7545. Melbourne University (Amendment)	\$0.10
7546. Crimes	\$0.15
7547. Instruments (Corporate Bodies Contracts) ..	\$0.10
7548. Land (Amendment)	\$0.25
7549. Water (Amendment)	\$0.10
7550. Dowling Forest Racecourse Lands	\$0.15
7551. Strata Titles	\$0.40
7552. Revocation and Excision of Crown Reser- vations	\$0.15
7553. Tullamarine Freeway Lands	\$0.15
7554. Friendly Societies Investment	\$0.10
7555. Victorian Institute of Colleges (Board of Studies)	\$0.10
7556. Consolidated Revenue	\$0.10
7557. Consolidated Revenue	\$0.10
7558. Joint Select Committee (Drainage)	\$0.15
7559. Consolidated Revenue	\$0.10
7560. Consolidated Revenue	\$0.10

STATE ACTS, 1967—continued.

No.		Price.
7561.	Grain Elevators (Borrowing Powers) ..	\$0.10
7562.	Building Societies (Unsecured Loans) ..	\$0.10
7563.	Money Lenders (Corporation Licences) ..	\$0.10
7564.	Barley Marketing (Amendment) ..	\$0.10
7565.	Medical (Foreign Practitioners) ..	\$0.10
7566.	Masseurs (Amendment) ..	\$0.10
7567.	Firearms (Prohibited Persons) ..	\$0.10
7568.	Joint Select Committee (Meat Industry) ..	\$0.10
7569.	Council of Law Reporting in Victoria ..	\$0.15
7570.	Marketable Securities ..	\$0.15
7571.	Railway Lands ..	\$0.10
7572.	Labour and Industry (Fees) ..	\$0.10
7573.	Geelong Waterworks and Sewerage ..	\$0.10
7574.	Aboriginal Affairs ..	\$0.25
7575.	Co-operative Housing Societies (Amendment) ..	\$0.10
7576.	Rural Finance (Amendment) ..	\$0.10
7577.	Crimes (Amendment) ..	\$0.10
7578.	Revocation and Excision of Crown Reservations (No. 2) ..	\$0.15
7579.	Gaols (Amendment) ..	\$0.10
7580.	Gas Regulation (Amendment) ..	\$0.10
7581.	Judges and Public Officers Salaries ..	\$0.15
7582.	Portland Harbor (Exchange of Land) ..	\$0.15
7583.	Carlton (Recreation Ground) (Amendment) Land ..	\$0.10
7584.	Superannuation (Amendment) ..	\$0.15
7585.	Stamps ..	\$0.30
7586.	Educational Grants ..	\$0.10
7587.	Motor Car (Hours of Driving) ..	\$0.10
7588.	Poisons (Amendment) ..	\$0.10
7589.	Housing (Amendment) ..	\$0.10
7590.	Water (Further Amendment) ..	\$0.15
7591.	Petroleum (Submerged Lands) ..	\$0.90
7592.	Supreme Court (Judges) ..	\$0.10
7593.	Motor Car ..	\$0.15
7594.	Labour and Industry (Bread) ..	\$0.15
7595.	Pesticides (Amendment) ..	\$0.10
7596.	Judicial Proceedings Report (Amendment) ..	\$0.10
7597.	Administration and Probate (Amendment) ..	\$0.10
7598.	Mental Health (Pathological Examinations) ..	\$0.10
7599.	Veterinary Surgeons (Amendment) ..	\$0.10
7600.	Licensing (Rutherglen Wine Festival) ..	\$0.10
7601.	Estate Agents (Objections) ..	\$0.10
7602.	Joint Select Committee (Road Safety) ..	\$0.10
7603.	Richmond High School Land ..	\$0.10
7604.	Fertilizers (Amendment) ..	\$0.15
7605.	Milk and Dairy Supervision (Amendment) ..	\$0.10
7606.	Country Fire Authority (Notices) ..	\$0.10
7607.	Stock Foods (Amendment) ..	\$0.15
7608.	Litter ..	\$0.10
7609.	Municipal Association (Amendment) ..	\$0.10
7610.	Maintenance (Amendment) ..	\$0.10
7611.	Yea Civic Centre and Court House ..	\$0.15
7612.	Shepparton Abattoirs ..	\$0.15
7613.	Yarraville (Recreation Ground) Lands ..	\$0.15
7614.	Swine Compensation ..	\$0.25
7615.	Cattle Compensation ..	\$0.25
7616.	Ringwood and Warrandyte Lands ..	\$0.10
7617.	Harbor Charges ..	\$0.15
7618.	Melbourne Harbor Trust Land ..	\$0.10
7619.	Justices (Amendment) ..	\$0.10
7620.	Portland Harbor Trust (Amendment) ..	\$0.10
7621.	Racing ..	\$0.15
7622.	Melbourne and Metropolitan Tramways (Detours) ..	\$0.10
7623.	Land (Committees of Management) ..	\$0.15
7624.	Mildura Irrigation and Water Trusts (Amendment) ..	\$0.10
7625.	Apprenticeship (Amendment) ..	\$0.10
7626.	Local Government (Municipalities Assistance Fund) ..	\$0.10
7627.	Fitzroy (Edinburgh Gardens) Lands ..	\$0.15
7628.	Coal Mines (Pensions) ..	\$0.10
7629.	Lifts and Cranes ..	\$0.15
7630.	Licensing (Amendment) ..	\$0.10
7631.	The Geelong Gas Company's (Amendment) ..	\$0.15
7632.	Extractive Industries (Amendment) ..	\$0.10
7633.	Land Tax (Rates) ..	\$0.10
7634.	Sunday Entertainment ..	\$0.15
7635.	Summary Offences ..	\$0.10
7636.	Stamps (Exemptions) ..	\$0.10
7637.	Rain-making Control ..	\$0.15
7638.	Cemeteries (St. Kilda Public Cemetery) ..	\$0.10
7639.	Weights and Measures (Pre-packed Articles) ..	\$0.30
7640.	State Forests Loan Application ..	\$0.10
7641.	Fisheries (Amendment) ..	\$0.15
7642.	Barry Beach Railway Construction ..	\$0.10

STATE ACTS, 1967—continued.

No.		Price.
7643.	Marketing of Primary Products (Amendment) ..	\$0.10
7644.	Victoria Institute of Colleges ..	\$0.15
7645.	Crimes (Driving Offences) ..	\$0.15
7646.	Private Agents ..	\$0.10
7647.	Teaching Service (Teachers Tribunal) ..	\$0.15
7648.	Motor Car (Compulsory Third Party Insurance) ..	\$0.10
7649.	Public Works Loan Application ..	\$0.15
7650.	Railway Loan Application ..	\$0.15
7651.	Juries ..	\$0.35
7652.	Westernport Development ..	\$0.15
7653.	North Melbourne Lands (Amendment) ..	\$0.10
7654.	Water Supply Loan Application ..	\$0.25
7655.	Appropriation of Revenue ..	\$1.15

A. C. BROOKS,
Government Printer.

THE "VICTORIA GOVERNMENT GAZETTE".

SUBSCRIPTIONS.—The subscription, including postage, is \$10 per annum, or \$5 per half year, payable in advance.

Subscriptions are required for whole months, and must cover at least a half year.

Single copies are 20 cents, posted 25 cents. Subscribers do not receive the Acts of Parliament with the GAZETTE.

GAZETTES are held in stock for five years only.

PRIVATE ADVERTISEMENTS.—The charge for insertion is 25 cents per line single column, and 50 cents per line double column. The title forms one or more lines as a heading. On an average ten words make a line of single column. Every signature must likewise be counted as a line. The final words of a paragraph, though only portion of a line, must be counted as one line. Signatures (in particular) and proper names must be written very plainly in the text; ONE SIDE ONLY of each sheet of paper should be WRITTEN UPON.

All documents illegibly written will be returned unpublished, and where brands occur unprovided for by the ordinary letters of the alphabet, a worded explanatory description must be furnished.

THE VICTORIA GOVERNMENT GAZETTE is published on WEDNESDAY EVENING in each week, and Notices for insertion will be received by the Government Printer at or before ONE p.m. at ordinary rates, and late advertisements between ONE p.m. and FOUR p.m. at double rates on the day preceding the day of publication.

PAYMENTS.—Unless the advertiser has a credit account, all payments are required in advance. Remittances should be made by cheque, postal order, or money order payable to "GOVERNMENT PRINTER".

ADDRESS.—All communications should be addressed to "The Government Printer, Box 203, P.O., North Melbourne", 3051.

PUBLICATION OF OFFICIAL MATTER.

ATTENTION is invited to the following procedure in relation to the publication of official matter in the Government Gazette:—

1. Matter submitted to the Executive Council.

Matters submitted to the Executive Council which requires gazettal will normally be published in the issue of the following week.

Where urgent gazettal is required, special arrangements should be made with the Gazette Officer, Room 9, first floor, Old Treasury Building.

Publication will be facilitated by the submission of carbon copies for the use of the Gazette Officer.

2. Other matter.

(a) All other matter duly certified by a responsible officer for publication should be lodged with the Gazette Officer not later than half-past Nine a.m. on Tuesday.

(b) Lengthy or involved notices should be forwarded several days before publication.

(c) Proofs, which will be supplied only when specifically requested or, at the direction of the Gazette Officer, should be returned promptly to avoid delay in publication.

(d) No additions or amendments to matter for publication will be accepted by telephone.

AGENTS FOR THE "VICTORIA GOVERNMENT
GAZETTE".

THE following have been appointed agents to receive Advertisements and Subscriptions for the *Victoria Government Gazette*:—

ARMSTRONG'S AGENCY, 205 Queen-street, Melbourne, Victoria 3000.
 ARNALL & JACKSON, 390 Barkly-street, Brunswick, Victoria 3056.
 BAIRNSDALE AUTHORIZED NEWSAGENCY, 132 Main-street, Bairnsdale, Victoria 3875.
 BICKNELL, M. J., Authorized Newsagent, 196 Timor-street, Warrnambool, Victoria 3280.
 R. G. CARTER ADVERTISING SERVICE PTY. LTD., 26-32 King-street, Melbourne, Victoria 3000.
 DAVIES, G. & M. V., 112 Gray-street, Hamilton, Victoria 3300
 DAVIS, WM. (MILDURA) PTY. LTD., 126 Eighth-street, Mildura, Victoria 3500.
 DIXON'S NEWSAGENCY, 89 Firebrace-street, Horsham, Victoria 3400.
 EDGAR'S NEWSAGENCY PTY. LTD.; 293 Hargreaves-street, Bendigo, Victoria 3550.
 EDGARS' AUTHORIZED NEWSAGENCY, 45 Bridge-street, Benalla, Victoria 3672.
 FRANKS, H., & CO., 184 Ryrie-street, Geelong, Victoria 3220.
 GORDON & GOTCH AUSTRALASIA LTD., 511 Little Collins-street, Melbourne, Victoria 3000.
 GULLAN'S NEWSAGENCY, 88 Bridge-street, Ballarat, Victoria 3350.
 HAMPTON, A. C., 243 Mitchell-street, Bendigo, Victoria 3550.
 HARSTON, PARTRIDGE & CO. PTY. LTD., 455 Little Collins-street, Melbourne, Victoria 3000.
 KYNETON GUARDIAN PTY. LTD., P.O. Box 18, Kyneton, Victoria 3444.
 LATIMER'S, Newsagents, 45 Station-street, Malvern, Victoria 3144.
 LIVINGSTON'S SHEPPARTON NEWSAGENCY, 246 Wyndham-street, Shepparton, Victoria 3630.
 THE MERCANTILE EXCHANGE, 67 Queen-street, Melbourne, Victoria, 3000.
 MCGILL'S AUTHORIZED NEWSAGENCY, 183-5 Elizabeth-street, Melbourne, Victoria 3000.
 PHILLIPS AUTHORIZED AGENCY, 83 Murphy-street, Wangaratta, Victoria 3677.
 PURDIE, J., & CO., 138 Moorabool-street, Geelong, Victoria 3220.
 SALE AUTHORIZED NEWSAGENCY, 142 Raymond-street, Sale, Victoria 3850.
 SKINNER'S AUTHORIZED NEWSAGENCY, 49-51 Franklin-street, Traralgon, Victoria 3844.

STEVENSON, A. C. & M., NEWSAGENTS, 132 Henty-street, Casterton, Victoria 3311.

VERNON, C. F. & H. J., 162 Bridge-road, Richmond, Victoria 3121.

VIEW POINT AUTHORIZED NEWSAGENCY, 4 View-Point, Bendigo, Victoria 3550.

A copy of the *Gazette* filed at each place for public reference.

CONTENTS

	PAGE
Acts of Parliament	1129
Acts of Parliament on sale at the Government Printing Office	1188
Additional Public Holiday	1130
Anzac Day Holiday	1130
Appointments	1149
Bank Holiday	1130
Cemeteries—Scale of Fees	1143
Contracts	1140
Easter Holidays	1130
Estates of Deceased Persons	1138
Government Notices	1130
Impoundings	1188
Lands	1160
Melbourne and Metropolitan Board of Works—Notices	1143
Mining	1146
Notice to attend for Radiological Examination	1139
Notice to Mariners	1134
Notice of Making of Statutory Rules	1188
Orders in Council—	
Acts—Coal Mines; Land; Country Roads; Local Government; Soil Conservation and Land Utilization; Hospitals and Charities; Forests; Sewerage Districts; Landlord and Tenant.	1150 et seq
Police Sale	1134
Private Advertisements	1170
Proclamations	1129
Publication of the <i>Victoria Government Gazette</i>	1130
Public Holidays	1130
Public Service Notices	1170
Regulations—	
Acts—Teaching Service	1169
Resignations	1150
State Rivers and Water Supply Commission	1145
Tenders	1168
Transport Regulation Board—Public Hearings	1131
Waterworks Trusts	1146