

[199]



VICTORIA GOVERNMENT GAZETTE

Published by Authority

[Registered at the General Post Office, Melbourne, for transmission by post as a newspaper.]

No. 5]

WEDNESDAY, JANUARY 24

[1968

PROCLAMATIONS

Land Act 1958.

UNALIENATED CROWN LAND AVAILABLE FOR SETTLEMENT UNDER IMPROVEMENT PURCHASE LEASES.

PROCLAMATION

By His Excellency the Governor of the State of Victoria and its Dependencies in the Commonwealth of Australia, &c., &c., &c.

IN pursuance of the provisions of Section 153 of the *Land Act 1958, I*, the Governor of the State of Victoria, in the Commonwealth of Australia, by and with the advice of the Executive Council of the said State, do by this Proclamation declare the unalienated Crown lands mentioned in the subjoined schedule, to be available for settlement under improvement purchase leases.

SCHEDULE.

County.	Parish.	Allotment.	Section.	Area.	Land Valuation.
Lowan	Toosan	56	..	727 acres ±	\$3 per acre
Benambra	Beloka	19	1	500 acres ±	\$2 per acre
Tanjil	Glenmaggie	65A	..	84 acres	\$4 per acre

Given under my Hand and the Seal of the State of Victoria aforesaid, at Melbourne, this sixteenth day of January in the year of our Lord One thousand nine hundred and sixty-eight, and in the sixteenth year of the reign of Her Majesty Queen Elizabeth II.

(L.S.)

By His Excellency's Command,

ROHAN DELACOMBE,

W. J. F. McDONALD,
Minister of Lands.

GOD SAVE THE QUEEN !

Land Act 1958.

AREA OF LAND COMPRISED IN CERTAIN CLASSES DIMINISHED OR INCREASED.

PROCLAMATION

By His Excellency the Governor of the State of Victoria and its Dependencies in the Commonwealth of Australia, &c., &c., &c.

WHEREAS by the Land Act 1958 it is amongst other things enacted that the Governor in Council may, by Proclamation to be published in the Government Gazette, at any time diminish or increase the area of land comprised in any of the classes mentioned in Part I, Division 1, Section 5, of the said Land Act 1958, but that the area of lands which may be sold by auction (Class 6), shall not be increased except as in certain cases in the said Act provided: Now therefore I, the Governor of the State of Victoria, in the Commonwealth of Australia, by and with the advice of the Executive Council of the said State, and in accordance with the provisions of Sections 94 and 117 of the Land Act 1958 aforesaid, do hereby diminish or increase (as the case may be) the areas of Crown lands comprised in Class 6 of the classes mentioned in Section 5 of the Land Act 1958 aforesaid, to the extent set forth in the subjoined Schedule (that is to say):—

Schedule referred to.

CLASSES DIMINISHED OR INCREASED.

County.	Parish.	Allotment.	Section.	Area.	Diminished.	Increased.	Description.
					Class.	Class.	
Karkaroc	Bumbaŋ	13A	C	A. R. P. 11 2 36	..	6	} Situated in the middle of the Parish 3 miles north of Barrakee
Karkaroc	Bumbaŋ	19A	C	5 0 28	..	6	
Gladstone	Charlton East	5B	B	71 3 18	..	6	

Given under my Hand and the Seal of the State of Victoria, aforesaid, at Melbourne, this sixteenth day of January, in the year of our Lord One thousand nine hundred and sixty-eight, and in the sixteenth year of the reign of Her Majesty Queen Elizabeth II.

ROHAN DELACOMBE.

(L.S.)

By His Excellency's Command,

W. J. F. McDONALD,
Minister of Lands.

GOD SAVE THE QUEEN!

ROAD PROCLAIMED.

PROCLAMATION

By His Excellency the Governor of the State of Victoria and its Dependencies in the Commonwealth of Australia, &c., &c., &c.

IN pursuance of the provisions of Section 25 of the Land Act 1958, the Governor of the State of Victoria, by and with the advice of the Executive Council of the said State, do hereby proclaim as a road the land in the Township of Wangaratta, Parish of Wangaratta, County of Bogong as indicated by hatching on plan hereunder.—(W.85*) (Rs.2715).

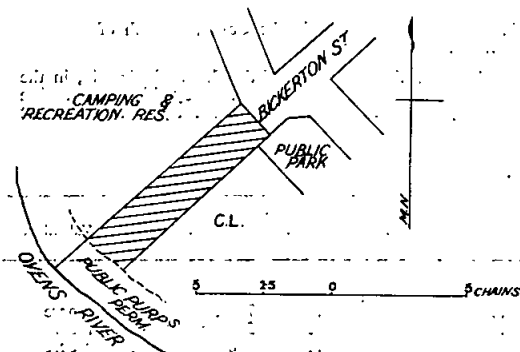

Given under my Hand and the Seal of the State of Victoria aforesaid, at Melbourne, this sixteenth day of January, in the year of our Lord One thousand nine hundred and sixty-eight, and in the sixteenth year of the reign of Her Majesty Queen Elizabeth II.

(L.S.)

ROHAN DELACOMBE.

By His Excellency's Command,

W. J. F. McDONALD,
Minister of Lands.

GOD SAVE THE QUEEN!

ROAD PROCLAIMED.

PROCLAMATION

By His Excellency the Governor of the State of Victoria and its Dependencies in the Commonwealth of Australia, &c., &c., &c.

IN pursuance of the provisions of Section 25 of the Land Act 1958, the Governor of the State of Victoria, by and with the advice of the Executive Council of the said State, do hereby proclaim as a road the land in the Parish of Waranga, County of Rodney as indicated by hatching on plan hereunder.—(W.37*) (H.030536.)

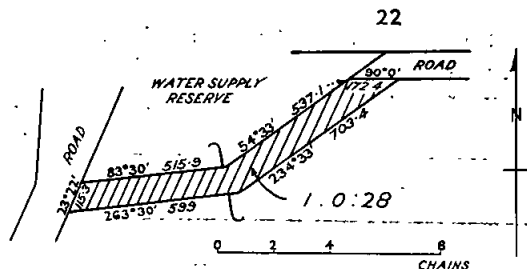

Given under my Hand and the Seal of the State of Victoria aforesaid, at Melbourne, this sixteenth day of January, in the year of our Lord One thousand nine hundred and sixty-eight, and in the sixteenth year of the reign of Her Majesty Queen Elizabeth II.

(L.S.)

ROHAN DELACOMBE.

By His Excellency's Command,

W. J. F. McDONALD,
Minister of Lands.

GOD SAVE THE QUEEN!

NOW THEREFORE I, the Governor of the State of Victoria in the Commonwealth of Australia, by and with the advice of the Executive Council of the said State, do by this Proclamation declare that the Corangamite Regional Library Service being an authority constituted for a joint purpose by the municipalities of the City of Colac, the Town of Camperdown, the Shire of Colac and the Shire of Hampden shall be an authority for the purpose of the said Act.

Given under my Hand and the Seal of the State of Victoria aforesaid, at Melbourne, this sixteenth day of January, in the year of our Lord One thousand nine hundred and sixty-eight, and in the sixteenth year of the reign of Her Majesty Queen Elizabeth II.

(L.S.) ROHAN DELACOMBE.

By His Excellency's Command,
R. J. HAMER,
Minister for Local Government.

GOD SAVE THE QUEEN !

BANK HOLIDAY.

PROCLAMATION

By His Excellency the Governor of the State of Victoria and its Dependencies in the Commonwealth of Australia, &c., &c., &c.

IN pursuance of the provisions of the *Bank Holidays Act 1958*, I, the Governor of the State of Victoria, in the Commonwealth of Australia, do by this my Proclamation appoint the day and date named hereunder a special day to be observed as a Bank Half-Holiday at the place mentioned, that is to say:—

Bank Half-Holiday from the Hour of Twelve o'clock noon:
WEDNESDAY, THE 21ST FEBRUARY, 1968, at Colac.

Given under my Hand and the Seal of the State of Victoria aforesaid, at Melbourne this 23rd day of January, in the year of our Lord One thousand nine hundred and sixty-eight, and in the sixteenth year of the reign of Her Majesty Queen Elizabeth II.

(L.S.) ROHAN DELACOMBE.

By His Excellency's Command,
JAMES W. MANSON,
for Chief Secretary.

GOD SAVE THE QUEEN !

MAINTENANCE (AMENDMENT) ACT 1967 No. 7610. DATE OF COMING INTO OPERATION.

PROCLAMATION

By His Excellency the Governor of the State of Victoria and its Dependencies in the Commonwealth of Australia, &c., &c., &c.

WHEREAS by an Act of Parliament of the State of Victoria passed in the sixteenth year of the reign of Her Majesty Queen Elizabeth II. intituled the MAINTENANCE (AMENDMENT) ACT 1967 No. 7610, it is amongst other things enacted that the said Act shall come into operation on a day to be fixed by Proclamation of the Governor in Council published in the *Government Gazette*: NOW THEREFORE I, the Governor of the State of Victoria, acting by and with the advice of the Executive Council thereof, do by this my proclamation fix Thursday the 1st day of February One thousand nine hundred and sixty-eight as the day upon which the MAINTENANCE (AMENDMENT) ACT 1967 No. 7610 shall come into operation.

Given under my hand and the Seal of the State of Victoria aforesaid at Melbourne, this twenty-third day of January, in the year of our Lord One thousand nine hundred and sixty-eight and in the sixteenth year of the reign of Her Majesty Queen Elizabeth II.

(L.S.) ROHAN DELACOMBE.

By His Excellency's Command,
G. O. REID,
Attorney-General.

GOD SAVE THE QUEEN !

GOVERNMENT NOTICES

PUBLIC HOLIDAY.—AUSTRALIA DAY.

IT is hereby notified that on—

MONDAY, THE 29TH JANUARY, 1968,

the Public Offices will be closed, such day having been appointed by the *Public Service Act 1958*, to be observed as a holiday in the Public Offices throughout the State of Victoria.

This notice relates only to the closing of the State Public Offices. All inquiries regarding the holiday in other offices and in shops and industry should be directed to the Department of Labour and Industry, 110 Exhibition-street, Melbourne, 3000. (Telephone 63 0321, Extension 6158, 6721 or 6859.)

A. G. RYLAH,
Chief Secretary.

Chief Secretary's Office,
Melbourne, 3rd January, 1968.

Hospitals and Charities Act 1958.

PETITION TO INCORPORATE CORILONG CENTRE FOR THE MENTALLY HANDICAPPED.

IT is notified in accordance with the provisions of sections 46 and 64 of the *Hospitals and Charities Act 1958*, that the Hospitals and Charities Commission has received a petition signed by not less than 25 contributors to an organization known as Corilong Centre for the Mentally Handicapped, praying that the organization be incorporated as a benevolent society under the provisions of the said Act.

The organization will have for its objects—

- (a) to co-operate with the Government in providing specialized school facilities to accommodate all mentally handicapped or deficient children, in improving transport to and from schools, and in improving existing facilities for such children;
- (b) to establish, manage and maintain an occupational day centre for mentally handicapped children;
- (c) to establish, manage and maintain occupational training centres for the training of mentally handicapped children and adults;
- (d) to establish, manage and maintain community centres and welfare organizations for mentally handicapped persons and their relatives—
 - (i) to provide activities in leisure hours,
 - (ii) to provide avenues of useful citizenship activities,
 - (iii) to provide study classes for parents and relatives, and
 - (iv) to give assistance on home problems;
- (e) to assist parents of mentally handicapped children who are in necessitous circumstances in problems relating to accommodation, transport, psychiatric or medical treatment or other problems of a like nature;
- (f) to arouse the general public to a greater understanding of the needs of mentally handicapped persons and of mental deficiency;
- (g) to have printed and published any newspapers, periodicals, books or leaflets that the Centre may think desirable for the promotion of its objects;
- (h) to watch over, protect and act in the interests of mentally handicapped children and adults;
- (i) to do all such things as are incidental or conducive to the attainment of any, or all, of the above objects.

If a counter petition signed by an equal or greater number of contributors is not lodged with the aforesaid Commission at No. 1 Nicholson-street, East Melbourne, within one calendar month of the publication of this notice, the Governor in Council may, by Order pursuant to the *Hospitals and Charities Act 1958*, declare the contributors for the time being to Corilong Centre for the Mentally Handicapped to be a body corporate by the name set forth in such Order.

VANCE DICKIE,
Minister of Health.

Department of Health,
Melbourne.

Transport Regulation Act.
TRANSPORT REGULATION BOARD.

HEARING OF APPLICATIONS.

NOTICE is hereby given that the following applications will be considered by the Transport Regulation Board at its offices at the corner of Lygon and Princes streets, Carlton, at 10.15 a.m., on Wednesday, 14th February, 1968.

BRIEN, J. H., & Co. PTY. LTD., 2 Whitehall-street, Footscray. Application for permit authority to operate vehicle licensed No. M.C.150 at a separate and distinct fare for the carriage of passengers between the corner of Barkly and Nicholson streets, Footscray, and the Brooklyn Speedway, Derrimut via Barkly-street, Geelong-road, Millers-road and Blyth-street, Altona; thence express to the Speedway.

Time-table (Saturdays only).

Depart Footscray 7.15 p.m.
Depart Brooklyn Speedway 10.30 p.m.

Fare.

\$1.50 return which includes admittance to the Speedway.

McKENZIES TOURIST SERVICES PTY. LTD., 53 Barkers-road, Kew. Two commercial passenger vehicles with large seating capacity to be purchased to operate as additional metropolitan special service omnibuses.

RYAN BROS. BUS SERVICE PTY. LTD., 42 Brunel-street, Essendon. One commercial passenger vehicle (S/C. 33) to operate as an additional metropolitan stage omnibus on Route 15A (Moonee Ponds—Aberfeldie) under the same terms and conditions as existing M.O. licences held by the applicant.

Notice of any objection should be forwarded to reach the Secretary of the Board not later than Wednesday, 7th February, 1968.

Applicants are advised that it will not be necessary to appear on the hearing date specified above, unless advised, in writing, by the Board.

B. P. KAY,
Secretary.

Corner of Lygon and Princes streets, Carlton, Wednesday, 24th January, 1968.

Commercial Goods Vehicles Act.
TRANSPORT REGULATION BOARD.

HEARING OF APPLICATIONS.

NOTICE is hereby given that the following applications will be considered by the Transport Regulation Board at its offices at the corner of Lygon and Princes streets, Carlton, at 10.15 a.m. on Wednesday, 14th February, 1968.

ASKEW, K. M., Duke-street, Yarram, 3971. One commercial goods vehicle (L/C. 253 cwt.) to operate: (a) Within a 50 mile radius from the post office at Yarram as a "Road Contractor"—road-making plant and materials. (b) Within a 25-mile radius of the post office at Yarram with the proviso that no one journey shall exceed 30 miles in length—general goods.

BLACKMAN, J. F., 41 Newman-crescent, Traralgon, 3844. Application to vary the conditions of licence No. D.T.1227 (L/C. 160 cwt.) by adding an additional paragraph (b):

"(b) From forest landings at Noojee, Matlock and Licola to the A.P.M. at Maryvale—pulpwood."

BLACKNEY, C. A., & SONS, Bass Highway, The Gurdies, via Lang Lang, 3984. Application to vary the conditions of licences numbered D.A.683/1, D.A.683/2 and D.A.683/3 (L/C. 247, 109 and 142 cwt.) by deleting from the present conditions "From and to Port Melbourne" and by adding in lieu: "From and to the BP Australia Ltd. depot at Dandenong."

BOND, T. L., Dillon-street, Cobram, 3644. One commercial goods vehicle (L/C. 25 cwt. approx.) to operate: (a) Within a 25-mile radius from the post office at Cobram provided that no goods be carried whether by one stage or by more than one stage between places within the above radius which are more than 30 miles apart by the nearest practicable route—general goods. (b) Within a 50-mile radius of the post office at Cobram in the course of business as "Agent for Esso Standard Oil (Aust.) Ltd."—petroleum products in prescribed types of containers and empty return containers. (c) Within a 50-mile radius of the post office at Cobram in the course of business as "Agent for Ramsay & Tregowan Ltd."—superphosphate and chemicals.

BOARD, N. F., Yarrara, 3496. One commercial goods vehicle (L/C. 30 cwt.) to operate within a 70-mile radius of the post office at Mildura as a mobile wheat grading and pickling unit—tools of trade and equipment.

BUSHHELLS TEA PTY. LTD., 452 Flinders-street, Melbourne, 3000. One commercial goods vehicle (L/C. 6 cwt.) to operate throughout the State of Victoria for the purpose of operating as a traveller's vehicle in the course of business as "Tea and Coffee Merchants"—samples, display and advertising materials and small quantities of tea and coffee in glass containers for replacement of stock damaged in transit or to supply a retailer temporarily out of stock.

STOCKFEEDS, C. C., Hammond-road, Dandenong, 3175. Application to vary the conditions of licence No. T.D.A.60931 (L/C. 180 cwt.) by adding to paragraph (b) the words "and to farms within a 10-mile radius of Binginwarri".

CARRACHER, B. J., Main-street, Rutherglen, 3685. One commercial goods vehicle (L/C. 180 cwt. approx.) to operate: (a) Within a 25-mile radius of the post office at Rutherglen with the proviso that no one journey shall exceed 30 miles in length—general goods. (b) Within a 25-mile radius of railway sidings at Rutherglen and Springhurst—bulk superphosphate subject to the condition that such commodity so carried shall only be that having been initially consigned to Rutherglen and Springhurst by rail.

CARTER, B. K., Box 28, Howlong, N.S.W., 2640. One commercial goods vehicle (L/C. 154 cwt.) to operate: (a) Within a 50-mile radius of the post office at Wodonga—road-making plant and materials. (b) Within a 25-mile radius of the post office at Wodonga with the proviso that no one journey shall exceed 30 miles in length—general goods.

CLOHESY, F. J., care of H. Banwell, P.O. Bullarook, 3352. One commercial goods vehicle (L/C. 140 cwt.) to operate: (a) Within a 50-mile radius from the post office at Ballarat as a "Road Contractor"—road-making plant and materials. (b) Within a 25-mile radius from the post office at Bullarook with the proviso that no one journey shall exceed 30 miles in length—general goods.

COCA COLA BOTTLERS (GEELONG) PTY. LTD., Corio Quay-road, North Geelong, 3220. One commercial goods vehicle (L/C. 144 cwt.) to operate in the course of business as "Aerated Water Manufacturers" as follows:—(a) Within a 25-mile radius of the chief post office in the City of Geelong—own goods. (b) Own soft drinks in glass containers and empty return containers to be carried from and to own premises at North Geelong to and from the following places namely:—(i) The Township of Lorne, via the Townships of Torquay and Anglesea and the Great Ocean-road. (ii) The City of Colac and the Townships of Birregurra, Beecac and Coragulac, via the Princes Highway. (iii) The City of Ballarat and places en route, via the Townships of Bacchus Marsh and Ballan.

COHNS (EASTERN) PTY. LTD., Tone-road, Wangaratta, 3677. One commercial goods vehicle (L/C. 109 cwt.) to operate: (a) Goods as follows in the course of business of "Soft Drink, Cordial, Sauce and Food Manufacturers" being an approved decentralized secondary industry carried on by the applicant at Wangaratta and similarly carried on by its associated companies, Cohns (Central) Pty. Ltd., at Bendigo and Cohns (Swan Hill) Pty. Ltd., at Swan Hill, namely:—(i) From points within the State of Victoria (but excluding the Gippsland area) to the approved decentralized secondary industry factory of the applicant at Wangaratta or of any of its aforesaid associated companies at Ararat, Bendigo and Swan Hill—raw materials and goods associated with or required solely for use in the manufacturing or processing of such approved decentralized industry but subject to the condition that the majority of raw sugar for use in the aforesaid industry at the said factories in each case shall be forwarded to the railway station nearest thereto namely, the railway stations at Ararat, Bendigo, Yea, Swan Hill or Wangaratta as the case may be; (ii) From the factory premises of the applicant and each of the aforesaid associated companies to points within the State of Victoria (but excluding the Gippsland area)—manufactured and/or processed products of such approved decentralized industry. (b) In the course of applicants business of "Soft Drink, Cordial, Sauce and Food Suppliers" in the following area only namely, within that part of the State of Victoria bounded on the east by a line drawn south from Khancoban (in the State of New South Wales) through the Township of Mount Beauty to Mansfield; on the south by an angular line extending from Mansfield to Euroa and thence from Euroa to Nagambie; on the west,

- by a line drawn north from Nagambie through the City of Shepparton to Numurkah and thence continuing west from Numurkah to Nathalia and thence due north to the River Murray—soft drink, cordial, sauce and food lines (not being own manufactured products of the approved decentralized secondary industry of the applicant or of its associated companies as specified in paragraph (a) above) together with empty return containers and subject to the condition that goods shall not be carried on the vehicle for transfer and/or trans-shipment to any other vehicle for carriage to any destination outside the boundaries specified herein.
- COMMONWEALTH INDUSTRIAL GASES LTD.**, The, 90 Bell-street, Preston, 3072. One commercial goods vehicle (L/C. 17 cwt.) to operate throughout the State of Victoria in the course of business as "Manufacturers of Commercial and Industrial Gases"—own gas and electric welding equipment solely for demonstration purposes.
- CROMPTON & SON (VICTORIA)**, Hamilton-street, Horsham, 3400. Application to vary the conditions of licence No. D.A.48136 (L/C. 62 cwt.) by deleting from the present conditions "Sea Lake" and adding in lieu "Horsham".
- CUST, R. W. & E. K.**, 28 Francis-street, Moama, New South Wales, 2739. One commercial goods vehicle (L/C. 140 cwt.) to operate: (a) Within a 50-mile radius of the border crossing at Echuca as a "Road Contractor"—road-making plant and materials. (b) Within a 25-mile radius of the border crossing at Echuca with the proviso that no one journey shall exceed 30 miles in length—general goods.
- DODDRELL, R. H.**, Koondrook, 3580. One commercial goods vehicle (L/C. 141 cwt.) to operate: (a) Within a 40-mile radius of the post office at Koondrook—red gum sleepers. (b) Within a 20-mile radius of the post office at Koondrook in the course of business as "Carrier"—general goods.
- DOWLING, N. A.**, 25 Marilyn-court, Blackburn, 3130. Application to vary the conditions of licence No. D.A.51503 (L/C. 223 cwt.) by deleting from the present conditions "City Brick Works Co. Pty. Ltd." and adding in lieu "Clifton Brick Holdings Ltd., Oakleigh".
- DUNCAN, B. W.**, Horsham-road, Balmoral, 3407. Two commercial goods vehicles (L/C. 255 cwt. and 100 cwt.) to operate: (a) Within a 25-mile radius of the post office at Balmoral with the proviso that no one journey shall exceed 30 miles in length—general goods. (b) Within a 50-mile radius of the Golden Fleece Petroleum Products depot at Balmoral—petroleum products in prescribed types of containers and empty return containers.
- DUNCAN, K. G. & M. J.**, 57 Francis-street, Bairnsdale, 3875. One commercial goods vehicle (L/C. 296 cwt.) to operate within a 95-mile radius of the Orbest Post Office (Bairnsdale Division of the Country Roads Board) and within a 70-mile radius of the Yarram Post Office (Traralgon Division of the Country Roads Board)—in the course of business as "Earth-moving and Road-making Contractor"—own plant, machinery and tools of trade.
- DWYER, R. B.**, 9 Ford-street, Ballarat, 3350. Application to vary the conditions of licence No. D.A.57021 (L/C. 21 cwt.) by adding to the present conditions: Special Condition: Not more than 10 cwt. of goods to be carried at any one time.
- FARMERS AND GRAZIERS CO-OPERATIVE CO. LTD.**, THE, (incorporated in N.S.W.) Standish-street, Myrtleford, 3737. One commercial goods vehicle (L/C. 11 cwt.) to operate within a 50-mile radius of own branch premises at Myrtleford in course of business as "General Merchants"—own goods.
- FINNEY, H.**, 265 Caravan Park, Elizabeth-street, East Coburg, 3058. One commercial goods vehicle (L/C. 23 cwt.) to operate: (a) Throughout the State of Victoria as a "Spray Painter and Floor Covering Contractor"—tools of trade and equipment incidental to own contracts and up to four 5-gallon drums of paint from contract to contract site for the initial commencement of such contracts. (b) Carpet and linoleum for laying purposes only and paint within a 20-mile radius of any contract site or from the nearest railway station thereto. Special Proviso: No goods to be move ex Melbourne by road.
- FLINN, R. B. & MOONEY, P. M.**, Omeo Highway, Bruthen, 3885. Application to vary the conditions of licence No. D.T.535/1 (L/C. 280 cwt.) by adding to the present conditions as an additional paragraph (c): (c) From Errinundra Plateau logging unit to the sawmill operated by Heyfield-Orbest Sawmilling Co. Pty. Ltd. at Brodribb—sawmill logs."
- FLINN, W.**, Omeo Highway, Bruthen, 3885. Application to vary the conditions of licences numbered D.T.195/2 and D.T.195/3 (L/C. 261 and 242 cwt.) by adding to the present conditions as an additional paragraph (d): "(d) From Errinundra Plateau logging unit to the sawmill operated by Heyfield-Orbest Sawmilling Co. Pty. Ltd. at Brodribb—sawmill logs."
- LINDSAY FOX CARTAGE PTY. LTD.**, 3 Henley-court, Moorabbin, 3189. One commercial goods vehicle (L/C. 67 cwt.) to operate: (a) Within a 50-mile radius from the plant of Schweppes Aust. Ltd. at Moorabbin, but excluding any operations whatsoever to or from the Geelong Urban District on behalf of the said company— aerated waters and empty containers for return. (b) Within a 25-mile radius of the post office situated at the corner of Bourke and Elizabeth streets in the City of Melbourne on behalf of B.P. Australia Ltd.—bulk heating oil.
- FRY, A. T.**, Leitchville, 3567. Application to vary the conditions of licences numbered D.A.58512 and D.A.58512/1 (L/C. 155 and 112 cwt.) by deleting from the present conditions paragraph (c) and adding in lieu: "From Benalla to own premises at Leitchville—hardwood scantling timber."
- FULLAGER, E. G. W.**, Katunga, 3640. One commercial goods vehicle (L/C. 28 cwt.) to operate within that part of the State of Victoria east of a north/south line drawn through Rochester and west of a north/south line drawn through Wodonga and north of an east/west line drawn through Kilmore in course of business as "Wholesale Food Distributor"—own agency lines. Proviso: It is a special proviso that all goods so carried will be those having been initially consigned by rail to Shepparton and Katunga.
- GALE, R. N.**, Darwin-street, Marysville, 3779. Application to vary the conditions of licence No. D.T.753/1 (L/C. 259 cwt.) by deleting paragraphs (a) and (b) and by adding to the existing conditions a new paragraph (a): "(a) From forest landings within a 20-mile radius of the post office at Marysville to the sawmill of J. L. Gould Pty. Ltd., at Marysville—logs."
- GENERAL ENGINEERING SALES PTY. LTD.**, 21 Benalla-road, Shepparton, 3630. One commercial goods vehicle (L/C. 11 cwt.) to operate within a 50-mile radius of the post office at Shepparton and from and to own premises at Shepparton to and from the cities and townships (as the case may be) of Wangaratta, Bendigo, Broadford and Swan Hill—forklifts for delivery or for repair or having been repaired, also tools of trade, spare parts and materials incidental thereto but excluding the carriage of new forklifts to the Township of Broadford subject to the conditions that all goods carried on the vehicle shall have been initially consigned by rail to the Shepparton Railway Station.
- GOULBURN VALLEY CAR SALES PTY. LTD.**, 8 Benalla-road, Shepparton, 3630. One commercial goods vehicle (L/C. 14 cwt.) to operate in the course of business as "Caravan Distributor and Hirer" for the purpose of towing own caravans from places of manufacture at Melbourne and Ballarat to own premises at Shepparton and also to own sales depot at Wangaratta and for delivery on site to places situated within a 50-mile radius from the post office at Shepparton.
- GREEN, F. L.**, Standish-street, Myrtleford, 3737. One commercial goods vehicle (L/C. 152 cwt.) to operate: (a) Within a 25-mile radius of the post office at Myrtleford—general goods; with the proviso that no one journey shall exceed 30 miles in length. (b) Within a 50-mile radius of Mobil Oil Australia Pty. Ltd. depot at Myrtleford—petroleum products in prescribed types of containers and empty return containers.
- VAN LISSUM, H. D.** (trading as Hanks Steam Laundry), 7-15 North-street, Shepparton, 3630. One commercial goods vehicle (L/C. 80 cwt. approximately), to operate: (a) Within a 20-mile radius from the G.P.O., Melbourne, in course of business as "Laundry Proprietor"—oil in drums and empty drums for return. (b) Within a 40-mile radius from the post office at Shepparton in course of business as "Laundry Proprietor"—oil in drums and empty drums for return. (c) From Bendigo, Kilmore, Yarrowonga, Puckapunyal and places en route to own premises at Shepparton—waste bulk oil in a specially constructed tanker and also oil in drums and empty drums for return. Proviso.—No more than 20 drums shall be carried in addition to the tanker at any one time.
- VAN LISSUM, H. D.** (trading as Hanks Steam Laundry), 7-15 North-street, Shepparton, 3630. Application to vary the conditions of licences numbered D.A.41862/1 and D.A.41862/2 (L/C. 125 and 58 cwt.) by deleting from the existing conditions paragraph (d).
- HARTLEY, D. R.**, 5 Mackay-street, Wangaratta, 3677. One commercial goods vehicle (L/C. not available) to operate: (a) Within a 50-mile radius from the post office at Wangaratta as a "Road Contractor"—road-making plant and materials. (b) Within a 25-

mile radius of the post office at Wangaratta with the proviso that no one journey shall exceed 30 miles in length—general goods.

HORNER, V. R., Princes Highway, Drouin, 3818. One commercial goods vehicle (L/C. 144 cwt.) to operate: (a) Within a 25-mile radius of Drouin with the proviso that no one journey shall exceed 30 miles in length—general goods. (b) From the State Electricity Commission at Morwell and Yallourn to places located in paragraph (a) above—briquettes.

HURLEY, T. M. & P. M., 90 David-street, Dandenong, 3175. Application to vary the conditions of licence No. D.A.53189 (L/C. 131 cwt.) by adding to the present conditions as an additional paragraph (c): "(c) from Bacchus Marsh to places within paragraph (a)—own river pebbles."

IMPERIAL CHEMICAL INDUSTRIES OF AUST. & NEW ZEALAND LTD., Nicholson-street, Melbourne, 3000. One commercial goods vehicle (L/C. 10 cwt.) to operate: (a) Within a 50-mile radius of own premises at Melbourne in the course of business as "Chemical Manufacturers"—own goods. (b) Throughout the State of Victoria for the purpose of servicing and demonstrating polythene products in connexion with agricultural activities—tools of trade, spare parts, polythene products, pumps and display materials for demonstration and display.

JENSON, A. H., 40 Last-street, Beechworth, 3747. One commercial goods vehicle (L/C. 74 cwt.) to operate: (a) Within a 50-mile radius of the post office at Beechworth as a "Road Contractor"—road-making plant and materials. (b) Within a 25-mile radius of the post office at Beechworth with the proviso that no one journey shall exceed 30 miles in length—general goods.

JACKSON, G. A., High-street, Violet Town, 3669. One commercial goods vehicle (L/C. 79 cwt.) to operate: (a) Within a 100-mile radius of the post office at Violet Town in the course of business as "Primary Producer"—own goods. (b) From and to places situated within a 25-mile radius of the post office at Violet Town to and from places situated within a 50-mile radius of the post office at Violet Town—livestock. (c) Within a 25-mile radius of the post office at Violet Town with the proviso that no one journey shall exceed 30 miles in length—general goods.

KENNEDY, P., PTY. LTD., 27 Oak-street, Wendouree, Ballarat, 3355. Application to vary the conditions of licence No. T.D.20382 (L/C. 260 cwt. approximately) by deleting from the existing conditions paragraphs (a) and (b) and by adding in lieu: "(a) Throughout the State of Victoria—own excavation machinery and a quantity of fuel sufficient only for the operation of such machinery on site. (b) Within a 25-mile radius of the site of any contract upon which licence holder is currently engaged—materials for use in such contract."

LAWN, G. W. N., Sebastopol, 3356. Application to vary the conditions of licence No. T.D.20139 (L/C. 11 cwt. and 40 cwt. trailer) by adding to the existing conditions additional paragraphs (d) and (e): "(d) From the premises of Ballarat 'Kwik Brick' Homes Pty. Ltd. to contract sites throughout the State of Victoria—small quantities, limited to a maximum of four (4) cwt. at any one time, of materials required for such contract: (e) From contract sites throughout the State of Victoria to the premises of Ballarat 'Kwik Brick' Homes Pty. Ltd.—materials, limited to a maximum of ten (10) cwt. at any time, no longer required at such contract site."

LINFOX DISTRIBUTORS (NORTHERN) PTY. LTD., 3 Henley-court, Moorabbin, 3189. Three commercial goods vehicles (L/C. 168, 167 and 168 cwt.) to operate: (a) Within a 50-mile radius from plant of Schweppes (Aust.) Ltd. at Moorabbin, but excluding any operations whatsoever to or from the Geelong Urban District on behalf of the said company—aerated waters and empty containers for return. (b) Within a 25-mile radius of the post office situated at the corner of Bourke and Elizabeth streets in the City of Melbourne on behalf of BP (Aust.) Ltd.—bulk heating oil.

MAHER, J. W. C., Daylesford, 3460. Application to vary the conditions of licence No. D.T.270 (L/C. 135 cwt.) by adding to the present conditions: "From own sawmill at Spargo Creek to places within the metropolitan area of Melbourne—own sawn timber."

MAHOMED, A. H., Beach-road, Foster, 3960. One commercial goods vehicle (L/C. 150 cwt. approx.) to operate within a 50-mile radius of the post office at Foster in the course of business as "Road Contractor"—own bulldozer when being moved from site to site.

ECLIPSE RADIO (Trading as Malvern Star Stores), 161-173 Sturt-street, South Melbourne, 3205. One commercial goods vehicle (L/C. 11 cwt.) to operate within a 50-mile radius of own branch premises at Horsham as "Hardware and Electrical Appliances Retailer"—own goods subject to the condition that every journey made is confined wholly within the said radius and that no goods are carried on the vehicle to any point within that radius for the purpose of transfer or transhipment to another vehicle (whether licensed in the name of the applicant or not) for carriage to a destination outside that radius.

MANNING, C. L., 46 Alexander-avenue, Moe, 3825. One commercial goods vehicle (L/C. 15 cwt.) to operate: (a) Within a 25-mile radius of the post office at Moe on behalf of Billy Bunter Pies Pty. Ltd.—packaged fruit juices, pies, pasties, sausage rolls and doughnuts. (b) Within a 50-mile radius of the post office at Moe in the course of business as "Pastry and Cake Retailer"—own goods.

MORTIMER, D. A. G., & N. J., High-street, Drysdale, 3222. Application to vary the conditions of licences numbered D.A.41456; D.A.41456/1 and D.A.41456/5 (L/C. 76, 240 and 112 cwt.) by adding to the existing conditions and additional paragraph (c): "Within a 50-mile radius from the post office at Drysdale—firewood."

MYER SOUTHERN STORES LTD., 301 Sturt-street, Ballarat, 3350. One commercial goods vehicle (L/C. 7 cwt.) to operate throughout the State of Victoria for the carriage of incidental deliveries of any item of general merchandise sold by Myer Southern Stores Ltd. and for use by the Ballarat Manager and Buyers, on isolated occasions only, to contact branch stores and Melbourne store with ability to carry stock urgently required.

MCDONALD, J. A., 79 Main-street, Winchelsea, 3241. One commercial goods vehicle (L/C. 230 cwt.) to operate: (a) Within a 25-mile radius of the post office at Winchelsea with the proviso that no one journey shall exceed 30 miles in length—general goods. (b) From and to places situated within the radius specified in paragraph (a) above to and from places outside that radius but within a 50-mile radius of the post office at Winchelsea—livestock.

MCKENZIE & HOLLAND PTY. LTD., P.O. Box 4, Newport, 3015. Two commercial goods vehicles (L/C. 29 and 11 cwt.) to operate: (a) Within a 50-mile radius from own premises at Spotswood—own goods. (b) Throughout the State of Victoria—tools of trade, equipment and materials incidental to the installation of signalling equipment along Victoria railway lines.

NORRIS, G. M. & N. L., 9 Phillip-avenue, North Springvale, 3170. One commercial goods vehicle (L/C. 66 cwt.) to operate within a 75-mile radius of the post office at Springvale in course of business as "Road Contractor"—as a water tanker.

O'CALLAGHAN, W., P.O. Box 12, Rutherglen, 3685. One commercial goods vehicle (L/C. 145 cwt.) to operate: (a) Within a 50-mile radius of Rutherglen—road-making plant and materials. (b) Within a 50-mile radius of the railway station at Rutherglen—bulk superphosphate for distribution. (c) Within a 50-mile radius of the railway station at Rutherglen to silos situated at rail heads within the said radius—bulk grain.

OHLSON, V. C., Creek-street, Omeo, 3898. Application to vary the conditions of licence No. D.A.44023 (L/C. 8 cwt.) by adding to the present conditions:

Monday to Saturday.

Arrive Omeo	5.45 p.m.
Leave Omeo	5.50 p.m.
Leave Hinnomunjie	6.05 p.m.
Arrive Benambra	6.20 p.m.
Leave Benambra	6.30 p.m.
Leave Hinnomunjie	6.45 p.m.
Arrive Omeo	7.00 p.m.

O'NEILL, H. E., Almora-avenue, Red Hill South, 3937. One commercial goods vehicle (L/C. 201 cwt.) to operate within a 50-mile radius of the premises of Supermix Concrete Pty. Ltd., at Springvale in a specially constructed agitator vehicle premixed concrete solely on behalf of the said company.

PALMER H. G. (VICTORIA) PTY. LTD., Cnr. Keys & Chester-ville roads, Moorabbin, 3189. Application to vary the conditions of licence No. D.A.38988/64 (L/C. 11 cwt.) by deleting from the present conditions "own branch premises at Echuca" and adding in lieu "own branch premises at 230 Wyndham-street, Shepparton."

PATERSONS PTY. LTD., 152 Bourke-street, Melbourne, 3000. One commercial goods vehicle (L/C. 11 cwt.) to operate within a 100-mile radius from own premises at Swan Hill in the course of business as "Furniture Retailers"—carpet and underfelt for laying purposes only, tools of trade and materials incidental thereto.

- PESTCO PTY. LTD.**, 1964 Princes Highway, Clayton, 3168. One commercial goods vehicle (L/C. 10 cwt.) to operate within a 50-mile radius of own branch premises at Traralgon in the course of business as "Pest Exterminators"—tools of trade, spraying equipment and small quantities of materials incidental to the completion of own contracts subject to the condition that all initial supplies of concentrated chemicals are consigned by rail to Traralgon.
- PETERSVILLE AUSTRALIA LTD.**, Wellington-road, Clayton, 3168. Two commercial goods vehicles (L/C. 78 and 67 cwt.) to operate throughout the State of Victoria as a specially constructed insulated and refrigerated van for the purpose of supplying own distributors with ice-cream, frozen vegetables, frozen fish and frozen poultry at a temperature not exceeding 10 degrees F.
- READ, G. W.**, 18 Nicholas-grove, Cheltenham, 3192. One commercial goods vehicle (L/C. 133 cwt.) to operate within a 25-mile radius of the post office situated at the corner of Bourke and Elizabeth streets in the City of Melbourne and to or from places within such radius, from or to places within a 25-mile radius respectively of the chief post office in the City of Geelong, chief post office in the City of Ballarat, post office, Ballan, post office, Sale, and post office, Traralgon in the course of business as "Sanitary Contractor"—own tools of trade and equipment incidental thereto.
- REGAL CREAM PRODUCTS**, 27 Arden-street, North Melbourne, 3051. Application to vary the conditions of licences numbered D.A.25421/2, D.A.25421/3 and D.A.25421/4 (L/C. 164, 159 and 153 cwt.) by adding to the existing conditions after the City "Bendigo", "Kerang and Anglesea".
- ROBERTSON, C. J. & Co.** (HORSHAM) PTY. LTD., 21 Stawell-road, Horsham, 3400. Seven commercial goods vehicles (Mobile Cranes) to operate within that part of the State of Victoria west of a north/south line drawn through the City of Ballarat in the course of business as "Wrecker and Power Line Construction Contractor"—own tools of trade and own equipment incidental to the completion of own contracts.
- ROSENTHAL, M.**, 21 Balston-street, East St. Kilda, 3182. One commercial goods vehicle (L/C. 7 cwt.) to operate throughout the State of Victoria in the course of business as "Hawker"—own drapery and footwear subject to the condition that any goods so carried shall not be supplied to retail stores for resale.
- ROYLANCE, R.**, Welshpool, 3966. Two commercial goods vehicles (L/C. 120 cwt. approx.) to operate: (a) Within a 50-mile radius of the post office at Welshpool—road-making materials, plant and equipment. (b) From railway stations situated within a 50-mile radius of the post office at Welshpool to consignees situated within the said radius—bulk superphosphate for spreading purposes only. (c) Within a 50-mile radius of the post office at Welshpool—towing own elevator for the loading and unloading of bulk superphosphate from rail heads mentioned in paragraph (b).
- RUSSELL, D. M.**, Box 158, Coleraine, 3315. One commercial goods vehicle (L/C. 241 cwt.) to operate: (a) Within a 25-mile radius from the post office at Coleraine with the provision that no one journey shall exceed 30 miles in length—general goods. (b) From and to places situate within the radius as defined in paragraph (a) above and to and from places situate within a 50-mile radius from the post office at Coleraine—livestock. (c) Within a 50-mile radius from the post office at Coleraine—petroleum products in prescribed types of containers and empty containers for return.
- SCHLUMBERGER SOUTH EAST ASIA CO. INCORP.**, 310 Raglan-parade, Warrnambool, 3280. One commercial goods vehicle (L/C. 26 cwt.) to operate throughout the State of Victoria in the course of business as "Oil Drilling and Exploration Contractors"—tools of trade, spare parts for servicing diesel equipment and own electrical equipment for use in oil well testing when being moved from site to site.
- SCHWEPPE (AUST.) LTD.**, Yarrowee-street, Sebastopol, 3356. One commercial goods vehicle (L/C. 112 cwt.) to operate within a 50-mile radius of own premises at Ballarat in course of business as "Aerated Waters and Cordial Manufacturers"—own goods.
- SINCLAIR, W. A.**, 2 Newry-street, Cheltenham, 3192. One commercial goods vehicle (L/C. 8 cwt.) to operate throughout the State of Victoria in course of business as "Electrical Contractor" for the carriage of tools of trade, equipment and a small quantity of materials for the completion of own contracts.
- SMITH, G. S. & A. W. M.**, Stawell, 3380. Application to vary the conditions of licence No. D.T.1156 (L/C. 137 cwt.) by adding to the present conditions: "To carry own crane and tractor from forest landings within a 50-mile radius of the post offices at Stawell and Horsham, in connexion with business as a "Logging Contractor".
- SNAM PROGETTI (AUST.) PTY. LTD.**, 566 St. Kilda-road, Melbourne, 3004. Five commercial goods vehicles (L/C. 97 cwt. each) to operate: (a) Within a 25-mile radius of the G.P.O., Melbourne in the course of business as "Pipe Line Engineers and Contractors"—own goods. (b) From own depot at Dandenong to peg points along the pipe-lined route to Dutton for the carriage of own contracting gear and associated equipment, tools of trade, and spare parts for servicing own equipment and gear in the field.
- SNAM PROGETTI (AUST.) PTY. LTD.**, 566 St. Kilda-road, Melbourne, 3004. Two commercial goods vehicles (L/C. 25 cwt. each) to operate: (a) Within a 25-mile radius of the G.P.O., Melbourne in the course of business as "Pipe Line Engineers and Contractors"—own goods. (b) From own depot at Dandenong to peg points along the pipe-lined route to Dutton for the carriage of own contracting gear and associated equipment, tools of trade and spare parts for servicing own equipment and gear in the field.
- SOUTH AUSTRALIAN RUBBER MILLS PTY. LTD.**, Cranbourne-road, Dandenong, 3175. Application to vary the conditions of licence No. D.A.62077 (L/C. 10 cwt.) by deleting the present conditions and adding in lieu: "Within a 50-mile radius of the post office at Traralgon and as far east as Bairnsdale and places en route—own goods in course of business as "Tire Retailers, Retreaders and Rubber Automotive Accessories Retailers", also, tires for retreading and having been retreaded, tubes and batteries for repair or having been repaired with the proviso that any retail goods so carried shall be initially consigned on rail to Traralgon."
- SPENCER, G. D.**, 53 Bair-street, Leongatha, 3953. One commercial goods vehicle (L/C. 240 cwt.) to operate: (a) Within the Shire of Woorayl as a "Road Contractor"—road-making plant and materials. (b) Within a 25-mile radius of the post office at Leongatha with the proviso that no one journey shall exceed 30 miles in length—general goods.
- SUPA FLAME PTY. LTD.**, 40A Johnston-street, Collingwood, 3066. One commercial goods vehicle (L/C. 11 cwt.) to operate throughout the State of Victoria for the purpose of installing, servicing and maintenance of slow combustion cookers and room heaters—tools of trade, spare parts and materials incidental to servicing only.
- UNDERWOOD, D. L.**, Gunbower, 3566. One commercial goods vehicle (L/C. 265 cwt.) to operate: (a) Within a 50-mile radius from the post office at Gunbower as a "Road Contractor"—road-making plant and materials. (b) Within a 25-mile radius from the post office at Gunbower with the proviso that no one journey shall exceed 30 miles in length—general goods.
- VALLE, F.**, 8 Cherry Orchard-rise, North Box Hill, 3129. One commercial goods vehicle (L/C. 108 cwt.) to operate within a 70-mile radius of the premises of Clifton Brick Holdings Ltd. at Oakleigh, solely on behalf of the said company—bricks.
- WATSON, L. R.**, 6 Lindel-court, Croydon, 3136. Application to vary the conditions of licence No. D.A.60362 (L/C. 110 cwt.) by deleting from the present conditions: "Brick and Pipe Industries of Northcote" and adding in lieu "Evans Brothers (Bricks) Pty. Ltd. at Scoresby."
- WHINRAY & SONS**, Tone-road, Wangaratta, 3677. One commercial goods vehicle (L/C. 149 cwt.) to operate: (a) Within a 50-mile radius from the post office at Wangaratta—road-making plant and materials. (b) Within a 25-mile radius from the post office at Wangaratta with the proviso that no one journey shall exceed 30 miles in length—general goods.
- WILDES, G. J.**, 108 Royal-parade, Reservoir, 3073. One commercial goods vehicle (L/C. 123 cwt.) to operate within a 70-mile radius of the premises of The City Brick Works Co. Pty. Ltd. at Tooronga, solely on behalf of the said company—bricks.
- WILLIAMSON, A. J. G.**, 21 Devon-grove, Oakleigh, 3166. Application to vary the conditions of licence No. D.A.21646 (L/C. 120 cwt.) by deleting from the present conditions "Glen Iris Brick, Tile and Terra Cotta Co. Pty. Ltd. at Oakleigh" and adding in lieu: "Evans Brothers (Bricks) Pty. Ltd. at Scoresby."
- WILTSHIRE C. R.**, 126 Minerva-road Geelong, 3220. One commercial goods vehicle (L/C. 69 and 60 cwt. trailer) to operate within a 100-mile radius from the chief post office in the City of Geelong in the course of business as "Superphosphate and Lime Spreading Contractor"—lime spreading plant and equipment also tools of trade and spare parts incidental to the servicing and maintenance of own vehicles in the field only.

- WOOD, J. R., 669 Whitehorse-road, Mitcham, 3132. One commercial goods vehicle (L/C. 20 cwt.) to operate throughout the State of Victoria in the course of business as "Weed Control Contractor"—own spraying plant and equipment and a small quantity of materials incidental to the completion of own contracts.
- WOOLWORTHS (VIC.) LTD., 1-15 Bridge-street, Ballarat, 3350. One commercial goods vehicle (L/C. 9 cwt.) to operate within a 50-mile radius of own branch store in the City of Ballarat in the course of business as "General Retailers"—own goods.
- WORRALL, P. E. T., Don-avenue, Mildura, 3500. Application to vary the conditions of licence No. D.A.61110 (L/C. 10 cwt.) by adding to the present conditions as an additional paragraph (b): "(b) Throughout the State of Victoria in course of business as 'Shearing Contractors'—tools of trade, materials and supplies incidental to own contracts."
- WRIGHT STEPHENSON & CO. LTD., 330 St. Kilda-road, Melbourne, 3004. Application to vary the conditions of licence No. D.A.38919/7 (L/C. 140 cwt.) by deleting from paragraph (b) of the present conditions and adding in lieu: "(b) Within a 75-mile radius of Heywood, in course of business as 'General Merchants'—bulk superphosphate and bulk lime for spreading purposes only."

TOW TRUCKS.

- ROBERTSON C. J. & CO. (HORSHAM) PTY. LTD., 21 Stawell-road, Horsham, 3400. Application to vary the conditions of licence No. D.A.23358 (L/C. 59 cwt.) by adding to the present conditions as an additional paragraph: "In the area west of a north/south line drawn through the City of Ballarat in the course of business as 'Wrecker and Power Line Construction Contractor'—own tools of trade and own equipment incidental to the completion of own contracts."
- ROBERTSON, C. J., & CO. (HORSHAM) PTY. LTD., 21 Stawell-road, Horsham, 3400. Application to vary the conditions of licence No. 23358/2 (L/C. 60 cwt.) by deleting the present conditions and adding in lieu: "(a) Within that part of the State of Victoria west of a north/south line drawn through the City of Melbourne as a 'Tow Truck' solely—(i) For the purpose of lifting and carrying or towing motor cars and the carriage of tools and equipment necessary for such purposes only, and (ii) the carriage of spare parts necessary for the repair of a disabled motor to and from the place at which such disablement has occurred. (b) In the area west of a north/south line drawn through the City of Ballarat in the course of business as 'Wrecker and Power Line Construction Contractor'—own tools of trade and own equipment incidental to the completion of own contracts."
- TREVASKIS, R. S., & A. R., 1 Benalla-road, Shepparton, 3630. Application to vary the conditions of licence No. D.A.46598/1 (L/C. 27 cwt.) by adding to the existing conditions an additional paragraph (b): "(b) Within a 50-mile radius of the post office at Shepparton in course of business as 'Machinery Agent'—agricultural machinery for distribution."
- WILSON, DICK, MOTORS PTY. LTD., Box 43, Nyah, 3594. One commercial goods vehicle (L/C. 30 cwt.) to operate throughout the State of Victoria as a "Tow Truck" solely: (a) For the purpose of lifting and carrying or towing motor cars and the carriage of tools and equipment necessary for such purposes only, and (b) The carriage of spare parts necessary for the repair of a disabled motor to and from the place at which such disablement has occurred.

RENEWALS.

- APPLICATIONS for renewal of licences as shown by persons listed hereunder to operate under the same terms and conditions from the expiry shown in each case.
- A. H. AGENCIES & SALES PTY. LTD., 1122 High-street, Armadale, 3143; T.D.A.45101/1; 8th January, 1968; 17 cwt.; T.D.A. 45101; 8th January, 1968; 16 cwt.
- AMORE, M. J. & M. J., 58 Fairy-street, Warrambool, 3280; D.A.37099/1; 2nd February, 1968; 70 cwt.
- AUSTRALIAN PAPER MANUFACTURERS LTD., South Gate, South Melbourne, 3205; D.A.569/3; 3rd March, 1968; 11 cwt.; D.A.569/4; 3rd March, 1968; 11 cwt.; D.A.569/6; 3rd March, 1968; 11 cwt.; D.A.569/8; 3rd March, 1968; 11 cwt.; D.A.569/18; 3rd March, 1968; 11 cwt.
- BATEMAN, G. W., 59 Dwyers-street, Clifton Hill, 3068; D.A.51215; 27th January, 1968; 89 cwt.
- BERTINO BROS., cnr. McLeod and Buchanan streets, Bairnsdale, 3875; D.A.47121/2; 3rd February, 1968; 17 cwt.
- BIELSKI, E. & E., 3 Beatty-avenue, Armadale, 3143; D.A.51043; 16th December, 1967; 20 cwt.
- CAMPANA BROS., 1117 Howitt-street, Ballarat, 3350; D.A.30981/2; 22nd February, 1968; 33 cwt.
- COLONIAL GAS ASSOCIATION LTD., THE, 480 St. Kilda-road, Melbourne, 3000; D.A.25112; 20th March, 1968; 19 cwt.
- COOPER, H. W., 17 Railway-avenue, Beechworth, 3747; D.A.39502; 2nd February, 1968; 136 cwt.
- DAY, E. E. & SONS PTY. LTD., Howitt-street, Ballarat, 3350; D.A.44530/2; 16th December, 1967; 9 cwt.; D.A.44530/3; 16th December, 1967; 9 cwt.; D.A.44530/4; 16th December, 1967; 9 cwt.
- DRAFFIN, BROS. PTY. LTD., 45 City-road, South Melbourne, 3205; D.A.27827/5; 21st March, 1968; 11 cwt.
- DUNDAS, J. A., PTY. LTD., 327 Plummer-street, Port Melbourne, 3207; D.A.1004; 12th February, 1968; 75 cwt.
- DUNLOP TYRE SERVICE (BAIRNSDALE) PTY. LTD., 237-245 Main-street, Bairnsdale, 3875; D.A.2374/7; 2nd February, 1968; 10 cwt.
- EMMERTON, I. J., Merino, 3310; D.A.39477; 2nd February, 1968; 73 cwt.
- FALKENBERG, A. F., 6 Shaftesbury-parade, Thornbury, 3071; D.A.27416/4; 28th March, 1968; 124 cwt.
- FORD, W. H. & CO., Wickliffe, 3291; D.A.40259/1; 17th February, 1968; 148 cwt.
- GAGLIARDI, A. & D., 26 Molyneux-street, Warracknabeal, 3393; D.A.38424; 2nd February, 1968; 223 cwt.
- GENERAL MOTORS-HOLDEN'S PTY. LTD., Princes Highway, Dandenong, 3175; D.A.27925/54; 23rd March, 1968; 11 cwt.; D.A.27925/55; 23rd March, 1968; 11 cwt.
- GREEN BROS. EPSOM PTY. LTD., Main-road, Epsom, 3551; D.A.1195/7; 22nd February, 1968; 10 cwt.; D.A.1195/8; 22nd February, 1968; 10 cwt.; D.A.1195/9; 22nd February, 1968; 9 cwt.
- GRINTER, W. & SONS PTY. LTD., Omeo Highway, Swifts Creek, 3896; D.A.1207; 21st February, 1968; 130 cwt.
- HEALESVILLE TRANSPORT SERVICES PTY. LTD., 35 Maroondah Highway, Healesville, 3777; D.A.32607/5; 12th February, 1968; 242 cwt.
- HICKS, J. A. J., Princes Highway, Officer, 3809; D.A.1293/4; 22nd February, 1968; 114 cwt.
- HODGINS, K. A., The Crescent, Tyabb, 3913; D.A.31734/1; 28th March, 1968; 19 cwt.
- HOFFMAN BRICK & POTTERIES PTY. LTD., Dawson-street, Brunswick, 3056; D.A.35003/11; 15th March, 1968; 145 cwt.
- ILLIDGE, RALPH, PTY. LTD., 75 Liebig-street, Warrambool, 3280; D.A.38481; 22nd February, 1968; 11 cwt.
- INTERNATIONAL HARVESTER CO. OF AUST. PTY. LTD., 171-205 City-road, South Melbourne, 3205; D.A.1351/11; 15th March, 1968; 8 cwt.
- JEFFREY, F. I., Private Bag, Timboon, 3268; D.A.52160; 17th February, 1968; 288 cwt.
- KERANG PLASTER SHEET CO. PTY. LTD., Broadcasting-House, View Point, Bendigo, 3550; D.A.2394/6; 17th February, 1968; 5 cwt.
- KIMPTON, W. S. & SONS PTY. LTD., 348 Arden-street, North Melbourne, 3031; T.D.A.6317/7; 28th March, 1968; 198 cwt.
- KNOX SCHLAPP PTY. LTD., 49 Graham-street, Port Melbourne, 3207; D.A.25298/2; 21st March, 1968; 11 cwt.
- LEURY, J. A., 6 Galtes-crescent, Brunswick, 3056; D.A.39633; 23rd February, 1968; 110 cwt.
- LEWIS, J. H., & SON, 15 Woodstock-street, Chilwell, Geelong, 3216; D.A.51270; 3rd February, 1968; 110 cwt.
- MARTIN, J. G. & E. M., Mt. Lyall-road, Yannathan South, 3981; D.A.38371; 2nd February, 1968; 148 cwt.
- MESSER & OPIE PTY. LTD., 17-19 Bridge-street, Ballarat, 3350; D.A.51214; 17th February, 1968; 10 cwt.; D.A.51214/1; 17th February, 1968; 10 cwt.; D.A.51214/2; 17th February, 1968; 10 cwt.
- MILLER, W. F., Wills-street, Bright, 3741; D.A.14742; 2nd February, 1968; 341 cwt.
- MILLS, I. R., 95 Wellington-street, Kerang, 3579; D.A.51379; 17th February, 1968; 243 cwt.
- MORTIMER, D. A. G. and N. J., High-street, Drysdale, 3222; D.A.41456; 9th February, 1968; 76 cwt.; D.A.41456/1; 9th February, 1968; 225 cwt.
- MCDONALD, L. F., White-road, Wonthaggi, 3995; D.A.1670/1; 2nd February, 1968; 8 cwt.
- MCINERNEY, J. L., 586 Calder Highway, East Keilor, 3036; D.A.18480/1; 13th February, 1968; 11 cwt.
- RAMSAY, W. M., Buchan, 3875; D.A.24429; 31st January, 1968; 8 cwt.
- ROBERTS, J. V., & SON PTY. LTD., Piangil, 3597; D.A.38370; 2nd February, 1968; 121 cwt.; D.A.38370/1; 2nd February, 1968; 105 cwt.
- RUDD, F. G., c/- Post Office, Wangaratta, 3677; T.D.A.43236/1; 11th February, 1968; 72 cwt.
- SOFFER, L., 27 Eulinga-avenue, Aspendale, 3195; D.A.2071/1; 21st March, 1968; 30 cwt.

SOLOMON, G. G., 7 Dougharty-road, West Heidelberg, 3081; D.A.51324; 3rd February, 1968; 119 cwt.
 SUNKIST FOODS PTY. LTD., 50 Nott-street, Port Melbourne, 3207; T.D.A.47865/16; 1st March, 1968; 40 cwt.; T.D.A.47865/18; 22nd March, 1968; 33 cwt.; T.D.A.47865/31; 28th February, 1968; 57 cwt.; T.D.A.47865/33; 28th March, 1968; 114 cwt.; T.D.A.47865/32; 28th March, 1968; 115 cwt.
 SUNSHINE PLUMBING SERVICE, 18 Aurisch-avenue, Glen Waverley, 3150; D.A.37919/1; 22nd February, 1968; 11 cwt.
 SWAN HILL TRADING CO. PTY. LTD., 134-136 Campbell-street, Swan Hill, 3585; D.A.38355; 2nd February, 1968; 7 cwt.
 VICTORIAN INDUSTRIAL SALES & SERVICE PTY. LTD., Hume Highway, Somerton, 3047; D.A.2205/15; 21st March, 1968; 11 cwt.
 VICTORIAN INDUSTRIAL SALES & SERVICE PTY. LTD., Hume Highway, Somerton, 3047; D.A.2205/12; 28th March, 1968; 11 cwt.
 VICTORIAN MASTER BUTCHERS LTD., 86 Stubbs-street, Kensington, 3031; D.A.38796; 28th March, 1968; 54 cwt.
 WAGSTAFF, L. C., 33 Buchanan-street, North Balwyn, 3104; D.A.38710; 21st March, 1968; 8 cwt.
 WALHOUT, J. M., Lot 43, Sommerville-road, Hampton Park, 3976; D.A.61292; 9th March, 1968; 47 cwt.
 WHITLOCK, G. T., 31 Railway-place, Fairfield, 3078; D.A.51549; 23rd March, 1968; 119 cwt.

TOW TRUCK RENEWALS.

BROWN, J. K., 148 Murray Valley Highway, Echuca, 3625; T.D.A.47663; 26th February, 1968; 70 cwt.
 MELTON MOTORS (BOORT) PTY. LTD., 44 Godfrey-street, Boort, 3537; D.A.34043/2; 10th February, 1968; 77 cwt.
 MOLIN'S GARAGE PTY. LTD., Main-street, Koondrook, 3580; T.D.A.46539; 18th February, 1968; 71 cwt.
 NEWSTEAD MOTORS, Newstead, 3462; D.A.47318; 14th January, 1968; 30 cwt.
 RANLEY PANELS PTY. LTD., 22 O'Callaghan-parade, Horsham, 3400; D.A.35033/1; 10th February, 1968; 54 cwt.
 RED CLIFFS CENTRAL MOTORS, 13 Jacaranda-street, Red Cliffs, 3496; T.D.A.46280; 10th December, 1967; 40 cwt.
 RODNEY MOTORS (KYABRAM) PTY. LTD., Church-street, Kyabram, 3620; T.D.A.46497; 10th February, 1968; 20 cwt.
 SHARPE, W., 220 Broadway, Reservoir, 3073; T.D.A.57646; 7th March, 1968; 25 cwt.
 TACEY MOTOR CO. PTY. LTD., 95-97 Hogan-street, Tatura, 3620; T.D.A.46885; 10th February, 1968; 50 cwt.
 TURNER, C. R. (MOTORS) PTY. LTD., 347 Main-street, Mornington, 3931; D.A.35515/1; 23rd March, 1968; 79 cwt.

APPPLICATION by the persons listed hereunder for renewal of the licences listed with variation of conditions in the manner set out opposite the names.

BRYANT, W. J. and E. M., 19 Pearson-street, Bairnsdale, 3875; D.A.51388; 17th February, 1968; application to renew and vary the conditions of licence No. D.A.51388 (L/C. 120 cwt.) by deleting from the existing conditions paragraph (c) and by adding in lieu a new paragraph "(c) within a 25-mile radius of the post office at Bairnsdale—general goods, provided that no goods shall be carried whether by one stage or by more than one stage between places within the above radius, which are more than 30 road miles apart by the nearest practicable route."
 CARR, J., Berrybank, 3323; D.A.38349; 2nd February, 1968; application to renew and vary the conditions of licence No. D.A.38349 (L/C. 195 cwt.) by deleting from the existing conditions these words "Wolbunya (via Camperdown)" wherever they appear and add in lieu: "Berrybank."
 DOWLING, N. S., 25 Marilyn-court, Blackburn, 3130; D.A.51503; 23rd March, 1968; Application to renew and vary the conditions of licence No. D.A.51503 (L/C. 144 cwt.) by deleting from the existing conditions "City Brick Works Co. Pty. Ltd. at Malvern" and by adding in lieu: "Clifton Brick Holdings Ltd. at Oakleigh."
 EAST, T. E., Crooke-street, East Bairnsdale, 3875; D.A.51269; 3rd February, 1968; Application to renew and vary the conditions of licence No. D.A.51269 (L/C. 130 cwt.) by deleting from the existing conditions paragraphs (a) and (c) and by adding in lieu new paragraphs (a) and (c): "(a) Within a 95-mile radius of the post office at Orbost (Bairnsdale Division of the C.R.B.)—plant the property of a contractor and required for use in connexion with the construction

or maintenance of some specific, existing or proposed road, street, footpath, bridge, wharf, pier, weir or channel: (c) Within a 25-mile radius of the post office at Bairnsdale—general goods, provided that no goods shall be carried whether by one stage or by more than one stage between places within the above radius, which are more than 30 road miles apart by the nearest practicable route."

KRAUSE, C. P., Dadswells Bridge, via Glenorchy, 3385; D.A.51266; 3rd February, 1968; Application to renew and vary the conditions of licence No. D.A.51266 (L/C. 117 cwt.) by deleting from the existing conditions paragraph (b) and by adding in lieu a new paragraph (b): "(b) Within a 25-mile radius of the post office at Dadswells Bridge provided that no one journey shall exceed 30 miles in distance within the said radius—general goods."

SLATTER, J. F., 444 Springvale-road, Forest Hill, 3131; D.A.51463; 17th February, 1968; Application to renew and vary the conditions of licence No. D.A.51463 (L/C. 128 cwt.) by deleting from the existing conditions "City Brick Works Co. Pty. Ltd. at Malvern" and by adding in lieu: "Brick and Pipe Industries Ltd. at Burwood."

WOODS, T. H., 288 Huddle-street, Collingwood, 3066; D.A.51507; 23rd March, 1968; Application to renew and vary the conditions of licence No. D.A.51507 (L/C. 184 cwt.) by deleting the word "Preston" and by adding in lieu: "Footscray."

Notice of any objections should be forwarded to reach the Secretary of the Board not later than Wednesday, 7th February, 1968.

Applicants are advised that it will not be necessary to appear on the hearing date specified above, unless advised in writing by the Board.

B. P. KAY,
Secretary.

Corner of Lygon and Princes streets, Carlton, 3053, Wednesday, 24th January, 1968.

AMENDMENT TO THE SITTINGS OF THE SUPREME COURT FOR THE HEARING OF CRIMINAL TRIALS AND FOR THE TRIAL OF CAUSES ELSEWHERE THAN IN MELBOURNE FOR THE YEAR 1968.

HIS Excellency the Governor of the State of Victoria, by and with the advice of the Executive Council thereof, doth, by Order made on the 16th day of January, 1968, amend the Order in Council approved on the 5th September, 1967, and published in the *Government Gazette* of the 13th September, 1967, on page 2837, appointing certain dates for the holding of the Sittings of the Supreme Court for the hearing of criminal trials and for the trial of causes elsewhere than in Melbourne for the year 1968, as indicated in the second column of the Schedule hereunder so far as the Court at Ballarat is concerned.

SCHEDULE.

Place; Alteration of Dates.

Ballarat; from Tuesday, the 12th March, 1968, to Monday, the 4th March, 1968.

F. R. KENNY,
Acting Clerk of the Executive Council.

At the Executive Council Chamber,
Melbourne, 16th January, 1968.

LOCAL GOVERNMENT DEPARTMENT.

ORDER CONFIRMED.—SHIRE OF DIAMOND VALLEY.

THE Minister of the Crown administering the *Local Government Act 1958*, as amended, on the 18th day of January, 1968, confirmed the Order hereinafter referred to in pursuance of section 514 of the said Act, namely:—

An Order of the Council of the Shire of Diamond Valley made on the 4th December, 1967, directing the compulsory taking of an easement for drainage purposes over all that piece of land being the right-of-way shown on Plan of Subdivision No. 11211 lodged in the Office of Titles abutting the eastern boundaries of Lots 51, 52, 53 and 54 of the said Plan.

R. J. HAMER,
Minister for Local Government.

Local Government Department,
Melbourne.

LOCAL GOVERNMENT DEPARTMENT.

ORDER CONFIRMED.—SHIRE OF MORNINGTON.

THE Minister of the Crown administering the *Local Government Act 1958*, as amended, on the 19th day of January, 1968, confirmed the Order hereinafter referred to in pursuance of section 514 of the said Act, namely:

An Order of the Council of the Shire of Mornington made on the 19th December, 1967, directing the compulsory taking of an easement for drainage purposes over the land described hereunder:

All that piece of land being part of Crown allotment 32, section 22, Parish of Moorooduc, commencing at a point on the south-eastern alignment of Kent-street 646 ft. 9 in. from Separation-street; thence by lines bearing 52 deg. 59 min. for 12 feet; 142 deg. 59 min. for 312 feet; 232 deg. 59 min. for 12 feet; 322 deg. 59 min. for 150 feet; 232 deg. 59 min. for 630 ft. 4 in; 317 deg. 11 min. for 12 ft. 1 in.; 52 deg. 59 min. for 631 ft. 6½ in, and 322 deg. 59 min. for 150 feet to the commencing point.

R. J. HAMER,
Minister for Local Government.

Local Government Department,
Melbourne.

Cemeteries Act 1958.

SCALE OF FEES OF KEILOR PUBLIC CEMETERY.

IN pursuance of the powers conferred upon them by the *Cemeteries Act* the trustees of the Keilor Public Cemetery hereby make the following scale of fees, which shall come into operation upon publication in the *Government Gazette*, and from and after such publication every scale of fees heretofore made by the said trustees shall be and is hereby rescinded to the extent to which it conflicts with this scale.

Land for Private Graves.

8 ft. x 4 ft., selected by Trustees	.. \$40.00
8 ft. x 4 ft., selected by applicant	.. \$48.00
On approval of the Trustees, a greater width at per foot	.. \$8.00

Public Graves (if available).

Single interment in grave, adult	.. \$20.00
Single interment in grave, child under 12 years	.. \$10.00
Interment in grave, still-born child	.. \$6.00

Sinking Private Graves.

4 feet 6 inches deep for child's body	.. \$12.00
6 feet deep for one burial	.. \$24.00
7 feet deep for two burials	.. \$32.00
9 feet deep for three burials	.. \$48.00
Oversize grave for American type casket—Double above charges.	.. \$48.00

Miscellaneous Charges.

Reopening grave for adult	.. \$28.00
Reopening grave for child under 12 years	.. \$12.00
Reopening grave for still-born child	.. \$12.00
Cancellation of order to sink (if commenced)	.. \$12.00
Inspecting Plan	.. \$2.00
Search of Records	.. \$2.00
Certified extract from register	.. \$2.00
Certificate of Right of Burial	.. \$2.00
Interment not in usual hours (extra)	.. \$12.00
Interment on Saturday morning (extra)	.. \$17.60
Interment on Saturday afternoon (extra)	.. \$25.20
Interment on Sunday for adult (when permitted) (extra)	.. \$25.20
Interment on Sunday for child (when permitted) (extra)	.. \$8.00
Interment on Public Holidays and Cemetery Employees' Picnic Day (extra)	.. \$25.20
Interment of ashes	.. \$10.00
Exhumation (when authorized), minimum charge	.. \$40.00
Re-interment of a body in a grave	.. \$16.00
Permission to construct or erect a fence, monument, headstone, kerbing or repairs to same to the value of \$10.00 or under (and 5 per cent. additional on the value of all work costing over \$10.00)	.. \$4.20
Additional inscriptions to monument	.. \$2.00

G. BONNETT, Trustee.
I. McNAB, Trustee.
B. BAILEY, Trustee.
R. F. B. KELLY, Acting Secretary.

Approved by the Governor in Council, 16th January, 1968.—F. R. KENNY, Acting Clerk of the Executive Council.

COUNTRY FIRE AUTHORITY ACT.

PERMISSION TO HOLD FIRE BRIGADE DEMONSTRATIONS.

IN pursuance with the provisions of section 103 of the *Country Fire Authority Act 1958*, the Country Fire Authority has granted permission for the holding of fire brigade demonstrations as under:—

Urban Fire Brigades.

At Warragul, on Saturday, 10th February, 1968, in lieu of at Chelsea, on Saturday, 10th February, 1968.
At Creswick, on Saturday, 17th February, 1968, in lieu of at Wendouree, on Saturday, 17th February, 1968.

Rural Fire Brigades.

At Ellinbank, on Monday, 11th March, 1968.
At Gormandale, on Saturday, 16th March, 1968.
At Melton, on Saturday, 30th March, 1968.
At Amphitheatre, on Friday, 22nd March, 1968.
At Underbool, on Saturday, 23rd March, 1968.
At Bendigo, on Saturday, 30th March, 1968.
At Wangaratta, on Monday, 11th March, 1968.
At Chiltern, on Saturday, 23rd March, 1968.
At Horsham, on Saturday, 6th April, 1968.
22nd January, 1968.

J. L. ALLEN,
Secretary.

Labour and Industry Act 1958.

LABOUR AND INDUSTRY (EXPLOSIVE POWERED TOOLS) REGULATIONS 1965.

PURSUANT to the provisions of the *Labour and Industry (Explosive Powered Tools) Regulations 1965*, I give notice that, having determined because of the characteristics of samples and drawings numbered 25010, 25011, 25012, 25013, 25016 and 25018 submitted by Ramset Fasteners (Australia) Proprietary Limited, of 77 Spensley-street, Clifton Hill, Melbourne, for approval as interchangeable components of Tom Thumb Jobmaster Model 122MT, serial No. S48, submitted and approved on 23rd April, 1964, I do hereby this 12th day of January, 1968, grant my approval for these components to be interchangeable with the corresponding components of the said sample tool.

P. F. PRIOR,
Chief Inspector of Factories and Shops.

Electric Light and Power Act 1958.

ORDER GRANTED BY THE GOVERNOR IN COUNCIL.

IT is hereby notified that an order, pursuant to the provisions of the *Electric Light and Power Act 1958* (No. 6241) as hereunder mentioned has been granted by His Excellency the Governor in Council, viz.:—

Order No. 346.—Order under section 10 of the above-mentioned Act granted to Mayor, Councillors and Citizens of the City of Heidelberg in respect of land within the City of Preston.

J. C. M. BALFOUR,
Minister for Fuel and Power.

Dairy Products Act.

QUOTAS FOR BUTTER AND CHEESE.

BUTTER QUOTA.

I, JAMES WILLIAMSON MANSON, Acting Minister of Agriculture in the State of Victoria, after consultation with the Victorian Dairy Products Board, and after ascertaining that the supply and distribution of butter at reasonable prices to consumers thereof in Victoria will be ensured, hereby determine a quota for butter as follows:—

The proportion shall be Seventy-Four point Six Nine per centum.

The period for which this quota is to operate shall be the month of February, 1968.

CHEESE QUOTA.

I, JAMES WILLIAMSON MANSON, Acting Minister of Agriculture in the State of Victoria, after consultation with the Victorian Dairy Products Board, and after ascertaining that the supply and distribution of cheese at reasonable prices to consumers thereof in Victoria will be ensured, hereby determine a quota for cheese as follows:—

The proportion shall be Fifty-Eight point Five Two per centum.

The period for which this quota is to operate shall be the month of February, 1968.

J. W. MANSON,
Acting Minister of Agriculture.

Private Agents Act 1966.

NOTICE OF RECEIPT OF APPLICATIONS FOR LICENCES UNDER THE PROVISIONS OF THE PRIVATE AGENTS ACT 1966.

THE Clerk(s) of the Court(s) of Petty Sessions as listed hereunder hereby give notice that applications, as under, have been lodged for hearing by the said Court(s) on the date(s) specified.

Any person desiring to object to any of such applications must—

(a) lodge with the respective Clerk of Petty Sessions a notice in the prescribed form of his objection and of the grounds thereof ;

(b) cause a copy of such notice to be served personally or by post upon the applicant at least three days before the hearing of the application ; and

(c) send or deliver—

(i) where the objection is not made by the officer in charge of the police district in which the Court is situated—a copy of the notice to such officer ; and

(ii) where the objection is not made by the Registrar or Deputy Registrar—a copy to the Registrar.

Full Name of Applicant or in the case of a Firm or Corporation, of the Nominee.	Place of Abode of Applicant or Nominee.	Name of Firm or Corporation.	Address for Registration.	Type of Licence.	Date of Hearing of Application.
COURT OF PETTY SESSIONS, MELBOURNE.					
Bakes, Stanley George ..	92 Clarendon-street, Coburg	Australian Watching Co. Pty. Ltd.	130 Abbotsford-street, North Melbourne	Watchman ..	26.1.68
Birch, John ..	36 Collins-street, Chadstone	Armoured Escorts Pty. Ltd.	c/o Armoured Escorts Pty. Ltd., cnr. Arden and Lothian streets, North Melbourne	" ..	"
Briglia, Peter Joseph ..	23 Lucas-street, Caulfield	Australian Watching Co. Pty. Ltd.	130 Abbotsford-street, North Melbourne	" ..	"
Carpenter, Kenneth John ..	49 Leamington-street, Reservoir	" "	" "	" ..	"
Clarke, Trevor Lance ..	165 Boldrewood-parade, Reservoir	Armoured Escorts Pty. Ltd.	c/o Armoured Escorts Pty. Ltd., cnr. Arden and Lothian streets, North Melbourne	" ..	"
Collins, Graham Alexander ..	Flat 10, 25 Ashly-street, Reservoir	" "	" "	" ..	"
Cooper, Mervyn Thomas ..	138 Keilor-road, North Essendon	" "	" "	" ..	"
Coulson, David Reginald ..	23 Glika-street, Donvale	" "	" "	" ..	"
Crosby, Peter Stafford ..	100 Manning-road, East Malvern	Australian Watching Co. Pty. Ltd.	103 Abbotsford-street, North Melbourne	" ..	"
Davis, Sylvan A. G. ..	23 Arthur-street, East Coburg	" "	" "	" ..	"
Eltham, John Andrew ..	11 Leeds-street, Canterbury	Armoured Escorts Pty. Ltd.	c/o Armoured Escorts Pty. Ltd., cnr. Arden and Lothian streets, North Melbourne	" ..	"
Evans, David Anthony ..	20 Briggs-street, Laverton	Australian Watching Co. Pty. Ltd.	103 Abbotsford-street, North Melbourne	" ..	"
Forryan, Barry Kenneth ..	9 Dumblane-avenue, Ascot Vale	Armoured Escorts Pty. Ltd.	c/o Armoured Escorts Pty. Ltd., cnr. Arden and Lothian streets, North Melbourne	" ..	"
Gain, Robert William ..	Flat 9, 119 Rushall-crescent, North Fitzroy	" "	" "	" ..	"
Gill, Brian Selby ..	30 Burroughs-road, Balwyn	" "	" "	" ..	"
Kemp, Basil Llewellyn ..	7 Lae-street, West Heidelberg	Australian Watching Co. Pty. Ltd.	130 Abbotsford-street, North Melbourne	" ..	"
Kneebone, Sydney Richard ..	82 Civic-parade, Altona	" "	" "	" ..	"
Loftus, John William ..	129 Kangaroo-road, Oakleigh	Armoured Escorts Pty. Ltd.	c/o Armoured Escorts Pty. Ltd., cnr. Arden and Lothian streets, North Melbourne	" ..	"
Lynch, Robert Raymond ..	21 Adler-grove, Merlynston	" "	" "	" ..	"
Mason, John Frederick ..	Flat 9, 24 Brixton-rise, Glen Iris	" "	" "	" ..	"
McCracken, William Ernest ..	11 Albert-street, Fawkner	" "	" "	" ..	"
McGinn, Ralph ..	16 Smiley-road, Broadmeadows	" "	" "	" ..	"
McIver, Francis Joseph ..	57 Elster-avenue, Gardenvale	Australian Watching Co. Pty. Ltd.	130 Abbotsford-street, North Melbourne	" ..	"

PRIVATE AGENTS—*continued.*

Full Name of Applicant or in the case of a Firm or Corporation, of the Nominee.	Place of Abode of Applicant or Nominee.	Name of Firm or Corporation.	Address for Registration.	Type of Licence.	Date of Hearing of Application.
<i>COURT OF PETTY SESSIONS, MELBOURNE—continued.</i>					
Nally, Kevin Gerrard ..	28 Cameron-street, Richmond	Armoured Escorts Pty. Ltd.	cnr. Arden and Lothian streets, North Melbourne	Watchman ..	26.1.68
Raynor, Thomas Edmund ..	82 Middleborough-road, Burwood	Australian Watching Co. Pty. Ltd.	130 Abbotsford-street, North Melbourne	" ..	"
Richardson, Colin William ..	18 York-street, Prahran	Armoured Escorts Pty. Ltd.	c/o Armoured Escorts Pty. Ltd., cnr. Arden and Lothian streets, North Melbourne	" ..	"
Sandle, Ronald ..	Flat 2, Lot 24, Longview-road, Croydon	" "	" "	" ..	"
Scales, John Derek ..	23 Lansell-crescent, Camberwell	Australian Watching Co. Pty. Ltd.	130 Abbotsford-street, North Melbourne	" ..	"
Sparkes, Valentine John ..	238 Warrigal-road, South Oakleigh	" "	" "	" ..	"
Treller, Robert Charles ..	24 Joy-street, Braybrook	" "	" "	" ..	"
Walker, Gordon Terry ..	50 Douglas-avenue, St. Albans	Armoured Escorts Pty. Ltd.	c/o Armoured Escorts Pty. Ltd., cnr. Arden and Lothian streets, North Melbourne	" ..	"
White, Anthony Robert ..	76 Moore-street, East Coburg	Australian Watching Co. Pty. Ltd.	130 Abbotsford-street, North Melbourne	" ..	"
Wilson, Maxwell Keith ..	4 Oulton-street, Fawkner	Armoured Escorts Pty. Ltd.	c/o Armoured Escorts Pty. Ltd., cnr. Arden and Lothian streets, North Melbourne	" ..	"
Wilson, William Stewart ..	32 Halsbury-street, Glenroy	" "	" "	" ..	"

Dated at Melbourne this 12th day of January, 1968.

G. L. WEBSTER,
Clerk of Petty Sessions.*COURT OF PETTY SESSIONS, PRAHRAN.*

Jones, David Frank ..	50 Maher-road, Laverton	614 St. Kilda-road, Melbourne	Watchman ..	12.2.68
-----------------------	-------------------------	-------	-------------------------------	-------------	---------

Dated at Prahran this 15th day of January, 1968.

G. T. WHEELHOUSE,
Clerk of Petty Sessions.*COURT OF PETTY SESSIONS, BOX HILL.*

Belsky, Stan ..	59 Oakhill-road, Mount Waverley	Commercial Sub-Agent	5.2.68
-----------------	---------------------------------	-------	-------	----------------------	--------

Dated at Box Hill this 15th day of January, 1968.

A. J. JOHNSON,
Clerk of Petty Sessions.*COURT OF PETTY SESSIONS, FOOTSCRAY.*

Snowden, William ..	Flat 1, 270 Barkly-street, St. Kilda	620 New Footscray-road, West Melbourne	Watchman ..	8.2.68
---------------------	--------------------------------------	-------	--	-------------	--------

Dated at Footscray this 17th day of January, 1968.

J. CAVEN,
Clerk of Petty Sessions.*COURT OF PETTY SESSIONS, ST. KILDA.*

Weyl, Herbert ..	1 Meaden-court, Darling	John Portman and Co. Pty. Ltd.	84 Chapel-street, St. Kilda	Commercial Agent	6.2.68
------------------	-------------------------	--------------------------------	-----------------------------	------------------	--------

Dated at St. Kilda this 17th day of January, 1968.

J. E. REILLY,
Clerk of Petty Sessions.*COURT OF PETTY SESSIONS, RICHMOND.*

Anderson, William John ..	Flat 3, 12 Nicholson-street, North Balwyn	Obique Collection Services	Suite 3, 34 Swan-street, Richmond	Commercial Agent for a Firm	7.2.68
" " "	" "	" "	" "	Commercial Agent (Individual)	"
Anderson, Beryl Joyce ..	" "	" "	" "	" "	"

Dated at Richmond this 17th day of January, 1968.

R. MEEHAN,
Clerk of Petty Sessions.

PRIVATE AGENTS—continued.

Full Name of Applicant or in the case of a Firm or Corporation, of the Nominee.	Place of Abode of Applicant or Nominee.	Name of Firm or Corporation.	Address for Registration.	Type of Licence.	Date of Hearing of Application.
COURT OF PETTY SESSIONS, MELBOURNE.					
Anderson, John	17 Link-parade, Fawkn- ner	Armoured Escorts Pty. Ltd.	Cnr. Arden and Lothian streets, North Melbourne	Watchman ..	2.2.68 "
Atherton, Leslie	36 Congram-street, Broadmeadows	Australian Watching Co. Pty. Ltd.	130 Abbotsford- street, North Mel- bourne	" ..	"
Birmingham, Malcolm Leslie ..	43 Thames-street, Box Hill	" "	" "	" ..	"
Brien, Ronald George ..	7 Deakin-court, Broad- meadows	" "	" "	" ..	"
Cook, Noel George ..	Flat 5, 14 Yendon- road, Glenhuntly	" "	" "	" ..	"
Franklin, John Robert ..	5 Gee-court, Nuna- wading	" "	" "	" ..	"
Grant, Francis Patrick ..	107 Halsey-road, Air- port West	Armoured Escorts Pty. Ltd.	Cnr. Arden and Lothian streets, North Melbourne	" ..	"
Hand, Ernest Robert ..	216 Reynard-street, Coburg	Australian Watching Co. Pty. Ltd.	130 Abbotsford- street, North Mel- bourne	" ..	"
Lothead, William ..	147 Hilton-street, Glenroy	" "	" "	" ..	"
Monday, Charles Edward ..	12 Beccles-street, North Fawkner	" "	" "	" ..	"
McGowan, Bartley ..	94 Farm-street, New- port	" "	" "	" ..	"
McIntyre, Andrew Lance ..	29 Rutland-street, Clifton Hill	Mayne Nickless Ltd.	94 York-street, South Melbourne	" ..	"
Nixon, Maurice Fordyce ..	55 Franklin-road, East Doncaster	Armoured Escorts Pty. Ltd.	Cnr. Arden and Lothian streets, North Melbourne	" ..	"
Redding, Michael Lorne ..	146 Balwyn-road, Balwyn	Australian Watching Co. Pty. Ltd.	130 Abbotsford- street, North Mel- bourne	" ..	"
Riddick, Stanley ..	3 Melbourne-avenue, Glenroy	Armoured Escorts Pty. Ltd.	Cnr. Arden and Lothian streets, North Melbourne	" ..	"
Saunders, Neville Raymond ..	630 Burke-road, Cam- berwell	Australian Watching Co. Pty. Ltd.	130 Abbotsford- street, North Mel- bourne	" ..	"
Schembri, Anthony Charles ..	Flat 1, 271 Lennox- street, Richmond	" "	" "	" ..	"
Spiller, Ronald Albert ..	13 Hemburrow-street, West Preston	" "	" "	" ..	"
Stokes, Malcolm Campbell ..	27 Princess-street, Kew	" "	" "	" ..	"
Sugg, Alan Douglas ..	7 Percival-street, Oak Park	Armoured Escorts Pty. Ltd.	Cnr. "Arden" and Lothian streets, North Melbourne	" ..	"
Todman, Arthur Francis ..	280 Rossmoyne-street, Thornbury	Max Hocking ..	288 Little Collins- street, Melbourne	" ..	"
White, Victor Raymond ..	87 Murray-road, East Coburg	Armoured Escorts Pty. Ltd.	Cnr. Arden and Lothian streets, North Melbourne	" ..	"

Dated at Melbourne this 15th day of January, 1968.

G. L. WEBSTER,
Clerk of Petty Sessions.

COURT OF PETTY SESSIONS, MELBOURNE.

Clark, George Dykes ..	1342 Sydney-road, Fawkner	Armoured Escorts Pty. Ltd.	Cnr. Arden and Lothian streets, North Melbourne	Watchman ..	5.2.68
------------------------	------------------------------	-------------------------------	---	-------------	--------

Dated at Melbourne this 17th day of January, 1968.

G. L. WEBSTER,
Clerk of Petty Sessions.

COURT OF PETTY SESSIONS, CARLTON.

Scholes, Henry Franklin ..	8 Ayr-street, Black- burn South	" ..	337A Drummond- street, Carlton	Inquiry Agent ..	12.2.68
----------------------------	------------------------------------	------	-----------------------------------	------------------	---------

Dated at Carlton this 18th day of January, 1968.

F. J. MORTIMER,
Clerk of Petty Sessions.

COURT OF PETTY SESSIONS, ST. KILDA.

Reynolds, Basil Keith ..	76 Carlisle-street, St. Kilda	Nominee of Collingwood and Fitzroy Security Services Pty. Ltd.	76 Carlisle-street, St. Kilda	Guard Agent ..	9.2.68
Reynolds, Basil Keith ..	76 Carlisle-street, St. Kilda	" ..	76 Carlisle-street, St. Kilda	" ..	"

Dated at St. Kilda this 19th day of January, 1968.

J. E. REILLY,
Clerk of Petty Sessions.

PRIVATE AGENTS—continued.

Full Name of Applicant or in the case of a Firm or Corporation, of the Nominee.	Place of Abode of Applicant or Nominee.	Name of Firm or Corporation.	Address for Registration.	Type of Licence.	Date of Hearing of Application.
---	---	------------------------------	---------------------------	------------------	---------------------------------

COURT OF PETTY SESSIONS, FOOTSCRAY.

Klasic, Vladimir	Flat 43, 10 Acland-street, St. Kilda		620 New Footscray-road, West Melbourne	Watchman	8.2.68
------------------	--------------------------------------	--	--	----------	--------

Dated at Footscray this 17th day of January, 1968.

J. CAVEN,
Clerk of Petty Sessions.

COURT OF PETTY SESSIONS, MELBOURNE.

Bennett, Ronald William	870 Drummond-street, North Carlton	Armoured Escorts Pty. Ltd.	Cnr. Arden and Lothian streets, North Melbourne	Watchman	30.1.68
Danby, Graeme Arthur	42 Duncan-road, Lalor	" "	" "	" "	" "
Dumas, Keith Ewan	46 Como-street, Alphington	" "	" "	" "	" "
Eastwood, Ross	12 Oulton-street, Fawkner	" "	" "	" "	" "
Egan, Noel	32 Thiele-street, Doncaster	" "	" "	" "	" "
Fouracre, Thomas Bruce	45 Lamart-street, Strathmore	" "	" "	" "	" "
Hecker, Keith	39 Sutherland-street, Glenroy	" "	" "	" "	" "
Hede, Kevin	291 Flemington-road, North Melbourne	" "	" "	" "	" "
Holdysz, Johann	16 Mathews-street, Sunshine	" "	" "	" "	" "
Holmesby, Paul Raymond	229 Dawson-street, West Brunswick	" "	" "	" "	" "
Hunter, Verdon Patrick	12 Hilltop-avenue, Macleod	" "	" "	" "	" "
Hynes, Gordon Aubrey	C/o Fire Station, Williamstown-road, Port Melbourne	" "	" "	" "	" "
Larkin, Patrick Michael	5 Gregory-street, Oak Park	" "	" "	" "	" "
Leonard, Kenneth Reginald Victor	55 Lynch-road, Fawkner	" "	" "	" "	" "
O'Callaghan, Gerald Peter	5 Boyne-street, East Coburg	" "	" "	" "	" "
O'Keefe, John Eugene	6 Wickham-grove, Strathmore	" "	" "	" "	" "
O'Keefe, Michael Thomas	45 Mary-street, Essendon	" "	" "	" "	" "
Phelps, Dudley Lawson	Flat 112, 480 Lygon-street, Carlton	" "	" "	" "	" "
Pribilovics, Bartholomew	26 Raleigh-street, Windsor	" "	" "	" "	" "
Scully, Brian Edward	250 West-street, Glenroy	" "	" "	" "	" "
Trembath, Brian Raymond	42 Moyangul-drive, East Keilor	" "	" "	" "	" "
Wilson, Kenneth James	211 Cecil-street, South Melbourne	" "	" "	" "	" "

Dated at Melbourne, this 15th day of January, 1968.

G. L. WEBSTER,
Clerk of Petty Sessions.

COURT OF PETTY SESSIONS, MELBOURNE.

Archer, Colin Raymond	"Woodsleigh", Main-road, Tremont	Factory Guard Service Pty. Ltd.	104 Wellington-parade, East Melbourne	Watchman	6.2.68
Brennan, John William Thomas	11 Derreck-avenue, Bulleen	Australian Watching Co. Pty. Ltd.	130 Abbotsford-street, North Melbourne	" "	" "
Dix, William Albert	7 Beatrice-street, Burwood	Factory Guard Service Pty. Ltd.	104 Wellington-parade, East Melbourne	" "	" "
Evans, Clifford Barry	886 Lygon-street, Carlton North	Australian Watching Co. Pty. Ltd.	130 Abbotsford-street, North Melbourne	" "	" "
Griffin, Gordon Frederick	17 Parslow-street, Malvern	" "	" "	" "	" "
Harkin, John Welsh	488 Barrys-road, Broadmeadows	Factory Guard Service Pty. Ltd.	104 Wellington-parade, East Melbourne	" "	" "
Helms, Noel David	6 Jersey-street, Balwyn	" "	" "	" "	" "
Hogg, Leonard Francis Peter	Russell-street, Warrandyte	Australian Watching Co. Pty. Ltd.	130 Abbotsford-street, North Melbourne	" "	" "
Howard, John Lester	42 Royal-avenue, Glenhuntly	Factory Guard Service Pty. Ltd.	104 Wellington-parade, East Melbourne	" "	" "
Hubbard, Anthony Jon	5 Sophi-court, Springvale	" "	" "	" "	" "

PRIVATE AGENTS—*continued.*

Full Name of Applicant or in the case of a firm or Corporation, of the Nominee.	Place of Abode of Applicant or Nominee.	Name of Firm or Corporation.	Address for Registration.	Type of Licence.	Date of Hearing of Application.
COURT OF PETTY SESSIONS, MELBOURNE—<i>continued.</i>					
Hurst, Ernest Frederick ..	Flat 8, 20 Cooper-street, Preston	Australian Watching Co. Pty. Ltd.	130 Abbotsford-street, North Melbourne	Watchman ..	6.2.68
Jones, John Lindsay Amos ..	30 Timber Ridge, Doncaster	Factory Guard Service Pty. Ltd.	104 Wellington-parade, East Melbourne	" ..	"
Kitch, Douglas Lawson ..	6 Moama-street, Braybrook	" "	" "	" ..	"
Medlicott, Harold John ..	20 Pine-avenue, Briar Hill	" "	" "	" ..	"
Mills, Eric ..	11 Samada-street, North Clayton	Australian Watching Co. Pty. Ltd.	130 Abbotsford-street, North Melbourne	" ..	"
McInnes, Robin Irvine Godfrey Angus	20 Wackett-street, Laverton	Factory Guard Service Pty. Ltd.	104 Wellington-parade, East Melbourne	" ..	"
Nott, John David ..	37 Willonga-street, Strathmore	Australian Watching Co. Pty. Ltd.	130 Abbotsford-street, North Melbourne	" ..	"
Pratt, Leonard Maxwell ..	27 Haig-street, Box Hill South	" "	" "	" ..	"
Wilson, Brian Ernest ..	91 Bellingham-road, Deer Park	Armoured Escorts Pty. Ltd.	Cnr. Arden and Lothian streets, North Melbourne	" ..	"

Dated at Melbourne this 17th day of January, 1968.

G. L. WEBSTER,
Clerk of Petty Sessions.

Soil Conservation and Land Utilization Act 1958 (No. 6372)

KOROITE CREEK NO. 2 GROUP CONSERVATION AREA.

NOTICE is hereby given that I, William John Farquhar McDonald, Her Majesty's Minister for Conservation for the State of Victoria under powers conferred by Division 1A Section 24A of the *Soil Conservation and Land Utilization Act 1958* (No. 6372) hereby declare to be a group conservation area the land embraced by the Crown Allotments listed below together with the Road Reserves in the Parishes of Brit Brit and Konongwootong as particularly designated in Drawing Nos. 1546, 1258, 1259 and 1526 marked "GA/67" and lodged at the office of the Soil Conservation Authority, 378 Cotham-road, Kew, and do further declare that it shall be known as the Koroite Creek No. 2 Group Conservation Area :—

Parish	Section.	Estate.	Settlement Allotment.	Crown Allotment.
Brit Brit	Konongwootong North	21, 21A, pt. 28
Konongwootong ..	II	Konongwootong North	1, pt. 2, 3, 4
..	..	Konongwootong South	9 ..	11, 12
..	Pt. 7
..	IV.	3
..	X.	Konongwootong South	..	1B, 2, 2A, 9
..	..	Konongwootong Creek	10, 11, 12
..	XI.	Konongwootong Creek	13, 14, 15
..	XII.	Wootong Vale ..	4, 5, 10, 11, 12, 13
..	..	Konongwootong South	..	3, 7
..	XV.	Pt. 1A, 1B.
..	..	Konongwootong Creek	3A, 6
..	XIX.	Konongwootong South	1, 2, 3, 4 ..	40
..	XX.	Konongwootong Creek	69, 70, 71
..	XXIII.	Konongwootong South	..	1, 1A, 3A, 6, 8, 10
..	..	Konongwootong South	..	53
..	..	Konongwootong Creek	5, 7, 8
..	PR.	Konongwootong Creek	16, 17
..	..	Konongwootong South	4, 5

and those Road and Crown Land Reserves embraced in the above listed Drawings.

16th January, 1968.

W. J. F. McDONALD,
Minister for Conservation.

Soil Conservation and Land Utilization Act 1958.
(No. 6372.)

CONCONGELLA NO. 2 GROUP CONSERVATION AREA.

NOTICE is hereby given that I, William John Farquhar McDonald, Her Majesty's Minister for Conservation for the State of Victoria under powers conferred by Division 1A section 24A of the Soil Conservation and Land Utilization Act 1958 (No. 6372) hereby declare to be a group conservation area the land embraced by the Crown allotments listed below together with the road reserves in the Parishes of Watta Wella, Stawell, Kirkella and Glynwylln designated in drawing Nos. 1616B, 1617B, 1629A, and 1638A marked "GA/46" and lodged at the office of the Soil Conservation Authority, 378 Cotham-road, Kew, and do further declare that it shall be known as the Concongella No. 2 Group Conservation Area:

Parish; Crown allotments;

Watta Wella.—45B, 45C, 69A, 69B, 84, 85, 86, 108, 105, 106A, 29A, 29B, 29D, 71, 72, 81A, 81B, 81C, 82, 83, 109A, 112, 113, 115, 115C, 107, 109, 109B, 109C, 110, 111, 125, 125A, 128, 128B, 128C, 129, 82A, 31B, 116A, 116B, 106, 130B, 130, 43, 43A, 43B, 44, 44A; Parts of allotments 45A, 46A, 66, 67, 87, 103, 104, 5E, 5, 103B, 131, 31A, 31C, 30B.

Stawell, No Section.—2B, 2E, 1, 2, 3, 4, B2, B1, 113, 1A, 2A, 2D, 3A, 3B, 3C, 4A, 4B, 4C, 32B, 34A, 34C, 35, 36, 37A, 37B, 38, 39, 40, 41, 73, 74, 75, 76, 77, 78, 79, 80A, 80B, 110, 111.

Section Z.—20, 32A, 32C, 32D, 33A, 33A1, 33A2, 33B1, 33B2, 34A1, 14, 15, 1, 2, 3A, 4, 5, 5A, 5B, 9A, 14A, 34A2.

Section I.—2B, 1B, 2, 3, 6. Part of allotment 113.

Section II.—117A, 117B, 117C, 2, 3, 6, 7, 10, 11, 14, 15. Parts of allotments 117D, 119D.

Kirkella.—184B1, 184B2, 185A1, 185B1, 186A1, 186B2, 186C, 186D. Parts of allotment 180.

Glynwylln.—Parts of allotments 130, 125E.

And those road reserves and Crown reserves in the above Parishes lying within the area designated in drawing Nos. 1616B, 1617B, 1629A, and 1637A, and 1638A.

W. J. F. McDONALD,
Minister for Conservation.

January, 1968.

DEPARTMENT OF MINES.
MINING LEASES GRANTED.

- 9251, Castlemaine; Frederick Arthur Clark; 20a. 0r. 10p., Parish of Strangways.
8217, Mineral; Anthony Malcolm Campbell Brown, Roger James Brown; 96a. 0r. 25p., Parish of Walwa.
8368, Mineral; Noel Lyndon Smith, Eustace Lyndon Smith; 11a. 0r. 13p., Parish of Terrick Terrick West.
8455, Mineral; Frederick Norman Simpson; Eric Stanley Humphreys; 34a. 1r. 13p., Parish of Kunat Kunat.

EXPLORATION LICENCE GRANTED.

- 81, Exploration Licence; Harold Neil Thomas, 3 square miles, County of Benambra.

TERM OF PETROLEUM EXPLORATION PERMIT EXTENDED.

- 42, Petroleum Exploration Permit; Woodside (Lakes Entrance) Oil Company No Liability; 1,507 square miles; County of Buln Buln and an offshore area.

TAILINGS LICENCES GRANTED.

- 3422, Tailings Licence; Cecil Cooper, 1a. 0r. 19p., Parish of Wollonaby.
3570, Tailings Licence; Leslie David Deas; "Mona" tailings dump situated in the Parish of Chiltern West (in lieu of 3514 Tailings Licence, expired).
3571, Tailings Licence; Ray Maltby; "Sardine Gully" and "Sardine Hill" tailings dumps situated in the Parish of Yehrip (in lieu of 3516 Tailings Licence, expired).
3572, Tailings Licence; The President, Councillors and Ratepayers of the Shire of Ballarat; "Koren Kopier" tailings dump situated in the Parish of Carngham (in lieu of 3380 Tailings Licence, expired).

J. C. M. BALFOUR,
Minister of Mines.

No. 5.—506/68.—2

Town and Country Planning Act 1961.
SHIRE OF KNOX PLANNING SCHEME 1965.

AMENDMENT No. 15, 1967.

Notice of Approval.

IN pursuance of the powers conferred by the Town and Country Planning Act 1961, the Governor in Council on the 23rd January, 1968, approved a planning scheme entitled the Shire of Knox Planning Scheme 1965, Amendment No. 15, 1967, in respect of part of the municipal district of the Shire of Knox and such planning scheme comes into operation on the date this notice of approval is published in the Government Gazette.

A copy of the planning scheme as approved may be inspected free of charge during office hours at the office of the Town and Country Planning Board, 179 Queen-street, Melbourne; at the office of the Shire of Knox at Fern Tree Gully, and when available, at the Office of Titles, Melbourne, and at the Central Plan Office of the Department of Crown Lands and Survey, Melbourne.

W. H. CRAIG, Secretary,
Town and Country Planning Board.

Town and Country Planning Act 1961.

TOWN AND COUNTRY PLANNING BOARD.—SIMPSON PLANNING SCHEME.

INTERIM DEVELOPMENT ORDER.

Notice of Approval.

IN pursuance of the powers conferred by the Town and Country Planning Act 1961, the Governor in Council, on the 23rd day of January, 1968, approved an Interim Development Order made by the Town and Country Planning Board over part of the municipal districts of the Shires of Otway and Heytesbury.

The Interim Development Order provides that the use, subdivision or development of any land within the area described and the erection, construction and carrying out of any buildings, roads or other works thereon is prohibited except that the Town and Country Planning Board may permit such uses, development, erection, construction or other works as it thinks proper.

A copy of the Interim Development Order and a map showing the area affected may be inspected free of charge at the office of the Shire of Otway at Beech Forest, the Shire of Heytesbury at Cobden and at the office of the Town and Country Planning Board, 179 Queen-street, Melbourne.

W. H. CRAIG, Secretary,
Town and Country Planning Board.

Pounds Act 1958.

CITY OF BOX HILL.

TABLE of Rates to be charged for the trespass of cattle and their sustenance while impounded, fixed by the Council of the City of Box Hill.

Description of Cattle Trespassing.	Trespass Rates.		Sustenance Fees.
	Upon Land other than Tillage Land Enclosed by a Substantial Fence.	Upon Tillage Land Enclosed by a Substantial Fence.	Amount to be Charged Daily for Sustenance while Impounded.
	\$	\$	\$
For every sheep ..	0·03	0·10	0·10
For every goat ..	1·00	2·00	1·00
For every pig ..	1·00	2·00	1·00
For every head of other cattle ..	1·00	2·00	1·00

By Order of the Council,
A. N. WALLS,
Town Clerk.

Approved by the Governor in Council, 16th January, 1968.—
F. R. KENNY, Acting Clerk of the Executive Council

CONTRACTS ACCEPTED.—(Series 1967-68.)**VICTORIAN RAILWAYS.**

67. Supply and delivery of Ballast Spot Tamping Machines, 5 ft. 3 in. gauge at the rate of \$A15,802.00 each, f.o.b., Hamburg (Contract 63205) Conquip Sales (Vic.) Pty. Ltd. 68. Manufacture, supply and lay bituminous concrete for pavement of loading areas between No. 8 and No. 9 roads and adjacent to the extension of No. 11 road, Dandenong Railway Yard at rates (Contract 63213).—Reid (Asphalting Contractors) Pty. Ltd. 69. Manufacture of telephone rail poles and stay anchors at Horsham at rates (Contract 63223).—L. McNeil & Son. 70. Supply and laying of bituminous concrete for pavement at Tallow Siding, Melbourne Yard at rates (Contract 63246).—Damman Asphalt Co. Pty. Ltd. 71. Supply of wooden piles at rates (Contract 63211).—L. Harvey. 72. Supply of wooden piles at rates (Contract 63240).—Alex Sturrock & Sons Pty. Ltd., as agents for Donchi Bros. 73. Supply of wooden piles at rates (Contract 63241).—W. Hoppner. 74. Supply of wooden crane stay legs at the rate of \$1.20 per lineal foot, f.o.r., Bainsdale (Contract 63242).—A. Norman.

By order of the Victorian Railways Commissioners.

W. WALKER, Secretary for Railways. 19.1.67.

PUBLIC WORKS.

2340. Warmambool, H.S. Residence, 301 Lava-street, painting and renovations. Original, \$996.60; Additional, \$145.54—\$1,142.14.—R. S. Thornton.

2341. Coburg, Penridge Gaol, electrical installation. Original, \$971.00; Additional, \$150.00—\$1,121.00.—J. Speedy.

2342. Longerenong, Agricultural College, replacement of hot-water boiler. Original, \$978.40; Additional, \$103.20—\$1,081.60.—G. Stone and Sons.

2343. Melbourne, Taxation Department, 436 Lonsdale-street, installation of sump pumps and additional storage tank. Original, \$825.00; Additional, \$360.17—\$1,185.17.—Smith & Osborne Pty. Ltd.

2344. Frankston, Teachers' Training College Residence, painting and repairs. Original, \$834.00; Additional, \$338.00—\$1,172.00.—L. Brown.

2345. Melbourne, R.M.I.T., electrical installation. Original, \$868.00; additional, \$960.00—\$1,828.—J. Newall Pty. Ltd.

2346. Melbourne R.M.I.T., electrical installation. Original, \$894.85; Additional, \$592.00—\$1,486.85.—K. J. Dupuy.

2347. McLeod, Prison Farm (French Island), maintenance of engines. Original, \$438.00; Additional, \$1,181.39—\$1,619.39.—Southern Cross Machinery Pty. Ltd.

2348. Beechworth, M.H., fluorescent lighting. Original, \$555.00; Additional, \$598.00—\$1,153.00.—I. D. McGuffie.

EXTRAS ON CONTRACTS.

2349. Serial No. 67/68-1583.—\$231.00.
 2350. Serial No. 66/67-2453.—\$1,608.50.
 2351. Serial No. 66/67-3211.—\$5,527.50.
 2352. Serial No. 65/66-3744.—\$242.00.
 2353. Serial No. 65/66-3749.—\$939.00.
 2354. Serial No. 66/67-2244.—\$352.70.
 2355. Serial No. 66/67-4066.—\$851.00.
 2356. Serial No. 64/65-4017.—\$342.50.
 2357. Serial No. 64/65-1886.—\$229.50.
 2358. Serial No. 66/67-2506.—\$5,106.93.
 2359. Serial No. 66/67-1791.—\$4,952.78.
 2360. Serial No. 66/67-924.—\$695.35.
 2361. Serial No. 66/67-2518.—\$4,942.39.
 2362. Serial No. 66/67-923.—\$628.35.
 2363. Serial No. 66/67-2502.—\$117.50.
 2364. Serial No. 66/67-3856.—\$508.00.
 2365. Serial No. 67/68-1492.—\$356.60.
 2366. Serial No. 66/67-2520.—\$1,014.88.
 2367. Serial No. 66/67-1806.—\$535.00.
 2368. Serial No. 67/68-1513.—\$11,225.00.
 2369. Serial No. 66/67-1929.—\$478.32.
 2370. Serial No. 67/68-1433.—\$3,527.45.
 2371. Serial No. 66/67-4096.—\$71.00.
 2372. Serial No. 67/68-1507.—\$130.24.
 2373. Serial No. 66/67-1413.—\$2,622.10.
 2374. Serial No. 67/68-1417.—\$2,672.00.
 2375. Serial No. 67/68-1438.—\$2,065.60.
 2376. Serial No. 66/67-3972.—\$1,749.60.
 2377. Serial No. 67/68-1428.—\$3,792.00.
 2378. Serial No. 67/68-1428.—\$1,549.00.
 2379. Serial No. 65/66-4374.—\$389.37.
 2380. Serial No. 67/68-1641.—\$169.90.
 2381. Serial No. 66/67-4045.—\$960.00.
 2382. Serial No. 66/67-1415.—\$234.70.
 2383. Serial No. 66/67-931.—\$1,340.00.
 2384. Serial No. 65/66-3422.—\$342.91.
 2385. Serial No. 66/67-624.—\$93.00.
 2386. Serial No. 67/68-1497.—\$184.00.

SOIL CONSERVATION AUTHORITY.**CONTRACT No. 6724.**

2408. Supply of 500 wooden posts and 200 strainers, Eppalock Catchment Project, \$430.—T. J. Hall, Heathcote.

N. J. DENTON, Acting Secretary.

CEREALS.

Requirements under Sub-schedule No. 10 of Schedule No. 1 for the period 1st February, 1968, to 30th April, 1968, are to be purchased from the under-mentioned firms at the rates per cwt. respectively indicated, viz., Ward, McKenzie Pty. Ltd., 192 Arden-street, North Melbourne, Barley, pearl, \$6.00; Peas, split, yellow, \$11.00; Tapioca, seed, 8 cents per lb; Robert Harper & Co. Ltd., Oatmeal, plain, \$7.00; Oatmeal, flaked, \$7.50; Rice, dressed, \$9.80.

H. COUTTS, Secretary to the Tender Board.
 23rd January, 1968.

ORDERS IN COUNCIL.—(Series 1967-68.)**EDUCATION DEPARTMENT.**

2387. Ten (10) only Gallenkamp, electrically heated melting point apparatus, cooling coil and 360 deg. thermometer and eight (8) only Labmaster, electrically heated stainless steel water baths with safety cut-out switch and reset device, \$1,562.00.—Drug Houses of Australia, Anax Division, Victoria Branch.

2388. Two (2) only Sauter Toppan Balances, \$746.00.—Agta Pty. Ltd.

2389. Seven (7) only Potentiometers with ranges and eight (8) only Portable Reflecting Galvanometers, \$1,731.00.—J. L. William.

2390. Five (5) only Sartorius Model 2254 top loading balances. Eight (8) only Sartorius Model 2402 single pan analytical balances. Ten (10) only sets of Test and Calibration substances No. 9506. Eighteen (18) only Metrohm Model E350 B pH meters with accessories. Twenty-six (26) only Metrohm EA 120 U Electrodes. Twenty-six (26) only Metrohm EA 201 Platinum Electrodes. Twenty-six (26) only Metrohm EA 402 Calomel Electrodes, and six (6) only Laboro hot plates 9 in. x 9 in. stainless steel top, \$8,144.00.—H. B. Selby & Co.

2391. Twenty-nine (29) only Assembly Quickfit & Quartz Ltd.; fifty-six (56) only Assembly Quickfit & Quartz Ltd.; six (6) only Assembly Quickfit & Quartz Ltd.; two (2) only sets Solvent Recovery Distillation Assemblies consisting of two (2) flasks at \$6.62 each; two (2) adaptors at \$6.69 each; two (2) clips at \$1.77 each; two (2) condensers at \$10.50 each; one (1) only water still with automatic feed Quickfit; six (6) only Semi Micro Distillation assemblies; and various individual items to match Quickfit Assemblies, \$4,123.37.—Townson & Mercer (Vic.) Pty. Ltd.

2392. Twenty-five (25) only Steristirrer magnetic stirrer. \$855.00.—Laboratory Supply (Vic.) Pty. Ltd.

2393. Twelve (12) only Mettler Model P160 Dig. precision balances; one (1) only ISO PAD heating mantle with built-in energy regulator; and fourteen (14) only ISO PAD heating mantles with built-in energy regulators, \$4,230.00.—Watson Victor Ltd.—for the use of various Technical Schools.

2394. One (1) only Dynavac OD600, three-stage, fractionating oil diffusion pump and one (1) only Dynavac SV4 4-in. combination high-conductance baffle valve, for Ballarat School of Mines, \$505.00.—Dynavac High Vacuum Pty. Ltd.

2395. One (1) only gas chromatograph and recorder, for Royal Melbourne Institute of Technology, \$5,027.00.—Hewlett Packard Australia Pty. Ltd.

2396. Various items of equipment for the home-science section, for Doveton Technical School, \$825.98.—Lyne Brown Pty. Ltd.

2397. Various items of metrology equipment for the tool-making department, for Maryborough Technical College, \$1,661.11.—McPherson's Ltd.

2398. Various items of metrology equipment for the tool-making department, for Maryborough Technical College, \$837.10.—Qualos Sales Pty. Ltd.

2399. One (1) only bench folder and one (1) only jewellers rollers, for Niddrie Technical School, \$379.50.—McPherson's Ltd.

2400. One (1) only steam cleaning plant, for Richmond Technical School, \$535.50.—E. A. Machin & Co. Ltd.

2401. One (1) only 4-in. centre model "A" lathe and accessories, for Richmond Technical School, \$762.95.—McPherson's Ltd., and

2402. Two (2) only portable wheel aligners, for Richmond Technical School, \$384.00.—Replacement Parts.

2403. One (1) only bench folding machine, for Shepparton Technical School, \$315.00.—McPherson's Ltd.

2404. One (1) only planer thicknesser, for Stawell Technical School, \$2,100.00.—J. R. Hall.

2405. One (1) only 24-in. thicknesser, for Warragul Technical School, \$2,125.00.—C. Wolfenden & Co. Pty. Ltd.

2406. One (1) only horizontal boring machine, for Warragul Technical School, \$206.00.—Northern Machinery Co.

Approved by the Governor in Council, 16th January, 1968.—F. R. KENNY, Acting Clerk of the Executive Council.

FORESTS COMMISSION.

2407. To the purchase of that lot 19 on plan of subdivision No. 26960, being part of Crown allotment 126, Parish of Scoresby, County of Mornington, for Forest purposes, \$800.00.—Douglas Stanley McGill and Marjorie Yvonne McGill.

Approved by Governor in Council, 8th November, 1967.—J. ROSSITER, Clerk of the Executive Council.

Loan Fund Act No. 7640, Item 6—

2409. To the purchase of that lot 304, on plan of subdivision No. 12973, being part of Crown allotments 86 and 87, Parish of Scoresby, County of Mornington, for Forest purposes, \$375.00.—Hugh H. Craig.

Approved by Governor in Council, 12th December, 1967.—J. ROSSITER, Clerk of the Executive Council.

Drainage Areas Act.

SPECIAL MAINTENANCE CHARGE MADE BY THE COUNCIL OF THE SHIRE OF WARRNAMBOOL IN RESPECT OF THE NULLAWARRE DRAINAGE AREA.

NOTICE is hereby given that on the sixteenth day of January, 1968, in accordance with the provisions of Section 36 of the Drainage Areas Act 1958, the Governor in Council approved of the estimate of the cost of proposed maintenance works in the Nullawarre Drainage Area submitted by the Council of the Shire of Warrnambool, and of the making by the Council of a Special Maintenance Charge on properties within the said Drainage Area, for the year ending 30th September, 1968.

F. R. KENNY,
Acting Clerk of the Executive Council.

At the Executive Council Chamber,
Melbourne, 16th January, 1968.

SHIRE OF ARARAT.
ROAD DEVIATION ORDER.

PURSUANT to the provisions of Sections 522 and 526 of the Local Government Act 1958 the Council of the Shire of Ararat hereby directs that the land in the Parish of Colvinsby indicated by hatching on the diagram hereunder which has been purchased taken or acquired by it shall be a public highway on and from the date of publication of this Order in the Government Gazette and declares that such land shall be a public highway in lieu of the land indicated by cross hatching on the said diagram.

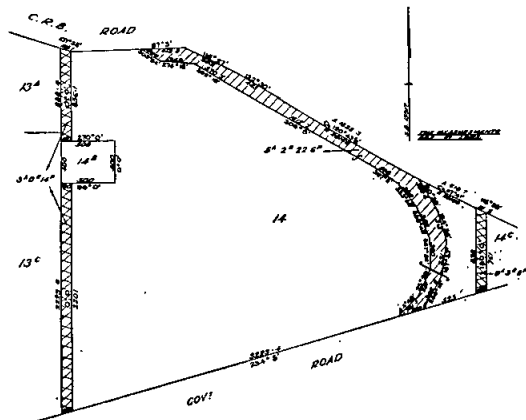

The common seal of the President, Councillors and Ratepayers of the Shire of Ararat was hereto affixed, this 17th day of October, 1967, in the presence of—

(SEAL) THOMAS FORD, President.
J. K. PICKFORD, Councillor.
K. N. BISHOP, Secretary.

Approved by the Governor in Council, 16th January, 1968.—F. R. KENNY, Acting Clerk of the Executive Council.

THE BALLARAT SEWERAGE AUTHORITY.

RATING BY-LAW NO. 47.

The Ballarat Sewerage District.

THE Ballarat Sewerage Authority, in pursuance and exercise of the powers conferred by the Sewerage Districts Act, doth hereby make the following By-law:—

The following Sewerage Rate is hereby made under the provisions of the Sewerage Districts Act, and shall be levied upon the nett annual value of all rateable sewered properties within the Ballarat Sewerage District:—

- (1) Of any land or tenements situate within the Ballarat Sewerage District, a sewerage rate of 4.2 cents in the dollar of the nett annual value of all rateable "sewered property" within the said District.
- (2) In no case shall the amount of sewerage rate payable annually be less than Eight dollars in respect of any rateable sewered property.
- (3) Such rate is made and shall be levied for the year beginning with the First day of January, 1968 and ending with the Thirty-first day of December, 1968 and shall be payable on the Thirty-first day of March, 1968, at the office of the Authority, situate at the Water and Sewerage Offices, Ballarat.
- (4) If any rateable property which is unsewered at the time of the making of the aforesaid rate becomes during the year 1968 a "sewered property", there shall be levied upon such property a proportionate part of the sewerage rate for the portion of the year after it has become a sewered property, and such property shall be deemed to have been lawfully rated accordingly.
- (5) For making and levying such rate the valuation for the time being of such lands and tenements for the municipal rate of the municipality in the municipal district of which such lands and tenements are situate shall be deemed and taken to be the valuation of such lands and tenements respectively; but if any such lands and tenements are not included in a valuation in force for the municipality in whose district they are situate, or if there is no such valuation, the nett annual value thereof may for all purposes of such rate be determined in the manner provided in the Sewerage Districts Act.
- (6) Such person or persons as The Ballarat Sewerage Authority may from time to time appoint for that purpose shall be and is or are hereby authorised to demand, receive, collect and recover the said rate and charges.

The resolution for passing the foregoing By-law was agreed to by The Ballarat Sewerage Authority on the Sixteenth day of November, 1967, and was confirmed by the said Authority on the Fourteenth day of December, 1967.

The common seal of the Ballarat Sewerage Authority was affixed hereto, on the Fourteenth day of December, 1967—

(SEAL) ARTHUR W. NICHOLSON, Chairman.
WILLIAM E. ROFF, Member.
CHAS. H. CLAMP, Secretary.

Approved by the Governor in Council, 16th January, 1968.—F. R. KENNY, Acting Clerk of the Executive Council.

MARYSVILLE WATERWORKS TRUST.

RATING BY-LAW FOR THE YEAR 1968.

THE Marysville Waterworks Trust, in pursuance and exercise of the powers conferred by the Water Acts, doth hereby make a rate for the supply of water for domestic purposes of Seven and one half cents in the dollar on the net annual valuation of lands and tenements liable to be rated within the Marysville Urban District, provided that in no case shall the amount payable per annum in respect of any tenement (other than land on which there is no building) be less than Two dollars and in respect of land on which there is no building less than One dollar.

Such rates are made and shall be levied upon the occupiers or owners of the said lands and tenements for the year commencing on the 1st day of January, 1968, and shall be payable on the 31st day of May, 1968, at the office of the said Trust.

The maximum quantity of water to be supplied in any one year without further charge to any property rated by the Trust is hereby fixed at the quantity which, at a charge of Ten cents per 1,000 gallons, would produce an amount equal to the amount of rate levied on such property for the said year.

The charge for water supplied by measure to any property rated by the Trust in excess of such maximum quantity, computed as in the last preceding clause, is hereby fixed at Ten cents per 1,000 gallons.

The charge for water supplied by measure to any property not rated by the Trust is hereby fixed at Ten cents per 1,000 gallons.

The charge for water supplied by measure shall be payable, on demand, at the office of the Trust.

Passed on 15th day of December, 1967.

(SEAL) J. A. GRIEVE, Chairman.
F. G. COBB, Secretary.

Approved, 11th January, 1968.—W. BORTHWICK, Minister of Water Supply.

MALMSBURY WATERWORKS TRUST.

RATING BY-LAW FOR THE YEAR 1968.

THE Malmsbury Waterworks Trust, in pursuance and exercise of the powers conferred by the Water Act, doth hereby make a rate for the supply of water for domestic purposes of eight cents (8c) in the Dollar (\$1) on the annual municipal valuation of lands and tenements liable to be rated within the Malmsbury Waterworks Trust Urban District.

Provided that in no case shall the amount of rate payable per annum of any tenements (other than land on which there is no building) be less than Ten dollars (\$10.00) and in respect of any land on which there is no building be less than Four dollars (\$4.00).

Such rates are made and shall be levied upon the occupiers or owners of the said lands and tenements for the year commencing the 1st day of January, 1968, and shall be due and payable on the 13th day of February, 1968 at the Office of the said Trust.

The maximum quantity of water to be supplied in any one year without further charge to any property rated by the Trust is hereby fixed at the quantity which, at a charge of Twenty cents (20c) per 1,000 gallons, would produce an amount equal to the amount of rate levied on such property for the said year.

The charge for water to be supplied by measure to any property rated by the Trust in excess of such maximum quantity computed as in the last preceding clause is hereby fixed at Twenty cents (20c) per 1,000 gallons.

The charge for water supplied by measure shall be payable on demand at the Office of the Trust.

Passed this 9th day of January, 1968.

(SEAL) F. LYNCH, Chairman.
S. G. PORTER, Secretary.

Approved, 12th January, 1968.—W. BORTHWICK, Minister of Water Supply.

HURSTBRIDGE WATERWORKS TRUST.

PROCLAMATION OF URBAN DISTRICT AT KANGAROO GROUND. By His Excellency the Governor of the State of Victoria and its Dependencies in the Commonwealth of Australia, &c., &c., &c.

UNDER the powers conferred by the Water Act and all other powers enabling him in that behalf, I, the Governor of the State of Victoria, in the Commonwealth of Australia, by and with the advice of the Executive Council of the said State, doth hereby proclaim that on and from the date hereof the portion of the Waterworks District of the Hurstbridge Waterworks Trust as shown on a plan deposited in the office of the State Rivers and Water Supply Commission, Melbourne (Corr. No. 1959/7459/159) shall be and become an Urban District for the purposes of and within the meaning of the said Act and shall be known as the Kangaroo Ground Urban District.

Given under my Hand and the Seal of the State of Victoria aforesaid, at Melbourne this 23rd day of January, in the year of our Lord One thousand nine hundred and sixty-eight, and in the sixteenth year of the reign of Her Majesty Queen Elizabeth II.

(L.S.) ROHAN DELACOMBE.

By His Excellency's Command,

W. BORTHWICK,
Minister of Water Supply.

GOD SAVE THE QUEEN!

AVOCA RIVER IMPROVEMENT TRUST.

RATING BY-LAW FOR YEAR, 1968.

THE Avoca River Improvement Trust, in pursuance and exercise of the powers conferred by the River Improvement Act 1958, doth hereby make the By-law following:—

1. The following rate, to be called the "Avoca River Improvement District Rate" is hereby made and shall be levied upon the occupiers or owners of all properties within the Avoca River Improvement District which are rateable to any municipality:—

A rate of eight tenths of a cent in the dollar on the net annual value of all properties in the First Division being those properties uncoloured on the plan of the Avoca River Improvement District, titled the "Avoca River Improvement District Rating Divisions 1968" approved by the Governor in Council and lodged at the office of the State Rivers & Water Supply Commission at Melbourne. Provided that the sum of fifty cents shall be the minimum amount payable in respect of any property liable to be rated in the said division.

No rate on all properties in the Second Division being those properties coloured red on the said Plan.

2. Such rates are made and shall be levied for the period beginning on the 1st day of January, 1968, and ending on the 31st day of December, 1968 and shall be payable on the 1st day of March, 1968 at the office of the Avoca River Improvement Trust, Kerang.

3. Such person or persons as the Avoca River Improvement Trust may from time to time appoint for the purpose shall be and is or are hereby authorised to demand, receive, collect and recover the said rate.

The foregoing By-law was made by the Avoca River Improvement Trust on the 21st day of December, 1967, and the common seal of the said Trust was hereunto affixed this 21st day of December, 1967, in the presence of—

(SEAL) D. R. MCFARLANE, Chairman.
E. F. DOYLE, Commissioner.
L. R. RUNDLE, Secretary.

Approved by the Governor in Council, 23rd January, 1968.—F. R. KENNY, Acting Clerk of the Executive Council.

YARRA JUNCTION WATERWORKS TRUST.

BY-LAW.

THE Yarra Junction Waterworks Trust (hereinafter referred to as the Trust) in pursuance and exercise of the powers conferred by the Water Act 1958, doth hereby make the By-law following restricting the use for other than domestic purposes of water supplied by the said Trust within the Yarra Junction and Wesburn Urban Districts.

1. This By-law shall come into operation at such time and in such Districts or parts of Districts (hereinafter referred to as the specified area) as the Trust from time to time directs by notice published in a newspaper circulating generally within the Districts and cease to have operation at such time as the Trust from time to time directs by a notice so published.

2. Subject to the provisions of Clause 3 of this By-law no person shall with water supplied by the Trust,

A. Water with fixed sprinklers or a hose any garden, lawn, or other land (other than commercial nurseries or land used for the growing of green feed for commercial poultry farms) within the specified area except between the hours of 7 a.m. and 9 a.m. and between the hours of 6 p.m. and 8 p.m. of each day.

B. Fill, add to or cleanse any private swimming pool within the specified area.

C. Hose down, any motor vehicle, footpath or roof within the specified area except between the hours of 7 a.m. and 9 a.m. and between the hours of 6 p.m. and 8 p.m. of each day.

3. No person shall with water supplied by the Trust, water any land comprising any sports grounds, golf courses, racecourses, public and club bowling and croquet greens and public and club tennis courts within the specified area by means of fixed sprinklers except between the hours of 7 p.m. and 12 midnight of each day.

4. Every person who uses or permits or suffers water supplied by the Trust to be used contrary to the provisions of this By-law shall be guilty of an offence and shall be liable to a penalty not exceeding One Hundred Dollars.

5. If any person supplied with water by the Trust wrongfully does or causes or permits to be done anything in contravention of this By-law the Trust may (without prejudice to any remedy in respect thereof) close or cut off any of the pipes by or through which water is supplied to him or for his use and may cease to supply him with water as provided by the *Water Act 1958*.

The foregoing By-law was made by the Yarra Junction Waterworks Trust on the 21st day of November, 1967, and the common seal of the said Trust was hereunto affixed on the 21st November, 1967, in the presence of—

(SEAL) A. PINDER, Commissioner.
F. DAVENPORT, Commissioner.
H. R. MITCHELL, Commissioner.
A. GLEESON, Secretary.

Approved by the Governor in Council, 23rd January, 1968.—F. R. KENNY, Acting Clerk of the Executive Council.

WALWA WATERWORKS TRUST.

AUTHORITY TO OBTAIN BANK OVERDRAFT.

HIS Excellency the Governor of the State of Victoria, by and with the advice of the Executive Council thereof, doth by Order made on the 23rd day of January, 1968, authorize the Walwa Waterworks Trust to obtain in pursuance of the provisions of section 286 of the *Water Act 1958* (No. 6413) an advance or advances during the year 1968, from the Australia and New Zealand Bank Ltd., Walwa, by overdraft of the Trust's current account thereat such overdraft not to exceed at any one time the sum of Two thousand dollars (\$2,000).

F. R. KENNY,
Acting Clerk of the Executive Council.

At the Executive Council Chamber,
Melbourne, 23rd January, 1968.

CUDGEWA WATERWORKS TRUST.

AUTHORITY TO OBTAIN BANK OVERDRAFT.

HIS Excellency the Governor of the State of Victoria, by and with the advice of the Executive Council thereof, doth by Order made on the 23rd day of January, 1968, authorize the Cudgewa Waterworks Trust to obtain in pursuance of the provisions of section 286 of the *Water Act 1958* (No. 6413) an advance or advances during the year 1968, from the Australia and New Zealand Bank Limited, Corryong by overdraft of the Trust's current account thereat, such overdraft not to exceed at any one time the sum of One thousand dollars (\$1,000).

F. R. KENNY,
Acting Clerk of the Executive Council.

At the Executive Council Chamber,
Melbourne, 23rd January, 1968.

APPOINTMENTS AND RESIGNATIONS

APPOINTMENTS.

HIS Excellency the Governor of the State of Victoria, by and with the advice of the Executive Council thereof, has, by Orders made on the 16th day of January, 1968, been pleased to make the under-mentioned appointments, viz.:—

CHIEF SECRETARY'S DEPARTMENT.

Electoral Registrars (Acting).

THOMAS MICHAEL O'DEA
to be Electoral Registrar (Acting) for the Koo-Wee-Rup, Korumburra, Loch, Pakenham and Wonthaggi Subdivisions of the Electoral District of Gippsland West; the Morwell and Yallourn Subdivisions of the Electoral District of Morwell; and for the Drouin, Neerim South, Newborough, Trafalgar, Warragul and Warragul North Subdivisions of the Electoral District of Narracan, to take effect on and from the 8th January, 1968, during the absence on leave of John Ronald Geoffrey Hayes;

RAYMOND ALPHONSUS MCINNES
to be Electoral Registrar (Acting) for the Bairnsdale, Bruthen, Lindenow, Lucknow, Maffra, Omeo and Orbost Subdivisions of the Electoral District of Gippsland East; the Foster, Leongatha, Rosedale, Sale, Stratford and Yarram Subdivisions of the Electoral District of Gippsland South; and the Mirboo North, Toongabbie, Traralgon and Walhalla Subdivisions of the Electoral District of Morwell, to take effect on and from the 22nd January, 1968, during the absence on leave of John Henry Page; and

JAMES THOMAS MCALLEN
to be Electoral Registrar (Acting) for the Pascoe Vale South Subdivision of the Electoral District of Brunswick West; the Pascoe Vale Subdivision of the Electoral District of Coburg; the Essendon and Essendon North Subdivisions of the Electoral District of Essendon; and for the Essendon West and Moonee Ponds Subdivisions of the Electoral District of Moonee Ponds, to take effect on and from the 22nd January, 1968, during the absence on leave of Oliver Hugh Robinson.

Governor of Training Prison.

ALEXANDER RYMER LAND,
pursuant to the provisions of the *Goals Act 1958*, to be Governor of Her Majesty's Training Prison, Geelong, from and inclusive of the 17th November, 1967.

Governor of Prison (Acting).

GEORGE JAMES LESLIE ARMSTRONG,
pursuant to the provisions of the *Goals Act 1958*, to be Governor (Acting) of Her Majesty's Prison, Ararat, from the 13th January, 1968, to the 4th February, 1968, during the absence on leave of Daniel Martin Kearney.

Governor of Rehabilitation Centre (Acting).

LAURENCE WILLIAM JENSEN,
pursuant to the provisions of the *Goals Act 1958*, to be Governor (Acting) of Dhurringile Rehabilitation Centre, from the 22nd December, 1967, to the 4th January, 1968, during the absence on leave of William Gould Bell.

Honorary Probation Officers.

ROBIN JAMES CHAPMAN, 72 Grafton-road, Warmambool,
WILLIAM ROBERT COLEMAN, "Windalea", Southern Cross, via Koroit,
FRANCIS ALBERT MCGREGOR (the Reverend), 22 Carrington-street, Robinvale,
MARK DOUGLAS ROLLS, 17 Kitchener-street, Trafalgar,
ELIZABETH CATHERINE BLEGG (Mrs.) (Salvation Army Officer), 4 Wimmera-street, Stawell,
MARGARET COATES BROWNING (Mrs.), "Riverslea", Box 43, Yarrawonga,
VALERIE GILLES CROMIE (Mrs.), 95 Wellington-street, Kew,
SUSAN CURWOOD (Mrs.), Flat 3, 127 Devonshire-road, Sunshine,
ELIZABETH MAITLAND McDONALD (Mrs.), Lorne-road, Winchelsea,
AALTJE CORNELIA WIERENGA (Mrs.), 20 Epping-street, Kyneton, Victoria, and
KATHLEEN SARA COBERT (Mrs.), Wayside Delivery, Nhill,
pursuant to the provisions of section 507 (2) of the *Crimes Act 1958*, to be Honorary Probation Officers for all Adult Courts in Victoria; and

THOMAS PETER GUTHRIE, "Warrawidge", Linton,
JOHN PATRICK NOONAN, Nazareth House, Cornell-street, Camberwell,

ANTHONY PATRICK O'HURLEY, P.O. Box 12 (Albert-street), Warmambool,
WILLIAM ERIC PLANT, 1 Aster-court, Mount Waverley, and

JOHN POON (the Reverend), Tyers-street, Stratford,
pursuant to the provisions of section 10 (1) of the *Children's Court Act 1958*, to be Honorary Probation Officers for all Children's Courts in Victoria.

Trustee of the National Museum of Victoria.

HENRY BEAUFORT SOMERSET, C.B.E., M.Sc.,
pursuant to the provisions of the *State Library National Gallery National Museum and Institute of Applied Science Act 1960*, to be a Trustee of the National Museum of Victoria, for the period ending the 15th March, 1969.

Deputy Member of the Police Service Board.

JOHN GERRARD LYONS,
pursuant to the provisions of section 77 of the *Police Regulation Act 1958*, to be and act as deputy of Duncan Stormont Ramage, appointed member of the Police Service Board from the date hereof, during the period of absence on leave of the said Duncan Stormont Ramage.

MINISTRY OF HEALTH.

Members of Committees of Management of Hospitals.

ARTHUR MACDONALD RICE
to be a Member of the Committee of Management of the Maffra District Hospital, pursuant to proviso (a) to section 48 (1) of the *Hospitals and Charities Act 1958*, for a further period of three years ending 31st January, 1971;

JOHN COBELL HABERSBERGER
to be a Member of the Committee of Management of the Alfred Hospital, pursuant to proviso (a) to section 48 (1) of the *Hospitals and Charities Act 1958*, for a period of three years; and

ROBERT STEWART DONALD
to be a Member of the Committee of Management of the Casterton Memorial Hospital, pursuant to proviso (a) to section 48 (1) of the *Hospitals and Charities Act 1958*, for a period of three years ending 10th February, 1971.

Trustees of Public Cemeteries.

LAWRENCE ROBERT KELLAS
to be a Trustee of the Trafalgar Public Cemetery, vice A. Sim, deceased;

JOHN JOYCE
to be a Trustee of the Ararat Public Cemetery, vice J. Davis, deceased;

SJOERD BOONSTRA,
JOHN PERCIVAL BARRETT,
SIMON LEENOERT VAREKAMP,
WILLIAM JOHN WHITE, and
ERIC SYLVESTER TABUTEAU,
to be Trustees of the Moe Public Cemetery, vice J. Shelton, G. Povell, C. Plant, T. Heatley, and G. McDonald, resigned;

WILLIAM EDGAR MALLOY
to be a Trustee of the Mooroopna Public Cemetery, vice M. O'Brien, deceased; and

FRANCIS REGINALD MCCAULEY
to be a Trustee of the Moorngag Public Cemetery, vice D. Ginnivan, resigned.

LAW DEPARTMENT.

Commissioners for Taking Declarations, &c.

EDWARD GEORGE ATKINSON, 22 Argyle-street, Mildura,
THOMAS GLADSTONE MARTIN, 131 Pasadena-grove,
Mildura,
GEOFFREY GORDON SIVERSEN, 1 Crellin-grove, Camberwell, and
MONA MAY FARRELL, 10 McKenzie-street, Belmont,
Geelong,
to be Commissioners for taking Declarations and Affidavits, pursuant to the provisions of the *Evidence Act 1958*, to resign upon removing from the neighbourhood of the addresses stated;

ARTHUR JAMES ROBBINS, care of Berg, Coleman, Morris and Associates, Public Accountants, 325 Collins-street, Melbourne, and
NOEL HERBERT WOODVINE, care of Houghton & Byrne (Vic.) Pty. Ltd., 22-28 Nicholson-street, East Brunswick,

to be Commissioners for taking Declarations and Affidavits, pursuant to the provisions of the *Evidence Act 1958*, to resign upon ceasing to occupy their present positions; and

ARTHUR WALTER HENRY EASTON, care of Office of Titles, 285 Queen-street, Melbourne,
to be a Commissioner for taking Declarations and Affidavits, pursuant to the provisions of the *Evidence Act 1958*, to refrain from charging fees and to resign upon ceasing to occupy his present position.

Judge's Associate.

BASIL SPENCER SIMS
to be Associate to His Honour Judge Harris, to take effect from the date of commencement of duty.

Prothonotary (Acting).

BRYAN MAURICE HICKEY
to act as Prothonotary of the Supreme Court of Victoria during the absence of A. J. T. Payne, on annual leave, to take effect from the date of commencement of duty.

DEPARTMENT OF THE TREASURER.

Collector of Imposts (Acting).

HENRY WALKER THOMPSON
to act temporarily as Collector of Imposts, Police Department, vice G. A. Moon, on recreation leave.

Receiver of Revenue (Acting).

THOMAS CHARLES WARD
to act temporarily as Receiver of Revenue, State Land Tax and Probate Duties Office, vice I. M. Green, on recreation leave.

DEPARTMENT OF WATER SUPPLY.

Improvement Trust Commissioner.

JOHN EDWIN CONNOLLY
to be a Commissioner of the Avon River Improvement Trust for a period of four years from the date hereof, subject to the provisions of the *River Improvement Act 1958*.

Sewerage Authority Member.

CLARENCE ROBERT DAVIS
to be a Member of the Casterton Sewerage Authority, to hold office as such, subject to the provisions of the *Sewerage Districts Act*, from the date hereof until 30th January, 1971.

Waterworks Trust Commissioner.

WALTER CONRAD SCHUBERT
to be a Commissioner of the Wurruk Waterworks Trust for a period of four years from the date hereof, subject to the provisions of the *Water Act 1958*.

F. R. KENNY,
Acting Clerk of the Executive Council.

At the Executive Council Chamber,
Melbourne, 16th January, 1968.

RESIGNATIONS.

HIS Excellency the Governor of the State of Victoria, by and with the advice of the Executive Council thereof, has, by Orders made on the 16th day of January, 1968, accepted the resignations of the persons named hereunder of the offices mentioned, viz.:—

CHIEF SECRETARY'S DEPARTMENT.

Licensing Inspector.

P. D. COLLINS, Chief Inspector, a Licensing Inspector for the purposes of the *Licensing Act 1958*, from the 7th December, 1967.

LAW DEPARTMENT.

Judges Associates.

PHILIP WAYNE ALLEN, as Associate to His Honour Judge Harris, to take effect from and including the 22nd January, 1968; and
BASIL SPENCER SIMS, as Associate to His Honour Mr. Justice McInerney, to take effect from midnight on the 31st January, 1968.

Justice of the Peace.

JOHN GLEESON, from the Commission of the Peace for the Western Bailiwick of the State of Victoria.

F. R. KENNY,
Acting Clerk of the Executive Council.

At the Executive Council Chamber,
Melbourne, 16th January, 1968.

ORDERS IN COUNCIL

LICENSING ACT 1958.

At the Executive Council Chamber, Melbourne, the sixteenth day of January, 1968.

PRESENT:

His Excellency the Governor of Victoria.
Sir William McDonald | Mr. Dickie.

EXTENSION OF THE ANNUAL SITTING OF THE VICTORIAN LICENSING COURT.

IN PURSUANCE of the powers conferred by the *Licensing Act 1958*, His Excellency the Governor of the State of Victoria, in the Commonwealth of Australia, by and with the advice of the Executive Council of the said State, doth by this Order extend the time for holding the Annual Sitting of the Victorian Licensing Court for the Licensing Areas set out in the Schedule hereunder to a date not later than 29th February, 1968—

SCHEDULE.

Geelong
Bairnsdale
Hamilton
Warrnambool
Bendigo
Mildura

And the Honorable Arthur Gordon Rylah, Her Majesty's Chief Secretary for the State of Victoria, shall give the necessary directions herein accordingly.

F. R. KENNY,
Acting Clerk of the Executive Council.

COUNTRY ROADS BOARD.

At the Executive Council Chamber, Melbourne, the sixteenth day of January, 1968.

PRESENT:

His Excellency the Governor of Victoria. Sir William McDonald | Mr. Dickie.

ORDER CONFIRMING RESOLUTIONS OF THE COUNTRY ROADS BOARD.

HIS Excellency the Governor of the State of Victoria, by and with the advice of the Executive Council thereof, doth hereby, in pursuance of the provisions of the Country Roads Act 1958, confirm the resolutions of the Country Roads Board, the dates whereof and the terms of which are scheduled hereunder:—

SCHEDULE.

State highways.

Resolution dated the Eighth day of January, One Thousand Nine Hundred and Sixty-eight, made pursuant to Sections 21 and 74 of the Country Roads Act 1958 declaring the widening of the Western Highway in the Shire of Bacchus Marsh as shown hatched on Plan numbered G.P. 10547 hereunder to be part of a State highway within the meaning and for the purposes of the said Act.

STATE HIGHWAY WESTERN HIGHWAY SHIRE OF BACCHUS MARSH Measurements in links

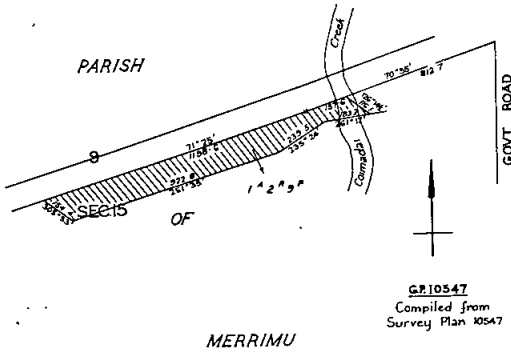

G.P. 10547 Compiled from Survey Plan 10547

Resolution dated the Eighth day of January, One Thousand Nine Hundred and Sixty-eight, made pursuant to Sections 21 and 74 of the Country Roads Act 1958 declaring the widening of the Princes Highway in the Shire of Berwick as shown hatched on Plan numbered G.P. 7209 hereunder to be part of a State highway within the meaning and for the purposes of the said Act.

STATE HIGHWAY PRINCES HIGHWAY SHIRE OF BERWICK Measurements in links

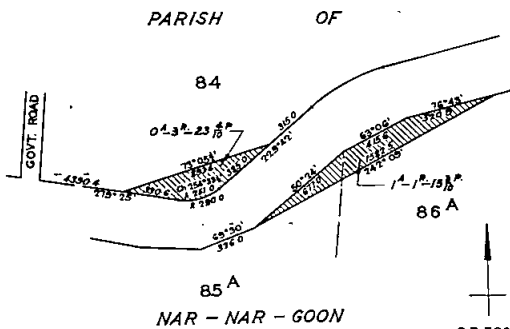

G.P. 7209 Compiled from Survey Plan 7209

Resolution dated the Eighth day of January, One Thousand Nine Hundred and Sixty-eight, made pursuant to Sections 21 and 74 of the Country Roads Act 1958 declaring the widening of the Glenelg Highway in the Shire of Grenville as shown hatched on Plan numbered G.P. 8128 to be part of a State highway within the meaning and for the purposes of the said Act.

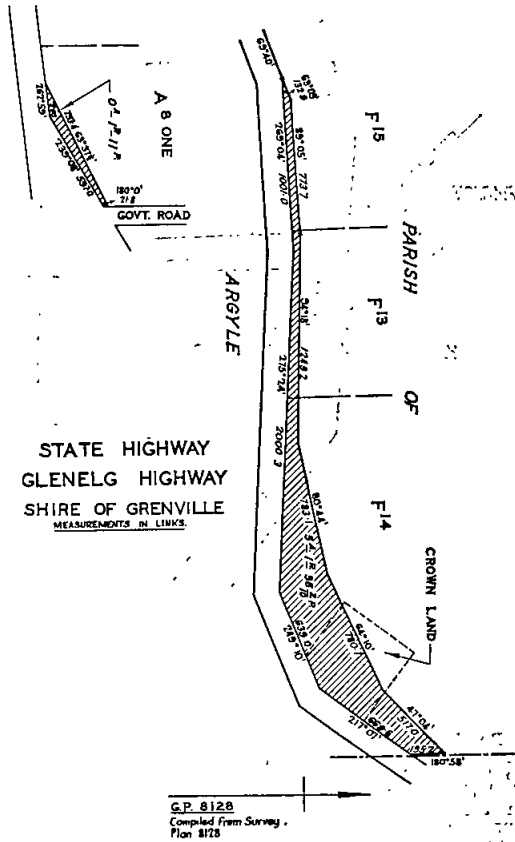

G.P. 8128 Compiled from Survey Plan 8128

Resolution dated the Eighth day of January, One Thousand Nine Hundred and Sixty-eight, made pursuant to Sections 21 and 74 of the Country Roads Act 1958 declaring the widening of the Northern Highway in the Shire of Kilmore as shown hatched on Plan numbered G.P. 10510 hereunder to be part of a State highway within the meaning and for the purposes of the said Act.

STATE HIGHWAY NORTHERN HIGHWAY SHIRE OF KILMORE Measurements in links

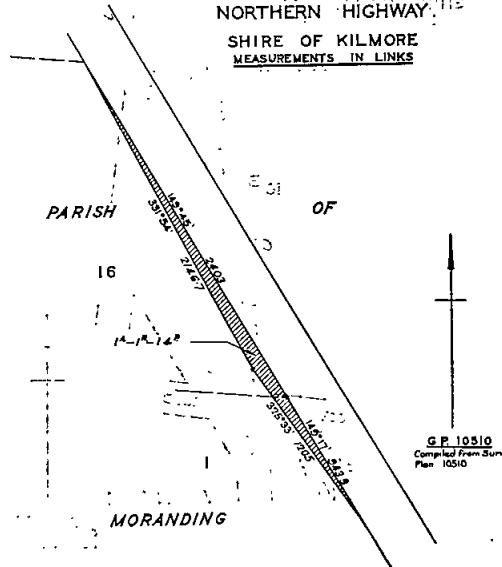

G.P. 10510 Compiled from Survey Plan 10510

Resolution dated the Third day of January, One Thousand Nine Hundred and Sixty-eight, made pursuant to Sections 21 and 74 of the Country Roads Act 1958 declaring the widening of the Omeo Highway in the Shire of Towong as shown hatched on Plan numbered G.P. 7752 hereunder to be part of a State highway within the meaning and for the purposes of the said Act.

STATE HIGHWAY
OMEO HIGHWAY
SHIRE OF TOWONG
Measurements in links

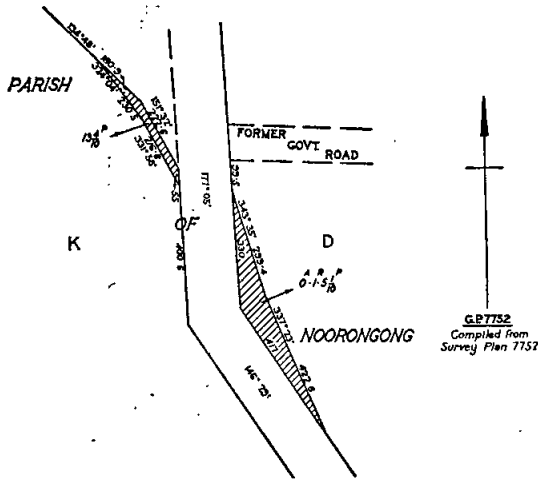

Resolution dated the Eighth day of January, One Thousand Nine Hundred and Sixty-eight, made pursuant to Section 21 of the Country Roads Act 1958 declaring the widening of the Hamilton Road in the Shire of Belfast as shown hatched on Plan numbered G.P. 10455 hereunder to be part of a main road within the meaning and for the purposes of the said Act.

MAIN ROAD
HAMILTON ROAD
SHIRE OF BELFAST
Measurements in links

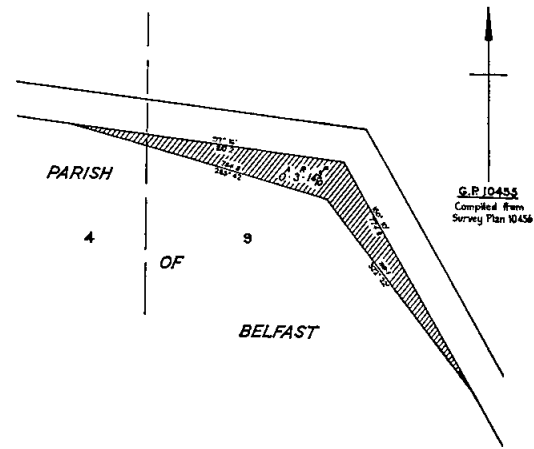

Resolution dated the Third day of January, One Thousand Nine Hundred and Sixty-eight, made pursuant to Sections 21 and 74 of the Country Roads Act 1958 declaring the widening of the South Gippsland Highway in the Shire of Woorayl as shown hatched on Plan numbered G.P. 8854 hereunder to be part of a State highway within the meaning and for the purposes of the said Act.

STATE HIGHWAY
SOUTH GIPPSLAND HIGHWAY
SHIRE OF WOORAYL
MEASUREMENTS IN LINKS.

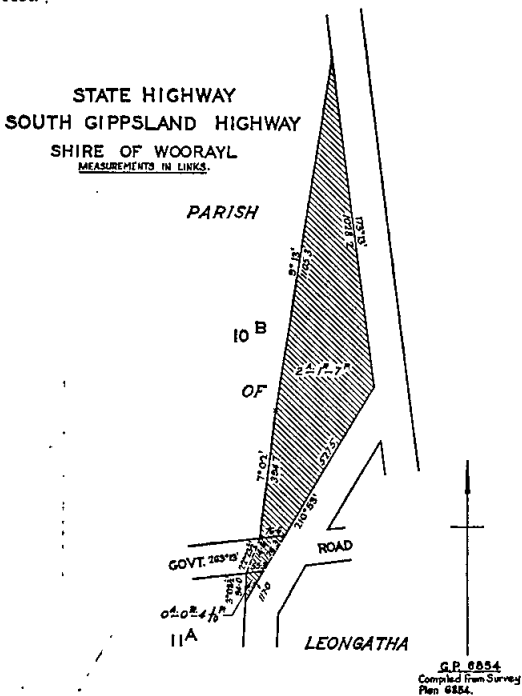

Resolution dated the Eighth day of January, One Thousand Nine Hundred and Sixty-eight, made pursuant to Section 21 of the Country Roads Act 1958 declaring the widening of the Benalla-Tatong Road in the Shire of Benalla as shown hatched on Plan numbered G.P. 10193 hereunder to be part of a main road within the meaning and for the purposes of the said Act.

MAIN ROAD
BENALLA - TATONG ROAD
SHIRE OF BENALLA
MEASUREMENTS IN LINKS

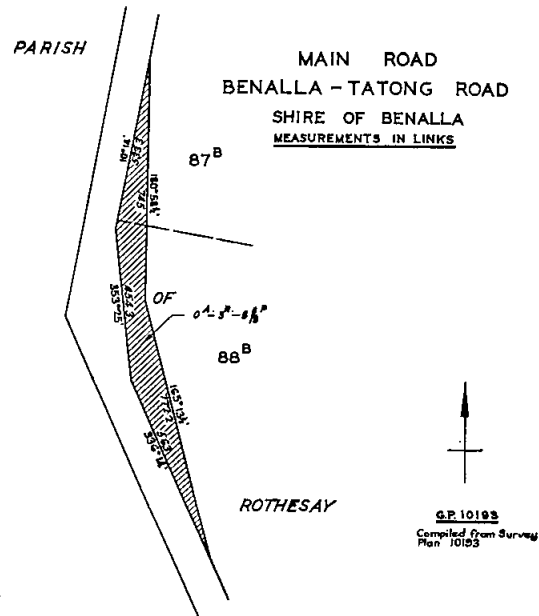

Resolution dated the Eighth day of January, One Thousand Nine Hundred and Sixty-eight, made pursuant to Section 21 of the *Country Roads Act 1958* declaring the widening of the Belgrave-Gembrook Road in the Shire of Berwick as shown hatched on Plan numbered G.P. 10513 hereunder to be part of a main road within the meaning and for the purposes of the said Act.

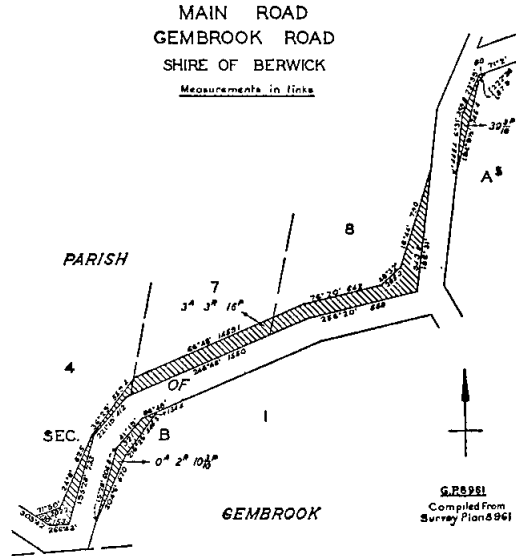
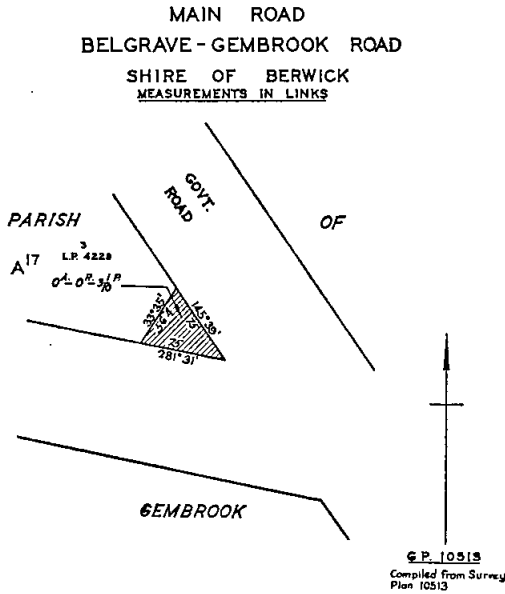

Resolution dated the Eighth day of January, One Thousand Nine Hundred and Sixty-eight, made pursuant to Section 21 of the *Country Roads Act 1958* declaring the widening of Gembrook Road in the Shire of Berwick as shown hatched on Plans numbered G.P. 8960 and G.P. 8961 hereunder to be part of a main road within the meaning and for the purposes of the said Act.

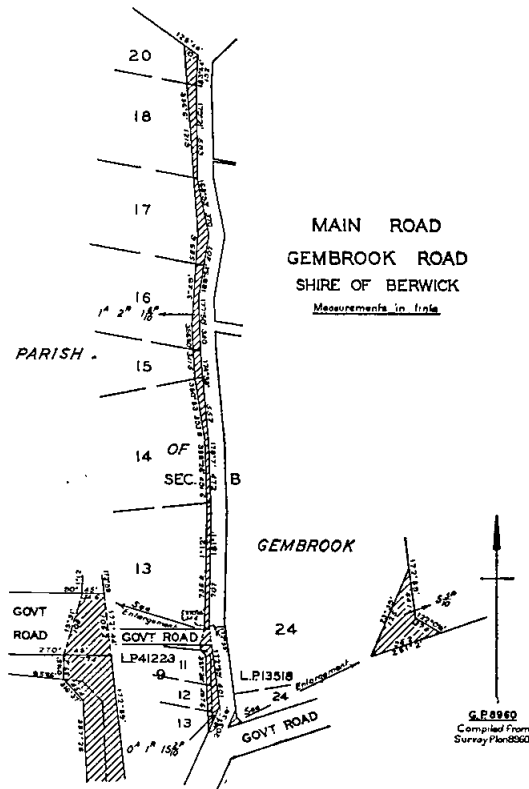

Resolution dated the Eighth day of January, One Thousand Nine Hundred and Sixty-eight, made pursuant to Section 21 of the *Country Roads Act 1958* declaring the widening of the Geelong-Ballan Road in Shire of Corio as shown hatched on Plan numbered G.P. 9762 hereunder to be part of a main road within the meaning and for the purposes of the said Act.

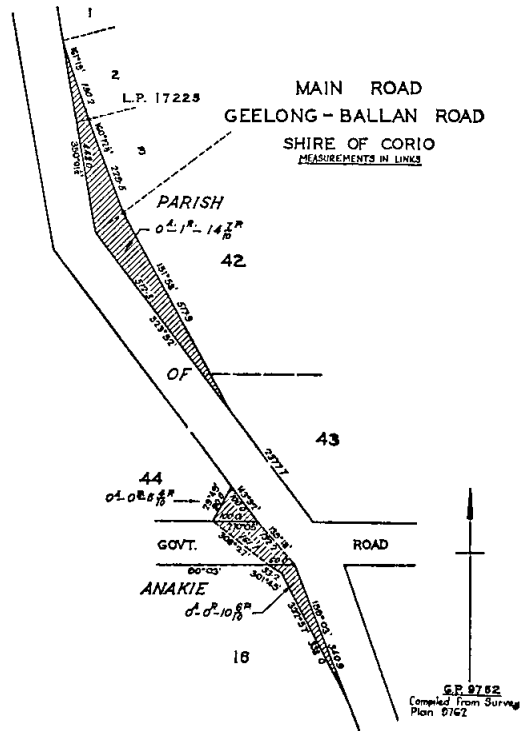

Resolution dated the Eighth day of January, One Thousand Nine Hundred and Sixty-eight, made pursuant to Section 21 of the *Country Roads Act 1958* declaring the widening of the Heathcote-Nagambie Road in the Shire of Goulburn as shown hatched on Plan numbered G.P. 10182 hereunder to be part of a main road within the meaning and for the purposes of the said Act.

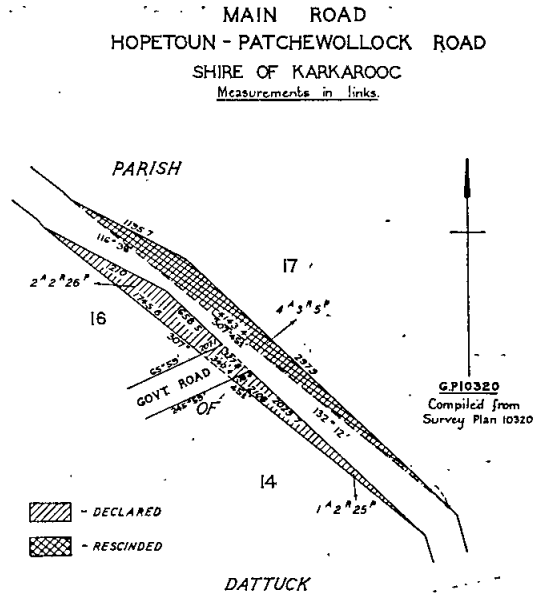
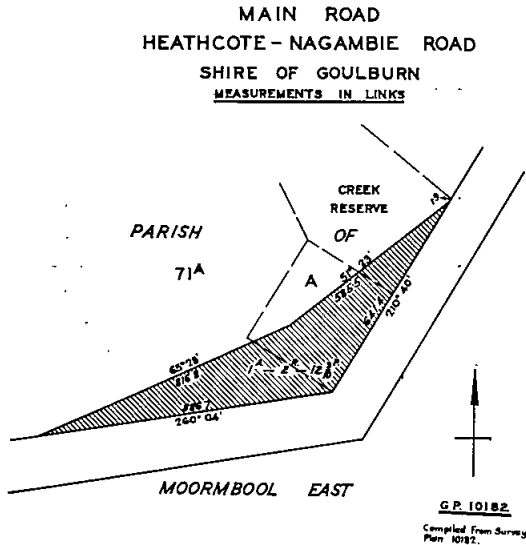

Resolution dated the Third day of January, One Thousand Nine Hundred and Sixty-eight, made pursuant to Sections 21 and 58 of the *Country Roads Act 1958* declaring the deviation from the Hopetoun-Patchewollock Road in the Shire of Karkaroc as indicated by diagonal hatching on Plans numbered G.P. 10319, G.P. 10320 and G.P. 10321 hereunder to be part of a main road within the meaning and for the purposes of the said Act and also declaring that such deviation shall be in lieu of the existing road or part thereof indicated by cross hatching on the said plans.

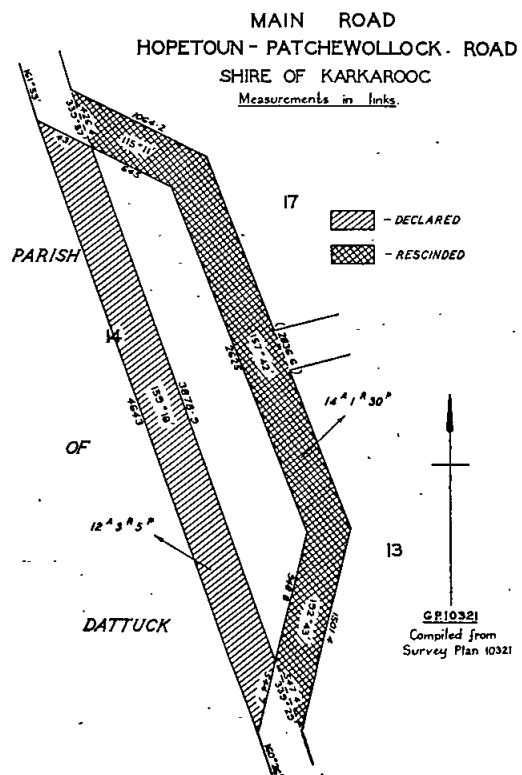
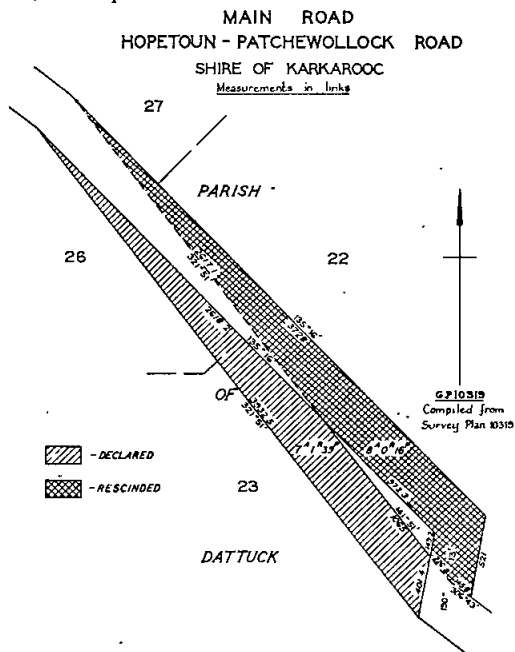

Resolution dated the Eighth day of January, One Thousand Nine Hundred and Sixty-eight, made pursuant to Section 21 of the *Country Roads Act 1958* declaring the widening of Murrabit Road in the Shire of Kerang as shown hatched on Plan numbered G.P. 8057 hereunder to be part of a main road within the meaning and for the purposes of the said Act.

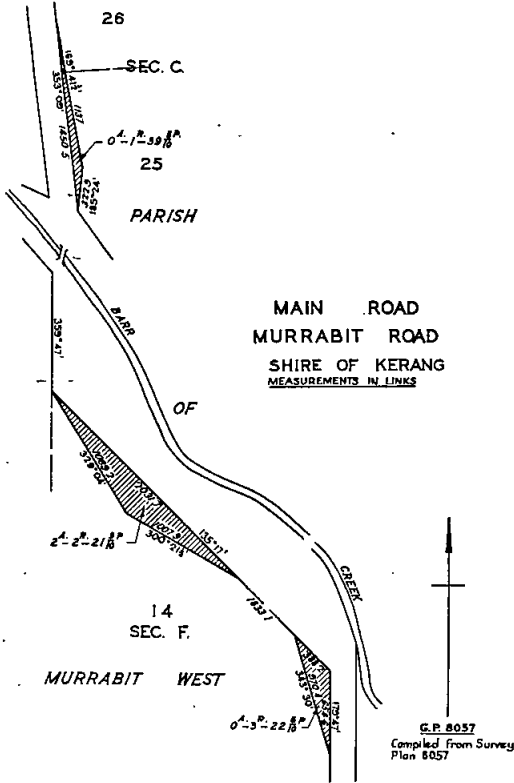

Resolution dated the Eighth day of January, One Thousand Nine Hundred and Sixty-eight, made pursuant to Section 21 of the *Country Roads Act 1958* declaring the widening of the Maffra-Newry Road in the Shire of Maffra as shown hatched on Plan numbered G.P. 8611 hereunder to be part of a main road within the meaning and for the purposes of the said Act.

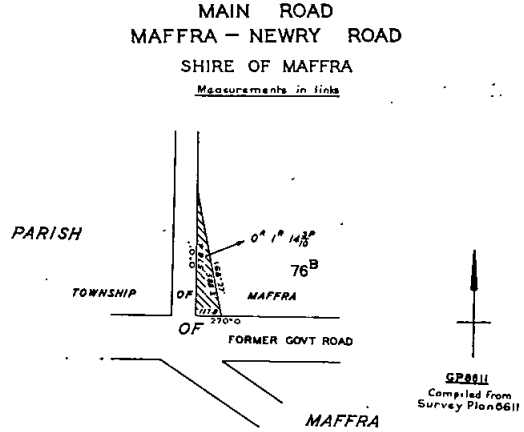

Resolution dated the Eighth day of January, One Thousand Nine Hundred and Sixty-eight, made pursuant to Section 21 of the *Country Roads Act 1958* declaring the widening of Balnarring Road in the Shire of Mornington as shown hatched on Plans numbered G.P. 7619 and G.P. 7620 hereunder to be part of a main road within the meaning and for the purposes of the said Act.

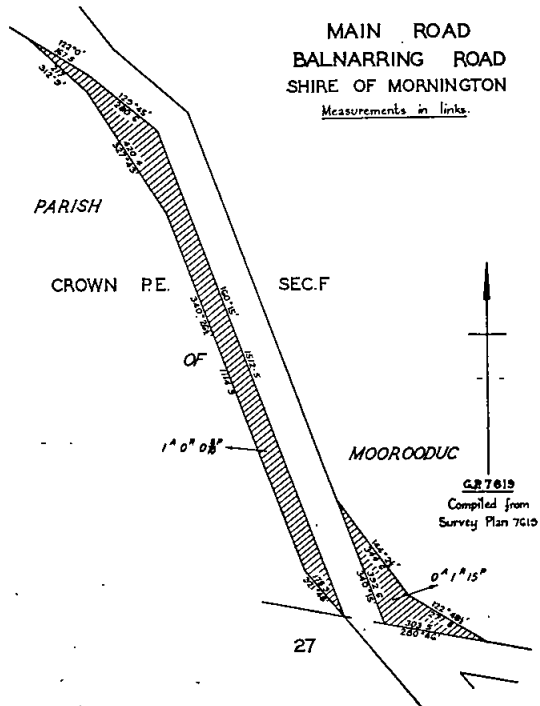

Resolution dated the Eighth day of January, One Thousand Nine Hundred and Sixty-eight, made pursuant to Section 21 of the *Country Roads Act 1958* declaring the widening of the St. Arnaud-Dunolly Road in the Shire of Korong as shown hatched on Plan numbered G.P. 9128 hereunder to be part of a main road within the meaning and for the purposes of the said Act.

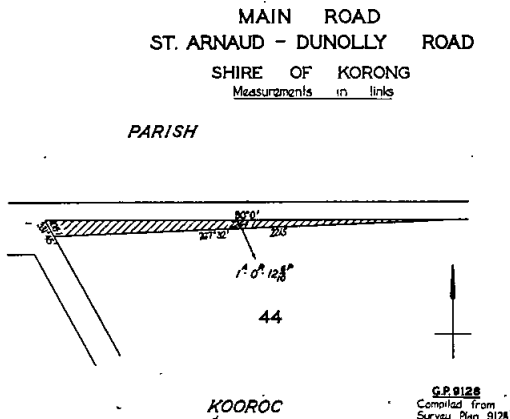

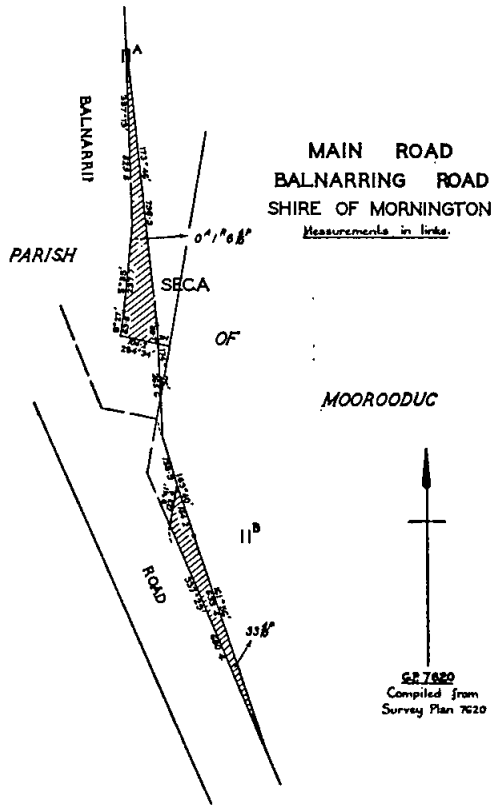

Resolution dated the Third day of January, One Thousand Nine Hundred and Sixty-eight, made pursuant to Section 21 of the Country Roads Act 1958 declaring the widening of Bright Road in the Shire of Oxley as shown hatched on Plan numbered G.P. 9884 hereunder to be part of a main road within the meaning and for the purposes of the said Act.

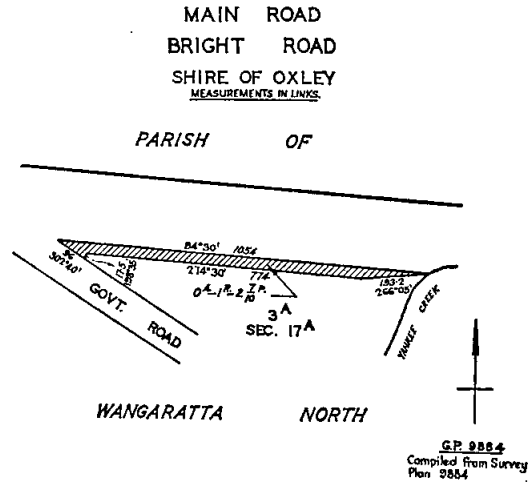

Resolution dated the Eighth day of January, One Thousand Nine Hundred and Sixty-eight, made pursuant to Sections 21 and 58 of the Country Roads Act 1958 declaring the deviation from Traralgon Creek Road in the Shire of Traralgon as indicated by diagonal hatching on Plan numbered G.P. 9607 hereunder to be part of a main road within the meaning and for the purposes of the said Act and also declaring that such deviation shall be in lieu of the existing road or part thereof indicated by horizontal hatching and cross hatching on the said plan which part indicated by cross hatching on the said plan shall be discontinued.

Resolution dated the Eighth day of January, One Thousand Nine Hundred and Sixty-eight, made pursuant to Section 21 of the Country Roads Act 1958 declaring the widening of Balnarring Road in the Shire of Mornington as shown hatched on Plan numbered G.P. 6018 hereunder to be part of a main road within the meaning and for the purposes of the said Act.

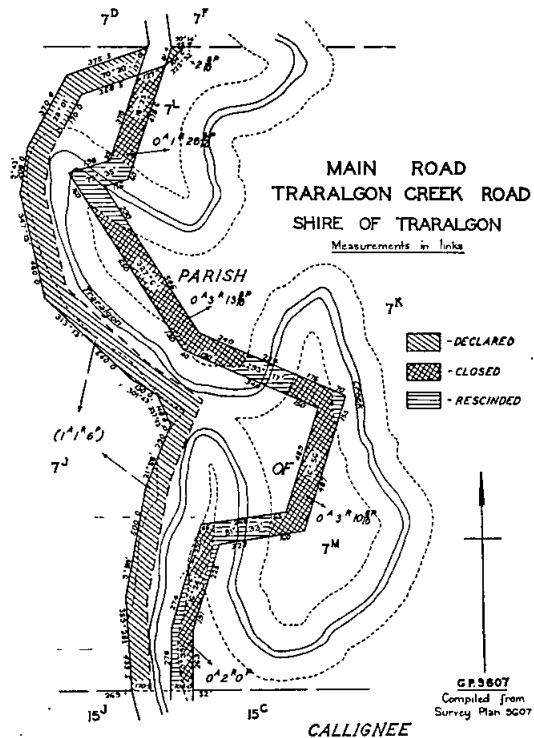
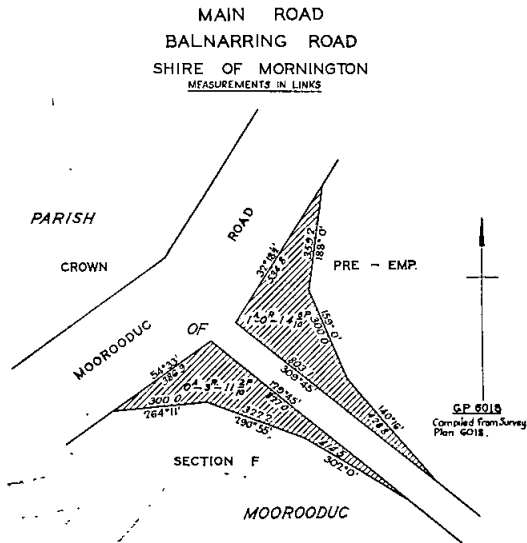

Resolution dated the Eighth day of January, One Thousand Nine Hundred and Sixty-eight, made pursuant to Sections 21 and 58 of the *Country Roads Act 1958* declaring the deviation from the Stawell-Pomonal Road in the Shire of Stawell as indicated by diagonal hatching on Plan numbered G.P. 10573 hereunder to be part of a main road within the meaning and for the purposes of the said Act and also declaring that such deviation shall be in lieu of the existing road or part thereof indicated by cross hatching on the said plan.

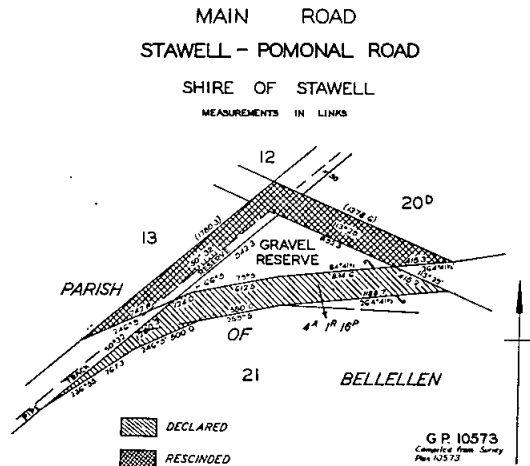

Resolution dated the Third day of January, One Thousand Nine Hundred and Sixty-eight, made pursuant to Sections 21 and 58 of the *Country Roads Act 1958* declaring the deviation from the Coleraine-Balmoral Road in the Shire of Wannan as indicated by diagonal hatching on Plan numbered G.P. 9284 hereunder to be part of a main road within the meaning and for the purposes of the said Act and also declaring that such deviation shall be in lieu of the existing road or part thereof indicated by cross hatching and horizontal hatching on the said plan which part indicated by cross hatching on the said plan shall be discontinued.

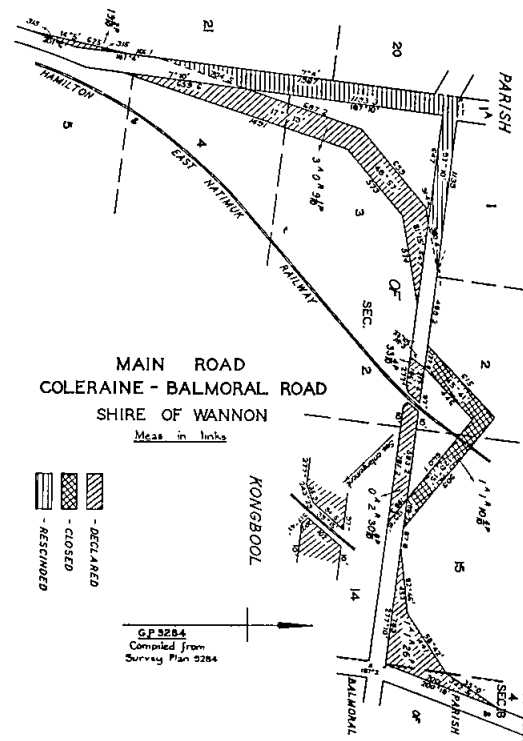

Resolution dated the Third day of January, One Thousand Nine Hundred and Sixty-eight, made pursuant to Section 21 of the *Country Roads Act 1958* declaring the widening of Tyers Road in the Shire of Traralgon as shown hatched on Plans numbered G.P. 6797 and G.P. 7167 hereunder to be part of a main road within the meaning and for the purposes of the said Act.

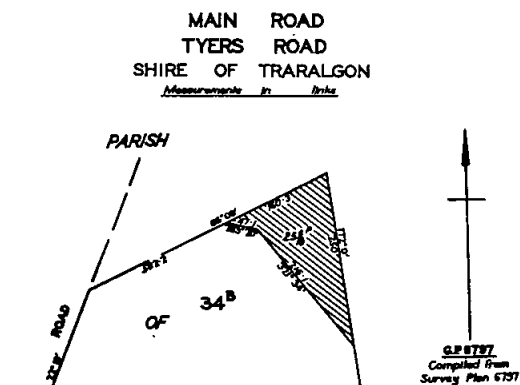

Resolution dated the Third day of January, One Thousand Nine Hundred and Sixty-eight, made pursuant to Section 21 of the *Country Roads Act 1958* declaring the widening of the Yarrowonga-Katamatite Road in the Shire of Yarrowonga as shown hatched on Plan numbered G.P. 6605 hereunder to be part of a main road within the meaning and for the purposes of the said Act.

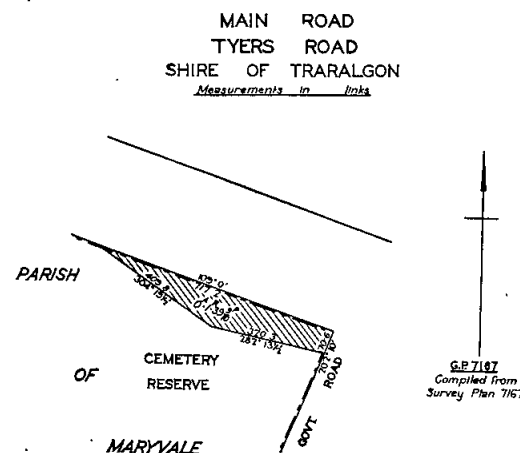
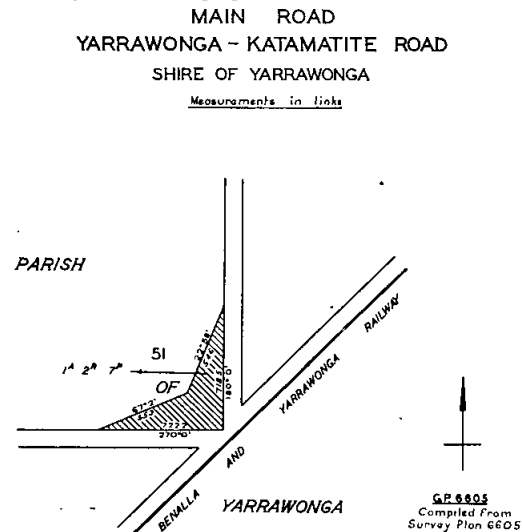

Resolution dated the Eighth day of January, One Thousand Nine Hundred and Sixty-eight, made pursuant to Sections 21 and 58 of the *Country Roads Act 1958* declaring the deviation from Brandy Creek Road in the

Shire of Warragul as indicated by diagonal hatching on Plan numbered G.P. 10135 hereunder to be part of a main road within the meaning and for the purposes of the said Act and also declaring that such deviation shall be in lieu of the existing road or part thereof indicated by cross hatching on the said plan.

MAIN ROAD
BRANDY CREEK ROAD
SHIRE OF WARRAGUL

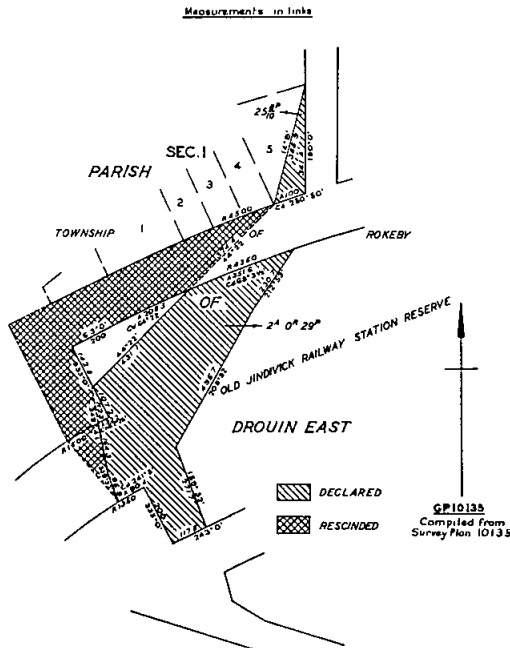

Resolution dated the Third day of January, One Thousand Nine Hundred and Sixty-eight, made pursuant to Section 21 of the Country Roads Act 1958 declaring the widening of Nerrena Road in the Shire of Woorayl as shown hatched on Plan numbered G.P. 6477 hereunder to be part of a main road within the meaning and for the purposes of the said Act

MAIN ROAD
NERRENA ROAD
SHIRE OF WOORAYL

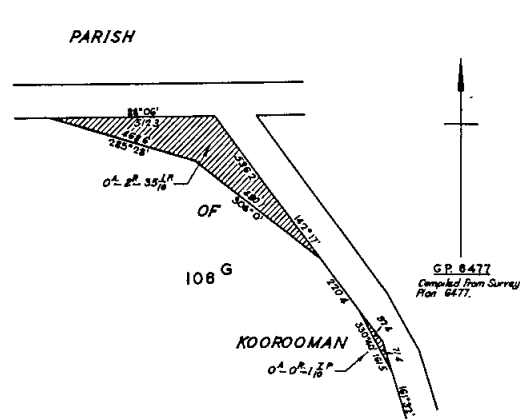

Resolution dated the Third day of January, One Thousand Nine Hundred and Sixty-eight, made pursuant to Sections 21 and 58 of the Country Roads Act 1958 declaring the deviation from the Wild Dog Valley Road in the Shire of Woorayl as indicated by diagonal hatching on Plan numbered G.P. 8602 hereunder to be part of a main road within the meaning and for the purposes of the said Act and also declaring that such deviation shall be in lieu of the existing road or part thereof indicated by cross hatching on the said plan and that such part of the said existing road shall be discontinued.

MAIN ROAD
WILD DOG VALLEY ROAD
SHIRE OF WOORAYL

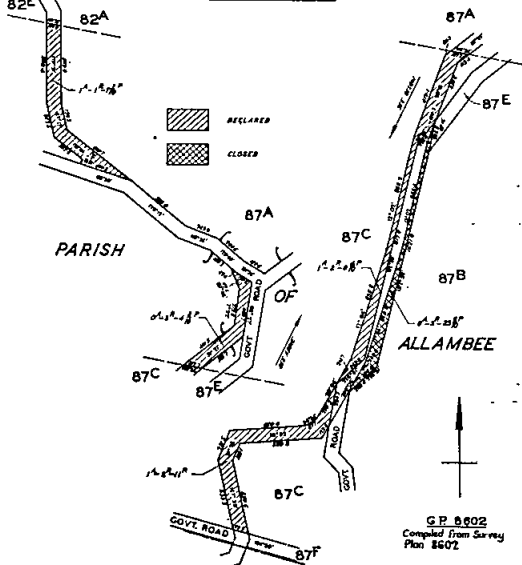

Resolution dated the Eighth day of January, One Thousand Nine Hundred and Sixty-eight, made pursuant to Section 21 of the Country Roads Act 1958 declaring the widening of the Yackandandah-Wodonga Road in the Shire of Yackandandah as shown hatched on Plan numbered G.P. 10825 hereunder to be part of a main road within the meaning and for the purposes of the said Act.

MAIN ROAD
YACKANDANDAH - WODONGA ROAD
SHIRE OF YACKANDANDAH

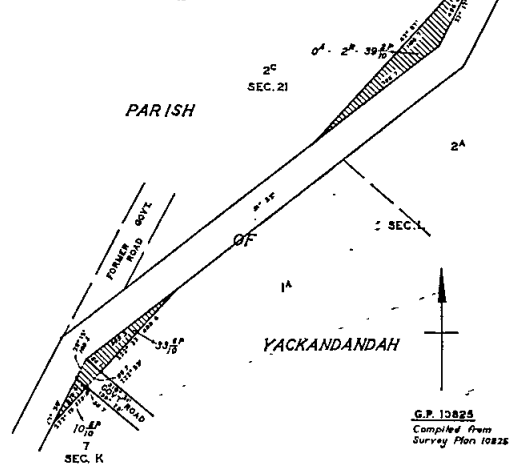

And the Honorable Murray Victor Porter, Her Majesty's Minister of Public Works for the State of Victoria shall give the necessary directions herein accordingly.

F. R. KENNY,
Acting Clerk of the Executive Council.

COUNTRY ROADS BOARD.

At the Executive Council Chamber, Melbourne, the sixteenth day of January, 1968.

PRESENT:

His Excellency the Governor of Victoria, Sir William McDonald | Mr. Dickie.

ORDER APPROVING OF LAND BEING ACQUIRED AND ROADS, DEVIATIONS OR WIDENINGS BEING MADE.

HIS Excellency the Governor of the State of Victoria, by and with the advice of the Executive Council thereof, being satisfied that there are funds legally available for acquiring the land, doth hereby approve the acquiring of the land described in the schedule hereunder and the making of new roads and deviations from and widenings of existing roads referred to in the said schedule.

SCHEDULE. By-pass road.

The land shown hatched on Plan numbered G.P. 11224 hereunder required for the making of the Lower Yarra Freeway By-pass Road in the Shire of Altona and the making of the road thereon.

BY-PASS ROAD LOWER YARRA FREEWAY BY-PASS ROAD SHIRE OF ALTONA

Measurements in feet and inches

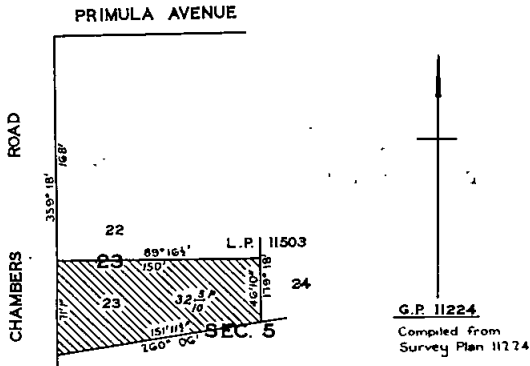

Forest road.

The land shown hatched on Plan numbered G.P. 11189 hereunder required for the deviation from the Warrowitue Road in the Shire of McIvor and making of the deviation thereon.

FOREST ROAD WARROWITUE ROAD SHIRE OF MCVOR

Measurements in links

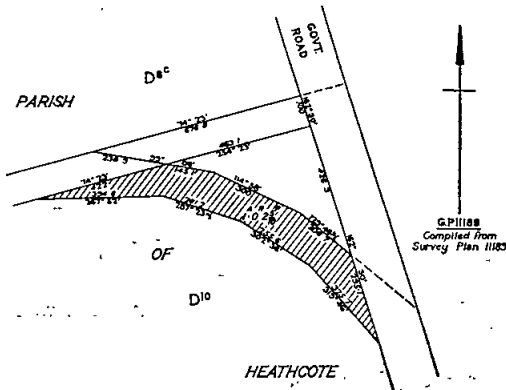

And the Honorable Murray Victor Porter, Her Majesty's Minister of Public Works for the State of Victoria, shall give the necessary directions herein accordingly.

F. R. KENNY, Acting Clerk of the Executive Council.

DEPARTMENT OF CROWN LANDS AND SURVEY.

At the Executive Council Chamber, Melbourne, the sixteenth day of January, 1968.

PRESENT:

His Excellency the Governor of Victoria, Sir William McDonald | Mr. Dickie.

REVOCATION OF TEMPORARY RESERVATION OF LAND BY ORDER IN COUNCIL.

HIS Excellency the Governor of the State of Victoria, by and with the advice of the Executive Council thereof, doth hereby, in pursuance of the provisions of the Land Act 1958, revoke the temporary reservation of land by Order in Council hereinafter referred to, viz.:-

OAKLEIGH.—Order in Council of 12th May, 1925 of 1 acre 1 rood 4 perches of land in the Township of Oakleigh as a site for Public Recreation Purposes so far only as regards the portion thereof comprised within the boundaries published in the Government Gazette of 29th November, 1967 and containing 34 perches.—(Rs.470).

And the Honorable Sir William John Farquhar McDonald, Her Majesty's Minister of Lands for the State of Victoria, shall give the necessary directions herein accordingly.

F. R. KENNY, Acting Clerk of the Executive Council.

DEPARTMENT OF CROWN LANDS AND SURVEY.

At the Executive Council Chamber, Melbourne, the sixteenth day of January, 1968.

PRESENT:

His Excellency the Governor of Victoria, Sir William McDonald | Mr. Dickie.

UNUSED ROADS CLOSED.

HIS Excellency the Governor of the State of Victoria, by and with the advice of the Executive Council thereof, doth hereby direct that, in pursuance of the provisions of section 349 of the Land Act 1958 the unused roads referred to hereunder be closed, viz.:-

At Bendigo, Parish of Sandhurst, County of Bendigo, being the roads and the portion of the width of road indicated by hatching on plan hereunder.—(S.372(127) (C.97951.)

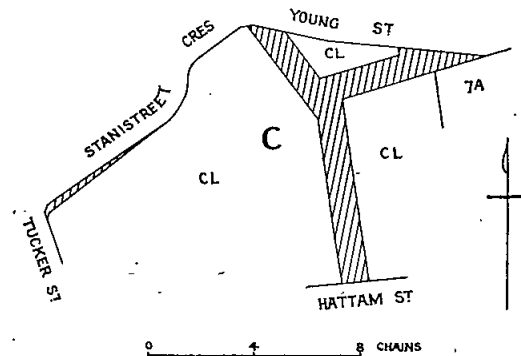

Parish of Bungil, County of Benambra, being the roads indicated by hatching on plan hereunder.—(B.655⁽⁶⁾) (H.032029.)

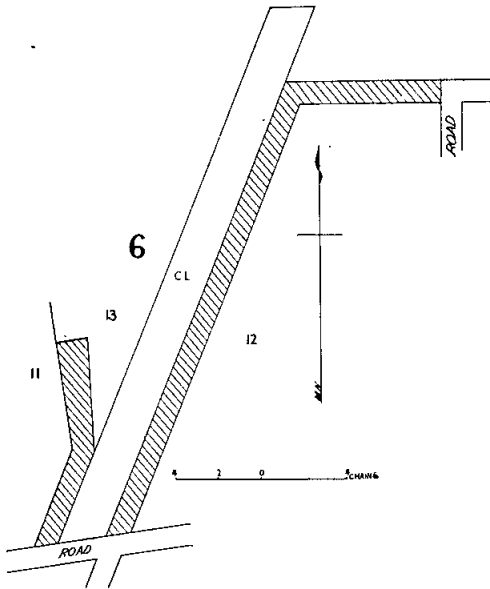

At Bendigo, Parish of Sandhurst, County of Bendigo, being the road indicated by hatching on plan hereunder.—(S.372^(12a)) (Rs.7267.)

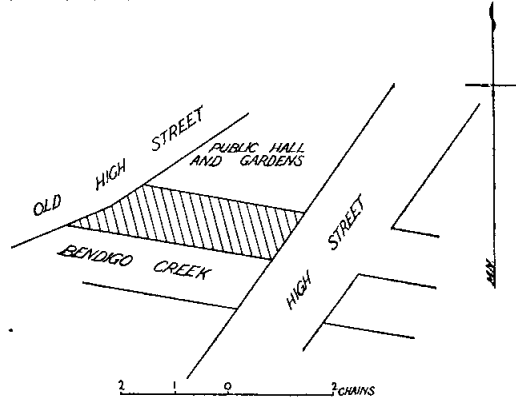

Parish of Willangie, County of Karkaroc, being the road between allotment 14B and allotments 12 and 13.—(W.385⁽¹⁾) (M.40913.)

And the Honorable Sir William John Farquhar McDonald, Her Majesty's Minister of Lands for the State of Victoria, shall give the necessary directions herein accordingly.

F. R. KENNY,
Acting Clerk of the Executive Council.

DEPARTMENT OF CROWN LANDS AND SURVEY.

At the Executive Council Chamber, Melbourne, the sixteenth day of January, 1968.

PRESENT:

His Excellency the Governor of Victoria.
Sir William McDonald | Mr. Dickie.

LAND TEMPORARILY RESERVED AS A SITE.

HIS Excellency the Governor of the State of Victoria, by and with the advice of the Executive Council thereof, doth hereby, in pursuance of section 14 of the Land Act 1958, reserve temporarily from sale, from being leased and from having a licence granted in respect thereof, and also except from occupation for mining purposes under any miner's right, the land hereinafter described:—

CARALULUP.—Site for Water Supply purposes 201 acres, more or less, Parish of Caralulup, County of Talbot, as indicated by hatching on plan hereunder.—(C.356⁽⁸⁾) (Rs.8911.)

Parishes of Illawarra and Stawell, County of Borung, being the roads indicated by hatching on plan hereunder.—(I.13⁽⁵⁾, S.329⁽¹⁵⁾) (M.60733.)

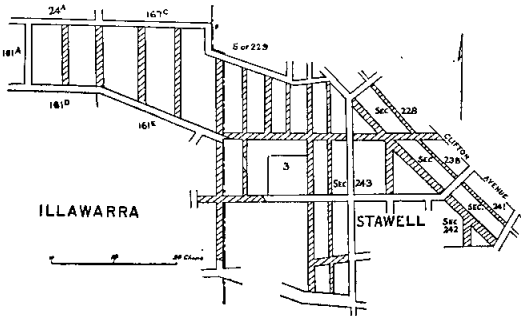

Township of Nandaly, Parish of Bimbourie, County of Karkaroc, being the road indicated by hatching on plan hereunder.—(N.177⁽⁴⁾) (Rs.1334.)

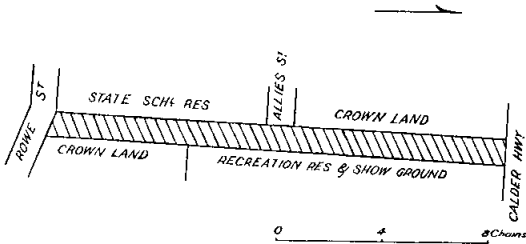

Parish of Nandemarriman, County of Karkaroc, being the roads indicated by hatching on plan hereunder.—(N.168⁽⁸⁾) (M.61291A.)

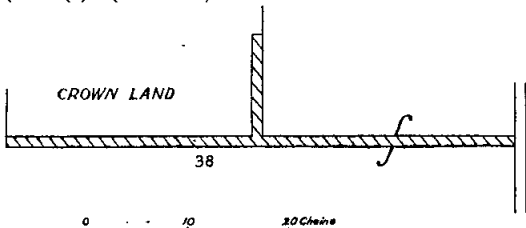

COHUNA.—Site for a Public Park, 30 perches, more or less, Township of Cohuna, Parish of Cohuna, County of Gunbower, as indicated by hatching on plan hereunder.—(C.424⁽⁸⁾) (Rs.8928.)

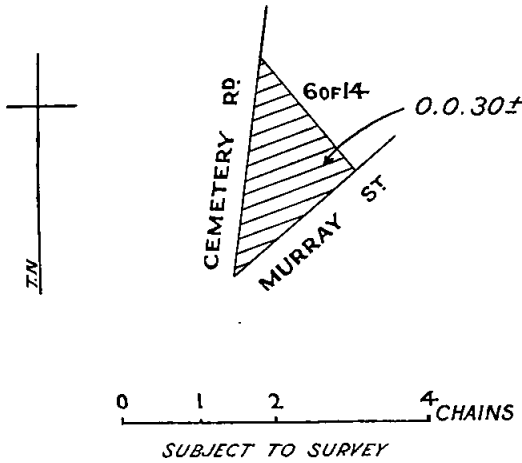

OLINDA.—Site for State school purposes 4 acres, 39 perches, Township of Olinda, Parish of Mooroolbark, County of Evelyn, as indicated by hatching on plan hereunder.—(O.25⁽⁶⁾) (Rs.6866.)

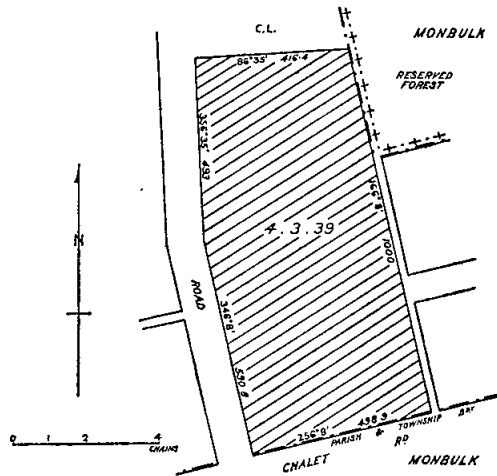

GEELONG.—Site for Public Purposes (Public Buildings) 35 perches, City of Geelong, Parish of Corio, County of Grant, as indicated by hatching on plan hereunder.—(G.29⁽¹⁰⁾) (Rs.8924.)

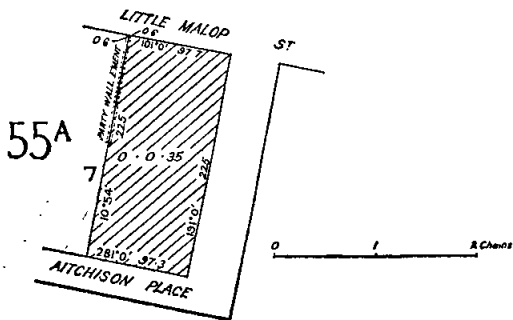

PENSHURST.—Site for Public Recreation 2 roods, Township of Peshurst, Parish of Yalimba, County of Villiers, as indicated by hatching on plan hereunder.—(P.29⁽⁴⁾) (Rs.8927.)

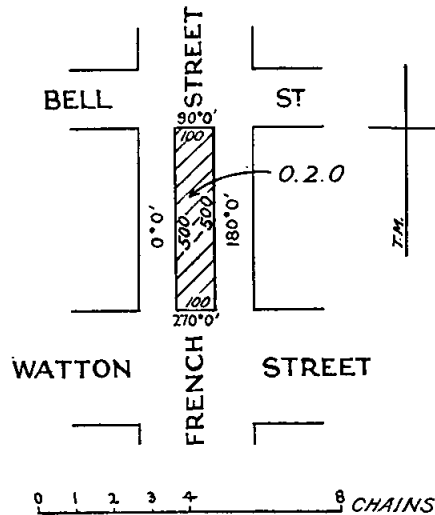

NANDALY AND BIMBOURIE.—Site for Public Recreation and Showground 39 acres 2 roods, more or less, Township of Nandaly and Parish of Bimbourie, County of Karkaroc, as indicated by hatching on plan hereunder.—(N.177⁽⁴⁾) (Rs.1334.)

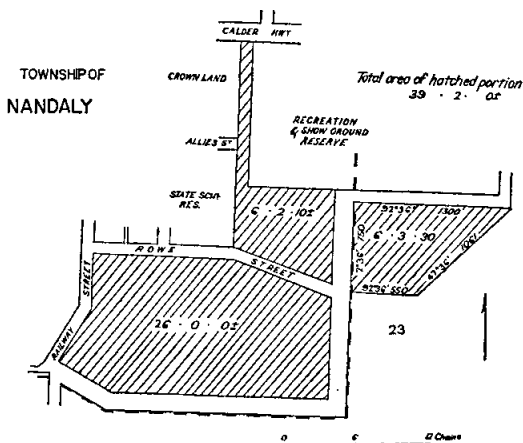

RUPANYUP.—Site for Water Supply purposes 18 acres 3 roods 29 perches, Parish of Rupanyup, County of Borung, as indicated by hatching on plan hereunder.—(R.79⁽⁶⁾) (Rs.8882.)

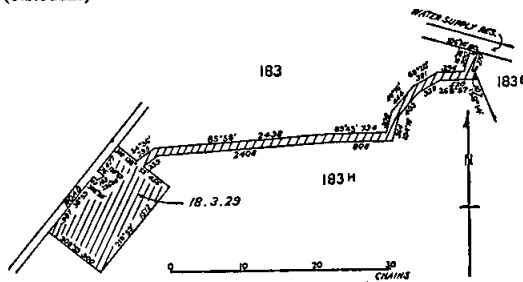

WONGARRA.—Site for Public Purposes (Tourist Camping) 11 acres 3 roods 31 perches, more or less, Parish of Wongarra, County of Polwarth, as indicated by hatching on plan hereunder.—(W.374⁽⁵⁾) (Rs.4936.)

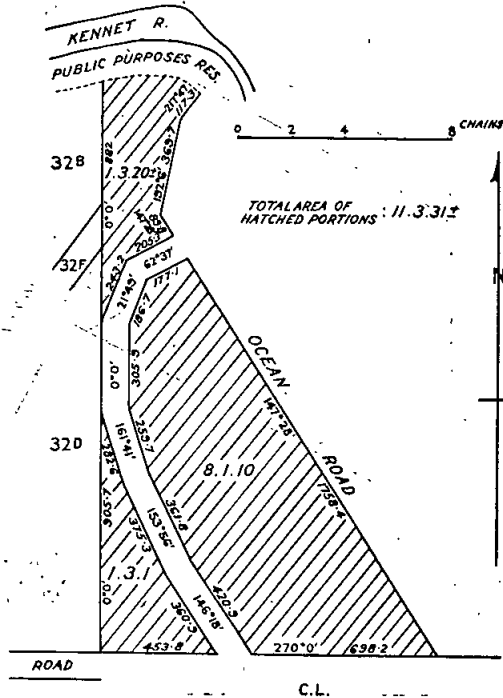

And the Honorable Sir William John Farquhar McDonald, Her Majesty's Minister of Lands for the State of Victoria, shall give the necessary directions herein accordingly.

F. R. KENNY,
Acting Clerk of the Executive Council.

DEPARTMENT OF CROWN LANDS AND SURVEY.

At the Executive Council Chamber, Melbourne, the sixteenth day of January, 1968.

PRESENT:

His Excellency the Governor of Victoria.
Sir William McDonald | Mr. Dickie.

LAND TEMPORARILY RESERVED FOR AN ADDITIONAL PURPOSE.

HIS Excellency the Governor of the State of Victoria, by and with the advice of the Executive Council thereof, and in pursuance of the provisions of the Land Act 1958, doth hereby direct that the remaining portion of Crown land in the Township of Swan Hill, reserved by Order in Council of the 19th May, 1896, as a site for a Racecourse, be temporarily reserved for the additional purpose of Public Recreation.—(Rs. 1789.)

And the Honorable Sir William John Farquhar McDonald, Her Majesty's Minister of Lands for the State of Victoria, shall give the necessary directions herein accordingly.

F. R. KENNY,
Acting Clerk of the Executive Council.

LOCAL GOVERNMENT DEPARTMENT.

At the Executive Council Chamber, Melbourne, the sixteenth day of January, 1968.

PRESENT:

His Excellency the Governor of Victoria.
Sir William McDonald | Mr. Dickie.

ROAD DISCONTINUED.—TOWN OF PORTLAND.

WHEREAS it is provided in Section 528 (2) of the Local Government Act 1958, as amended, that where a road (whether or not a public highway but not being a road set out on land of the Crown) or any part thereof is not required for public use, the Governor-in-Council, on the request of the Council of the municipality in which such road is situated made not less than one month after publishing in a newspaper generally circulating in the district and posting to the registered proprietor (if any) of the land and any person known to have an interest in the land notice of intention to make such a request may by Order published in the Government Gazette direct that such road or part shall be discontinued and thereupon such road or part shall be discontinued accordingly.

AND WHEREAS the Council of the Town of Portland has requested that the Governor-in-Council direct that a right-of-way off Silvester Street, Portland be discontinued and not less than one month previously has published in a newspaper generally circulating in the district and posted to the registered proprietor of the land in the said road and to all persons known to have an interest in the said land notice of intention to make such request.

NOW THEREFORE, His Excellency the Governor of the State of Victoria by and with the advice of the Executive Council thereof, hereby directs that the said road, which is shown hatched on the plan hereunder, shall be discontinued and that the land may be sold by the Council of the Town of Portland by agreement.

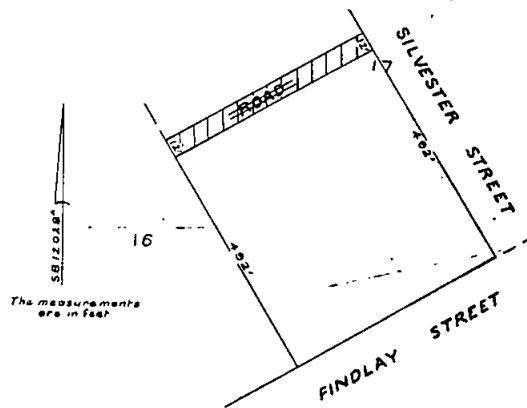

The Fee of the road was on 29-11-67 under the Old Law

And the Honorable Rupert James Hamer, Her Majesty's Minister for Local Government for the State of Victoria, shall give the necessary directions herein accordingly.

F. R. KENNY,
Acting Clerk of the Executive Council.

LOCAL GOVERNMENT DEPARTMENT.

At the Executive Council Chamber, Melbourne, the sixteenth day of January, 1968.

PRESENT:

His Excellency the Governor of Victoria.
Sir William McDonald | Mr. Dickie.

ROAD DISCONTINUED.—CITY OF OAKLEIGH.

WHEREAS it is provided in Section 528 (2) of the Local Government Act 1958, as amended, that where a road (whether or not a public highway but not being a road set out on land of the Crown) or any part thereof is not required for public use, the Governor-in-Council, on the

request of the Council of the municipality in which such road is situated made not less than one month after publishing in a newspaper generally circulating in the district and posting to the registered proprietor (if any) of the land and any person known to have an interest in the land notice of intention to make such a request may by Order published in the *Government Gazette* direct that such road or part shall be discontinued and thereupon such road or part shall be discontinued accordingly.

AND WHEREAS the Council of the City of Oakleigh has requested that the Governor-in-Council direct that portion of Kelly Street, Oakleigh be discontinued and not less than one month previously has published in a newspaper generally circulating in the district and posted to the registered proprietor of the land in the said road and to all persons known to have an interest in the said land notice of intention to make such request.

NOW THEREFORE, His Excellency the Governor of the State of Victoria, by and with the advice of the Executive Council thereof, hereby directs that the portion of the said road, which is shown hatched on the plan hereunder, shall be discontinued and that the land may be sold by the Council of the City of Oakleigh by agreement.

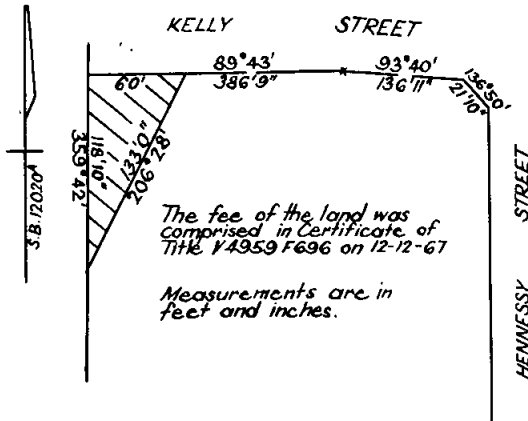

And the Honorable Rupert James Hamer, Her Majesty's Minister for Local Government for the State of Victoria, shall give the necessary directions herein accordingly.

F. R. KENNY,
Acting Clerk of the Executive Council.

LOCAL GOVERNMENT DEPARTMENT.

At the Executive Council Chamber, Melbourne, the sixteenth day of January, 1968.

PRESENT:

His Excellency the Governor of Victoria.
Sir William McDonald | Mr. Dickie.

ROAD DISCONTINUED.—CITY OF SOUTH MELBOURNE.

WHEREAS it is provided in Section 528 (2) of the *Local Government Act 1958*, as amended, that where a road (whether or not a public highway but not being a road set out on land of the Crown) or any part thereof is not required for public use, the Governor-in-Council, on the request of the Council of the municipality in which such road is situated made not less than one month after publishing in a newspaper generally circulating in the district and posting to the registered proprietor (if any) of the land and any person known to have an interest in the land notice of intention to make such a request may by Order published in the *Government Gazette* direct that such road or part shall be discontinued and thereupon such road or part shall be discontinued accordingly.

AND WHEREAS the Council of the City of South Melbourne has requested that the Governor-in-Council direct that a right-of-way, off Tope Street, South Melbourne, be discontinued and not less than one month previously has published in a newspaper generally circulating in the district and posted to the proprietor of the land in the said road and to all persons known to have an interest in the said land notice of intention to make such request.

NOW THEREFORE His Excellency the Governor of the State of Victoria, by and with the advice of the Executive Council thereof, hereby directs that the said road, which is shown hatched on the plan hereunder, shall be discontinued and that the land may be sold by the Council of the City of South Melbourne by agreement.

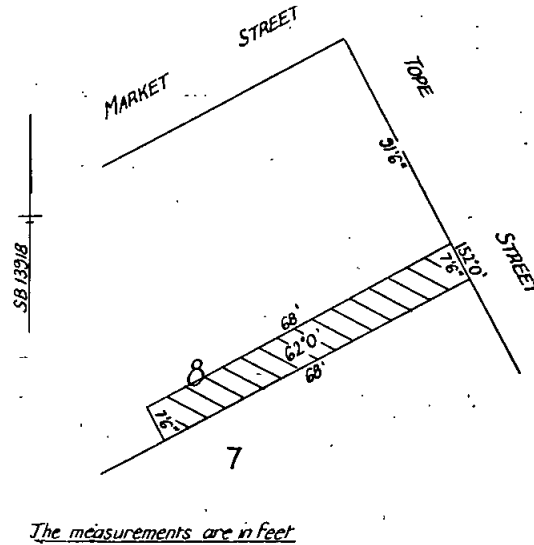

And the Honorable Rupert James Hamer, Her Majesty's Minister for Local Government for the State of Victoria, shall give the necessary directions herein accordingly.

F. R. KENNY,
Acting Clerk of the Executive Council.

LOCAL GOVERNMENT DEPARTMENT.

At the Executive Council Chamber, Melbourne, the sixteenth day of January, 1968.

PRESENT:

His Excellency the Governor of Victoria.
Sir William McDonald | Mr. Dickie.

ROAD DISCONTINUED.—CITY OF ECHUCA.

WHEREAS it is provided in Section 528 (2) of the *Local Government Act 1958*, as amended, that where a road (whether or not a public highway but not being a road set out on land of the Crown) or any part thereof is not required for public use the Governor-in-Council on the request of the Council of the municipality in which such road is situated made not less than one month after publishing in a newspaper generally circulating in the district and posting to the registered proprietor (if any) of the land and any person known to have an interest in the land notice of intention to make such a request may by Order published in the *Government Gazette* direct that such road or part shall be discontinued and thereupon such road or part shall be discontinued accordingly.

AND WHEREAS the Council of the City of Echuca has requested that the Governor-in-Council direct that portion of Hospital-avenue, Echuca, be discontinued and not less than one month previously has published in a newspaper generally circulating in the district and posted to the registered proprietor of the land in the said road and to all persons known to have an interest in the said land notice of intention to make such request.

NOW THEREFORE, His Excellency the Governor of the State of Victoria, by and with the advice of the Executive Council thereof, hereby directs that the portion of the said road, which is delineated on the plan hereunder, shall be discontinued and that the land may be sold by the Council of the City of Echuca by agreement.

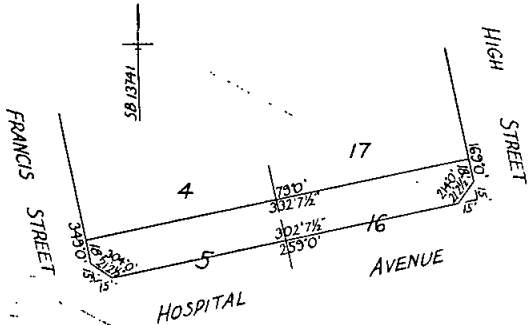

The measurements are in feet and inches

And the Honorable Rupert James Hamer, Her Majesty's Minister for Local Government for the State of Victoria, shall give the necessary directions herein accordingly.

F. R. KENNY,
Acting Clerk of the Executive Council.

LOCAL GOVERNMENT DEPARTMENT.

At the Executive Council Chamber, Melbourne, the sixteenth day of January, 1968.

PRESENT:

His Excellency the Governor of Victoria.
Sir William McDonald | Mr. Dickie.

APPLICATION TO ELECTIONS OF COUNCILLORS FOR THE SHIRE OF MYRTLEFORD OF REGULATIONS RELATING TO COMPULSORY VOTING.

WHEREAS it is provided in Section 149 of the Local Government Act 1958, as amended, that the Governor-in-Council on the petition of the Council of any municipality, may by Order published in the Government Gazette, apply to elections of councillors for such municipality with any modifications provided for in such Order all or any of the Regulations relating to compulsory voting made under the said Section 149.

NOW THEREFORE His Excellency the Governor of the State of Victoria, by and with the advice of the Executive Council thereof, and in pursuance of a petition of the Council of the Shire of Myrtleford, doth hereby order that the Regulations relating to compulsory voting at municipal elections made pursuant to the provisions of the said Section 149 shall apply to elections of councillors for the municipality of the Shire of Myrtleford.

And the Honorable Rupert James Hamer, Her Majesty's Minister for Local Government for the State of Victoria, shall give the necessary directions herein accordingly.

F. R. KENNY,
Acting Clerk of the Executive Council.

LOCAL GOVERNMENT DEPARTMENT.

At the Executive Council Chamber, Melbourne, the sixteenth day of January, 1968.

PRESENT:

His Excellency the Governor of Victoria.
Sir William McDonald | Mr. Dickie.

ROADS DISCONTINUED.—CITY OF SOUTH MELBOURNE.

WHEREAS it is provided in Section 528 (2) of the Local Government Act 1958, as amended, that where a road (whether or not a public highway but not being a road set out on land of the Crown) or any part thereof is not required for public use, the Governor-in-Council, on the request of the Council of the municipality in which

such road is situated made not less than one month after publishing in a newspaper generally circulating in the district and posting to the registered proprietor (if any) of the land and any person known to have an interest in the land notice of intention to make such a request may by Order published in the Government Gazette direct that such road or part shall be discontinued and thereupon such road or part shall be discontinued accordingly:

AND WHEREAS the Council of the City of South Melbourne has requested that the Governor-in-Council direct that two rights-of-way, off Tope Street, South Melbourne, be discontinued and not less than one month previously, has published in a newspaper generally circulating in the district and posted to the registered proprietor of the land in the said roads and to all persons known to have an interest in the said land notice of intention to make such request:

NOW THEREFORE, His Excellency the Governor of the State of Victoria, by and with the advice of the Executive Council thereof, hereby directs that the said roads, which are shown hatched on the plan hereunder, shall be discontinued and that the land may be sold by the Council of the City of South Melbourne by agreement.

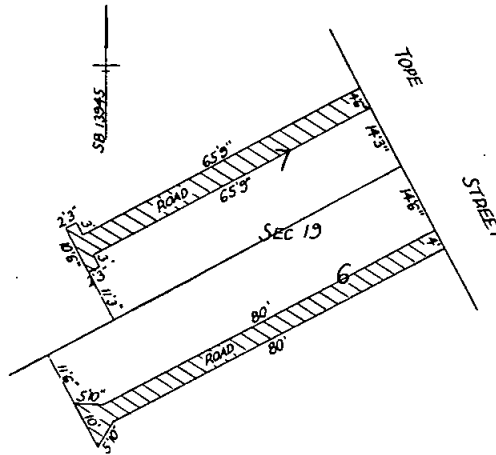

The measurements are in feet and inches

And the Honorable Rupert James Hamer, Her Majesty's Minister for Local Government for the State of Victoria, shall give the necessary directions herein accordingly.

F. R. KENNY,
Acting Clerk of the Executive Council.

Victoria.

STATE ELECTRICITY COMMISSION ACT 1958.

At the Executive Council Chamber, Melbourne, the sixteenth day of January, 1968.

PRESENT:

His Excellency the Governor of Victoria.
Sir William McDonald | Mr. Dickie.

AUTHORITY TO SUPPLY ELECTRICITY WITHIN THE PORT PHILLIP REGION.

WHEREAS, pursuant to the provisions of the State Electricity Commission Act 1958 (No. 6377) the State Electricity Commission of Victoria is empowered, subject to that Act, on behalf of Her Majesty, to construct, maintain and work any electrical undertaking as defined in that Act: AND WHEREAS by the North Melbourne Electric Tramways and Lighting Company Act 1924 No. 3247, the Melbourne Electric Supply Company Act 1924 No. 3377, the State Electricity Commission (Chelsea Purchase) Act 1936 No. 4407 and an Order in Council approved by the Governor in Council on 30th day of January, 1923, and published in the Government Gazette on the 7th day of February, 1923, the State Electricity Commission of Victoria was authorised to supply electricity to certain persons and bodies of persons in certain portions of the Port Phillip Region of Victoria: NOW THEREFORE His Excellency the Governor of the State of Victoria by and with the advice of the Executive Council thereof doth

hereby without prejudice to the rights of any undertakers under the *Electric Light and Power Act 1958* approve the erection, construction, provision, maintenance and operation by the State Electricity Commission of Victoria of an undertaking or undertakings, works, appliances and conveniences for the generation of electricity and for the reception, storage, distribution, transmission, use, supply and sale of electricity in bulk or otherwise in accordance with the *State Electricity Commission Act 1958* to persons and bodies of persons (including corporations) in the whole of the Port Phillip Region as shown on Maps 'A' and 'B' in the report of the State Regional Boundaries Committee on "Regional Boundaries" dated 27th December, 1944.

And the Honorable James Charles Murray Balfour, Her Majesty's Minister for Fuel and Power for the State of Victoria, shall give the necessary directions herein accordingly.

F. R. KENNY,
Acting Clerk of the Executive Council.

ROAD TRAFFIC ACT 1958.

At the Executive Council Chamber, Melbourne, the sixteenth day of January, 1968.

PRESENT:

His Excellency the Governor of Victoria.
Sir William McDonald | Mr. Dickie.

ORDER EXTENDING THE APPLICATION OF THE ROAD TRAFFIC ACT 1958 TO CERTAIN LAND UNDER THE CONTROL OF THE CITY OF BROADMEADOWS.

IN PURSUANCE of the powers conferred by the *Road Traffic Act 1958*, His Excellency the Governor of the State of Victoria in the Commonwealth of Australia, by and with the advice of the Executive Council of the said State, and at the request in writing of the Council of the City of Broadmeadows doth by this Order extend the provisions of the said Act to the following land under the control of the City of Broadmeadows:

All that piece of land being the area known as the Dallas Shopping Centre.

Commencing at the south east corner of Phillip and Millewa Crescent, then easterly on the southern boundary of Phillip Street for a distance of 448 feet, then southerly by the western boundary of Blair Street for a distance of 217 feet, thence south westerly of the western boundary of Blair Street for a distance of 814 feet, thence north westerly of the southern boundary of the car park for a distance of 359 feet, thence north easterly on the east boundary of Millewa Crescent for a distance of 352 feet, thence north on the east boundary of Millewa Crescent for a distance of 540 feet back to the commencement point.

And the Honorable Arthur Gordon Rylah, Her Majesty's Chief Secretary for the State of Victoria, shall give the necessary directions herein accordingly.

F. R. KENNY,
Acting Clerk of the Executive Council.

SUNBURY WATERWORKS TRUST.

At the Executive Council Chamber, Melbourne, the twenty-third day of January, 1968.

PRESENT:

His Excellency the Governor of Victoria.
Mr. Porter | Mr. Balfour.

REPEAL OF ORDER AS TO PART.

UNDER the powers conferred by the Water Act and all other powers enabling him in that behalf, His Excellency the Governor of the State of Victoria, by and with the advice of the Executive Council of the said State, doth hereby repeal that part approving a plan marked "B" showing details of offtake weirs, of the Order in Council dated 1st day of February, 1961, approving of plans showing sites for offtake weirs and pipe-lines and details of diversion structures to be constructed by the Sunbury Waterworks Trust.

And the Honorable William Archibald Borthwick, Her Majesty's Minister of Water Supply for the State of Victoria, shall give the necessary directions herein accordingly.

F. R. KENNY,
Acting Clerk of the Executive Council.

WARRNAMBOOL CITY COUNCIL.—WATER SUPPLY DISTRICT.

At the Executive Council Chamber, Melbourne, the twenty-third day of January, 1968.

PRESENT:

His Excellency the Governor of Victoria.
Mr. Porter | Mr. Balfour.

CONSENT TO BORROWING \$50,000.

UNDER the powers conferred by the Water Act and all other powers enabling him in that behalf, His Excellency the Governor of the State of Victoria, by and with the advice of the Executive Council of the said State, doth hereby consent to the Warrnambool City Council borrowing at interest the sum of Fifty thousand dollars (\$50,000) to meet the cost of water supply works.

And the Honorable William Archibald Borthwick, Her Majesty's Minister of Water Supply for the State of Victoria, shall give the necessary directions herein accordingly.

F. R. KENNY,
Acting Clerk of the Executive Council.

PORT FAIRY WATERWORKS TRUST.

At the Executive Council Chamber, Melbourne, the twenty-third day of January, 1968.

PRESENT:

His Excellency the Governor of Victoria.
Mr. Porter | Mr. Balfour.

CONSENT TO BORROWING \$35,000.

UNDER the powers conferred by the Water Act and all other powers enabling him in that behalf, His Excellency the Governor of the State of Victoria, by and with the advice of the Executive Council of the said State, doth hereby consent to the Port Fairy Waterworks Trust borrowing at interest the sum of Thirty-five thousand dollars (\$35,000) to meet the cost of water supply works.

And the Honorable William Archibald Borthwick, Her Majesty's Minister of Water Supply for the State of Victoria, shall give the necessary directions herein accordingly.

F. R. KENNY,
Acting Clerk of the Executive Council.

CHELSEA SEWERAGE AUTHORITY.

At the Executive Council Chamber, Melbourne, the twenty-third day of January, 1968.

PRESENT:

His Excellency the Governor of Victoria.
Mr. Porter | Mr. Balfour.

CONSENT TO BORROWING \$60,000.

UNDER the powers conferred by the Sewerage Districts Act and all other powers enabling him in that behalf, His Excellency the Governor of the State of Victoria, by and with the advice of the Executive Council of the said State, doth hereby consent to the Chelsea Sewerage Authority borrowing by mortgage of the General Fund the sum of Sixty thousand dollars (\$60,000) to meet the cost of sewerage works as set forth in the detailed statement bearing date 18th January, 1968.

And the Honorable William Archibald Borthwick, Her Majesty's Minister of Water Supply for the State of Victoria, shall give the necessary directions herein accordingly.

F. R. KENNY,
Acting Clerk of the Executive Council.

ROCHESTER SEWERAGE AUTHORITY.

At the Executive Council Chamber, Melbourne, the
twenty-third day of January, 1968.

PRESENT:

His Excellency the Governor of Victoria.
Mr. Porter | Mr. Balfour.

CONSENT TO BORROWING \$150,000.

UNDER the powers conferred by the Sewerage Districts Act and all other powers enabling him in that behalf, His Excellency the Governor of the State of Victoria, by and with the advice of the Executive Council of the said State, doth hereby consent to the Rochester Sewerage Authority borrowing at interest the sum of One hundred and fifty thousand dollars (\$150,000) to meet the cost of sewerage works as set forth in the detailed statement bearing date 18th January, 1968.

And the Honorable William Archibald Borthwick, Her Majesty's Minister of Water Supply for the State of Victoria, shall give the necessary directions herein accordingly.

F. R. KENNY,
Acting Clerk of the Executive Council.

SMYTHESDALE-SCARSDALE WATERWORKS TRUST.

At the Executive Council Chamber, Melbourne, the
twenty-third day of January, 1968.

PRESENT:

His Excellency the Governor of Victoria.
Mr. Porter | Mr. Balfour.

AMENDMENT OF ORDER.

UNDER the powers conferred by the Water Act and all other powers enabling him in that behalf, His Excellency the Governor of the State of Victoria, by and with the advice of the Executive Council of the said State, doth hereby amend as follows the Order made by the Governor in Council on 25th July, 1967, and published in the *Victoria Government Gazette* dated 26th July, 1967, fixing the limit of the overdraft to be obtained by the Smythesdale-Scarsdale Waterworks Trust.

For the expression "at Fifty thousand dollars (\$50,000)" there shall be substituted the expression "at Ninety thousand dollars (\$90,000)".

And the Honorable William Archibald Borthwick, Her Majesty's Minister of Water Supply for the State of Victoria, shall give the necessary directions herein accordingly.

F. R. KENNY,
Acting Clerk of the Executive Council.

GAS REGULATION ACT 1958.

At the Executive Council Chamber, Melbourne, the
twenty-third day of January, 1968.

PRESENT:

His Excellency the Governor of Victoria.
Mr. Porter | Mr. Balfour.

CALORIFIC VALUE OF GAS SUPPLIED BY THE GAS AND FUEL CORPORATION OF VICTORIA FROM THE GAS BLENDING STATION AT DANDENONG.

WHEREAS it is provided in sub-section (1) of section 15 of the *Gas Regulation Act 1958* that gas supplied by an undertaker with respect to calorific value shall be as prescribed in the Second Schedule to the said Act or in respect of all or a specified part of the undertaking of such other standard as is prescribed from time to time by Order of the Governor in Council:

Now therefore His Excellency the Governor of the State of Victoria, in the Commonwealth of Australia, by and with the advice of the Executive Council of the said State, and in pursuance of the powers conferred by the *Gas Regulation Act 1958*, doth by this Order prescribe 525 British thermal units (gross) per cubic foot as the standard of calorific value of gas supplied on and from the thirteenth day of February, 1968 in that part of the reticulation area

of the undertaking of the Gas and Fuel Corporation of Victoria supplied with gas from the said Corporation's Gas Blending Station at Dandenong.

And the Honorable James Charles Murray Balfour, Her Majesty's Minister of Mines for the State of Victoria, shall give the necessary directions herein accordingly.

F. R. KENNY,
Acting Clerk of the Executive Council.

TOWN AND COUNTRY PLANNING ACT 1961.

At the Executive Council Chamber, Melbourne, the
twenty-third day of January, 1968.

PRESENT:

His Excellency the Governor of Victoria.
Mr. Porter | Mr. Balfour.

REVOCATION OF INTERIM DEVELOPMENT ORDER—
SIMPSON PLANNING SCHEME.

WHEREAS by virtue of the *Town and Country Planning Act 1961* it is provided that the Governor in Council may at any time after consultation by the Minister with the responsible authority and the Board revoke, amend or vary any interim development order in whole or in part and any such revocation, amendment or variation shall come into operation upon publication of notice thereof in the *Government Gazette*. Now, therefore, His Excellency the Governor of the State of Victoria, by and with the advice of the Executive Council and after consultation by the Minister with the responsible authority and the Board doth hereby revoke the interim development order made by the responsible authority, the Town and Country Planning Board, in respect of the Simpson Planning Scheme which was approved by the Governor in Council on the 17th May, 1966, and published in the *Government Gazette* on the 25th May, 1966.

And the Honorable Rupert James Hamer, Her Majesty's Minister for Local Government for the State of Victoria shall give the necessary directions herein accordingly.

F. R. KENNY,
Acting Clerk of the Executive Council.

LANDS DEPARTMENT NOTICES

APPROACHING LAND SALES.

SALES of Crown Lands, in fee-simple, will be held at the under-mentioned places and dates, viz.:

	No. of Gazette.
Ballarat.—Thursday, 7th March, 1968	2
Benalla.—Thursday, 22nd February, 1968	2
Bright.—Wednesday, 14th February, 1968	2
Chiltern.—Thursday, 22nd February, 1968	2
Myrtleford.—Wednesday, 14th February, 1968	2
Yarrawonga.—Thursday, 22nd February, 1968	2

SALE OF CLOSER SETTLEMENT LAND BY AUCTION.

Numurkah.—Thursday, 22nd February, 1968 2

PROPOSED REVOCATIONS OF TEMPORARY RESERVATIONS OF LANDS BY ORDERS IN COUNCIL.

IN pursuance of the provisions of the *Land Act 1958*, notice is hereby given that it is the intention of the Governor in Council to revoke the temporary reservations of lands by Orders in Council hereunder referred to, viz.:

The following Notices were published 1^o on the 16th January, 1968, pursuant to Orders of the 24th January, 1968.

BIRREGURRA.—The temporary reservation, by Order in Council of the 20th July, 1925, of 1 acre 1 rood 29 perches of land in the Parish of Birregurra as a site for Police Purposes is about to be revoked.—(B.395(2)) (Rs.3172.)

TALLANDON.—The temporary reservation, by Order in Council of the 15th March, 1898, (see *Government Gazette* 18th March, 1898, page 1051) of 35,700 acres, more or less of land in the Parishes of Bolga, Noorrongong, Tallandon and Gundowing as a site for the Growth and Preservation of Timber, revoked as to part by Order of the 5th May,

1964, is about to be revoked so far only as the portion containing 274 acres, more or less, in the Parish of Tallandoon, indicated by hatching on plan hereunder, is concerned.—(T.254^(s)) (Rs.8308).

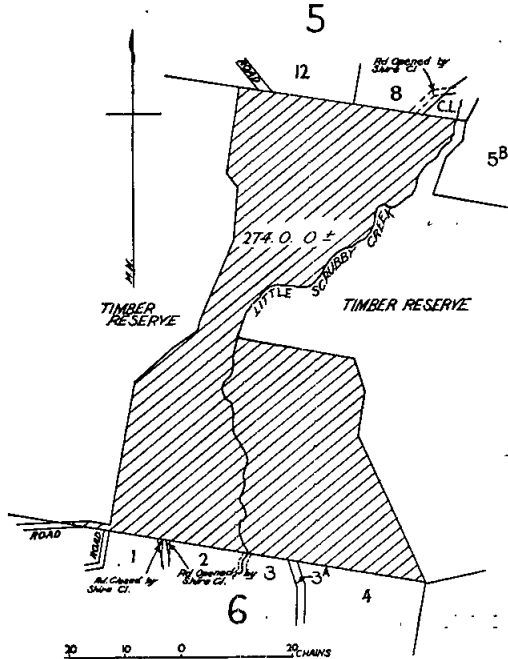

CORINDHAP.—The temporary reservation, by Order in Council of the 14th December, 1926, of 26 acres 31 perches of land in the Township of Corindhap as a site for Supply of Gravel is about to be revoked.—(C.269^(s)) (Rs.3400.)

DARTMOOR.—The temporary reservation, by Order in Council of the 17th February, 1916, of 10 acres of land in the Township of Dartmoor as a site for Public Recreation is about to be revoked so far only as the portion containing 39 perches, indicated by hatching on plan hereunder, is concerned.—(D.32^(s)) (Rs.901.)

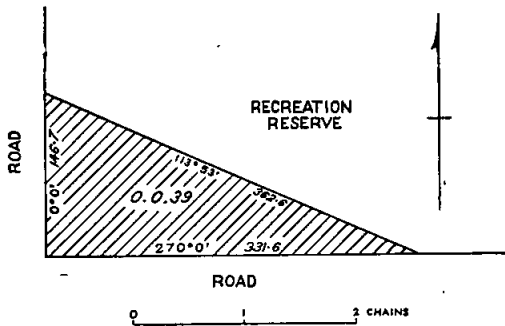

DRY DIGGINGS.—The temporary reservation, by Order in Council of the 24th April, 1871, of 3 roods 22 perches of land in the Township of Dry Diggings as a site for Common School purposes is about to be revoked so far only as the portion containing 37 perches, indicated by hatching on plan hereunder, is concerned.—(D.221^(s)) (Rs.8853.)

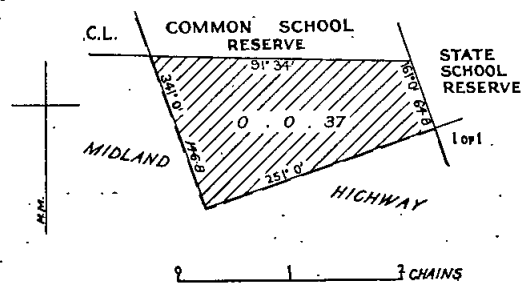

KANIVA.—The temporary reservation, by Order in Council of the 14th June, 1955, of 1 acre 3 roods 20 perches, more or less, of land in the Township of Kaniva as a site for a Children's Playground is about to be revoked.—(K.147^(s)) (Rs.7362.)

LAKES ENTRANCE.—The temporary reservation, by Order in Council of the 26th February, 1957, of 1 rood 1 perch of land in the Township of Lakes Entrance as a site for Police purposes is about to be revoked.—(C.838F^(s)) (Rs.7540.)

MILDURA.—The temporary reservation, by Order in Council of the 10th October, 1932, of 498 acres, more or less, of land in the Parish of Mildura as a site for Public Recreation, revoked as to part by Order of the 29th January, 1958, is about to be revoked so far only as the portion containing 9 acres, more or less, indicated by hatching on plan hereunder, is concerned.—(M.556⁽¹¹⁾) (Rs.4244.)

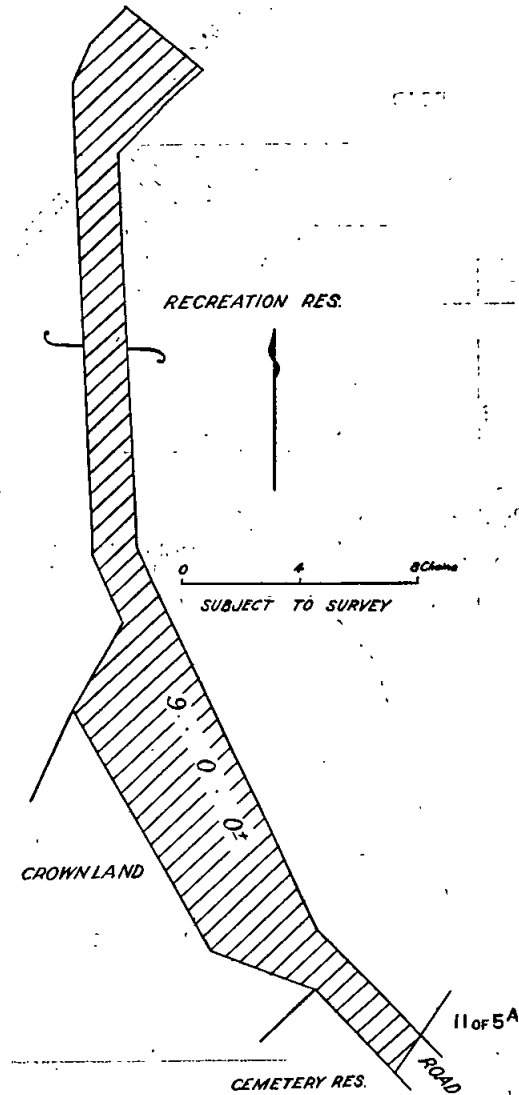

DRY DIGGINGS.—The temporary reservation, by Order in Council of the 23rd March, 1874, of 2 acres 1 rood 7 perches of land in the Township of Dry Diggings as a site for State School purposes is about to be revoked so far only as the portion containing 7 perches, indicated by hatching on plan hereunder, is concerned.—(D.221⁽²⁾) (Rs.8553.)

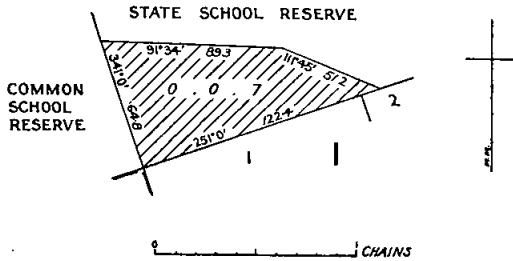

FRANKLIN.—The temporary reservation by Order in Council of the 2nd November, 1874, of 4 acres 1 rood 2 perches of land in the Parish of Franklin as a site for Recreation purposes is about to be revoked so far only as the portion containing 1 perch, indicated by hatching on plan hereunder, is concerned.—(F.77⁽⁹⁾) (Rs.4774.)

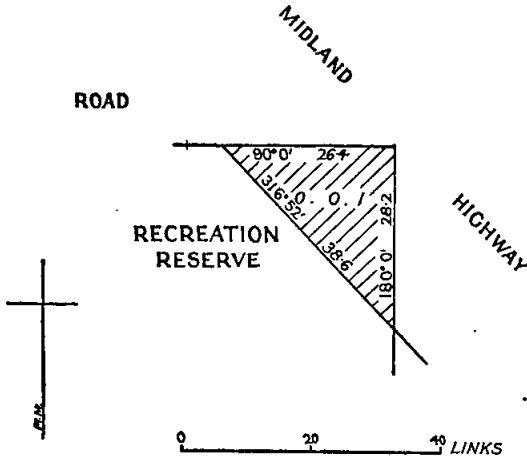

MOE.—The temporary reservation, by Order in Council of the 28th April, 1886, of 2 acres 2 roods 4 perches of land in the Parish of Moe as a site for Watering purposes, revoked as to part by Order in Council of the 24th June, 1902, is about to be revoked so far only as the portion containing 12 perches, indicated by hatching on plan hereunder, is concerned.—M.498⁽¹¹⁾ (C.69819.)

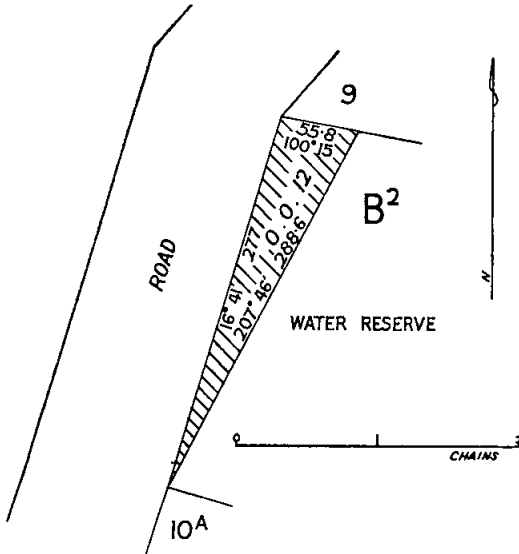

PURRUMBETE SOUTH.—The temporary reservation, by Order in Council of the 21st October, 1919 (see *Government Gazette*, 29th October, 1919, page 2563) of 2 acres 2 perches of land in the Parish of Purrumbete South as a site for a State School is about to be revoked so far only as the portion containing 1 rood 1 perch, indicated by hatching on plan hereunder, is concerned.—(P.98⁽³⁾) (Rs.2030.)

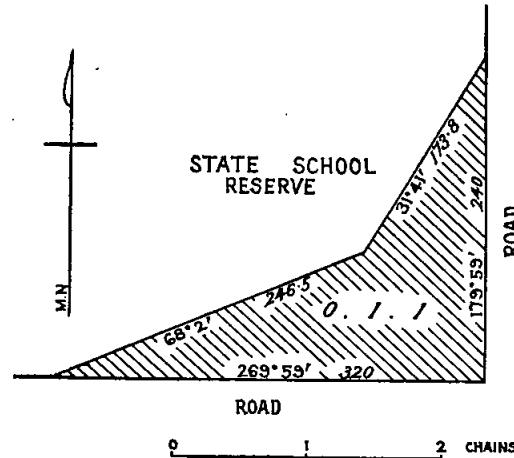

BENDIGO.—The temporary reservation, by Order in Council of the 16th June, 1954, of 2 roods, more or less, of land at Bendigo, Parish of Sandhurst, as a site for a Public Hall and for Public Gardens is about to be revoked.—(S.372⁽¹²³⁾) (Rs.7267.)

SARSFIELD.—The temporary reservation, by Order in Council of the 11th December, 1894, of 20 acres of land in the Parish of Sarsfield as a site for a Hospital or Place for isolating persons suffering from smallpox, cholera or other dangerous infections or contagious disease is about to be revoked.—(S.246⁽³⁾) (Rs.1258.)

WARRNAMBOOL.—The temporary reservation, by Order in Council of the 16th March, 1960, of 124 acres 18 perches of land in the Township of Warrnambool as a site for Public Park and Public Recreation, revoked as to part by Order of the 6th September, 1966, is about to be revoked so far only as the portion containing 1 acre 3 roods 10 perches, more or less, indicated by hatching on plan hereunder, is concerned.—(W.99⁽⁸⁾) (Rs.283.)

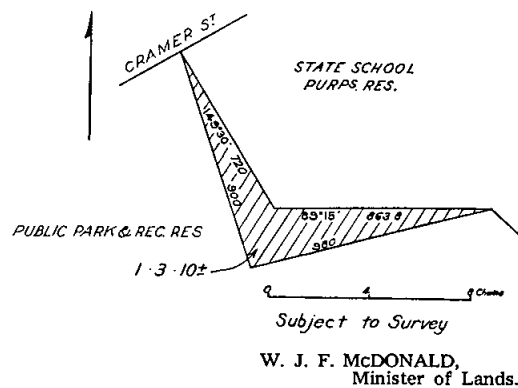

PROPOSED PERMANENT RESERVATION OF LAND AS A SITE.

IN pursuance of sections 14 and 21 of the *Land Act 1958*, notice is hereby given that it is the intention of the Governor in Council to reserve permanently from sale, from being leased and from having a licence granted in respect thereof the land hereinafter described:—

The following Notice was published 1^o on the 24th January, 1968, pursuant to Order of the 16th January, 1968.

MOOLAP (LEOPOLD).—Land proposed to be permanently reserved as a site for the Recreation, Convenience or Amusement of the people, 2 acres 2 roods 36 perches, more

or less, Parish of Moolap, County of Grant, as indicated by hatching on plan hereunder.—(M.226^(*)) (Rs.8540).

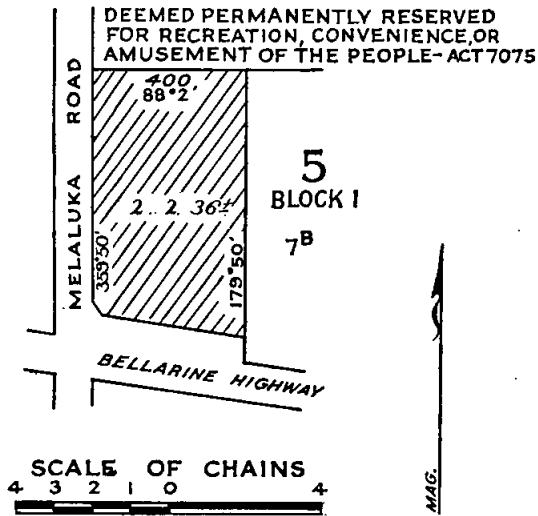

W. J. F. McDONALD,
Minister of Lands.

PRAHRAN (CAULFIELD).—Land proposed to be permanently reserved as a site for Recreation, Convenience and Amusement of the People, 9 acres 2 roods 27 perches, Parish of Prahran, at Caulfield, County of Bourke, as indicated by hatching on plan hereunder.—(P.81⁽¹¹⁾) (Rs.8923).

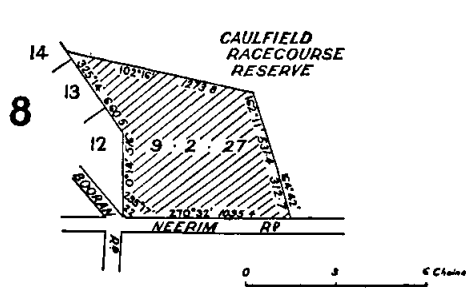

PROPOSED PERMANENT RESERVATIONS OF LANDS AS SITES.

IN pursuance of the provisions of the Land Act 1958, notice is hereby given that it is the intention of the Governor in Council to permanently reserve as sites, and also except from occupation for mining purposes under any miner's right, the lands hereunder referred to:—

The following Notices were published 1^o on the 10th January, 1968, pursuant to Orders of the 19th December, 1967.

BALNARRING.—Land proposed to be permanently reserved as a site for Public Purposes, 3 acres 3 roods 3 perches, Parish of Balnarring, County of Mornington, as indicated by hatching on plan hereunder.—(B.74^(*)) (Rs.2091).

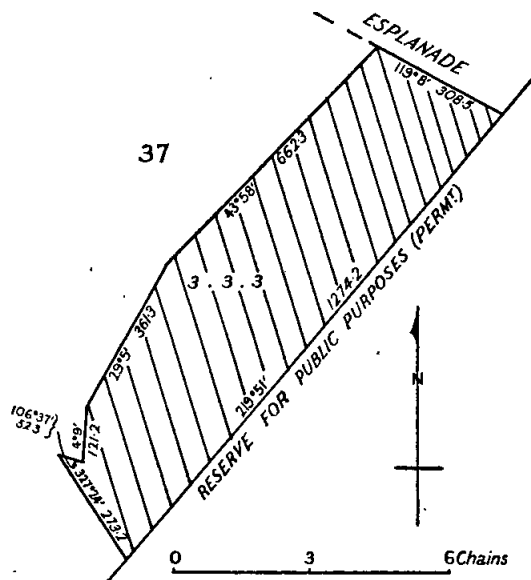

BULLARTO SOUTH.—Land proposed to be permanently reserved as a site for Water Supply purposes, 3 acres 2 roods 25 perches, Township of Bullarto South, Parish of Bullarto, County of Talbot, as indicated by hatching on plan hereunder.—(B.645⁽¹²⁾) (Rs.2547).

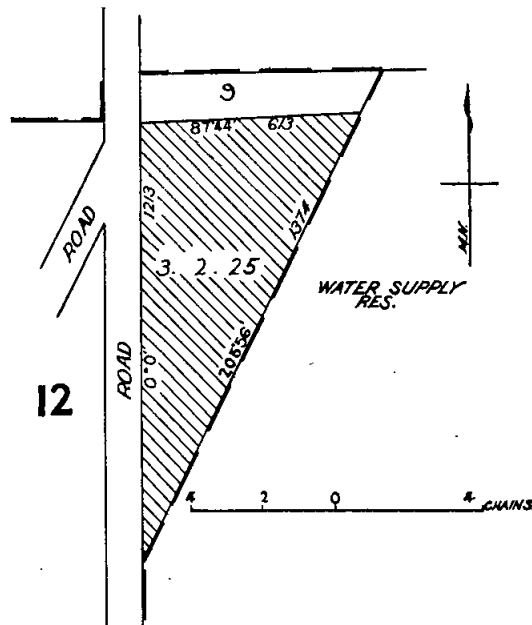

W. J. F. McDONALD,
Minister of Lands.

COMMONS ABOUT TO BE DIMINISHED.

IN pursuance of the provisions contained in the *Land Act* 1958, notice is hereby given that it is the intention of the Governor in Council to diminish the common herein-after mentioned, viz.:—

The following Notices were published 1° on the 24th January, 1968, pursuant to Orders of the 8th November, 1967.

The Moyston Common, proclaimed as such by the Governor-in-Council on the 5th March, 1889, is about to be diminished by the excision therefrom of all lands except the portions indicated by hatching on plan hereunder and containing 100 acres, more or less.—(M.299(*), (F^s) (Rs.465).

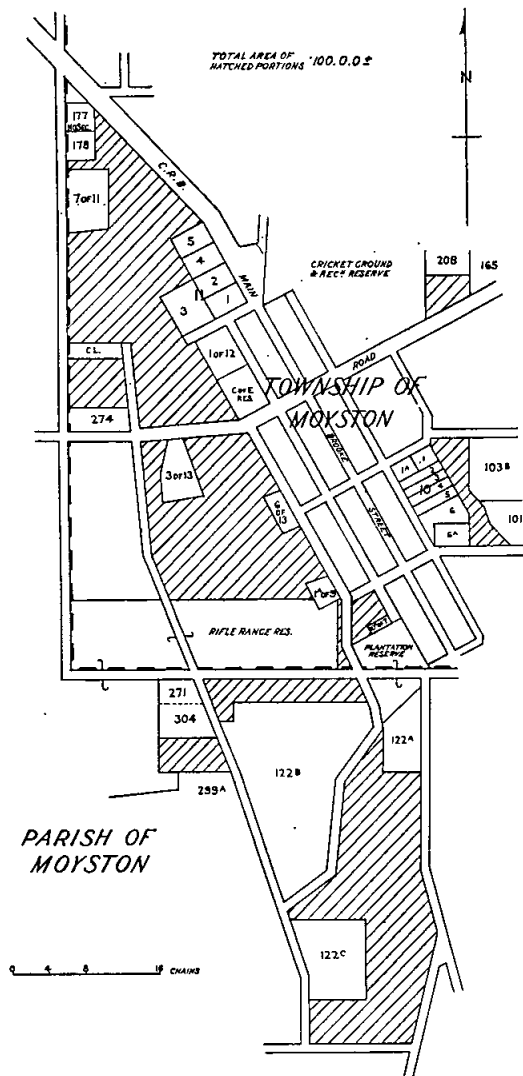

The Maldon Shire Common, proclaimed as such by the Governor in Council on the 2nd April, 1889, and altered by Order in Council of the 23rd April, 1912, is about to be diminished by the excision therefrom of the portion in the Township of Maldon containing 8 acres 2 roods 10 perches, more or less, indicated by hatching on plan hereunder.—(Rs.353.)

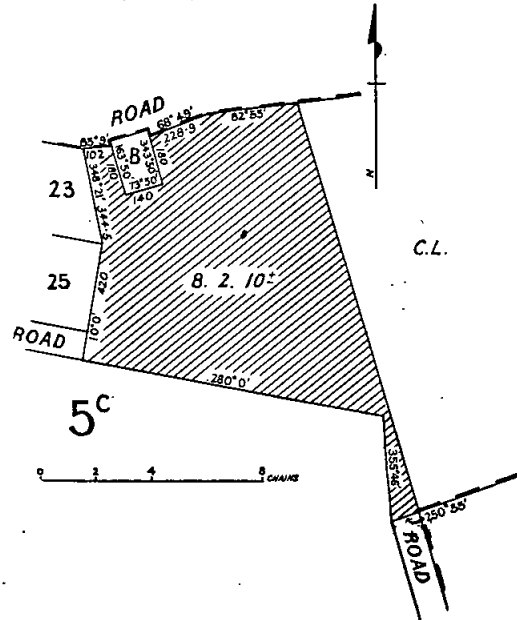

W. J. F. McDONALD,
Minister of Lands.

ADDITIONAL REGULATION FOR THE CARE, PROTECTION AND MANAGEMENT OF THE MORTLAKE PUBLIC PARK AND GARDENS RESERVE.

WHEREAS by Section 218 of the *Land Act* 1958 power is given to the Minister of Lands to make Regulations in respect of the care, protection and management of any Crown land which has been reserved under the *Land Acts* for any public purpose whatsoever and which has not been conveyed to or vested in trustees, and for further purposes so enacted: Now therefore the Minister of Lands in pursuance of the power conferred aforesaid doth hereby make the following additional Regulations in respect of the remaining portion of the land in the Township of Mortlake temporarily reserved by Order in Council dated 19th August, 1872, as a site for Public Park and Garden.

REGULATION.

(30) No person shall drive any vehicle within the Mortlake Public Park and Garden Reserve at a greater speed than 15 miles per hour.—(Rs.5959.)

Given under my hand at Melbourne on the 17th day of January, 1968.

W. J. F. McDONALD,
Minister of Lands.

Every person who contravenes or fails to comply with these Regulations shall, in accordance with the provisions of section 218 of the *Land Act* 1958, for each offence be liable to a penalty of not more than Fifty dollars, and every person who contravenes or fails to comply with any such Regulations, and who, after he has been warned by any bailiff of Crown lands or by any member of the Police Force, does not desist therefrom may be forthwith apprehended by such bailiff or member of the Police Force and taken before some justice to be dealt with according to law and shall be liable to a penalty of not more than One hundred dollars.

LOCAL GOVERNMENT ACT 1958.

IN pursuance of the powers conferred by sub-section 3A of section 575 of the *Local Government Act* 1958, I, William John Farquhar McDonald, Her Majesty's Minister of Lands in the State of Victoria, hereby declare that the road set out on Crown land in the Township of Mallacoota, Parish of Mallacoota, County of Croajingolong, as delineated and indicated by hachure on the plan hereunder

be a private street within the meaning of and for the purposes of Division 10, Part XIX. of the said Act.—(Corres. No. H.031670.)

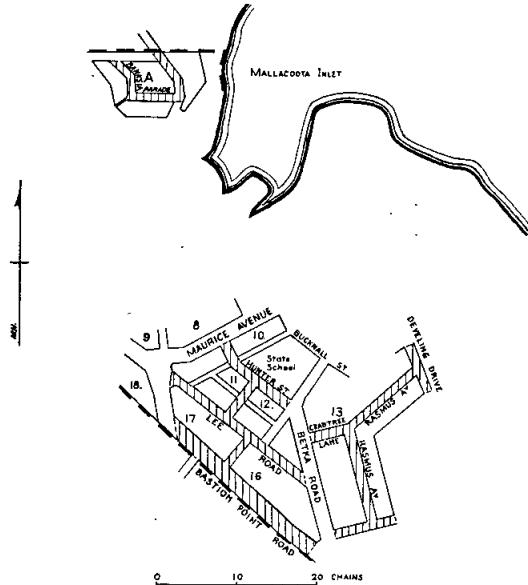

Dated at Melbourne this 17th day of January, 1968.

W. J. F. McDONALD,
Minister of Lands.

COMMITTEES OF MANAGEMENT OF RESERVES.

APPOINTMENTS.

NOTICE is hereby given that, in pursuance of section 221 of the Land Act 1958, the following appointments of Committees of Management of reserved Crown lands have been made by the Minister of Lands:—

"ARARAT PUBLIC RECREATION RESERVE."

Council of the City of Ararat as a Committee of Management of the land in the Township and Parish of Ararat temporarily reserved by Order in Council dated the 14th November, 1967, as a site for Public Recreation and known as the "Ararat Trotting Arena".—(Corres. Rs.8890.)

"BANNERTON NORTH RECREATION RESERVE."

James Kempton, Alex Joseph Licence, Roy Daniel Brice, Mervyn Keith Tyers and Donald George Gordon, as a Committee of Management for a period of three (3) years of the land in the Parish of Bumbang temporarily reserved by Order in Council dated the 9th October, 1962, as a site for Public Recreation and known as the "Banner-ton North Recreation Reserve".—(Corres. Rs.7810.)

"BEECHWORTH POWDER MAGAZINE."

David Aloysius Patrick McKenzie McHarg, James Jackson Macaulay, Rodney Disney Davidson (as Chairman) and Frank Strahan as a Committee of Management of the land in the Parish of Beechworth temporarily reserved by Order in Council dated the 11th April, 1967, as a site for Public Purposes (Historical purposes) and known as the "Beechworth Powder Magazine".—(Corres. Rs.8801.)

"COWANGIE RACECOURSE AND RECREATION RESERVE."

Harold Ray Wills, Allan Keith Gibson and William Richard James Kelly as a Committee of Management for a period of three (3) years of the land in the Township of Cowangie, Parish of Tutey, temporarily reserved by Order in Council dated the 30th October, 1923 as a site for Racecourse and Recreation purposes and known as the "Cowangie Racecourse and Recreation Reserve".—(Corres. Rs.2433.)

SITE FOR PUBLIC RECREATION AT DANDENONG.

The Council of the City of Dandenong as a Committee of Management of the land in the Township and Parish of Dandenong temporarily reserved by Order in Council dated the 14th November, 1967 as a site for Public Recreation.—(Corres. Rs.314.)

"DIGBY MECHANICS' INSTITUTE RESERVE."

Donald Alexander McIntyre, Ralph Norman Dunn and Leslie Gordon Guthridge as a Committee of Management for a period of three (3) years of the land in the Township of Digby temporarily reserved by Order in Council dated the 10th August, 1868 as a site for a Mechanics' Institute and known as the "Digby Mechanics' Institute Reserve".—(Corres. Rs.1583.)

"ECHUCA PUBLIC PURPOSES (COMMUNITY CENTRE) RESERVE."

Betty Joyce Graham, Frances Veronica Galvin, Wendy Margaret Gallaway, Avis Rosamond Simmons, Elaine Maree Flint, David Charles Bennie, John William Willoughby, Edward Wallace Thomas, Barry Richard Brown and Arthur Ernest Rosendale as a Committee of Management for a period of three (3) years of the land in the Parish of Echuca North temporarily reserved by Order in Council dated the 20th October, 1964 as a site for Public Purposes.—(Corres. Rs.8380.)

"GEELONG EAST PUBLIC HALL, FREE LIBRARY AND RECREATION RESERVE."

Dawson Ford Gillies, Evan Raymond McKinnon, Leonard James Hoyle, Valentine Satchell, Herbert Hoyle, Murray Cairncross, William Henry James Newcombe and Wilfred Frank Anderson (for a period of three (3) years) and Harold George Verrall (for so long only as he shall continue to be a Councillor and the elect of the Council of the City of Geelong) of the land in the City of Geelong temporarily reserved by Order in Council dated the 11th April, 1906 as a site for a Public Hall, Free Library and Recreation Purposes and known as the "Geelong East Public Hall, Free Library and Recreation Reserve".—(Corres. Rs.5491.)

"GORMANDALE MECHANICS' INSTITUTE RESERVE."

James Charles Thexton, Victor Alan Bissett, William Russell Hemphill, William Alan Bissett, Herman Bernhard Lenghaess, Victor Thomas Morley, Ernest George Turner, Richard Kemp Rouse, Lindsay Alfred Onley, Reginald Edward Missen, Sydney James Lay and Noel William Schroeter as a Committee of Management for a period of three (3) years of the land in the Parish of Willung permanently reserved by Order in Council dated the 3rd October, 1932 as a site for a Mechanics' Institute and known as the "Gormandale Mechanics' Institute Reserve".—(Corres. Rs.4229.)

"KANIVA RACECOURSE RESERVE."

William Henry Hicks, Robert William Hicks, Horace Marshall Powell, Alan Thomas Dalziel, John Cliffy Grant and Percival Lloyd Williams as a Committee of Management for a period of three (3) years of the land in the Parish of Kaniva temporarily reserved by Order in Council dated the 25th November, 1924 as a site for a Racecourse and Public Recreation and known as the "Kaniva Racecourse Reserve".—(Corres. Rs.3019.)

"LARA RECREATION RESERVE."

Ronald John Branch, James Wilson Pettitt, Allan William Mathieson, John Darcy, Roy Alexander Grills, John Robert Spalding, Donald Frank Walker, Cyril John Olive and Roy William Cook as a Committee of Management for a period of three (3) years of the land in the Township of Lara temporarily reserved for Cricket and other purposes of Public Recreation and known as the "Lara Recreation Reserve".—(Corres. Rs.2307.)

"MARLO PUBLIC PURPOSES RESERVE."

The Council of the Shire of Orbost as the Committee of Management of the remaining portions of the reserved Crown lands in the Parish of Orbost East, together with such portion of the foreshore reserve, both of which are indicated by red color on plan "O/18.2.1941" attached to Lands Department correspondence Rs.5157, and the land in the Parish of Orbost East, Township of Marlo temporarily reserved by Order in Council dated the 14th November, 1967, the whole known as the "Marlo Public Purposes Reserve".—(Corres. Rs.5157.)

"MARNOO SOLDIERS' MEMORIAL PARK."

Allan Brabender Cameron, James Galloway Aitken, Robert William Anderson, James Bevan Barham and Allan Woods as a Committee of Management for a period of three (3) years from the 5th December, 1967, of the land in the Parish of Marnoo permanently reserved by Order in Council dated the 26th May, 1924 as a site for a Public

Park and Recreation Grounds, to serve as a Memorial to the Soldiers who took part in the recent War and known as the "Marnoo Soldiers' Memorial Park".—(Corres. Rs.1696.)

"MODELLA RECREATION RESERVE."

Reginald Ernest Purvis, Kelvin L. Vistarini, James Purvis, Stanley Kemp, Robert Athol John Camp, James Edward Dawson, Eric William Rogers, Robert Norton, Fred Strybosch and Harold Wilby as a Committee of Management for a period of three (3) years of the land in the Parish of Yannathan temporarily reserved by Order in Council dated the 25th October, 1961 as a site for Public Recreation, and known as the "Modella Recreation Reserve".—(Corres. Rs.8080.)

"MOUNT HOTHAM ALPINE RESERVE."

Mr. Mick Hull as a representative of the Victorian Ski Association in the place of Neil MacLean (resigned) as a member of the Committee of Management of the reserved Crown land within the red outline on plan marked MH/9.4.62 attached to Lands Department correspondence Rs.8115, and known as the "Mount Hotham Alpine Reserve".—(Corres. Rs.8115.)

"MURMUNGEE RECREATION RESERVE."

James Neary, Donald George Witherow, Russell Francis Caldwell, Albert Maxwell Sonnemann, Geoffrey A. Heywood, Robert James Witherow, Alexander Bruce Witherow, David James Ferguson, Clemens James Orton and Ronald Patrick O'Connor as a Committee of Management for a period of three (3) years of the land in the Parish of Murrunggee, temporarily reserved by Order in Council, dated the 22nd December, 1939, as a site for Public Recreation and known as the "Murrunggee Recreation Reserve".—(Corres. Rs.5009.)

"NAREEB RECREATIONAL RESERVE."

Donald McKenzie, Allan Archie Roll, William Thomas Schofield, David Hugh Edwards, Thomas James Giles, Alfred Frost and William Ernest Wilkens as a Committee of Management for a period of three (3) years of the land in the Parish of Bilpah, temporarily reserved as a site for Public Recreation by Order in Council, dated the 29th July, 1952, and known as the "Nareeb Recreation Reserve".—(Corres. Rs.6984.)

"OUTTRIM RECREATION RESERVE."

Leslie Michael Whelan, Mervyn George Close, Robert Russell Drysdale, Douglas James Close, Ernest James Thomas, Ernest James Watt, Edward Coleman Grabham, Edgar John Thomas Olden, Gordon Thomas Whelan and John Alexander MacKay as a Committee of Management for a period of three (3) years of the land temporarily reserved by Order in Council dated the 22nd December, 1902, as a site for Public Recreation in the Parish of Kongwak, and known as the "Outtrim Recreation Reserve".—(Corres. Rs.5429.)

"PATCHEWOLLOCK RACECOURSE AND RECREATION RESERVE."

James Alexander Jolly, James Alexander Bathgate, George Alexander Cummings, Raymond Keith Loxton, Neil Alex Walch and Alan Edward Grigg as a Committee of Management for a period of three (3) years of the land in the Parish of Patchewollock, temporarily reserved by Order in Council dated the 25th October, 1927, as a site for Racecourse, Public Recreation and Show Grounds and known as the "Patchewollock Racecourse and Recreation Reserve".—(Corres. Rs.3563.)

"POOWONG EAST PUBLIC HALL RESERVE."

Barry Lester Olsen, Gordon Robert Peel, Kelvin Dudley Olsen, Henry Moorhead Osborne, Wilbur Henry Olsen, Gwladys Evelyn Gooch, George Bond Ronalds, Jessie Catherine Osborne, and Frederick Lester Olsen as a Committee of Management for a period of three (3) years of the land in the Parish of Poowong East, temporarily reserved by Order in Council dated the 25th October, 1961, as a site for a Public, Hall and known as the "Poowong East Public Hall Reserve".—(Corres. Rs.8076.)

"PRINCESS PARK", SHEPPARTON.

The Council of the City of Shepparton as the Committee of Management of the remaining portion of land in the Township and Parish of Shepparton, temporarily reserved by Orders in Council dated the 5th September, 1950, and 8th November, 1967, as sites for Public Recreation, and known as "Princess Park".—(Corres. Rs.1080.)

"QUEEN'S PARK PUBLIC RECREATION RESERVE", HEALESVILLE.

The Council of the Shire of Healesville as a Committee of Management of the remaining portion of land in the Township of Healesville, Parish of Gracedale, temporarily reserved by Orders in Council dated the 9th August, 1886, and 22nd November, 1955, as sites for Public Recreation, together with the land in the Township of Healesville, Parish of Gracedale temporarily reserved by Order in Council dated the 14th November, 1967, as a site for Public Recreation, the whole known as "Queen's Park Public Recreation Reserve".—(Corres. Rs.625.)

This appointment is made in lieu of all previous appointments which are hereby revoked.

"RESERVOIR AND GATHERING GROUND FOR WATER SUPPLY PURPOSES, TOWNSHIP OF MARYSVILLE."

Marysville Waterworks Trust as a Committee of Management of the land in the Township of Marysville, Parish of Steavenson, temporarily reserved by Order in Council dated the 14th November, 1967, as a site for Reservoir and gathering ground for Water Supply purposes.—(Corres. Rs.8897.)

"SAMPSON'S LOOKOUT" CAMPING RESERVE AT MARLO.

The Council of the Shire of Orbost as the Committee of Management of the land in the Township of Marlo, temporarily reserved by Orders in Council dated the 31st May, 1932, 20th September, 1960, and 14th November, 1967, as sites for Camping Purposes, and known as "Sampson's Lookout".—(Corres. Rs.4205.)

"ST. ALBANS RECREATION RESERVE."

Eric Roy Reid, Robert Edward Warren, Clifford John Grinter, Alan Leslie Reid and Alexander James Wellman as a Committee of Management for a period of three (3) years of the land permanently reserved by Order in Council dated the 10th April, 1922, as a site for Public Park and Recreation Purposes in the City of Geelong, and known as the "St. Albans Recreation Reserve".—(Corres. Rs.2447.)

"SWAN HILL RACECOURSE AND PUBLIC RECREATION RESERVE."

Brian Esmond Dillon, Norman S. Fountain, George Murray Drummond, Keith Hillgrove and Alex Michael Hayes as a Committee of Management for a period ending the 23rd November, 1968, of the remaining portion of land temporarily reserved as a site for a Racecourse in the Township of Castle Donnington (Swan Hill), and known as the "Swan Hill Racecourse and Public Recreation Reserve".—(Corres. Rs.1789.)

"SWAN HILL RACECOURSE AND GOLFCOURSE PAVILION SITE."

The Corporation of the City of Swan Hill as a Committee of Management of those portions of reserved land in the Township of Castle Donnington (Swan Hill), shown coloured blue and red on plan S/3.1.68, and known as the "Swan Hill Racecourse and Golfcourse Pavilion Site".—(Corres. Rs.1789.)

"TRAGOWEL RECREATION RESERVE."

Jack P. Everest, Alan Hayward Pleasance, Stanley John Phillips, Graham C. Long, Kevin H. McIntosh, Reginald J. Mowat and George S. Jobling as a Committee of Management for a period of three (3) years of the land in the Parish of Tragowel, temporarily reserved by Order in Council dated the 1st June, 1915, as a site for Public Recreation, and known as the "Tragowel Recreation Reserve".—(Corres. Rs.773.)

"VINIFERA RECREATION RESERVE."

Kenneth Ian McLean, Albert William Roberts, Alan Leslie Shadbolt, William George Ditchfield, Kenneth William Phelan, Francis Joseph Dickinson, Harold William Bailey and Frederick Lawrence Boulton as a Committee of Management for a period of three (3) years of the land in the Parish of Tyntynder West, reserved by Order in Council dated the 22nd March, 1949, as a site for Public Recreation, and known as the "Vinifera Recreation Reserve".—(Corres. Rs.6335.)

"WHITTLESEA RESERVES."

Leslie David Russell and John William Turner (for a period of three (3) years) and Kenneth Noel Balharrie, Stanley William Owen and John William Towt (for so long only as they shall continue to be Councillors and the elect of the Shire of Whittlesea) together with Robert Leslie Batten, James Nicholas Clements, Lewis Winslade

Jackson and Kenneth McPhee (as representatives of the Whittlesea Agricultural Society) and Keith Leonard Hall and Howard Athol Jemmeson (as representatives of the Whittlesea Football Club) as a Committee of Management of the land in the Township of Whittlesea, permanently reserved as a site for a Public Park and that portion of the permanent reservation along the Plenty River, both of which are indicated by yellow and blue colours respectively on plan marked WA/3.8.39 attached to Lands Department correspondence Rs.2111 and known as the "Whittlesea Public Park", together with the land in the Township of Whittlesea, temporarily reserved by Order in Council dated the 10th October, 1905, as a site for Agricultural Show Yards and by Order in Council dated the 19th May, 1954, for the additional purpose of Public Recreation, and known as the "Whittlesea Show Grounds and Public Recreation Reserve", together with the land in the Township of Whittlesea, temporarily reserved by Orders in Council dated the 23rd May, 1906, and 30th

July, 1907, as a site for Cricket and other purposes of Public Recreation, and known as the Whittlesea Recreation Reserve".—(Corres. Rs.2111, Rs.2491, Rs.937.)

"WILLIAMSTOWN HOMES FOR THE AGED RESERVE."

James Taylor Gray, Theopoulius William Nelson and Edward Dann (for so long only as they shall continue to be trustees of the Williamstown Elderly Citizens' Village Society) as a Committee of Management of the land in the Parish of Cut-paw-paw, at Williamstown, temporarily reserved by Order in Council dated the 14th November, 1967, as a site for Public Purposes (Homes for the Aged) and known as the "Williamstown Homes for the Aged Reserve".—(Corres. Rs.8901.)

W. J. F. McDONALD,
Minister of Lands.

Department of Crown Lands and Survey,
Melbourne, 17th January, 1968.

Land Act 1958.

LEASE SURRENDERED.

NOTICE is hereby given that the Governor in Council has accepted the surrender of the Lease mentioned in the Schedule hereunder for the reason specified.

District.	Corr. No.	Name.	Section of Land Act under which Leased.	Parish.	Allotment.	Section.	Area.	Reason.
Mallee ..	0349/217	The President Councillors and Rate-payers of the Shire of Walpeup	..	Timberoo ..	Pt. 40A and 40	..	A. R. P. 7 0 3	To become Government road

Department of Crown Lands and Survey,
Melbourne, 15th January, 1968.

W. J. F. McDONALD,
Minister of Lands.

PUBLIC SERVICE NOTICES

No. 1813.

Public Service Act 1958, Section 50.

REGULATIONS.—PART IV.—SALARIES AND INCREMENTS.

THE Public Service Board, in pursuance of the powers conferred by the Public Service Act 1958, hereby amends its Regulations as shown below :—

SIXTH SCHEDULE.

TEMPORARY EMPLOYEES.

Designations of Positions and Rates of Salaries.

Department and Designation of Position.	Yearly Rate of Salary.		Increments (Annual).
	Minimum.	Maximum.	
WATER SUPPLY DEPARTMENT.	\$	\$	
Delete— Assistant (Materials and Testing), Grade I. ..	2,458	2,724	Σ
Add— Assistant (Materials and Testing), Grade I.— Junior— At 20 years of age ..	2,458	1,906	..
Adult ..	2,458	2,724	Σ
Σ See Regulation 83 (2).			

F. E. CAHILL, Chairman.
R. H. DURRANT, Acting Secretary.

Office of the Public Service Board,
Melbourne, 8th January, 1968.

No. 1810.

Public Service Act 1958, Section 50.

REGULATIONS.—PART IV.—SALARIES AND INCREMENTS.

THE Public Service Board, in pursuance of the powers conferred by the Public Service Act 1958, hereby amends its Regulations as shown below :—

SIXTH SCHEDULE.

TEMPORARY EMPLOYEES.

Designations of Positions and Rates of Salaries.

Department and Designation of Position.	Yearly Rate of Salary.		Increments (Annual).
	Minimum.	Maximum.	
WATER SUPPLY DEPARTMENT.	\$	\$	
Add— Research Officer (Female) ..	3,030	3,758	2 of \$115, 1 of \$248 and 2 of \$125

F. E. CAHILL, Chairman.
R. H. DURRANT, Acting Secretary.

Office of the Public Service Board,
Melbourne, 8th January, 1968.

No. 1811.

Public Service Act 1958, Section 50.

REGULATIONS.—PART IV.—SALARIES AND INCREMENTS.

THE Public Service Board, in pursuance of the powers conferred by the *Public Service Act 1958*, hereby amends its Regulations as shown below :—

SIXTH SCHEDULE.

TEMPORARY EMPLOYEES.

Designations of Positions and Rates of Salaries.

Department and Designation of Position.	Yearly Rate of Salary.		Increments (Annual).
	Minimum.	Maximum.	
GENERAL.			
<i>Add—</i>			
Caretaker, Grade II.// ..	2,334	2,572	£
Caretaker, Grade I.// ..	2,108	2,382	£
DEPARTMENT OF AGRICULTURE.			
<i>Delete—</i>			
Caretaker, Milk Board ..	2,108	2,382	£
CHIEF SECRETARY'S DEPARTMENT.			
<i>Delete—</i>			
Caretaker, Accident Insurance Office// ..	2,298	2,572	£
<i>Immigration.</i>			
<i>Delete—</i>			
Caretaker, Reception Centre	2,108	2,382	£
<i>Office of the Chief Commissioner of Police.</i>			
<i>Delete—</i>			
Caretaker	2,108	2,382	£
PUBLIC WORKS DEPARTMENT.			
<i>Delete—</i>			
Caretaker #	2,108	2,382	£

With quarters when required to reside on premises.
 @ With quarters when required to reside on premises.
 £ See Regulation 83 (2).

F. E. CAHILL, Chairman.
 R. H. DURRANT, Acting Secretary.

Office of the Public Service Board,
 Melbourne, 18th December, 1967.

No. 1812.

Public Service Act 1958, Section 39.

REGULATIONS.—PART IV.—SALARIES AND INCREMENTS.

THE Public Service Board, in pursuance of the powers conferred by the *Public Service Act 1958*, hereby amends its Regulations as shown below :—

FOURTH SCHEDULE.

ADMINISTRATIVE DIVISION.

Amount of Salary Assigned to Offices in Class "A1".

Office.	Yearly Rate of Salary.
EDUCATION DEPARTMENT.	
<i>Delete—</i>	
Special Duties Officer	8,948
<i>Add—</i>	
Special Duties Officer	10,048

F. E. CAHILL, Chairman.
 R. H. DURRANT, Acting Secretary.

Office of the Public Service Board,
 Melbourne, 12th January, 1968.

TENDERS

PUBLIC WORKS DEPARTMENT

TENDERS will be received at Public Works Department, Treasury-place, Melbourne, until **TWO** p.m. on dates shown and for purposes mentioned hereunder.

Particulars and tender forms available at Contracts Office, Room 7, Building Division, Parliament-place and at places indicated in brackets hereunder.

Abbreviations in brackets mean:—W.O.—Inspector of Works Office; P.S.—Police Station; C.S.—Consolidated School; H.E.S.—Higher Elementary School; H.S.—High School; S.S.—State School; T.S.—Technical School.

Tenders to be submitted on the Department's printed Tender Form and will not be received by telephone. All tenders must be on a "Firm Tender" basis. The lowest or any tender will not necessarily be accepted.

Address tenders to the Minister of Public Works, and endorse the envelope containing the tender "Tender for closing Tuesday,

Hand delivered tenders to be placed in the Tender Box of the Public Works Department, located on the wall of the centre entrance foyer, Ground Floor, New Treasury Building, Treasury-place, Melbourne.

No preliminary deposit is required with any tender, but a successful tenderer will be required to pay a deposit for any accepted tender of \$5,000 or over.

Tuesday, 30th January, 1968.

Building, Electrical and Mechanical Works.

Alvie.—Renovations, &c., Consolidated School. (W.O., Camperdown.) (Amended Specification.)

Bairnsdale.—Roof repairs, Technical School. (W.O., Bairnsdale.)

Ballarat.—Erection of six class-rooms, S.S. 4936. (W.O., Ballarat.)

Ballarat.—Electrical installation, S.S. 4936. (W.O., Ballarat.)

Ballarat.—Mechanical services, S.S. 4936. (W.O., Ballarat.)

Brooklyn West.—Enclosing entrance, re-blocking, &c., S.S. 4825. (Re-advertised.) (Amended Specification.)

Buninyong.—Renewal of slate roof with terra cotta or concrete tiles, S.S. 1270. (W.O., Ballarat; P.S., Buninyong.)

Colac.—Renovations, High School. (W.O., Geelong.) (Amended Specification.)

Dooen.—Additional floor to Dormitory, &c., Longerenong Agricultural College. (W.O., Horsham and Ballarat.)

Dooen.—Electrical installation, Agricultural College. (W.O., Ballarat and Horsham.)

Dooen.—Mechanical services, Agricultural College. (W.O., Ballarat, Bendigo and Horsham.)

Dookie.—Erection of new kitchen and dining hall, Agricultural College. (Bills of Quantities Available.) (W.O., Shepparton.)

Footscray West.—Re-blocking of class-rooms, S.S. 3890.

Heatherton.—Erection of store, Sanatorium.

Kingsbury.—Renovations, Technical School.

Millbrook.—Conversion of septic closets, &c., S.S. 1972. (W.O., Ballarat.)

Mitcham.—Removal and resiting of shelter shed, &c., S.S. 2904. (Re-advertised.)

Oakleigh.—Extensions and alterations, Police Station.

Warncoort.—Renovations, S.S. 2218 and Residence. (W.O., Geelong.)

Wendouree.—Renovations, Bristol Building, S.S. 1813. (W.O., Ballarat.)

Williamstown North.—Renovations to toilet blocks, S.S. 1409. (Re-advertised.)

Site Works.
 Casterton.—Asphalt, concrete and gravel works, &c., High School. (W.O., Warrnambool.)

Miscellaneous.
 Melbourne.—Supply of stoneware pipes and fittings, Public Works Department.

Stony Point.—Re-charging, acetoneing and inspection of acetylene navigation light cylinders from 1st January, 1968 to 31st December, 1968, Buoy Depot, Ports & Harbours Branch. (Re-advertised.)

Tuesday, 6th February, 1968.**Building, Electrical and Mechanical Works.**

Balwyn.—Erection of double brick garage, "Illoura" House. (Re-advertised.)
 Bayswater North.—Sewerage filter and humus tank installation, S.S. 4143.
 Beechworth.—Repairs to slate roof, S.S. 1560. (W.O., Wangaratta.)
 Beverley Hills.—Connexion to sewer, S.S. 4813.
 Boronia.—Renovations and new toilet block, S.S. 4081.
 Dromana.—Erection of new Court House. (W.O., Mornington.)
 Dromana.—Electrical installation, Court House. (W.O., Mornington.)
 Essendon.—Renovations, &c., High School.
 Geelong East.—Renovations, Technical School. (W.O., Geelong.)
 Glenhuntly.—New brick toilet block, S.S. 3703. (Re-advertised.)
 Mooroolbark.—Construction of classrooms, canteen, &c., Technical School.
 Mooroolbark.—Mechanical services, Technical School.
 Porepunkah.—Renovations, S.S. 1144. (W.O. Benalla.)
 Prahran.—Construction of a new Chest Clinic. (Bills of Quantities Available.)
 Prahran.—Electrical installation, Chest Clinic.
 Prahran.—Mechanical services, Chest Clinic.
 Prahran.—Oil-electric passenger lift, Chest Clinic.
 Prahran.—Electric service lift, Chest Clinic.
 Toorak.—Renovations, Marathon Spastic Centre, Malvern-road.
 Tower Hill.—Erection of a Natural History Centre. (W.O., Warrambool.)
 Wantirna South.—Renovations, S.S. 4582.

Furniture and Furnishings.

Bendigo.—Supply and fix curtains, Teachers' College Hostel.

Site Works.

Brighton.—Asphalt, concrete and drainage works, &c., High School.
 Merri.—Asphalt, concrete and drainage works, &c., S.S. 3110.
 Tottenham North.—Asphalt repairs, &c., S.S. 4703.
 Traralgon.—Concrete and drainage works, Hobson Park Hospital. (W.O., Traralgon and Warragul.)

Miscellaneous.

Kew.—Supply and delivery of one drying tumbler, Mental Hospital.

Tuesday, 13th February, 1968.**Building, Electrical and Mechanical Works.**

Alberton West.—Renovations, &c., Residence, S.S. 2140. (W.O., Traralgon.)
 Bayswater.—Renovations, &c., S.S. 2163.
 Beechworth.—Renovations, Ward F.9, Mental Hospital. (W.O. Wangaratta.)
 Brunswick South-West.—Renovations, S.S. 4304.
 Carronbank.—New addition, alterations and renovations, S.S. 4883.
 Dookie.—New Staff and Visitors Quarters, Agricultural College. (W.O., Shepparton.)
 Dookie.—Electrical installation in new kitchen and dining block, Agricultural College. (W.O., Benalla and Shepparton.)
 Dookie.—Mechanical services in new kitchen and dining block, Agricultural College. (W.O., Bendigo and Wangaratta.)
 Dookie.—Supply and installation of refrigeration system, Agricultural College. (W.O., Bendigo.)
 Garfield.—Re-stumping and renovations, S.S. 2724. (Re-advertised.) (Amended Specification.)
 Kew.—Interior painting, Residences, 4 and 8 Wells-street, Mental Hospital.
 Mont Park.—Fuel oil installation in Kitchen, Larundel Mental Hospital.
 Newborough East.—Renovations, &c., S.S. 4670. (W.O., Traralgon.)
 Ormond.—Renovations, S.S. 3074.
 Richmond.—Construction of a new three-story building, High School. (Specified Bills of Quantities available.) (Re-advertised.)
 Richmond.—Electrical services, High School. (Re-advertised.)
 Richmond.—Mechanical services, High School. (Re-advertised.)
 Werribee.—Erection of sheep holding and experiment shed, Research Farm. (W.O., Geelong.)

Furniture and Furnishings.

Ararat.—Supply and fix curtains, Mental Hospital.
 Ballarat.—Supply of foam mattresses and pillows, Mental Hospital.
 Broadmeadows West.—Supply of furniture, Technical School.
 Bundoora.—Supply and lay rubber flooring, Repatriation Hospital.
 Sunbury.—Supply of curtain material, Mental Hospital.

Site Works.

Nunawading South.—Asphalt repairs and concreting, S.S. 4808.
 Sandringham.—Asphalt repairs, Technical School.

Miscellaneous.

Ballarat.—Supply of timber, &c., Mental Hospital.
 Coburg.—Supply and delivery of reinforcing steel, Pentridge Prison.
 Coburg.—Supply and delivery of steel windows and security grilles, Pentridge Prison.
 Coburg.—Supply and delivery of pre-mix concrete, Pentridge Prison.
 Noble Park.—Supply and delivery of fabricated stands, &c., Technical School.
 Mont Park.—Supply and fix refrigerator, Janefield Training Centre.

Tuesday, 20th February, 1968.**Building, Electrical and Mechanical Works.**

Ballarat.—Internal painting, Residences, Mental Hospital. (W.O., Ballarat.)
 Ballarat.—Erection of six class-rooms, S.S. 4981. (W.O., Ballarat.)
 Ballarat.—Electrical installation. S.S. 4981. (W.O., Ballarat.)
 Ballarat.—Plenum heating, S.S. 4981. (W.O., Ballarat.)
 Blackburn.—Connexion to sewer, Technical School.
 Digby.—Renovations, S.S. 2047. (W.O., Warrambool.) (Amended Specification.)
 Greensborough.—Renovations, Residence, Police Station.
 Hawthorn.—Attention to roof plumbing, Moorakynne, 6A Lisson-grove.
 Oakleigh.—Renovations, S.S. 4214.
 Pakenham.—Renovations, Residence, 2 Lawn-street, Consolidated School.
 Preston.—External painting of toilet area, Carmel Hostel, 12 Hotham-street.
 Royal Park.—Renovations—Dawson Ward, Psychiatric Hospital.
 Scoresby.—Renovations, Research Station.
 Sunbury.—Renovations, Residence, Mental Hospital.
 Sunbury.—Renovations, Hill Wards, Mental Hospital.
 Sunbury.—Renovations, Ward F.9., Mental Hospital.
 Sunbury.—Rebricking of two steam boilers, Mental Hospital.

Furniture and Furnishings.

Beechworth.—Supply and fix curtains, Mental Hospital.
 Carlton.—Supply of steel filing cabinets, Motor Registration Branch.
 Mont Park.—Floor treatment and laying of sheet vinyl, Ward M.F.3., Mental Hospital.

Site Works.

Sunvale.—Asphalt, drainage and gravel works, S.S. 4818.

Miscellaneous.

Kew.—Supply and delivery of one clothes press, Mental Hospital.
 Mont Park.—Supply and fix heavy duty electric mincing machine, Mental Hospital.
 Port Melbourne.—Supply and delivery of chassis and cabin, gross combination weight 52,000 lb., Plant Depot, Public Works Department.

M. V. PORTER,
 Minister of Public Works.

Public Works Department,
 Melbourne, 3002, 22nd January, 1968.

PRIVATE ADVERTISEMENTS

Water Acts.

PROPOSED WOODS POINT WATERWORKS TRUST.

NOTICE is hereby given that the Mansfield Shire Council has made application to the Honorable the Minister of Water Supply for the constitution of a Waterworks Trust and for the proclamation of a Waterworks District at Woods Point and the construction, maintenance and continuance of Water Supply works within that district under the provisions of the Water Acts.

A general plan and description of the proposed works have been submitted with the application, and copies of same may be seen at the Shire Office at Mansfield and at the General Store at Woods Point.

Any objections should be forwarded to the undersigned.

Dated at Mansfield on the 19th day of January, 1968.
869 R. WOMERSLEY, Secretary.

FRANKSTON SEWERAGE AUTHORITY.

DECLARATION OF SEWERED AREA NO. 1.

THE Frankston Sewerage Authority having made provision for carrying off sewage from each and every property which or any part of which is within the sewerage area hereinafter described doth hereby declare that on and after the 1st day of February, 1968, each and every property which or any part of which is within the said sewerage area shall be deemed to be a seweraged property within the meaning of the *Sewerage Districts Act 1958*.

The boundaries of the sewerage area hereinbefore referred to are—

The Esplanade north of Nolan-street, Bay-street, Nepean Highway from Bay-street to Overton-road, Overton-road, the Frankston-Melbourne railway line from Overton-road to Yuille-street, Flinders-road from Yuille-street to the eastern boundary of the Frankston Community Hospital, the southern boundary of the Frankston Community Hospital, the rear boundaries of the properties facing the southern boundary of the Flinders-road between Yuille-street and Baxter-street, Baxter-street between the northern boundary of No. 7 and Park-street, the western boundary of the Croquet Green, the eastern boundary of No. 60 High-street, the southern boundaries of Nos. 40 to 60 High-street, the southern boundary of No. 5A Kars-street, Kars-street south to Nolan-street and Nolan-street west of Kars-street to The Esplanade.

By order of the said Sewerage Authority.

V. S. McCOMB, Chairman.
G. C. PENTLAND, Secretary.

Dated January 19th, 1968.
Civic Centre, Frankston.

920

SPRINGVALE AND NOBLE PARK SEWERAGE AUTHORITY.

GENERAL NOTICE.

THE above-mentioned Sewerage Authority having made provision for carrying off the sewage from each and every property which or any part of which is within the Sewerage Areas hereinafter described, doth hereby declare that on and after the 1st day of February, 1968, each and every property which or any part of which is within the said Sewerage Areas shall be deemed to be a seweraged property within the meaning of the *Sewerage Districts Act 1958*.

The boundaries of the Sewerage Areas hereinbefore referred to are:—

Sewerage Area No. 204—Springvale:

All those pieces of land comprising Lots 3 to 13 inclusive and Lots 20 and 21 on Lodged Plan of Subdivision No. 79895.

Sewerage Area No. 205—Noble Park.

All those pieces of land comprising Lots 1 to 34 inclusive on Lodged Plan of Subdivision No. 77522.

Sewerage Area No. 206—Springvale:

Commencing at a point being the intersection of the north-eastern side of Princes Highway and the north-western side of Grace-street; thence north-westerly along the north-eastern side of Princes Highway to the southern angle of Lot 1 on Lodged Plan of Subdivision No. 16057; thence northerly along the eastern boundary of the said Lot 1 to its north-eastern angle; thence north-westerly along the north-eastern boundaries of the said Lot 1 and Lots 2, 3, 4 and 5 on the said Lodged Plan to the

eastern boundary of the Springvale North State School Reserve; thence northerly along the eastern boundary of the said School Reserve to the southern side of Police-road; thence easterly along the southern side of Police-road to its intersection with the western side of Hillside-street; thence southerly along the western side of Hillside-street to the southern angle of Lot 65 on Lodged Plan of Subdivision No. 10899; thence north-westerly along the south-western boundary of the said Lot 65 to the northern angle of Lot 8 on the said Lodged Plan; thence south-westerly along the north-western boundary of the said Lot 8 to the north-eastern side of Princes Highway; thence north-westerly along the north-eastern side of Princes Highway to the point of commencement.

For the purposes of these descriptions the Lodged Plans of Subdivision herein referred to shall be taken as those lodged at the Office of Titles, Melbourne.

By Order of the Springvale and Noble Park Sewerage Authority.

A. A. ERICKSEN, Chairman.
H. L. WILLIAMS, Secretary.

898

BOROUGH OF KYABRAM.

LOAN No. 16.

Notice of Intention to Borrow the Sum of \$26,700 for Permanent Works and Undertakings.

NOTICE is hereby given that the Council of the Borough of Kyabram proposes to borrow the principal sum of \$26,700 secured by a charge over the general rates of the municipality, such sum to be raised by the grant of a mortgage in accordance with the provisions of the *Local Government Act 1958*.

1. The maximum rate of interest that may be paid is 5½ per cent. per annum.

2. The purposes for which the loan is to be applied are—

Construction of concrete kerb, channels and footpaths—Fenaughty-street Church-street, Allan-street, Dawes-road, McCormick-road, Saleyards-road and Albion-street	\$7,500
Council proportion of costs of construction of Oswald-street	1,200
Construction of Fire Brigade Training Track—Northern Sports Oval	6,500
Renovations to Town Hall	3,000
Purchase of land for Drainage Reserve—Kyabram Tongala-road	5,000
Purchase of land for future road requirements—Allan-street	3,500
	\$26,700

3. The period of the loan shall be ten years.

4. The moneys borrowed shall be repayable by providing out of the municipal fund half-yearly instalments of approximately \$1,774 each including principal and interest on the 1st day of April and the 1st day of October during the currency of the loan. The first instalments shall be payable on the 1st day of October, 1968.

5. Such money shall be repayable to The Commissioners of the State Savings Bank of Victoria at the Office of the said Commissioners, corner of Elizabeth and Bourke streets, Melbourne.

The plans and specifications and the estimate of the cost of the proposed works and a statement showing the proposed expenditure of the moneys to be borrowed are open for inspection at the office of the Council of the Borough of Kyabram at Lake-road, Kyabram.

E. T. CORNISH, Town Clerk.

Dated 19th January, 1968.

Borough Offices, Kyabram.

862

SHIRE OF CORIO.

LOAN No. 75.

Notice of Intention to Borrow the Sum of \$50,000 for Permanent Works and Undertakings.

NOTICE is hereby given that the Council of the Shire of Corio proposes to borrow the principal sum of \$50,000 secured by a charge over the general rates of the municipality, such sum to be raised by the grant of a mortgage in accordance with the provisions of the *Local Government Act 1958*.

1. The maximum rate of interest that may be paid is 5½ per cent. per annum.

2. The purpose for which the loan is to be applied is:—

(a) Lara Hall Supper Room	\$5,000	
(b) Donnybrook Road	22,000	
(c) Concrete Footpaths—		
1. Walkers-road	\$710	
2. Cox-road	1,980	
3. Watsonia Part	720	
4. Vines-road	825	
5. Separation-street	745	
6. Thompson-road	1,020	6,000
(d) Main Drain West Anakie-road		17,000
		<u>\$50,000</u>

3. The period of the loan shall be ten years.

4. The moneys borrowed shall be repayable by providing out of the municipal fund half-yearly instalments of approximately \$3,322 each including principal and interest on the 1st day of April and the 1st day of October during the currency of the loan. The first instalment shall be payable on the 1st day of October, 1968.

5. Such moneys shall be repayable to The Commissioners of the State Savings Bank of Victoria at the office of the said Commissioners, corner Elizabeth and Bourke streets, Melbourne.

The plans and specifications and the estimate of the cost of the proposed works and a statement showing the proposed expenditure of the moneys to be borrowed are open for inspection at the office of the Council of the Shire of Corio, Osborne House, North Geelong.

868 W. H. MYERS, Shire Secretary.

SHIRE OF CROYDON.

PURSUANT to the powers conferred by section 522 (1) of the *Local Government Act 1958*, the President, Councillors and Ratepayers of the Shire of Croydon, hereby order that the following lands purchased by the Council for road purposes shall be public highways—

(a) All that piece of land being part of Lot 2, L.P.63599, C.A. 28A, Parish of Ringwood, commencing at a point being the south-east building line of Eastfield-road and Morinda-street, and bearing easterly 69 deg. 36 min. for a distance of 159 feet 2 inches; thence further easterly bearing 98 deg. 58.5 min. for a distance of 30 feet 9 inches; thence southerly bearing 8 deg. 25.5 min. for a distance of 20 feet 5.5 inches; thence westerly bearing 69 deg. 36 minutes for a distance of 187 feet 10 inches; thence northerly bearing 179 degrees 13 minutes for a distance of 35 feet 1 inch to the point of commencement. (Corner of Eastfield-road and Morinda-street.)

(b) All that piece of land being part of Crown allotment 1, Parish of Warrandyte, commencing at a point on the north-west corner of Lincoln-road and Dorset-road, and bearing in a northerly direction 178 deg. 43 min. for a distance of 97 feet; thence south-westerly bearing 43 deg. 43 min. for a distance of 56 feet 7 inches; thence westerly bearing 268 deg. 43 min. for a distance of 79 feet 7 inches; thence south-easterly bearing 294 deg. 12 min. for a distance of 132 feet 6 inches to the point of commencement. (Corner Dorset-road and Lincoln-road.)

Dated this 15th day of January, 1968.

The common seal of the President, Councillors and Ratepayers of the Shire of Croydon, was hereunto affixed in the presence of—

(SEAL) G. L. PILE, Councillor.
G. S. BEANLAND, Councillor.
K. A. McKAY, Shire Secretary.

865

SHIRE OF KORUMBURRA.

LOAN No. 45.

Notice of Intention to Borrow the Sum of \$47,680 for Permanent Works and Undertakings.

NOTICE is hereby given that the Council of the Shire of Korumburra proposes to borrow the principal sum of \$47,680 secured by a charge over the general rates of the municipality, to be raised by the grant of a mortgage in accordance with the provisions of the *Local Government Act 1958*.

1. The maximum rate of interest that may be paid is 5½ per cent. per annum.

2. The purpose for which the loan is to be applied is the construction of a tyre retreading works under the provisions of Part XLA. of the said Act.

3. The period of the loan shall be ten years.

No. 5.—506/68.—4

4. The moneys borrowed shall be repaid by providing out of the municipal fund half-yearly instalments of approximately \$3,167.92 each, including principal and interest on the 1st day of May and 1st day of November, during the currency of the loan. The first payment will be made on 1st November, 1968.

5. Such moneys shall be repayable at the Australia and New Zealand Savings Bank, Melbourne.

The plans and specifications and the estimate of cost of the proposed works and a statement showing the proposed expenditure of the moneys to be borrowed are open for inspection at the office of the Council of the Shire of Korumburra, Commercial-street, Korumburra, during office hours.

908

W. O. CLARK, Shire Secretary.

SHIRE OF MORNINGTON.

Town and Country Planning Act 1961 (Twelfth Schedule).

SHIRE OF MORNINGTON PLANNING SCHEME, 1959.

NOTICE THAT A PLANNING SCHEME HAS BEEN PREPARED AND IS AVAILABLE FOR INSPECTION.

Amendment No. 32, 1967.

NOTICE is hereby given that the Council of the Shire of Mornington in pursuance of its powers under the *Town and Country Planning Act 1961* has prepared a Planning Scheme for:—

Land abutting Boundary-road, Moorooduc-road and Moorooduc Station Ground, Moorooduc, for the purpose of amending the zoning from Agricultural Zone to Public Open Space Reserve (Recreation Reserve) and Public Purpose Reserve (Municipal Garbage Depot.)

A copy of the scheme has been deposited at the Shire Office at Mornington and at the office of the Town and Country Planning Board, 179 Queen-street, Melbourne, and will be open for inspection during office hours by any person free of charge.

Any persons affected by the planning scheme are required to set forth, in writing, all objections they may have, addressed to the Shire Secretary, Shire of Mornington, Shire Office, Mornington, on or before the 26th day of April, 1968, and to state whether they wish to be heard in respect of their objections.

17th January, 1968.

870

D. G. COLLINGS, Shire Secretary.

SHIRE OF MORNINGTON.

Town and Country Planning Act 1961 (Twelfth Schedule).

SHIRE OF MORNINGTON PLANNING SCHEME, 1959.

NOTICE THAT A PLANNING SCHEME HAS BEEN PREPARED AND IS AVAILABLE FOR INSPECTION.

Amendment No. 33, 1967.

NOTICE is hereby given that the Council of the Shire of Mornington in pursuance of its powers under the *Town and Country Planning Act 1961* has prepared a Planning Scheme for:—

Land abutting Nepean Highway and Stewart-street, Mount Eliza, for the purpose of amending the zoning from Residential "C" Zone to Commercial "A" Zone.

A copy of the scheme has been deposited at the Shire Office at Mornington and at the office of the Town and Country Planning Board, 179 Queen-street, Melbourne, and will be open for inspection during office hours by any person free of charge.

Any persons affected by the planning scheme are required to set forth, in writing, all objections they may have, addressed to the Shire Secretary, Shire of Mornington, Shire Office, Mornington, on or before the 26th day of February, 1968, and to state whether they wish to be heard in respect of their objections.

17th January, 1968.

871

D. G. COLLINGS, Shire Secretary.

SHIRE OF MORNINGTON.

Town and Country Planning Act 1961 (Twelfth Schedule).

SHIRE OF MORNINGTON PLANNING SCHEME, 1959.

NOTICE THAT A PLANNING SCHEME HAS BEEN PREPARED AND IS AVAILABLE FOR INSPECTION.

Amendment No. 34, 1967.

NOTICE is hereby given that the Council of the Shire of Mornington in pursuance of its powers under the *Town and Country Planning Act 1961* has prepared a Planning Scheme for:—

Land abutting Octavia-street, Mornington, for the purpose of amending the zoning from Residential "A" Zone to Industrial "A" Zone.

A copy of the scheme has been deposited at the Shire Office at Mornington and at the office of the Town and Country Planning Board, 179 Queen-street, Melbourne, and will be open for inspection during office hours by any person free of charge.

Any persons affected by the planning scheme are required to set forth, in writing, all objections they may have, addressed to the Shire Secretary, Shire of Mornington, Shire Office, Mornington, on or before the 26th day of February, 1968, and to state whether they wish to be heard in respect of their objections.

18th January, 1968.

872 D. G. COLLINGS, Shire Secretary.

DISSOLUTION OF PARTNERSHIP BETWEEN
P. M. DOUGHERTY AND W. J. CAMPBELL.

NOTICE is hereby given that the partnership heretofore subsisting between Patricia Mary Dougherty and Wallace John Campbell, carrying on business as private tutors at 221 Lonsdale-street, Dandenong, in the State of Victoria, under the style or firm of Academy of Private Tutors and Dandenong and District Coaching College and Tutoring Service, has been dissolved as from the 23rd day of August, 1967.

Dated the 17th day of January, 1968.

863 PATRICIA MARY DOUGHERTY.

NOTICE is hereby given that the partnership between Donald Gordon Grey and James Arnold Burns, formerly trading under the name of D. G. Grey and Burns, at Grey's Building, corner of Main and Devon streets, Croydon, was dissolved by mutual consent on the 31st day of December, 1967.

HEDDERWICK, FOOKES & ALSTON, 103 William-street,
Melbourne. 919

NOTICE is hereby given that the partnership carrying on business as packagers and distributors of coffee and dealers in coffee machines at 162 Sydney-road, Coburg, under the style or firm name of "Coffee Mio", has been dissolved as from the date hereof as far as concerns Bruno Trevisan and Fulvia Trevisan who retire from the said firm and notice is further given that the said partnership has admitted Frank Berra to be a partner therein as from the 9th day of October, 1967, and the said partnership will be continued under the style or firm name of "Coffee Mio".

Dated the 20th day of December, 1967.

899 CLAUDIA BERRA.

Companies Act 1961. Section 272.

BUILDERS STEEL FORM SUPPLY CO. LTD.
(IN LIQUIDATION).

NOTICE is hereby given that a General Meeting of the above company will be held at the Office of F. J. Watty, 620 High-street, East Kew, on Wednesday, 21st February, 1968, at 10 a.m., to receive a final account from the liquidator as to how the winding-up has been conducted, and to give any explanation thereof.

Dated this 18th day of January, 1968.

864 F. J. WATTY, Liquidator.

Companies Act 1961.

WARNER MECHELSEN (CIVIL ENGINEERING) PTY.
LIMITED (IN VOLUNTARY LIQUIDATION).

NOTICE TO CREDITORS OF INTENTION TO DECLARE A DIVIDEND.
A FIRST dividend is intended to be declared in the above matter. Any creditor who does not prove his debt by the 14th day of February, 1968, will be excluded from the distribution.

The date of the liquidation was the 25th day of August, 1967.

867 E. JOHN BROWN, Liquidator.

The Companies Act 1961.—In the matter of STAK-N-FOLD
FURNITURE PROPRIETARY LIMITED (in liquidation).

NOTICE is hereby given that pursuant to section 272 of the Companies Act a final meeting of the creditors of the above company, will be held at the offices of Kennedy, Smail and Middlemiss, 296-300 Little Lonsdale-street, Melbourne, on Wednesday the 21st day of February, 1968, at 10.30 a.m.

Business to receive the liquidator's accounts.

Dated this 17th day of January, 1968.

A. M. HORSBURGH, Liquidator.

Kennedy, Smail & Middlemiss, 296-300 Little Lonsdale-street, Melbourne, 3000. 896

The Companies Act 1961.

UNIVERSAL CHEMICAL INDUSTRIES OF AUSTRALIA
PROPRIETARY LIMITED.

PURSUANT TO SECTION 260 OF THE COMPANIES ACT 1961.

NOTICE is hereby given that a Meeting of Creditors of Universal Chemical Industries of Australia Proprietary Limited will be held at the Institute of Chartered Accountants, 23 McKillop-street, Melbourne, on Friday, the 23rd day of February, 1968, at 11 o'clock in the forenoon for the purpose of considering the company's affairs, the company having convened an Extraordinary General Meeting of its Members to be held on the same day, and for the purpose of considering and if thought fit passing a Special Resolution that the company be wound up voluntarily.

Dated this 19th day of January, 1968.

G. GINSBOURG, Director.

Hall & Rose, chartered accountants, 260 Queen-street,
Melbourne, Vic. 880

The Companies Act 1961.

REGENCY CANDLE CO. PTY. LTD. (IN LIQUIDATION).

NOTICE CONVENING FINAL MEETING OF MEMBERS AND
CREDITORS, PURSUANT TO SECTION 272.

NOTICE is hereby given in pursuance of section 272 of the Companies Act 1961, that a Meeting of the Members and Creditors of the above-named company will be held on the 26th day of February, 1968, at the offices of Hall & Rose, 260 Queen-street, Melbourne, at 11 o'clock in the forenoon for the purpose of having an account laid before them, showing the manner in which the winding up has been conducted and the property of the company disposed of, and of hearing any explanations that may be given by the liquidator.

Dated this 19th day of January, 1968.

S. M. NUNAN, Liquidator.

Hall & Rose, chartered accountants, 260 Queen-street,
Melbourne, Vic. 881

Companies Act 1961. Section 260.

CLEORA CONSOLIDATED (VICTORIA) PTY. LTD.
NOTICE OF MEETING OF CREDITORS.

NOTICE is hereby given that a Meeting of Creditors of the above-named company will be held at the Meeting Room of the Bankers Institute of Australasia, 51 Queen-street, Melbourne, on 26th January, 1968, at 10.30 a.m., the company having convened a Meeting of its Members for same day for the purpose of considering a resolution that the company be wound up voluntarily.

AGENDA.

To consider and if thought fit, resolve:

1. The company be wound up voluntarily and that Mr. Peter William Harvey, chartered accountant of 440 Collins-street, Melbourne, be appointed liquidator.
2. The liquidator be paid remuneration in accordance with the scale of fees from time to time paid by the Institute of Chartered Accountants in Australia.

Dated this 17th day of January, 1968.

B. FORSHAW, Director.

A. L. Royce and Warne-Smith, chartered accountants,
440 Collins-street, Melbourne. 888

Companies Act 1961.—In the matter of J. M. ENGINEERING
COMPANY PROPRIETARY LIMITED (in Voluntary Liquidation).—Members Winding Up—Notice of Final Meeting.

NOTICE is hereby given, pursuant to section 272 of the Companies Act 1961, that the Final General Meeting of the members of the above-named company will be held at 70 Collins-street, Melbourne, on 26th February, 1968, at 10 a.m., when I shall lay before the meeting an account of how the winding up has been conducted and the property of the company disposed of.

Dated this 19th day of January, 1968.

901 K. J. HITCHEN, Liquidator.

In the Supreme Court of Victoria.—1967. No. Co. 7462.—
In the matter of the Companies Act 1961 and in the
matter of MARKSMAN CORPORATION (VIC.) PROPRIETARY
LIMITED.

NOTICE is hereby given that a petition for the winding up of the above-named company by the Supreme Court was, on the 21st day of December, 1967, presented by E. Charles Anzarut (Aust.) Pty. Limited. And that the said petition is directed to be heard before the Court sitting at Practice Court, Law Courts Building, William-street, Melbourne, at the hour of 10.30 o'clock in the

forenoon, on the 7th day of February, 1968, and any creditor or contributory of the said company desiring to support or oppose the making of an order on the said petition may appear at the time of hearing by himself or his counsel for that purpose; and a copy of the petition will be furnished to any creditor or contributory of the said company requiring the same by the undersigned on payment of the regulated charge for the same.

The registered office of the petitioner is at 34 Queens-road, Melbourne.

The petitioner's solicitors are Messrs. Davies Campbell & Piesse, of 401 Collins-street, Melbourne, and the petitioner's address for service is at the office of Messrs. Davies Campbell & Piesse of 401 Collins-street, Melbourne.

DAVIES CAMPBELL & PIESSE.

NOTE.—Any person who intends to appear on the hearing of the said petition must serve on or send by post to the above-named Davies Campbell & Piesse notice, in writing, of his intention so to do. The notice must state the name and address of the person, or, if a firm, the name and address of the firm, and must be signed by the person or firm, or his or their solicitor (if any), and must be served, or, if posted, must be sent by post in sufficient time to reach the above-named not later than 4 o'clock in the afternoon of the 6th day of February, 1968. 882

Companies Act 1961.

M.B.A. (CARPORTS) PTY. LTD.

M.B.A. (MANUFACTURING) PTY. LTD.

NOTICE OF INTENTION TO PAY DIVIDEND.

THESE companies were placed in voluntary liquidation on 21st December, 1967, when C. A. J. Tempany, F.C.A., was appointed as liquidator. It is proposed to pay a first dividend, any creditor who does not lodge a proof of debt, by 14th February, 1968, will be excluded from the dividend.

Proofs should be forwarded to the office of Tempany & Penfold, 441 Bay-street, Brighton. 916

CREDITORS, next of kin and others having claims in respect of the estate of Franz Xaver Spanner, late of 51 Tucker-road, East Bentleigh, electrical contractor, (who died on the 16th day of February, 1967), are requested to send particulars of their claims to the executors Arthur Leslie Park and Richard Lawrence Park, care of the under-mentioned solicitors on or before the 26th day of March, 1968, after which date they will distribute the assets, having regard only to the claims of which they then have notice.

McKEAN & PARK, solicitors, 84 William-street, Melbourne. 912

CREDITORS, next of kin and others having claims in respect of the estate of Emanuel (also known as and in the will described as Emmanuel) James Miller, late of 81 Walnut-avenue, Mildura, retired milk carter, deceased (who died on the 1st day of June, 1967), are to send particulars of their claims to Royston T. Cahir & Martin, solicitors, of 475 Collins-street, Melbourne, by the 26th day of March, 1968, after which date the executrix will distribute the assets of the said estate, having regard only to claims of which she then has notice.

ROYSTON T. CAHIR & MARTIN, solicitors, 475 Collins-street, Melbourne, 3000. 914

CREDITORS, next of kin and others having claims in respect of the estate of Clive Harry Boan, late of 369 St. Kilda-street, Brighton, pharmacist, deceased (who died on 31st July, 1966), are to send particulars of their claims to the executrix, Berwyn Boan, of 369 St. Kilda-street, Brighton, widow, care of the under-mentioned solicitors by the 28th March, 1968, after which date she will convey or distribute the assets, having regard only to the claims of which she then has notice.

UPTON & ETTTELSON, solicitors, 100 Queen-street, Melbourne. 891

CREDITORS, next of kin and others having claims in respect of the estate of Annie McWhirter Darnton, (usually known as Annie McWhirter Boyle), late of 561 Brunswick-street, North Fitzroy, widow, deceased (who died on the 9th October, 1967), are requested to send particulars of their claims to the executor, Frederick Ormond Owen, care of the undersigned by the 3rd day of April, 1968, after which date the executor will distribute the assets, having regard only to the claims of which he then has notice.

FREDERICK OWEN & ASSOCIATES, solicitors, 84 William-street, Melbourne. 892

LUIGI BENINI, late of 19 Mackenel-street, East Ivanhoe, retired, DECEASED.

CREDITORS, next of kin and others having claims against the estate of the said deceased (who died on 25th May, 1967), are to send particulars of their claims to the executors, Allesandro Benini, of 72 Burke-road north, East Ivanhoe, company director, Peter Sartori, of 509 Collins-street, Melbourne, accountant and John Dale Collins, of 120 William-street, Melbourne, solicitor, care of 120 William-street, Melbourne, by the 27th day of March, 1968, after which date they will distribute the assets, having regard only to the claims of which they then have notice.

BLAKE & RIGGALL, solicitors, 120 William-street, Melbourne. 915

HARRY RUMBLE, late of Hereford-road, Mount Evelyn, in the State of Victoria, retired, DECEASED.

CREDITORS, next of kin and others having claims in respect of the estate of the above-named, deceased (who died on the 4th day of November, 1967), are required by the trustee The Trustees Executors and Agency Company Limited, of 401 Collins-street, Melbourne, in the said State to send particulars to it by the 7th day of April, 1968, after which date the trustee may convey or distribute the assets, having regard only to the claims of which it then has notice.

E. P. JOHNSON & DAVIES, 339 Collins-street, Melbourne. 917

JOAN ELIZABETH LUCAS, late of 10 Olga-street, Coburg, married woman, DECEASED (who died on the 2nd November, 1967).

CREDITORS, next of kin and others having claims against the estate of the deceased are required by the executor The Trustees Executors and Agency Company Limited to send particulars of their claims to The Trustees Executors and Agency Company Limited, of 401 Collins-street, Melbourne, on or before the 29th March, 1968, after which date the executor will distribute the assets, having regard only to the claims of which it then has notice.

HOME, WILKINSON & LOWRY, solicitors, of 401 Collins-street, Melbourne. 918

Trustee Act 1958.

NOTICE TO CLAIMANTS.

PURSUANT to the Trustee Act 1958, creditors, next of kin and all other persons having claims in respect of the estate of any deceased person named below are required to send particulars to the legal personal representative or representatives at the addresses stated, after which date the representative or representatives will distribute the assets, having regard only to the claims of which notice has been received:—

Agnes Jane McFarland, late of 188 Collins-street, Thornbury, in the State of Victoria, widow, deceased, who died on the 2nd day of February, 1967.—Claims to the executors, Marjorie Jean Dunn and Sergio Zamprogno, care of Gray and Gray, solicitors, 188 High-street, Northcote, by the 25th day of March, 1968. Gray and Gray, solicitors, Northcote. 913

CREDITORS, next of kin and others having claims in respect of the estate of Bowden Lynn Kirk, late of 438 Beach-road, Beaumaris, company director, deceased (who died on 29th May, 1967), are to send particulars of their claims to the executors, Amy Agnes Kirk (usually known as Aimee Agnes Kirk), of 438 Beach-road, Beaumaris, widow, John Charles Lynn Kirk, of 2 Reserve-road, Beaumaris, public servant, and Charles Henry Mylius, of 9 Wolseley-grove, Brighton, manufacturer, care of the under-mentioned solicitors by the 28th March, 1968, after which date they will convey or distribute the assets, having regard only to the claims of which they then have notice.

UPTON & ETTTELSON, solicitors, 100 Queen-street, Melbourne 890

JOSEPH ROBERT PARSONS, late of 47 Graham-street, Sunshine (formerly known as 43 Graham-street, Sunshine), managing director, DECEASED.

CREDITORS, next of kin and others having claims in respect of the estate of the deceased (who died on the 15th day of December, 1966), are required by the executors, Joseph Robert Parsons, of 98 Sibley-road, Wynnym, North Queensland, factory manager, and The Equity Trustees Executors and Agency Company Limited, of 472 Bourke-street, Melbourne, to send particulars of

their claims to the said company by the 5th day of April, 1968, after which date the executors may convey or distribute the assets, having regard only to the claims of which they then have notice.

Dated the 17th day of January, 1968.

MADDEN BUTLER ELDER & GRAHAM, solicitors, 31 Queen-street, Melbourne. 893

CREDITORS, next of kin and others having claims in respect of the estate of Alfred Ernest Benjamin Joppick, late of 29 Ryan-street, Northcote, in the State of Victoria, coachsmith, deceased, intestate (who died on the 7th October, 1967), are required to send particulars of their claims to the administratrix, care of the under-mentioned solicitor by the 1st day of April, 1968, after which date the administratrix will distribute the assets, having regard only to the claims of which she then has notice.

K. P. REES, B.A., LL.B., solicitor, 89 Queen-street, Melbourne. 894

EFFIE OCTAVIA MACMEIKAN, late of 326 Glenferrie-road, Malvern, widow, DECEASED.

CREDITORS, next of kin and others having claims in respect of the estate of the deceased (who died on the 16th day of March, 1967), are required by the executors, Thomas Graham and Hugh Malcolm Graham, both of 31 Queen-street, Melbourne, solicitors, to send particulars to them, care of the under-mentioned solicitors by the 2nd day of April, 1968, after which date the executors may convey or distribute the assets, having regard only to the claims of which they then have notice.

Dated the 18th day of January, 1968.

MADDEN BUTLER ELDER & GRAHAM, solicitors, 31 Queen-street, Melbourne. 895

CREDITORS, next of kin and others having claims in respect of the estate of Alice Muriel Todd, late of Flat 14, 11 Lord-street, Bacchus Marsh, widow, deceased (who died on the 4th day of May, 1967, and probate of whose will has been granted to John Arthur Todd, of 19 Glenora-street, Chadstone, sales representative and Neil William Todd of Main-street, Bacchus Marsh, transport driver), are required to send particulars of their claims to the said executors care of the under-mentioned solicitors, by the 25th day of March, 1968, after which date they will distribute the assets having regard only to the claims of which they then have notice.

PEARCE & WEBSTER, solicitors, of 430 Little Collins-street, Melbourne. 874

GEORGE CAMPBELL PATERSON, formerly of 45 Abbott-street, but late of 44 Abbott-street, Sandringham, gentleman, DECEASED.

CREDITORS, next of kin and others having claims in respect of the estate of the deceased (who died on the 28th day of October, 1967), are required by the executor Charles Richard Stevens, of 37 Queen-street, Melbourne, solicitor, to send particulars of their claims to the said executor by the 4th day of April, 1968, after which date he may convey or distribute the assets, having regard only to the claims of which he shall then have had notice.

DUGDALE, DIMMICK & STEVENS, solicitors, 37 Queen-street, Melbourne. 875

ERNEST EDWARD HOGG, late of 207 Bluff-road, Sandringham, retired gas worker, DECEASED.

CREDITORS, next of kin and others having claims in respect of the estate of the deceased (who died on 18th March, 1967), are required by the executor Leslie Pope, of 65 Linacre-road, Hampton, storeman, to send particulars to him care of, Keith Hercules & Sons, of 443 Little Collins-street, Melbourne, by the 31st day of March, 1968, after which date he may convey or distribute the assets, having regard only to the claims of which he then has notice.

KEITH HERCULES & SONS, solicitors, 443 Little Collins-street, Melbourne. 876

CREDITORS, next of kin and others having claims in respect of the estate of James McCall, late of 51 Ballarat-road, Footscray, gentleman, deceased (who died on the 31st day of July, 1967), are to send the particulars of their claims to the National Trustees Executors and Agency Company of Australasia Limited, of 95 Queen-street, Melbourne, by the 27th day of March, 1968, after which date it will distribute the assets, having regard only to the claims of which it then has notice.

ARTHUR SECOMB & CO., solicitors, 128 William-street, Melbourne. 877

CREDITORS, next of kin and others having claims against the estate of John Brennan Hearity, late of 35 Homer-street, Moonee Ponds, in the State of Victoria, labourer, deceased (who died on the 16th day of November, 1967), are required to send particulars of their claims to the executor Thomas Leslie Hearity, care of the under-mentioned solicitor before the 1st day of April, 1968, after which date he will distribute the assets, having regard only to the claims of which he then has notice.

JOHN F. CARROLL, solicitor, 118 Queen-street, Melbourne. 878

ALAN GROSVENOR, late of 85 Bay-road, Sandringham, project engineer, DECEASED.

CREDITORS, next of kin and others having claims in respect of the estate of the said deceased (who died on the 23rd March, 1967), are required by Anita Grosvenor, of 85 Bay-road, Sandringham, widow, to send particulars to her, care of the undersigned on or before the 18th March, 1968, after which date she will distribute the assets, having regard only to the claims of which she then has notice.

WISEWOULD, DUNCAN & HANGER, solicitors, 11 Bank-place, Melbourne. 879

ETHEL MAY CUMMING, formerly of 9 Lascelles-avenue, but late of 8 Glenbervie-road, Toorak, widow, DECEASED.

CREDITORS, next of kin and others having claims against the estate of the said deceased (who died on 30th May, 1967), are to send particulars of their claims to the executors, Margaret Selina MacKnight, of "Myrning", Rutherglen, married woman, Muriel Mary Downie, of 16 Cloverdale-avenue, Toorak, married woman, and Hubert Silvers Black, of 120 William-street, Melbourne, solicitor, c/- 120 William-street, Melbourne, by the 27th day of March, 1968, after which date they will distribute the assets, having regard only to the claims of which they then have notice.

BLAKE & RIGGALL, solicitors, 120 William-street, Melbourne. 883

DONALD CAMERON, late of Onewhero, in New Zealand, sheep farmer, DECEASED.

CREDITORS, next of kin and others having claims against the estate of the said deceased (who died on 20th May, 1967), are to send particulars of their claims to The Trustees, Executors and Agency Company Limited, the registered office of which is situate at 401 Collins-street, Melbourne, by the 27th day of March, 1968, after which date it will distribute the assets, having regard only to the claims of which it then has notice.

BLAKE & RIGGALL, solicitors, 120 William-street, Melbourne. 884

CHARLES HENRY KING, late of 706 Inkerman-road, Caulfield, in the State of Victoria, gentleman, DECEASED.

CREDITORS, next of kin and others having claims in respect of the estate of the deceased (who died on the 24th day of August, 1967), are required by The Perpetual Executors and Trustees Association of Australia Limited, of 100-104 Queen-street, Melbourne, to send particulars of their claims to the said company by the 17th day of April, 1968, after which date it will convey or distribute the assets, having had regard only to the claims of which the company then has notice.

FORD, ASPINWALL & DEGRUCHY, solicitors, of 100-104 Queen-street, Melbourne. 886

CREDITORS, next of kin and others having claims in respect of the estate of Minnie Oddie, formerly of 12 Third-street, Black Rock, but late of Dingley Rest Home Centre, Dandenong-road, Dingley, in the State of Victoria, widow, deceased (who died on 16th July, 1967), are required to send particulars of their claims to the executors, Harvey George Stait, of 91 Ontario-avenue, Mildura, gentleman, and Alan Frederick Stait, of 9 Richardson-crescent, Burnie, Tasmania, manager, care of the under-mentioned solicitors, by the 31st day of March, 1968, after which date the trustees will distribute the assets, having regard only to the claims of which they then have notice.

HERBERT, GEER & RUNDLE, solicitors, 612-614 Balcombe-road, Black Rock. 887

KATE LYDIA DENNY, formerly of 20 Wimba-avenue, Kew, but late of 15 Knutsford-street, Balwyn, in the State of Victoria, married woman, DECEASED.

CREDITORS, next of kin and others having claims in respect of the estate of the deceased (who died on the 1st day of October, 1967), are required by the executor, Cyril Howard Denny, of 15 Knutsford-street, Balwyn, retired company director, to send particulars to him, care of the undersigned solicitors, by the 25th March, 1968, after which date he may convey or distribute the assets, having regard only to the claims of which he then has notice.

R. E. LEWIS, ORR & GIBSON, solicitors, 406 Lonsdale-street, Melbourne. 885

ESTHER CHARLOTTE ANDREWS, late of 312 Gore-street, Fitzroy, pensioner, DECEASED (who died on the 20th day of November, 1966).

CREDITORS, next of kin and others having claims against the estate of the deceased are required by the executor, John Charles Andrews, to send particulars of their claims to the executor, care of the undersigned solicitors, on or before the 25th March, 1968, after which date he will distribute the assets, having regard only to the claims of which he then has notice.

HOME, WILKINSON & LOWRY, solicitors, 401 Collins-street, Melbourne. 889

MARGARET KEENAN, late of 256 Gower-street, Preston, widow, deceased (who died on the 15th March, 1967.)

CREDITORS, next of kin and others having claims against the estate of the deceased are required by the administratrix, Joyce Dickens, to send particulars of their claims to the administratrix, care of the undersigned solicitors, on or before the 27th March, 1968, after which date she will distribute the assets, having regard only to the claims of which she then has notice.

HOME, WILKINSON & LOWRY, solicitors, of 401 Collins-street, Melbourne. 897

CREDITORS, next of kin and others having claims against the estate of Ernst Mosheim, late of 7 Gardiner-road, Hawthorn, in the State of Victoria, merchant, deceased (who died on the 21st day of January, 1967), are required to send particulars of their claims to the executrix of his will, Kathe Mosheim, care of the under-mentioned solicitors, before the 1st day of April, 1968, after which date the said executrix will distribute the estate of the said deceased, having regard only to the claims of which she has then notice.

J. OKNO & CO., solicitors, of 390 Lonsdale-street, Melbourne. 906

PURSUANT to the *Trustee Act 1958* notice is hereby given that all persons having claims against the estate of Annie Noon, late of 2 Lenne-court, East Camberwell, in the State of Victoria, deceased (who died on the 21st day of September, 1967), are hereby required to send particulars, in writing, of such claims to National Trustees Executors and Agency Company of Australasia Limited, of 95 Queen-street, Melbourne, the applicant for a grant of probate of the will of the said deceased on or before the 24th of March, 1968, after which date the said National Trustees Executors and Agency Company of Australasia Limited will proceed to distribute the assets of the said Annie Noon, deceased, which shall have come to its hands amongst the persons entitled thereto, having regard only to the claims of which it shall then have had notice. And notice is hereby further given that the said National Trustees Executors and Agency Company of Australasia Limited will not be liable for the assets so distributed or any part thereof to any person of whose claim it shall not have had notice as aforesaid.

Dated this 16th day of January, 1968.

E. P. PRENDERGAST O'SULLIVAN & HENNESSY, of 118 Queen-street, Melbourne, solicitors for the said National Trustees Executors and Agency Company of Australasia Limited. 900

CREDITORS, next of kin and others having claims in respect of the estate of Jeremiah Wallace, late of 34 Myrmong-crescent, Ascot Vale, cleaner, deceased (who died on the 18th October, 1967), are to send particulars of their claims to National Trustees Executors and Agency Company of Australasia Limited, of 95 Queen-street, Melbourne, by the 27th March, 1968, after which date it will distribute the assets, having regard only to the claims of which it then has notice.

CORR & CORR, solicitors, 290 Latrobe-street, Melbourne. 903

CREDITORS, next of kin and others having claims against the estate of Henry Shein, late of 253A Glen Eira-road, Caulfield, in the State of Victoria, manufacturer, deceased (who died on the 13th day of January, 1967), are required to send particulars of their claims to the executrix of his will, Anna Shein, care of the under-mentioned solicitors, before the 1st day of April, 1968, after which date the said executrix will distribute the estate of the said deceased, having regard only to the claims of which she has then notice.

J. OKNO & CO., solicitors, of 390 Lonsdale-street, Melbourne. 904

CREDITORS, next of kin and others having claims against the estate of Violet Merinda Long, late of 53 Balmoral-avenue, Pascoe Vale, in the State of Victoria, married woman, deceased (who died on the 20th day of August, 1967), are required to send particulars of their claims to the executors of her will, The Union Fidelity Trustee Company of Australia Limited, and Raymond Joseph Hugh Long, care of The Union Fidelity Trustee Company of Australia Limited, of 100 Exhibition-street, Melbourne, before the 1st day of April, 1968, after which date the said executors will distribute the estate of the said deceased, having regard only to the claims of which they have then notice.

J. OKNO & CO., solicitors, of 390 Lonsdale-street, Melbourne. 905

CREDITORS, next of kin and others having claims in respect of the estate of Annie Grace Byrne, late of "Grange Lynne", Grange-road, Toorak, in the State of Victoria, spinster, deceased (who died on the 6th day of November, 1967), are to send particulars of their claims to the executor, The Union-Fidelity Trustee Company of Australia Limited, of 100 Exhibition-street, Melbourne, in the said State (formerly The Union Trustee Company of Australia Limited, of 333 Collins-street, Melbourne, in the said State) by the 27th day of March, 1968, after which date it will distribute the assets, having regard only to the claims of which it then has notice.

ABBOTT, STILLMAN & WILSON, solicitors, of 406 Lonsdale-street, Melbourne. 866

RUBY AGNES STONE, late of 22 Athol-street, Prahran, widow, DECEASED.

CREDITORS, next of kin and others having claims in respect of the estate of the deceased (who died on 24th May, 1967), are required by the executors, Laurence John Stone, of 13 Rollings-road, Upper Ferntree Gully, process superintendent, Owen Dorman Stone, of 30 Burns-street, Wangaratta, inspector, and Maxwell Stone, of 22 Athol-street, Prahran, plumber, to send particulars to them, care of the under-mentioned solicitors at their said address, by the 31st day of March, 1968, after which date they may convey or distribute the assets, having regard only to the claims of which they then have notice.

KEITH HERCULES & SONS, solicitors, 443 Little Collins-street, Melbourne. 902

In the Supreme Court of the State of Victoria.

SALE BY THE SHERIFF.

ON Monday, the 4th March, 1968 at 11 a.m., at the Police Station, Clayton (unless process be stayed or satisfied):—

Firstly all the estate and interest (if any) of Gunars Normunds Novackis, of 1809 Dandenong-road, Clayton, real estate agent, as joint proprietor with Rita Novackis, married woman, of an estate in fee-simple in the land described in certificate of title, volume 8090, folio 056, upon which is erected a brick veneer dwelling-house known as 1809 Dandenong-road, Clayton, Registered mortgage No. C.761967, affects the said estate and interest.

Secondly, at the Police Station, East Malvern, at 12 noon, all the estate and interest (if any) of the said Gunars Normunds Novackis, as proprietor of an estate in fee-simple in the land described in certificate of title, volume 7879, folio 073, upon which is erected a two-storey brick shop and dwelling known as 173 Darling-road, East Malvern. Registered mortgage No. C.469867 affects the said estate and interest.

Thirdly, at the Police Station, Fitzroy, at 2 p.m., all the estate and interest (if any) of the aforesaid Gunars Normunds Novackis as proprietor of an estate in fee-simple in the land described in certificate of title, volume 4930, folio 870, upon which is erected a brick dwelling-house known as 7 Smith-street, Fitzroy. Registered mortgage No. C.469866 affects the said estate and interest.

Terms: Cash only.

DAVID J. JOHNSTON, Sheriff's Officer.

23rd January, 1968.

911

In the Supreme Court of the State of Victoria.

SALE BY THE SHERIFF.

ON Monday, the 4th of March, 1968, at 10.30 a.m., at the Police Station, Clayton (unless process be stayed or satisfied):—

All the estate and interest (if any) of John Oakley Stewart, of 67 Patrick-street, North Clayton, clerk, as joint proprietor with Dawn Stewart, married woman, of an estate in fee-simple in the land described in certificate of title, volume 7898, folio 098, upon which is erected a weatherboard dwelling-house, known as No. 67 Patrick-street, North Clayton.

Registered mortgages Nos. A.189754 and A.790116 affect the said estate and interest.

Terms: Cash only.

DAVID J. JOHNSTON, Sheriff's Officer.

23rd January, 1968. 910

In the Supreme Court of the State of Victoria.

SALE BY THE SHERIFF.

ON Tuesday, the 5th of March, 1968, at 2 p.m., at the Police Station, Hastings (unless process be stayed or satisfied):—

All the estate and interest (if any) of Clifford James Croucher, of Hall-road, South Warrandyte, director, as proprietor of an estate in fee-simple in the land described in certificate of title, volume 4705, folio 976. The land is vacant and is known as lot 140, with a frontage of 66 feet by a depth of 165 feet and is situated on the west side of Gorrie-place, Crib Point, commencing 186 feet south of Mills-avenue, Crib Point.

Terms: Cash only.

DAVID J. JOHNSTON, Sheriff's Officer.

23rd January, 1968. 909

IMPOUNDINGS

BENALLA.—Impounded in Benalla Pound by Mr. J. S. Stickland, from Sale Yards on the 16th January, 1968, at 2.30 p.m.

- 1 Merino crossbred ewe with nick out of front left ear, no visible brand
- 1 Merino crossbred wether with nick out of left and right ear, no visible brand
- 1 Border Leicester—Merino crossbred with 2 nicks front right ear, no visible brand

If not claimed and expenses paid, to be sold on 8th February, 1968.

873—\$3.25 C. H. WALLACE, Poundkeeper.

MORTLAKE.—Impounded in Mortlake Pound.

- 1 Jersey and white heifer, eighteen months old, no visible brands or ear marks.

If not claimed and expenses paid to be sold on 2nd February, 1968.

921—\$1.75 H. M. ROBERTSON, Poundkeeper.

RINGWOOD.—Impounded in Ringwood Pound by the Ranger.

- 8 head of Hereford heifers with various brands

If not claimed and expenses paid; to be sold on 8th February, 1968.

907—\$1.50 L. GRATION, Poundkeeper.

Subordinate Legislation Act 1962.

NOTICE OF MAKING OF STATUTORY RULES.

IN pursuance of the provisions of the Subordinate Legislation Act 1962 and the Regulations made thereunder, notice is given of the making of the following statutory rules:—

No.	Apprenticeship Act 1958.	Price.
6/1968.	Apprenticeship (Butchering Trades) (Amendment) Regulations 1968	10c
	Apprenticeship Act 1958.	
7/1968.	Apprenticeship (Tile Laying Trade) Regulations 1968	15c
	Labour and Industry Act 1958.	
8/1968.	Labour and Industry (Rescission) Regulations 1968	10c

No. Marketing of Primary Products Act 1958. Price. 9/1968. Marketing of Primary Products (Polls and Elections) (Amendment) Regulations 1968 10c

Racing Act 1958.

10/1968. Racing (Plumpton Coursing Matches Permits) Regulations 1968 10c

Copies of these statutory rules may be purchased at the Sale of Publications Section of the Government Printing Office, located at Macarthur-street, Melbourne, C.2. If ordered by mail, remittance should be addressed to "The Government Printer, Box 203, P.O., North Melbourne, N.1.", and should include 5c extra for postage. If a credit account is held at this office, no remittance is required with the mail order.

The annual subscription rate for Statutory Rules (including a Bound Volume) is \$15, payable in advance. The subscription year commences on 1st January.

A. C. BROOKS,

Government Printer.

ACTS REPRINTED IN ACCORDANCE WITH THE AMENDMENTS INCORPORATION ACT 1958 (No. 6422), AND FOR SALE AT THE SALE OF PUBLICATIONS BRANCH OF THE GOVERNMENT PRINTING OFFICE, MACARTHUR-STREET, MELBOURNE, 3002.

(These prices do not include postage.)

No.		Price.
6189.	Acts Interpretation (Incorporating amendments up to No. 7146)	\$0.15
6191.	Administration and Probate (Third Reprint—Incorporating amendments up to No. 7332)	\$0.38
6194.	Agricultural Colleges (First Reprint—Incorporating amendments up to No. 7302)	\$0.15
7117.	Appeal Costs Fund Act 1964 (First Reprint—Incorporating amendments up to No. 7488)	\$0.25
6199.	Apprenticeship (First Reprint—Incorporating amendments up to No. 7312)	\$0.25
6203.	Audit (First Reprint—incorporating amendments up to No. 7377)	\$0.35
6209.	Boiler Inspection (Incorporating amendments up to No. 7072)	\$0.18
6210.	Building Societies (Incorporating amendments up to No. 7125)	\$0.25
6218.	Children's Court (Incorporating amendments up to No. 7084)	\$0.20
6219.	Children's Welfare (Second Reprint—Incorporating amendments up to No. 7084)	\$0.35
6220.	Clean Air (Incorporating amendments up to No. 6886)	\$0.10
6222.	Commercial Goods Vehicles (Second Reprint—Incorporating amendments up to No. 7358)	\$0.22
6839.	Companies Act 1961 (Second Reprint—Incorporating amendments up to No. 7332)	\$2.32
6225.	Co-operation (Second Reprint—Incorporating amendments up to No. 7083)	\$0.42
6226.	Co-operative Housing Societies (Incorporating amendments up to No. 7097)	\$0.40
6228.	Country Fire Authority (Second Reprint—Incorporating Amendments up to No. 7476)	\$0.50
6229.	Country Roads (Second Reprint—Incorporating Amendments up to No. 7506)	\$0.60
6230.	County Court Act (First Reprint—Incorporating amendments up to No. 7420)	\$0.35
6231.	Crimes (Second Reprint—Incorporating amendments up to No. 7407)	\$1.33
6236.	Dog (Second Reprint—Incorporating amendments up to No. 7065)	\$0.15
6240.	Education (First Reprint—Incorporating amendments up to No. 7533)	\$0.45
6242.	Employers and Employées (Incorporating amendments up to No. 6740)	\$0.18
6243.	Entertainments Tax (First Reprint—Incorporating amendments up to No. 7315)	\$0.25
6245.	Estate Agents (Second Reprint—Incorporating amendments up to No. 7134)	\$0.38
6249.	Fences (Incorporating amendments up to No. 6550)	\$0.12
6246.	Evidence (Second Reprint—Incorporating amendments up to No. 7366)	\$0.42
6250.	Fertilizers (Incorporating amendments up to No. 7142)	\$0.25
6251.	Firearms (Second Reprint—Incorporating amendments up to No. 7484)	\$0.40
6252.	Fisheries Act (First Reprint—Incorporating amendments up to No. 7389)	\$0.35
6916.	Foreign Judgments Act 1962 (First Reprint—including amendments made by No. 7332)	\$0.15

ACTS REPRINTED IN ACCORDANCE WITH THE AMENDMENTS
INCORPORATION ACT 1958 (No. 6422)—*continued*.

No.	Price.
6585. Forests (Pulpwood Agreement) (Incorporating amendments up to No. 6886)	\$0.15
6254. Forests (<i>First Reprint</i> —Incorporating amendments up to No. 7356)	\$0.60
6256. Fruit and Vegetables (<i>First Reprint</i> —Incorporating amendments up to No. 6944)	\$0.30
6258. Game—(<i>First Reprint</i> —Incorporating amendments up to No. 7389)	\$0.30
6259. Gaols (Incorporating amendments up to No. 6651)	\$0.15
6262. Geelong Harbor Trust (<i>First Reprint</i> —Incorporating amendments up to No. 7547)	\$0.45
6263. Geelong Waterworks and Sewerage (<i>First Reprint</i> —Incorporating amendments up to No. 7547)	\$0.75
6265. Goods (<i>Third Reprint</i> —Incorporating amendments up to No. 7131)	\$0.35
6266. Grain Elevators (<i>First Reprint</i> —Incorporating amendments up to No. 7486)	\$0.35
6270. Health (<i>Second Reprint</i> —Incorporating amendments up to No. 7490)	\$1.65
6933. Home Finance Act 1962 (<i>First Reprint</i> —Incorporating amendments up to No. 7363)	\$0.25
6274. Hospitals and Charities (Incorporating amendments up to No. 6716)	\$0.35
6274. Hospitals and Charities (<i>Second Reprint</i> —Incorporating amendments up to No. 7455)	\$0.50
6275. Housing (<i>First Reprint</i> —Incorporating amendments up to No. 7507)	\$0.85
6279. Instruments (<i>Third Reprint</i> —Incorporating amendments up to No. 7315)	\$0.38
6282. Justices (<i>Second Reprint</i> —Incorporating amendments up to No. 7369)	\$1.23
6283. Labour and Industry (<i>Third Reprint</i> —Incorporating amendments up to No. 7410)	\$1.00
6284. Land (Incorporating amendments up to No. 7360)	\$1.53
6534. Land Settlement Act 1959 (<i>First Reprint</i> —Incorporating amendments up to No. 7328)	\$0.30
6289. Land Tax (<i>Second Reprint</i> —Incorporating amendments up to No. 7466)	\$0.40
6285. Landlord and Tenant (<i>Second Reprint</i> —Incorporating amendments up to No. 6996)	\$0.50
6286. Lands Compensation—(<i>First Reprint</i> —Incorporating amendments up to No. 7332)	\$0.25
6290. Latrobe Valley (<i>First Reprint</i> —Incorporating amendments up to No. 7332)	\$0.35
6291. Legal Profession Practice (Incorporating amendments up to No. 7065)	\$0.45
6293. Licensing (<i>Second Reprint</i> —Incorporating amendments up to No. 7054)	\$0.95
6577. Lifts and Cranes (Incorporating amendments up to No. 6886)	\$0.12
6295. Limitation of Actions (Incorporating amendments up to No. 6845)	\$0.15
6298. Local Authorities Superannuation (Incorporating amendments up to No. 6894)	\$0.25
6299. Local Government (Incorporating amendments up to No. 7052)	\$3.50
6302. Marine (Incorporating amendments up to No. 7350)	\$0.72
6304. Marketing of Primary Products (<i>First Reprint</i> —Incorporating amendments up to No. 7491)	\$0.45
6306. Marriage (<i>First Reprint</i> —Incorporating amendments up to No. 6959)	\$0.25
6309. Medical (<i>Second Reprint</i> —Incorporating amendments up to No. 7408)	\$0.40
6310. Melbourne and Metropolitan Board of Works (<i>Second Reprint</i> —Incorporating amendments up to No. 7547)	\$1.10
6312. Melbourne Harbor Trust (<i>First Reprint</i> —Incorporating amendments up to No. 7356)	\$0.48
6605. Mental Health (Incorporating amendments up to No. 7135)	\$0.45
6315. Metropolitan Fire Brigades (Incorporating amendments up to No. 6886)	\$0.28
6316. Mildura Irrigation and Water Trusts (<i>First Reprint</i> —Incorporating amendments up to No. 7448)	\$0.75
6317. Milk and Dairy Supervision (Incorporating amendments up to No. 6964)	\$0.40
6318. Milk Board (Incorporating amendments up to No. 7093)	\$0.22
6184. Monash University (<i>First Reprint</i> —Incorporating amendments up to No. 7533)	\$0.30
6324. Money Lenders (Incorporating amendments up to No. 6886)	\$0.25
6832. Motor Boating (Incorporating amendments up to No. 6961)	\$0.15

ACTS REPRINTED IN ACCORDANCE WITH THE AMENDMENTS
INCORPORATION ACT 1958 (No. 6422)—*continued*.

No.	Price.
6325. Motor Car (<i>Second Reprint</i> —Incorporating amendments up to No. 7361)	\$0.82
6326. National Parks (Incorporating amendments up to No. 7275)	\$0.25
6328. Nurses (Incorporating amendments up to No. 6716)	\$0.20
6330. Partnership (<i>Second Reprint</i> —Incorporating amendments up to No. 7315)	\$0.25
6331. Patriotic Funds (<i>First Reprint</i> —Incorporating amendments up to No. 7338)	\$0.25
6889. Poisons (Incorporating amendments up to No. 7065)	\$0.35
6337. Police Offences (Incorporating amendments up to No. 7145)	\$0.82
6338. Police Regulation (Incorporating amendments up to No. 7081)	\$0.45
6340. Portland Harbor Trust (<i>First Reprint</i> —Incorporating amendments up to No. 7475)	\$0.35
6341. Pounds (<i>First Reprint</i> —Incorporating amendments up to No. 7315)	\$0.25
6890. Probate Duty (Incorporating amendments up to No. 6970)	\$0.38
6343. Process Servers and Inquiry Agents (Incorporating amendments up to No. 7126)	\$0.12
6344. Property Law (Incorporating amendments up to No. 6867)	\$0.90
6349. Public Service (<i>Second Reprint</i> —Incorporating amendments up to No. 7356)	\$0.40
6350. Public Trustee (Incorporating amendments up to No. 6961)	\$0.35
6353. Racing (<i>First Reprint</i> —Incorporating amendments up to No. 7404)	\$0.70
6355. Railways (<i>First Reprint</i> —Incorporating amendments up to No. 7475)	\$0.75
6359. Road Traffic (<i>Second Reprint</i> —Incorporating amendments up to No. 7332)	\$0.18
6360. Rural Finance (<i>First Reprint</i> —Incorporating amendments up to No. 7328)	\$0.12
6846. Rural Finance and Settlement Commission Act 1961 (<i>First Reprint</i> —Incorporating amendments up to No. 7332)	\$0.20
6975. Sale of Land Act 1962 (<i>First Reprint</i> —Incorporating amendments up to No. 7332)	\$0.18
6363. Second-Hand Dealers	\$0.12
6367. Settled Land (<i>Second Reprint</i> —Incorporating amendments up to No. 7065)	\$0.50
6368. Sewerage Districts (<i>First Reprint</i> —Incorporating amendments up to No. 7332)	\$0.62
6651. Social Welfare Act 1960 (<i>Third Reprint</i> —Incorporating amendments up to No. 7332)	\$0.20
6372. Soil Conservation and Land Utilization (Incorporating amendments up to No. 6961)	\$0.20
6373. Soldier Settlement (<i>First Reprint</i> —Incorporating amendments up to No. 7328)	\$0.42
6375. Stamps (<i>Third Reprint</i> —Incorporating amendments up to No. 7359)	\$0.82
6377. State Electricity Commission (<i>Second Reprint</i> —Incorporating Amendments up to No. 7421)	\$0.65
6379. State Savings Bank (Incorporating amendments up to No. 6886)	\$0.42
6381. Stock and Share Brokers (<i>First Reprint</i> —Incorporating amendments up to No. 7444)	\$0.15
6886. Subordinate Legislation (Incorporating amendments up to No. 6961)	\$0.15
6386. Superannuation (<i>First Reprint</i> —Incorporating amendments up to No. 7417)	\$0.60
6387. Supreme Court (<i>First Reprint</i> —Incorporating amendments up to No. 7522)	\$0.75
6391. Teaching Service (<i>First Reprint</i> —Incorporating amendments up to No. 7536)	\$0.35
7223. Tomato Processing Industry (Uniform Agreement) Act 1964 (<i>First Reprint</i> —Incorporating amendments up to No. 7342)	\$0.15
6395. Tourist (<i>First Reprint</i> —Incorporating amendments up to No. 7335)	\$0.15
6849. Town and Country Planning (<i>First Reprint</i> —Incorporating amendments up to No. 7276)	\$0.45
6399. Transfer of Land (<i>Second Reprint</i> —Incorporating amendments up to No. 7130)	\$0.52
6400. Transport Regulation (<i>First Reprint</i> —Incorporating amendments up to No. 7358)	\$0.22
6401. Trustee (<i>Second Reprint</i> —Incorporating amendments up to No. 6963)	\$0.42
6879. Unclaimed Moneys (Incorporating amendments up to No. 6961)	\$0.12

ACTS REPRINTED IN ACCORDANCE WITH THE AMENDMENTS
INCORPORATION ACT 1958 (No. 6422)—continued.

No.	Price.
6653. Valuation of Land Act 1960 (Second Reprint—Incorporating amendments up to No. 7333)	\$0.22
6407. Vegetation and Vine Diseases (First Reprint—Incorporating amendments up to No. 7423)	\$0.30
6409. Vermin and Noxious Weeds (First Reprint—Incorporating amendments up to No. 7463)	\$0.35
6410. Veterinary Surgeons (First Reprint—Incorporating amendments up to No. 7343)	\$0.15
6413. Water (Incorporating amendments up to No. 7228)	\$1.42
6414. Weights and Measures (Second Reprint—Incorporating amendments up to No. 7332)	\$0.32
6419. Workers Compensation (Second Reprint—Incorporating amendments up to No. 7332)	\$0.52

A. C. BROOKS,
Government Printer.

PUBLICATION OF OFFICIAL MATTER.

ATTENTION is invited to the following procedure in relation to the publication of official matter in the *Government Gazette*:—

1. *Matter submitted to the Executive Council.*
Matters submitted to the Executive Council which requires gazettal will normally be published in the issue of the following week.

Where urgent gazettal is required, special arrangements should be made with the *Gazette Officer*, Room 9, first floor, Old Treasury Building.

Publication will be facilitated by the submission of carbon copies for the use of the *Gazette Officer*.

2. *Other matter.*

(a) All other matter duly certified by a responsible officer for publication should be lodged with the *Gazette Officer* not later than half-past Ten a.m. on Tuesday.

(b) Lengthy or involved notices should be forwarded several days before publication.

(c) Proofs, which will be supplied only when specifically requested or, at the direction of the *Gazette Officer*, should be returned promptly to avoid delay in publication.

(d) No additions or amendments to matter for publication will be accepted by telephone.

THE "VICTORIA GOVERNMENT GAZETTE".

SUBSCRIPTIONS.—The subscription, including postage, is \$10 per annum, or \$5 per half year, payable in advance.

Subscriptions are required for whole months, and must cover at least a half year.

Single copies are 20 cents, posted 25 cents. Subscribers do not receive the Acts of Parliament with the GAZETTE.

GAZETTES are held in stock for five years only.

PRIVATE ADVERTISEMENTS.—The charge for insertion is 25 cents per line single column, and 50 cents per line double column. The title forms one or more lines as a heading. On an average ten words make a line of single column. Every signature must likewise be counted as a line. The final words of a paragraph, though only portion of a line, must be counted as one line. Signatures (in particular) and proper names must be written very plainly in the text; ONE SIDE ONLY of each sheet of paper should be WRITTEN UPON.

All documents illegibly written will be returned unpublished, and where brands occur unprovided for by the ordinary letters of the alphabet, a worded explanatory description must be furnished.

THE VICTORIA GOVERNMENT GAZETTE is published on WEDNESDAY EVENING in each week, and Notices for insertion will be received by the Government Printer at or before ONE p.m. at ordinary rates, and late advertisements between ONE p.m. and FOUR p.m. at double rates on the day preceding the day of publication.

PAYMENTS.—Unless the advertiser has a credit account, all payments are required in advance. Remittances should be made by cheque, postal order, or money order payable to "GOVERNMENT PRINTER".

ADDRESS.—All communications should be addressed to "The Government Printer, Box 203, P.O., North Melbourne", 3051.

CONTENTS

	PAGE
Acts of Parliament on sale at the Government Printing Office	252
Appointments	219
Bank Holiday	202
Cemetery—Scale of Fees	209
Contracts	216
Courts	208
Government Notices	202
Impoundings	252
Lands	236
Mining	215
Notice of Making of Statutory Rules	252
Orders in Council—	
Acts—Licensing; Country Roads; Land; Local Government; State Electricity Commission; Road Traffic; Water; Sewerage Districts; Gas Regulation; Town and Country Planning.	220 et seq
Private Advertisements	246
Private Agents	210
Proclamations	199
Public Holiday—Australia Day	202
Public Service Notices	243
Resignations	220
Tenders	244
Transport Regulation Board—Public Hearings	203
Waterworks Trusts	217