



VICTORIA GOVERNMENT GAZETTE

Published by Authority

[Registered at the General Post Office, Melbourne, for transmission by post as a newspaper.]

No. 5]

WEDNESDAY, JANUARY 22

[1969

Land Act 1958.

AREA OF LAND COMPRISED IN CERTAIN CLASSES DIMINISHED OR INCREASED.

PROCLAMATION

By His Excellency the Governor of the State of Victoria and its Dependencies in the Commonwealth of Australia, &c., &c., &c.

WHEREAS by the *Land Act 1958* it is amongst other things enacted that the Governor in Council may, by Proclamation to be published in the *Government Gazette*, at any time diminish or increase the area of land comprised in any of the classes mentioned in Part I., Division 1, Section 5, of the said *Land Act 1958*, but that the area of lands which may be sold by auction (Class 6), shall not be increased except as in certain cases in the said Act provided: Now therefore I, the Governor of the State of Victoria, in the Commonwealth of Australia, by and with the advice of the Executive Council of the said State, and in accordance with the provisions of Sections 94 and 117 of the *Land Act 1958* aforesaid, do hereby diminish or increase (as the case may be) the areas of Crown lands comprised in Classes 6 and 7 of the classes mentioned in Section 5 of the *Land Act 1958* aforesaid, to the extent set forth in the subjoined Schedule (that is to say):—

Schedule referred to.

CLASSES DIMINISHED OR INCREASED.

County.	Parish.	Allotment.	Section.	Area.	Diminished.	Increased.	Description.
					Class.	Class.	
				A. R. P.			
Dalhousie ..	Baynton ..	73N ²	..	1 0 16	..	6	In the north-east of the Parish North of Creswick-Ballarat Railway line
Talbot ..	Creswick ..	2	4	9 3 38	7	1	

Given under my Hand and the Seal of the State of Victoria, aforesaid, at Melbourne, this fourteenth day of January, in the year of our Lord One thousand nine hundred and sixty-nine, and in the seventeenth year of the reign of Her Majesty Queen Elizabeth II.

(L.S.)

By His Excellency's Command,

ROHAN DELACOMBE.

W. J. F. McDONALD,
Minister of Lands.

GOD SAVE THE QUEEN !

MELBOURNE AND METROPOLITAN BOARD OF WORKS
(AMENDMENT) ACT 1968, No. 7778.

DAYS OF COMING INTO OPERATION OF CERTAIN PROVISIONS.

PROCLAMATION

By His Excellency the Governor of the State of Victoria and its Dependencies in the Commonwealth of Australia, &c., &c., &c.

IN pursuance of the provisions of Section 1 of the *Melbourne and Metropolitan Board of Works (Amendment) Act 1968*, I, the Governor of the State of Victoria, by and with the advice of the Executive Council thereof, do, by this my Proclamation fix the respective days specified hereunder as those on which the provisions of the said Act specified opposite such days shall come into operation:—

Sections 1 to 8 inclusive; 10 to 13 inclusive; 16; 18 to 22 inclusive; sub-section (1) of Section 23 excepting that portion thereof being sub-section (1A) of section 27 of the Principal Act; and sections 26 to 31 inclusive—22nd January, 1969.

Sections 14, 15 and 25—1st July, 1969.

Given under my Hand and the Seal of the State of Victoria aforesaid, at Melbourne, this fourteenth day of January, in the year of our Lord One thousand nine hundred and sixty-nine, and in the seventeenth year of the reign of Her Majesty Queen Elizabeth II.

(L.S.) ROHAN DELACOMBE.

By His Excellency's Command,

R. J. HAMER,
Minister for Local Government.

GOD SAVE THE QUEEN !

*Apprenticeship Act 1958.*VARIATION OF PROCLAMATION OF THE FILM
PRINTING TRADE AS AN APPRENTICESHIP TRADE.

PROCLAMATION

By His Excellency the Governor of the State of Victoria and its Dependencies in the Commonwealth of Australia, &c., &c., &c.

WHEREAS Section 13 of the *Apprenticeship Act 1958* provides, *inter alia*, that after the Minister has taken into consideration any recommendation made by the Apprenticeship Commission, the Governor in Council, for the purposes of the said Act, may from time to time by Proclamation proclaim any trade to be an apprenticeship trade and that the Governor in Council (whether with or without any recommendation of the said Commission) may by Proclamation at any time revoke, amend or vary any such Proclamation:

AND WHEREAS on the 28th November, 1961, the trade of *film printing* was proclaimed to be an apprenticeship trade in so far as it is carried on in the Metropolitan District, the Cities of Ballarat, Bendigo and Geelong (except in daily newspaper offices in the said Cities), the Cities of Geelong West, Newtown and Chilwell and the Boroughs of Eaglehawk and Sebastopol:

AND WHEREAS the Apprenticeship Commission of Victoria has recommended to the Minister that the said proclamation be varied in the manner following:

AND WHEREAS the Minister has taken the said recommendation into consideration:

NOW THEREFORE I, His Excellency the Governor of the State of Victoria in the Commonwealth of Australia, by and with the advice of the Executive Council of the said State, do by this my Proclamation vary the aforesaid proclamation by substituting for the apprenticeship trade proclaimed thereby the trade of Flexible packaging printing, (flexographic and/or gravure) in so far as it is carried on in the Metropolitan District, the Cities of Ballarat, Bendigo and Geelong (except in daily newspaper offices in the said cities), the Cities of Geelong West, Newtown and Chilwell and the Boroughs of Eaglehawk and Sebastopol:

Given under my Hand and the Seal of the State of Victoria aforesaid, at Melbourne, this fourteenth day of January, in the year of our Lord, One thousand nine hundred and sixty-nine, and in the seventeenth year of the reign of Her Majesty Queen Elizabeth II.

(L.S.) ROHAN DELACOMBE.

By His Excellency's Command,

J. F. ROSSITER,
Minister of Labour and Industry.

GOD SAVE THE QUEEN !

*Apprenticeship Act 1958.*CERTAIN TRADES PROCLAIMED TO BE
APPRENTICESHIP TRADES.

PROCLAMATION

By His Excellency the Governor of the State of Victoria and its Dependencies in the Commonwealth of Australia, &c., &c., &c.

WHEREAS section 13 of the *Apprenticeship Act 1958* provides, *inter alia*, that after the Minister has taken into consideration any recommendation made by the Apprenticeship Commission the Governor in Council, for the purposes of the said Act, may from time to time by Proclamation proclaim any trades to be apprenticeship trades:

AND WHEREAS the Apprenticeship Commission having notified in the manner prescribed by the said Act its intention to recommend that the trades set out hereunder, in so far as they are carried on in the whole of the State of Victoria, be proclaimed apprenticeship trades under the said Act, and having considered the representations made on behalf of the employers and employees in the said trades, has recommended to the Minister that the said trades be so proclaimed:

AND WHEREAS the Minister has taken the said recommendation into consideration:

NOW THEREFORE I, the Governor of the State of Victoria, in the Commonwealth of Australia, by and with the advice of the Executive Council of the said State, do by this my Proclamation proclaim the trades set out hereunder, in so far as they are carried on in the whole of the State of Victoria, to be apprenticeship trades, viz.:—

Shipwrighting
Boatbuilding
Shipwrighting and Boatbuilding.

Given under my Hand and the Seal of the State of Victoria aforesaid, at Melbourne, this fourteenth day of January, in the year of our Lord One thousand nine hundred and sixty-nine, and in the seventeenth year of the reign of Her Majesty Queen Elizabeth II.

(L.S.) ROHAN DELACOMBE.

By His Excellency's Command,

J. F. ROSSITER,
Minister of Labour and Industry.

GOD SAVE THE QUEEN !

MEDICAL (ORGAN TRANSPLANTS) ACT 1968.

DATE OF COMING INTO OPERATION.

PROCLAMATION

By His Excellency the Governor of the State of Victoria and its Dependencies in the Commonwealth of Australia, &c., &c., &c.

WHEREAS by the *Medical (Organ Transplants) Act 1968*, it is amongst other things enacted that the said Act shall come into operation on a day to be fixed by the Governor in Council published in the *Government Gazette*:

Now therefore I, the Governor of the State of Victoria, by and with the advice of the Executive Council of the said State, do by this Proclamation fix Saturday the first day of February One thousand nine hundred and sixty-nine as the day on which the *Medical (Organ Transplants) Act 1968*, shall come into operation.

Given under my Hand and the Seal of the State of Victoria aforesaid, at Melbourne, this fourteenth day of January, in the year of our Lord One thousand nine hundred and sixty-nine, and in the seventeenth year of the reign of Her Majesty Queen Elizabeth II.

(L.S.) ROHAN DELACOMBE.

By His Excellency's Command,

VANCE DICKIE,
Minister of Health.

GOD SAVE THE QUEEN !

FORESTS (AMENDMENT) ACT 1968.
DATE OF COMING INTO OPERATION.

PROCLAMATION

By His Excellency the Governor of the State of Victoria and its Dependencies in the Commonwealth of Australia, &c., &c., &c.

WHEREAS by an Act of the Parliament of the State of Victoria passed in the seventeenth year of the reign of Her Majesty Queen Elizabeth II. intitled the *Forests (Amendment) Act 1968* (No. 7740) it is amongst other things enacted that the said Act shall come into operation on a day to be fixed by Proclamation of the Governor in Council published in the *Government Gazette*: Now therefore I, the Governor of the State of Victoria acting by and with the advice of the Executive Council of the said State do by this my Proclamation fix Thursday the twenty-third day of January One thousand nine hundred and sixty-nine as the day upon which the *Forests (Amendment) Act 1968* (No. 7740) shall come into operation.

Given under my Hand and the Seal of the State of Victoria aforesaid, at Melbourne, this twenty-first day of January in the year of our Lord One thousand nine hundred and sixty-nine, and in the seventeenth year of the reign of Her Majesty Queen Elizabeth II.

(L.S.) ROHAN DELACOMBE.

By His Excellency's Command,

E. R. MEAGHER,
Minister of Forests.

GOD SAVE THE QUEEN!

GOVERNMENT NOTICES

PUBLIC HOLIDAY.—AUSTRALIA DAY.

IT is hereby notified that on—

MONDAY, THE 27TH JANUARY, 1969,

the Public Offices will be closed, such day having been appointed by the *Public Service Act 1958*, to be observed as a holiday in the Public Offices throughout the State of Victoria.

This notice relates only to the closing of the State Public Offices. All inquiries regarding the holiday in other offices and in shops and industry should be directed to the Department of Labour and Industry, 110 Exhibition-street, Melbourne, 3000. (Telephone 63 0321, Extension 6158, 6721 or 6859.)

A. G. RYLAH,
Chief Secretary.

Chief Secretary's Office,
Melbourne, 3rd January, 1969.

KERANG WATERWORKS TRUST.

BY-LAW No. 4.

THE Kerang Waterworks Trust in pursuance of and in exercise of the powers conferred by the *Water Act 1958* and of any and every other power it thereunto enabling doth hereby make a By-Law as follows:—

1. The Trust hereby makes and levies a rate in respect of all the lands and tenements within the Kerang Urban District of six cents in the dollar on the net annual value set out in the valuation at present in force of such lands and tenements for the purposes of the municipal rate of the Borough of Kerang which is hereby adopted as the valuation of such lands and tenements respectively.

2. Such rate shall be made and levied upon the occupiers and owners of such lands and tenements for the year commencing on the 1st day of January 1969 and shall be payable on the 6th day of June 1969 at the office of the said Trust.

3. In no case shall the rate payable hereunder in respect of any land be less than six dollars.

Passed on the 4th day of December, 1968.

(SEAL) J. G. GILMORE, Chairman.
G. H. TATE, Secretary.

Approved, 8th January, 1969.—W. BORTHWICK, Minister of Water Supply.

YEA WATERWORKS TRUST.

BY-LAW No. 101.

THE YEA WATERWORKS TRUST in pursuance of and in exercise of the powers conferred by the *Water Act 1958* and of any and every other power it thereunto enabling doth hereby make a By-Law as follows:—

1. The meter or meters measuring the supply of water to any land or tenement shall be read as near as practicable to twelve months from the date that it was read previously and the quantity of water so measured as having been supplied during the period between any two successive such readings hereinafter called "the meter year") shall be the basis of the calculating of charges payable under this By-Law provided always that where a meter has been installed on any land or tenement during the course of a meter year the quantity of water measured as having been supplied during the period between the date of such installation and the date of the reading shall be the basis of calculating such charges.

2. Subject as is hereinafter provided in respect of any land or tenement rated by the Trust—

(a) The maximum quantity of water to be supplied in any meter year without charge is hereby fixed as a quantity which if charged at 25 cents per thousand gallons for any meter year would give an amount equal to the amount of the rate payable in respect of the land or tenement for the financial year in which the said meter year ended.

(b) For all water supplied in any meter year in excess of the maximum quantity referred to in paragraph (a) of this clause the charge is hereby fixed at 25 cents per thousand gallons for any meter year.

3. Subject as is hereinafter provided the charge for water supplied by measure to any property not rated by the Trust is hereby fixed at 25 cents per thousand gallons.

4. The minimum charge for water supplied by measure to any property not rated by the Trust is hereby fixed at ten dollars.

5. The aforesaid charges shall be payable within seven days of demand upon the owner or occupier at the office of the Trust during normal business hours.

6. The provisions of Clauses 2, 3 and 4 of this By-law shall not apply to any land tenement or property supplied with water by the Trust under a special agreement pursuant to Section 215 of the *Water Act 1958*.

Passed on the 13th day of December, 1968.

(SEAL) K. D. BRYANT, Chairman.
F. F. BERKERY, Secretary.

Approved, 3rd January, 1969.—W. BORTHWICK, Minister of Water Supply.

YEA WATERWORKS TRUST.

RATING BY-LAW—1969.

THE YEA WATERWORKS TRUST in pursuance of and in exercise of the powers conferred by the *Water Act 1958* and of any and every other power it thereunto enabling doth hereby make a By-law as follows:—

1. The Trust hereby makes and levies a rate in respect of all the lands and tenements within the Yea Urban District of 8.3 cents in the dollar on the net annual value set out in the valuation at present in force of such lands and tenements for the purposes of the municipal rate of the Shire of Yea which is hereby adopted as the valuation of such lands and tenements respectively.

2. Such rate shall be made and levied upon the occupiers and owners of such lands and tenements for the year commencing on the 1st day of January, 1969 and shall be payable on the 31st day of March, 1969, at the office of the said Trust.

3. In no case shall the rate payable hereunder in respect of any land on which there is a building be less than thirteen dollars fifty cents and in respect of land on which there is no building be less than four dollars.

Passed on the 13th day of December, 1968.

(SEAL) K. D. BRYANT, Chairman.
F. F. BERKERY, Secretary.

Approved, 3rd January, 1969.—W. BORTHWICK, Minister of Water Supply.

WALWA WATERWORKS TRUST.

BY-LAW No. 104.

RATING BY-LAW—1969.

THE Walwa Waterworks Trust, in pursuance of and in exercise of the powers conferred by the Water Acts, doth hereby make a rate for the supply of water for domestic purposes of Two cents in the dollar on the Unimproved Capital Valuation of lands and tenements liable to be rated in the Walwa Urban District.

Provided that in no case shall the amount of the rate payable per annum in respect of any tenement other than land on which there is no building be less than Thirty Dollars and in respect of land on which there is no building be less than Eight Dollars.

Such rates are made and shall be levied upon the occupiers or owners of the said lands and tenements for the year commencing the 1st day of January 1969 and shall be payable on the 1st day of April 1969 at the office of the said Trust.

Passed on the 18th day of December, 1968.

(SEAL) J. H. HARVEY, Chairman.
J. HALLINAN, Member.
W. D. RYLAH, Secretary.

Approved, 6th January, 1969.—W. BORTHWICK, Minister of Water Supply.

WALWA WATERWORKS TRUST.

BY-LAW No. 102 FIXING CHARGES FOR WATER SUPPLIED BY MEASURE.

THE Walwa Waterworks Trust, in pursuance and exercise of the powers conferred by the Water Act doth hereby make the By Law following:—

(1) The meter or meters measuring the supply of water to any property shall be read once in every financial year as near as practicable to the same date and the quantity so measured as having been supplied during the period (hereinafter called the meter year) between two successive such readings shall be the basis of charges payable under this By-Law.

(2) In respect of any property rated by the Trust:—

(a) The maximum quantity of water to be supplied in any meter year without charge shall be the quantity which if charged at Forty cents per thousand gallons would give an amount equal to the amount of the rate payable in respect of the property for the financial year in which the meter year ended; and,

(b) for all water supplied in any meter year in excess of the maximum quantity referred to in paragraph (a) of this clause the charge shall be Thirty cents per thousand gallons.

(3) In respect of any property not liable to be rated by the Trust the charge for water supplied by measure in any meter year shall except where a special agreement with the Trust applies, be thirty cents per thousand gallons. Provided that the minimum quantity of water to be charged for, shall be that which yields the minimum annual charge if any fixed by the Trust applying to the property at the end of the meter year.

(4) This By Law shall apply within the Walwa Urban District and notwithstanding the provisions of any previous By Law shall take effect in respect of the meter year in course at the commencement of this By Law and in respect of any Meter beginning after the commencement of this By Law.

(5) The charges as set out in Clauses 3 and 4 of this By Law shall be payable on demand at the office of the Trust.

The foregoing By-Law was made by the Walwa Waterworks Trust on the 18th day of December, 1968.

In witness whereof the common seal of the Trust was hereunto affixed in the presence of—

(SEAL) J. H. HARVEY, Chairman.
J. HALLINAN, Commissioner.
W. D. RYLAH, Secretary.

Approved, 6th January, 1969.—W. BORTHWICK, Minister of Water Supply.

KIEWA WATERWORKS TRUST.

RATING BY-LAW FOR THE YEAR 1969.

THE Kiewa Waterworks Trust, in pursuance and exercise of the powers conferred by the Water Act, doth hereby make the following Rates for the supply of water for domestic purposes on lands and tenements liable to be rated within the Kiewa Urban District.

On such land and tenements a rate of Twenty Cents in the Dollar on the amount of the annual municipal valuation not exceeding One Hundred Dollars, and where the annual municipal valuation exceeds One Hundred Dollars a rate of Twenty Cents in the Dollar for the first One Hundred Dollars and Five Cents in the Dollar for every Dollar exceeding One Hundred Dollars of such valuation.

Provided that in no case shall amount of rate payable in respect of any tenement (other than land on which there is no building) be less than Twenty Dollars and in respect of any lands on which there is no building be less than One Dollar.

Such rates are made and shall be levied upon the occupiers or owners of such lands and tenements for the period commencing on the 1st day of January, 1969, and ending on the 31st day of December, 1969 and shall be payable on the 3rd day of April, 1969, to the said Trust.

The maximum quantity of water to be supplied in any one year without any further charge to any property rated by the Trust is hereby fixed at the quantity which at a charge of Twenty Cents per 1,000 gallons would produce an amount equal to the amount of the rate levied on such property for the said year.

The charge for water supplied by measure to any property rated by the Trust in excess of such maximum quantity computed as in the last preceding clause is hereby fixed at Twenty Cents per 1,000 gallons.

The charge for water supplied by measure shall be payable, on demand to the said Trust.

Passed this 12th day of December, 1968.

(SEAL) ARNOLD T. COULSTON, Chairman.
L. KRUTLI, Secretary.

Approved, 3rd January, 1969.—W. BORTHWICK, Minister of Water Supply.

MOOROOPNA WATERWORKS TRUST.

BY-LAW No. 2.

THE Mooroopna Waterworks Trust, in pursuance and exercise of the powers conferred by the Water Acts, doth hereby make the By-Law following for its Waterworks District.

By-Law No. 2 made by the Mooroopna Waterworks Trust on the 11th day of August, 1966; amended on the 29th day of December, 1966; amended on the 14th day of December, 1967, is hereby amended as follows:—

1. In Paragraphs (i) and (ii) of Clause (a) of Section No. 3, for the words "twenty-five cents" there shall be substituted the words "twenty-three cents".

2. In Paragraphs (i) and (ii) of Clause (b) of Section No. 3, for the words "twenty-five cents" there shall be substituted the words "twenty-three cents".

3. In Clauses (i) and (ii) of Section No. 4, for the words "twenty-five cents" there shall be substituted the words "twenty-three cents".

4. In Section No. 4A, for the words "twenty-five cents" there shall be substituted the words "twenty-three cents".

The foregoing By-Law was made by the Mooroopna Waterworks Trust on the 12th day of December, 1968.

In witness whereof, the Common Seal of the Mooroopna Waterworks Trust was hereto affixed in the presence of—

(SEAL) CECIL T. J. THOMPSON, Chairman.
E. D. PARSONS, Commissioner.
F. J. COOPER, Secretary.

Approved, 3rd January, 1969.—W. BORTHWICK, Minister of Water Supply.

SKIPTON WATERWORKS TRUST.

RATING BY-LAW FOR THE PERIOD 1ST OF JANUARY, 1969,
TO THE 31ST OF DECEMBER, 1969.

THE Skipton Waterworks Trust, in pursuance and exercise of the powers conferred by the Water Acts, doth hereby make a rate for the supply of water for domestic purposes of thirteen cents in the dollar of the annual municipal valuations of lands and tenements liable to be rated within the Skipton Urban District. Provided that in no case shall the amount of rate payable per annum in respect of any tenement (other than land on which there is no building) be less than ten dollars, and in respect of any land on which there is no building be less than two dollars.

Such rates are made and shall be levied upon the occupiers or the owners of the said lands and tenements for the period commencing the 1st day of January 1969 and shall be payable on the 1st day of March 1969 at the Office of the said Trust.

The maximum quantity of water to be supplied in the period without further charge to any property rated by the Trust is hereby fixed at the quantity which, at a charge of twenty-eight cents per thousand gallons, would produce an amount equal to the amount of the rate levied on such property for the said period.

The charge for water supplied by measure to any property rated by the Trust in excess of such maximum quantity, computed as in the last preceding clause, is hereby fixed at twenty-eight cents per one thousand gallons. The charge for water supplied by measure shall be payable on demand at the Office of the said Trust.

Passed this 2nd day of January 1969.

(SEAL) S. W. WALDRON, Chairman.
W. R. FOWLER, Commissioner.
J. E. ROWE, Secretary.

Approved, 6th January, 1969.—W. BORTHWICK, Minister of Water Supply.

SHIRE OF SHEPPARTON WATERWORKS TRUST.

RATING BY-LAW—1969.

THE Commissioners of the Shire of Shepparton Waterworks Trust in pursuance of the powers conferred by the Water Act 1958 do hereby make the following By-Law:—

BY-LAW No. 77.

1. That a rate of 1.25 cents in the dollar on the net annual valuation of all rateable property within the Shire of Shepparton Waterworks Trust district, according to the valuation for the time being of all lands and tenements for the municipal rates of the Shire of Shepparton is hereby made for the year commencing on the first day of January, 1969, and ending on the 31st day of December, 1969.

2. Such rate is hereby made payable in one instalment and shall be due and payable on 30th March, 1969.

3. Such person or persons as the Trust may from time to time appoint for that purpose shall be authorised to demand and collect the said rate.

The foregoing By-Law was made by the Commissioners of the Shire of Shepparton Waterworks Trust on the 5th day of December, 1968.

The Common Seal of the Shire of Shepparton Waterworks Trust was affixed by the authority of the said Trust, and in the presence of—

(SEAL) R. A. ROSS, Chairman.
J. W. REED, Secretary.

Approved, 6th January, 1969.—W. BORTHWICK, Minister of Water Supply.

SWAN HILL WATERWORKS TRUST.

AUTHORITY TO OBTAIN BANK OVERDRAFT.

HIS Excellency the Governor of the State of Victoria, by and with the advice of the Executive Council thereof, doth by Order made on the 21st day of January, 1969, authorize the Swan Hill Waterworks Trust to obtain in pursuance of the provisions of Section 286 of the Water Act 1958 (No. 6413) an advance or advances during the year 1969, by overdraft of the Trust's current account, such overdraft not to exceed at any one time the sum of Forty thousand dollars (\$40,000).

J. ROSSITER,
Clerk of the Executive Council.

At the Executive Council Chamber,
Melbourne, 21st January, 1969.

MOORoopNA WATERWORKS TRUST.

RATING BY-LAW FOR THE YEAR 1969.

THE Mooroopna Waterworks Trust, in pursuance and exercise of the powers conferred by the Water Act, doth hereby make a rate for the supply of water for domestic purposes of 3.8 cents in the dollar of the net annual valuation of the lands and tenements liable to be rated within the Mooroopna Urban District.

Provided that in no case shall the amount of the rate payable per annum in respect of any tenement (other than land on which there is no building) be less than Eleven dollars, and in respect of any land on which there is no building, less than Seven dollars.

Such rates are made and shall be levied upon the occupiers or owners of the said lands and tenements for the year commencing on the 1st day of January, 1969, and shall be payable on the 1st day of February, 1969, at the Office of the Trust.

For each public trough supplied with water by the Trust, the sum of Two dollars per annum shall be charged.

Passed this 12th day of December, 1968.

(SEAL) CECIL T. J. THOMPSON, Chairman.
FRANCIS J. COOPER, Secretary.

Approved, 3rd January, 1969.—W. BORTHWICK, Minister of Water Supply.

CARISBROOK WATERWORKS TRUST.

WATER CHARGES BY-LAW 1969.

THE Carisbrook Waterworks Trust in pursuance of and in exercise of the powers conferred by the Water Act 1958 and of any and every other power it thereunto enabling doth hereby make a By-law as follows:—

1. The meter or meters measuring the supply of water to any land or tenement shall be read as near as practicable to twelve months from the date that it was read previously and the quantity of water so measured as having been supplied during the period between any two successive such readings (hereinafter called "the meter year") shall be the basis of the calculating of charges payable under this By-law provided always that where a meter has been installed on any land or tenement during the course of a meter year the quantity of water measured as having been supplied during the period between the date of such installation and the date of the reading shall be the basis of calculating such charges.

2. Subject as hereinafter provided in respect of any land or tenement rated by the Trust—

(a) The maximum quantity of water to be supplied in any meter year without charge is hereby fixed as a quantity which if charged at Twenty cents per thousand gallons for any meter year would give an amount equal to the amount of the rate payable in respect of the land or tenement for the financial year in which the said meter year ended.

(b) For all water supplied in any meter year in excess of the maximum quantity referred to in paragraph (a) of this clause the charge is hereby fixed at Twenty cents per thousand gallons for any meter year.

3. Subject as is hereinafter provided the charge for water supplied by measure to any property not rated by the Trust is hereby fixed at Twenty cents per thousand gallons.

4. The minimum charge for water supplied by measure to any property not rated by the Trust is hereby fixed at Eighteen dollars.

5. The aforesaid charges shall be payable within seven days of demand upon the owner or occupier at the office of the Trust during normal business hours.

6. The provisions of Clauses 3, 4 and 5 of this By-law shall not apply to any land tenement or property supplied with water by the Trust under a special agreement pursuant to Section 215 of the Water Act 1958.

The resolution for passing this By-law was agreed to by the Carisbrook Waterworks Trust on the 17th day of December 1968.

The Corporate Seal of the Carisbrook Waterworks Trust was hereunto affixed in the presence of:—

(SEAL) E. M. DOWIE, Commissioner.
M. SNOW, Commissioner.
BRIAN F. O'CONNOR, Secretary.

Approved, 17th January, 1969.—W. BORTHWICK, Minister of Water Supply.

MOYHU WATERWORKS TRUST.

By-Law 102.

THE Moyhu Waterworks Trust in pursuance of and in exercise of the powers conferred by the *Water Act 1958* and of any and every other power it thereunto enabling doth hereby make a By-Law as follows:—

1. The Trust hereby makes and levies a rate in respect of all the lands and tenements within the Moyhu Waterworks District of 7 cents in the dollar on the Net Annual Value set out in the valuation at present in force of such lands and tenements for the purposes of the municipal rate of the Shire of Oxley which is hereby adopted as the valuation of such lands and tenements respectively.

2. Such rate shall be made and levied upon the occupiers and owners of such lands and tenements for the year commencing on the 1st day of January, 1969 and shall be payable on the 30th day of April, 1969, at the office of the said Trust.

3. In no case shall the rate payable hereunder in respect of any land on which there is a building be less than Seventeen dollars and in respect of land on which there is no building be less than Four dollars.

The common seal of the Moyhu Waterworks Trust was attached hereto, in the presence of—

(SEAL) C. BAKER, Chairman.
D. M. EVANS, Commissioner.
E. F. VAN LEEUWEN, Secretary.

Approved, 3rd January, 1969.—W. BORTHWICK, Minister of Water Supply.

ROMSEY WATERWORKS TRUST.

RATING BY-LAW FOR 1969.

THE Romsey Waterworks Trust in pursuance of and exercise of the powers conferred by the *Water Act*, doth hereby make a rate for the supply of water for domestic purposes of eight and one-quarter cents in the dollar of the annual municipal valuation of lands and tenements liable to be rated within the Romsey Urban District.

Provided that in no case shall the amount of the rate payable per annum in respect of any tenement (other than land on which there is no building) be less than Ten dollars and in respect of any land on which there is no building less than Three dollars.

Such rates are made and shall be levied upon the occupiers or owners of the said lands and tenements for the year commencing on the 1st day of January, 1969, and ending the 31st day of December, 1969, and shall be payable on the 1st day of May, 1969, at the office of the said Trust.

The maximum quantity of water to be supplied in any one year without further charge to any property rated by the Trust is hereby fixed at the quantity which at a charge of Twenty cents per 1,000 gallons would produce an amount equal to the amount of rate levied on such property for the said year.

The charge for water supplied by measure to any property rated by the Trust in excess of such maximum quantity computed as in the last preceding clause is hereby fixed at Twenty cents per 1,000 gallons.

The charge for water supplied to any property not rated by the Trust shall be by agreement and at the rate of Twenty cents per 1,000 gallons.

The charge for water supplied by measure shall be payable on demand.

Passed this 18th day of December, 1968.

(SEAL) L. J. COOK, Chairman.
BRIAN F. CARNE, Secretary.

Approved, 3rd January, 1969.—W. BORTHWICK, Minister of Water Supply.

CARISBROOK WATERWORKS TRUST.

RATING BY-LAW 1969.

THE Carisbrook Waterworks Trust in pursuance of and in exercise of the powers conferred by the *Water Act 1958* and of any and every other power it thereunto enabling doth hereby make a By-law as follows:—

1. The Trust hereby makes and levies a rate in respect of all the lands and tenements within the Carisbrook Urban District of 6 cents in the dollar on the net annual value set out in the valuation at present in force of such lands

and tenements for the purpose of the municipal rate of the Shire of Tullaroop which is hereby adopted as the valuation of such lands and tenements respectively.

2. Such rate shall be made and levied upon the occupiers and owners of such lands and tenements for the year commencing on the 1st day of January 1969 and shall be payable on the 10th day of June 1969 at the office of the said Trust.

3. In no case shall the rate payable hereunder in respect of any land on which there is a building be less than Eighteen dollars and in respect of land on which there is no building be less than Eighteen dollars.

The Resolution for passing this By-law was agreed to by the Carisbrook Waterworks Trust on the 17th day of December 1968.

The Corporate Seal of the Carisbrook Waterworks Trust was hereunto affixed in the presence of:—

(SEAL) E. M. DOWIE, Commissioner.
M. SNOW, Commissioner.
BRIAN F. O'CONNOR, Secretary.

Approved, 17th January, 1969.—W. BORTHWICK, Minister of Water Supply.

HURSTBRIDGE WATERWORKS TRUST.

RATING BY-LAW FOR THE YEAR 1968-69.

THE Hurstbridge Waterworks Trust, in pursuance of and in exercise of the powers conferred by the *Water Act 1958* and of any and every other power it thereunto enabling, doth hereby make a By-law as follows.

1. The Trust hereby makes and levies a rate in respect of all the lands and tenements within the Hurstbridge, Wattle Glen, Panton Hill and Kangaroo Ground Urban Districts of fifteen cents in the dollar on the net annual value set out in the valuations at present in force of such lands and tenements for the purposes of the municipal rates of the Shire of Eltham, the Shire of Whittlesea, and the Shire of Diamond Valley which are hereby adopted as the valuations of such lands and tenements respectively.

2. Such rate shall be made and levied upon the occupiers and owners of such lands and tenements for the year commencing on the 1st day of October, 1968, and shall be payable on the 1st day of February, 1969, at the office of the said Trust.

3. In no case shall the rate payable hereunder in respect of any land on which there is a building be less than Seventeen dollars and in respect of land on which there is no building be less than Ten dollars.

Signed and sealed this 18th day of December, 1968.

(SEAL) F. W. NANKERVIS, Chairman.
JAMES J. KIRKPATRICK, Commissioner.
M. B. WATSON, Secretary.

Approved, 15th January, 1969.—W. BORTHWICK, Minister of Water Supply.

WORKERS COMPENSATION ACT 1958.—Section 72.

HIS Excellency the Governor of the State of Victoria, by and with the advice of the Executive Council thereof, doth by Order made on the 21st day of January, 1969, and pursuant to the provisions of section 72 of the *Workers Compensation Act*, approve of the Catholic Church Property Insurance Company of Australasia Limited as an insurer for the period ending 30th June, 1969.

J. ROSSITER,
Clerk of the Executive Council.

At the Executive Council Chamber,
Melbourne, 21st January, 1969.

Electric Light and Power Act 1958.

ORDER GRANTED BY THE GOVERNOR IN COUNCIL.

IT is hereby notified that an Order pursuant to the provisions of the *Electric Light and Power Act 1958* (No. 6241) as hereunder mentioned has been granted by His Excellency the Governor in Council viz.:

Order No. 350, 1968.—Order under section 10 of the above-mentioned Act granted to the Mayor, Councillors and Citizens of the City of Preston, in respect of land within the Shire of Whittlesea.

J. C. M. BALFOUR,
Minister for Fuel and Power.

Transport Regulation Act.
TRANSPORT REGULATION BOARD.

HEARING OF APPLICATIONS.

NOTICE is hereby given that the following applications will be considered by the Transport Regulation Board at its offices at the corner of Lygon and Princes streets, Carlton, at 10.15 a.m. on Wednesday, 12th February, 1969.

BARNES COACHES SUNSHINE PTY. LTD., 43 Fraser-street, Sunshine. A required number of commercial passenger vehicles each with large seating capacity to operate as Metropolitan Stage Omnibuses on Route 130A (Sunshine-Deer Park-St. Albans) as presently operated under M.O. licences by the applicant with the ability to extend service from St. Albans Railway Station via Main-road East, Alfreda-street, Arthur-street, Taylors-road, St. Albans-road and Macedon-street, to Keilor Township. Fares to be determined. Monday-Friday.

Minimum service six (6) trips per day.

CHRISTIE, M. J., High-street, Heathcote. One commercial passenger vehicle (S/C. 11) to operate for the carriage of school children only, between Mt. Camel and Heathcote, under contract to the Education Department.

HAOUST, V., (Estate of the late), 59 Camberwell-road, Hawthorn. One commercial passenger vehicle (S/C. 27) to operate as an additional metropolitan stage omnibus on Route 10 (Camberwell Junction-Hawthorn Bridge).

HONICKE, J. F., Club Terrace. One commercial passenger vehicle (S/C. 5) to operate for the carriage of school children only between Club Terrace and Combenbar, under contract to the Education Department.

NIXON, W. E., D. J. & W. B. (Trading as Valley Bus Lines), 326 Bell-street, Preston. Two commercial passenger vehicles (S/C. 35) to operate as additional metropolitan stage omnibuses on Route 87A (Heidelberg-Northland-Lower Plenty-Greensborough-Eltham-Research).

PINCINI, E. J. & L., 492 Pascoe Vale-road, North Essendon. One commercial passenger vehicle (S/C. 35) to operate as an additional metropolitan stage omnibus on route 48A (Moonee Ponds-Glenroy).

Notice of any objection should be forwarded to reach the Secretary of the Board not later than Wednesday, 5th February, 1969.

Applicants are advised that it will not be necessary to appear on the hearing date specified above, unless advised in writing by the Board.

B. P. KAY,
Secretary.

Corner Lygon and Princes streets, Carlton, Wednesday, 22nd January, 1969.

Commercial Goods Vehicles Act.
TRANSPORT REGULATION BOARD.

HEARING OF APPLICATIONS.

NOTICE is hereby given that the following applications will be considered by the Transport Regulation Board at its offices at the corner Lygon and Princes streets, Carlton, at 10.15 a.m. on Wednesday, 12th February, 1969.

ALLAN, J. J., 12 Chicago-street, Maribyrnong, 3032. One commercial goods vehicle (L/C. 55 cwt.) to operate throughout the State of Victoria in the course of business as "Travelling Showman"—own sideshow equipment and novelty prizes.

ALLEN BROS. (ASPHALTING CONTRACTORS) PTY. LTD., 29 Metropolitan-avenue, Nunawading, 3101. One commercial goods vehicle (L/C. 21 cwt.) to operate throughout the State of Victoria as a specially constructed road spraying unit—bitumen and tar in bulk for road spraying.

AUSTRALIA & NEW ZEALAND BANK LTD., 177 Toorak-road, South Yarra, 3141. One commercial goods vehicle (L/C. 6 cwt.) to operate from and to own various bank branch premises throughout the State of Victoria in the course of business as "Banking"—stationery, own used accounting machines, typewriters and office equipment for own use in such bank premises, also tools of trade and materials incidental to the servicing and maintenance of such equipment.

BARBER, W. A., Western Highway, Beaufort, 3373. One commercial goods vehicle (L/C. 148 cwt.) to operate: (a) Within a 55-mile radius of the post office at Beaufort (Ballarat Division of the Country Roads

Board)—road-making plant. (b) Within a 20-mile radius from current construction site or from the nearest railway station thereto—materials. (c) Within a 25-mile radius from the post office at Beaufort—general goods, provided that no goods shall be carried whether by one stage or by more than one stage between places within the above radius which are more than 30 miles apart by the nearest practicable route. (d) Within a 10-mile radius of the site of construction or maintenance work performed pursuant to paragraph (a) above—water in a bulk tanker.

BEATTIE, R. M. P., Box 42, Goroke, 3412. Three commercial goods vehicles (L/C. 142, 143 and 140 cwt.) to operate: (a) Within a 25-mile radius of the post office at Goroke—general goods provided that no goods shall be carried whether by one stage or by more than one stage between places within the above radius which are more than 30 miles apart by the nearest practicable route. (b) From rail sidings and stations situated within a 50-mile radius of the post office at Goroke to places situated within the said radius—bulk superphosphate for spreading purposes.

BENDIGO DELUXE CATERING SERVICE PTY. LTD., 27 Queen-street, Bendigo, 3550. One commercial goods vehicle (L/C. 17 cwt.) to operate throughout the State of Victoria in the course of business as "Caterer"—own catering equipment and victuals.

BOORD, N., Yarrara, 3496. One commercial goods vehicle (L/C. 70 cwt.) to operate within a 70-mile radius of the post office at Mildura in the course of business as "Wheat Grader and Pickler"—own tools of trade and equipment incidental to own contracts.

BRUNT, R., TRANSPORT PTY. LTD., 61 Beverin-street, Sebastopol, 3356. One commercial goods vehicle (L/C. 100 cwt.) to operate: (a) Within a 25-mile radius of the post office at Ballarat—general goods. (b) Within a 150-mile radius of the post office at Ballarat solely on behalf of Whitelaw Monier Pty. Ltd.—tiles, battens, tile fixing materials and oxide colouring.

BULLOCK, H. T. & J., Princes Highway, Sale, 3850. Application to vary the conditions of licences numbered T.T.D.617/4 and D.T.617/5 (L/C. 400 and 140 cwt.) by deleting the present conditions and adding in lieu—"In course of business as 'Timber Merchant' for the carriage of own sawn timber: (a) From the sawmills of E. R. Hug and Licola Sawmilling Co. at Heyfield and from the sawmill of the Stratford Sawmilling Co. at Stratford to own yard at Sale and to building sites at Morwell, Churchill and Traralgon. (b) From own yard at Sale for delivery to building sites situated within a 50-mile radius of Sale. (c) From the sawmill of Mount Alfred Timber Mills Pty. Ltd. at Lindenow for delivery to building sites situated within a 50-mile radius of the post office at Lindenow. (d) From own yard at Dandenong for delivery to building sites situated within a 25-mile radius of the post office at Dandenong."

BUNGALOWS PTY. LTD., 24 Bell-street, Preston, 3072. One commercial goods vehicle (L/C. 202 cwt.) to operate throughout the State of Victoria in the course of business as "House Remover and Builder"—houses and sheds for removal from site to site and for subsequent re-erection, also tools of trade and equipment incidental thereto.

C. & I. CLEANING PTY. LTD., 173 Grange-road, Fairfield, 3078. Two commercial goods vehicles (L/C. 7 cwt. each) to operate throughout the State of Victoria in course of business as "Industrial Cleaning Service"—own specialized cleaning equipment and cleaning materials incidental only to own contracts.

CANT, F. W., 88 Waterloo-road, Trafalgar, 3824. One commercial goods vehicle (L/C. 240 cwt.) to operate within a 50-mile radius of the post office at Morwell and from and to Morwell to and from the Townships of Wonthaggi, San Remo and Cowes—aerated waters and empty containers for return solely on behalf of Marchants Aerated Waters and Cordials Pty. Ltd., provided that all goods carried shall have been initially consigned by rail to Morwell.

CASTLES, REX, PTY. LTD., 63 Raymond-street, Sale, 3850. One commercial goods vehicle (L/C. 200 cwt. approximately) to operate within a 50-mile radius from the post office at Sale in course of business as "Hardware Merchants"—own goods.

CHRISTY, E. N., 12 Hopetoun-street, Rochester, 3561. One commercial goods vehicle (L/C. 60 cwt.) to operate within the Shires of Rochester and Cohuna in the course of business as "Sanitary and Garbage Collection Contractors"—tools of trade, equipment and waste for disposal.

- CLELAND, P., & SONS (CLAYTON) PTY. LTD., 548 Clayton-road, Clayton, 3168. One commercial goods vehicle (L/C. 26 cwt.) to operate: (a) Within a 50-mile radius of own premises at Clayton in the course of business as "Smallgoods and Cream Distributors"—own goods. (b) Throughout the State of Victoria in a specially constructed refrigerated vehicle—fresh cream, meat and bacon and limited quantities not exceeding 3 cwt. at any one time of tinned ham and butter and not more than 6 cwt. per commodity at any one time of cheese and margarine (under refrigeration) for incidental delivery.
- CLELAND, P., & SONS PTY. LTD., 149 Bell-street, Preston, 3072. One commercial goods vehicle (L/C. 38 cwt.) to operate: (a) Within a 50-mile radius of own premises at Preston in the course of business as "Smallgoods and Cream Distributors"—own goods. (b) Throughout the State of Victoria in a specially constructed refrigerated vehicle—fresh cream, meat and bacon and limited quantities not exceeding 3 cwt. at any one time of tinned ham and butter and not more than 6 cwt. per commodity at any one time of cheese and margarine (under refrigeration) for incidental delivery.
- CORIDAS, B. R., 96 McAdam-street, Maffra, 3860. One commercial goods vehicle (L/C. 153 cwt.) to operate: (a) Within a 50-mile radius of the post office at Maffra in course of business as "Demolition, Excavation and Site Preparation Contractor"—own tools of trade and equipment, and materials incidental to the completion of own contracts. (b) Within a 50-mile radius of the post office at Maffra in course of business as "Primary Producer"—own goods.
- COX, L. W. & M. I., 141 Glenroy-road, Glenroy, 3046. Application to vary the conditions of licence No. D.A.48219 (L/C. 263 cwt.) by adding to the existing conditions as an additional paragraph (b)—"(b) From the pit of Peninsula Potteries at Somerville to the premises of Brick Industries Ltd., at Burwood—clay solely on behalf of Brick Industries Ltd."
- CURLING, R., Hazeldene, via Broadford, 3658. One commercial goods vehicle (L/C. 140 cwt.) to operate: (a) Within a 20-mile radius of own premises at Hazeldene in course of business as "Earth-moving Contractor"—own goods. (b) From the depot of Mobil Oil (Aust.) Ltd., at Yarraville, to own premises at Hazeldene and to places within a 10-mile radius thereof and places *en route*—petroleum products and empty return containers. (c) From Melbourne to places within a 10-mile radius of own premises at Hazeldene and places *en route* in course of business as "Machinery Agent & Store Owner"—own goods. (d) From places within a 10-mile radius of Hazeldene to Melbourne—sawn timber and logs. (e) Between the City of Melbourne and places within a 10-mile radius of Hazeldene—farm supplies, excluding wool and beer with the right to pick up and set down at farms *en route*.
This application replaces licence No. D.A.24253 previously held by the applicant.
- DAVIDSON, C. C. & J. M., 12 Anderson-street, Bairnsdale, 3875. Application to vary the conditions of licences numbered D.T.1281, D.T.1281/1 and D.T.1281/2 (L/C. 220, 270 and 250 cwt.) by adding to the existing conditions as an additional paragraph: "From the premises of Alpine Ash Joinery & Cabinet Works Pty. Ltd. at East Bairnsdale to places situated within a 25-mile radius of post office at Bairnsdale—bricks, cement, fibro-cement products and general builder's hardware."
- DAWSON, R. N., 15 Nullawill-street, Springvale North, 3170. One commercial goods vehicle (L/C. 10 cwt.) to operate throughout the State of Victoria as a "Sales Agent" of Hoover (Aust.) Pty. Ltd. for the purpose of demonstrating and servicing Hoover electrical household appliances—tools of trade, spare parts, appliances for demonstration, with the ability to leave an appliance when required.
- DELLAR, A. G. & B. F., 60 Barton-street, Reservoir, 3073. Application to vary the conditions of licence No. D.A.57375 (L/C. 145 cwt.) by adding to the existing conditions as an additional paragraph (b)—"(b) From the pit of Peninsula Potteries at Somerville to the premises of Brick Industries Ltd. at Burwood—clay solely on behalf of Brick Industries Ltd."
- DE VOND, L., 16 Kiama-court, North Clayton, 3169. Application to vary the conditions of licence No. D.A.61793 (L/C. 119 cwt.) by deleting "Clifton Brick Holdings Ltd. at Oakleigh" from the existing conditions and adding in lieu "The City Brick Works Co. Pty. Ltd. at Malvern".
- DOBBYN, H. B. (trading as Dobbyn's Music), 76A Langtree-avenue, Mildura, 3500. One commercial goods vehicle (L/C. 20 cwt.) to operate throughout the State of Victoria in the course of business as "Musical Instruments, Retailing & Service"—tools of trade, spare parts and materials incidental to tuning and repairing pianos and electronic organs, with the ability also to carry one piano, electronic organs and other musical merchandise for demonstration purposes or sale.
- DOENSEN, J. G., Warrandyte-road, Ringwood, 3134. Application to vary the conditions of licence No. D.A.59998 (L/C. 24 cwt.) by adding to the existing conditions after "tools of trade, carpets and floor coverings" the words "for installation purposes only".
- DUNLOP TYRE SERVICE (VIC.) PTY. LTD., Warracknabeal Branch, 9 Scott-street, Warracknabeal, 3393. One commercial goods vehicle (L/C. 11 cwt.) to operate within a 70-mile radius of own premises at Warracknabeal in the course of business as "Tire Distributors and Repairers"—tires and tubes for repair or retreading or having been repaired or retreaded, new tires and tubes and batteries, oil and motor car accessories.
- EASTHAM, L. E. Nicholson-street, Healesville, 3777. One commercial goods vehicle (L/C. 8 cwt.) to operate within a 50-mile radius of the premises of C. Dovaston, Farnham-road, Healesville, painter and decorator solely on behalf of the said person—tools of trade, ladders and paint incidental to the completion of contracts of the said person.
- ELLANKAY TRADING PTY. LTD., Burwood-road, Wantirna South, 3152. One commercial goods vehicle (L/C. 216 cwt.) to operate within a 50-mile radius from the premises of Albion Reid Pty. Ltd. at North Melbourne—road-making plant, materials, premix and hot asphalt solely on behalf of the said company excluding the carriage of cement or lime from the Geelong Urban District.
- EMOLEUM (AUSTRALIA) LTD., Arden-street, North Melbourne, 3051. One commercial goods vehicle (L/C. 241 cwt.) to operate throughout the State of Victoria in the course of business as "Manufacturers and Suppliers of Bitumen Emulsion" for the purpose of operating the vehicle as a spray unit for road spraying—bitumen and bituminous emulsion.
- ENSGN SERVICES (VIC.) PTY. LTD., 24 Leinster-grove, Northcote, 3070. One commercial goods vehicle (L/C. 48 cwt.) to operate within a 50-mile radius from own premises at Northcote in the course of business as "Dry Cleaners"—garments for laundering or dry cleaning or having been laundered or dry cleaned.
- FULLER, J. J., Lot 21, Alamein-street, Noble Park, 3174. One commercial goods vehicle (L/C. 136 cwt.) to operate within a 50-mile radius of the G.P.O., Melbourne, solely on behalf of Cottees Pty. Ltd.—aerated waters and empty return containers but excluding any operations to or from the City of Geelong.
- GIPPSLAND CONSOLIDATED MILK LTD., Post Office Box 195, Maffra, 3860. Application to vary the conditions of licences numbered D.A.61872/45 and D.A.61872/46 (L/C. 57 and 72 cwt.) by deleting paragraph (a) and adding in lieu—"(a) Within a 50-mile radius of the post office at Glengarry—cream and empty return containers;" and also deleting paragraph (b) sections (ii) and (iii) and paragraph (d) and also adding as an additional paragraph:—"From Yallourn to farms of primary producers from whom milk or cream is collected by the licence holder within a 25-mile radius of the post office at Glengarry—bagged briquettes."
- GREEN, H., 5 Hastings-avenue, Boronia, 3155. One commercial goods vehicle (L/C. 11 cwt.) to operate within a 50-mile radius of the G.P.O., Melbourne, as a "Contract Fitter" solely on behalf of Dural Leeds Pty. Ltd.—tools of trade, blinds and awnings and materials incidental to the installation of such goods.
- GRIFFITHS, VES., PTY. LTD., 4 Seaview-parade, Dromana, 3936. Application to vary the conditions of licences numbered D.A.34878, D.A.34878/1, D.A.34878/2, D.A.34878/3, and D.A.34878/4 (L/C. 103, 236, 254, 252 and 222 cwt.) by adding to the existing conditions as additional paragraphs:—1. From and to the premises of Courage Breweries Ltd. at Broadmeadows to and from places situated on or within 3 miles from the Point Nepean Highway between the Townships of Frankston and Portsea—beer and empty return containers. 2. From and to the premises of Brownbuilt Pty. Ltd. at Nunawading to and from places situated on or within 3 miles from the Point Nepean Highway between the Townships of Frankston and Portsea—roofing materials. 3. From and to the premises of Nuroof Pty. Ltd., at Heatherdale, to and from places situated on or within 3 miles from the Point Nepean Highway between the Townships of Frankston and Portsea—roofing materials.

- GURRIE, V. J., 2 Walker-street, Anglesea, 3230. One commercial goods vehicle (L/C. 153 cwt.) to operate within a 50-mile radius of the chief post office in the City of Geelong as a "Road Contractor"—road-making plant and materials.
- INGRAM CONTRACTORS AUSTRALIA PTY. LTD., 140 Queen-street, Melbourne, 3000. One commercial goods vehicle (L/C. 19 cwt.) to operate in the course of business as "Marine Constructors and Pipeline Contractors" in the South Gippsland area between Lakes Entrance and Barry's Beach—own supplies and equipment for off-shore operations.
- INTERNATIONAL HARVESTER CO. OF AUST. PTY. LTD., Mill-street, Horsham, 3400. One commercial goods vehicle (L/C. 73 cwt.) to operate within a 50-mile radius of own branch premises at Horsham in course of business as "Truck, Tractor and Farm Implement Manufacturer"—own goods.
- HAUGHTON BUXTON (FUTURES) PTY. LTD. (trading as Kennons (Gippsland) & Co.), 12 Bond-street, Sale, 3850. One commercial goods vehicle (L/C. 40 cwt.) to operate within a 50-mile radius of branch premises at Sale in the course of business as "Wool and Skin Merchants"—own wool, hides, skins and tallow.
- LANGSKAIL, A. (trading as Langskail Bros.), Buchan, 3892. Two commercial goods vehicles (L/C. 62 and 280 cwt.) to operate: (a) Between the Nowa Nowa Railway Station and places on or reached from the road between the Townships of Nowa Nowa and Wulgulmerang—general goods. (b) From and to places situated on or reached from the road between the Townships of Nowa Nowa and Wulgulmerang to and from the Townships of Bairnsdale and Orbost—general goods. (c) Within the Shire of Ormeo and within a 50-mile radius of the Buchan Post Office—livestock. Replaces Licence D.A.1470/4.
- LOYD-TAYLOR, E. M., 8 Wilson-street, Rosebud, 3939. One commercial goods vehicle (L/C. 153 cwt.) to operate within a 30-mile radius of the premises of Hillview Quarries Pty. Ltd. at Dromana solely on behalf of the said company—screenings, stone dust and quarry products.
- MCDONALD, R., Post Office Box 119, Edenhope, 3318. One commercial goods vehicle (L/C. 260 cwt.) to operate (a) Within a 25-mile radius of the post office at Edenhope—general goods provided that no goods shall be carried whether by one stage or by more than one stage between places within the above radius which are more than 30 road miles apart by the nearest practicable route. (b) Within a 50-mile radius of the post office at Edenhope in the course of business as "Primary Producer"—own goods.
- MCNEILL, J. R., 99 Bell-street, Preston, 3072. One commercial goods vehicle (L/C. 132 cwt.) to operate within a 50-mile radius of the G.P.O., Melbourne solely on behalf of Marchants Aerated Waters and Cordials Pty. Ltd.—aerated waters and empty return containers but excluding any operations to or from the City of Geelong.
- NORTHHAUSEN, F. J. & C. M., 22 Purdey-street, Tongala, 3621. One commercial goods vehicle (L/C. 122 cwt.) to operate: (a) Within a 25-mile radius of the post office at Tongala—general goods, provided that no goods shall be carried whether by one stage or by more than one stage between places within the above radius which are more than 30 miles apart by the nearest practicable route. (b) From and to places situated within the radius specified in paragraph (a) above to and from places outside that radius but wholly within a 50-mile radius of the post office at Tongala—livestock. (c) Within a 50-mile radius of the post office at Tongala—fresh fruit.
- PIERCE, F. K., 28 Batt-avenue, Wodonga, 3690. One commercial goods vehicle (L/C. 112 cwt.) to operate: (a) Within a 25-mile radius of the post office at Wodonga—general goods provided that no goods shall be carried whether by one stage or by more than one stage between places within the above radius which are more than 30 road miles apart by the nearest practicable route. (b) Within a 50-mile radius of the post office at Wodonga in the course of business as "Sand and Screening Supplier"—own gravel, sand, screenings and soil.
- POHL, J. (trading as Pohl Bros. Drilling Contractors), 5 Olive-grove, Niddrie, 3042. One commercial goods vehicle (L/C. 108 cwt.) to operate: (a) Throughout the State of Victoria in course of business as "Drilling Contractors"—tools of trade and drilling equipment. (b) Within a 25-mile radius of any current contract site or from the nearest railway station thereto—materials for use on such contract.
- PORTER, I. A., Box 194, Heywood, 3304. Application to vary the conditions of licence No. D.T.1280 (L/C. 273 cwt.) by adding to the existing conditions as an additional paragraph (c)—"(c) Within a 50-mile radius of the post office at Heywood in course of business as 'Logging Contractors'—own logging equipment and own tractors".
- PROVINCIAL MOTORS (BENDIGO) PTY. LTD., 123 High-street, Bendigo, 3550. One commercial goods vehicle (L/C. 27 cwt.) to operate within a 75-mile radius of own premises at Bendigo in the course of business as "Garage Proprietor and Ford Dealer"—tools of trade, spare parts and farm equipment incidental to the repair of tractors and farm machinery but excluding any operations whatsoever to or from the premises of the Ford Motor Co. of Australia Ltd., at Campbellfield.
- RENIC, F., 45 Lester-avenue, St. Albans, 3021. One commercial goods vehicle (L/C. 129 cwt.) to operate: (a) Within a 25-mile radius of own premises at St. Albans in course of business as "Solid Plasterer"—own goods. (b) From pits at Cranbourne to places situated within a 25-mile radius of the G.P.O., Melbourne—sand.
- RYAN EQUIPMENT CO. PTY. LTD., Post Office Box 148, Shepparton, 3630. One commercial goods vehicle (L/C. 73 cwt.) to operate: (a) Within a 25-mile radius of the post office at Shepparton—general goods provided that no goods shall be carried whether by one stage or by more than one stage between places within the said radius which are more than 30 miles apart by the nearest practicable route. (b) Within a 50-mile radius of own premises at Shepparton in the course of business as "Primary Producer" own goods. (c) Within a 50-mile radius of the post office at Shepparton in the course of business as "Machinery Dealer"—used farm and earth-moving machinery.
- SELKIRK FREIGHT LINES PTY. LTD., Howitt-street, Ballarat, 3350. One commercial goods vehicle (L/C. 221 cwt.) to operate: (a) From the brick kilns of James Selkirk Pty. Ltd. in the Ballarat District to points within the State of Victoria—products manufactured and/or processed by the said James Selkirk Pty. Ltd. at such brick kilns. (b) From any points within the State of Victoria to the brick kilns of James Selkirk Pty. Ltd. in the Ballarat District—goods solely for use by the said company in the manufacture and processing of their products at such brick kilns. (c) From the Metropolitan Area (as defined in the Transport Regulation Act 1958) to points within the Ballarat Urban District (also as defined in the said Act)—bricks.
- SOUTHERN PENINSULA TRANSPORT SERVICE PTY. LTD., Post Office Box 4, Rosebud, 3939. Application to vary the conditions of licences numbered D.A.2075, D.A. 2075/1, D.A.2075/2, D.A.2075/3, D.A.2075/7, D.A.2075/9, D.A.2075/11 and D.A.2075/12 (L/C. 140, 300, 241, 217, 59, 205, 60 and 66 cwt) by adding to the existing conditions as an additional paragraph (e)—"(e) From and to the premises of Courage Breweries Ltd. at Broadmeadows to and from places on or within 3 miles distance from that portion of the Nepean Highway situated between the Township of Portsea and the bridge over Dunn's Creek—beer and empty return containers.
- STANDARD TELEPHONE & CABLES PTY. LTD., 314 St. George's-road, Thornbury, 3071. One commercial goods vehicle (L/C. 17 cwt.) to operate within a 150-mile radius from own premises at Thornbury in course of business as "Telecommunication Engineers"—tools of trade, component parts, cable, mobile radios, Reznor gas heaters, and telephone systems for installation purposes only.
- TAYLOR, L. R. (trading as Taylor Bros.), 73 Forest-street, Castlemaine, 3450. Application to vary the conditions of licence No. D.A.4146 (L/C. 121 cwt.) by adding to the existing conditions after "Within a 50-mile radius from the post office at Castlemaine" the words "and to and from the Town of St. Arnaud".
- TOORALAC MILK PRODUCTS PTY. LTD., 141 Osborne-street, South Yarra, 3141. One commercial goods vehicle (L/C. 321 cwt.) to operate: (a) From the farms of Primary Producers situated within a 50-mile radius of the post office at Toora to own Milk Factory at Toora—milk and cream cans. (b) From own Milk Factory at Toora to the farms of Primary Producers from whom milk and cream is collected—empty milk and cream cans, also general goods for delivery to any such primary producer when required. (c) Goods associated with own approved decentralized secondary industry (Milk Products Manufacture) carried on at the premises at Toora as follows:—(1) To the said premises from the City of Melbourne and/or from South Gippsland district of the State of Victoria—goods and material required solely in the manufacturing process of such decentralized industry. (2) From

- the said premises at Toora to the City of Melbourne and/or to points within the said Gippsland District—own manufactured Milk Products.
- TOY, A. E., 18 Spray-street, Mornington, 3931. Application to vary the conditions of licences numbered D.A.21762/2, D.A.21762/3, D.A.21762/4 and D.A.21762/5 (L/C. 80, 184, 19 and 242 cwt.) by adding to the existing conditions as an additional paragraph:—"From and to the premises of Courage Breweries Ltd. at Broadmeadows to and from places situated on or reached from the road between and including the Townships of Frankston and Portsea—beer and empty return containers".
- WEATHERMASTER PTY. LTD., 17 McKellar-crescent, Mooroopna, 3629. One commercial goods vehicle (L/C. 65 cwt.) to operate within a 50-mile radius of own branch premises at Mooroopna in course of business as "Insulation Contractors"—own goods.
- WHELAN, J. E., 20 Lindsay-street, Macleod, 3085. One commercial goods vehicle (L/C. 62 cwt.) to operate throughout the State of Victoria in the course of business as "Petrol Pump and Tank Installation Contractors" solely on behalf of B.P. Australia Ltd.—petrol pumps and small capacity tanks for installation, tools of trade and fittings incidental thereto.
- SMITH, H. I., Wood-street, Flinders, 3929. Two commercial goods vehicles (L/C. 145 and 233 cwt.) to operate: (a) From and to places situate within the corporate limits of the City of Melbourne and within a distance of 8 miles beyond the limits thereof, direct only via the route set out below, to and from places situate within a 9-mile radius from the post office at Flinders and to and from the Township of Somers—general goods. Route referred to:—The main road from Flinders to Frankston via the Townships of Merrick, Balnarring, Bittern, Hastings and Tyabb; thence via the Point Nepean-road to the City of Melbourne. (b) From and to the railway station at Bittern to and from places situated within a 9-mile radius from the post office at Flinders and to and from the Township of Somers—general goods. (c) To and from the Township of Stony Point and the Township of Hastings from and to the City of Melbourne and within a distance of 8 miles beyond the limits thereof—fresh fish in boxes and empty boxes. (d) To and from Flinders via Balnarring, Merricks, Crib Point, Bittern, Hastings, Tyabb and Somerville and to include Long Island Project (Hastings) from and to Melbourne serving places *en route*—general goods.
- TOW TRUCK.
- RILEY MOTORS PTY. LTD., 258 Gray-street, Hamilton, 3300. One commercial goods vehicle (to be purchased) to operate throughout the State of Victoria as a "Tow Truck" solely:—(a) For the purpose of lifting and carrying or towing motor cars and the carriage of tools and equipment necessary for such purpose only. (b) The carriage of spare parts necessary for the repair of a disabled motor to and from the place at which such disablement has occurred.
- RENEWALS.
- A**PPPLICATIONS for renewal of licences as shown by persons listed hereunder to operate under the same terms and conditions from the expiry shown in each case.
- BRIMSMEAD, R. H. (trading as Agricultural and Domestic Sprays), 14 Whitehorse-road, Ringwood, 3134; D.A.10588/13; 15th February, 1969; 87 cwt.; D.A.10588/14; 23rd February, 1969; 55 cwt.
- AKERS, W. L. G., Maude-street, Dunnolly, 3472; D.A.54575; 23rd February, 1969; 108 cwt.
- ALBION REID PTY. LTD., Benmore-street, North Geelong; D.A.520/88; 15th February, 1969; 161 cwt.
- ALFA-LAVAL (Vic.) PTY. LTD., 288 Coventry-street, South Melbourne, 3205; D.A.22799/16; 20th February, 1969; 14 cwt.
- ARNOW, A. D., 49 Bennett-parade, East Kew, 3102; D.A.1876; 16th February, 1969; 6 cwt.
- BLACKNEY, C. A. (trading as Blackney's Fish Supply), 34 Smyth-street, Geelong, 3220; T.D.A.36140/5; 15th February, 1969; 63 cwt.
- BOYD, O. I., Eagle Point, 3878; D.A.54433/1; 26th January, 1969; 6 cwt.
- BROWN, H. V., PTY. LTD., 5 Alex-avenue, Moorabbin, 3189; D.A.54618; 23rd February, 1969; 10 cwt.
- CAMPERDOWN-GLENORMISTON DAIRYING CO. LTD., Princes Highway, Camperdown, 3260; D.A.54036; 2nd February, 1969; 249 cwt.; D.A.54036/1; 2nd February, 1969; 160 cwt.; D.A.54036/2; 2nd February, 1969; 250 cwt.; D.A.54036/3; 2nd February, 1969; 164 cwt.; D.A.54036/4; 2nd February, 1969; 257 cwt.
- CERAMIC TRANSPORT PTY. LTD., corner Princes Highway and Smith-road, Springvale, 3171; D.A.50824/28; 2nd February, 1969; 140 cwt.
- CIGARETTE SERVICE PTY. LTD., 171 Bridge-street, Bendigo, 3550; D.A.40870/7; 16th January, 1969; 67 cwt.
- CLEMENTS, K. G., 1 Dunstan-street, Frankston, 3199; D.A.62170; 16th February, 1969; 37 cwt.
- COMMONWEALTH INDUSTRIAL GASES LTD., THE, 90 Bell-street, Preston, 3072; D.A.838/24; 20th February, 1969; 85 cwt.
- ELLIOT, W. J., Leneva, via Wodonga, 3690; D.A.41809; 20th February, 1969; 116 cwt.
- ELLIS, M., 809-811 Sturt-street, Ballarat, 3350; D.A.1037; 21st February, 1969; 12 cwt.
- FALCON CABINET & JOINERY CO. PTY. LTD., 210 Stanley-street, West Melbourne, 3003; D.A.41769; 20th February, 1969; 28 cwt.
- GENERAL MOTORS-HOLDEN'S PTY. LTD., Princes Highway, Dandenong, 3175; D.A.27925/30; 20th February, 1969; 14 cwt.; D.A.27925/31; 20th February, 1969; 14 cwt.
- GLENMIX PTY. LTD., Beaconsfield-parade, Glenrowan, 3675; D.A.53997/1; 26th January, 1969; 168 cwt.
- GREEN, K. C., 21 Crawford-street, Seymour, 3660; D.A.41770; 20th February, 1969; 141 cwt.
- GRINTER, W., & SONS PTY. LTD., Swifts Creek, 3896; D.A.1207/2; 21st February, 1969; 317 cwt.
- HAYNES, R. L., & CO. PTY. LTD., 4 Wells-road, Oakleigh, 3166; D.A.8467/2; 18th August, 1968; 56 cwt.
- HICKS, JAMES, PTY. LTD., Princes Highway, Officer, 3809; D.A.1293; 16th February, 1969; 83 cwt.
- HORBY, L. J., Dinglee, 3571; D.A.54580; 15th February, 1969; 262 cwt.
- HUTCHINSON, L. J., 16 Nimmo-street, Essendon, 3040; D.A.11668/1; 20th February, 1969; 70 cwt.
- HUTCHINSON, ROBERT, LTD., Hartington-street, Glenroy; D.A.27836/11; 20th February, 1969; 134 cwt.
- IERACI, N., & SONS PTY. LTD., 76 McIlwraith-street, Princes Hill, 3054; D.A.28250; 29th January, 1969; 44 cwt.
- KEATH, ROBIN (S.A.) PTY. LTD., Post Office Box 128, Horsham, 3400; D.A.22517/22; 26th January, 1969; 10 cwt.
- KEOGH, P., PTY. LTD., 371 Francis-street, Yarraville, 3013; D.A.6989/9; 1st March, 1969; 294 cwt.
- KRAFT FOODS LTD., Salmon-street, Port Melbourne, 3207; D.A.1456/16; 20th February, 1969; 80 cwt.
- MATHRICK, H. & C., PTY. LTD., 64 Princes Highway, Warrambool, 3280; D.A.41216; 16th January, 1969; 19 cwt.; D.A.41216/1; 16th January, 1969; 19 cwt.
- MELOCCO BROS. PTY. LTD., Post Office Box 113, Springvale, 3171; D.A.53368/2; 21st February, 1969; 151 cwt.
- KENNEDY, J. (trading as Moree Quarries), Post Office Box 39, Harrow, 3317; D.A.40985/2; 20th February, 1969; 142 cwt.
- MCMAHON, J., & SONS, 491 Ryrie-street, Geelong, 3220; T.D.A.61256; 22nd January, 1969; 127 cwt.
- MCCLUSKEY, K. J., 69 Kerr-street, Warrambool, 3280; D.A.7360/1; 23rd February, 1969; 141 cwt.
- MCKENZIE CREEK QUARRYING CO. PTY. LTD., 122 Firebrace-street, Horsham, 3400; D.A.1686/7; 11th January, 1969; 192 cwt.
- MCKINLAY, J. C., 16 Dawson-street, Ararat, 3377; D.A.54622/1; 23rd February, 1969; 79 cwt.
- MCNAMARA, G. M., 108 Latrobe-terrace, Geelong West, 3220; D.A.20029; 20th February, 1969; 142 cwt.
- NIBLETT, K. & L., Bradvale, via Skipton, 3361; D.A.54376; 26th January, 1969; 135 cwt.
- O'FARRELL, R. W. & P. J., 36 Princes-street North, Ballarat, 3350; D.A.54527; 2nd February, 1969; 135 cwt.
- OGLE, E., Flat 3, No. 11 Ian-grove, Burwood, 3125; D.A.29343/1; 15th February, 1969; 20 cwt.
- PETERSVILLE AUSTRALIA LTD., Wellington-road, Clayton, 3168; T.D.A.1813/32; 4th February, 1969; 140 cwt.; T.D.A.1813/33; 4th February, 1969; 75 cwt.
- PETERSVILLE AUSTRALIA LTD., Wellington-road, Clayton, 3168; T.D.A.1813/34; 11th February, 1969; 73 cwt.; T.D.A.1813/35; 26th February, 1969; 74 cwt.; T.D.A.1813/82; 3rd February, 1969; 77 cwt.; T.D.A.1813/83; 3rd February, 1969; 77 cwt.; T.D.A.1813/86; 4th February, 1969; 70 cwt.; T.D.A.1813/87; 17th February, 1969; 70 cwt.; T.D.A.1813/88; 17th February, 1969; 71 cwt.; T.D.A.1813/114; 2nd February, 1969; 71 cwt.; T.D.A.1813/115; 15th February, 1969; 72 cwt.; T.D.A.1813/138; 31st January, 1969; 223 cwt.
- PETERSVILLE AUSTRALIA LTD., Wellington-road, Clayton, 3168; T.D.A.1813/113; 2nd February, 1969; 19 cwt.
- PERKIN, T. W., 5 Jolly-street, Dandenong West, 3076; D.A.54637; 23rd February, 1969; 152 cwt.
- PERMEWAN WRIGHT LTD., 147-179 Alexandra-parade, Abbotsford, 3067; D.A.1809/4; 25th February, 1969; 77 cwt.

- POLITIS, A., 5 Bradley-street, Pascoe Vale, 3044; D.A.54476; 2nd February, 1969; 146 cwt.
- PRIDHAM, W. (AUST.) PTY. LTD., 11 Evans-street, Braybrook, 3019; D.A.1864/1; 21st January, 1969; 61 cwt.
- PURNELL, ROBERT (TRANSPORT) PTY. LTD., 47 Moorabool-street, Geelong, 3220; D.A.28157; 25th February, 1969; 202 cwt.
- REID (ASPHALTING CONTRACTORS) PTY. LTD., 29 Metropolitan-avenue, Nunawading, 3131; D.A.48009/3; 20th February, 1969; 67 cwt.
- RENOUF, A. H., 429 Springfield-road, Mitcham, 3132; D.A.24042; 31st January, 1969; 97 cwt.
- RICHARDS, F. H., 15 Velma-grove, Ringwood East, 3135; D.A.54151; 21st December, 1968; 148 cwt.
- SIDES, W. L., & SON PTY. LTD., Wellington-road, Clayton, 3168; D.A.28601/9; 13th February, 1969; 109 cwt.
- SOUTHERN CROSS MACHINERY PTY. LTD., 133-135 McIntyre-road, Sunshine, 3020; D.A.52380/2; 11th January, 1969; 42 cwt.
- SUNBEAM CORPORATION LTD., Sloan-street, Maribyrnong, 3032; D.A.14579/44; 15th February, 1969; 10 cwt.
- TARAX DRINKS (ALBURY) PTY. LTD., 26 High-street, Wodonga, 3690; T.D.A.39288/5; 12th February, 1969; 111 cwt.; T.D.A.39288/6; 12th February, 1969; 10 cwt.; T.D.A.39288/7; 12th February, 1969; 10 cwt.; T.D.A.39288/8; 12th February, 1969; 52 cwt.
- TUPPERWARE OF AUSTRALIA PTY. LTD., Lysterfield-road, Fern Tree Gully, 3156; D.A.54379/2; 23rd February, 1969; 8 cwt.; D.A.54379/3; 23rd February, 1969; 8 cwt.; D.A.54379/4; 23rd February, 1969; 8 cwt.; D.A.54379/5; 23rd February, 1969; 8 cwt.; D.A.54379/6; 23rd February, 1969; 8 cwt.; D.A.54379/7; 23rd February, 1969; 8 cwt.; D.A.54379/8; 23rd February, 1969; 8 cwt.; D.A.54379/9; 23rd February, 1969; 8 cwt.; D.A.54379/10; 23rd February, 1969; 8 cwt.; D.A.54379/11; 23rd February, 1969; 8 cwt.; D.A.54379/12; 23rd February, 1969; 8 cwt.; D.A.54379/13; 23rd February, 1969; 8 cwt.; D.A.54379/14; 23rd February, 1969; 8 cwt.; D.A.54379/15; 23rd February, 1969; 8 cwt.; D.A.54379/16; 23rd February, 1969; 8 cwt.; D.A.54379/17; 23rd February, 1969; 8 cwt.; D.A.54379/18; 23rd February, 1969; 8 cwt.; D.A.54379/19; 23rd February, 1969; 8 cwt.; D.A.54379/20; 23rd February, 1969; 8 cwt.; D.A.54379/21; 23rd February, 1969; 8 cwt.; D.A.54379/22; 23rd February, 1969; 8 cwt.
- WALLACE, D. F., Teesdale, 3328; D.A.16643/3; 15th February, 1969; 250 cwt.
- WILLIAMSON, J. C., 127 East Boundary-road, East Bentleigh, 3165; D.A.13198; 23rd January, 1969; 160 cwt.

TOW TRUCK RENEWALS

- BREWSTER & MADDERN PTY. LTD., Allan-street, Kyabram, 3620; T.D.A.45968; 10th February, 1969; 63 cwt.
- FARRAR, J. P., 32 Bank-street, Port Fairy, 3284; T.D.A.45834; 3rd February, 1969; 10 cwt.
- BAIRNSDALE G.P. MOTORS (ORBOST) PTY. LTD., 118 Nicholson-street, Orbost, 3888; T.D.A.582; 11th February, 1969; 25 cwt.
- LAFFAN, B. V. (trading as Laffan Bros.), Wallan, 3654; D.A.2359; 16th February, 1969; 40 cwt.
- RILEYS MOTORS PTY. LTD., 120 Percy-street, Portland, 3305; D.A.44573/1; 9th November, 1968; 62 cwt.
- THOMPSON, K. R. (trading as Stratford Motors), Tyers-street, Stratford, 3862; T.D.A.47271; 14th January, 1969; 30 cwt.
- TRANS OTWAY LTD., Corner Ryrie and Fenwick streets, Geelong, 3220; T.D.A.2179/23; 18th February, 1969; 20 cwt.

RENEWAL WITH VARIATION.

APPLICATION by the persons listed hereunder for renewal of licence listed with variation of conditions in the manner set out opposite the name.

- CENTRE VALE BATTERY SUPPLIES PTY. LTD., 105-107 Poath-road, Hughesdale, 3166; D.A.54130; 2nd February, 1969; Application to renew and vary conditions of licence No. D.A.54130 (L/C. 75 cwt.) by adding to the existing conditions as an additional paragraph:—"Within a 25-mile radius of the post office at Hughesdale in course of business as 'Battery Suppliers'—own batteries."

- DAVIS, R., 20 Morgan-street, Bairnsdale, 3875; D.A.41602; 16th January, 1969; Application to renew and vary conditions of licence No. D.A.41602 (L/C. 104 cwt.) by deleting paragraph (c) of the existing conditions and adding in lieu:—" (c) Within a 25-mile radius of the post office at Bairnsdale—general goods provided that no goods shall be carried whether by one stage or by more than one stage between places within the above radius, which are more than 30 road miles apart by the nearest practicable route."
- GOTTS, H. J., 20 Boisdale-street, Maffra, 3860; D.A.47309; 13th February, 1969; Application to renew and vary conditions of licence No. D.A.47309 (L/C. 10 cwt.) by deleting the existing conditions and adding in lieu—"Within that part of the State of Victoria situated east of a north/south line drawn through the City of Dandenong in course of business as 'Bag and Jute Merchant'—second-hand uncleaned bags."
- MCKENZIE CREEK QUARRYING CO. PTY. LTD., 122 Firebrace-street, Horsham, 3400; D.A.1686/5; 16th January, 1969; Application to renew and vary the conditions of licence No. D.A.1686/5 (L/C. 102 cwt.) by deleting the existing conditions and adding in lieu—" (a) Within a 25-mile radius of the post office at McKenzie Creek—general goods provided that no goods shall be carried whether by one stage or by more than one stage between places within the above radius which are more than 30 miles apart by the nearest practicable route. (b) Within a 50-mile radius of the post office at McKenzie Creek—own screenings."
- MCKENZIE, E. T., 95 Marley-street, Sale, 3850; D.A.37601; 14th December, 1968; Application to renew and vary conditions of licence No. D.A.37601 (L/C. 135 cwt.) by deleting paragraph (c) of the existing conditions and adding in lieu:—" (c) Within a 25-mile radius of the post office at Sale—general goods, provided that no goods shall be carried whether by one stage or by more than one stage between places within the above radius, which are more than 30 miles apart by the nearest practicable route."

Notice of any objection should be forwarded to reach the Secretary of the Board not later than 5th February, 1969.

Applicants are advised that it will not be necessary to appear on the hearing date specified above, unless advised in writing by the Board.

B. P. KAY,
Secretary.

Corner Lygon and Princes streets, Carlton, 3053,
Wednesday, 22nd January, 1969.

TEACHING SERVICE ACT 1958, SECTION 73.

PUBLIC SERVICE ACT 1958, SECTIONS 55 AND 56.

EDITH KREUZER, Teacher, Secondary Schools Division, Hamilton High School, Education Department, having been charged under the provisions of section 55 of the Public Service Act 1958, as extended and made applicable to members of the teaching service by section 73 of the Teaching Service Act 1958, with being absent without leave from and including the 6th February, 1968, and such charge having been referred, by direction of the Honorable the Minister of Education, to the Teachers Tribunal, the Tribunal after enquiry find such charge proved and under the provisions of the section of the Act above cited, hereby dispenses with the services of the said Edith Kreuzer from and including the 23rd December, 1968.

W. E. SAMPSON, Chairman.
A. F. LE CLERCQ, Secretary.

Office of the Teachers Tribunal,
Melbourne, 23rd December, 1968.

TEACHING SERVICE ACT 1958.—SECTION 73.

PUBLIC SERVICE ACT 1958.—SECTIONS 55 AND 56.

VICTORIA ANN MARANTZ, teacher, Primary Schools Division, State School No. 4931, Altona North, Education Department, having been charged under the provisions of section 55 of the Public Service Act 1958, as extended and made applicable to members of the teaching service by section 73 of the Teaching Service Act 1958, with being absent without leave from and including the 7th February, 1967, and such charge having been referred, by direction of the Honorable the Minister of Education, to the Teachers Tribunal, the Tribunal after enquiry finds such charge proved and under the provisions of the section of the Act above cited, hereby dispenses with the services of the said Victoria Ann Marantz from and including the 23rd December, 1968.

W. E. SAMPSON, Chairman.
A. F. LE CLERCQ, Secretary.

Office of the Teachers Tribunal,
Melbourne, 23rd December, 1968.

Private Agents Act 1966.

NOTICE OF RECEIPT OF APPLICATIONS FOR LICENCES UNDER THE PROVISIONS OF THE PRIVATE AGENTS ACT 1966.

THE Clerk(s) of the Court(s) of Petty Sessions as listed hereunder hereby give notice that applications, as under, have been lodged for hearing by the said Court(s) on the date(s) specified.

Any person desiring to object to any of such applications must—

- (a) lodge with the respective Clerk of Petty Sessions a notice in the prescribed form of his objection and of the grounds thereof ;
- (b) cause a copy of such notice to be served personally or by post upon the applicant at least three days before the hearing of the application ; and
- (c) send or deliver—
 - (i) where the objection is not made by the officer in charge of the police district in which the Court is situated—a copy of the notice to such officer ; and
 - (ii) where the objection is not made by the Registrar or Deputy Registrar—a copy to the Registrar.

Full Name of Applicant or in the case of a Firm or Corporation, of the Nominee.	Place of Abode of Applicant or Nominee.	Name of Firm or Corporation.	Address for Registration.	Type of Licence.	Date of Hearing of Application.
COURT OF PETTY SESSIONS, MELBOURNE.					
Reed, Frederick John	36 Shalbury-avenue, Eltham		Bailiff's Office, Ground Floor, 223 William-street, Melbourne	Process Server (Individual)	5.2.69
Barrett, John William	13 Collings-street, Hartwell	Armoured Escorts Pty. Ltd.	Cnr. Arden and Lothian-streets, North Melbourne	Watchman	"
Berry, Vivian Stanley	85 Cuthbert-street, Broadmeadows	Australian Watching Co. Pty. Ltd.	340 Abbotsford-street, North Melbourne	"	"
Bos, Gerhard	31 Berry-street, Coburg	"	"	"	"
Bridson, Steven Matthew	21 High-street, Mont Albert	Armoured Escorts Pty. Ltd.	Cnr. "Arden" and Lothian-streets, North Melbourne	"	"
Gartside, Leslie Winzer	16 Rae-street, East Bentleigh	Australian Watching Co. Pty. Ltd.	340 Abbotsford-street, North Melbourne	"	"
Hoegel, Karl	126 Lee-street, North Carlton	"	"	"	"
Hewat, Robert John	147 Railway-avenue, Laverton	"	"	"	"
Hickson, Alfred John	100 Wellington-street, St. Kilda	"	"	"	"
Ilan, Menachem	Flat 6, 27 Gladwyn-avenue, East Bentleigh	"	"	"	"
King, Frederick Thomas	304 Albert-road, South Melbourne	"	"	"	"
Knight, Allan Keith	4 Duke-street, Ashburton	Mayne Nickless Ltd.	94 York-street, South Melbourne	"	"
Knight, John Darlington	Brysons-road, South Warrandyte	Australian Watching Co. Pty. Ltd.	340 Abbotsford-street, North Melbourne	"	"
Macrae, William Alfred	4 Callaghan-street, Noble Park	"	"	"	"
Muntz, Antonius	44 Hansen-street, West Footscray	"	"	"	"
Ritchie, Thomas George	9 Waranga-crescent, Broadmeadows	"	"	"	"
Roelofs, Albert Louis	87 Mason-street, Newport	"	"	"	"
Simmonds, Barry Raymond	8 Balgonie-place, Northcote	Armoured Escorts Pty. Ltd.	Cnr. Arden and Lothian-streets, North Melbourne	"	"
Stewart, Viggo Robert	"York Cottage", Yarra-street, Warrandyte	Australian Watching Co. Pty. Ltd.	340 Abbotsford-street, North Melbourne	"	"
Sullivan, Norman Joseph	243 Huntingdale-road, Ashburton	"	"	"	"
Tucknott, Alan Roy	119 Spensley-street, Clifton Hill	Armoured Escorts Pty. Ltd.	Cnr. Arden and Lothian-streets, North Melbourne	"	"
Wells, Henry George	13 Reynolds-parade, Pascoe Vale South	Australian Watching Co. Pty. Ltd.	340 Abbotsford-street, North Melbourne	"	"
White, William Wallace	1389 Centre-road, Clayton	"	"	"	"
Whitley, Herbert Macoboy	84A William-street, Balaclava	"	"	"	"

Dated at Melbourne this 15th day of January, 1969.

G. L. WEBSTER, Clerk of Petty Sessions.

COURT OF PETTY SESSIONS, NORTHCOTE.

Smith, Edwin Raymond	28 Bellara-street, Doncaster	Smiths Mercantile	35 Como-street, Alphington	Commercial Sub-agent	14.2.69
----------------------	------------------------------	-------------------	----------------------------	----------------------	---------

Dated at Northcote this 17th day of January, 1969.

J. G. DENAHY, Clerk of Petty Sessions.

PRIVATE AGENTS—continued.

Full Name of Applicant or in the case of a Firm or Corporation, of the Nominee.	Place of Abode of Applicant or Nominee.	Name of Firm or Corporation.	Address for Registration.	Type of Licence.	Date of Hearing of Application.
---	---	------------------------------	---------------------------	------------------	---------------------------------

COURT OF PETTY SESSIONS, FOOTSCRAY.

McDonald, Norman James ..	45 Tuppen-street, Yarraville	Mayne Nickless Security Branch	4 Cross-street, Footscray	Watchman ..	10.2.69
---------------------------	---------------------------------	-----------------------------------	------------------------------	-------------	---------

Dated at Footscray this 17th day of January, 1969.

G. S. HOARE, Clerk of Petty Sessions.

COURT OF PETTY SESSIONS, FRANKSTON.

Allemand, Wilfred Alan ..	26 Excelsior-drive, Frankston	26 Excelsior-drive, Frankston	Inquiry Agent ..	6.2.69
---------------------------	----------------------------------	---------	----------------------------------	------------------	--------

Dated at Frankston this 13th day of January, 1969.

K. G. MASON, Clerk of Petty Sessions.

CLERK OF PETTY SESSIONS, PRESTON.

Burleigh, Rexford James ..	27 Golf-road, North Coburg	269 High-street, Preston	Watchman ..	30.1.69
Vinar, Eric Peter ..	6 Town Hall-avenue, Preston	" " "	" ..	"

Dated at Preston this 13th day of January, 1969.

P. C. CLOTHIER, Clerk of Petty Sessions.

COURT OF PETTY SESSIONS, SOUTH MELBOURNE.

Krause, Gunter Ernst Karl ..	14 Delos-street, South Oakleigh	34 Queens-road, Melbourne	Process Server ..	12.2.69
" " "	" " "	" " "	Inquiry Agent ..	"

Dated at South Melbourne this 15th day of January, 1969.

G. MILLER, Clerk of Petty Sessions.

COURT OF PETTY SESSIONS, PRAHRAN.

Blennerhassett, David Evan ..	4 Lunette-avenue, Preston	Melbourne Night Patrol Service	614 St. Kilda-road, Melbourne	Watchman ..	6.2.69
Seggie, David Ross ..	10 Irving-avenue, Murrumbeena	" "	" "	" ..	"

Dated at Prahran this 16th day of January, 1969.

J. M. DUGAN, Clerk of Petty Sessions.

COURT OF PETTY SESSIONS, PRAHRAN.

Sharman, Barry Clive ..	8/400 Murray-street, Preston	Factory Service	Guard Suite 17, 562 St. Kilda-road, Mel- bourne	Watchman ..	7.2.69
-------------------------	---------------------------------	--------------------	---	-------------	--------

Dated at Prahran this 17th day of January, 1969.

J. M. DUGAN, Clerk of Petty Sessions.

LOCAL GOVERNMENT DEPARTMENT.

ORDER CONFIRMED.—CITY OF DONCASTER AND TEMPLESTOWE.

THE Minister of the Crown administering the *Local Government Act 1958*, on the 17th day of January, 1969, confirmed the Order hereinafter referred to in pursuance of section 514 of the said Act namely:

An Order made by the Council of the City of Doncaster and Templestowe on the 9th December, 1968, directing the compulsory taking of the land described hereunder for the purpose of opening a road.

All that piece of land being part of lot 42 on plan of subdivision No. 19064, lodged at the Office of Titles commencing at a point being the north-west corner of the said lot; thence by lines bearing 58 deg. 40 min. for 10 feet; 209 deg. for 17 feet 4½ inches and 359 deg. 20 min. for 10 feet to the point of commencement.

R. J. HAMER,
Minister for Local Government.

Local Government Department,
Melbourne.

LOCAL GOVERNMENT DEPARTMENT.

ORDER CONFIRMED.—SHIRE OF BARRABOOL.

THE Minister of the Crown administering the *Local Government Act 1958*, on the 17th day of January, 1969, confirmed the Order hereinafter referred to in pursuance of section 514 of the said Act namely:

An Order of the Council of the Shire of Barrabool made on the 16th October, 1968, directing the compulsory taking of the land described hereunder for the purpose of the provision of a road, car parking area and places of public resort and recreation.

All that piece of land being part of lot 6 on plan of subdivision No. 63527, Parish of Jan Juc commencing at the easternmost corner of the said lot and bounded on the south-east by lines bearing 205 deg. 38 min. for 1,532.3 links and 214 deg. 35 min. for 2,525 links, on the south by a line bearing 272 deg. 51 min. for 1,500 links; thence by lines bearing 46 deg. 10 min. for 1,377 links; 96 deg. 19 min. for 150 links; 3 deg. 36 min. for 1,234 links; 9 deg. 12 min. for 502.5 links; 54 deg. 22 min. for 141 links; 99 deg. 32 min. for 1,220 links and 49 deg. 16 min. for 1,288.3 links to the point of commencement

R. J. HAMER,
Minister for Local Government.

Local Government Department,
Melbourne.

LOCAL GOVERNMENT DEPARTMENT.

ORDER CONFIRMED.—SHIRE OF GISBORNE.

THE Minister of the Crown administering the *Local Government Act 1958*, on the 17th day of January, 1969, confirmed the Order hereinafter referred to in pursuance of section 514 of the said Act, namely:

An Order of the Council of the Shire of Gisborne made on the 7th October, 1968, directing the compulsory taking of the land described in Certificate of Title, volume 1910, folio 841, for the purpose of providing a place of public resort and recreation.

R. J. HAMER,
Minister for Local Government.

Local Government Department, Melbourne.

Local Government Department.

ORDER CONFIRMED.—SHIRE OF BET BET.

THE Minister of the Crown administering the *Local Government Act 1958*, on the 17th day of January, 1969, confirmed the Order hereinafter referred to in pursuance of section 514 of the said Act, namely:

An Order of the Council of the Shire of Bet Bet, made on the 29th November, 1968, directing the compulsory taking of the land described in Conveyance No. 941, Book 454, registered at the Registrar-General's Office for the purpose of providing public conveniences in the Township of Tarnagulla.

R. J. HAMER,
Minister for Local Government.

Local Government Department, Melbourne.

Swine Compensation Act 1967 (No. 7614).

APPROVED AGENTS.

NOTICE UNDER SECTION 14.

I HEREBY declare each of the persons named hereunder, being a person carrying on business as a stock and station agent, to be an "approved agent" for the purposes of Part II. of the *Swine Compensation Act 1967*, with effect from Saturday, the 1st February, 1969.

Number in the
Register.

Name.

C.S.-44.	Peter Aubin Proprietary Limited.
C.S.-45.	Lewis Coady Proprietary Limited.
C.S.-46.	Maskell Bros. Proprietary Limited.
C.S.-47.	John William Ogilvie Bennett, trading as "John Bennett".

R. M. PHIBBS,
Comptroller of Stamps.

Chief Office for Stamp Duties,
Melbourne, 15th January, 1969.

Cattle Compensation Act 1967 (No. 7615).

APPROVED AGENTS.

NOTICE UNDER SECTION 14.

I HEREBY declare each of the persons named hereunder, being a person carrying on business as a stock and station agent, to be an "approved agent" for the purposes of Part II. of the *Cattle Compensation Act 1967*, with effect from Saturday, the 1st February, 1969.

Number in the
Register.

Name.

C.S.-44.	Peter Aubin Proprietary Limited.
C.S.-45.	Lewis Coady Proprietary Limited.
C.S.-46.	Maskell Bros. Proprietary Limited.
C.S.-47.	John William Ogilvie Bennett, trading as "John Bennett".

R. M. PHIBBS,
Comptroller of Stamps.

Chief Office for Stamp Duties,
Melbourne, 15th January, 1969.

Stamps Act 1958, Section 97.

ANNUAL LICENCE.

I HEREBY notify that the necessary stamp duty has been paid by the under-mentioned company for a licence to carry on assurance and insurance business in Victoria from 1st January, 1969, to 31st December, 1969, and that the relevant Annual Licence has been issued accordingly—

STEEL BROTHERS & HARLOCK PROPRIETARY LIMITED.

R. M. PHIBBS,
Comptroller of Stamps.

Chief Office for Stamp Duties,
Melbourne, 13th January, 1969.

Water Act 1958.

STATE RIVERS AND WATER SUPPLY COMMISSION.

RED CLIFFS URBAN DISTRICT.

NOTICE to owners of tenements in the under-mentioned streets in the Red Cliffs Urban District and the private streets, lanes, courts and alleys opening thereto—

RED CLIFFS.

Jacaranda-street, from Plenty-avenue to Snowy-avenue.
Richardson-avenue.
Snowy-avenue.

The main pipe in the said streets being laid down, the owners of all tenements situated as above are hereby required, on or before the first day of March next, to cause proper pipes and stop cocks to be laid, so as to supply water within such tenements from the main pipe.

G. W. LEWIS, Secretary.

State Rivers and Water Supply Commission.
Melbourne, 17th January, 1969.

DRAINAGE AREAS ACT.

SPECIAL MAINTENANCE CHARGE MADE BY THE COUNCIL OF THE SHIRE OF SOUTH GIPPSLAND IN RESPECT OF THE YANAKIE DRAINAGE AREA.

NOTICE is hereby given that on the fourteenth day of January, 1969, in accordance with the provisions of section 36 of the *Drainage Areas Act 1958*, the Governor in Council approved of the estimate of the cost of proposed maintenance works in the Yanakie Drainage Area submitted by the Council of the Shire of South Gippsland, and of the making by the Council of a Special Maintenance Charge on properties within the said Drainage Area, for the year ending 30th September, 1969.

J. ROSSITER,
Clerk of the Executive Council.

Local Government Department,
Melbourne, 14th January, 1969.

Town and Country Planning Act 1961.

MELBOURNE METROPOLITAN PLANNING SCHEME.

NOTICE OF EXECUTION OF INSTRUMENT OF DELEGATION.

WITH the approval of the Minister, notice is hereby given that the Melbourne and Metropolitan Board of Works has in respect of the Melbourne Metropolitan Planning Scheme executed a separate instrument of delegation in favour of each of the Councils of the Municipalities set forth in the Schedule hereto whereby such powers authorities and responsibilities conferred or imposed (as the case may be) under the *Town and Country Planning Act 1961* or the said Planning Scheme as are described in the said instrument of delegation are delegated to the Council of the Municipality named therein in relation to so much of the municipal district of such Municipality as is comprised in the said Planning Scheme other than those parts of such municipal district which are in the said instrument of delegation excluded from the delegation, and that in such instrument it is provided that such delegation shall have force and effect from the first day of February, 1969.

A copy of the instrument of delegation may be inspected during office hours at the office of the Melbourne and Metropolitan Board of Works and at the office of the Council to which it relates.

SCHEDULE.

MUNICIPALITIES HEREINBEFORE REFERRED.

City of Altona.	City of Heidelberg.
Shire of Berwick.	City of Kew.
City of Box Hill.	City of Malvern.
City of Brighton.	City of Melbourne.
City of Brunswick.	Shire of Melton.
Shire of Bulla.	City of Moorabbin.
City of Camberwell.	City of Mordialloc.
City of Caulfield.	City of Northcote.
City of Chelsea.	City of Oakleigh.
City of Coburg.	City of Port Melbourne.
City of Collingwood.	City of Prahran.
Shire of Cranbourne.	City of Preston.
City of Dandenong.	City of Ringwood.
Shire of Diamond Valley.	City of Sandringham.
City of Doncaster and Templestowe.	City of South Melbourne.
Shire of Eltham.	City of Springvale.
City of Essendon.	City of St. Kilda.
City of Fitzroy.	City of Sunshine.
City of Footscray.	City of Waverley.
City of Frankston.	Shire of Werribee.
City of Hawthorn.	Shire of Whittlesea.
	City of Williamstown.

Dated this 20th day of January, 1969.

H. J. SNADDEN,
Secretary,
Melbourne and Metropolitan Board of Works.

Police Regulation Act 1958, Section 122.

SALE OF UNCLAIMED MOTOR VEHICLE.

AN owner is required for a 1954 model, green Ford Zephyr sedan motor vehicle, engine No. EOTTA 31524.

The vehicle came into the possession of Police on the 29th June, 1968, and, if not claimed, will be sold by public auction at the Werribee Police Station, Station-street, Werribee, at 2 p.m., on the 12th February, 1969.

N. WILBY,
Acting Chief Commissioner of Police.

Police Regulation Act 1958.
POLICE FORCE OF VICTORIA.

DETERMINATION No. 149 OF THE POLICE SERVICE BOARD.

THE Police Service Board, in pursuance of the powers in that behalf conferred by the *Police Regulation Act 1958*, hereby makes the following Determination, that is to say:—

1. The Determination No. 107 of the Police Service Board of the 15th November, 1963, and published in the *Government Gazette* of the 4th February, 1964, as amended, is hereby further amended as follows:—

(a) In paragraph 9, by inserting after sub-paragraph (d), the following sub-paragraph:—

“PARKS AND GARDENS PATROL.

(e) There shall be paid to a member while performing the duties of a member of the Parks and Gardens Patrol for the City of Melbourne an allowance at the following rate:—

Rank or Position.	Allowance per Day.
	c.
First Constables and Constables	30”.

(b) In paragraph 12 (b) (ii), by deleting the words “Second Class Commercial Operator’s Certificate of Proficiency” and substituting therefor the words “Radio Mechanic’s Certificate of Proficiency”.

(c) In paragraph 20 (b), by deleting the words “mean and”.

2. This Determination shall come into operation on the 12th day of January, 1969.

Dated at Melbourne this 10th day of January, 1969.

BEN J. DUNN,
A Judge of the County Court of Victoria,
Chairman and Member of the Police
Service Board.

C. H. PETTY,
Member of the Police Service Board.

P. H. BENNETT,
Deputy Member of the Police Service Board.

Farm Produce Merchants and Commission Agents Act 1965.
(No. 7274).

LISTS of names and addresses of persons to whom licences have been granted during November, 1968. In accordance with the above act, those issued with a Merchants or Commission Agents Licence have lodged a fidelity bond. All licences, unless cancelled earlier, shall continue in force until 30th June, 1969.

D. S. WISHART,
Director of Agriculture.

Name; Principal Place of Business.

MERCHANTS.

Adelaide & Local Tomato Supply; 65 Peel-street, West Melbourne.
Agosta, F., & Sons; 29 Pender-street, Thornbury.
Aloi C.D.N. & P.; 67 Bruce-street, Colac.
Archibald Honey Co.; Spring-road, Dingley.
Benalla Fruit Market; 17 Carrier-street, Benalla.
Campagna, F., & Son; 45 Murphy-street, Wangaratta.
Caveny, W.; Wayside, Koroit.
Diggerson, J. & L.; 42 Blantyre-avenue, Chelsea.
DiStefano, N. & V.; 74 Bridge-street, Benalla.
Drinkwater, J. A.; 11 McCrae-street, Bendigo.
Hall, J.; 35 Victoria-street, Nhill.
Hunscha, A. R. & J. G.; Sands-avenue, Jeparit.
Hyland, T. P. & M. D.; 183 Fairy-street, Warrnambool.
Lagogiannis, G.; 17 Talbot-street, Ballarat.
Lavithis, L.; 47 Firebrace-street, Horsham.
Lee, G. W. & Co.; 2 Violet-crescent, South Blackburn.
Lepre, G.; 80 Rose-street, West Coburg.
Misuraca, M. & Co.; 29 Smith-street, Warragul.
Motta, G.; 24 Prince-street, Flemington.
Murchison Produce Co.; High-road, Murchison.
Murray Citrus Marketing Co. Pty. Ltd.; 286 Victoria-street, North Melbourne.

Parish, E. J.; 6 Feckner-avenue, Horsham.
Rodriguez Bros.; 156 Donald-street, Brunswick.
S.A.M. Citrus Sales Pty. Ltd.; 126 Franklin-street, Melbourne.
Sparks & Chandler; 6 Dudley-street, West Melbourne.
Western District Fruit Supply; 281 Timor-street, Warrnambool.

COMMISSION AGENTS.

Carrozza, D.; 15 Birch-street, West Preston.
Cutrale, T.; 39 Mirams-street, Ascot Vale.
Farmers & Graziers Co-operative Co. Ltd.; 505 Collins-street, Melbourne.
Midgley, L. B.; Box 214, Robinvale.
Nichols, J.; Lalors-road, Healesville.
Pakenham Fruitgrowers and Producers Co-op. Ltd.; 38 James-street, Pakenham East.
Pignataro, G.; Monbulk-Seville-road, Silvan.
Smith, G. E.; Army-road, Pakenham East.
Soccio, S.; 1 Henshall-road, Strathmore.
Southern Farmers Co-op. Ltd.; Hamilton.
Symes, S. R. & E. B.; Hein-road, Pakenham.
Valos, S.; 16 Fanny-street, Moonee Ponds.
Winloch & Fireside Fruits; Barker-road, Main Ridge.
Woodward, K. & V. F.; Koo-Wee-Rup North.

SECONDARY WHOLESALERS.

Ash Bros.; 26 Fishmarket, Footscray-road, Footscray.
Bendigo Quick Frozen Foods Pty. Ltd.; 109 Sarsed-street, Bendigo.
Bidwell, T.; Princes Highway, Cann River.
Zagami, G., & Sons; Lakes Entrance.

CHANGE OF NAME.

The Company Tesoriero & Natoli Pty. Ltd., holder of Licence No. M.887 as a Licensed Farm Produce Merchant, has changed its name to G. & C. Natoli Pty. Ltd., as from the 14th October, 1968.

CONTRACTS ACCEPTED.—(Series 1968-69.)**GENERAL STORES.**

Gazette No. 58, 1st July, 1968, Schedule No. 25, Chemicals, &c.—Item No. 9, delete Calcium Cyanide powder, in 25 lb. tins "Calcyan".

Gazette No. 58, 1st July, 1968, Schedule No. 49, Steel (Mild).—For rates shown opposite the following items, substitute the rates as set out hereunder as from 9th December, 1968:—Item No. 1, \$128.50; Item No. 2, \$124; Item No. 3, \$121.50; Item No. 4, $\frac{3}{8}$ -in., \$121.50, $\frac{1}{2}$ -in., \$120, $\frac{5}{8}$ -in. to $1\frac{1}{4}$ -in., \$119, $1\frac{1}{2}$ -in. to $2\frac{1}{2}$ -in., \$118 (3-in. \$118); Item No. 7, \$128.50; Item No. 8, \$124; Item No. 9, \$121.50; Item No. 10, $\frac{3}{8}$ -in. to $\frac{1}{2}$ -in., \$120, $\frac{5}{8}$ -in. to $2\frac{1}{4}$ -in., \$119, 3-in. and over, \$124; Item No. 12, \$133.50; Item No. 13, \$128.50; Item No. 14, $\frac{1}{8}$ -in. to under $3/16$ -in., \$133.50, $3/16$ -in., to under $\frac{1}{4}$ -in., \$128.50, $\frac{1}{4}$ -in. and over, \$124; Item No. 15, 1-in. to under 3-in., under $3/16$ -in., \$128.50, $3/16$ -in. to under $\frac{1}{4}$ -in., \$124, $\frac{1}{4}$ -in. to under $\frac{3}{8}$ -in., \$121.50, $\frac{3}{8}$ -in. and over, \$119; 3-in. to under 5-in., $3/16$ -in. to under $\frac{1}{4}$ -in., \$124, $\frac{1}{4}$ -in. to under $\frac{3}{8}$ -in., \$121.50, $\frac{3}{8}$ -in. to under 1-in., \$119, over 1-in., \$124; 5-in. to 6-in., $3/16$ -in. to under $\frac{1}{4}$ -in., \$122.50, $\frac{1}{4}$ -in. to under $5/16$ -in., \$120, $5/16$ -in. to 1-in., \$119, over 1-in., \$124; Item No. 16, 1-in. x 1-in. x $\frac{1}{4}$ -in. to $1\frac{1}{4}$ -in. x $1\frac{1}{4}$ -in. x $\frac{1}{4}$ -in., \$128.50, $1\frac{1}{4}$ -in. x $1\frac{1}{4}$ -in. x $\frac{1}{4}$ -in. to $1\frac{1}{4}$ -in. x $1\frac{1}{4}$ -in. x $\frac{1}{2}$ -in., \$126, 1-in. x 1-in. x $\frac{1}{2}$ -in. to $1\frac{1}{4}$ -in. x $1\frac{1}{4}$ -in. x $\frac{1}{2}$ -in., \$133.50, 1-in. x 1-in. x $3/16$ -in. to $1\frac{1}{4}$ -in. x $1\frac{1}{4}$ -in. x $3/16$ -in., \$131, $1\frac{1}{4}$ -in. x $1\frac{1}{4}$ -in. x $\frac{1}{2}$ -in. to $1\frac{1}{4}$ -in. x $1\frac{1}{4}$ -in. x $\frac{1}{2}$ -in., \$131, $1\frac{1}{4}$ -in. x $1\frac{1}{4}$ -in. x $3/16$ -in. to $1\frac{1}{4}$ -in. x $1\frac{1}{4}$ -in. x $3/16$ -in., \$128.50; Item No. 17, 2-in. x 2-in., x $\frac{1}{2}$ -in. to 3-in. x 3-in. x $\frac{1}{2}$ -in., \$124; 2-in. x 2-in. x $\frac{1}{2}$ -in., \$131, 2-in. x 2-in. x $3/16$ -in., \$126, 3-in. x 3-in. x $3/16$ -in., \$126; Item No. 18, \$130.50, Rate for lengths 20-ft. to 30-ft., over 30-ft. to 40-ft., \$129, over 40-ft. to 50ft., \$131.50.

E. P. WATSON, Secretary to the Tender Board. 20.1.69.

VICTORIAN RAILWAYS.

60. Railways Stores Suspense Account Act 6355, Division 4, subdivision 111-112, supply and delivery of general stores at rates, as may be ordered during the period 1st January, 1969, to 31st December, 1970. Items 1-1980 inclusive. Details as per book No. 1 on display at Comptroller of Stores Room, 109 and Comptroller of Accounts, Room 177, Head Office, Spencer-street. 61. Erection and completion of a new station building on the existing platform at Thomastown, for the amount of \$25,881.00 (Contract 63356).—McDonald Constructions Pty. Ltd. 62. Supply and delivery of 800 No. roller bearing axle boxes for \$67.45 each net (f.i.s. Newport Workshops) (Contract 63376).—The S.K.F. Ball Bearing Co. (Aust.) Pty. Ltd.

By order of the Victorian Railways Commissioners,

W. WALKER, Secretary. 17.1.69.

STATE RIVERS AND WATER SUPPLY COMMISSION.

1678. Sand blast, metal spray paint—300,000-gallon tank—Gellibrand River Pumps, \$7,625.—Dimet (Vic.) Pty. Ltd. Sealed by Commission, 4th October, 1968.

1679. Construction of office building at Lawson-avenue, Frankston, \$259,000.—Dennis Brooke Construction Co. Pty. Ltd.

Sealed by Commission, 18th October, 1968.

1680. Supply and delivery of 4 lock gates for Lock 11, Mildura, \$29,903.—Standard Steel (S.A.) Pty. Ltd.

Sealed by Commission, 24th October, 1968.

1681. Construction of brick pump house at Berwick, \$3,780.—S. W. & J. Gardiner Pty. Ltd.

Sealed by Commission, 24th October, 1968.

1682. Construction of residence S.N.4 type—at Katandra West, \$12,219.—Graham & Nightingale.

Sealed by Commission, 24th October, 1968.

1683. Construction of residence S.N.4 type—at Katandra West, \$12,219.—Graham & Nightingale.

Sealed by Commission, 24th October, 1968.

1684. Construction of excavated storage at Tyabb—15,000,000 gallons capacity, \$55,232.—Jack Legge Contractors Pty. Ltd.

Sealed by Commission, 1st November, 1968.

1685. Demolition of bridge and erection of new bridge over Gum Scrub Drain, Bullarto-road, Koo-Wee-Rup, \$10,340.—A. Lombardi.

Sealed by Commission, 20th November, 1968.

1686. Demolition of bridge, and erection of new bridge over Toomuc Drain, Bullarto-road, Koo-Wee-Rup, \$10,340.—A. Lombardi.

Sealed by Commission, 20th November, 1968.

1687. Fencing of sites at Shoreham basin and pumping station, \$3,908.—Diamond Fence & Gate Co. Pty. Ltd.

Sealed by Commission, 20th November, 1968.

1688. Construction of S.N.4. type residence at Lockington, \$12,650.—M. Diedrich.

Sealed by Commission, 26th November, 1968.

1689. Construction of Staff Training Lecture Room at Tatura, \$15,658.—W. J. Montgomery & Sons Pty. Ltd.

Sealed by Commission, 26th November, 1968.

1690. Construction of S.N.4 type residence at Newlyn, \$12,733.—J. L. Kellett.

Sealed by Commission, 19th December, 1968.

1691. Demolition of old residence and construction of new residence at Murrabit, \$13,745.—T. J. & W. P. Laursen.

Sealed by Commission, 19th December, 1968.

SOIL CONSERVATION AUTHORITY.**CONTRACT No. 17/6801.**

1692. Erection only of approximately 2½ miles of round treated, post driven prefabricated fencing at Birregurra Project.—Erection \$1.95 a chain, and \$1.80 for each single end assembly.—S. K. & K. R. Powell, Birregurra.

CONTRACT No. 15/6802.

1693. Earthworks in the Parwan Valley and Brisbane Ranges Projects.—Stan Thompson Plant Hire, Bacchus Marsh, for hire of a case 1000D dozer and ancilliary equipment at \$9.50 an hour.

CONTRACT No. 6819.

1694. Erection of two R.C. structures in the Eildon Project Area.—T. K. & G. P. Millott, Mansfield, \$1.20.

CONTRACT No. 15/6803.

1695. Supply of grass hay in the Lake Merrimu Water Supply Catchment.—C. E. Fry, Bacchus Marsh, at 25 cents a bale, delivered to Baling, and 30 cents a bale delivered to Coimadai.

P. J. McCALLUM,
Secretary.

ORDERS IN COUNCIL.—(Series 1968-69.)**PUBLIC WORKS.**

1663. Yarraman Creek Drainage Scheme, drainage works, \$6,250.00.—Dandenong Valley Authority.—(S.E.112582.)

1664. Preston South, S.S. No. 824, demolition of burnt out buildings and erection of new East Wing, \$61,842.00.—Consolidated Home Industries Ltd.—(N.W.92148.)

1665. Melbourne, Treasury Reserve, New State Offices and Laboratories' Buildings, supply of furniture—

Aristoc Industries Pty. Ltd., \$13,142.00.
Bendix Consolidated Industries Ltd., \$18,510.11.
H. A. Branchflower Pty. Ltd., \$9,798.00.
Harvey Nudex Pty. Ltd., \$14,403.95.
Danish De Luxe Pty. Ltd., \$6,148.10.
Melbourne Carpet Specialists, \$19,912.00.

—(C.60381 II.)

Approved by the Governor in Council, 14th January, 1969.—J. ROSSITER, Clerk of the Executive Council.

STATE ELECTRICITY COMMISSION.

1666. For the supply of P.V.C. insulated, lead alloy sheathed, P.V.C. served control cable for 500 kV switchyard, Keilor Terminal Station, to Specification No. 68/353, \$74,782.—Cablemakers (A.C.T.) Pty. Ltd.

1667. For the provision, operation and the hire of earth-moving and construction plant for a period of two years, to Specification No. 68/342, at Schedule rates.—Construction Machinery Pool Pty. Ltd.

1668. For the supply of electrical appliances and spare parts for a period of three years, to Quotation No. 2302, at Schedule rates.—T. S. Nettlefold Sales Pty. Ltd.

1669. For the supply of four 66/22 kV, 20/30 MVA transformers and accessories for metropolitan substations, to Specification No. 68/227, \$247,419.—Tyree Industries (Vic.) Pty. Ltd.

1670. For the supply of two 66/11 kV, 20/30 MVA transformers and accessories for metropolitan substations, to Specification No. 68/227, \$113,808.—Wilson Electric Transformer Co. Pty. Ltd.

1671. For the supply of 66 kV insulators for a period of two years with optional extension of three months, to Specification No. 68/328, at Schedule rates.—Doulton Insulators (Aust.) Pty. Ltd.

1672. For the supply of 66 kV insulators for a period of two years with optional extension of three months, to Specification No. 68/328, at Schedule rates.—R. M. Hall Pty. Ltd.

Approved by the Governor in Council, 17th December, 1968.—J. ROSSITER, Clerk of the Executive Council.

1673. For the supply of nine elevating platforms for overhead line maintenance, to Specification No. 68/346, \$73,341.—Marfleet and Weight (Sales) Pty. Ltd.

1674. For pre-maintenance repairs and comprehensive maintenance of Latrobe Valley lifts for a period of ten years, to Quotation No. 1043, \$255,277.—Otis Elevator Co. Pty. Ltd.

1675. For the construction of seven brick buildings, Hazelwood Terminal Station, to Specification No. 68/364.—\$227,948.—Sola Construction (Gippsland, Victoria) Pty. Ltd.

Approved by the Governor in Council, 10th December, 1968.—J. ROSSITER, Clerk of the Executive Council.

1676. For the supply of copper and brass sections, sheets and tubes for a period of two years with optional extension of three months, to Specification No. 68/209, at Schedule rates.—Austral Bronze Metal Manufacturers Pty. Ltd.

1677. For the supply of copper and brass sections, sheets and tubes for a period of two years with optional extension of three months, to Specification No. 68/209, at Schedule rates.—Noyes Bros. Pty. Ltd.

Approved by the Governor in Council, 26th November, 1968.—J. ROSSITER, Clerk of the Executive Council.

SOIL CONSERVATION AND LAND UTILIZATION ACT 1958 (No. 6372).

WANDO PONDS No. 3 GROUP CONSERVATION AREA.

NOTICE is hereby given that I, William John Farquhar McDonald, Her Majesty's Minister for Conservation in the State of Victoria under the powers conferred by Division 1, section 24A of the *Soil Conservation and Land Utilization Act 1958* (No. 6372) hereby declare to be a Group Conservation Area the land embraced by Crown allotments listed below together with the Road Reserves in the Parishes of Bruk Bruk, Dewrang and Wando and the estate of Bruk Bruk designated in drawings Nos. 1655, 1151, 1656, 1068, 1659 and 1069, which have been marked GA/33 and lodged at the office of the Soil Conservation Authority, 378 Cotham-road, Kew, and do further declare that it shall be known as the Wando Ponds No. 3 Group Conservation Area.

Parish.	Section.	Crown Allotments.
Bruk Bruk ..	A.	Parts of 1A, 4 and 5.
	A.	2, 5, 6 and part of 4.
Dewrang ..	XI.	1B, 2, 3 and 4.
	XIV.	1, B and 4.
	XV.	Parts of 2A, 3A and 3B.
Wando ..	V.	1, 2, 3, 4, 5, 6, 7, 7A,
		8, 8A, 9, 10, 11, 12,
	VI.	13 and 14.
		Parts of 1, 4, 5, 8, 10,
		11 and 12.
Estate.	Section.	Lots.
Bruk Bruk ..	A.	7, 8, 8A and 10.
	2	7 and 9.

And those Road Reserves and Crown Reserves in the above Parishes, located within the area designated in drawings Nos. 1655, 1151, 1656, 1068, 1659 and 1069.

W. J. F. McDONALD,
Minister for Conservation.

SOIL CONSERVATION AND LAND UTILIZATION ACT 1958 (No. 6372).

MOORALLA No. 1 GROUP CONSERVATION AREA.

NOTICE is hereby given that I, William John Farquhar McDonald, Her Majesty's Minister for Conservation in the State of Victoria under the powers conferred by Division 1, section 24A of the *Soil Conservation and Land Utilization Act 1958* (No. 6372) hereby declare to be a Group Conservation Area the land embraced by Crown allotments listed below together with the Road Reserves in the Parishes of Mooralla and Geerak designated in drawing Nos. 1685 and 1686 which have been marked GA/41 and lodged at the office of the Soil Conservation Authority, 378 Cotham-road, Kew, and do further declare that it shall be known as the Mooralla No. 1 Group Conservation Area.

Parish.	Section.	Crown Allotments.
Mooralla ..	IV.	Part 3.
	VI.	3A.
	VII.	1, 2, 3.
	VIII.	1, 2, 3.
	XIII.	1, 2, part 3, 4.
	XIV.	1, 2.
	Kelsall's Estate	Lot 1.
	Kelsall's Estate	Lot 2.
	Kelso Estate	Part lot 5.
	Geerak ..	
		6E, 6F, 6G, 9, 10B,
		10C, and parts of 3A,
		6A.

And those Road Reserves and Crown Reserves in the above Parishes, located within the area designated in drawing Nos. 1685 and 1686.

W. J. F. McDONALD,
Minister for Conservation.

15th January, 1969.

SOIL CONSERVATION AND LAND UTILIZATION ACT 1958 (No. 6372).

NETHERBY No. 1 GROUP CONSERVATION AREA.

NOTICE is hereby given that I, William John Farquhar McDonald, Her Majesty's Minister for Conservation in the State of Victoria under the power conferred by Division 1, Section 24A of the *Soil Conservation and Land Utilization Act 1958* (No. 6372) hereby declare to be a Group Conservation Area the land embraced by Crown allotments listed below together with the Road Reserves in the Parish of Warraquil designated in Drawing No. 1599 which has been marked GA/27 and lodged at the office of the Soil Conservation Authority, 378 Cotham-road, Kew, and do further declare that it shall be known as the Netherby No. 1 Group Conservation Area.

Parish.	Crown Allotments.
Warraquil ..	102, 103, 107

and those Road Reserves and Crown Reserves in the above Parish located within the area designated in Drawing No. 1599.

15th January, 1969.

W. J. F. McDONALD,
Minister for Conservation.

SOIL CONSERVATION AND LAND UTILIZATION ACT 1958 (No. 6372).

WYPERFELD No. 1 GROUP CONSERVATION AREA.

NOTICE is hereby given that I, William John Farquhar McDonald, Her Majesty's Minister for Conservation in the State of Victoria under the powers conferred by Division 1, Section 24A of the *Soil Conservation and Land Utilization Act 1958* (No. 6372) hereby declares to be a Group Conservation Area the land embraced by Crown allotments listed below together with the Road Reserves in the Parishes of Wyperfeld, Nypo and Tyamonnya designated in Drawings Nos. 2210, 2211, 2212, and 2213, which have been marked GA/77 and lodged at the office of the Soil Conservation Authority, 378 Cotham-road, Kew, and do further declare that it shall be known as the Wyperfeld No. 1 Group Conservation Area.

Parish.	Crown Allotments.
Wyperfeld ..	7, 8, 8A, 9, 10, 10A, 11, 23
Nyppo ..	1, 2, 3, 3A, 4, 33, 34, 35, 49, 50, 51 and part 4A.
Tyamonna ..	1, 2, 3, 4, 5.

and those Road Reserves and Crown Reserves in the above Parishes located within the area designated in Drawings Nos. 2210, 2211, 2212 and 2213.

15th January, 1969.

W. J. F. McDONALD,
Minister for Conservation.

ADOPTION OF CHILDREN ACT 1964.

PURSUANT to the provisions of section 21 of the Adoption of Children Act 1964, notice is hereby given that Miss A. P. Evans has been appointed as Principal Officer of the Echuca District Hospital Private Adoption Agency.

A. G. RYLAH,

Chief Secretary.

Chief Secretary's Office,
Melbourne, 17th January, 1969.

DEPARTMENT OF MINES.

SUBJECT to any necessary excisions, &c., it is proposed to grant the following lease:—

8432, Beechworth; Hayden Ewart, Mervyn Cocks, Dulcie May Body, Kathleen Mary Meagher, Grace Agnes Meagher, 23a. Or. Sp., Parish of Bungil.

APPLICATIONS FOR MINING LEASE REFUSED.

8816, Mineral; Lindsay Gordon McRae, Keith McRae; 90 acres, Parish of Buchan.

APPLICATIONS FOR EXTRACTIVE INDUSTRY LEASES REFUSED.

- 9, Extractive Industry Lease; Grame O'Connor Devanny; 50 acres, Parish of Sandhurst.
- 32, Extractive Industry Lease; Glen Iris Brick Tile and Terra Cotta Company Proprietary Limited; 228 acres; Parish of Garrockburkghap.
- 33, Extractive Industry Lease; Glen Iris Brick Tile and Terra Cotta Company Proprietary Limited; 238 acres; Parish of Merrimu.
- 34, Extractive Industry Lease; Glen Iris Brick Tile and Terra Cotta Company Proprietary Limited; 540 acres; Parish of Garrockburkghap.

APPLICATION FOR EXTRACTIVE INDUSTRY LEASE DECLARED ABANDONED.

17, Extractive Industry Lease; William Albert Wilkinson; 7 acres; Parish of Taminick.

EXPLORATION LICENCES GRANTED.

- 112, Exploration Licence; Grace Ore and Mining Co., 152 square miles; Parishes of Noorengong, Yabba Wyebou, Tallandoon, Mitta Mitta, Dorchap and Magorra.
- 115, Exploration Licence; George Milton, Rio de Janeiro Mines; 35 square miles; Parish of Bete Bolong North.

MINERAL SEARCH LICENCES GRANTED.

- 826, Mineral Search Licence; Gippsland Mineral Prospecting Company Proprietary Limited; 5 square miles; Parishes of Buragwonduc and Sargood.
- 856, Mineral Search Licence; Gippsland Mineral Prospecting Company Proprietary Limited; 2 square miles; Parish of Sargood.

MINING LEASE GRANTED.

- 8836, Mineral; Coopers Creek Mines Pty. Limited; 0 acres, 3 roods, 36 perches; Parish of Numbruk.
- 859, Mineral Search Licence; Bernhard Striet and Samuel J. Wilson; 126 acres; Parish of Canabore.
- 861, Mineral Search Licence; William Arthur Vickery; 551 acres; Parish of Canabore.
- 862, Mineral Search Licence; William Arthur Vickery; 30 acres; Parish of Granya.
- 864, Mineral Search Licence; Edward Charles Peirce and Sydney John Treasure; 500 acres; Parish of Toonginbooka.

EXPLORATION LICENCE DECLARED ABANDONED.

98, Exploration Licence; Edward Vaughan Dent and John Alan Savory; 12 square miles; Parishes of Coopracambra and Weeragua.

TAILINGS LICENCES GRANTED.

- 3601, Tailings Licence; The President, Councillors and Ratepayers of the Shire of Yackandandah; "Briseis Tin & General" mine dump situated in the Parish of Tangambalanga.
- 3623, Tailings Licence; B. Williams; "North Ajax" mine dump situated at Daylesford (in lieu of 3558 Tailings Licence expired).
- 3626, Tailings Licence; Albury Brick Pty. Ltd., "Great Southern Consul" mine dump situated at Rutherglen (in lieu of 3560, Tailings Licence expired).
- 3627, Tailings Licence; The President, Councillors and Ratepayers of the Shire of Ballarat; "Kopke's" mine dump situated in the Parish of Cardigan (in lieu of 3442, Tailings Licence expired).

TERM OF EXPLORATION LICENCE EXTENDED.

61, Exploration Licence; Alliance Oil Development Australia N. L., 97 square miles; County of Buln Buln.

MINING LEASE TRANSFERRED.

11373, Bendigo; From Maurice James Steeth and Michael Delany to Maurice James Steeth.

J. C. M. BALFOUR,
Minister of Mines.

APPOINTMENTS AND RESIGNATIONS

APPOINTMENTS.

HIS Excellency the Governor of the State of Victoria, by and with the advice of the Executive Council thereof, has by Orders made on the 14th day of January, 1969, been pleased to make the under-mentioned appointments, viz.:—

CHIEF SECRETARY'S DEPARTMENT.

Chief Commissioner of Police.

NOEL WILBY

pursuant to the provisions of the Police Regulation Act 1958, to be Chief Commissioner of Police, as from the 1st February, 1969, vice Rupert Henry Arnold, Q.P.M., J.P., retired.

Deputy Commissioner of Police.

REGINALD JACKSON

pursuant to the provisions of the Police Regulation Act 1958, to be Deputy Commissioner of Police, as from the 1st February, 1969, in place of Noel Wilby, promoted.

Electoral Registrars (Acting)..

RAYMOND ALPHONSUS MCINNES

to be Electoral Registrar (Acting) for the Bairnsdale, Bruthen, Lindenow, Lucknow, Maffra, Omeo and Orbost Subdivisions of the Electoral District of Gippsland East; the Foster, Leongatha, Rosedale, Sale, Stratford and Yarram Subdivisions of the Electoral District of Gippsland South; and the Mirboo North, Toongabbie and Traralgon Subdivisions of the Electoral District of Morwell; to take effect on and from the 30th December, 1968, during the absence on leave of James Thomas McAllen.

JOHN WEBB

to be Electoral Registrar (Acting) for the Balwyn and Deepdene Subdivisions of the Electoral District of Balwyn; the Hawthorn Subdivision of the Electoral District of Hawthorn; and the Balwyn North, Kew and Kew North Subdivisions of the Electoral District of Kew; to take effect on and from the 3rd January, 1969, during the absence on leave of George William John Jenkins.

WILLIAM WOOLMORE

to be Electoral Registrar (Acting) for the Doncaster Subdivision of the Electoral District of Box Hill; the Whittlesea Subdivision of the Electoral District of Evelyn; and the Diamond Creek, Eltham and Rosanna East Subdivisions of the Electoral District of Greensborough, to take effect on and from the 13th January, 1969, during the absence on leave of Norman Russell Arnold.

LANCE LIVINGSTON SLATTER

to be Electoral Registrar (Acting) for the Avenel Subdivision of the Electoral District of Benalla; the Bendigo, Eaglehawk, Elmore, Raywood and Sandhurst East Subdivisions of the Electoral District of Bendigo; the Kilmore Subdivision of the Electoral District of Evelyn; the

Gisborne and Lancefield Subdivisions of the Electoral District of Gisborne; and the Castlemaine, Golden Square, Heathcote, Maldon, Marong, Seymour and Strathfieldsaye Subdivisions of the Electoral District of Midlands; to take effect on and from the 13th January, 1969, during the absence on leave of William Frederick Bridger.

MINISTRY OF HEALTH.

Official Visitor.

IRVING SAMUEL PLOTKIN, LL.B.
to be a member of the Panel of Official Visitors to Psychiatric Hospital and Psychiatric Unit, Royal Park, pursuant to section 66 of the *Mental Health Act 1959*, for the period ending 17th October, 1971.

Superintendent of Hospital and Clinic.

CHARLES STEELE HAUGHTON, M.B., B.S., D.P.M.
to be Superintendent of Lakeside Hospital and of Parkland Clinic, pursuant to section 26 (1) of the *Mental Health Act 1959* as from and inclusive of 18th December, 1968.

Deputy Superintendent of Hospital and Clinic.

GEORGE SIMPSON FIDDLER, M.B., Ch.B., D.P.M.
to be Deputy Superintendent of Lakeside Hospital and of Parklands Clinic.

LAW DEPARTMENT.

Commissioners for Taking Declarations, &c.

PETER GRAEME CHESTERFIELD,
IAN MILTON DOUGHERTY,
JAMES ARCHDALL EAGLESON,
KEVIN FRANCIS FLANAGAN,
WILLIAM CHARLES BARRY HOOLEY,
EDWIN JOHN HOWDEN, and
KERRY ANTHONY MURPHY, care of Department of Labour and Industry, 110 Exhibition-street, Melbourne,
to be Commissioners for taking Declarations and Affidavits, pursuant to the provisions of the *Evidence Act 1958*, to refrain from charging fees and to resign upon ceasing to occupy their present positions.

HENRY JAMES McDONALD, 21 Edis-street, Kyabram,
BRIAN HUGH MACINTOSH, 4 McGregor-road, Pakenham East,
HAROLD REGINALD WILLINGHAM, 15 Scott-street, Camperdown,
ALLISON FLORENCE REIMANN-BASCH, 445 Victoria-street, Melbourne, and
WILLIAM HENRY ARGYLE, 7 Bladin-street, Laverton,
to be Commissioners for taking Declarations and Affidavits, pursuant to the provisions of the *Evidence Act 1958*, to resign upon removing from the neighbourhood of the addresses stated.

IAN FREDERICK PETERING, care of Commonwealth Savings Bank of Australia, Canterbury,
GEOFFREY NOEL KEITH BENNETT, care of Joseph Lucas (Australia) Pty. Ltd., Nepean Highway, Cheltenham,
KENNETH RUSSELL PORTER, care of Australia and New Zealand Bank Limited, 394 Collins-street, Melbourne.
LEONARD CYRIL BINKS, care of Terang and District (Norah Cosgrove) Community Hospital, Terang, and
JOHN McVEY, care of G. W. & B. G. Thom, public accountants, 54 Malop-street, Geelong,
to be Commissioners for taking Declarations and Affidavits, pursuant to the provisions of the *Evidence Act 1958*, to resign upon ceasing to occupy their present positions.

Justices of the Peace.

JAMES WILLIAM RUMPF, 7 Mutual-road, North Balwyn,
JEFFREY KEMP JAMIESON, 599 Station-street, Box Hill,
ROBERT JAMES TOWLER, Hawkesdale,
IAN WHITNEY GEER, 9 Tarra-street, Orbost, and
PATRICK JOSEPH CLANCY, 114 Macalister-street, Sale,
to keep the Peace in the State of Victoria.

Acting Judge of the Supreme Court of Victoria.

HIS HONOUR JUDGE FRANCIS ROBERT NELSON, a Judge of the County Court of the State of Victoria, to be an Acting Judge of the Supreme Court of the State of Victoria for the period commencing on the 3rd day of February, 1969, and concluding on the 31st day of March, 1969, both dates inclusive, as specified by the Chief Justice in the certificate dated the 2nd day of December, 1968, pursuant to section 11 (2) of the *Supreme Court Act 1958* as amended by section 3 of the *Supreme Court (Judges) Act 1967*.

DEPARTMENT OF THE TREASURER.

Receivers of Revenue (Acting).

GRAHAM COLLINS
to act temporarily as Receiver of Revenue, Swan Hill, vice B. G. Meehan, on leave.

JAMES COLIN MURRAY
to act temporarily as Receiver of Revenue, Taxation (Land Tax) Office, Treasury Department, vice I. M. Green, on leave.

Receiver of Revenue.

GEOFFREY GORDON MOON
to act as Receiver of Revenue, Warrnambool, vice V. G. Stafford, transferred.

Collectors of Imposts (Acting).

EDMOND BRIAN MITCHAM
to act temporarily as Collector of Imposts, Companies Office, Law Department, vice E. S. Martin, on leave.

JAMES RONALD NOLAN
to act temporarily as Collector of Imposts, Education Department, vice R. J. C. Senior, on leave.

EDWARD NORMAND MANSFIELD
to act as Collector of Imposts, Workers Compensation Board, vice G. O. Smith, retired.

CLIVE WILLIAM CRICK
to act temporarily as Collector of Imposts, Department of Agriculture, vice W. D. J. Gray, on leave.

IAN JOSEPH HOYNE
to act temporarily as Collector of Imposts, Tourist Development Authority, vice H. F. Ruglen, on leave.

VICTOR GEORGE FARMER
to act temporarily as Receiver of Revenue, Stamp Duties Office, Treasury Department, vice R. M. Phipps, on leave.

WILLIAM JUDE MORLEY
to act temporarily as Collector of Imposts, Titles Office, Law Department, vice C. P. Allen, on leave.

DEPARTMENT OF WATER SUPPLY.

Sewerage Authority Member.

CLARENCE RAYMOND JOCHINKE
to be a Member of the Jeparit Sewerage Authority to hold such position for a period of four years from the date hereof, subject to the provisions of the Sewerage Districts Act.

Waterworks Trust Commissioners.

JOHN WILLIAM TURNER
to be a Commissioner of the Forrest Waterworks Trust to hold such position for a period of four years from the date hereof subject to the provisions of the Water Act.

ANDREW FRANCIS BALDWIN
to be a Commissioner of the Foster Waterworks Trust, to hold such position from the date hereof until the 16th September, 1972, subject to the provisions of the Water Act.

EUGENE RICHARD SHALDERS
to be a Commissioner of the Yarra Junction Waterworks Trust to hold such position for a period of four years from the date hereof, subject to the provisions of the Water Act.

J. ROSSITER,
Clerk of the Executive Council.

At the Executive Council Chamber,
Melbourne, 14th January, 1969.

APPOINTMENT.

HIS Excellency the Governor of the State of Victoria, by and with the advice of the Executive Council thereof, has, by Order made on the 14th day of January, 1969, been pleased to make the under-mentioned appointment, viz:—

CROWN LANDS AND SURVEY DEPARTMENT.

Trustee of Melbourne Cricket Ground.

Senator JOHN ALBERT LITTLE

to be a trustee of the land permanently reserved by Order in Council dated 20th February, 1934, as a site for the Melbourne Cricket Ground in the City of Melbourne, in place of the Honorable Thomas Hayes, deceased.

J. ROSSITER,
Clerk of the Executive Council.

At the Executive Council Chamber,
Melbourne, 14th January, 1969.

Liquor Control Act 1968.

APPOINTMENT OF LICENSING INSPECTOR.

IN accordance with the authority conferred upon me by Section 6 of the *Police Regulation Act 1958*, I, Noel Wilby, Deputy Commissioner of Police, hereby appoint, under Sub-section (1) of Section 22 of the *Liquor Control Act 1968*, the following Officer of Police as a Licensing Inspector for the Division of the Police District as shown.

Division Number.	Police District.	Rank and Name
1	Mallee	Inspector Frederick Charles Warnock

N. WILBY,
Deputy Commissioner of Police.

SOCIAL WELFARE ACT 1960.

IN pursuance of the powers conferred by the *Social Welfare Act 1960*, I do hereby appoint—

GEORGE STEWART SMALE,
to be Chairman of the Social Welfare Training Council for a period of twelve months, commencing on the twenty-first day of November, 1968.

A. G. RYLAH,
Chief Secretary.

Chief Secretary's Office,
Melbourne, 14th January, 1969.

SOCIAL WELFARE ACT 1960.

IN pursuance of the powers conferred by the *Social Welfare Act 1960*, I do hereby appoint—

RONALD ATKINSON REED, Acting Assistant Director-General of Education,
to be a member of the Social Welfare Training Council for the term ending on the twentieth day of November, 1970, vice William Binns Russell, on leave.

A. G. RYLAH,
Chief Secretary.

Chief Secretary's Office,
Melbourne, 14th January, 1969.

LOCAL GOVERNMENT DEPARTMENT.

APPOINTMENT OF CHAIRMAN AND MEMBERS OF THE TOWN PLANNING APPEALS TRIBUNAL.

HIS Excellency the Governor of the State of Victoria, by and with the advice of the Executive Council thereof, doth by Order appoint—

HAROLD CARTER CHIPMAN, a barrister and solicitor of the Supreme Court of Victoria, who shall be Chairman, for the period ending 11th June, 1971;

TALBOT CECIL CLAUDE WIDDOP, a person having experience in town and country planning for the period ending 2nd February, 1970, and

ALAN DOUGLAS WHALLEY, a person having knowledge of and experience in public administration, commerce or industry, for the period ending 2nd February, 1972,
to be chairman and members of the Town Planning Appeals Tribunal, commencing the 3rd February, 1969.

J. ROSSITER,
Clerk of the Executive Council.

At the Executive Council Chamber,
Melbourne, 15th January, 1969.

RESIGNATIONS.

HIS Excellency the Governor of the State of Victoria, by and with the advice of the Executive Council thereof, has, by Orders made on the 14th day of January, 1969, accepted the resignations of the persons named hereunder of the offices mentioned, viz.:—

LAW DEPARTMENT.

Commissioner for Taking Declarations, &c.

ATHOL SILAS TANGYE BOWKER
as a Commissioner for taking Declarations and Affidavits, pursuant to the provisions of the *Evidence Act 1958*.

Justices of the Peace.

GEORGE JAMES NELSON, and
ERNEST EDWARD BOND,
from the Commission of the Peace for the State of Victoria.

J. ROSSITER,
Clerk of the Executive Council.

At the Executive Council Chamber,
Melbourne, 14th January, 1969.

ORDERS IN COUNCIL

DEPARTMENT OF CROWN LANDS AND SURVEY.

At the Executive Council Chamber, Melbourne, the
fourteenth day of January, 1969.

PRESENT:

His Excellency the Governor of Victoria.
Sir William McDonald | Mr. Borthwick.

REVOCATION OF TEMPORARY RESERVATIONS OF LAND BY ORDER IN COUNCIL.

HIS Excellency the Governor of the State of Victoria, by and with the advice of the Executive Council thereof, doth hereby, in pursuance of the provisions of the *Land Act 1958*, revoke the temporary reservations of land by Orders in Council hereinafter referred to, viz.:—

BRANJEE.—Order in Council of 6th October, 1884, of 2 acres of land in the Parish of Branjee, as a site for Public purposes.—(C.100199.)

CLEAR LAKE.—Order in Council of 10th October, 1922, of 3 acres of land in the Township of Clear Lake as a site for Public Recreation purposes, so far only as regards the portion thereof comprised within the boundaries published in the *Government Gazette* of 27th November, 1968, and containing 5 perches.—(Rs.2630.)

DANYO.—Order in Council of 12th May, 1925, of 5 acres of land in the Parish of Danyo as a site for a State School.—(Rs.3099.)

DOEN.—Order in Council of 14th December, 1874, of 193 acres 1 rood 8 perches of land in the Parish of Doen, as a site for Watering and Camping purposes, so far only as regards the portion thereof comprised within the boundaries published in the *Government Gazette* of 27th November, 1968, and containing 4 acres 0 roods 18 perches.—(Rs.6340.)

ECHUCA.—Order in Council of 16th March, 1914, of 1 acre 3 roods of land in the Township of Echuca as a site for Public purposes, so far only as regards the portion thereof comprised within the boundaries published in the *Government Gazette* of 27th November, 1968, and containing 23 perches.—(Rs.6175.)

KERRIE.—Order in Council of 15th May, 1888, of 66 acres, more or less, of land in the Parish of Kerrie as a site for Recreation and Road purposes, so far only as regards the portion thereof comprised with the boundaries published in the *Government Gazette* of 27th November, 1968, and containing 36 acres, more or less.—(Rs.5818.)

LONGERENONG.—Order in Council of 2nd June, 1873, of 176 acres 3 roods 5 perches of land in the Parish of Longereng, as a site for Watering and Camping purposes.—(Rs.5662.)

PIAMBIE.—Order in Council of 24th August, 1920, of 3 acres of land in the Parish of Piambie, as a site for a State School.—(Rs.2188.)

TERANG.—Order in Council of 5th August, 1910, of 3 roods 14 7/10 perches of land in the Township of Terang as a site for Municipal purposes, so far only as regards the portion thereof comprised within the boundaries published in the *Government Gazette* of 27th November, 1968, and containing 20 perches.—(Rs.2970.)

WERRAP.—Order in Council of 27th April, 1954, of 255 acres 3 roods 12 perches of land in the Parish of Werrap, as a site for the purposes of the Soil Conservation Authority, so far only as regards the portion thereof comprised within the boundaries published in the *Government Gazette* of 27th November, 1968, and containing 1 rood 3 perches.—(Rs.7244.)

WHITFIELD.—Order in Council of 19th June, 1945, of 2 roods 19 4/10 perches of land in the Parish of Whitfield as a site for Police purposes, so far only as regards the portion thereof comprised within the boundaries published in the *Government Gazette* of 27th November, 1968, and containing 1 rood.—(Rs.5673.)

And the Honorable Sir William John Farquhar McDonald, Her Majesty's Minister of Lands for the State of Victoria, shall give the necessary directions herein accordingly.

J. ROSSITER,
Clerk of the Executive Council.

LOCAL GOVERNMENT DEPARTMENT.

At the Executive Council Chamber, Melbourne, the fourteenth day of January, 1969.

PRESENT:

His Excellency the Governor of Victoria. Sir William McDonald | Mr. Borthwick.

CONSENT TO VARIATION OF USE OF RESERVES BY THE SANDRINGHAM CITY COUNCIL.

WHEREAS the Council of the City of Sandringham is the registered proprietor of certain lands being the Car Park Reserves coloured green and green-hatched and the Recreation Reserve coloured purple and purple-hatched on Plan of Subdivision No. 40619 lodged in the Office of Titles and the said Council is now of the opinion that the respective lands are no longer required for the purposes for which they were reserved and has requested that consent be given, pursuant to Section 569BA of the Local Government Act 1958, to the use of the said lands for the purposes of Car Park and Recreation Reserves.

And Whereas the said Council:

- (a) Has published in a newspaper generally circulating in the municipal district a notice describing the lands and the proposal for the altered use thereof and stating that at the next ordinary meeting of the Council after the expiration of forty days notice the Council would consider any objection to the proposal; and
(b) There being no registered mortgagee chargee or lessee has posted similar notice upon the lands in question.

And Whereas no objection to the proposal has been received.

Now Therefore, the Governor of the State of Victoria, by and with the advice of the Executive Council thereof, doth hereby consent to the use of the respective lands in the Car Park Reserves coloured green and green-hatched and the Recreation Reserve coloured purple and purple-hatched on Plan of Subdivision No. 40619 lodged in the Office of Titles for the purposes of Car Park and Recreation Reserves.

And the Honorable Rupert James Hamer, Her Majesty's Minister for Local Government for the State of Victoria, shall give the necessary directions herein accordingly.

J. ROSSITER, Clerk of the Executive Council.

LOCAL GOVERNMENT DEPARTMENT.

At the Executive Council Chamber, Melbourne, the fourteenth day of January, 1969.

PRESENT:

His Excellency the Governor of Victoria. Sir William McDonald | Mr. Borthwick.

ROAD DISCONTINUED—CITY OF FOOTSCRAY.

WHEREAS it is provided in Section 528 (2) of the Local Government Act, as amended, that where a road (whether or not a public highway but not being a road set out on land of the Crown) or any part thereof is not required for public use the Governor-in-Council on the request of the Council of the Municipality in which such road is situated made not less than one month after publishing in a newspaper generally circulating in the district and posting to the registered proprietor (if any) of the land and the owners and occupiers (if any) of the lands abutting or immediately adjacent to the road notice of intention to make such a request may by Order published in the Government Gazette direct that such road or part shall be discontinued accordingly.

AND WHEREAS the Council of the City of Footscray has requested that the Governor-in-Council direct that portion of a right-of-way off Lyons Street, Footscray be discontinued and not less than one month previously has published in a newspaper generally circulating in the district and posted to the registered proprietor of the land in the road and to the owners and occupiers (if any) of lands abutting or immediately adjacent to the road notice of intention to make such request.

NOW THEREFORE, His Excellency the Governor of the State of Victoria, by and with the advice of the Executive Council thereof, hereby directs that the portion of the said road, which is shown hatched on the plan hereunder shall be discontinued and that the land may be sold by the Council of the City of Footscray by agreement.

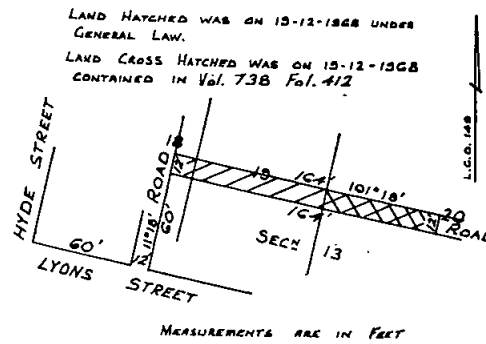

And the Honorable Rupert James Hamer, Her Majesty's Minister for Local Government for the State of Victoria, shall give the necessary directions herein accordingly.

J. ROSSITER, Clerk of the Executive Council.

ROAD TRAFFIC ACT 1958.

At the Executive Council Chamber, Melbourne, the fourteenth day of January, 1969.

PRESENT:

His Excellency the Governor of Victoria. Sir William McDonald | Mr. Borthwick.

IN pursuance of the powers conferred by the Road Traffic Act 1958, His Excellency the Governor of the State of Victoria, in the Commonwealth of Australia, by and with the advice of the Executive Council of the said State, and at the request in writing of the Council of the City of Melbourne doth by this Order extend the provisions of the said Act to the land under the control of the City of Melbourne at 24-32 Spencer Street and 565-579 Flinders Street, Melbourne, shown delineated on the Plan marked "A" hereunder.

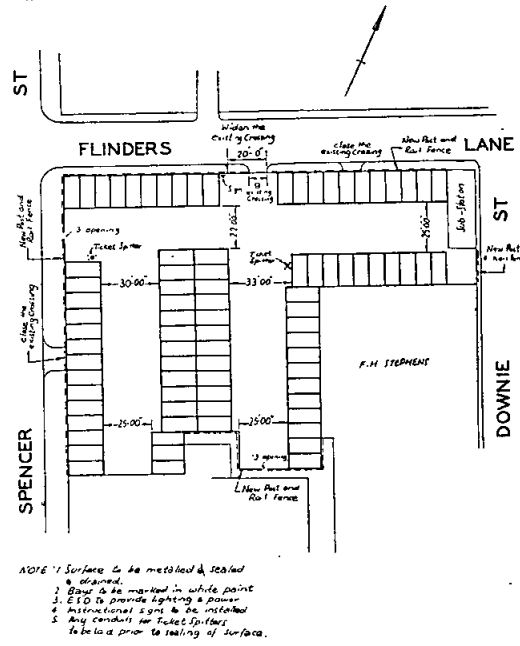

Capacity 90° Angle parked 84 Cars Width of bays 8'-0" minimum.

PROPOSED OPERATION BY TICKET SPITTERS

And the Honorable Sir Arthur Gordon Rylah, Her Majesty's Chief Secretary for the State of Victoria, shall give the necessary directions herein accordingly.

J. ROSSITER, Clerk of the Executive Council

ROAD TRAFFIC ACT 1958.

At the Executive Council Chamber, Melbourne, the fourteenth day of January, 1969.

PRESENT:

His Excellency the Governor of Victoria.
Sir William McDonald | Mr. Borthwick.

IN pursuance of the powers conferred by the Road Traffic Act 1958, His Excellency the Governor of the State of Victoria, in the Commonwealth of Australia, by and with the advice of the Executive Council of the said State, and at the request in writing of the Council of the City of Northcote doth by this Order extend the provisions of the said Act to the following land under the control of the City of Northcote:—

All that land shown delineated and hachured on the Plan marked "A" hereunder.

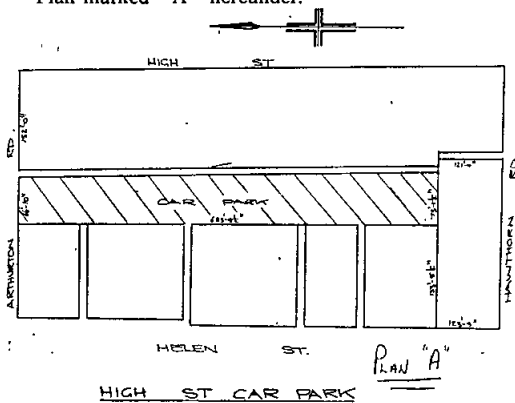

And the Honorable Sir Arthur Gordon Rylah, Her Majesty's Chief Secretary for the State of Victoria, shall give the necessary directions herein accordingly.

J. ROSSITER,
Clerk of the Executive Council.

ROAD TRAFFIC ACT 1958.

At the Executive Council Chamber, Melbourne, the fourteenth day of January, 1969.

PRESENT:

His Excellency the Governor of Victoria.
Sir William McDonald | Mr. Borthwick.

IN pursuance of the powers conferred by the Road Traffic Act 1958, His Excellency the Governor of the State of Victoria, in the Commonwealth of Australia, by and with the advice of the Executive Council of the said State, and at the request in writing of the Council of the City of Prahran doth by this Order extend the provisions of the said Act to the following land under the control of the City of Prahran:—

All that land shown delineated and hachured on the Plans marked "A" and "B" hereunder.

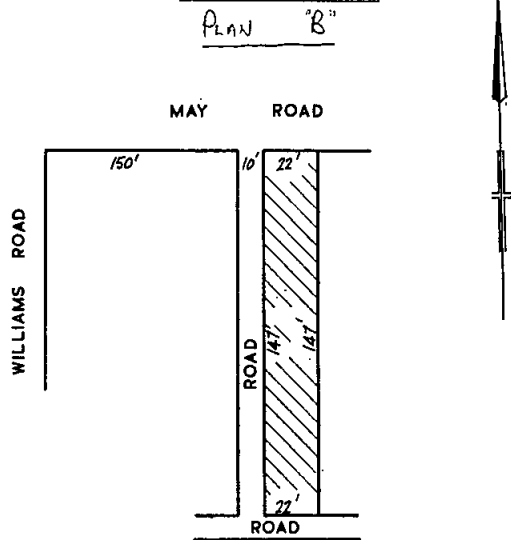
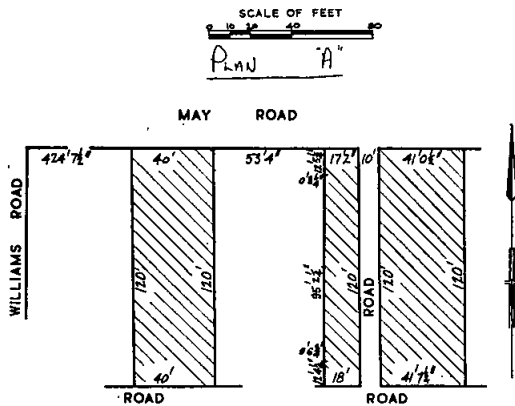

And the Honorable Sir Arthur Gordon Rylah, Her Majesty's Chief Secretary for the State of Victoria, shall give the necessary directions herein accordingly.

J. ROSSITER,
Clerk of the Executive Council.

LABOUR AND INDUSTRY ACT 1958.

At the Executive Council Chamber, Melbourne, the fourteenth day of January, 1969.

PRESENT:

His Excellency the Governor of Victoria.
Sir William McDonald | Mr. Borthwick.

APPOINTMENT OF A CHAIRMAN OF WAGES BOARDS.

IN pursuance of the powers conferred by the Labour and Industry Act 1958, His Excellency the Governor of the State of Victoria, by and with the advice of the Executive Council thereof, doth by this Order appoint JOHN CLIFFORD THOMAS to be a Chairman of Wages Boards for a period of five years from and including the first day of February, 1969.

And the Honorable John Frederick Rossiter, Her Majesty's Minister of Labour and Industry for the State of Victoria, shall give the necessary directions herein accordingly.

J. ROSSITER,
Clerk of the Executive Council.

DEPARTMENT OF CROWN LANDS AND SURVEY.

At the Executive Council Chamber, Melbourne, the fourteenth day of January, 1969.

PRESENT:

His Excellency the Governor of Victoria.
Sir William McDonald | Mr. Borthwick.

LANDS TEMPORARILY RESERVED AS SITES.

HIS Excellency the Governor of the State of Victoria, by and with the advice of the Executive Council thereof, doth hereby, in pursuance of section 14 of the Land Act 1958, reserve temporarily from sale, from being leased and from having a licence granted in respect thereof, and also except from occupation for mining purposes under any miner's right, the land hereinafter described:—

KORUMBURRA.—Site for Public Park and Recreation, 26 acres 1 rood 25 perches more or less Township of Korumburra, Parish of Korumburra, County of Buln Buln, as indicated by hatching on plan hereunder.—(K.172⁽¹⁸⁾) (Rs.9048).

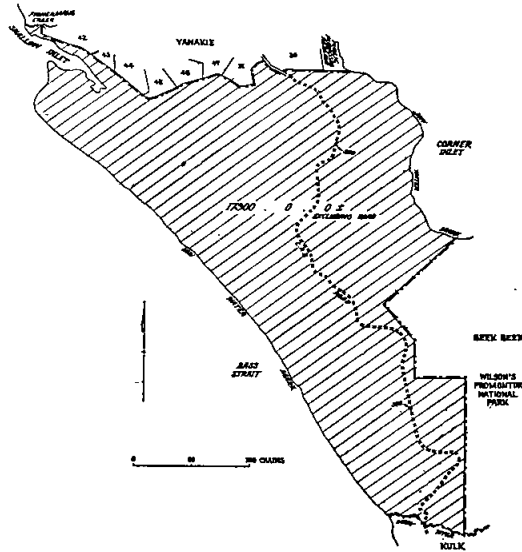
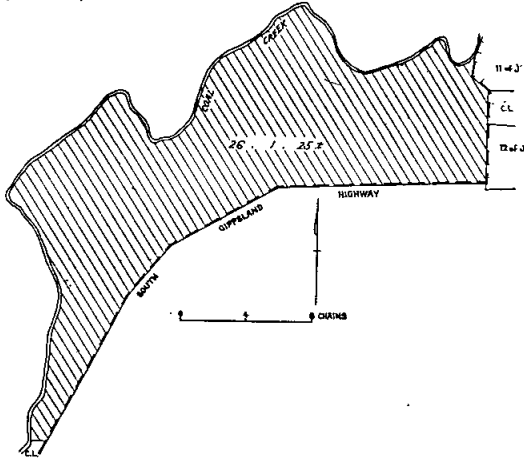

Parish of Yanakie South
County of Buln Buln

Cur. No. R3/1051

Prepared from O.P.'s W.384^(B) Y117A Y117⁺ C.R.B. centre line 10030 on Misc 267 & military sheet 1710; 1 inch Yanakie

A. J. Fisher
Chief Draughtsman
22-1-69 C.T.

MELBOURNE NORTH AT EAST MELBOURNE.—Site for the Recreation, Convenience and Amusement of the People and for a Children's Playground, 3 roods 1 perch, at East Melbourne, City of Melbourne, Parish of Melbourne North, County of Bourke, as indicated by hatching on plan hereunder.—(M.314⁽⁹⁾) (Rs.525).

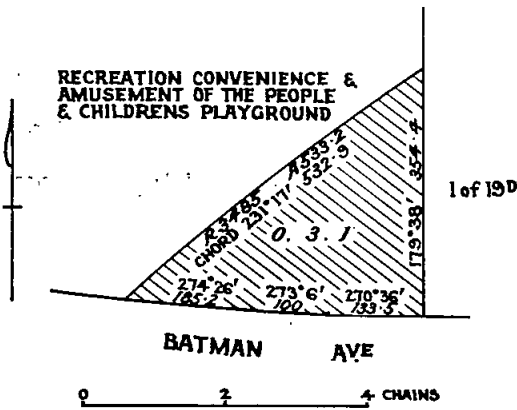

And the Honorable Sir William John Farquhar McDonald, Her Majesty's Minister of Lands for the State of Victoria, shall give the necessary directions herein accordingly.

J. ROSSITER,
Clerk of the Executive Council.

DEPARTMENT OF CROWN LANDS AND SURVEY.

At the Executive Council Chamber, Melbourne, the fourteenth day of January, 1969.

PRESENT:

His Excellency the Governor of Victoria.
Sir William McDonald | Mr. Borthwick.

UNUSED ROADS CLOSED.

HIS Excellency the Governor of the State of Victoria, by and with the advice of the Executive Council thereof, doth hereby direct that, in pursuance of the provisions of section 349 of the Land Act 1958, the unused roads referred to hereunder be closed, viz.:

Parish of Ilawarra, County of Borung, being the road indicated by hatching on plan hereunder.—(I.13⁽⁹⁾) (M.60868).

SWAN HILL.—Site for a State High School.—3 acres 2 roods 3 perches, Township of Swan Hill, Parish of Castle Donnington, County of Tatchera, as indicated by hatching on plan hereunder.—(S.464⁽⁴⁾) (Rs.2229).

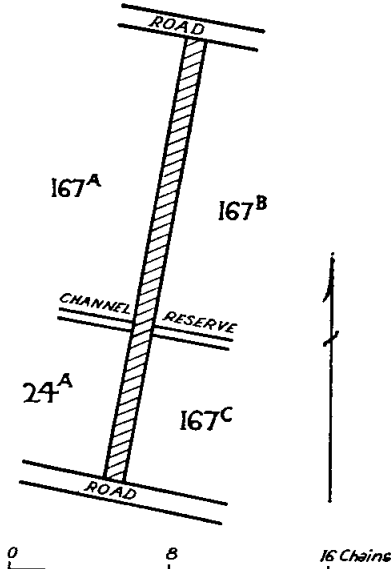
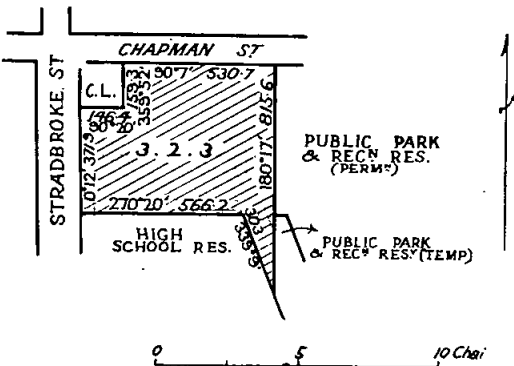

YANAKIE SOUTH.—Site for a National Park, 17,900 acres, more or less, Parish of Yanakie South, County of Buln Buln, as indicated by hatching on plan hereunder.—(W.384^(B)) (Rs.1051).

Township of Katamatite, Parish of Katamatite, County of Moira, being the road indicated by hatching on plan hereunder.—(K.137(4) (Rs.2306).

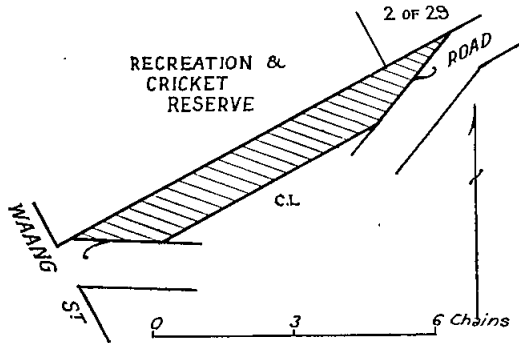

Parish of Orbost East, County of Croajingolong, being the road indicated by hatching on plan hereunder.—(O.23(11) (H.030113).

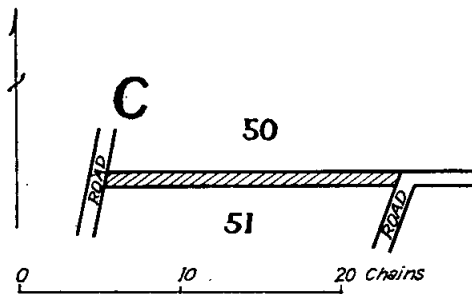

And the Honorable Sir William John Farquhar McDonald, Her Majesty's Minister of Lands for the State of Victoria, shall give the necessary directions herein accordingly.

J. ROSSITER,
Clerk of the Executive Council.

COUNTRY ROADS BOARD.

At the Executive Council Chamber, Melbourne, the fourteenth day of January, 1969.

PRESENT:
His Excellency the Governor of Victoria,
Sir William McDonald | Mr. Borthwick.

ORDER CONFIRMING RESOLUTIONS OF THE COUNTRY ROADS BOARD.

HIS Excellency the Governor of the State of Victoria, by and with the advice of the Executive Council thereof, doth hereby, in pursuance of the provisions of the Country Roads Act 1958, confirm the resolutions of the Country Roads Board, the dates whereof and the terms of which are scheduled hereunder:—

SCHEDULE.
State highway.

Resolution dated the third day of January, One Thousand Nine Hundred and Sixty-nine, made pursuant to Section 70 of the Country Roads Act 1958, declaring the highway in the City of Melbourne as shown hatched on Plan numbered G.P.11520 hereunder to be a State highway (Princes Highway) within the meaning and for the purposes of the said Act.

STATE HIGHWAY
PRINCES HIGHWAY
CITY OF MELBOURNE

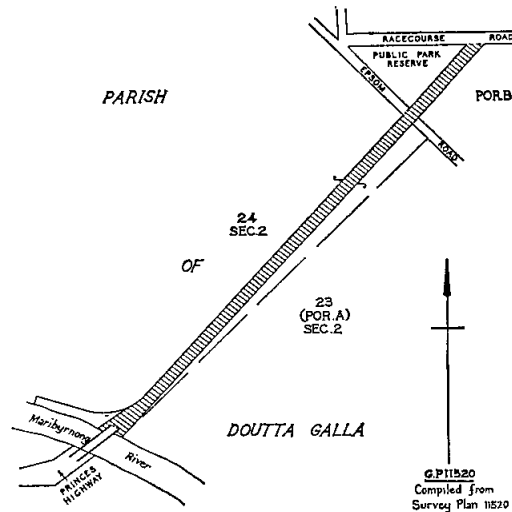

Main Roads.

Resolution dated the twenty-third day of December, One Thousand Nine Hundred and Sixty-eight, made pursuant to Sections 21 and 58 of the Country Roads Act 1958 declaring the deviation from Hamilton Road in the Shire of Belfast as indicated by diagonal hatching on Plans numbered G.P.11133A and G.P.11133B hereunder to be part of a main road within the meaning and for the purposes of the said Act, and also declaring that such deviation shall be in lieu of the existing road or part thereof indicated by cross hatching on Plan numbered G.P.11133A and cross hatching and horizontal hatching on Plan numbered G.P.11133B which part indicated by cross hatching on the said plans shall be discontinued.

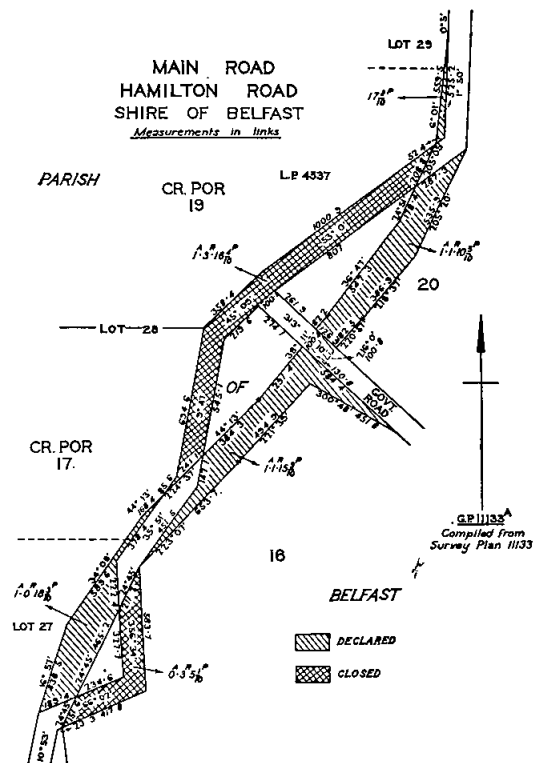

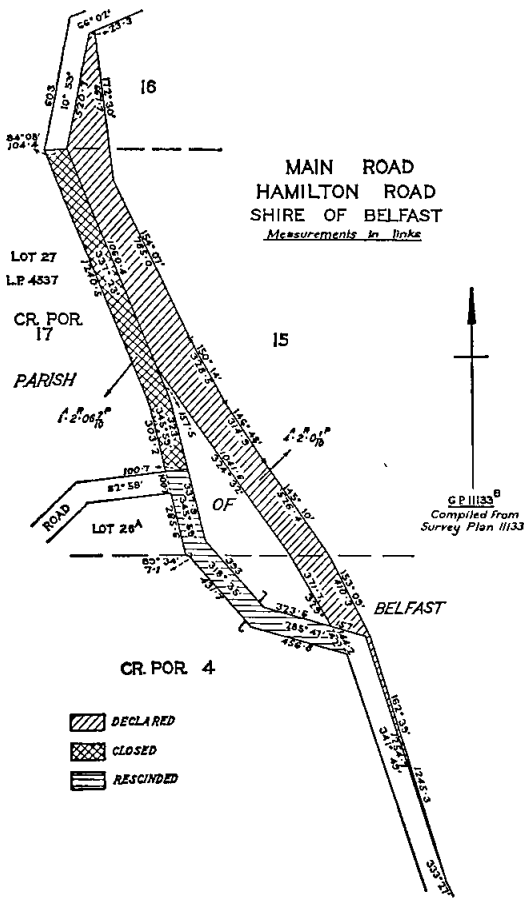

Resolution dated the twenty-third day of December, One Thousand Nine Hundred and Sixty-eight, made pursuant to Section 21 of the *Country Roads Act 1958*, declaring the widening of the Sea Lake-Robinvale Road in the Shire of Swan Hill as shown hatched on Plan numbered G.P.5389 hereunder to be part of a main road within the meaning and for the purposes of the said Act.

Resolution dated the third day of January, One Thousand Nine Hundred and Sixty-nine, made pursuant to Section 18 of the *Country Roads Act 1958* declaring the highway in the Shire of Creswick as shown hatched on Plan numbered G.P.10961B hereunder to be a main road (Castlemaine-Ballarart Road) within the meaning and for the purposes of the said Act.

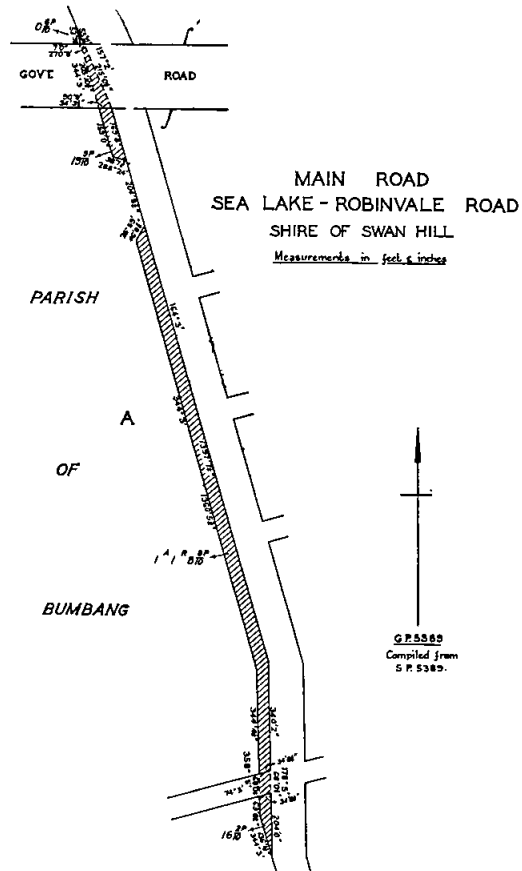
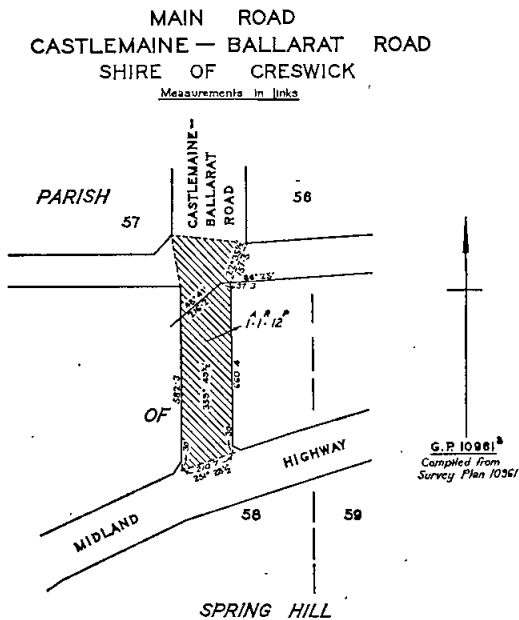

Resolution dated the twenty-third day of December, One Thousand Nine Hundred and Sixty-eight, made pursuant to Section 21 of the *Country Roads Act 1958*, declaring the widening of the Coleraine-Edenhope Road in the Shire of Wannon as shown hatched on Plan numbered G.P.6900 hereunder to be part of a main road within the meaning and for the purposes of the said Act.

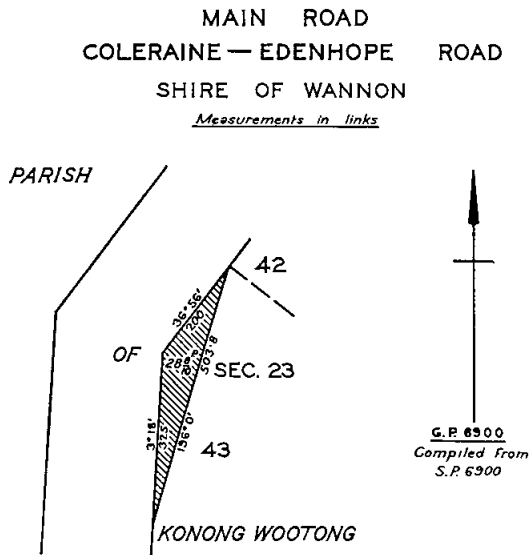

STATE HIGHWAY
OVENS HIGHWAY
SHIRE OF BEECHWORTH
Measurements in Links

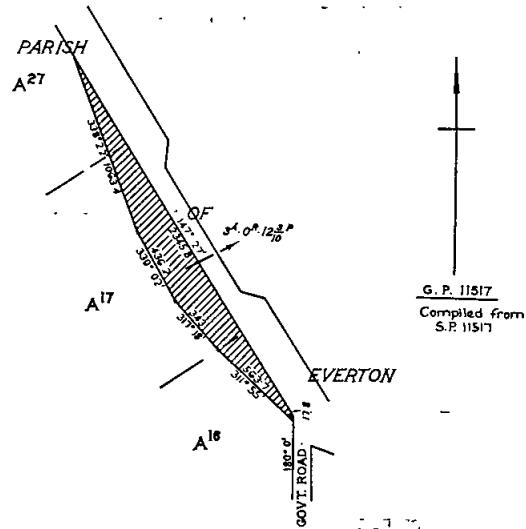

The land shown hatched on Plans numbered G.P.10551 and G.P.10552 hereunder required for the widening of the Midland Highway in the Shire of Waranga and making of the widening thereon.

And the Honorable Murray Victor Porter, Her Majesty's Minister of Public Works for the State of Victoria, shall give the necessary directions herein accordingly.

J. ROSSITER,
Clerk of the Executive Council.

COUNTRY ROADS BOARD.

At the Executive Council Chamber, Melbourne, the fourteenth day of January, 1969.

PRESENT:
His Excellency the Governor of Victoria.
Sir William McDonald | Mr. Borthwick.

ORDER APPROVING OF LAND BEING ACQUIRED AND ROADS, DEVIATIONS OR WIDENINGS BEING MADE.

HIS Excellency the Governor of the State of Victoria, by and with the advice of the Executive Council thereof, being satisfied that there are funds legally available for acquiring the land, doth hereby approve the acquiring of the land described in the schedule hereunder and the making of new roads and deviations from and widenings of existing roads referred to in the said schedule.

SCHEDULE.
State highways.

The lands shown hatched on Plan numbered G.P.11517 hereunder required for the widening of the Ovens Highway in the Shire of Beechworth and making of the widening thereon.

STATE HIGHWAY
MIDLAND HIGHWAY
SHIRE OF WARANGA
Measurements in Links

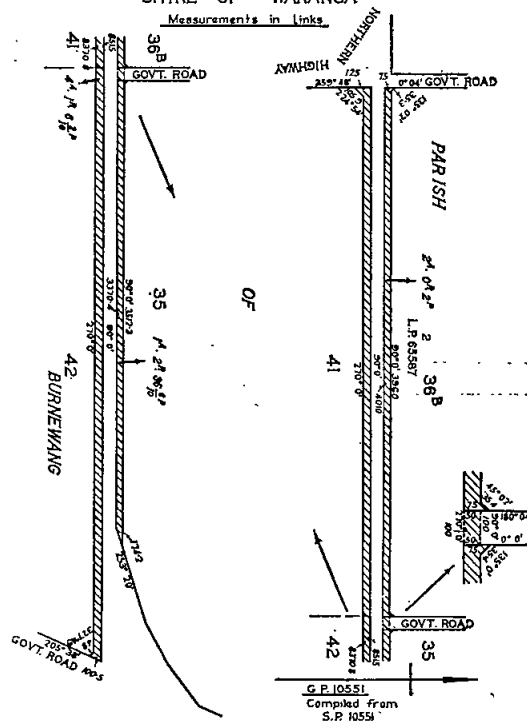

The land shown hatched on Plan numbered G.P.11555 hereunder required for the deviation from the Lismore-Pittong Road in the Shire of Grenville and making of the deviation thereon.

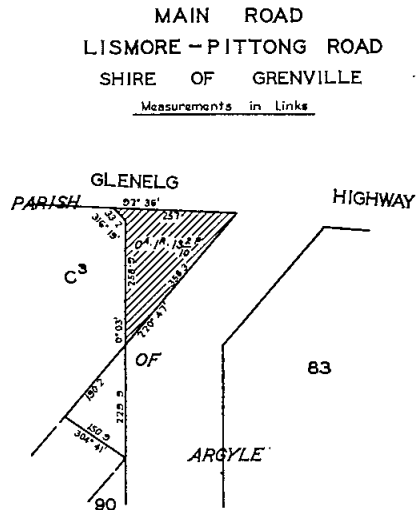
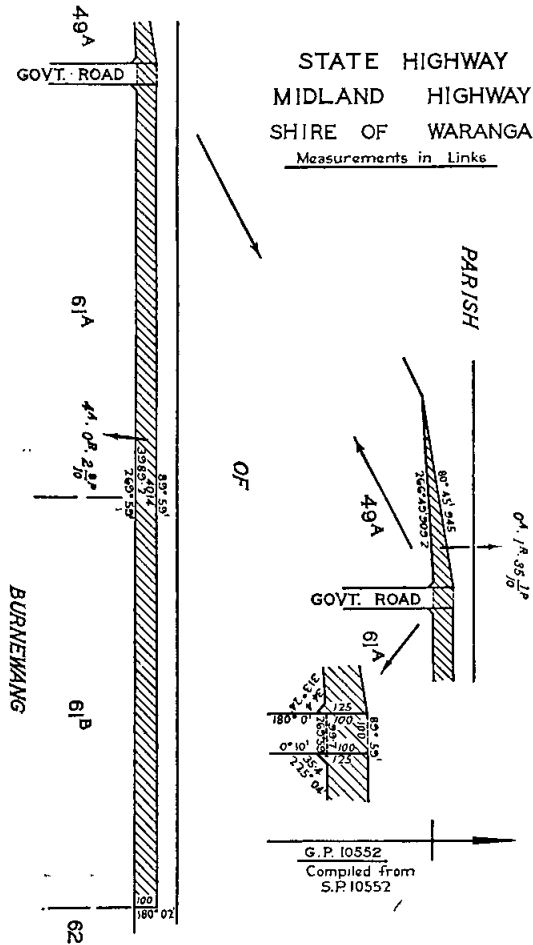

The land shown hatched on Plans numbered G.P.11557 and G.P.11558 hereunder required for the deviation from the Mansfield-Whitfield Road in the Shire of Oxley and making of the deviation thereon.

Main roads.

The land shown hatched on Plan numbered G.P.11597 hereunder required for the widening of the Diggers Rest-Coimadai Road in the Shire of Bacchus Marsh and making of the widening thereon.

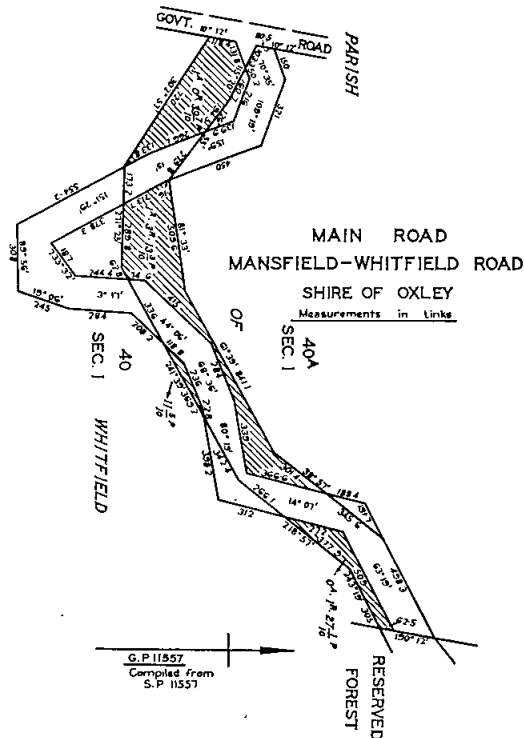
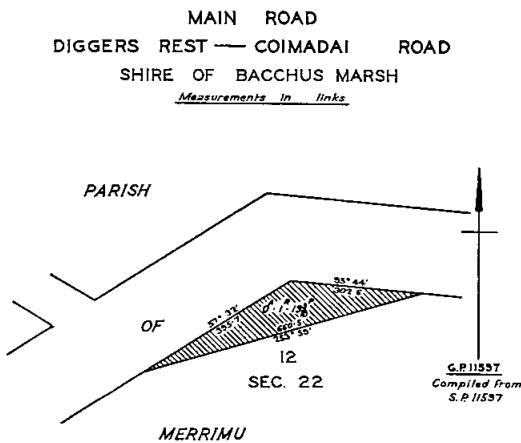

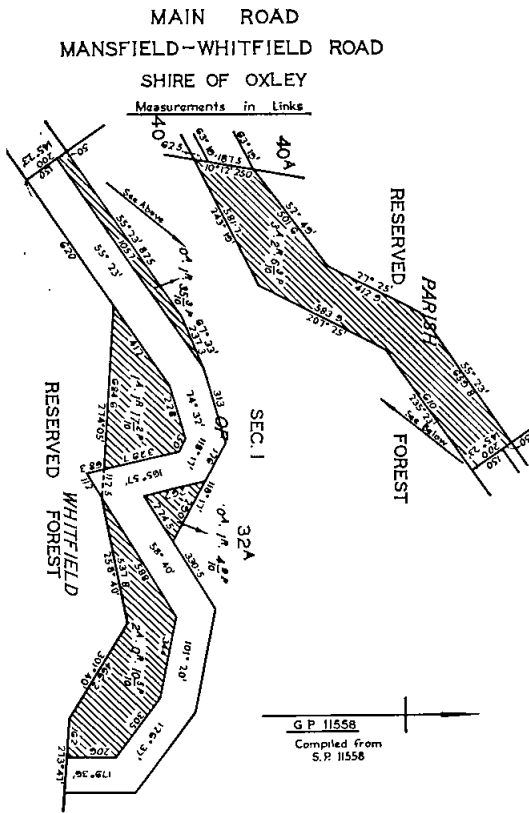

The land shown hatched on Plan numbered G.P.6136 hereunder required for the widening of the Wangaratta-Kilfeera Road in the City of Wangaratta and making of the widening thereon.

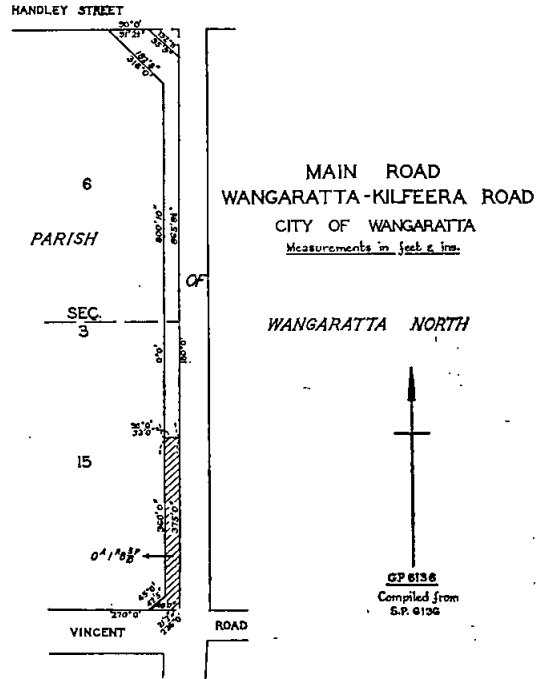

The land shown hatched on Plan numbered G.P.11596 hereunder required for the widening of Epping Road in the Shire of Whittlesea and making of the widening thereon.

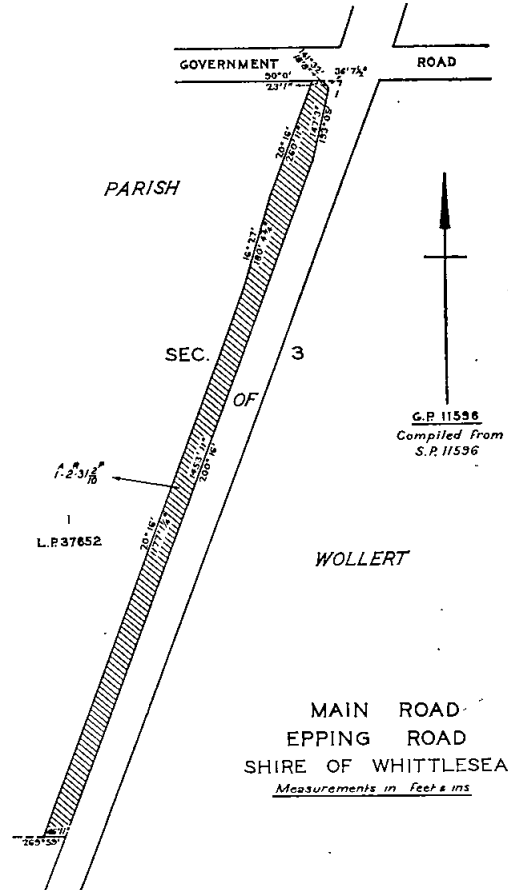

The land shown hatched on Plan numbered G.P.11573 hereunder required for the widening of the Coleraine-Balmoral Road in the Shire of Wannon and making of the widening thereon.

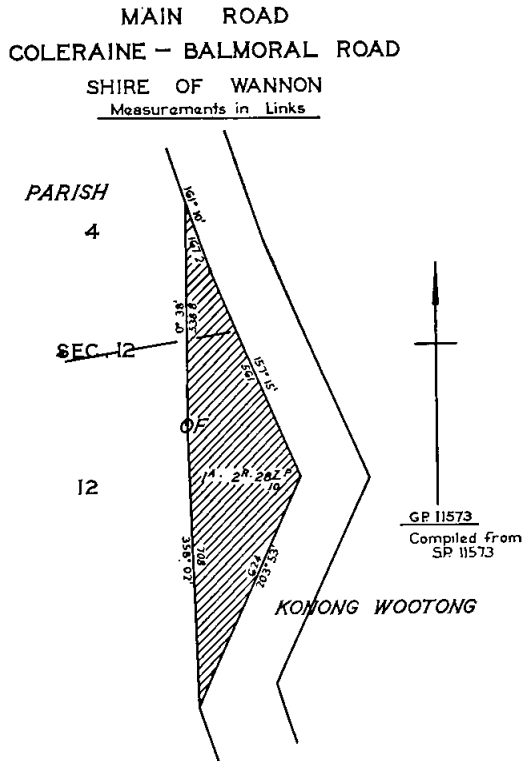

The land shown hatched on Plan numbered G.P.11467 hereunder required for the deviation from Mardan Road in the Shire of Wooralyl and making of the deviation thereon.

**MAIN ROAD
MARDAN ROAD
SHIRE OF WOORAYL**
Measurements in Links

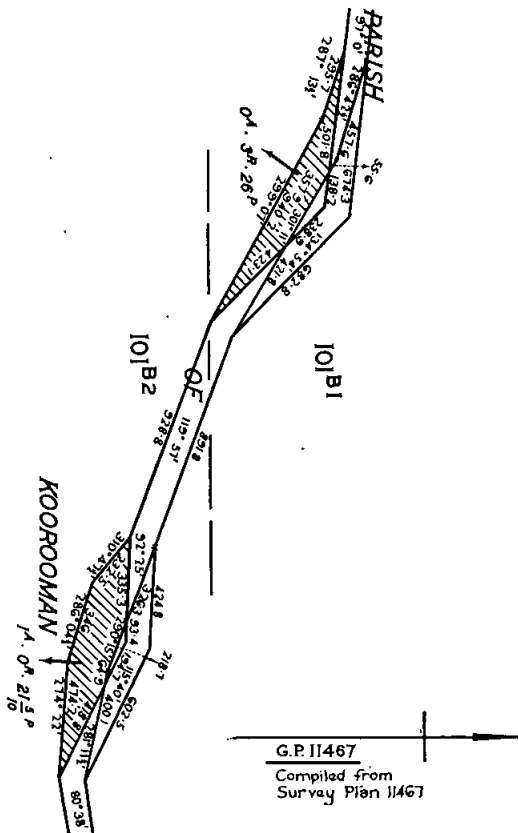

The land shown hatched on Plan numbered G.P.11561 hereunder required for the deviation from Mount Dandenong Road in the Shire of Sherbrooke and making of the deviation thereon.

**TOURISTS' ROAD
MOUNT DANDENONG ROAD
SHIRE OF SHERBROOKE**
MEASUREMENTS IN LINKS

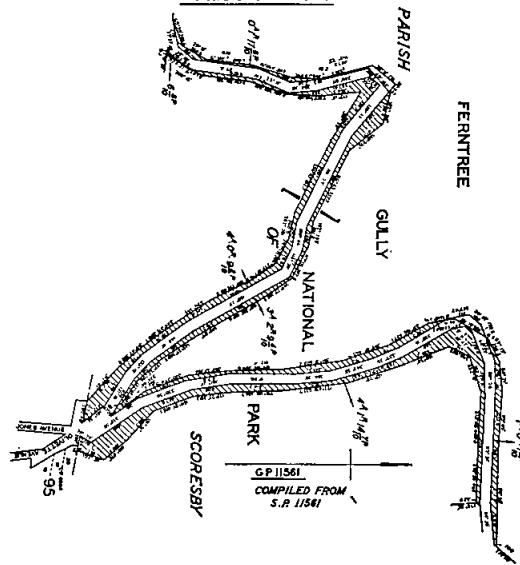

Unclassified road.

The land shown hatched on Plan numbered G.P.11587 hereunder required for the deviation from Pondage Road in the Shire of Bright and making of the deviation thereon.

**ROAD
PONDAGE ROAD
SHIRE OF BRIGHT**
Measurements in feet & inches

Tourists' roads.
The land shown hatched on Plan numbered G.P.11586 hereunder required for the widening of the Bogong High Plains Road in the Shire of Bright and making of the widening thereon.

**TOURISTS' ROAD
BOGONG HIGH PLAINS ROAD
SHIRE OF BRIGHT**
Measurements in feet & inches

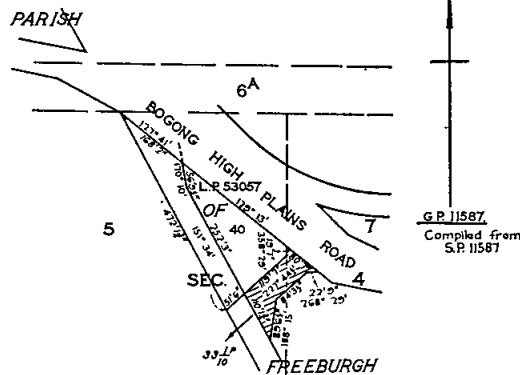
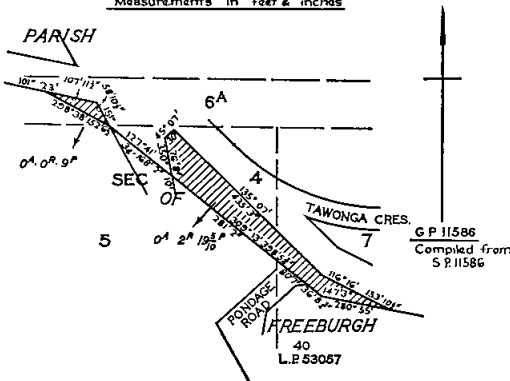

And the Honorable Murray Victor Porter, Her Majesty's Minister of Public Works for the State of Victoria, shall give the necessary directions herein accordingly.

J. ROSSITER,
Clerk of the Executive Council.

HOUSING ACT 1958.

At the Executive Council Chamber, Melbourne, the twenty-first day of January, 1969.

PRESENT:

His Excellency the Governor of Victoria.
Mr. Porter | Mr. Meagher.

DECLARATION OF PRIVATE STREETS AS PUBLIC HIGHWAYS WITHIN THE SHIRE OF MORNINGTON.

WHEREAS pursuant to Section 107 of the Housing Act 1958 it is among other things enacted that where works have been carried out in accordance with an agreement for the full construction of any roads, pavements, culverts or drains made pursuant to the provisions of the said Section 107 such roads, pavements, culverts or drains shall be under the care and management of the Municipality which shall be liable for the cost of any maintenance, repair, alteration or reconstruction thereof and the Governor-in-Council may by order published in the Government Gazette declare any road so constructed to be a public highway.

AND WHEREAS by Order dated the eighth day of November, 1967, the Governor-in-Council consented to an agreement between the Housing Commission and the Shire of Mornington regarding street and drainage construction in Myuna Court and parts of Robertson Drive, Currawong Street and Falconer Avenue in the Tanti Park Estate situate in the municipality of the Shire of Mornington and the carrying out of the works enumerated in the said Agreement.

AND WHEREAS the works of road pavements, culvert and drainage construction have now been carried out in accordance with the said agreement between the Housing Commission and the Shire of Mornington.

NOW THEREFORE His Excellency the Governor of the State of Victoria by and with the advice of the Executive Council of the said State and in pursuance of the powers conferred by Section 107 of the Housing Act and upon recommendation of the Housing Commission DOETH by this order declare the streets more particularly delineated and shown hatched on the plan hereunder to be absolutely dedicated to the public as Public Highways within the meaning of any law now or hereafter in force AND THAT the Council of the Municipality in which the streets are situate shall hereafter be liable for all cost of any maintenance, repair, alteration or reconstruction thereof.

PART OF CROWN PORTION 13

PARISH OF MOOROODUC

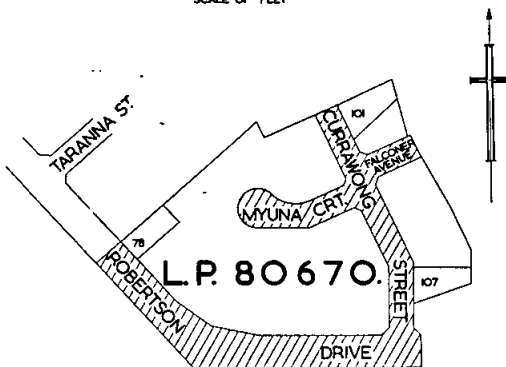
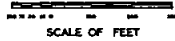

And the Honorable Edward Raymond Meagher, Her Majesty's Minister of Housing for the State of Victoria shall give the necessary directions herein accordingly.

J. ROSSITER,
Clerk of the Executive Council.

WESTERNPORT WATERWORKS TRUST.

At the Executive Council Chamber, Melbourne, the twenty-first day of January, 1969.

PRESENT:

His Excellency the Governor of Victoria.
Mr. Porter | Mr. Meagher.

EXTENT OF DISTRICTS INCREASED.

UNDER the powers conferred by the Water Act and all other powers enabling him in that behalf, His Excellency the Governor of the State of Victoria, by and with the advice of the Executive Council of the said State, doth hereby declare, order and direct that the extent of the Waterworks District and Cowes Urban District of the Westernport Waterworks Trust be increased by adding to the same the land comprised within the boundaries shown on a plan approved by the Governor in Council and deposited in the office of the State Rivers and Water Supply Commission, Melbourne (Corr. 65/2391/228) and as on and from the date hereof, the extent of such Districts shall be and be deemed to be increased accordingly.

And the Honorable William Archibald Borthwick, Her Majesty's Minister of Water Supply for the State of Victoria, shall give the necessary directions herein accordingly.

J. ROSSITER,
Clerk of the Executive Council.

WESTERNPORT WATERWORKS TRUST.

At the Executive Council Chamber, Melbourne, the twenty-first day of January, 1969.

PRESENT:

His Excellency the Governor of Victoria.
Mr. Porter | Mr. Meagher.

EXTENT OF DISTRICTS INCREASED.

UNDER the powers conferred by the Water Act and all other powers enabling him in that behalf, His Excellency the Governor of the State of Victoria, by and with the advice of the Executive Council of the said State, doth hereby declare, order and direct that the extent of the Waterworks District and Newhaven Urban District of the Westernport Waterworks Trust be increased by adding to the same the lands comprised within the boundaries shown on a plan approved by the Governor in Council and deposited in the office of the State Rivers and Water Supply Commission, Melbourne (Corr. 65/2391/242) and as on and from the date hereof the extent of such Districts shall be and be deemed to be increased accordingly.

And the Honorable William Archibald Borthwick, Her Majesty's Minister of Water Supply for the State of Victoria, shall give the necessary directions herein accordingly.

J. ROSSITER,
Clerk of the Executive Council.

WOODEND WATERWORKS TRUST.

At the Executive Council Chamber, Melbourne, the twenty-first day of January, 1969.

PRESENT:

His Excellency the Governor of Victoria.
Mr. Porter | Mr. Meagher.

ALTERATION IN THE CONSTITUTION OF THE TRUST.

UNDER the powers conferred by the Water Act and all other powers enabling him in that behalf, His Excellency the Governor of the State of Victoria, by and with the advice of the Executive Council of the said State, doth hereby amend as follows the Order constituting the Woodend Waterworks Trust made by the Governor in Council on 14th February, 1888, and published in the Victoria Government Gazette dated 20th February, 1888,

as amended by Order made by the Governor in Council on 2nd May, 1962 and published in the *Victoria Government Gazette* dated 9th May, 1962:—

In Clause 2 for the expression "and two other persons" there shall be substituted the expression "and three other persons".

And the Honorable William Archibald Borthwick, Her Majesty's Minister of Water Supply for the State of Victoria, shall give the necessary directions herein accordingly.

J. ROSSITER,
Clerk of the Executive Council.

SHIRE OF KANIVA WATERWORKS TRUST.

At the Executive Council Chamber, Melbourne, the twenty-first day of January, 1969.

PRESENT:

His Excellency the Governor of Victoria.
Mr. Porter | Mr. Meagher.

EXTENT OF KANIVA URBAN DISTRICT INCREASED AND WATERWORKS DISTRICT DIMINISHED.

UNDER the powers conferred by the Water Act and all other powers enabling him in that behalf, His Excellency the Governor of the State of Victoria, by and with the advice of the Executive Council of the said State, doth hereby declare, order and direct as follows:—

- (a) that the extent of the Kaniva Urban District of the Shire of Kaniva Waterworks Trust be increased by adding to the same the lands comprised within the boundaries shown on Plan B and as on and from the date hereof the extent of the said Urban District shall be and be deemed to be increased accordingly;
- (b) that the extent of the Waterworks District of the Shire of Kaniva Waterworks Trust be diminished by excising therefrom the lands comprised within the boundaries shown on Plan A and as on and from the date hereof the extent of the said Waterworks District shall be and be deemed to be diminished accordingly;
- (c) that as on and from the date hereof all the assets, liabilities and properties of the Shire of Kaniva Waterworks Trust in connexion with the lands shown on the said Plan A shall be and do hereby become the assets, liabilities and properties of the Kaniva Shire Council.

The said Plans A and B are approved by the Governor in Council by and with this Order and deposited in the office of the State Rivers and Water Supply Commission, Melbourne.—(Corr. No. 59/8873/112.)

And the Honorable William Archibald Borthwick, Her Majesty's Minister of Water Supply for the State of Victoria, shall give the necessary directions herein accordingly.

J. ROSSITER,
Clerk of the Executive Council.

TOWN OF STAWELL.—WATER SUPPLY DISTRICT

At the Executive Council Chamber, Melbourne, the twenty-first day of January, 1969.

PRESENT:

His Excellency the Governor of Victoria.
Mr. Porter | Mr. Meagher.

CONSENT TO BORROWING \$19,000.

UNDER the powers conferred by the Water Act and all other powers enabling him in that behalf, His Excellency the Governor of the State of Victoria, by and with the advice of the Executive Council of the said State, doth hereby consent to the Council of the Town of Stawell borrowing at interest by mortgage of the General Fund, the sum of Nineteen thousand dollars (\$19,000) for the conversion of Loan No. 17.

And the Honorable William Archibald Borthwick, Her Majesty's Minister of Water Supply for the State of Victoria, shall give the necessary directions herein accordingly.

J. ROSSITER,
Clerk of the Executive Council.

ORBOST WATERWORKS TRUST.

At the Executive Council Chamber, Melbourne, the twenty-first day of January, 1969.

PRESENT:

His Excellency the Governor of Victoria.
Mr. Porter | Mr. Meagher.

CONSENT TO BORROWING \$100,000.

UNDER the powers conferred by the Water Act and all other powers enabling him in that behalf, His Excellency the Governor of the State of Victoria, by and with the advice of the Executive Council of the said State, doth hereby consent to the Orbost Waterworks Trust borrowing at interest by mortgage of the General Fund the sum of One hundred thousand dollars (\$100,000) in two amounts each of Fifty thousand dollars (\$50,000) to meet the cost of water supply works.

And the Honorable William Archibald Borthwick, Her Majesty's Minister of Water Supply for the State of Victoria, shall give the necessary directions herein accordingly.

J. ROSSITER,
Clerk of the Executive Council.

THE BALLARAT SEWERAGE AUTHORITY.

At the Executive Council Chamber, Melbourne, the twenty-first day of January, 1969.

PRESENT:

His Excellency the Governor of Victoria.
Mr. Porter | Mr. Meagher.

CONSENT TO BORROWING \$15,653.

UNDER the powers conferred by the Sewerage Districts Act and all other powers enabling him in that behalf, His Excellency the Governor of the State of Victoria, by and with the advice of the Executive Council of the said State, doth hereby consent to The Ballarat Sewerage Authority borrowing at interest by mortgage of the General Fund the sum of Fifteen thousand six hundred and fifty-three dollars (\$15,653) for the conversion of Loan E.

And the Honorable William Archibald Borthwick, Her Majesty's Minister of Water Supply for the State of Victoria, shall give the necessary directions herein accordingly.

J. ROSSITER,
Clerk of the Executive Council.

THE BALLARAT SEWERAGE AUTHORITY.

At the Executive Council Chamber, Melbourne, the twenty-first day of January, 1969.

PRESENT:

His Excellency the Governor of Victoria.
Mr. Porter | Mr. Meagher.

CONSENT TO BORROWING \$115,500.

UNDER the powers conferred by the Sewerage Districts Act and all other powers enabling him in that behalf, His Excellency the Governor of the State of Victoria, by and with the advice of the Executive Council of the said State, doth hereby consent to The Ballarat Sewerage Authority borrowing at interest by mortgage of the General Fund the sum of One hundred and Fifteen thousand Five hundred dollars (\$115,500) for the conversion of Loan U.

And the Honorable William Archibald Borthwick, Her Majesty's Minister of Water Supply for the State of Victoria, shall give the necessary directions herein accordingly.

J. ROSSITER,
Clerk of the Executive Council.

FRANKSTON SEWERAGE AUTHORITY.

At the Executive Council Chamber, Melbourne, the
twenty-first day of January, 1969.

PRESENT:

His Excellency the Governor of Victoria.
Mr. Porter | Mr. Meagher.

CONSENT TO BORROWING \$50,000.

UNDER the powers conferred by the Sewerage Districts Act and all other powers enabling him in that behalf, His Excellency the Governor of the State of Victoria, by and with the advice of the Executive Council of the said State, doth hereby consent to the Frankston Sewerage Authority borrowing at interest by mortgage of the General Fund the sum of Fifty thousand dollars (\$50,000) to meet the cost of sewerage works as set forth in the detailed statement bearing date 16th January, 1969.

And the Honorable William Archibald Borthwick, Her Majesty's Minister of Water Supply for the State of Victoria, shall give the necessary directions herein accordingly.

J. ROSSITER,
Clerk of the Executive Council.

PORTLAND SEWERAGE AUTHORITY.

At the Executive Council Chamber, Melbourne, the
twenty-first day of January, 1969.

PRESENT:

His Excellency the Governor of Victoria.
Mr. Porter | Mr. Meagher.

CONSENT TO BORROWING \$50,000.

UNDER the powers conferred by the Sewerage Districts Act and all other powers enabling him in that behalf, His Excellency the Governor of the State of Victoria, by and with the advice of the Executive Council of the said State, doth hereby consent to the Portland Sewerage Authority borrowing at interest by mortgage of the General Fund the sum of Fifty thousand dollars (\$50,000) to meet the cost of sewerage works as set forth in the detailed statement bearing date 16th January, 1969.

And the Honorable William Archibald Borthwick, Her Majesty's Minister of Water Supply for the State of Victoria, shall give the necessary directions herein accordingly.

J. ROSSITER,
Clerk of the Executive Council.

WARRNAMBOOL SEWERAGE AUTHORITY.

At the Executive Council Chamber, Melbourne, the
twenty-first day of January, 1969.

PRESENT:

His Excellency the Governor of Victoria.
Mr. Porter | Mr. Meagher.

CONSENT TO BORROWING \$19,000.

UNDER the powers conferred by the Sewerage Districts Act and all other powers enabling him in that behalf, His Excellency the Governor of the State of Victoria, by and with the advice of the Executive Council of the said State, doth hereby consent to the Warrnambool Sewerage Authority borrowing at interest by mortgage of the General Fund the sum of Nineteen thousand dollars (\$19,000) for the conversion of Loan No. 13.

And the Honorable William Archibald Borthwick, Her Majesty's Minister of Water Supply for the State of Victoria, shall give the necessary directions herein accordingly.

J. ROSSITER,
Clerk of the Executive Council.

MINISTRY OF TRANSPORT.

At the Executive Council Chamber, Melbourne, the
twenty-first day of January, 1969.

PRESENT:

His Excellency the Governor of Victoria.
Mr. Porter | Mr. Meagher.

MELBOURNE AND METROPOLITAN TRAMWAYS BOARD.—NOTICE OF APPROVAL OF BY-LAW FIXING TOLLS, FARES AND CHARGES.

PURSUANT to Section 110 of the *Melbourne and Metropolitan Tramways Act 1958*, it is hereby notified, for public information, that His Excellency the Governor of the State of Victoria, by and with the advice of the Executive Council thereof, has this day, in accordance with the provisions of the *Melbourne and Metropolitan Tramways Acts*, approved the following By-Law made by the Melbourne and Metropolitan Tramways Board:—

Title of By-Law, No. 22, Tolls, Fares and Charges.

General purport of By-Law—Rescinding By-Law No. 21 of the Melbourne and Metropolitan Tramways Board and prescribing tolls, fares and charges which may be demanded and taken by the Board for the conveyance of passengers on its tramways, or any part thereof, or on any omnibus of the Board.

And the Honorable Vernon Francis Wilcox, Her Majesty's Minister of Transport for the State of Victoria, shall give the necessary directions herein accordingly.

J. ROSSITER,
Clerk of the Executive Council.

LANDS DEPARTMENT NOTICES

APPROACHING LAND SALES.

SALES of Crown Lands, in fee-simple, will be held at the under-mentioned places and dates, viz.:

	No. of Gazette.
Camperdown.—Friday, 14th March, 1969 ..	5
Colac.—Friday, 14th March, 1969 ..	5
Geelong East.—Thursday, 6th March, 1969 ..	5
Melbourne.—Wednesday, 29th January, 1969 ..	107
Wonthaggi.—Friday, 24th January, 1969 ..	107

SALE OF CROWN LAND BY AUCTION.

The land will be offered for sale in fee-simple, and subject to the provisions of the Land Act and Regulations thereunder.

The upset price is the sum at which bidding will start, and no bid below that sum can be accepted. The highest bidder at or above that sum shall be the purchaser, subject to signature of contract and any necessary payment.

TERMS:—

A deposit of at least 12½% of the purchase price must be paid at the sale, either in cash or by cheque.

The residue is payable in half-yearly instalments, in accordance with the following scale, or may be paid off at any earlier time.

\$40 and under, 6 instalments.
Over \$40, and not exceeding \$100, 8 instalments.
Over \$100, and not exceeding \$200, 10 instalments.
Over \$200, and not exceeding \$400, 12 instalments.
Over \$400, and not exceeding \$600, 14 instalments.
Over \$600, and not exceeding \$800, 16 instalments.
Over \$800, and not exceeding \$1,000, 18 instalments.
Over \$1,000, 20 instalments.

Interest at the rate of 5% per annum is payable with all payments of residue, and is computed for each instalment from the date of sale to the date of such payment. Additional interest is charged if any instalment is not paid on or before the due date.

If paid off within 30 days of sale, no interest is payable.

FEES, ETC.:

Also payable at the sale, in addition to the deposit, are the survey fee and, if applicable, the valuation of improvements (if purchaser be not the owner thereof).

Payable with balance of purchase money—

Crown Grant fee—	
50 acres and under	\$3
Over 50 acres	\$4
Purchase money \$10 or under	\$2

Assurance Fund contribution.—One cent in every Five dollars or part thereof of purchase price. (This is a fund established to guarantee the validity of freehold titles.)

Transfer of interest prior to completion of payment may be allowed on payment of \$2 fee and subject to stamp duty.

If unable to attend personally, a prospective purchaser may arrange for another person to bid as his agent.

Attention is drawn to section 95, *Land Act 1958*, which provides that the purchaser shall be deemed to be the owner for the purposes of other Acts; also to an amendment to the Local Government Act providing for Government roads, in certain circumstances, to be declared "private streets", thus making the purchaser liable to contribute to the cost of street construction.

W. J. F. McDONALD,
Minister of Lands.

Office of Crown Lands and Survey,
Melbourne, 13th November, 1968.

COLAC.—Sale (No. 11983) of Crown land in fee-simple by auction will be held at the AUCTION ROOMS of J. G. JOHNSTONE & CO. PTY. LTD., of 144 MURRAY-STREET, COLAC, on FRIDAY, the 14th MARCH, 1969, at TEN o'clock A.M. Sale to be conducted by D. M. O'CONNOR, Land Officer, Geelong. Auctioneers J. G. JOHNSTONE & CO. PTY. LTD.

Lot 1.

PARISH OF NATTE MURRANG, COUNTY OF POLWARTH.
5 miles north-east of Carlisle River on Colac-road.
Upset price \$500 the lot. Survey fee \$32.25.
Area 33a. 2r. 20p. Allotment 20n.—(G.61141.)

Lot 2.

PARISH OF BIRREGURRA, COUNTY OF POLWARTH.
Fronting west side of Ennis-street, bordering the Township of Birregurra, 3 chains south of Colac-Geelong road.
Upset price \$200 the lot. Survey fee \$16.
Area 1a. 1r. 29p., subject to survey allotment H1, section 28. Valuation of improvements \$30. (Fencing) (Crown).—(G.72554.)

Lot 3.

PARISH OF BARONGAROOK, COUNTY OF POLWARTH.
On north bank of Loves River and north-east of Kawarren Station Ground.
Upset price \$40 the lot. Survey fee \$17.
Area 6 acres, subject to survey. Allotment 65k.—(G.71385.)

CAMPERDOWN.—A Sale of Freehold Land by Auction, for and on behalf of the Minister of Education, will be held at the LAND INSPECTOR'S OFFICE, CAMPERDOWN, on FRIDAY, 14th MARCH, 1969, at half-past ONE o'clock P.M. Sale to be conducted by D. M. O'CONNOR, Land Officer, Geelong.

CONDITIONS.—Deposit of at least 12½ per cent. of purchase price payable at sale and balance within 60 days. Purchaser to arrange for and bear costs of registration of transfer of title.

Lot 1.

TOWNSHIP OF DARLINGTON, PARISH OF DARLINGTON, COUNTY OF HAMPDEN.
On the north side of Ware-street, about 3 chains west of Ware and Hall streets intersection, frontage 132 feet, depth 164 feet approximately, being former Education Department residence at Darlington.
Upset price \$2,200 the lot.

Area 2 roods, part allotments 6 and 7, section 6, and being the land more particularly described in Crown Grant, volume 3899, folio 685. The valuation of improvements (house, laundry and garage) is included in upset.—(G.69209.)

GEELONG EAST.—Sale of Freehold Land by Auction, for and on behalf of the Minister of Education, will be held at the site, 38 GURR-STREET, GEELONG EAST, on THURSDAY, 6th MARCH, 1969, at THREE o'clock P.M. Sale to be conducted by D. M. O'CONNOR, Land Officer, Geelong. Auctioneers FRIER REID PTY. LTD., 187A Moorabool-street, Geelong.

CONDITIONS.—Deposit of at least 12½ per cent. of purchase price payable at sale and balance within 60 days. Purchaser to arrange for and bear costs of registration of transfer of title.

Lot 1.

CITY OF GEELONG, PARISH OF CORIO, COUNTY OF GRANT.
At 38 Gurr-street, Geelong East, frontage 36 feet, depth 153 feet approximately, being former Education Department residence.
Upset price \$3,000 the lot.

Area 20 perches, part allotment 21 of section 94, and being the land more particularly described in Crown Grant, volume 4150, folio 938. The valuation of improvements (weatherboard house 12½ squares, laundry and garage) is included in upset.—(G.69207.)

Land Act 1958.

LICENCE UNDER THE LAND ACTS DECLARED VOID.

NOTICE is hereby given that the Licence in the Schedule hereunder has been Declared Void for the reason specified.

District.	Corr. No.	Name of Licensee.	Section of Land Act under which Licensed.	Parish.	Allotment.	Section.	Area.	Annual Rental.	Reason for Voiding.
Bairnsdale	242/138	J. T. Bailey	138	Township Bemm	11	A	A. R. P. 0 1 2±	\$ 35.00	Non-payment of rental; fencing and residence conditions not complied with

Department of Crown Lands and Survey,
Melbourne, 20th December, 1968.

W. J. F. McDONALD,
Minister of Lands.

Land Act 1958.

LEASE DECLARED VOID.

NOTICE is hereby given that the Governor in Council has declared void the Lease mentioned in the schedule hereunder for the reason specified.

District.	Corr. No.	Name.	Section of Land Act 1958 under which Leased.	Parish.	Allotment.	Section.	Area.	Reason.
Mallee ..	13/155	Herbert Henry Meyer	155	Nateyip ..	15	..	A. R. P. 1,349 2 0	Issue of fresh lease

Department of Crown Lands and Survey,
Melbourne, 14th January, 1969.

W. J. F. McDONALD,
Minister of Lands.

PROPOSED REVOCATIONS OF TEMPORARY RESERVATIONS OF LAND BY ORDERS IN COUNCIL.

IN pursuance of the provisions of the Land Act 1958, notice is hereby given that it is the intention of the Governor in Council to revoke the temporary reservations of lands by Orders in Council hereunder referred to, viz.:—
The following Notices were published 1° on the 18th December, 1968, pursuant to Orders of the 10th December, 1968.

ARARAT.—The temporary reservation by Order in Council of the 26th November, 1860, of 11 acres 1 rood 16 perches of land in the Township of Ararat, as a site for the purpose of extending the area of the Reservoir for water in connexion with the Municipal District of Ararat, revoked as to part by various Orders, is about to be revoked so far as the balance thereof containing 9 acres 0 roods 11 perches, is concerned.—(A.148°) (Rs.1161).

ARARAT.—The temporary reservation, by Order in Council of the 2nd September, 1861, of 14 acres 2 roods 14 perches of land in the Township of Ararat, as a site for Public Gardens, revoked as to part by various Orders, is about to be revoked so far as the balance thereof containing 13 acres 0 roods 12 6/10 perches, is concerned.—(A.148°) (Rs.1160).

ARARAT.—The temporary reservation, by Order in Council of the 19th February, 1906, of 4 acres 1 rood 34 perches of land in the Township of Ararat, as a site for Public Gardens, is about to be revoked.—(A.148°) (Rs.1160).

ARARAT.—The temporary reservation, by Order in Council of the 22nd November, 1921, of 2 roods 17 perches of land in the Township of Ararat, as a site for Public Gardens, is about to be revoked.—(A.148°) (Rs.1160).

PORTLAND.—The temporary reservation as a site for Public Recreation and the withholding from sale, leasing and licensing by Order in Council of the 20th October, 1884, of 200 acres, more or less, of land in the Parish of Portland, are about to be revoked, save and except the area of 97 acres, more or less, indicated by hatching on plan hereunder, is concerned.—(P.69°) (Rs.6026).

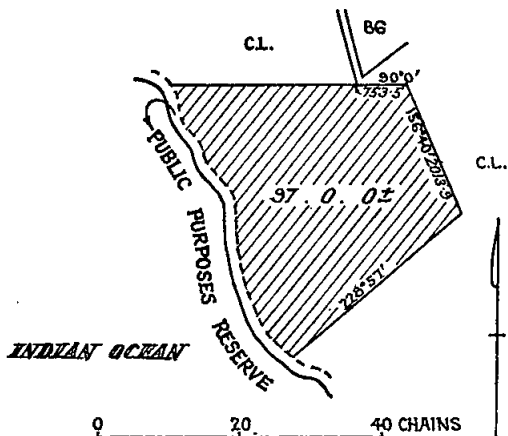

BRIGHT.—The temporary reservation, by Order in Council of the 10th August, 1874, of 2 acres 0 roods 12 6/10 perches of land in the Township of Bright as a site for Police purposes, revoked as to part by various Orders, is about to be revoked so far only as the portion containing 32 perches, more or less, indicated by hatching on plan hereunder, is concerned.—(B.573°) (Rs.4670).

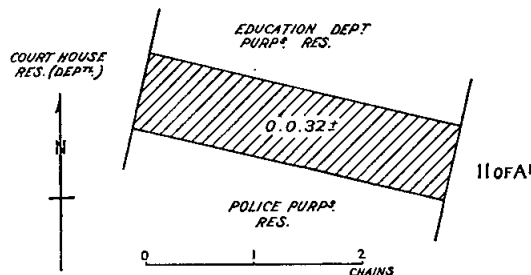

BRIGHT.—The temporary reservation, by Order in Council of the 26th September, 1938, of 2 acres 2 roods 16 perches, more or less, of land in the Township of Bright as a site for Public Recreation and Camping, is about to be revoked so far only as the portion containing 1 rood 12 perches, indicated by hatching on plan hereunder, is concerned.—(B.573°) (Rs.3832).

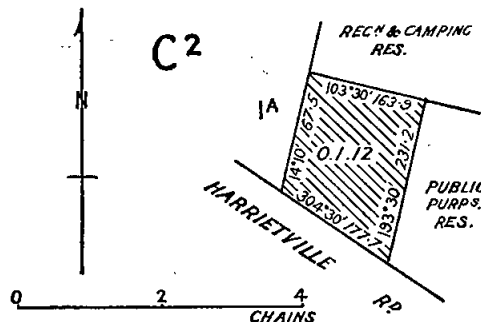

BRIGHT.—The temporary reservation, by Order in Council of the 11th April, 1967, of 2 roods 15 perches of land in the Township of Bright as a site for Public purposes (Education Department purposes), is about to be revoked.—(B.573°) (Rs.8808).

BRIGHT.—The temporary reservation, by Order in Council of the 3rd December, 1901, of 1 rood of land in the Township of Bright, as a site for Public purposes, is about to be revoked.—(B.573°) (Rs.5182).

GLENORCHY.—The temporary reservation as a site for Racecourse and other purposes of Public Recreation and the withholding from sale, leasing and licensing by Order in Council of the 8th December, 1884, of 88 acres 0 roods 18 perches of land in the Township of Glenorchy, revoked as to part by Order of the 16th July, 1901, are about to be

revoked, so far only as the portion containing 2 roods, more or less, indicated by hatching on plan hereunder, is concerned.—(G.79^(a)) (Rs.5216).

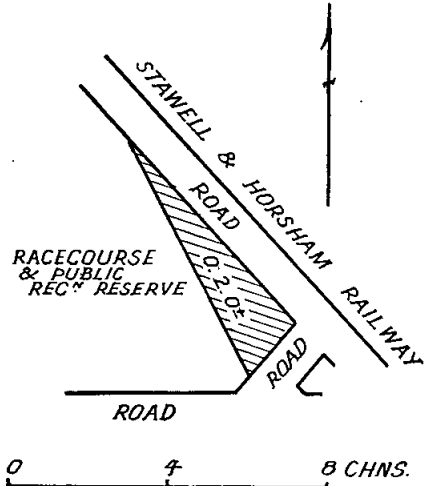

W. J. F. McDONALD,
Minister of Lands.

PROPOSED REVOCATIONS OF TEMPORARY RESERVATIONS OF LANDS BY ORDERS IN COUNCIL.

IN pursuance of the provisions of the Land Act 1958, notice is hereby given that it is the intention of the Governor in Council to revoke the temporary reservations of lands by Orders in Council hereunder referred to, viz.:

The following Notices were published 1^o on the 8th January, 1969, pursuant to Orders of the 17th December, 1968.

PORTLAND.—The temporary reservation, by Order in Council of the 11th August, 1879, of certain Crown lands situated on the shore of Bass Strait and the Indian Ocean (named Southern Ocean in Order) as a site for Public purposes, revoked as to part by various Orders, is about to be revoked so far only as the portion containing 28 acres, more or less, indicated by hatching on plan hereunder, is concerned.—(P.69^(a)) (Rs.2362).

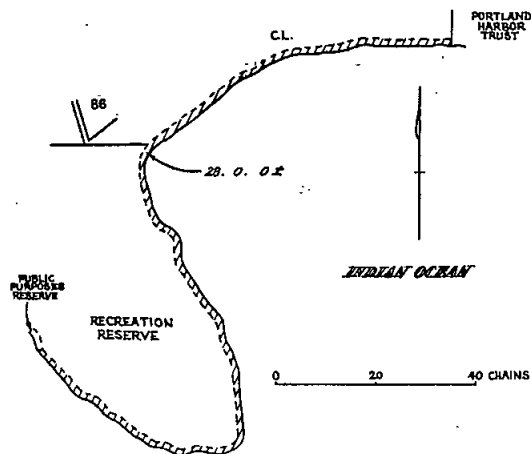

BONNIE DOON.—The temporary reservation as a site for Public Recreation by Order in Council of the 26th March, 1901, of 6 acres 3 roods 38 perches of land in the Township of Bonnie Doon (formerly At Doon) is about to be revoked so far only as the portion containing 24 perches indicated by hatching on plan hereunder is concerned.—(D.164⁽²⁾) (Rs.599).

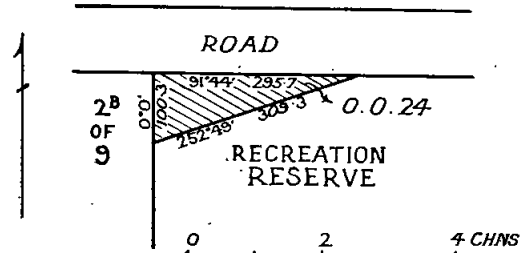

HAZELWOOD.—The temporary reservation as a site for a Public Hall by Order in Council of the 4th November, 1953, of 2 roods of land in the Parish of Hazelwood is about to be revoked, so far only as the portion containing 14 perches indicated by hatching on plan hereunder is concerned.—(H.120^(A4)) (Rs.5910).

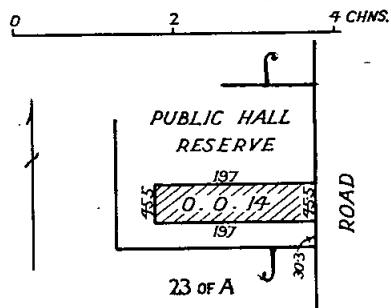

CAPE CLEAR.—The temporary reservation, by Order in Council of the 24th November, 1873, of 1 acre 3 roods 5 perches of land in the Township of Cape Clear as a site for State School purposes is about to be revoked, so far only as the portion containing 9 perches, indicated by hatching on plan hereunder, is concerned.—(C.480⁽¹⁾) (Rs.6948).

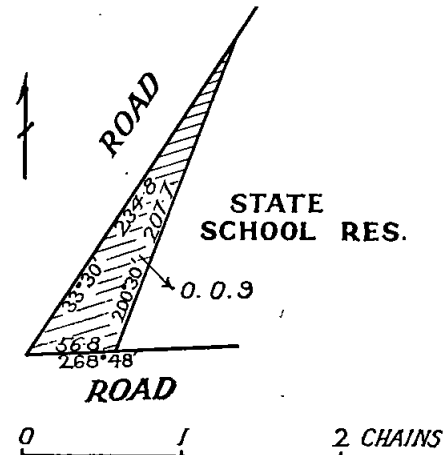

BORODOMANIN.—The temporary reservation by Order in Council of the 20th July, 1891, of 5 acres of land in the Parish of Borodomanin as a site for a State School is about to be revoked.—(B.710^(a)) (H.029414).

BREWSTER.—The temporary reservation as a site for Road purposes and for affording access to Water and the withholding from sale, leasing and licensing by Order in Council of the 5th March, 1884, of 13 acres, more or less, of land in the Parish of Brewster are about to be revoked.—(B.433⁽⁴⁾) (C.100179).

DRUMDLEMARA.—The temporary reservation, by Order in Council of the 2nd December, 1912, of 2 acres 19 perches of land in the Parish of Drumdlemara as a site for Watering purposes is about to be revoked.—(D.197⁽⁴⁾) (Rs.3559).

OUYEN (KIAMAL).—The temporary reservation, by Order in Council of the 20th January, 1926, of 9 acres 1 rood 10 perches of land in the Parish of Ouyen as a site for Public Recreation is about to be revoked.—(O.22^(a)) (Rs.3245).

W. J. F. McDONALD,
Minister of Lands.

PROPOSED REVOCATIONS OF TEMPORARY RESERVATIONS OF LANDS BY ORDERS IN COUNCIL.

IN pursuance of the provisions of the *Land Act 1958*, notice is hereby given that it is the intention of the Governor in Council to revoke the temporary reservations of lands by Orders in Council hereunder referred to, viz.:—
The following Notices were published 1° on the 8th January, 1969, pursuant to Orders of the 24th December, 1968.

CASTLEMAINE.—The temporary reservation, by Order in Council of the 18th February, 1941, of 3 roods 20 perches, more or less, of land in the Township of Castlemaine, as a site for Recreation and Public purposes, is about to be revoked.—(C.99(°)) (Rs.5170).

CONGUPNA.—The temporary reservation as a site for Public purposes (State School) and the withholding from sale, leasing and licensing by Order in Council of the 2nd October, 1882, of 2 acres of land in the Parish of Congupna, are about to be revoked.—(C.418(°)) (C.96515).

LURG.—The temporary reservation, by Order in Council of the 20th May, 1901, of 9 acres 1 rood 7 perches of land in the Parish of Lurg, as a site for Supply of Gravel, is about to be revoked.—(L.157(°)) (Rs.7151).

WOORRAGEE NORTH.—The temporary reservation, by Order in Council of the 12th May, 1885, of 143 acres, more or less, of land in the Parish of Wooragee North as a site for Camping and Watering purposes, revoked as to part by Order of the 9th November, 1965, is about to be revoked so far only as the portions containing 9 acres 3 roods 20 perches, more or less, indicated by hatching on plan hereunder, is concerned.—(W.210(°)) (C.73322).

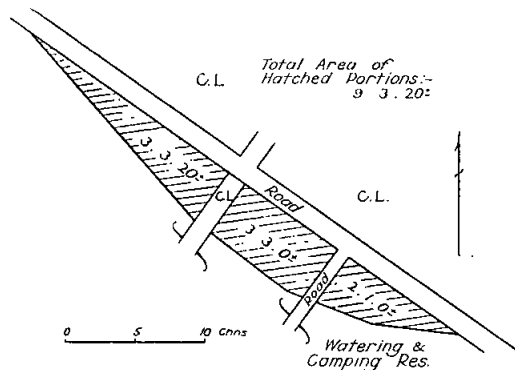

WOORRAGEE NORTH.—The temporary reservation, by Order in Council of the 21st October, 1872 (see *Government Gazette*, 25th October, 1872, page 1966), of 4 acres 2 roods, more or less, of land in the Parish of Wooragee North, as a site for Watering and Camping purposes, is about to be revoked.—(W.210(°)) (H.021344).

W. J. F. McDONALD,
Minister of Lands.

PROPOSED REVOCATIONS OF TEMPORARY RESERVATIONS OF LANDS BY ORDERS IN COUNCIL.

IN pursuance of the provisions of the *Land Act 1958*, notice is hereby given that it is the intention of the Governor in Council to revoke the temporary reservations of lands by Orders in Council hereunder referred to, viz.:—
The following Notices were published 1° on the 22nd January, 1969, pursuant to Orders of the 14th January, 1969.

YANAKIE SOUTH.—The temporary reservation, by Order in Council of the 11th August, 1879, of certain Crown lands situated on the shore of Bass Strait and the Southern Ocean as a site for Public purposes, revoked as to part by various Orders, is about to be revoked, so far only as the portion thereof containing 110 acres, more or less, in the Parish of Yanakie South, between Shallow Inlet and the Darby River.—(Y.117(°)) (Rs.2362).

BEECHWORTH.—The temporary reservation, by Order in Council of the 5th September, 1922, of 29 acres, more or less of land in the Township of Beechworth as a site for Watering purposes is about to be revoked, so far only as the portion containing 2 acres 2 roods 10 perches, more or less, indicated by hatching on plan hereunder, is concerned.—(B.348(°)) (Rs.2559).

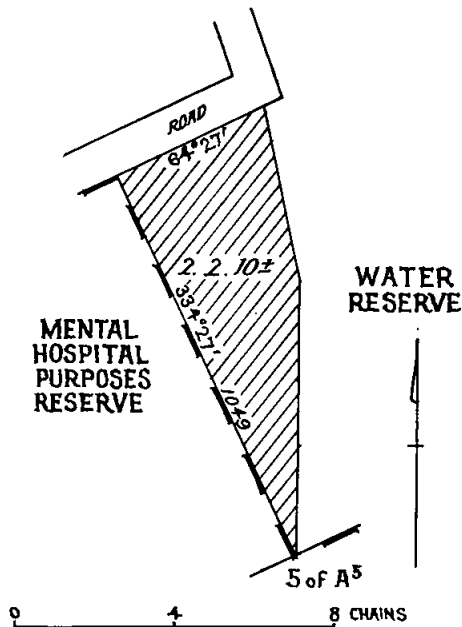

BEECHWORTH.—The temporary reservation, by Order in Council of the 30th June, 1959, of 23 acres 0 roods 39 perches of land in the Township and Parish of Beechworth as a site for Mental Hospital purposes is about to be revoked, so far only as the portion containing 3 roods 25 perches, indicated by hatching on plan hereunder, is concerned.—(B.348(°)) (Rs.770).

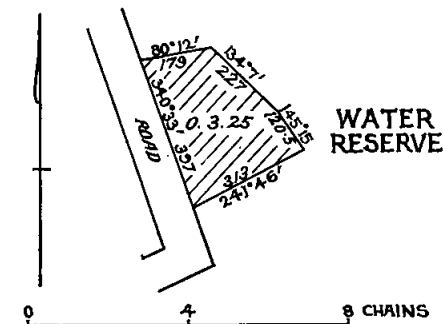

COONOOER WEST.—The temporary reservation as a site for Public purposes and the withholding from sale, leasing and licensing by Order in Council of the 16th October, 1876 (see *Government Gazette*, 20th October, 1876, page 1933), of 80 acres of land in the Parish of Coonooer West, are about to be revoked.—(C.404(°)) (W.87256).

DUNOLLY.—The temporary reservation, by Order in Council of the 5th January, 1863, of 5 acres 1 rood 24 perches of land in the Township of Dunolly as a site for Water Supply, is about to be revoked.—(D.124(°)) (Rs.6256).

MELBOURNE NORTH, AT EAST MELBOURNE.—The temporary reservation, by Order in Council of the 24th August, 1909, of 25 acres 0 roods 13 perches of land at East Melbourne, City of Melbourne, Parish of Melbourne North, as a site for the Recreation, Convenience and Amusement of the People and for a Children's Playground is about to be revoked save and except the area of 24 acres 3 roods 31 perches, indicated by hatching on plan hereunder.—(M.314^(b)) (Rs.525).

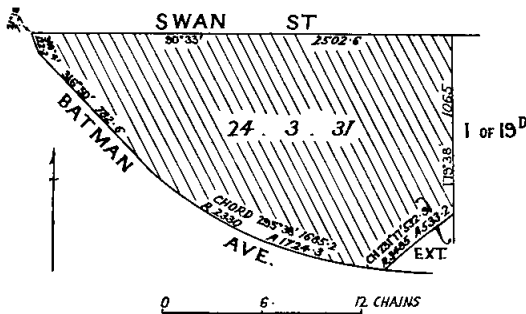

SCORESBY.—The temporary reservation, by Order in Council of the 28th July, 1953, of 8 acres 2 roods 10 perches, more or less, of land in the Parish of Scoresby as a site for Public Recreation is about to be revoked, so far only as the portion containing 3 roods 26 perches, indicated by hatching on plan hereunder, is concerned.—(S.250(A^b)) (Rs.7131).

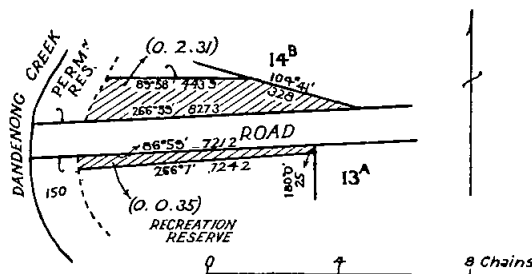

Total Area of Hatched Portions:—0. 3. 26

W. J. F. McDONALD,
Minister of Lands.

LOCAL LAND BOARDS.

IN pursuance of the provisions of section 34 of the Land Act 1958, notice is hereby given that public hearings at the following places and times will be conducted by the persons respectively mentioned, being duly appointed in that behalf.

W. J. F. McDONALD,
Minister of Lands.

Department of Crown Lands and Survey,
Melbourne.

SCHEDULE.

- MANSFIELD, LAND INSPECTOR'S OFFICE, on Thursday, 6th February, 1969, at 10 a.m.—E. Kennedy and J. Cox.
- YEA, LAND INSPECTOR'S OFFICE, on Thursday, 6th February, 1969, at 10 a.m.—E. Kennedy and J. Cox.
- BALLARAT, LAND OFFICE, on Tuesday, 11th February, 1969, at 9 a.m.—N. J. Fitzgerald and P. T. Ledger.
- RED CLIFFS, LAND OFFICE, on Wednesday, 26th February, 1969, at 9 a.m.—N. J. Fitzgerald.
- GEELONG, LAND OFFICE, 123 RYRIE-STREET, GEELONG, on Monday, 17th to Friday, 21st February, 1969 (inclusive), at 9 a.m.—D. O'Connor and E. Kennedy.
- COLAC, LAND INSPECTOR'S OFFICE, on Monday, 24th to Friday, 28th February, 1969 (inclusive), at 9.30 a.m.—D. O'Connor and E. Kennedy.

TENDERS

PUBLIC WORKS DEPARTMENT

TENDERS will be received at Public Works Department, 2 Treasury-place, Melbourne, until TWO p.m. on dates shown and for purposes mentioned hereunder.

Particulars and tender forms available at Contracts Office, Room 7, Building Division, Parliament-place and at places indicated in brackets hereunder.

Abbreviations in brackets mean:—W.O.—Inspector of Works Office; P.S.—Police Station; C.S.—Consolidated School; H.E.S.—Higher Elementary School; H.S.—High School; S.S.—State School; T.S.—Technical School.

Tenders to be submitted on the Department's printed Tender Form and will not be received by telephone. All tenders must be on a "Firm Tender" basis. The lowest or any tender will not necessarily be accepted.

Address tenders to the Minister of Public Works, and endorse the envelope containing the tender "Tender for closing Tuesday,

Hand delivered tenders to be placed in the Tender Box of the Public Works Department, located on the wall of the centre entrance foyer, Ground Floor, 2 Treasury-place, Melbourne.

No preliminary deposit is required with any tender, but a successful tenderer will be required to pay a deposit for any accepted tender of \$4,000 or over.

Wednesday, 29th January, 1969.

Building, Electrical and Mechanical Works.

- Altona.—External painting, High School.
 - Altona East.—Replacement of fencing, S.S. 4805.
 - Ararat.—Mechanical services, Prison. (W.O., Ballarat and Bendigo.)
 - Chesney Vale.—Transfer of school buildings from Wilby S.S. 2208 and old Chesney Vale to new site, S.S. 4403. (W.O., Benalla.)
 - Coburg.—External repairs and painting, Technical School. (Amended Specification.)
 - Fentons Creek.—Transfer and resiting of Woodstock West S.S. 1236 building, S.S. 2145. (W.O., Bendigo.)
 - Foster.—Renovations and repairs to Residence, Consolidated School. (W.O., Korumburra.)
 - Glen Waverley.—Renovations, S.S. 2219.
 - Heatherton.—Erection of a new Hospital Ward Building, Sanatorium. (Bills of quantities available.)
 - Heatherton.—Electrical installation, Sanatorium. (W.O., Mornington.)
 - Heatherton.—Mechanical services, Sanatorium.
 - Korumburra.—General renovations, S.S. 3077. (W.O., Korumburra.)
 - Melbourne.—Installation of temporary steam line, William Angliss Food Trades School.
 - Melbourne.—Renovations to various rooms, Toorak Teachers' Hostel, 470 St. Kilda-road.
 - Melbourne.—Renovations, Central Chest Clinic, 364-372 Little Lonsdale-street.
 - Newlands.—External renovations, S.S. 4646.
 - Pascoe Vale.—Additional drinking and washing facilities, Girls' High School.
 - Pascoe Vale North.—Partial reblocking of school building, S.S. 4731.
 - Preston.—Remodelling of main building, kitchen and Nurses' Hostel, Alcoholics Assessment Centre. (Specified bills of quantities available.)
 - Preston.—Electrical installation, Alcoholics Assessment Centre.
 - Preston.—Mechanical services, Alcoholics Assessment Centre.
 - Preston.—Fire detection system, Alcoholics Assessment Centre.
 - Preston.—Refrigeration system for three (3) cool rooms, Alcoholics Assessment Centre.
 - Swifts Creek.—External and internal renovations, Lands and Survey Department Residence. (W.O., Bairnsdale; Orbst.)
- Furniture and Furnishings.
- Caulfield.—Supply of steel framed tables, Institute of Technology.
 - Knox.—Supply of furniture, Technical School.
- Site Works.
- Drouin.—Resheeting of asphalt tennis courts, High School. (W.O., Warragul; Traralgon.)
 - Forest Hill.—Asphalt, concrete and drainage works, &c., S.S. 4251.
 - Heatherton.—Drainage works, Sanatorium.

Monterey.—Asphalt, concrete and drainage works, &c., Technical School.

Wodonga.—Asphalt, concrete and drainage works, &c., Technical School. (Amended Specification.) (W.O., Wangaratta.)

Miscellaneous.

Portarlington.—Supply of timber piles, Ports and Harbours Branch.

Tuesday, 4th February, 1969.

Building, Electrical and Mechanical Works.

Ballarat.—Renovations, new fire escape stairs and new balcony to Junior Technical School, School of Mines. (W.O., Ballarat.)

Beechworth.—Replacement of floors and floor coverings to Ward M.11, Mental Hospital. (W.O., Wangaratta.)

Boronia.—Renovations, High School.

Bright.—Renovations, &c., Residence, Police Station. (W.O. Wangaratta; P.S., Bright.)

Brunswick.—Stripping and re-sheeting roofs with tiles, S.S. 1213.

Buxton.—Electrical services, "Acheron" Youth Training Centre. (W.O., Alexandra.)

Echuca.—Renovations, Residence, Police Station. (W.O., Shepparton.)

Fitzroy.—Renovations, &c., Police Station.

Kyneton.—Erection of Trade Wing and remodelling, High School. (W.O., Kyneton.)

Langi Kal Kal.—Erection of Education Block, Youth Training Centre. (W.O., Maryborough.)

Langi Kal Kal.—Mechanical services, Youth Training Centre. (W.O., Ballarat.)

Northcote.—Painting, repairs and installation of ablation troughs, High School.

Parkville.—Erection of Library, Melbourne Teachers' College. (Bills of Quantities Available.)

Parkville.—Electrical installation, Melbourne Teachers' College.

Parkville.—Mechanical services, Melbourne Teachers' College.

Parkville.—Supply and installation of oil electric passenger lift, Melbourne Teachers' College.

Seaford.—Renovations, S.S. 3835.

St. Kilda.—Toilet block extensions and new internal female staff toilet, S.S. 1479.

Sunshine.—Erection of Trade Workshop Block, Technical School. (Specified Bills of Quantities Available.)

Sunshine.—Electrical services, Technical School.

Sunshine.—Mechanical services, Technical School.

Tatura.—Erection of ten class-rooms, &c., S.S. 1441. (W.O., Shepparton.)

Tatura.—Electrical installation, S.S. 1441. (W.O., Bendigo and Shepparton; P.S., Tatura.)

Tatura.—Mechanical services, S.S. 1441. (W.O., Bendigo, Shepparton and Wangaratta.)

Wandiligong.—Renovations, S.S. 275 and Residence. (W.O., Benalla.)

Warrnambool.—Erection of two Male Wards and alterations to Artisans' Work Shop, Mental Hospital. (W.O. Geelong and Warrnambool.) (Bills of Quantities Available.)

Warrnambool.—Electrical installation, Mental Hospital. (W.O. Warrnambool.)

Warrnambool.—Mechanical services, Mental Hospital. (W.O. Warrnambool.)

Westgarth.—Renovations, Residence, S.S. 4177. (Amended Specification.)

Woorarra.—Renovations, &c., S.S. 3410. (W.O., Korumburra.)

Site Works.

Hawksburn.—Asphalt, concrete and drainage works, &c., S.S. 1467.

Tuesday, 11th February, 1969.

Building, Electrical and Mechanical Works.

Aberfeldie.—Modifications to heating system, S.S. 4220.

Beechworth.—Renovations, &c., Chief Warder's Quarters, Training Prison. (W.O., Wangaratta; P.S., Beechworth.)

Flemington.—Improved water supply, Girls' High School.

Coburg.—Erection of type "800 C" multi-purpose hall, Technical School.

Coburg.—Electrical services, Technical School.

Coburg.—Mechanical services, Technical School.

Coburg.—Erection of visiting block at Main Gate, Pentridge Prison.

Fitzroy.—Erection of new classroom block, S.S. 450.

Kyneton.—Mechanical services, High School. (W.O., Kyneton.)

Ringwood.—Erection of new science wing, High School.

Ringwood.—Mechanical services, High School.

Royal Park.—Erection of Reception and Classification Centre—Stage 2 (Baltara), "Turana". (Bills of Quantities Available.)

Royal Park.—Electrical services—Stage 2, Reception and Classification Centre, "Turana".

Royal Park.—Mechanical services—Stage 2, Reception and Classification Centre, "Turana".

Stradbroke West.—Provision of septic sewerage system, S.S. 2754. (W.O., Traralgon.)

Site Works.

Armadale.—Asphalt, concrete and drainage works, &c., S.S. 2634.

Carlton North.—Asphalt and drainage works, &c., S.S. 522.

Cranbourne.—Asphalt, concrete, drainage and gravel works, &c., S.S. 2068.

Longwood.—Concrete and drainage works, &c., S.S. 2707 and Residence. (W.O., Benalla and Shepparton.)

Maribyrnong.—Construction of retaining walls and earthworks, Workshop and Store, Lands and Survey Department.

Rushworth.—Construction of a hockey field and basketball court, &c., High School. (W.O., Shepparton.)

Tuesday, 18th February, 1969.

Building, Electrical and Mechanical Works.

Ballarat.—Erection of two brick veneer Proprietary Type Residences, Mental Hospital.

Mont Park.—Erection of two brick veneer Proprietary Type Residences, Larundel Psychiatric Hospital.

Preston.—Additional stores and workshops, Alcoholics Assessment Centre.

Sunbury.—Erection of two brick veneer Proprietary Type Residences, Mental Hospital.

Various.—Erection of three brick veneer Proprietary Type Residences, Mental Hospital, Kew and Travancore Developmental Centre, Flemington.

M. V. PORTER,
Minister of Public Works.

Public Works Department,
Melbourne, 3002, 20th January, 1969.

COUNCIL OF ADULT EDUCATION.

APPLICATIONS are invited for the position of Technician-Projectionist to the Council of Adult Education.

Duties.—To maintain and to be responsible for the repair and distribution of audio-visual aids, to keep the records relating thereto, to operate such equipment as required, to set out and prepare class-rooms and perform other duties associated with the Council's class and school activities. The position necessitates regular evening work at overtime rates during class term.

Qualifications.—To be experienced in the operation and maintenance of audio-visual aid equipment, at least to have successfully completed the R.M.I.T. 16-mm. Projectionists' Course or its equivalent, to be an experienced licensed driver of motor vehicles, to have a knowledge of the content and availability of suitable documentary film.

Conditions of Appointment.—If an officer of the Victorian Public Service or of the Teaching Service is appointed to the position, he will retain rights under the Superannuation Acts and the Public Service Act 1958, or the Teaching Service Act 1958, as provided in section 73 of the Education Act 1958. The successful applicant will otherwise be required to make suitable arrangements for superannuation by agreement with the Council.

Salary.—\$3,645–\$3,754 per annum.

Applications close with the Chairman, Council of Adult Education, 256 Flinders-street, Melbourne, on Wednesday, 29th January, 1969.

J. W. COPE, Secretary,
Council of Adult Education.

PUBLIC SERVICE NOTICES

No. 136.

Public Service Act 1958, Section 50.
REGULATIONS.—PART IV.—SALARIES AND INCREMENTS.

THE Public Service Board, in pursuance of the powers conferred by the *Public Service Act 1958*, hereby amends its Regulations as shown below:—

SIXTH SCHEDULE.
TEMPORARY EMPLOYEES.
Designations of Positions and Rates of Salaries.

Department and Designation of Position.	Yearly Rate of Salary.		Increments (Annual).
	Minimum.	Maximum.	
PREMIER'S DEPARTMENT.	\$	\$	
<i>Add—</i> Technical Officer, Office of the Public Service Board	3,934	4,684	//

// Increments in accordance with the scale of rates of salaries as set out for Professional Officer, Class "OP-13" in Part B of the Third Schedule

F. E. CAHILL, Chairman.
V. P. SCULLY, Secretary.

Office of the Public Service Board,
Melbourne, 20th December, 1968.

No. 137.

Public Service Act 1958, Section 50.
REGULATIONS.—PART IV.—SALARIES AND INCREMENTS.

THE Public Service Board, in pursuance of the powers conferred by the *Public Service Act 1958*, hereby amends its regulations as shown below:—

FIFTH SCHEDULE.
TEMPORARY EMPLOYEES.
DEPARTMENT OF HEALTH.
MENTAL HYGIENE.
Designations of Positions and rates of Salaries.

Designation of Position.	Yearly Rate of Salary. £	
	Minimum.	Maximum.
	\$	\$
<i>Delete the existing yearly rates of salary for the following position and substitute the rates shown hereunder in lieu thereof—</i> Labourer	2,040	2,298

£ Annual increments shall be in accordance with those prescribed by Sub-Regulations 97 (2) and 97 (3), provided that in the case of the position of Assistant (Male), Administrative, the annual increments shall be in accordance with those prescribed by Part A of the Third Schedule.

SIXTH SCHEDULE.
TEMPORARY EMPLOYEES.
Designations of Positions and Rates of Salaries.

Department and Designation of Position.	Yearly Rate of Salary.		Increments (Annual).
	Minimum.	Maximum.	
	\$	\$	
PREMIER'S DEPARTMENT.			
TOURIST DEVELOPMENT AUTHORITY†			
<i>Add—</i> General Assistant, Victorian Government Tourist Bureau	2,074	2,298	£
† See Regulation 158.			
<i>Delete the existing yearly rates of salary for the following positions and substitute the rates shown hereunder in lieu thereof—</i>			
GENERAL.			
Field Assistant (Survey), Grade II.	2,800	3,041	£
Field Assistant (Survey), Grade I.—			
Junior—			
Under 16 years of age	996	..
At 16 years of age	1,063	..
At 17 years of age	1,252	..
At 18 years of age	1,479	..
At 19 years of age	1,702	..
At 20 years of age	1,971	..
Adult	2,515	2,762	£
Labourer, Senior	2,154	2,401	£
Labourer	2,040	2,298	£
CHIEF SECRETARY'S DEPARTMENT.			
STATE LIBRARY, NATIONAL GALLERY, NATIONAL MUSEUM AND INSTITUTE OF APPLIED SCIENCE.			
General Assistant, Senior	2,154	2,401	£
General Assistant	2,040	2,298	£
LAW DEPARTMENT.			
General Assistant, Coroner's Court	2,040	2,298	£
STATE FORESTS DEPARTMENT.			
Propagator, Forest Plants	2,534	2,686	£
£ See Regulation 97 (2).			

This Regulation shall have effect as on and from the 22nd December, 1968.

F. E. CAHILL, Chairman.
V. P. SCULLY, Secretary.

Office of the Public Service Board,
Melbourne, 20th December, 1968.

No. 131.

Public Service Act 1958, Section 50.

REGULATIONS.—PART IV.—SALARIES AND INCREMENTS.

THE Public Service Board, in pursuance of the powers conferred by the *Public Service Act 1958*, hereby amends its Regulations as shown below :—

SECOND SCHEDULE.

TECHNICAL AND GENERAL DIVISION.

Grades and Salary Scales.

MALES.

The following Grade is added :—

Grade Number.	Yearly Rate of Salary.
	\$
65	6,840

SIXTH SCHEDULE.

TEMPORARY EMPLOYEES.

Designations of Positions and Rates of Salaries.

Department and Designation of Position.	Yearly Rate of Salary.		Increments (Annual).
	Minimum.	Maximum.	
	\$	\$	
TREASURY.			
GOVERNMENT PRINTING OFFICE			
<i>Delete—</i>			
Night Watchman	2,280	2,439	Σ
Plate Grainer	2,280	2,439	Σ
<i>Delete the existing yearly rates of salary for the following positions and substitute the rates shown hereunder in lieu thereof—</i>			
EDUCATION DEPARTMENT.			
Linotype Operator, Visual Education Centre	3,288	3,486	Σ
TREASURY.			
GOVERNMENT PRINTING OFFICE.			
Binder	3,164	3,324	Σ
Binding, Guillotine Operator	3,164	3,324	Σ
Binding, Paper Ruler	3,164	3,324	Σ
Compositor	3,164	3,324	Σ
Despatcher, Grade I.	2,477	2,648	Σ
Electrician	3,164	3,324	Σ
Engineer	3,164	3,324	Σ
Fork Lift Truck Operator	2,553	2,724	Σ
Machineman	3,164	3,324	Σ
Mechanic, Linotype	3,164	3,324	Σ
Operator, Linotype	3,468	3,594	Σ
Operator, Monotype	3,468	3,594	Σ
Photo Engraver	3,199	3,360	Σ
Photo Lithographer	3,199	3,360	Σ
Plumber, Mechanical	3,164	3,324	Σ
Equipment	3,164	3,324	Σ
Pressman	3,164	3,324	Σ
Printer, Lithographic	3,164	3,324	Σ
Printer, Lithographic, Assistant	2,401	2,572	Σ
Printer's Joiner	3,164	3,324	Σ
Reader	3,234	3,450	Σ
Stereotyper	3,164	3,324	Σ
Storeman	2,477	2,648	Σ
Σ See Regulation 97 (2).			

SEVENTH SCHEDULE.

TECHNICAL AND GENERAL DIVISION.

DEPARTMENT OF HEALTH.

MENTAL HYGIENE.

Grades and Salary Scales.

MALES.

The following Grades are added :—

Grade Number.	Yearly Rate of Salary.
	\$
49A	4,750
51A	5,000
52A	5,125
53A	5,250
54A	5,375
55A	5,500
56A	5,626
57A	5,756
58A	5,891
59A	6,031
60A	6,177
61A	6,323
62A	6,470
63A	6,618
65	6,840

This Regulation shall have effect as on and from the 15th December, 1968.

F. E. CAHILL, Chairman.
V. P. SCULLY, Secretary.

Office of the Public Service Board,
Melbourne, 16th December, 1968.

No. 132.

PUBLIC SERVICE ACT 1958.

THE Public Service Board, in pursuance of the powers conferred by the *Public Service Act 1958*, hereby amends the Public Service (Public Service Board) Regulations as shown below :—

PART IV.—SALARIES AND INCREMENTS.

DIVISION IV.—TECHNICAL AND GENERAL DIVISION.

Regulation 97 (2).

Under the heading "Males" the amount "\$6,839" is substituted for the amount "\$6,691".

This Regulation shall have effect as on and from the 15th December, 1968.

F. E. CAHILL, Chairman.
V. P. SCULLY, Secretary.

Office of the Public Service Board,
Melbourne, 16th December, 1968.

No. 134.

Public Service Act 1958, Section 50.

REGULATIONS.—PART IV.—SALARIES AND INCREMENTS.

THE Public Service Board, in pursuance of the powers conferred by the *Public Service Act 1958*, hereby amends its Regulations as shown below—

SECOND SCHEDULE.

TECHNICAL AND GENERAL DIVISION.

Grades and Salary Scales.

JUNIOR GRADES.

Females.

In Grade G the amount "\$1,169" is substituted for the amount "\$1,246".

This Regulation shall have effect as on and from the 15th December, 1968.

F. E. CAHILL, Chairman.
V. P. SCULLY, Secretary.

Office of the Public Service Board,
Melbourne, 16th December, 1968.

No. 125.

PUBLIC SERVICE ACT 1958.

THE Public Service Board, in pursuance of the powers conferred by the *Public Service Act 1958*, hereby amends the Public Service (Public Service Board) Regulations as shown below:—

PART V.—ALLOWANCES.

DIVISION I.—ALLOWANCES FOR QUALIFICATIONS OR EFFICIENCY.
TECHNICAL AND GENERAL DIVISION.

CHIEF SECRETARY'S DEPARTMENT—SOCIAL WELFARE BRANCH.
After Regulation 118 the following Regulation is inserted—
“118A. Any Nurse, Prisons Division, who holds a Midwifery Certificate shall be paid an allowance at the rate of \$104 a year.”

F. E. CAHILL, Chairman.
V. P. SCULLY, Secretary.

Office of the Public Service Board,
Melbourne, 20th December, 1968.

No. 126.

Public Service Act 1958, Section 50.

REGULATIONS.—PART IV.—SALARIES AND INCREMENTS.

THE Public Service Board, in pursuance of the powers conferred by the *Public Service Act 1958*, hereby amends its Regulations as shown below:—

SIXTH SCHEDULE.
TEMPORARY EMPLOYEES.

Designations of Positions and Rates of Salaries.

Department and Designation of Position.	Yearly Rate of Salary.		Increments (Annual).
	Minimum.	Maximum.	
TREASURY.	\$	\$	
HOUSING COMMISSION.			
Add— Assistant, Engineering Supervision	3,631	3,958	Σ
Σ See Regulation 97 (2).			

F. E. CAHILL, Chairman.
V. P. SCULLY, Secretary.

Office of the Public Service Board,
Melbourne, 20th December, 1968.

No. 127.

Public Service Act 1958, Section 50.

REGULATIONS.—PART IV.—SALARIES AND INCREMENTS.

THE Public Service Board, in pursuance of the powers conferred by the *Public Service Act 1958*, hereby amends its Regulations as shown below:—

SIXTH SCHEDULE.
TEMPORARY EMPLOYEES.

Designations of Positions and Rates of Salaries.

Department and Designation of Position.	Yearly Rate of Salary.		Increments (Annual).
	Minimum.	Maximum.	
MINES DEPARTMENT.	\$	\$	
EXPLOSIVES AND GAS EXAMINING.			
Add— Inspector of Explosives ..	2,986	3,306	Σ
Inspector of Gas Meters ..	2,496	2,648	Σ
Σ See Regulation 97 (2).			

F. E. CAHILL, Chairman.
V. P. SCULLY, Secretary.

Office of the Public Service Board,
Melbourne, 20th December, 1968.

No. 133.

Public Service Act 1958.

THE Public Service Board, in pursuance of the powers conferred by the *Public Service Act 1958*, hereby amends the Public Service (Public Service Board) Regulations as shown below—

PART III.—PROMOTIONS AND TRANSFERS.

DIVISION III.—SPECIAL REQUIREMENTS.

TECHNICAL AND GENERAL DIVISION.

Regulation 70 is revoked and the following Regulation is substituted therefor—

“General—Stenographers.”

70. (1) No officer shall be promoted or transferred to the office of Stenographer, Grade IV., unless she has satisfied the Board, by test, of her ability to write shorthand at the rate of 120 words a minute. Provided that any officer appointed as a Shorthand Writer and Typist (Female), Senior, prior to 13th October, 1963, shall be regarded as being so qualified.

(2) No officer shall be promoted or transferred to the office of Stenographer, Grade III., or Stenographer, Grade II., unless she has satisfied the Board, by test, of her ability to write shorthand at the rate of 100 words a minute.

(3) No officer shall be promoted or transferred to the office of Shorthand Writer (Female), Licensed, unless she is licensed under the provisions of the *Evidence Act 1958* as a shorthand writer.”

This Regulation shall have effect as on and from the 15th December, 1968.

F. E. CAHILL, Chairman.
V. P. SCULLY, Secretary.

Office of the Public Service Board,
Melbourne, 16th December, 1968

No. 130.

Public Service Act 1958, Section 50.

REGULATIONS.—PART IV.—SALARIES AND INCREMENTS.

THE Public Service Board, in pursuance of the powers conferred by the *Public Service Act 1958*, hereby amends its Regulations as shown below:—

FIFTH SCHEDULE.

TEMPORARY EMPLOYEES.

DEPARTMENT OF HEALTH.

MENTAL HYGIENE.

Designations of Positions and Rates of Salaries.

Designation of Position.	Yearly Rate of Salary.Σ	
	Minimum.	Maximum.
	\$	\$
Delete— Hairdresser (Male)	2,420	2,572
Add— Hairdresser (Male)	2,648	2,800

Σ Annual increments shall be in accordance with those prescribed by Sub-Regulations 97 (2) and 97 (3), provided that in the case of the position of Assistant (Male), Administrative, the annual increments shall be in accordance with those prescribed by Part A of the Third Schedule.

This Regulation shall have effect as on and from the 22nd December, 1968.

F. E. CAHILL, Chairman.
V. P. SCULLY, Secretary.

Office of the Public Service Board,
Melbourne, 16th December, 1968.

No. 135.

Public Service Act 1958, Section 50.

REGULATIONS—PART IV.—SALARIES AND INCREMENTS.

THE Public Service Board, in pursuance of the powers conferred by the Public Service Act 1958, hereby amends its Regulations as shown below :—

SIXTH SCHEDULE.

TEMPORARY EMPLOYEES.

Designations of Positions and Rates of Salaries.

Department and Designation of Position.	Yearly Rate of Salary.		Increments (Annual).
	Minimum.	Maximum.	
	\$	\$	
EDUCATION DEPARTMENT.			
TEACHERS' COLLEGES AND SCHOOLS.*			
<i>Delete the existing yearly rates of salary for the following position and substitute the rates shown hereunder in lieu thereof—</i>			
Typist (Female), Grade I. † Junior—			
Under 16 years of age	..	1,010	..
At 16 years of age	..	1,041	..
At 17 years of age	..	1,169	..
At 18 years of age	..	1,335	..
At 19 years of age	..	1,496	..
At 20 years of age	..	1,639	..
Adult	1,876	2,032	Σ
* Excluding Colleges and Schools approved by the Board			
† See Regulations 115 and 119.			
Σ See Regulation 97 (2)			

This Regulation shall have effect as on and from the 15th December, 1968.

F. E. CAHILL, Chairman.
V. P. SCULLY, Secretary.

Office of the Public Service Board,
Melbourne, 16th December, 1968.

No. 128.

Public Service Act 1958, Section 50.

REGULATIONS.—PART IV.—SALARIES AND INCREMENTS.

THE Public Service Board, in pursuance of the powers conferred by the Public Service Act 1958, hereby amends its Regulations as shown below :—

FIFTH SCHEDULE.

TEMPORARY EMPLOYEES.

DEPARTMENT OF HEALTH.

MENTAL HYGIENE.

Designations of Positions and Rates of Salaries.

Designation of Position.	Yearly Rate of Salary. Σ	
	Minimum.	Maximum.
	\$	\$
Add— Nurse, Principal (Female)	3,789	3,914

Σ Annual increments shall be in accordance with those prescribed by Sub-Regulations 97 (2) and 97 (3), provided that in the case of the position of Assistant (Male), Administrative, the annual increments shall be in accordance with those prescribed by Part A of the Third Schedule.

F. E. CAHILL, Chairman.
V. P. SCULLY, Secretary.

Office of the Public Service Board,
Melbourne, 16th December, 1968.

No. 129.

PUBLIC SERVICE ACT 1958.

THE Public Service Board, in pursuance of the powers conferred by the Public Service Act 1958, hereby amends the Public Service (Public Service Board) Regulations as shown below :—

PART V.—ALLOWANCES.

DIVISION IV.—OTHER ALLOWANCES.

DEPARTMENT OF HEALTH—MENTAL HYGIENE BRANCH.

After Regulation 148b the following Regulation is inserted—

“ 148c. Ward Assistants and Training Assistants whose ordinary hours of duty are worked in accordance with a roster of 8-hour shifts shall be paid an allowance of 70 cents for each period of rostered duty which finishes between 6 p.m. and 8 a.m. or commences between 6 p.m. and 6.30 a.m.

Provided that, if such officers are required to permanently work any such rostered shift which finishes on the day after it commences or which commences between midnight and 5 a.m., the allowance shall be increased to \$1. “ Permanently work ” shall mean work for any period in excess of four weeks.

Provided further that this Regulation shall not apply to rostered time of ordinary duty performed during weekends or on public holidays.”

F. E. CAHILL, Chairman.
V. P. SCULLY, Secretary.

Office of the Public Service Board,
Melbourne, 16th December, 1968.

PRIVATE ADVERTISEMENTS

NOTICE is hereby given that James Richardson Proprietary Limited, has applied for a lease pursuant to section 134 of the Land Act 1958, for a term of twenty years in respect of allotment 7A, section C, City of South Melbourne, containing 1 rood and 3 perches as a site for stores, garage and general engineering works and textile manufacturing and a warehouse for the storage of building materials and hardware products.

SACKVILLE, WILKS & CO., solicitors. 6042

SEWERAGE DISTRICTS ACT.

PROPOSED SEWERAGE AUTHORITY.

NOTICE is hereby given that the Council of the Shire of Bellarine has made application to the Honorable the Minister of Water Supply for the constitution of a Sewerage Authority and for the proclamation of a Sewerage District at Leopold and for the construction, maintenance and continuance of sewerage works within that District under the provisions of the Sewerage Districts Act.

A general plan and description of the proposed works have been submitted with the application and copies of same may be seen at the Shire Office, Drysdale.

Dated at Drysdale, the 24th day of December, 1968.

H. A. WILLIAMS, Shire Secretary.

The Act requires that this Notice be published weekly for three weeks in a newspaper circulating locally and the Government Gazette and provides that within one month of the third Notice in the Government Gazette any person having an interest therein, who is likely to be injuriously affected by the proposed sewerage works, may forward to the Minister of Water Supply, a petition seeking refusal or amendment to the application.

In this case the period for objections will expire on 24th of February, 1969. 6121

NOTICE is hereby given that Charlesworth Rubber Proprietary Limited has applied for a lease pursuant to Section 134 of the Land Act 1958, for a term of 40 years in respect of Allotment 13, Section 59, City of Port Melbourne, containing 1 acre 0 roods 17 perches as a site for manufacturing and warehousing. 6368

NOTICE OF INTENTION TO APPLY FOR A LICENCE TO DIVERT WATER AND CUT RACE FROM THE GOULBURN RIVER AT TRAWOOL.

I HEREBY give notice that I intend to apply for a licence empowering me to divert water for a term of four years to the extent of twenty acre-feet per annum at a maximum rate of 3 acre-feet per day of 24 hours for the irrigation of pastures—30 acres lucerne and permanent pasture, being part of allotments 8 and 9, Parish of Trawool, and to occupy certain Crown lands for works of diversion, and to cut a race thereon.

Any objection to such application must be forwarded in writing, to reach the State Rivers and Water Supply Commission, Melbourne, before 16th February, 1969, being thirty days from the first publication of this notice.

MESCAM PTY. LTD.

Care of Anderson Hodgson & Co., 360 Collins-street, Melbourne, 3000. 6295

Victoria.

ACT No. 391.—FIRST SCHEDULE.

I, THE RIGHT REVEREND WILLIAM AUCHTERLONIE HARDIE, of Cathedral Buildings, Ballarat, Bishop of Ballarat, head or authorized representative of the denomination known as the Church of England in the Diocese of Ballarat in Victoria, with the consent of the Corporation styled The Ballarat Diocesan Trustees, of Cathedral Buildings, Dana-street, Ballarat, the trustee of the land described in the subjoined statement of trusts and of the Reverend Walter Charles Duffy being the person entitled to minister in or occupy a building or buildings upon the said land hereby apply to the Governor of the State of Victoria for leave to dispose of the land by the means and for the purposes mentioned in the said statement of trusts and I hereby certify that the said land hereinafter mentioned was temporarily reserved from sale by the Governor in Council as a site for Episcopalian Church and School Purposes by Order in Council dated the 8th day of March, 1853. That the only trustee of the said land is the said corporation styled The Ballarat Diocesan Trustees. That there are no buildings upon the said land and that the only person entitled to minister in or occupy the same (if any) is the above-named Walter Charles Duffy.

Dated the 8th day of November, 1968.

Signature of head or authorized representative.—
WILLIAM BALLARAT.

The Corporation styled The Ballarat Diocesan Trustees hereby consents to this application.

The common seal of The Corporation styled The Ballarat Diocesan Trustees was affixed hereto in the presence of us being three of the trustees authorized to attest the affixing of such seal.

(SEAL) R. ACHESON MUST, Trustee.
ROBERT G. PORTER, Trustee.
P. ROWLANDS, Trustee.

Signature of person entitled to minister in or occupy building or buildings.—WALTER C. DUFFY.

STATEMENT OF TRUSTS.

Description of Land.—Site for Episcopalian Church and School purposes set apart on the 8th March, 1853. Two acres, Township of Lexton, Parish of Lexton, County of Talbot, being allotment 1, section 49. Commencing at the intersection of the south-eastern alignment of Williamson-street and the south-western alignment of Donalds-street, bounded thence by Donalds-street bearing 145 deg. 30 min. 400 links, by allotment 2 bearing 235 deg. 30 min. 500 links, by Hamilton-street bearing 325 deg. 30 min. 400 links; and thence by Williamson-street bearing 55 deg. 30 min. 500 links to the point of commencement.

Name of Trustees.—The Ballarat Diocesan Trustees of Cathedral Buildings, Dana-street, Ballarat.

Powers of Disposition.—To permit and suffer so much of the land as shall not be disposed of under the powers hereinafter specified to be used for the purposes for which it was promised or permanently reserved from sale by the Crown. To let lease sell mortgage or exchange if concurred in by the said head or authorized representative for the time being, the said land or any portion thereof or any building thereon on such terms and conditions as shall be specified by such head or representative.

Purposes to which Proceeds of Disposition are to be Applied.—Moneys obtained from sale leases mortgages or exchanges to be paid to the Bishop to be dealt with for Church of England purposes as shall be directed by the said trustee but to be subject nevertheless to the payment or deduction therefrom of all costs charges and expenses incurred by the trustee or for which it shall be liable in respect of the trust estate.

CUTHBERT MORROW MUST & SHAW, Lydiard-street, Ballarat, solicitors for the applicant. 6322

STAWELL SEWERAGE AUTHORITY.

GENERAL NOTICE.

Sewerage Area No. 33.

THE above-mentioned Sewerage Authority having made provision for carrying off the sewage from each and every property which or any part of which is within the sewerage area hereinafter described, doth hereby declare that on and after the 1st day of February, 1969, each and every property which or any part of which is within the said sewerage area shall be deemed to be a seweraged property within the meaning of the *Sewerage District Act 1958*.

The boundaries of the sewerage area referred to are:—

Commencing at a point being the north easterly corner of Declared Sewerage Area No. 17; thence easterly along the southerly boundary of D'Arcy-street, bearing 116 deg. 23 min. for a distance of 400 links, thence on a line bearing 26 deg. 23 min. for a distance of 493.2 links to a point on the northerly boundary of Cooper-street; thence westerly along the northerly boundary of Cooper-street for a distance of 400 links to the south-easterly corner of Declared Sewerage Area No. 17; thence northerly along the easterly boundary of Declared Sewerage Area No. 17 to the point of commencement.

By order of the said Sewerage Authority.

6296

F. K. LAWSON, Chairman.
D. H. HUTTON, Secretary.

THE BALLARAT SEWERAGE AUTHORITY.

RATING BY-LAW.

NOTICE is hereby given that By-law Number Forty-eight was made by The Ballarat Sewerage Authority on the 12th day of December, 1968, and approved by the Governor in Council on the 14th day of January, 1969.

The By-law provides:

1. Sewerage Rate for the year commencing on the 1st day of January, 1969, 4.3 cents in the dollar on the net annual valuation.
2. Minimum Rate of Twelve dollars per annum in respect of any land on which there is a building and Ten dollars per annum in respect of land on which there is no building.

The By-law is open for inspection, free of charge, during office hours at the offices of the Authority, Grenville-street, Ballarat.

6360

CHAS. H. CLAMP, Secretary.

THE BALLARAT WATER COMMISSIONERS.

NOTICE is hereby given to owners of tenements in the streets set out in the Schedule hereto and the private streets lanes courts and alleys opening thereto that the main pipes in the said streets being laid down the owners of all tenements situated as above are required to cause proper pipes and stopcocks to be laid so as to supply water within such tenements from the main pipe and the laying of all such pipes and stopcocks shall be completed in accordance with By-Law Number 17 of The Ballarat Water Commissioners on or before the First day of March 1969.

SCHEDULE.

- Arthur-street, from Vale-street easterly 1½ chains.
Bala-street (Sebastopol), from 2½ chains east of Yarrowee-street easterly 2 chains.
Bruce-drive (Sebastopol) throughout.
Chisholm-street, from 4 chains east of Sims-street easterly 6 chains.
Gear-avenue, from 18½ chains east of Midland Highway easterly 3½ chains.
Grandview-grove, from Grevillea-road northerly 4 chains.
Grevillea-road, from Walton-street to Grandview-grove.
Government-road, from Daylesford-road (at junction with Springs-road) northerly 10½ chains.
Harvard-street, from 3½ chains north of Cambridge-street northerly 2 chains.
Harrow-street, from 1½ chains east of Forest-street to Webbcona-parade.
Indi-street, from Towong-street westerly 8½ chains.
Marina-drive, from Landale-avenue southerly 4½ chains.
Mawarra-drive, from Whitelaw-avenue, southerly 6 chains.
Philip-avenue, from Walker-street northerly 6½ chains.
Queen-street throughout.
Queen Victoria-street, from Malakoff-street westerly 3 chains.

Rokewood-road, from 11½ chains south of Docwra-street southerly 4 chains.

Russell-street, from Jessie-street north-westerly 3¼ chains.
Spencer-street (Sebastopol), from 9 chains south of Victoria-street southerly 1 chain.

Trethowan-street throughout.

Vale-street (Sebastopol), from Edwards-street easterly 6 chains.

Walton-street, from 5½ chains north-west of Cambridge-street to Grevillea-road.

Warrina-drive, from Whitelaw-avenue southerly 6 chains.

Webbcona-parade, from Harrow-street southerly ½ chain.

Weemala-avenue, from Warrina-drive easterly 4 chains.

Whitelaw-avenue, from Mawarra-drive westerly to Warrina-drive.

Waller-avenue throughout.

Dated the 10th January, 1969.

CHAS. H. CLAMP, Secretary of The Ballarat Water Commissioners. 6302

CITY OF BENDIGO.

NOTICE OF COMPULSORY ACQUISITION OF LAND.

THE Council of the City of Bendigo proposes to compulsorily acquire the following allotments of land for municipal purposes:—

- (a) Allotment 8, section 5, Parish of Sandhurst, in Raglan-street, adjoining the Baptist Church.
- (b) Allotment 307, section 0, Parish of Sandhurst, at corner of Lloyd and Fox streets.
- (c) Allotments 1 and 2, Section K, Parish of Sandhurst, on northern side of Holdsworth-road and east of Prouses-road.
- (d) Allotment 25, section 57B, Parish of Sandhurst, 1½ acres in Druid-street between McKenzie-street West and Aspinall-street.
- (e) Allotment 395, section K, Parish of Sandhurst, corner Bannister and Nolan streets.

Maps and documents describing these allotments are deposited at the City Hall, Bendigo, and may be inspected during normal office hours.

Any person affected by the proposed compulsory acquisition of land may within 40 clear days lodge an objection in writing addressed to the Town Clerk, City Hall, Bendigo, 3550.

6287

A. J. WATTS, Town Clerk.

CITY OF CAMBERWELL.

BY-LAW NO. 184.

METROPOLITAN HAWKERS BY-LAW.

A By-Law of the City of Camberwell made under the provisions of Section 36 of the *Hawkers and Pedlers Act 1958* and numbered 184 for prescribing the limits whether as to time or place within which a person holding a Metropolitan Hawkers Licence may sell or offer or expose for sale any articles specified in his licence in any street, road or public place.

PURSUANT to the powers conferred by the *Hawkers and Pedlers Act 1958* and of any and every other power it thereunto enabling the Mayor, Councillors and Citizens of the City of Camberwell orders as follows:—

1. This By-Law may be known as the Metropolitan Hawkers By-Law.

2. In this By-Law the words "Metropolitan Hawker" means the holder of a Metropolitan Hawkers Licence under the *Hawkers and Pedlers Act 1958*.

3. The limits as to time within which the selling or offering or exposing for sale by a Metropolitan Hawker of any article specified in his licence issued under the *Hawkers and Pedlers Act 1958* is permitted within any street, road or public place within the Municipal District of the City of Camberwell are hereby prescribed as between the hours of 9 o'clock to 11 o'clock in the forenoon and 1.30 o'clock to 3.30 o'clock in the afternoon on Monday, Tuesday, Wednesday, Thursday and Friday in any week save and except any such day which is a holiday within the Public Services Act, and shall not sell or offer or expose for sale, any article specified in his licence in any street, road or public place within the said Municipal District at any other time.

4. No Metropolitan Hawker shall so sell or offer or expose for sale any articles specified in his licence issued under the *Hawkers and Pedlers Act 1958* at any time other than a time permitted by the last preceding clause.

5. Any person guilty of any wilful act or default contrary to this By-Law shall be liable to a penalty of not more than forty dollars.

Resolution for passing this By-law agreed to by the Council of the City of Camberwell on the 28th day of October, 1968, and confirmed the 2nd day of December, 1968.

The Common Seal of the Mayor, Councillors and Citizens of the City of Camberwell was hereunto affixed the 2nd day of December, 1968, in the presence of:—

(SEAL) W. A. FORDHAM, Mayor.
AUBREY P. McLAREN, Councillor.
L. F. CHEFFERS, Town Clerk.

Approved by the Governor in Council the 24th December, 1968. 6314

CITY OF FOOTSCRAY.

BY-LAW NO. 287.

A By-Law of the City of Footscray made under Sections 197 and 198 of the *Local Government Act 1958*, and Section 93 of the *Health Act* and numbered 287 for Regulating the keeping of animals.

IN pursuance of the powers conferred by the *Local Government Act 1958* the *Health Act 1958*, and any and every other power it thereunto enabling the Mayor Councillors and Citizens of the City of Footscray orders as follows:—

In this By-Law unless inconsistent with the context or subject matter; "Animal" means cow, heifer, bull, bullock, horse, ferret, goat, swine, pig and sheep and includes the young thereof.

"Approved Materials" means materials approved by the Building Surveyor or Health Inspector of the Municipality.

"Dwelling" includes a living room, sleepout or tent and all rooms for sleeping, living and cooking.

"Horse" means any stallion, mare, gelding, pony, colt or foal, ass or mule and includes any animal used for burden or draught or for carrying persons.

"Stable" includes any building, erection or cage intended to be used for the purpose of confining, protecting or sheltering any horse.

(1) No person shall without a written licence from the Council permitting him so to do keep on any premises more than two horses or other animals. Such licence shall be effective to the end of the year in which it is issued and may thereafter on application, at the discretion of the Council, be renewed annually.

(2) No person shall on any land keep any horse within a distance of:

- (a) 50 feet from any street or road to which such land has a frontage.
- (b) 10 feet from any other street or road.
- (c) 5 feet from the boundary or any adjoining allotment of land.
- (d) 30 feet from any dwelling whether on the same or any adjoining land.

(3) The occupier of any land on which any animal is kept shall:

(a) Cause all manure refuse and rubbish produced or accumulated on such land to be forthwith placed in a properly constructed fly and vermin proofed receptacle with impervious walls and impervious floor and shall:

(i) at all times maintain such receptacle in a good state of repair so as to prevent the escape or leakage of the contents.

(ii) keep such receptacle at all times covered with a fly and vermin proofed lid and from time to time as may be required by the Health Inspector of the Municipality effectively deodorize the same.

(iii) cause the contents of such receptacle to be removed and disposed of to the satisfaction of the Health Inspector at least once in every week.

(b) Cause the floor of such receptacle to be paved with concrete or other approved impervious material and properly graded and drained to an approved silt trap and outlet.

- (c) Maintain such receptacle at all times in a clean and sanitary condition.
- (4) The ground surrounding any stable receptacle for manure shall be well drained.
- (5) The occupier of any land on which any stable is erected shall keep the area of land within five feet of such stable free from all dry grass weeds refuse rubbish or other materials capable of harbouring rats or vermin.
- (6) The occupier of any land shall cause any stable thereon to be thoroughly cleansed as often as may be necessary to keep it in a clean and sanitary condition and in any case not less frequently than once a day.

Resolution for passing this By-law agreed to by the Council of the City of Footscray on the 30th September, 1968 and confirmed on the 28th October, 1968.

The common seal of the Mayor, Councillors and Citizens of the City of Footscray was hereto affixed, in the presence of—

(SEAL) R. BASSETT, Mayor.
K. C. ANDERSON, Councillor.
W. H. SWABY, Town Clerk.

Submitted to the Commission of Public Health on the 3rd December, 1968.—A. T. GARDNER, Secretary, Commission of Public Health.

Approved by the Governor in Council, 17th December, 1968.—J. ROSSITER, Clerk of the Executive Council. 6356

CITY OF MARYBOROUGH.

LOAN No. 28.

Notice of Intention to Borrow the Sum of \$32,000 for Permanent Works and Undertakings.

NOTICE is hereby given that the Council of the City of Maryborough proposes to borrow the sum of \$32,000 secured by a charge over the general rates of the municipality, such sum to be raised by the grant of a mortgage in accordance with the provisions of the *Local Government Act 1958*.

1. The maximum rate of interest that may be paid is 5.875 per centum per annum.
2. The purpose for which the loan is to be applied is:—
Erection of building on land vested in the Council pursuant to Part XLA of the *Local Government Act* \$32,000
3. The period of the loan shall be twenty years.
4. The moneys borrowed shall be repayable by providing out of the municipal fund half-yearly instalments of \$1,370.45 each including principal and interest on the 1st day of October and the 1st day of April during the currency of the loan. The first instalment shall be payable on the 1st October, 1969.
5. Such moneys shall be repayable at the Commonwealth Savings Bank, Melbourne.

The plans and specifications and the estimate of cost of the proposed works and a statement showing the proposed expenditure of the moneys to be borrowed are open for inspection at the office of the Council, Town Hall, Maryborough.

Dated 22nd January, 1969.
6316 E. S. MOORE, Town Clerk.

CITY OF SANDRINGHAM.

LOAN No. 98.

Notice of Intention to Borrow the Sum of \$61,000 for Permanent Works and Undertakings.

NOTICE is hereby given that the Council of the City of Sandringham proposes to borrow the principal sum of Sixty-one thousand dollars (\$61,000) secured by a charge over the general rates of the municipality, such sum to be raised by the grant of a mortgage in accordance with the provisions of the *Local Government Act 1958*.

1. The maximum rate of interest that may be paid is 5.875 per centum per annum.
2. The purpose for which the loan is to be applied is:—
(i) Road reconstruction \$41,000
(ii) Improvements at Places of Public Resort and Recreation 20,000
\$61,000
3. The period of the loan shall be fifteen years.
4. The moneys borrowed shall be repayable by providing out of the municipal fund 30 half-yearly instalments of \$3,087.09 each including principal and interest on the

5th day of March and 5th day of September, during the currency of the loan. The first instalment shall be payable on the 5th day of September, 1969.

5. Such moneys shall be repayable at the C.B.C. Savings Bank Limited, Melbourne.

The plans and specifications and the estimate of the cost of the proposed works, and a statement showing the proposed expenditure of the moneys to be borrowed, are open for inspection at the offices of the Council, Royal-avenue, Sandringham, during office hours.

Dated this 15th day of January, 1969.
6285 J. L. ANDERSON, Town Clerk.

CITY OF WAVERLEY.

NOTICE is hereby given that the Council of the City of Waverley has, pursuant to Section 621 of the *Local Government Act 1958*, fixed a new alignment on the south side of Waverley-road, Glen Waverley, between points 140 feet and 567 feet east of Springvale-road, which varies between 16 feet and 0 feet south of the old alignment.

A plan showing the new alignment is open for inspection at the municipal offices, Springvale-road, Glen Waverley, by any person without fee at any time which such offices are open for business.

Dated the 22nd day of January, 1969.
By Order of the Council,
6349 F. S. BALES, Town Clerk.

CITY OF WAVERLEY.

LOAN No. 84.

Notice of Intention to Borrow the Sum of \$200,000 for Permanent Works and Undertakings.

NOTICE is hereby given that the Council of the City of Waverley proposes to borrow the sum of Two hundred thousand dollars (\$200,000), secured by a charge over the general rates of the municipality, by the grant of a mortgage in accordance with the provisions of the *Local Government Act*.

In connexion therewith the following information is stated:—

- (a) The amount of the principal moneys which it is proposed to borrow is \$200,000.
- (b) The maximum rate of interest that may be paid is 5.875 per centum per annum.
- (c) The times which the moneys borrowed are to be repayable are the 1st day of September, 1969, and the 1st days of March and September, during the years 1970-1983 inclusive, with a final payment on the 1st day of March, 1984.
- (d) The purpose for which the loan is to be applied is:—

1. The erection of a pavilion on the Waverley Central Reserve \$150,000
2. The construction of the following drainage works:—
(i) Jells-road outfall drain .. \$9,000
(ii) Watsons-road drain (Part) 7,500
(iii) Mulgrave Reserve outfall drain 3,500
(iv) Carrol-grove outfall drain .. 2,000
(v) Glen Waverley drain—Mount view branch 5,000
27,000
3. The construction of O'Sullivan-road from Kingsway westerly 23,000
\$200,000

(e) The manner in which the loan is to be liquidated is by the provision, out of the municipal fund in each half year during the currency of the loan, of the sum of \$10,121.59, which includes principal and interest.

(f) Such moneys shall be repayable at the E.S. & A. Savings Bank Limited, Springvale-road, Glen Waverley.

The plans and specifications and estimate of the cost of the works and a statement showing the proposed expenditure of moneys to be borrowed are open for inspection at the municipal offices, Springvale-road, Glen Waverley.

Dated this 22nd day of January, 1969.
6350 F. S. BALES, Town Clerk.

CITY OF WAVERLEY.

LOAN No. 86.

NOTICE OF INTENTION TO BORROW.

NOTICE is hereby given that the Council of the City of Waverley intends to borrow One hundred thousand dollars (\$100,000) secured by a charge over the general rates of the municipality, by the grant of a mortgage in accordance with the provisions of the Local Government Acts.

In connexion therewith, the following information is stated:—

(a) The amount of the principal moneys which it is proposed to borrow is One hundred thousand dollars.

(b) The maximum rate of interest that may be paid is 5.75 per centum per annum.

(c) The times which the moneys borrowed are to be repayable are the 1st day of September, 1969, and the 1st days of March and September during the years 1969-1973 inclusive, and that the place such moneys shall be repayable is at the Bank of New South Wales.

(d) The purpose for which the loan is to be applied is:—

- | | |
|--|------------------|
| (1) The construction of Surrey-road, Mt. Waverley, from High Street-road to Essex-road | 50,000 |
| (2) The construction of Essex-road from Surrey-road to Huntingdale-road | 50,000 |
| | <u>\$100,000</u> |

(e) The manner in which the loan is to be liquidated is by provision out of the municipal fund, in each half-year during the currency of the loan, of the sum of \$6,644.13 which includes principal and interest.

The plans and specifications and estimate of the cost of the works and a statement showing the proposed expenditure of the moneys to be borrowed are open for inspection at the municipal offices, Springvale-road, Glen Waverley.

Dated this 22nd day of January, 1969.

6352 F. S. BALES, Town Clerk.

CITY OF WAVERLEY.

LOAN No. 85.

Notice of Intention to Borrow the Sum of \$100,000 for Permanent Works and Undertakings.

NOTICE is hereby given that the Council of the City of Waverley proposes to borrow the principal sum of \$100,000 secured by a charge over the general rates of the municipality, such sum to be raised by the grant of a mortgage in accordance with the provisions of the Local Government Act 1958.

1. The maximum rate of interest that may be paid is 5.75 per centum per annum.

2. The purpose for which the loan is to be applied is:—

- | | |
|--|------------------|
| (a) Construction of Gallaghers-road, Glen Waverley, from Waverley-road to Shepherds-lane | \$67,000 |
| (b) Construction of the following drainage works— | |
| (i) Watsons-road drain (Part) | \$8,500 |
| (ii) Jacksons-road drain | 4,500 |
| (iii) Garramar-street outfall drain | 2,000 |
| (iv) Waverley-road drain, Lum-road to Jells-road | 2,000 |
| (v) Winbirra-parade outfall drain | 4,000 |
| (vi) Miller-crescent outfall drain (Part) | 2,000 |
| | <u>\$23,000</u> |
| (c) Construction of concrete footpaths, kerbs and channels— | |
| (i) Waverley-road, Bales-street to Mayfield-drive | \$5,000 |
| (ii) Police-road, Wanda-street to Wilina-street | 2,500 |
| (iii) High Street-road — Rose-avenue to Edith-street | 2,500 |
| | <u>\$10,000</u> |
| | <u>\$100,000</u> |

3. The period of the loan shall be ten years.

4. The moneys borrowed shall be repayable by providing out of the municipal fund half-yearly instalments of approximately \$6,644.14 each, including principal and interest, on the 1st day of March and the 1st day of September during the currency of the loan. The first instalment shall be payable on the 1st day of September, 1969.

5. Such moneys shall be repayable to The Commissioners of The State Savings Bank of Victoria, at the office of the said Commissioners, corner Elizabeth and Bourke streets, Melbourne.

The plans and specifications and the estimate of the cost of the proposed works and a statement showing the proposed expenditure of the moneys to be borrowed are open for inspection at the office of the Council of the City of Waverley, at Springvale-road, Glen Waverley.

Dated this 22nd day of January, 1969.

6351 F. S. BALES, Town Clerk.

BOROUGH OF KYABRAM.

BY-LAW No. 22.

A By-Law of the Council of the Borough of Kyabram, made pursuant to the provisions of the Dog Act 1958, and numbered 22, for fixing registration fees and other fees thereunder.

IN pursuance of the powers conferred by the Dog Act and of any and every other power it thereunto enabling, the Council of the Borough of Kyabram order as follows:—

1. By-Law No. 17 of the Borough of Kyabram is hereby repealed.

2. The following fees and sums are fixed pursuant to the Dog Act 1958, as amended.

- (a) For registration pursuant to Section 6 of the Dog Act 1958, as amended by any Act—\$1.00.
- (b) For particulars of any dog or for the name of the registered owner thereof, or for a certified copy of the receipt mentioned in Section 12 of the Dog Act 1958, as amended by any Act—\$0.25.
- (c) Sum payable to the Registration Officer pursuant to Section 15 of the Dog Act 1958, as amended by any Act—\$6.00.
- (d) Sum payable to the Registration Officer pursuant to Section 16 of the Dog Act 1958, as amended by any Act—\$6.00.

3. This By-Law shall apply to and have operation throughout the whole of the Municipal District of the Borough of Kyabram.

A Resolution for passing this By-Law was agreed to by the Council of the Borough of Kyabram on the 11th day of December, 1968, and confirmed on the 14th day of January, 1969.

The common seal of the Mayor, Councillors and Burgesses of the Borough of Kyabram was hereunto affixed this 14th day of January, 1969, in the presence of:—

(SEAL) W. A. ROBINSON, Mayor.
L. J. STOCK, Councillor.
6355 E. T. CORNISH, Town Clerk.

SHIRE OF BERWICK.

NOTICE is hereby given that pursuant to the provisions of the Local Government Act 1958, the Council of the Shire of Berwick doth order that the name of the following road within the municipality be Gazetted as:

Old Name.—Un-named.

New Name.—Norbury-road.

Location.—A one chain Government road on the southern boundary of the Parish of Gembrook, County of Mornington, commencing at the westernmost corner of Crown allotment 14, section C, and continuing generally south-easterly along the south-western boundaries of Crown allotment's 14, 1, 2, 3, 4, 5, 6 and 7, and thence northerly along the eastern boundary of Crown allotment 7, section C, for a distance of 461 links.

6297 B. J. WALLIS, Shire Secretary.

SHIRE OF BUNGAREE.

By-Law No. 29.

A By-Law of the Shire of Bungaree made under Section 93 of the *Health Act 1958*, and numbered 29, for fixing the limits within which it shall be unlawful to keep pigs or pig-sties.

IN pursuance of the powers conferred by the *Health Act 1958* and all other powers it thereunto enabling, the President, Councillors, and Ratepayers of the Shire of Bungaree order as follows:—

1. No person shall keep or permit or suffer to be kept any swine or any pig-sty within the limits of the area prescribed by this By-Law.

2. This By-Law shall apply and have operation within the whole of that part of the Water District of the Bungaree and Wallace Waterworks Trust which exists within the Shire and north of the existing Western Highway.

Resolution for passing this By-Law was agreed to by the Council of the Shire of Bungaree on the seventh day of October, 1968.

Confirmed this fourth day of November, 1968.

In Witness whereof the Common Seal of the President, Councillors and Ratepayers of the Shire of Bungaree was hereunto affixed this fourth day of November, 1968, in the presence of:—

(SEAL) J. P. DUGGAN, President.
F. M. CULLINAN, Councillor.
G. LITTLE, Shire Secretary.

Approved by the Governor in Council, 17th December, 1968.—J. ROSSITER, Clerk of the Executive Council. 6288

Town and Country Planning Act 1961 (Twelfth Schedule).

SHIRE OF CRANBOURNE.

CRANBOURNE PLANNING SCHEME 1960.

Amendment No. 1.

NOTICE is hereby given that the Council of the Shire of Cranbourne in pursuance of its powers under the *Town and Country Planning Act 1961*, has prepared a Planning Scheme for—

Land abutting the south side of Cranbourne-drive between High-street and Scott-street, being part of Lot 24 on L/P No. 50912 in the Township of Cranbourne for the purpose of amending the zoning from Commercial "B" zone to Residential Zone.

A copy of the scheme has been deposited at the Shire Offices at Cranbourne and at the Offices of the Town and Country Planning Board, 179 Queen-street, Melbourne, and will be open for inspection during office hours by any person, free of charge.

Any persons affected by the planning scheme are required to set forth, in writing, all objections they may have, addressed to the Shire Secretary, Shire of Cranbourne, Shire Office, Cranbourne, on or before the 22nd February, 1969, and to state whether they wish to be heard in respect of their objections.

22nd January, 1969.

6294

T. W. GRANT, Shire Secretary.

SHIRE OF CROYDON.

By-Law No. 28.

A BY-LAW of the Shire of Croydon made under the provisions of the *Local Government Act 1958* and numbered 28 for the purpose of amending By-Law No. 19 which *inter alia* declared streets and roads or part thereof within the Municipal District to be roads of limited access, by adding to the Schedule the following words:—

"Lincoln Road."

Resolution for passing this By-Law agreed to by the Council on the 16th September, 1968, and confirmed on the 21st October, 1968.

The common seal of the President, Councillors and Ratepayers of the Shire of Croydon was hereto affixed in the presence of:—

(SEAL) KENNETH BULL, Councillor.
R. T. DICKSON, Councillor.
K. A. MCKAY, Shire Secretary.

Approved by the Governor in Council on the 24th December, 1968.—J. ROSSITER, Clerk of the Executive Council. 6299

SHIRE OF GLENELG.

LOAN No. 37.

Notice of Intention to Borrow the sum of \$17,850 for Permanent Works and Undertakings.

NOTICE is hereby given that the Council of the Shire of Glenelg intends to borrow the sum of Seventeen thousand eight hundred and fifty dollars (\$17,850) on the credit of the Municipal revenues of the President, Councillors and Ratepayers of the Shire of Glenelg, such sum to be raised by the grant of a mortgage, in accordance with the provisions of the *Local Government Act 1958*.

The maximum amount of interest that may be paid is 5.75 per centum per annum.

The purposes for which the loan is to be applied are:—

Fencing Airfield Site	\$2,000
Drainage Works, Casterton	2,000
Purchase of Low Loader	5,000
Construction of Mitchell-street, Casterton ..	4,500
Construction Recreation Reserve Road, Sandford	3,500
Youth Centre Improvements	850
	<hr/>
	\$17,850

The period of the loan shall be ten years.

The money borrowed shall be repayable by providing out of the municipal fund twenty half-yearly instalments of approximately \$1,185.98 each, including principal and interest, on the 1st day of March and the 1st day of September during the currency of the loan. The first instalment shall be payable on the 1st day of September, 1969.

Such moneys shall be repayable at the National Bank Savings Bank Melbourne.

The plans, specifications and estimate of cost of the proposed works, and a statement showing the proposed expenditure of the money to be borrowed, are open for inspection at the Shire Office, Casterton.

6311 J. B. HANSEN, Shire Secretary.

SHIRE OF KILMORE.

LOAN No. 33.

Notice of Intention to Borrow the Sum of \$7,000 for Permanent Works and Undertakings.

NOTICE is hereby given that the Council of the Shire of Kilmore proposes to borrow the principal sum of \$7,000 secured by a charge over the general rates of the municipality, such sum to be raised by the grant of a mortgage in accordance with the provisions of the *Local Government Act 1958*.

1. The maximum rate of interest that may be paid is 5.75 per cent. per annum.

2. The purpose for which the loan is to be applied is—
The preparation of Town Planning and Drainage Schemes.

3. The period of the loan shall be ten years.

4. The moneys borrowed shall be repayable by providing out of the municipal fund half-yearly instalments of approximately \$465 each including principal and interest on the 1st day of April and the 1st day of October during the currency of the loan. The first instalment shall be payable on the 1st day of October, 1969.

5. Such moneys shall be repayable to The Commissioners of The State Savings Bank of Victoria at the office of the said Commissioners, corner Elizabeth and Bourke streets, Melbourne.

The plans and specifications and the estimate of the cost of the proposed works and a statement showing the proposed expenditure of the moneys to be borrowed are open for inspection at the office of the Council of the Shire of Kilmore at Sydney-street, Kilmore, Victoria.

6306

B. J. HOBAN, Shire Secretary.

SHIRE OF KILMORE.

LOAN No. 34.

Notice of Intention to Borrow the Sum of \$15,000 for Permanent Works and Undertakings.

NOTICE is hereby given that the Council of the Shire of Kilmore proposes to borrow the principal sum of \$15,000 secured by a charge over the general rates of the municipality, such sum to be raised by the grant of a mortgage in accordance with the provisions of the *Local Government Act 1958*.

1. The maximum rate of interest that may be paid is 5.875 per cent. per annum.

2. The purpose for which the loan is to be applied is—
Carrying out kerb and channel works in Kilmore.
3. The period of the loan shall be fifteen years.
4. The moneys borrowed shall be repayable by providing out of the municipal fund half-yearly instalments of approximately \$759 each including principal and interest on the 1st day of April and the 1st day of October during the currency of the loan. The first instalment shall be payable on the 1st day of October, 1969.
5. Such moneys shall be repayable at the office of the C.B.C. Savings Bank Ltd., Melbourne.

The plans and specifications and the estimate of the cost of the proposed works and a statement showing the proposed expenditure of the moneys to be borrowed are open for inspection at the office of the Council of the Shire of Kilmore at Sydney-street, Kilmore.

6th January, 1969.

6307

BRIAN J. HOBAN, Shire Secretary.

SHIRE OF KORUMBURRA.

Deviation Order.

ANDERSON'S INLET ROAD.

PURSUANT to the provisions of Section 522 of the Local Government Act 1958, the Council of the Shire of Korumburra hereby directs that the land in the Parish of Jumbunna East indicated by hatching on the diagram attached hereto which has been purchased, taken or acquired by it shall be a public highway on and from the date of publication of this Order in the Government Gazette.

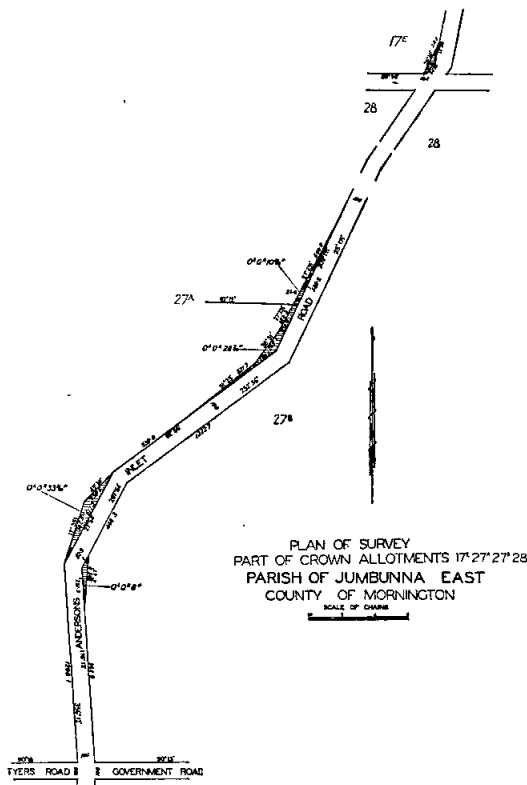

The Common Seal of the President Councillors and Ratepayers of the Shire of Korumburra was hereunto affixed this 15th day of January 1969.

(SEAL)
R. W. RITCHIE, President.
JOHN W. LITTLE, Councillor.
W. O. CLARK, Secretary.

6354

SHIRE OF KORUMBURRA.

LOAN NO. 47.

Notice of Intention to Borrow the Sum of \$30,000 for Permanent Works and Undertakings.

NOTICE is hereby given that the Council of the Shire of Korumburra proposes to borrow the principal sum of \$30,000, secured by a charge over the general rates of the municipality, such sum to be raised by the grant of a mortgage in accordance with the provisions of the Local Government Act 1958.

1. The maximum rate of interest that may be paid is 5.875 per cent. per annum.

2. The purpose for which the loan is to be applied is:—

Commercial Lane—Development of off-street parking facilities	\$25,000
Purchase of Vibrating Roller (Part cost)	\$5,000
	\$30,000

3. The period of the loan shall be fifteen years.
4. The moneys borrowed shall be repayable by providing out of the municipal fund half-yearly instalments of approximately \$1,518 each including principal and interest on the 1st day of April and the 1st day of October during the currency of the loan. The first instalment shall be payable on the 1st day of October, 1969.

5. Such moneys shall be repayable to The Commissioners of The State Saving Bank of Victoria at the office of the said Commissioners, corner Elizabeth and Bourke streets, Melbourne.

The plans and specifications and the estimate of the cost of the proposed works and a statement showing the proposed expenditure of the moneys to be borrowed are open for inspection at the office of the Council of the Shire of Korumburra, Commercial-street, Korumburra during office hours.

Dated 16th January, 1969.

6315

W. O. CLARK, Shire Secretary.

SHIRE OF MILDURA.

LOAN NO. 50.

Notice of Intention to Borrow.

NOTICE is hereby given that the Council of the Shire of Mildura intends to borrow Thirty Thousand Dollars (\$30,000), secured by a charge over the General Rates of the Municipality by the grant of a mortgage in accordance with the provisions of the Local Government Acts.

In connexion therewith the following information is stated:—

- (a) The amount of principal moneys which it is proposed to borrow is \$30,000.
- (b) The maximum rate of interest that may be paid is \$5.875 per centum per annum.
- (c) The times which the moneys borrowed are to be repayable are the Thirtieth day of September, 1969, and the Thirty-first day of March and the Thirtieth day of September in each year, during the years 1970–1983 inclusive, and a final payment on the Thirty-first day of March, 1984, and that the place such moneys shall be repayable is at the Bank of New South Wales, Red Cliffs.

(d) The purpose for which the loan is to be applied is:—

Purchase of Roadmaking Plant	\$20,000
Red Cliffs Senior Citizens' Club	5,000
Mildura South Kindergarten/Infant Welfare Centre	5,000
	Total: \$30,000

(e) The manner in which the Loan is to be liquidated is by provision out of the Municipal Fund in each half-year during the currency of the loan of the sum of \$1,518.24, which includes principal and interest.

The plans and specifications and estimate of the cost of the works and a statement showing the proposed expenditure of the moneys to be borrowed are open for inspection at the Shire Office, Deakin-avenue, Mildura.

Dated this 17th day of January, 1969.

6313

A. D. HARVEY, Shire Secretary.

Water Acts

SHIRE OF OTWAY.

PROPOSED GELLIBRAND RIVER WATERWORKS TRUST.

NOTICE is hereby given that the Shire of Otway has made application to the Honorable the Minister of Water supply for the constitution of a Waterworks Trust, and for the proclamation of a Waterworks District at Gellibrand River and the construction, maintenance, and continuance of Water Supply Works within that District under the provisions of the Water Acts.

A general plan and description of the proposed works have been submitted with the application, and copies of same may be seen at the shire office at Beech Forest.

Dated at Beech Forest the 18th day of December, 1968.
6087 T. J. FRY, Shire Secretary.

SHIRE OF SWAN HILL.

LOAN No. 52.

Notice of intention to borrow the sum of \$20,000 for Permanent Works and Undertakings.

NOTICE is hereby given that the Council of the Shire of Swan Hill proposes to borrow the principal sum of \$20,000 secured by a charge over the general rates of the municipality. Such sum is to be raised by the grant of a mortgage in accordance with the provisions of the Local Government Act 1958. The following conditions will apply:—

- (i) The maximum rate of interest that may be paid is 5.875 per cent. per annum.
- (ii) The purpose for which the Loan is to be applied is for construction of a new football pavilion at Robinvale.
- (iii) The period of the loan shall be fifteen years.
- (iv) The monies borrowed shall be repayable by providing out of the Municipal Fund 30 half-yearly instalments of \$1,012.16 each, including principal and interest on the first day of April and the first day of October during the currency of the Loan. The first instalment shall be payable on the first day of October, 1969.
- (v) Such monies shall be repayable at the Commonwealth Savings Bank of Australia, Melbourne.

Plans and Specifications and estimates of cost of the proposed works and a statement showing the proposed expenditure of the monies to be borrowed are open for inspection at the Office of the Council of the Shire of Swan Hill, Beveridge-street, Swan Hill during office hours.

Dated this fifteenth day of January, 1969.
6318 J. D. LAURITZ, Shire Secretary.

SHIRE OF SWAN HILL.

LOAN No. 51.

Notice of Intention to Borrow the Sum of \$50,000 for Permanent Works and Undertakings.

NOTICE is hereby given that the Council of the Shire of Swan Hill proposes to borrow the principal sum of \$50,000 secured by a charge over the General Rates of the Municipality. Such sum is to be raised by the grant of a mortgage in accordance with the provisions of the Local Government Act 1958. The following conditions will apply:—

- (i) The maximum rate of interest that may be paid is 5.75 per centum per annum.
- (ii) The purpose for which the loan is to be applied is:—

Road Making Plant	\$33,000
Alterations and additions to Council Properties	2,000
Office Equipment	5,000
Kerbing and Channelling	4,000
Road Construction	2,343
Nyah Swimming Pool Construction	3,657
	\$50,000
- (iii) The period of the loan shall be ten years.
- (iv) The moneys borrowed shall be repayable by providing out of the Municipal Fund twenty half-yearly instalments of \$3,322.07 each, including principal and interest on the 1st day of April and the 1st day of October during the currency of the loan. The first instalment shall be payable on the 1st day of October, 1969.
- (v) Such moneys shall be repayable at the Commonwealth Savings Bank of Australia, Melbourne.

Plans and specifications and estimates of cost of the proposed works and a statement showing the proposed expenditure of the moneys to be borrowed are open for inspection at the Office of the Council of the Shire of Swan Hill, Beveridge-street, Swan Hill during office hours.

Dated this 15th day of January, 1969.

6317 J. D. LAURITZ, Shire Secretary.

SHIRE OF WARRAGUL.

Notice of Intention to Borrow the Sum of \$17,000 for Permanent Works and Undertakings.

NOTICE is hereby given that the Council of the Shire of Warragul proposes to borrow the sum of Seventeen thousand dollars (\$17,000) on the credit of the general rates of the President, Councillors and Ratepayers of the said Shire, such sum to be raised by the grant of a mortgage in accordance with the provisions of the Local Government Act 1958.

- 1. The maximum rate of interest that may be paid is 5.75 per centum per annum.
- 2. The purpose for which the loan is to be applied is:—
 - (a) Purchase of roadmaking plant .. \$12,000
 - (b) Buildings at depot \$5,000
- 3. The period of the loan shall be ten years.
- 4. The moneys borrowed shall be repayable by providing out of the municipal fund twenty half-yearly instalments of approximately \$1,129.50 each, including principal and interest on the 1st day of April and the 1st day of October, during the currency of the loan. The first instalment shall be payable on the 1st day of October, 1969.
- 5. Such moneys shall be repayable at the A.N.Z. Savings Bank Ltd., Melbourne.

The plans and specifications and the estimate of the cost of the proposed works and a statement showing the proposed expenditure of the moneys to be borrowed are open for inspection at the Shire office, Warragul.

6309 D. McADIE, Shire Secretary.

NOTICE OF DISSOLUTION OF PARTNERSHIP.

NOTICE is hereby given that the partnership heretofore subsisting between the undersigned Leslie Lockey, of 26 Torquay-road, Belmont, Graeme Maxwell Putland, of 11 Kirriemuir-street, North Geelong, and Arthur Kevin Adams, of 76 The Avenue, Ocean Grove, carrying on business as Plant Installation and Maintenance, General and Constructional Engineers at 68 Seaforth-street, North Shore, under the name of "Danum Tooling & Construction Co." has been dissolved by mutual consent as from the 30th day of December, 1968. All debts due to and owing by the said late firm will be received and paid by the said Leslie Lockey and Graeme Maxwell Putland, who will continue to carry on the said business in partnership at the same place and under the same name.

Dated the 30th day of December, One thousand nine hundred and sixty-eight.

L. LOCKEY.

Signed by the said Leslie Lockey in the presence of—
J. NICHOLLS, Bank Manager.

GRAEME M. PUTLAND.

Signed by the said Graeme Maxwell Putland in the presence of—J. NICHOLLS, Bank Manager.

K. ADAMS.

Signed by the said Arthur Kevin Adams in the presence of—J. NICHOLLS, Bank Manager.

WM. C. AINSWORTH & CO., solicitors, 71 Yarra-street, Geelong. 6319

NOTICE is hereby given that the partnership heretofore subsisting between the undersigned Suzanne Betty Stone and Marie Stone, carrying on business as florists at 48 East Concourse, Beaumaris, under the name of Stone's Florist, has been dissolved by mutual consent as from the 17th day of January, 1969. All debts due to and owing by the firm will be received and paid by the said Suzanne Betty Stone, who will continue to carry on the business in the same name and at the same place.

Dated at Melbourne, the 17th day of January, 1969.

SUZANNE STONE.
MARIE STONE.

NOTICE is hereby given that the partnership heretofore subsisting between Gordon Leopold Roberts, Herbert Francis Dick and Peter Joseph Morriss, carrying on business as barristers and solicitors at Gillies-street, Rochester, under the style or firm of Roberts, Dick and Morriss, has been dissolved by mutual consent as and from the 17th day of January, 1969. The said Gordon Leopold Roberts and Herbert Francis Dick, will continue to carry on business as barristers and solicitors, at Gillies-street, Rochester aforesaid, under the style or firm of H. W. Raleigh, Roberts and Dick, as and from the 18th day of January, 1969, and will duly pay in satisfaction or cause to be paid in satisfaction all debts and liabilities of the partnership of Roberts, Dick and Morriss. All accounts owing to the partnership of Roberts, Dick and Morriss are duly payable to the firm of H. W. Raleigh, Roberts and Dick.

Dated this 17th day of January, 1969.

G. L. ROBERTS.
H. F. DICK.
P. J. MORRISS.

6310

NOTICE is hereby given that the partnership heretofore subsisting between Edward Patrick Gavin and Donald Gregory Gavin, carrying on business as farmers at Toolong, under the style or firm of Edward Gavin & Son, has been dissolved as from the 10th day of December, 1968.

Dated this 13th day of January, 1969.

EDWARD GAVIN.
DONALD GREGORY GAVIN.

6289

Companies Act 1961.

RAYMOND PHILLIPS PTY. LTD. (IN VOLUNTARY LIQUIDATION.)

NOTICE is hereby given that a Final Meeting of members and creditors of the above-named company will be held on the 7th day of March, 1969, at 2.30 p.m. at 732 High-street, Thornbury, pursuant to section 272 of the *Companies Act 1961*, for the purpose of laying before the meeting an account showing how the winding up has been conducted and how the assets have been disposed of.

Dated this 14th day of January, 1969.

6283

R. L. PHILLIPS, Liquidator.

Companies Act 1961.

PHILLIPS O'CONNOR SERVICES PTY. LTD.
(IN VOLUNTARY LIQUIDATION.)

NOTICE is hereby given that a Final Meeting of members and creditors of the above-named company will be held on the 7th day of March, 1969, at 2 p.m., at 732 High-street, Thornbury, pursuant to section 272 of the *Companies Act 1961*, for the purpose of laying before the meeting an account showing how the winding up has been conducted and how the assets have been disposed of.

Dated this 14th day of January, 1969.

6284

R. L. PHILLIPS, Liquidator.

STANHILL ESTATES PROPRIETARY LIMITED (IN LIQUIDATION).

NOTICE is hereby given that all debts owing by the above company must be proved by 31st March, 1969.

Creditors who have not proved their debts by that date may be excluded from a dividend.

P. D. GEORGE, Liquidator.

440 Collins-street Melbourne, 3000.

6343

Companies Act 1961.—In the matter of DORE INVESTMENTS PTY. LTD.

NOTICE is hereby given that at a General Meeting of the members of Dore Investments Pty. Ltd., duly convened and held at Blaigowrie on the 15th day of January, 1969, the following Resolution was passed as a Special Resolution:—

“That the company be wound up voluntarily and that Mr. R. N. R. Johnston, of 446 Collins-street, Melbourne, be appointed liquidator.”

Dated this 20th day of January, 1969.

6344

G. W. DORE, Director.

The *Companies Act 1961.*

G. & P. RYAN HOLDINGS PROPRIETARY LIMITED
(IN VOLUNTARY LIQUIDATION).

NOTICE CONVENING FINAL MEETING OF MEMBERS PURSUANT TO SECTION 272.

NOTICE is hereby given in pursuance of section 272 of the *Companies Act 1961*, that a General Meeting of the members of the above-named company will be held on the 26th day of February, 1969, at 3.30 p.m., at the offices of Hughes, Fincher & Rodda, 290 La Trobe-street, Melbourne, for the purposes of having an account laid before them showing the manner in which the winding up has been conducted and the property of the company disposed of and hearing any explanation that may be given by the liquidator.

Dated this 8th day of January, 1969.

NORMAN HARRIS, Liquidator.

Hughes, Fincher & Rodda, chartered accountants, 290 La Trobe-street, Melbourne, Vic., 3000. 6345

Companies Act 1961.

PRO-TEL INSTALLATIONS PTY. LIMITED.

NOTICE OF MEETING OF CREDITORS.

NOTICE is hereby given that a Meeting of Creditors of Pro-Tel Installations Pty. Limited will be held at the offices of the Institute of Chartered Accountants in Australia, 23 McKillop-street, Melbourne, on Friday, 31st January, 1969, at 10.30 a.m. in the forenoon, the company having convened a meeting of its members for the same day for the purpose of considering a Resolution that the company be wound up.

Dated this 17th day of January, 1969.

6303

R. SCHEMBRI, Director.

Companies Act 1961.

LYNNE CONSTRUCTION CO. PTY. LTD.

NOTICE OF RESOLUTION.

AT an Extraordinary General Meeting of members, duly convened and held at 12 Goldie-place, Melbourne, on the 15th January, 1969, the following Resolution was passed as a Special Resolution:

“That the company be wound up voluntarily as a members' voluntary winding up in accordance with the provisions of the *Companies Act 1961*, and that Mr. Morris Rosner, public accountant, of 299 Lygon-street, East Brunswick, be appointed liquidator for the purpose of the winding up.”

Dated this 15th day of January, 1969.

6304

MORRIS ROSNER, Liquidator.

In the Supreme Court of Victoria—1969 No. of Coy. 7665—
In the matter of the *Companies Act 1961*—And in the matter of CROYDON PLANT HIRE PROPRIETARY LIMITED.

NOTICE is hereby given that a petition for the winding up of the above-named company by the Supreme Court was on the 15th day of January, 1969, presented by James Canny, Deputy Commissioner of Taxation of the Commonwealth of Australia and that the said petition is directed to be heard before the Court sitting at the Fourteenth Court, Law Courts, William-street, Melbourne, at the hour of 10.30 o'clock in the forenoon on the 19th day of February, 1969, and any creditor or contributory of the said company desiring to support or oppose the making of an order on the said petition may appear at the time of hearing by himself or his Counsel for that purpose; and a copy of the said petition will be furnished to any creditor or contributory of the said company requiring the same by the under-signed on payment of the regulated charge for the same.

The Petitioner's official address is 436 Lonsdale-street, Melbourne.

The Petitioner's Solicitor is Harold Edward Renfree, Crown Solicitor for the Commonwealth of 99 Queen-street, Melbourne.

H. E. RENFREE.

NOTE.—Any person who intends to appear on the hearing of the said petition must serve on or send by post to the above-named H. E. Renfree, notice in writing of his intention so to do. The notice must state the name and address of the person, or, if a firm, the name and address of the firm, and must be signed by the person or firm, or his or their solicitor (if any), and must be served or, if posted, must be sent by post in sufficient time to reach the above-named not later than 4 o'clock in the afternoon of the 18th day of February, 1969. 6346

In the Supreme Court of Victoria—1969 No. of Coy. 7666—
In the matter of the *Companies Act 1961*—And in the
matter of AMERICAN AUSTRALASIAN CHARTER LINE (1965)
PTY. LTD.

NOTICE is hereby given that a petition for the winding up of the above-named company by the Supreme Court was on the 15th day of January, 1969, presented by James Canny, Deputy Commissioner of Taxation of the Commonwealth of Australia and that the said petition is directed to be heard before the Court sitting at the Fourteenth Court, Law Courts, William-street, Melbourne, at the hour of 10.30 o'clock in the forenoon on the 19th day of February, 1969, and any creditor or contributory of the said company desiring to support or oppose the making of an order on the said petition may appear at the time of hearing by himself or his Counsel for that purpose; and a copy of the said petition will be furnished to any creditor or contributory of the said company requiring the same by the under-signed on payment of the regulated charge for the same.

The Petitioner's official address is 436 Lonsdale-street, Melbourne.

The Petitioner's Solicitor is Harold Edward Renfree, Crown Solicitor for the Commonwealth of 99 Queen-street, Melbourne.

H. E. RENFREE.

NOTE.—Any person who intends to appear on the hearing of the said petition must serve on or send by post to the above-named H. E. Renfree, notice in writing of his intention so to do. The notice must state the name and address of the person, or, if a firm, the name and address of the firm, and must be signed by the person or firm, or his or their solicitor (if any), and must be served or, if posted, must be sent by post in sufficient time to reach the above-named not later than 4 o'clock in the afternoon of the 18th day of February, 1969. 6347

In the matter of the *Companies Act 1961*, and in the matter of CO-OPERATIVE FARMERS AND GRAZIERS DIRECT MEAT SUPPLY LIMITED.

NOTICE is hereby given that creditors who have not proved their debts or claims against the Society as at the 6th day of May, 1968, are required to do so by the 12th day of February, 1969, else they may be excluded from any distribution to be declared and paid in the future. Statutory Proof of Debt: General Forms, are to be lodged with Mr. L. P. Smart, Co-operative Farmers and Graziers Direct Meat Supply Limited, McDonald-road, Brooklyn, 3012.

6353 L. P. SMART, Administrator.

In the matter of the *Companies Act 1961*, and in the matter of FINGAL MANUFACTURING CO. PTY. LIMITED (Members' Voluntary Winding-up).

NOTICE is hereby given that a General Meeting of members of the company is convened to be held at the offices of Messrs. E. S. Owens & Co., Chartered Accountants, 20th Floor, Gold Fields House, 1 Alfred-street, Sydney on Tuesday the 18th day of February, 1969, for the purpose of laying before the meeting an account showing how the winding-up has been conducted and the property of the company has been disposed of and of giving an explanation of the account.

Dated this 17th day of January, 1969.
6323 M. J. SCOTT, Liquidator.

In the matter of the *Companies Act 1961*, and in the matter of TIMMS HOLDINGS PTY. LIMITED.

NOTICE is hereby given that an Extraordinary General Meeting of the above-named company duly convened and held at 422 Collins-street, Melbourne, at ten o'clock in the forenoon on the 15th day of January, 1969, the following Special Resolution was duly passed—

"That the company be wound up voluntarily and that Mr. John Stuart Walker, Chartered Accountant of 422 Collins-street, Melbourne be appointed liquidator for the purposes of such winding up, and that the remuneration of John Stuart Walker, be fixed in accordance with the scale of fees of the Institute of Chartered Accountants."

Dated the 15th day of January, 1969.
6348 R. TIMMS, Chairman.

The *Companies Act 1961*.—In the matter of BLAKELEY & SONS PTY. LTD.—Notice of Final Meeting.

NOTICE is hereby given that, pursuant to section 272 of the *Companies Act 1961*, a General Meeting of the above-named company will be held at Flat 4, 2 Waratah-avenue, Glenhuntly, on Wednesday the 26th day of February, 1969, at 12 noon, for the purpose of having an account laid before them showing the manner in which

the winding up has been conducted and the property of the company disposed of, and of hearing any explanation that may be given by the liquidator.

Dated the 11th January, 1969.
6290 ELSIE BLAKELEY, Liquidator.

The *Companies Act 1961*.—In the matter of GAINGER'S PTY. LTD.—Notice of Final Meeting.

NOTICE is hereby given that, pursuant to section 272 of the *Companies Act 1961*, a General Meeting of the members of the above-named company will be held at 26 Margaret-street, North Geelong, on Wednesday the 26th day of February, 1969, at 10 o'clock in the forenoon, for the purpose of having an account laid before them showing the manner in which the winding up has been conducted and the property of the company disposed of, and of hearing any explanation that may be given by the liquidator.

Dated the 11th day of January, 1969.
6291 A. R. GAINGER, Liquidator.

The *Companies Act 1961*.—In the matter of A. & J. GAINGER'S BUS SERVICE PTY. LTD.—Notice of Final Meeting.

NOTICE is hereby given that, pursuant to section 272 of the *Companies Act 1961*, a General Meeting of the members of the above-named company will be held at 26 Margaret-street, North Geelong, on Wednesday the 26th day of February, 1969, at 12 noon, for the purpose of having an account laid before them, showing the manner in which the winding up has been conducted and the property of the company disposed of, and of hearing any explanation that may be given by the liquidator.

Dated the 13th day of January, 1969.
6292 A. R. GAINGER, Liquidator.

The *Companies Act 1961*.—In the matter of A. A. PINDER PTY. LTD.—Notice of Final Meeting.

NOTICE is hereby given that, pursuant to section 272 of the *Companies Act 1961*, a General Meeting of the members of the above-named company will be held at Yarra Junction on Wednesday, the 26th day of February, 1969, at 12 noon, for the purpose of having an account laid before them showing the manner in which the winding up has been conducted and the property of the company disposed of, and of hearing any explanation that may be given by the liquidator.

Dated the 14th day of January, 1969.
6293 A. PINDER, Liquidator.

NOTICE is given that a General Meeting of members of H. C. BEST & COMPANY PTY. LTD, in voluntary liquidation, will be held at the registered office of the company, 129 Drummond-street, Carlton, on Wednesday, 5th March, 1969, at 12 noon, for the purpose of laying before the meeting an account showing how the winding up has been conducted and the property of the company has been disposed of.

Dated this 21st day of January, 1969.
6359 D. F. GORDON, Liquidator.

FREEHOLDS (DOERY AND TILLEY) PTY. LTD. (IN VOLUNTARY LIQUIDATION).

NOTICE is hereby given that a meeting of the shareholders of the company will be held pursuant to section 272 of the *Companies Act 1961* for the purpose of the liquidator laying before the meeting an account showing how the winding up has been conducted and the property of the company disposed.

The meeting will be held at 10 a.m. on 28th February, 1969, at the office of Wootton Sons & Elvish, 6th Floor, 37 Queen-street, Melbourne.

6362 H. L. RICHARDSON, Liquidator.

KILLESHANDRA PROPRIETARY LIMITED.

AT an Extraordinary General Meeting of the above-named company duly convened and held at 419 Lonsdale-street, Melbourne, on 20th January, 1969, the following Special Resolution was passed:—

"That the company be wound up voluntarily and that Norman Frank Henning, chartered accountant, of 419 Lonsdale-street, Melbourne, be appointed liquidator for the purpose of the winding up."

6363 RICHARD DU COUDRAY TRONSON, Director.

Companies Act 1966.

C. R. HOSE PTY. LTD. (UNDER OFFICIAL MANAGEMENT).

NOTICE is hereby given that a Meeting of Creditors and the members of the above-named company will be held at 2.30 p.m. on Monday, the 3rd day of February, 1969, at Room 315, 3rd Floor, Princes Gate, East Par, 151 Flinders-street, Melbourne. The object of the meeting is to consider the statement of assets and liabilities made up to 11th December, 1968, and the report of the official manager. The statement and report may be inspected at the office of the official manager between the hours of 10 a.m. and 4 p.m. on week-days.

A. NEVILLE BIRD, Official Manager.

A. Neville Bird & Co., chartered accountants, 289 Flinders-lane, Melbourne, Telephone 63 8833. 6364

Companies Act 1961.—In the matter of WONDERGLASS (AUSTRALASIA) PROPRIETARY LIMITED.

NOTICE is hereby given that at an Extraordinary General Meeting of the members of the above-mentioned company held on the 15th day of January, 1969, it was resolved that the company be wound up voluntarily and that Geoffrey Royce Howard, of 11th Floor, 550 Bourke-street, Melbourne, be appointed liquidator for the purpose of such winding up.

Dated this 21st day of January, 1969.

G. R. Howard, liquidator, 11th Floor, 550 Bourke-street, Melbourne, 3000. 6369

Companies Act 1961.—In the matter of TUNSTALL ENGINEERING PTY. LIMITED.

NOTICE is hereby given that at an Extraordinary General Meeting of the members of the above-mentioned company held on the 15th day of January, 1969, it was resolved that the company be wound up voluntarily and that Geoffrey Royce Howard, of 11th Floor, 550 Bourke-street, Melbourne, be appointed liquidator for the purpose of such winding up.

Dated this 21st day of January, 1969.

G. R. Howard, liquidator, 11th Floor, 550 Bourke-street, Melbourne, 3000. 6370

Companies Act 1961.—In the matter of BAY ROAD PROPERTIES PTY. LIMITED.

NOTICE is hereby given that at an Extraordinary General Meeting of the members of the above-mentioned company held on the 15th day of January, 1969, it was resolved that the company be wound up voluntarily and that Geoffrey Royce Howard, of 11th Floor, 550 Bourke-street, Melbourne, be appointed liquidator for the purpose of such winding up.

Dated this 21st day of January, 1969.

G. R. Howard, liquidator, 11th Floor, 550 Bourke-street, Melbourne, 3000. 6371

Companies Act 1961.—In the matter of BOOKER STEEL PTY. LIMITED.

NOTICE is hereby given that at an Extraordinary General Meeting of the members of the above-mentioned company held on the 15th day of January, 1969, it was resolved that the company be wound up voluntarily and that Geoffrey Royce Howard, of 11th Floor, 550 Bourke-street, Melbourne, be appointed liquidator for the purpose of such winding up.

Dated this 21st day of January, 1969.

G. R. Howard, liquidator, 11th Floor, 550 Bourke-street, Melbourne, 3000. 6372

Companies Act 1961.—In the matter of DOTT & COMPANY PROPRIETARY LIMITED.

NOTICE is hereby given that at an Extraordinary General Meeting of the members of the above-mentioned company held on the 15th day of January, 1969, it was resolved that the company be wound up voluntarily and that Geoffrey Royce Howard, of 11th Floor, 550 Bourke-street, Melbourne, be appointed liquidator for the purpose of such winding up.

Dated this 21st day of January, 1969.

G. R. Howard, liquidator, 11th Floor, 550 Bourke-street, Melbourne, 3000. 6373

Companies Act 1961.—In the matter of A.C.I. LIGHTING PTY. LTD.

NOTICE is hereby given that at an Extraordinary General Meeting of the members of the above-mentioned company held on the 15th day of January, 1969, it was resolved that the company be wound up voluntarily and that Geoffrey Royce Howard, of 11th Floor, 550 Bourke-street, Melbourne, be appointed liquidator for the purpose of such winding up.

Dated this 21st day of January, 1969.

G. R. Howard, liquidator, 11th Floor, 550 Bourke-street, Melbourne, 3000. 6374

CREDITORS, next of kin and others having claims in respect of the estate of Elsie Mary Eliza Hindson, late of "Seacombe" Sorrento, (who died on the 28th day of July, 1968), and probate of whose will and codicils thereto was granted by the Supreme Court of Victoria to The Trustees Executors and Agency Company Limited, of 401 Collins-street, Melbourne, one of the executors named in the said will are to send particulars of their claims to the said executor at its address above-mentioned by the 28th day of March, 1969, after which date it will distribute the assets having regard only to the claims of which it then has notice.

Dated this 14th day of January, 1969.

SEWELL & SEWELL, 422 Collins-street, Melbourne, solicitors for the said executor. 6324

CREDITORS, next of kin and others having claims in respect of the estate of Emily Bessie Barton, late of 18 View-street, Reservoir, married woman, deceased (who died on 16th June, 1968), are to send particulars of their claims to The Union-Fidelity Trustee Company of Australia Limited, of 100 Exhibition-street, Melbourne, by the 24th March, 1969, after which date it will distribute the assets having regard only to the claims of which it then has notice.

KIERNAN & FORREST, solicitors, 431 Bourke-street, Melbourne. 6325

CREDITORS, next of kin and others having claims in respect of the estate of Laurence Stanley Dunen, late of Lot 5 Dundas-street, Darley, press operator, deceased intestate (who died on the 14th day of June, 1968), and letters of administration of whose estate have been granted, to Kaye Elizabeth Dunen, of Lot 5 Dundas-street, Darley, his widow, are required to send particulars of their claims to the said administratrix, care of the under-mentioned solicitors by the 3rd day of April, 1969, after which date she will distribute the assets having regard only to the claims of which she then has notice.

PEARCE & WEBSTER, solicitors, of 430 Little Collins-street, Melbourne. 6326

DAPHNE JULIA EDITH MIDDOWS, formerly of 6 Stonnington-place, Toorak, in the State of Victoria, but late of 16 Lexton-grove, Prahran, in the said State, widow, DECEASED.

CREDITORS, next of kin and others having claims in respect of the estate of the deceased (who died on the 13th day of October, 1968), are required by the Trustee The Equity Trustees Executors and Agency Company Limited, of 472 Bourke-street, Melbourne, to send particulars to it by the 15th day of April, 1969, after which date the trustee may convey or distribute the assets having regard only to the claims of which it then has notice.

Dated this 21st day of January, 1969.

EGGLESTON, CLIFTON-JONES & Co., solicitors, 578 Bourke-street, Melbourne. 6327

CREDITORS, next of kin and other persons having claims against the estate of Margaret Ann Callahan (usually known as Margaret Callahan), late of 77 York-street, Prahran, in the State of Victoria, widow, deceased (who died on the 9th day of November, 1967), are required to send particulars of their claims to the executor James Patrick Ogge, care of the under-mentioned solicitors, by the 20th March, 1969, after which date the executor will distribute the assets having regard only for the claims of which he has had notice.

JAMES P. OGGE & Co. solicitors, of 165 Greville-street, Prahran. 6328

EMILY AGNES NATION, late of 63 Hart-street, Colac, widow, DECEASED.

CREDITORS, next of kin and others having claims in respect of the estate of the deceased (who died on the 25th day of June, 1968), are required by the applicant for a grant of administration of her estate, National Trustees Executors and Agency Company of Australasia Limited, of 95 Queen-street, Melbourne, to send particulars to it by the 31st day of March, 1969, after which date it may convey or distribute the assets having regard only to the claims of which it then has notice.

SEWELL & SEWELL, solicitors, Colac. 6329

CREDITORS, next of kin and others having claims in respect of the estate of Violet Dorothy Tregent, late of 18 Cecil-street, Eltham, widow, deceased, intestate (who died on the 20th day of June, 1968), are to send particulars of their claims to Royston T. Cahir & Martin, solicitors of 475 Collins-street, Melbourne, by the 24th day of March, 1969, after which date the administrator will distribute the assets of the estate having regard only to claims of which he then has notice.

ROYSTON T. CAHIR & MARTIN, solicitors, 475 Collins-street, Melbourne. 3000. 6330

CREDITORS next of kin and others having claims against the estate of Jessie Mead, late of 112 (formerly 1) Lane-street, Ballarat, spinster, deceased (who died on the 5th day of September, 1968), are required by the Executor, The Union Fidelity Trustee Company of Australia Limited, of 100 Exhibition-street, Melbourne to send particulars of their claims to the said executor, care of the said company at 101 Lydiard-street, North Ballarat, by the 22nd day of March, 1969, after which date the said executor, will distribute the assets, having regard only to the claims of which it then has notice.

RAMSAY, GAUNT & FRASER, solicitors, 41 Lydiard-street, South Ballarat. 6320

CHARLES ROBERT WENNING, late of 1107 Gregory-street, Ballarat, retired fitter, DECEASED (who died on the 3rd November, 1968).

CREDITORS, next of kin and all persons having claims against the estate of the deceased are required to send particulars to the executors, The Union Fidelity Trustee Company of Australia Limited, of 101 Lydiard-street, North Ballarat, on or before the 23rd March, 1969, after which date it will distribute the assets, having regard only to the claims of which it shall then have notice.

HEINZ & GORDON, solicitors, 209 Dana-street, Ballarat. 6321

EDNA KNIGHT, late of 9 Connell-street, Swan Hill, in the State of Victoria, married woman, DECEASED (who died on the 6th day of March, 1968).

CREDITORS, next of kin and all other persons having claims against the estate of the deceased are required by the executor of the will, Leslie Roy Knight, to send particulars to him care of the under-signed on or before the 16th day of April, 1969, after which date he will distribute the assets, having regard only to the claims of which he then has notice.

GARDEN & GREEN, solicitors, 4 McCallum-street, Swan Hill. 6312

Trustee Act 1958.
NOTICE TO CLAIMANTS.

PURSUANT to the Trustee Act 1958, creditors, next of kin and all other persons having claims in respect of the estate of any deceased person named below are required to send particulars to the legal personal representative or representatives at the addresses stated, after which date the representative or representatives will distribute the assets, having regard only to the claims of which notice has been received:—

Frank Alexander Rigby, formerly of Mt. Dandenong-road, Kilsyth, late of 13 Ware-crescent, Ringwood East, gentleman, died 11th July, 1968.—Claims to the executor, The Union-Fidelity Trustee Company of Australia Limited, of 100 Exhibition-street, Melbourne, by 31st March, 1969.

J. W. GLOVER, LL.B., 422 Collins-street, Melbourne. 6333

EUPHEMIA TAYLOR, late of 26 Webster-street, Ballarat, spinster, DECEASED.

CREDITORS, next of kin and others having claims in respect of the estate of the deceased (who died on the 2nd day of January, 1968), are required to send particulars of their claims to The Union-Fidelity Trustee Company of Australia Limited to its registered office, at 101 Lydiard-street North, Ballarat, by the 1st day of April, 1969, after which date it may convey or distribute the assets, having regard only to the claims of which it then has notice.

D. & A. ARONSON, solicitors, 104 Lydiard-street South.

WILFRED LANGFORD COLLINS, late of "Wilnba" Hill-street, Kangaroo Flat, Minister of Religion, DECEASED.

CREDITORS, next of kin and others having claims in respect of the estate of the deceased (who died on the 1st day of July, 1968), are requested to send particulars of their claims to the executor, David Jenkin Collins, care of the undersigned solicitor, by the 24th day of March, 1969, after which date the said executor will proceed to distribute the estate, having regard only to the claims of which he then has notice.

MARJORY C. COATES, solicitor, of 422 Collins-street, Melbourne, 3000. 6337

LEONARD ALFRED BAILES, late of 12 Alison-street, Moorabbin, builder, DECEASED.

CREDITORS, next of kin and others having claims in respect of the estate of the deceased (who died on the 9th day of February, 1968), are required by the Perpetual Executors and Trustees Association of Australia Limited, of 100 Queen-street, Melbourne, to send particulars of their claims to the said company, by the 22nd day of March, 1969, after which date it will convey or distribute the assets, having regard only to the claims of which the company then has notice.

BEST HOOPER RINTOUL & SHALLARD, 100 Queen-street, Melbourne. 6338

CREDITORS, next of kin and others having claims in respect of the estate of Muriel Alice Murray Murton, late of "Warra Willah", Healesville, spinster (who died on 23rd October, 1968) are to send particulars of their claims to The Union-Fidelity Trustee Company of Australia Limited, of 100 Exhibition-street, Melbourne, by the 23rd day of March, 1969, after which date it will distribute the assets, having regard only to the claims of which it then has notice.

RYLAH & RYLAH, solicitors, 349 Collins-street, Melbourne. 6339

CREDITORS, next of kin and others having claims against the estate of Walter Reginald Pickering, late of Campbell's Bridge, via Stawell, in Victoria, farmer, deceased (who died on 29th August, 1968), are required by the executor, David Leslie Pickering, of 74 Nicholson-street, East Brunswick, to send to him particulars of their claims, by the 31st day of March, 1969, after which date the said executor will distribute the assets, having regard only to claims of which he then has notice.

A. G. ALLAWAY & SON, solicitors, 386 Flinders-lane, Melbourne. 6340

CREDITORS, next of kin and others having claims in respect of the estate of Anne Kathleen Brennan, late of Flat 7, 628 St. Kilda-road, Melbourne, spinster, deceased (who died on the 7th day of July, 1968), are required to send particulars of their claims to the executors, Thomas Patrick Brophy and Thomas Cairns, care of the under-mentioned solicitors, by the 24th day of March, 1969, after which date they will distribute the assets, having regard only to the claims of which they then have notice.

MAHONY, O'BRIEN & DUGGAN, solicitors, 37 Queen-street, Melbourne. 6341

ALL persons having claims against the estate of John Meagher, late of 38 Ninth-avenue, Coorparoo, Brisbane, in the State of Queensland, retired, deceased (who died on the 23rd August, 1968, and probate of whose will was granted by the Supreme Court of Victoria to The Trustees, Executors and Agency Company Limited on the 19th December, 1968), are hereby required to send particulars of such claims to The Trustees, Executors and Agency Company Limited at its registered office at 401 Collins-street, Melbourne, on or before 24th March, 1969, after which date the said company will proceed to transfer, convey or distribute the said estate to or among the persons entitled thereto, having regard only to the claims of which it shall then have had notice, and will not be liable for the assets so transferred, conveyed or distributed to any persons of whose claim it shall not then have had notice. 6342

JOHN CRAWFORD, late of 10 Swan-road, Murrumbidgee, retired, DECEASED.

CREDITORS, next of kin and others having claims in respect of the estate of the deceased (who died on the 27th day of November, 1968), are requested to send particulars of their claims to the executrix, Edith Crawford, care of the undersigned solicitor, by the 22nd March, 1969, after which date the said Executrix will proceed to distribute the estate, having regard only to the claims of which she then has notice.

MARJORY C. COATES, solicitor, 422 Collins-street.

ROY ROBINSON, late of 34 Madeline-street, East Preston, retired, DECEASED.

CREDITORS, next of kin and others having claims in respect of the estate of the deceased (who died on the 27th day of November, 1968), are requested to send particulars of their claims to the executrix, Edith Mary Robinson, care of the undersigned solicitor, by the 22nd March, 1969, after which date the said executrix will proceed to distribute the estate, having regard only to the claims of which she then has notice.

MARJORY C. COATES, solicitor, 422 Collins-street, Melbourne. 6366

CREDITORS, next of kin and others having claims in respect of the estate of Bernice Marion Mackay, late of 30 Pacific Boulevard, Beaumaris, in the State of Victoria, widow (who died on the 9th of August, 1967), are to send the particulars of their claims to the executor of the estate, John James Mackay, care of Jack Cohen, Marks & Co., solicitors, 224 Queen-street, Melbourne, by the 30th of April, 1969, after which date he will distribute the assets, having regard only to the claims of which he then has notice.

JACK COHEN, MARKS & Co., solicitors, 224 Queen-street, Melbourne. 6367

CREDITORS, next of kin and others having claims in respect of the estate of Ethel Agnes Schulte, late of 12 Holroyd-avenue, East St. Kilda, spinster, deceased (who died on the 7th day of June, 1968), are to send particulars of their claims to National Trustees, Executors and Agency Company of Australasia Limited, of 95 Queen-street, Melbourne, by the 24th day of March, 1969, after which date the executor will distribute the assets of the said estate, having regard only to claims of which it then has notice.

ROYSTON T. CAHIR & MARTIN, solicitors, 475 Collins-street, Melbourne, 3000. 6331

CREDITORS, next of kin and others having claims in respect of the estate of Eileen Mary Coghlin, late of 7 Glencairn-avenue, Moreland, deceased intestate (who died on the 5th day of August, 1968), are to send particulars of their claims to Royston T. Cahir & Martin, solicitors, of 475 Collins-street, Melbourne, by the 24th day of March, 1969, after which date the administrators will distribute the assets of the estate, having regard only to claims of which they then have notice.

ROYSTON T. CAHIR & MARTIN, solicitors, 475 Collins-street, Melbourne, 3000. 6332

CREDITORS, next of kin and others having claims in respect of the estate of Robina Margaret Anderson, late of Gracedale Private Hospital, 1 Sefton-place, East Camberwell, matron (who died on the 29th November, 1968), are required to send particulars of their claims to The Trustees, Executors & Agency Company Limited, of 401 Collins-street, Melbourne, by the 26th March, 1969, after which date it will distribute the assets, having regard only to the claims of which it then has notice.

COOKE & CUSSEN, solicitors, 472 Bourke-street, Melbourne. 6335

ALLAN WALTON ARNOLD, late of Flat 4, 388 Toorak-road, South Yarra, Victoria, merchant, DECEASED.

CREDITORS, next of kin and others having claims in respect of the estate of the deceased (who died on 18th August, 1968), are required by the personal representative, The Equity Trustees, Executors and Agency Company Limited, of 472 Bourke-street, Melbourne, to send particulars to the said company by 28th March, 1969, after which date it may convey or distribute the assets, having regard only to the claims of which it then has notice.

HEDDERWICK, FOOKES & ALSTON, solicitors, 103 William-street, Melbourne, 3000. 6336

DANIEL JOHN COWIN, late of 114 Skeels-street, Heyfield, in the State of Victoria, retired farmer, DECEASED.

CREDITORS, next of kin and others having claims in respect of the estate of the above-named deceased (who died on the 30th day of August, 1968), are required by the personal representative, Frederick William Wilson, of Dawson via Heyfield, farmer, to send particulars to him, care of the under-mentioned solicitors, by the 30th day of March, 1969, after which date he may convey or distribute the assets, having regard only to the claims of which he then has notice.

SEMMENS, HATCH & ANDERSON, solicitors, Maffra. 6308

LOUIS NEWTON LYELL, late of "Caversham Court", The Esplanade, Mornington, in the State of Victoria, retired insurance inspector, DECEASED.

CREDITORS, next of kin and all other persons having claims against the estate of the deceased are required by the executor of the will, Alan George Field Marsh, of 30A Hawthorn Glen, Hawthorn, state manager for Victoria of the Commercial Bank of Australia Limited, to send particulars to him, care of the under-mentioned solicitor, on or before the 26th day of March, 1969, after which date he will distribute the assets, having regard only to the claims of which he then has notice.

T. A. MILLER, LL.B., solicitor, 61 Main-street, Mornington. 6305

BRIAN WILLIAM SLATER, late of Ingleburn, in the State of New South Wales, army officer, DECEASED.

CREDITORS, next of kin and others having claims in respect of the estate of the deceased (who died on the 13th day of April, 1968), are required by the administrator, Edgar Francis Slater, of 7 Butler-street, Essendon, in the State of Victoria, to send particulars to him, care of David Bullard, solicitor, 443 Law Courts-place, Melbourne, in the State of Victoria, by the 23rd day of March, 1969, after which date the administrator may convey or distribute the assets, having regard only to the claims of which he then has notice. 6286

JOHN PATRICK HOGAN, late of Kulwin, in the State of Victoria, farmer, DECEASED.

CREDITORS, next of kin and others having claims in respect of the estate of the deceased (who died on the 14th day of June, 1968), are required by the administratrix of the will and estate, Helen Mary Young, of Kulwin aforesaid, widow, to send particulars to her, care of the under-mentioned solicitors, by the 27th day of March, 1969, after which date she may convey or distribute the assets, having regard only to the claims of which she then has notice.

SCHLEIGER & SMALLEY, solicitors, 290 Williamson-street, Bendigo. 6298

In the Supreme Court of the State of Victoria.

SALE BY THE SHERIFF.

ON Monday, the 3rd day of March, 1969, at 2 p.m., at the Police Station, Geelong West (unless process be stayed or satisfied):—

All the estate and interest (if any) of Jose Luis Martinez, of 65 Autumn-street, Geelong West, as proprietor of an estate in fee simple in the land described in Certificate of Title, volume 8492, folio 597, upon which is erected a dwelling-house and convenience and garage known as No. 65 Autumn-street, Geelong West.

Terms: Cash only.

A. G. STEWART, Sheriff's Officer, Geelong.
15th January, 1969. 6334

IMPOUNDINGS

BENALLA.—Impounded in Benalla Pound by Mr. J. Stickland (Ranger) in Benalla, on 11th January, 1969, at 4.15 p.m., in Margaret-street.

1 fine wool crossbred ewe lamb, no visible brand

If not claimed and expenses paid, to be sold on 6th February, 1969.

C. H. WALLACE,
6358—\$2.00 Poundkeeper.

SUNBURY.—Impounded in Sunbury Pound by Shire Ranger, on the 10th January, 1969.

1 crossbred ewe lamb, no visible brands or marks

If not claimed and expenses paid, to be sold on 7th February, 1969.

E. M. PHILLIPS,
6357—\$1.75 Poundkeeper.

TRAFALGAR.—Impounded at Trafalgar Pound.

No. 15. Dark Jersey bull, dehorned, no visible brand approximately 15 months old.

No. 16. Dark Jersey bull, dehorned, no visible brand approximately 15 months old.

No. 17. Friesian heifer, horned, no visible brand approximately 10 months old.

If not claimed and expenses paid, they will be sold at the Trafalgar saleyards on Wednesday, 29th January, 1969.

V. KAYE,
6300—\$3.00 Poundkeeper.

Subordinate Legislation Act 1962.

NOTICE OF MAKING OF STATUTORY RULES.

IN pursuance of the provisions of the *Subordinate Legislation Act 1962* and the Regulations made thereunder, notice is given of the making of the following statutory rules:—

No.	Justices Act 1958.	Price.
17/1969.	Justices (Registration) (Amendment) Rules 1968	10c
<i>Social Welfare Act 1960.</i>		
18/1969.	Social Welfare (Cadetships Amendment) Regulations 1969	10c
<i>Cemeteries Act 1958.</i>		
19/1969.	Cemeteries (Amendment) Regulations 1969	10c
<i>Mental Health Act 1959.</i>		
20/1969.	Mental Health (Medical Positions and Salaries) Regulations 1969	10c
<i>Health Act 1958.</i>		
21/1969.	Labelling of Hazardous Household Substances (Amendment) Regulations 1969	10c

Copies of these statutory rules may be purchased at the Sale of Publications Section of the Government Printing Office, located at Macarthur-street, Melbourne, 3002. If ordered by mail, remittance should be addressed to "The Government Printer, Box 203, P.O., North Melbourne, 3051", and should include 5c extra for postage. If a credit account is held at this office, no remittance is required with the mail order.

The annual subscription rate for Statutory Rules (including a Bound Volume) is \$15, payable in advance. The subscription year commences on 1st January.

A. C. BROOKS,
Government Printer.

STATE ACTS, 1968

COPIES of the following Acts of Parliament of Victoria may be obtained at the Government Printing Office, Sale of Publications Branch, off Parliament-place, Melbourne, phone 63 0321, extension 6181, or from any accredited agent, at the price set opposite to each (these prices do not include postage).

The annual subscription for State Acts 1968 et seq. is \$8 payable in advance.

Bound Volumes of State Acts are also available on a subscription basis of \$15 per annum.

No.	Price.
7656. The Constitution Act Amendment (Governor's Salary)	\$0.10
7657. Victorian Limbless Soldiers' Provident Fund (Closing)	\$0.15
7658. Country Roads (Borrowing Powers)	\$0.10
7659. Hairdressers Registration (Amendment)	\$0.10
7660. Evidence (Attestations)	\$0.10
7661. Melbourne Harbor Trust (Borrowing Powers)	\$0.10
7662. Cheltenham Cemetery Lands Exchange	\$0.10
7663. Administration and Probate (Amendment)	\$0.10
7664. Road Traffic (Infringements)	\$0.10
7665. Transport Regulation (Amendment)	\$0.10
7666. Commercial Goods Vehicles (Amendment)	\$0.10
7667. Tyabb to Long Island Railway Construction	\$0.10
7668. Marriage (Liability in Tort)	\$0.10
7669. La Trobe University (Amendment)	\$0.10
7670. Children's Court (Procedure)	\$0.10
7671. Labour and Industry (Amendment)	\$0.15
7672. Cemeteries (Exhumation Licences)	\$0.10
7673. Consolidated Revenue	\$0.10
7674. Forests (Amendment)	\$0.10
7675. Drought Relief	\$0.15
7676. Town and Country Planning (Amendment)	\$0.35
7677. Sunday Entertainment (Amendment)	\$0.10
7678. Police Offences (Publications)	\$0.10
7679. The Constitution Act Amendment	\$0.10
7680. Portland Harbor Trust (Borrowing Powers)	\$0.10
7681. Acts Interpretation (Prior Convictions)	\$0.10

STATE ACTS, 1968—continued.

No.	Price.
7682. Aerial Spraying Control (Amendment)	\$0.10
7683. Shearers Accommodation (Amendment)	\$0.15
7684. Racing (Amendment)	\$0.15
7685. Health (Amendment)	\$0.10
7686. State Electricity Commission (Amendment)	\$0.15
7687. Kyneton Cattle Market Lands Exchange	\$0.15
7688. Swine (Application of Fund)	\$0.10
7689. Local Government (Amendment)	\$0.40
7690. Royal Society for the Prevention of Cruelty to Animals	\$0.15
7691. Racing (Trotting Meetings)	\$0.10
7692. Labour and Industry (Shop Trading Hours)	\$0.10
7693. Justices (General Sessions Jurisdiction)	\$0.10
7694. Latrobe Valley (Amendment)	\$0.10
7695. Liquor Control	\$0.75
7696. Crimes (Amendment)	\$0.10
7697. Country Roads (Amendment)	\$0.10
7698. West Moorabool Water Board	\$0.35
7699. Melbourne and Metropolitan Board of Works (Borrowing Powers)	\$0.10
7700. Teaching Service (Amendment)	\$0.10
7701. Children's Welfare (Amendment)	\$0.10
7702. Consolidated Revenue	\$0.10
7703. Abolition of Bailiwicks	\$0.15
7704. Footscray (Recreation Ground) Lands	\$0.15
7705. County Court (Jurisdiction)	\$0.25
7706. Shrine of Remembrance Trustees (Powers)	\$0.10
7707. Margarine (Amendment)	\$0.10
7708. National Parks (Amendment)	\$0.10
7709. Revocation and Excision of Crown Reservations	\$0.15
7710. West Melbourne Lands	\$0.15
7711. Kew Lands (Grant Amendment)	\$0.10
7712. Agricultural Education (Amendment)	\$0.10
7713. Melbourne Sailors' Home (Powers of Trustees)	\$0.10
7714. Margarine (Penalties)	\$0.10
7715. State Coal Mines (Winding Up)	\$0.10
7716. Property Law (Amendment)	\$0.10
7717. Auction Sales (Night Auctions)	\$0.10
7718. Coal Mines (Pensions)	\$0.10
7719. Teaching Service (Amendment)	\$0.10

A. C. BROOKS,
Government Printer.

THE "VICTORIA GOVERNMENT GAZETTE".

SUBSCRIPTIONS.—The subscription, including postage, is \$10 per annum, or \$5 per half year, payable in advance.

Subscriptions are required for whole months, and must cover at least a half year.

Single copies are 20 cents, posted 25 cents. Subscribers do not receive the Acts of Parliament with the GAZETTE.

GAZETTES are held in stock for five years only.

PRIVATE ADVERTISEMENTS.—The charge for insertion is 25 cents per line single column, and 50 cents per line double column. The title forms one or more lines as a heading. On an average ten words make a line of single column. Every signature must likewise be counted as a line. The final words of a paragraph, though only portion of a line, must be counted as one line. Signatures (in particular) and proper names must be written very plainly in the text; ONE SIDE ONLY of each sheet of paper should be WRITTEN UPON.

All documents illegibly written will be returned unpublished, and where brands occur unprovided for by the ordinary letters of the alphabet, a worded explanatory description must be furnished.

THE VICTORIA GOVERNMENT GAZETTE is published on WEDNESDAY EVENING in each week, and Notices for insertion will be received by the Government Printer at or before ONE p.m. at ordinary rates, and late advertisements between ONE p.m. and FOUR p.m. at double rates on the day preceding the day of publication.

PAYMENTS.—Unless the advertiser has a credit account, all payments are required in advance. Remittances should be made by cheque, postal order, or money order payable to "GOVERNMENT PRINTER".

ADDRESS.—All communications should be addressed to "The Government Printer, Box 203, P.O., North Melbourne", 3051.

PUBLICATION OF OFFICIAL MATTER.

ATTENTION is invited to the following procedure in relation to the publication of official matter in the *Government Gazette*:—

Publication will be facilitated by the submission of carbon copies for the use of the *Gazette* Officer.

1. *Matter submitted to the Executive Council.*

Matters submitted to the Executive Council which requires gazettal will normally be published in the issue of the following week.

Where urgent gazettal is required, special arrangements should be made with the *Gazette* Officer, Room 9, first floor, Old Treasury Building.

2. *Other matter.*

(a) All other matter duly certified by a responsible officer for publication should be lodged with the *Gazette* Officer not later than half-past Nine a.m. on Tuesday.

(b) Lengthy or involved notices should be forwarded several days before publication.

(c) Proofs, which will be supplied only when specifically requested or, at the direction of the *Gazette* Officer, should be returned promptly to avoid delay in publication.

(d) No additions or amendments to matter for publication will be accepted by telephone.

LATIMER'S, Newsagents, 45 Station-street, Malvern, Victoria 3144.

LIVINGSTON'S SHEPPARTON NEWSAGENCY, 246 Wyndham-street, Shepparton, Victoria 3630.

THE MERCANTILE EXCHANGE, 67 Queen-street, Melbourne, Victoria, 3000.

McGILL'S AUTHORIZED NEWSAGENCY, 183-5 Elizabeth-street, Melbourne, Victoria 3000.

PHILLIPS AUTHORIZED AGENCY, 83 Murphy-street, Wangaratta, Victoria 3677. Victoria 3220.

PURDIE, J., & CO., 138 Moorabool-street, Geelong, SALE AUTHORIZED NEWSAGENCY, 142 Raymond-street, Sale, Victoria 3850.

SKINNER'S AUTHORIZED NEWSAGENCY, 49-51 Franklin-street, Traralgon, Victoria 3844.

STEVENSON, A. C. & M., NEWSAGENTS, 132 Henty-street, Casterton, Victoria 3311.

VERNON, C. F. & H. J., 162 Bridge-road, Richmond, Victoria 3121.

VIEW-POINT AUTHORIZED NEWSAGENCY, 4 View-street, Bendigo, Victoria 3550.

A copy of the *Gazette* filed at each place for public reference.

AGENTS FOR THE "VICTORIA GOVERNMENT GAZETTE".

THE following have been appointed agents to receive Advertisements and Subscriptions for the *Victoria Government Gazette*:—

ARMSTRONG'S AGENCY, 205 Queen-street, Melbourne, Victoria 3000.

ARNALL & JACKSON, 390 Barkly-street, Brunswick, Victoria 3056.

BAIRNSDALE AUTHORIZED NEWSAGENCY, 132 Main-street, Bairnsdale, Victoria 3875.

BICKNELL, M. J., Authorized Newsagent, 196 Timor-street, Warrambool, Victoria 3280.

BLANE'S AUTHORIZED NEWSAGENTS, 162 Murray-street, Colac, Victoria 3250.

CARTER, R. G., ADVERTISING SERVICE PTY. LTD., Suite 24, 65 Queens-road, Melbourne, Victoria 3004.

DAVIES, G. & M. V., 112 Gray-street, Hamilton, Victoria 3300.

DAVIS, WM. (MILDURA) PTY. LTD., 126 Eighth-street, Mildura, Victoria 3500.

DIXON'S NEWSAGENCY, 89 Firebrace-street, Horsham, Victoria 3400.

EDGAR'S NEWSAGENCY PTY. LTD., 293 Hargreaves-street, Bendigo, Victoria 3550.

EDGARS' AUTHORIZED NEWSAGENCY, 45 Bridge-street, Benalla, Victoria 3672.

FRANKS, H., & CO., 184 Ryrie-street, Geelong, Victoria 3220.

GATLEY, A. & J., 250 Lonsdale-street, Dandenong, Victoria 3175.

GORDON & GOTCH AUSTRALASIA LTD., 511 Little Collins-street, Melbourne, Victoria 3000.

GULLAN'S NEWSAGENCY, 88 Bridge-street, Ballarat, Victoria 3350.

HAMPTON, A. C., 243 Mitchell-street, Bendigo, Victoria 3550.

HARSTON, PARTRIDGE & CO. PTY. LTD., 455 Little Collins-street, Melbourne, Victoria 3000.

KYNETON GUARDIAN PTY. LTD., P.O. Box 18, Kyneton, Victoria 3444.

CONTENTS

Acts of Parliament on sale at the Government Printing Office	177
Appointments	140
Contracts	138
Government Notices	125
Impoundings	176
Lands	154
Mining	140
Notice of Making of Statutory Rules	177
Orders in Council—	
Acts—Land; Local Government; Road Traffic; Labour and Industry; Country Roads; Housing; Water; Sewerage Districts; Melbourne and Metropolitan Tramways.	142 et seq
Police Sale	136
Private Advertisements	164
Proclamations	123
Public Holiday—Australia Day	125
Public Service Notices	161
Regulations—	
Acts—Police Regulation	137
Resignations	142
State Rivers and Water Supply Commission	136
Tenders	159
Transport Regulation Board—Public Hearings	129
Waterworks Trusts	125