

[1961]



VICTORIA GOVERNMENT GAZETTE

Published by Authority

[Registered at the General Post Office, Melbourne, for transmission by post as a newspaper.]

No. 561

WEDNESDAY, JULY 2

[1969

PROCLAMATIONS

Land Act 1958.

AREA OF LAND COMPRISED IN CERTAIN CLASSES DIMINISHED OR INCREASED.

PROCLAMATION

By the Lieutenant-Governor as Deputy for His Excellency the Governor of the State of Victoria and its Dependencies in the Commonwealth of Australia, &c., &c., &c.

WHEREAS by the *Land Act 1958* it is amongst other things enacted that the Governor in Council may, by Proclamation to be published in the *Government Gazette*, at any time diminish or increase the area of land comprised in any of the classes mentioned in Part I, Division 1, Section 5, of the said *Land Act 1958*, but that the area of lands which may be sold by auction (Class 6), shall not be increased except as in certain cases in the said Act provided: Now therefore I, the Lieutenant-Governor as Deputy for the Governor of the State of Victoria, in the Commonwealth of Australia, by and with the advice of the Executive Council of the said State, and in accordance with the provisions of Sections 94 and 117 of the *Land Act 1958* aforesaid, do hereby diminish or increase (as the case may be) the areas of Crown lands comprised in Class 6 of the classes mentioned in Section 5 of the *Land Act 1958* aforesaid, to the extent set forth in the subjoined Schedule (that is to say) :—

Schedule referred to

CLASSES DIMINISHED OR INCREASED.

County.	Parish.	Allotment.	Section.	Area.	Diminished.	Increased.	Description.
					Class.	Class.	
Dundas	Warrock	12A	3	A. R. P. 73 0 12	..	6	In the north of the Parish

Given under my Hand and the Seal of the State of Victoria, aforesaid, at Melbourne, this twenty-fourth day of June, in the year of our Lord One thousand nine hundred and sixty-nine, and in the eighteenth year of the reign of Her Majesty Queen Elizabeth II.

(L.S.)

By His Excellency's Command,

E. F. HERRING.

W. J. F. McDONALD,

Minister of Lands.

GOD SAVE THE QUEEN !

Land Act 1958.

UNALIENATED CROWN LAND AVAILABLE FOR SETTLEMENT UNDER IMPROVEMENT PURCHASE LEASES.

PROCLAMATION

By the Lieutenant-Governor as Deputy for His Excellency the Governor of the State of Victoria and its Dependencies in the Commonwealth of Australia &c., &c., &c.

IN pursuance of the provisions of Section 153 of the *Land Act 1958*, I, the Lieutenant-Governor as Deputy for the Governor of the State of Victoria, in the Commonwealth of Australia, by and with the advice of the Executive Council of the said State, do by this Proclamation declare the unalienated Crown lands mentioned in the subjoined schedule, to be available for settlement under improvement purchase leases.

SCHEDULE.

County.	Parish.	Allotment.	Section.	Area.		Land Valuation.
				A. R. P.		
Mornington	Corinella	224c	..	176	0 35	\$15 per acre
Tambo	Detarka	51b	..	60	acres	\$7 per acre
Delatite	Harrietville	24, 25	2	95	acres	\$10 per acre
Bogong	Bingo-Nunjie	13A	1	350	acres	\$5 per acre
Delatite	Bungamero	11	7	120	acres	\$8 per acre

Given under my Hand and the Seal of the State of Victoria aforesaid, at Melbourne, this twenty-fourth day of June, in the year of our Lord One thousand nine hundred and sixty-nine, and in the eighteenth year of the reign of Her Majesty Queen Elizabeth II.

(L.S.)

By His Excellency's Command,

E. F. HERRING.

W. J. F. McDONALD,
Minister of Lands.

GOD SAVE THE QUEEN !

Land Act 1958.—Section 25.

ROAD PROCLAIMED.

PROCLAMATION

By the Lieutenant-Governor as Deputy for His Excellency the Governor of the State of Victoria and its Dependencies in the Commonwealth of Australia, &c., &c., &c.

IN pursuance of the provisions of section 25 of the *Land Act 1958*, I, the Lieutenant-Governor as Deputy for the Governor of the State of Victoria, by and with the advice of the Executive Council of the said State, do hereby proclaim as a road the land in the Parish of Boosey, County of Moira, as indicated by hatching on plan hereunder.—(B.632(*) (H.032900).

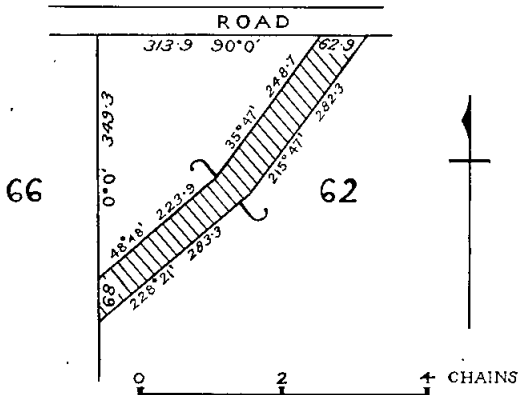

Given under my Hand and the Seal of the State of Victoria aforesaid, at Melbourne, this twenty-fourth day of June, in the year of our Lord One thousand nine hundred and sixty-nine, and in the eighteenth year of the reign of Her Majesty Queen Elizabeth II.

(L.S.)

E. F. HERRING.

By His Excellency's Command,

W. J. F. McDONALD,
Minister of Lands.

GOD SAVE THE QUEEN !

LOCAL GOVERNMENT ACT 1958.

PROCLAMATION OF THE SHIRE OF KNOX AS A CITY.

WHEREAS it is provided by Part II. of the *Local Government Act 1958*, as amended, that the Governor in Council may, after the receipt of a petition to proclaim a municipality a city from the council of a municipality which is substantially urban in character and has a population of at least ten thousand inhabitants and which in the year ended on the thirtieth day of September last passed yielded a revenue from general and extra rates of not less than One Hundred and Sixty Thousand Dollars, proclaim that municipality a city:

And whereas the Shire of Knox is substantially urban in character, has a population of at least ten thousand inhabitants and in the year ended on the thirtieth day of September last passed yielded revenue from general and extra rates of not less than One Hundred and Sixty Thousand Dollars, and in pursuance of the Shire have presented a petition praying for the exercise of such power:

Now therefore, I, the Governor of the State of Victoria, by and with the advice of the Executive Council thereof and with effect on and from the fourth day of July, 1969, hereby proclaim the Shire of Knox to be a city under the name of the City of Knox.

Given under my Hand and the Seal of the State of Victoria aforesaid, at Melbourne, this first day of July, in the year of our Lord One thousand nine hundred and sixty-nine and in the eighteenth year of the reign of Her Majesty Queen Elizabeth II.

(L.S.)

ROHAN DELACOMBE.

By His Excellency's Command,

R. J. HAMER,
Minister for Local Government.

GOD SAVE THE QUEEN !

Public Service Act 1958.

ALTERATION OF DAY APPOINTED A PUBLIC HOLIDAY IN THE SHIRE OF GISBORNE.

PROCLAMATION

By the Lieutenant-Governor as Deputy for His Excellency the Governor of the State of Victoria and its Dependencies in the Commonwealth of Australia, &c., &c., &c.

WHEREAS by sub-section (1) of section 67 of the *Public Service Act 1958*, Thursday, the twenty-fifth day of September, 1969, shall be observed as a public holiday throughout the municipalities mentioned in the Fourth Schedule to the said Act, including the Shire of Gisborne:

And whereas it is made to appear to me expedient that the said day should not be a public holiday throughout the Shire of Gisborne:

Now therefore I, the Lieutenant-Governor as Deputy for the Governor of the State of Victoria, in the Commonwealth of Australia, by and with the advice of the Executive Council of the said State, and in pursuance of the provisions of sub-section (3) of Section 67 of the *Public Service Act 1958*, do by this my Proclamation declare that the said day shall not be a public holiday throughout the Shire of Gisborne and appoint Wednesday, the twenty-fourth day of September, 1969, to be a public holiday throughout the Shire of Gisborne.

Given under my Hand and the Seal of the State of Victoria aforesaid, at Melbourne, this twenty-fourth day of June, in the year of our Lord One thousand nine hundred and sixty-nine, and in the eighteenth year of the reign of Her Majesty Queen Elizabeth II.

(L.S.) E. F. HERRING.

By His Excellency's Command,
MURRAY PORTER,
Acting Chief Secretary.

GOD SAVE THE QUEEN!

GOVERNMENT NOTICES

MELBOURNE WHOLESALE FRUIT AND VEGETABLE MARKET ACT 1968.

APPOINTMENT OF FRUIT AND VEGETABLE MARKETING ADVISORY COMMITTEE.

I, GILBERT LAWRENCE CHANDLER, Minister of Agriculture for the State of Victoria hereby give notice that in accordance with the provisions of sections 14 and 15 of the *Melbourne Wholesale Fruit and Vegetable Market Act 1968*, I have appointed the under-mentioned persons as members of the Fruit and Vegetable Marketing Advisory Committee for a term of three years from and inclusive of the 2nd July, 1969:—

ROBERT S. HARPER, Chief, Division of Horticulture (Chairman) (Representing the Department of Agriculture).

HYMAN HYMAN, of 406A Dandenong-road, Caulfield (Representing the interests of wholesale fruit merchants).

JAMES QUINN, of 26 Livingstone-street, Ivanhoe (Representing the interests of wholesale vegetable merchants).

AMATO VARAPODIO, 37 South-avenue, Moorabbin (Representing the interests of wholesale fruit and vegetable commission agents).

EDWARD J. TAYLOR, of Moorooduc, and BERNARD J. BURGI, of Wandin North (Jointly representing the interests of fruitgrowers resident within a radius of 100 miles from the post office at the corner of Bourke and Elizabeth streets, Melbourne).

LESLIE W. ALLEN, of Fern Tree Gully-road, Wheeler's Hill, and KENNETH C. MARRIOTT, of Boundary-road, Heatherton (Jointly representing the interests of vegetable growers resident within a radius of 100 miles from the post office at the corner of Bourke and Elizabeth streets, Melbourne).

ROCCO FRANZONI, of 1 Elora-road, South Oakleigh (Representing the interests of retail fruiterers and greengrocers).

ARTHUR J. JONAS, of 17 Tormey-street, North Balwyn (Representing the interests of buyers of fruit and vegetables other than retail fruiterers and greengrocers).

ERNEST H. JOHNSON, of Iraak, via Red Cliffs (Representing the interests of fruit and vegetable growers resident beyond a radius of 100 miles from the post office of the corner of Bourke and Elizabeth streets, Melbourne).

ERNEST G. A. HUMPHRIS, of Cardigan-road, Mooroolbark (Representing the interests of flowergrowers and nurserymen).

I have appointed PETER M. WILSON, an officer of the Department of Agriculture, to be Secretary to the Committee.

27th June, 1969.

G. L. CHANDLER,
Minister of Agriculture.

SHIRE OF ORBOST.

ROAD DEVIATION ORDER.

Order of the Council of the Shire of Orbost pursuant to Section 522 of the Local Government Act 1958.

PURSUANT to the provisions of sections 522 and 526 of the *Local Government Act 1958*, the Council of the Shire of Orbost hereby orders and directs that the land being part of Crown allotment 5, section 3, Township and Parish of Newmerella, County of Tambo, being part of the land described in certificate of title, volume 3422, folio 351, indicated by hatching on the diagram annexed hereto which has been purchased taken or acquired by it, shall be a public highway on and from the date of publication of this Order in the *Government Gazette*, and declares that the said land shall be a public highway in lieu of the land indicated by cross hatching on the diagram hereunder, such last-mentioned land being part of the land in the said Parish.

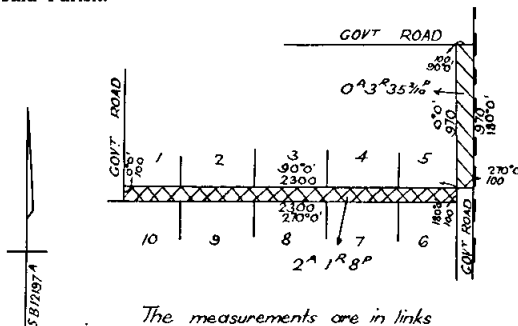

Resolution for making this Order was passed by a majority of the whole number of Members of the Council on the fourteenth day of July, 1967.

The common seal of the President, Councillors and Citizens of the Shire of Orbost was affixed hereto, this fourteenth day of July, 1967, in the presence of—

(SEAL) E. W. JOHNSTON, President.
J. D. TORLEY, Councillor.
R. G. HEWSON, Secretary.

Confirmed by the Governor in Council, 24th June, 1969.—
J. ROSSITER, Clerk of the Executive Council.

GEE LONG REGIONAL LIBRARY SERVICE.

NOTICE OF APPROVAL OF AGREEMENT.

THE agreement made between the Mayor, Councillors and Citizens of the City of Geelong, the President, Councillors and Ratepayers of the Shire of Corio and the President, Councillors and Ratepayers of the Shire of Werribee for the provision of a joint library service in the municipal districts of the said municipalities was approved by the Governor in Council pursuant to the provisions of section 799 of the *Local Government Act 1958*, on the 24th day of June, 1969.

J. ROSSITER,
Clerk of the Executive Council.

At the Executive Council Chamber,
Melbourne, 24th June, 1969.

State Electricity Commission Acts.

STATE ELECTRICITY COMMISSION OF VICTORIA.

ELECTRICAL APPROVALS BOARD.

IN accordance with the requirements of the Electrical Approvals Regulations—Proceedings of Electrical Approvals Board, the State Electricity Commission of Victoria hereby gives notice that the following appointment has been made pursuant to the provisions contained in section 51 of the *State Electricity Commission Act 1958*, and the said Regulations, viz.:—

HAROLD WILLIAM REYNOLDS,
as Deputy of the Chairman of the Electrical Approvals Board,
with effect from 1st July, 1969.

Dated the thirtieth day of June, 1969.

F. P. CHIPPERFIELD,
Secretary.

Transport Regulation Act.
TRANSPORT REGULATION BOARD.
HEARING OF APPLICATIONS.

NOTICE is hereby given that the following applications will be considered by the Transport Regulation Board at its offices at the corner of Lygon and Princes streets, Carlton, at 10.15 a.m., on Wednesday, 23rd July, 1969.

DREW, G. O., 362 Thompsons-road, Lower Templestowe. One commercial passenger vehicle (S/C. 5) to operate for the carriage of passengers and equipment from the first car park on Lake Mountain to the summit of Lake Mountain during the snow season.

TIME-TABLE.
Saturdays, Sundays and Public Holidays between 8.00 a.m. and 6.00 p.m.

Fares.

First car park to summit, \$1.

KARAKATSANIS, M., 48 Leicester-street, West Preston. Application for a required number of commercial passenger vehicles with large seating capacity to be purchased to operate as metropolitan stage omnibuses on a route as follows:—

City—Fairfield.—Commencing at the corner of Dudley and William streets; thence via William, Howard, Courtney, Errol, Gatehouse streets, College-crescent, Cemetery-road, Princes-street, Alexandra-parade, Eastern Freeway, Chandler Highway, Grange-road, Christmas-street, Fulham-road, Steane-street to Grange-road.

Sections.

1. Corner Dudley and William streets—corner Courtney and Errol streets.
2. Corner Courtney and Errol streets—corner Gatehouse-street and Royal-parade.
3. Corner Gatehouse-street and Royal-parade—corner Cemetery-road and Lygon-street.
4. Corner Cemetery-road and Lygon-street—corner Alexandra-parade and Brunswick-street.
5. Corner Alexandra-parade and Brunswick-street—corner Alexandra-parade and Gold-street.
6. Corner Alexandra-parade and Gold-street—Eastern Freeway and Merri Creek.
7. Eastern Freeway and Merri Creek—Eastern Freeway and Yarra River.
8. Eastern Freeway and Yarra River—corner Chandler Highway and Yarra Boulevard.
9. Corner Chandler Highway and Yarra Boulevard—corner Grange-road and Wingrove-street.
10. Corner Grange-road and Wingrove-street—corner Grange-road and Sheane-street.

Fares to be Charged.

Sections.										
1	2	3	4	5	6	7	8	9	10	
7c	12c	14c	15c	16c	17c	18c	19c	20c	21c	

TIME-TABLE.

Monday—Friday.

6.00 a.m.—8.00 a.m.: 20-minute frequency.
8.00 a.m.—10.30 p.m.: 30-minute frequency.

Saturday.

6.00 a.m.—10.30 p.m.: 20-minute frequency.

Sunday and Public Holidays.

6.00 a.m.—10.30 p.m.: 30-minute frequency.

BARNES COACHES (SUNSHINE) PTY. LTD., 39 Fraser-street, Sunshine. One commercial passenger vehicle with large seating capacity to operate as a metropolitan stage omnibus on a route commencing in Sun-crescent at Sunshine Railway Station via Sun-crescent, the Overpass, Station-street, Monash-street, Cornwall-road, Devonshire-road, Churchill-avenue, Curtin-street, Richelieu-street, Burns-street, Sonley-street, Babb-street, Richelieu-street and Curtin-street to normal route.

Sections and Fares.

Sections.	Fare.
Sun-crescent to—	
1. Corner Devonshire-road and Duke-street	7c
2. Corner Churchill-avenue and Melon-street	12c
3. Corner Sonley and Babb streets	14c

TIME-TABLE.

Monday—Friday.

Tentatively 30 minutes between 6.00 a.m. and 7.30 p.m.

Saturday.

Tentatively 30 minutes between 7.00 a.m. and 7.00 p.m.

Sunday.

Tentatively 30 minutes between 9.00 a.m. and 7.30 p.m.

BONO, FRANK, PTY. LTD., 53 Wattle-road, Maidstone. Application for a required number of commercial passenger vehicles with large seating capacity to operate as metropolitan stage omnibuses on a route as follows:— East Keilor to Sunshine, via Avondale Heights, Maribyrnong and Braybrook. Commencing at the corner of Dinah-parade and Milleara-road, East Keilor; thence via Milleara and North roads, Doyle-street, Mountain View-avenue, Skewes-street, Ridley-avenue, Doyle-street, Rogerson-street, Military-road, Canning-street, Cordite-avenue, Wests and Hampstead roads, Mitchell-street, Churchill-avenue, Churchill Highway, Devonshire-road, Gertrude and Dickson streets and Sunshine Round-about to a stand west side of Hampshire-road adjacent to the Sunshine Railway Station.

TIME-TABLE.

Monday to Friday.

6.30 a.m.—6.30 p.m.: 30-minute frequency.

Saturday.

6.30 a.m.—1.00 p.m.: 30-minute frequency.
1.00 p.m.—6.30 p.m.: 60-minute frequency.

Sunday and Public Holidays.

7.00 a.m.—6.30 p.m.: 60-minute frequency.

Sections and Fares.

To be determined.

MELBOURNE & METROPOLITAN TRAMWAYS BOARD, 616 Little Collins-street, Melbourne. Application for authority, pursuant to section 33 (1) of the Transport Regulation Act, No. 6400, to operate an extension of the Footscray-Ballarat road bus route from the present terminus at the corner of Ballarat and Summerhill roads, via Summerhill-road, Suffolk-road, Richelieu-street, Curtain-street, Churchill-avenue; thence via either Duke-street or Cornwall-road to Monash-street; thence via Monash-street, Station-street and the Overpass to a stand in Sun-crescent adjacent to the Sunshine Market.

Sections and fares to be determined.

TIME-TABLE.

6.30 a.m. to 7.00 p.m.

Peak hours—12 minute service.

Off peak hours—30 minute service.

LUCAS, W. C. (executor of estate of late C. Lucas), Maddox-road, Newport. Application for variation of M.O. licence conditions on route 106A (Newport—North Altona, via Blackshaws-road) to extend service from corner Blackshaws-road and Knapp-street, via Blackshaws-road to corner Blackshaws and Geelong roads.

McDOWALL, J. L., 20 Barber-street, Pyramid Hill. One commercial passenger vehicle (S/C. 37) to operate for the carriage of school children only between Yarrowalla East and Pyramid Hill, under contract to the Education Department.

MCHARRY, A. M. & N. J., 23 Catherine-street, Geelong West. One commercial passenger vehicle (S/C. 45) to operate as follows:—(a) Under the same terms and conditions as Permit No. 42191. (b) Under the same terms and conditions as all C.O. licences held in the name of Geelong Associated Buslines Pty. Ltd.

SITCH BUS SERVICES PTY. LTD., Service-street, Sunshine. Application for a required number of commercial passenger vehicles each with large seating capacity to operate as metropolitan stage omnibuses on a route from Sunshine Railway Station, via Hampshire-road, Devonshire-road, Churchill-avenue, Curtin-street, Richelieu-street, Burns-street, Sonley-street, Babb-street, Richelieu-street and Curtin-street to normal route.

Sections and Fares.

Sections.	Fare.
Sunshine Railway Station to—	
1. Corner Duke-street and Devonshire-road	7c
2. Corner Vine-street and Churchill-avenue	12c
3. Sonley-street	14c

TIME-TABLE.

Monday—Saturday.

Proposed service 6.00 a.m.—7.00 p.m. frequency to be determined.

Sunday.

Proposed service 1.00 p.m.—7.00 p.m. frequency to be determined.

YOUNG, C. F. W., 5 McDowell-street, Mitcham. Application for variation of all C.O. licence conditions on Route 207A, Part (c) (Mitcham—East Vermont) to extend service from the corner of Centre-road and Blanche-drive to the corner of Luske-drive and Boronia-road, via Centre-road, Graeme and Cosgrove streets and Luske-drive. Return trip to be operated via Boronia and Centre roads.

APPLICATIONS for renewal of licences as shown, by persons listed hereunder to operate under the same terms and conditions.

DYSON'S BUS SERVICE PTY. LTD., 753 Plenty-road, Reservoir; M.C. 602 and M.C.608.

QUINCE'S SCENICRUISERS PTY. LTD., 64 Ardyne-street, Murrumbidgee; M.C.5.

MELBOURNE MOTOR COACH SERVICE PTY. LTD., 207 New-street, Brighton; M.C.257.

Notice of any objection should be forwarded to reach the Secretary of the Board not later than Wednesday, 16th July, 1969.

Applicants are advised that it will not be necessary to appear on the hearing date specified above, unless advised, in writing, by the Board.

B. P. KAY.
Secretary.

Corner Lygon and Princes streets, Carlton, Wednesday, 2nd July, 1969.

Commercial Goods Vehicles Act.
TRANSPORT REGULATION BOARD.

HEARING OF APPLICATIONS.

NOTICE is hereby given that the following applications will be considered by the Transport Regulation Board at its offices at the corner of Lygon and Princes streets, Carlton, at 10.15 a.m., on Wednesday, 23rd July, 1969.

ANTONE, W. C., 529 William-street, Albury, N.S.W., 2640. Application to vary the conditions of licence No. D.T.1158 (L/C. 324 cwt.) by adding as an additional paragraph (b)—“(b) From forest landings situated within a 20-mile radius of Sandy Creek to the Rutherglen Timber Co. at Rutherglen—logs.”

ASQUITH, E. F., 278 White-road, Wonthaggi, 3995. Application to vary the conditions of licence No. D.A.41550/1 (L/C. 53 cwt.) by—(i) Deleting from paragraph (a) “within a 50-mile radius” and adding in lieu—“within an 80-mile radius” and (ii) By deleting from paragraph (b) “within a 15-mile radius” and adding in lieu—“within a 20-mile radius”.

AUSTRALIAN GYPSUM LTD., 350 La Trobe-street, Melbourne, 3000. Application to vary the conditions of licences numbered D.A.46341, D.A.46341/1, D.A.46341/2 and D.A.46341/3 (L/C. 199, 216, 195, 198 cwt.) by adding after Maryborough “and Ararat” and also an additional paragraph (b)—“(b) From own premises at Port Melbourne to consignees situated within paragraph (a) above—own special plaster (not to exceed 6 bags) two rolls of wire mesh and up to ½ cwt. of nails.”

BARCLAY, A. J., 88 Scott-street, Beaumaris, 3193. One commercial goods vehicle (L/C. 11 cwt.) to operate within a 50-mile radius of the G.P.O., Melbourne as a “Supervisor” employed by South Coast Fabricating and Engineering Pty. Ltd. of Frankston—tools of trade and a small quantity of materials incidental to companies engineering contracts.

BARRAH, H. W. (trading as H. & I. Barrah), 5 Magdalen-street, Pascoe Vale South, 3044. One commercial goods vehicle (L/C. 159 cwt.) to operate within a 50-mile radius of the premises of Albion Reid Pty. Ltd. at Hawthorn solely on behalf of the said company—premixed concrete in a specially constructed agitator vehicle.

BERGMEIER, R. J., Foster-road, Meeniyah, 3956. One commercial goods vehicle (L/C. 291 cwt.) to operate: (a) Within a 100-mile radius of the post office at Meeniyah in the course of business as “Earth-moving Contractor”—own bulldozer and own earth-moving equipment and fuel sufficient for own operational purposes only (not to exceed three 44 gallon drums). (b) Within a 50-mile radius of the post office at Meeniyah—earth-moving equipment and machinery on behalf of other contractors.

BRANDT, H. P., Flat 4, 20 Payne-street, Caulfield, 3162. One commercial goods vehicle (L/C. 7 cwt.) to operate throughout the State of Victoria in the course of business as “Remote Control Installer” solely on behalf of Arens Universal Controls—own tools of trade and testing equipment, remote control systems for installation, repair or having been repaired.

BURGE, E. G., 45 Koronia-street, Belmont, 3216. One commercial goods vehicle (L/C. 137 cwt.) to operate: (a) Within a 25-mile radius from the chief post office in the City of Geelong—general goods. (b) From and to places situated within the radius as defined in paragraph (a) above to and from places situated within a 50-mile radius from the post office at Geelong—livestock.

COSTELOW, G. V., 56 Cooper-avenue, North Altona, 3025. One commercial goods vehicle (L/C. 258 cwt.) to operate: (a) Within a 25-mile radius of the post office situated at the corner of Bourke and Elizabeth streets in the City of Melbourne on behalf of Pronto Mixed Concrete Pty. Ltd.—sand and screenings. (b) From pits at the You Yangs to plants of Pronto Mixed Concrete Pty. Ltd. situated within a 25-mile radius of the post office at the corner of Bourke and Elizabeth streets in the City of Melbourne—sand and gravel.

ENGLAND, P. J., Flat 1, 15 Gould-street, Frankston, 3199. One commercial goods vehicle (L/C. 6 cwt.) to operate within a 50-mile radius of the G.P.O., Melbourne, as a “Supervisor” employed by South Coast Fabricating and Engineering Pty. Ltd. of Frankston—tools of trade and a small quantity of materials incidental to companies engineering contracts.

ETHERIDGE & CONDER PTY. LTD., 120 Lydiard-street, Ballarat, 3350. One commercial goods vehicle (L/C. 11 cwt.) to operate within that part of the State of Victoria west of a north/south line drawn through Myrning and south of an east/west line drawn through Castlemaine in the course of business as “Electrical Appliance Serviceman”—tools of trade, spare parts and washing machines for repair or having been repaired.

GIACOMINI, J., 127 Dunne-street, Kingsbury, 3083. One commercial goods vehicle (L/C. 193 cwt.) to operate within a 50-mile radius of the premises of Pronto Mixed Concrete Co. Pty. Ltd. at Footscray solely on behalf of the said company—premixed concrete in a specially constructed agitator vehicle.

GOOCH, N. V., 2 Butler-street, Doveton, 3177. One commercial goods vehicle (L/C. 140 cwt.) to operate within a 35-mile radius of the G.P.O., Melbourne, solely on behalf of Consolidated Quarries Ltd.—screenings, stone dust and quarry products.

SHEARS, D. S. (trading as E. D. Greenfield & Co.), Maroondah Highway, Lilydale, 3140. One commercial goods vehicle (L/C. 53 cwt.) to operate: (a) Within a 25-mile radius of own premises at Lilydale in course of business as “Primary Producers and Produce Merchants”—own goods. (b) Within a 50-mile radius of the premises of Pict Ltd. at Notting Hill—waste vegetable material.

KENNEDY, G. A., Collingwood-street, Apollo Bay, 3233. One commercial goods vehicle (L/C. 14 cwt.) to operate: (a) Within a 50-mile radius of the post office at Apollo Bay in the course of business as a “Café Proprietor and Fishing Boat Lessor”—own goods. (b) From the Township of Apollo Bay to the Cities of Geelong and Melbourne—fresh crayfish from own leased fishing boats. (c) From and to the Township of Apollo Bay, from and to the Cities of Geelong and Melbourne, spare parts and equipment for repair or having been repaired and new parts and equipment for vessels owned and leased by the applicant. (d) From the City of Geelong to the Township of Apollo Bay—general fish café requirements for use and sale in own shop.

MILLER, K. C., care of Post Office, Forrest, 3236. Application to vary the conditions of licences numbered D.T.587, D.T.587/1 (L/C. 264, 251 cwt.) by deleting the existing conditions and adding in lieu—“(a) From J. Sharpe & Sons Sawmills and the Otway Sawmills at Forrest to the Birregurra Railway Yards and to consignees within the Geelong Urban Area and to consignees within the Geelong Urban Area —sawn timber. (b) From John Sharpe and Sons Pty. Ltd. and the Otway Sawmills at Forrest to consignees at Anglesea, Torquay, Barwon Heads, Ocean Grove, Point Lonsdale, Queenscliff, St. Leonards, Portarlington and Drysdale—sawn timber. (c) On behalf of Otway Sawmills and Frizon and Sons Sawmills from bush landings on the Otway Ranges within a 20-mile radius of Forrest to Kennett River and Forrest—logs. (d) Within a 20-mile radius of the post office at Forrest—general goods.”

MORGAN, G., Sayle-street, Sebastopol, 3356. One commercial goods vehicle (L/C. 56 cwt.) to operate: (a) Throughout the State of Victoria in the course of business as “Marine Collector”—special wares, marine stores and old metals as defined in the Marine Stores and Old Metals Act 1958 (No. 6303), Part 1, section 3, but excluding the carriage of any such Marine Stores or Old Metals to wharves, docks or ships for shipment or export purposes with the proviso that the combined load capacity of both prime mover and any trailer attached thereto shall not exceed 120 cwt. (b) Within a 25-mile radius of the chief post office in the City of Ballarat—general goods.

- PERMEWAN WRIGHT LTD., 147 Alexandra-parade, Abbotsford, 3067. One commercial goods vehicle (L/C. 10 cwt.) to operate: (a) Within a 50-mile radius of own premises at Sale in the course of business as "General Merchants"—own goods. (b) Within a 50-mile radius of own premises at Sale on behalf of H. C. Sleigh Ltd.—petroleum products in prescribed types of containers and empty containers for return.
- PINDER, C. R., 24 Benson-street, Benalla, 3672. Application to vary the conditions of licence No. D.A.62474 (L/C. 15 cwt. and 30 cwt. trailer) by deleting from paragraph (a) "own goods" and adding in lieu "polished and/or dressed stone."
- R.T. BRICK Co., a Division of Glen Iris Brick Holdings Ltd., Trawalla-avenue, Campbellfield, 3061. Twelve commercial goods vehicles (L/C. 145, 145, 176, 176, 189, 189, 190, 190, 192, 192, 194, 194 cwt.) to operate in the course of business as "Brick Manufacturers"—(a) Within a 20-mile radius of the post office at Campbellfield—own goods. (b) Within a 70-mile radius of own premises at Campbellfield—bricks.
- READY MIXED CONCRETE (Vic.), 68 Burwood-road, Burwood, 3125. One commercial goods vehicle (L/C. 366 cwt.) to operate within a 25-mile radius of the post office at the corner of Bourke and Elizabeth streets, in the City of Melbourne and also from and to own plant at Crib Point in the course of business as "Concrete Manufacturers"—own bulk cement in a specially-constructed bulk vehicle.
- REARDON, J. B., 63 James-street, Fawkner, 3060. One commercial goods vehicle (L/C. 65 cwt.) to operate throughout the State of Victoria in the course of business as "Travelling Showman"—own sideshow equipment and novelty prizes.
- SCOLYER, A., 6 High-street, Eaglehawk, 3556. One commercial goods vehicle (L/C. 15 cwt. and trailer) to operate: (a) Within that part of the State of Victoria bounded by a line drawn from Cobram through Kilmore, Ballarat, Horsham, Hopetoun and Swan Hill and to and from Melbourne and Dandenong in the course of business as "Scrap Tyre Dealer"—scrap tyres. (b) Within a 50-mile radius of the chief post office in the City of Bendigo in the course of business as "Drum Dealer"—second-hand drums.
- SOTIROPOULOS, T., 66 Islington-street, Collingwood, 3066. One commercial goods vehicle (L/C. 124 cwt.) to operate within a 35-mile radius of the G.P.O., Melbourne, solely on behalf of "Consolidated Quarries Ltd."—sand, soil, screenings, premix and hot asphalt.
- SPITERI, E., 17 Basil-street, Fawkner, 3060. One commercial goods vehicle (L/C. 142 cwt.) to operate within a 70-mile radius of the premises of Atlas Industries Australia Ltd. at Springvale, solely on behalf of the said company—roof tiles and tile battens.
- T.R. SERVICES PTY. LTD., 497-499 Queensberry-street, North Melbourne, 3051. One commercial goods vehicle (L/C. 6 cwt.) to operate throughout the State of Victoria in the course of business as "Telephone Communication Engineers" for the purposes of servicing telephone equipment—tools of trade, spare parts, telephone equipment for repair or having been repaired and materials incidental thereto.
- TIMOR ENTERPRISES PTY. LTD., 34 Tibrockney-street, Highett, 3190. One commercial goods vehicle (L/C. 11 cwt.) to operate throughout the State of Victoria in the course of business as "Boring Contractors" for the purpose of servicing and maintenance of own equipment—tools of trade, spare parts and materials incidental to servicing and maintenance.
- TRICKEY, L. A., 44-46 High-street, Kyneton, 3444. One commercial goods vehicle (L/C. 14 cwt.) to operate: (a) Within a 50-mile radius of the post office at Kyneton in the course of business as "Dry Cleaner"—articles for laundering or dry-cleaning or having been laundered or dry-cleaned. (b) From Broadford to own premises at Kyneton—own dry-cleaning chemicals and coat hangers.
- WARREN & MACMAHON, Queenscliffe-road, Leopold, 3221. One commercial goods vehicle (L/C. 67 cwt.) to operate in the course of business as "Joinery Manufacturers and Builders"—(a) Within a 50-mile radius of own premises at Leopold—own goods. (b) Throughout the State of Victoria for the purpose of completing own contracts—workmen's huts, tools of trade, builders' gear and equipment, glazed fittings and highly polished wooden fittings and fitments. (c) Within a 20-mile radius of any contract site or from the nearest railway station thereto—materials required for such contracts.
- WIFFEN, F. G., 6 Fenwick-street, Portarlington, 3228. One commercial goods vehicle (L/C. 172 cwt.) to operate within a 50-mile radius of the chief post office in the City of Geelong—premixed concrete in a specially-constructed agitator vehicle solely on behalf of Pioneer Concrete (Vic.) Pty. Ltd.
- WODONGA SMASH REPAIRS PTY. LTD., 34 Hovell-street, Wodonga, 3690. One commercial goods vehicle (L/C. 8 cwt. and 25 cwt. trailer) to operate within a 50-mile radius of own premises at Wodonga in the course of business as "Panel Beater"—wrecked or damaged motor vehicles for repair on a specially-constructed car-carrying trailer, but excluding the carriage of any such vehicles from the scene of an accident.
- WORLD WIDE MOTORS PTY. LTD., Lime-avenue, Mildura, 3500. One commercial goods vehicle (L/C. 29 cwt.) to operate within a 100-mile radius of own premises at Mildura in course of business as "Motor Car and Farm Machinery Distributors"—motor cars and tractors for repair or having been repaired.

RENEWALS.

APPLICATIONS for renewal of licences as shown by persons listed hereunder to operate under the same terms and conditions from the expiry shown in each case.

- AGORIANITIS, K., 96 Yarra-street, Abbotsford, 3067; D.A.56608; 16th August, 1969; 122 cwt.
- ASCOM PTY. LTD., 63 Queens Bridge-street, South Melbourne, 3205; D.A.34589/10; 4th September, 1969; 24 cwt.; D.A.34589/11; 4th September, 1969; 11 cwt.; D.A.34589/33; 14th September, 1969; 18 cwt.
- ASCOM PTY. LTD., 63 Queens Bridge-street, South Melbourne, 3205; D.A.34589/42; 6th September, 1969; 19 cwt.; D.A.34589/43; 6th September, 1969; 23 cwt.; D.A.34589/44; 6th September, 1969; 23 cwt.
- ASSOCIATED DIAMOND DRILLERS PTY. LTD., 64 Bell-street, Preston, 3072; D.A.43371; 13th June, 1969; 14 cwt.; D.A.43371/1; 13th June, 1969; 13 cwt.
- BOYER, C. H., 3 Wheatley-street, Kyneton, 3444; D.A.43421; 19th June, 1969; 127 cwt.
- BRASHES PTY. LTD., 108 Elizabeth-street, Melbourne, 3000; D.A.56978; 27th September, 1969; 13 cwt.
- CENTURY STORAGE BATTERY CO. PTY. LTD., 288 Macaulay-road, North Melbourne, 3051; D.A.11772/1; 27th September, 1969; 9 cwt.
- COMMONWEALTH INDUSTRIAL GASES LTD., THE, 90 Bell-street, Preston, 3072; D.A.838/22; 23rd September, 1969; 10 cwt.
- DICKENS, S. E., PTY. LTD., 16 Nicholson-street, East Brunswick, 3057; D.A.28229/3; 23rd September, 1969; 11 cwt.
- GARDNER, A. J. (trading as L. Gardner Bros.), Private Bag 125, Colac, 3250; D.A.53155/2; 26th July, 1969; 151 cwt.
- HARBOUR, R., Yendon, 3332; D.A.30462; 16th September, 1969; 114 cwt.
- SHERR, M. B. (trading as Harpers Drapery Supply), 6 Carrington-grove, East St. Kilda, 3183; D.A.56438; 19th July, 1969; 10 cwt.
- HILLGROVE, A. D., P.O. Box 176, Birchip, 3488; D.A.1302/1; 29th August, 1969; 290 cwt.
- HOWLETT, R. M., Dergholm, 3312; D.A.44431; 11th September, 1969; 12 cwt.
- KEATTE, P. M., 9 Abbot-court, Glen Waverley, 3150; D.A.56916; 14th September, 1969; 122 cwt.
- LONERGAN AUTOS PTY. LTD., 2 Punt-road, Cobram, 3644; D.A.45042; 11th September, 1969; 46 cwt.
- LUMSDEN, J. C., & SON, White-road, Warrambool, 3280; D.A.33360/1; 27th September, 1969; 122 cwt.
- MANSFIELD, R. H., 36 Windsor-avenue, Strathmore, 3041; D.A.56687; 23rd September, 1969; 136 cwt.
- MAYNE NICKLESS LTD., Foster-street, Ballarat, 3350; D.A.19753/10; 27th September, 1969; 239 cwt.; D.A.19753/11; 27th September, 1969; 229 cwt.; D.A.19753/12; 27th September, 1969; 228 cwt.; D.A.19753/13; 27th September, 1969; 240 cwt.; D.A.19753/14; 27th September, 1969; 264 cwt.; D.A.19753/15; 27th September, 1969; 239 cwt.; D.A.19753/17; 27th September, 1969; 284 cwt.; D.A.19753/18; 27th September, 1969; 132 cwt.; D.A.19753/19; 27th September, 1969; 229 cwt.
- MEADE, W. E., 422 Main-street, Bairnsdale, 3875; D.A.3617; 21st September, 1969; 56 cwt.
- MILDURA QUARRIES & READY MIXED PTY. LTD., Scott-crescent, Mildura, 3500; D.A.40758/8; 14th September, 1969; 206 cwt.
- MURNANE, K. M., 30 Water-street, Ballarat, 3350; D.A.44453; 11th September, 1969; 78 cwt.
- MCKAY MACLEOD PTY. LTD., 63-73 Mair-street, Ballarat, 3350; D.A.8150; 28th September, 1969; 141 cwt.
- MCKENZIE & HOLLAND (AUSTRALIA) PTY. LTD., Stephenson-street, Spotswood, 3015; D.A.42575/1; 4th September, 1969; 11 cwt.

O'DONNELL BROS., TYRE SERVICE PTY. LTD., 90 Kepler-street, Warrnambool, 3280; D.A.30833; 16th September, 1969; 14 cwt.

OXLEE, J. D., Cave Hill, Lilydale, 3140; D.A.56982; 27th September, 1969; 137 cwt.

PEACH, R. J. (trading as Peach's Transport), High-street, Macarthur, 3286; T.D.A.1788; 1st September, 1969; 159 cwt.

POOWONG BUTTER FACTORY PTY. LTD., 141 Osborne-street, South Yarra, 3141; D.A.55740/2; 16th August, 1969; 196 cwt.; D.A.55740/5; 16th August, 1969; 108 cwt.; D.A.55740/6; 16th August, 1969; 14 cwt.

ROWE, F. C., Katunga, 3640; D.A.44441; 11th September, 1969; 84 cwt.

SIDES, W. L., & SON PTY. LTD., P.O. Box 228, Clayton, 3168; D.A.28601/12; 17th September, 1969; 78 cwt.

TONISSEN, L. J., Box 27, Tarrington, 3301; D.A.44068; 14th August, 1969; 306 cwt.

WALSH, J. & W. & K., 239 Scott-parade, Ballarat, 3350; D.A.57103; 27th September, 1969; 55 cwt.

WARRACK TYRE & RUBBER CO. PTY. LTD., 761 Scott-street, Warracknabeal; D.A.15063/2; 23rd September, 1969; 11 cwt.

WRIGHT, N. Y., 426 Balcombe-road, Beaumaris, 3193; D.A.55794; 21st June, 1969; 132 cwt.

YOUNGS READY MIX PTY. LTD., 182 High-street, Shepparton, 3630; D.A.33594/6; 17th September, 1969; 209 cwt.

TOW TRUCK RENEWAL.

AUBURN AUTOMOBILE TOWING SERVICE, 529 Burwood-road, Hawthorn, 3122; D.A.36814/3; 14th September, 1969; 30 cwt.

RENEWALS WITH VARIATION.

APPLICATIONS by the persons listed hereunder for renewal of the licences listed with variation of conditions in the manner set out opposite the names.

BLENCOWE, R. R., 15 Stud-road, Dandenong, 3175; D.A.44450; 17th September, 1969; Application to renew and vary the conditions of licence No. D.A.44450 (L/C. 144 cwt.) by deleting the existing conditions and adding in lieu—"Within a 35-mile radius of G.P.O., Melbourne on behalf of Consolidated Quarries Ltd.—screenings, stone dust, hot asphalt and quarry products.

HILLGROVE, A. D., P.O. Box 176, Birchip, 3483; D.A.1302/14; 23rd August, 1969; Application to renew and vary the conditions of licence No. D.A.1302/14 (L/C. 18 cwt.) by deleting the existing conditions and adding in lieu:—"Throughout the State of Victoria for the purpose of servicing and maintaining own earthmoving equipment in the course of business of the licence holder as 'Earth-moving Contractor'—tools of trade, spare parts and materials incidental thereto but excluding the carriage of any goods from the area within a 20-mile radius of the post office situated at the corner of Bourke and Elizabeth streets, Melbourne".

KUMMER, I. H., 13 Rose-avenue, Bulleen, 3105; D.A.44487; 17th September, 1969; Application to renew and vary the conditions of licence No. D.A.44487 (L/C. 10 cwt.) by deleting "washing machines for installation" and adding in lieu "lawn mowers and space heating".

Notice of any objection should be forwarded to reach the Secretary of the Board not later than 16th July, 1969.

Applicants are advised that it will not be necessary to appear on the hearing date specified above, unless advised in writing by the Board.

B. P. KAY,
Secretary.

Corner Lygon and Princes streets, Carlton, 3053, Friday, 27th June, 1969.

HERNE'S OAK WATERWORKS TRUST.

AUTHORITY TO OBTAIN BANK OVERDRAFT.

HIS Excellency the Governor of the State of Victoria, by and with the advice of the Executive Council thereof doth by Order made on the 1st day of July, 1969, authorize the Herne's Oak Waterworks Trust to obtain in pursuance of the provisions of section 286 of the Water Act 1958 (No. 6413) an advance or advances during the year 1969, by overdraft of the Trust's current account, such overdraft not to exceed at any one time the sum of One thousand dollars (\$1,000).

J. ROSSITER,
Clerk of the Executive Council.

At the Executive Council Chamber,
Melbourne, 1st July, 1969.

RUTHERGLEN WATERWORKS TRUST.

BY-LAW No. 4.

THE Rutherglen Waterworks Trust in pursuance of and in exercise of the powers conferred by the Water Act 1958 and of any and every other power it thereunto enabling doth hereby make a By-law as follows:—

1. The meter or meters measuring the supply of water to any land or tenement shall be read as near as practicable to twelve months from the date that it was read previously and the quantity of water so measured as having been supplied during the period between any two successive such readings (hereinafter called "the meter year") shall be the basis of calculating charges payable under this By-law provided always that where a meter has been installed on any land or tenement during the course of a meter year the quantity of water measured as having been supplied during the period between the date of such installation and the date of the reading shall be the basis of calculating such charges.

2. Subject as is hereinafter provided in respect of any land or tenement rated by the Trust—

(a) The maximum quantity of water to be supplied in any meter year without charge is hereby fixed as a quantity which if charged at Fifteen cents per thousand gallons for any meter year would give an amount equal to the amount of the rate payable in respect of the land or tenement for the financial year in which the said meter year ended.

(b) For all water supplied in any meter year in excess of the maximum quantity referred to in paragraph (a) of this clause is hereby fixed at Fifteen cents per thousand gallons for any meter year.

3. Subject as is hereinafter provided the charge for water supplied by measure to any property not rated by the Trust is hereby fixed at Fifteen cents per thousand gallons.

4. The minimum charge for water supplied by measure to any property not rated by the Trust is hereby fixed at Fifteen dollars per annum.

5. The aforesaid charges shall be payable within seven days of demand upon the owner or occupier at the office of the Trust, Shire Hall, Rutherglen, during normal business hours.

6. The provisions of Clauses 3, 4 and 5 of this By-law shall not apply to any land tenement or property supplied with water by the Trust under a special agreement pursuant to Section 215 of the Water Act 1958.

Passed this 18th day of June, 1969.

(SEAL) A. N. WOODROFFE, Acting Chairman.
J. T. PARKIN, Commissioner.
W. J. McQUILLEN, Secretary.

Approved, 25th June, 1969.—JIM BALFOUR, Acting Minister of Water Supply.

RUTHERGLEN WATERWORKS TRUST.

RATING BY-LAW FOR THE YEAR 1969.

THE Rutherglen Waterworks Trust in pursuance of and in exercise of the powers conferred by the Water Act 1958 and of any and every other power it thereunto enabling doth hereby make a By-law as follows:—

1. The Trust hereby makes and levies a rate in respect of all the lands and tenements within the Rutherglen Urban District of Eleven cents in the dollar on the net annual value set out in the valuation at present in force of such lands and tenements for the purposes of the municipal rate of the Shire of Rutherglen which is hereby adopted as the valuation of such lands and tenements respectively.

2. Such rate shall be made and levied upon the occupiers and owners of such lands and tenements for the year commencing on the 1st day of January, 1969, and shall be payable on the 9th day of July, 1969, at the office of the said Trust, Shire Hall, Rutherglen.

3. In no case shall the rate payable hereunder in respect of any land on which there is a building be less than Eleven dollars and in respect of land on which there is no building be less than Seven dollars.

Passed this 18th day of June, 1969.

(SEAL) A. N. WOODROFFE, Acting Chairman.
J. T. PARKIN, Commissioner.
W. J. McQUILLEN, Secretary.

Approved, 25th June, 1969.—JIM BALFOUR, Acting Minister of Water Supply.

GEMBROOK, COCKATOO AND EMERALD
WATERWORKS TRUST.

BY-LAW No. 8.

THE Gembrook, Cockatoo and Emerald Waterworks Trust, in pursuance and exercise of the powers conferred by the Water Acts, doth hereby make the By-law following for its Waterworks District:—

By-law No. 6 made by the Gembrook, Cockatoo and Emerald Waterworks Trust on the 17th day of July 1968 is hereby amended as follows:—

In Clause 4 there shall be inserted after the words "Minimum Annual Charge" and before the words "house and land having an area not more than one acre \$20" the expression "House and land having an area not more than one half acre \$17."

The foregoing By-law was made by the Gembrook, Cockatoo and Emerald Waterworks Trust on the 18th day of June, 1969.

In witness thereof the Common Seal of the Gembrook, Cockatoo and Emerald Waterworks Trust was hereunto affixed in the presence of:—

(SEAL) J. G. HOSKING, Chairman,
W. J. PARSONS, Commissioner.
BEATRICE THOMAS, Secretary.

Approved, 25th June, 1969.—JIM BALFOUR, Acting Minister of Water Supply.

COLERAINE AND CASTERTON WATERWORKS TRUST.

RATING BY-LAW FOR THE YEAR 1969.

THE Coleraine and Casterton Waterworks Trust, in pursuance and exercise of the powers conferred by the Water Acts, doth hereby make a rate for the supply of water for domestic purposes of Eleven Cents in the Dollar on the annual municipal valuation of lands and tenements liable to be rated within the Coleraine Urban District, provided that in no case shall the amount of rate payable per annum in respect of any tenement (other than land on which there is no building) be less than \$15.00 and in respect of any land on which there is no building less than \$8.00.

Such rates are made and shall be levied upon the occupiers or owners of the said lands and tenements for the year commencing the 1st day of January 1969, and shall be payable on the 2nd day of July 1969, at the office of the said Trust.

The maximum quantity of water supplied in any one year without further charge to any property rated by the Trust is hereby fixed at the quantity produced by the charge of Twenty Cents per 1,000 gallons to the value of the rate.

The charge for water supplied to any property by the Trust in excess of such maximum quantity, is hereby fixed at Twenty Cents per 1,000 gallons.

The charge for water supplied by measure shall be payable, on demand, at the office of the Trust.

This By-Law shall apply to the Urban District of Coleraine as such District is proclaimed and defined in an order in Council bearing the date of 22nd June 1927.

Passed this 3rd day of April 1969.

(SEAL) PETER F. CRAM, Chairman.
J. R. HARGREAVES, Commissioner.
T. J. HOWLETT, Commissioner.
T. A. W. McBEAN, Secretary.

Approved, 25th June, 1969.—JIM BALFOUR, Acting Minister of Water Supply.

Survey Co-ordination (Place Names) Act No. 7360.

NOTICE OF INTENTION TO ALTER A NAME.

PURSUANT to the power conferred under section 28 of the above Act, the Place Names Committee hereby gives notice of its intention to alter the under-mentioned name:—

Municipality.—Shire of Kowree.

Present Name.—Telangatuk East.

Proposed Name.—Telangatuk.

Any person who objects to the proposed name may give notice of objection in writing stating the reasons therefor, to the Secretary of the Committee, not more than two months following the publication of this notice.

By order of the Committee,

C. E. E. BARLOW,
Secretary of the Place Names Committee.

Survey Co-ordination (Place Names) Act No. 7360.

NOTICE OF INTENTION TO OMIT A NAME.

PURSUANT to the powers conferred under section 28 of the above Act, the Place Names Committee hereby gives notice of its intention to omit the under-mentioned name from maps and plans.

Municipality.—Shire of Kowree.

Name to be Omitted.—Telangatuk.

Any person who objects to the above proposal may give notice of objection, in writing, stating the reasons therefor, to the Secretary of the Committee, not more than two months following the publication of this notice.

By order of the Committee,

C. E. E. BARLOW,
Secretary of the Place Names Committee.

Survey Co-ordination (Place Names) Act No. 7360.

NOTICE OF ASSIGNMENT.

PURSUANT to the powers conferred under section 32 of the above Act, the Place Names Committee hereby gives notice of the assignment of the following names to the under-mentioned automatic telephone exchanges.

Shire; Exchange Name.

Kowree; Telangatuk.

Wannon; Muntham.

By order of the Committee,

C. E. E. BARLOW,
Secretary of the Place Names Committee.

Survey Co-ordination (Place Names) Act No. 7360.

NOTICE OF INTENTION.

PURSUANT to the powers conferred under section 28 of the above Act, the Place Names Committee hereby gives notice of its intention to assign the following names to the creeks mentioned hereunder:—

Municipalities.—Shires of Knox and Sherbrooke.

Location.—From its source in Crown allotments 17 and 19, section A, Parish of Scoresby; thence flowing generally south and west to a point near the south-east corner of Crown allotment 6A of the said Parish.

Proposed Name.—Ferry Creek.

Location.—From its source in Crown allotment 11, section A, Parish of Narree Worrان; thence flowing generally south-westerly by westerly to its junction with Ferry Creek in allotment 6A, Parish of Scoresby.

Proposed Name.—Monbulk Creek.

Location.—From the above-mentioned junction of the Ferry and Monbulk Creeks to its outfall into the Dandenong Creek.

Proposed Name.—Corhanwarrabul Creek.

Any person who objects to the above names may give notice of objection, in writing, stating the reasons therefor, to the Secretary of the Committee not more than two (2) months following the publication of this notice.

This notice replaces the notice of intention published in *Victoria Government Gazette* No. 107, dated 18th December, 1968.

By order of the Committee,

C. E. E. BARLOW,
Secretary of the Place Names Committee.

PUBLIC NOTICE.

AN auction of unclaimed and confiscated goods in the possession of the Police will be held at the Police Auditorium, corner Russell and Latrobe streets, Melbourne, at 9.30 a.m., on 6th August, 1969.

N. WILBY,

Chief Commissioner of Police.

Police Regulation Act 1958, Section 122.

SALE OF UNCLAIMED MOTOR VEHICLE.

AN owner is required for a 1959 model, white Holden utility motor vehicle, ex-registered No. (N.S.W.) CNS-895, engine No. L.608048.

The vehicle came into the possession of Police on 16th July, 1967, and it is intended that it be sold by public auction at the Police Traffic Centre, Dawson-street, Brunswick, at 2 p.m., on 10th July, 1969.

N. WILBY,

Chief Commissioner of Police.

Health Act 1958.

VICTORIA—DEPARTMENT OF HEALTH.

NOTICE TO ATTEND FOR RADIOLOGICAL EXAMINATION.

To all persons aged twenty-one years and over enrolled or resident in the State Electoral District of Scoresby.

TAKE notice that you are required to attend at a Department of Health X-ray unit sited in the public street at or as near as possible to the main entrance to the premises specified in this notice, at any time between the hours specified on one of the days specified and during the period specified in respect of those premises, and thereat to submit yourself to radiological examination of the chest for the purpose of ascertaining whether you may be suffering from pulmonary tuberculosis. If you have had a Chest X-ray within the last twelve months and for this reason do not wish to be examined now, you should attend the unit as directed and submit particulars of the previous examination.

SPECIFIED PREMISES, PERIODS, DAYS AND HOURS.

Premises.	Period.	Days.	Hours.
Quinns Self Service Store, Franciscrescent, Ferntree Gully	Friday, 11th July, 1969, to Thursday, 17th July, 1969 (inclusive)	Friday, 11th July, 1969 .. All other days during the period except Saturday, Sunday and Public Holidays	From 11 a.m. to 6 p.m. and 7.30 p.m. to 9 p.m. From 10 a.m. to 6 p.m. and 7.30 p.m. to 9 p.m.
Municipal Library, Main-road, Ferntree Gully	Friday, 11th July, 1969, and Monday, 14th July, 1969	Friday, 11th July, 1969 .. Monday, 14th July, 1969	From 11 a.m. to 6 p.m. and 7.30 p.m. to 9 p.m. From 10 a.m. to 6 p.m. and 7.30 p.m. to 9 p.m.
Nancarrow's Store, Mountain Gate, Ferntree Gully	Tuesday, 15th July, 1969, to Thursday, 17th July, 1969 (inclusive)	Tuesday, 15th July, 1969 All other days during the period except Public Holidays	From 11 a.m. to 6 p.m. and 7.30 p.m. to 9 p.m. From 10 a.m. to 6 p.m. and 7.30 p.m. to 9 p.m.
(1) Infant Welfare Centre } Boronia-road, Boronia (2) Rowells Hardware Store, 91 } Boronia-road, Boronia	Friday, 18th July, 1969, to Friday, 25th July, 1969 (inclusive)	Friday, 18th July, 1969 .. All other days during the period except Saturday, Sunday and Public Holidays	From 11 a.m. to 6 p.m. and 7.30 p.m. to 9 p.m. From 10 a.m. to 6 p.m. and 7.30 p.m. to 9 p.m.
Lukassen's Milk Bar, Mountain Highway, Bayswater East	Friday, 18th July, 1969 ..	Friday, 18th July, 1969 ..	From 11 a.m. to 6 p.m. and 7.30 p.m. to 9 p.m.
Hevey's Licensed Grocery, The Basin	Monday, 21st July, 1969, and Tuesday, 22nd July, 1969	Monday, 21st July, 1969 .. Tuesday, 22nd July, 1969	From 11 a.m. to 6 p.m. and 7.30 p.m. to 9 p.m. From 10 a.m. to 6 p.m. and 7.30 p.m. to 9 p.m.
Seal's Milk Bar, Knoxfield	Wednesday, 23rd July, 1969 to Friday, 25th July, 1969 (inclusive)	Wednesday, 23rd July, 1969 All other days during the period except Public Holidays	From 11 a.m. to 6 p.m. and 7.30 p.m. to 9 p.m. From 10 a.m. to 6 p.m. and 7.30 p.m. to 9 p.m.
Bellotti's Milk Bar, Manuka-drive, Ferntree Gully (Fairhills)	Monday, 28th July, 1969, and Tuesday, 29th July, 1969	Monday, 28th July, 1969 Tuesday, 29th July, 1969	From 11 a.m. to 6 p.m. and 7.30 p.m. to 9 p.m. From 10 a.m. to 6 p.m. and 7.30 p.m. to 9 p.m.
Post Office, Rowville	Monday, 28th July, 1969 ..	Monday, 28th July, 1969 ..	From 12 noon to 8.30 p.m.
Public Hall, Scoresby	Monday, 28th July, 1969 ..	Monday, 28th July, 1969 ..	From 12 noon to 8.30 p.m.
(1) Fletcher's Pharmacy, Mountain Highway, Bayswater	Tuesday, 29th July, 1969, to Friday, 1st August, 1969 (inclusive)	Each day during the period except Public Holidays	From 12 noon to 8.30 p.m.
(2) Ampol Service Station, Mountain Highway, Bayswater	Wednesday, 30th July, 1969, to Friday, 1st August, 1969 (inclusive)	Each day during the period except Public Holidays	From 12 noon to 8.30 p.m.
Wards Pharmacy, Studfield Shopping Centre, Wantirna South	Monday, 4th August, 1969 ..	Monday, 4th August, 1969	From 12 noon to 8.30 p.m.
Shell Service Station, Cnr. Stud and Burwood roads, Wantirna South	Monday, 4th August, 1969, and Tuesday, 5th August, 1969	Monday, 4th August, 1969 Tuesday, 5th August, 1969	From 12 noon to 8.30 p.m. From 12 noon to 8.30 p.m.
Moore's Milk Bar, Cnr. Coleman-parade and Lewis-street, Wantirna South	Monday, 4th August, 1969, and Tuesday, 5th August, 1969	Monday, 4th August, 1969 Tuesday, 5th August, 1969	From 12 noon to 8.30 p.m. From 12 noon to 8.30 p.m.
Post Office, Boronia-road, Wantirna	Tuesday, 5th August, 1969, to Friday, 8th August, 1969 (inclusive)	Each day during the period except Public Holidays	From 12 noon to 8.30 p.m.
Post Office, Nurlendi-road, Vermont	Monday, 4th August, 1969, and Tuesday, 5th August, 1969	Monday, 4th August, 1969 Tuesday, 5th August, 1969	From 12 noon to 8.30 p.m. From 12 noon to 8.30 p.m.
Woolworths Store, Brentford-square, Parkmore	Wednesday, 6th August, 1969, to Monday, 11th August, 1969 (inclusive)	Each day during the period except Saturday, Sunday and Public Holidays	From 12 noon to 8.30 p.m.
Caltex Service Station, Springvale-road, Glen Waverley	Wednesday, 6th August, 1969, to Tuesday, 12th August, 1969 (inclusive)	Each day during the period except Saturday, Sunday and Public Holidays	From 12 noon to 8.30 p.m.
George's Milk Bar, Cnr. Kerrie and High streets, Glen Waverley	Monday, 11th August, 1969, to Wednesday, 13th August, 1969 (inclusive)	Each day during the period except Public Holidays	From 12 noon to 8.30 p.m.
Valewood Pharmacy, Wanda-valestreet, Mulgrave	Tuesday, 12th August, 1969, to Friday, 15th August, 1969 (inclusive)	Each day during the period except Public Holidays	From 12 noon to 8.30 p.m.

NOTICE TO ATTEND FOR RADIOLOGICAL EXAMINATION—*continued*.

Premises.	Period.	Days.	Hours.
Clareville Pharmacy, Dundon-court, Mulgrave	Wednesday, 13th August, 1969, to Friday, 15th August, 1969 (inclusive)	Each day during the period except Public Holidays	From 12 noon to 8.30 p.m.
Chapman's Milk Bar, Cnr. View-point-avenue and Waverley-road, Glen Waverley East	Thursday, 14th August, 1969, and Friday, 15th August, 1969	Thursday, 14th August, 1969 Friday, 15th August, 1969	From 12 noon to 8.30 p.m. From 12 noon to 8.30 p.m.

NOTE.—Any person to whom this notice applies and who without reasonable excuse fails to comply with the requirements of the notice shall be guilty of an offence, and shall be liable to a penalty of not more than Forty dollars.

Dated this 23rd day of June, One thousand nine hundred and sixty-nine.

R. J. FARNBACH, Chief Health Officer.

MONEY LENDERS ACT 1958.

IN accordance with the provisions of the above-mentioned Act the following is published for general information.

List of persons to whom Money Lenders' Licences have been issued for the year ending 30th June, 1969.

Name.	Authorized Name.	Authorized Address.	Date of Issue.
Associated Securities Limited (G. L. Richards, Appointee)	Associated Securities Limited ..	4 Station-street, Moorabbin ..	2.5.69
*Australian Guarantee Corp. Ltd. (D. M. Campbell, Appointee)	Australian Guarantee Corp. Ltd. ..	67 Lime-avenue, Mildura ..	7.3.69
Custom Credit Corporation Limited (A. J. Rodd, Appointee)	Custom Credit Corporation Limited	228 Maude-street, Shepparton ..	12.6.69
Esanda Limited (M. L. Broun, Appointee)	Esanda Limited	Main-street, Beecac	16.4.69
Esanda Limited (M. L. Broun, Appointee)	Esanda Limited	Cnr. Whyte and Henty streets, Coleraine	2.5.69
Esanda Limited (M. L. Broun, Appointee)	Esanda Limited	Duverney-street, Cressy	16.4.69
Heller Factors Pty. Ltd. (N. G. Craig, Appointee)	Heller Factors Pty. Ltd.	224 Queen-street, Melbourne ..	19.5.69
J. & J. Hudson Investments Proprietary Limited (A. G. J. Hudson, Appointee)	J. & J. Hudson Investments Proprietary Limited	36 Baker-avenue, Kew	29.5.69
*David Smith (Financiers) Pty. Ltd. (J. Fishelson, Appointee)	David Smith (Financiers) Pty. Ltd. ..	118 Chapel-street, Balaclava ..	13.6.69
*Traders Finance Corp. Ltd. (D. M. Campbell, Appointee)	Traders Finance Corp. Ltd.	67 Lime-avenue, Mildura	7.3.69

* New Authorized Address.

State Treasury,
Melbourne, Vic. 3002.

W. WATTS, Registrar,
Money Lenders Act.

Soil Conservation and Land Utilization Act 1958.

LAKE MERRIMU—GOODMAN'S CREEK WATER SUPPLY CATCHMENT.

NOTICE OF DETERMINATION OF LAND-USE, PLAN No. 2246.

PROCLAIMED 13th February, 1968, *Victoria Government Gazette*, No. 14, dated 21st February, 1968, pursuant to section 22 of the *Soil Conservation and Land Utilization Act 1958*.

In pursuance of the provisions of section 23, sub-section (1) of the *Soil Conservation and Land Utilization Act 1958* (No. 6372), the Soil Conservation Authority, after consultation with the Land Utilization Advisory Council, has determined the land-use for all that area of land in the Parishes of Coimadai, Bullengarook and Coornmill within the boundaries of the Lake Merrimu-Goodman's Creek Water Supply Catchment delineated and marked on plan No. 2246, the original of which is lodged at the Head Office of the Soil Conservation Authority. All land within this area shall be used in accordance with the provisions of the particular category of land-use to which each area has been assigned. The boundaries of land-use areas shown on plan No. 2246 are intended as a guide to landholders, who should consult with the Soil Conservation Authority before making any changes in land-use.

The provisions of each of the land-use categories are set out hereunder.

Category No. 1.

Land which shall be used for permanent forest where forestry operations shall be carried out only in accordance with management conditions made or approved by the Soil Conservation Authority. No tree shall be removed and no soil shall be disturbed within a minimum distance of 1 chain from the banks of all streams and watercourses without the specific approval of the Authority. Grazing, the construction of roads, dams, or earthworks of any description are subject to the approval of the Authority.

Category No. 2.

Land which may be used for grazing subject to conditions made or approved by the Authority, such conditions to include:—

- A. The specification of areas suitable for clearing and those which are to remain under forest.
- B. The application of management and conservation practices where necessary.

Category No. 3.

Land which shall be used primarily for grazing where cropping may be practised only under management conditions made or approved by the Authority. Such conditions to include the specification of length of rotation and conservation practices where necessary.

Category No. 4.

Land suitable for cropping, subject to conditions imposed by the Authority for particular circumstances and where changes in land-use shall be subject to approval by the Soil Conservation Authority.

Category No. 5.

Land which shall be used for the protection of streams and watercourses where:—

1. No tree shall be removed or soil disturbed in any way without the specific approval of the Authority.
2. The crossing of streams and watercourses is permitted only by means of properly constructed crossings specifically approved for the particular site by the Soil Conservation Authority.

This category covers areas within 5 chains of the offtake weir and within 1 chain or such greater distance as the Authority may require from the banks of streams, springs and watercourses within this catchment.

Category No. 6.

- 6A. Land used or reserved for roads on which any changes in land-use shall be made only after consultation with the Soil Conservation Authority.
- 6B. Land reserved for roads on which any changes in land-use shall be made only with the approval of the Soil Conservation Authority.

PLAN NO. 2246.

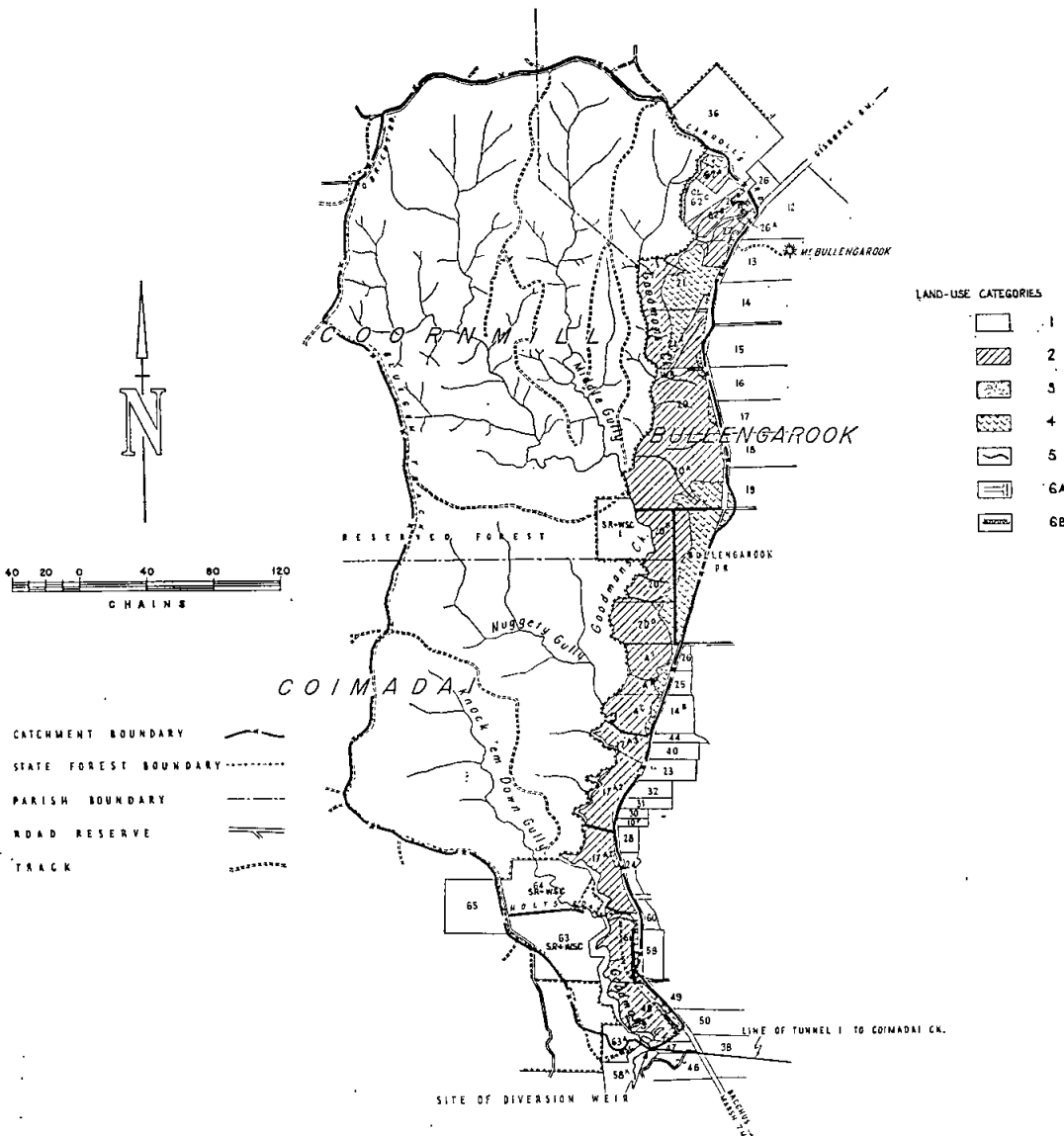

P. J. McCALLUM, Secretary,
Soil Conservation Authority.

STATE RIVERS AND WATER SUPPLY COMMISSION.

BY-LAW NO. 5601—URBAN DISTRICTS—FIXING CHARGES FOR WATER SUPPLIED BY MEASURE AND REVOKING BY-LAW NO. 5525.

THE State Rivers and Water Supply Commission, in pursuance and exercise of the powers conferred by the Water Act, doth hereby make the By-law following:—

1. This By-law shall be substituted for By-law No. 5525 which is hereby revoked.

2. This By-law shall apply within the urban districts named in the Schedule hereunder and shall take effect as hereinafter provided notwithstanding the provisions of any previous By-law.

3. The meter or meters measuring the supply of water to any property within the said urban districts shall be read once in every financial year as near as practicable to the same date and the quantity so measured as having been supplied during the period (hereinafter called the "meter year") between any two successive such readings shall be the basis of charges payable under this By-law.

4. (a) In respect of any property rated or supplied by the Commission the maximum quantity of water to be supplied in any meter year without charge shall, except where a special agreement with the Commission applies, be the quantity which if charged at twenty-five cents per thousand gallons would give an amount equal to:—

- (i) the amount of the rate or minimum annual charge payable, if any, in the previous financial year if the meter year ends at any time from 1st July to 30th September, both dates inclusive, or
- (ii) the amount of the rate or minimum annual charge payable, if any, in the current financial year if the meter year ends at any time from 1st October to 30th June, both dates inclusive.

(b) For all water supplied in any meter year in excess of the maximum quantity referred to in paragraph (a) of this clause the charge shall be twenty-five cents per thousand gallons.

5. The charges as set out in Clause 4 of this By-law shall be payable on demand at the office of the State Rivers and Water Supply Commission at the place mentioned in Column 2 opposite the name of the respective urban districts in Column 1 of the Schedule hereunder.

6. Interest will be chargeable on all charges for water remaining unpaid for a period of three months from the date they become payable.

7. Such person or persons as the State Rivers and Water Supply Commission may from time to time appoint for that purpose shall be and is or are hereby authorized to demand receive collect and recover the said charges for water.

SCHEDULE.

Name of Respective Urban District.	Place at which Charges Shall be Payable.
Column 1.	Column 2.

Supplied from Bellarine Peninsula System.

Anglesea-Torquay	Geelong
Bellarine	Geelong
Birregurra	Geelong

Supplied from Mornington Peninsula System.

Baxter-Pearcedale	Frankston
Berwick	Frankston
Bunyip	Frankston
Centreville-South Lyndhurst	Frankston
Cranbourne	Frankston
Dandenong-Springvale	Frankston
Dromana-Portsea	Frankston
Frankston-Mornington	Frankston
Garfield	Frankston
Hampton Park	Frankston
Longwarry	Frankston
Nar-Nar-Goon and Tynong	Frankston
Narre Warren	Frankston
Officer	Frankston
Pakenham	Frankston
Somers-Flinders	Frankston
Westernport	Frankston

Supplied from Otway System.

Camperdown	Camperdown
Otway	Camperdown
Simpson	Camperdown

SCHEDULE—continued.

Name of Respective Urban District.	Place at which Charges Shall be Payable.
Column 1.	Column 2.

Supplied from Goulburn, Campaspe and Loddon System.

Corop	Tongala
Dingee	Pyramid Hill
Gunbower	Cohuna
Leitchville	Cohuna
Lockington	Rochester
Macorna	Pyramid Hill
Mitiamo	Pyramid Hill
Murrabit	Kerang
Pyramid Hill	Pyramid Hill
Stanhope	Tongala
Tallygaroopna	Shepparton

Supplied direct from River Murray.

Carwarp	Merbein
Koondrook	Kerang
Lake Boga	Swan Hill
Merbein	Merbein
Meringur	Merbein
Nyah	Nyah West
Nyah West	Nyah West
Piangel	Nyah West
Red Cliffs	Red Cliffs
Robinvale	Robinvale
Werrimull	Merbein

Supplied from Wimmera-Mallee System.

Antwerp	Horsham
Berrillock	Birchip
Beulah	Hopetoun
Birchip	Birchip
Brim	Murtoa
Chillingollah	Nyah West
Chinkapook	Ouyen
Culgoa	Birchip
Dimboola	Horsham
Dooen	Horsham
Hopetoun	Hopetoun
Jeparit	Horsham
Jung Jung	Horsham
Laibert	Nyah West
Lascelles	Hopetoun
Manangatang	Nyah West
Marnoo	Murtoa
Minyip	Murtoa
Nandaly	Ouyen
Natimuk	Horsham
Nullawil	Birchip
Ouyen	Ouyen
Patchewollock	Hopetoun
Pimpinio	Horsham
Quambatook	Nyah West
Rainbow	Hopetoun
Rupanyup	Murtoa
Sea Lake	Birchip
Speed	Hopetoun
Tempy	Hopetoun
Ultima	Nyah West
Waitchie	Nyah West
Walpeup	Ouyen
Watchem	Birchip
Woomelang	Birchip
Woorinen	Nyah West
Wycheproof	Birchip
Yaapeet	Hopetoun

Miscellaneous.

Coliban Urban System	Bendigo or Castlemaine
Eildon	Armadale
Elphinstone	Castlemaine
Heyfield	Maffra
Marong	Bendigo
Newstead	Castlemaine
Strathfieldsaye	Bendigo
Wonthaggi	Wonthaggi

The foregoing By-law was made by the State Rivers and Water Supply Commission on the 23rd day of June, 1969, and the common seal of the said Commission was hereunto affixed on the 25th day of June, 1969, in the presence of—

(SEAL) R. A. HORSFALL, Commissioner.
K. D. GREEN, Commissioner.

Approved by the Governor in Council, 1st July, 1969.—
J. ROSSITER, Clerk of the Executive Council.

STATE RIVERS AND WATER SUPPLY COMMISSION.

LICENCE TO DIVERT WATER AND CUT RACE PURSUANT TO THE PROVISIONS OF SECTION 204 OF THE WATER ACT 1958 (AS AMENDED).

SCHEDULE of one Licence to Divert Water and Cut Race has been revoked by the Governor in Council:—

Licence No.	Term of Licence and Commencing Date.	Name and Address of Person to Whom Licence Granted.	Source of Supply.
539/374	Fifteen years from 1.7.57 ..	Joakim Radoslav and Maria Radoslav, Gunbower ..	Gunbower Creek

Office of the State Rivers and Water Supply Commission.
Melbourne, 1st July, 1969.

G. W. LEWIS, Secretary,
State Rivers and Water Supply Commission.

STATE RIVERS AND WATER SUPPLY COMMISSION.

LICENCES TO DIVERT WATER AND CUT RACES PURSUANT TO THE PROVISIONS OF SECTION 204 OF THE WATER ACT 1958 (AS AMENDED).

THE Governor in Council has approved of the granting by the State Rivers and Water Supply Commission of the licences as detailed hereunder for the term of years from the date specified to the persons named in the following Schedule:—

Licence No.	Term of Licence and Commencing Date.	Name and Address of Person to Whom Licence is to be Granted.	Source of Supply.	Area Authorized to be Irrigated Per Annum.	Volume of Water Authorized to be Diverted Per Annum.	Annual Fee.
2689	Four years from 1.7.68	Kenneth William Baynes, Molesworth	Goulburn River ..	acres 30	ac. ft. 60	\$60.00 (1st year) thence \$75.00
2690	Four years from 1.7.68	William Cooper, Molesworth ..	Goulburn River ..	15	30	\$30.00 (1st year) thence \$37.50
2691	Four years from 1.7.68	Robert Ernest Thomson and Ernest Oram Thomson, Murchison North	Goulburn River ..	12	24	\$24.00 (1st year) thence \$30.00

Office of the State Rivers and Water Supply Commission.
Melbourne, 1st July, 1969.

G. W. LEWIS, Secretary,
State Rivers and Water Supply Commission.

NOTICE TO MARINERS.
(No. 8 of 1969) T.

AUSTRALIA—VICTORIA.
BASS STRAIT.
Dredging Works.

POSITION.—Lakes Entrance Bar Lat. 37 deg. 53.5 min. S. Long. 147 deg. 58.5 min. E. (approx.).

Mariners and others concerned are advised that commencing on or about 1st July, 1969, dredging will be carried out on the seaward side of Lakes Entrance Bar.

Four (4) barrel buoys coloured yellow and black with the reflecting topmarks will be located in approximately eighteen (18) feet of water on the seaward side of the bar.

These buoys will be placed to the eastward and westward of a line joining the flagstaff and the green Entrance Light.

Several small flag buoys may also be laid in the area.

Mariners are required to keep clear of the above buoys and of the dredger whilst it is working in the area.

A. J. WAGGLEN,
Port Officer in Victoria.

Public Works Department,
Ports and Harbours Branch,
Melbourne, Vic. 3002, 20th June, 1969.

NOTICE TO MARINERS.
[No. 9 of 1969.]

THE following information which has been received from the Harbor Master, Portland, is published for general information.

A. J. WAGGLEN,
Port Officer in Victoria.

Public Works Department,
Ports and Harbours Branch,
Treasury-place,
Melbourne, Vic., 3002, 26th June, 1969.

PORTLAND HARBOR TRUST COMMISSIONERS.

PORT OF PORTLAND.

Light Established.

Position.—Whaler Point Lighthouse, Lat. 38 deg. 20 min. 20 sec. S., Long. 141 deg. 36 min. 35 sec. E.

Details.—A fixed red light has been established on the northern extremity of the Fishermen's Breakwater 166 deg. distant 4,600 feet from the above position.

Remarks.—The light is visible for approximately 0.5 mile and is intended as a guide for fishermen only.

Chart Affected.—Aust. 786.

Publication.—Sailing Directions, Victoria, 1959, page 81.

Private Agents Act 1966.

NOTICE OF RECEIPT OF APPLICATIONS FOR LICENCES UNDER THE PROVISIONS OF THE PRIVATE AGENTS ACT 1966.

THE Clerk(s) of the Court(s) of Petty Sessions as listed hereunder hereby give notice that applications, as under, have been lodged for hearing by the said Court(s) on the date(s) specified.

Any person desiring to object to any of such applications must—

- (a) lodge with the respective Clerk of Petty Sessions a notice in the prescribed form of his objection and of the grounds thereof;
- (b) cause a copy of such notice to be served personally or by post upon the applicant at least three days before the hearing of the application; and
- (c) send or deliver—
 - (i) where the objection is not made by the officer in charge of the police district in which the Court is situated—a copy of the notice to such officer; and
 - (ii) where the objection is not made by the Registrar or Deputy Registrar—a copy to the Registrar.

Full Name of Applicant or in the Case of a Firm or Corporation, of the Nominee.	Place of Abode of Applicant or Nominee.	Name of Firm or Corporation.	Address for Registration.	Type of Licence.	Date of Hearing of Application
---	---	------------------------------	---------------------------	------------------	--------------------------------

COURT OF PETTY SESSIONS, PRAHRAN.

Brett, Harry	1 McNamara-street, Laverton	Melbourne Night Patrol Service Pty. Ltd.	18/614 St. Kilda-road, Melbourne	Watchman ..	14.7.69
Stark, John	Flat 28, 43 Caroline-street, South Yarra	Flat 28, 43 Caroline-street, South Yarra	Process Server ..	21.7.69

Dated at Prahran this 24th day of June, 1969.

G. T. WHEELHOUSE, Clerk of Petty Sessions.

COURT OF PETTY SESSIONS, SOUTH MELBOURNE.

Aitken, Marshall	3 Finley-road, Altona	101-105 Clarke-street, Melbourne South	Watchman ..	16.7.69
Ambrose, Terence Stanley ..	29 Parkmore-road, East Bentleigh	" "	" ..	"
Byrne, Alan Edward	15 Docker-street, Elwood	" "	" ..	"
Hickey, Bartholomew James ..	16 Parnay-road, Mount Waverley	" "	" ..	"
McNamara, Michael Joseph ..	5 Chloris-crescent, Caulfield	" "	" ..	"
Makram, Fakhry Effat	Flat 4, 245 Riversdale-road, Hawthorn	" "	" ..	"
Ness, Kenneth Francis	64 Kiewa-crescent, Dallas	" "	" ..	"

Dated at South Melbourne this 20th day of June, 1969.

G. MILLER, Clerk of Petty Sessions.

COURT OF PETTY SESSIONS, SOUTH MELBOURNE.

Todd, Phillip Richard	36 Sullivan-street, Springvale	101/105 Clarke-street, Melbourne South	Watchman ..	22.7.69
Stevenson, Deirdre Janet	63 Park-street, South Yarra	63 Park-street, South Yarra	Inquiry Agent ..	22.7.69
" " " "	" " " "	" "	Process Server ..	"

Dated at South Melbourne this 25th day of June, 1969.

G. MILLER, Clerk of Petty Sessions.

COURT OF PETTY SESSIONS, MELBOURNE.

Kingsberry, David Mason	12 Doris-street, Greensborough	340 Abbotsford-street, North Melbourne	Inquiry Agent —Individual	9.7.69
Boyle, John Adams Forbes	Flat 7, 46 King-street, Dandenong	Australian Watching Co. Pty. Ltd.	" "	Watchman ..	"
Cook, Arthur Jack	13 Grant-grove, East Keilor	" "	" "	" ..	"
Cope, Allan Leonard	Lot 47, Scenic-crescent, Eltham North	" "	" "	" ..	"
Epema, William Bouke	Stenson-road, St. Albans	" "	" "	" ..	"
Hughes, Jack Peart	38 O'Keefe-street, West Heidelberg	" "	" "	" ..	"
Kurth, Ronald Leon	129 Cremorne-street, Richmond	" "	" "	" ..	"
Mountford, Douglas Bertram ..	46 Kings-road, St. Albans	" "	" "	" ..	"
MacDougall, William Edward ..	15 Norfolk-avenue, Ringwood	" "	" "	" ..	"
Paxton, Ronald James	221 Tyler-street, East Preston	" "	" "	" ..	"
Scott, James Alexander	2 Peter-street, Preston	" "	" "	" ..	"
Toro, Nestor	Flat 5, 33 Byron-street, Elwood	" "	" "	" ..	"

Dated at Melbourne this 18th day of June, 1969.

G. L. WEBSTER, Clerk of Petty Sessions.

PRIVATE AGENTS—continued.

Full Name of Applicant or in the Case of a Firm or Corporation, of the Nominee.	Place of Abode of Applicant or Nominee.	Name of Firm or Corporation.	Address for Registration.	Type of Licence.	Date of Hearing of Application.
COURT OF PETTY SESSIONS, PRAHRAN.					
Stephens, David George ..	132 Fordham ave., Hartwell	Factory Guard Service Pty. Ltd.	Suite 17, 562 St. Kilda road, Melbourne	Watchman ..	21.7.69
Moye, Raymond Laurence ..	2035 Malvern-road, East Malvern	" "	" "	" ..	1.8.69
Dated at Prahran this 26th day of June, 1969.					
G. T. WHEELHOUSE, Clerk of Petty Sessions.					
COURT OF PETTY SESSIONS, BALLARAT.					
Wright, Robert George ..	308 Larter-street, Ballarat East	" "	308 Larter-street, Ballarat East	Process Server ..	17.7.69
Dated at Ballarat this 27th day of June, 1969.					
E. N. KINCHINGTON, Clerk of Petty Sessions.					
COURT OF PETTY SESSIONS, ST. KILDA.					
Saas, Josef ..	66 Clyde-street, St. Kilda	" "	66 Clyde-street, St. Kilda	Process Server ..	22.7.69
Dated at St. Kilda this 30th day of June, 1969.					
J. E. REILLY, Clerk of Petty Sessions.					
COURT OF PETTY SESSIONS, COBURG.					
Crawford, Graeme George ..	104 Hotham-road, Niddrie	" "	88 Bakers-road, North Coburg	Watchman ..	17.7.69
Dated at Coburg this 27th day of June, 1969.					
F. J. TENNI, Clerk of Petty Sessions.					

COUNTRY ROADS BOARD.

RESOLUTIONS OF THE COUNTRY ROADS BOARD.

THE Country Roads Board, in pursuance of the provisions of the Country Roads Act 1958, has passed Resolutions the dates whereof and the terms of which are scheduled hereunder:—

SCHEDULE.

State Highway.

Resolution dated Twenty-third day of June, One thousand nine hundred and sixty-nine, made pursuant to sections 21 and 74 of the Country Roads Act 1958 declaring the widening of the Pyrenees Highway in the Shire of Ararat as shown hatched on plan numbered G.P.11404 hereunder to be part of a State highway within the meaning and for the purposes of the said Act.

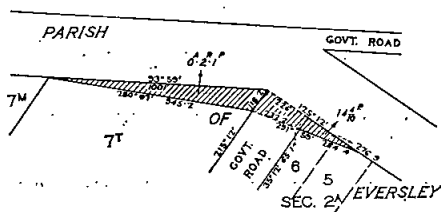
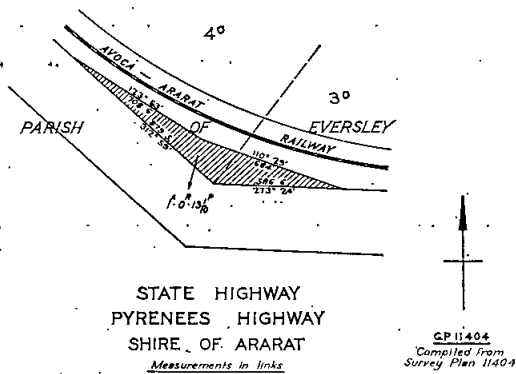

Resolution dated Twenty-third day of June, One thousand nine hundred and sixty-nine, made pursuant to section 21 of the Country Roads Act 1958, declaring the widening of the Timboon-Nullawarre road in the Shire of Heytesbury as shown hatched on plans numbered G.P.11427 and G.P.11428 hereunder to be part of a main road within the meaning and for the purposes of the said Act.

Main Road.

MAIN ROAD
TIMBOON — NULLAWARRE ROAD
SHIRE OF HEYTESBURY

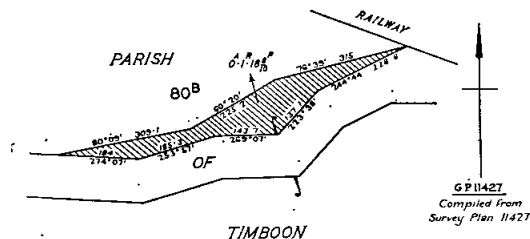

MAIN ROAD
TIMBOON — NULLAWARRE ROAD
SHIRE OF HEYTESBURY

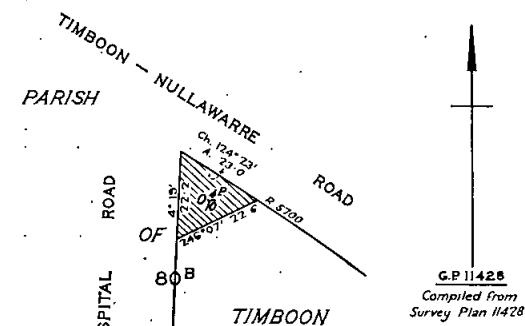

N. L. ALLANSON,
Secretary.

Stamps Act 1958, Section 97.

ANNUAL LICENCES.

I hereby notify that the necessary stamp duty has been paid by the under-mentioned companies for licences to carry on assurance and insurance business in Victoria from the dates respectively set out opposite the name of each company to 31st December, 1969, and that the relevant Annual Licences have been issued accordingly :—

Name of Company.	Date of Commencement of Licence.
Cambridge Insurance Company Pty. Ltd. . .	12th May, 1969
General Mutual Insurance Co. Ltd.	4th June, 1969
B. T. Investments Pty. Ltd.	4th June, 1969
Motorists Mutual Insurance Company Ltd.	12th June, 1969

R. M. PHIBBS,
Comptroller of Stamps.

Chief Office for Stamp Duties,
Melbourne, 2nd July, 1969.

Stamps Act 1958, Section 57.

ANNUAL LICENCE.

I HEREBY notify that the necessary stamp duty has been paid by the under-mentioned company for a licence to carry on assurance and insurance business in Victoria from 24th June, 1969, to 31st December, 1969, and that the relevant Annual Licence has been issued accordingly.

C. I. L. AUSTRALIA PROPRIETARY LIMITED.

R. M. PHIBBS,
Comptroller of Stamps.

Chief Office for Stamp Duties,
Melbourne, 2nd July, 1969.

LOCAL GOVERNMENT DEPARTMENT.

ORDER CONFIRMED.—CITY OF GEELONG WEST.

THE Minister of the Crown administering the Local Government Act 1958, on the 23rd day of June, 1969, confirmed the Order hereinafter referred to in pursuance of section 514 of the said Act namely:

An Order of the Council of the City of Geelong West made on the 30th April, 1969, directing the compulsory taking of the land described hereunder for the purposes of widening Autumn-street, Geelong West:

- (a) All that piece of land being part of Crown allotment 6, section 1, Parish of Moorpanyal commencing at the intersection of the western side of LaTrobe-terrace with the old northern alignment of Autumn-street and bounded on the south by the said old alignment bearing 270 deg. by survey 186 ft. 9½ in. on the west by an unnamed road bearing 359 deg. 57½ in. for 6 ft. 5 in. on the north by the new northern alignment of Autumn-street bearing 90 deg. 2½ min. for 186 ft. 9 in. and on the east by LaTrobe-terrace bearing 179 deg. 47½ min. for 6 ft. 3½ in. to the commencing point.
- (b) All that piece of land being part of Crown allotment 6, section 1, Parish of Moorpanyal commencing 11 ft. 8 in. westerly from the preceding land bounded on the south by the said old alignment bearing 270 deg. 5 min. by survey for 188 ft. 6½ in. and 270 deg. 2 min. for 23 ft. 1 in. on the west by an unnamed road bearing 359 deg. 32 min. for 6 ft. 3 in. on the north by the said new alignment bearing 90 deg. 2½ min. for 211 ft. 8 in. and on the east by an unnamed road bearing 179 deg. 57½ min. for 6 ft. 5 in. to the point of commencement.
- (c) All that piece of land being part of Crown allotment 6, section 1, Parish of Moorpanyal commencing 12 ft. 8 in. westerly from the immediately preceding land bounded on the south by the said old alignment bearing 270 deg. 2 min. by survey 336 ft. 8½ in. on the west by Western-street bearing 359 deg. 56 min. for 6 ft. 4 in. on the north by the said new alignment bearing 90 deg. 2½ min. for 336 ft. 8½ in. and on the east by an unnamed road bearing 180 deg. 2 min. for 6 ft. 3 in. to the point of commencement.

R. J. HAMER,
Minister for Local Government.

Local Government Department,
Melbourne.

WORKERS COMPENSATION ACT 1958.—SECTION 72.

HIS Excellency the Governor of the State of Victoria, by and with the advice of the Executive Council thereof doth by Order made on the 1st day of July, 1969, and pursuant to section 72 of the Workers Compensation Act 1958, approve of the General Mutual Insurance Company Limited as an Insurer for the period from the first day of July, 1969, to the thirty-first day of July, 1969.

J. ROSSITER,
Clerk of the Executive Council.

At the Executive Council Chamber,
Melbourne, 1st July, 1969.

Melbourne and Metropolitan
BOARD OF WORKS.

NOTICE TO THE OWNERS OF TENEMENTS IN THE UNDER-MENTIONED STREETS AND THE PRIVATE STREETS, LANES, COURTS AND ALLEYS OPENING THERETO.

THE main pipe in the said streets being laid down, the owners of all tenements situated as under are hereby required on or before the 4th August, 1969, to cause a proper pipe and stopcocks, to be laid so as to supply water within such tenements from the main pipe.

W. K. Y. BROMLEY,
Acting Secretary.

24th June, 1969.

STREET AND POSITION.

Dandenong.

Shalimar-crescent, from Third-avenue to Brady-road.
Purley-drive, from Shalimar-crescent eastwards 520 feet.
Morris-court, from Purley-drive southwards 320 feet.
Wilma-avenue, from 280 feet north of Highland-street northwards 120 feet.

Doncaster and Templestowe.

Vista-street, from Ayr-street westwards 520 feet.
Cone-street, from Dale-street to Vista-street.
Dale-street, from Cone-street to Vista-street.
Union-street, from James-street to Parker-street.
James-street, from Union-street eastwards 1,220 feet.
James-street, from Mahoney-street to Lankester-street.
Ruffey-street, from Parker-street to James-street.
Currajong-street, from Woodhouse-road northwards 690 feet.
Lantana-street, from Woodhouse-road northwards 380 feet.
Correa-court, from Currajong-street westwards 590 feet.
Abelia-street, from Currajong-street westwards 680 feet.
Snow Gum-road, from Currajong-street eastwards, north-eastwards and eastwards 940 feet.
Botanic-drive, from George-street northwards and eastwards 1,730 feet.
Miller-place, from George-street to Botanic-drive.
Earl-street, from George-street to Roseland-grove.
Lantana-street, from 380 feet north of Woodhouse-road to Abelia-street.
Abelia-street, from 680 feet west of Currajong-street westwards 380 feet.
Station-street, from Doncaster-road southwards 370 feet.
Station-street, from Arthur-street southwards 290 feet.
Frederick-street, from Doncaster-road southwards 330 feet.
Frederick-street, from Arthur-street southwards 350 feet.

Eltham.

Karingal-drive, from Sherbourne-road northwards 680 feet.
Bonds-road, from Cleveland-avenue southwards 3,820 feet.

Keilor.

St. Atbans-road, from Sunshine-road to Fox-road.
Hedgeley-road, from St. Albans-road eastwards 130 feet.
Hedgeley-road, from Fox-road westwards 100 feet.
Fox-road, from St. Albans-road southeastwards 960 feet.

Moorabbin.

Keys-road, from Chesterville-road eastwards 908 feet.
Keys-road, from Friars-road eastwards 1,080 feet.

Nunawading.

South-parade, from 1386 feet west of Main-street westwards 120 feet.

Oakleigh.

Huntingdale-road, from Carrol-grove southwards 1,230 feet.

Sunshine.

Railway-parade, from Vincent-street westwards 990 feet.
 Railway-parade, from Neimur-avenue to Station-street.
 Wood-street, from Station-street to Byrne-street.
 Lloyd-street, from Wood-street northwards 280 feet.
 Byrne-street, from Railway-parade northwards 200 feet.
 Wakool-avenue, from Railway-parade to Poole-street.
 Edward-street, from Railway-parade to Poole-street.
 Vincent-street, from Railway-parade northwards to Railway-parade.

Waverley.

Janford-court, from Forster-road northeastward 1,030 feet.
 Greenham-crescent, from Janford-court to Forster-road.
 Winterton-drive, from Cambrian-crescent southwards 540 feet.
 Duton-court, from Winterton-drive northwestwards 330 feet.
 Cambrian-crescent, from Winterton-drive eastwards 730 feet.
 Walden-avenue, from Cambrian-crescent southwards 180 feet.
 Huntingdale-road, from Carroll-grove southwards 1,230 feet.
 Right of Way, 400 feet east of Palm Beach-crescent, from Ferntree Gully-road to Bellerive-avenue.

Whittlesea.

Huskisson-avenue, from Kiania-drive northwards 610 feet.
 Bellarine-drive, from Huskisson-avenue eastwards 710 feet.
 Currawong-avenue, from Bellarine-drive southwards 560 feet.
 Columbie-road, from Bellarine-drive southwards 610 feet.
 Edgars-road, from Spring-street to Main-street.

ORDERS IN COUNCIL.—(Series 1968-69.)**PUBLIC WORKS.**

2318. Preston South, S.S. No. 824, mechanical services, \$5,347.00.—Gray & Wood.—(N.W.92148 "B".)

Approved by the Governor in Council, 24th June, 1969.—
 J. ROSSITER, Clerk of the Executive Council.

STATE ELECTRICITY COMMISSION.

2319. For the supply of distribution transformers for a period of one year, to Specification No. 69/32, at Schedule rates.—A.S.E.A. Electric (Aust.) Pty. Ltd.

2320. For the supply of distribution transformers for a period of one year, to Specification No. 69/32, at Schedule rates.—Baldwin Transformer & Engineering Co. Pty. Ltd.

2321. For the supply of distribution transformers for a period of one year, to Specification No. 69/32, at Schedule rates.—Machinery Construction Heidelberg Pty. Ltd.

2322. For the supply of distribution transformers for a period of one year, to Specification No. 69/32, at Schedule rates.—Tyree Industries (Vic.) Pty. Ltd.

2323. For the supply of distribution transformers for a period of one year, to Specification No. 69/32, at Schedule rates.—Wilson Electric Transformer Co. Pty. Ltd.

2324. For the design and construction of reinforced concrete chimney, Yallourn "W" Power Station, to Specification No. 69/53, \$550,756.—Tileman (A'asia) Pty. Ltd.

Approved by the Governor in Council, 27th May, 1969.—
 J. ROSSITER, Clerk of the Executive Council.

PUBLIC TRUSTEE ACT 1958 (No. 6350), SECTION 17.

I HEREBY give notice that on the 11th June, 1969, the Public Trustee filed elections to administer the following deceased persons' estates, in accordance with section 17 of the *Public Trustee Act 1958*:—

CANTY, JOHN FRANCIS, late of Flat 7, 209 Dorcas-street, South Melbourne, cleaner, died 5th October, 1968.

CRAIGIE, ALICE MYRTLE, late of 28 Bradshaw-street, Kingsbury, overlocker, died 3rd March, 1969.

DOUGLAS, JOHN HENRY CHARLES, late of 59 McDonald-street, Murtoa, retired railway employee, died 1st July, 1968.

HOWARD, ISOBEL CARMICHAEL, late of 71 Annerley-road, Woolloongabba, Queensland, widow, died 23rd April, 1965.

RYAN, JAMES, formerly of Gordon House, 24 Little Bourke-street, Melbourne, but late of St. Arnaud District Hospital, St. Arnaud, pensioner, died 22nd April, 1968.

WILLIAMS, GEORGE, late of 24 Little Bourke-street, Melbourne, retired theatre hand, died 1st May, 1968.

I HEREBY give notice that on the 20th June, 1969, the Public Trustee filed elections to administer the following deceased persons' estates, in accordance with section 17 of the *Public Trustee Act 1958*:—

GOODSHIP, ARTHUR JOHN, in the will called GOODSHIP, ARTHUR, formerly of 41 Bridport-street, South Melbourne, but late of Mont Park, messenger, died 9th November, 1967.

No. 56.—5478/69.—2

HANCOCK, HENRY WALTER, in the will called Hancock, Harry, late of 28 High-street, Nunawading, pensioner, died 19th April, 1969.

HOARE, HARRY VERNAN, late of 16 Hamilton-street, Kew, labourer, died 4th January, 1969.

HUNTER, WILLIAM CHARLES, also known as Charles Hunter, late of 4 Barker-street, South Blackburn, retired farmer, died 22nd February, 1969.

KAVANAGH, GERTRUDE ANN, in the will called Gertrude Anne Kavanagh, late of Flat 13, 8 Mitchell-street, Mentone, widow, died 30th March, 1969.

LAMB, HARRY FREDERICK, late of 6 Fenwick-street, Clifton Hill, retired boot trade employee, died 8th January, 1969.

THOMAS, ANNE, late of Emerald Country Club, Lakeside-drive, Emerald, housemaid, died 16th April, 1969.

N. P. BRODY,
 Public Trustee.

256 Flinders-street, Melbourne, 3000, 26th June, 1969.

CREDITORS, next of kin and others having claims against the estate of any of the under-mentioned deceased persons, are required to send particulars of their claims to the Public Trustee, 256 Flinders-street, Melbourne, 3000, the personal representative, on or before the 9th September, 1969, after which date the Public Trustee may convey or distribute the assets, having regard only to the claims of which the Public Trustee then has notice:—

BUTTERS, MARY, late of 2 St. Edmonds-road, Prahran, widow, died 15th April, 1969.

CANTY, JOHN FRANCIS, late of Flat 7, 209 Dorcas-street, South Melbourne, cleaner, died 5th October, 1968.

CODE, ROBINA VICTORIA THERESA, formerly of 38 Repton-road, East Malvern, but late of 15 Staniland-avenue, Malvern, widow, died 28th February, 1969.

COOLING, CARL SEALE, late of 2 Elizabeth-avenue, Frankston, retired taxation officer, died 17th April, 1969.

CRAIGIE, ALICE MYRTLE, late of 28 Bradshaw-street, Kingsbury, overlocker, died 3rd March, 1969.

DOUGLAS, JOHN HENRY CHARLES, late of 59 McDonald-street, Murtoa, retired railway employee, died 1st July, 1968.

DRINKELL, FREDERICK ERNEST, late of 55 Albion-road, Box Hill, steel moulder, died 30th March, 1969.

ELLIS, HAROLD JAMES, late of 10A Hazel-street, Camberwell, retired technical school teacher, died 23rd March, 1969.

EPSTEIN, NATHAN, also known as Nacham Epstein and Nachman Epstein, formerly of 7 Olga-street, West Coburg, but late of 1A Farmer-street, North Perth, formerly marine collector, late retired woolbuyer, died 5th June, 1968.

FALLOWES, ALBERT VICTOR WILLIAM, also known as Fallows, Albert Victor, late of 222 Glenlyon-road, East Brunswick, retired police officer, died 26th April, 1969.

GOODSHIP, ARTHUR JOHN, in the will called Goodship, Arthur, formerly of 41 Bridport-street, South Melbourne, but late of Mont Park, messenger, died 9th November, 1967.

HANCOCK, HENRY WALTER, in the will called Hancock, Harry, late of 28 High-street, Nunawading, pensioner, died 19th April, 1969.

HANDLEY, TOM LEONARD, late of 8 Rathmines-grove, Auburn, retired messenger, died 28th February, 1969.

HIGGINS, VIOLET EVELINE, late of 49 Retreat-road, Newtown, married woman, died 24th August, 1968.

HOARE, HARRY VERNAN, late of 16 Hamilton-street, East Kew, labourer, died 4th January, 1969.

HOWARD, ISOBEL CARMICHAEL, late of 71 Annerley-road, Woolloongabba, Queensland, widow, died 23rd April, 1965.

HUNTER, WILLIAM CHARLES, also known as Charles Hunter, late of 4 Barker-street, South Blackburn, retired farmer, died 22nd February, 1969.

KAVANAGH, GERTRUDE ANN, in the will called Gertrude Anne Kavanagh, late of Flat 13, 8 Mitchell-street, Mentone, widow, died 30th March, 1969.

KELLY, ROBERT, late of Flat 7, 3 Cooke-avenue, Moorabin, bricklayer, died 11th March, 1968.

LAMB, HARRY FREDERICK, late of 6 Fenwick-street, Clifton Hill, retired boot trade employee, died 8th January, 1969.

RYAN, JAMES, formerly of Gordon House, 24 Little Bourke-street, Melbourne, but late of St. Arnaud District Hospital, St. Arnaud, pensioner, died 22nd April, 1968.

SKEWS, ELSIE ELLEN, late of 17 Menzie-grove, Ivanhoe, widow, died 1st April, 1969.

THOMAS, ANNE, late of Emerald Country Club, Lakeside-drive, Emerald, housemaid, died 16th April, 1969.

WILLIAMS, GEORGE, late of 24 Little Bourke-street, Melbourne, retired theatre hand, died 1st May, 1968.

N. P. BRODY,
 Public Trustee.

Melbourne, 26th June, 1969.

APPOINTMENTS AND RESIGNATIONS

APPOINTMENTS.

THE Lieutenant-Governor as Deputy for His Excellency the Governor of the State of Victoria, by and with the advice of the Executive Council thereof, has, by Orders made on the 24th day of June, 1969, been pleased to make the under-mentioned appointments, viz.:—

CHIEF SECRETARY'S DEPARTMENT.

Members of the Parole Board.

DOCTOR CLYDE CORNWALL FENTON, O.B.E.,
HAMISH CONNOLLY MATHEW,
GRAHAM BENNETT INCE,
PHYLLIS IRENE FROST, C.B.E.,
GLADYS BROWN, and
KATHLEEN PERRIN, M.B.E.,
pursuant to the provisions of the *Crimes Act 1958*, to be members of the Parole Board, for a period of three (3) years, from and inclusive of the 2nd July, 1969.

Electoral Registrar (Acting).

WALTER WILLIAM PRESLEY
to be Electoral Registrar (Acting) for the Rosanna Sub-division of the Electoral District of Greensborough; the Heidelberg North Subdivision of the Electoral District of Ivanhoe; the Preston East, Preston North and Preston West Subdivisions of the Electoral District of Preston, and the Reservoir, Reservoir East, Reservoir North and Reservoir West Subdivisions of the Electoral District of Reservoir, to take effect on and from the 20th May, 1969, during the absence on leave of Samuel Mitchelmore.

Honorary Probation Officers.

PATRICIA BRENNAN (Mrs.), 16 Fisher-street, Wendouree,
BETTY MAY COMEADOW (Mrs.), 20 Anderson-street,
Euroa,
JUDITH LOUISE HUNT, 123 Albert-street, Ballarat,
JEAN KIRSOPP (Mrs.), 3 Drummond-street, Horsham,
BETTY MARKS (Mrs.), 125 Lexton-street, Wendouree,
PATRICIA BERYL PEARSON (Miss), 16 Macarthur-place,
Carlton, and
UNA ANNETTA PENNY (Mrs.), Sommer-avenue, Bright,
pursuant to the provisions of section 10 (1) of the *Children's Court Act 1958* to be Honorary Probation Officers for all Children's Courts in Victoria.

Public Auditors.

BARRY ROBERT JAMISON, and
GEOFFREY ERNEST SIMONSEN,
to be Public Auditors, pursuant to the provisions of the *Friendly Societies Act 1958*.

DEPARTMENT OF CROWN LANDS AND SURVEY.

Bailiff of Crown Lands.

WILLIAM HOWARD WALLACE
to be a Bailiff of Crown Lands, without additional salary, in pursuance of section 30 of the *Land Act 1958*.

Members of Place Names Committee.

ALEXANDER SADLER CRAIG, as nominee of the Municipal Association of Victoria, and
HOWARD SPENCER MCCOMB, as nominee of the Royal Historical Society of Victoria,
to be members of the Place Names Committee for a term of three (3) years, pursuant to section 24 of the *Survey Co-ordination Act 1958*, No. 6388.

MINISTRY OF HEALTH.

Member of Committee of Management of Hospital.

HAROLD DOUGLAS STEWART
to be a Member of the Committee of Management of After Care Hospital, pursuant to proviso (a) to section 48 (1) of the *Hospitals and Charities Act 1958*, for a period of three years.

Members of the Masseurs Registration Board of Victoria.

LEIGH THORNTON WEDLICK, M.B., B.S., M.R.C.P.,
HENRY BYRNE, M.B., B.S., F.R.C.P., F.R.A.C.S.,
PATRICIA COSH,
TREVOR GLADSTONE RICE,
RUTH MARJORIE GREEN, and
NORMAN ARTHUR LIDDICUT,
to be Members of the Masseurs Registration Board of Victoria, pursuant to the provisions of section 4 (3) of the *Masseurs Act 1958* for the period of three years ending 30th June, 1972.

LAW DEPARTMENT.

Commissioners for Taking Declarations, &c.

JAMES FREDERICK CHRISTOE, Undera,
HERBERT WILLIAM LEVERSHA, 6 Illoura-avenue,
Ringwood, and
REGINALD ROBERT ANDERSON, 60 View-street, Bendigo,
to be Commissioners for taking Declarations and Affidavits, pursuant to the provisions of the *Evidence Act 1958*, to resign upon removing from the neighbourhood of the addresses stated; and
ALAN KEITH DARBYSHIRE, care of Hewlett Packard Pty. Ltd., 22-26 Weir-street, Glen Iris,
to be a Commissioner for taking Declarations and Affidavits, pursuant to the provisions of the *Evidence Act 1958*, to resign upon ceasing to occupy his present position.

Justices of the Peace.

CHARLES JAMES ELLIS, 475 Main-road, Tecoma, and
ARCHER KEMP HARCUS, the Chalet, Mount Buffalo,
to Keep the Peace in the State of Victoria.

Registrar of Probates and Administrations.

DANIEL WALTER KENNEDY
to be Registrar of Probates and Administrations, to take effect from the date of commencement of duty.

Deputy Coroners.

GEORGE ALLAN MURRAY, 161 Lawrence-street,
Wodonga,
to be Deputy Coroner, pursuant to the provisions of the *Coroner's Act 1958*, to act and have jurisdiction for and during the absence of the Coroner at and in the vicinity of Wodonga, to take effect from the date of commencement of duty; and
FRANK REGINALD HARRISON, 5 Riverview-road, Benalla,
to be Deputy Coroner, pursuant to the provisions of the *Coroner's Act 1958*, to act and have jurisdiction for and during the absence of the Coroner at and in the vicinity of Benalla, to take effect from the date of commencement of duty.

DEPARTMENT OF THE TREASURER.

Collector of Imposts (Acting).

RUSSELL GARNER FRENCH
to act temporarily as Collector of Imposts, Department of Crown Lands and Survey, vice A. L. Peverill, on leave.

Collector of Imposts.

STEWART JOSEPH COWAN
to be Collector of Imposts, Ministry of Aboriginal Affairs, from and inclusive of 1st July, 1969.

DEPARTMENT OF WATER SUPPLY.

Improvement Trust Commissioners.

WILFRIED BURGERMEISTER,
MICHAEL HIGGINS, and
WILLIAM ALFRED WRIGGLESWORTH,
to be Commissioners of the Avon River Improvement Trust to hold such position for a period of four years from the date hereof, subject to the provisions of the River Improvement Act.

J. ROSSITER,
Clerk of the Executive Council.

At the Executive Council Chamber,
Melbourne, 24th June, 1969.

LAW DEPARTMENT.

AMENDED APPOINTMENT.

THE Lieutenant-Governor as Deputy for His Excellency the Governor of the State of Victoria, by and with the advice of the Executive Council thereof doth by Order made on the 24th day of June, 1969, amend the Order in Council made on the 27th day of May, 1969, appointing certain persons to Keep the Peace in the State of Victoria by the substitution of the name RONALD ARTHUR MILNE for that of DONALD ARTHUR MILNE appearing therein.

J. ROSSITER,
Clerk of the Executive Council.

At the Executive Council Chamber,
Melbourne, 24th June, 1969.

Vermin and Noxious Weeds Act 1958.

APPOINTMENT OF INSPECTOR.

IT is hereby notified that the Public Service Board in exercise of its powers has appointed the undermentioned persons as Inspectors under the provisions of section 4 of the *Vermin and Noxious Weeds Act 1958* without additional salary:

JOHN WILLIAM MURPHY, and
LESLIE JOHN BARTON.
A. J. HOLT,
Secretary for Lands.

Melbourne, 27th June, 1969.

DEPARTMENT OF MINES.
MEMBER AND CHAIRMAN OF THE SLUDGE
ABATEMENT BOARD.

HIS Excellency the Governor of the State of Victoria, by and with the advice of the Executive Council thereof doth by Order made on the 1st day of July, 1969, appoint—

RALPH IAN RANKIN, M.M.E. M.Aust. I.M.M., A.M.I.E. Aust., General Manager, McDougall Ireland, Pty. Ltd.,
to be a Member and Chairman of the Sludge Abatement Board, pursuant to the provisions of section 455 of the *Mines Act 1958*, vice Henry Haughton Dunkin, resigned.

J. ROSSITER,
Clerk of the Executive Council.
At the Executive Council Chamber,
Melbourne, 1st July, 1969.

RESIGNATIONS.

THE Lieutenant-Governor as Deputy for His Excellency the Governor of the State of Victoria, by and with the advice of the Executive Council thereof, has by Orders made on the 24th day of June, 1969, accepted the resignations of the persons named hereunder of the offices mentioned, viz.:—

LAW DEPARTMENT.
Commissioners for Taking Declarations, &c.
JOHN ALEXANDER STEWART, and
FRANCIS ANTHONY CLEARY
as Commissioners for taking Declarations and Affidavits, pursuant to the provisions of the *Evidence Act 1958*.

J. ROSSITER,
Clerk of the Executive Council.
At the Executive Council Chamber,
Melbourne, 24th June, 1969.

ORDERS IN COUNCIL

FORESTS DEPARTMENT.

At the Executive Council Chamber, Melbourne, the twenty-fourth day of June, 1969.

PRESENT:

The Lieutenant-Governor as Deputy for His Excellency the Governor of Victoria.
Mr. Chandler | Mr. Balfour.

ALIENATED LAND ACQUIRED BY EXCHANGE, ETC., AND DEDICATED AS RESERVED FOREST.

WHEREAS by section 42, sub-section 8, of the *Forests Act 1958*, it is prescribed that the Governor in Council may acquire by exchange of land dedicated as reserved forest—

- (a) any alienated land or Crown land licensed or leased with an inchoate right of purchase; or
- (b) any land, public or private, and whether vested in trustees or otherwise,

and may by Order published in the *Government Gazette* dedicate the same as reserved forest:
Now, therefore, the Lieutenant-Governor as Deputy for His Excellency the Governor of the State of Victoria, by and with the advice of the Executive Council of the said State, and in pursuance of the provisions of section 42, sub-section 8, of the *Forests Act 1958*, doth by this Order—

- (1) acquire the alienated land described in Schedule "A" hereto by exchange of land dedicated as reserved forest described in Schedule "B" hereto;
- (2) excise from the reserved forest the area described in the aforesaid Schedule "B", such excision to take effect 30 days from date hereof;

- (3) dedicate the land described in Schedule "A" aforementioned as reserved forest, such dedication to take effect 30 days from date hereof.

SCHEDULE "A"—DEDICATION SCHEDULE No. 207.

Alienated land acquired from Arthur James Maxey Norwood and George Arthur Norwood both of 20 Clare-street, Croydon, being Crown allotment 53c, Parish of Bingenwarri, County of Buln Buln, and comprising 137 acres 0 roods 16 perches.

SCHEDULE "B"—EXCISION SCHEDULE No. 167.

Land excised from reserved forest for Arthur James Maxey Norwood and George Arthur Norwood both of 20 Clare-street, Croydon, being Crown allotment 22d, Parish of Bruthen, County of Buln Buln and comprising 161 acres 3 roods 25 perches.

And the Honorable Lindsay Hamilton Simpson Thompson, Her Majesty's Acting Minister for Forests for the State of Victoria, shall give the necessary directions herein accordingly.

J. ROSSITER,
Clerk of the Executive Council.

FORESTS DEPARTMENT.

At the Executive Council Chamber, Melbourne, the twenty-fourth day of June, 1969.

PRESENT:

The Lieutenant-Governor as Deputy for His Excellency the Governor of Victoria.
Mr. Chandler | Mr. Balfour.

DEDICATION OF UNOCCUPIED CROWN LANDS AS RESERVED FOREST IN THE PARISHES OF FARADAY AND CASTLEMAINE, COUNTY OF TALBOT.

IN pursuance of the provisions of section 45 of the *Forests Act 1958*, the Lieutenant-Governor as Deputy for His Excellency the Governor of the State of Victoria, by and with the advice of the Executive Council thereof doth hereby Order that the area of unoccupied Crown lands described in Schedule No. 204 hereunder be dedicated as reserved forest.

DEDICATION SCHEDULE No. 204.—AREA TO BE DEDICATED AS RESERVED FOREST.

1,170 acres, more or less, of unoccupied Crown lands in the Parishes of Faraday and Castlemaine, County of Talbot, being the whole of the unoccupied Crown lands within the area indicated by diagonal hatched lines on diagram 959 hereunder, the original of which is contained in File of Correspondence No. 68/2007, of the Forests Department.

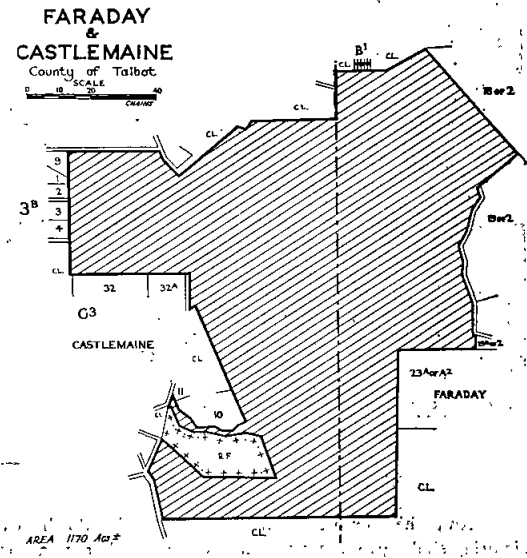

And the Honorable Edward Raymond Meagher, Her Majesty's Minister for Forests for the said State shall give the necessary directions herein accordingly.

J. ROSSITER,
Clerk of the Executive Council.

ROAD TRAFFIC ACT 1958.

At the Executive Council Chamber, Melbourne, the twenty-fourth day of June, 1969.

PRESENT:

The Lieutenant-Governor as Deputy for His Excellency the Governor of Victoria.

Mr. Chandler

Mr. Balfour.

IN pursuance of the powers conferred by the Road Traffic Act 1958, the Lieutenant-Governor as Deputy for His Excellency the Governor of the State of Victoria, in the Commonwealth of Australia, by and with the advice of the Executive Council of the said State, and at the request in writing of the Council of the City of Hawthorn, doth by this Order extend the provisions of the said Act to the following land under the control of the City of Hawthorn—

All that land shown delineated and hachured on the Plan hereunder.

CITY OF HAWTHORN

NOT NECESSARILY TO SCALE

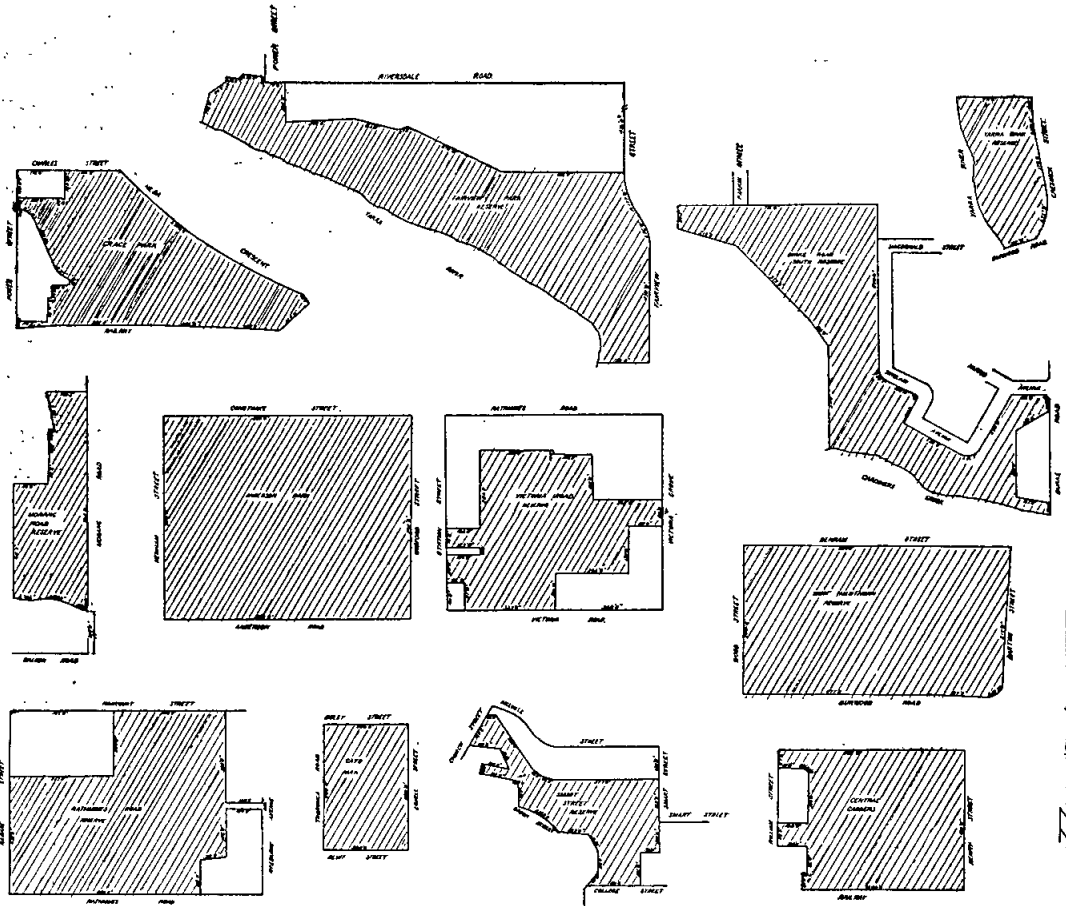

And the Honorable William Archibald Borthwick, Her Majesty's Acting Chief Secretary for the State of Victoria, shall give the necessary directions herein accordingly.

J. ROSSITER,
Clerk of the Executive Council.

COUNTRY ROADS BOARD.

At the Executive Council Chamber, Melbourne, the twenty-fourth day of June, 1969.

PRESENT:

The Lieutenant-Governor as Deputy for His Excellency the Governor of Victoria.
Mr. Chandler | Mr. Balfour.

ORDER APPROVING OF LAND BEING ACQUIRED AND ROADS DEVIATIONS OR WIDENINGS BEING MADE.

THE Lieutenant-Governor as Deputy for His Excellency the Governor of the State of Victoria, by and with the advice of the Executive Council thereof, being satisfied that there are funds legally available for acquiring the land, doth hereby approve the acquiring of the land described in the Schedule hereunder and the making of new roads and deviations from and widenings of existing roads referred to in the said schedule.

SCHEDULE.

State Highways.

The land shown hatched on plan numbered G.P.11795 hereunder required for the widening of the Princes Highway in the Shire of Avon and making of the widening thereon.

STATE HIGHWAY
PRINCES HIGHWAY
SHIRE OF AVON

Measurements in links.

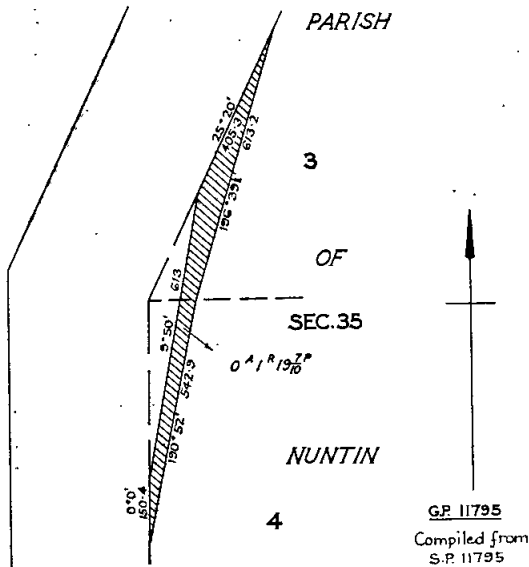

The land shown hatched on plans numbered G.P.11731 and G.P.11732 hereunder required for the widening of the Midland Highway in the Shire of Buninyong and making of the widening thereon.

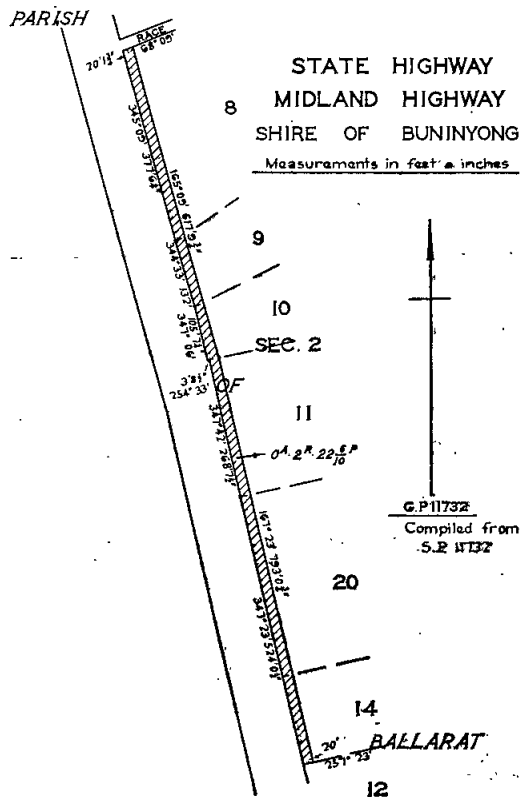
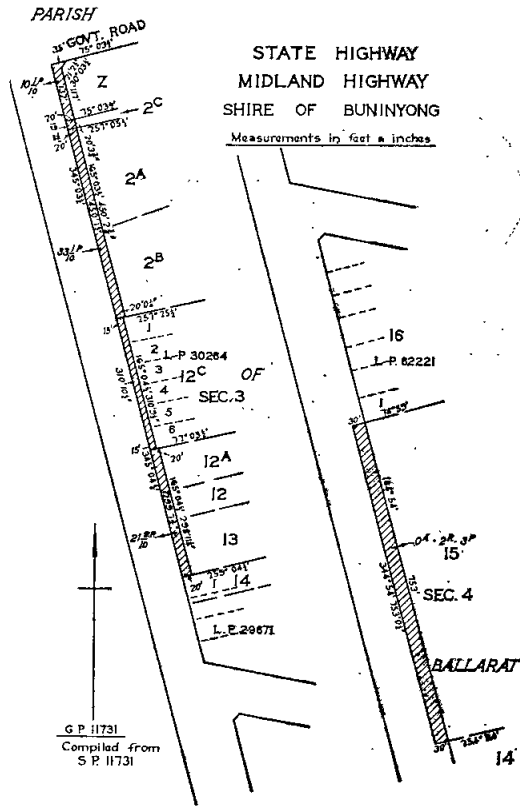

Unclassified Road.

The land shown hatched on plan numbered G.P.11700 hereunder required for the making of a new road (Snowy River-road) in the Shire of Tambo.

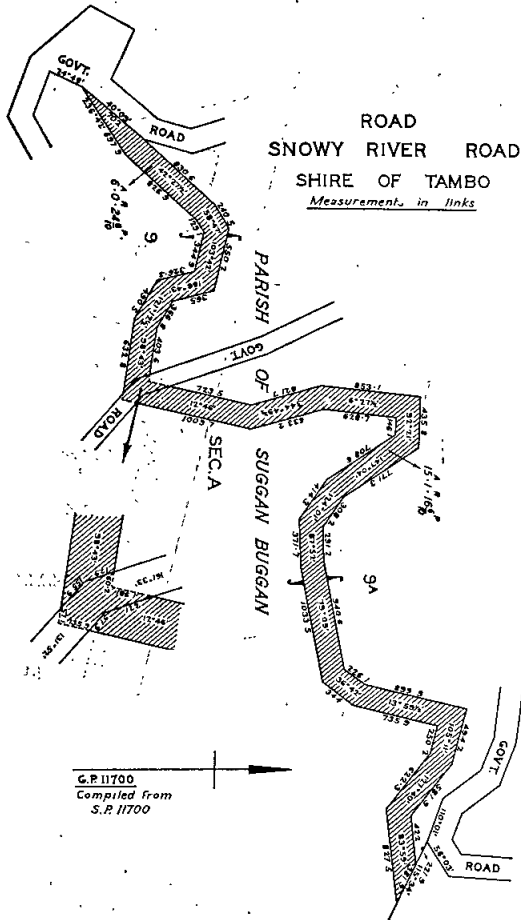

And the Honorable Murray Victor Porter, Her Majesty's Minister of Public Works for the State of Victoria, shall give the necessary directions herein accordingly.

J. ROSSITER,
Clerk of the Executive Council.

LOCAL GOVERNMENT DEPARTMENT.

At the Executive Council Chamber, Melbourne, the twenty-fourth day of June, 1969.

PRESENT:

The Lieutenant-Governor as Deputy for His Excellency the Governor of Victoria.

Mr. Chandler | Mr. Balfour.

VESTING OF A RESERVE IN THE MORNINGTON SHIRE COUNCIL.

WHEREAS it is provided by section 569BA of the Local Government Act 1958, that where any map or plan has been lodged or deposited with the Registrar of Titles pursuant to section 97 of the Transfer of Land Act or any corresponding previous enactment (whether before or after the commencement of the Local Government Act 1963) and any allotment on that map or plan has been transferred to the Council in Council on the request of the Council of the municipality may by Order published in the Government Gazette direct that the whole or any part of the land comprised in any reserve shown on that map or plan shall vest in the council whereupon such land shall so vest freed and discharged from any mortgage charge lease or sub-lease:

And whereas the Council of the Shire of Mornington has requested that a reserve shown on a plan of subdivision be vested in the Council and an allotment on such plan has been transferred:

Now therefore, the Lieutenant-Governor as Deputy for His Excellency the Governor of the State of Victoria, by and with the advice of the Executive Council thereof, doth by this Order vest in the Council of the Shire of Mornington certain land being the Park Reserve coloured blue on plan of subdivision No. 10897 lodged in the Office of Titles.

And the Honorable Rupert James Hamer, Her Majesty's Minister for Local Government for the State of Victoria, shall give the necessary directions herein accordingly.

J. ROSSITER,
Clerk of the Executive Council.

MELBOURNE AND METROPOLITAN BOARD OF WORKS ACT 1958 (AS AMENDED).

At the Executive Council Chamber, Melbourne, the twenty-fourth day of June, 1969.

PRESENT:

The Lieutenant-Governor as Deputy for His Excellency the Governor of Victoria.

Mr. Chandler | Mr. Balfour.

VARIATION OF AN ORDER RELATING TO THE INCLUSION OF PARTS OF THE CITIES OF MORDIALLOC, SPRINGVALE AND CHELSEA IN THE METROPOLIS FOR WATER SUPPLY PURPOSES.

WHEREAS by an Order in Council made the 19th day of June, 1962, it was ordered *inter alia* that the land described in the Schedule thereto should be included in the Metropolis as defined by the said Act and further provided that the functions of any Sewerage Authority and of any Drainage Authority should continue in respect of such land: And whereas by Order in Council made the 30th day of April, 1963, the above-mentioned Order in Council was varied to describe more particularly the works and property to be vested in the Melbourne and Metropolitan Board of Works (hereinafter called "the Board"): And whereas by Order in Council made the 16th day of June, 1965, the first-mentioned Order was further varied to include a further portion of the Municipality of Chelsea within the said Metropolis: And whereas the Chelsea Sewerage Authority (hereinafter called "the Authority") has duly constructed a sewerage treatment works with pumping stations and main and reticulation sewers within the Municipality of Chelsea to provide sewerage services for the portion of the area which is subject to its jurisdiction: And whereas it is proposed that the Board will take over all the works and property of the Authority with the exception of the lands described in certificates of title, volume 8690, folio 339 and volume 7665, folio 056 and the sewerage treatment works constructed thereon on the 1st October, 1969: And whereas in pursuance of the powers conferred on the Board by the said Act the Lieutenant-Governor as Deputy for His Excellency the Governor of Victoria by and with the advice of the Executive Council thereof hereby orders that the Order in Council made on the 19th day of June, 1962, and published in the Government Gazette on the 27th June, 1962, and as subsequently varied be further varied as follows:—

1. That Clause 3 of the said Order in Council shall be deleted and in substitution therefor there shall be inserted the following clause:—

"3. That all lands situate within the Municipality of the City of Chelsea whether vested in fee or otherwise in the Authority and the inheritance of all such lands in fee and interests rights benefits and advantages appurtenant to or relating to all or any of such lands and the mains pumping stations buildings plant or works thereon and all interests rights benefits and advantages vested in possessed by or accruing to the Authority over in or relating to any other land adjacent to such land and all sewer mains pipes branches manholes pumping plant and ancillary equipment rising mains valves penstocks and all other works and all personal property connected therewith and used or intended to be used for the purposes of providing sewerage facilities to persons residing or being on the said land (other than the land comprised in certificates of title, volume 8690, folio 339, and volume 7665, folio 056 and all interests rights benefits and advantages appurtenant thereto including the metering equipment associated with the reticulation rising main) shall from the 1st day of October, 1969, be vested in the Board."

2. That Clause 4 of the said Order in Council shall be deleted and in substitution therefor the following clause shall be inserted:—

"4. That consequent on the extension of the Metropolis as aforesaid Parts I. to IX. inclusive of the said Act shall apply to the land so included in the Metropolis."

3. That the following clauses be added to the said Order namely:—

"7. That in respect of the said land the Board may as from the 1st day of October, 1969, make and levy a Sewerage Rate (in the said Act described as a Metropolitan General Rate) greater than the same rate levied in respect of land in the Metropolis generally but in any case not exceeding 12 cents in the dollar provided that in respect of the period from the 1st day of October, 1969, until the 30th day of June, 1970, there shall be levied a proportionate part only of the Sewerage Rate (Metropolitan General Rate) appropriate to this period."

"8. That the functions of any Sewerage Authority pursuant to the *Sewerage Districts Act 1958*, other than the said Authority shall continue to apply to any land affected by this Order."

And the Honorable Rupert James Hamer, Her Majesty's Minister for Local Government for the State of Victoria shall give the necessary directions herein accordingly.

J. ROSSITER,
Clerk of the Executive Council.

DEPARTMENT OF CROWN LANDS AND SURVEY.

At the Executive Council Chamber, Melbourne, the twenty-fourth day of June, 1969.

PRESENT:

The Lieutenant-Governor as Deputy for His Excellency the Governor of Victoria.

Mr. Chandler | Mr. Balfour.

UNUSED ROADS CLOSED.

THE Lieutenant-Governor as Deputy for His Excellency the Governor of the State of Victoria, by and with the advice of the Executive Council thereof, doth hereby direct that, in pursuance of the provisions of section 349 of the *Land Act 1958*, the unused roads referred to hereunder be closed viz.:—

Parish of Commeralghip, County of Grenville, being the roads indicated by hatching on plan hereunder.—(C.264^(S), (C.264^(E)) (J.31744).

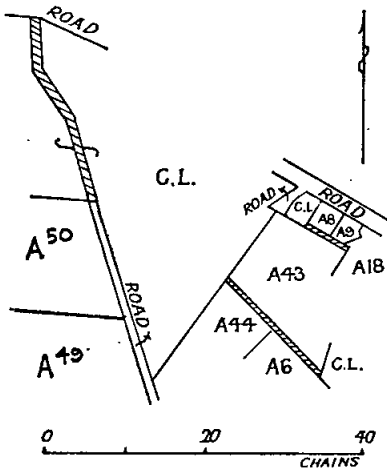

Parish of Greta, County of Delatite, being the road between allotments 11B, 10 and allotments 14B, 14C, 14A.—(G.131^(S)) (H.031067).

And the Honorable Sir William John Farquhar McDonald, Her Majesty's Minister of Lands for the State of Victoria, shall give the necessary directions herein accordingly.

J. ROSSITER,
Clerk of the Executive Council.

DEPARTMENT OF CROWN LANDS AND SURVEY.

At the Executive Council Chamber, Melbourne, the twenty-fourth day of June, 1969.

PRESENT:

The Lieutenant-Governor as Deputy for His Excellency the Governor of Victoria.

Mr. Chandler | Mr. Balfour.

LANDS TEMPORARILY RESERVED AS SITES.

THE Lieutenant-Governor as Deputy for His Excellency the Governor of the State of Victoria, by and with the advice of the Executive Council thereof, doth hereby, in pursuance of section 14 of the *Land Act 1958*, reserve temporarily from sale, from being leased and from having a licence granted in respect thereof, and also except from occupation for mining purposes under any miner's right, the land hereinafter described:—

ARARAT.—Site for Public Gardens and Recreation Purposes, 36 acres 1 rood 29 perches, Township of Ararat, Parish of Ararat, County of Ripon, as indicated by hatching on plan hereunder.—(A.148^(S)) (Rs.1160).

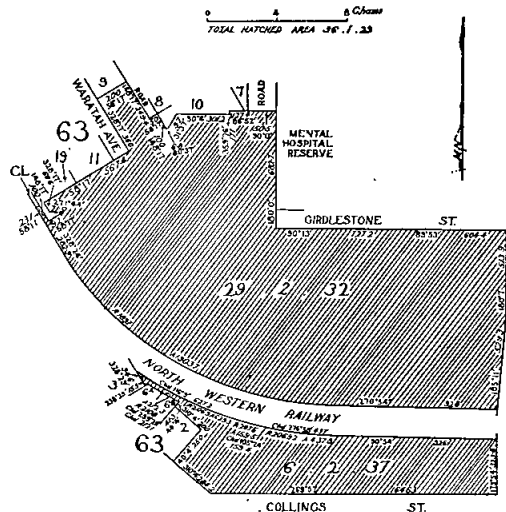

BUNGALALLY.—Site for Public Recreation, 2 acres, more or less, Parish of Bungalally, County of Borung, as indicated by hatching on plan hereunder.—(H.95^(T)) (Rs.9179).

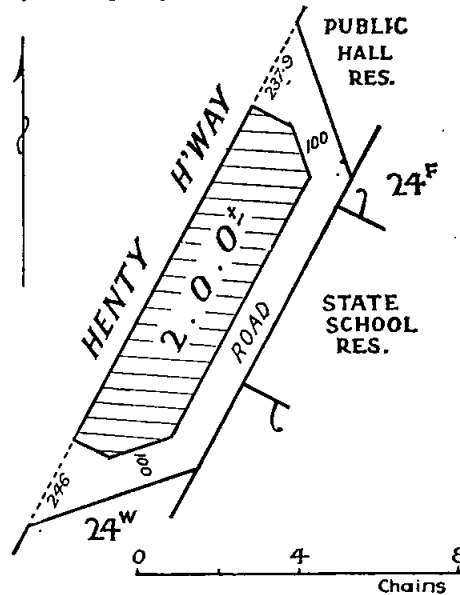

KOOEM.—Site for Water Supply Purposes, 4 acres 3 perches, Parish of Kooem, County of Tatchera, as indicated by hatching on plan hereunder.—(K.193^(*)) (Rs.9176).

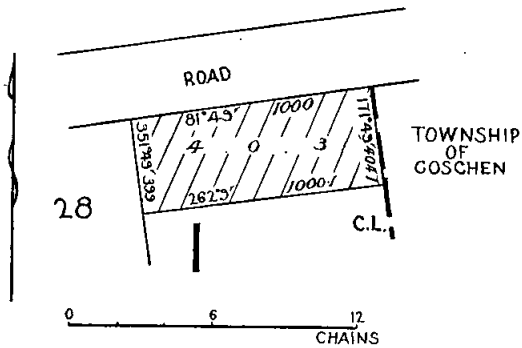

DEPARTMENT OF CROWN LANDS AND SURVEY.

At the Executive Council Chamber, Melbourne, the twenty-fourth day of June, 1969.

PRESENT:

The Lieutenant-Governor as Deputy for His Excellency the Governor of Victoria.

Mr. Chandler | Mr. Balfour.

REVOCATION OF PERMANENT RESERVATION OF LAND BY ORDER IN COUNCIL.

IN pursuance of the provisions of section 15 (2) (a) of the Land Act 1958, the Lieutenant-Governor as Deputy for His Excellency the Governor of the State of Victoria, by and with the advice of the Executive Council thereof, doth hereby revoke the permanent reservation of land by Order in Council hereinafter referred to, viz.:-

TRENTHAM.—The permanent reservation, by Order in Council of the 15th June, 1875, of 5 acres 1 rood 34 perches of land in the Township of Trentham as a site for State School Purposes, is hereby revoked, so far only as the portion containing 1 acre 2 roods, more or less, indicated by hatching on plan hereunder, is concerned.—(T.168^(*)) (Rs.9164).

MALLACOOTA.—Site for Hospital Purposes, 3 roods 10 perches, more or less, Township of Malla-coota, Parish of Malla-coota, County of Croajingolong, as indicated by hatching on plan hereunder.—(M.550^(*)) (Rs.9133).

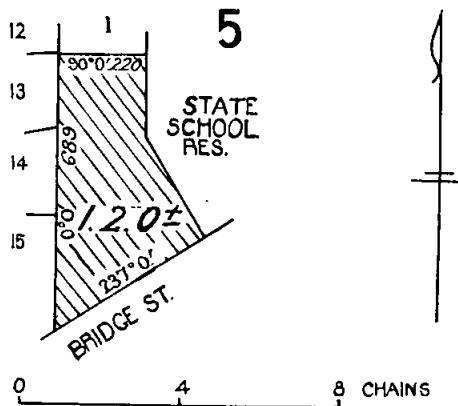
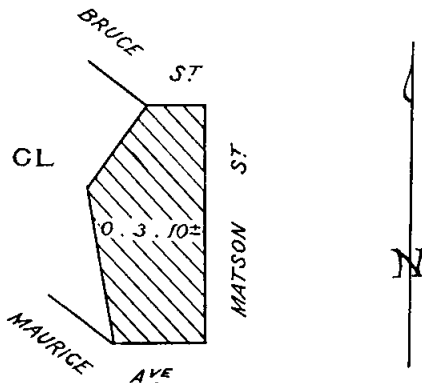

MELBOURNE (EAST MELBOURNE).—Site for Eye and Ear Hospital Purposes, 11 perches, at East Melbourne, City of Melbourne, Parish of Melbourne North, County of Grant, as indicated by hatching on plan hereunder.—(M.314^(*)) (Rs.5543).

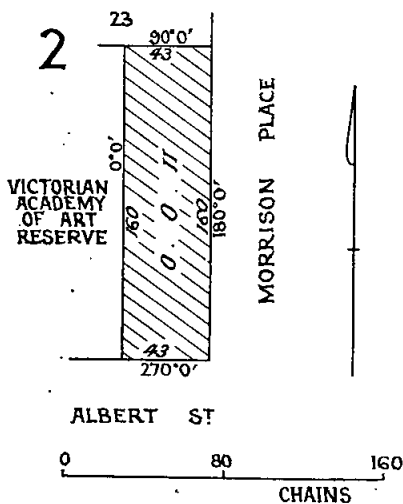

And the Honorable Sir William John Farquhar McDonald, Her Majesty's Minister of Lands for the State of Victoria, shall give the necessary directions herein accordingly.

J. ROSSITER,
Clerk of the Executive Council.

LABOUR AND INDUSTRY ACT 1958.

At the Executive Council Chamber, Melbourne, the twenty-fourth day of June, 1969.

PRESENT:

The Lieutenant-Governor as Deputy for His Excellency the Governor of Victoria.

Mr. Chandler | Mr. Balfour.

ABOLITION OF CERTAIN WAGES BOARDS.

IN pursuance of the powers conferred by the Labour and Industry Act 1958, the Lieutenant-Governor as Deputy for His Excellency the Governor of the State of Victoria, by and with the advice of the Executive Council thereof, doth hereby abolish the following wages Boards, viz.:-

- The Artificial Manure Board.
- The Bottle Covers Board.
- The Brewers Board.
- The Coal Miners Board.
- The Coopers Board.
- The Country Flour Board.
- The Dry Batteries Board.
- The Entertainment Employees (Non-performers) Board.
- The Fellmongers Board.
- The Flour Board.
- The Gold Miners Board.

And the Honorable Sir William John Farquhar McDonald, Her Majesty's Minister of Lands for the State of Victoria, shall give the necessary directions herein accordingly.

J. ROSSITER,
Clerk of the Executive Council.

The Gramophone Records Board.
 The Ham and Bacon Curers Board.
 The Industrial Life Assurance Canvassers Board.
 The Malt Board.
 The Plan Copying Board.
 The Provincial Printers Board.
 The Tie Makers Board.
 The Tramway Board.
 The Tramway Conversion Board.
 The Tuckpointers Board.
 The Waterproof Clothing Board.

And the Honorable Vernon Francis Wilcox, Her Majesty's Acting Minister of Labour and Industry for the State of Victoria, shall give the necessary directions herein accordingly.

J. ROSSITER,
 Clerk of the Executive Council.

RIDDELL'S CREEK WATERWORKS TRUST.

At the Executive Council Chamber, Melbourne, the first day of July, 1969.

PRESENT:

His Excellency the Governor of Victoria.
 Mr. Wilcox | Sir William McDonald.

EXTENT OF WATERWORKS DISTRICT INCREASED.

UNDER the powers conferred by the Water Act and all other powers enabling him in that behalf, His Excellency the Governor of the State of Victoria, by and with the advice of the Executive Council of the said State, doth hereby declare, order and direct that the extent of the Waterworks District of the Riddell's Creek Waterworks Trust be increased by adding to the same the lands comprised within the boundaries shown in red on a plan approved by the Governor in Council and deposited in the office of the State Rivers and Water Supply Commission, Melbourne (Corr. 59/4868/99) and as on and from the date hereof the extent of such District shall be and be deemed to be increased accordingly.

And the Honorable James Charles Murray Balfour, acting for and on behalf of Her Majesty's Minister of Water Supply for the State of Victoria, shall give the necessary directions herein accordingly.

J. ROSSITER,
 Clerk of the Executive Council.

GELLIBRAND WATERWORKS TRUST CONSTITUTED.

At the Executive Council Chamber, Melbourne, the first day of July, 1969.

PRESENT:

His Excellency the Governor of Victoria.
 Mr. Wilcox | Sir William McDonald.

HIS Excellency the Governor of the State of Victoria, by and with the advice of the Executive Council thereof, doth hereby approve, in accordance with the provisions of the Water Act, of the construction of works for the water supply to the Township of Gellibrand as set out in the application of the Councillors of the Shire of Otway for the constitution of a Waterworks Trust to construct, manage and maintain the said works in accordance with the provisions of the said Act and doth hereby order and appoint as follows:—

1. That a Waterworks Trust is hereby constituted and its corporate name shall be the Gellibrand Waterworks Trust.

2. That the Commissioners of the Trust shall comprise six Commissioners to be elected by the ratepayers of the proposed Waterworks Trust together with one other person appointed by the Governor in Council.

3. That the estimated cost of carrying out the proposed waterworks shall be Thirty-six thousand eight hundred dollars (\$36,800).

4. That the principal works to be constructed or carried out by the said Trust shall be pumping equipment at Lardner's Creek, service basin, rising main and reticulation.

5. That the lands within the boundaries as shown on the plan accompanying this Order shall be the Waterworks District of the said Trust to be known as the Gellibrand Waterworks District, such lands being within the municipal District of the Shire of Otway.

The location of the said works and the boundaries of the said Waterworks District are shown on a plan approved by the Governor in Council by and with this Order and deposited in the office of the State Rivers and Water Supply Commission, Melbourne (65/812/15).

And the Honorable James Charles Murray Balfour, acting for and on behalf of Her Majesty's Minister of Water Supply for the State of Victoria, shall give the necessary directions herein accordingly.

J. ROSSITER,
 Clerk of the Executive Council.

DANDENONG VALLEY AUTHORITY.

At the Executive Council Chamber, Melbourne, the first day of July, 1969.

PRESENT:

His Excellency the Governor of Victoria.
 Mr. Wilcox | Sir William McDonald.

CONSENT TO BORROWING \$50,000.

UNDER the powers conferred by the Dandenong Valley Authority Act and all other powers enabling him in that behalf, His Excellency the Governor of the State of Victoria, by and with the advice of the Executive Council of the said State, doth hereby consent to the Dandenong Valley Authority borrowing at interest by mortgage of the General Fund the sum of Fifty thousand dollars (\$50,000) to meet the cost of river improvement and drainage works.

And the Honorable James Charles Murray Balfour, acting for and on behalf of Her Majesty's Minister of Water Supply for the State of Victoria, shall give the necessary directions herein accordingly.

J. ROSSITER,
 Clerk of the Executive Council.

MORNINGTON SEWERAGE AUTHORITY.

At the Executive Council Chamber, Melbourne, the first day of July, 1969.

PRESENT:

His Excellency the Governor of Victoria.
 Mr. Wilcox | Sir William McDonald.

CONSENT TO BORROWING \$19,000.

UNDER the powers conferred by the Sewerage Districts Act and all other powers enabling him in that behalf, His Excellency the Governor of the State of Victoria, by and with the advice of the Executive Council of the said State, doth hereby consent to the Mornington Sewerage Authority borrowing at interest by mortgage of the General Fund the sum of Nineteen thousand dollars (\$19,000) for the conversion of Loan No. 12.

And the Honorable James Charles Murray Balfour, acting for and on behalf of Her Majesty's Minister of Water Supply for the State of Victoria, shall give the necessary directions herein accordingly.

J. ROSSITER,
 Clerk of the Executive Council.

WARRNAMBOOL SEWERAGE AUTHORITY.

At the Executive Council Chamber, Melbourne, the first day of July, 1969.

PRESENT:

His Excellency the Governor of Victoria.
Mr. Wilcox | Sir William McDonald.

CONSENT TO BORROWING \$50,000.

UNDER the powers conferred by the Sewerage Districts Act and all other powers enabling him in that behalf, His Excellency the Governor of the State of Victoria, by and with the advice of the Executive Council of the said State, doth hereby consent to the Warrnambool Sewerage Authority borrowing at interest, by mortgage of the General Fund, the sum of Fifty thousand dollars (\$50,000) to meet the cost of sewerage works as set forth in the detailed statement bearing date 26th June, 1969.

And the Honorable James Charles Murray Balfour, acting for and on behalf of Her Majesty's Minister of Water Supply for the State of Victoria, shall give the necessary directions herein accordingly.

J. ROSSITER,
Clerk of the Executive Council.

SEYMOUR SEWERAGE AUTHORITY.

At the Executive Council Chamber, Melbourne, the first day of July, 1969.

PRESENT:

His Excellency the Governor of Victoria.
Mr. Wilcox | Sir William McDonald.

CONSENT TO BORROWING \$50,000.

UNDER the powers conferred by the Sewerage Districts Act and all other powers enabling him in that behalf, His Excellency the Governor of the State of Victoria, by and with the advice of the Executive Council of the said State, doth hereby consent to the Seymour Sewerage Authority borrowing at interest by mortgage of the General Fund the sum of Fifty thousand dollars (\$50,000) to meet the cost of sewerage works as set forth in the detailed statement bearing date 26th June, 1969.

And the Honorable James Charles Murray Balfour, acting for and on behalf of Her Majesty's Minister of Water Supply for the State of Victoria, shall give the necessary directions herein accordingly.

J. ROSSITER,
Clerk of the Executive Council.

LANDS DEPARTMENT NOTICES

APPROACHING LAND SALES.

SALES of Crown Lands, in fee-simple, will be held at the under-mentioned places and dates, viz.:-

	No. of Gazette.
Bendigo.—Thursday, 24th July, 1969 ..	47
Geelong.—Monday, 4th August, 1969 ..	55
Kyabram.—Thursday, 7th August, 1969 ..	50
Meredith.—Thursday, 31st July, 1969 ..	49
Moe.—Tuesday, 19th August, 1969 ..	43
Natimuk.—Tuesday, 8th July, 1969 ..	45
Red Cliffs.—Tuesday, 22nd July, 1969 ..	45

SALE OF FREEHOLD LAND BY AUCTION.

Rushworth.—Thursday, 7th August, 1969 .. 50

SALE OF CROWN LAND BY AUCTION.

The land will be offered for sale in fee-simple, and subject to the provisions of the Land Act and Regulations thereunder, as varied and applied pursuant to the Geelong Harbor Trust Act.

The upset price is the sum at which bidding will start, and no bid below that sum can be accepted. The highest bidder at or above that sum shall be the purchaser, subject to signature of contract and any necessary payment.

TERMS:

A deposit of at least 12½% of the purchase price must be paid at the sale, either in cash or by cheque.

The residue is payable within 30 days.

FEES, ETC.:

Survey fee is payable at the sale.

The following fees are payable with the balance of purchase money:—

Crown Grant fee—\$3.

Assurance Fund contribution.—One cent in every five dollars or part thereof of purchase price. (This is a fund established to guarantee the validity of freehold titles.)

If unable to attend personally, a prospective purchaser may arrange for another person to bid as his agent.

W. J. F. McDONALD,
Minister of Lands.

Office of Crown Lands and Survey,
Melbourne, 2nd July, 1969.

GEELONG.—Sale (No. 12006) of Crown land in fee-simple, by auction, will be held at the LAND OFFICE, 123 RYRIE-STREET, GEELONG, on MONDAY, the FOURTH day of AUGUST, 1969, at HALF-PAST TEN o'clock a.m. To be conducted by D. M. O'CONNOR, Land Officer, Geelong.

Lot 1.

PARISH OF CORIO, COUNTY OF GRANT.

At the South-west corner of the intersection of Fellmonger-street and Boundary-road with frontages of 515 feet and 260 feet respectively.

Upset price \$6,000 the lot. Survey fee \$150.

Area 2a. 3r. 22 7/10 p., subject to survey, allotment 9q of Section 6A.

SPECIAL CONDITION.

The purchaser shall within a period of twelve months from the date of sale erect on the land improvements to the value of at least \$130,000.

Satisfactory compliance with this condition is subject to approval by the Minister of Lands on the recommendation of the Geelong Harbor Trust Commissioners, and the Crown Grant will not issue until after such approval.—(G.69776).

COMMON ABOUT TO BE DIMINISHED.

IN pursuance of the provisions contained in the Land Act 1958, notice is hereby given that it is the intention of the Governor in Council to diminish the common hereinafter mentioned, viz.:-

The following Notice was published 1° on the 2nd July, 1969, pursuant to Order of the 24th June, 1969.

The Cape Clear Common, proclaimed as such by the Governor in Council, on the 26th July, 1904, is about to be abolished.—(C.65187.)

W. J. F. McDONALD,
Minister of Lands.

PROPOSED REVOCATIONS OF TEMPORARY RESERVATIONS OF LANDS BY ORDERS IN COUNCIL.

IN pursuance of the provisions of the Land Act 1958, notice is hereby given that it is the intention of the Governor in Council to revoke the temporary reservations of lands by Orders in Council hereunder referred to, viz.:-

The following Notices were published 1° on the 25th June, 1969, pursuant to Orders of the 18th June, 1969.

AMHERST.—The temporary reservation as a site for a Quarry and the withholding from sale, leasing and licensing by Order in Council of the 13th August, 1907 (see Government Gazette, 21st August, 1907, page 3907), of 4 acres 32 perches of land in the Parish of Amherst are

about to be revoked so far only as the portion containing 17 perches, indicated by hatching on plan hereunder is concerned.—(A.28⁽¹⁶⁾) (W.88397).

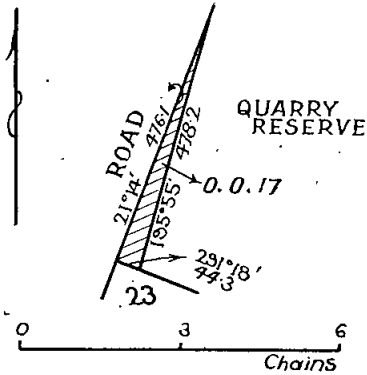

SEASPRAY.—The temporary reservation by Order in Council of the 4th February, 1947, of 7 acres 22 perches, more or less, of land in the Township of Seaspray as a site for Public purposes, revoked as to part by Order of the 21st December, 1960, is about to be revoked so far only as the portion containing 2 roods 22 perches, indicated by hatching on plan hereunder, is concerned.—(S.461⁽⁶⁾) (Rs.3585).

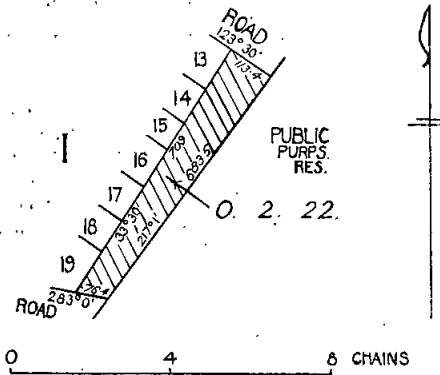

CASTLEMAINE.—The temporary reservation, by Order in Council of the 13th August, 1900, of 1 acre 1 rood 2 perches of land in the Township of Castlemaine as a site for an Ornamental Plantation, is about to be revoked.—(C.99⁽⁷⁾) (C.9925).

DUNOLLY.—The temporary reservation by Order in Council of the 29th March, 1949, of 5 acres 2 roods, more or less, of land in the Township of Dunolly as a site for Public Recreation and Public Gardens is about to be revoked so far only as the portion containing 5 perches, indicated by hatching on plan hereunder, is concerned.—(D.124⁽⁸⁾) (Rs.3790).

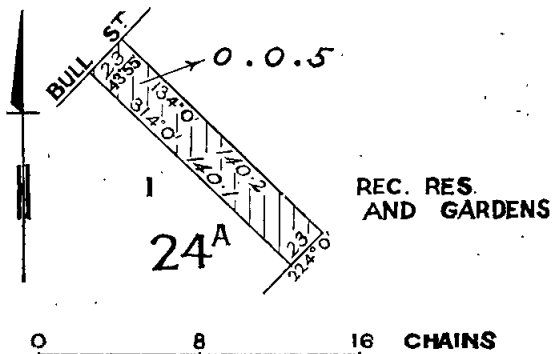

SKIPTON.—The temporary reservation as a site for Affording Access to Water and the withholding from sale, leasing and licensing by Order in Council of the 9th March, 1880, of 18 acres 33 perches of land in the Township of Skipton, revoked as to part by Order of the 27th September, 1955, are about to be revoked so far as the balance thereof containing 17 acres 3 roods 25 perches, more or less, is concerned.—(S.289⁽⁹⁾) (Rs.6462).

WILLAM.—The temporary reservation by Order in Council of the 26th April, 1887 (see *Government Gazette*, 29th April, 1887, page 1136) of 883 acres of land in the Parish of Willam as a site for Water Supply purposes revoked as to part by order of the 22nd November, 1905 (see *Government Gazette*, 29th November, 1905, page 4519) is about to be revoked save and except the area of 27 acres 2 roods, more or less, indicated by hatching on plan hereunder is concerned.—(W.346⁽³⁾) (Rs.9150).

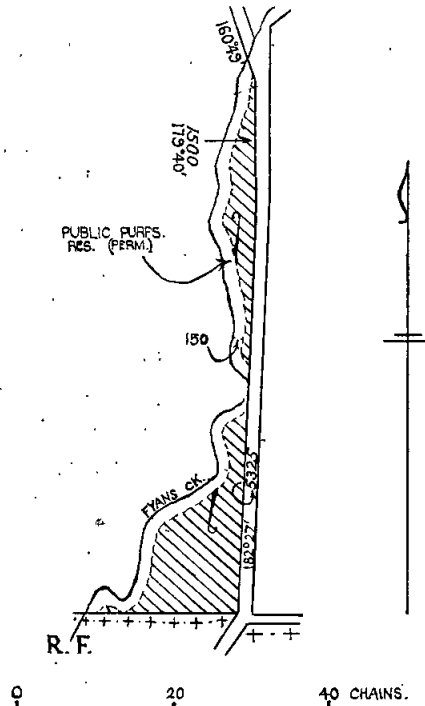

NARRACAN.—The temporary reservation by Order in Council of the 14th December, 1954, of 9 acres 2 roods 35 perches of land in the Parish of Narracan as a site for Hospital purposes revoked as to part by various orders is about to be revoked so far only as the portion containing 2 roods 10 perches, indicated by hatching on plan hereunder is concerned.—(N.129⁽¹²⁾) (Rs.6912).

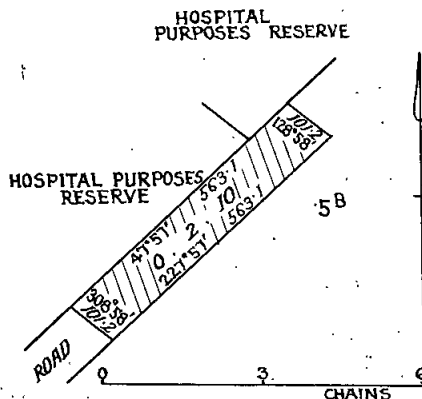

Total Hatched Portions 27.2.0±

W. J. F. McDONALD,
Minister of Lands.

PROPOSED REVOCATION OF TEMPORARY RESERVATION OF LAND BY ORDER IN COUNCIL.

IN pursuance of the provisions of the Land Act 1958, notice is hereby given that it is the intention of the Governor in Council to revoke the temporary reservation of land by Order in Council hereunder referred to, viz.:—

The following Notices were published 1° on the 2nd July, 1969, pursuant to Orders of the 24th June, 1969.

KYNETON.—The temporary reservation by Order in Council of the 24th March, 1885, of 10 acres, more or less, of land in the Township of Kyneton as a site for a Public Park is about to be revoked, so far only as the portion containing 1 acre 2 roods 25 perches indicated by hatching on plan hereunder is concerned.—(K.96(2) (Rs.2080.)

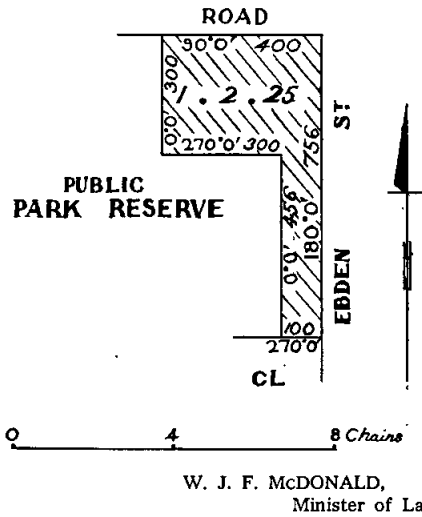

HEIDELBERG.—The temporary reservation by Order in Council of the 21st January, 1964, of 2 acres 1 rood, more or less, of land in the Township of Heidelberg, as a site for Public purposes (Government Buildings) is about to be revoked, so far only as the portion containing 20 perches, more or less, indicated by hatching on plan hereunder is concerned.—(H.133(1) (Rs.8298.)

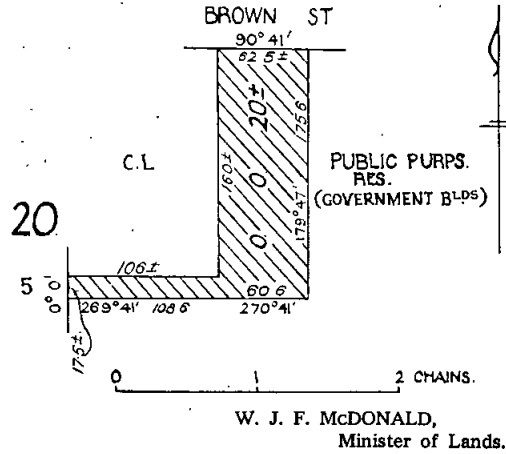

COMMITTEES OF MANAGEMENT OF RESERVES.

APPOINTMENTS.

NOTICE is hereby given that, in pursuance of section 221 of the Land Act 1958, the following appointments of Committees of Management of reserved Crown lands have been made by the Minister of Lands:—

“BARNAWARTHA RECREATION RESERVE.”

Eric Milthorpe, Edwin John Baxter, James Alexander Welladsen, Sidney Raymond Pennington, Jack Treyvard Tanner, Robert Stuart Oates, Charles Neil Eames, Colin Clive Margery and Ernest Cyrus Wood as a Committee of Management for a period of three (3) years of the land in the Township of Barnawartha temporarily reserved by Orders in Council dated the 4th May, 1891, 18th April, 1902, and 17th June, 1964, as sites for Public Recreation, and together known as the “Barnawartha Recreation Reserve”.—(Corres. No. Rs.246.)

“BATYO CATYO WATER SUPPLY AND RECREATION RESERVE.”

Robert Francis Jones (as the representative of the Department of Crown Lands and Survey) in the place of Dominic Joseph Yurcina (transferred) and who shall be chairman, and Richard Fellows Lewis Nicholson (as representative of the State Rivers and Water Supply Commission) as members of the Committee of Management of the land in the Parish of Rich Avon East, temporarily reserved by Order in Council dated the 1st February, 1956, as a site for Water Supply and Public Recreation, and known as the “Batyo Catyo Water Supply and Recreation Reserve”.—(Corres. No. Rs.7425.)

“ENSAY SWIMMING POOL RESERVE.”

Sylvester Ulick Browne, Hugh Thomas Fraser, Alan Bernard Lucas, James Arthur Commins, George Lilburn Thompson and William George Ffrench as a Committee of Management for a period of three (3) years from the 23rd May, 1969, of that portion of the lands in the Parish of Numbie Munjie, temporarily reserved by Order in Council dated the 9th April, 1946, as a site for Public purposes, as is indicated by red color on plan marked “N/25.3.46” attached to Lands Department correspondence Rs.5774, and known as the “Ensay Swimming Pool Reserve”.—(Corres. No. Rs.5774.)

PROPOSED REVOCATIONS OF TEMPORARY RESERVATIONS OF LANDS BY ORDERS IN COUNCIL.

IN pursuance of the provisions of the Land Act 1958, notice is hereby given that it is the intention of the Governor in Council to revoke the temporary reservations of lands by Orders in Council hereunder referred to, viz.:—

The following Notices were published 1° on the 18th June, 1969, pursuant to Orders of the 10th June, 1969.

BEAUFORT.—The temporary reservation by Order in Council of the 25th September, 1894 (see Government Gazette 28th September, 1894, page 3758) of 35 acres 12 perches of land in the Parish of Beaufort as a site for Water Supply Purposes revoked as to part by Order of the 10th December, 1929 (see Government Gazette 18th December, 1929, page 4247) is about to be revoked so far only as the portion containing 5 acres 1 rood 19 perches indicated by hatching on plan hereunder is concerned.—(B.305(7) (C.98285.)

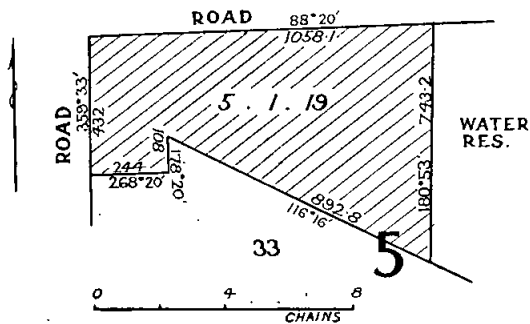

"GREAT WESTERN RECREATION RESERVE."

Frederick Hamill Thomson, Colin Thomas Preece, Donald John McKay, Albert George Illig and Frederick Charles Grellet as a Committee of Management for a period of three (3) years of the remaining portion of the reserved land in the Parish of Concongella South, temporarily reserved by Order in Council dated the 13th May, 1967, as a site for Racing and General Recreation purposes, at Great Western, and known as the "Great Western Recreation Reserve".—(Corres. No. Rs.2903.)

"GREENWALD PUBLIC HALL AND RECREATION RESERVE."

James P. Murphy, Norman Richard Cowland, Leslie John Natrass, Trevor Roy Emerson and Raymond George Malseed as a Committee of Management for a period of three (3) years of the land in the Parish of Drik Drik, temporarily reserved by Order in Council dated the 6th May, 1952, as a site for a Public Hall and Public Recreation, and known as the "Greenwald Public Hall and Recreation Reserve".—(Corres. No. Rs.6913.)

"HALLORA PUBLIC HALL RESERVE."

Patrick E. Reilly, John C. Phillips, Arnold A. Mills, Allan S. Hutton, Harold E. Pollard, Kenneth J. Hick, Bruce A. Eccles, Robert A. Allen and Graham T. Brock as a Committee of Management for a period of three (3) years of the land in the Parish of Longwarry, temporarily reserved by Order in Council dated the 19th February, 1906, as a site for a Public Hall, and known as the "Hallora Public Hall Reserve".—(Corres. No. Rs.4251.)

"HERNE'S OAK RECREATION RESERVE AND CHILDREN'S PLAYGROUND."

Oscar Harrington, Walter Thomas Shaw, Gerald Laurence Morrissey, John Austin Hughes, Leonard Emms Abbott, Percival Henry Palmer, Allan Douglas McHenry, Leonard Joseph Daugh and Francis Gerald McClare as a Committee of Management for a period of three (3) years of the land in the Parish of Narracan temporarily reserved by Order in Council dated the 3rd May, 1938, as a site for Public Recreation and Children's Playground, and known as the "Herne's Oak Recreation Reserve and Children's Playground".—(Corres. No. Rs.4809.)

"KENNINGTON PUBLIC HALL RESERVE."

Glen Heywood Neil, Jack Stephens, Thomas Henry Noble, Angus McKinnon and Alexander Dundas Reid as a Committee of Management for a period ending the 13th September, 1969, of the land in the Parish of Sandhurst temporarily reserved by Order in Council dated the 4th April, 1918, as a site for a Public Hall, and known as the "Kennington Public Hall Reserve".—(Corres. No. Rs.1755.)

"KYNETON RACECOURSE AND RECREATION RESERVE."

John Richard Louis Smith, Leslie Fowler and James Frederick Roberts (as representatives of the public) Robert Clarence Charles, William Jaboor and Robert George Tosh Ramsay (as representatives of the Kyneton District Racing Club) as a Committee of Management for a period ending the 19th June, 1972, of the land in the Parish of Lauriston, at Kyneton permanently reserved by Order in Council dated the 10th September, 1877, for Racing and Recreation purposes and for Drilling and Reviewing Volunteers, and known as the "Kyneton Racecourse and Recreation Reserve".—(Corres. No. Rs.6056.)

"MOONDARRA RECREATION RESERVE."

Harry Francis Blanche, James Samuel Wallace, Raymond Harold Macklin, Cecil Stewart, Harry Thomas, Thomas C. Grieve, Maxwell John Horton, Frank Pasquale and Mervyn Charles Morgan as a Committee of Management for a period of three (3) years of the land in the Township of Moondarra temporarily reserved by Order in Council dated the 20th January, 1914, as a site for Public Recreation, and known as the "Moondarra Recreation Reserve".—(Corres. No. Rs.585.)

"NYAH PUBLIC HALL RESERVE."

Malcolm Leslie Patman, Henry Albert Dowel, Leslie Raymond Baines, Frank Horobin, Andrew McGregor, John William Grundy and Maxwell George Olsen as a Committee of Management for a period of three (3) years of

the land in the Township of Nyah, Parish of Lang Lang East temporarily reserved by Order in Council dated the 10th September, 1968, as a site for Public purposes (Public Hall), and known as the "Nyah Public Hall Reserve".—(Corres. No. Rs.774.)

"STRATFORD RESERVOIR PARK."

Anthony Richard Lee, James Robert Stewart, Bruce William Shingles, Gordon Baxter Dugan, Leonard Arthur Watson and Harold Vernon Ripper as a Committee of Management for a period of three (3) years of the remaining portion of land in the Parish of Stratford temporarily reserved by Order in Council dated the 10th February, 1959, as a site for Public Recreation and Camping purposes, and known as the "Stratford Reservoir Park".—(Corres. No. Rs.7794.)

"THOONA MECHANICS' INSTITUTE AND FREE LIBRARY RESERVE."

Ivan Maxwell Rowlands, Andrew Brown Alexander Ellis, James Alexander Irvine, Geoffrey Norman Walker, Kenneth Robert Gibson, William Norman Irvine, Arthur Frank Johnston, Arthur Martin Irvine as a Committee of Management for a period of three (3) years of the land in the Parish of Mokoan temporarily reserved by Orders in Council dated the 15th April, 1890, and 3rd May, 1949, as sites for Mechanics' Institute and Free Library purposes, and known as the "Thoona Mechanics' Institute and Free Library Reserve".—(Corres. No. Rs.6024.)

**"TRAWALLA RECREATION (PICNIC) RESERVE",
PARISH OF BREWSTER.**

Leslie Francis Broadbent, John Albert Wallish, Sidney William Sly, Colin McKenzie, William Robert Broadbent, Kenneth William Mackenzie and George Thomas Riddoch as a Committee of Management for a period of three (3) years of the land in the Parish of Brewster temporarily reserved by Order in Council dated the 3rd June, 1969, as a site for Public Recreation, and known as the "Trawalla Recreation (Picnic) Reserve".—(Corres. No. Rs.9155.)

"WERRIBEE RACECOURSE AND RECREATION RESERVE."

Maurice Thomas Rushford, John Henry McNaughton, James Henry Carter and Walter Carter (for a period of three (3) years) and Aloysius Joseph Louis Hayes, Warwick Calmady Cayley, John O'Toole and William Garfield (as representatives of the Werribee Racing Club) and Jack W. Frost and Leonard Charles Grant (as representatives of the Werribee Golf Club) as a Committee of Management of the land temporarily reserved by Order in Council dated the 22nd April, 1861, as a site for a Racecourse and General Recreation purposes in the Township of Wyndham (now Werribee), and known as the "Werribee Racecourse and Recreation Reserve".—(Corres. No. Rs.925.)

"WILLENABRINA PUBLIC HALL RESERVE."

Percival James Roberts, Ronald William Gebert, Ian Nicholson Fisher, Wallace Sturrock, Clement Martin Quick, Ronald Keith Preston, Clement Reginald Quick, Garnet Leslie Wiedermann and Ronald William Porker as a Committee of Management for a period of three (3) years of the land in the Parish of Willenabrina temporarily reserved by Order in Council dated the 31st May, 1938, as a site for a Public Hall, and known as the "Willenabrina Public Hall Reserve".—(Corres. No. Rs.4515.)

**"BRIGHT PUBLIC RECREATION AND CAMPING RESERVE AND
MORSE'S CREEK FRONTAGE."**

The Corporation of the Shire of Bright as the Committee of Management of the land in the Township of Bright, Parish of Bright temporarily reserved by Order in Council dated the 17th December, 1968, as a site for Public Recreation and Camping purposes, together with such portions of the abutting permanent reservation along Morse's Creek, the total area as shown hatched black on plan marked "B/13.6.69" attached to Lands Department correspondence C.99800.—(Corres. Nos. Rs.3832, C.99800.)

SITE FOR PUBLIC RECREATION, MARYBOROUGH.

The Corporation of the City of Maryborough as the Committee of Management of the land in the Parish of Maryborough temporarily reserved by Order in Council dated the 29th April, 1969, as a site for Public Recreation.—(Corres. No. Rs.9158.)

SITE FOR PUBLIC PURPOSES, PARISH OF MUNDOONA.

The State Rivers and Water Supply Commission as the Committee of Management of the land in the Parish of Mundoona temporarily reserved by Order in Council dated the 25th March, 1969, as a site for Public purposes.—(Corres. No. Rs.9106.)

SITE FOR PUBLIC PURPOSES (SUPPLY OF GRAVEL)
PARISH OF WATGANIA WEST.

The Corporation of the Shire of Ararat as the Committee of Management of the land in the Parish of Watgania West temporarily reserved by Order in Council dated the 13th May, 1969, as a site for Public purposes (Supply of Gravel).—(Corres. No. Rs.9168.)

W. J. F. McDONALD,
Minister of Lands.

Department of Crown Lands and Survey,
Melbourne, 23rd June, 1969.

Land Act 1958.

LICENCES UNDER THE LAND ACTS DECLARED VOID.

NOTICE is hereby given that the Licences in the Schedule hereunder have been Declared Void for the reason specified in each case.

SCHEDULE

District.	Corr. No.	Name of Licensee.	Section of Land Act under which Licensed.	Parish.	Allotment.	Section.	Area.	Annual Rental.	Reasons for Voiding.
							A. R. P.	\$	
Bendigo ..	02243/138	Robert James Waddington	138	Sandhurst	65F	0	0 0 19	33.00 per annum	Licence surrendered
Ballarat ..	1121/138	J. H. Brown and Son Pty. Ltd.	138	Sebastopol (Tp.)	3	2	0 1 27	50.00	Non-compliance with conditions
Hamilton	0212/138	Herbert Leslie Bloomfield	138	Balmoral (Tp.)	7	18A	2 3 39	2.00	Licence surrendered

Department of Crown Lands and Survey,
Melbourne, 23rd June, 1969.

W. J. F. McDONALD,
Minister of Lands.

Land Act 1958.

LEASES SURRENDERED.

NOTICE is hereby given that the Governor in Council has accepted the surrender of the Leases mentioned in the schedule hereunder for the reason specified in each case.

District.	Corr. No.	Name.	Section of Land Act under which Leased.	Parish.	Allotment.	Section.	Area.	Annual Rental.	Reason.
							A. R. P.	\$	
Bairnsdale	61/155	Alan Kenneth Beveridge	155	Gillingall	1A	..	161 3 31	16 20	Substitute lease to issue—pursuant to Section 4 of Land (Amendment) Act.
Bairnsdale	26/155	Reinhold Strecker	155	Wy-Yung	10	4	190 1 26	23.88	Substitute lease to issue—pursuant to Section 4 of Land (Amendment) Act.

Department of Crown Lands and Survey,
Melbourne, 23rd June, 1969.

W. J. F. McDONALD,
Minister of Lands.

PUBLIC SERVICE NOTICES

No. 238.

Public Service Act 1958, Section 50.

REGULATIONS.—PART IV.—SALARIES AND INCREMENTS.

THE Public Service Board, in pursuance of the powers conferred by the *Public Service Act 1958*, hereby amends its Regulations as follows :—

SECOND SCHEDULE.

TECHNICAL AND GENERAL DIVISION.

Grades and Salary Scales.

FEMALES.

The following Grades are added :—

Grade Number.	Yearly Rate of Salary.
	\$
F58	5,477
F59	5,540
F60	5,603
F61	5,666

SEVENTH SCHEDULE.

TECHNICAL AND GENERAL DIVISION.

DEPARTMENT OF HEALTH.

MENTAL HYGIENE.

Grades and Salary Scales.

FEMALES.

The following Grades are added :—

Grade Number.	Yearly Rate of Salary.
	\$
F58	5,477
F59	5,540
F60	5,603
F61	5,666

JUNIOR GRADES.

Males.

Add—

Grade.	Yearly Rate of Salary at Each Age in Years.					
	Under 16.	16.	17.	18.	19.	20.
	\$	\$	\$	\$	\$	\$
I			1,362	1,645	1,838	2,037

Females.

Grade.	Yearly Rate of Salary at Each Age in Years.					
	Under 16.	16.	17.	18.	19.	20.
	\$	\$	\$	\$	\$	\$
K			1,214	1,441	1,590	1,735

FIFTH SCHEDULE.

TEMPORARY EMPLOYEES.

DEPARTMENT OF HEALTH.

MENTAL HYGIENE.

Designations of Positions and Rates of Salaries.

Designation of Position.	Yearly Rate of Salary. £	
	Minimum.	Maximum.
	\$	\$
<i>Delete the existing yearly rates of salary for the following positions and insert the rates shown hereunder in lieu thereof—</i>		
Hospital Sister, Senior		3,262
Hospital Sister, Deputy, Senior		3,045
Hospital Sister		2,813
Nurse, Charge (Male)	3,306	3,540
Nurse, Head (Female)	3,607	3,716
Nurse, Head, Assistant (Female)	3,262	3,498
Nurse, Charge (Female)	2,813	3,045
Nurse, Principal (Female)	3,955	4,080
Nurse, Senior, Surgical Unit		3,306
Nurse, Staff (Male)		2,705
Nurse, Staff (Female)		2,236
Nurse, Student (Male)—		
Junior†—		
At 17 years of age		1,362
At 18 years of age		1,645
At 19 years of age		1,838
At 20 years of age		2,037
Adult††	2,190	2,350
Nurse, Student (Female)—		
Junior†—		
At 17 years of age		1,214
At 18 years of age		1,441
At 19 years of age		1,590
At 20 years of age		1,735
Adult††	1,768	1,906
Nurse, Ward (Male)	2,781	3,092
Nurse, Ward (Female)	2,312	2,595
Sister	2,312	2,595
Tutor (Male)		3,867
Tutor (Female)		3,371

† See Regulation 124.
 †† See Regulation 97 (3).

SIXTH SCHEDULE.

TEMPORARY EMPLOYEES.

Designations of Positions and Rates of Salaries.

Department and Designation of Position.	Yearly Rate of Salary.		Increments (Annual).
	Minimum.	Maximum.	
	\$	\$	
<i>Delete the existing yearly rates of salary for the following positions and insert the rates shown hereunder in lieu thereof—</i>			
GENERAL.			
Nurse	2,595	2,669	£
MINISTRY OF ABORIGINAL AFFAIRS.			
Nurse, Visiting	2,669	3,045	£
Sister	2,669	3,045	£
Sister, Senior	3,498	3,607	£

SIXTH SCHEDULE—continued.

Department and Designation of Position.	Yearly Rate of Salary.		Increments (Annual).
	Minimum.	Maximum.	
CHIEF SECRETARY'S DEPARTMENT.	\$	\$	
SOCIAL WELFARE.			
<i>Family Welfare Division.</i>			
Field Officer (Female), Senior		3,371	
Field Officer (Female) ..	3,045	3,153	Σ
Field Officer (Foster Care and Adoption) (Female)†† ..	3,045	3,153	Σ
Nurse, "Turana"†† ..	2,669	2,937	Σ
Matron, Deputy, "Allambie"†† ..		3,830	
Ward Sister, "Allambie"†† ..	2,813	3,153	Σ
<i>Youth Welfare Division.</i>			
Nurse, "Turana"†† ..	2,669	2,937	Σ
Sister, "Winlaton" ..	2,669	3,045	Σ
<i>Prisons Division.</i>			
Nurse	2,669	3,045	Σ
OFFICE OF THE CHIEF COMMISSIONER OF POLICE.			
Police Hospital—			
Matron		3,607	
Sister	2,669	3,045	Σ
†† See Regulation 118.			
DEPARTMENT OF HEALTH.			
GENERAL HEALTH.			
Adviser, Assistant, Community Welfare Services ..	2,669	3,045	Σ
Exotic Diseases—Sister ..	2,669	3,045	Σ
Nurse, Venereal Diseases Clinic ..	2,669	3,045	Σ
Nurse, Visiting	2,669	3,045	Σ
MATERNAL AND CHILD WELFARE			
School Nurse	2,669	3,045	Σ
Sister, Dental Services ..	2,669	3,045	Σ
Sister, Infant Welfare* ..		3,371	
TUBERCULOSIS ^φ			
Nurse, Tuberculosis Bureau ..	2,669	3,045	Σ
Nurse, Visiting	2,669	3,045	Σ
STATE SANATORIA. ^φ			
Matron		4,205	
Matron, Deputy		3,498	
Nurse, Charge (Male)	3,092	3,540	Σ
Sister	2,669	3,045	Σ
Tutor Sister	3,153	3,262	Σ
* See Regulation 120.			
^φ See Regulation 121.			
^Σ See Regulation 97 (2).			

This Regulation shall have effect as on and from the 25th May, 1969.

F. E. CAHILL, Chairman.
V. P. SCULLY, Secretary.

Office of the Public Service Board,
Melbourne, 30th May, 1969.

No. 239.

Public Service Act 1958, Section 50.

REGULATIONS.—PART IV.—SALARIES AND INCREMENTS.

THE Public Service Board, in pursuance of the powers conferred by the Public Service Act 1958, hereby amends its Regulations as shown below :—

FIFTH SCHEDULE.

TEMPORARY EMPLOYEES.

DEPARTMENT OF HEALTH.

MENTAL HYGIENE.

Designations of Positions and Rates of Salaries.

Designation of Position.	Yearly Rate of Salary. ^Σ	
	Minimum.	Maximum.
	\$	\$
<i>Delete—</i>		
Dental Mechanic	2,800	3,092
<i>Add—</i>		
Dental Mechanic	2,800	3,147

^ΣAnnual increments shall be in accordance with those prescribed by Sub-Regulations 97 (2) and 97 (3), provided that in the case of the position of Assistant (Male), Administrative, the annual increments shall be in accordance with those prescribed by Part A of the Third Schedule.

This Regulation shall have effect as on and from the 6th April, 1969.

F. E. CAHILL, Chairman.
V. P. SCULLY, Secretary.

Office of the Public Service Board,
Melbourne, 6th June, 1969.

No. 240.

Public Service Act 1958, Section 50.

REGULATIONS.—PART IV.—SALARIES AND INCREMENTS.

THE Public Service Board, in pursuance of the powers conferred by the Public Service Act 1958, hereby amends its Regulations as shown below :—

SIXTH SCHEDULE.

TEMPORARY EMPLOYEES.

Designations of Positions and Rates of Salaries.

Department and Designation of Position.	Yearly Rate of Salary.		Increments (Annual).
	Minimum.	Maximum.	
	\$	\$	
DEPARTMENT OF AGRICULTURE.			
<i>Dookie Agricultural College.</i>			
<i>Delete—</i>			
Farm Assistant	2,350	2,572	Σ
Motor Truck Driver	2,334	2,572	Σ
<i>Longerenong Agricultural College.</i>			
<i>Delete—</i>			
Farm Assistant	2,350	2,572	Σ
Motor Truck Driver	2,334	2,572	Σ
^Σ See Regulation 97 (2).			

This Regulation shall have effect as on and from the 6th April, 1969.

F. E. CAHILL, Chairman.
V. P. SCULLY, Secretary.

Office of the Public Service Board,
Melbourne, 6th June, 1969.

No. 244.

Public Service Act 1958, Section 50.

REGULATIONS.—PART IV.—SALARIES AND INCREMENTS.

THE Public Service Board, in pursuance of the powers conferred by the *Public Service Act 1958*, hereby amends its Regulations as shown below :—

THIRD SCHEDULE.

PART B.

PROFESSIONAL DIVISION.

Scale of Rates of Annual Salaries.

The existing salary scales for "Agricultural Officers (non-Graduate)" and "Conservation Officers (non-Graduate)" are deleted and the following salary scales are substituted therefor—

AGRICULTURAL OFFICERS (NON-GRADUATE).

Class.	Annual Salary of Each Subdivision of Each Class.										
	1.	2.	3.	4.	5.	6.	7.	8.	9.	10.	11.
	\$	\$	\$	\$	\$	\$	\$	\$	\$	\$	\$
AO-1 ..	3,343	3,494	3,727	3,850	3,975	4,225	4,392	4,517	4,759	4,910	5,063
AO-2 ..	5,385	5,519	5,704

CONSERVATION OFFICERS (NON-GRADUATE).

Class.	Annual Salary of Each Subdivision of Each Class.										
	1.	2.	3.	4.	5.	6.	7.	8.	9.	10.	11.
	\$	\$	\$	\$	\$	\$	\$	\$	\$	\$	\$
CO-1 ..	3,343	3,494	3,727	3,850	3,975	4,225	4,392	4,517	4,759	4,910	5,063
CO-2 ..	5,385	5,519	5,704
CO-3 ..	6,100	6,238	6,431
CO-4 ..	7,013

This Regulation shall have effect as on and from the 15th June, 1969.

F. E. CAHILL, Chairman.
V. P. SCULLY, Secretary.

Office of the Public Service Board,
Melbourne, 13th June, 1969.

No. 242.

Public Service Act 1958.

THE Public Service Board, in pursuance of the powers conferred by the *Public Service Act 1958*, hereby amends the Public Service (Public Service Board) Regulations as follows :—

PART VI.—TRAVELLING AND OTHER EXPENSES.

DIVISION I.—REIMBURSEMENT OF PERSONAL EXPENSES.

GENERAL.

Regulation 172.

Sub-regulation (2) is revoked and the following sub-regulation is substituted therefor :—

"(2) Subject to the provisions of sub-regulation (3) hereunder, reimbursement of personal expenses shall be allowed to officers visiting places within Australia at the appropriate daily rates set out in the following table :—

	Capital Cities Including Canberra.	All Other Places Within Australia.
	\$	\$
Permanent Heads and officers in receipt of a standard salary of \$8,298 and above ..	15	10
Other officers ..	13	10"

This Regulation shall have effect as on and from the 1st July, 1969.

F. E. CAHILL, Chairman.
V. P. SCULLY, Secretary.

Office of the Public Service Board,
Melbourne, 23rd June, 1969.

No. 243.

Public Service Act 1958, Section 50.

REGULATIONS.—PART IV.—SALARIES AND INCREMENTS.

THE Public Service Board, in pursuance of the powers conferred by the *Public Service Act 1958*, hereby amends its Regulations as shown below :—

SIXTH SCHEDULE.

TEMPORARY EMPLOYEES.

Designations of Positions and Rates of Salaries.

Department and Designation of Position.	Yearly Rate of Salary.		Increments (Annual)
	Minimum.	Maximum.	
	\$	\$	
DEPARTMENT OF AGRICULTURE.			
<i>Delete—</i> Agricultural Officer ..	3,114	4,684	‡
<i>Add—</i> Agricultural Officer ..	3,343	5,063	‡
‡ Increments in accordance with the scale of rates of salaries as set out for "Agricultural Officer, Class "AO-1" in Part B of the Third Schedule.			
PREMIER'S DEPARTMENT.			
<i>Soil Conservation Authority.</i>			
<i>Delete—</i> Conservation Officer ..	3,114	4,684	d
<i>Add—</i> Conservation Officer ..	3,343	5,063	d
d Increments in accordance with the scale of rates of salaries as set out for "Conservation Officer, Class "CO-1" in Part B of the Third Schedule.			

This Regulation shall have effect as on and from the 15th June, 1969.

F. E. CAHILL, Chairman.
V. P. SCULLY, Secretary.

Office of the Public Service Board,
Melbourne, 13th June, 1969.

No. 237.

PUBLIC SERVICE ACT 1958.

THE Public Service Board, in pursuance of the powers conferred by the *Public Service Act 1958*, hereby amends the Public Service (Public Service Board) Regulations as follows :—

PART IV.—SALARIES AND INCREMENTS.

DIVISION IV.—TECHNICAL AND GENERAL DIVISION.

Regulation 97.

In sub-regulation (2) under the heading—
For Salaries Falling Within Amount of Increment.

FEMALES.

Add : "\$5,414—\$5,665" \$126"
In sub-paragraph (i) of sub-regulation 3 (a) substitute the amounts \$72 and \$66 for the amounts \$77 and \$72 respectively.

In sub-paragraph (ii) of sub-regulation 3 (a) substitute the amounts \$90 and \$70 for the amounts \$82 and \$72 respectively.

This Regulation shall have effect as on and from the 25th May, 1969.

F. E. CAHILL, Chairman.
V. P. SCULLY, Secretary.

Office of the Public Service Board,
Melbourne, 30th May, 1969.

No. 241.

PUBLIC SERVICE ACT 1958.

THE Public Service Board, in pursuance of the powers conferred by the *Public Service Act 1958*, hereby amends the Public Service (Public Service Board) Regulations as follows:—

PART V.—ALLOWANCES.

DIVISION IV.—OTHER ALLOWANCES.

PUBLIC WORKS DEPARTMENT—PORTS AND HARBOURS.

Regulation 154 (1).

Immediately after the words—

“ Motor Boat Driver and Crane Driver . . . \$32 a year ”

insert the following—

“ Navigation Lights Officer, Assistant . . . \$112 a year ”

F. E. CAHILL, Chairman.

V. P. SCULLY, Secretary.

Office of the Public Service Board,
Melbourne, 9th June, 1969.

EXAMINATION FOR LICENCE AS SHORTHAND WRITER.

IT is hereby notified that the under-mentioned persons passed the examination, held on the 28th June, 1969, for licence as shorthand writers under the Evidence Act:—

Barnes, Beth L. (Mrs.).
Crothers, June Frances (Mrs.).
Cullen, David Graeme.
Freeston, Dorothy A.
McMullan, Mary.
Maund, Lawrence Joseph.
Morris, Mavis Alison.
Parkins, Anne (Mrs.).
Seng, Coralee.
Stacey, Trevor John.
Stanton, Janeen.

By order,

V. P. SCULLY,
Secretary.

Office of the Public Service Board,
Melbourne, 30th June, 1969.

TENDERS

PUBLIC WORKS DEPARTMENT

TENDERS will be received at Public Works Department, 2 Treasury-place, Melbourne, until TWO p.m. on dates shown and for purposes mentioned hereunder.

Particulars and tender forms available at Contracts Office, Room 7, Building Division, Parliament-place and at places indicated in brackets hereunder.

Abbreviations in brackets mean:—W.O.—Inspector of Works Office; P.S.—Police Station; C.S.—Consolidated School; H.E.S.—Higher Elementary School; H.S.—High School; S.S.—State School; T.S.—Technical School.

Tenders to be submitted on the Department's printed Tender Form and will not be received by telephone. All tenders must be on a "Firm Tender" basis. The lowest or any tender will not necessarily be accepted.

Address tenders to the Minister of Public Works, and endorse the envelope containing the tender "Tender for , closing Tuesday,

Hand delivered tenders to be placed in the Tender Box of the Public Works Department, located on the wall of the centre entrance foyer, Ground Floor, 2 Treasury-place, Melbourne.

No preliminary deposit is required with any tender, but a successful tenderer will be required to pay a deposit for any accepted tender of \$4,000 or over.

Tuesday, 8th July, 1969.

Building, Electrical and Mechanical Works.

Burnley.—Extensions to Virus House, Victorian Plant Research Institute.

Geelong.—Erection of Standard Assembly Hall, "Type 800C", High School. (W.O., Geelong.)

Geelong.—Electrical installation, High School. (W.O., Geelong.)

Geelong.—Mechanical services, High School. (W.O., Geelong and Ballarat.)

Melton.—Installation of sewerage treatment unit, S.S. 430.

Site Works.

Box Hill.—Concrete and drainage works, &c., High School.

Dandenong.—Asphalt, concrete and drainage works, &c., Psychiatric Centre.

Euroa.—Asphalt, concrete and gravel works, &c., High School. (W.O., Benalla and Shepparton.)

Janefield.—Drainage and pavement works, &c., Training Centre.

Miscellaneous.

Melbourne.—Annual contract for the supply and delivery of London Type lighting fittings, from 1st July, 1969, to 30th June, 1970, Public Works Department.

Tuesday, 15th July, 1969.

Building, Electrical and Mechanical Works.

Balwyn North.—Roof repairs to Bristol Building, S.S., 4638.

Bendigo.—Erection of Motor Registration and Licence Testing Office. (W.O., Bendigo.)

Brunswick North.—Internal and external renovations, S.S. 3585.

Cheltenham.—Erection of new Science Wing, High School.

Cheltenham.—Mechanical services, High School.

Port Melbourne.—External and internal renovations, S.S. 2932.

Shepparton.—Installation of fire service and water supply, S.S. 4657. (W.O., Shepparton.)

Thornbury.—Internal renovations, S.S. 3889.

Site Works.

Watsonia.—Drainage and paving works, &c., S.S. 4838.

Miscellaneous.

Ballarat.—Supply of timber (F.O.R. Melbourne), Lakeside Mental Hospital. (Amended Specification.)

Tuesday, 22nd July, 1969.

Building, Electrical and Mechanical Works.

Ararat.—Renovations to Ward M9, Mental Hospital. (W.O., Ararat.)

Ararat.—Supply and installation of steam heating and hot water, Ward M9, Mental Hospital. (W.O., Ballarat.)

Coburg.—Erection of Multi-purpose Hall "Type 800c", Technical School. (Re-advertised.)

Cohuna.—Connexion to town sewer, Consolidated and High Schools and six residences, and Lands Department Depot and residence.

Parkville.—Aluminium windows, doors and screens to library, Melbourne Teachers' College.

Springvale.—New staff toilets and renovations, S.S. 3507.

Site Works.

Caulfield.—Asphalt, concrete and drainage works, &c., High School.

Miscellaneous.

Coburg.—Supply, delivery and placing in position on site, kitchen equipment, Northern Suburbs Motor School.

M. V. PORTER,
Minister of Public Works.

Public Works Department,
Melbourne, 3002, 30th June, 1969.

TENDERS FOR THE SERVICE, 1969-70.

REQUISITES FOR EDUCATION DEPARTMENT.

TENDERS will be received until Eleven o'clock a.m. on Friday, 18th July, 1969, from persons willing to supply the under-mentioned articles, in such quantities as may be ordered by the Victorian Government, from the 1st September, 1969, to the 31st August, 1970:—

Schedule No.

1. Requisites (Junior School).
2. Exercise Books and Requisites.

The prices tendered must not include sales tax.

Security.—Five per cent. of total amount of tender accepted, but in no case will security of less than \$6 be received.

Schedules as above, with full particulars, may be obtained from the Secretary to the Tender Board, by whom also the samples will be shown and any information afforded to persons tendering.

Should the tenderer be in a position to supply a suitable substitute of Commonwealth production or manufacture in place of any sample exhibited that may be of imported origin, he may tender for such substitute, but must submit with his tender a sample of the article offered.

In all cases the country of origin of the articles tendered must be stated, and the total cost of each item extended in the columns provided.

Security will be required either in Commonwealth Treasury Bonds, or approved bank guarantee, fixed deposit receipt, Savings Bank deposit book, or non-negotiable cheque in favour of the Secretary to the Tender Board, as the tenderer may elect.

The security must be completed and the contract signed within five days of acceptance of the tender, failing which the contract may be again advertised, or another tender accepted.

The lowest or any tender will not necessarily be accepted.

In the event of tenderers withdrawing or attempting to withdraw their tenders before notification of acceptance of same, or failing to take up their accepted tenders within the prescribed period after notification of acceptance, they may be disqualified from tendering or holding any future contracts for Government supplies for a period of one year, such disqualification to date from the notification of acceptance of tender. It is also stipulated that, if a tenderer be a member of a firm and such firm be interested in the contract, the tender shall be in the name of the firm and not in that of the individual and that, for a breach of this condition the tender will be declared informal.

Tenders enclosed in a separate envelope, and having the words "*Tender for—*" (as the case may be) written thereon, must be deposited in the Tender-box at the Tender Board Offices, 2nd Floor, South Building, New State Public Offices, Treasury-place, Melbourne, 3002, or if sent by post, postage must be prepaid, and the tenders addressed to the Chairman of the Tender Board, Tender Board Offices, 2nd Floor, South Building, New State Public Offices, Treasury-place, Melbourne, 3002, which office they must reach not later than by first post on the date of closing of tenders.

CONDITIONS OF CONTRACT.

1. Except where definite quantities are specified the Government will not be bound to order from the contractor all the articles enumerated in the schedule, but only those articles, and such quantities of those articles, as it may be found necessary to order. Should the Government, however, require a larger supply of any article than the estimated quantity stated in the schedules, the contractor will nevertheless be bound to supply the same at contract rates.

The Government reserves the right to purchase otherwise than from the contractor articles of any of the several kinds enumerated in the schedules the purchase of which is, in the opinion of the Tender Board, necessary in order to meet special circumstances or special requirements.

2. The supplies are to be the same as sample where so stated, and of the particular manufacture indicated in the schedule of tenders. In the case of different makers' goods, the contractor will be required to supply the kind ordered. *The supplies are to be the best quality of their several kinds or manufacture.* In the event of the tender having been accepted for goods manufactured within the Commonwealth or manufactured within any other part of the British Empire (as the case may be), all such goods supplied shall, if required by the Government, bear evidence

that they are of the particular manufacture tendered for, and, in addition, the contractor may at any time during the currency of the contract be called on to furnish a statutory declaration as to the country of origin of the goods supplied.

3. Except where otherwise stated in the schedule, the value of all packages, cases, casks, &c., whether bulk be broken or not, must be included in the prices stated in the contractor's tender; all such packages, &c., to be considered the property of the Government, and no charges or expenses whatsoever beyond the price tendered and set out in the schedule will be allowed to the contractor for any articles or packages, cases, casks, &c. The net weight or quantity only will be paid for. Contractors must provide, without extra charge, whatever labour may be required in the packing of stores, and the stores shall be packed in such a manner as shall secure them from injury during transit, and until delivery such stores shall be at the risk of the contractor.

4. All orders for supplies will emanate from the Education Department. The goods shall be delivered as may be directed by the officer ordering the supply.

5. Supplies ordered for delivery in the Melbourne District are to be delivered free of all charges (whether cartage, freight, &c.), and, for the purposes of these contracts, Melbourne District will include a radius of 12 miles from the Elizabeth-street Post Office. For supplies outside that radius the goods must be delivered free on rails at Flinders-street or Spencer-street Railway Stations as required.

6. Arrangements as to time of delivery and inspection of goods will be made by the Secretary, Education Department, or such other officer whom he may appoint.

7. Orders must receive prompt execution; and in the event of the goods not being delivered within forty-eight hours after the contractor shall have received the order, or within such other time as the order may specify for delivery, it will be competent for the officer named in clause 6, or the head of the department to whom the goods are to be supplied, on giving the contractor twenty-four hours' notice to purchase the supplies, or any like supplies that are suitable for the service, at the contractor's risk, and the extra expense incurred over and above the contract price (if any) will be deducted from the contractor's account or from the security money.

8. Delivery will not be deemed to have been made until the goods have been approved. In case of the rejection or return of any supplies, the contractor shall bear the whole cost of replacing the supplies rejected or returned, otherwise purchases will be effected at the contractor's risk and the extra expense deducted as in clause 7.

9. The official order issued by the Education Department shall be forwarded by the contractor to the officer authorized to accept delivery, who shall acknowledge thereon the receipt of the goods accepted and return the order to the contractor, who will attach same to his claim for payment.

10. All orders, duly receipted, shall be returned to the Education Department at the end of each month, accompanied by an account in the prescribed form for the articles supplied during the month, and, on receipt of same, the contractor shall be entitled to payment, due time to be allowed for the examination and verification of the claim.

11. The acceptance of the supplies shall be subject to the approval of the officer authorized to take delivery of the stores, or such other officer as shall be named in the schedules. Delivery of the articles will not be deemed to have been made until they have been handed in good order and condition to the head teacher of the school or such other person as may be authorized to accept delivery, &c. The contractor may, however, claim a survey on any goods objected to; but in that case he must, within twenty-four hours after objection is made give notice thereof, in writing, to the officer rejecting the goods. If, after the delivery of the supplies has been taken, any deficiency or defect is discovered therein, such deficient or defective stores may be returned to the contractor.

12. The members of Boards of survey will be appointed by the Treasurer of the State for the time being, and the decision of the Board is to be considered as final. If the Board shall decide that the article is not of proper quality it must be immediately replaced by the contractor, failing which it, or any like supply that is suitable for the service, will be procured elsewhere, and the survey fees and extra expense (if any) will be deducted as in clause 7.

13. All goods forwarded under these contracts shall, where practicable, be forwarded by rail, and all consignments shall bear the number of the consignment notes under which they are forwarded, and also the name of the contractor by whom consigned, on a legibly-written business label.

14. When the contractor is required to make delivery of goods at a railway station for transmission by rail, he shall obtain a receipt for the goods in duplicate on the Stores and Transport consignment note, at the same time handing in a triplicate and quadruplicate of the form as an authority for the Railways to act as agent for, and charge the freight to, the Stores and Transport Office or such other Department as shall be named therein. He shall as soon as possible, and not later than twenty-four hours thereafter, deliver the original at the Tender Board Offices, the duplicate to be forwarded to consignee in accordance with clause 15, and the quintuplicate to be retained by himself. Should the goods thus forwarded be rejected, the contractor must bear the cost of replacing such goods, for which service the departmental consignment note is not to be used. Any infringement of this condition will subject the contractor to such mulct as the Tender Board may recommend under clause 17 of these conditions. Such mulct may be deducted as in clause 7.

15. Immediately after the consignment of the goods, the officer to whom they are forwarded shall be notified by the contractor, on the duplicate consignment note provided for the purpose, that the goods have been sent. On receipt of this document, the officer to whom it has been forwarded shall acknowledge thereon the receipt of the goods without delay to the Stores and Transport Office. In the event of loss through failure on the part of the contractor to comply with this condition he will be held responsible, and the amount of the loss incurred for same will be deducted as in clause 7.

16. Should the order on the contractor specially provide that goods of a fragile character, or such as are liable to suffer loss by leakage, shall be consigned at the risk of the Railways Commissioners under special freight conditions, the contractor shall in such instance provide in writing, on the consignment note an intimation to that effect, failing which, in the event of loss, he shall bear the whole cost of replacing the goods, the amount being deducted from the contractor's account or the security money.

17. A refusal to execute orders, irregularity in the quantity or quality of the supplies, delay in delivering or replacing them when required, or non-compliance with the terms of clauses 14 and 15 of these conditions respecting the forwarding of consignment notes, &c., will subject the contractor, upon report from the Tender Board, to such mulct not exceeding one hundred dollars as the said Treasurer may direct and the amount may be deducted as in clause 7. It will also be in the power of the said Treasurer upon such refusal, irregularity, or delay, to terminate the contract forthwith, and declare forfeit the whole or any portion of the security money; and, in addition, the contractor will be disqualified from tendering or holding any future contract or contracts for a period of one year from the date of such disqualification.

18. Contractors are not at liberty to transfer their contracts under cover of power of attorney, coupled with an interest or otherwise; and no such transfer will be recognized by the Government. If it is found during the currency of the contract that the contractor has not conformed to the condition of advertisement—which stipulates that if a tenderer be a member of a firm, and such firm be interested in the contract, the tender shall be in the name of the firm, and not in that of the individual—then the said Treasurer may, on the recommendation of the Tender Board, determine the contract, and forfeit the security money.

19. The contracts entered into under these conditions are not to be considered as being broken, infringed, or vitiated by the importation of stores for the Government service, or by any contracts or purchases made by the Agent-General for Victoria, or by any contracts or agreements made for supplies to Technical Schools, or by any article being made at any Government establishment and supplied for the use of the Education Department, or by the consumption of the surplus stock of any Government establishment.

20. Notwithstanding anything contained to the contrary in section 152 of the Customs Act 1901-36, it is hereby expressly provided that upon any alteration of the duty collected affecting the goods included in this contract, the contract price shall not be altered, and the contract may be terminated at the opinion of either party by two months' notice in writing from the first day of the calendar month next ensuing, and within the period for which the contract is made. The contract for the unaffected items shall remain in full force and effect. Any notice to be served under this condition shall be deemed to have been duly served if sent to the contractor in a registered letter to his last known place of business or abode.

21. Under no circumstances, other than those mentioned in clause 20, will a contractor be permitted to abandon his contract. In the event of the contractor failing to carry

on the contract, the contract security money will in that case be absolutely forfeited; and, in addition, the contractor will be held liable for any loss which the Government may sustain in consequence of such failure.

22. Should the Minister of Education for the time being decide to discontinue the use of any book, map, or any other article in the schedule, or to direct that any book, map, or any other article other than those enumerated therein be taken into use he shall at any time to the contractor, and after the expiration of the period of such notice the Education Department shall not be bound to take any further supply of such book, map, or time give six months' notice of such intention or decision any other article, nor shall the contractor be bound to supply the same, and all books or maps not in the schedule, but which it may be decided to introduce, shall be supplied by the contractor after expiration of such notice at a price to be agreed on between the Minister of Education for the time being and the contractor.

The Treasury,
Melbourne, 30th June, 1969.

A. G. RYLAH,
Acting Treasurer.

TENDERS FOR THE SERVICE, 1969-70.

GENERAL STORES.

TENDERS will be received until Eleven o'clock a.m. on Friday, 18th July, 1969, from persons willing to supply the under-mentioned articles in such quantities as may be ordered by the Victorian Government, from the 1st September, 1969, to the 31st August, 1970:—

Schedules, as above, with full particulars, may be obtained from the Secretary to the Tender Board, by whom also the samples will be shown and any information afforded to persons tendering.

In all cases the total cost of each item must be extended in the columns provided.

Schedule No.

68. Stamps, Rubber.

69. Stationery (General) and Typewriters. Carbon Papers, Typewriter Ribbons, &c., Typograph Material.

The prices tendered must not include sales tax.

Security.—Five per cent. of total amount of tender accepted, but in no case will security of less than \$6 be received.

Security will be required either in Commonwealth Treasury Bonds, or approved bank guarantee, fixed deposit receipt, Savings Bank deposit book, or non-negotiable cheque in favour of the Secretary to the Tender Board, as the tenderer may elect.

The security must be completed and the contract signed within five days of acceptance of the tender, failing which the contract may be again advertised, or another tender accepted.

The lowest or any tender will not necessarily be accepted.

In the event of tenderers withdrawing or attempting to withdraw their tenders before notification of acceptance of same or failing to take up their accepted tenders within the prescribed period after notification of acceptance, they may be disqualified from tendering or holding any future contracts for Government supplies for a period of twelve months, such disqualification to date from the notification of acceptance of tender. It is also stipulated that, if a tenderer be a member of a firm and such firm be interested in the contract, the tender shall be in the name of the firm and not in that of the individual and that, for a breach of this condition, the tender will be declared informal.

Tenders enclosed in a separate envelope, and having the words "Tender for———" (as the case may be) written thereon, must be deposited in the Tender-box at the Tender Board Offices, 2nd Floor, South Building, New State Public Offices, Treasury-place, Melbourne, 3002, or if sent by post, postage must be prepaid, and the tenders addressed to the Chairman of the Tender Board, Tender Board Offices, 2nd Floor, South Building, New State Public Offices, Treasury-place, Melbourne, 3002, which office they must reach not later than by first post on the date of closing of tenders.

The conditions of contract are those published in the Victoria Government Gazette, No. 25, dated 20th March, 1968.

The Treasury,
Melbourne, 30th June, 1969.

A. G. RYLAH,
Acting Treasurer.

PRIVATE ADVERTISEMENTS

NOTICE OF INTENTION TO APPLY FOR A LICENCE TO DIVERT WATER FROM THE BUFFALO RIVER, AT MERRIANG.

WE hereby give notice that we intend to apply for a licence empowering us to divert water for a term of fifteen years to the extent set out and on the lands described in the Schedule hereunder and to occupy certain Crown lands for works of diversion.

Volume.		Area to be Irrigated (Acres).	Location.		
Per Annum (Ac. Ft.).	Maximum rate per day.		Allotment.	Section.	Parish.
75	4	50	30, 31, 32, 33	P	Myrtleford
60	4	40	168A	..	Whorouly

Any objection to such application must be forwarded, in writing, to reach the State Rivers and Water Supply Commission, Melbourne, before 1st August, 1969, being 30 days from the first publication of this notice.

W. J. MCGUFFIE.
W. R. MCGUFFIE.

Myrtleford, 3737. 8745

NOTICE OF INTENTION TO APPLY FOR A LICENCE TO DIVERT WATER AND CUT RACE (RE-ISSUE) FROM THE RIVER MURRAY, AT NICHOLS POINT.

I HEREBY give notice that I intend to apply for a licence empowering me to divert water for a term of three years to the extent of 9 acre-feet per annum at a maximum rate of 1 acre-foot per day of 24 hours for the irrigation of 3 acres, being part of allotment 15, section 5A, block F, Parish of Mildura, and to occupy certain Crown lands for works of diversion, and to cut a race thereon.

Any objection to such application must be forwarded, in writing, to reach the State Rivers and Water Supply Commission, Melbourne, before 30th July, 1969, being 30 days from the first publication of this notice.

ROBERT ALEXANDER JOHN NELSON.

Box 441, Mildura, Victoria. 8933

NOTICE OF INTENTION TO APPLY FOR A LICENCE TO DIVERT WATER AND CUT RACE FROM THE RIVER MURRAY, AT MILDURA.

WE hereby give notice that we intend to apply for a licence empowering us to divert water for a term of four years to the extent of 87 acre-feet per annum at a maximum rate of 4 acre-feet per day of 24 hours for the irrigation of approximately 29 acres of market garden and vines on land being parts of allotments 9 and 10 and allotments 16, 17 and 18, section 9, block E, Parish of Mildura, and to occupy certain Crown lands for works of diversion, and to cut a race thereon.

Any objection to such application must be forwarded, in writing, to reach the State Rivers and Water Supply Commission, Melbourne, before 31st July, 1969, being 30 days from the first publication of this notice.

GREGORIO BARILA.
CONCETTA BARILA.
ANTONIO BARILA.
GUISEPPE BARILA.

Flora-avenue, Mildura, 3500. 8934

NOTICE OF INTENTION TO APPLY FOR A LICENCE TO DIVERT WATER AND CUT RACE (RE-ISSUE) FROM THE RIVER MURRAY, AT MERBEIN.

I HEREBY give notice that I intend to apply for a licence empowering me to divert water for a term of fifteen years to the extent of 9 acre-feet per annum at a maximum rate of 2 acre-feet per day of 24 hours for the irrigation of 3 acres of vines, being part of allotment 4N, section G, Parish of Merbein, and to occupy certain Crown lands for works of diversion, and to cut a race thereon.

Any objection to such application must be forwarded, in writing, to reach the State Rivers and Water Supply Commission, Melbourne, before 27th July, 1969, being 30 days from the first publication of this notice.

FRANCIS THOMAS ROSE.

Box 10, Merbein. 8936

NOTICE OF INTENTION TO APPLY FOR A LICENCE TO DIVERT WATER AND CUT RACE (RE-ISSUE) FROM THE RIVER MURRAY, AT MERBEIN.

I HEREBY give notice that I intend to apply for a licence empowering me to divert water for a term of fifteen years to the extent of 7½ acre-feet per annum at a maximum rate of 1 acre-foot per day of 24 hours for the irrigation of 2½ acres of vines, being part of allotment 4P, section G, Parish of Merbein, and to occupy certain Crown lands for works of diversion, and to cut a race thereon.

Any objection to such application must be forwarded, in writing, to reach the State Rivers and Water Supply Commission, Melbourne, before 27th July, 1969, being 30 days from the first publication of this notice.

AMY M. ROSE.

Box 10, Merbein. 8937

NOTICE OF INTENTION TO APPLY FOR A LICENCE TO DIVERT WATER AND CUT RACE (RE-ISSUE) FROM THE RIVER MURRAY, AT GOORAMADDA.

I HEREBY give notice that I intend to apply for a licence empowering me to divert water for a term of fifteen years to the extent of 200 acre-feet per annum at a maximum rate of 2 acre-feet per day of 24 hours for the irrigation of 100 acres, being part of Gooramadda Pre-emptive Right, Parish of Gooramadda, and to occupy certain Crown lands for works of diversion, and to cut a race thereon.

Any objection to such application must be forwarded, in writing, to reach the State Rivers and Water Supply Commission, Melbourne, before 1st August, 1969, being 30 days from the first publication of this notice.

JAMES RIGBY RILEY.

P.O. Box 22, Rutherglen, 3685, Victoria. 8935

NOTICE OF INTENTION TO APPLY FOR A LICENCE TO DIVERT WATER AND CUT RACE (RE-ISSUE) FROM THE RIVER MURRAY, AT NANGILOC.

I HEREBY give notice that I intend to apply for a licence empowering me to divert water for a term of fifteen years to the extent of 150 acre-feet per annum at a maximum rate of 4 acre-feet per day of 24 hours for the irrigation of 50 acres, being part of allotment 19, Parish of Carwarp, and to occupy certain Crown lands for works of diversion, and to cut a race thereon.

Any objection to such application must be forwarded, in writing, to reach the State Rivers and Water Supply Commission, Melbourne, before 27th July, 1969, being 30 days from the first publication of this notice.

KEVIN LAURENCE WIFFEN.

Nangiloc, 3494, Victoria. 8938

NOTICE OF INTENTION TO APPLY FOR A LICENCE TO DIVERT WATER AND CUT RACE (RE-ISSUE) FROM THE RIVER MURRAY, AT COLIGNAN.

I HEREBY give notice that I intend to apply for a licence empowering me to divert water for a term of fifteen years to the extent of 120 acre-feet per annum at a maximum rate of 3 acre-feet per day of 24 hours for the irrigation of 40 acres, being part of allotment 22, Parish of Colignan, and to occupy certain Crown lands for works of diversion, and to cut a race thereon.

Any objection to such application must be forwarded, in writing, to reach the State Rivers and Water Supply Commission, Melbourne, before 24th July, 1969, being 30 days from the first publication of this notice.

IVAN L. T. WIFFEN.

P.O. Box 103, Redcliffs. 8940

NOTICE OF INTENTION TO APPLY FOR A LICENCE TO DIVERT WATER AND CUT RACE (RE-ISSUE) FROM THE RIVER MURRAY, AT PIANGIL.

I HEREBY give notice that I intend to apply for a licence empowering me to divert water for a term of fifteen years to the extent of 18 acre-feet per annum at a maximum rate of 2 acre-feet per day of 24 hours for the purpose of irrigation of 6 acres of vegetables, being part of allotment 147B, Parish of Piangil, and to occupy certain Crown lands for works of diversion, and to cut a race thereon.

Any objection to such application must be forwarded, in writing, to reach the State Rivers and Water Supply Commission, Melbourne, before 25th July, 1969, being 30 days from the first publication of this notice.

AMEDEO SILVERII.

Piangil, 3597. 8863

NOTICE OF INTENTION TO APPLY FOR A LICENCE TO DIVERT WATER AND CUT RACE (RE-ISSUE) FROM THE RIVER MURRAY, AT COBRAM.

I HEREBY give notice that I intend to apply for a licence empowering me to divert water for a term of three years to the extent of 402 acre-feet per annum at a maximum rate of 5 acre-feet per day of 24 hours for spray and flood irrigation, being part of allotment 1, Parish of Boosey, sections 17 and 18, Parish of Cobram, and to occupy certain Crown lands for works of diversion, and to cut a race thereon.

Any objection to such application must be forwarded, in writing, to reach the State Rivers and Water Supply Commission, Melbourne, before 30th July, 1969, being 30 days from the first publication of this notice.

HUGH CRAIG DICK,
for H. C. Dick & Sons.

Box 62, Cobram, 3644. 8898

NOTICE OF INTENTION TO APPLY FOR A LICENCE TO DIVERT WATER AND CUT RACE (RE-ISSUE) FROM THE RIVER MURRAY, AT VINIFERA.

WE hereby give notice that we intend to apply for a licence empowering us to divert water for a term of fifteen years to the extent of 226 acre-feet per annum at a maximum rate of 6 acre-feet per day of 24 hours for the irrigation of 113 acres, being part of allotment 49, Parish of Tyntynder West, and to occupy certain Crown lands for works of diversion, and to cut a race thereon.

Any objection to such application must be forwarded, in writing, to reach the State Rivers and Water Supply Commission, Melbourne, before 1st August, 1969, being 30 days from the first publication of this notice.

DAVID JAMES WATSON,
EILEEN PATRICIA WATSON.

Box 94, Nyah West, 3595. 8899

NOTICE OF INTENTION TO APPLY FOR A LICENCE TO DIVERT WATER AND CUT RACE (RE-ISSUE) FROM THE GOULBURN RIVER, AT ARCADIA.

I HEREBY give notice that I intend to apply for a licence empowering me to divert water for a term of four years to the extent of 26 acre-feet per annum at a maximum rate of 4 acre-feet per day of 24 hours for the irrigation of 13 acres of lucerne and pasture, being part of allotment 48A, Parish of Kialla, and to occupy certain Crown lands for works of diversion, and to cut a race thereon.

Any objection to such application must be forwarded, in writing, to reach the State Rivers and Water Supply Commission, Melbourne, before 27th June, 1969, being 30 days from the first publication of this notice.

WILLIAM JOHN KINGSTON.

Roadside Delivery, Arcadia, 3613. 8972

NOTICE OF INTENTION TO APPLY FOR A LICENCE TO DIVERT WATER AND CUT RACE (RE-ISSUE) FROM THE RIVER MURRAY, AT PIANGIL.

I HEREBY give notice that I intend to apply for a licence empowering me to divert water for a term of fifteen years to the extent of 40 acre-feet per annum at a maximum rate of 2 acre-feet per day of 24 hours for irrigation purposes, being part of allotment 135b, Parish of Piangil, and to occupy certain Crown lands for works of diversion, and to cut a race thereon.

Any objection to such application must be forwarded, in writing, to reach the State Rivers and Water Supply Commission, Melbourne, before 1st August, 1969, being 30 days from the first publication of this notice.

ALFRED CLARENCE HUNT.

P.O. Box 13, Tooleybuc, N.S.W., 2739. 8973

NOTICE OF INTENTION TO APPLY FOR A LICENCE TO DIVERT WATER AND CUT RACE (RE-ISSUE) FROM THE RIVER MURRAY, AT YELTA.

I HEREBY give notice that I intend to apply for a licence empowering me to divert water for a term of fifteen years to the extent of 26½ acre-feet per annum at a maximum rate of 2 acre-feet per day of 24 hours for the irrigation of 8½ acres, being part of allotment 41, Parish of Yelta, and to occupy certain Crown lands for works of diversion, and to cut a race thereon.

Any objection to such application must be forwarded, in writing, to reach the State Rivers and Water Supply Commission, Melbourne, before 26th July, 1969, being 30 days from the first publication of this notice.

GEORGE NEMTSAS.

1 O'Bryan-street, Merbein. 8866

NOTICE OF INTENTION TO APPLY FOR A LICENCE TO DIVERT WATER AND CUT RACE (RE-ISSUE) FROM THE CAMPASPE RIVER, AT GOORNONG.

WE hereby give notice that we intend to apply for a licence empowering us to divert water for a term of fifteen years to the extent of 1,300 acre-feet per annum at a maximum rate of 16 acre-feet per day of 24 hours for the irrigating of approximately 810 acres, being part of allotments 1 and 2, section 1, Parish of Nolan, allotments 1, 2, 3, 4 and 5, section 4, Parish of Nolan, allotments 1A, 3A, 3B, 4, and 4A, section 5, Parish of Nolan, allotments 1A, 1C, 1C', 1D, 1D', 1E, 1F, 2, 2A, 2B, 3A, section 7, Parish of Nolan, allotments 1, 1A, 2, 5, 6, 6A, 7, 8, 9, 10, 11, 12, section 8, Parish of Nolan, allotment 3, section 9, Parish of Nolan, allotments 2, 2A, 5, 6, 8, 9, 10, 11, section 10, Parish of Nolan, and allotments 1, 2, 3 and 4, section 11A, Parish of Goornong, and to occupy certain Crown lands for works of diversion, and to cut a race thereon.

Any objection to such application must be forwarded, in writing, to reach the State Rivers and Water Supply Commission, Melbourne, before 25th July, 1969, being 30 days from the first publication of this notice.

GOORNONG IRRIGATORS SYNDICATE.

Goornong. 8939

NOTICE OF INTENTION TO APPLY FOR A LICENCE TO DIVERT WATER AND CUT RACE (RE-ISSUE) FROM THE GOULBURN RIVER, AT NORTHWOOD.

WE hereby give notice that we intend to apply for a licence empowering us to divert water for a term of four years to the extent of 40 acre-feet per annum at a maximum rate of 2 acre-feet per day of 24 hours for the irrigation of 20 acres of grape vines, being part of allotments 9 and 10, Parish of Northwood, and to occupy certain Crown lands for works of diversion, and to cut a race thereon.

Any objection to such application must be forwarded, in writing, to reach the State Rivers and Water Supply Commission, Melbourne, before 26th July, 1969, being 30 days from the first publication of this notice.

BRYAN EDWARD FITZPATRICK.

KERRY JOHN FITZPATRICK.

1 Emily-street, Seymour. 8865

NOTICE OF INTENTION TO APPLY FOR A LICENCE TO DIVERT WATER AND CUT RACE (RE-ISSUE) FROM THE RIVER MURRAY, AT MILDURA.

WE hereby give notice that we intend to apply for a licence empowering us to divert water for a term of 15 years to the extent of 18 acre-feet per annum at a maximum rate of 1 acre-foot per day of 24 hours for the irrigation of 6 acres, being part of allotments 8 and 9, section 5A, block F, Parish of Mildura, and to occupy certain Crown lands for works of diversion, and to cut a race thereon.

Any objection to such application must be forwarded, in writing, to reach the State Rivers and Water Supply Commission, Melbourne, before 30th July, 1969, being 30 days from the first publication of this notice.

K. J. HEARNE.

A. L. HEARNE.

P.O. Box 1161, Mildura. 8974

NOTICE OF INTENTION TO APPLY FOR A LICENCE TO DIVERT WATER AND CUT RACE (RE-ISSUE) FROM THE RIVER MURRAY (YARRAWONGA WEIR POOL), AT BUNDALONG.

I HEREBY give notice that I intend to apply for a licence empowering me to divert water for a term of fifteen years to the extent of 300 acre-feet per annum at a maximum rate of 10 acre-feet per day of 24 hours for the irrigation of 150 acres, being part of allotments 14A, 15A, 18A, 25A, 16, 17, 19, 20, Parish of Bundalong, and to occupy certain Crown lands for works of diversion, and to cut a race thereon.

Any objection to such application must be forwarded, in writing, to reach the State Rivers and Water Supply Commission, Melbourne, before 26th July, 1969, being 30 days from the first publication of this notice.

WILLIAM ERNEST STEVENSON.

"Woodlands", P.O. Box 57, Yarrawonga. 8867

GEELONG WATERWORKS AND SEWERAGE TRUST.

THE above-mentioned Trust having made provision for carrying off the sewage from each and every property which or any part of which is within the sewerage area hereinafter described, doth hereby declare that on and after the 1st day of July, 1969, each and every property which or any part of which is within the said sewerage area shall be deemed and taken to be sewered property within the meaning of the *Geelong Waterworks and Sewerage Act 1958*.

SEWERAGE AREA No. 413.

Shire of Corio—Parish of Moorpanyal, County of Grant.

Commencing at a point being the south-east corner of the intersection of Giddings and Enmore streets, North Geelong, which is also on the northern boundary of Sewerage Area No. 218; thence northerly across Enmore-street and continuing northerly along the east side of Giddings-street and crossing Inkerman and Kerr streets to the south side of Geelong-Fyansford Railway; thence north-easterly along the south side of Geelong-Fyansford Railway to the north-east corner of the intersection of Kerr and Kildare streets; thence southerly along the east side of Kildare-street to the north-east corner of the intersection of Kildare and Inkerman streets; thence easterly along the north side of Inkerman-street to the north-west corner of the intersection of Inkerman-street and Fitzroy-square; thence northerly and easterly along the boundary of Fitzroy-square and crossing Mornington-street to the north-east corner of Mornington-street and Fitzroy-square; thence northerly along the east side of Mornington-street and crossing Mina-street and Geelong-Fyansford Railway to the boundary of Sewerage Area No. 248; thence easterly along the boundary of Sewerage Area No. 248 to the west side of Douro-street; thence southerly along the west side of Douro-street and crossing Geelong-Fyansford Railway to the north-west corner of Douro and Mina streets; thence south-easterly across Douro-street and continuing south-easterly along the north side of Mina-street to the north-east corner of the intersection of Mina and Roseneath streets; thence south-easterly by a line bearing 134 deg. 0 min. for a distance of 123 feet; thence south-easterly by a line bearing 156 deg. 52½ min. for a distance of 415 feet; thence southerly by a line bearing 180 deg. 0 min. for a distance of 518 ft. 4 in.; thence westerly by a line bearing 270 deg. 4¼ min. and crossing Roseneath-street to the west side of Roseneath-street; thence southerly along the west side of Roseneath-street for a distance of 279 feet, which is also the northern boundary of Sewerage Area No. 168; thence westerly and southerly following boundaries of Sewerage Area No. 168 to the south-east corner of the intersection of Douro-street and Enmore-street; thence across Douro-street to the south-west corner of the intersection of Douro and Enmore streets; thence westerly along the south side of Enmore-street and crossing Bryanston-square for a distance of 200 feet; thence northerly by a line bearing 0 degrees for a distance of 207 feet and crossing Bryanston-square to the north side of Bryanston-square; thence westerly along the north side of Bryanston-square for a distance of 272 feet and crossing Mornington-street; thence southerly along the west side of Bryanston-square and crossing Enmore-street to the south side of Enmore-street; thence westerly along the south side of Enmore-street and crossing Kildare-street to the point of commencement.

SEWERAGE AREA No. 414.

Shire of South Barwon—Parish of Barrarbool, County of Grant.

Commencing at a point being on the west side of Stork-avenue, East Belmont, the said point being also on the boundaries of Sewerage Areas Nos. 305 and 362; thence northerly, easterly and southerly following the boundaries of Sewerage Areas Nos. 305 and 334 and crossing Stork-avenue to the south-east corner of allotment No. 46 Cyril-court, which is also on the boundary of Sewerage Area No. 334; thence westerly, northerly and westerly following the boundary of Sewerage Area No. 334 to the south-west corner of allotment No. 21 Berramongo-court, which is also on the boundaries of Sewerage Areas Nos. 334 and 362; thence northerly and westerly following the boundary of Sewerage Area No. 362 and crossing Stork-avenue to the point of commencement.

SEWERAGE AREA No. 415.

Shire of South Barwon—Parish of Barrarbool, County of Grant.

Commencing at a point being on the southern boundary of allotment No. 43 Bundoora-crescent, Highton, which is also on the boundary of Sewerage Area No. 358; thence westerly along the southern boundary of the said allotment No. 43 to the east side of Bundoora-crescent; thence

south-westerly across Bundoora-crescent to the south-east corner of allotment No. 24 Bundoora-crescent; thence westerly along the southern boundaries of allotments Nos. 24 Bundoora-crescent and 23 Aringa-avenue to the eastern boundary of allotment No. 10 Sherwood-court; thence southerly along the eastern boundaries of allotments Nos. 10 and 11 Sherwood-court and No. 29 Gwyther-road to the north side of Gwyther-road; thence westerly along the north side of Gwyther-road to the south-west corner of allotment No. 26 Gwyther-road; thence northerly along the western boundary of the said lot No. 26 to the southern boundary of allotment No. 13 Sherwood-court; thence westerly along the southern boundary of the said allotment No. 13 to the south-west corner of allotment No. 14 Sherwood-court; thence northerly along the western boundary of the said allotment No. 14 to the south-east corner of allotment No. 20 Linthwaite-close; thence north-westerly along the southern boundary of the said allotment No. 20 to the east side of Linthwaite-close; thence north-westerly and northerly along the east side of Linthwaite-close to the prolongation of the southern boundary of allotment No. 10 Linthwaite-close; thence westerly across Linthwaite-close and continuing westerly along the southern boundary of the said allotment No. 10 to the eastern boundary of Sewerage Area No. 307; thence north-westerly, easterly and northerly following the boundary of Sewerage Area No. 307 to the north side of Aringa-avenue; thence easterly along the north side of Aringa-avenue to the south-west corner of the boundary of Sewerage Area No. 358; thence south-easterly, easterly, south-easterly, easterly and southerly following the boundary of Sewerage Area No. 358 and crossing Aringa-avenue to the point of commencement.

SEWERAGE AREA No. 416.

Shire of South Barwon—Parish of Barrarbool, County of Grant.

Commencing at a point being on the north side of Brassey-avenue, Highton, 140 feet east from the north-east corner of the intersection of Brassey-avenue and Dunsmore-road, which is also on the boundary of Sewerage Area No. 280 and the south-west corner of lot No. 5 Brassey-avenue; thence northerly by a line bearing 359 degrees 54 minutes for a distance of 120 feet; thence easterly by a line bearing 90 deg. 3 min. for a distance of 380 ft. 5 in.; thence southerly by a line bearing 177 deg. 57 min. to the north side of Brassey-avenue, the said point being on the south-east corner of lot No. 1 Brassey-avenue and also on the boundary of Sewerage Area No. 280; thence westerly along the north side of Brassey-avenue to the point of commencement.

Signed under seal of the Trust this 26th day of June, 1969.

8878 (SEAL) J. W. CARR, Chairman.
L. C. SPITTY, Acting Secretary.

MOE WATERWORKS TRUST.

EIGHTH SCHEDULE.

NOTICE to the owners in the under-mentioned streets and private streets, lanes, courts and alleys opening thereto:—

Moffatt-street—Nos. 1, 3, 5, 4, 6, 8, 10, 12.

Glasgow-street.

Evelyn-street.

Abbott-street—Nos. 24, 26.

The main pipe in the said streets being laid down, the owners of all tenements situated as above are hereby required, on or before the 1st day of August, 1969 next, to cause a proper pipe and stop-cocks to be laid, so as to supply water within such tenements from the main pipe.

A. DEWAR, Secretary of the Moe Waterworks Trust.

8885

CITY OF ARARAT.

LOAN No. 67.

Notice of Intention to Borrow.

NOTICE is hereby given that the Council of the City of Ararat intends to borrow Two hundred thousand dollars (\$200,000) secured by a charge over the general rates of the municipality by the grant of a mortgage in accordance with the provisions of the Local Government Acts.

(a) The amount of the principal moneys which it is proposed to borrow is \$200,000—Two hundred thousand dollars.

(b) The maximum rate of interest that may be paid is 5.75 per centum per annum.

(c) The times which the moneys borrowed are to be repayable are the first days of March and September during the years 1970-1979, and that the place such moneys shall be repayable is at the Bank of New South Wales, Ararat Branch.

(d) The purpose for which the loan is to be applied is:—

Provision of a 66,000/22,000 volt main sub-station at Ararat, and the conversion of the existing 6.6 KV distribution system to a 22 KV system and associated reconstruction work.

(e) The manner in which the loan is to be liquidated is by provision out of the municipal fund in each half-year during the currency of the loan for the sum of \$13,288.26, which includes principal and interest.

The plans and specifications and estimate of the cost of the works and a statement showing the proposed expenditure of the moneys to be borrowed are open for inspection at the municipal offices (Town Clerk's Department), Ararat.

Dated this 23rd day of June, 1969.

8858. J. I. GRENFELL, Town Clerk.

CITY OF BALLAARAT.

LOAN No. 18.

Notice of Intention to Borrow the Sum of \$9,750 for Permanent Works and Undertakings.

NOTICE is hereby given that the Council of the City of Ballaarat proposes to borrow the principal sum of \$9,750, secured by a charge over the general rates of the municipality, such sum to be raised by the grant of a mortgage in accordance with the provisions of the *Local Government Act 1958*.

1. The maximum rate of interest that may be paid is 5.75 per cent. per annum.

2. The purpose for which the loan is to be applied is part cost of purchase of Accounting Machine.

3. The period of the loan shall be ten years.

4. The moneys borrowed shall be repayable by providing out of the municipal fund half-yearly instalments of approximately \$647.81 each, including principal and interest, on the 1st day of March and the 1st day of September during the currency of the loan. The first instalment shall be payable on the 1st day of March, 1970.

5. Such moneys shall be repayable to the Commissioners of the State Savings Bank of Victoria, at the office of the said Commissioners, corner Elizabeth and Bourke-streets, Melbourne.

The plans and specifications and the estimate of the cost of the proposed works and a statement showing the proposed expenditure of the moneys to be borrowed are open for inspection at the office of the Council of the City of Ballaarat, at Town Hall, Ballaarat.

Dated 24th June, 1969.

8889 F. J. ROGERS, Town Clerk.

CITY OF BRIGHTON.

NOTICE OF INTENTION TO TAKE LAND COMPULSORILY.

WHEREAS the Council of the City of Brighton deems it expedient to exercise its power of taking land compulsorily for the work or undertaking mentioned hereunder.

Notice is hereby given as follows:—

1. That for the purpose of executing the work or undertaking pursuant to section 605 of the *Local Government Act 1958* for altering and increasing the width of Francis-road or Snooks-lane and associated re-development of the surrounding area, the Council intends to acquire property commonly known as 1 Snooks-lane, Brighton, owned by Alma Langley, such land being described in certificate of title, volume 4398, folio 879521, and commencing at a point 111 ft. 6½ in. northerly of the north-west corner of the intersection of Bay-street and Francis-road or Snooks-lane; thence westerly 86 ft. 9½ in.; thence north-westerly 12 ft. 7 in.; thence northerly 10 ft. 9 in.; thence northerly 80 ft. 4 in.; thence easterly 94 ft. 7 in.; thence southerly 100 ft. 9 in., back to the point of commencement.

2. The Council has caused to be prepared maps and other papers describing the proposed work or undertaking and the land proposed to be taken and particulars of persons known to have an interest in the property and such maps and other papers are deposited at the Municipal Offices, Boxshall-street, Brighton, and are available for inspection by all interested parties during office hours for the period of forty (40) clear days from the date of publication of this notice in the *Government Gazette*.

3. The Council hereby requires all persons affected by the proposed taking of the land to set forth in writing addressed to the Town Clerk, Municipal Offices, Boxshall-street, Brighton, within forty (40) clear days from the publication of this notice all objections which they may have to the taking of the said land.

Dated 27th June, 1969.

A. C. G. DE GARIS, Town Clerk.

Municipal Offices, Boxshall-street, Brighton. 8956

CITY OF BRIGHTON.

NOTICE OF INTENTION TO TAKE LAND COMPULSORILY.

WHEREAS the Council of the City of Brighton deems it expedient to exercise its powers of taking land compulsorily for the work or undertaking mentioned hereunder.

Notice is hereby given as follows:—

1. That for the purpose of executing the work or undertaking pursuant to section 605 of the *Local Government Act 1958* for altering and increasing the width of Francis-road or Snooks-lane and associated re-development of the surrounding area, the Council intends to acquire property commonly known as 13 Cochrane-street, Brighton, owned by Elsie Myrtle Dowling, such land being described in certificate of title volume 1999, folio 399707, and commencing at a point 228 ft. northerly from the north-west corner of the intersection of Bay-street and Cochrane-street; thence 323 ft. 9 in. westerly; thence 46 ft. 3½ in. northerly; thence 323 ft. 5 in. easterly; thence 46 ft. 2 in. southerly, back to the point of commencement.

2. The Council has caused to be prepared maps and other papers describing the proposed work or undertaking and the land proposed to be taken and particulars of persons known to have an interest in the property and such maps and other papers are deposited at the Municipal Offices, Boxshall-street, Brighton, and are available for inspection by all interested parties during office hours for the period of forty (40) clear days from the date of publication of this notice in the *Government Gazette*.

3. The Council hereby requires all persons affected by the proposed taking of the land to set forth in writing addressed to the Town Clerk, Municipal Offices, Boxshall-street, Brighton, within forty (40) clear days from the publication of this notice all objections which they may have to the taking of the said land.

Dated 27th June, 1969.

A. C. G. DE GARIS, Town Clerk.

Municipal Offices, Boxshall-street, Brighton. 8957

CITY OF CAMBERWELL.

ORDER CHANGING NAME OF STREET.

IN accordance with the powers conferred by the *Local Government Act 1958*, 15th Schedule, the Council of the City of Camberwell, at its Meeting on Monday, 23rd June, 1969, made an Order changing the name of the following street in the Municipality:—

Old Name.—Shamrock-street.

New Name.—Graham-street.

Location.—All of the street known as Shamrock-street in the centre ward of the City of Camberwell, located in a generally north-south direction, between Allie-street and Rose-avenue.

8897

L. F. CHEFFERS, Chief Administrator.

CITY OF DONCASTER AND TEMPLESTOWE.

WHEREAS the Council of the City of Doncaster and Templestowe deems it expedient to exercise its power of taking compulsorily the land delineated and hatched on the map at the foot hereof for the work or undertaking of constructing a road thereon: And whereas the Council has caused to be prepared maps and other papers setting out the general description of the work or undertaking for which the land proposed to be taken is to be used the description of the land proposed to be taken and the names of the owners or reputed owners lessees or reputed lessees mortgagees and occupiers of that land so far as those names are known to or can be ascertained by the Council: And whereas the said maps and other papers are deposited at the office of the said council at Doncaster and are and shall be open for inspection by all persons interested at all reasonable hours for the space of 40 clear days after the publication of this notice in the *Government Gazette*: Now notice is hereby given to all persons affected by the proposed taking of the said land to set forth, in writing, addressed to the Council or the Town Clerk within

40 clear days of the publication of this notice in the *Government Gazette* all objections which they may have to the taking of the said land.

Dated this 23rd day of June, 1969.

By order of the Council,
8857 J. W. THOMSON, Town Clerk.

CITY OF FRANKSTON.

ORDER CHANGING NAME OF STREET.

IN accordance with the powers conferred by the Local Government Act, 15th Schedule, Part 1, Clause 8, the Council of the City of Frankston does hereby make an Order changing the name of a street within the Municipal District.

Old Name.—Hope-street.

New Name.—Hope-court.

Location Referred to.—As appearing on Plan of Sub-division No. 51886 on the east side of Dandenong-road East, Frankston.

Civic Centre, Frankston.
8860 J. P. SCOTT, Acting Town Clerk.

CITY OF FRANKSTON.

LOAN No. 132.

Notice of Intention to Borrow the Sum of \$25,000 for Permanent Works and Undertakings.

NOTICE is hereby given that the Council of the City of Frankston proposes to borrow the principal sum of \$25,000 secured by a charge over the general rates of the municipality, such sum to be raised by the grant of a mortgage in accordance with the provisions of the *Local Government Act 1958*.

(i) The maximum rate of interest that may be paid is 5½ per centum per annum.

(ii) The purpose for which the loan will be applied is:—

(a) Towards construction of Infant Welfare Centres ..	\$13,000
(b) Towards installation of traffic lights ..	6,000
(c) Towards the construction of a pavilion at Seaford Reserve ..	6,000
Total ..	\$25,000

(iii) The period of the loan shall be fifteen (15) years.

(iv) The moneys borrowed shall be repayable out of the municipal fund by 30 half-yearly instalments of approximately \$1,265.20 each, including principal and interest on the 10th day of March and the 10th day of September during the currency of the loan. The first instalment shall be payable on the 10th day of March, 1970.

(v) Such moneys shall be repayable at the Commercial Savings Bank of Australia Limited, Melbourne.

The plans and specifications and estimates of the cost of proposed works and a statement showing the proposed expenditure of the moneys to be borrowed are open for inspection at the Civic Centre, Frankston.

J. P. SCOTT, Acting Town Clerk.
Civic Centre, Frankston. 8876

CITY OF MOORABBIN.

DECLARATION OF PUBLIC HIGHWAY.

NOTICE is hereby given that at a Meeting held on the 23rd day of June, 1969, the Council of the City of Moorabbin passed the following Resolution:—

“That pursuant to the powers conferred by section 522 of the *Local Government Act 1958*, the Council of the City of Moorabbin having purchased the land being lot 35 on plan of subdivision No. 6446 for the purpose of extending Station-street, Hightt, through to View-street, hereby orders and directs that the whole of the said land now forming part of Station-street, Hightt, shall be a public highway.”

8855 V. A. SMITH, Town Clerk.

CITY OF MOORABBIN.

NOTICE OF INTENTION TO TAKE LAND COMPULSORILY.

NOTICE is hereby given that it is the intention of the Council of the City of Moorabbin, in exercise of the powers conferred on it by the *Local Government Act 1958*, to take compulsorily—

All that piece of land off Nancy-street, Cheltenham, containing 5,257 square feet or thereabouts and being part of Crown allotment 1, section 17, Parish

of Mordialloc, County of Bourke, and more particularly being the balance of land described in Certificate of Title, Volume 5798, Folio 473.

The said land is required and being taken for the purpose of executing the following work or undertaking by the said Council—the providing of a place of public resort or recreation.

The Council has caused to be prepared maps and other papers to show the general description of the work or undertaking, the description of the lands proposed to be taken and stating that the name of the owner of the said land is the executor of the estate of George Thomas Allnutt, deceased, of 264 Warrigal-road, Cheltenham.

The said maps and other papers have been approved by the Council and are now deposited for inspection by all persons interested at the offices of the City of Moorabbin situate Nepean Highway, Moorabbin, and may be inspected there during office hours.

All persons affected by the proposed taking of the land are hereby required to set forth in writing addressed to the Council or the Municipal Clerk within forty (40) clear days of the publication of this notice in the *Government Gazette* all objections which they may have to the taking of the land.

Dated the 1st day of July, 1969.

By Order of the Council,
8851 V. A. SMITH, Town Clerk & Municipal Clerk.

CITY OF SHEPPARTON.

Town and Country Planning Act 1961.

NOTICE THAT A PLANNING SCHEME HAS BEEN PREPARED AND IS AVAILABLE FOR INSPECTION.

City of Shepparton Planning Scheme 1953, Amendment No. 19, 1969.

NOTICE is hereby given that the Council of the City of Shepparton, in pursuance of its powers under the *Town and Country Planning Act 1961*, has prepared a Planning Scheme for the whole of the municipal district of the City of Shepparton for the purpose of—

(a) Extending the Special Uses Zone “A” in Maple-street to include all land owned by the Albanian-Moslem Society in one reservation.

(b) Extending the Public Purpose Reserve—13. Civic Centre.

(c) Controlling the use of land and buildings for Junk Yards.

(d) Re-zoning areas of land from Agricultural to Residential.

(e) Removing the reservation for a school site north of Cameron-avenue on land proposed to be used for recreational purposes.

(f) Re-zoning, to Residential, an area in the Commercial “C” Zone.

(g) Zoning, to Residential, a disused channel.

(h) Re-zoning, to Commercial “A”, one allotment in the Residential Zone.

A copy of the Scheme has been deposited at the municipal offices, Civic Centre, Shepparton, and at the office of the Town and Country Planning Board, 235 Queen-street, Melbourne, and will be open for inspection during office hours by any person, free of charge.

Any persons affected by the Planning Scheme are required to set forth, in writing, all objections they may have, addressed to the Town Clerk, Civic Centre, Shepparton, on or before the 2nd day of October, 1969, and to state whether they wish to be heard in respect of their objections.

8896 R. O'BRIEN, Town Clerk.

CITY OF SOUTH MELBOURNE.

LOAN No. 67.

Notice of Intention to Borrow the Sum of \$12,000 for Permanent Works and Undertakings.

NOTICE is hereby given that the Council of the City of South Melbourne proposes to borrow the principal sum of Twelve thousand dollars (\$12,000), secured by a charge over the general rates of the municipality, such sum to be raised by the grant of a mortgage in accordance with the provisions of the *Local Government Act 1958*.

(1) The maximum rate of interest that may be paid is 5.75 per centum per annum.

(2) The purpose for which the loan is to be applied is the purchase of additional land for the Lillian Cannam Kindergarten, Eastern-road, South Melbourne .. \$12,000.

(3) The period of the loan shall be ten years.

(4) The moneys borrowed shall be repayable by providing out of the municipal fund twenty equal half-yearly instalments of \$797.30 each, including principal and interest, on the 1st day of September and the 1st day of March, during the currency of the loan. The first instalment shall be payable on the 1st day of March, 1970.

(5) Such moneys shall be repayable at the Australia and New Zealand Savings Bank Limited, 394-396 Collins-street, Melbourne.

The plan and specification and the estimate of the cost of the proposed undertaking and a statement showing the proposed expenditure of the moneys to be borrowed are open for inspection at the office of the Council of the City of South Melbourne, at the Town Hall, Bank-street, South Melbourne, during office hours.

Dated 13th June, 1969.

8852

J. J. COX, Town Clerk.

CITY OF TRARALGON.
NAMING OF STREET/ROAD.

NOTICE is hereby given that in pursuance of the powers conferred by the Local Government Act the Council did at a meeting held on the 26th day of May, 1969, order the naming of the under-mentioned road:

Old Name.—Government-road.

New Name.—Stammers-road.

Location.—North from Princes Highway adjacent east boundary, lodged plan 8835.

8868

K. J. SAUNDERS, Town Clerk.

CITY OF WAVERLEY.

WHEREAS the Council of the City of Waverley deems it expedient to exercise its power of taking compulsorily the land described in the Schedule hereto for road purposes and acquiring the said land for that purpose: And whereas the Council has caused to be prepared a map and other papers setting out a general description of the work or undertaking for which the land proposed to be taken is to be used, the description of the land proposed to be taken and the names of the owners or reputed owners, lessees or reputed lessees, mortgagees and occupiers of that land, so far as those names are known to or can be ascertained by the Council.

And whereas the said map and other papers are deposited at the office of the Council at Glen Waverley, and are and shall be open for inspection by all persons interested, at all reasonable hours, for the space of 40 clear days after the publication of this notice in the *Government Gazette*.

Now notice is hereby given to all persons affected by the proposed taking of the said land to state forthwith, in writing, addressed to the Council or the Town Clerk within 40 clear days of the publication of this notice in the *Government Gazette*, all objections which they may have to the taking of the said land.

THE SCHEDULE HEREINBEFORE REFERRED TO:—

All that piece of land being portion of lot 3 on plan of subdivision No. 40974, described in certificate of title, volume 8154, folio 672, commencing at the north-west corner of the land; thence along its western boundary for a distance of 33 feet; thence easterly by a line bearing 89 deg. 51½ min. to the eastern boundary of the land; thence northerly along its eastern boundary for a distance of 33 feet to its northern boundary; thence westerly along its northern boundary to the point of commencement.

Dated this 2nd day of July, 1969.

8894

F. S. BALES, Town Clerk.

BOROUGH OF WONTHAGGI.

LOAN No. 29.

Notice of Intention to Borrow the Sum of \$18,000 for Permanent Works and Undertakings.

NOTICE is hereby given that the Council of the Borough of Wonthaggi proposes to borrow the sum of \$18,000, secured by a charge over the general rates of the municipality, such sum to be raised by the grant of a mortgage in accordance with the provisions of the *Local Government Act 1958*.

1. The maximum rate of interest that may be paid is 5.5625 per cent. per annum.

2. The purpose for which the loan is to be applied is the purchase of road-making plant.

3. The period of the loan shall be seven years.

4. The moneys borrowed shall be repayable by providing out of the municipal fund half-yearly instalments of approximately \$1,569.81 each, including principal and interest on the first day of March and the first day of September, during the currency of the loan. The first instalment shall be repayable on the 1st day of March, 1970.

5. Such moneys shall be repayable at the National Bank of Australasia Ltd., Melbourne.

The plans and specifications and the estimate of the cost of the proposed works and a statement showing the proposed expenditure of the moneys to be borrowed are open for inspection at the office of the Council of the Borough of Wonthaggi, at Wonthaggi.

8895

F. R. DUNN, Acting Town Clerk.

SHIRE OF CROYDON.

NOTICE OF INTENTION TO TAKE LAND COMPULSORILY.

NOTICE is given that it is the intention of the Council of the Shire of Croydon, in exercise of the powers conferred on it by the *Local Government Act 1958*, to take compulsorily all that piece of land being part of Lot 6, L.P. 27304, Sturt-street, corner of Lacey-street.

1. The said land is required for, and it is proposed to take it compulsorily for the purpose of, executing the work or undertaking by the said Council of providing road deviation.

2. The said Council has caused to be prepared maps and other papers showing a general description of the said work or undertaking, a description of the land to be taken and that the owners of the said land are Mrs. Eunice Amelia McKie, care of Messrs. Robertson, McMillan and Co., 191 Bank-street, South Melbourne, 3205.

3. The said maps and other papers have been approved by the said Council, and are now deposited for inspection by all persons affected by the proposed taking of the said land, at the office of the Shire of Croydon, situate in Railway-crescent, Croydon, during office hours.

4. All persons affected by the proposed taking of the said land are hereby required to set forth, in writing, addressed to the said Council or the Municipal Clerk thereof, within 40 clear days of the publication of this notice in the *Government Gazette*, all objections which they may have to the taking of the said land.

Dated the 20th day of June, 1969.

8847

K. A. MCKAY, Shire Secretary.

SHIRE OF DUNDAS WATERWORKS TRUST.

By-Law No. 1.

NOTICE is hereby given that the Shire of Dundas Waterworks Trust, in pursuance and exercise of the powers conferred by the *Water Act 1958* and of any and every other power it thereunto enabling, has made By-Law No. 1, for the purpose of regulating and appointing the place and hour of Meetings of the Shire of Dundas Waterworks Trust, and providing for the management and conduct of Business thereat.

The By-Law was passed on the 6th February, 1969 and approved by the Governor in Council on 22nd April, 1969.

A copy of the By-Law is open for inspection at the Trust's Office during normal office hours.

8862

J. R. MITCHELL, Secretary.

SHIRE OF ELTHAM.

LOAN No. 84.

Notice of Intention to Borrow the Sum of \$6,000 for Permanent Works and Undertakings.

NOTICE is hereby given that the Council of the Shire of Eltham proposes to borrow the principal sum of Six thousand dollars secured by a charge over the general rates of the municipality, such sum to be raised by the grant of a mortgage in accordance with the provisions of the *Local Government Act 1958*.

1. The maximum rate of interest that may be paid is 5½ per cent. per annum.

2. The purpose for which the loan is to be applied is the establishment of a pre-school dental clinic in Eltham.

3. The period of the loan shall be ten years.

4. The moneys borrowed shall be repayable by providing out of the municipal fund twenty half-yearly instalments of \$398.65 each, including principal and interest, on the 1st day of March and the 1st day of September during the currency of the loan. The first instalment shall be payable on the 1st day of March, 1970.

5. Such moneys shall be repayable to the Hurstbridge Waterworks Trust, c/o Shire Offices, Eltham, or at the office for the time being of the Trust.

The plans and specifications and the estimate of the cost of the proposed works and a statement showing the proposed expenditure of the moneys to be borrowed, are open for inspection at the Shire Offices, Main-road, Eltham.

8869 M. B. WATSON, Shire Secretary.

SHIRE OF ELTHAM.

NAMING OF ROAD.

NOTICE is hereby given that the unnamed government road, running westerly from the Kangaroo Ground-road, Warrandyte North, to Stony Creek, between Crown allotments 3E, 3G, 2B, 3H, 3A and 3F, section 8A, Parish of Nillumbik, has been named Bellbird-lane.

8871 M. B. WATSON, Shire Secretary.

SHIRE OF LEIGH.

NOTICE is hereby given that the Council of the Shire of Leigh has, pursuant to the Pounds Act, appointed Ernest Percy Dunstan the Poundkeeper for the Rokewood Pound in the Shire of Leigh.

8856 C. G. HALLUM, Shire Secretary.

SHIRE OF LILLYDALE.

NOTICE THAT A PLANNING SCHEME HAS BEEN PREPARED AND IS AVAILABLE FOR INSPECTION.

Shire of Lillydale Planning Scheme, 1958, Amendment No. 10, 1968.

NOTICE is hereby given that the Shire of Lillydale, in pursuance of its powers under the *Town and Country Planning Act 1961*, has prepared a Planning Scheme for portions of the Shire of Lillydale for the purpose of amending the Principal Scheme (Shire of Lillydale Planning Scheme 1958).

A copy of the scheme has been deposited at the Shire Offices, Lillydale, and at the office of the Town and Country Planning Board, 235 Queen-street, Melbourne, and will be open for inspection during office hours by any person free of charge.

Any persons affected by the Planning Scheme are required to set forth, in writing, all objections they may have, addressed to the Shire Secretary, Shire of Lillydale, Shire Offices, Lillydale-Monbulk-road, Lillydale, on or before the 2nd day of August, 1969, and to state whether they wish to be heard in respect of their objections.

8874 F. O. KENT, Shire Secretary.

SHIRE OF MANSFIELD.

LOAN No. 61.

Notice of Intention to Borrow.

NOTICE is hereby given that the Council of the Shire of Mansfield intends to borrow Twenty-one thousand eight hundred dollars (\$21,800.00) secured by a charge over the general rates of the municipality by the grant of a mortgage, in accordance with the provisions of the Local Government Acts. In connexion therewith the following information is stated:—

(a) The amount of the principal moneys which it is proposed to borrow is Twenty-one thousand eight hundred dollars.

(b) The maximum rate of interest that may be paid is 5.5 per centum.

(c) The time which the moneys borrowed are to be repayable are the 1st day of February, 1970, and the 1st days of August and February during the years 1970 to 1974 inclusive, and that the place such moneys shall be payable is at the Bank of New South Wales, Mansfield.

(d) The purpose for which the loan is to be applied is purchase of a Trojan 204A Loader.

(e) The manner in which the loan is to be liquidated is by provision out of the municipal fund in each half-year during the currency of the loan of the sum of \$3,072.88, which includes principal and interest.

The plans and specifications and estimate of the cost of the works, and a statement showing the proposed expenditure of the moneys to be borrowed, are open for inspection at the Shire Office, Mansfield.

Dated this 26th day of June, 1969.

8884 R. WOMERSLEY, Shire Secretary.

SHIRE OF MORNINGTON.

NOTICE OF PROPOSED COMPULSORY ACQUISITION OF LAND.

WHEREAS the *Local Government Act 1958* (as amended) provides that the Council of any Municipality may take land compulsorily for the purpose of executing works or undertakings which it is by or under that or any other Act authorized to execute, and

Whereas section 805 of the said Act provides that the Council of any Municipality may acquire land for car parks, and

Whereas for the purpose of providing car parks, the Council of the Shire of Mornington has deemed it expedient to exercise its powers of taking compulsorily the following land namely:—

All that piece of land known as numbers 10/12 Blake-street, Mornington, being lot 1 on lodged plan number 71161, in the Office of Titles and all that piece of land known as number 12 Gordon-street, Mornington, being lot 2 on lodged plan number 78123 in the Office of Titles, and

Whereas the said Council has caused to be prepared and has approved maps and other papers which show the names of the owners of the land and other particulars as are required by the said Act, and

Whereas such maps and other papers are deposited for inspection at the office of the said Council, Queen-street, Mornington.

Now therefore, all persons affected by the proposed taking of the land are required to set forth, in writing, addressed to the Council or the Municipal Clerk within 40 clear days of the publication of this notice in the *Government Gazette* all objections which they may have to the taking of the land.

8872 D. G. COLLINGS,
Shire Secretary and Municipal Clerk.

SHIRE OF ROCHESTER.

By-Law No. 34.

Cattle Driving.

NOTICE is hereby given that the Council of the Shire of Rochester in pursuance of the powers conferred by the *Local Government Act 1958* has made By-Law No. 34 to control the driving of cattle in or along streets or roads in the Shire, under the title of Rochester Shire Cattle Driving By-Law 1968, the following being a summary of such By-Law:—

Cattle includes horses, mares, fillies, foals, geldings, colts, bulls, bullocks, cows, heifers, steers, calves, asses, mules, sheep, ewes, wethers, rams, lambs, goat and swine which must NOT be driven in or along any street or road except in accordance with a permit issued by the Shire Engineer.

A permit, which must be in the custody of the person in charge of the cattle and produced on request will specify the number of cattle, commencing point and destination, precise route and date of travel and name of person in charge.

Minimum Distance per day: Sheep, ewes, wethers, rams, lambs, goats and swine to be driven at least 4 miles per day, all other cattle at least 10 miles per day.

The Engineer will have the discretion to refuse a permit if he considers the driving of cattle would be dangerous to the public, or likely to damage roads, streets, &c.

Short Journeys :

Permit will not be required if total time cattle are driven does not exceed three hours in the aggregate in any one day.

The owner and the person in charge of cattle are both jointly and severally liable for any breach of the By-Law, the following being the penalties for every person guilty of an offence:—

FIRST OFFENCE

Minimum: \$2.00 each head of cattle—10 cents per head ewes, wethers, lambs.

Maximum: \$4.00 per head of cattle—50 cents per head ewes, wethers, lambs.

SECOND OR MORE OFFENCES

Minimum: \$4.00 per head; maximum: \$10.00 per head. Plus compensation for damage to roads, streets, &c.

A copy of the By-Law referred to is open for inspection free of charge during office hours at the office of the Council, Mackay-street, Rochester.

8886 H. R. WESTCOTT, Shire Secretary.

SHIRE OF SEYMOUR.

LOAN No. 29.

Notice of Intention to Borrow the Sum of \$10,000 for Permanent Works and Undertakings.

NOTICE is hereby given that the Council of the Shire of Seymour proposes to borrow the principal sum of Ten thousand dollars (\$10,000), secured by a charge over the general rates of the municipality, such sum to be raised by the grant of a mortgage in accordance with the provisions of the *Local Government Act 1958*.

1. The maximum rate of interest that may be paid is 5.5625 per centum per annum.
2. The purpose for which the loan is to be applied is:—
Part cost of new plant.
3. The period of the loan shall be seven years.
4. The moneys borrowed shall be repayable by providing out of the municipal fund fourteen half-yearly instalments of \$872.12 each, including principal and interest, on the 15th day of February and 15th day of August, during the currency of the loan. The first instalment shall be payable on the 15th day of February, 1970.

5. Such moneys shall be repayable at the C.B.C. Savings Bank Limited, Melbourne.

The plans and specifications and the estimate of the cost of the proposed works and a statement showing the proposed expenditure of the moneys to be borrowed, are open for inspection at the offices of the Council, Station-street, Seymour, during office hours.

Dated this 18th day of June, 1969.

8853

G. G. McWHINNEY, Shire Secretary.

NOTICE is hereby given that the partnership heretofore subsisting between the undersigned, Donald Murdock Campbell and William Desmond Papworth, carrying on business as plumbers and sheetmetal workers, at 18 Armstrong-street, Sunshine, and 9 Snowden-street, Sunshine, under the style or the firm name of Sunshine Plumbing Service, has been dissolved by mutual consent, as from the 31st day of January, 1969. All debts due to and owing by the firm will be received by the said William Desmond Papworth whose present address is 18 Aurisch-avenue, Glen Waverley.

Dated the 30th day of March, 1969.

8849

D. M. CAMPBELL.
W. D. PAPWORTH.

NOTICE is hereby given that the partnership heretofore existing between us, the undersigned, Rex Gordon Sheppard, of 4 Nixon-court, East Bentleigh, and Norman Hocking, of 42 Weatherall-road, Cheltenham, carrying on business as printers, at 4 Nixon-court, East Bentleigh under the style or firm name of Highview Printers, has been dissolved as on the 11th day of February, 1969, and that the said firm is ceasing business operations.

R. G. SHEPPARD.
N. HOCKING.

Lachlan K. Gardiner & Co., solicitors, 195 Bridge-road, Richmond, 3121. Telephone: 42 2091. 8859

NOTICE is hereby given that the partnership heretofore subsisting between Malcolm Scott McGraw and Phyllis Margaret McGraw, carrying on business as Clothing Retailers under the firm name of "McGraw House", at 403 Sturt-street, and Shop 4, 107 Sturt-street, Ballarat, has been dissolved as from the 26th day of June, 1969.

CUTHBERT MORROW MUST & SHAW, solicitors, Ballarat. 8880

NOTICE is hereby given that the partnership between Jessie Ross Hopkins, Jean Clapham Emery, William Stone, Mabel Stone, Violet May Christopher, Gwendoline Amy Stone, Edith Mary Jones, Gladys Tonkin, Alan George Stone, Lewis Macdonald Stone, Maxwell Alfred Stone, Joyce Dorothea Fazekas de St. Groth and Douglas John Wallace Stone, carrying on a timber merchant's business at 157 Napier-street, Fitzroy, in the State of Victoria, under the firm name of "John Stone", has been dissolved by mutual consent as from the 30th day of May, 1969. All debts due to and owing by the late firm will be received and paid respectively by Douglas John Wallace Stone, of 3A Fordham-road, Hawthorn.

Dated this 23rd day of June, 1969.

DOUGLAS J. W. STONE.
Corr & Corr, solicitors, 290 Latrobe-street, Melbourne.

8915

NOTICE is hereby given that on the 30th day of June, 1969, Neil James Williams retired from partnership with Gifford Valmyn Harris, Henry Hawkins Gillam, Douglas Herbert Knight and Ronald Lewis Eilenberg, in the practice carried on under the name of Oswald Burt & Co., at 178 William-street, Melbourne. The last-mentioned persons will continue in partnership under the same name at the same address.

Dated this 1st day of July, 1969.

OSWALD BURT & CO., solicitors, 178 William-street, Melbourne. 8964

Companies Act 1961, Section 254.

76 LEOPOLD STREET PROPRIETARY LIMITED.

NOTICE is hereby given that at an Extraordinary General Meeting of the members of the above-named company held on 24th June, 1969, the following Resolution was passed as a Special Resolution:—

"That this company be wound up voluntarily and that Robert Arthur Waters, of 170 Queen-street, Melbourne, be appointed liquidator for the purpose of such winding up."

8881

R. A. WATERS, Liquidator.

Companies Act 1961.—In the matter of P. J. TIMBER & TRADING Co. PTY. LTD.—Notice Re Meeting of Creditors, pursuant to section 260.

NOTICE is hereby given that a Meeting of Creditors of the above-named company will be held at Room 328, 3rd Floor, East Par, Princes Gate, 151 Flinders-street, Melbourne, at 2.30 p.m., on the 11th day of July, 1969, the company having convened a meeting of its members for the same day for the purpose of considering a Resolution that the company be wound up voluntarily.

Dated the 30th day of June, 1969.

JOHN C. HARDIMAN, Director.

A. Neville Bird & Co., chartered accountants, 289 Flinders-lane, Melbourne. Telephone: 63 8833. 8967

ROBINSONS' RADIO PROPRIETARY LIMITED.

SPECIAL RESOLUTION TO WIND UP.

Pursuant to Section 254 of the *Companies Act 1961*.

AT an Extraordinary General Meeting of the above-named company, duly convened and held at Snodgrass-street, Yea, on the 27th day of June, 1969, the following Resolution was duly passed as a Special Resolution:—

"That the company be wound up voluntarily."

And at such last-mentioned meeting Albert Edward Robinson was appointed liquidator for the purpose of the winding up.

Dated this 27th day of June, 1969.

8953

A. E. ROBINSON, Liquidator.

In the Supreme Court of Victoria.—No. Co. 7725 of 1969.—In the matter of the *Companies Act 1961*; and in the matter of STONETEX COATINGS (AUST.) PTY. LTD.

NOTICE is hereby given that a petition for the winding up of the above-named company by the Supreme Court was on the 6th day of May, 1969, presented by Ipec Transport Pty. Ltd., and that the said petition is directed to be heard before the Court sitting at the Fourteenth Court, Law Courts, William-street, Melbourne, on the 29th day of July, 1969, at the hour of 10.30 o'clock in the forenoon: And any creditor or contributory of the said company desiring to support or oppose the making of an Order on the said petition may appear at the time of hearing by himself or his counsel for that purpose; and a copy of the petition will be furnished to any creditor or contributory of the said company requiring the same by the undersigned on payment of the regulated charge for the same.

The petitioner's address is 259 Glen Osmond-road, Frewville, South Australia.

The petitioner's solicitors are Messrs. Joseph B. Murphy and Wilby, of 406 Lonsdale-street, Melbourne.

JOSEPH B. MURPHY AND WILBY, solicitors for the petitioner.

NOTE.—Any person who intends to appear on the hearing of the said petition must serve or send by post to the above-named solicitors, notice, in writing, of his intention so to do. The notice must state the name and address of the person, or, if a firm the name and address of the firm must be signed by the person or firm, or his or her solicitor (if any) and must be served or if posted must be sent by post in sufficient time to reach the above named not later than 4 o'clock in the afternoon of the 28th July, 1969.

8968

The Companies Act 1961.—In the matter of the following companies (in Voluntary Liquidation).—Members' Winding Up:—

DUNLOP TYRE SERVICE (BOX HILL) PTY. LTD.
 DUNLOP TYRE SERVICE (HORSHAM) PTY. LTD.
 DUNLOP TYRE SERVICE (MELBOURNE) PTY. LTD.
 DUNLOP TYRE SERVICE (MILDURA) PTY. LTD.
 DUNLOP TYRE SERVICE (HAMILL) PTY. LTD.
 DUNLOP TYRE SERVICE (SHEPPARTON) PTY. LTD.
 DUNLOP TYRE SERVICE (GEELONG) PTY. LTD.
 DUNLOP TYRE SERVICE (WARRAGUL) PTY. LTD.
 DUNLOP TYRE SERVICE (TRARALGON) PTY. LTD.
 DUNLOP TYRE SERVICE (FOOTSCRAY) PTY. LTD.
 DUNLOP TYRE SERVICE (BAIRNSDALE) PTY. LTD.
 DUNLOP TYRE SERVICE (SWAN HILL) PTY. LTD.
 DUNLOP TYRE SERVICE (BENDIGO) PTY. LTD.
 DUNLOP TYRE SERVICE (PRESTON) PTY. LTD.
 DUNLOP TYRE SERVICE (HAMILTON) PTY. LTD.
 DUNLOP TYRE SERVICE (WARRNAMBOOL) PTY. LTD.
 DUNLOP TYRE SERVICE (BRUNSWICK) PTY. LTD.
 DUNLOP TYRE SERVICE (TYRESOLES SOUTH MELBOURNE) PTY. LTD.
 DUNLOP TYRE SERVICE (WANGARATTA) PTY. LTD.
 DUNLOP TYRE SERVICE (NORTH GEELONG) PTY. LTD.
 DUNLOP TYRE SERVICE (ARARAT) PTY. LTD.
 DUNLOP TYRE SERVICE (DANDENONG) PTY. LTD.
 DUNLOP TYRE SERVICE (COLAC) PTY. LTD.
 DUNLOP TYRE SERVICE (KERANG) PTY. LTD.
 DUNLOP TYRE SERVICE (BALLARAT) PTY. LTD.
 DUNLOP TYRE SERVICE (FRANKSTON) PTY. LTD.
 DUNLOP TYRE SERVICE (LEONGATHA) PTY. LTD.
 DUNLOP TYRE SERVICE (ESSENDON) PTY. LTD.
 DUNLOP TYRE SERVICE (OAKLEIGH) PTY. LTD.
 DUNLOP TYRE SERVICE (LILYDALE) PTY. LTD.
 NATIONAL TYRE SERVICE (CASTLEMAINE) PTY. LTD.
 DUNLOP TYRE SERVICE (FAWKNER) PTY. LTD.
 DUNLOP TYRE SERVICE (RINGWOOD) PTY. LTD.
 DUNLOP TYRE SERVICE (TERANG) PTY. LTD.
 DUNLOP TYRE SERVICE (MOORABBIN) PTY. LTD.
 DUNLOP TYRE SERVICE (ECHUCA) PTY. LTD.
 DUNLOP TYRE SERVICE (BENALLA) PTY. LTD.

NOTICE is hereby given that at the Extraordinary General Meeting of the above-named companies duly convened and held at 108 Flinders-street, Melbourne, in the State of Victoria, on the 1st day of July, 1969, the following Resolution was proposed and passed as a Special Resolution:—

"That the company be wound up voluntarily."

Dated this 2nd day of July, 1969.

R. F. HUGHES, Liquidator.

Messrs. Cooper Brothers & Co., chartered accountants,
 360 Collins-street, Melbourne. 8877

The Companies Act 1961.

HARVE PROPRIETARY LIMITED.

NOTICE is hereby given that, pursuant to section 272 of the Companies Act 1961, a Final Meeting of the members of the company will be held at 249 William-street, Melbourne, on Monday, the 4th August, 1969, at 10.30 in the forenoon for the purpose of having an account laid before them, showing the manner in which the winding up has been conducted and the property of the company disposed of, and of hearing any explanation that may be given by the liquidator.

Dated this 25th day of June, 1969.

8905

C. G. ROBERTS, Liquidator.

The Companies Act 1961.—In the matter of BEAVER CONSTRUCTORS PROPRIETARY LIMITED.

NOTICE is hereby given that at an Extraordinary General Meeting of the members of the above-named company held on the 25th day of June, 1969, it was resolved that the company be wound up voluntarily, and at a meeting of creditors held on the same day, pursuant to section 260, it was resolved that for such purpose Alan Murray Horsburgh, of 296 Little Lonsdale-street, Melbourne, accountant, be appointed liquidator.

Notice is also given that after 21 days from this date I shall proceed to distribute the assets. All creditors having any claims against the company should furnish particulars of same by that date, otherwise I shall proceed to distribute the assets without regard to their claim.

Dated this 26th day of June, 1969.

A. M. HORSBURGH, Liquidator.

Kennedy, Small & Middlemiss, 296 Little Lonsdale-street,
 Melbourne, 3000. 8930

The Companies Act 1961.—In the matter of MELBOURNE TAVERNS PTY. LTD.—Notice re Meeting of Creditors Pursuant to Section 260.

NOTICE is hereby given that a Meeting of Creditors of the above-named company will be held at Victoria Employers' Federation meeting rooms, room 326, 3rd floor, East Tower Princes Gate, 151 Flinders-street, Melbourne, on Thursday, the 17th July, 1969, at 11 a.m., the company having convened a meeting of its members for the same day for the purpose of considering a Resolution that the company be wound up voluntarily.

Dated this 26th day of June, 1969.

J. A. HUDSON, Director.

Bent & Cogle, Suite 18, 545 St. Kilda-road, Melbourne.
 8882

The Companies Act 1961.—In the matter of COMPASS TOURS PTY. LTD.

NOTICE is hereby given that at a Meeting of the Members of Compass Tours Pty. Ltd. held at Melbourne, on 26th June, 1969, the following Resolution was passed as a Special Resolution:—

That the company be placed in voluntary liquidation and that Messrs. Leslie Philip Smart and Vernon Keith Reynolds of Marquand & Co., 51 Queen-street, Melbourne, be and are hereby appointed liquidators of the company to act jointly and severally.

L. P. SMART, Liquidator.

8966

V. K. REYNOLDS, Liquidator.

H. F. & J. M. WHITE PROPRIETARY LIMITED.

SPECIAL RESOLUTION TO WIND UP.

Pursuant to Section 254 of the Companies Act 1961.

At an Extraordinary General Meeting of the above-named company, duly convened and held at Main-road, Hurstbridge, on the 27th day of June, 1969, the following Resolution was duly passed as a Special Resolution:

"That the company be wound up voluntarily."

And at such last-mentioned meeting Harold Frederick White was appointed liquidator for the purpose of the winding up.

Dated this 27th day of June, 1969.

8893

H. WHITE, Liquidator.

The Companies Act 1961.—In the matter of INTERNATIONAL HOMES COMPANY PTY. LTD. (in Liquidation).

NOTICE is hereby given that pursuant to section 272 of the Companies Act 1961, a Final Meeting of creditors and members of International Homes Company Pty. Ltd. (in Liquidation), will be held at the offices of Marquand & Co., 9th Floor, 51 Queen-street, Melbourne, 3000, on Thursday, 7th August, 1969, at 2 p.m., for the purpose of laying before the meeting an account showing the manner in which the winding up has been conducted, and the property of the company disposed of, and of hearing any explanation that may be given by the liquidator.

Dated this 2nd day of July, 1969.

8969

L. P. SMART, Liquidator.

Companies Act 1961, Section 260.

C.M.R. PRODUCTS PTY. LIMITED (RECEIVER APPOINTED).

NOTICE OF MEETING OF CREDITORS.

NOTICE is hereby given that a meeting of the creditors of C.M.R. Products Pty. Limited (Receiver Appointed) will be held at the Board Room, Institute of Chartered Accountants, 23 McKillop-street, Melbourne, on the 18th day of July, 1969, at 10.30 o'clock in the forenoon.

Agenda:

To consider and if thought fit, resolve—

1. The company be wound up voluntarily and Peter William Harvey, chartered accountant, be appointed liquidator.

2. The liquidator be paid a remuneration in accordance with the scale of fees from time to time allowed by the Chartered Institute of Accountants.

3. All fees of all solicitors and accountants of and in connexion with the winding up and preparation for the same, be paid with the same priority as the liquidator's remuneration.

Dated the 23rd day of June, 1969.

W. F. TITCHENER, Secretary, registered office, 51
 Clarence-street, Elsternwick, 3185. 8931

Companies Act 1961.

INDEPENDENT TRANSPORT MANAGEMENT &
SERVICES PROPRIETARY LIMITED
(IN VOLUNTARY LIQUIDATION).

AT an Extraordinary General Meeting of the above-named company duly convened and held on 25th June, 1969, at Room 11, Ground Floor, 11 Bank-place, Melbourne, the following Special Resolution was passed:

"That Independent Transport Management & Services Pty. Ltd. be placed in voluntary liquidation under section 254 (1) of the Companies Act 1961, and that Alan Leigh Middleton, of 11 Bank-place, Melbourne, be appointed liquidator."

Dated this 26th day of June, 1969.

8906

A. L. MIDDLETON, Liquidator.

The Companies Act 1961.

BRANKO ORIGINALS PTY. LTD. (UNDER OFFICIAL
MANAGEMENT).

NOTICE TO CREDITORS OF INTENTION TO DECLARE DIVIDEND.

A FIRST Dividend is intended to be declared in the above matter. Creditors who have not proved their debt by the 12th day of July, 1969, will be excluded from this dividend.

Dated this 28th day of June, 1969.

A. NEVILLE BIRD, Official Manager.

A. Neville Bird & Co., chartered accountants, 289 Flinders-lane, Melbourne, 3000, Telephone No. 63 4989.

8929

Companies Act 1961.

STAR HAULAGE PROPRIETARY LIMITED (IN VOLUNTARY
LIQUIDATION).

NOTICE CONVENING FINAL MEETING.

PURSUANT TO SECTION 272 (2).

NOTICE is hereby given that a General Meeting of the members of the company will be held at Geelong-road, Brooklyn, on Friday, the 1st day of August, 1969, at 11 o'clock in the forenoon for the purpose of having an account laid before them, showing the manner in which the winding up has been conducted and the property of the company disposed of, and of hearing any explanations that may be given by the liquidators.

Dated this 25th day of June, 1969.

A. W. STEEDMAN, Liquidator.

F. J. K. STEEDMAN, Liquidator.

K. W. STEEDMAN, Liquidator.

C. D. STEEDMAN, Liquidator.

8916

The Companies Act 1961.—In the matter of ERICSCOTT CONSTRUCTIONS PTY. LTD., 619 High-street, Thornbury.—Notice Re Meeting of Creditors, pursuant to section 260.

NOTICE is hereby given that a Meeting of Creditors of the above-named company will be held at Suite 18, 545 St. Kilda-road, Melbourne, on Thursday, 10th July, 1969, at 2.30 p.m., the company having convened a meeting of its members for earlier the same day, for the purpose of considering a Resolution that the company be wound up voluntarily.

Dated this 23rd day of June, 1969.

E. LOFT, Director.

Bent & Cogle, public accountants, Suite 18, 545 St. Kilda-road, Melbourne, 3004.

8854

Companies Act 1961.—Section 254 (2).

HEPBURN SPA PROPRIETARY LIMITED.

AT a General Meeting of Members of Hepburn Spa Proprietary Limited duly convened and held on Tuesday, 24th June, 1969, the Special Resolution set out below was duly passed—

"That the company be wound up voluntarily."

It was resolved that for such purpose Warwick Niven Johanson, of National Bank Chambers, Pall Mall, Bendigo, be appointed liquidator. Notice is given that after 21 days from this date I shall proceed to distribute the assets and creditors having any claim against the company should furnish particulars to me by that date.

Dated this 24th day of June, 1969.

8861

W. N. JOHANSON, Liquidator.

Companies Act 1961.

SUN-MATES PTY. LTD.

NOTICE OF MEETING OF CREDITORS.

NOTICE is hereby given that, pursuant to section 260 (i) of the Companies Act 1961, a meeting of the creditors of Sun-Mates Pty. Ltd. will be held at the Institute of Chartered Accountants in Australia, 23 McKillop-street, Melbourne, on Friday, 11th day of July, 1969, at 11 o'clock.

The company having convened a meeting of its members for the same day, for the purpose of considering, and if thought fit, passing a Special Resolution:—

"That the company be wound up voluntarily."

Dated this 3rd day of July, 1969.

I. ROZEN, Director.

Cox, Johnston & Co., 446 Collins-street, Melbourne, 3000.

8971

Companies Act 1961.

M. DALLEY & COMPANY PROPRIETARY LIMITED.

MEMBERS VOLUNTARY WINDING UP.

AT an Extraordinary General Meeting of the members of M. Dalley & Company Proprietary Limited, duly convened and held at 206 Capel-street, North Melbourne, on the 27th day of June, 1969, the following Resolution was passed as a Special Resolution:—

"That the above company, M. Dalley & Company Proprietary Limited be wound up voluntarily under the provisions of the Companies Act 1961, applicable to a members' voluntary winding up and that John Morgan Hare, accountant, of 206 Capel-street, North Melbourne, be appointed liquidator."

Dated the 27th day of June, 1969.

8951

JOHN M. HARE, Liquidator.

ACME TYRE SERVICE (VIC.) PTY. LIMITED (IN
LIQUIDATION).

MEMBERS VOLUNTARY LIQUIDATION.

NOTICE is hereby given that at an Extraordinary General Meeting of the above-named company duly convened and held on the 24th day of June, 1969, the following Special Resolution was duly passed:—

"That the company be wound up voluntarily."

It was further resolved—

"That John Gordon Duff, of 13th level, 20 O'Connell-street, Sydney, be appointed liquidator for the purposes of such winding up."

Dated 24th June, 1969.

8941

J. L. KIPLING, Chairman.

ARMSTRONGS UNITED TYRE SERVICE PTY. LIMITED
(IN LIQUIDATION).

MEMBERS VOLUNTARY LIQUIDATION.

NOTICE is hereby given that at an Extraordinary General Meeting of the above-named company duly convened and held on the 24th day of June, 1969, the following Special Resolution was duly passed:—

"That the company be wound up voluntarily."

It was further resolved—

"That John Gordon Duff, of 13th level, 20 O'Connell-street, Sydney, be appointed liquidator for the purposes of such winding up."

Dated 24th June, 1969.

8942

J. L. KIPLING, Chairman.

UNITED TYRE SERVICE (VIC.) PTY. LIMITED (IN
LIQUIDATION).

MEMBERS VOLUNTARY LIQUIDATION.

NOTICE is hereby given that at an Extraordinary General Meeting of the above-named company duly convened and held on 28th May, 1969, the following Special Resolution was duly passed:—

"That the company be wound up voluntarily."

It was further resolved—

"That John Gordon Duff, of 13th level, 20 O'Connell-street, Sydney, be appointed liquidator for the purposes of such winding up."

Dated 28th May, 1969.

8943

J. L. KIPLING, Chairman.

The Companies Act 1961.—In the matter of INTERNATIONAL TRAVEL PROMOTIONS PTY. LTD.

NOTICE is hereby given that at a meeting of the members of International Travel Promotions Pty. Ltd., held at Melbourne, on 26th June, 1969, the following Resolution was passed as a Special Resolution:—

“That the company be placed in voluntary liquidation and that Messrs. Leslie Philip Smart and Vernon Keith Reynolds, of Marquand & Co., 51 Queen-street, Melbourne, be and are hereby appointed liquidators of the company to act jointly and severally.”

L. P. SMART, Liquidator.
V. K. REYNOLDS, Liquidator.

8970

Companies Act 1961.—In the matter of SYSTEMS AND INSTRUMENTS PROPRIETARY LIMITED (in Voluntary Liquidation Winding Up).

NOTICE is hereby given that, pursuant to section 272 of the above Act, the Final General Meeting of the members of the company for the purpose of receiving the liquidator's account, showing how the winding up has been conducted and how the property of the company has been disposed of will be held at the office of Grant & Co., 108 Queen-street, Melbourne, in the State of Victoria, on Wednesday, the 6th day of August, 1969, at 2.30 p.m.

Dated this 25th day of June, 1969.

E. H. NIEMANN, Liquidator.
Grant & Co., solicitors, 108 Queen-street, Melbourne.

8932

Unclaimed Moneys Act 1962.

REGISTER of Unclaimed Moneys held by the—

Name of Owner on Books and Last Known Address.	Total Amount Due to Owner.	Description of Unclaimed Moneys.	Date when Amount First Became Payable.
\$ c			
MAC. ROBERTSON (AUSTRALIA) LIMITED.			
Goldie, Caroline Mary, Heskitt-road, Woodend	13.00	Dividend	15.12.67
Beeton, Marlene Lillian, Flat 3, 6 Francis-grove, Fitzroy	11.36	Wages	13.3.67
Nettleton, Margaret Lorraine, 11 Margaret-grove, Alphington	12.44	”	3.4.67
Clark, Dorcen Mary, 441 Cardigan-street, Carlton	18.50	”
Horsfall, Ian Charles, 4 Palm-grove, Balwyn	33.57	”	29.1.68
8757			

Trustee Act 1958.

NOTICE TO CLAIMANTS.

PURSUANT to the Trustee Act 1958, creditors, next of kin and all other persons having claims in respect of the estate of any deceased person named below are required to send particulars to the legal personal representative or representatives at the addresses stated, after which date the representative or representatives will distribute the assets, having regard only to the claims of which notice has been received:—

Leslie James Mills, late of 10 Clive-street, West Footscray, retired gardener, deceased, died on the 27th day of April, 1969.—Claims to the executrix, Mabel Mills, of 10 Clive-street, West Footscray, widow, care of John F. Carroll, of 4 Paisley-street, Footscray, solicitor, by the 4th day of September, 1969. John F. Carroll, LL.B. solicitor, 4 Paisley-street, Footscray. 8949

JOHN WILLIAM POLLOCK, formerly of 8 Webster-street, Alexandra, chemist, but late of Alexandra, retired chemist, DECEASED.

CREDITORS, next of kin and others having claims against the estate of the deceased are required by the executors, The Trustees, Executors and Agency Company Limited, of 401 Collins-street, Melbourne, and Marie Jean Pollock, to send particulars of their claims to the said company on or before the 4th September, 1969, after which date the executors will distribute the assets, having regard only to the claims of which they then have notice.

HOME, WILKINSON & LOWRY, solicitors, of 401 Collins-street, Melbourne. 8924

ALL persons having claims against the estate of Lloyd Alfred Bowley, late of 11 Barnsbury-road, Balwyn, director, deceased (who died on the 6th November, 1968, and probate of whose will was granted by the Supreme Court of Victoria to The Equity Trustees, Executors and Agency Company Limited, on the 27th day of May, 1969), are hereby required to send particulars of such claims to The Equity Trustees, Executors and Agency Company Limited, at its registered office, at 472 Bourke-street, Melbourne, on or before the 2nd September, 1969, after which date the said company will proceed to transfer, convey or distribute the said estate to or among the persons entitled thereto, having regard only to the claims of which it shall then have had notice and will not be liable for the assets so transferred, conveyed or distributed to any persons of whose claim it shall not then have had notice.

ELLISON, HEWISON & WHITEHEAD, 379 Collins-street, Melbourne. 8923

KARLIS KRUMINS late of Warragul-road, Strzelecki, via Korumburra, Victoria, farmer, DECEASED.

ERIKA KRUMINS, of Warragul-road, Strzelecki, via Korumburra, Victoria, widow, the executrix of the will of the deceased (who died on the 1st day of November, 1968), requires all creditors, next of kin and others having claims against the property or estate of the said deceased, to send to her, care of the under-mentioned solicitors on or before the 1st day of September, 1969, particulars, in writing, of such claims, after which date the said executrix intends to convey or distribute such property or estate to or among the persons entitled thereto, having regard only to the claims of which she shall have had notice.

Dated this 25th day of June, 1969.

I. DIZGALVIS & CO., solicitors, 390 Lonsdale-street, Melbourne, 3000. 8907

HAROLD HOLTON, late of 33 Ferndale-road, Glen Iris, sworn valuer, DECEASED.

CREDITORS, next of kin and others having claims in respect of the estate of the above-named deceased (who died on the 22nd day of January, 1969), are required by The Perpetual Executors and Trustees Association of Australia Limited, of 100-104 Queen-street, Melbourne, to send particulars of their claims to the said company by the 3rd day of September, 1969, after which date it will convey or distribute the assets, having had regard only to the claims of which the company then has notice.

UPTON & ETTELSON, solicitors, 100 Queen-street, Melbourne. 8928

CREDITORS, next of kin and others having claims against the estate of Elsie Daisy Emma Stott, late of 148 Roslyn-road, Belmont, Geelong, in the State of Victoria, married woman, deceased (who died on the 17th day of March, 1969), are required by the executors, The Union-Fidelity Trustee Company of Australia Limited, of 100 Exhibition-street, Melbourne, in the said State, and Dorothy Joan Crompton, of 114 Clarence-street, Geelong West, in the said State, married woman, to send particulars to the executors' company, The Union-Fidelity Trustee Company of Australia Limited, at its Geelong office, at 8 Malop-street, Geelong, aforesaid, on or before 11th day of September, 1969, after which date the executors may convey or distribute, having regard only to the claims of which they then have notice.

PRICE, HIGGINS & FIDGE, solicitors, Douglas House, 47 Yarra-street, Geelong. 8875

CREDITORS, next of kin and others having claims in respect of the estate of William Joseph Draper, late of Glenburn, farmer, deceased (who died on the 7th day of January, 1969), are requested to send written particulars of their claims to the executors, care of the under-mentioned solicitor, by the 10th day of September, 1969, after which date the executors will distribute the assets, having regard only to the claims of which they then have notice.

O. H. M. JACKSON, solicitor, High-street, Yea. 8944

CREDITORS, next of kin and others having claims in respect of the estate of Edward Matthews, late of 273 Mitcham-road, Mitcham, retired, deceased (who died on the 28th day of November, 1968), are required to send particulars of their claims to the executor, Edward George Matthews, care of Oakley Thompson & Co., solicitors, of 626 Bourke-street, Melbourne, on or before the 9th day of September, 1969, after which date the said executor will proceed to distribute the assets, having regard only to the claims of which he then has notice.

OAKLEY THOMPSON & CO., solicitors, 626 Bourke-street, Melbourne. 8945

MADGE FRANCES GUNNER, late of 317 Auburn-road, Hawthorn.

CREDITORS, next of kin and others having claims in respect of the estate of the deceased (who died on the 18th day of January, 1969), are required by The Perpetual Executors and Trustees Association of Australia Limited, of 100-104 Queen-street, Melbourne, to send particulars of their claims to the said company, by the 9th day of September, 1969, after which date it will convey or distribute the assets, having had regard only to the claims of which the company then has notice.

OAKLEY THOMPSON & CO., solicitors, 626 Bourke-street, Melbourne. 8946

CREDITORS, next of kin and others having claims in respect of the estate of Sidney George Risby (also known as Sydney George Risby), formerly of 60 Leopold-street, South Yarra, but late of 19 Barkly-street, Burwood, systems department manager, deceased (who died on the 29th day of May, 1969), are required to send particulars of their claims to the executrix, Violet Risby, care of Oakley Thompson & Co., solicitors, of 626 Bourke-street, Melbourne, on or before the 9th day of September, 1969, after which date the said executrix will proceed to distribute the assets, having regard only to the claims of which she then has notice.

OAKLEY THOMPSON & CO., solicitors, 626 Bourke-street, Melbourne. 8947

CREDITORS, next of kin and others having claims in respect of the estate of Alice Jane Thomas, late of 2c Cunningham-street, Northcote, gentlewoman, deceased (who died on the 6th day of March, 1969), are required to send particulars of their claims to the executor, Harold Alfred Thomas, care of Oakley Thompson & Co., solicitors, of 626 Bourke-street, Melbourne, on or before the 9th day of September, 1969, after which date the said executor will proceed to distribute the assets, having regard only to the claims of which he then has notice.

OAKLEY THOMPSON & CO., solicitors, 626 Bourke-street, Melbourne. 8948

CREDITORS, next of kin and others having claims in respect of the estate of Thomas James Knox, late of 26 Pleasant Rise, Croydon, in the State of Victoria, retired printer, deceased (who died on the 5th day of March, 1969), are required to send particulars of their claims to The Union-Fidelity Trustee Company of Australia Limited, of 100 Exhibition-street, Melbourne, by the 9th day of September, 1969, after which date the said company will distribute the assets, having regard only to the claims of which it then has notice.

GILLOTT, MOIR & WINNEKE, solicitors, 95 Queen-street, Melbourne. 8962

CREDITORS, next of kin and others having claims in respect of the estate of Isabella Margaret Trezise, late of 29 Churchill-avenue, Cheltenham, spinster, deceased (who died on the 14th day of January, 1969), are requested to send particulars of their claims to the executors, Hubert O'Brien and Nellie Evelyn Robertson, care of the under-mentioned solicitors, by the 11th day of September, 1969, after which date they will distribute the assets, having regard only to the claims of which they then have notice.

MAHONY O'BRIEN & DUGGAN, solicitors, 37 Queen-street, Melbourne. 8963

MAY ROSE VOLART, late of 15 Dight-street, Collingwood, widow, DECEASED, intestate.

CREDITORS, next of kin and others having claims in respect of the estate of the above-named deceased (who died on the 7th day of November, 1968), are required to send particulars of their claims to the administratrix of the estate of the said deceased, Mrs. Martha Rebecca Mahood, in care of J. T. Ryan, solicitor, 28 Adeney-avenue, Kew, by the 24th day of September, 1969, after which date the said administratrix will distribute the assets of the said deceased, having regard only to the claims of which she has then had notice. 8887

ELSIE ISABEL BARING, late of 6 Fletcher-court, Mount Waverley, in the State of Victoria, widow, DECEASED.

CREDITORS, next of kin and others having claims in respect of the estate of the deceased (who died on the 9th day of March, 1969), are required by the trustee Joseph Harold D'Amer Drew, of 354 Park-street, South Melbourne, in the said State, to send particulars to him by the 2nd day of September, 1969, after which date the trustee may convey or distribute the assets, having regard only to the claims of which he then has notice.

Dated this 27th day of June, 1969.

EGGLESTON, CLIFTON-JONES & CO., solicitors, 578 Bourke-street, Melbourne. 8890

GILBERT MARK CRAFT, late of Modewarre, farmer, DECEASED.

CREDITORS, next of kin and others having claims in respect of the estate of the deceased (who died on 12th day of December, 1968), are required by the personal representative, Norma Sarah Agnes Royce, of York-street, Camperdown, widow, to send particulars to her, care of the under-mentioned solicitors, by the 10th day of September, 1969, after which date the personal representative may convey or distribute the assets, having regard only to the claims of which she then has notice.

WHYTE, JUST & MOORE, solicitors, 27 Malop-street, Geelong. 8892

ABRAHAM ROSENBERG, formerly of 31 Chrystobel-crescent, Hawthorn, but late of 33 Chrystobel-crescent, Hawthorn, in the State of Victoria, retired shop proprietor, DECEASED.

CREDITORS, next of kin and others having claims in respect of the estate of the deceased (who died on the 16th January, 1969), are required by the applicants for grant of probate of the will of the deceased, Margaret Sheldon, of 3 Riverside-drive, East Kew, and Judith Anne Mitchell, of 33 Chrystobel-crescent, Hawthorn, both married women, to send particulars to them, care of the undersigned solicitors, by the 10th September, 1969, after which date they may convey or distribute the assets, having regard only to the claims of which they then have notice.

Dated the 27th June, 1969.

LEWIS ORR & GIBSON, solicitors, 825 Burke-road, Camberwell. 8903

CREDITORS, next of kin and others having claims in respect of the estate of James Norman Howell, late of 33 Denman-avenue, Glen Iris, in the State of Victoria, retired, deceased (who died on the 31st day of March, 1969), are required by the executors, The Union-Fidelity Trustee Company of Australia Limited, of 100 Exhibition-street, Melbourne, and Shirley Ellen Fowler, of 33 Denman-avenue, Glen Iris, married woman, to send particulars of their claims to them, care of the said company, by the 16th day of September, 1969, after which date the said executors will distribute the assets of the deceased, having regard only to the claims of which they then shall have had notice.

STRONGMAN & CROUCH, solicitors, of 118 Queen-street, Melbourne. 8950

CREDITORS, next of kin and others having claims in respect of the estate of Joan Douglas Calvert, late of "Kornong", Streatham, in Victoria, widow, deceased (who died on the 24th day of January, 1969), are required by the executor, Alan Murray Calvert, of "Kornong", Streatham, grazier, to send particulars of their claims to him, care of the under-mentioned solicitors, by the 3rd day of September, 1969, after which date the executor may convey and distribute the assets, having regard only to the claims of which he then has notice.

AITKEN, WALKER & STRACHAN, 414 Collins-street, Melbourne, solicitors to the executor. 8952

CREDITORS, next of kin and others having claims in respect of the estate of Julia Louisa O'Shaughnessy, formerly of 683 High-street, East Prahran, but late of Nazareth House, Cornell-street, East Camberwell, spinster, deceased (who died on the 1st day of May, 1969), are required to send particulars of their claims to the executors, the National Trustees, Executors and Agency Company of Australasia Limited, of 95 Queen-street, Melbourne, by the 11th day of September, 1969, after which date the company will distribute the assets, having regard only to the claims of which it then has notice.

MAHONY O'BRIEN & DUGGAN, solicitors, 37 Queen-street, Melbourne. 8965

CREDITORS, next of kin and others having claims against the estate of Una Dulcie Lowthian, late of the William Angliss Hospital, Ferntree Gully, in the State of Victoria, nursing sister, deceased (who died on the 20th day of April, 1969), are required to send particulars of their claims to the executor, Maxwell John Lowthian, of 27 Barnes-avenue, Burwood, in the said State, before the 9th day of September, 1969, after which date the said executor will distribute the estate of the said deceased, having regard only to the claims of which he then has notice.

8961

CREDITORS, next of kin and others having claims against the estate of Joan Gertrude Mack, late of 46 Adams-street, South Yarra, in the State of Victoria, spinster, deceased (who died on the 10th day of March, 1969), are required to send particulars of their claims to the executor, John Herbert Mack, of 4 Devon-court, Mount Waverley, in the said State, before the 18th day of September, 1969, after which date the said executor will distribute the estate of the said deceased, having regard only to the claims of which he then has notice.

8960

ERICH ARTHUR EMIL VOGEL, late of Clarkson-road, Kallista, in the State of Victoria, retired manufacturer, DECEASED.

CREDITORS, next of kin and others having claims in respect of the estate of the deceased (who died on the 8th day of December, 1967), are required by the executors, Gunter Karl Friedrich Vogel, of Viewbank-road, Oakleigh, shopkeeper, and Gerhard Erich Wilhelm Vogel, of Flat 24, 3 Brickfield-street, Glen Iris, manufacturer, to send particulars to them, care of the under-signed solicitors, by the 8th September, 1969, after which date they may convey or distribute the assets, having regard only to the claims of which they then have notice.

Dated the 24th June, 1969.

LEWIS ORR & GIBSON, 825 Burke-road, Camberwell. 8904

CREDITORS, next of kin and others having claims against the estate of Herbert Augustus Noltey, late of 7 Centre-road, East Brighton, in the State of Victoria, gentleman, deceased (who died on the 28th day of April, 1969), are to send particulars of their claims to The Equity Trustees, Executors and Agency Company Limited, of 472 Bourke-street, Melbourne, by the 18th day of September, 1969, after which date it will distribute the assets, having regard only to the claims of which it then has notice.

G. A. BURCHILL, solicitor, 34 Queen-street, Melbourne. 8909

WINIFRED CROW, late of 9 The Esplanade, Geelong West, widow, DECEASED (who died on the 1st day of July, 1968).

ALL persons having claims against the estate of the said deceased are required by the executor, The Union-Fidelity Trustee Company of Australia Limited, of 100 Exhibition-street, Melbourne, to send particulars to it by the 3rd day of September, 1969, after which date it may convey or distribute the assets, having regard only to the claims of which it then has notice.

ANDREWS & BACKHOUSE, solicitors, 76 Ryrie-street, Geelong. 8864

JOHN WALTER EVERARD JEFFERY, formerly of Tower-road, Werribee, in the State of Victoria, but late of 16 High-street, Werribee in the said State, retired, deceased, after fourteen clear days Thelma Jeffery, of 16 High-street, Werribee, in the said State, the executrix appointed by the will of the above-named deceased, dated the 21st August, 1950, will apply to the Supreme Court of Victoria for a grant of probate of the said will.

GERALD E. DELANY & CO., solicitors, of 452 Lonsdale-street, Melbourne. 8908

ALLAN LOUIS WHITING, late of 1022 Gregory-street, Ballarat, railway employee, DECEASED, intestate.

CREDITORS, next of kin and others having claims in respect of the estate of the deceased (who died on the 13th day of September, 1968), are required by the administratrix, Annie Winifred Ross, of 618 Peel-street, Ballarat, married woman, to send particulars to her, care of the under-signed solicitors, by the 15th day of August, 1969, after which date the administratrix may convey or distribute the assets, having regard only to the claims of which she then has notice.

D. & A. ARONSON, solicitors, 104 Lydiard-street South, Ballarat. 8873

CREDITORS, next of kin and others having claims in respect of the estate of Edith Mary Mitchell, formerly of 23 Grace-street, Mont Albert, but late of 44 Galeka-street, Merlynston, widow, deceased (who died on the 1st day of March, 1969), are required to send particulars of their claims to The Equity Trustees, Executors and Agency Company Limited, of 472 Bourke-street, Melbourne, by the 3rd day of September, 1969, after which date it will distribute the assets, having regard only to the claims of which it then has notice.

STRUGNELL & STRUGNELL, solicitors, 106 Bell-street, Coburg. 8870

CREDITORS, next of kin and others having claims in respect of the estate of Stella Elizabeth Page, late of 12 Mary-street, Hawthorn, married woman, deceased (who died on the 16th day of April, 1969), are required by the executor, John McDonald Page, to send the particulars of their claims to him, care of Middletons, solicitors, 224 Queen-street, Melbourne, by the 2nd day of September, 1969, after which date the executor will distribute the assets, having regard only to the claims of which he then has notice.

MIDDLETONS, solicitors, 224 Queen-street, Melbourne. 8911

CREDITORS, next of kin and others having claims in respect of the estate of Keith Keneley Moore, late of 2 Jersey-parade, Carnegie, in the State of Victoria, pensioner, deceased (who died on 28th January, 1969), are to send the particulars of their claims to the administrator, The Union-Fidelity Trustee Company of Australia Limited, of 100 Exhibition-street, Melbourne, by the 3rd September, 1969, after which date it will distribute the assets, having regard only to the claims of which it then has notice.

Dated the 26th June, 1969.

COLIN KEON-COHEN, solicitors, 472 Bourke-street, Melbourne. 8912

CREDITORS, next of kin and others having claims in respect of the estate of Ethel May Francis Hogan, late of 63 Donald-street, Brunswick, in the State of Victoria, widow, deceased (who died on the 24th day of March, 1969), are required to send particulars of their claims to the executrix, Mary Felicitas Dwyer, care of the under-mentioned solicitors by the 16th day of September, 1969, after which date she will distribute the assets, having regard only as to the claims of which she then has notice.

HEFFEY & BUTLER, solicitors, 358 Lonsdale-street, Melbourne. 8914

CREDITORS, next of kin and others having claims in respect of the estate of Graeme Stobie, late of Flat 1, 405 Toorak-road, Toorak, chartered accountant, deceased (who died on the 26th day of March, 1969), are required by the executrix, Eves Irene Stobie, of Flat 1, 405 Toorak-road, Toorak, aforesaid, widow, to send particulars of their claims to her in care of the under-mentioned solicitors by the 4th day of September, 1969, after which date she will distribute the assets, having regard only to the claims of which she then has notice.

McCAY & THWAITES, solicitors, 374 Little Collins-street, Melbourne. 8917

CREDITORS, next of kin and others having claims in respect of the estate of Norman Foster, late of 6 Illawarra-street, Williamstown, gentleman, deceased (who died on the 28th day of June, 1967), are required to send particulars of their claims to the executors, Nancy Katherine Cambrey and Jean Bastian, both care of the under-mentioned solicitors, by the 15th day of September, 1969, after which date they will distribute the assets, having regard only to the claims of which they then have notice.

J. A. REDMOND & CO., solicitors, of 358 Collins-street, Melbourne, Victoria. 8918

CREDITORS, next of kin and others having claims in respect of the estate of Charles Frederick Vardy, late of 20 Doonkuna-avenue, Camberwell, retired electrician, deceased, intestate (who died on the 24th April, 1968), are to send particulars of their claims to The Equity Trustees, Executors and Agency Company Limited, of 472 Bourke-street, Melbourne, by the 8th September, 1969, after which date it will distribute the assets, having regard only to the claims of which it then has notice.

MOULE, HAMILTON & DERHAM, solicitors, 224 Queen-street, Melbourne. 8921

HAROLD IRVING JONES, late of 253 Pasir Panjang-road, Singapore, gentleman, DECEASED.

CREDITORS, next of kin and others having claims in respect of the estate of the deceased (who died on the 14th day of March, 1968), are required by The Perpetual Executors and Trustees Association of Australia Limited, of 100-104 Queen-street, Melbourne, to send particulars of their claims to the said company by the 5th day of September, 1969, after which date it will convey or distribute the assets, having regard only to the claims of which the company then has notice.

COOK & McCALLUM, solicitors, 422 Collins-street, Melbourne. 8922

GIUSEPPE BELLOFIORE, late of Swan Hill, in the State of Victoria, orchardist, DECEASED.

CREDITORS, next of kin and other persons having claims against the estate of the said deceased (who died on the 1st day of March, 1969), are required to send particulars of same to the executrix, Sebastiana Bellofiore, in care of the undersigned on or before the 1st day of September, 1969, after which date they will distribute the assets, having regard only to the claims of which they then have notice.

DELANY & DWYER, barristers and solicitors, 201 Campbell-street, Swan Hill. 8910

NOEL VINCENT KNIGHT, late of 306 The Avenue, Parkville, company representative, DECEASED (who died on 24th day of February, 1969).

CREDITORS, next of kin and all other persons having claims against the estate of the deceased, are required by the executrix of his will, Noreen Denise Knight, of 306 The Avenue, Parkville, to send particulars thereof to her, care of the under-mentioned solicitors before the 10th day of September, 1969, after which date she may distribute the assets of the deceased, having regard only to the claims of which she then has notice.

COLTMAN, WYATT & ANDERSON, solicitors, of 578 Bourke-street, Melbourne. 8913

CREDITORS, next of kin and others having claims in respect of the estate of Harold George Hicks, late of 18 Woods-street, Ascot Vale, retired launch proprietor (who died on the 21st day of January, 1969), are to send particulars of their claims to the executors, Bertram Daniel Hicks and Mary Elizabeth Hicks, care of the under-mentioned by the 9th day of September, 1969, after which date they shall commence to distribute the assets, having regard only to the claims of which they then have notice.

RENNICK & GAYNOR, solicitors, 473 Bourke-street, Melbourne. 8920

FLORENCE CLUCAS, late of 28 Victoria-road, Camberwell, in the State of Victoria, widow, DECEASED.

CREDITORS, next of kin and others having claims in respect of the estate of the above-named deceased (who died on the 31st July, 1968), are required by the executrix, Olive Henrietta Stillwell, to send particulars to her, care of the under-mentioned solicitor by the 4th September, 1969, after which date the executrix may convey or distribute the assets, having regard only to the claims of which she then has had notice.

K. P. REES, B.A., LL.B., solicitor, 89 Queen-street, Melbourne, 3000. 8927

CREDITORS, next of kin and others having claims in respect of the estate of Raymond John Perry, late of 21 Hargreaves-crescent, Braybrook, in the State of Victoria, bank officer, deceased, intestate (who died on the 19th day of April, 1969), are required to send particulars of their claims to the administrator, John William Perry, care of the under-mentioned solicitors, by the 3rd day of September, 1969, after which date the administrator will distribute the assets, having regard only for the claims of which he then has had notice.

J. McDONALD SMITH & CO., solicitors, of 59-61 Irving-street, Footscray. 8919

PERCY DANIEL CLUCAS, late of 18 Derby-street, East Camberwell, in the State of Victoria, retired gentleman, DECEASED.

CREDITORS, next of kin and others having claims in respect of the estate of the above-named deceased (who died on the 30th July, 1968), are required by the executrix to send particulars, care of The Equity Trustees, Executors and Agency Company Limited, of 472 Bourke-street, Melbourne, by the 4th September, 1969, after which date conveyance or distribution of the assets may take place, having regard to the claims of which the said company then has had notice.

K. P. REES, B.A., LL.B., solicitor, 89 Queen-street, Melbourne, 3000. 8926

SUSAN ALICE CLEMENTS, formerly of 316 Whitehorse-road, Nunawading, in the State of Victoria, but late of Alexander Homes, Castlemaine, in the said State, widow, DECEASED.

CREDITORS, next of kin and others having claims in respect of the estate of the above-named deceased (who died on the 1st January, 1969), are required by the executor, Kingsley Percival Rees, to send particulars to him, care of the under-mentioned address by the 4th September, 1969, after which date the executor may convey or distribute the assets, having regard only to the claims of which he then has had notice.

K. P. REES, B.A., LL.B., solicitor, 89 Queen-street, Melbourne, 3000. 8925

In the Supreme Court of the State of Victoria.

SALE BY THE SHERIFF.

ON Monday, the 11th day of August, 1969, at 10 a.m., at the Police Station, Mitcham (unless process be stayed or satisfied):—

All the estate and interest (if any) of John Francis Owen, of 5 Mountfield-road, Mitcham, as joint proprietor with Edna Florence Owen, of an estate in fee-simple in the land described in certificate of title, volume 8049, folio 650, upon which is erected a brick veneer dwelling-house known as No. 5 Mountfield-road, Mitcham.

Registered mortgages Nos. C.17249, C.214806 and C.404181 affect the said estate and interest.

Terms: Cash only.

N. FROGLEY, Sheriff's Officer.

30th June, 1969.

8900

In the Supreme Court of the State of Victoria.

SALE BY THE SHERIFF.

ON Tuesday, the 12th of August, 1969, at 12.30 p.m. at the Police Station, Bayswater (unless process be stayed or satisfied):—

All the estate and interest (if any) of J. P. Gage, of 15 Buchanan-street, Boronia, engineer, and H. M. Gage, of 16 Robertson-crescent, Bayswater, married woman, as joint proprietors of an estate in fee-simple in the land described in certificate of title, volume 8361, folio 976, upon which is erected a dwelling-house known as No. 16 Robertson-crescent, Bayswater.

Registered mortgage No. C.573607 and caveat No. D.322895 affect the said estate and interest.

Terms: Cash only.

DAVID J. JOHNSTON, Sheriff's Officer.

30th June, 1969.

8901

In the Supreme Court of the State of Victoria.

SALE BY THE SHERIFF.

ON Tuesday, the 12th of August, 1969, at 10 a.m., at the Police Station, Northcote (unless process be stayed or satisfied):—

All the estate and interest (if any) of Thomas Wilson, of 4 Creek-parade, Northcote, brass moulder, as proprietor of an estate in fee-simple in the land described in certificate of title, volume 3544, folio 625, upon which is erected a weatherboard dwelling-house known as No. 4 Creek-parade, Northcote.

Terms: Cash only.

DAVID J. JOHNSTON, Sheriff's Officer.

30th June, 1969.

8902

IMPOUNDINGS

COLAC.—Impounded in Colac Shire Pound, Elliminyt.
 1 black and white steer, no visible brand or no ear mark
 If not claimed and expenses paid, to be sold on 10th July, 1969.
 8975—\$1.50 G. J. DUNN, Poundkeeper.

COLERAINE.—Impounded in Coleraine Pound, by Kevin Shaw, from his settlement paddock.
 No. 9. Corriedale wether, weener, front notch both ears, no visible brand
 If not claimed and expenses paid, to be sold on 12th July, 1969.
 8848—\$2.00 GEO. SPRONG, Poundkeeper.

DRYSDALE.—Impounded in Drysdale Pound.
 2 half-grown red and white Hereford steers, no visible brand
 If not claimed and expenses paid, to be sold on 17th July, 1969.
 8879—\$1.75 G. NORMAN, Poundkeeper.

KEILOR.—Impounded in Keilor City Pound.
 1 grey pony gelding, shod, no visible brand
 If not claimed and expenses paid, to be sold on 17th July, 1969.
 8959—\$1.50 C. M. MISSEN, Poundkeeper.

RUSHWORTH.—Impounded in Rushworth Pound, by Mr. R. H. Barlow, on 19th June, 1969.
 4 woolly lambs, one with long tail and horns, no visible brands
 If not claimed and expenses paid, to be sold on 17th July, 1969.
 8850—\$2.00 G. R. ROBERTS, Poundkeeper.

SHEPPARTON.—Impounded in Shepparton Pound.
 1 small Jersey bull calf, no visible brand
 If not claimed and expenses paid, to be sold on 17th July, 1969.
 8958—\$1.50 C. L. MANSELL, Poundkeeper.

SWAN HILL.—Impounded in Swan Hill Pound on Friday, 20th June, 1969, at 4 p.m.
 1 red and white Hereford bull
 If not claimed and expenses paid, to be sold on 14th July, 1969.
 8888—\$1.75 F. G. BLAIR, Poundkeeper.

TATURA.—Impounded in Tatura Pound.
 1 wether lamb, no visible brand
 If not claimed and expenses paid, to be sold on 24th July, 1969.
 8954—\$1.50 J. H. MACTIER, Poundkeeper.

WINCHELSEA.—Impounded in Winchelsea Pound, by Country Roads Board Inspector, Mr. Arthur E. Wilson.
 3 sheep, no visible brand
 Impounded 28th June, 1969.
 1 2-tooth ewe, long tail, no visible brand
 1 ewe, orange coloured tag left ear, no visible brand
 Impounded 29th June, 1969.
 1 2-tooth ewe, long tail, no visible brand
 If not claimed and expenses paid, to be sold on 21st July, 1969.
 8955—\$3.25 W. HOLE, Poundkeeper.

WINCHELSEA.—Impounded in Winchelsea Pound by Shire Ranger, Mr. C. E. Mawson.
 6 horned rams, long tails, no visible brand
 1 Polwarth ram, long tail, no visible brand
 2 full mouth ewes, no visible brand
 1 aged ewe, 2 notches right ear, punch hole left ear, no visible brand
 1 ram lamb, no visible brand
 If not claimed and expenses paid, to be sold on 21st July, 1969.
 8883—\$3.00 W. HOLE, Poundkeeper.

Subordinate Legislation Act 1962.

NOTICE OF MAKING OF STATUTORY RULES.

IN pursuance of the provisions of the *Subordinate Legislation Act 1962* and the Regulations made thereunder, notice is given of the making of the following statutory rules:—

No.	Fisheries Act 1968.	Price.
120/1969.	Fisheries (Spear Fishing Boundaries) Regulations 1969	10c
	<i>Road Traffic Act 1958.</i>	
121/1969.	Road Traffic (Infringements Amendment) Regulations 1969	10c
	<i>Apprenticeship Act 1958.</i>	
122/1969.	Apprenticeship (Butchering Trades) (Amendment) Regulations 1969	10c
	<i>Valuation of Land Act 1960.</i>	
123/1969.	Valuation of Land (Fees for Valuations) Regulations 1969	10c

Copies of these statutory rules may be purchased at the Sale of Publications Section of the Government Printing Office, located at Macarthur-street, Melbourne, 3002. If ordered by mail, remittance should be addressed to "The Government Printer, Box 203, P.O., North Melbourne, 3051", and should include 5c extra for postage. If a credit account is held at this office, no remittance is required with the mail order.

The annual subscription rate for Statutory Rules (including a Bound Volume) is \$15, payable in advance. The subscription year commences on 1st January.

A. C. BROOKS,
 Government Printer.

CONTENTS

	PAGE
Appointments	1978
Contracts	1977
Estates of Deceased Persons	1977
Government Notices	1963
Impoundings	2012
Lands	1986
Melbourne and Metropolitan Board of Works— Notice	1976
Money Lenders Act 1958—Supplementary List	1970
Notice to Attend for Radiological Examination	1969
Notices to Mariners	1973
Notice of Making of Statutory Rules	2012
Orders in Council— Acts—Forests; Road Traffic; Country Roads; Local Government; Melbourne and Metropolitan Board of Works; Land; Labour and Industry; Water; Dandenong Valley Authority; Sewerage Districts.	1979 et seq
Police Sale	1968
Private Advertisements	1998
Proclamations	1961
Public Notice	1968
Public Service Notices	1992
Resignations	1979
State Rivers and Water Supply Commission	1972
Tenders	1995
Transport Regulation Board—Public Hearings	1964
Waterworks Trusts	1967