



VICTORIA  
GOVERNMENT GAZETTE

Published by Authority

No. 93]

WEDNESDAY, SEPTEMBER 26

[1973

PROCLAMATIONS

*Vegetation and Vine Diseases Act 1958.*  
REVOKING PROCLAMATION DECLARING PROCLAIMED  
AREAS FOR THE CONTROL OF FRUIT FLY.

PROCLAMATION

By the Lieutenant-Governor as Deputy for His Excellency the Governor of the State of Victoria and its Dependencies in the Commonwealth of Australia, &c., &c., &c.

Whereas by the *Vegetation and Vine Diseases Act 1958* it is amongst other things enacted that any proclamation made under section 25 of the said Act may be amended or revoked by a subsequent proclamation: Now therefore, I, the Lieutenant-Governor as Deputy for the Governor of the State of Victoria, in the Commonwealth of Australia, by and with the advice of the Executive Council thereof, do by this my Proclamation hereby revoke:—

The proclamation made under the said section on the twenty-seventh day of April, 1971 and amended on the eleventh day of May, 1971 declaring that portion of Victoria within the Parish of Yarrowonga in the County of Moira to be a proclaimed area.

Given under my Hand and the Seal of the State of Victoria aforesaid, at Melbourne, this twenty-fifth day of September, in the year of our Lord One thousand nine hundred and seventy-three, and in the twenty-second year of the reign of Her Majesty Queen Elizabeth II.

(L.S.) H. A. WINNEKE.

By His Excellency's Command,  
IAN SMITH,  
Minister of Agriculture.

GOD SAVE THE QUEEN!

*Vegetation and Vine Diseases Act 1958.*  
REVOKING PROCLAMATION DECLARING PROCLAIMED  
AREAS FOR THE CONTROL OF FRUIT FLY.

PROCLAMATION

By the Lieutenant-Governor as Deputy for His Excellency the Governor of the State of Victoria and its Dependencies in the Commonwealth of Australia, &c., &c., &c.

Whereas by the *Vegetation and Vine Diseases Act 1958* it is amongst other things enacted that any proclamation made under section 25 of the said Act may be amended or revoked by a subsequent proclamation: Now therefore,

No. 93.—8910/73.—PRICE 30 cents; Half-Yearly \$11.25; Yearly \$22.50.

I, the Lieutenant-Governor as Deputy for the Governor of the State of Victoria, in the Commonwealth of Australia, by and with the advice of the Executive Council thereof, do by this my Proclamation hereby revoke:—

The proclamation made under the said section on the sixth day of April, 1971 declaring that portion of Victoria within the Parish of Carlyle in the County of Bogong to be a proclaimed area.

Given under my Hand and the Seal of the State of Victoria aforesaid, at Melbourne, this twenty-fifth day of September, in the year of our Lord One thousand nine hundred and seventy-three, and in the twenty-second year of the reign of Her Majesty Queen Elizabeth II.

(L.S.) H. A. WINNEKE.

By His Excellency's Command,  
IAN SMITH,  
Minister of Agriculture.

GOD SAVE THE QUEEN!

*Weights and Measures Act 1958.*  
ALTERATION OF CONSTITUTION OF A UNION.

PROCLAMATION

By His Excellency the Governor of the State of Victoria and its Dependencies in the Commonwealth of Australia, &c., &c., &c.

Whereas by the *Weights and Measures Act 1958*, it is amongst other things enacted that the Governor in Council may at the request by municipalities constituting a Union alter or revoke any such proclamation declaring such municipalities to be a Union for the purposes of the aforesaid Act:

And whereas the Cities of Echuca and Shepparton, the Borough of Kyabram and the Shires of Cohuna, Deakin, Goulburn, Nathalia, Numurkah, Rochester, Rodney, Rutherglen, Shepparton, Waranga and Yarrowonga do constitute a Union for the purposes of the *Weights and Measures Act 1958*, under the name of "Goulburn Region Weights and Measures Union":

And whereas the Council of each of the said municipalities has requested that the Shires of Rutherglen and Yarrowonga shall cease to be included in the aforesaid Union:

Now therefore I, the Governor of the State of Victoria in the Commonwealth of Australia, by and with the advice of the Executive Council of the said State and in pursuance

of the powers conferred by the *Weights and Measures Act 1958*, do by this proclamation alter the proclamation under which the Goulburn Region Weights and Measures Union is constituted on and from the first day of October, 1973, and declare that on and from such date—

- (a) the Cities of Echuca and Shepparton, the Borough of Kyabram and the Shires of Cohuna, Deakin, Goulburn, Nathalia, Numurkah, Rochester, Rodney, Shepparton and Waranga shall constitute a Union under the name of "Goulburn Region Weights and Measures Union"; and
- (b) the apportionment of the expenses devolving on the said Union under the *Weights and Measures Act* shall be fixed as follows:—

(1) The amount to be contributed by each municipality of the Union as re-constituted in accordance with this proclamation shall bear the same proportion to the expenses devolving upon the Union as the number of persons residing in each such municipality bears to the total number of persons residing in all the municipalities of the Union.

(2) For the purposes of computing the amounts to be contributed by any municipality pursuant to Clause (1) hereof during any period of twelve months beginning on the first day of October in any year, the population of each such municipality shall be deemed to be the estimated population as disclosed by the latest previous statement of such population by the Commonwealth Bureau of Census and Statistics contained in—

- (i) a declaration or publication of the result of the periodical census showing the population of each such municipality; or
- (ii) a declaration or publication, in relation to Victoria, entitled "Estimated Population and Dwellings by Local Government Areas".

Given under my Hand and the Seal of the State of Victoria aforesaid, at Melbourne, this eighteenth day of September, in the year of our Lord One thousand nine hundred and seventy-three, and in the twenty-second year of the reign of Her Majesty Queen Elizabeth II.

(L.S.) ROHAN DELACOMBE.

By His Excellency's Command,  
A. J. HUNT,  
Minister for Local Government.  
GOD SAVE THE QUEEN!

*Stock Foods Act 1958.*

ALTERING THE CHEMICAL STANDARDS OF  
BRAN AND POLLARD.

PROCLAMATION

By the Lieutenant-Governor as Deputy for His Excellency the Governor of the State of Victoria and its Dependencies in the Commonwealth of Australia, &c., &c., &c.

Whereas by sub-section (3) of Section 16 of the *Stock Foods Act 1958* it is amongst other things provided that the Chief Chemist of the Department of Agriculture shall in every year conduct chemical, physical and milling tests upon a portion of the official fair average quality wheat sample fixed for that year and that if necessary the Second Schedule to the *Stock Foods Act 1958* shall by Proclamation of the Governor in Council published in the *Government Gazette* be amended by altering any standard provided for therein in accordance with the results of those tests; and whereas as a consequence of the chemical, physical and milling tests conducted by such Chief Chemist upon a portion of the official fair average quality wheat sample fixed for the year 1972-73 it is necessary to amend the said Schedule by altering the chemical standards provided for therein to accord with the results of those tests:

Now therefore, I, the Lieutenant-Governor as Deputy for the Governor of the State of Victoria by and with the advice of the Executive Council thereof, do by this my Proclamation amend the said Schedule as follows:—

- (1) For the expression "14.0 per cent." which, by virtue of the Proclamation of the second day of May, 1967, published in the *Government Gazette*

No. 40 of the tenth day of May, 1967, appears in the first line of the sentence opposite the words "Chemical Standard" under the heading "Bran" there shall be substituted the expression "15.0 per cent."

(2) For the expression "14.0 per cent." which, by virtue of the Proclamation of the second day of May, 1967, published in the *Government Gazette* No. 40 of the tenth day of May, 1967 appears in the first line of the sentence opposite the words "Chemical Standard" under the heading "Pollard" there shall be substituted the expression "15.0 per cent."

Given under my Hand and the Seal of the State of Victoria aforesaid, at Melbourne, this twenty-fifth day of September, in the year of our Lord One thousand nine hundred and seventy-three, and in the twenty-second year of the reign of Her Majesty Queen Elizabeth II.

(L.S.) H. A. WINNEKE.

By His Excellency's Command,  
IAN SMITH,  
Minister of Agriculture.

GOD SAVE THE QUEEN!

*Weights and Measures Act 1958.*

PROCLAMATION OF OVENS AND MURRAY WEIGHTS  
AND MEASURES UNION.

PROCLAMATION

By His Excellency the Governor of the State of Victoria and its Dependencies in the Commonwealth of Australia, &c., &c., &c.

Whereas by the *Weights and Measures Act 1958*, it is amongst other things enacted that the Governor in Council may at the request of two or more municipalities declare such municipalities to be a Union for the purposes of the said Act:

Now therefore I, the Governor of the State of Victoria, in the Commonwealth of Australia, by and with the advice of the Executive Council of the said State, in pursuance of the powers conferred by the *Weights and Measures Act 1958*, and at the request of the Councils of the Shires of Oxley, Rutherglen, Wangaratta and Yarrawonga, do by this my proclamation declare the Shires of Oxley, Rutherglen, Wangaratta and Yarrawonga to be a Union for the purposes of the said Act under the title of "Ovens and Murray Weights and Measures Union" and do further declare that the apportionment among such municipalities of the expenses devolving on such Union under the said Act shall be as follows:—

1. Any expenditure which is capital expenditure within the meaning of Clause 3 hereunder shall be apportioned as follows:—

Shire of Oxley .. .. .	25 per centum
Shire of Rutherglen .. .. .	25 per centum
Shire of Wangaratta .. .. .	25 per centum
Shire of Yarrawonga .. .. .	25 per centum

2. Any expenditure which is not capital expenditure within the meaning of Clause 3 hereunder shall be apportioned as follows:—

Shire of Oxley .. .. .	20 per centum
Shire of Rutherglen .. .. .	25 per centum
Shire of Wangaratta .. .. .	10 per centum
Shire of Yarrawonga .. .. .	45 per centum

3. Any expenditure on the purchase of inspectors' standards or apparatus or accessories used in carrying out the provisions of the aforesaid Act shall be capital expenditure for the purposes of Clauses 1 and 2 hereof.

Given under my Hand and the Seal of the State of Victoria aforesaid, at Melbourne, this eighteenth day of September, in the year of our Lord One thousand nine hundred and seventy-three, and in the twenty-second year of the reign of Her Majesty Queen Elizabeth II.

(L.S.) ROHAN DELACOMBE.

By His Excellency's Command,  
A. J. HUNT,  
Minister for Local Government.

GOD SAVE THE QUEEN!

Soil Conservation and Land Utilization Act 1958.

Land Conservation Act 1970.

BETKA RIVER WATER SUPPLY CATCHMENT.

PROCLAMATION

By His Excellency the Governor of the State of Victoria and its Dependencies in the Commonwealth of Australia, &c., &c., &c.

I, the Governor of the State of Victoria in the Commonwealth of Australia, by and with the advice of the Executive Council thereof and having considered a recommendation of the Land Conservation Council in pursuance of the provisions contained in Section 22 (1) of the Soil Conservation and Land Utilization Act 1958 (No. 6372) and Section (1) (b) of the Land Conservation Act 1970 (No. 8008) do by this Proclamation define the water supply catchment area to be known as the Betka River Water Supply Catchment.

The area proclaimed is the catchment to an offtake weir and pumping station which have been constructed by the Mallacoota Waterworks Trust on the Betka River four miles upstream of the river mouth, in the Parish of Betka.

The use of land within this catchment is subject to specification by notice or by determination made by the Soil Conservation Authority, acting under the provisions of Sections 22 (2) and 23 (1) (a) (b) and (c) of the Soil Conservation and Land Utilization Act 1958, as amended.

The area described is indicated on Plan No. 2751 hereunder, the original of which is lodged at Head Office of the Soil Conservation Authority, 378 Cotham-road, Kew, 3101.

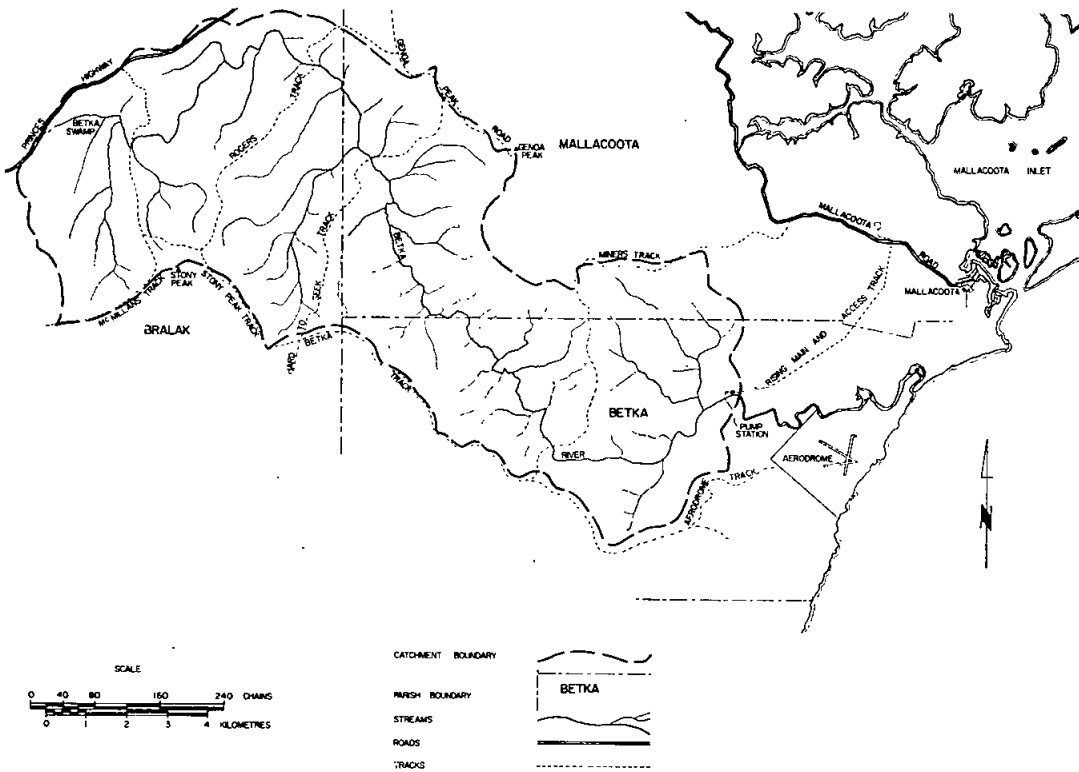

Given under my Hand and the Seal of the State of Victoria aforesaid, at Melbourne, this eighteenth day of September, in the year of our Lord One thousand nine hundred and seventy-three, and in the twenty-second year of the reign of Her Majesty Queen Elizabeth II.

(L.S.) ROHAN DELACOMBE.

By His Excellency's Command,

W. BORTHWICK,  
Minister for Conservation.

GOD SAVE THE QUEEN!

*Apprenticeship Act 1958.*  
**FLOOR FINISHING AND COVERING TRADE  
 PROCLAIMED TO BE AN APPRENTICESHIP TRADE.**

**PROCLAMATION**

By His Excellency the Governor of the State of Victoria and its Dependencies in the Commonwealth of Australia, &c., &c., &c.

Whereas Section 13 of the *Apprenticeship Act 1958* provides, *inter alia*, that after the Minister has taken into consideration any recommendation made by the Apprenticeship Commission the Governor in Council, for the purposes of the said Act, may from time to time by Proclamation proclaim any trades to be apprenticeship trades:

And whereas the Apprenticeship Commission, having notified in the manner prescribed by the said Act its intention to recommend that the trade of floor finishing and covering be proclaimed an apprenticeship trade under the said Act, insofar as it is carried on anywhere in the State of Victoria and having considered the representations made on behalf of the employers and employees in the said trade, has recommended to the Minister that the said trade be so proclaimed:

And whereas the Minister has taken the said recommendation into consideration:

Now therefore I, the Governor of the State of Victoria, in the Commonwealth of Australia, by and with the advice of the Executive Council of the said State, do by this my Proclamation proclaim the trade of floor finishing and covering to be an apprenticeship trade under the said Act insofar as it is carried on anywhere in the State of Victoria:

Given under my Hand and the Seal of the State of Victoria aforesaid, at Melbourne, this eighteenth day of September, in the year of our Lord One thousand nine hundred and seventy-three, and in the twenty-second year of the reign of Her Majesty Queen Elizabeth II.

(L.S.) ROHAN DELACOMBE.

By His Excellency's Command,

J. A. RAFFERTY,  
 Minister of Labour and Industry.

GOD SAVE THE QUEEN!

**MEDICAL PRACTITIONERS (AMENDMENT) ACT 1973,  
 No. 8424.**

**DATE OF COMING INTO OPERATION.**

**PROCLAMATION**

By the Lieutenant-Governor as Deputy for His Excellency the Governor of the State of Victoria and its Dependencies in the Commonwealth of Australia, &c., &c., &c.

Whereas by an Act of Parliament of the State of Victoria entitled *Medical Practitioners (Amendment) Act 1973, No. 8424* it is amongst other things enacted that the several provisions of this Act shall come into operation on a day or the respective days to be fixed by Proclamation or successive Proclamations of the Governor in Council published in the *Government Gazette*.

Now therefore I, the Lieutenant-Governor as Deputy for the Governor of the State of Victoria in the Commonwealth of Australia, by and with the advice of the Executive Council of the said State do by this my Proclamation fix the 26th day of September, 1973 as the day upon which the provisions of the said Act No. 8424 shall come into operation.

Given under my Hand and the Seal of the State of Victoria aforesaid, at Melbourne, this twenty-fifth day of September, in the year of our Lord One thousand nine hundred and seventy-three, and in the twenty-second year of the reign of Her Majesty Queen Elizabeth II.

(L.S.) H. A. WINNEKE.

By His Excellency's Command,

A. J. SCANLAN,  
 Minister of Health.

GOD SAVE THE QUEEN!

**GOVERNMENT NOTICES**

**HOLIDAY—ROYAL AGRICULTURAL SHOW.**

Notice is hereby given that on—

THURSDAY, THE 27TH SEPTEMBER, 1973,

the Public Offices in the municipalities mentioned hereunder will be closed, that day being appointed by the *Public Service Act 1958* to be observed as a holiday in the Public Offices:—

The Cities of Altona, Box Hill, Brighton, Broadmeadows, Brunswick, Camberwell, Caulfield, Chelsea, Coburg, Collingwood, Croydon, Dandenong, Doncaster and Templestowe, Essendon, Fitzroy, Footscray, Frankston, Hawthorn, Heidelberg, Keilor, Kew, Knox, Malvern, Melbourne, Moorabbin, Mordialloc, Northcote, Nunawading, Oakleigh, Port Melbourne, Prahran, Preston, Richmond, Ringwood, St. Kilda, Sandringham, South Melbourne, Springvale, Sunshine, Waverley and Williamstown; the Shires of Bacchus Marsh, Berwick, Bulla, Cranbourne, Diamond Valley, Eltham, Hastings, Lillydale, Melton, Mornington, Sherbrooke, Werribee and Whittlesea.

This notice relates only to the closing of the State Public Offices. All inquiries regarding holidays in other offices and in shops and industry should be directed to the Department of Labour and Industry, 110 Exhibition-street, Melbourne, 3000. (Telephone 63 0321, Extensions 6158, 6859, and 6924.)

J. F. ROSSITER,  
 Chief Secretary.

Chief Secretary's Office,  
 Melbourne, 23rd August, 1973.

**COMPANIES ACT 1961.**

Notice is hereby given in pursuance of sections 308 (2) and 308 (3) of the *Companies Act 1961*, that at the expiration of three months from the date hereof the names of the following companies will, unless cause is shown to the contrary, be struck off the Register, and the said companies will be dissolved.

Dated this 21st day of September, 1973.

E. B. MITCHAM,  
 Deputy Registrar of Companies.

Companies Office,  
 Melbourne.

**COMPANIES ABOVE REFERRED TO.**

Name of Company.	Number of Registration.
Molden & Budden Proprietary Limited ..	10322
"Koorngong" .. .. .	23668
Guild of Dental Technology .. .. .	23735
"Clinic for Psychotherapy" .. .. .	24475
The Blackburn and Mutton Labour Party ..	24555
Tenexe Proprietary Limited .. .. .	25188
Mellody's Pottery Proprietary Limited ..	25801
The Larcher Milk Bars Proprietary Limited ..	25933
Haswell Industries Pty. Limited .. .. .	34126
Syndicated Properties Proprietary Limited ..	36155
Independent Schools Supplies Limited ..	38408
Biblical Press Distributors (Aust.) Pty. Limited	42497
Robertson & Associates Pty. Ltd. .. .. .	44744
Alan L. Johnson Proprietary Limited .. ..	47974
Kingsley Court Pty. Limited .. .. .	49931
Shearing Contractors Pty. Limited .. .. .	55017
District Plaster Board Service Pty. Limited ..	56189
Melbourne Insurance Brokers Proprietary Limited	57962
P. L. Brown & Associates Proprietary Limited ..	58519
Bayland Proprietary Limited .. .. .	60161
R. B. Humphrey (Australia) Pty. Ltd. .. ..	60828
Lithgow's Chair Centre Proprietary Limited ..	61654
Friso Proprietary Limited .. .. .	63771
Title Secured Investments Pty. Limited .. ..	63960
Carcoy (Brunswick) Pty. Limited .. .. .	64307
XVIII International Dairy Congress Committee ..	64544
Keneter Construction Co. Pty. Ltd. .. .. .	67833
Henry B. Burgess Proprietary Limited .. ..	68094
Apex Freight Lines Proprietary Limited .. ..	69037
Luxatred Carpet Industries Pty. Limited .. ..	71584
G. C. Wilkins & Co. Proprietary Limited .. ..	72774
S.I.C.E.R.F. (Aust.) Co. Pty. Limited .. ..	79090
Treviso Carpenters Pty. Ltd. .. .. .	79265
Custom Heating Products Proprietary Limited ..	80488
Erisos Finance Proprietary Limited .. .. .	81362
Student Press Pty. Ltd. .. .. .	82999
Wells Coppin Life Brokers Pty. Ltd. .. ..	84302
H. K. & E. R. Booth Pty. Limited .. .. .	85667
Norstralian Minerals N.L. .. .. .	86289

Transport Regulation Act.  
**TRANSPORT REGULATION BOARD.**  
 HEARING OF APPLICATIONS.

Notice is hereby given that the following applications will be considered by the Transport Regulation Board at its offices at the corner of Lygon and Princes streets, Carlton, at 10.15 a.m. on 17th October, 1973.

**BELL, M., & R. K. GAY,** 18 Tarlee-court, Aspendale. Application for one commercial passenger vehicle with seating capacity for 60 persons (double decker) to operate as an additional touring omnibus under the same terms and conditions as existing licence No. T.O.88.

**MELBOURNE-BRIGHTON BUS LINES PTY. LTD.,** 43 Head-street, Elwood. Application to operate 26 commercial passenger vehicles on Metropolitan Routes 601 (Melbourne-Gardenvale) and 602 (Melbourne-Middle Brighton Beach) with currency period from 1st January, 1974, to 31st December, 1977, subject to the cancellation of 26 Metropolitan Omnibus licences which expire 31st December, 1975, held by the applicant company.

NOTE.—The purpose of application is to extend the currency of the existing "M.O." licences from five years to seven years.

**SIEMENS INDUSTRIES LTD.,** 544 Church-street, Richmond. Application for one commercial passenger vehicle with seating capacity for eleven persons to operate for the carriage of company documents, operating supplies and employees, free of charge between the company's premises in Church-street, Richmond and Mountain Highway, Bayswater, via Church-street, Alexandra-avenue, Williams and Toorak roads and Mountain Highway to the company's premises. Time-table—as and when required.

**TODAH PTY. LTD.,** 86 Monbulk-road, Belgrave. Application for one commercial passenger vehicle, to be purchased, to operate as an additional Metropolitan Stage Omnibus under the same terms and conditions as existing licences held by the applicant.

**UNIVERSAL RADIO TAXIS PTY. LTD.,** 51 Davey-street, Frankston. Application for one commercial passenger vehicle with seating capacity for five (5) persons to operate as a substitute country taxi cab in Zone F subject to the following condition:—The vehicle shall only operate as a replacement unit in substitution for a licensed taxi-cab operating from the radio network of the company at Frankston.

**RICHARDSON, H. I.,** 3 Lambert-street, Lakes Entrance. Application for one commercial passenger vehicle with seating capacity for 45 persons to operate as follows:—  
 (i) In substitution for but not in addition to existing T.S. licensed vehicles in the name of the applicant.  
 (ii) As a special service omnibus within a 2-mile radius of the Orbest Post Office.

NOTE.—This replaces application gazetted on 7th February, 1973, which has been withdrawn by the applicant.

Applications for renewal of licences as shown by persons listed hereunder to operate under the same terms and conditions:—

**ALEXANDROPOULOS, I.,** 6 Douglas-avenue, Box Hill; M.T.4246.

**BADGER, D. R.,** 29 Lysbeth-street, McKinnon; M.T.4626.

**BARMBY, R. W.,** 5/23 Elder-street, Clayton, M.T.1344.

**BLACKNEY, W. A.** (trading as Coastal Seafoods), 16 Curtis-street, Belmont; T.P.231.

**BOUTERAKOS, D.,** 28 Ramsden-street, Clifton Hill; M.T.4132.

**COWLING, L.,** 5 Dundas-place, Albert Park; M.T.2527.

**CUMMINS, B. J.,** 31 Almurta-road, East Bentleigh; C.T.519.

**DANIELS, D. A.,** 13 View Point-road, North Balwyn; M.T.2549.

**DICKER, K. T.,** 82 Bindy-street, Forest Hill; M.T.2511.

**DYSON, L. C.,** BUS SERVICES PTY. LTD., 753 Plenty-road, Reservoir; M.C.260; M.C.602.

**ELGAR, M. T.,** 23 Nowra-street, Moorabbin; M.T.2519.

**FABRIZIO, A.,** 27 Best-street, North Fitzroy; M.T.1629.

**FORD MOTOR CO. OF AUSTRALIA LTD.,** THE, Norlane, Geelong; T.P.40; T.P.262.

**GRANT, H.,** 36 Council-street, Doncaster; M.T.4231.

**GRAHAM, J. J.,** 4/2 Moule-street, West Brunswick; M.T.1702.

**HANDLEY, R. F.,** rear 319 Clarendon-street, South Melbourne; M.T.4599.

**HART, M. K.,** 149 Willsmere-road, Kew; M.T.2543.

**KELLY, F. W.,** 56 Kars-street, Frankston; C.T.58.

**KENNETT, A. C.,** 36 Orwil-street, Frankston; C.T.433.

**LINCOLN, T. W. E.,** 7 Wykeham-court, Frankston; C.T.297.

**LOCK, W. J.,** TAXI SERVICE, 427 Lygon-street, East Brunswick; M.T.810.

**MARTIN, C. A.,** 4 Allenby-street, Frankston; C.T.668.

**MOFFAT, F. W.,** 36 Victoria-street, Daylesford; C.T.338.

**O'BRIEN, H. P.,** Mellool-street, Barham; T.P.126.

**O'DEA, J. W.,** 8 Allen-drive, Mt. Eliza; C.T.255.

**O'DEA, J. H.,** 8 Allen-drive, Mt. Eliza; C.T.296.

**O'DONOGHUE, W. A. & D. L.,** 100 Dare-street, Ocean Grove; C.T.139.

**PETERSEN, P. J.,** 29 Francis-street, Hamilton; C.T.490.

**PIVETTA, R. A. M.,** 1A Melvin-street, Frankston; C.T.440.

**PRITSIS, S.,** 38 Cope-street, Coburg; M.T.4718.

**PSALIDAS, A.,** 69 Lewisham-road, Prahran; M.T.4182.

**SMALE, G. V.,** 120 Kars-street, Frankston; C.T.644.

**STANKOVIC, R.,** 28 De Chene-parade, Coburg; M.T.4191.

**STRATFORD, E. C.,** 2 Modoline-street, Pascoe Vale; M.T.2525.

**TOLSON, W.,** 14 Aubrey-street, Armadale; M.T.4603.

**TUSON, N. A. & G. I.,** 24 Tallangatta-road, Wodonga; C.T.136.

**SKONDRAS, G.,** 103 Victoria-street, Brunswick; M.T.4172.

**WOODHOUSE, A. P.,** 4 Colin-avenue, Frankston; C.T.254.

**WYMAN, H.,** 18 Belmont-avenue, Glen Iris; M.T.1422.

Notice of any objection should be forwarded to reach the Secretary of the Board not later than 10th October, 1973.

Applicants are advised that it will not be necessary to appear on the hearing date specified, unless advised in writing by the Board.

A. V. C. COOK,  
 Secretary.

Corner Lygon and Princes streets, Carlton, 3053,  
 26th September, 1973.

Commercial Goods Vehicles Act.  
**TRANSPORT REGULATION BOARD.**  
 HEARING OF APPLICATIONS.

Notice is hereby given that the following applications will be considered by the Transport Regulation Board at its offices at the corner Lygon and Princes streets, Carlton, at 10 a.m., on Wednesday, 17th October, 1973.

**ALLEN, R. F.,** 3 Macadam-street, Daylesford, 3460. One commercial goods vehicle (L/C. 283 cwt.) to operate from bush sites at Daylesford, Woodend, Gisborne and Creswick, to Hardboards Australia Pty. Ltd. at Bacchus Marsh—waste timber.

**BOHMER, D. Y.,** 39 Warren-street, Stawell, 3380. One commercial goods vehicle (L/C. 8 cwt.) to operate between the post offices situated at Stawell and Deep Lead on Tuesday and Friday of each week—mails under contract to the P.M.G.'s Department and parcels with the ability to carry a maximum of two passengers on any one trip.

**BOUKER, G. G. & N. J.,** 17 Hanleth-avenue, South Springvale, 3172. One commercial goods vehicle (L/C. 145 cwt.) to operate within a 70-mile radius of the premises of Pearl Cement Products Pty. Ltd., at Springvale, solely on behalf of the said company—cement roofing tiles and roof battens.

**BRUNI & BISOGNI PTY. LTD.,** Broadway-street, Cobram, 3644. One commercial goods vehicle (L/C. 15 cwt.) to operate: (a) Within a 50-mile radius from the post office at Cobram, in the course of business as "Building Contractors"—own goods. (b) Throughout the State of Victoria in the course of business as "Building Contractors"—own tools of trade and own equipment. (c) Within a 20-mile radius of the site of any contract currently engaged upon or from the nearest railway station thereto—materials required for use on such contract.

**CARTER, N. J.,** 19 Hayes-street, Northcote, 3070. One commercial goods vehicle (L/C. 109 cwt.) to operate solely on behalf of Fleetways Transport Services Pty. Ltd.—(a) From the premises of Motor Vehicle Distributors and Dealers direct to consignees throughout the State of Victoria—complete motor vehicles. (b) From the premises of motor vehicle manufacturers situated at Melbourne, Geelong and Dandenong direct to those wharves only where there are no rail facilities—motor car bodies.

**VAN BERGEN, L. H.** (trading as W. A. R. Chislett Soft Drinks), 154 Commercial-street, Merbein, 3505. One commercial goods vehicle (L/C. 77 cwt.) to operate: (a) In the course of business as "Soft Drink and Cordial Manufacturers", being an approved decentralized secondary industry with a factory situated at Merbein, for the carriage of goods as follows:—(1) From points within the State of Victoria to the said approved decentralized secondary industry factory at Merbein—raw materials and goods associated with or required solely for use in the manufacturing or processing of such approved decentralized secondary industry. (2) From the premises of the aforesaid

- factory at Merbein to points within the State of Victoria—manufactured and/or processed products of such approved decentralized secondary industry. (b) In the course of business as "Soft Drink, Cordial and Food Suppliers" for the carriage of canned soft drinks, sauces, pickles, jams and canned fruit, not being manufactured products of the approved decentralized secondary industry as specified in paragraph (a) above, together with empty return containers as follows:—(1) Within that part of the State of Victoria, north of a line drawn due east and west through the Township of Woomelang and bounded on the north by the River Murray and west of a line drawn due north and south through the Township of Culgoa and bounded on the west by the South Australian border. (2) Provided that all agency lines carried on the vehicle pursuant to paragraph (b) shall have been initially consigned by rail to the railway stations at either Merbein or Mildura.
- CLARK, B., 165 Scotts-parade, Ballarat, 3350. One commercial goods vehicle (L/C. 60 cwt.) to operate throughout the State of Victoria in the course of business as "Marine Collector"—marine stores and old metals as defined in the *Marine Stores and Old Metals Act 1958* (No. 6303), but excluding the carriage of such goods to wharves, docks or ships for shipment or export purposes, and provided that the combined load capacity of the prime mover and any trailer attached thereto does not exceed 120 cwt.
- COBELAS, R., 33 Ethel-street, Traralgon, 3844. Application to vary the conditions of licence No. D.T.1258/3 (L/C. 263 cwt.) by deleting the existing conditions and adding in lieu—(a) From forest landings situated within a 10-mile radius of the post office at Noojee to the premises of the Australian Paper Manufacturers Ltd. at Maryvale—pulpwood. (b) From forest landings situated within a 5-mile radius of English's Corner to the premises of the Australian Paper Manufacturers Ltd. at Maryvale—pulpwood. (c) To and from forest landings specified in paragraphs (a) and (b) above and from and to own premises at Traralgon—own logging equipment."
- DAVELCO ENGINEERING & MANUFACTURING CO. PTY. LTD., Settlement-road, Bundoora, 3083. One commercial goods vehicle (L/C. 14 cwt.) to operate throughout the State of Victoria in the course of business as "Engineering Manufacturers" for the purpose of servicing machinery—tools of trade, equipment and spare parts incidental to the servicing and repair of manufactured and hire machines in the field only.
- DAVELCO ENGINEERING & MANUFACTURING CO. PTY. LTD., Settlement-road, Bundoora, 3083. One commercial goods vehicle (L/C. 14 cwt.) to operate throughout the State of Victoria in the course of business as "Engineering Manufacturers" for the purpose of installing and servicing food handling machinery—food handling machinery for installation or servicing, tools of trade, equipment and spare parts incidental to the installation or servicing of such machinery on site.
- FINN, E. A. & H. M., 5 Banff-court, Corio, 3214. One commercial goods vehicle (L/C. 170 cwt.) to operate within a 50-mile radius of the chief post office in the City of Geelong, solely on behalf of Pioneer Concrete (Geelong) Pty. Ltd.—premixed concrete in a specially constructed agitator vehicle.
- GARNER & WHEELER EXCAVATIONS PTY. LTD., 27 Shane-crescent, Croydon, 3136. One commercial goods vehicle (L/C. 323 cwt.) to operate: (a) Throughout the State of Victoria in the course of business as "Earth-moving Contractor"—own earth-moving plant and own equipment. (b) Within a 25-mile radius of own premises at Nunawading—earth-moving plant the property of other contractors.
- GODWIN'S HAY & GRAIN PTY. LTD., 99 Lonsdale-street, Dandenong, 3175. One commercial goods vehicle (L/C. 20 cwt.) to operate: (a) From and to own premises at Gembrook, Ferntree Gully and Dandenong to and from points within a 30-mile radius of the post office at Ferntree Gully in the course of business as "General Merchants, Agents for Shell Co. of Aust. Ltd., Neptune Oil Co. Pty. Ltd. and Fertilizer Distributors"—own goods. (b) From the depot of the Shell Co. of Aust. Ltd. at Dandenong to points within a 50-mile radius thereof—petroleum products and empty return containers.
- GORDON, I. A. & M. L., "Inverness", Peterborough, 3270. One commercial goods vehicle (L/C. approximately 280 cwt.) to operate within a 50-mile radius of the post office at Peterborough in the course of business as "Earth-moving Contractor"—own earth-moving equipment, spare parts and materials incidental to own contracts.
- GRUNDY, R. H., 9 Salisbury-street, North Essendon, 3040. One commercial goods vehicle (L/C. 139 cwt. and 160 cwt. trailer) to operate: (a) From the premises of motor vehicle distributors and dealers direct to consignees throughout the State of Victoria—complete motor vehicles on behalf of Fleet X Press. (b) Between the Cities of Melbourne, Geelong and Dandenong—motor car bodies on behalf of Fleet X Press subject to the condition that no delivery shall be made to, any wharf at which rail facilities are available.
- HALE, A. F., 6 Stirling-road, Blackburn South, 3130. Application to vary the conditions of licence No. D.A.66186 (L/C. 134 cwt.) by deleting "Own Road" from the existing conditions.
- HEAVY TRUCK SERVICES PTY. LTD., 66 Renver-road, Clayton, 3168. Two commercial goods vehicles (L/C. 13 cwt. each) to operate: (a) Within a 50-mile radius of own premises at Clayton in course of business as "Truck Service Engineers"—own goods. (b) Throughout the State of Victoria in the course of business as "Truck Service Engineers"—tools of trade and spare parts incidental to on site servicing in the field only.
- HERSEY, D., 5 Boronia-grove, Wendouree, 3355. One commercial goods vehicle (L/C. 169 cwt.) to operate within a 50-mile radius of the premises of Pioneer Concrete (Vic.) Pty. Ltd. at Ballarat solely on behalf of the said company—premixed concrete in a specially constructed agitator vehicle.
- JOLLY, H. G. F. & B. E., 54-56 Highett-street, Mansfield, 3722. One commercial goods vehicle (L/C. 440 cwt.) to operate: (a) From forest landings situated within a 50-mile radius of the post office at Swanpool to sawmills at Mansfield and Swanpool—sawmill logs. (b) From sawmills at Swanpool to consignees within a 50-mile radius thereof—sawn timber.
- LARRAD, E. I. & A., 1 Albert-street, Oak Park, 3046. One commercial goods vehicle (L/C. 114 cwt.) to operate solely on behalf of Fleetways Transport Services Pty. Ltd.—(a) From the premises of motor vehicle distributors and dealers direct to consignees throughout the State of Victoria—complete motor vehicles. (b) From the premises of Motor Manufacturers situated at Melbourne, Geelong and Dandenong direct to those wharves only where there are no rail facilities—motor car bodies.
- LINDSAY, D. C., 61 Albert-street, Tatura, 3616. One commercial goods vehicle (L/C. 157 cwt.) to operate: (a) Within a 50-mile radius from the post office at Shepparton as a "Road Contractor"—road-making plant and materials. (b) Within a 25-mile radius of the post office at Shepparton—general goods, provided no goods shall be carried whether by one stage or by more than one stage between places within the above radius, which are more than thirty (30) road miles apart by the nearest practicable route.
- LLEWELLYN, K. C., 73 Sandells-road, Tecoma, 3160. One commercial goods vehicle (L/C. 129 cwt.) to operate within a 70-mile radius of the premises of The City Brick Works Co. Pty. Ltd. at Scoresby on behalf of the said company—bricks.
- MAJOR BUILDING SERVICE PTY. LTD., 27 McArthur-road, North Altona, 3025. One commercial goods vehicle (L/C. 20 cwt.) to operate: (a) Throughout the State of Victoria in the course of business as "Maintenance Builders" on behalf of Caltex Oil (Australia) Pty. Ltd., Mobil Oil Australia Ltd., Total (Australia) Ltd. and Esso Standard Oil (Australia) Ltd. for the purpose of supervising own contracts at service stations and depots—tools of trade and own plant and equipment. (b) Throughout the State of Victoria on behalf of the aforementioned companies in paragraph (a) above for the purposes of repairing and erecting advertising signs—tools of trade, own plant and equipment together with advertising signs for erection. (c) Within a 25-mile radius of any current contract site or from the nearest railway station thereto—materials for use on such contract.
- MARNOCK VALE QUARRIES PTY. LTD., 19 Catherine-street, Geelong West, 3218. One commercial goods vehicle (L/C. 158 cwt.) to operate: (a) Within a 50-mile radius from the chief post office in the City of Geelong but excluding the Metropolitan Area as defined in the *Transport Regulation Act 1958*—plant the property of a contractor and required by him for use in connection with the construction or maintenance of some specific, existing or proposed road, street, footpath, bridge, pier, wharf, weir or channel and also the following materials viz.:—metal, stones, screenings, ashes, gravel, sand and earth. (b) Within a 20-mile radius from the site of any construction or maintenance work performed pursuant to paragraph (a) above, or

from the railway station nearest thereto—any other materials required for such work. (c) Within a 25-mile radius of the chief post office in the City of Geelong—general goods.

**MILES INDUSTRIAL PAINTING SERVICES PTY. LTD.**, 1032 Dandenong-road, Carnegie, 3163. Three commercial goods vehicles (L/C. 9 cwt. each) to operate throughout the State of Victoria in the course of business as "Signwriters and Maintenance Painters"—tools of trade, scaffolding, ladders and small quantities of materials incidental to the completion of own contracts.

**NICHOL TRADING PTY. LTD.**, Lockington, 3563. One commercial goods vehicle (L/C. 287 cwt.) to operate: (a) Within a 50-mile radius from the post office at Lockington as a "Road Contractor"—road-making plant and materials. (b) Within a 25-mile radius of the post office at Lockington—general goods, provided that no goods shall be carried whether by one stage or by more than one stage between places within the above radius which are more than thirty (30) road miles apart by the nearest practicable route.

**PACIFIC PHOTO SERVICE PTY. LTD.**, 456 Houghton-road, Clayton, 3168. One commercial goods vehicle (L/C. 10 cwt.) to operate within a 50-mile radius of own branch premises at Horsham and to Wycheproof, Charlton, Wedderburn and St. Arnaud and places en route in course of business as "Film Processors"—unexposed film for printing and printed films.

**PATERSONS PTY. LTD.**, 152 Bourke-street, Melbourne, 3000. Application to vary the conditions of licence No. D.A.1782/43 (L/C. 14 cwt.) by deleting "Bairnsdale" from the existing conditions and adding in lieu "Hamilton".

**PATERSONS PTY. LTD.**, 152 Bourke-street, Melbourne, 3000. Application to vary the conditions of licence No. D.A.1782/48 (L/C. 14 cwt.) by deleting "Shepparton" from the existing conditions and adding in lieu "Warmambool".

**PENNELL, J. R.**, 157 High-street, Maryborough, 3465. One commercial goods vehicle (L/C. 25 cwt.) to operate: (a) Throughout the State of Victoria in the course of business as "Building Contractor"—own tools of trade, own builders' equipment, one 44-gallon drum of fuel and one cylinder of gas for operating own equipment on-site. (b) Within a 20-mile radius of any contract currently engaged upon or from the nearest railway station thereto—materials for use on such project.

**PRAZNOVSKY CARRIERS PTY. LTD.**, 654-712 Clayton-road, Clayton South, 3169. One commercial goods vehicle (L/C. approximately 160 cwt.) to operate: (a) Within a 25-mile radius from the general post office in the City of Melbourne—general goods. (b) From pits at Cranbourne and Pearceale to places situated within paragraph (a) above—sand. (c) From pits at Cranbourne and Pearceale to the M.M.B.W. Yarra Valley Conduit, Upper Yarra via Gilderoy and Warburton—pipe bedding sand.

**ROWBOTTOM, C. E.**, Orford, 3285. One commercial goods vehicle (L/C. 72 cwt.) to operate: (a) Within a 25-mile radius of the post office at Orford—general goods provided that no goods shall be carried whether by one stage or by more than one stage between places within the above radius which are more than thirty (30) road miles apart by the nearest practical route. (b) From and to places within the above radius to and from places within a 50-mile radius of the post office at Macarthur—livestock. (c) Within a 50-mile radius of the post office at Macarthur in the course of business as "Primary Producer"—own goods.

**RUSSELL, E. A. C.**, (DANDENONG) PTY. LTD., 10 Podmore-street, Dandenong, 3175. Application to vary the conditions of licence No. D.A.64704/5 (L/C. 154 cwt.) by adding an additional paragraph to the existing conditions:—"(c) From the premises of Phosphate Co-Operative Co. Ltd., at Yarraville to points within a 30-mile radius of Dandenong—bulk and bagged fertilizers".

**SIMPSON POPE LTD.**, 128 Wellington-street, Collingwood, 3066. One commercial goods vehicle (L/C. 15 cwt.) to operate within a 100-mile radius from own premises at Collingwood for the purposes of installing and repairing washing machines, electric stoves, refrigerators, air conditioners and motor-mowers, washing machines and electric stoves for installation and/or repair or having been repaired, tools of trade, spare parts and materials incidental thereto.

**SLUGA, I.**, 48 Smith-street, Alphington, 3078. One commercial goods vehicle (L/C. approximately 250 cwt.) to operate within a 50-mile radius of the premises of Albion Reid Pty. Ltd. at North Melbourne on behalf of the said company—road-making plant, hot asphalt, premix and road-making materials but excluding the carriage of cement and lime from the Geelong Urban District (as defined in the Transport Regulation Act 1958).

**STRAMIT INDUSTRIES LTD.**, 96 Franklin-street, Melbourne, 3000. One commercial goods vehicle (L/C. 16 cwt.) to operate throughout the State of Victoria in the course of business as "Roofing Contractors" for the purpose of supervising own contracts—tools of trade and a small quantity of materials incidental to repair work or completion of a new contract.

**WILLIAMS, J. F.**, Main-street, Gembrook, 3783. One commercial goods vehicle (L/C. 129 cwt.) to operate: (a) From bush sites within a 20-mile radius of Gembrook and from Yan Yean to own mill at Gembrook—logs. (b) From own mill at Gembrook to places within a 25-mile radius of G.P.O., Melbourne—sawn timber. (c) From own mill at Gembrook to Hicksons Timber Impregnation Co. (Aust.) Pty. Ltd., at Officer—own sawn timber. (d) From own mill at Gembrook to consignees within a 20-mile radius of Gembrook—own manufactured boxes.

**WILLIAMS, J. F.**, Main-street, Gembrook, 3783. Application to vary the conditions of licence No. D.T.532/5 (L/C. 351 cwt.) by deleting "Kingleake" from paragraph (a) of the existing conditions and adding in lieu "Yan Yean".

#### RENEWALS.

Applications for renewal of licences as shown by persons listed hereunder to operate under the same terms and conditions from the expiry shown in each case.

**ANSWER, E. H.**, Dunlop-street, Mortlake, 3272; D.A.58139; 31st January, 1974; 8 cwt.

**AUTOCARE PTY. LTD.**, 117 Gilbert-road, Preston, 3072; D.A.45365; 19th February, 1974; 80 cwt.

**BARWON HEADS FISHERMEN'S CO-OP SOCIETY LTD.**, Pier Head, Barwon Heads, 3227; D.A.37425/1; 9th February, 1974; 65 cwt.

**BEAGLEY, K. & E. M.**, Kenilworth-avenue, Wonga Park, 3136; D.A.41540/3; 19th February, 1974; 128 cwt.

**BLACK RANGE TIMBER CO. PTY. LTD.**, Marysville-road, Buxton, 3711; D.T.1513; 7th March, 1974; 270 cwt.

**CLEARY, M. J.**, 7 Russell-avenue, Berwick, 3806; D.A.63544; 16th February, 1974; 142 cwt.

**COTTEE'S GENERAL FOODS**, 160 Whitehorse-road, Blackburn, 3130; D.A.30358/30; 16th February, 1974; 11 cwt.

**CRANES & SHOVELS PTY. LTD.**, 28-32 Cochranes-road, Moorabbin, 3189; D.A.30723; 26th August, 1973; 11 cwt.

**DEIPENAU, H. E.**, PTY. LTD., 73 Victoria-street, East Brunswick; T.D.A.17846/27; 2nd March, 1974; 227 cwt.;

T.D.A.17846/28; 2nd March, 1974; 227 cwt.;

T.D.A.17846/29; 2nd March, 1974; 259 cwt.;

T.D.A.17846/30; 2nd March, 1974; 236 cwt.;

T.D.A.17846/31; 2nd March, 1974; 249 cwt.;

T.D.A.17846/33; 8th February, 1974; 247 cwt.;

T.D.A.17846/34; 8th February, 1974; 300 cwt.

**DODDS, B. A.**, 1/56A Albert-avenue, Springvale, 3171; D.A.59766/1; 16th February, 1974; 137 cwt.

**DUNLOP TYRE SERVICE (VIC.) PTY. LTD.** (Mildura Branch), 124 Langtree-avenue, Mildura, 3500; D.A.60416/94; 16th February, 1974; 23 cwt.

**FEIGLIN, M. & SONS PTY. LTD.**, Station-street, Nunawading, 3131; D.T.193/5; 7th March, 1974; 129 cwt.

**FLEETWAYS HAULWAY PTY. LTD.**, 61 Bertie-street, Port Melbourne, 3207; D.A.48588/8; 17th February, 1974; 237 cwt.

**FLOGERAS, K.**, 1 Moorea-court, East Oakleigh, 3166; D.A.63511; 16th February, 1974; 220 cwt.

**GALPIN, M. J.** (trading as M. J. & S. A. Galpin), 27 Jackson-street, Horsham, 3400; T.T.D.1425; 8th February, 1974; 228 cwt.

**LAWFORD'S ENGINEERING CO.**, 82 Echuca-road, Rochester, 3561; D.A.63392; 9th February, 1974; 261 cwt.

**LOADMASTER TRAILERS PTY. LTD.**, Brook-street, Woodend, 3442; D.A.36531/2; 9th February, 1974; 18 cwt.

**MALE, A. H. & Co.**, 21 Hilton-street, Beaumaris, 3193; T.D.A.60462; 6th March, 1974; 15 cwt.

**MEDCRAFT, B. W.**, 9 Chenery-street, Mansfield, 3722; D.T.1099; 31st January, 1974; 261 cwt.

**MESSINA, A.**, 1 Osbert-street, Sunshine, 3020; D.A.63496; 16th February, 1974; 284 cwt.

**MIDDLING, G. G.**, 27 Benedikt-street, Scoresby, 3179; D.A.63480; 9th February, 1974; 119 cwt.

**MINTERN, M. & SONS**, 67 McPherson-street, Horsham, 3400; D.A.48394/4; 31st January, 1974; 164 cwt.

MOLAN, J. R. (trading as W. A. Molan & Sons), 6 Grey-street, Terang, 3264; D.A.37797/3; 16th February, 1974; 146 cwt.

MOORE, D. H., 5 Scott-crescent, Mildura, 3500; T.D.A.50951/4 12th February, 1974; 138 cwt.

NORTON, F., PTY. LTD., 9 Sargood-street, Altona, 3018; D.A.31887; 17th February, 1974; 10 cwt.

PACELLA, C. & R., 138 Keon-street, Thornbury, 3071; D.A.63540; 16th February, 1974; 196 cwt.

PRICE, R. C., Panmure, 3276; D.A.63548; 16th February, 1974; 252 cwt.

PYLE, T. J., Tawonga South, 3697; D.A.1873/1; 19th February, 1974; 200 cwt.

QUEEN'S BRIDGE MOTOR & ENGINEERING CO. PTY. LTD., 359 Plummer-street, Port Melbourne, 3207; D.A.1783/48; 10th February, 1974; 14 cwt.

READ'S SEPTIC TANK CLEANING SERVICE PTY. LTD., Wellington-road, Clematis, 3159; D.A.62947/1; 16th February, 1974; 132 cwt.

STEPHENSON, A. D., 27 Treestbank-avenue, Springvale, 3171; D.A.63465; 9th February, 1974; 8 cwt.; D.A.63465/1; 9th February, 1974; 14 cwt.

TATSIDIS, D., 34 The Crossway, East Keilor, 3042; D.A.63487; 9th February, 1974; 232 cwt.

TUCKFIELDS TEAS PTY. LTD., 12-13 Yarra-street, South Yarra, 3141; D.A. 19662; 10th February, 1974; 25 cwt.

TYRE-LUG (AUST.) PTY. LTD., 55 Market-road, Footscray West, 3012; D.A.35254/8; 10th February, 1974; 39 cwt.

VUKMIROVIC, N., 39 Olive-road, Doveton, 3177; D.A.63464; 9th February, 1974; 144 cwt.

## TOW TRUCK RENEWALS.

VIDOTTO, C. (trading as A.W. Panels), 104 Dandenong-road, Frankston, 3199; D.A.46852/3; 28th March, 1974; 50 cwt.

BOX HILL TOWING PTY. LTD., 4 Shipley-street, Box Hill, 3128; D.A.31809; 10th February, 1974; 73 cwt.; D.A.31809/2; 10th February, 1974; 34 cwt.; D.A.31809/3; 10th February, 1974; 76 cwt.

KENNY, P. A. (trading as Essendon Towing Service), 378 Mt. Alexander-road, Ascot Vale, 3032; D.A.66048; 28th August, 1973; 79 cwt.

## RENEWALS WITH VARIATION.

Applications made by the persons listed hereunder for renewal of the licences listed with variation of conditions in the manner set out opposite the names.

GODWIN'S HAY & GRAIN PTY. LTD., 99 Lonsdale-street, Dandenong, 3175; D.A.64705; 13th February, 1974; application to renew and vary the conditions of licence No. D.A.64705 (L/C. 93 cwt.) by deleting "Belgrave" from paragraph (a) of the existing conditions and by also deleting paragraph (c) and adding in lieu "(c) From the premises of Phosphate Co-operative Co. Ltd. at Yarraville to points within a 30-mile radius of Dandenong—bulk and bagged fertilizers."

RUSSELL, E. A. C., PTY. LTD., Main-street, Gembrook, 3783; D.A.4901/10; 2nd April, 1974; application to renew and vary the conditions of licence No. D.A.4901/10 (L/C. 16 cwt.) by deleting "Belgrave" from paragraph (a) of the existing conditions and by also deleting paragraph (c).

Notice of any objection should be forwarded to reach the Secretary of the Board not later than 10th October, 1973.

Applicants are advised that it will not be necessary to appear on the hearing date specified above, unless advised in writing by the Board.

A. V. C. COOK,  
Secretary.

Corner Lygon and Princes streets, Carlton, Vic., 3053,  
Wednesday, 26th September, 1973.

## LOTTERIES GAMING AND BETTING ACT 1966.

Notice is hereby given that in the Supreme Court at Melbourne on the 17th day of September, 1973, a declaration pursuant to the provisions of section 51 (1) (a) of the *Lotteries Gaming and Betting Act 1966*, was made by His Honour Mr. Justice Anderson that the house or place situate at the first floor, 353 Chapel-street, Prahran, and the means of access to that floor from the lane on the north side of the said house or place is a common gaming house or place.

Dated at Melbourne the 17th day of September, 1973.  
F. A. SILVESTER,  
Inspector of Police.

JOHN DOWNEY, Crown Solicitor and Solicitor for the Applicant.

## THE TOBACCO LEAF MARKETING BOARD ELECTION.

A Poll is to be taken on Wednesday, 17th October, 1973, for the purpose of electing four elective members of The Tobacco Leaf Marketing Board. Voting will be by personal ballot, following the style of Parliamentary elections, at the following places:—

C. W. A. Hall, Myrtleford.  
Meeting Room, Public Library, Bright.  
Public Hall, Markwood.  
Public Hall, Whitfield.  
Public Hall (Supper Room), Tawonga.  
Public Hall, Whorouly.  
Memorial Hall, Gunbower.

Polling booths will be open to enrolled voters from 9 a.m. to 6 p.m. One electoral area has been adopted covering the whole of the State of Victoria. The full names of each candidate standing for election, as supplied to the undersigned, are as follows:—

DARLING, HARRY GUY.  
DE GRAZIA, CAMILLO.  
FRASCA, GAUDENZIO (JACK).  
GREEN, FRANCIS JAMES.  
KNEEBONE, HUGHIE HAMILTON.  
McCORMACK, DESMOND JOHN.  
MCGUFFIE, WILLIAM.  
RIGONI, ANGELO.  
WOODWARD, CECIL FRANCIS.

## Postal Voting.

The only persons entitled to vote by post are voters who are unable to attend personally for one of the following reasons:—

- that he resides at least ten miles from the nearest polling place; or
- that he will not throughout the hours of polling on the polling day be within ten miles of the nearest polling place; or
- that he will throughout the hours of polling on the polling day be travelling under conditions which will preclude him from voting at a polling place; or
- that he is seriously ill or infirm and by reason thereof will be prevented from voting personally at a polling place; or
- that by reason of approaching maternity the person will be prevented from voting personally at a polling place.

An application for a postal vote must be made on a special form, which is obtainable from the Returning Officer, The Tobacco Leaf Marketing Board Election, Box 4105, Melbourne, Vic. 3001 (telephone 651 7376). Requests for such application forms should be made as soon as possible, as the processes involved in obtaining a vote by this method may well occupy several days. After obtaining one of the special forms, the application may be lodged personally or by post. The closing date for receiving applications is 10 a.m., on Tuesday, the 16th October, 1973, i.e., the day before polling day.

If the application is lodged by post, applicants should allow sufficient time for a postal voting ballot paper to be forwarded to them through the post, and then sent to the Returning Officer, after completion by the voter, so as to reach the Returning Officer not later than 6 p.m., on polling day, the 17th October, 1973.

Voting is compulsory for those voters whose names appear on the roll. Applications for enrolment and objections to enrolment closed on the 22nd August, 1973. The nomination of individual representatives of multiple-name producers closed on the 5th September, 1973, and the roll has now been finalized. Failure to vote by an enrolled voter renders him liable to a penalty.

K. C. WHEATLAND, Returning Officer.

The Tobacco Leaf Marketing Board Election, 17th October, 1973.

## CAULFIELD-MALVERN REGIONAL LIBRARY.

## NOTICE OF APPROVAL OF AMENDING AGREEMENT.

The amending agreement made between the Mayor, Councillors and Citizens of the City of Caulfield and the Mayor, Councillors and Citizens of the City of Malvern in relation to the joint library service in the municipal districts of the said municipalities was approved by the Governor in Council, pursuant to the provisions of section 799 of the *Local Government Act 1958*, on the 18th day of September, 1973.

T. J. FORRISTAL,  
Clerk of the Executive Council.

At the Executive Council Chamber,  
Melbourne, 18th September, 1973.



COUNTRY ROADS BOARD.

RESOLUTIONS OF THE COUNTRY ROADS BOARD.

The Country Roads Board, in pursuance of the provisions of the Country Roads Act 1958, has passed Resolutions the dates whereof and the terms of which are Scheduled hereunder:—

SCHEDULE.  
Freeways.

Resolution dated the seventeenth day of September, One thousand nine hundred and seventy-three, made pursuant to sections 21 and 101 of the Country Roads Act 1958, declaring the road in the Shires of Werribee and Corio as shown hatched on plans numbered G.P.12839A, G.P.12840A, G.P.12840B, G.P.12841A, G.P.12841B, G.P.12842, G.P.12843, G.P.12844A, G.P.12844B, G.P.12785A, G.P.12784, G.P.12783A, G.P.12783B, G.P.12373, G.P.12372, G.P.12710A, G.P.12711A and G.P.12712A hereunder to be a freeway (Princes Freeway) within the meaning and for the purposes of the said Act.

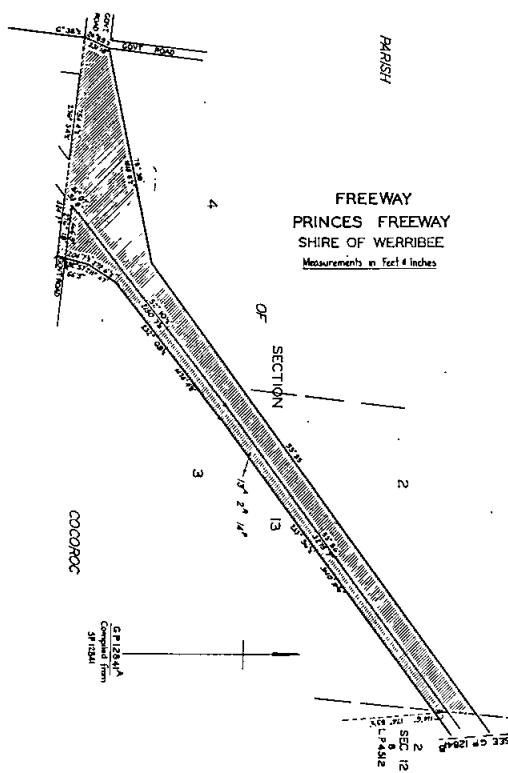
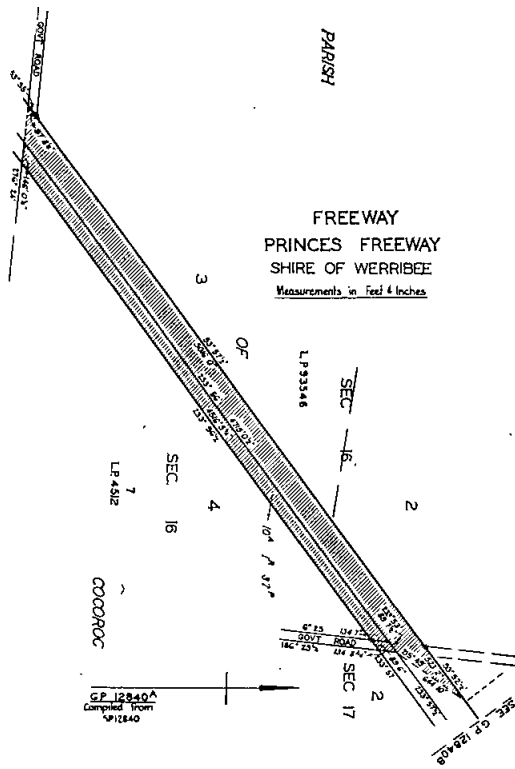
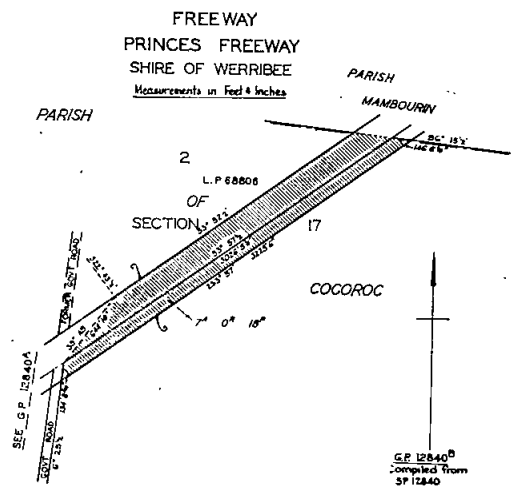
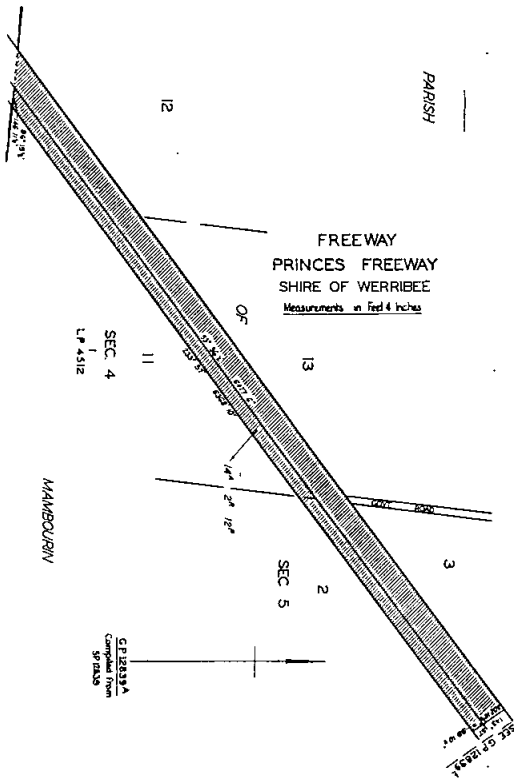

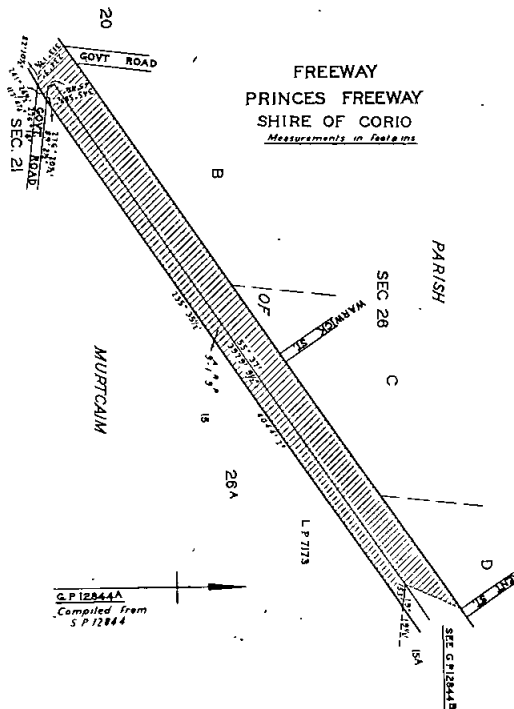
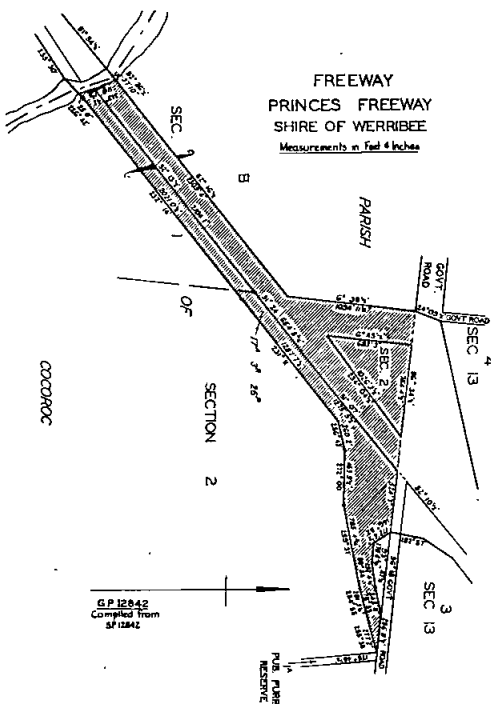
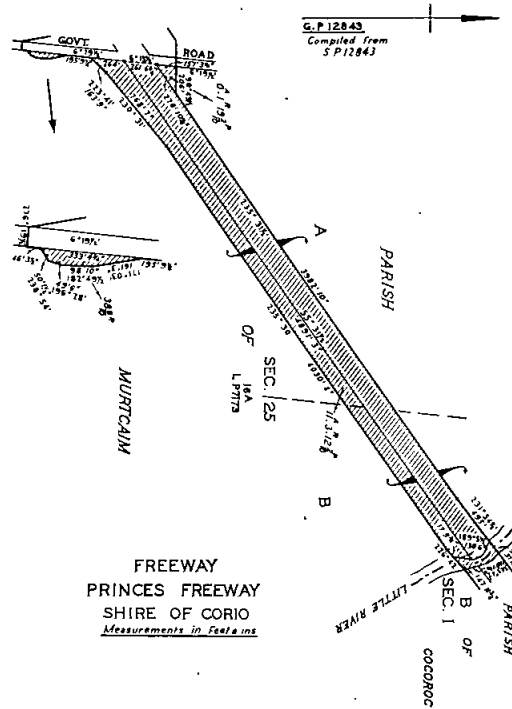
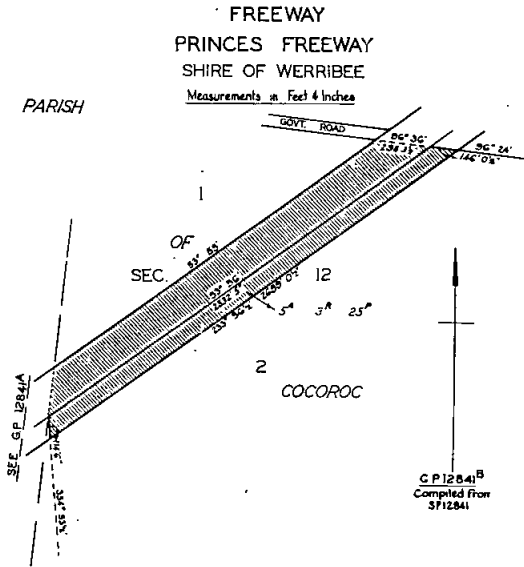

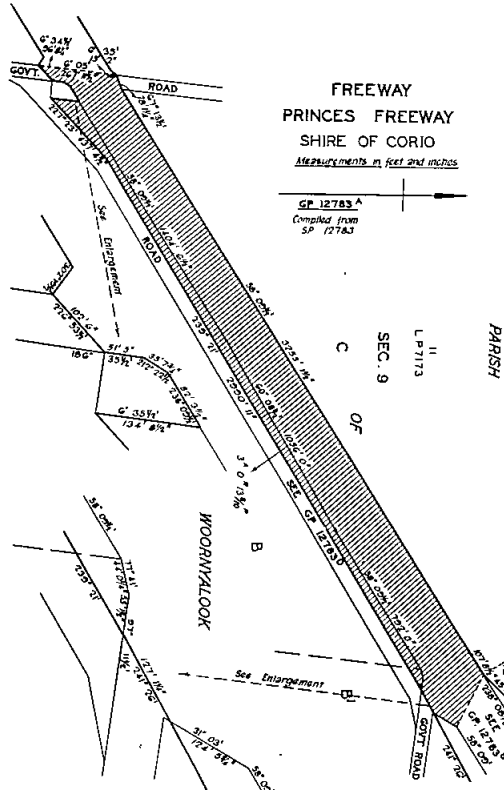
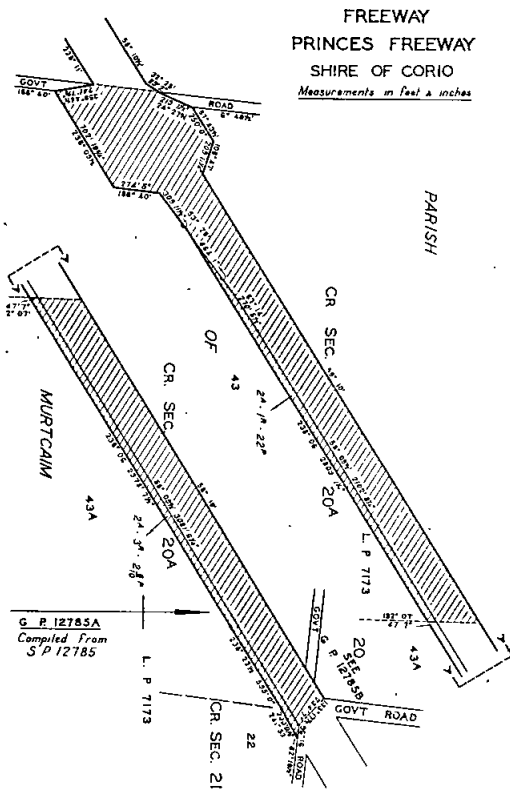
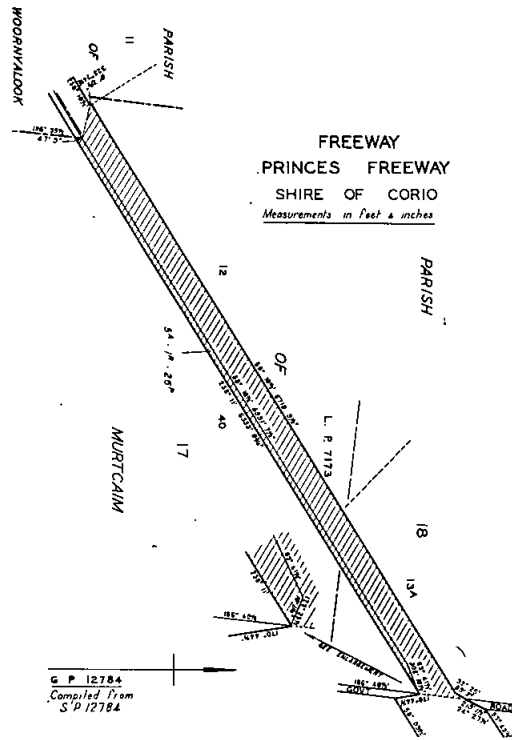
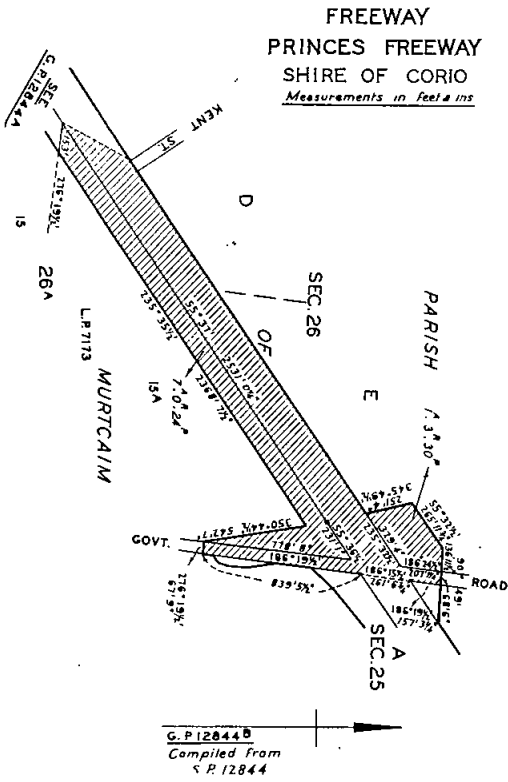

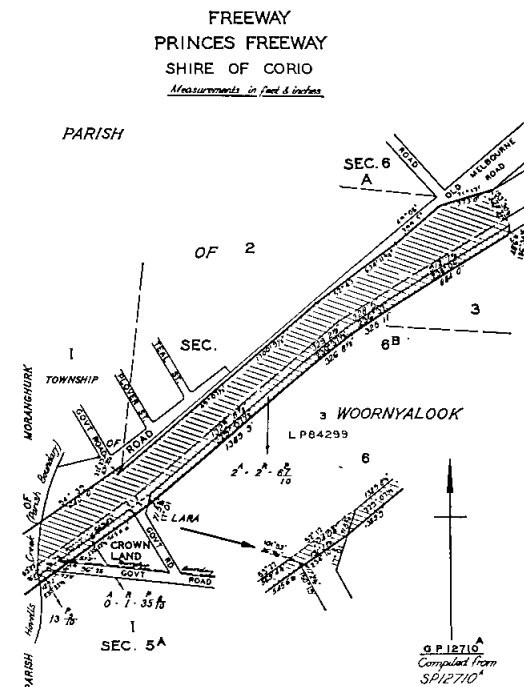
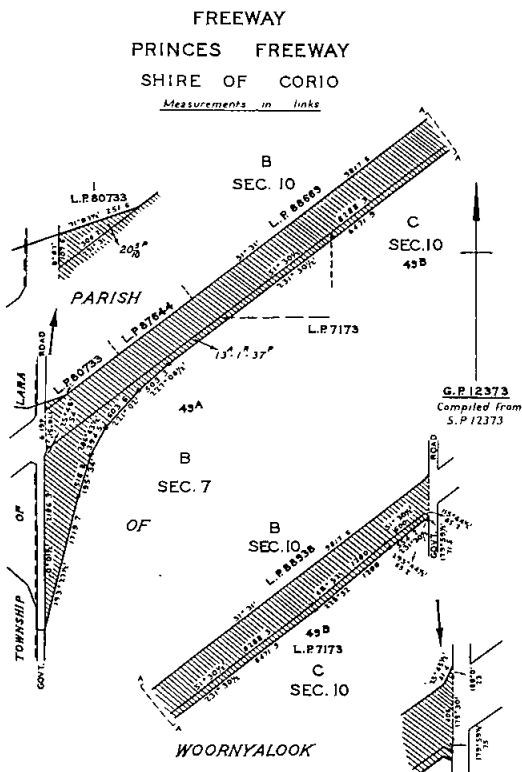
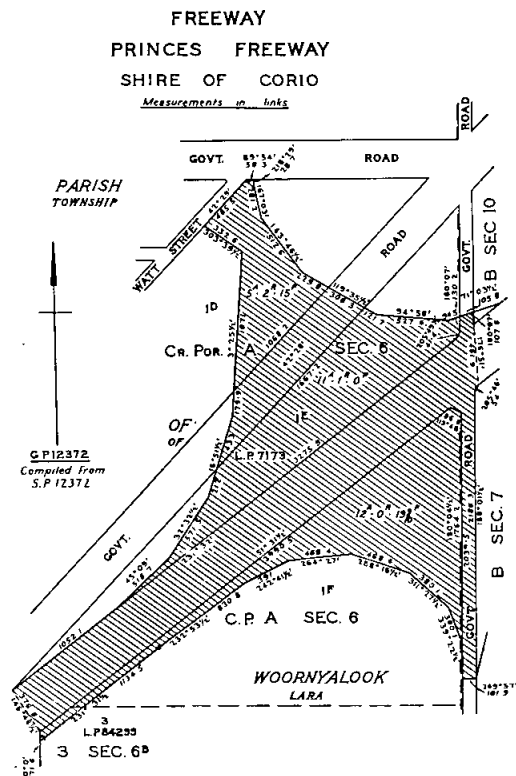
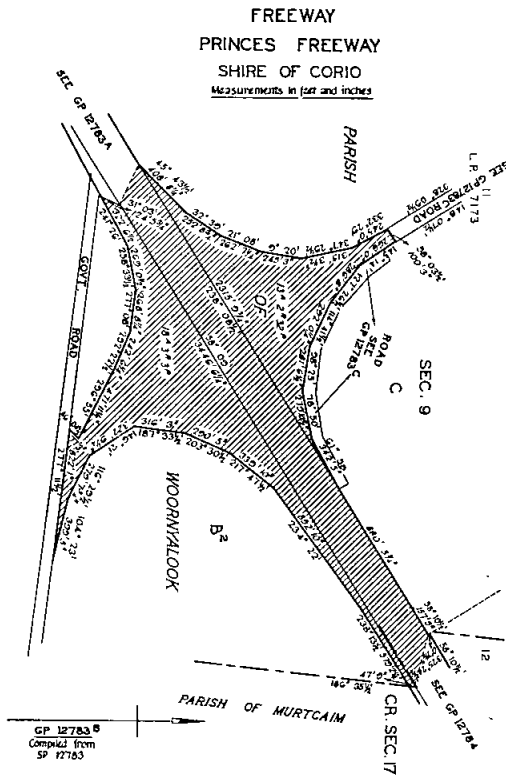

in the Shire of Werribee as shown hatched on plan numbered G.P.12839B hereunder to be part of a freeway within the meaning and for the purposes of the said Act.

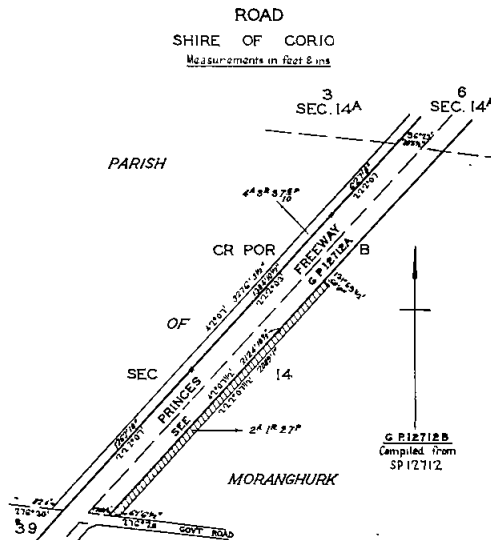
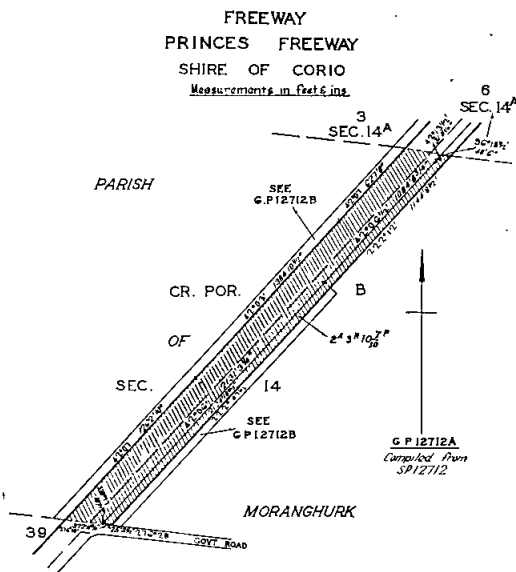
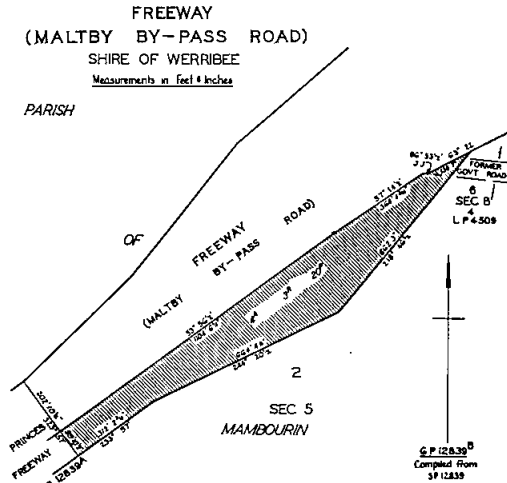
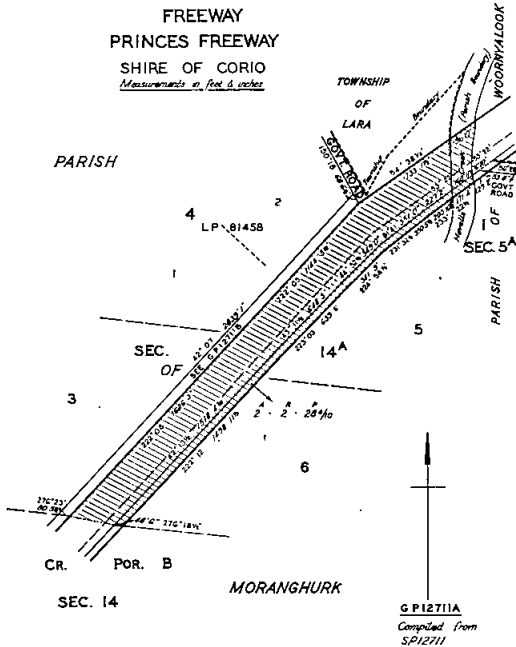

Unclassified Roads.

Resolution dated the seventeenth day of September, One thousand nine hundred and seventy-three, made pursuant to sections 21 and 110 of the Country Roads Act 1958, declaring the roads in the Shire of Corio as shown hatched on plans numbered G.P.12712B, G.P.12783c and G.P.12785B hereunder to be roads within the meaning and for the purposes of the said Act.

Resolution dated the seventeenth day of September, One thousand nine hundred and seventy-three, made pursuant to sections 21 and 101 of the Country Roads Act 1958, declaring the widening of a freeway (Maltby By-pass road)

COUNTRY ROADS BOARD.

RESOLUTIONS OF THE COUNTRY ROADS BOARD.

The Country Roads Board, in pursuance of the provisions of the Country Roads Act 1958, has passed Resolutions the dates whereof and the terms of which are Scheduled hereunder:—

SCHEDULE.

State Highways.

Resolution dated the Tenth day of September, One thousand nine hundred and seventy-three, made pursuant to sections 21 and 74 of the Country Roads Act 1958, declaring the widening of the Midland Highway in the Shire of Creswick as shown hatched on plans numbered G.P.12830A and G.P.12830B hereunder to be part of a State highway within the meaning and for the purposes of the said Act.

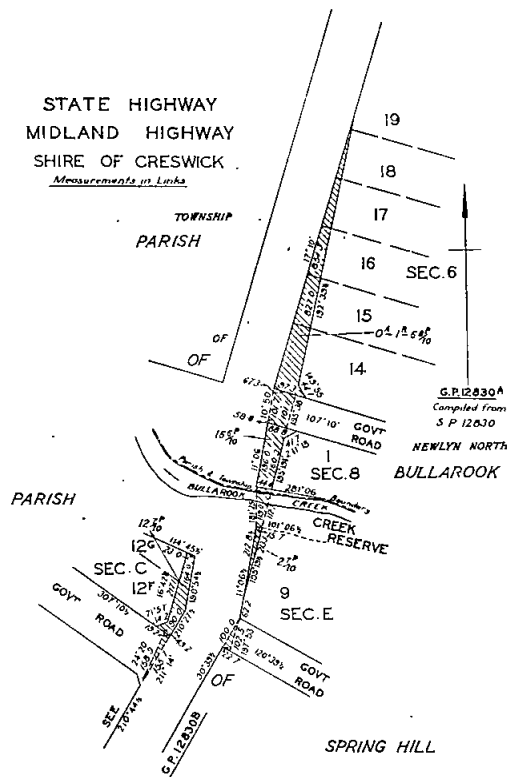
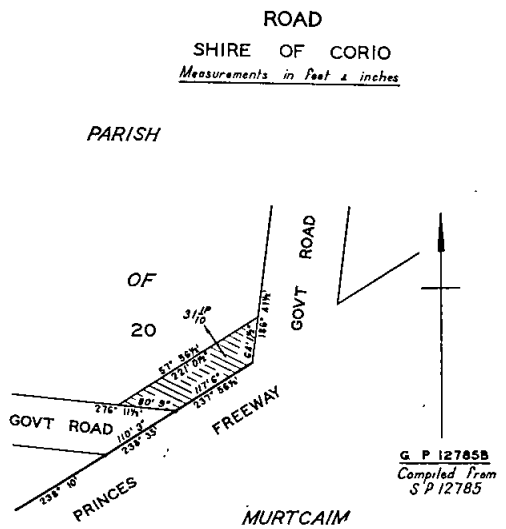
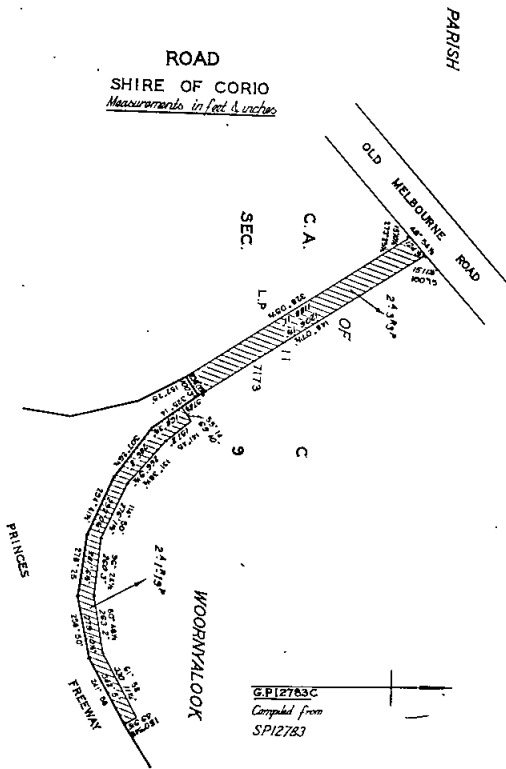

N. L. ALLANSON,  
Secretary.

20th September, 1973.

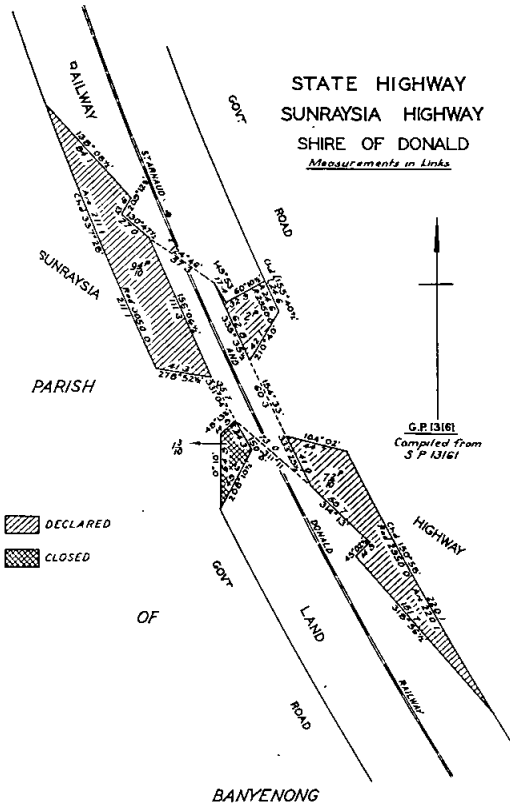
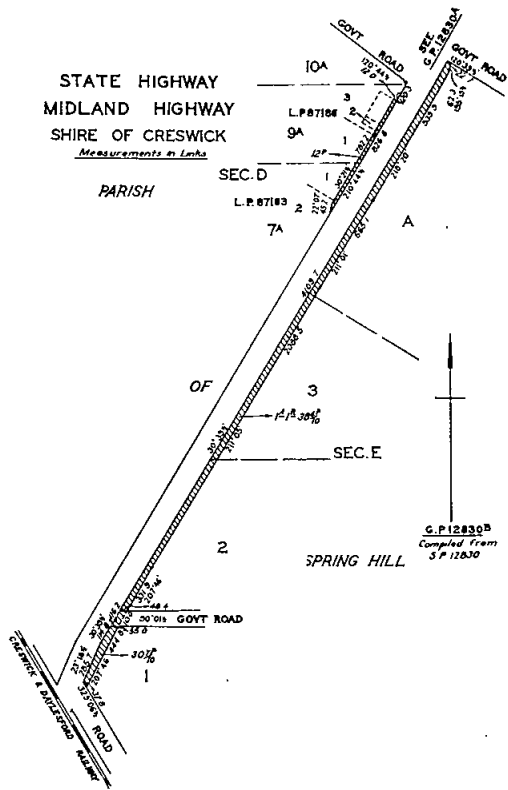

Resolution dated the Tenth day of September, One thousand nine hundred and seventy-three, made pursuant to sections 21, 58 and 74 of the Country Roads Act 1958, declaring the deviation from the Sunraysia Highway in the Shire of Donald as indicated by diagonal hatching on plans numbered G.P.12612<sup>B</sup> and G.P.13161 hereunder to be part of a State highway within the meaning and for the purposes of the said Act, and also declaring that such deviation shall be in lieu of the existing road or part thereof indicated by cross-hatching on plan numbered G.P.13161 and that such part of the said existing road shall be discontinued.

Resolution dated the Tenth day of September, One thousand nine hundred and seventy-three, made pursuant to sections 21 and 74 of the Country Roads Act 1958, declaring the widening of the Omeo Highway in the Shire of Tambo as shown hatched on plan numbered G.P.12680 hereunder to be part of a State highway within the meaning and for the purposes of the said Act.

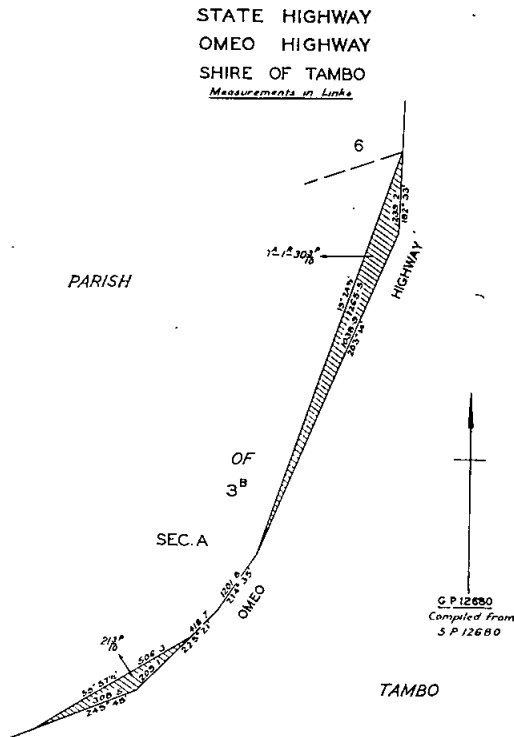
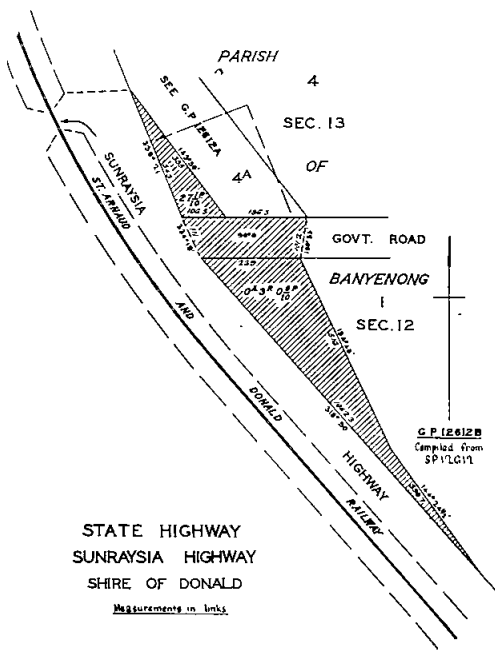

Resolution dated the Tenth day of September, One thousand nine hundred and seventy-three, made pursuant to sections 21 and 74 of the *Country Roads Act 1958*, declaring the widening of the Princes Highway in the Shire of Tambo as shown hatched on plan numbered G.P.13026 hereunder to be part of a State highway within the meaning and for the purposes of the said Act.

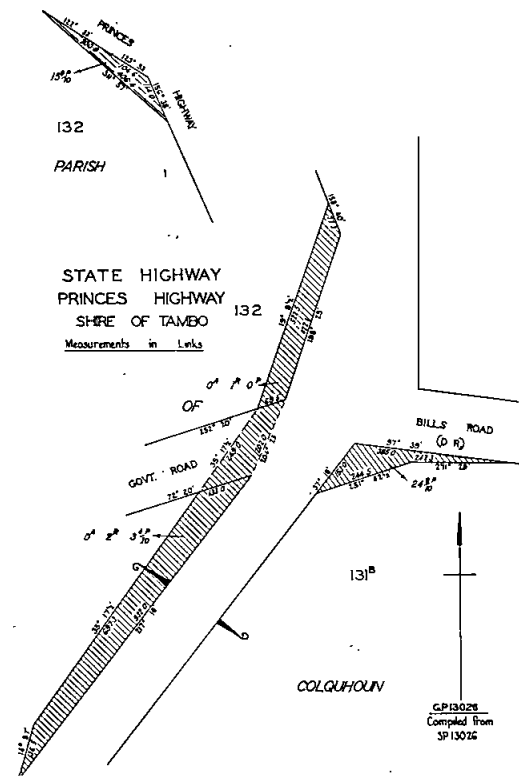

**Main Roads.**

Resolution dated the Tenth day of September, One thousand nine hundred and seventy-three, made pursuant to sections 21 and 58 of the *Country Roads Act 1958*, declaring the deviation from Jeeralang West-road in the Shire of Morwell, as indicated by diagonal hatching on plans numbered G.P.12988A, G.P.12988B, G.P.12988C, G.P.12989, G.P.12990A, G.P.12990B, G.P.12990C, G.P.12991A, G.P.12991B and G.P.12991C hereunder to be part of a main road within the meaning and for the purposes of the said Act, and also declaring that such deviation shall be in lieu of the existing road or part thereof indicated by cross-hatching on plans numbered G.P.12988A, G.P.12988B, G.P.12990A and G.P.12990C and that such part of the said existing road shall be discontinued.

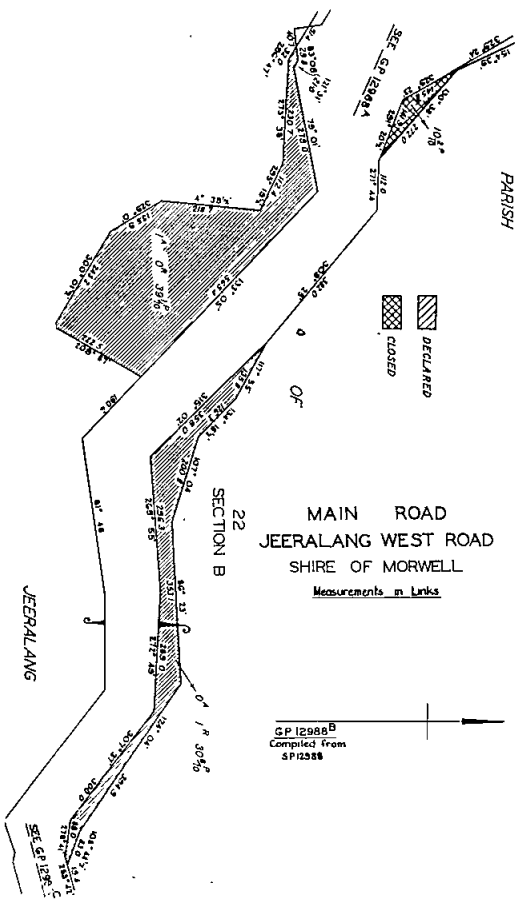
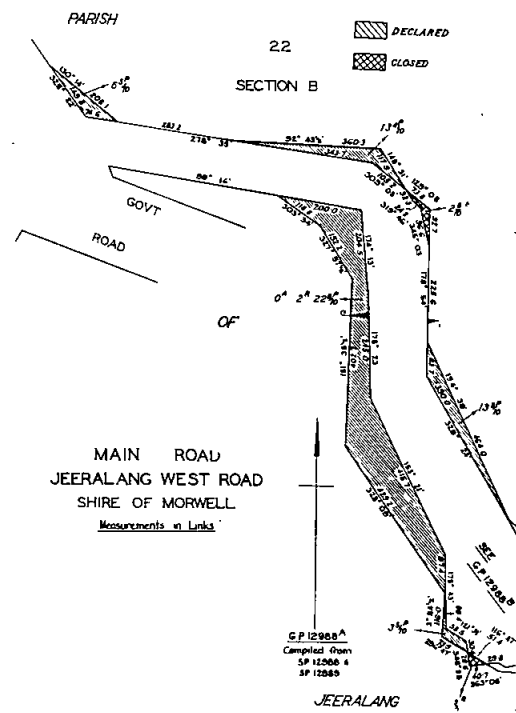



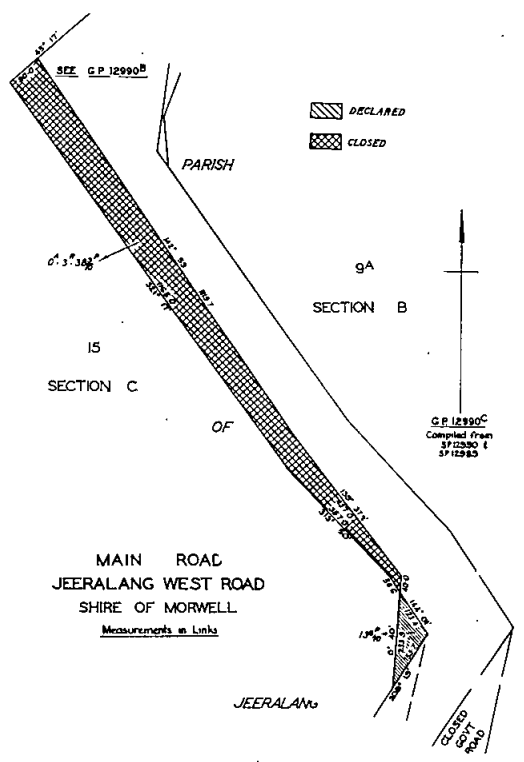
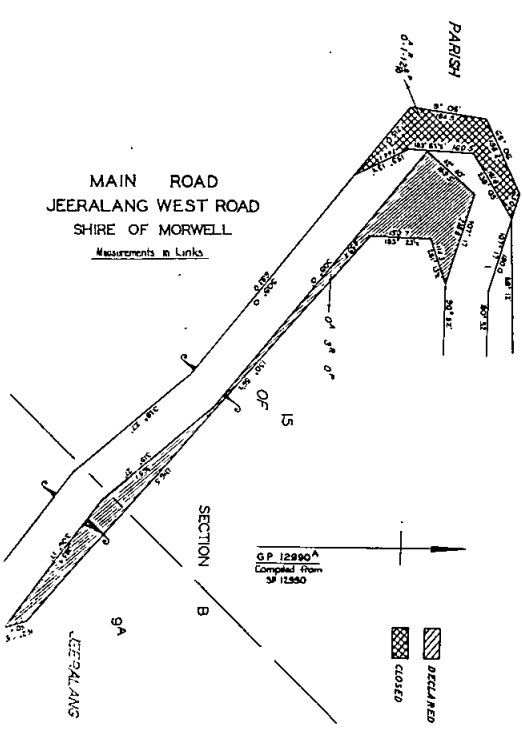
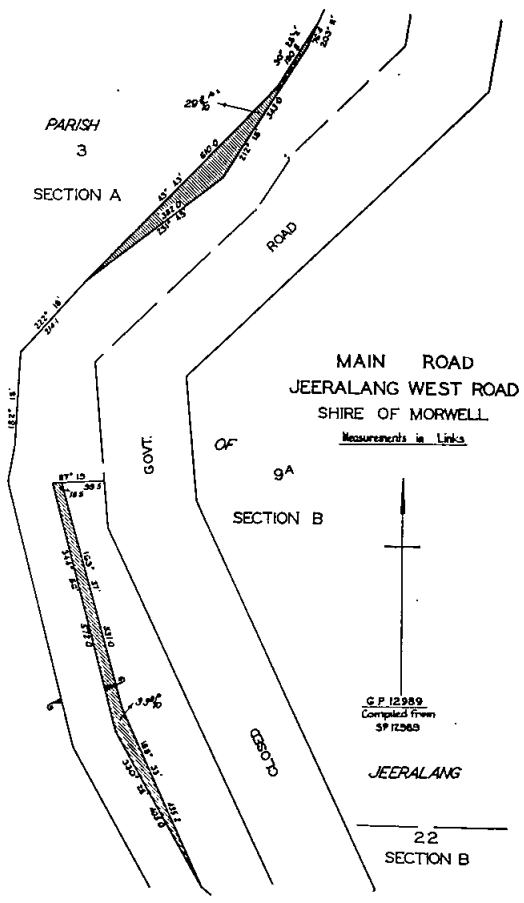
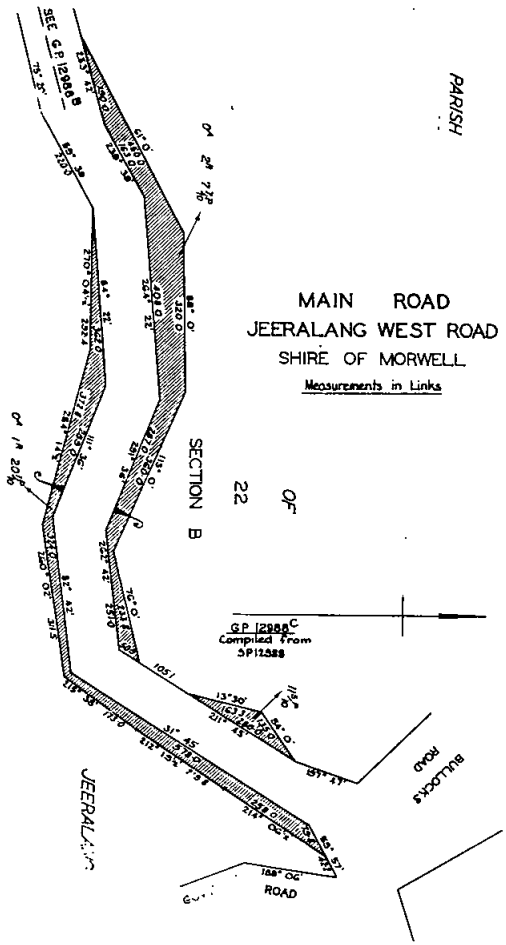

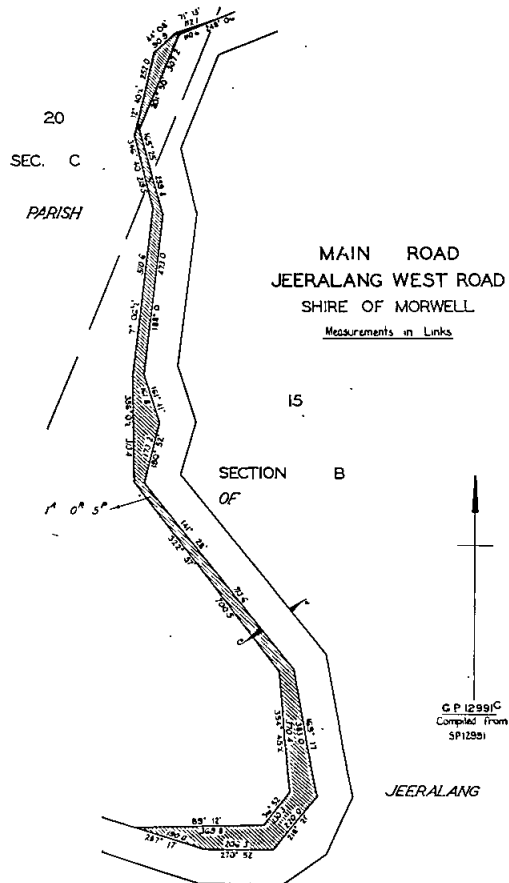
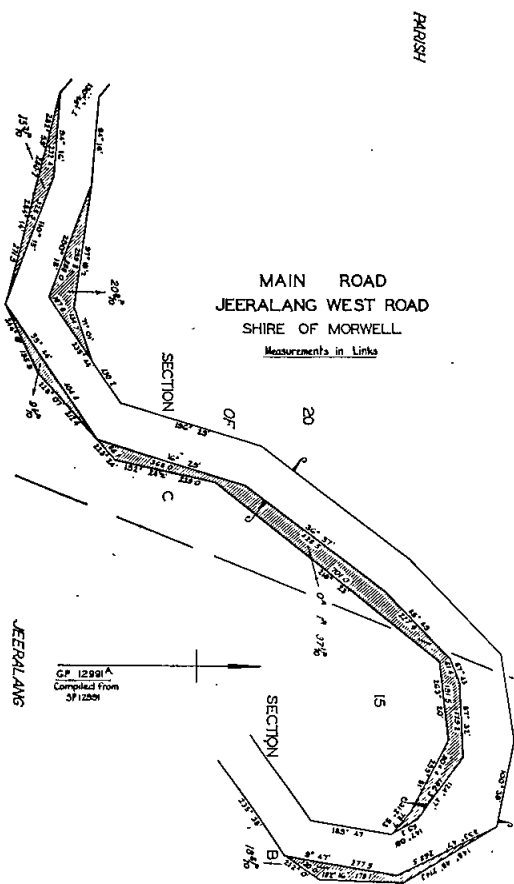
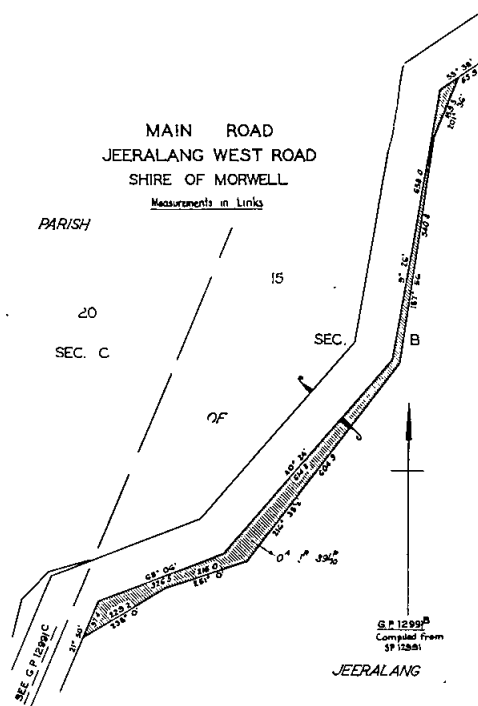
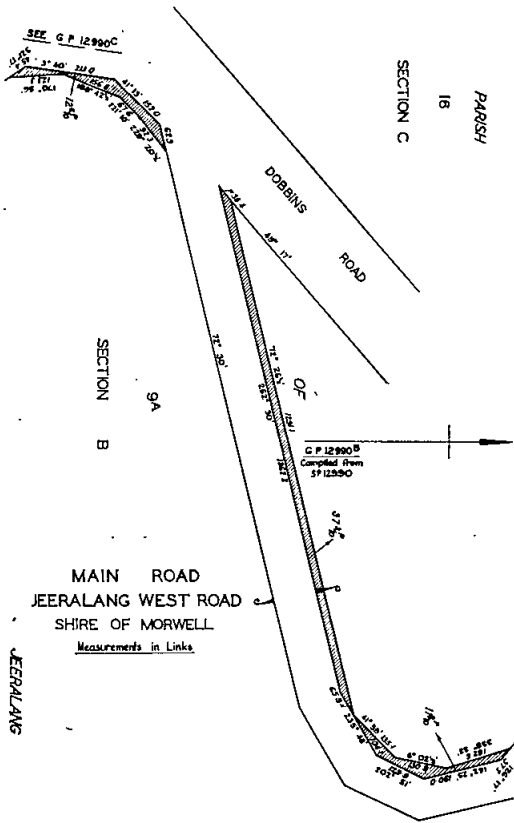

Resolution dated the Tenth day of September, One thousand nine hundred and seventy-three, made pursuant to section 21 of the *Country Roads Act 1958*, declaring the widening of the Gormandale—Stradbroke road in the Shire of Rosedale as shown hatched on plan numbered G.P.12866 hereunder to be part of a main road within the meaning and for the purposes of the said Act.

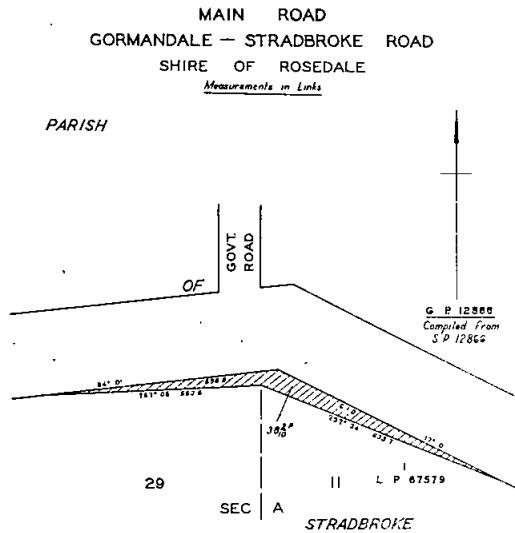

Resolution dated the Tenth day of September, One thousand nine hundred and seventy-three, made pursuant to section 21 of the *Country Roads Act 1958*, declaring the widening of the Kororoit Creek—road in the City of Williamstown as shown hatched on plan numbered G.P.10626 hereunder to be part of a main road within the meaning and for the purposes of the said Act.

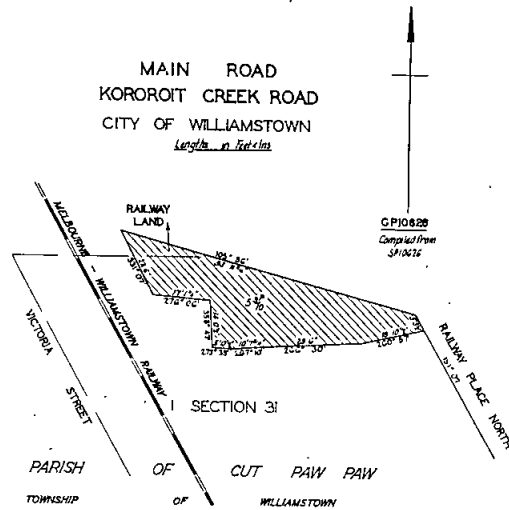

Resolution dated the Tenth day of September, One thousand nine hundred and seventy-three, made pursuant to section 21 of the *Country Roads Act 1958*, declaring the widening of the Belgrave—Gembrook road in the Shire of Sherbrooke as shown hatched on plan numbered G.P.13139 hereunder to be part of a main road within the meaning and for the purposes of the said Act.

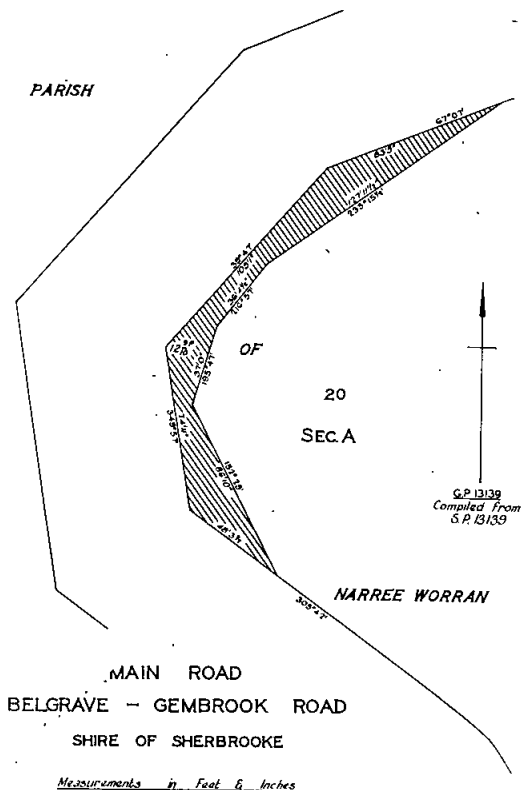

Resolution dated the Tenth day of September, One thousand nine hundred and seventy-three, made pursuant to section 21 of the *Country Roads Act 1958*, declaring the widening of the Birregurra—Forrest road, in the Shire of Winchelsea as shown hatched on plan numbered G.P.12900A hereunder to be part of a main road within the meaning and for the purposes of the said Act.

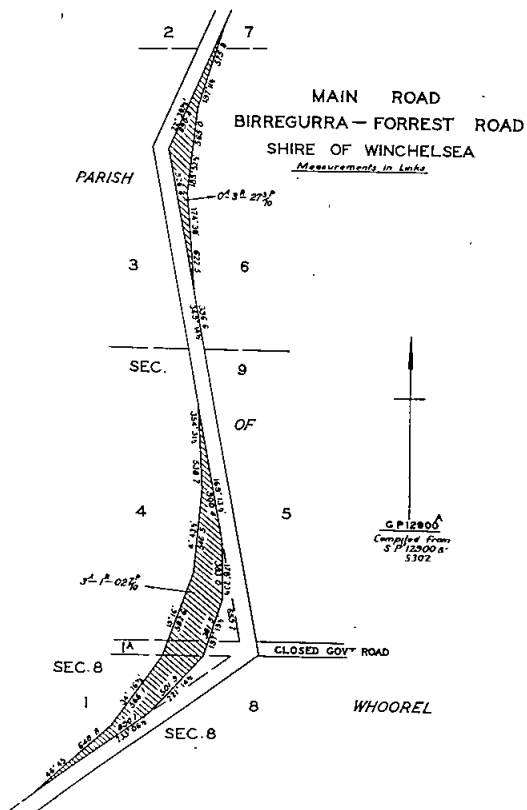

Resolution dated the Tenth day of September, One thousand nine hundred and seventy-three, made pursuant to sections 21 and 58 of the *Country Roads Act 1958*, declaring the deviation from Mardan-road in the Shire of Woorayl as indicated by diagonal hatching on plans numbered G.P.13183A, G.P.13183B, G.P.13184A and G.P.13184B hereunder to be part of a main road within the meaning and for the purposes of the said Act, and also declaring that such deviation shall be in lieu of the existing road or part thereof indicated by cross-hatching on plan numbered G.P.13184B and that such part of the said existing road shall be discontinued.

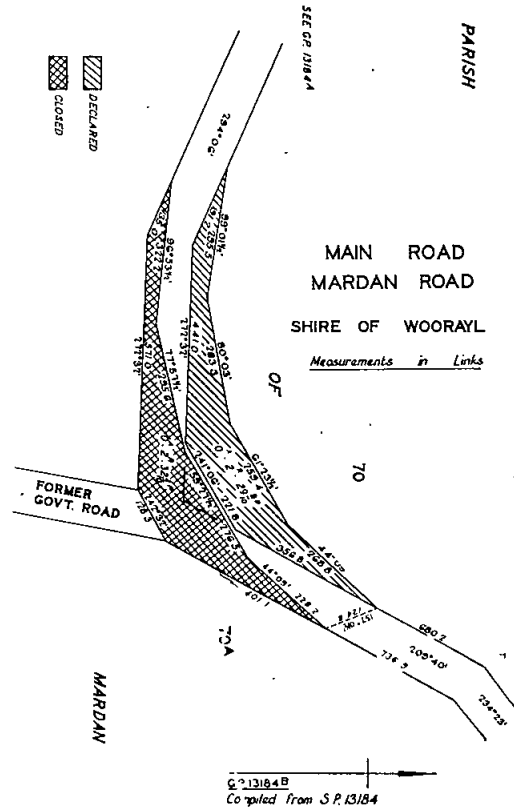
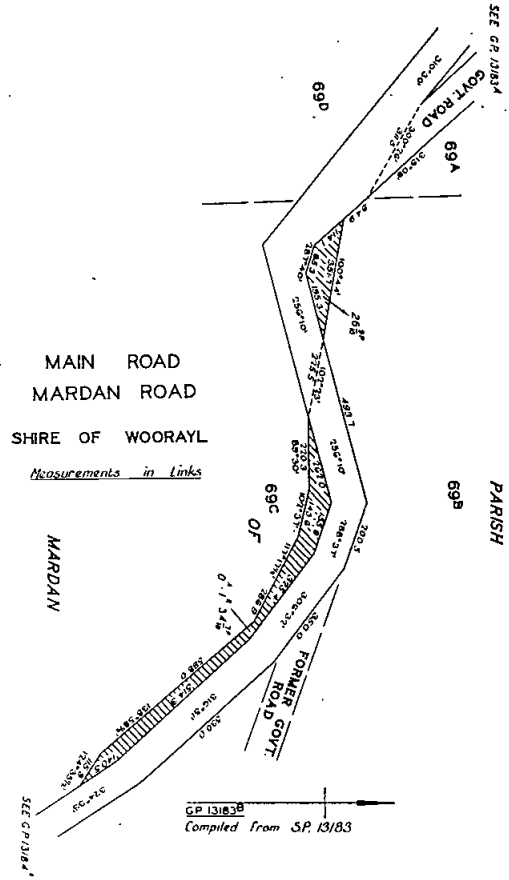
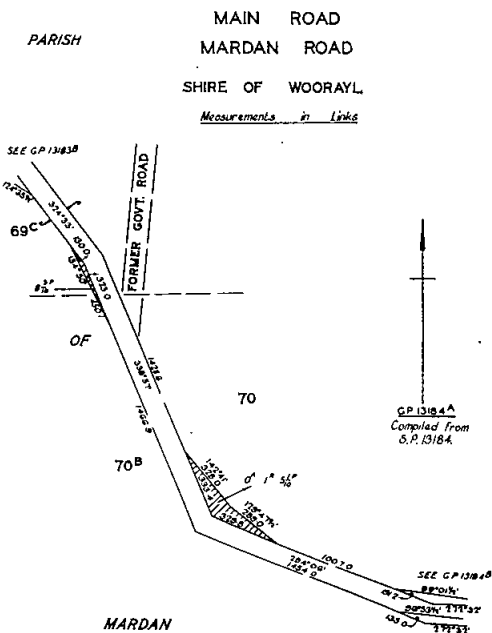
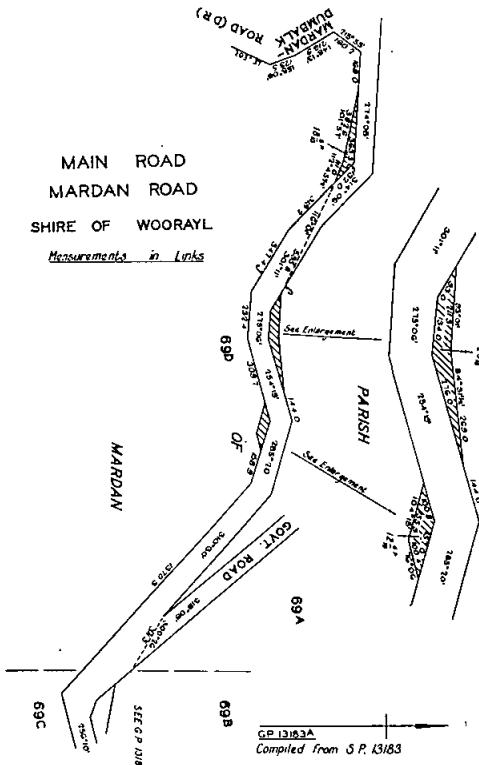

**Unclassified Roads.**

Resolution dated the Tenth day of September, One thousand nine hundred and seventy-three, made pursuant to sections 21 and 110 of the *Country Roads Act 1958*, declaring the widening of a road in the Shire of Donald as shown hatched on plan numbered G.P.12612A hereunder to be part of a road within the meaning and for the purposes of the said Act.

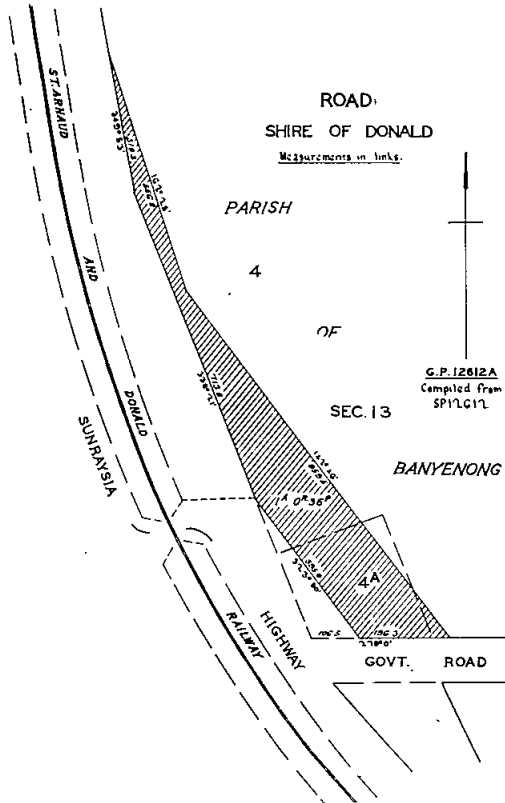

Resolution dated the Tenth day of September, One thousand nine hundred and seventy-three, made pursuant to sections 21 and 110 of the *Country Roads Act 1958*, declaring the widening of a road in the City of Waverley as shown hatched on plan numbered G.P.12686 hereunder to be part of a road within the meaning and for the purposes of the said Act.

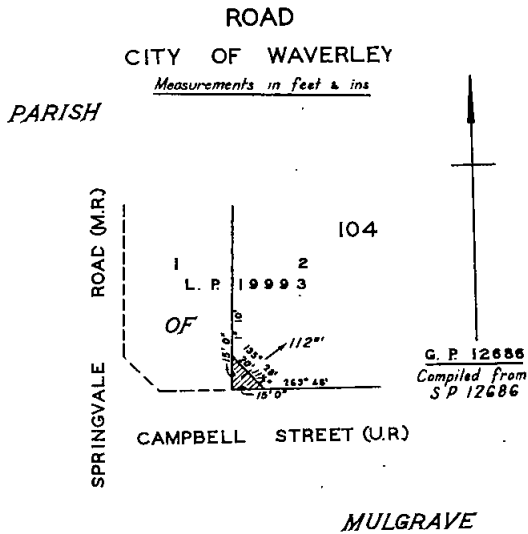

N. L. ALLANSON,  
Secretary.

18th September, 1973.

**Town and Country Planning Act 1961.**  
**CITY OF MILDURA PLANNING SCHEME.**

AMENDMENT No. 5, 1972.

*Notice of Approval.*

In pursuance of the powers conferred by the *Town and Country Planning Act 1961*, the Governor in Council on the 18th September, 1973, approved a Planning Scheme entitled the City of Mildura Planning Scheme, Amendment No. 5, 1972, in respect of the municipal district of the City of Mildura, and such planning scheme comes into operation on the date this notice of approval is published in the *Government Gazette*.

A copy of the Planning Scheme as approved may be inspected, free of charge, during office hours at the office of the Town and Country Planning Board, 235 Queen-street, Melbourne; at the office of the City of Mildura at Mildura, and when available, at the Office of Titles, Melbourne, and at the Central Plan Office of the Department of Crown Lands and Survey, Melbourne.

W. H. CRAIG, Secretary,  
Town and Country Planning Board.

**Town and Country Planning Act 1961.**  
**TOWN OF STAWELL PLANNING SCHEME 1963.**

AMENDMENT No. 3, 1972.

*Notice of Approval.*

In pursuance of the powers conferred by the *Town and Country Planning Act 1961*, the Governor in Council on the 18th September, 1973, approved a Planning Scheme entitled the Town of Stawell Planning Scheme 1963, Amendment No. 3, 1972, in respect of part of the municipal district of the Town of Stawell and such planning scheme comes into operation on the date this notice of approval is published in the *Government Gazette*.

A copy of the Planning Scheme as approved may be inspected, free of charge, during office hours at the office of the Town and Country Planning Board, 235 Queen-street, Melbourne; at the office of the Town of Stawell at Stawell; and when available, at the Office of Titles, Melbourne, and at the Central Plan Office of the Department of Crown Lands and Survey, Melbourne.

W. H. CRAIG, Secretary,  
Town and Country Planning Board.

**Town and Country Planning Act 1961.**  
**SHIRE OF BACCHUS MARSH PLANNING SCHEME**  
**INTERIM DEVELOPMENT ORDER.**

AMENDMENT No. 3.

*Notice of Amendment.*

In pursuance of the powers conferred by section 26 of the *Town and Country Planning Act 1961*, the Governor in Council, by and with the advice of the Executive Council on the 18th September, 1973, amended the Shire of Bacchus Marsh Planning Scheme Interim Development Order to extend the Bacchus Marsh urban area to cover Crown allotments 1, 2 and 3, section 15, Parish of Korkuperrimul, in Albert-street, Bacchus Marsh.

A copy of the amendment may be inspected during office hours at the office of the Town and Country Planning Board, 235 Queen-street, Melbourne, and at the office of the Council of the Shire of Bacchus Marsh at Bacchus Marsh.

W. H. CRAIG, Secretary,  
Town and Country Planning Board.

**Town and Country Planning Act 1961.**  
**SHIRE OF BACCHUS MARSH PLANNING SCHEME**  
**INTERIM DEVELOPMENT ORDER.**

AMENDMENT No. 4.

*Notice of Amendment.*

In pursuance of the powers conferred by section 26 of the *Town and Country Planning Act 1961*, the Governor in Council, by and with the advice of the Executive Council on the 18th September, 1973, amended the Shire of Bacchus Marsh Planning Scheme Interim Development Order to provide that Crown allotment A11, Parish of Myrning, can be subdivided into not more than two allotments and a road.

A copy of the amendment may be inspected during office hours at the office of the Town and Country Planning Board, 235 Queen-street, Melbourne, and at the office of the Council of the Shire of Bacchus Marsh at Bacchus Marsh.

W. H. CRAIG, Secretary,  
Town and Country Planning Board.

## Health Act 1958.

VICTORIA—DEPARTMENT OF HEALTH.

**NOTICE TO ATTEND FOR RADIOLOGICAL EXAMINATION.**

To all persons aged twenty-one years and over enrolled or resident in the subdivisions Specified hereunder in the State Electoral District of BRUNSWICK EAST.

Take notice that you are required to attend at a Department of Health X-ray Unit sited in the public street at or as near as possible to the main entrance to the premises specified in this notice, at any time between the hours specified on one of the days specified and during the period specified in respect of those premises, and thereat to submit yourself to radiological examination of the chest for the purpose of ascertaining whether you may be suffering from pulmonary tuberculosis. If you have had a Chest X-ray within the last twelve months and for this reason do not wish to be examined now, you should attend the unit as directed and submit particulars of the previous examination.

## SPECIFIED SUBDIVISIONS, PREMISES, PERIODS, DAYS AND HOURS.

Subdivision.	Premises.	Period.	Days.	Hours.
Brunswick East	Warr Reserve, De Carle-street, Brunswick	Friday, 5th October, 1973 and Monday, 8th October, 1973	Friday, 5th October, 1973 Monday, 8th October, 1973	From 10 a.m. to 8.30 p.m. From 10 a.m. to 8.30 p.m.
	Likatis' Milk Bar, cnr. George and Victoria streets, Brunswick	Friday, 5th October, 1973 to Tuesday, 9th October, 1973 (inclusive)	Each day during the period except Saturday, Sunday and Public Holidays	From 10 a.m. to 8.30 p.m.
	St. John's Hall, cnr. Davies and Holmes streets, Brunswick	Tuesday, 9th October, 1973 to Thursday, 11th October, 1973 (inclusive)	Each day during the period except Public Holidays	From 10 a.m. to 8.30 p.m.
	Cnr. Blyth and Lygon streets, Brunswick	Tuesday, 9th October, 1973 to Friday, 19th October, 1973 (inclusive)	Each day during the period except Saturday, Sunday and Public Holidays	From 10 a.m. to 8.30 p.m.
	Shell Service Station, 183 <sup>1/2</sup> Nicholson-street, Brunswick	Thursday, 11th October, 1973 to Tuesday, 16th October, 1973 (inclusive)	Each day during the period except Saturday, Sunday and Public Holidays	From 10 a.m. to 8.30 p.m.
Moreland	Shopping Centre, cnr. Blair-street and Sydney-road, Coburg	Tuesday, 9th October, 1973 and Wednesday, 10th October, 1973	Tuesday, 9th October, 1973 Wednesday, 10th October, 1973	From 10 a.m. to 8.30 p.m. From 10 a.m. to 8.30 p.m.
	King's Butcher Shop, cnr. Olengyle and Barrow streets, Coburg	Wednesday, 10th October, 1973 and Thursday, 11th October, 1973	Wednesday, 10th October, 1973 Thursday, 11th October, 1973	From 10 a.m. to 8.30 p.m. From 10 a.m. to 8.30 p.m.
Edward	B.O.N. Printing Works, 28 Edward-street, Brunswick	Wednesday, 10th October, 1973 and Thursday, 11th October, 1973	Wednesday, 10th October, 1973 Thursday, 11th October, 1973	From 10 a.m. to 8.30 p.m. From 10 a.m. to 8.30 p.m.
	Cnr. Park and Rath-downe streets, Carlton North	Friday, 12th October, 1973 and Monday, 15th October, 1973	Friday, 12th October, 1973 Monday, 15th October, 1973	From 10 a.m. to 8.30 p.m. From 10 a.m. to 8.30 p.m.
	Aupal Travel Agency, 62 Lygon-street, Brunswick East	Friday, 12th October, 1973 to Wednesday, 17th October, 1973 (inclusive)	Each day during the period except Saturday, Sunday and Public Holidays	From 10 a.m. to 8.30 p.m.
Fitzroy North	Merri State School, cnr. Ida and Miller streets, North Fitzroy	Friday, 12th October, 1973 to Tuesday, 16th October, 1973 (inclusive)	Each day during the period except Saturday, Sunday and Public Holidays	From 10 a.m. to 8.30 p.m.
	Cnr. Best-street and St. George's-road, North Fitzroy	Wednesday, 17th October, 1973 to Wednesday, 24th October, 1973 (inclusive)	Each day during the period except Saturday, Sunday and Public Holidays	From 10 a.m. to 8.30 p.m.
	National Bank, cnr. Del-bridge-street, and Queen's-parade, North Fitzroy	Monday, 22nd October, 1973 to Wednesday, 24th October, 1973 (inclusive)	Each day during the period except Public Holidays	From 10 a.m. to 8.30 p.m.
Carlton North	Kindergarten, cnr. Amess and Richardson streets, Carlton North	Tuesday, 16th October, 1973 to Friday, 19th October, 1973 (inclusive)	Each day during the period except Public Holidays	From 10 a.m. to 8.30 p.m.
	State School, cnr. Canning and Lee streets, Carlton	Wednesday, 17th October, 1973 to Monday, 22nd October, 1973 (inclusive)	Each day during the period except Saturday, Sunday and Public Holidays	From 10 a.m. to 8.30 p.m.
	Cnr. Paterson and Lygon streets, Princes Hill	Thursday, 18th October, 1973 to Monday, 22nd October, 1973 (inclusive)	Each day during the period except Saturday, Sunday and Public Holidays	From 10 a.m. to 8.30 p.m.
Clifton Hill	Police Station, cnr. Grant and Spensley streets, Clifton Hill	Monday, 22nd October, 1973 to Wednesday, 24th October, 1973 (inclusive)	Each day during the period except Public Holidays	From 10 a.m. to 8.30 p.m.
	Darling Gardens, North-terrace (Near Hoddle-street), Clifton Hill	Tuesday, 23rd October, 1973 and Wednesday, 24th October, 1973	Tuesday, 23rd October, 1973 Wednesday, 24th October, 1973	From 10 a.m. to 8.30 p.m. From 10 a.m. to 8.30 p.m.
	Primary School, Spensley-street, Clifton Hill	Tuesday, 23rd October, 1973 and Wednesday, 24th October, 1973	Tuesday, 23rd October, 1973 Wednesday, 24th October, 1973	From 10 a.m. to 8.30 p.m. From 10 a.m. to 8.30 p.m.

NOTE.—Any person to whom this notice applies and who without reasonable excuse fails to comply with the requirements of the notice shall be guilty of an offence, and shall be liable to a penalty of not more than five hundred dollars.

Dated this thirtieth day of August, One thousand nine hundred and seventy-three.

B. P. McCLOSKEY, Acting Chief Health Officer.

Private Agents Act 1966.

NOTICE OF RECEIPT OF APPLICATION FOR LICENCES UNDER THE PROVISIONS OF THE PRIVATE AGENTS ACT 1966.

The Clerk(s) of the Magistrates' Court(s) as listed hereunder hereby give notice that applications, as under, have been lodged for hearing by the said Court(s) on the date(s) specified.

Any person desiring to object to any of such applications must—

- (a) lodge with the respective Clerk of the Magistrates' Court a notice in the prescribed form of his objection and of the grounds thereof;
- (b) cause a copy of such notice to be served personally or by post upon the applicant at least three days before the hearing of the application; and
- (c) send or deliver—
  - (i) where the objection is not made by the officer in charge of the police district in which the Court is situated—a copy of the notice to such officer; and
  - (ii) where the objection is not made by the Registrar or Deputy Registrar—a copy to the Registrar.

Full Name of Applicant or in the Case of a Firm or Corporation of the Nominee.	Place of Abode of Applicant or Nominee.	Name of Firm or Corporation.	Address for Registration.	Type of Licence.	Date of Hearing of Application.
--	---	------------------------------	---------------------------	------------------	---------------------------------

MAGISTRATES' COURT, SHEPPARTON.

Haycock, Douglas Lionel ..	23 Philip-street, Shepparton	.. .. .	c/o Mayne Nickless, 41 Nixon-street, Shepparton	Watchman ..	5.10.73
----------------------------	------------------------------	---------	---	-------------	---------

Dated at Shepparton this 13th day of September, 1973.

W. J. JEFFREY, Clerk of the Magistrates' Court.

MAGISTRATES' COURT, SALE.

White, Barry John ..	8 Elston-court, Sale	Sale Security Agents	8 Elston-court, Sale	Guard Agent ..	2.10.73
----------------------	----------------------	----------------------	----------------------	----------------	---------

Dated at Sale this 11th day of September, 1973.

M. W. GERKENS, Clerk of the Magistrates' Court.

MAGISTRATES' COURT, NORTHCOTE.

Dick, Frederick Gordon ..	6/19 Rathmines-street, Fairfield	.. .. .	.. .. .	Inquiry Agent ..	5.10.73
---------------------------	----------------------------------	---------	---------	------------------	---------

Dated at Northcote this 13th day of September, 1973.

J. G. DENAHY, Clerk of the Magistrates' Court.

MAGISTRATES' COURT, SPRINGVALE.

Quinn, Jeffrey Thomas ..	5 Wattle-tree-road, Fern-tree Gully	Mayne Nickless Ltd.	94 York-street, South Melbourne	Watchman ..	5.10.73
Maxwell, Don Crawford ..	304 Warrigal-road, Cheltenham	" " "	" " "	" ..	"

Dated at Springvale this 13th day of September, 1973.

J. B. DENNIS, Clerk of the Magistrates' Court.

MAGISTRATES' COURT, OAKLEIGH.

Kelly, Rowland Garnet ..	Pangatter Farm, Cape Schank-road, Cape Schank	Mulgrave Security Pty. Ltd.	6-8 Hamilton-place, Mount Waverley	Watchman ..	5.10.73
Erbacher, Harold Emil ..	29 Hensen-street, Mt. Waverley	" " "	" " "	" ..	"

Dated at Oakleigh this 14th day of September, 1973.

G. F. MEEHAN, Clerk of the Magistrates' Court.

MAGISTRATES' COURT, FOOTSCRAY.

Fogarty, John ..	120 Mt. Alexander-road, Flemington	.. .. .	4 Cross-street, West Footscray	Watchman ..	12.10.73
------------------	------------------------------------	---------	--------------------------------	-------------	----------

Dated at Footscray this 18th day of September, 1973.

D. A. THOMPSON, Clerk of the Magistrates' Court.

MAGISTRATES' COURT, MORWELL.

Edmiston, Mark Allan ..	48 Williams-avenue, Churchill	Guard Roger Pedley	101 Grey-street, Traralgon	Watchman ..	5.10.73
-------------------------	-------------------------------	--------------------	----------------------------	-------------	---------

Dated at Morwell this 17th day of September, 1973.

D. M. CRANE, Clerk of the Magistrates' Court.

MAGISTRATES' COURT, BOX HILL.

Lavalle, John Arthur ..	2 Ashburton-drive, Mitcham	.. .. .	2 Ashburton-drive, Mitcham	Inquiry Agent ..	19.10.73
-------------------------	----------------------------	---------	----------------------------	------------------	----------

Dated at Box Hill this 17th day of September, 1973.

R. J. McALLISTER, Clerk of the Magistrates' Court.

MAGISTRATES' COURT, BOX HILL.

Smarrelli, Tony ..	52 Albion-road, Box Hill	.. .. .	52 Albion-road, Box Hill	Inquiry Agent ..	11.10.73
--------------------	--------------------------	---------	--------------------------	------------------	----------

Dated at Box Hill this 14th day of September, 1973.

R. J. McALLISTER, Clerk of the Magistrates' Court.

MAGISTRATES' COURT, COBURG.

Foster, Rex James ..	11 Scarborough-drive, Rosanna	Mayne Nickless Ltd.	94 York-street, South Melbourne	Watchman ..	9.10.73
----------------------	-------------------------------	---------------------	---------------------------------	-------------	---------

Dated at Coburg this 19th day of September, 1973.

V. McDONALD, Clerk of the Magistrates' Court.

PRIVATE AGENTS—continued.

Full Name of Applicant or in the Case of a Firm or Corporation, of the Nominee.	Place of Abode of Applicant or Nominee.	Name of Firm or Corporation.	Address for Registration.	Type of Licence.	Date of Hearing of Application.
MAGISTRATES' COURT, SPRINGVALE.					
Anderson, James Loch	Lot 13, Simpson-drive, North Dandenong		21 Clarke-road, Springvale	Watchman	12.10.73
Dated at Springvale this 20th day of September, 1973.					
J. B. DENNIS, Clerk of the Magistrates' Court.					
MAGISTRATES' COURT, MALVERN.					
McNulty, Donald George	445 Elizabeth-street, Melbourne	Security Watching Co. Pty. Ltd.	281 High-street, Ashburton	Watchman	22.10.73
Dated at Malvern this 20th day of September, 1973.					
P. J. RODDA, Clerk of the Magistrates' Court.					

ERRATUM.

In the Order in Council published on pages 3259 and 3260 of *Government Gazette*, No. 90, of the 19th September, 1973, amending an Order consenting to the Bendigo Sewerage Authority borrowing the sum of \$31,200, for the expression—  
 "LOAN NO. B.5",  
 substitute the expression—  
 "LOAN NO. B.S."

ERRATUM.

LANDLORD AND TENANT ACT 1958.  
 In the Order in Council extending the application of Part V. of the *Landlord and Tenant Act 1958* to certain premises, published on page 3258 of *Government Gazette*, No. 90, of the 19th September, 1973, for the expression—  
 "doth hereby declare that the application of Part VI. of the *Landlord and Tenant Act 1958* shall extend to the following premises . . .",  
 substitute the expression—  
 "doth hereby declare that the application of Part V. of the *Landlord and Tenant Act 1958* shall extend to the following premises . . .".

Co-operation Act 1958.

2ND SEAFORD BOY SCOUT CO-OPERATIVE LIMITED.  
 NOTICE OF DISSOLUTION OF SOCIETY.  
 Notice is hereby given that I have this day registered the dissolution of the above-named society and cancelled its registration under the above-named Act.  
 Dated at Melbourne, this 19th day of September, 1973.  
 J. W. JUNGWIRTH,  
 Registrar of Co-operative Societies.

Co-operation Act 1958.

BULLEEN PRIMARY SCHOOL CO-OPERATIVE LIMITED.  
 NOTICE OF DISSOLUTION OF SOCIETY.  
 Notice is hereby given that I have this day registered the dissolution of the above-named society and cancelled its registration under the above-named Act.  
 Dated at Melbourne, this 20th day of September, 1973.  
 J. W. JUNGWIRTH,  
 Registrar of Co-operative Societies.

DRAINAGE AREAS ACT.

SPECIAL MAINTENANCE CHARGE NO. 4 MADE BY THE WARRNAMBOOL SHIRE COUNCIL IN RESPECT OF THE NULLAWARRE DRAINAGE AREA.  
 Notice is hereby given that on the 18th day of September, 1973, in pursuance of the provisions of section 36 of the *Drainage Areas Act 1958*, the Governor in Council approved of the estimate of the cost of the proposed maintenance works in the Nullawarre Drainage Area submitted by the Warrnambool Shire Council, and of the making by the Council of a Special Maintenance Charge on properties within the said drainage area for the year ending 30th September, 1973.

T. J. FORRISTAL,  
 Clerk of the Executive Council.  
 At the Executive Council Chamber,  
 Melbourne, 18th September, 1973.

SHIRE OF BARRABOOL.

ROAD DEVIATION ORDER.

Pursuant to the provisions of sections 522 and 526 of the *Local Government Act 1958*, the Council of the Shire of Barrabool hereby directs that the land in the Parish of Duneed indicated by hatching on the diagram hereunder, which has been purchased taken or acquired by it shall be a public highway on and from the date of publication of this order in the *Government Gazette*, and declares that such land shall be a public highway in lieu of the land indicated by cross-hatching on the said diagram.

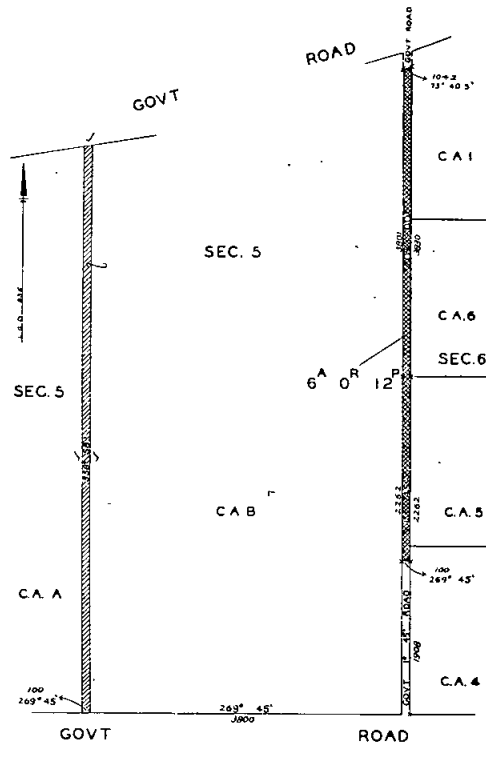

The common seal of the President, Councillors and Ratepayers of the Shire of Barrabool was hereto affixed this 24th day of August, 1973, in the presence of—

(SEAL) R. W. PETTITT, President.  
 L. R. NEWMAN, Councillor.  
 GRAEME L. PEARCE, Shire Secretary.

Confirmed by the Governor in Council, 18th September, 1973.—T. J. FORRISTAL, Clerk of the Executive Council.



*Pounds Act 1958.*  
SHIRE OF YEA.

Table of rates to be charged for the trespass of cattle, their conveyance to the Pound where motor transport is used and their sustenance while impounded, fixed by the Council of the Shire of Yea.

*A. For Trespass.*

Description of Cattle Trespassing.	Upon Tillage Land Enclosed by a Substantial Fence.	Upon Land other than Tillage Land Enclosed by a Substantial Fence.
	\$	\$
For every sheep .. .. .	0.20	0.03
For every goat .. .. .	2.00	0.50
For every pig .. .. .	2.00	0.50
For every head of other cattle ..	2.00	1.00
	\$	
In addition for the trespass of any entire horse ..	20.00	
In addition for the trespass of any bull ..	10.00	
In addition for the trespass of any ram ..	5.00	

*B. For Transport.*

Description of Cattle.	Amount.
	\$
For every sheep .. .. .	0.50
For every entire horse any bull or any ram ..	8.00
For every head of other cattle .. .. .	4.00

*C. For Sustenance.*

Description of Cattle.	Amounts to be Charged Daily for Sustenance While Impounded.
	\$
For every sheep .. .. .	0.10
For every goat .. .. .	0.20
For every pig .. .. .	0.40
For every head of other cattle .. .. .	1.00

By Order of the Council,  
F. F. BERKERY,  
Shire Secretary.

Approved by the Governor in Council, 18th September, 1973.  
—T. J. FORRISTAL, Clerk of the Executive Council.

RECREATION VEHICLES ACT 1973, SECTION 12 (3).

Notice is hereby given that, for the purpose of section 12 (3) of the *Recreation Vehicles Act 1973*, approval has been granted to the associations listed below to organize and conduct official motor vehicle races in which recreation vehicles participate.

- Western Suburbs Mini-Bike Club.
- Geelong Mini-Bike Club.
- Springvale Mini-Bike Club.

A. L. CARMICHAEL,  
Acting Chief Commissioner.

RECREATION VEHICLES ACT 1973, SECTION 12 (3).

Notice is hereby given that, for the purpose of section 12 (3) of the *Recreation Vehicles Act 1973*, approval has been granted to the associations listed below to organize and conduct official motor vehicle races in which recreation vehicles participate.

- Trail Wheels of Nunawading Club.
- Bill Paterson—Ringwood Pty. Ltd.

R. JACKSON,  
Chief Commissioner of Police.

Teaching Service (Teachers Tribunal) Regulations.  
ELECTION OF A MEMBER AND DEPUTY MEMBER OF THE COMMITTEE OF CLASSIFIERS FOR THE PRIMARY SCHOOLS DIVISION.

Pursuant to clause 12 of Regulation 2 of the Teaching Service (Teachers Tribunal) Regulations at the election of a Member of the Committee of Classifiers for the Primary Schools Division, Phillip Thurlby Dwyer was the only candidate duly nominated, and I hereby declare the said—

PHILLIP THURLBY DWYER  
to be duly elected to the office of Member of the Committee of Classifiers for the Primary Schools Division for the period commencing on 17th November, 1973.

I further advise that for the election of a Deputy to such Member, to be held on Thursday the 8th November, 1973, the following candidates have been duly nominated, namely:—

DEPUTY MEMBER.

*Candidate; Department; Branch.*

- John Michael Kelly; Education Department; Heatherdale Primary School.
- Terence Kingston; Education Department; Williamstown North Primary School.
- Jack Ellis Reilly; Education Department; Croydon West Primary School.
- Robert James Storey; Education Department; Moomba Park Primary School.
- Maxwell Graham Walker; Education Department; Doveton North Primary School.

J. T. MINTER,  
Returning Officer.

Education Department, Treasury-place, Melbourne, 17th September, 1973.

Dairy Products Act.  
QUOTAS FOR BUTTER AND CHEESE.

BUTTER QUOTA.

I, Ian Winton Smith, Minister of Agriculture in the State of Victoria, after consultation with the Victorian Dairy Products Board, and after ascertaining that the supply and distribution of butter at reasonable prices to consumers thereof in Victoria will be ensured, hereby determine a quota for butter as follows:—

The proportion shall be thirty-five point nine per centum. The period for which this quota is to operate shall be the month of October, 1973.

CHEESE QUOTA.

I, Ian Winton Smith, Minister of Agriculture in the State of Victoria, after consultation with the Victorian Dairy Products Board, and after ascertaining that the supply and distribution of cheese at reasonable prices to consumers thereof in Victoria will be ensured, hereby determine a quota for cheese as follows:—

The proportion shall be twenty-four point seven zero per centum. The period for which this quota is to operate shall be the month of October, 1973.

I. W. SMITH,  
Minister of Agriculture.

PUBLIC WORKS DEPARTMENT.

TONNAGE DUTY.

His Excellency the Governor of the State of Victoria, by and with the advice of the Executive Council thereof, by Order made on the 18th day of September, 1973, and pursuant to the provisions of the *Marine Act 1958*, as from fourteen (14) days after the date of the Order, doth fix—

- (1) a duty of fifteen cents per gross ton to be payable on all ships arriving in any port in Victoria, provided that no ship shall be liable to pay the said duty more than once within any six months; and
- (2) in respect of any ship arriving in any port in Victoria in ballast, in lieu of (1) above, a duty of five cents per gross ton per trip to be payable, but so that the total amount, so paid on any such ship shall not exceed ten cents per gross ton within any six months.

T. J. FORRISTAL,  
Clerk of the Executive Council.

At the Executive Council Chamber,  
Melbourne, 18th September, 1973.

State Savings Bank Act 1958, Section 30.  
THE STATE SAVINGS BANK OF VICTORIA.  
ESTABLISHMENT OF BRANCH.

The Commissioners of The State Savings Bank of Victoria, hereby give notice of the establishment of Corio Village Branch of the Bank, at Lot 7, Purnell-road, Corio, 3124, on 3rd October, 1973.

D. ROSS,  
General Manager.

Co-operative Housing Societies Act 1958.  
ASSOCIATED TOBACCO COMPANIES CO-OPERATIVE  
HOUSING SOCIETY No. 2 LIMITED.

NOTICE OF DISSOLUTION OF SOCIETY.

Notice is hereby given that I have this day registered the dissolution of the above-named society and cancelled its registration under the above-named Act.

Dated at Melbourne this 10th day of September, 1973.

R. F. SCOLLARD,  
Deputy Registrar of Co-operative Housing Societies.

DEPARTMENT OF MINES.

Subject to any necessary excisions &c., it is proposed to grant the following mining lease:—

- 47, Mining Lease; Wattle Gully Gold Mines No Liability; 927a. 0r. 34p., Parishes of Castlemaine, Chewton and Fryers.

APPLICATIONS FOR LEASES DECLARED ABANDONED.

- 9180, Mineral; Ray Borchers, Stanley Lincoln, Duncan McLean and Arthur Hamilton; 640 acres, Parish of Manago.  
11392, Bendigo; Peter Francis Austin; 86a. 2r. 24p., Parish of Derril.

APPLICATIONS FOR MINING LEASES REFUSED.

- 150, Mining Lease; Michael Richard Martindale Stephens; 120 acres, Parish of Kimbolton.  
163, Mining Lease; Mildura Plaster Mills Pty. Ltd.; 300 acres, Parish of Goonegul.

MINING LEASES GRANTED.

- 113, Mining Lease; Samuel Phillip Farley; 7a. 0r. 7p., Parish of Budgerum East.  
126, Mining Lease; Steetley Australasia Pty. Limited, 5a. 3r. 26p., Parish of Bungal.  
9284, Castlemaine; Ronald Dowell, Barry Lyons and Robert Henderson; 23a. 1r. 18p., Parish of Maldon.  
5647, Gippsland; Burton Alexander Terry, Phillip Thomas Gude and David James Denner; 23a. 0r. 12p., Parish of Bogong.

MINING LEASE TRANSFERRED.

- 8632, Mineral; From David Alexander Owen Clinton to James Edward Nason, Robert Burdett and Leslie Rubinstein.

EXPLORATION LICENCES GRANTED.

- 503, Exploration Licence; C.R.A. Exploration Pty. Limited; 175 square miles, County of Dargo.  
504, Exploration Licence; C.R.A. Exploration Pty. Limited; 25 square miles, County of Dargo.

APPLICATIONS FOR MINERAL SEARCH LICENCES  
DECLARED ABANDONED.

- 1096, Mineral Search Licence; Gippsland Minerals No Liability; 3,360 acres. Parishes of Guttamurra and Jinderboine.  
1097, Mineral Search Licence; Gippsland Minerals No Liability; 2,000 acres, Parish of Guttamurra.

MINERAL SEARCH LICENCE GRANTED.

- 1098, Mineral Search Licence; Harold Jack Helms, Huon Stevens and Peter Crowe; 15a. 0r. 0p., Parish of Nerran.

APPLICATIONS FOR TAILINGS LICENCES DECLARED  
ABANDONED.

- 3807, Tailings Licence; Ocean Resources N.L.; to treat tailings, Township of Eaglehawk.  
3808, Tailings Licence; Ocean Resources N.L.; to treat tailings, Township of Eaglehawk.  
3809, Tailings Licence; Ocean Resources N.L.; to treat tailings, Township of Eaglehawk.  
3810, Tailings Licence; Ocean Resources N.L.; to treat tailings, Parish of Sandhurst.  
3811, Tailings Licence; Ocean Resources N.L.; to treat tailings, Parish of Nerring.  
3812, Tailings Licence; Ocean Resources N.L.; to treat tailings, Parish of Nerring.  
3813, Tailings Licence; Ocean Resources N.L.; to treat tailings, Parish of Nerring.

TAILINGS LICENCES GRANTED.

- 3888, Tailings Licence; William Akers; to remove tailings from the mullock dump known as the "Caledonia Mine" dump, Parish of Dunolly.  
3891, Tailings Licence; William Akers; to remove tailings from the mine mullock dump known as the "Sydenham Mine" dump, Parish of Dunolly.  
3916, Tailings Licence; Country Roads Board; to remove tailings from the Long Tunnel Mine Dump, Parish of Walhalla.

J. C. M. BALFOUR,  
Minister of Mines.

MINING LEASES DECLARED VOID.

- 9153, Mineral; Gippsland Minerals No Liability; 31a. 0r. 24p., Parish of Sargood.  
7147, Maryborough; Walter Lewis Griffiths, Peter Griffiths; 20a. 3r. 4p., Parish of Maryborough.

E. CONDON,  
Secretary for Mines.

PUBLIC TRUSTEE ACT 1958 (No. 6350), SECTION 17.

I hereby give notice that on the 4th September, 1973, the Public Trustee filed elections to administer the following deceased persons' estates, in accordance with section 17 of the Public Trustee Act 1958:—

BONE, CATHERINE LOUISE, late of 15 Clyde-street, St. Kilda, spinster, died 3rd May, 1973.

COE, ERNEST ROBERT, formerly of Repatriation General Hospital, Heidelberg, but late of 34 Rosemount-terrace, Windsor, Brisbane, salesman, died 10th May, 1973.

CROTTY, MAURICE, late of Flat 5, 8 Ridgeway-avenue, Kew, pensioner, died 23rd January, 1969.

FISHER, CAROLINE HENRIETTA, late of Gippsland Home and Hospital, McKean-street, Bairnsdale, spinster, died 15th April, 1973.

JOSLYN, KENNETH, late of 20 Lewisham-road, Prahran, storeman, died 15th February, 1973.

MCBRIDE, EDWARD, late of Flat 3, 4 McMillan-court, Shepparton, retired labourer, died 15th April, 1973.

MCINTOSH, FLORENCE MARY, late of 30 Evansdale-road, Hawthorn, married woman, died 17th June, 1973.

ODGERS, GLADYS, formerly of 97 Ormond Esplanade, Elwood, but late of Greenvale Village, Greenvale, spinster, died 7th July, 1973.

PETTERSON, PAUL OSSIEAN, formerly of 13 Victoria-street, St. Kilda, but late of Flat 3, 10 Tennyson-street, Elwood, pensioner, died 20th May, 1973.

RAE, RUBY ELIZA, late of 96 High-street, Ararat, pensioner, died 18th May, 1973.

RICKETTS, ERNEST WILLIAM, late of Valinda Rest Home, Olinda, retired traveller, died 8th July, 1973.

RIDDELL, ADA VIOLET, formerly of 13 Tuhans-road, Mount Waverley, but late of "Fuchsia Lodge", 20 Fuchsia-street, Blackburn, widow, died 10th June, 1973.

SOUTHAM, THOMAS FLEMING, formerly of 2 Oxford-street, Burwood, and Flat 1, 354 Riversdale-road, Camberwell, but late of Kew, retired sales representative, died 13th May, 1973.

STEWART, ALEXANDER HENRY, late of 10 Craigmere-street, Glen Iris, retired storeman, died 20th April, 1973.

SUSKOVIC, FRANK, also known as Franjo Suskovic, late of 100 Essex-street, West Footscray, labourer, died 6th March, 1973.

WALKER, BETTY LILY, late of 3 Thorpe-street, West Newport, married woman, died 6th June, 1973.

WEBB, BEATRICE, formerly of 66 Avoca-street, South Yarra, but late of Ararat, widow, died 29th October, 1972.

WEATHERALL, BERNARD, late of 39 Thomas-street, Hampton, retired seaman, died 25th April, 1973.

WILSON, ALEXANDER, formerly of 45 Heller-street, West Brunswick, but late of 36 Reserve-avenue, Mitcham, retired carpenter, died 4th July, 1973.

I hereby give notice that on the 10th September, 1973, the Public Trustee filed elections to administer the following deceased persons' estates, in accordance with section 17 of the Public Trustee Act 1958:—

BELL, GEORGE ERNEST, formerly of Mont Park, but late of "Merrigum", Centre Dandenong-road, Dingley, retired farm hand, died 10th February, 1973.

BILLINGS, JOHN ROBERT, late of 2 McIntosh-street, Huntingdale, accounting supervisor, died 24th June, 1973.

ELDER, CHARLES JOHN, late of 27 Banool-street, East Preston, retired sheet metal worker, died 12th May, 1973.

GREY, MARJORIE, late of Ballarat, spinster, died 7th May, 1973.

KANE, NELL, also known as Ellen Olive Kane, formerly of 12 Barkly-place, Heidelberg, but late of Mont Park, spinster, died 2nd April, 1973.

LITTLE, CHARLES FREDERICK, late of "Wattlebrea", Acacia-avenue, Belgrave, operator, died 29th May, 1973.

MORTON, ROY JOSEPH, also known as Joseph Roy Morton, late of 70 Curzon-street, North Melbourne, pensioner, died 18th May, 1973.

MOUNTFORD, ALBERT EDWARD, late of 40 Nicholson-street, Fitzroy, retired mill hand, died between 19th and 21st of June, 1973.

MCALINEY, MAURICE PAGE, late of 137 Devonshire-road, Sunshine, retired watchman, died 11th July, 1973.

MCCLOSKEY, IDA MARGARET, formerly of 60 Mayston-street, Hawthorn East, but late of Caritas Christi Hospice, 134 Studley Park-road, Kew, spinster, died 30th June, 1973.

O'CALLAGHAN, MOLLIE MAY, also known as Mollie Margaret Callaghan, late of Ballarat, pensioner, died 4th March, 1973.

THORNE, SARAH ALICE, formerly of 56 Mayston-street, Hawthorn, but late of Sackville Private Hospital, Sackville-street, Kew, spinster, died 23rd September, 1972.

N. P. BRODY,  
Public Trustee.

168 Exhibition-street, Melbourne, 3000, 19th September, 1973.

#### NOTICE.

Creditors, next of kin and others having claims against the estate of any of the under-mentioned deceased persons are required to send particulars of their claims to the Public Trustee, 168 Exhibition-street, Melbourne, Vic. 3000, the personal representative, on or before the 3rd December, 1973, after which date the Public Trustee may convey or distribute the assets, having regard only to the claims of which the Public Trustee then has notice:—

BELL, GEORGE ERNEST, formerly of Mont Park, but late of "Merrigum", Centre Dandenong-road, Dingley, retired farm hand, died 10th February, 1973.

BILLINGS, JOHN ROBERT, late of 2 McIntosh-street, Huntingdale, accounting supervisor, died 24th June, 1973.

BIRD, WILLIAM MCQUEEN, late of 73 Sir Garnet-road, Surrey Hills, retired public servant, died 8th May, 1973.

BONE, CATHERINE LOUISE, late of 15 Clyde-street, St. Kilda, spinster, died 3rd May, 1973.

COE, ERNEST ROBERT, formerly of Repatriation General Hospital, Heidelberg, but late of 34 Rosemount-terrace, Windsor, Brisbane, salesman, died 10th May, 1973.

CROTTY, MAURICE, late of Flat 5, 8 Ridgeway-avenue, Kew, pensioner, died 23rd January, 1969.

DUNKLEY, JOSEPH CUTHBERT, late of 2 Valnere-street, North Footscray, retired storeman, died 3rd December, 1972.

ELDER, CHARLES JOHN, late of 27 Banool-street, East Preston, retired sheet metal worker, died 12th May, 1973.

FISHER, CAROLINE HENRIETTA, late of Gippsland Home and Hospital, McKean-street, Bairnsdale, spinster, died 15th April, 1973.

FRANKLIN, EVELYN, late of 4 Burch-street, Blackburn, retired public servant, died 1st June, 1973.

FRAZER, ELIZABETH, late of 13 Fenwick-street, North Carlton, widow, died 27th March, 1973.

GREER, MARTHA EMMA, late of 36 Pilgrim-street, Footscray, widow, died 26th June, 1973.

GREY, MARJORIE, late of Ballarat, spinster, died 7th May, 1973.

HAIGH, WILLIAM REGINALD, late of 63 Arbroath-road, Wantirna South, motor mechanic, died 2nd June, 1973.

HOCKING, CLAUDE DESMOND, late of 11 Abert-street, Williamstown, retired electrical engineer, died 30th June, 1973.

HUDSWELL, MARY EVELYN, late of 7 (formerly lot 22) Dobson-avenue, North Clayton, widow, died 3rd February, 1973.

JENSEN, STELLA MYRTLE, also known as Stella Jensen and Stella Murtle Jensen, late of 22 Alvena-crescent, Heathmont, widow, died 5th July, 1973.

JOSLYN, KENNETH, late of 20 Lewisham-road, Prahran, storeman, died 15th February, 1973.

KANE, NELL, also known as Ellen Olive Kane, formerly of 12 Barkly-place, Heidelberg, but late of Mont Park, spinster, died 2nd April, 1973.

KAY, HAROLD MALCOLM, late of 12 Bayview-crescent, The Basin, despatch clerk, died 25th December, 1972.

LITTLE, CHARLES FREDERICK, late of "Wattlebrea", Acacia-avenue, Belgrave, operator, died 29th May, 1973.

MAISEY, RONALD HERBERT, late of Unit 3, 142A Tucker-road, East Bentleigh, cleaner, died 3rd November, 1972.

MATTHEWS, JAMES HANDLEY, formerly of 104 Bouverie-street, Carlton, but late of 467 George-street, Fitzroy, retired wicker worker, died 18th May, 1940.

MORTON, ROY JOSEPH, also known as Joseph Roy Morton, late of 70 Curzon-street, North Melbourne, pensioner, died 18th May, 1973.

MOUNTFORD, ALBERT EDWARD, late of 40 Nicholson-street, Fitzroy, retired mill hand, died between 19th and 21st of June, 1973.

MCALINEY, MAURICE PAGE, late of 137 Devonshire-road, Sunshine, retired watchman, died 11th July, 1973.

MCBRIDE, EDWARD, late of Flat 3, 4 McMillan-court, Shepparton, retired labourer, died 15th April, 1973.

MCCLOSKEY, IDA MARGARET, formerly of 60 Mayston-street, Hawthorn East, but late of Caritas Christi Hospice, 134 Studley Park-road, Kew, spinster, died 30th June, 1973.

MCGRATH, VERONICA ANNIE, formerly of 17 Gallant-street, Footscray, but late of 10 Geelong-road, Footscray, spinster, died 16th April, 1973.

MCGUINNESS, STUART GORDON, late of 30 Emma-street, Caulfield, retired hairdresser, died 21st January, 1973.

MCINTOSH, FLORENCE MARY, late of 30 Evansdale-road, Hawthorn, married woman, died 17th June, 1973.

O'CALLAGHAN, MOLLIE MAY, also known as Mollie Margaret Callaghan, late of Ballarat, pensioner, died 4th March, 1973.

OGGERS, GLADYS, formerly of 97 Ormond Esplanade, Elwood, but late of Greenvale Village, Greenvale, spinster, died 7th July, 1973.

PETTERSON, PAUL OSSIEAN, formerly of 13 Victoria-street, St. Kilda, but late of Flat 3, 10 Tennyson-street, Elwood, pensioner, died 20th May, 1973.

PLATT, JAMES FREDERICK, late of 11 Franklin-avenue, Chelsea, retired electrical fitter, died 5th July, 1973.

RAE, RUBY ELIZA, late of 96 High-street, Ararat, pensioner, died 18th May, 1973.

RICKETTS, ERNEST WILLIAM, late of Valinda Rest Home, Olinda, retired traveller, died 8th July, 1973.

RIDDELL, ADA VIOLET, formerly of 13 Tuhans-road, Mount Waverley, but late of "Fuchsia Lodge", 20 Fuchsia-street, Blackburn, widow, died 10th June, 1973.

ROSE, GEORGE THOMAS, late of 51 Service-road, Moe, T.P.I. pensioner, died between the 18th day of January, 1973, and the 5th day of February, 1973.

SOUTHAM, THOMAS FLEMING, formerly of 2 Oxford-street, Burwood, and Flat 1, 354 Riversdale-road, Camberwell, but late of Kew, retired sales representative, died 13th May, 1973.

STEWART, ALEXANDER HENRY, late of 10 Craigmore-street, Glen Iris, retired storeman, died 20th April, 1973.

SUSKOVIC, FRANK, also known as Franjo Suskovic, late of 100 Essex-street, West Footscray, labourer, died 6th March, 1973.

THORNE, SARAH ALICE, formerly of 56 Mayston-street, Hawthorn, but late of Sackville Private Hospital, Sackville-street, Kew, spinster, died 23rd September, 1972.

THRELFALL, FLORENCE ALBERTA, late of Maxfield-street, Longwood, spinster, died 21st March, 1973.

VONTHETHOFF, ANNE ADELAIDE, late of 38 Coronation-street, West Footscray, spinster, died 20th April, 1973.

WALKER, BETTY LILY, late of 3 Thorpe-street, West Newport, married woman, died 6th June, 1973.

WALSH, RICHARD, late of 59 Seymour-grove, Camberwell, retired public servant, died 4th July, 1973.

WATSON, FRANCIS HERBERT, also known as Frank Herbert Watson, late of 20 Naroon-road, Alphington, retired cleaner and watchman, died 15th May, 1973.

WEBB, BEATRICE, formerly of 66 Avoca-street, South Yarra, but late of Ararat, widow, died 29th October, 1972.

WEATHERALL, BERNARD, late of 39 Thomas-street, Hampton, retired seaman, died 25th April, 1973.

WILSON, ALEXANDER, formerly of 45 Heller-street, West Brunswick, but late of 36 Reserve-avenue, Mitcham, retired carpenter, died 4th July, 1973.

N. P. BRODY,  
Public Trustee.

Melbourne, 19th September, 1973.

as from 11th September, 1973; Index page 2795, for address of Tomlin J. W. Pty. Ltd., substitute P.O. Box 130, Alexandria, 2015.

#### MOTOR SPIRIT, ETC.

Gazette No. 22, 30th March, 1972.—For rates shown opposite the following items, substitute the rates set out hereunder as from the date shown:—Schedule No. 56, Motor Spirit, etc.—Item No. 4 (b), \$0.443; Item No. 4 (d), \$0.443 (Esso), \$0.466 (Mobil), from 23rd August, 1973. The following amendments are made to the list. Country areas:—substitute under-mentioned suppliers for locations shown—Stawell, R. D. & V. A. Cooper; Wodonga, R. & G. Penney, as from 3rd September, 1973.—Benalla, K. D. & F. G. Bissett closed as from 28th September, 1973.—Bulk deliveries and drum requirements in area ex Wangaratta agent L. J. & M. I. Richards, Vincent-road. Into vehicle service—Esso Servicecentre, M. Glynn, Cnr. Hume Highway and Coomalibee-street, Benalla. E. P. WATSON, Secretary to the Tender Board. 24.9.73.

#### CONTRACTS ACCEPTED.—(Series 1973-74.)

##### VICTORIAN RAILWAYS.

19. Position and fix steel reinforcement for tunnel construction work associated with the Melbourne Underground Rail Loop Connections, at rates, (Contract No. 63923).—McLean Constructions.

C. S. MORRIS, Secretary. 21.9.73.

##### PUBLIC WORKS.

396. Pakenham High School, electrical services, original, \$3,152.50; additions, \$2,147.74—\$5,300.24.—Dandee Electrical Services.—(E.4908 "A".)

397. Timboon High School, internal and external renovations, original, \$3,467.00; additions, \$1,698.40—\$5,165.40.—Hammond & Sons Contracting Pty. Ltd.—(W.63168.)

398. Sunbury Mental Hospital, service of alarm system, original, \$3,336.00; additions, \$1,507.00—\$4,843.00.—Wormald International (Aust.) Pty. Ltd.—(N.47453.)

399. Williamstown Primary School 1183, installation of electrical services, original, \$2,894.00; additions, \$2,914.40—\$5,808.40.—M. Harrison.—(W.135639 "A".)

400. Ballan Primary School, internal renovations, original, \$3,400.00; additions, \$750.00—\$4,150.00.—J. J. Patmore.—(W.67510.)

401. Turana Training Centre, laundry extension, original, \$2,950.00; additions, \$1,271.00—\$4,221.00.—Jarrett & Crikis Pty. Ltd.—(P.C.153411 "A".)

402. Quambatook Group School No. 2443, original, \$3,600.00; additions, \$905.90—\$4,505.90.—R. E. Loveland.—(W.63667 "A".)

403. State Public Library, Swanston-street, Melbourne, supply and installation of radiators, original, \$3,710.00; additions, \$374.55—\$4,084.55.—Bilstan Building Services.—(C.26909.)

404. Mount Waverley High School, site works, original, \$3,640.00; additions, \$2,421.10—\$6,061.10.—Infantino Constructions Pty. Ltd.—(E.5712 "D".)

405. Torquay Primary School No. 3368, sewerage, original, \$3,678.00; additions, \$497.00—\$4,175.00.—James Nott & Co.—(W.62175.)

G. SERPELL, Director-General. 20.9.73.

##### PROVISIONS.

Gazette No. 43, 1st June, 1973.—For rates shown opposite the following items, substitute the rates as set out hereunder from the dates shown:—Schedule No. 8, Beechworth.—Sub-Schedule No. 4, Groceries.—Item No. 31, 1 kg, \$10.30 as from 1st September, 1973; Schedule No. 12, Shepparton.—Sub-Schedule No. 4, Groceries.—Item No. 5, \$2.86; Item No. 24, Safcol, \$5.75 from 17th September, 1973.

##### GENERAL STORES.

Gazette No. 77, 30th July, 1973, Schedule No. 25, Chemicals etc.—Item No. 9, add 5 gallon containers charged @ \$1.50 ea. credited on return, taps \$0.30 ea. non refundable; Item No. 43, for name of contractor substitute Atlachem Pty. Ltd.—Schedule No. 46, Hose, Sheetting etc. (Nylon-Plastic-Rubber); Item Nos. 18, 19, 20, 1", 1 1/2" and 1" Plastic Garden Hose, available only in 60 ft. and 300 ft. lengths; Schedule No. 49, Steel (Mild); Item No. 1. Rates shown in "1 tonne and over"—column of price list dated 1st July, 1973, to operate from that date.—Schedule No. 54, Metals, (Brass, Copper and Lead); Item No. 5, \$401.55,

#### ORDERS IN COUNCIL.—(Series 1973-74.)

##### STATE ELECTRICITY COMMISSION.

406. For the supply of natural or fully preserved wooden power line poles for a period of one year, to Specification No. 73/45, at Schedule rates.—Arthur H. Hasell and Co. Pty. Ltd.

407. For the supply of natural or fully preserved wooden power line poles for a period of one year, to Specification No. 73/45, at Schedule rates.—Hickson's Timber and Impregnation Co. (Aust.) Pty. Ltd.

408. For the supply of concrete poles for use in the distribution system for a period of one year with optional extension of three months, to Specification No. 73/51, at Schedule rates.—Fernando Bosco (Aust.) Pty. Ltd.

Approved by the Governor in Council, 31st July, 1973.—T. J. FORRISTAL, Clerk of the Executive Council.

409. For the supply of leather, cotton and P.V.C.-gloves for a period of one year with optional extension of three months, to Specification No. 73/150, at Schedule rates.—Simpson's Gloves Pty. Ltd.

Approved by the Governor in Council, 21st August, 1973.—T. J. FORRISTAL, Clerk of the Executive Council.

410. For the supply of "Westinghouse" electrical appliances and spare parts for resale in Commission show-rooms for a period of three years, to Quotation No. 673, at Schedule rates.—Email Ltd.

411. For the supply of copper conductors for a period of two years with optional extension of three months, to Specification No. 73/160, at Schedule rates.—Olex Cables Pty. Ltd.

412. For the supply of galvanized mild steel washers for a period of two years with optional extension of three months, to Specification No. 73/178, at Schedule rates.—West Footscray Engineering Works Pty. Ltd.

413. For the supply of three "Caterpillar" D8H winch equipped tractors and one "Caterpillar" D8H ripper equipped tractor for replacement of plant in the Latrobe Valley, to Specification No. 73/196, \$295,219.—William Adams Tractors Pty. Ltd.

Approved by the Governor in Council, 28th August, 1973.—T. J. FORRISTAL, Clerk of the Executive Council.

414. For the supply of 55A and 80A active or neutral junction boxes for a period of two years with optional extension of three months, to Specification No. 73/163, at Schedule rates.—G.W. Engineering Pty. Ltd.

415. For the supply of 31 "International" vehicles for replacement of high mileage vehicles, to Quotation No. 4731, \$151,242.—International Harvester Co. of Australia Pty. Ltd.

416. For the supply and delivery of bluestone metal ballast, screenings and fine crushed rock for the Yallourn and Morwell-Hazelwood Works areas, for a period of two years with optional extension of three months, to Specification No. 73/190, at Schedule rates.—Ready Mixed Concrete (Victoria) Pty. Ltd.

Approved by the Governor in Council, 4th September, 1973.—T. J. FORRISTAL, Clerk of the Executive Council.

## PUBLIC WORKS.

394. Carlton, Motor Registration Branch, Chief Secretary's Department, supply of filing cabinets, \$6,364.00.—Duff Steel Industries (Vic.) Pty. Ltd.—(I. & D. 89128.)

395. St. Kilda, cost of a visit by a technical expert to provide continued advice on the St. Kilda Foreshore Action Plan Study, rates estimated at \$4,200.00.—British Hovercraft Corporation Ltd.—(P. & H. 16635.)

Approved by the Governor in Council, 18th September, 1973.—T. J. FORRISTAL, Clerk of the Executive Council.

---

**APPOINTMENTS AND RESIGNATIONS**

---

## APPOINTMENTS.

His Excellency the Governor of the State of Victoria, by and with the advice of the Executive Council thereof, has, by Orders made on the 18th day of September, 1973, been pleased to make the under-mentioned appointments, viz.:—

## CHIEF SECRETARY'S DEPARTMENT.

*Chairman of Motor Accidents Board.*

VICTOR HENRY ARNOLD, F.I.A., A.A.I.I., A.S.A. to be Chairman of the Motor Accidents Board, pursuant to the *Motor Accidents Act 1973*, for a period of two years from and inclusive of the 19th September, 1973.

*Members of Motor Accidents Board.*

Sir BENJAMIN KEITH RANK, C.M.G., M.B., M.S., L.R.C.P., F.R.C.S., F.R.A.C.S., F.A.C.S., and JACK STANLEY BARWICK, A.A.I.I., A.S.A., to be members of the Motor Accidents Board pursuant to the *Motor Accidents Act 1973*, for a period of five years from and inclusive of the 19th September, 1973.

*Acting Chairman and Member of Metropolitan Fire Brigades Appeal Tribunal.*

CYRIL JOHN THOMPSON, Deputy Chief Stipendiary Magistrate, pursuant to the provisions of the *Metropolitan Fire Brigades Act 1958*, to be a Member and Acting Chairman of the Metropolitan Fire Brigades Appeal Tribunal, for the period ending the 31st October, 1973, during the absence on leave of William John Cuthill, Chief Stipendiary Magistrate and Chairman of the Appeal Tribunal.

## MINISTRY OF HEALTH.

*Members of Committees of Management of Hospitals.*

HERBERT HENRY FULLERTON HOLMBERG to be Government appointee on Committee of Management of Elmore District Hospital, for a period of three years pursuant to the provisions of sub-paragraph (ii) of paragraph (a) of the proviso to sub-section (1) of section 48 of the *Hospitals and Charities Act 1958*, vice Mr. E. F. Hore resigned; and

HERBERT RONALD WESTCOTT to be Government appointee on Committee of Management of Rochester and District War Memorial Hospital, for a period of three years pursuant to the provisions of sub-paragraph (ii) of paragraph (a) of the proviso to sub-section (1) of section 48 of the *Hospitals and Charities Act 1958*, vice Mr. J. E. Costello resigned.

## LAW DEPARTMENT.

*Commissioners for Taking Declarations, &c.*

BRUCE CHARLES SHEARER, 151 Through-road, Burwood, JAMES HISLOP HALL, care of Hoechst Australia Ltd., 606 St. Kilda-road, Melbourne, JAMES ROBERT OWENS, 159 King George-street, Cohuna, CHARLES BRYANT PAINTER, 153 King George-street, Cohuna, SHAMUS BRUCE INGRAM, 19 Fourth-avenue, Chelsea Heights, ROBERT MAXWELL DEMPSTER, 17 Rivett-crescent, Mulgrave, LAURENCE WILLIAM THOMAS GARDINER, 235 Gower-street, Preston, IAN ORMOND MITCHELL, care of A.M.P. Society, 67 Atherton-road, Oakleigh, GEOFFREY ORMOND HARRISON, care of Hall & Rose, Chartered Accountants, 395 Collins-street, Melbourne, BRIAN RAYMOND BILLETT, 17 Swan-street, Wangaratta, JOSEPH CARUANA, 50 Avondale-avenue, St. Albans, BRIAN SOWDEN, care of Messrs. Topsis and Harding, International Adjusters, 53 Rosslyn-street, West Melbourne,

FRANK REGINALD TILLEY, 8 Aroona-avenue, Mitcham, RODNEY JOHN STRIBLEY, 23 Beacon-street, South Vermont,

ANDRIANUS WILHELMUS MARIA BENNE, 120 Melbourne-road, Norlane,

JAMES VALENTINE CORSER, 32B Hatfield-street, North Balwyn,

RODNEY FREDERICK SNOW,

PETER JOHN CHRISTIE,

TERRENCE DENNIS FITZGERALD,

BRIAN JAMES WRIGHT,

care of Education Department, Treasury-place, Melbourne,

GRAEME DONALD BARTLETT, care of Department of Labour and Industry, 110 Exhibition-street, Melbourne,

JOHN ROSEMEYER, care of Workers Compensation Board, 570 Bourke-street, Melbourne, and

JOHN CERNECKY, care of Department of Supply, Jensen House, 339 Swanston-street, Melbourne,

to be Commissioners for taking Declarations and Affidavits under the *Evidence Act 1958*.

*Deputy Prothonotary.*

PETER CHARLES CLOTHIER

to be Deputy Prothonotary at Mildura, vice G. H. Schmidt, on recreation leave; to take effect as from the date of commencement of duty.

*Justices of the Peace.*

NORMAN BRUCE HARPER, 12 Julia-street, Kyabram, MAXWELL JOHN WHITE, Waratah-avenue, The Basin, HARRY BOYD BORLAND, Shady Creek-road, Yarragon, FRANK JOSEPH BRUDNA, 56 Harold-road, Springvale South,

JAMES MALCOLM MITCHELL, 40 Derham-street, Port Melbourne, and

ARTHUR LESLIE WELFARE, Bradvale, via Skipton, to keep the Peace in the State of Victoria.

## DEPARTMENT OF THE TREASURER.

*Receiver of Revenue (Acting).*

PETER CHARLES CLOTHIER

to act temporarily as Receiver of Revenue, Mildura, vice G. H. Schmidt, on leave.

*Collector of Imposts (Acting).*

GEOFFREY NEVILLE ERNEST CHURCHWARD

to act temporarily as Collector of Imposts, Police Department, vice B. N. Benedict, on leave.

## DEPARTMENT OF WATER SUPPLY.

*Improvement Trust Commissioner.*

JOHN PATRICK O'KEEFE

to be a Commissioner of the Black Dog Creek Improvement Trust, to hold such position for a period of four years from 22nd September, 1973, subject to the provisions of the River Improvement Act.

*Waterworks Trust Commissioner.*

LEO CLARENCE LLOYD

to be a Commissioner of the Corryong Waterworks Trust, to hold such position for a period of four years from the date hereof, subject to the provisions of the Water Act.

T. J. FORRISTAL,

Clerk of the Executive Council.

At the Executive Council Chamber,

Melbourne, 18th September, 1973.

---

**APPOINTMENT OF TRUSTEE OF RACECOURSE RESERVE.**

His Excellency the Governor of the State of Victoria, by and with the advice of the Executive Council thereof, doth by Order made on the 18th day of September, 1973, and in pursuance of the provision of the Crown grant, volume 7275, folio 814, in respect of the Crown lands reserved as a site for Racing, Recreation and Public Park purposes, at Caulfield, appoint the under-mentioned gentleman as a Trustee of the said lands:—

WILLIAM RONALD WALTERS (for so long only as he continues to be a Councillor and the elect of the Council of the City of Caulfield), in the place of Andrew John George Sinclair (no longer a Councillor).

T. J. FORRISTAL,

Clerk of the Executive Council.

At the Executive Council Chamber,

Melbourne, 18th September, 1973.

*Liquor Control Act 1968.*

**APPOINTMENT OF LICENSING INSPECTOR.**

In accordance with the authority conferred upon me by section 6 of the *Police Regulation Act 1958*, I, Angus Lindsay Carmichael, Deputy Commissioner of Police, do hereby appoint under sub-section (1) of section 22 of the *Liquor Control Act 1968*, the following Officer of Police as a Licensing Inspector for the Division of the Police District as shown :—

Division Number.	Police District.	Rank and Name.
1	Melbourne	Inspector Eric Roy Sutton, V.A. (from 24.8.73 to 15.9.73)
		A. L. CARMICHAEL, Deputy Commissioner of Police.
6.9.1973		

*Liquor Control Act 1968.*

**APPOINTMENT OF LICENSING INSPECTOR.**

In accordance with the authority conferred upon me by section 6 of the *Police Regulation Act 1958*, I, Angus Lindsay Carmichael, Deputy Commissioner of Police, do hereby appoint under sub-section (1) of section 22 of the *Liquor Control Act 1968*, the following Officer of Police as a Licensing Inspector for the Division of the Police District as shown :—

Division Number.	Police District.	Rank and Name.
3	Westernport	Inspector John Augustus Costelloe (from 2.9.73 to 23.9.73)
		A. L. CARMICHAEL, Deputy Commissioner of Police.
12.9.1973		

*Liquor Control Act 1968.*

**APPOINTMENT OF LICENSING INSPECTORS.**

In accordance with the authority conferred upon me by Section 6 of the *Police Regulation Act 1958*, I, Angus Lindsay Carmichael, Deputy Commissioner of Police, do hereby appoint under sub-section (1) of Section 22 of the *Liquor Control Act 1968*, the following Officers of Police as Licensing Inspectors for the Divisions of the Police Districts as shown :—

Division Number	Police District.	Rank and Name.
3	Gippsland	Inspector Alan Findley Stock
2	Goulburn	Inspector Ira Vendor Smith <i>vice</i> Inspector Stock
		A. L. CARMICHAEL, Deputy Commissioner of Police.
13.9.1973.		

*Marine Act 1958.*

**APPOINTMENT OF INSPECTOR**

His Excellency the Governor of the State of Victoria, by and with the advice of the Executive Council thereof, doth by Order made on the 18th day of September, 1973, appoint Sergeant Alan Herbert Young, Registered No. 10971, being a member of the Motor Boating Squad, to act as an Inspector, in accordance with section 95 of the *Marine Act 1958*, for purposes in regard to the survey and licensing of vessels.

T. J. FORRISTAL,  
Clerk of the Executive Council.

At the Executive Council Chamber,  
Melbourne, 18th September, 1973.

*Education Act 1958.*

**SUMMONING OFFICER.**

Under section 5 of the *Education Act 1958*, I hereby appoint—

Senior Sergeant RONALD ROYSTON McCOOKE,  
to summon parents within the State of Victoria.  
14th September, 1973.

VASEY HOUGHTON,  
Minister for Social Welfare.

*Education Act 1958.*

**SUMMONING OFFICER.**

Under section 5 of the *Education Act 1958*, I hereby appoint—

Sergeant DONALD MATTHIES,  
to summon parents within the State of Victoria.  
18th September, 1973.

VASEY HOUGHTON,  
Minister for Social Welfare.

**RESIGNATIONS.**

His Excellency the Governor of the State of Victoria, by and with the advice of the Executive Council thereof, has, by Orders made on the 18th day of September, 1973, accepted the resignations of the persons named hereunder of the offices mentioned, viz.:—

**LAW DEPARTMENT.**

*Commissioner for Taking Declarations, &c.*

FRANK JOSEPH BRUDNA  
as a Commissioner for taking Declarations and Affidavits under the *Evidence Act 1958*.

*Member of Patriotic Funds Council.*

ROY WARWICK NEVILLE, C.B.E.,  
as a Member of the Patriotic Funds Council.

T. J. FORRISTAL,  
Clerk of the Executive Council.

At the Executive Council Chamber,  
Melbourne, 18th September, 1973.

**ORDERS IN COUNCIL**

**FORESTS COMMISSION OF VICTORIA.**

At the Executive Council Chamber, Melbourne, the eleventh day of September, 1973.

**PRESENT:**

His Excellency the Governor of Victoria.  
Mr. Balfour                      Mr. Borthwick.  
Mr. Houghton

In pursuance of the provision of section 45 (1) of the *Forests Act 1958*, No. 6254, His Excellency the Governor of the State of Victoria, by and with the advice of the Executive Council, doth hereby order that the area of unoccupied Crown land described in the accompanying Schedule No. 212 and comprising 7 acres 2 roods 0 perches be dedicated as permanent forest.

**THE SCHEDULE ABOVE REFERRED TO.**

*Dedication Schedule No. 212.*

Area to be Dedicated as Permanent Forest: 7 acres 2 roods 0 perches, more or less, of unoccupied Crown lands in the Parishes of Derril and Flowerdale, County of Anglesey, being the areas indicated by diagonal hatched lines on diagram No. 978 on the plan hereunder.—(Correspondence No. 72/724, H.032384).

**DERRIL & FLOWERDALE**

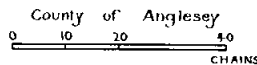

Area:- 7<sup>1</sup> 2<sup>0</sup> 0<sup>±</sup>

H032384  
67/1697

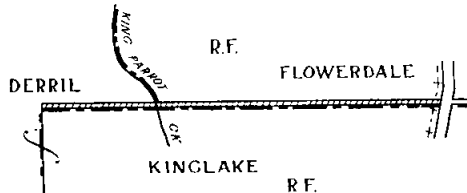

T. J. FORRISTAL,  
Clerk of the Executive Council.

COUNTRY ROADS BOARD.

At the Executive Council Chamber, Melbourne, the eighteenth day of September, 1973.

PRESENT:

His Excellency the Governor of Victoria.  
Mr. Meagher | Mr. Hunt.

ORDER APPROVING OF LAND BEING ACQUIRED AND ROADS, DEVIATIONS OR WIDENINGS BEING MADE.

His Excellency the Governor of the State of Victoria, by and with the advice of the Executive Council thereof, being satisfied that there are funds legally available for acquiring the land, doth hereby approve the acquiring of the land described in the Schedule hereunder and the making of new roads and deviations from and widenings of existing roads referred to in the said Schedule.

SCHEDULE.

Main Roads.

The land shown hatched on plans numbered G.P.12930A, G.P.12930B, G.P.12931A and G.P.12931B hereunder required for the widening of Bell-street in the City of Preston and making of the widening thereon.

MAIN ROAD  
BELL STREET  
CITY OF PRESTON  
*Measurements in Feet & Inches*

G.P.12930B  
Compiled from  
S.P.12930

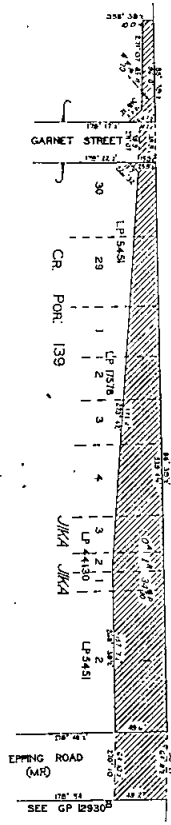
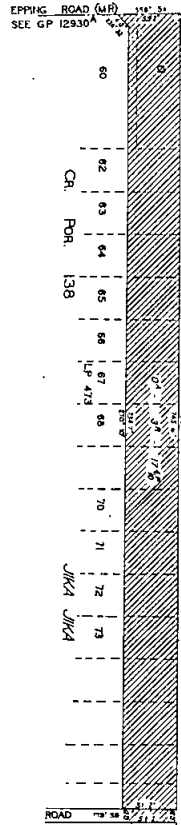

MAIN ROAD  
BELL STREET  
CITY OF PRESTON  
*Measurements in Feet & Inches*

G.P.12930A  
Compiled from  
S.P.12930



MAIN ROAD  
BELL STREET  
CITY OF PRESTON  
*Measurements in Feet & Inches*

G.P.12931B  
Compiled from  
S.P.12931

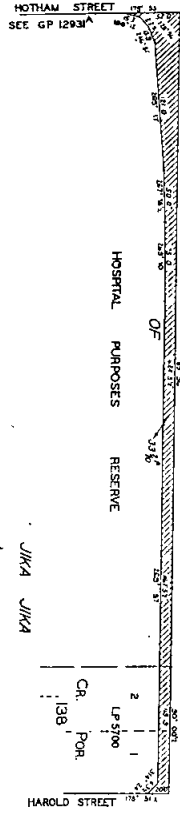

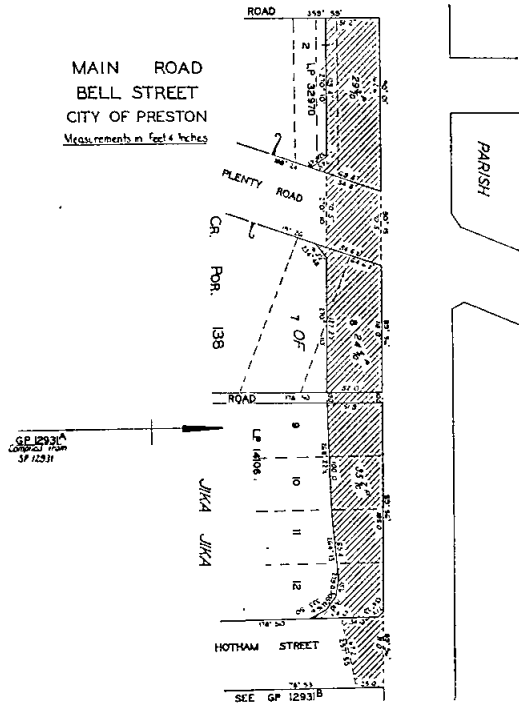

The land shown hatched on plan numbered G.P.13091 hereunder required for the widening of Yabba-road in the Shire of Towong and making of the widening thereon.

MAIN ROAD  
YABBA ROAD  
SHIRE OF TOWONG  
*Measurements in Links*

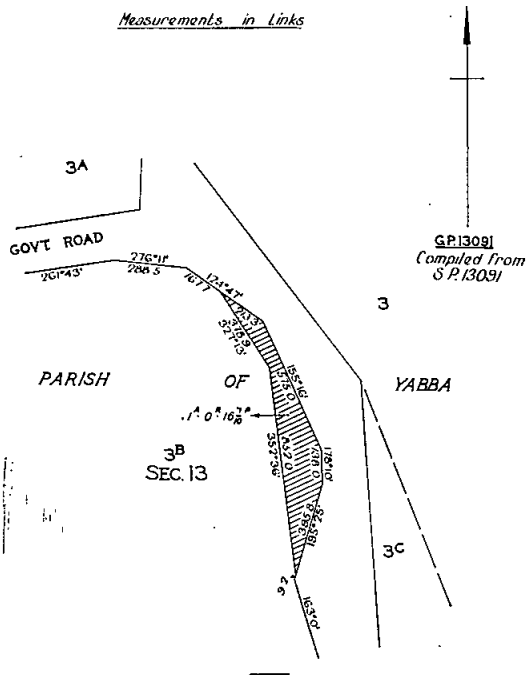

And the Honorable Edward Raymond Meagher, Her Majesty's Minister of Transport for the State of Victoria, shall give the necessary directions herein accordingly.

T. J. FORRISTAL,  
Clerk of the Executive Council.

SUPERANNUATION ACT 1958.

At the Executive Council Chamber, Melbourne, the eighteenth day of September, 1973.

PRESENT:

His Excellency the Governor of Victoria.  
Mr. Meagher | Mr. Hunt.

Pursuant to the powers conferred by the provisions of paragraph (ja) of sub-section (1) of section 3 of the Superannuation Act 1958, His Excellency the Governor of the State of Victoria, by and with the advice of the Executive Council thereof doth by this Order declare that the provisions of the Superannuation Act shall apply to Victor Henry Arnold, Chairman of the Motor Accidents Board, constituted pursuant to the provisions of the Motor Accidents Act 1973 No. 8429.

And the Honorable Rupert James Hamer, Her Majesty's Treasurer for the State of Victoria, shall give the necessary directions herein accordingly.

T. J. FORRISTAL,  
Clerk of the Executive Council.

ROAD TRAFFIC ACT 1958.

At the Executive Council Chamber, Melbourne, the eighteenth day of September, 1973.

PRESENT:

His Excellency the Governor of Victoria.  
Mr. Meagher | Mr. Hunt.

In pursuance of the powers conferred by the Road Traffic Act 1958, His Excellency the Governor of the State of Victoria, in the Commonwealth of Australia, by and with the advice of the Executive Council of the said State, and at the request in writing of the Council of the City of Camberwell, doth by this Order extend the provisions of the said Act to the land under the control of the City of Camberwell, such lands being those described hereunder:—

**Balwyn-road, Balwyn.**—Commencing at a point on the east building line of Balwyn-road at 162 ft. 0 in. south of the south building line of Whitehorse-road; thence easterly on a bearing of 89 deg. 55½ min. for a distance of 150 feet; thence southerly on a bearing of 179 deg. 51 min. for a distance of 55 ft. 6 in.; thence westerly on a bearing of 269 deg. 55½ min. for a distance of 150 feet; thence northerly on a bearing of 359 deg. 51 min. for a distance of 55 ft. 6 in. to the commencement point, as shown by hachure on Plan "A" hereunder.—(M.615).

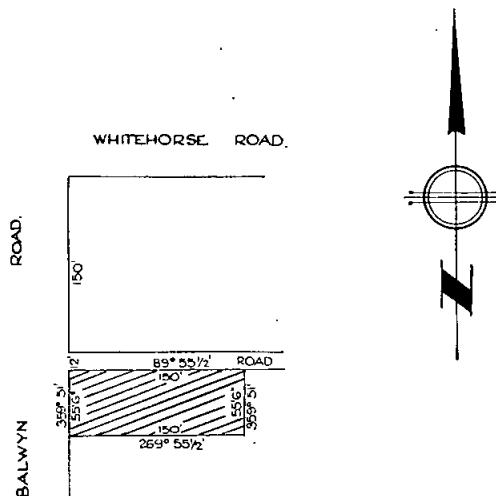

**Clapham-street, Balwyn.**—Commencing at a point on the east building line of Clapham-street at 231 ft. 0 in. north of the north building line of Whitehorse-road; thence easterly on a bearing of 90 deg. 0 min. for a distance of 165 ft. 0 in.; thence southerly on a bearing of 180 deg.



05 min. for a distance of 66 ft. 0 in.; thence westerly on a bearing of 270 deg. 0 min. for a distance of 165 ft. 0 in.; thence northerly on a bearing of 0 deg. 05 min. for a distance of 66 ft. 0 in. to the commencement point, as shown by hachure on Plan "B" hereunder.—(M.616).

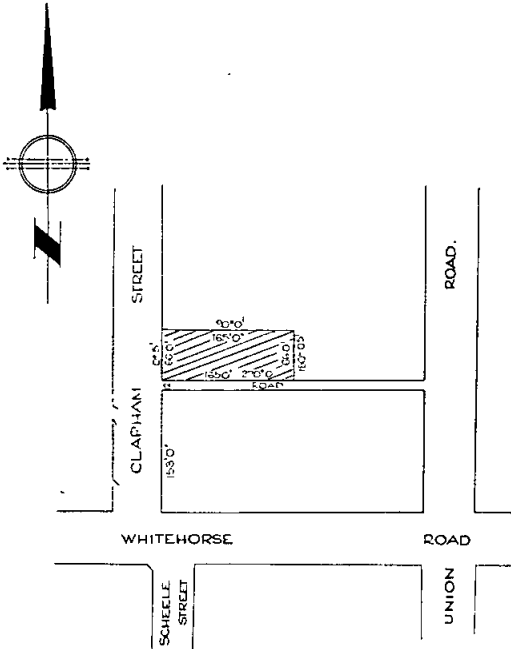

Duke-street, Ashburton.—Commencing at a point on the east building line of Duke-street at 200 ft. 0 in. north of the north building line of High-street; thence easterly on a bearing of 90 deg. 0 min. for a distance of 150 ft. 0 in.; thence southerly on a bearing of 179 deg. 28 min. for a distance of 66 ft. 0 in.; thence westerly on a bearing of 270 deg. 0 min. for a distance of 150 ft. 0 in.; thence northerly on a bearing of 359 deg. 28 min. for a distance of 66 ft. 0 in. to the commencement point, as shown by hachure on Plan "C" hereunder.—(M.617).

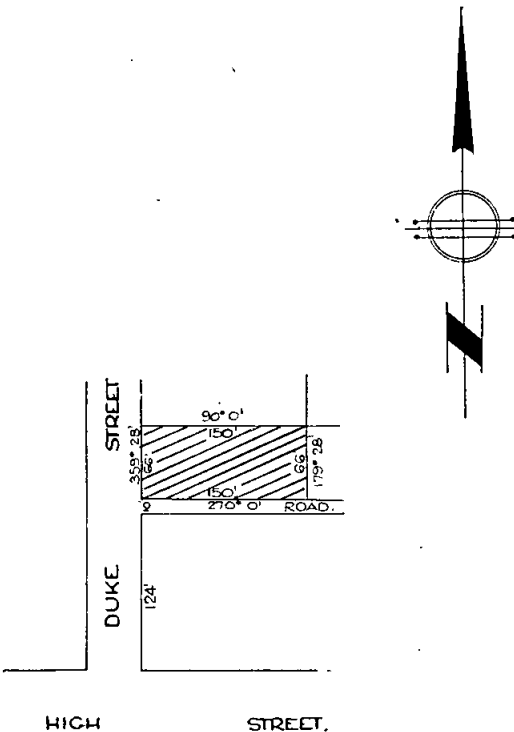

Glen Iris-road, Glen Iris.—Commencing at a point on the western building line of Glen Iris-road, at a distance of 140 ft. 0 in. north of the north building line of High-street; thence westerly on a bearing of 269 deg. 29 min. for a distance of 88 ft. 5 1/2 in.; thence northerly on a bearing of 000 deg. 0 min. for a distance of 10 ft. 8 in.; thence westerly on a bearing of 269 deg. 29 min. for a distance of 176 ft. 9 in.; thence northerly on a bearing of 000 deg. 0 min. for a distance of 51 ft. 2 1/2 in.; thence easterly on a bearing of 89 deg. 53 min. for a distance of 176 ft. 10 in.; thence easterly on a bearing of 90 deg. 0 min. for a distance of 88 ft. 5 1/2 in.; thence southerly on a bearing of 180 deg. for a distance of 59 ft. 10 in., to the commencement point, as shown by hachure on Plan "D" hereunder.—(M.618).

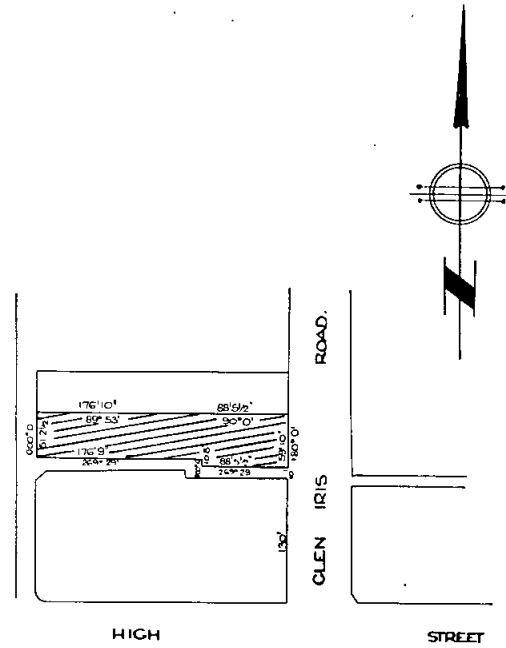

And the Honorable John Frederick Rossiter, Her Majesty's Chief Secretary for the State of Victoria, shall give the necessary directions herein accordingly.

T. J. FORRISTAL,  
Clerk of the Executive Council.

DEPARTMENT OF CROWN LANDS AND SURVEY.

At the Executive Council Chamber, Melbourne, the eighteenth day of September, 1973.

PRESENT:

His Excellency the Governor of Victoria.  
Mr. Meagher | Mr. Hunt.

REVOCATION OF TEMPORARY RESERVATIONS OF LANDS BY ORDERS IN COUNCIL.

His Excellency the Governor of the State of Victoria, by and with the advice of the Executive Council thereof, doth hereby, in pursuance of the provisions of the Land Act 1958, revoke the temporary reservations of Lands by Orders in Council hereinafter described, viz.:

RAYWOOD.—The temporary reservation by Order in Council of the 13th August, 1866 of 8094 square metres (2 acres) of land in the Township of Raywood as a site for a Pound.—(R.57<sup>(3)</sup>) (C.101026).

SALE.—The temporary reservation by Order in Council of the 14th November, 1961 of 1593 square metres (1 rood 23 perches) of land in the Township of Sale as a site for State School purposes.—(S.239<sup>(3)</sup>) (Rs.894).

SALE.—The temporary reservation by Order in Council of the 17th February, 1916 of 1.743 hectares (4 acres 1 rood 9 perches) of land in the Township of Sale (called Borough of Sale in Order) as a site for a High School.—(S.239<sup>(3)</sup>) (Rs.894).

**ALEXANDRA.**—The temporary reservation by Order in Council of the 30th June, 1964 of 2.327 hectares (5 acres 3 roods, more or less) of land in the Parish of Alexandra, as a site for Public Recreation, so far only as regards the portion defined by description and hatching on plan published in the *Government Gazette* of 15th August, 1973, and containing 5400 square metres, more or less.—(A.161<sup>(5)</sup>) (Rs.8116).

**ALEXANDRA.**—The temporary reservation by Order in Council of the 16th January, 1962, of 40.47 hectares (100 acres, more or less) of land in the Parish of Alexandra as a site for public Recreation, so far only as regards the portion defined by description and hatching on plan published in the *Government Gazette* of 15th August, 1973, and containing 15.80 hectares, more or less.—(A.161<sup>(5)</sup>) (Rs.8116).

**DROMANA.**—The temporary reservation by Order in Council of the 28th December, 1864 of 1164 square metres (1 rood 6 perches) of land in the Township of Dromana, as a site for Police purposes, so far only as regards the portion defined by description and hatching on plan published in the *Government Gazette* of 15th August, 1973, and containing 113 square metres.—(D.98<sup>(2)</sup>) (Rs.9736).

**METUNG.**—The temporary reservation by Order in Council of the 17th March, 1959 of 1.851 hectares (4 acres 2 roods 12 perches) of land in the Township of Metung as a site for Public Recreation so far only as regards the portion defined by description and hatching on plan published in the *Government Gazette* of 15th August, 1973, and containing 1874 square metres.—(M.515<sup>(3)</sup>) (Rs.7789).

**SWAN HILL.**—The temporary reservation by Order in Council of the 16th September, 1872, of 10.02 hectares (24 acres 3 roods, more or less) of land in the Town of Castle Donnington (Swan Hill), (now Township of Swan Hill) as a site for Police purposes, revoked as to part by Order of the 2nd April, 1897, so far as regards the balance thereof containing 9.935 hectares, is concerned.—(S.464<sup>(4)</sup>) (Rs.2748).

And the Honorable William Archibald Borthwick, Her Majesty's Minister of Lands for the State of Victoria, shall give the necessary directions herein accordingly.

T. J. FORRISTAL,  
Clerk of the Executive Council.

DEPARTMENT OF CROWN LANDS AND SURVEY.

At the Executive Council Chamber, Melbourne, the eighteenth day of September, 1973.

PRESENT:

His Excellency the Governor of Victoria.  
Mr. Meagher | Mr. Hunt.

REVOCATION OF TEMPORARY RESERVATIONS OF LANDS BY ORDERS IN COUNCIL.

His Excellency the Governor of the State of Victoria, by and with the advice of the Executive Council thereof, doth hereby, in pursuance of the provisions of the *Land Act* 1958, revoke the temporary reservations of lands by Orders in Council hereinafter described, viz.:—

**BEARII.**—The temporary reservation by Order in Council of the 23rd December, 1886, of 8094 square metres (2 acres) of land in the Township of Bearii (called Village of Bearii in Order) as a site for a State School.—(B.695<sup>(2)</sup>) (C.100960).

**BEARII.**—The temporary reservation by Order in Council of the 31st October, 1908, of 4047 square metres (1 acre) of land in the Township of Bearii (called Village of Bearii in Order) as a site for a State School.—(B.695<sup>(2)</sup>) (C.100960).

**LACEBY (LACEBY SOUTH).**—The temporary reservation by Order in Council of the 19th January, 1886, of 9156 square metres (2 acres 1 rood 2 perches) of land in the Parish of Laceby as a site for a State School.—(L.113<sup>(2)</sup>) (C.83639).

**SWAN HILL.**—The temporary reservation by Order in Council of the 12th February, 1889, of 4047 square metres (1 acre) of land in the Township of Swan Hill (called Town of Castle Donnington in Order) as a site for Railway purposes.—(S.464<sup>(4)</sup>) (C.101014).

And the Honorable William Archibald Borthwick, Her Majesty's Minister of Lands for the State of Victoria, shall give the necessary directions herein accordingly.

T. J. FORRISTAL,  
Clerk of the Executive Council.

DEPARTMENT OF CROWN LANDS AND SURVEY.

At the Executive Council Chamber, Melbourne, the eighteenth day of September, 1973.

PRESENT:

His Excellency the Governor of Victoria.  
Mr. Meagher | Mr. Hunt.

LANDS TEMPORARILY RESERVED AS SITES.

His Excellency the Governor of the State of Victoria, by and with the advice of the Executive Council thereof, doth hereby, in pursuance of section 14 of the *Land Act* 1958, reserve temporarily from sale, from being leased and from having a licence granted in respect thereof, and also except from occupation for mining purposes under any miner's right, the land hereinafter described:—

**BRIGHT.**—Site for Public Recreation, 4725 square metres, Parish of Bright, County of Delatite, as indicated by hatching on plan hereunder.—(B.574<sup>(11)</sup>) (Rs.790).

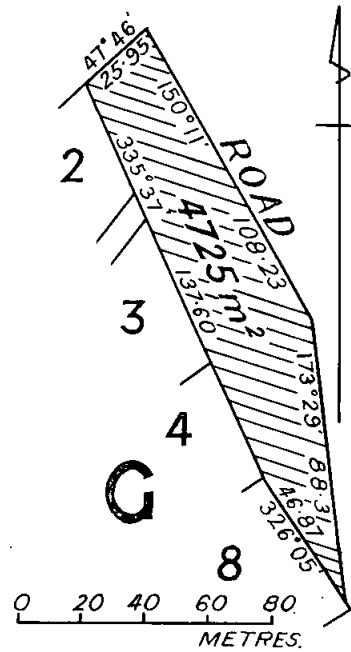

**BULLA.**—Site for Public purposes (State School Forest Plantation), 9787 square metres, Township of Bulla, Parish of Bulla Bulla, County of Bourke, as indicated by hatching on plan hereunder.—(B.522<sup>(4)</sup>) (Rs.3845).

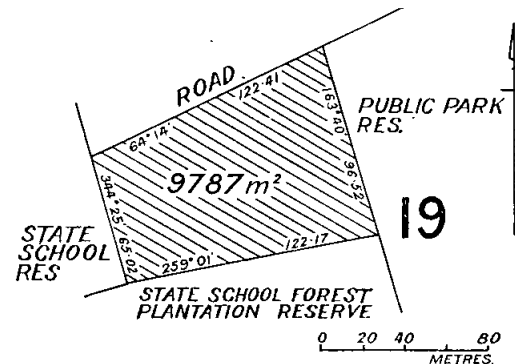

CARAMUT.—Site for Public purposes (State School Forest Plantation), 5.951 hectares, Township of Caramut, Parish of Caramut, County of Villiers, as indicated by hatching on plan hereunder.—(C.190<sup>(1)</sup>) (Rs.9784).

COLAC.—Site for Public Recreation, 3022 square metres, more or less, Township of Colac, Parish of Colac, County of Polwarth, as indicated by hatching on plan hereunder.—(C.279<sup>(5)</sup>) (Rs.9774).

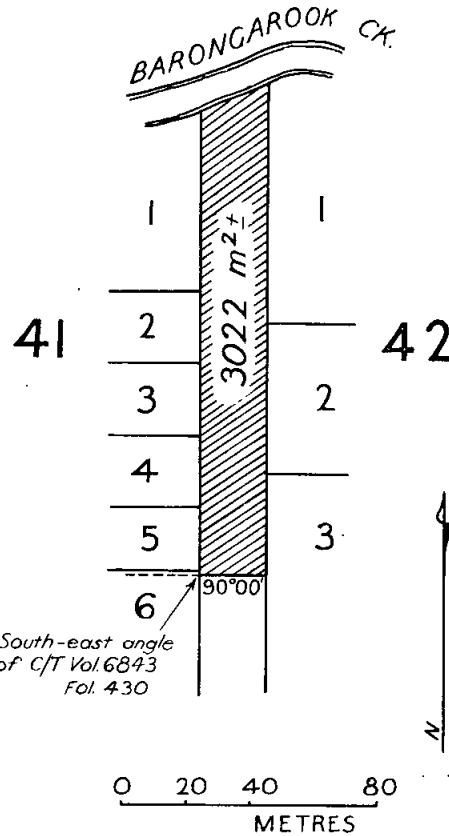
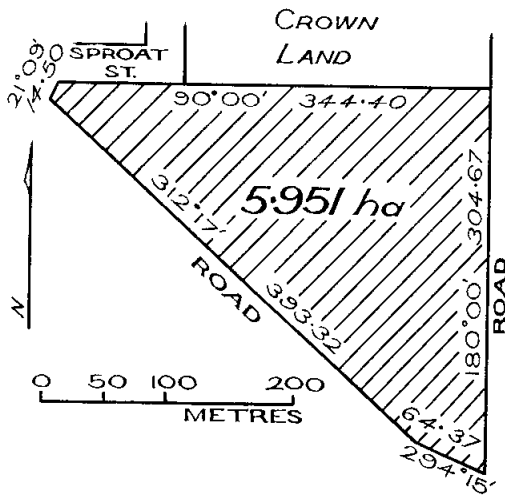

CLEAR LAKE.—Site for State School purposes, 582 square metres, Township of Clear Lake, Parish of Carchap, County of Loran, as indicated by hatching on plan hereunder.—(C.501<sup>(1)</sup>) (Rs.3640).

CURYO.—Site for Public Recreation and Public Hall, 4047 square metres, Township of Curyo, Parish of Curyo, County of Karkaroo, as indicated by hatching on plan hereunder.—(C.455<sup>(6)</sup>) (Rs.6109).

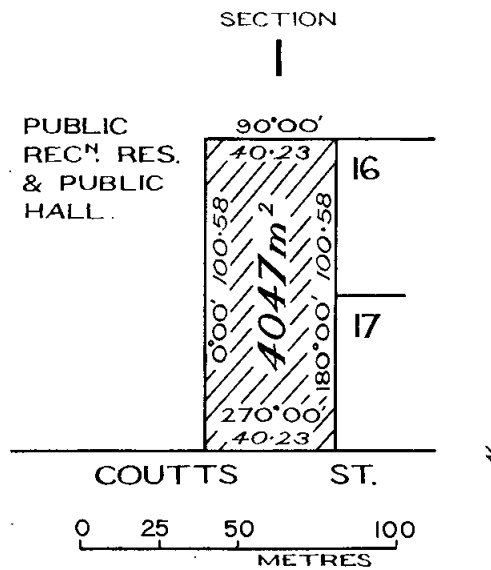
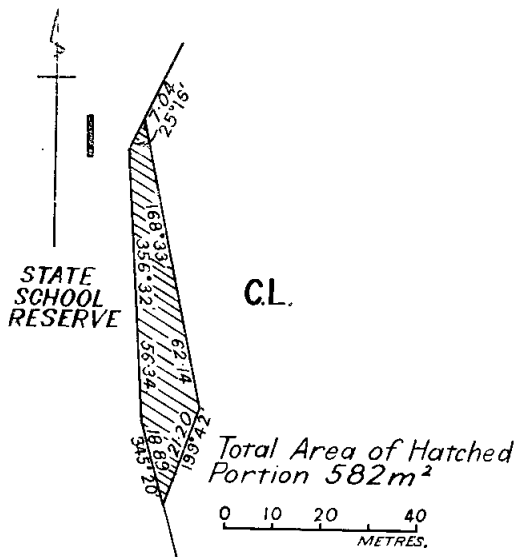

PORTLAND.—Site for Public purposes (Kindergarten), 252 square metres, Township of Portland, Parish of Portland, County of Normanby, as indicated by hatching on plan hereunder.—(P.69(7) (Rs.8622).

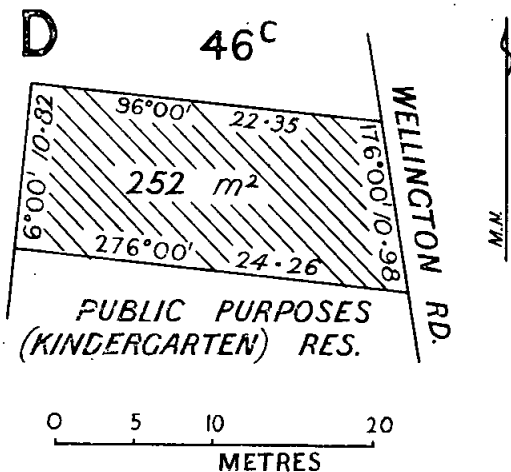

And the Honorable William Archibald Borthwick, Her Majesty's Minister of Lands for the State of Victoria, shall give the necessary directions herein accordingly.

T. J. FORRISTAL,  
Clerk of the Executive Council.

MOTOR CAR ACT 1958.

At the Executive Council Chamber, Melbourne, the eighteenth day of September, 1973.

PRESENT:  
His Excellency the Governor of Victoria.  
Mr. Meagher | Mr. Hunt.

MOTOR CAR TRIALS OF SPEED ON BUNDOOL-ROAD, DUNKELD WITHIN THE SHIRE OF DUNDAS.

Whereas it is enacted by sub-section (2) of section eighty-three of the Motor Car Act 1958 that, if a motor car is used on a highway for purposes of racing or of trial of speed, the driver or the person in charge thereof shall be liable to a penalty of not more than One hundred dollars, provided that the said sub-section (2) shall not apply to a motor car used as aforesaid on any highway or portion thereof specified by Order in Council published in the Government Gazette and on such days and during such hours as are specified in the Order:

And whereas the Hamilton and District Car Club has requested that such an Order be made to enable motor car trials of speed to be conducted by the said Club on Bundool-road, Dunkeld, on Sunday, 2nd December, 1973.

Now therefore, His Excellency the Governor of the State of Victoria, by and with the advice of the Executive Council thereof, and in pursuance of the powers conferred by the Motor Car Act 1958, doth by this Order specify that portion of Bundool-road, Dunkeld within the Shire of Dundas as a highway in respect of which any motor car may, without being subject to the application of the said sub-section (2) of section 83 of the Motor Car Act, be used for purposes of trials of speed under the control of the said Hamilton and District Car Club on Sunday, the 2nd December, 1973, between the hours of twelve noon and five-thirty o'clock in the afternoon provided that the Officer-in-Charge of Police in attendance is satisfied that the highway is in a satisfactory condition for racing purposes and that adequate arrangements have been made for the safety of the public.

And the Honorable John Frederick Rossiter, Her Majesty's Chief Secretary for the State of Victoria, shall give the necessary directions herein accordingly.

T. J. FORRISTAL,  
Clerk of the Executive Council.

MELBOURNE UNDERGROUND RAIL LOOP ACT 1970, No. 8023.

At the Executive Council Chamber, Melbourne, the eighteenth day of September, 1973.

PRESENT:  
His Excellency the Governor of Victoria.  
Mr. Meagher | Mr. Hunt.

Whereas His Excellency the Governor of the State of Victoria by and with the advice of the Executive Council thereof has this day consented pursuant to the provisions of the Melbourne Underground Rail Loop Act 1970 to the Melbourne Underground Rail Loop Authority raising by way of a loan the sum of Five hundred thousand dollars (\$500,000); And whereas His Excellency the Governor in Council is satisfied that a sufficient proportion of the loan to be raised will fall due and be repaid in each year during the currency of the proposed loan; Now therefore it is directed pursuant to the provisions of section 16 (3) of the said Act, that it shall not be necessary to provide a sinking fund in connection with such loan.

And the Honorable Rupert James Hamer, Her Majesty's Treasurer for the State of Victoria, shall give the necessary directions herein accordingly.

T. J. FORRISTAL,  
Clerk of the Executive Council.

MELBOURNE UNDERGROUND RAIL LOOP ACT 1970, No. 8023.

At the Executive Council Chamber, Melbourne, the eighteenth day of September, 1973.

PRESENT:  
His Excellency the Governor of Victoria.  
Mr. Meagher | Mr. Hunt.

Whereas His Excellency the Governor of the State of Victoria by and with the advice of the Executive Council thereof has this day consented pursuant to the provisions of the Melbourne Underground Rail Loop Act 1970 to the Melbourne Underground Rail Loop Authority raising by way of a loan the sum of Five hundred thousand dollars (\$500,000); And whereas His Excellency the Governor in Council is satisfied that a sufficient proportion of the loan to be raised will fall due and be repaid in each year during the currency of the proposed loan; Now therefore it is directed pursuant to the provisions of section 16 (3) of the said Act, that it shall not be necessary to provide a sinking fund in connection with such loan.

And the Honorable Rupert James Hamer, Her Majesty's Treasurer for the State of Victoria, shall give the necessary directions herein accordingly.

T. J. FORRISTAL,  
Clerk of the Executive Council.

ELECTRIC LIGHT AND POWER ACT 1958 AND STATE ELECTRICITY COMMISSION ACTS.

At the Executive Council Chamber, Melbourne, the eighteenth day of September, 1973.

PRESENT:  
His Excellency the Governor of Victoria.  
Mr. Meagher | Mr. Hunt.

REVOCATION OF THE PRESTON (LIMITED) ELECTRIC LIGHTING ORDER No. 350—1968.

Whereas on the 21st day of January, 1969, the Mayor, Councillors and Citizens of the City of Preston (hereinafter called "the undertakers") were granted an Order under the Electric Light and Power Act 1958, cited as the Preston (Limited) Electric Lighting Order No. 350—1968 (hereinafter called "the said Order") authorizing the transmission of bulk electricity supply from the State Electricity Commission's sub-station "TT" situated in the Shire of Whittlesea to the undertaker's municipal boundary: And whereas the undertakers have made application for revocation of the said Order: Now therefore His Excellency the Governor of the State of Victoria by and with the advice of the Executive Council thereof and under the powers in that behalf contained in the said Order and by and with the consent and concurrence of the undertakers as expressed

in their application dated 30th July, 1973, addressed to the Secretary of the State Electricity Commission of Victoria doth hereby revoke the said Order.

And the Honorable James Charles Murray Balfour, Her Majesty's Minister for Fuel and Power for the State of Victoria, shall give the necessary directions herein accordingly.

T. J. FORRISTAL,  
Clerk of the Executive Council.

#### BOILERS AND PRESSURE VESSELS ACT 1970.

*At the Executive Council Chamber, Melbourne, the eighteenth day of September, 1973.*

PRESENT:

His Excellency the Governor of Victoria.  
Mr. Meagher | Mr. Hunt.

#### ORDER OF EXEMPTION UNDER SECTION 9.

Pursuant to the powers conferred by section 9 of the *Boilers and Pressure Vessels Act 1970*, and all other powers him therunto enabling, His Excellency the Governor of the State of Victoria, by and with the advice of the Executive Council thereof, doth hereby make the following Order, that is to say:—

1. This Order may be cited as the "Boilers and Pressure Vessels (Certificated Attendant Exemptions) (Number 2) Order 1973".

2. All boilers listed in the Third Schedule in the Order in Council of 28th August, 1973, *Government Gazette*, No. 86, 5th September, 1973, are hereby exempted from the operation of Division 2 of Part II. of the said *Boilers and Pressure Vessels Act 1970*, until 31st October, 1973.

And the Honorable Joseph Anstice Rafferty, Her Majesty's Minister of Labour and Industry for the State of Victoria, shall give the necessary directions herein accordingly.

T. J. FORRISTAL,  
Clerk of the Executive Council.

#### LOCAL GOVERNMENT DEPARTMENT.

*At the Executive Council Chamber, Melbourne, the eighteenth day of September, 1973.*

PRESENT:

His Excellency the Governor of Victoria.  
Mr. Meagher | Mr. Hunt.

#### ADVISORY COMMITTEE FOR TIRRENGOWER (No. 2) DRAINAGE AREA.—SHIRE OF HEYTESBURY.

Pursuant to the provisions of section 7 of the *Drainage Areas Act 1958*, His Excellency the Governor of the State of Victoria, by and with the advice of the Executive Council thereof, hereby orders that the advisory committee to be appointed for the Tirrengower (No. 2) Drainage Area in the Shire of Heytesbury shall consist of one member representing the Council of the said Shire and four (4) members representing the owners of land in the drainage area.

And the Honorable Alan John Hunt, Her Majesty's Minister for Local Government for the State of Victoria, shall give the necessary directions herein accordingly.

T. J. FORRISTAL,  
Clerk of the Executive Council.

#### LOCAL GOVERNMENT DEPARTMENT.

*At the Executive Council Chamber, Melbourne, the eighteenth day of September, 1973.*

PRESENT:

His Excellency the Governor of Victoria.  
Mr. Meagher | Mr. Hunt.

#### VESTING OF RESERVES IN THE CAMBERWELL CITY COUNCIL.

Whereas it is provided in section 569BA of the *Local Government Act 1958*, that where any map or plan has been lodged or deposited with the Registrar of Titles,

pursuant to section 97 of the *Transfer of Land Act 1958*, or any corresponding previous enactment (whether before or after the commencement of the *Local Government Act 1963*), and any allotment on that map or plan has been transferred the Governor in Council on the request of the Council of the municipality may by Order published in the *Government Gazette*, direct that the whole or any part of the land comprised in any reserve shown on that map or plan shall vest in the Council whereupon such land shall so vest freed and discharged from any mortgage charge lease or sub-lease.

And whereas the Council of the City of Camberwell has requested that reserves shown on plans of subdivision be vested in the Council and an allotment on the plans has been transferred:

Now therefore, His Excellency the Governor of the State of Victoria, by and with the advice of the Executive Council thereof, doth by this Order vest in the Council of the City of Camberwell the drainage and sewerage reserve coloured green and purple on plan of subdivision No. 20100 lodged in the Office of Titles, the Drainage and Sewerage Reserve coloured green on plan of subdivision No. 13394 lodged as aforesaid, and that part of the Reserve for Recreation coloured green on plan of subdivision No. 13193 which lies to the south of Denman-street.

And the Honorable Alan John Hunt, Her Majesty's Minister for Local Government for the State of Victoria, shall give the necessary directions herein accordingly.

T. J. FORRISTAL,  
Clerk of the Executive Council.

#### LOCAL GOVERNMENT DEPARTMENT.

*At the Executive Council Chamber, Melbourne, the eighteenth day of September, 1973.*

PRESENT:

His Excellency the Governor of Victoria.  
Mr. Meagher | Mr. Hunt.

#### ROADS DISCONTINUED.—CITY OF MALVERN.

Whereas it is provided in section 528 (2) of the *Local Government Act 1958*, that where a road (whether or not a public highway but not being a road set out on land of the Crown) or any part thereof is not required for public use, the Governor in Council, on the request of the Council of the municipality in which such road is situated made not less than one month after publishing in a newspaper generally circulating in the district and posting to the registered proprietor (if any) of the land and the owners and occupiers (if any) of lands abutting or immediately adjacent to the road notice of intention to make such request may by Order published in the *Government Gazette* direct that such road or part shall be discontinued and thereupon such road or part shall be discontinued accordingly.

And whereas the Council of the City of Malvern has requested that the Governor in Council direct that portions of the Boulevard, Lomond-terrace and Ambrose-avenue, Chadstone, be discontinued and not less than one month previously has published in a newspaper generally circulating in the district and posted to the registered proprietor of the land in the roads and to the owners and occupiers of lands abutting or immediately adjacent to the roads notice of intention to make such request.

Now therefore, His Excellency the Governor of the State of Victoria, by and with the advice of the Executive Council thereof hereby directs—

- (a) that the said portions of roads, which are shown by hachure and cross-hachure on the plans hereunder, shall be discontinued;
- (b) that notwithstanding such discontinuance the Melbourne and Metropolitan Board of Works shall continue to have and possess the same right title power authority or interest in or in relation to the whole of the land shown by cross-hachure on the said plan as it had or possessed prior to such discontinuance with respect to or in connection with any drains or pipes laid or erected in on or over such lands for the purposes of drainage or sewerage; and

(c) that, subject to any such right title power authority or interest, the land in the said roads shall be retained by the Council of the City of Malvern for municipal purposes.

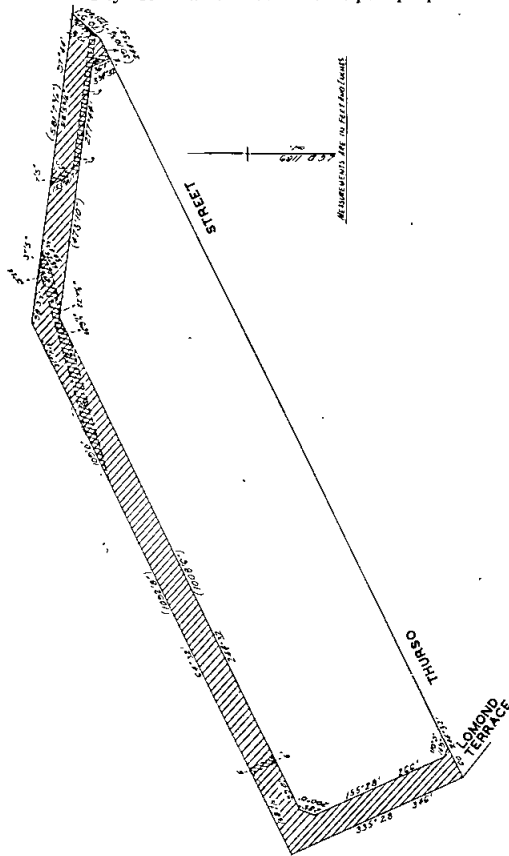

And the Honorable Alan John Hunt, Her Majesty's Minister for Local Government for the State of Victoria, shall give the necessary directions herein accordingly.

T. J. FORRISTAL,  
Clerk of the Executive Council.

LOCAL GOVERNMENT DEPARTMENT.

At the Executive Council Chamber, Melbourne, the eighteenth day of September, 1973.

PRESENT:

His Excellency the Governor of Victoria.  
Mr. Meagher | Mr. Hunt.

APPOINTMENT OF MEMBERS OF THE LOCAL GOVERNMENT ADVISORY BOARD.

Pursuant to the provisions of section 17 (1) of the Local Government Act 1958, His Excellency the Governor of the State of Victoria, by and with the advice of the Executive Council thereof, hereby appoints the following persons with a knowledge of local government to be members of the Local Government Advisory Board for the periods specified:—

LOUIS VOUMARD for a period of six months ending the 31st March, 1974.

ALBERT KEITH LINES for a period of six months ending the 31st March, 1974.

DONALD MAXWELL PURDIE for a period of three years ending the 10th October, 1976.

And the Honorable Alan John Hunt, Her Majesty's Minister for Local Government for the State of Victoria, shall give the necessary directions herein accordingly.

T. J. FORRISTAL,  
Clerk of the Executive Council.

LOCAL GOVERNMENT DEPARTMENT.

At the Executive Council Chamber, Melbourne, the eighteenth day of September, 1973.

PRESENT:

His Excellency the Governor of Victoria.  
Mr. Meagher | Mr. Hunt.

ROAD DISCONTINUED.—CITY OF FOOTSCRAY.

Whereas it is provided in section 528 (2) of the Local Government Act 1958, that where a road (whether or not a public highway but not being a road set out on land of the Crown) or any part thereof is not required for public use, the Governor in Council, on the request of the Council of the municipality in which such road is situated made not less than one month after publishing in a newspaper generally circulating in the district and posting to the registered proprietor (if any) of the land and the owners and occupiers (if any) of lands abutting or immediately adjacent to the road notice of intention to make such request may by Order published in the Government Gazette direct that such road or part shall be discontinued and thereupon such road or part shall be discontinued accordingly.

And whereas the Council of the City of Footscray has requested that the Governor in Council direct that portion of a road off York-street, Yarraville, be discontinued and not less than one month previously has published in a newspaper generally circulating in the district and posted to the registered proprietor of the land in the road and to the owners and occupiers of lands abutting or immediately adjacent to the road notice of intention to make such request.

Now therefore, His Excellency the Governor of the State of Victoria, by and with the advice of the Executive Council thereof, hereby directs that the said road which is shown by hachure on the plan hereunder, shall be discontinued and that the land may be sold by the Council of the City of Footscray by agreement.

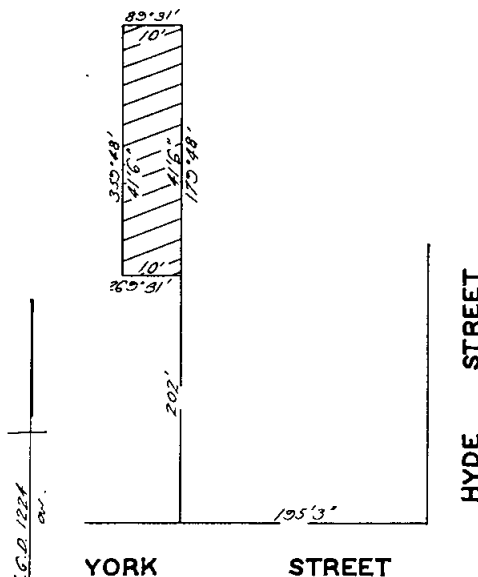

MEASUREMENTS ARE IN FEET AND INCHES

And the Honorable Alan John Hunt, Her Majesty's Minister for Local Government for the State of Victoria, shall give the necessary directions herein accordingly.

T. J. FORRISTAL,  
Clerk of the Executive Council.

LOCAL GOVERNMENT DEPARTMENT.

At the Executive Council Chamber, Melbourne, the eighteenth day of September, 1973.

PRESENT:

His Excellency the Governor of Victoria.  
Mr. Meagher | Mr. Hunt.

ROAD DISCONTINUED.—CITY OF SOUTH MELBOURNE.

Whereas it is provided in section 528 (2) of the *Local Government Act 1958*, that where a road (whether or not a public highway but not being a road set out on land of the Crown) or any part thereof is not required for public use the Governor in Council on the request of the Council of the municipality in which such road is situated made not less than one month after publishing in a newspaper generally circulating in the district and posting to the registered proprietor (if any) of the land and the owners and occupiers (if any) of the lands abutting or immediately adjacent to the road notice of intention to make such a request may by Order published in the *Government Gazette*, direct that such road or part shall be discontinued and thereupon such road or part shall be discontinued accordingly.

And whereas the Council of the City of South Melbourne has requested that the Governor in Council direct that a road off Thomson-street, South Melbourne, be discontinued and not less than one month previously has published in a newspaper generally circulating in the district and posted to the registered proprietor of the land in the said road and to the owners and occupiers of lands abutting or immediately adjacent to the road notice of intention to make such request.

Now therefore, His Excellency the Governor of the State of Victoria, by and with the advice of the Executive Council thereof, hereby directs:—

- (a) that the portion of the said road, which is shown by hachure and cross-hachure on the plan hereunder, shall be discontinued;
- (b) that notwithstanding such discontinuance the Melbourne and Metropolitan Board of Works shall continue to have and possess the same right title power authority or interest in or in relation to the whole of the land shown by hachure and cross-hachure on the said plan as it had or possessed prior to such discontinuance with respect to or in connection with any drains or pipes laid or erected in on or over such land for the purposes of drainage or sewerage; and
- (c) that, subject to any such right title power authority or interest the land in the said road may be sold by the Council of the City of South Melbourne by agreement.

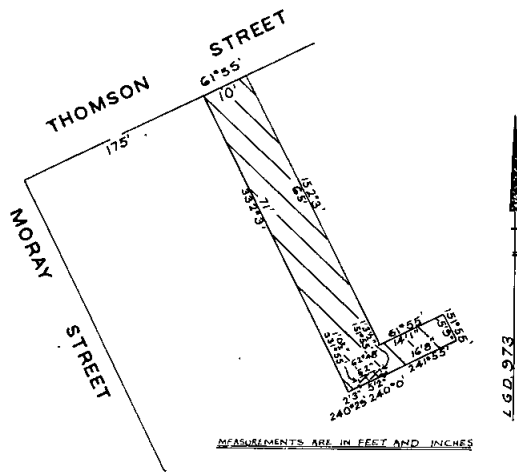

And the Honorable Alan John Hunt, Her Majesty's Minister for Local Government for the State of Victoria, shall give the necessary directions herein accordingly.

T. J. FORRISTAL,  
Clerk of the Executive Council.

LOCAL GOVERNMENT DEPARTMENT.

At the Executive Council Chamber, Melbourne, the eighteenth day of September, 1973.

PRESENT:

His Excellency the Governor of Victoria.  
Mr. Meagher | Mr. Hunt.

CONSENT TO THE INCLUSION OF A PROPERTY DURING THE CURRENCY OF A SEPARATE RATE.—SHIRE OF ELTHAM.

Whereas:

(a) By Order published in the *Government Gazette* on the 21st February, 1973, the Governor in Council, pursuant to the provisions of section 287 of the *Local Government Act 1958*, confirmed a separate rate made by the Council of the Shire of Eltham on the 6th November, 1972, for the purpose of constructing retaining walls in Rattray-road, Montmorency.

(b) The Council of the Shire of Eltham is now of the opinion that a certain property being Number 170 Rattray-road, Montmorency, not being a property with respect to which the rate is levied would benefit from the works or undertakings carried out or to be carried out with the proceeds of the rate or with any moneys borrowed on the security of the rate; and

(c) The Council has not sooner than one month after serving written notice on the owner and occupier of the said property made and levied a rate of three point four three (3.43) cents in the dollar on the unimproved capital value of the property.

Now therefore, His Excellency the Governor of the State of Victoria, by and with the advice of the Executive Council thereof and in pursuance of the provisions of section 290 of the said Act hereby consents to the rate so made and levied forming part of the separate rate confirmed by notice published in the *Government Gazette* as aforesaid.

And the Honorable Alan John Hunt, Her Majesty's Minister for Local Government for the State of Victoria, shall give the necessary directions herein accordingly.

T. J. FORRISTAL,  
Clerk of the Executive Council.

LOCAL GOVERNMENT DEPARTMENT.

At the Executive Council Chamber, Melbourne, the eighteenth day of September, 1973.

PRESENT:

His Excellency the Governor of Victoria.  
Mr. Meagher | Mr. Hunt.

ROAD DISCONTINUED.—CITY OF SUNSHINE.

Whereas it is provided in section 528 (2) of the *Local Government Act 1958*, that where a road (whether or not a public highway but not being a road set out on land of the Crown) or any part thereof is not required for public use, the Governor in Council on the request of the municipality in which such road is situated made not less than one month after publishing in a newspaper generally circulating in the district and posting to the registered proprietor (if any) of the land and the owners and occupiers (if any) of lands abutting or immediately adjacent to the road notice of intention to make such a request may by Order published in the *Government Gazette*, direct that such road or part shall be discontinued and thereupon such road or part shall be discontinued accordingly.

And whereas the Council of the City of Sunshine has requested that portion of Ethel-street, Sunshine, be discontinued and not less than one month previously has published in a newspaper generally circulating in the district and posted to the registered proprietor of the land in the road and to the owners and occupiers of lands abutting or immediately adjacent to the road notice of intention to make such request.

Now therefore, His Excellency the Governor of the State of Victoria, by and with the advice of the Executive Council thereof, hereby directs:—

- (a) that the said road, which is shown by hachure and cross-hachure on the plan hereunder, shall be discontinued;

- (b) that notwithstanding such discontinuance the Melbourne and Metropolitan Board of Works shall continue to have and possess the same right title power authority or interest in or in relation to the whole of the land shown by cross-hachure and cross-hachure marked "A" on the said plan as it had or possessed prior to such discontinuance with respect to or in connection with any drains or pipes laid or erected in on or over such land for the purposes of drainage or sewerage;
- (c) that notwithstanding such discontinuance the State Electricity Commission of Victoria shall continue to have and possess the same right title power authority or interest in or in relation to the whole of the land shown by cross-hachure marked "A" and cross-hachure marked "B" on the said plan as it had or possessed prior to such discontinuance with respect to or in connection with any wires or cables laid or erected in on or over such land for the purposes of the supply of Electricity; and
- (d) that subject to any such right title power authority or interest, the land in the said road may be sold by the Council of the City of Sunshine by agreement.

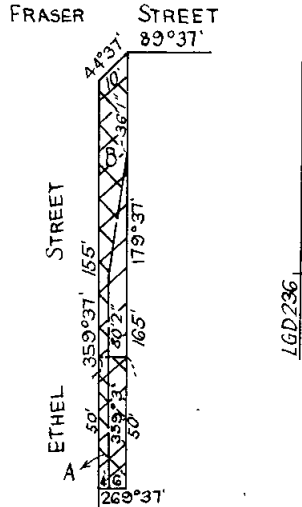

*The fee of the road shown hatched and crosshatched was on the 10-7-69 contained in CJT 8285-699. Measurements are in Feet and Inches*

And the Honorable Alan John Hunt, Her Majesty's Minister for Local Government for the State of Victoria, shall give the necessary directions herein accordingly.

T. J. FORRISTAL,  
Clerk of the Executive Council.

LOCAL GOVERNMENT DEPARTMENT.

At the Executive Council Chamber, Melbourne, the eighteenth day of September, 1973.

PRESENT:  
His Excellency the Governor of Victoria.  
Mr. Meagher | Mr. Hunt.

ROAD DISCONTINUED.—CITY OF PRAHRAN.

Whereas it is provided in section 528 (2) of the Local Government Act 1958, that where a road (whether or not a public highway but not being a road set out on land of the Crown) or any part thereof is not required for public use, the Governor in Council on the request of the municipality in which such road is situated made not less than one month after publishing in a newspaper generally circulating in the district and posting to the registered proprietor (if any) of the land and the owners and occupiers (if any) of lands abutting or immediately adjacent to the road notice of intention to make such request may by Order published in the *Government Gazette*,

direct that such road or part shall be discontinued and thereupon such road or part shall be discontinued accordingly.

And whereas the Council of the City of Prahran has requested that portion of a road off Norman-avenue, Prahran, be discontinued and not less than one month previously has published in a newspaper generally circulating in the district and posted to the registered proprietor of the land in the road and to the owners and occupiers of lands abutting or immediately adjacent to the said road notice of intention to make such request.

Now therefore, His Excellency the Governor of the State of Victoria, by and with the advice of the Executive Council thereof, hereby directs that the said road which is shown by hachure on the plan hereunder, shall be discontinued and that the land shall be sold by the Council of the City of Prahran by agreement.

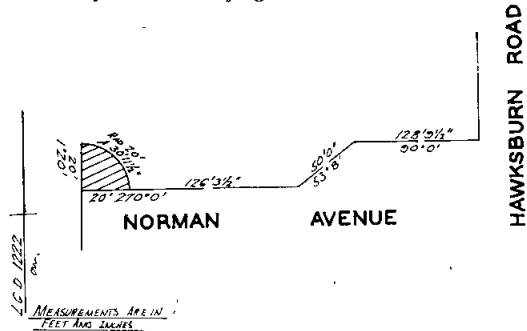

And the Honorable Alan John Hunt, Her Majesty's Minister for Local Government for the State of Victoria, shall give the necessary directions herein accordingly.

T. J. FORRISTAL,  
Clerk of the Executive Council.

LOCAL GOVERNMENT DEPARTMENT.

At the Executive Council Chamber, Melbourne, the eighteenth day of September, 1973.

PRESENT:  
His Excellency the Governor of Victoria.  
Mr. Meagher | Mr. Hunt.

ROAD DISCONTINUED.—CITY OF WAVERLEY.

Whereas it is provided in section 528 (2) of the Local Government Act 1958, that where a road (whether or not a public highway but not being a road set out on land of the Crown) or any part thereof is not required for public use, the Governor in Council, on the request of the Council of the municipality in which such road is situated made not less than one month after publishing in a newspaper generally circulating in the district and posting to the registered proprietor (if any) of the land and the owners and occupiers (if any) of the lands abutting or immediately adjacent to the road notice of intention to make such request may by Order published in the *Government Gazette* direct that such road or part shall be discontinued and thereupon such road or part shall be discontinued accordingly.

And whereas the Council of the City of Waverley has requested that the Governor in Council direct that a road between Kirstina-road and Joyce-avenue, Glen Waverley, be discontinued and not less than one month previously has published in a newspaper generally circulating in the district and posted to the registered proprietor of the land in the said road and to the owners and occupiers of lands abutting or immediately adjacent to the road notice of intention to make such request.

Now therefore, His Excellency the Governor of the State of Victoria, by and with the advice of the Executive Council thereof hereby directs—

- (a) that the said road, which is shown by hachure and cross-hachure on the plan hereunder, shall be discontinued;
- (b) that notwithstanding such discontinuance the Melbourne and Metropolitan Board of Works shall continue to have and possess the same right title power authority or interest in or in relation to the whole of the land shown by cross-hachure on the said plan as it had or possessed, prior to such discontinuance with



respect to or in connection with any drains or pipes laid or erected in on or over such land for the purposes of drainage or sewerage; and

(c) that subject to any such right title power authority or interests, the land in the said road may be sold by the Council of the City of Waverley by agreement.

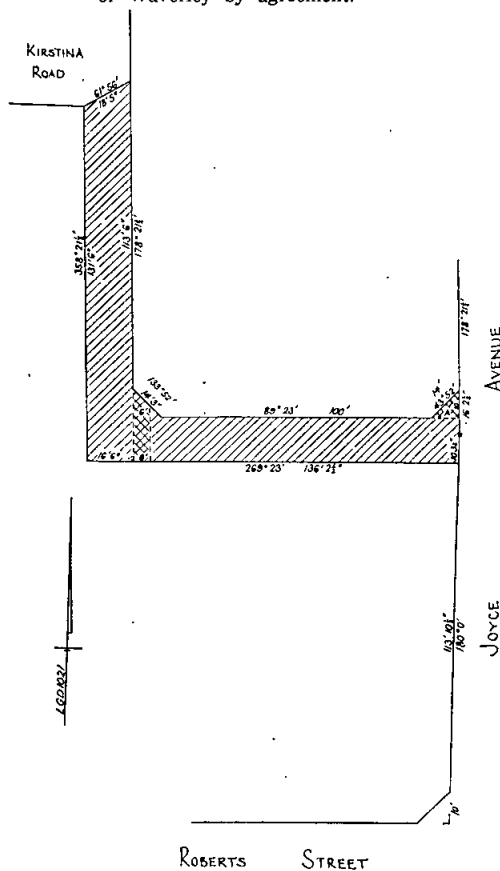

And the Honorable Alan John Hunt, Her Majesty's Minister for Local Government for the State of Victoria, shall give the necessary directions herein accordingly.

T. J. FORRISTAL,  
Clerk of the Executive Council.

LOCAL GOVERNMENT DEPARTMENT.

At the Executive Council Chamber, Melbourne, the eighteenth day of September, 1973.

PRESENT:  
His Excellency the Governor of Victoria.  
Mr. Meagher | Mr. Hunt.

ROAD DISCONTINUED.—CITY OF MORDIALLOC.

Whereas it is provided in section 528 (2) of the Local Government Act 1958, that where a road (whether or not a public highway but not being a road set out on land of the Crown) or any part thereof is not required for public use the Governor in Council on the request of the Council of the municipality in which such road is situated made not less than one month after publishing in a newspaper generally circulating in the district and posting to the registered proprietor (if any) of the land and the owners and occupiers (if any) of lands abutting or immediately adjacent to the road notice of intention to make such request may by Order published in the Government Gazette, direct that such road or part shall be discontinued and thereupon such road or part shall be discontinued accordingly.

And whereas the Council of the City of Mordialloc has requested that the Governor in Council direct that a road off Johnston-street, Mentone be discontinued and not less

than one month previously has published in a newspaper generally circulating in the district and posted to the registered proprietors of the land in the road and to the owners and occupiers of land abutting or immediately adjacent to the road notice of intention to make such request.

Now therefore, His Excellency the Governor of the State of Victoria, by and with the advice of the Executive Council thereof, hereby directs that the road which is shown hatched on the plan hereunder shall be discontinued and that the land may be sold by the Council of the City of Mordialloc by agreement.

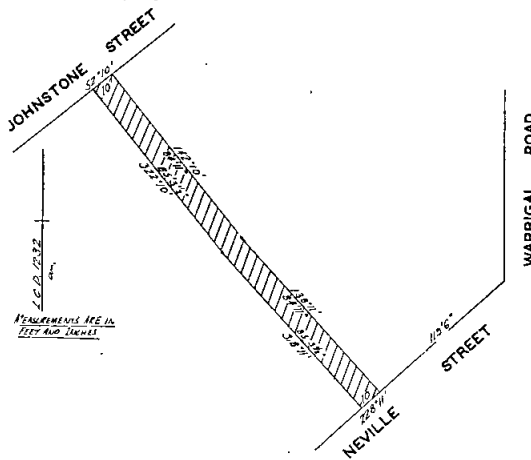

And the Honorable Alan John Hunt, Her Majesty's Minister for Local Government for the State of Victoria, shall give the necessary directions herein accordingly.

T. J. FORRISTAL,  
Clerk of the Executive Council.

LOCAL GOVERNMENT DEPARTMENT.

At the Executive Council Chamber, Melbourne, the eighteenth day of September, 1973.

PRESENT:  
His Excellency the Governor of Victoria.  
Mr. Meagher | Mr. Hunt.

ROAD DISCONTINUED.—CITY OF HEIDELBERG.

Whereas it is provided in section 528 (2) of the Local Government Act 1958, that where a road (whether or not a public highway but not being a road set out on land of the Crown) or any part thereof is not required for public use, the Governor in Council on the request of the Council of the municipality in which such road is situated made not less than one month after publishing in a newspaper generally circulating in the district and posting to the registered proprietor (if any) of the lands abutting or immediately adjacent to the road notice of intention to make such request may by Order published in the Government Gazette, direct that such road or part shall be discontinued and thereupon such road or part shall be discontinued accordingly.

And whereas the Council of the City of Heidelberg requested that the Governor in Council direct that portion of a road off Darbin-street, Heidelberg, be discontinued and not less than one month previously has published in a newspaper generally circulating in the district and posted to the registered proprietor of the land in the road and to the owners and occupiers of lands abutting or immediately adjacent to the road notice of intention to make such request.

Now therefore, His Excellency the Governor of the State of Victoria, by and with the advice of the Executive Council thereof, hereby directs—

- (a) that the said road, which is shown by hachure on the plan hereunder, shall be discontinued;
- (b) that notwithstanding such discontinuance the Melbourne and Metropolitan Board of Works shall continue to have and possess the same right title power authority or interest in or in relation to the whole of the land shown by hachure on the said plan as it had or possessed prior to such

discontinuance with respect to or in connection with any drain or pipes laid or erected in on or over such lands for the purposes of drainage or sewerage; and

- (c) that, subject to any such right title power authority or interest, the land in the said road may be sold by the Council of the City of Heidelberg by agreement.

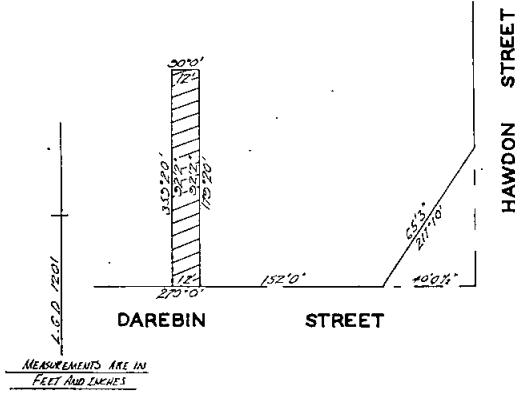

And the Honorable Alan John Hunt, Her Majesty's Minister for Local Government for the State of Victoria, shall give the necessary directions herein accordingly.

T. J. FORRISTAL,  
Clerk of the Executive Council.

LOCAL GOVERNMENT DEPARTMENT.

At the Executive Council Chamber, Melbourne, the eighteenth day of September, 1973.

PRESENT:

His Excellency the Governor of Victoria.  
Mr. Meagher | Mr. Hunt.

ROAD DISCONTINUED.—CITY OF FITZROY.

Whereas it is provided in section 528 (2) of the *Local Government Act 1958*, that where a road (whether or not a public highway but not being a road set out on land of the Crown) or any part thereof is not required for public use the Governor in Council on the request of the Council of the municipality in which such road is situated made not less than one month after publishing in a newspaper generally circulating in the district and posting to the registered proprietor (if any) of the land and the owners and occupiers (if any) of the lands abutting or immediately adjacent to the road notice of intention to make such request may by Order published in the *Government Gazette*, direct that such road or part shall be discontinued and thereupon such road or part shall be discontinued accordingly.

And whereas the Council of the City of Fitzroy has requested that the Governor in Council direct that portion of a road off Little Gore-street, Fitzroy, be discontinued and not less than one month previously has published in a newspaper generally circulating in the district and posted to the registered proprietor of the land in the road and to the owners and occupiers of lands abutting or immediately adjacent to the road notice of intention to make such request.

Now therefore, His Excellency the Governor of the State of Victoria, by and with the advice of the Executive Council thereof, hereby directs—

- (a) that the said road which is shown by hachure on the plan hereunder shall be discontinued;
- (b) that notwithstanding such discontinuance the Melbourne and Metropolitan Board of Works shall continue to have and possess the same right title power authority or interest in or in relation to the whole of the land shown by hachure on the said plan as it had or possessed prior to such discontinuance with respect to or in connection with any drains or pipes laid or erected in on or over such lands for the purposes of drainage or sewerage; and

- (c) that subject to any such right title power authority or interest, the land in the said road may be sold by the Council of the City of Fitzroy by agreement.

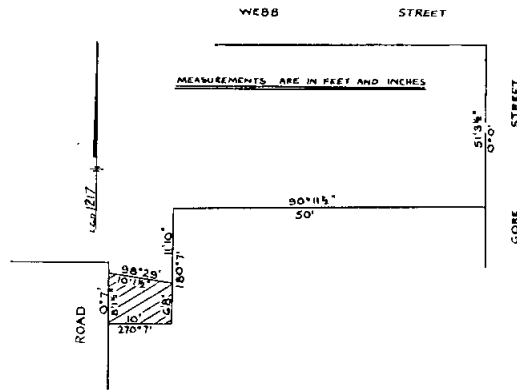

And the Honorable Alan John Hunt, Her Majesty's Minister for Local Government for the State of Victoria, shall give the necessary directions herein accordingly.

T. J. FORRISTAL,  
Clerk of the Executive Council.

LOCAL GOVERNMENT DEPARTMENT.

At the Executive Council Chamber, Melbourne, the eighteenth day of September, 1973.

PRESENT:

His Excellency the Governor of Victoria.  
Mr. Meagher | Mr. Hunt.

ROAD DISCONTINUED.—CITY OF HEIDELBERG.

Whereas it is provided in section 528 (2) of the *Local Government Act 1958*, that where a road (whether or not a public highway but not being a road set out on land of the Crown) or any part thereof is not required for public use, the Governor in Council on the request of the municipality in which such road is situated made not less than one month after publishing in a newspaper generally circulating in the district and posting to the registered proprietor (if any) of the land and the owners and occupiers (if any) of lands abutting or immediately adjacent to the road notice of intention to make such request may by Order published in the *Government Gazette* direct that such road or part shall be discontinued and thereupon such road or part shall be discontinued accordingly.

And whereas the Council of the City of Heidelberg requested that Trelic-avenue, Heidelberg West be discontinued and not less than one month previously has published in a newspaper generally circulating in the district and posted to the registered proprietor of the land in the road and to the owners and occupiers of lands abutting or immediately adjacent to the said road notice of intention to make such request.

Now therefore, His Excellency the Governor of the State of Victoria, by and with the advice of the Executive Council thereof, hereby directs—

- (a) that the said road which is shown by hachure and cross-hachure on the plan hereunder, shall be discontinued;
- (c) that notwithstanding such discontinuance the Melbourne and Metropolitan Board of Works shall continue to have and possess the same right title power authority or interest in or in relation to the whole of the land shown by cross-hachure on the said plan as it had or possessed prior to such discontinuance with respect to or in connection with any drains or pipes laid or erected in on or over such lands for the purposes of drainage or sewerage; and

(c) that subject to any such right title power authority or interest, the land in the said road may be sold by the Council of the City of Heidelberg by agreement.

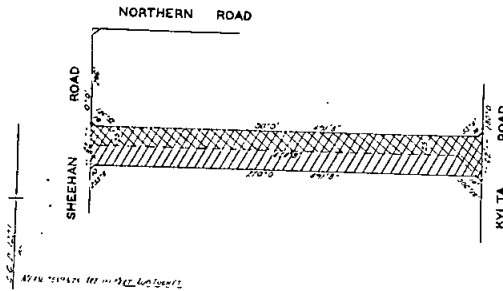

And the Honorable Alan John Hunt, Her Majesty's Minister for Local Government for the State of Victoria, shall give the necessary directions herein accordingly.

T. J. FORRISTAL,  
Clerk of the Executive Council.

LOCAL GOVERNMENT DEPARTMENT.

At the Executive Council Chamber, Melbourne, the eighteenth day of September, 1973.

PRESENT:

His Excellency the Governor of Victoria.  
Mr. Meagher | Mr. Hunt.

BOUNDARIES OF THE CITY OF BROADMEADOWS AND THE SHIRE OF BULLA SET FORTH AND DECLARED.

Pursuant to the provisions of section 12 (2) of the Local Government Act 1958, His Excellency the Governor of the State of Victoria, by and with the advice of the Executive Council thereof, hereby sets forth and declares the boundaries described hereunder as the boundaries of the City of Broadmeadows and of the subdivisions of that City and of the Shire of Bulla and of the subdivisions of that Shire.

CITY OF BROADMEADOWS.

(Re-defined.)

Commencing on the Hume Highway at the junction of Somerton-road; thence southerly by that highway to the road on the southern boundary of section 6, Parish of Wollert; thence easterly by that road to Merri Creek; thence generally southerly by that creek to the northern boundary of section 149, Parish of Jika Jika; thence westerly by that boundary and the northern boundary of section 150, and southerly by the western boundary of the last-mentioned section to Gaffney-street; thence westerly by that street to the Moonee Ponds Creek; thence south-easterly by that creek to Woodlands-street; thence westerly by that street to the south-western angle of allotment 13, section 16, Parish of Dousta Gallia; thence north-westerly by a direct line to the southern angle of allotment D, section 22 and further north-westerly by the western boundary of that allotment and a road to Victoria-street (Nash's-lane); thence north-easterly and northerly by that street to the Moonee Ponds Creek; thence easterly by that creek to the western boundary of the Township of Broadmeadows; thence northerly and easterly by the western and northern boundaries of that township to the western boundary of the land contained in Certificate of Title, volume 5534, folio 765; thence northerly by that boundary to the southern boundary of Crown portion 9, Parish of Will-will-rook; thence easterly by that road to the Hume Highway, being the point of commencement.

(Area of City—7078.4 hectares.)

(Previous Gazettal 1958/1453.)

BROADMEADOWS WARD.

(Re-defined.)

Commencing on the southern boundary of the City at the intersection of Gaffney-street and the Moonee Ponds Creek; thence north-westerly and northerly by that creek to the eastern boundary of the Township of Broadmeadows; thence northerly and westerly by the eastern and northern boundaries of that township to the city boundary; and thence westerly generally south-easterly and northerly by the city boundary to the point of commencement.

(Previous Gazettal 1959/1315.)

CAMPBELLFIELD WARD.

(Re-defined.)

Commencing on the southern boundary of the City where it is intersected by Derby-street; thence northerly by Derby-street, easterly by South-street to East-street, northerly by East-street and easterly by Box Forest-road to the Somerton Railway; thence north-westerly by that railway to the city boundary; and thence easterly, southerly and westerly by the city boundary to the point of commencement.

(Previous Gazettal 1959/1315.)

GLENROY WARD.

(Re-defined.)

Commencing at the southern boundary of the City where it is intersected by Derby-street; thence northerly by Derby-street; easterly by South-street to East-street; northerly by East-street and westerly by Hilton-street and a line to the North-Eastern Railway; thence northerly by that railway to a point in line with Eleanor-street and westerly and south-westerly by that street to Augustine-terrace; thence westerly by that terrace and a line in continuation thereof to the Moonee Ponds Creek; thence south-easterly by that creek to the southern boundary of the city at Gaffney-street; and thence easterly, northerly and easterly by the city boundary to the point of commencement.

(Previous Gazettal 1958/1315.)

SOMMERTON WARD.

(Re-defined.)

Commencing on the northern boundary of the City at the Somerton Railway; thence south-easterly by that railway to Box Forest-road; thence westerly by Box Forest-road, Hilton-street and a line to the North-Eastern Railway; thence northerly by that railway to a point in line with Eleanor-street; thence westerly by a line to Eleanor-street and westerly and south-westerly by that street to Augustine-terrace; thence westerly by that terrace and a line in continuation thereof to the Moonee Ponds Creek; thence northerly by that creek to the eastern boundary of the Township of Broadmeadows; thence northerly and westerly by the eastern and northern boundaries of that township to the city boundary; and thence northerly and easterly by that boundary to the point of commencement.

(Previous Gazettal 1959/1315-6.)

SHIRE OF BULLA.

(Re-defined.)

Commencing on the Hume Highway where it intersects the northern boundary of the Parish of Kalkallo; thence westerly by that boundary and the northern boundary of the Parish of Mickleham to Deep Creek; thence southerly by that creek to the northern boundary of the Parish of Bollinda; thence westerly by that boundary to the Country Roads Board road (know as the Konagaderra Developmental road); thence north-westerly, south-westerly, north-westerly and south-westerly by that road to the Melbourne-Lancefield road; thence southerly by that road to the north boundary of allotment 1, section 19, Parish of Bollinda; thence westerly by a line in continuation of that boundary to the eastern boundary of the Parish of Buttlejorck; thence northerly by that boundary, westerly and southerly by the northern and western boundaries of that parish to the Calder Highway; thence south-easterly by that highway to the north boundary of the Parish of Maribyrnong; thence easterly by that boundary to the north boundary of section 9, Parish of Tullamarine; thence easterly by that boundary and the northern boundaries of sections 8 and 7 to the Lancefield-road; thence south-easterly by that road to Victoria-street (Nash's-lane); thence north-easterly and northerly by that street to the Moonee Ponds Creek; thence easterly by that creek to the western boundary of the Township of Broadmeadows; thence northerly and easterly by the western and northern boundaries of that township to the western boundary of the land contained in Certificate of Title, volume 5534, folio 765; thence northerly by that boundary to the southern boundary of Crown portion 9, Parish of Will-will-rook; thence easterly by that boundary and northerly by the eastern boundaries of the said portion and allotment F, section 3, Parish of Yuroke to Somerton-road; thence easterly by that road to the Hume Highway; thence northerly by that highway to the point of commencement.

(Area of Shire 42 216.8 hectares.)

(Previous Gazettal 1959/1315.)

EAST RIDING.

(Re-defined.)

Commencing on the southern boundary of the Shire at the junction of Deep Creek with the Maribyrnong River; thence easterly and northerly by the Shire boundary to the south-western angle of allotment R, section 10, Parish of

Yuroke; thence northerly by the eastern boundary of the Parish of Bulla Bulla to the south-eastern angle of allotment 18 in that parish; thence westerly by a road to the south-western angle of allotment 18A and northerly by a road to Deep Creek; thence northerly by that creek to the northern boundary of the Shire at the north-eastern corner of the Parish of Bollinda; thence westerly by the Shire boundary to Emu Creek; and thence southerly by that creek and Deep Creek to the point of commencement.

(Previous Gazetteal—1959/1315.)

MICKLEHAM RIDING.

(Re-defined.)

Commencing on the Moonsee Ponds Creek at a point in line with the western boundary of section 6, Parish of Tullamarine; thence north-westerly by that creek to the southern boundary of the Parish of Bulla Bulla; thence easterly and northerly by the southern and eastern boundaries of that parish to the south-eastern angle of allotment 18; thence westerly by a road to the south-western angle of allotment 18A and northerly by a road to Deep Creek; thence northerly by that creek to the northern boundary of the Shire at the north-eastern corner of the Parish of Bollinda; and thence northerly, easterly, southerly and westerly by the Shire boundary to the point of commencement.

(Previous Gazetteal 1959/1315.)

WEST RIDING.

(Re-defined.)

Commencing on the northern boundary of the shire where it is intersected by Emu Creek; thence southerly by that creek and Deep Creek to the Shire Boundary; and thence westerly, north-westerly and easterly by the Shire Boundary to the point of commencement.

(Previous Gazetteal 1959/1315.)

And the Honorable Alan John Hunt, Her Majesty's Minister for Local Government for the State of Victoria, shall give the necessary directions herein accordingly.

T. J. FORRISTAL,  
Clerk of the Executive Council.

LOCAL GOVERNMENT DEPARTMENT.

At the Executive Council Chamber, Melbourne, the eighteenth day of September, 1973.

PRESENT:

His Excellency the Governor of Victoria.  
Mr. Meagher | Mr. Hunt.

ADJUSTMENT OF COMMON BOUNDARY.—SHIRE OF BUNINYONG AND SHIRE OF GRENVILLE.

Pursuant to the provisions of Part II. of the *Local Government Act 1958*, His Excellency the Governor of the State of Victoria by and with the advice of the Executive Council thereof and with effect on and from the 1st October, 1973, hereby orders that, for the purpose of adjustment—

- (a) the boundaries of the municipal district of the Shire of Buninyong and the Ridings thereof shall be altered and re-defined as set forth hereunder; and
- (b) the boundaries of the municipal district of the Shire of Grenville and of the Ridings thereof shall be altered and re-defined as set forth hereunder:—

SHIRE OF BUNINYONG.

(Re-defined.)

(Previous Gazetteal 1915—3338/9.)

Commencing at the south-western angle of the Bonshaw pre-emptive section, Parish of Yarrowee; thence northerly and easterly by the western and northern boundaries of that section to the Yarrowee River; thence northerly by that river to the southern boundary of the Township of Ballarat East; thence easterly and northerly by the southern and eastern boundaries of that Township to the Western Highway; thence easterly by that highway to the north-eastern angle of allotment 5, section 10, Parish of Kerrit Baret; thence southerly by a road to the north-eastern angle of allotment 37; thence easterly by a road to the road from Gordon to Egerton; thence southerly by that road to the northern boundary of the Township of Egerton; thence westerly, southerly and easterly by the northern, western and southern boundaries of that Township to the Geelong-road; thence southerly by that road to the southern

boundary of the Bungal pre-emptive section; thence westerly by that boundary to the western branch of the Moorabool River; thence south-easterly by that river to the road from Bungal to Mount Doran; thence generally south-westerly by that road to the eastern angle of allotment 104, Parish of Borhoneyghurk; thence generally southerly by a road to the south-eastern angle of allotment 9A; thence westerly by a road to the north-western angle of allotment 133, Parish of Meredith; thence southerly by the western boundary of that allotment, allotments 132, 129 and 128, a road and a line to the south-western side of the Geelong and Ballarat Railway; thence generally north-westerly by the said side of that railway to the south-eastern angle of allotment 167; thence generally westerly by a road to the southern boundary of allotment 63B, Parish of Cargerie; thence westerly by that boundary and the southern boundary of the Cargerie pre-emptive section to the south-western angle thereof; thence south-westerly by a road to the northern boundary of allotment 32; thence westerly by that boundary and the northern boundary of allotment 31 to the Meredith-Mount Mercer road; thence northerly and generally westerly by that road to the northern boundary of the Parish of Lawaluk; thence westerly by that boundary and the northern boundaries of the Parishes of Warrambine and Dereel to the Mount Misery Creek; thence generally north-easterly by that creek to a point in line with the northern boundary of allotment 1G, section C, Parish of Lynchfield; thence westerly by a line and the northern boundary of allotment 1G to a point on the said boundary due south of the south-eastern angle of allotment 2, section B; thence north by a line to the said angle; thence north-westerly by the north-eastern boundaries of allotments 2 and 3A to a point on the north-eastern boundary of allotment 3A due south of the south-western angle of allotment 110B, Parish of Yarrowee; thence north by a line to the said angle; thence easterly, northerly and easterly by the southern boundary of that allotment to the south-eastern angle thereof; thence further easterly by a line to the road forming the eastern boundary of allotment 109B; thence northerly by that road to the south-eastern angle of allotment 109B; thence easterly by a line and the northern boundary of allotment 129B to the north-eastern angle thereof; thence northerly by a road to the north-western angle of allotment 131B; thence easterly by a road to the north-eastern angle of allotment 131H; thence northerly by a road to the north-western angle of allotment 72C; thence easterly by a road to the south-eastern angle of allotment 50; thence northerly by the eastern boundary of that allotment, allotment 59, a line and the eastern boundaries of allotments 66A<sup>1</sup> and 66B<sup>1</sup> to the north-eastern angle of the last-mentioned allotment; thence easterly by a road to the south-western angle of allotment 18, section 6; thence northerly by a road to the north-western angle of allotment 22; thence easterly by a road to the south-western angle of allotment 16, section 11; and thence northerly by a road to the point of commencement.

(Area of Shire: 77,700 hectares.)

SHIRE OF BUNINYONG.

BUNINYONG RIDING.

(Unaltered but Re-defined.)

Commencing at a point in the centre of the Government road due north from the north-eastern angle of allotment 35A, Parish of Buninyong; thence west by a line passing through the centre of that road three miles; thence south to a point fifty links due south of the south-western angle of allotment 123B in the said Parish; thence east by a line passing through the centre of the Government road three miles; and thence north by a road to the point of commencement.

NORTH RIDING.

(Unaltered but Re-defined.)

Commencing at a point on the eastern boundary of the Township of Ballarat East where that boundary is intersected by the Western Highway which forms part of the northern boundary of the Shire; thence easterly by that boundary and southerly by the eastern boundary of the shire to a point where it is intersected by the road from Yendon to Egerton; thence westerly by that road to a point where it is intersected by the Ballarat and Geelong railway; thence north-westerly by that railway to the eastern boundary of the Township of Ballarat East; and thence northerly by that boundary to the point of commencement.

MIDDLE RIDING.

(Re-defined.)

Commencing at a point on the eastern boundary of the Township of Ballarat East where that boundary is intersected by the Ballarat and Geelong railway; thence south-easterly by that railway to a point where it is intersected by the road from Yendon to Egerton; thence easterly by that road to the eastern boundary of the shire; thence

southerly by that boundary to a point thereon due east of the bridge crossing Williamson Creek at Clarendon on the Midland Highway; thence due west by a line to the said bridge; thence north-westerly by the Midland Highway to its intersection with the eastern boundary of the Buninyong Riding; thence northerly and westerly by the eastern and northern boundaries of the said riding to a point where the said northern boundary is intersected by the Midland Highway; thence north-westerly by that highway to the southern boundary of the Township of Ballarat East; and thence easterly and northerly by the southern and eastern boundaries of that Township to the point of commencement.

## SOUTH RIDING.

(Unaltered but Re-defined.)

Commencing at the south-western angle of the Buninyong Riding; thence by a line due south to the southern boundary of the shire; thence easterly and northerly by the southern and eastern shire boundaries to a point on the eastern boundary due east of the bridge crossing Williamson Creek at Clarendon on the Midland Highway; thence due west by a line to the said bridge; thence north-westerly by the Midland Highway to its intersection with the eastern boundary of the Buninyong Riding; and thence southerly and westerly by the eastern and southern boundaries of that riding to the point of commencement.

## WEST RIDING.

(Re-defined.)

Commencing at a point on the northern boundary of the shire where it is intersected by the Midland Highway; thence south-easterly by that highway to the northern boundary of the Buninyong Riding; thence westerly and southerly by the northern and western boundaries of that riding to the south-western angle thereof; thence due south by a line to the shire boundary; and thence westerly, northerly and north-easterly by the Shire boundary to the point of commencement.

## SHIRE OF GRENVILLE.

(Re-defined.)

(Previous Gazetteal 1942—1225.)

Commencing at the intersection of the road forming the eastern boundary of section 8, Parish of Haddon and the road from Carngham to Ballarat; thence north-easterly and easterly by the latter road to the north-eastern angle of section 3, Parish of Cardigan; thence southerly by a road to the road forming the northern boundary of the Bonshaw pre-emptive section; thence westerly by that road and southerly by the road forming the western boundary of the said pre-emptive section to the south-eastern angle of allotment 15, section 11, Parish of Yarrowee; thence westerly by a road to the south-eastern angle of allotment 3b, section 13; thence southerly by a road to the south-eastern angle of allotment 148a; thence westerly by a road to the north-western angle of allotment 65b; thence southerly by the western boundaries of that allotment and allotment 65a, a line and the western boundaries of allotments 60 and 49 to the south-western angle of the last-mentioned allotment; thence westerly by a road to the north-eastern angle of allotment 73c; thence southerly by a road to the south-eastern angle of allotment 83c; thence westerly by a road to the south-western angle of allotment 131c; thence southerly by a road to the north-eastern angle of allotment 129b; thence westerly by the northern boundary of that allotment and a line to the road forming the eastern boundary of allotment 109b; thence southerly by that road to a point due east of the south-eastern angle of allotment 110b; thence westerly by a line to the said angle; thence further westerly by the southern boundary of the last-mentioned allotment to the south-western angle thereof; thence southerly by the western boundary of the Parish of Yarrowee and a line to the north-eastern boundary of allotment 3a, section B, Parish of Lynchfield; thence south-easterly by that boundary and the north-eastern boundary of allotment 2 to the south-eastern angle of the latter allotment; thence southerly by a line to a point on the northern boundary of allotment 1g, section C due south of the last-mentioned angle; thence easterly by the said northern boundary and a line to Mount Misery Creek; thence generally southerly by that creek and the Woody Yaloak River to the northern boundary of the Parish of Wilgul North; thence westerly by that boundary and the northern boundary of the Parish of Poliah North to the eastern boundary of the County of Hampden; thence northerly by that boundary to the Mount Emu Creek; thence north-easterly by that creek to the road forming the northern boundary of allotment 6A, section 12, Parish of Mortchup; thence easterly by that road forming the western boundary of allotment 7, section 13; thence southerly by that road to the southern boundary of the parish; thence easterly south-westerly and easterly by that boundary and north-westerly and northerly by the eastern boundary of

the parish to a point on the latter boundary due east of the south-western angle of allotment 2c, section B, Parish of Argyle; thence easterly by a line and the southern boundary of allotment 2c, to the south-eastern angle thereof; thence northerly by the eastern boundary of allotment 2c to the southern boundary of allotment 2a; thence easterly by that boundary to the road forming the eastern boundary thereof; thence northerly by that road to the south-western angle of allotment 2a; thence easterly and northerly by the southern and eastern boundaries of that allotment to the south-eastern boundary of allotment 1a; thence north-westerly by the south-eastern and north-eastern boundaries of that allotment to the northern boundary of the Parish of Scarsdale; thence easterly by that boundary to the western boundary of allotment 1, section 32b, Parish of Carngham; thence northerly by that boundary and easterly and south-easterly by the northern boundary of the said allotment to the road forming the western boundary of allotment 8, section 15A, Parish of Smythesdale; thence northerly by that road to the northern boundary to the said allotment; thence easterly by that boundary to the road forming the eastern boundary of allotment 6; thence northerly by that road to the north-eastern angle of allotment 2; thence northerly by a line to the south-eastern angle of allotment 17c, section 14A, Parish of Carngham; and thence northerly by a road to the point of commencement.

(Area of Shire: 84,434 hectares.)

## SHIRE OF GRENVILLE.

WEST RIDING.

(Unaltered but Re-defined.)

Commencing at a point on the western boundary of the shire where it is intersected by the road from Skipton to Rokewood; thence south-easterly by that road to the Woody Yaloak River; thence south-easterly by that river to the shire boundary; and thence southerly, westerly and northerly by the shire boundary to the point of commencement.

## CENTRAL RIDING.

(Re-defined.)

Commencing at a point on the western boundary of the shire where it is intersected by the road from Skipton to Rokewood; thence northerly and easterly by the shire boundary to the northern boundary of the Parish of Scarsdale; thence easterly, southerly and westerly by the northern, eastern and southern boundaries of the parish to the Woody Yaloak River; thence generally southerly by that river to the road from Skipton to Rokewood; and thence north-westerly by that road to the point of commencement.

## NORTH RIDING.

(Re-defined.)

Commencing at the north-eastern corner of the Parish of Scarsdale being a point on the eastern boundary of the shire; thence westerly by the northern boundary of that parish to the north-eastern angle of allotment 16, section 44 being a point on the shire boundary; and thence northerly, easterly and south-westerly by the shire boundary to the point of commencement.

## EAST RIDING.

(Unaltered but Re-defined.)

Commencing at the south-eastern corner of the Parish of Scarsdale being a point on the eastern boundary of the shire; thence southerly by that boundary to the junction of Mount Misery Creek with the Woody Yaloak River; thence generally northerly by that river to the southern boundary of the Parish of Scarsdale; and thence easterly by that boundary to the point of commencement.

And the Honorable Alan John Hunt, Her Majesty's Minister for Local Government for the State of Victoria, shall give the necessary directions herein accordingly.

T. J. FORRISTAL,  
Clerk of the Executive Council.

## LOCAL GOVERNMENT DEPARTMENT.

At the Executive Council Chamber, Melbourne, the  
eighteenth day of September, 1973.

PRESENT:

His Excellency the Governor of Victoria.  
Mr. Meagher | Mr. Hunt.

## ROAD DISCONTINUED.—CITY OF PORT MELBOURNE.

Whereas it is provided in section 528 (2) of the *Local Government Act 1958*, that where a road (whether or not a public highway but not being a road set out on land of

the Crown) or any part thereof is not required for public use, the Governor in Council on the request of the Council of the municipality in which such road is situated made not less than one month after publishing in a newspaper generally circulating in the district and posting to the registered proprietor (if any) of the land and the owners and occupiers (if any) of lands abutting or immediately adjacent to the road notice of intention to make such request may by Order published in the *Government Gazette* direct that such road or part shall be discontinued and thereupon such road or part shall be discontinued accordingly.

And whereas the Council of the City of Port Melbourne requested that the Governor in Council direct that a road off Princess-street, Port Melbourne, be discontinued and not less than one month previously has published in a newspaper generally circulating in the district and posted to the registered proprietor of the land in the road and to the owner and occupiers of lands abutting or immediately adjacent to the road notice of intention to make such request.

Now therefore, His Excellency the Governor of the State of Victoria, by and with the advice of the Executive Council thereof, hereby directs—

- (a) that the said road, which is shown by hachure on the plan hereunder, shall be discontinued;
- (b) that notwithstanding such discontinuance the Melbourne and Metropolitan Board of Works shall continue to have and possess the same right title power authority or interest in or in relation to the whole of the land shown by hachure on the said plan as it had or possessed prior to such discontinuance with respect to or in connection with any drains or pipes laid or erected in on or over such lands for the purposes of drainage or sewerage; and
- (c) that, subject to any such right title power authority or interest, the land in the said road may be sold by the Council of the City of Port Melbourne by agreement.

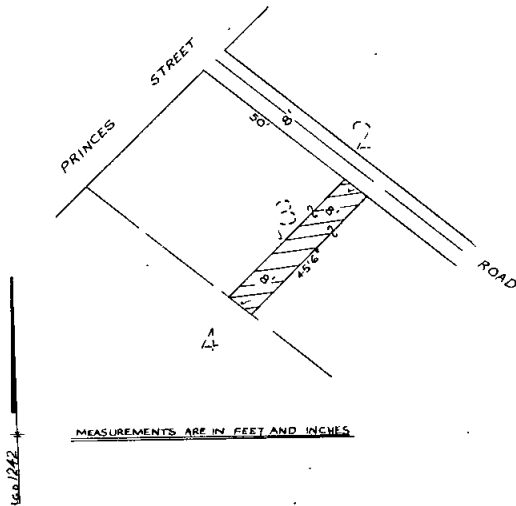

And the Honorable Alan John Hunt, Her Majesty's Minister for Local Government for the State of Victoria, shall give the necessary directions herein accordingly.

T. J. FORRISTAL,  
Clerk of the Executive Council.

HOUSING ACT 1958.

At the Executive Council Chamber, Melbourne, the eighteenth day of September, 1973.

PRESENT:

His Excellency the Governor of Victoria.  
Mr. Meagher | Mr. Hunt.

DECLARATION OF PRIVATE STREET AS A PUBLIC HIGHWAY WITHIN THE SHIRE OF GLENELG.

Whereas pursuant to section 107 of the *Housing Act* 1958, it is among other things enacted that where works have been carried out in accordance with an agreement for the full construction of any roads, pavements, culverts

or drains made pursuant to the provisions of the said section 107 such roads, pavements, culverts or drains shall be under the care and management of the municipality which shall be liable for the cost of any maintenance, repair, alteration or reconstruction thereof and the Governor in Council may by order published in the *Government Gazette* declare any road so constructed to be a public highway.

And whereas by Order dated the 8th December, 1970, the Governor in Council consented to an agreement between the Housing Commission and the Shire of Glenelg regarding street and drainage construction in part Queen-street in the Casterton Estate situate in the municipality of the Shire of Glenelg and the carrying out of the works enumerated in the said agreement.

And whereas the works of road pavements, culvert and drainage construction have now been carried out in accordance with the said agreement between the Housing Commission and the Shire of Glenelg.

Now therefore His Excellency the Governor of the State of Victoria, by and with the advice of the Executive Council of the said State, and in pursuance of the powers conferred by section 107 of the *Housing Act* and upon recommendation of the Housing Commission doth by this order declare the street more particularly delineated and shown hatched on the plan hereunder to be absolutely dedicated to the public as a Public Highway within the meaning of any law now or hereafter in force: And that the Council of the municipality in which the street is situate shall hereafter be liable for all cost of any maintenance, repair, alteration or reconstruction thereof.

PART OF CROWN ALLOTMENT 5 SECTION 23<sup>A</sup>

TOWNSHIP OF CASTERTON

PARISH OF CASTERTON

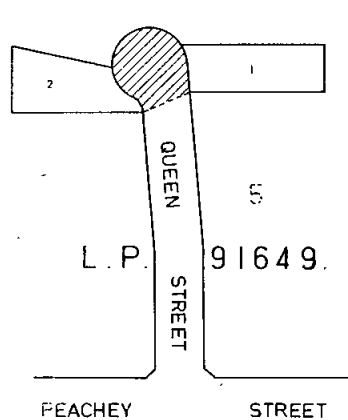
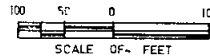

And the Honorable Vance Oakley Dickie, Her Majesty's Minister of Housing for the State of Victoria, shall give the necessary directions herein accordingly.

T. J. FORRISTAL,  
Clerk of the Executive Council.

HOUSING ACT 1958.

At the Executive Council Chamber, Melbourne, the eighteenth day of September, 1973.

PRESENT:

His Excellency the Governor of Victoria.  
Mr. Meagher | Mr. Hunt.

DECLARATION OF PRIVATE STREETS AS PUBLIC HIGHWAYS WITHIN THE CITY OF COLAC.

Whereas pursuant to section 107 of the *Housing Act* 1958, it is among other things enacted that where works have been carried out in accordance with an agreement

for the full construction of any roads, pavements, culverts or drains made pursuant to the provisions of the said section 107 such roads, pavements, culverts or drains shall be under the care and management of the municipality which shall be liable for the cost of any maintenance, repair, alteration or reconstruction thereof and the Governor in Council may by order published in the *Government Gazette* declare any road so constructed to be a public highway.

And whereas by Order dated the 16th March, 1971, the Governor in Council consented to an agreement between the Housing Commission and the City of Colac regarding street and drainage construction in Bilson-street and Ball-street in the Colac Estate situate in the municipality of the City of Colac and the carrying out of the works enumerated in the said agreement.

And whereas the works of road pavements, culvert and drainage construction have now been carried out in accordance with the said agreement between the Housing Commission and the City of Colac.

Now therefore His Excellency the Governor of the State of Victoria, by and with the advice of the Executive Council of the said State, and in pursuance of the powers conferred by section 107 of the Housing Act and upon recommendation of the Housing Commission doth by this order declare the streets more particularly delineated and shown hatched on the plan hereunder to be absolutely dedicated to the public as Public Highways within the meaning of any law now or hereafter in force: And that the Council of the municipality in which the streets are situate shall hereafter be liable for all cost of any maintenance, repair, alteration or reconstruction thereof.

PART OF CROWN ALLOTMENT 6 SECTION 9

PARISH OF ELLIMINYT

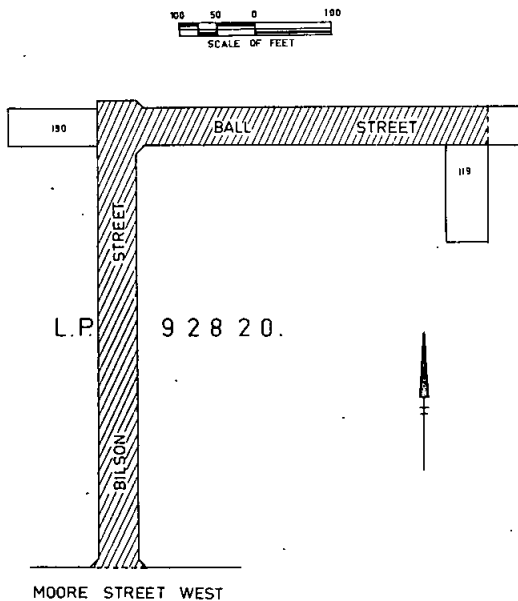

And the Honorable Vance Oakley Dickie, Her Majesty's Minister of Housing for the State of Victoria, shall give the necessary directions herein accordingly.

T. J. FORRISTAL,  
Clerk of the Executive Council.

MEDICAL PRACTITIONERS ACT 1970.

At the Executive Council Chamber, Melbourne, the twenty-fifth day of September, 1973.

PRESENT:

The Lieutenant Governor as Deputy for His Excellency the Governor of Victoria.

Mr. Byrne	Mr. Rossiter
Mr. Dunstan	Mr. Scanlan.

Pursuant to the provisions of section 7A of the *Medical Practitioners Act 1970*, the Lieutenant-Governor as Deputy for His Excellency the Governor of the State of Victoria,

by and with the advice of the Executive Council of the said State, hereby appoints the following persons as members of the Hospitals Accreditation Committee:—

Name.	Statutory Provision.
HOWARD HADFIELD EDEY, B.Sc., M.B., B.S., F.R.C.S., F.R.A.C.S., F.A.C.S., who shall be Chairman.	Section 7A (2)(a).
DAVID GEOFFREY PENINGTON, B.M., B.Ch., M.R.C.P., M.R.A.C.P.	Section 7A (2)(b).
RICHARD RODERICK ANDREW, M.D., F.R.C.P., F.R.A.C.P.	Section 7A (2)(c).
ROBERT FREDERICK FITZGERALD HARBISON, M.B., B.S., F.R.A.C.G.P.	Section 7A (2)(d).
LEONARD BUTTELL SWINDON, F.H.A., F.A.S.A., F.C.I.S., A.F.A.I.M.	Section 7A (2)(e).
WILLIAM MICHAEL KEANE, M.B., B.S., F.A.C.M.A.	Section 7A (2)(f).
FREDERICK ERNEST MAIR, M.B., B.S., M.R.A.C.P.	Section 7A (2)(f).
HENRY BUCKHURST KAY, M.D., F.R.A.C.P., F.R.C.P.	Section 7A (2)(g).
EMANUEL WILDER, M.B., Ch.B., F.R.C.P.A., F.R.C.Path.	Section 7A (2)(f).

And the Honorable Alan Henry Scanlan, Her Majesty's Minister of Health for the State of Victoria shall give the necessary directions herein accordingly.

T. J. FORRISTAL,  
Clerk of the Executive Council.

LOCAL GOVERNMENT DEPARTMENT.

At the Executive Council Chamber, Melbourne, the twenty-fifth day of September, 1973.

PRESENT:

The Lieutenant-Governor as Deputy for His Excellency the Governor of Victoria.

Mr. Byrne	Mr. Rossiter
Mr. Dunstan	Mr. Scanlan.

SEVERANCE OF A PORTION OF THE SHIRE OF OMEO AND ANNEXATION THEREOF TO THE SHIRE OF BRIGHT.

Pursuant to the provisions of part II. of the *Local Government Act 1958*, the Lieutenant-Governor as Deputy for His Excellency the Governor of the State of Victoria, by and with the advice of the Executive Council thereof hereby orders:—

1. That on and from 1st October, 1973, the portion of the municipal district of the Shire of Omeo described hereunder shall be severed from the Omeo Riding of the said Shire and annexed to the South Riding of the Shire of Bright.
2. That the boundaries of the municipal districts of the said municipalities shall be redefined accordingly as described hereunder.
3. That this Order shall not affect the retirement, in accordance with the provisions of division 2 of part III. of the said Act of Councillors of the said municipalities.

PORTION TO BE SEVERED FROM THE SHIRE OF OMEO AND ANNEXED TO THE SHIRE OF BRIGHT.

Commencing on Mt. Cope on the eastern boundary of the Parish of Darbalang; thence southerly by that boundary and the eastern boundary of the Parish of Hotham to the south-eastern angle of that Parish; thence westerly by the northern boundary of the Parish of Theddora to the Great Dividing Range; thence north-westerly by that range to Mt. Hotham; thence north-easterly and south-easterly by a range to the point of commencement.

Area—132 square kilometres.

SHIRE OF BRIGHT.

(Enlarged and redefined.)

Previous *Gazetta* 1960/1684.

Commencing at Mt. Buffalo; thence southerly by the watershed between the Buckland River and the Buffalo River to the Great Dividing Range; thence south-westerly by that range to the source of the Wonnangatta River; thence south-easterly by that river to a point due west of Mt. Birregun; thence east by a line to that mount and north-easterly by a range to the Great Dividing Range; thence

north-westerly by that range to the northern boundary of the Parish of Theddora; thence easterly by that boundary to the south-eastern angle of the Parish of Hotham; thence northerly by the eastern boundary of that parish and the eastern boundary of the Parish of Darbalang to Mt. Cope; thence generally northerly by the range forming the watershed between the Kiewa River and the Big River to Mt. Bogong; thence north-westerly by the range forming the watershed between the Mitta Mitta River and the Kiewa River to a point due east of the north-eastern angle of allotment 48, Parish of Mullagong; thence west by a line to that angle; thence southerly by the eastern boundary of that allotment, westerly by the northern boundary of allotment 4, section 11 and south-westerly and westerly by a road to the south-western angle of allotment 1; thence southerly by the Kiewa River to the north-western angle of allotment 3, section 19, Parish of Tawanga; thence southerly and westerly by a road to the south-western angle of allotment 2A, section 19; thence north-westerly by a road to the south-eastern angle of allotment 1B; thence south-westerly by the southern boundary and north-westerly by the western boundary of that allotment to a point in line with the southern boundary of the Tawanga Pre-emptive section; thence westerly by a line and that boundary and northerly by a road to the south-eastern angle of allotment 8, section 4; thence westerly and south-westerly by a road and further westerly by the Timber Reserve boundary, a line and the southern boundary of allotment 5, section 1, to Running Creek; thence southerly by that creek to the southern boundary of allotment 2, section 15; thence south-westerly by that boundary and north-westerly by a road to the southern boundary of allotment 4; thence westerly by that boundary and northerly by the western boundary of that allotment to the southern boundary of allotment 3; thence westerly by that boundary, northerly by the western boundaries of that allotment and allotment 1 and north-westerly by a road to the western watershed of the Kiewa River; thence southerly by that watershed to the northern boundary of allotment 42, Parish of Tawanga; thence south-westerly by a road on the boundary of that allotment to the Permanent Forest boundary and further south-westerly and easterly by that road through the forest to the point where it again intersects the forest boundary; thence southerly by a direct line to the north-eastern angle of allotment 5, section 27; thence southerly by the eastern boundary of that allotment, south-westerly by a direct line to the south-eastern angle of the Havilah Cemetery, and further south-westerly by a direct line to the south-eastern angle of allotment 3, section 26, Parish of Barwidgee; thence westerly by the southern boundary of that allotment and north-westerly by a line in the direction of Trigonometrical station No. 26 to a point in line with the western boundary of allotment 4, section 22; thence south-westerly by a direct line to the north-western angle of allotment B17, no section; thence south-westerly by the western boundary of that allotment to the Ovens Highway; thence south-easterly by that highway to the Western boundary of allotment B3, no section; thence south-westerly by that boundary and a line to the Ovens River; thence westerly by that river to a point in line with the western boundary of allotment 8A, section 30; thence southerly by a line and that boundary and generally westerly by a road to the south-eastern angle of allotment 2; thence westerly by the southern boundaries of allotments 2, 1 and 3 to a point in line with the eastern boundary of allotment 4; thence southerly by a line and that boundary, westerly and northerly by the southern and western boundaries of that allotment to a point in line with the southern boundary of allotment B14A, no section; thence westerly and north-westerly by a line and that boundary to the eastern boundary of the Parish of Myrtleford; thence southerly by the eastern boundary of allotment 14, section 24, in that parish and thence further southerly by a direct line to the commencing point.

Area of Shire—3100 square kilometres.

#### SHIRE OF OMEO.

(Reduced and Re-defined.)

Previous Gazette 1890/1918.

Commencing at Mt. Cope being a point on the range dividing the watersheds of the Kiewa and Big Rivers; thence generally northerly by that range to Mt. Bogong; thence generally easterly by a range to Mt. Cooper; thence north-easterly by a direct line to Mt. Gibbo; thence south-easterly by a direct line towards Forest-Hill to the Indi River; thence southerly and easterly by that river to the Great Dividing Range; thence south-westerly by that range to its intersection with the 148th meridian of longitude; thence southerly by that meridian to the Timbarra River; thence generally south-westerly by that river and the Tambo River to the northern boundary of the Parish of Tambo; thence westerly by that boundary to the Nicholson

River; thence generally north-westerly by that river to its source; thence northerly by a direct line to Mt. Baldhead; thence north-westerly by a direct line towards Mt. Phipps to the Great Dividing Range; thence generally north-westerly by that range to the northern boundary of the Parish of Theddora; thence easterly by that boundary to the south-eastern angle of the Parish of Hotham; and thence northerly by the eastern boundary of that parish and the eastern boundary of the Parish of Darbalang to the point of commencement.

Area of Shire—5641 square kilometres.

And the Honorable Alan John Hunt, Her Majesty's Minister of Local Government for the State of Victoria, shall give the necessary directions herein accordingly.

T. J. FORRISTAL,  
Clerk of the Executive Council.

#### MOTOR CAR ACT 1958.

At the Executive Council Chamber, Melbourne, the twenty-fifth day of September, 1973.

##### PRESENT:

The Lieutenant-Governor as Deputy for His Excellency the Governor of Victoria.	
Mr. Byrne	Mr. Rossiter
Mr. Dunstan	Mr. Scanlan.

#### APPROVED BREATH ANALYZING INSTRUMENTS.

Pursuant to the provisions of sub-section (14) of section 80F of the Motor Car Act 1958, the Lieutenant-Governor as Deputy for His Excellency the Governor of the State of Victoria, in the Commonwealth of Australia, by and with the advice of the Executive Council of the said State, doth hereby approve for the purpose of the said section 80F, of apparatus of the types described hereunder for ascertaining by analysis of a person's breath what percentage of alcohol is present in his blood:—

##### TYPES OF APPARATUS.

- Instrument for ascertaining by analysis of a person's breath what percentage of alcohol is present in his blood and bearing thereon (*inter alia*) the word "breathalyzer" and the expression "U.S. Patent 2,824,789".
- Instrument for ascertaining by analysis of a person's breath what percentage of alcohol is present in his blood and bearing thereon (*inter alia*) the word "breathalyzer" and the expression "USA Patent No. 2,824,789".

And the Honorable John Frederick Rossiter, Her Majesty's Chief Secretary for the State of Victoria, shall give the necessary directions herein accordingly.

T. J. FORRISTAL,  
Clerk of the Executive Council.

#### ARARAT SEWERAGE AUTHORITY.

At the Executive Council Chamber, Melbourne, the twenty-fifth day of September, 1973.

##### PRESENT:

The Lieutenant-Governor as Deputy for His Excellency the Governor of Victoria.	
Mr. Byrne	Mr. Rossiter
Mr. Dunstan	Mr. Scanlan.

#### CONSENT TO BORROWING \$10,000.

Under the powers conferred by the Sewerage Districts Act and all other powers enabling him in that behalf, the Lieutenant-Governor as Deputy for His Excellency the Governor of the State of Victoria by and with the advice of the Executive Council of the said State, hereby consents to the Ararat Sewerage Authority, borrowing the sum of Ten thousand dollars (\$10,000), to meet the cost of sewerage works as set forth in the detailed statement bearing date 19th September, 1973.

And the Honorable Frederick James Granter, Her Majesty's Minister of Water Supply for the State of Victoria, shall give the necessary directions herein accordingly.

T. J. FORRISTAL,  
Clerk of the Executive Council.



**BENDIGO SEWERAGE AUTHORITY.**

At the Executive Council Chamber, Melbourne, the  
twenty-fifth day of September, 1973.

PRESENT:

The Lieutenant-Governor as Deputy for His Excellency  
the Governor of Victoria.

Mr. Byrne		Mr. Rossiter
Mr. Dunstan		Mr. Scanlan.

**CONSENT TO BORROWING \$21,000.**

Under the powers conferred by the Sewerage Districts Act and all other powers enabling him in that behalf, the Lieutenant-Governor as Deputy for His Excellency the Governor of the State of Victoria by and with the advice of the Executive Council of the said State, hereby consents to the Bendigo Sewerage Authority, borrowing the sum of Twenty-one thousand dollars (\$21,000) for the conversion of Loan No. B.T.

And the Honorable Frederick James Granter, Her Majesty's Minister of Water Supply for the State of Victoria, shall give the necessary directions herein accordingly.

T. J. FORRISTAL,  
Clerk of the Executive Council.

**FRANKSTON SEWERAGE AUTHORITY.**

At the Executive Council Chamber, Melbourne, the  
twenty-fifth day of September, 1973.

PRESENT:

The Lieutenant-Governor as Deputy for His Excellency  
the Governor of Victoria.

Mr. Byrne		Mr. Rossiter
Mr. Dunstan		Mr. Scanlan.

**CONSENT TO BORROWING \$400,000.**

Under the powers conferred by the Sewerage Districts Act and all other powers enabling him in that behalf, the Lieutenant-Governor as Deputy for His Excellency the Governor of the State of Victoria by and with the advice of the Executive Council of the said State, hereby consents to the Frankston Sewerage Authority, borrowing the sum of Four hundred thousand dollars (\$400,000), to meet the cost of sewerage works as set forth in the detailed statement bearing date 19th September, 1973.

And the Honorable Frederick James Granter, Her Majesty's Minister of Water Supply for the State of Victoria, shall give the necessary directions herein accordingly.

T. J. FORRISTAL,  
Clerk of the Executive Council.

**KILMORE SEWERAGE AUTHORITY.**

At the Executive Council Chamber, Melbourne, the  
twenty-fifth day of September, 1973.

PRESENT:

The Lieutenant-Governor as Deputy for His Excellency  
the Governor of Victoria.

Mr. Byrne		Mr. Rossiter
Mr. Dunstan		Mr. Scanlan.

**CONSENT TO BORROWING \$100,000.**

Under the powers conferred by the Sewerage Districts Act and all other powers enabling him in that behalf, the Lieutenant-Governor as Deputy for His Excellency the Governor of the State of Victoria by and with the advice of the Executive Council of the said State, hereby consents to the Kilmore Sewerage Authority, borrowing a sum of One hundred thousand dollars (\$100,000), to meet the cost of sewerage works as set forth in the detailed statement bearing date 19th September, 1973.

And the Honorable Frederick James Granter, Her Majesty's Minister of Water Supply for the State of Victoria, shall give the necessary directions herein accordingly.

T. J. FORRISTAL,  
Clerk of the Executive Council.

No. 93.—8910/73.—4

**MELTON SEWERAGE AUTHORITY.**

At the Executive Council Chamber, Melbourne, the  
twenty-fifth day of September, 1973.

PRESENT:

The Lieutenant-Governor as Deputy for His Excellency  
the Governor of Victoria.

Mr. Byrne		Mr. Rossiter
Mr. Dunstan		Mr. Scanlan.

**CONSENT TO BORROWING \$75,000.**

Under the powers conferred by the Sewerage Districts Act and all other powers enabling him in that behalf, the Lieutenant-Governor as Deputy for His Excellency the Governor of the State of Victoria, by and with the advice of the Executive Council of the said State, hereby consents to the Melton Sewerage Authority borrowing the sum of Seventy-five thousand dollars (\$75,000) to meet the cost of sewerage works, as set forth in the detailed statement bearing date 19th September, 1973.

And the Honorable Frederick James Granter, Her Majesty's Minister of Water Supply for the State of Victoria, shall give the necessary directions herein accordingly.

T. J. FORRISTAL,  
Clerk of the Executive Council.

**LANDS DEPARTMENT NOTICES****APPROACHING LAND SALES.**

Sale of Crown Land, in fee-simple, will be held at the under-mentioned places and dates, viz.:—

	No. of Gazette.
Korumburra.—Friday, 28th September, 1973 ..	83

**PROPOSED REVOCATIONS OF TEMPORARY RESERVATIONS OF LANDS BY ORDERS IN COUNCIL.**

In pursuance of the provisions of the Land Act 1958, notice is hereby given that it is the intention of the Governor in Council to revoke the temporary reservations of lands by Orders in Council hereunder referred to, viz.:—

The following Notices were published 1° on the 5th September, 1973, pursuant to Orders of the 28th August, 1973.

**BALLARAT EAST.**—The temporary reservation by Order in Council of the 2nd December, 1969, of 6,475 square metres (1 acre 2 roods 16 perches) of land in the Township of Ballarat East as a site for Public purposes (Educational purposes) is about to be revoked.—(B.128<sup>(47)</sup>) (Rs.2789).

**BALLARAT EAST.**—The temporary reservation by Order in Council of the 16th March, 1948, of 3,490 square metres (3 roods 18 perches) of land in the Township of Ballarat East (called City of Ballarat in Order) as a site for Educational purposes is about to be revoked.—(B.128<sup>(47)</sup>) (Rs.6128).

**SEBASTOPOL.**—The temporary reservation by Order in Council of the 29th December, 1932, of 2,408 square metres (2 roods 15 2/10 perches) of land in the Township of Sebastopol (called Borough of Sebastopol in Order) as a site for Municipal purposes is about to be revoked.—(S.353<sup>(10)</sup>) (Rs.4282).

**WONGARRA.**—The temporary reservation by Order in Council of the 8th October, 1900, of 4,047 square metres (1 acre) of land in the Parish of Wongarra as a site for a State School is about to be revoked.—(W.374<sup>(6)</sup>) (C.19372).

**NHILL.**—The temporary reservation as a site for Afford Access to Water and the withholding from sale, leasing and licensing by Order in Council of the 13th October, 1879, of 30.85 hectares (76 acres 38 perches) of land in the Parish of Balrootan (now in the Township of Nhill) revoked as to part by various Orders is about to be revoked so far as the balance thereof is concerned.—(N.102<sup>(4)</sup>) (Rs.379).

JIM BALFOUR,  
Acting Minister of Lands.

**PROPOSED REVOCATIONS OF TEMPORARY RESERVATIONS OF LANDS BY ORDERS IN COUNCIL.**

In pursuance of the provisions of the *Land Act 1958*, notice is hereby given that it is the intention of the Governor in Council to revoke the temporary reservations of lands by Orders in Council hereunder referred to, viz.:—

The following Notices were published 1° on the 26th September, 1973, pursuant to Orders of the 18th September, 1973.

**CARAMUT.**—The temporary reservation by Order in Council of the 24th August, 1954, of 6070 square metres (1 acre 2 roods), more or less, of land in the Township of Caramut as a site for Public Recreation, is about to be revoked.—(C.190<sup>(1)</sup>) (Rs.7005).

**CARAMUT.**—The temporary reservation by Order in Council of the 19th August, 1952, of 2.023 hectares (5 acres), more or less, of land in the Township of Caramut as a site for Public Recreation, is about to be revoked.—(C.190<sup>(1)</sup>) (Rs.7005).

**DROUIN.**—The temporary reservation by Order in Council of the 13th May, 1969, of 2529 square metres (2 roods 20 perches), more or less, of land in the Township of Drouin as a site for Public Recreation, is about to be revoked.—(C.190<sup>(1)</sup>) (Rs.7005).

**LICOLA.**—The temporary reservation by Order in Council of the 1st February, 1967, of 2276 square metres (2 roods 10 perches) of land in the Parish of Licola as a site for Public purposes (Forests Department purposes), is about to be revoked.—(L.176<sup>(4)</sup>) (Rs.8649).

**PANYYABYR.**—The temporary reservation as a site for Public purposes (State School) and the withholding from sale, leasing and licensing by Order in Council of the 29th April, 1879, of 2.013 hectares (4 acres 3 roods 36 perches) of land in the Parish of Panyyabyr, are about to be revoked.—(P.126<sup>(3)</sup>) (C.100809).

**PANYYABYR.**—The temporary reservation by Order in Council of the 24th September, 1900, of 8094 square metres (2 acres) of land in the Parish of Panyyabyr as a site for a State School, is about to be revoked.—(P.126<sup>(3)</sup>) (C.100808).

**TCHUTERR.**—The temporary reservation by Order in Council of the 2nd March, 1920, of 23 acres 2 perches of land in the Parish of Tchuterr as a site for Supply of Gravel, is about to be revoked.—(T.192<sup>(2)</sup>) (Rs.2108).

**CHATSWORTH.**—The temporary reservation by Order in Council of the 27th July, 1915, of 5691 square metres of land in the Township of Chatsworth as a site for a Public Hall, is about to be revoked, save and except the area of 5431 square metres indicated by hatching on plan hereunder.—(C.201<sup>(4)</sup>) (Rs.941).

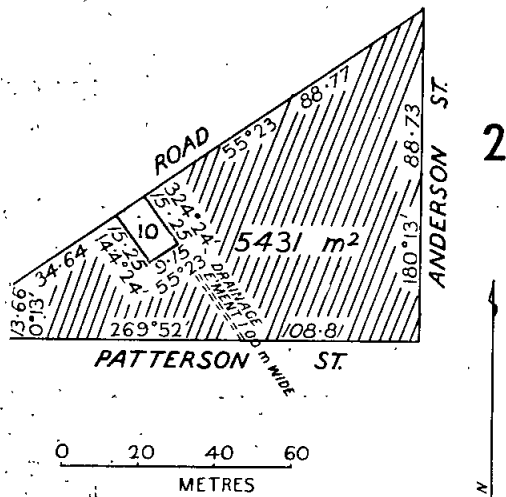

W. BORTHWICK,  
Minister of Lands.

**PROPOSED REVOCATION OF TEMPORARY RESERVATION OF LAND BY ORDER IN COUNCIL.**

In pursuance of the provisions of the *Land Act 1958*, notice is hereby given that it is the intention of the Governor in Council to revoke the temporary reservation of land by Order in Council hereunder referred to, viz.:—  
The following Notice was published 1° on the 12th September, 1973, pursuant to Order of the 4th September, 1973.

**SANDHURST.**—The temporary reservation by Order in Council of the 22nd May, 1945, of 3465 square metres (3 roods 17 perches), more or less, of land in the Parish of Sandhurst, as a site for Recreation purposes, is about to be revoked.—(S.371<sup>(47)</sup>) (Rs.5656).

JIM BALFOUR,  
Acting Minister of Lands.

**REGULATIONS FOR THE CARE, PROTECTION AND MANAGEMENT OF THE LAKE MARMA RESERVE.**

I, William Archibald Borthwick, Her Majesty's Minister of Lands in and for the State of Victoria, in pursuance of the powers conferred on me, do hereby declare that in the preamble to the Regulations made on the 4th November, 1968, and published in the *Government Gazette*, of the 13th November, 1968, for or with respect to certain Crown lands in the Parish of Ashens, such lands mean the lands in the said Parish reserved for Public Park and Gardens, pursuant to Orders in Council dated the 10th December, 1889, and the 14th March, 1962.

Given under my hand at Melbourne on the 18th day of September, 1973.

W. BORTHWICK,  
Minister of Lands.

**REGULATIONS FOR THE CARE, PROTECTION AND MANAGEMENT OF THE GRANTVILLE GRAVEL RESERVE.**

I, William Archibald Borthwick, Her Majesty's Minister of Lands in and for the State of Victoria, in pursuance of the powers conferred on me, do hereby declare that in the preamble to the Regulations made on the 26th April, 1967, and published in the *Government Gazette*, of the 3rd May, 1967, for or with respect to certain Crown lands in the Parish of Corinella, such lands mean such portion of the lands in the said Parish reserved as a site for Gravel purposes, pursuant to Order in Council dated the 27th September, 1921, as are shown hachured on the plan hereunder.

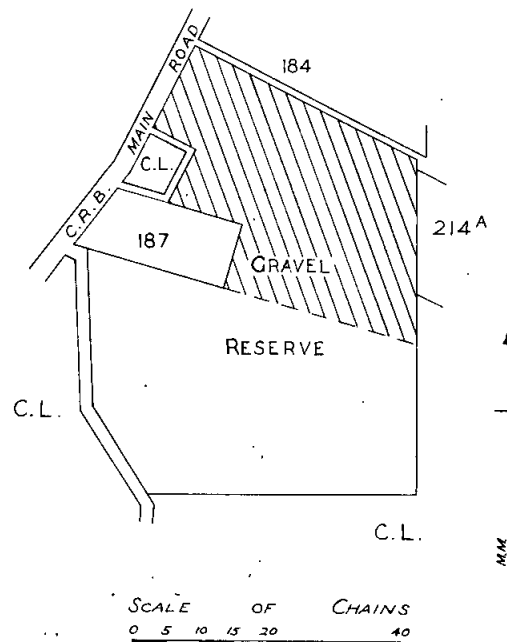

Given under my hand at Melbourne on the 20th day of September, 1973.

W. BORTHWICK,  
Minister of Lands.

REGULATIONS FOR THE CARE, PROTECTION AND MANAGEMENT OF THE "PHILLIP ISLAND KOALA RESERVES".

I, William Archibald Borthwick, Her Majesty's Minister of Lands in and for the State of Victoria, in pursuance of the powers conferred on me, do hereby declare that in the preamble to the Regulations made on the 4th April, 1968, and published in the *Government Gazette*, of the 10th April, 1968, for or with respect to certain Crown lands in the Parish of Phillip Island such lands mean the lands in the said Parish temporarily reserved as sites for the preservation of Koalas, pursuant to Orders in Council dated the 21st March, 1940, the 41st April, 1958, and the 16th April, 1962, and as a site for a Sanctuary for Native Bears, pursuant to Order in Council dated the 24th December, 1937.—(Rs.79, Rs.4770, Rs.7714.)

Given under my hand at Melbourne on the 20th day of September, 1973.

W. BORTHWICK,  
Minister of Lands.

REGULATIONS FOR THE CARE, PROTECTION AND MANAGEMENT OF THE "KYABRAM LAKE RESERVE".

I, William Archibald Borthwick, Her Majesty's Minister of Lands in and for the State of Victoria, in pursuance of the powers conferred on me by section 218 of the *Land Act 1958*, do hereby make the following Regulations for or with respect to the land in the Parish of Kyabram East, temporarily reserved pursuant to Orders in Council dated the 7th November, 1898, 12th November, 1903, and 16th March, 1910, as sites for Public Recreation and hereinafter referred to as "the Reserve".

The Reserve has been placed under the control of a Committee of Management (hereinafter referred to as "the Committee") appointed, pursuant to the provisions of section 221 of the *Land Act 1958*, with power and authority to enforce the following Regulations.

REGULATIONS.

*Definitions.*

1. In these Regulations the under-mentioned words shall, unless inconsistent with the context, have the following meaning shown opposite them, that is to say:—

"Animal Enclosure"—that area of the Reserve enclosed by a fence or fences within which animals are maintained and/or kept by the Committee.

"Animal Sanctuaries"—those areas within the Animal Enclosure enclosed by fences or walls within which animals are maintained or kept by the Committee and access to which by the public is prohibited.

"Building"—includes any shed, stall, shelter, tent or other erection or structure.

*Hours.*

2. All areas of the Reserve, except the Animal Enclosure, shall be open to the public every day between the hours of sunrise and sunset.

3. The Animal Enclosure shall be open to the public every day between the hours of 10 a.m. and 5 p.m. or by special appointment with the Committee.

*Fees.*

4. The Committee may from time to time prescribe and collect fees or other charges for entering or using any facility or convenience provided by it in the Reserve.

*Flora and Fauna.*

5. No person shall in or upon the Reserve kill, wound, net, trap, poison or snare or attempt to kill, wound, net, trap, poison or snare any bird, animal, fish or reptile or have any dead bird, animal, fish or reptile or the skin or pelt thereof in his or her possession.

6. No person shall disturb, interfere with, damage, destroy or remove any skin, eggs, feathers, nests, nesting boxes or part thereof in or from the Reserve.

7. No person shall in or upon the Reserve, chase, annoy, frighten or tease any bird, animal, fish or reptile or permit any child or other person to chase, annoy, frighten or tease any bird, animal, fish or reptile.

8. No person unless authorised in writing by the Committee shall enter any Building in or upon the Reserve except where the same is shown by a sign thereon to be then open to the public.

9. No person shall discharge in the Reserve any explosive, cracker, fireworks or firearm of any description or set any trap, snare or net.

10. No person shall bring into or carry within the Reserve a firearm of any description or any weapon or instrument capable of discharging a missile.

11. No person shall bring into or carry within the Reserve any poison, fireworks, crackers, nets, traps or snares.

*Animal Enclosure and Animal Sanctuaries.*

12. No person shall enter or remain within the Animal Enclosure except when the same is lawfully open to the public unless the written permission of the Committee is first obtained.

13. No person shall allow to remain open any gate or other form of access to or from the Animal Enclosure unless the written permission of the Committee is first obtained.

14. No person shall open or allow to remain open any gate, door or other means of access to or from any Animal Sanctuary unless the written permission of the Committee is first obtained.

15. No person shall enter any Animal Sanctuary unless the written permission of the Committee is first obtained.

16. No person shall remove or attempt to remove any bird, animal, fish or reptile from the Animal Enclosure unless the written permission of the Committee is first obtained.

17. No person shall leave or deposit in the Animal Enclosure any bird, animal, fish or reptile unless the written permission of the Committee or an Officer of the Department of Fisheries and Wildlife is first obtained.

*Animals.*

18. No person shall bring into the Reserve any cattle, horses, sheep, goats, dogs, cats or other animals or permit the same to enter the Reserve. Any cattle as defined by Section 3 of the *Pound Act 1958* found trespassing within the Reserve shall be liable to be impounded. Any dog found trespassing in the Reserve shall be liable to be destroyed.

*Damage to Buildings, &c.*

19. No person shall interfere with, remove, damage or destroy any tracks, signs, buildings, water control structures, earthen banks, fences, Animal Sanctuaries, wildlife shelters or any other improvements or structures in the Reserve.

20. No person shall interfere with, remove, damage or destroy any vehicles, equipment, fixtures or other property of the Committee in the Reserve.

21. No person shall interfere with the flow of any water into, out of, or within the Reserve or remove water from the Reserve by any method unless the written permission of the Committee is first obtained.

*Fences, Gates and Buildings, &c.*

22. No person shall—

(a) Climb or jump over gates or fences in the Reserve, stick bills or posters or cut names on or in any way damage mark or injure any of the buildings, gates, fences, seats or trees in the Reserve or roll or throw stones or missiles of any kind therein.

(b) Remove, deface or displace any board or fitting, written or printed notice for the exhibition of any Regulations or notice affixed by the Committee in the Reserve.

*Boats.*

23. No person shall, unless the written permission of the Committee is first obtained, use in the Reserve any boat or watercraft other than boats available for hire from the Committee.

*Entertainment, Public Address.*

24. No person shall—

(a) Take part in any public entertainment of any kind in the Reserve or

(b) On any portion of the Reserve cause or permit any outcry, sound or noise to be emitted from an amplifier, loud speaker, public address system or any instrument unless the written permission of the Committee is first obtained.

*Litter.*

25. No person shall break glass of any kind or deposit any litter of any kind whatsoever on the Reserve or deposit any rubbish, debris or material of any kind on the Reserve unless the written permission of the Committee is first obtained.

*Liquor.*

26. No person shall enter or remain in the Reserve whilst in a state of intoxication or sell in the Reserve any intoxicating liquor.

27. No person shall bring or distribute in the Animal Enclosure any intoxicating liquor.

**Fires.**

28. No person shall light or maintain any fire in the Reserve except in a properly constructed fireplace provided and no person shall leave any fire so lit or maintained unattended without completely extinguishing it.

**Materials, &c.**

29. No person shall dig in or remove from the Reserve any sand, soil or other material.

**Selling and Advertising.**

30. No person shall hawk or sell or offer for sale in the Reserve any goods, fruit or merchandise or any thing or solicit or gather money therein unless the written permission of the Committee is first obtained.

31. No person shall give out or distribute any hand bills, placards, notices, advertisements, books, pamphlets, or papers in the Reserve or affix to any building, fence, tree or other object any hand bills, placards, notices, advertisements, books, pamphlets or papers.

**Nuisance.**

32. No person shall spit or expectorate on the paths or seats or any wall, structure or property in the Reserve.

33. No person shall offend against decency as regards dress, language or conduct or permit any other nuisance in the Reserve.

**Vehicles.**

34. No person shall drive, ride, place, leave or park any motor vehicle, motor cycle or bicycle in the Reserve except in an area set apart for the purpose by the Committee.

35. No person shall drive any motor vehicle or ride any motor cycle or bicycle in the Reserve at a speed in excess of 10 m.p.h. or in such a manner as to create undue dust or to cause damage to the roadways, parking area or property in the Reserve.

**Camping.**

36. Camping is prohibited in the Reserve. The prohibition includes caravans and any vehicles used for camping.

**Sport.**

37. No person shall play or engage in any organised game or sport in the Reserve except in an area set aside for the purpose by the Committee.

**Other.**

38. If, in the opinion of any duly authorised Officer of the Committee, or any member of the Committee, any person has contravened or failed to comply with any

provision of these Regulations then such officer or person may demand and receive the name and address of such person and any person who refuses to furnish his name or address or who furnishes an incorrect name and address shall be deemed to have committed an offence against these Regulations.

39. No person shall obstruct, hinder or interfere with any person employed in the Reserve.

40. No person shall remain within the Reserve when lawfully directed to leave the same by any Bailiff of Crown Lands, member of the Police Force or authorised officer or member of the Committee.—(Rs.1918.)

Given under my Hand at Melbourne, on the thirteenth day of September, 1973.

W. BORTHWICK,  
Minister of Lands.

Every person who contravenes or fails to comply with these Regulations shall in accordance with the provisions of section 218 of the Land Act 1958, for each offence be liable to a penalty of not more than \$50.00 and every person who contravenes or fails to comply with such Regulations and who, after he has been warned by any bailiff of Crown Lands or by any member of the Police Force does not desist therefrom may be forthwith apprehended by such bailiff or member of the Police Force and taken before some justice to be dealt with according to law and shall be liable to a penalty of not more than \$100.00 provided that every person who contravenes any Regulation made under the said Section for or with respect to prohibiting the depositing and leaving of any unwanted material or thing or rubbish of any kind on any land to which the Section relates shall for each offence be liable to a penalty of not more than \$200.00.

**LOCAL LAND BOARDS.**

In pursuance of the provisions of section 34 of the Land Act 1958, notice is hereby given that a public hearing at the following place and time will be conducted by the person mentioned, being duly appointed in that behalf.

W. A. BORTHWICK,  
Minister of Lands.

Department of Crown Lands and Survey,  
Melbourne, 24th September, 1973.

EDENHOPE (SHIRE OFFICE).—Thursday, 4th October, 1973, at 10.30 a.m.—E. M. Floyd and K. C. Gittins.

**SALE BY AUCTION.**

Notice is hereby given that the following Contracts of Sale have been cancelled.

Lot.	Place of Sale.	Date of Sale.	Allotment.	Section.	Township.	Area.	Purchaser.
8	Wonthaggi .. ..	29.1.1965	3	F	Wonthaggi ..	A. R. P. — — 32	K. C. Sykes (G.61243)

Department of Crown Lands and Survey,  
Melbourne, 3002. 24th September, 1973.

W. BORTHWICK,  
Minister of Lands.

**TENDERS**

**PUBLIC WORKS DEPARTMENT**

Tenders will be received at Public Works Department, 2 Treasury-place, Melbourne, until **TWO** p.m. on dates shown and for purposes mentioned hereunder.

Particulars and tender forms available at Contracts Office, Room 27, Ground Floor, No. 2, Treasury-place, and at places indicated in brackets hereunder.

Abbreviations in brackets mean:—W.O.—Inspector of Works Office; P.S.—Police Station; C.S.—Consolidated School; H.E.S.—Higher Elementary School; H.S.—High School; Pr.S.—Primary School; T.S.—Technical School.

Tenders to be submitted on the Department's printed Tender Form and will not be received by telephone. All tenders must be on a "Firm Tender" basis. The lowest or any tender will not necessarily be accepted.

Address tenders to the Minister of Public Works, and endorse the envelope containing the tender "Tender for .. closing Tuesday,

Hand delivered tenders to be placed in the Tender Box of the Public Works Department, located on the wall of the centre entrance foyer, Ground Floor, 2 Treasury-place, Melbourne.

No preliminary deposit is required with any tender, but a successful tenderer will be required to pay a deposit for any accepted tender of \$4,000 or over.

**Tuesday, 2nd October, 1973.**

**Building, Electrical and Mechanical Works.**

BALWYN.—Removal and renewal of iron roof, H.S.

BRIGHTON.—Erection of library, H.S.

BRIGHTON.—Electrical services—Library, H.S.

BRIGHTON.—Mechanical services—Library, H.S.  
 CRIB POINT.—Internal and external renovations, Residence, Ports & Harbors Division. (W.O., Mornington.)  
 CROYDON.—Electrical services—Library, H.S.  
 CROYDON.—Mechanical services—Library, H.S.  
 FLEMINGTON.—Internal renovations, P.S.  
 FOSTER.—Standardization of mechanical services to Metalcraft Rooms, H.S.  
 FRANKSTON.—Modifications and additions to mechanical services—Plumbing and Sheetmetal Workshops, T.S. (Re-advertised.)  
 HUGHESDALE.—Renovations and painting—Girls Toilet Block and Store Room, Pr.S.4176.  
 MACLEOD.—Erection of library, T.S.  
 MONTEREY.—External and internal repairs and painting, T.S. (Re-advertised.)  
 PARKDALE.—Erection of new brick veneer toilet block, resiting of shelter shed and re-blocking general purpose hall, Pr.S.4171.  
 PINEWOOD.—Erection of new store and staff accommodation improvements, Pr.S.4874.  
 RICHMOND.—Electrical installation—Open Planning Block, Pr.S.2084.  
 RINGWOOD.—Electrical services—Library, H.S.  
 RINGWOOD.—Mechanical services—Library, H.S.  
 SHEPPARTON.—Mechanical services, Pr.S.4742. (W.O., Shepparton.)  
 SOMERS.—Internal and external renovations, Children's Camp 4647. (W.O., Mornington.)  
 TEMPLESTOWE VALLEY.—External and internal renovations, Pr.S.4985.  
 THOMASTOWN.—Exterior and interior renovations, Pr.S.631.  
 VARIOUS.—L.P. gas services, portable class-rooms, 1973-74, Schools.  
 WARRANDYTE.—Staff accommodation improvements, Pr.S.12.  
 WARRNAMBOOL.—Erection of two additional rooms and general renovations, P.S. (W.O., Warrnambool.)  
 WERRIMULL.—Internal and external renovations and painting, C.S. (W.O., Mildura.) (Re-advertised.)  
 WINDSOR.—External renovations, Pr.S.1896.  
 YARRA JUNCTION.—Staff accommodation improvements, Pr.S.3216.

**Site Works.**

DOVETON.—Asphalt and concrete pavements, drainage, landscaping and associated work, T.S.  
 STAWELL.—Site works, H.S. (W.O., Ballarat and Horsham.)

**Miscellaneous.**

MELBOURNE.—Supply and installation of P.A.B.X. telephone system, 271 William-street.  
 VARIOUS.—Supply of incinerators and spare parts for the period 1st October, 1973 to 30th September, 1974, Schools and other Government Departments.

**Tuesday, 9th October, 1973.****Building, Electrical and Mechanical Works.**

BEAUMARIS.—Electrical services—Library, H.S.  
 BEAUMARIS.—Heating and hot water services—Library, H.S.  
 BURNLEY.—Erection of a screenhouse, Victorian Plant Research Institute.  
 CAMPMEADOWS.—External and internal renovations and painting, Pr.S.4833.  
 ECHUCA.—Conversion of class-room to library and staff accommodation improvements, Pr.S.208. (W.O., Bendigo and Shepparton.)  
 EDITHVALE.—New brick veneer toilet block, covered way and staff accommodation improvements, Pr.S.3790.  
 IRYMPLE.—Internal and external painting and renovations, Pr.S.3174. (W.O., Mildura.) (Re-advertised.)  
 KARINGAL.—Electrical services—Library, H.S. (W.O., Mornington.)

KARINGAL.—Heating and hot water services—Library, H.S.  
 NORTHCOTE.—Internal renovations, H.S.  
 SANDRINGHAM.—Electrical services—Library, T.S.  
 SANDRINGHAM.—Heating and hot water services—Library, T.S.  
 SYNDAL.—Staff accommodation improvements, Pr.S.4714.  
 VARIOUS.—Water treatment for air conditioning installations for the period 1st October, 1973 to 1st July, 1974, Schools and other Government Departments.  
 WODONGA.—Exterior renovations, H.S. (W.O., Wangaratta.) (Re-advertised.)  
 YARRAWONGA.—External repairs and repainting, H.S. (W.O., Wangaratta.)

**Site Works.**

GLADESVILLE.—Site works, Pr.S.5066.  
 GOWRIE PARK.—Site works, Pr.S.4806.  
 HURSTBRIDGE.—Site works, H.S.  
 MOE.—Site works, Special School 5079. (W.O., Traralgon and Warragul.)  
 NORWOOD.—Site works, Pr.S.4736.  
 WANTIRNA.—Site works, Pr.S.3709.

**Miscellaneous.**

EAST MELBOURNE.—Maintenance cleaning for the period 15th October, 1973 to 31st October, 1976, Public Offices, 240 Victoria-parade.  
 GLEN WAVERLEY.—Supply and installation of curtains, Police Training Academy.  
 MELBOURNE.—Maintenance cleaning for period 5th November, 1973 to 4th November, 1976, Civil Defence and Training Centre, 31 Queens-road.  
 PORT MELBOURNE.—Supply and delivery of five (5) only chassis and cabin with tray type body—capacity one ton, Plant Depot.

**Tuesday, 16th October, 1973.****Building, Electrical and Mechanical Works.**

ALTONA NORTH.—Electrical installation—Library, H.S.  
 ALTONA NORTH.—Heating and hot water services—Library, H.S.  
 BENTLEIGH WEST.—Internal renovations, Pr.S.4318.  
 BUCKLEY PARK.—Internal painting and renovations, H.S.  
 EAST LODDON.—Replacement of roofs, exterior and interior renovations, C.S. (W.O., Bendigo and Shepparton.)  
 MACLEOD.—Electrical services—Library, T.S.  
 MACLEOD.—Mechanical services—Library, T.S.  
 MELBOURNE.—New demountable partitioning, 2nd and 3rd floors, Public Offices, 2 Treasury-place.  
 NUMURKAH.—Replacement of water service, H.S. (W.O., Shepparton.)  
 NUNAWADING SOUTH.—Internal painting, Pr.S.4808.  
 POINT GELLIBRAND.—Re-blocking, re-roofing, external and internal repairs and painting, H.S.  
 TRARALGON.—External repairs and painting, Hobson Park Hospital. (W.O., Traralgon.)  
 WILLIAMSTOWN.—Electrical installation—Library, T.S.  
 WILLIAMSTOWN.—Heating and hot water services—Library, T.S.  
 WOORINEN NORTH.—External and internal repairs and painting, Pr.S.4148. (W.O., Swan Hill.)

**Site Works.**

LILYDALE WEST.—Site works, Pr.S.5057.  
 WODONGA.—Asphalt re-seal and concrete paving, H.S. (W.O., Wangaratta.)

ROBERTS DUNSTAN,  
 Minister of Public Works.

Public Works Department,  
 Melbourne, 3002, 24th. September, 1973.



**Regulation 141.**

The amount "\$39" is deleted and the amount "\$106" is inserted in lieu thereof.

**DIVISION IV.—SHIFT DUTY AND ROSTERED TIME OF ORDINARY DUTY PERFORMED BY OFFICERS DURING WEEKENDS OR ON PUBLIC HOLIDAYS.**

DEPARTMENT OF HEALTH.—MENTAL HYGIENE BRANCH.

**Regulation 158.**

The amounts "70c" and "\$1" are deleted and the amounts "\$1.50" and "\$2.90" are inserted in lieu thereof respectively.

**DIVISION V.—OTHER ALLOWANCES.**

DEPARTMENT OF HEALTH.—MENTAL HYGIENE BRANCH.

**Regulation 169.**

The expression "\$1.50 a week" is deleted and the expression "9c an hour, with a minimum payment of 50c a week whilst so engaged" is inserted in lieu thereof.

**Regulation 170.**

The amount "15c" is deleted and the amount "20c" is inserted in lieu thereof.

**Regulation 171.**

The amount "\$40" is deleted and the amount "\$182" is inserted in lieu thereof.

**Regulation 172.**

The existing scale of rates is deleted and the following scale is inserted in lieu thereof:—

"Training Assistant, Sandhurst Boys' Centre, Bendigo— at the rate of \$1,533 a year.

Ward Assistant, St. Nicholas Hospital, Carlton—at the rate of \$1,533 a year.

Nurse, Hobson Park Hospital, Traralgon—

- 1st year—at the rate of \$2,352 a year;
- 2nd year—at the rate of \$2,142 a year;
- 3rd year—at the rate of \$1,932 a year;
- 4th year—at the rate of \$1,722 a year;
- 5th and subsequent years—at the rate of \$1,512 a year."

This Regulation shall have effect as on and from the 16th September, 1973.

A. J. A. GARDNER, Chairman.  
P. CARRIGAN, Secretary.

Office of the Public Service Board,  
Melbourne, 17th September, 1973.

No. 528.

*Public Service Act 1958, Section 39.*

**REGULATIONS.—PART IV.—SALARIES AND INCREMENTS.**

The Public Service Board, in pursuance of the powers conferred by the *Public Service Act 1958*, hereby amends the Public Service (Public Service Board) Regulations as follows:—

**THIRD SCHEDULE.**

**PART B.**

PROFESSIONAL DIVISION.

*Scale of Rates of Annual Salaries.*

NATIONAL GALLERY OFFICERS, MINISTRY FOR THE ARTS,  
PREMIER'S DEPARTMENT.

Class.	Annual Salary of Each Subdivision of Each Class.					
	1.	2.	3.	4.	5.	6.
	\$	\$	\$	\$	\$	\$
Add— NG-7 ..	14,414	..	..	..	..	..

A. J. A. GARDNER, Chairman.  
P. CARRIGAN, Secretary.

Office of the Public Service Board,  
Melbourne, 7th September, 1973.

No. 530.

*Public Service Act 1958, Section 39.*

**REGULATIONS.—PART IV.—SALARIES AND INCREMENTS.**

The Public Service Board, in pursuance of the powers conferred by the *Public Service Act 1958*, hereby amends its Regulations as shown below:—

**FIRST SCHEDULE.**

PROFESSIONAL DIVISION.

*Amount of Salary Assigned to Offices in "Special" Class.*

Office.	Yearly Rate of Salary.
MINISTRY FOR CONSERVATION.	\$
Delete— Director of Fisheries and Wildlife ..	19,918
Add— Director of Fisheries and Wildlife ...	18,796

A. J. A. GARDNER, Chairman.  
P. CARRIGAN, Secretary.

Office of the Public Service Board,  
Melbourne, 14th September, 1973.

**PRIVATE ADVERTISEMENTS**

**CITY OF BALLAARAT.**

LOAN No. 40.

*Notice of Intention to Borrow the Sum of \$122,580 for Permanent Works and Undertakings.*

Notice is hereby given that the Council of the City of Ballarat proposes to borrow the principal sum of One hundred twenty-two thousand five hundred and eighty dollars (\$122,580), secured by a charge over the general rates of the municipality, such sum to be raised by the grant of a mortgage, in accordance with the provisions of the *Local Government Act 1958*.

1. The maximum rate of interest that may be paid is 7.3 per centum per annum.
2. The purposes for which the loan is to be applied are:—

Town Hall Redevelopment—part cost \$122,580.

3. The period of the loan shall be fifteen years.
4. The money borrowed shall be repayable by providing out of the municipal fund, 30 half-yearly instalments of \$6,790.68 each, including principal and interest, on the 10th day of May, and the 10th day of November during the currency of the loan. The first instalment shall be payable on the 10th day of May, 1974.

Such moneys are to be repayable at the office of the Commercial Savings Bank of Australia Ltd., in Melbourne.

The plans and specifications and the estimate of the cost of the works and a statement showing the proposed expenditure of the moneys to be borrowed, are open for inspection at the Town Hall, Ballarat.

Dated 24th September, 1973.

4640

F. J. ROGERS, Town Clerk.

**CITY OF BENALLA.**

LOAN No. 32.

*Notice of Intention to Borrow.*

Notice is hereby given that the Council of the City of Benalla intends to borrow Fifty thousand dollars (\$50,000), secured by a charge over the general rates of the municipality by the grant of a mortgage, in accordance with the provisions of the *Local Government Acts*.

In connection therewith the following information is stated:—

- (a) The amount of the principal moneys which it is proposed to borrow is \$50,000 (Fifty thousand dollars).
- (b) The maximum rate of interest that may be paid is 7.1 per centum per annum.
- (c) The times which the moneys borrowed are to be repayable are the 1st day of June, 1974, and the 1st days of December and June, during

the currency of the loan, and that the place such moneys shall be repayable is at the Bank of New South Wales, Benalla, Victoria.

- (d) The purpose for which the loan is to be applied is the establishment of a decentralized industry in Benalla.
- (e) The manner in which the loan is to be liquidated is by provision out of the municipal fund in each half-year during the currency of the loan the sum of \$2,846.96, which includes principal and interest.
- (f) The loan will be for a period of fourteen (14) years.

The plans and specifications and estimate of the cost of the works, and a statement showing the proposed expenditure of the moneys to be borrowed, are open for inspection at the Civic Centre, Benalla.

Dated this 26th day of September, 1973.

4571 L. A. HEMLEY, Town Clerk.

CITY OF CROYDON.

BY-LAW No. 45.

Adoption of Fifteenth Schedule Part IV (1) Public Libraries and Museums.

A By-Law of the City of Croydon made under Section 197 of the Local Government Act 1958 and numbered 45 for adopting certain of the provisions of the Fifteenth Schedule to the said Act and carrying out the purpose provided for in the said schedule.

In pursuance of the powers conferred by the Local Government Act 1958 and of any and every other power it thereunto enabling the Mayor Councillors and Citizens of the City of Croydon orders as follows:

- 1. This By-Law shall be known as the Adoption of Fifteenth Schedule Part IV (1) By-Law.
- 2. Such of the provisions of the Fifteenth Schedule to the Local Government Act 1958, as are set out hereunder are hereby adopted namely:

Part IV—Places of Improvement and Recreation Etc.

(1) Public Libraries and Museums.

- 1. Every person who, being intoxicated, enters or remains in any public library, or museum belonging to the municipality or under the control or management of the Council, or who uses therein any abusive improper or unbecoming language, or who by unnecessarily loud talking or any unnecessary noise or otherwise disturbs or annoys the person using or resorting to such library or museum, or who without lawful excuse but without felony removes any property from such library or museum, shall forfeit a sum not exceeding \$20 and every such person may be forthwith removed by any officer of the Council in charge of such library or museum.
- 2. It shall be lawful for the Council from time to time to make regulations for the proper management and control of every such library and museum, and every person offending against any such regulations shall forfeit a sum not exceeding \$10.
- 3. This By-Law shall apply to and have operation throughout the municipal district.

Resolution for the passing of this By-Law agreed to by the Council of the City of Croydon on the 6th day of August, 1973, and confirmed on the 3rd day of September, 1973.

The common seal of the Mayor, Councillors and Citizens of the City of Croydon was hereto affixed on 17th September, 1973, in the presence of—

(SEAL) S. J. BANNAN, Councillor.  
P. I. CLARK, Councillor.  
R. BURTON, Town Clerk.

4580

CITY OF FITZROY.

Notice is hereby given that the Council of the City of Fitzroy has appointed Senior Sergeant Reginald George Wilkinson, No. 11539, Police Station, Fitzroy; to be Prosecuting Officer of the Council of the City of Fitzroy, for the Municipality of Fitzroy, as from 1st September, 1973.

4573 J. P. JAMES, Town Clerk.

CITY OF HEIDELBERG.

LOAN No. 173.

Notice of Intention to Borrow the Sum of \$100,000 for Permanent Works and Undertakings.

Notice is hereby given that the Council of the City of Heidelberg proposes to borrow the principal sum of \$100,000 (One hundred thousand dollars), secured by a

charge over the general rates of the municipality, such sum to be raised by the grant of a mortgage in accordance with the provisions of the Local Government Act 1958.

- 1. The maximum rate of interest that may be paid is 7.4 per cent. per annum.
- 2. The purposes for which the loan is to be applied are:—

Kitchen Equipment, Town Hall, Ivanhoe Gratings for Filtration Plant, Ivanhoe Swimming Pool Swimming Pool Complex, Macleod (part cost) Council proportion, Country Roads Board works	}	\$100,000
--	---	-----------

- 3. The period of the loan shall be twenty (20) years.
- 4. The moneys borrowed shall be repayable by providing out of the municipal fund half-yearly instalments of approximately \$4,829.05 each, including principal and interest, on the 1st day of June and the 1st day of December, during the currency of the loan. The first instalment shall be payable on the 1st day of June, 1974.

5. Such moneys shall be repayable to The Commissioners of The State Savings Bank of Victoria at the office of the said Commissioners, corner Elizabeth and Bourke streets, Melbourne.

The plans and specifications and the estimate of the cost of the proposed works and a statement showing the proposed expenditure of the moneys to be borrowed are open for inspection at the office of the Council of the City of Heidelberg, at Town Hall, Ivanhoe, 3079.

Dated 24th September, 1973.

4598 ALAN JONES, Town Clerk.

CITY OF HORSHAM.

CHANGE OF ROAD NAMES.

Notice is hereby given that in pursuance of the powers conferred by the Local Government Act, the Council of the City of Horsham has resolved to make the following alterations to road names:—

Old Name.—Government-road (west leg of Rasmussen-road).

New Name.—Riley-road.

Location.—From Curran-road to Davis-drive.

Old Name.—Howard-street.

New Name.—Mills-avenue.

Location.—From Frederick-street to Wawunna-road.

Old Name.—Howard-street.

New Name.—Bleakley-street.

Location.—From Bleakley-street to Kalkee-road.

Old Name.—Healey-street.

New Name.—Dixon-drive.

Location.—From Hocking-street towards Wimmera River.

4589 A. R. CONN, Town Clerk.

CITY OF KNOX.

Whereas the Council of the City of Knox deems it expedient to execute the work or undertaking of providing the land described hereunder for a drainage easement: And whereas for the purpose thereof the exercise of the power of taking land compulsorily will in the opinion of the Council be necessary and desirable: And whereas the Council has caused to be prepared maps and other papers showing a general description of the work or undertaking for which the land proposed to be taken is to be used, a description of the lands proposed to be taken and the names of the owners or reputed owners, lessees, reputed lessees, mortgagees, occupiers of such lands so far as those names are known to or can be ascertained by the Council: And whereas such maps and other papers are deposited at the office of the said Council situate at Fern Tree Gully and are open for inspection by all persons affected by the proposed taking of lands during normal office hours for the space of 40 clear days after the publication of this notice in the Government Gazette, now notice is hereby given to all persons affected by the proposed taking of the said land to set forth, in writing, addressed to the Council or the Town Clerk within 40 clear days of the publication of this notice in the Government Gazette, all objections which they may have to the taking of the said land.

THE LAND REFERRED TO.

A 6-ft. easement over part of lot 2, L.P.23399, The Crescent, Fern Tree Gully.

Dated this 18th day of September, 1973.

By Order of the Council,

4575 N. G. HAYNES, Town Clerk.



## CITY OF MOORABBIN.

## LOAN No. 182.

*Notice of Intention to Borrow the Sum of \$200,000 for Permanent Works and Undertakings.*

Notice is hereby given that the Council of the City of Moorabbin proposes to borrow the principal sum of Two hundred thousand dollars, secured by a charge over the general rates of the municipality, such sum to be raised by the grant of a mortgage in accordance with the provisions of the *Local Government Act 1958*.

1. The maximum rate of interest that may be paid is 7.1 per cent. per annum.

2. The purposes for which the loan is to be applied are:—

Construction of drains .. .. .	\$81,200
Contribution to C.R.B. road works .. .. .	16,400
Installation of traffic lights .. .. .	20,000
Improvements to reserves and places of resort and recreation—	
(i) Golf links .. .. .	\$1,700
(ii) Northern Swimming Pool .. .. .	5,100
(iii) Various reserves .. .. .	33,700
	40,500
Purchase of land for disposal of garbage and refuse—part cost .. .. .	7,500
Construction of kindergarten—Higgins-road—part cost .. .. .	4,600
Construction of Infant Welfare Centre—Gordon-street—part cost .. .. .	1,800
Construction of Senior Citizen's Clubrooms—Derry-street—part cost .. .. .	28,000
	<u>\$200,000</u>

3. The period of the loan shall be ten years.

4. The moneys borrowed shall be repayable by providing out of the municipal fund twenty half-yearly instalments of approximately \$14,136 each, including principal and interest on the 1st days of May and November, during the currency of the loan. The first instalment shall be payable on the 1st May, 1974.

5. Such moneys shall be repayable to the Australia and New Zealand Savings Bank Limited, 394 Collins-street, Melbourne, or at such other place as the Bank may require.

The plans and specifications and the estimate of the cost of the proposed works, and a statement showing the proposed expenditure of the moneys to be borrowed, are open for inspection at the offices of the Council of the City of Moorabbin, at Nepean Highway, Moorabbin.

Dated the 26th September, 1973.

4632 JAMES W. WATERS, Town Clerk.

## CITY OF PRESTON.

## BY-LAW No. 91.

A By-law of the City of Preston made under the *Health Act 1958* and numbered 91 for the provision, use and control of receptacles for the deposit and collection of refuse (whether temporary or otherwise) and prescribing the size and shape and the materials to be used in the construction of such receptacles.

In pursuance of the powers conferred by the *Health Act 1958* and every other power enabling them in that behalf, the Mayor, Councillors and Citizens of the City of Preston order as follows—

1. By-law No. 74 is hereby repealed.

2. This By-law shall come into operation on the day after the day of its publication in the *Victoria Government Gazette*.

3. This By-law shall apply to and have operation throughout the whole of the municipal district of the City of Preston and unless exempted by the Council shall apply to every house, shop, factory and other building and premises therein.

4. In this By-law unless inconsistent with the context or subject matter—

“Council” means the Mayor, Councillors and Citizens of the City of Preston and their duly appointed and authorised servants, agents, contractors and employees.

“Premises” includes land upon which no house or building is erected if the same is occupied and/or used for any purpose in respect of which refuse or household garbage is produced or accumulated.

“Proprietor” means the proprietor of any house, shop, factory or other building or premises and includes the owner, occupier and/or any person having the management or control thereof.

“Refuse” includes all wastes (except sewage and manure) produced or accumulated in or about any house, building or premises.

5. The proprietor of every house, shop, factory or other building or premises shall provide, keep and maintain at all times upon his premises or land upon which such house, shop, factory or other building is erected a properly constructed rat-proof and fly-proof receptacle or receptacles in which he shall from time to time cause to be deposited all refuse produced or accumulated in or about such house, shop, factory or other building or premises.

6. Each receptacle shall—

(a) have a suitable close fitting lid with a flange that overlaps the top of such receptacle, shall be fitted with properly attached side lifting handles and shall be constructed of not less than 26 gauge galvanised iron so as to prevent any absorption by any part of such receptacle or lid of the contents of such receptacle; or

(b) be of non-returnable paper sack system bearing the trade-name GARBAG; or

(c) be a non-returnable plastic bag conforming to the Specifications of the Australian Standards Association No. A.S. 1251 “Polyethylene (Polythene) Garbage Bags”, but shall not include any other receptacle that is constructed of plastic or of similar material.

7. (a) In the case of a receptacle referred to under part (a) of Clause 6 hereof, such receptacle shall be kept constantly covered with its lid (except when refuse is being deposited therein or discharged therefrom) and such receptacle shall be washed at frequent intervals so as to maintain it in a sanitary condition.

(b) In the case of a receptacle referred to under parts (b) or (c) of Clause 6 hereof, such receptacle shall be kept constantly covered with a close fitting lid with a flange that overlaps the top of such receptacle (except when refuse is being deposited therein).

8. Each receptacle shall have a capacity of not more than 2½ cubic feet and shall be so constructed or tied or secured as the case may be, that it may be easily and conveniently lifted by one man.

9. No person shall place or cause or permit to be placed any dust from any vacuum cleaner or any ashes in any receptacle unless such dust or ashes is effectually wrapped in paper so as to remain confined in such paper whilst within such receptacle and so as not to become loose or spread in such receptacle.

10. The proprietor shall, at such hours and at such times as may be appointed by the Council, cause the receptacle to be deposited on the nature strip or footpath or in an approved collection area of the premises in order that the contents may be conveniently removed by the Council, and in the case of a receptacle referred to under parts (b) or (c) of Clause 6 hereof, such receptacle shall be tied or otherwise secured so as to prevent discharge of the contents therefrom.

11. Any person who commits a breach of this By-law shall be liable to a penalty of not more than \$500.00 for every such breach and in the case of a continuing offence, to a further daily penalty of not more than \$100.00.

Resolution for passing this By-law agreed to by the Council on the 23rd day of July, 1973.

Confirmed on the 20th day of August, 1973.

The common seal of the Mayor, Councillors and Citizens of the City of Preston was affixed hereto, by Order of the Council, this the 20th day of August, 1973, in the presence of—

(SEAL) D. R. ATKINSON, Mayor.  
B. T. CONNOR, Councillor.  
J. C. DONATH, Town Clerk.

Submitted to the Commission of Public Health.—J. F. RAYNER, Acting Secretary, Commission of Public Health.

Approved by the Governor in Council, 11th September, 1973.—T. J. FORRISTAL, Clerk of the Executive Council.

4579

## CITY OF SANDRINGHAM.

## LOAN No. 114.

*Notice of Intention to Borrow.*

Notice is hereby given that the Council of the City of Sandringham intends to borrow One hundred and eighty-five thousand dollars (\$185,000), secured by a charge over the general rates of the municipality by the grant of a mortgage in accordance with the provisions of the *Local Government Acts*.

In connection therewith the following information is stated:—

- (a) The amount of the principal moneys which it is proposed to borrow is \$185,000.
- (b) The maximum rate of interest that may be paid is 7.30 per centum per annum.
- (c) The times which the moneys borrowed are to be repayable are the 15th day of May, 1974, and the 15th days of May and November, during the years 1974–1988 inclusive, and that the place such moneys shall be repayable is at the National Bank Savings Bank Limited, Melbourne.
- (d) The purpose for which the loan is to be applied is—
  - (a) Road works (Hampton, Rouen, Medhurst Hamel, Favril, Passchendale and Langnicourt streets, Littlewood-street (Hood to May streets) Linacre-road (Beach-road to Hampton-street)) .. \$112,000
  - (b) Improvements to places of Public Resort and Recreation—
    - Beach Oval .. 20,000
    - Donald McDonald Reserve .. 33,000
  - (c) Drainage works, Jack Lane drain, Black Rock .. 20,000

\$185,000
- (e) The manner in which the loan is to be liquidated is by provision out of the municipal fund in each half-year during the currency of the loan of the sum of \$10,248.62, which includes principal and interest.

The plans and specifications and estimate of the cost of the works, and a statement showing the proposed expenditure of the moneys to be borrowed, are open for inspection at the Municipal Offices, Royal-avenue, Sandringham.

Dated this 20th day of September, 1973.

4574

J. L. ANDERSON, Town Clerk.

CITY OF SHEPPARTON.

Notice is hereby given that Sergeant BERNARD MONCRIEFF, No. 12710, has been appointed Prosecuting Officer for the City of Shepparton, in place of Sergeant Douglas John Elms, No. 10570.

4596

R. O'BRIEN, Town Clerk.

CITY OF SHEPPARTON.

LOAN No. 70.

Notice of Intention to Borrow the Sum of \$115,000 for Permanent Works and Undertakings.

Notice is hereby given that the Council of the City of Shepparton proposes to borrow the sum of \$115,000, secured by a charge over the general rates of the municipality, such sum to be raised by the grant of a mortgage in accordance with the provisions of the Local Government Act 1958.

- 1. The principal amount to be borrowed is \$115,000.
- 2. The maximum rate of interest to be paid is 7.3 per centum per annum.
- 3. The times and place at which the moneys borrowed are to be repayable are the 15th day of May and the 15th day of November during the years 1974 to 1988. Such moneys shall be payable to the Commonwealth Savings Bank of Australia in Shepparton.
- 4. The purpose for which the loan is to be applied is:—
  - Erection of Buildings for decentralized industry—\$115,000.
- 5. The loan shall be liquidated by the provision out of the municipal fund of 30 half-yearly instalments of approximately \$6,370.77 each, including principal and interest, on the 15th day of May and the 15th day of November, during the currency of the loan. The first instalment shall be payable on the 15th day of May, 1974.
- 6. The plans and specifications and the estimate of the cost of the proposed works and a statement showing the proposed expenditure of the moneys to be borrowed, are open for inspection at the office of the Council of the City of Shepparton, Civic Centre, Welsford-street, Shepparton.

4591

R. O'BRIEN, Town Clerk.

CITY OF SPRINGVALE.

LOAN No. 157.

Notice of Intention to Borrow the Sum of \$250,000 for Permanent Works and Undertakings.

Notice is hereby given that the Council of the City of Springvale proposes to borrow the principal sum of \$250,000, secured by a charge over the general rates of the municipality, such sum to be raised by the grant of a mortgage, in accordance with the provisions of the Local Government Act 1958.

- 1. The maximum rate of interest that may be paid shall be such amount as may be fixed and approved by the Director of Finance at the date of settlement.
- 2. The purpose for which the loan is to be applied is—
  - (a) Payments to the M.M.B.W. for land purchases .. \$40,000
  - (b) Construction of Springvale Youth Club Building .. \$60,000
  - (c) Construction of Lightwood-road .. \$100,000
  - (d) Construction of car park, Civic Centre, Springvale .. \$7,000
  - (e) Purchase of land and buildings, Grace Park-avenue, Springvale .. \$36,000
  - (f) Construction of pavilion at Burden Reserve (part cost only) .. \$7,000
- 3. The period of the loan shall be fifteen years.
- 4. The moneys borrowed shall be repayable by providing out of the municipal fund 30 half-yearly instalments, including principal and interest, on the 30th day of April and the 31st day of October during the currency of the loan, and the first instalment shall be payable on the 30th day of April, 1974. Such moneys shall be repayable at the Australia and New Zealand Banking Group, Springvale-road, Springvale.

The plans and specifications and the estimate of the cost of such works, and a statement showing the proposed expenditure of the moneys to be borrowed, are open for inspection by ratepayers, during office hours, at the City Offices, Civic Centre, Springvale-road, Springvale, for one month after the publication of this notice.

Dated 19th September, 1973.

4563

H. L. WILLIAMS, Town Clerk.

BOROUGH OF WONTHAGGI.

ORDER PURSUANT TO THE DOG ACT 1970.

Pursuant to the powers conferred by section 16 of the Dog Act 1970, No. 8079, the Council of the Borough of Wonthaggi orders as follows:—

The beach commencing at the eastern boundary of the municipality of the Borough of Wonthaggi, being the eastern boundary of the recreation reserve known as Cape Paterson Beach Reserve and extending in a south-westerly and north-westerly direction until it meets the northern boundary of the said recreation reserve, and the area within 500 yards of the said beach on the southern side and up to the northern boundary of the said recreation reserve on the northern side, being within 500 yards of the said beach, is hereby specified a beach for the purpose of section 16 of the Dog Act 1970, No. 8079. Dogs are not permitted thereon between the hours of 9 a.m. and sunset from the 1st day of December to the 30th day of April in any year, both days inclusive.

The above order was made by the Council of the Borough of Wonthaggi, on the 12th day of July, 1971.

4609

N. M. SIMMONS, Town Clerk.

SHIRE OF ALEXANDRA.

BY-LAW No. 56.

A by-law of the Shire of Alexandra made under Section 197 of the Local Government Act 1958, and numbered 56 for prohibiting cattle being allowed to graze or wander upon any land not enclosed by a substantial fence.

In pursuance of the powers conferred by the Local Government Act 1958 and every other power enabling it in that behalf the President Councillors and Ratepayers of the Shire of Alexandra order as follows:—

- 1. In this by-law the word "cattle" includes horses mares fillies foals geldings colts bulls bullocks cows heifers steers calves asses mules sheep ewes wethers rams lambs goats and swine.
- 2. No person being the owner of or having the possession care charge management custody control or supervision of any cattle shall allow any one or more of such cattle to graze or wander upon any land which is in the opinion of the Council of the Shire of Alexandra not enclosed by a substantial fence.

3. Any person guilty of any wilful act or default contrary to this by-law shall be liable to a penalty of not more than \$100.00 and any person guilty of a continuing offence against this by-law shall be liable to a penalty of not more than \$10.00 for each day on which an offence against this by-law is continued after a conviction or order in respect thereof by any Court.

4. This by-law shall apply to and have operation throughout the whole of the municipal district of the Shire of Alexandra.

Resolution for passing this by-law agreed to by the Council of the Shire of Alexandra the 8th day of August, 1973.

Confirmed the 12th day of September, 1973.

(SEAL) W. J. E. MOORE, J.P., Shire President.  
4606 R. G. RENNIE, Councillor.  
DONALD O. McLEAN, Shire Secretary.

#### SHIRE OF ALEXANDRA.

##### BY-LAW No. 54.

A by-law of the Shire of Alexandra made under Section 228 of the Local Government Act 1958 and numbered 54 for repealing certain By-laws.

In pursuance of the powers conferred by the Local Government Act 1958, and every other power enabling it in that behalf, the President, Councillors, and Ratepayers of the Shire of Alexandra order as follows:—

1. The following By-Laws shall be and the same are hereby repealed as to the whole:

- By-Laws Nos. 16, (sixteen)  
24, (twenty-four)  
37, (thirty-seven)  
38, (thirty-eight)  
42, (forty-two)  
47, (forty-seven).

Resolution for passing this By-law agreed to by the Council the 11th day of July, 1973.

Confirmed the 8th day of August, 1973.

(SEAL) E. E. SOUTHAM, Shire President.  
4605 R. G. RENNIE, Councillor.  
DONALD O. McLEAN, Shire Secretary.

#### SHIRE OF GISBORNE.

##### BY-LAW No. 41.

Notice is hereby given that the Council has made By-Law Numbered 41 which provides for the collection, removal and disposal of refuse from private premises at Gisborne, New Gisborne, Macedon and Mount Macedon as defined in the schedule.

A copy of the by-law is available for inspection, free of charge, during office hours at the Shire Office, 10 Hamilton Street, Gisborne.

The resolution for passing the by-law was agreed to by the Council on 10th day of July, 1973, and confirmed on 6th day of August, 1973. It was submitted to the Commission of Public Health and approved by the Governor in Council on 11th September, 1973.

4564 K. V. ROBINSON, Shire Secretary.

#### River Improvement Act 1958.

##### SHIRE OF KORUMBURRA.

##### PROPOSED RIVER IMPROVEMENT DISTRICT.

Notice is hereby given that the Council of the Shire of Korumburra has forwarded to the Minister of Water Supply an application for the constitution of a River Improvement District under the jurisdiction and control of a River Improvement Trust and comprising the whole of the Shire of Korumburra under the provisions of the River Improvement Act 1958.

Copies of the application and general plan, and description of the works, have been deposited for inspection at the offices of—

- (1) The Minister of Water Supply, State Rivers and Water Supply Commission, 590 Orrong-road, Armadale, 3143.
- (2) The Shire of Korumburra, Commercial-street, Korumburra.

4597 W. O. CLARK, Shire Secretary.

#### SHIRE OF NARRACAN.

##### BY-LAW No. 47.

Notice is hereby given that the Council of the Shire of Narracan has made By-law No. 47 pursuant to the provisions of the Local Government Acts and all other powers it thereunto enabling, for the purpose of:

- (a) Repealing By-Law No. 27:

- (b) Regulating the market place and the buildings, stalls, pens and standings therein and for preventing nuisances or obstructions therein or in the immediate approaches to the Trafalgar Municipal Saleyards.

- (c) Fixing the days and hours during each day on which the market shall be held.

A copy of the By-Law is open for inspection free of charge during office hours at the Shire Office, Trafalgar. 4603 W. F. NELSON, Shire Secretary.

#### SHIRE OF NARRACAN.

##### BY-LAW No. 48.

Notice is hereby given that the Council of the Shire of Narracan has made By-law No. 48 pursuant to the provisions of the Local Government Acts and all other powers it thereunto enabling, for the purpose of:

- Regulating the proceedings of Council meetings, Committee meetings and other meetings conducted by the Shire of Narracan.

A copy of the By-Law is open for inspection free of charge during office hours at the Shire Office, Trafalgar. 4602 W. F. NELSON, Shire Secretary.

#### SHIRE OF ROSEDALE.

##### NOTICE OF INTENTION TO TAKE LAND COMPULSORILY.

Whereas the Council of the Shire of Rosedale deems it expedient to exercise its power of taking compulsorily the land described at the foot hereof for Recreation or Open Space Reserve: And whereas the Council has caused to be prepared a map and other papers setting out the general description of the work or undertaking for which the land proposed to be taken is to be used, the description of the land proposed to be taken, and the names of the owners or reputed owners, lessees or reputed lessees, mortgagees and occupiers of that land so far as those names are known or as far as can be ascertained by the Council: And whereas the said map and other papers are deposited at the office of the said Council at Rosedale, and are open for inspection by all persons interested, at all reasonable hours for the space of forty (40) clear days after the publication in the *Government Gazette*: Now notice is hereby given to all persons affected by the proposed taking of the said land to set forth, in writing, addressed to the Council, or to the Shire Secretary, within forty (40) clear days of publication of this notice in the *Government Gazette*, all objections which they must have to the taking of the said land.

##### THE SCHEDULE HEREINBEFORE REFERRED TO.

Being Crown allotments 2, 3, 4 and 5, part section 28, Township and Parish of Rosedale, County of Buln Buln, required for an Open Space or Recreation Reserve, and being more particularly described in Crown grant, volume 8064, folio 192.

Dated this 18th day of June, 1973.

By Order of the Council,  
4592 G. W. THOMSON, Shire Secretary.

##### Town and Country Planning Act 1961.

#### SHIRE OF SHERBROOKE.—SHIRE OF SHERBROOKE PLANNING SCHEME.

##### AMENDMENT No. 60, 1973.

Notice is hereby given that the Council of the Shire of Sherbrooke in pursuance of its powers under the *Town and Country Planning Act 1961*, has prepared a Planning Scheme for portions of the Shire of Sherbrooke for the purpose of amending the Principal Scheme, as follows:—

Rezoning from Residential General to Commercial General, lots 10 to 16 (inclusive), L.P. 8321, Burwood Highway, Upper Fern Tree Gully.

A copy of the Scheme has been deposited at the Shire Office, Glenfern-road, Upwey, and at the office of the Town and Country Planning Board, 235 Queen-street, Melbourne, and will be open for inspection during office hours by any person, free of charge.

Any persons affected by the Planning Scheme are required to set forth, in writing, any objections they may have, addressed to the Shire Secretary, Shire of Sherbrooke, Glenfern-road, Upwey, 3158, on or before the 26th October, 1973, in respect of Amendment No. 60, 1973, and to state whether they wish to be heard in respect of their objections.

4585 R. K. REILLY, Acting Shire Secretary.

*Town and Country Planning Act 1961.*  
SHIRE OF SHERBROOKE.—SHIRE OF SHERBROOKE  
PLANNING SCHEME.

AMENDMENT No. 61, 1973.

Notice is hereby given that the Council of the Shire of Sherbrooke, in pursuance of its powers under the *Town and Country Planning Act 1961*, has prepared a planning scheme for portions of the Shire of Sherbrooke for the purpose of amending the Principal Scheme, as follows:—

Rezoning from Rural to Residential Medium, Part K6, Parish of Narree Worran, the land generally bounded by Belgrave—Hallam road, Belgrave—Hallam Deviation and the rear of Nathalia-road, South Belgrave.

A copy of the Scheme has been deposited at the Shire Office, Glenfern-road, Upwey, and at the office of the Town and Country Planning Board, 235 Queen-street, Melbourne, and will be open for inspection during office hours by any person, free of charge.

Any persons affected by the Planning Scheme are required to set forth, in writing, any objections they may have, addressed to the Shire Secretary, Shire of Sherbrooke, Glenfern-road, Upwey, 3158, on or before the 26th October, 1973, in respect of Amendment No. 61, 1973, and to state whether they wish to be heard in respect of their objections.

4586 R. K. REILLY, Acting Shire Secretary.

*Town and Country Planning Act 1961.*  
SHIRE OF SHERBROOKE.—SHIRE OF SHERBROOKE  
PLANNING SCHEME.

AMENDMENT No. 63, 1973.

Notice is hereby given that the Council of the Shire of Sherbrooke in pursuance of its powers under the *Town and Country Planning Act 1961*, has prepared a Planning Scheme for portions of the Shire of Sherbrooke for the purpose of amending the Principal Scheme, as follows:—

Rezoning of land in Belgrave South, generally bounded by Lower Mount Morton-road, Apsley-road, Marama-road, Licence-road, and Denham-road, from Residential Medium to Residential Mountain as shown by the displayed amending planning scheme.

A copy of the Scheme has been deposited at the Shire Office, Glenfern-road, Upwey, and at the office of the Town and Country Planning Board, 235 Queen-street, Melbourne, and will be open for inspection during office hours by any person, free of charge.

Any persons affected by the Planning Scheme are required to set forth, in writing, any objections they may have, addressed to the Shire Secretary, Shire of Sherbrooke, Glenfern-road, Upwey, 3158, on or before the 26th October, 1973, in respect of Amendment No. 63, 1973, and to state whether they wish to be heard in respect of their objections.

4587 R. K. REILLY, Acting Shire Secretary.

SHIRE OF WARANGA.

ABOLITION OF POUNDS.

Notice is hereby given that the Council of the Shire of Waranga has revoked the appointment of the places named in the Schedule hereunder as pounds pursuant to the provisions of section 4 of the *Pounds Act 1958*.

SCHEDULE.

1. The Murchison Pound located in Willoughby-street, Murchison, being portion of the Police Purposes Reserve, Town of Murchison, Parish of Murchison, County of Rodney.

2. The Stanhope Pound located in Midland Highway, Stanhope, being allotment 106, Section D, Parish of Girgarre, County of Rodney.

4581 G. K. CALDER, Shire Secretary.

SHIRE OF WARANGA.

NOTICE OF INTENTION TO TAKE LAND COMPULSORILY.

Whereas the Council of the Shire of Waranga deems it expedient to exercise its power of taking compulsorily the land described in the Schedule hereto for the purpose of constructing a public hall and pre-school centre and acquiring the land for the purpose: And whereas the Council has caused to be prepared a map and other papers setting out the general description of the work or undertaking for which the land proposed to be taken is to be used the description of the lands proposed to be taken and the names of the owners or reputed owners, lessees or reputed lessees, mortgagees and occupiers of the land so far as those names are known to or can be ascertained by the Council: And whereas the said map and other papers are deposited at the office of the said Council situate at High-street, Rushworth, and are and shall be open for in-

spection by all persons interested at all reasonable hours for the space of 40 clear days after the publication of this notice: Now notice is hereby given to all persons affected by the proposed taking of the said land to set forth, in writing, addressed to the Council or the Shire Secretary within 40 clear days of the publication of this notice in the *Government Gazette*, all objections which they may have to the taking of the said land.

THE SCHEDULE HEREINBEFORE REFERRED TO.

(a) All that land being Crown allotment 9, section 3, Town of Murchison, Parish of Murchison, County of Rodney, being more particularly described in certificate of title, volume 1621, folium 324082; and

(b) All that land being parts of Crown allotments 2, 3 and 8, section 3, Town of Murchison, Parish of Murchison, County of Rodney, being more particularly described in memorial No. 66, book No. 588.

Dated this 18th day of September, 1973.

4569 G. K. CALDER, Shire Secretary.

SHIRE OF WHITTLESEA.

LOAN No. G.32.

*Notice of Intention to Borrow the Sum of \$100,000 for Permanent Works and Undertakings.*

Notice is hereby given that the Council of the Shire of Whittlesea proposes to borrow the principal sum of \$100,000, secured by a charge over the general rates of the municipality, such sum to be raised by the grant of a mortgage in accordance with the provisions of the *Local Government Act 1958*.

1. The maximum rate of interest that may be paid is 7.4 per cent. per annum.

2. The purposes for which the loan is to be applied are:—

Reserves, Thomastown and Lalor .. .. .	\$50,000
Reconstruction part Cooper-street .. .. .	20,000
Construction of Flanks, Epping .. .. .	10,000
Main Drainage, South Morang .. .. .	20,000
	<hr/>
	\$100,000

3. The period of the loan shall be twenty years.

4. The moneys borrowed shall be payable by providing out of the municipal fund half-yearly instalments of \$4,829.04 each, including principal and interest, on the 14th day of June and the 14th day of December during the currency of the loan. The first instalment shall be payable on the 14th day of June, 1974.

5. Such moneys shall be repayable to the Australasian Temperance and Mutual Life Assurance Society Limited, Melbourne.

The plans and specifications and the estimate of the cost of the proposed works and a statement showing the proposed expenditure of the moneys to be borrowed are open for inspection at the office of the Council of the Shire of Whittlesea, at High-street, Epping.

4594 R. G. C. COOK, Shire Secretary.

THE BALLARAT SEWERAGE AUTHORITY.

Pursuant to section 119 (2) of the *Sewerage Districts Act 1958* (No. 6368), notice is hereby given of the intention to construct sewers to provide for properties situated in the vicinity of the following streets:—

Shire of Ballarat.—Forest-street and Kirk-street;  
Borough of Sebastopol.—Bala-street and Yarrowee-street,

more particularly as shown on maps which are open for inspection at this office between the hours of 9 a.m. and 4 p.m. Monday to Friday inclusive.

14th September, 1973.

4588 CHAS. H. CLAMP, Secretary.

BARWON HEADS SEWERAGE AUTHORITY.

GENERAL NOTICE.

The above-mentioned Sewerage Authority, having made provision for carrying off the sewage from each and every property which or any part of which is within the Sewerage Area hereinafter described, doth hereby declare that on and after the 1st day of October, 1973, each and every property which or any part of which is within the said Sewerage Area shall be deemed to be a sewered property within the meaning of the *Sewerage Districts Act 1958*.

The boundaries of the Sewerage Area hereinbefore referred to are:—

*Sewerage Area No. 1.*—As defined on plans which have been lodged in the office of the State Rivers and Water Supply Commission and the Authority's office, Barwon Heads, where they may be inspected during office hours.

By order of the said Sewerage Authority.

4576

C. J. LAHEY, Chairman.  
A. SAYERS, Secretary.

#### CRANBOURNE SEWERAGE AUTHORITY.

##### GENERAL NOTICE.

The Cranbourne Sewerage Authority having made provision for carrying off sewage from each and every property which or any part of which is within the Sewered Area hereinafter described doth hereby declare that on and after the 1st day of October, 1973, each and every property which or any part of which is within the said Sewerage Area shall be deemed to be a sewered property within the meaning of the *Sewerage Districts Act 1958*. The boundaries of the Sewerage Area hereinbefore referred to are:—

*Description—Area No. 1.*—Commencing on the south-western corner of lot 15, Turner-road; then northerly along the rear boundaries of lots 15 to 1, Turner-road, to the north-western corner of lot 1; then easterly along the side or rear boundaries of lots 1, 40, 49, 50, 58, 59 and 60 to the north-eastern corner of lot 60, Lorraine-avenue; then southerly along the side boundary to Lorraine-avenue; then easterly to the north-western corner of lot 99; then southerly and easterly along the side and rear boundaries to the north-eastern corner of lot 98; then southerly along Long-street to the southern corner of lot 93; then westerly along the side boundary to the south-western corner of lot 93; then southerly and south-westerly along the rear and side boundaries of lot 89, to Lorraine-avenue; then north-westerly and south-westerly along and across Lorraine-avenue to the north-eastern corner of lot 69; then south-westerly and north-westerly along the side and rear boundaries of lot 69 to the north-eastern corner of lot 109, Raymond-avenue; then south-westerly along the side boundary to Raymond-avenue; then westerly and northerly along Raymond-avenue and Turner-road to the south-eastern corner of lot 15, Turner-road; then westerly along the side boundary of lot 15 to the point of commencement.

13th September, 1973.

By order of the Cranbourne Sewerage Authority,

4607

G. F. KNOWLES, Chairman.  
T. VICKERMAN, Secretary.

#### KILMORE SEWERAGE AUTHORITY.

##### INSPECTION OF SEWERAGE PLANS.

I hereby give notice, in accordance with section 119 of the *Sewerage Districts Act 1968*, that plans showing the proposed location of sewers in that part of the Kilmore Township west of and including Powlett-street, and south of and including Piper-street, are available for inspection at the Shire Offices, 16 Sydney-street, Kilmore, between the hours of 9 a.m. and 5 p.m.

4565

B. J. HOBAN, Secretary.

#### KILMORE SEWERAGE AUTHORITY.

##### INSPECTION OF AMENDED SEWERAGE PLANS.

I hereby give notice, in accordance with section 119 of the *Sewerage Districts Act 1968*, that plans showing the proposed amended location of sewers in that part of Kilmore west of and including Powlett-Sydney streets, and north of Piper-street, are available for inspection at the Shire Office, 16 Sydney-street, Kilmore, between the hours of 9 a.m. and 5 p.m.

4566

B. J. HOBAN, Secretary.

#### NOTICE OF INTENTION TO APPLY FOR A LICENCE TO DIVERT WATER AND CUT RACE FROM THE RIVER MURRAY, VIA LAKE MOODEMERE, AT WAHGUNYAH.

We hereby give notice that we intend to apply for a licence empowering us to divert water for a term of four years to the extent of 494 megalitres per annum, at a maximum rate of nine megalitres per day of 24 hours, for the irrigation of 82.3 hectares of vines and pastures, being part of allotments 11 and 13, section I, and 10 and 11, section J, Parish of Lilliput, and to occupy certain Crown lands for works of diversion, and to cut a race thereon.

Any objection to such application must be forwarded, in writing, to reach the State Rivers and Water Supply Commission, Melbourne, before 26th October, 1973, being 30 days from the first publication of this notice.

A. D. CAMPBELL & CO.

Box 44, Rutherglen, Vic. 3685.

4636

#### NOTICE OF APPLICATION FOR A LICENCE TO DIVERT WATER FROM THE LINDSAY CREEK, AT LINDSAY POINT.

I hereby give notice of an application for a licence empowering me to divert water for a term of fifteen years to the extent of 801 megalitres per annum at a maximum rate of 7 megalitres per day of 24 hours for the irrigation of citrus, being part of allotment 3A, Section 11, Parish of Olney, and to occupy certain Crown lands for diversion works.

Any objection to the granting of this application must be forwarded, in writing, to reach the State Rivers and Water Supply Commission, 590 Orrong-road, Armadale, 3143, before 28th October, 1973, being 30 days from the publication of this notice.

IMPI ORCHARDS PTY. LTD.

per JUDITH CATHERINE CANT.

Box 410, P.O. Renmark, South Australia, 5341.

4658

Notice is hereby given that the partnership heretofore subsisting between Ernst Niederer, of 200 Carlisle-street, Balaclava, pastrycook, and Ivar Kongsdal Kongsdorf, of 75 Ormond Esplanade, Elwood, pastrycook, carrying on business as pastrycooks at Shop 5, Number 217-223 Chapel-street, Prahran, under the style or firm of "Danish-Crest" will be dissolved as from the 16th day of January, 1974. Ernst Niederer shall continue to carry on the said business as a sole trader. Creditors must ensure that any credit given to the retiring partner is confirmed by Ernst Niederer.

TRIBE STRASSER & GORR, solicitors for Ernst Niederer. 4584

Notice is hereby given that the partnership heretofore subsisting between the undersigned, Edna Therese Duff and Joyce MacRobbie, carrying on business as Restaurant Proprietors at 159b High-street, Belmont, under the name of "Sitar Indian Curry Restaurant", has been dissolved by mutual consent as from the 1st day of July, 1973, and notice is further given that Joyce MacRobbie will henceforth carry on the said business at the above-mentioned address under the same firm name.

PETER J. HUTCHINSON, LL.B., solicitor, 6 Windmill-street, Newtown, Geelong. 4599

Yarrahill Pastoral Company Pty. Ltd., 78820, on the 20th September, 1973, passed a Special Resolution that the company will be wound up voluntarily. 4572

#### Companies Act 1961, Section 272 (2).

TRADE HOMES PTY. LTD. (IN VOLUNTARY LIQUIDATION).

##### NOTICE OF FINAL MEETING.

Notice is hereby given that a meeting of creditors and members of the above-named company will be held at 264 High-street, St. Kilda, on the 30th day of October, at 5 p.m., for the purpose of receiving the accounts of the liquidator, showing the manner in which the winding up has been conducted and the property of the company disposed of.

Dated this 18th day of September, 1973.

K. H. GOLDING, liquidator, 264 High-street, St. Kilda.

4570

#### Companies Act 1961.

##### R. BRUNT TRANSPORT PTY. LTD.

At a General Meeting of the members of R. Brunt Transport Pty. Ltd., duly convened and held at the offices of J. N. Cooke, Foley & Co., 3rd Floor, A.M.P. Building, 17 Lydiard-street north, Ballarat, on the 20th day of September, 1973, it was resolved that the company be wound up voluntarily, and that Kevin Foley, public accountant, of 17 Lydiard-street north, Ballarat, be appointed liquidator.

Dated this 24th day of September, 1973.

K. FOLEY, Liquidator.

J. N. Cooke, Foley & Co., public accountants, 3rd Floor, A.M.P. Building, 17 Lydiard-street north, Ballarat. 4635

Form 67.

Companies Act 1961, Section 280 (1).  
**MAX BECK CONSTRUCTIONS PROPRIETARY LIMITED.**

NOTICE OF APPOINTMENT AND SITUATION OF OFFICE  
 OF PROVISIONAL LIQUIDATOR.

To the Registrar of Companies,

I, David Alexander Crawford, of Messrs. Peat, Marwick, Mitchell & Co., 447 Collins-street, Melbourne, hereby give notice that—

- (a) by an order of the Supreme Court, made on the 15th day of August, 1973, I was appointed provisional liquidator of Max Beck Constructions Proprietary Limited; and
- (b) my office is situated at the offices of Messrs. Peat, Marwick, Mitchell & Co., 12th Floor, 447 Collins-street, Melbourne.

Dated this 29th day of August, 1973.

4637

D. A. CRAWFORD.

Companies Act 1961.

**EDOR INVESTMENTS PROPRIETARY LIMITED.**

PURSUANT TO SECTION 254 (2).

At an Extraordinary General Meeting of the above-named company, duly convened and held at Flat 4-1, 9 Struan-street, Toorak, Victoria, on the 22nd day of September, 1973, the following Resolution was passed:—

“That the company be wound up voluntarily.”

And at such meeting, Clifford Leslie James, of the firm of Fitzgerald Gunn & Partners, 10th Floor, 470 Collins-street, Melbourne, was appointed liquidator for the purpose of the winding up.

Dated this 24th day of September, 1973.

4646

E. A. C. WADE, Chairman of Meeting.

**STEPHENS (COLAC) INVESTMENTS PROPRIETARY LIMITED (IN LIQUIDATION).**

NOTICE OF FINAL MEETING.

In Voluntary Winding Up.

Take notice that the affairs of the above-named company are now fully wound up and that in pursuance of section 272 (1) of the Companies Act 1961, a General Meeting of the company will be held at the office of Cowan, Gavens & Baldwin, 56 Hesse-street, Colac, on the 5th day of November, 1973, at 12 noon, for the purpose of laying before it an account showing how the winding up has been conducted and the property of the company disposed of, and giving any explanation thereof.

Dated the 20th day of September, 1973.

4651

D. K. COWAN, Liquidator.

Companies Act 1961.

**MUSKETEERS (AUST.) PTY. LTD. (IN VOLUNTARY LIQUIDATION).**

NOTICE CONVENING FINAL MEETING OF MEMBERS, PURSUANT TO SECTION 272.

Notice is hereby given, in pursuance of section 272 of the Companies Act 1961, that a Final Meeting of members of the above-named company will be held on Wednesday, 31st October, 1973, at 2 p.m., at 121 William-street, Melbourne, for the purpose of having an account laid before them, showing the manner in which the winding up has been conducted and the property of the company disposed of, and of hearing any explanations that may be given by the liquidator.

Dated this 21st day of September, 1973.

HARRY E. LEVY, liquidator, 121 William-street, Melbourne. 4583

In the matter of the Companies Act; and in the matter of  
**MOORE PLASTICS PROPRIETARY LIMITED.**

Notice is hereby given that at an Extraordinary General Meeting of the above-named company duly convened and held at 3 o'clock in the afternoon of the 14th day of September, 1973, the following Special Resolution was duly passed, viz.:—

That the company be wound up voluntarily.

Dated this 17th day of September, 1973.

4626

A. E. DAVIS, Chairman.

**SOUTHAM ENGINEERING PROPRIETARY LIMITED**  
 (IN VOLUNTARY LIQUIDATION).

Notice is hereby given, pursuant to section 254 (2) of the Companies Act 1961, that at an Extraordinary General Meeting of the company held on 20th December, 1972, a Special Resolution was passed that the company be wound up voluntarily, and that Philip Douglas George, of 440 Collins-street, Melbourne, be appointed as liquidator for the purposes of such winding up.

P. D. GEORGE, Liquidator.

Arthur Young & Company, 440 Collins-street, Melbourne, Vic. 3000. 4625

**GEORGE SOUTHAM & COMPANY PROPRIETARY LIMITED (IN VOLUNTARY LIQUIDATION).**

Notice is hereby given, pursuant to section 254 (2) of the Companies Act 1961, that at an Extraordinary General Meeting of the company held on 20th December, 1972, a Special Resolution was passed that the company be wound up voluntarily, and that Philip Douglas George, of 440 Collins-street, Melbourne, be appointed as liquidator for the purposes of such winding up.

P. D. GEORGE, Liquidator.

Arthur Young & Company, 440 Collins-street, Melbourne, Vic. 3000. 4624

Companies Act 1961, Section 272.

**R.L.D. PROPRIETARY LIMITED (IN VOLUNTARY LIQUIDATION).**

Notice is hereby given, in pursuance to section 272 (2) of the Companies Act 1961, that the Final Meeting of the members of the above company will be held at the offices of Wilson, Bishop, Bowes & Craig, 12th Floor, 271 William-street, Melbourne, on Friday, 16th October, 1973, at 11 a.m.

4623

D. C. PETLEY, Liquidator.

The Companies Act 1961.

**L. BALDOCK & CO. PTY. LTD. (IN LIQUIDATION).**

Notice is hereby given that a First Dividend is intended to be declared in the above matter. Creditors who have not proved their debts by the 11th day of October, 1973, may be excluded from this dividend.

Dated this 19th day of September, 1973.

G. O. HARRISON, Liquidator.

Hall & Rose, chartered accountants, 395 Collins-street, Melbourne. 4612

Companies Act 1961.

**CONLANS HOTEL PROPRIETARY LTD. (IN VOLUNTARY LIQUIDATION).**

NOTICE OF FINAL MEETING.

Notice is hereby given that, pursuant to section 272 of the Companies Act 1961, a Final Meeting of the members of the above-named company will be held at 2 Claremont-avenue, Malvern, on Monday, 29th October, 1973, at 10 a.m., for the purpose of having an account laid before them, showing how the winding up of the company has been conducted and the property of the company disposed of.

Dated this 21st day of September, 1973.

K. M. LISTON, Liquidator.

Bourke, Liston & Co., 2 Claremont-avenue, Malvern. 4608

It is proposed to pay a First and Final Dividend to creditors of Jockels Books Pty. Ltd. (in Liquidation) who have lodged proof of debt by 30th November, 1973.

JOHN RUFFIN, liquidator, 100 Mt. Eliza-way, Mt. Eliza, 3930. 4634

In the Supreme Court of Victoria.—1973 No. Co. 8704.—  
 In the matter of the Companies Act 1961, as amended; and in the matter of **PARIS SEAFOODS PTY. LTD.**—Notice of Winding-up Order.

Winding-up order made the 18th day of September, 1973, at the Supreme Court, Melbourne.

Name and address of liquidator, Edward Ronald Smail, of Messrs. Kennedy, Smail & Middlemiss, 296 Little Lonsdale-street, Melbourne.

Dated the 26th day of September, 1973.

MALLESONS, solicitors for the petitioner. 4631

The Companies Act 1961.

**BELWAY MACHINE & TOOL CO. PROPRIETARY LIMITED (IN LIQUIDATION).**

NOTICE CONVENING FINAL MEETING OF MEMBERS AND CREDITORS, PURSUANT TO SECTION 272.

Notice is hereby given, pursuant to section 272 of the Companies Act 1961, that a General Meeting of the members and creditors of the above-named company will be held in the offices of Kennedy, Smail & Middlemiss, 296-304 Little Lonsdale-street, Melbourne, on Wednesday, the 24th day of October, 1973, at 11 a.m., for the purpose of having an account laid before them, showing the manner in which the winding up has been conducted and the property of the company disposed of, and of hearing any explanations that may be given by the liquidator.

Dated this 18th day of September, 1973.

JOHN MARTIN WALSH, Liquidator.

Kennedy, Smail & Middlemiss, 296-304 Little Lonsdale-street, Melbourne, 3000. 4628

The Companies Act 1961.

**MORISONS PROPRIETARY LIMITED (IN LIQUIDATION).**

NOTICE CONVENING FINAL MEETING OF MEMBERS AND CREDITORS, PURSUANT TO SECTION 272.

Notice is hereby given, pursuant to section 272 of the Companies Act 1961, that a General Meeting of the members and creditors of the above-named company will be held in the offices of Kennedy, Smail & Middlemiss, 296-304 Little Lonsdale-street, Melbourne, on Wednesday, the 24th day of October, 1973, at 11.30 a.m., for the purpose of having an account laid before them, showing the manner in which the winding up has been conducted and the property of the company disposed of, and of hearing any explanations that may be given by the liquidator.

Dated this 18th day of September, 1973.

EDWARD RONALD SMAIL, Liquidator.

Kennedy, Smail & Middlemiss, 296-304 Little Lonsdale-street, Melbourne, 3000. 4629

The Companies Act 1961.

**N-COMPASS (AUST.) PROPRIETARY LIMITED (IN LIQUIDATION).**

NOTICE CONVENING FINAL MEETING OF MEMBERS AND CREDITORS, PURSUANT TO SECTION 272.

Notice is hereby given, pursuant to section 272 of the Companies Act 1961, that a General Meeting of the members and creditors of the above-named company will be held in the offices of Kennedy, Smail & Middlemiss, 296-304 Little Lonsdale-street, Melbourne, on Wednesday, the 24th day of October, 1973, at 10.30 a.m., for the purpose of having an account laid before them, showing the manner in which the winding up has been conducted and the property of the company disposed of, and of hearing any explanations that may be given by the liquidator.

Dated this 18th day of September, 1973.

ROBERT EASTAUGH RAMSAY, Liquidator.

Kennedy, Smail & Middlemiss, 296-304 Little Lonsdale-street, Melbourne, 3000. 4630

In the matter of the Companies Act 1961; and in the matter of HARRIS & LEWIN PTY. LTD.

Notice is hereby given that a petition for the winding up of the above-named company by the Supreme Court was, on the 19th day of September, 1973, presented by Geo. Thompson & Co. (Australia) Pty. Ltd., of 447 Collins-street, Melbourne; and that the said petition is directed to be heard before the Court sitting at Melbourne at the hour of 10.30 o'clock in the forenoon on the 24th day of October, 1973; and any creditor or contributory of the said company desiring to support or oppose the making of an order on the said petition may appear at the time of hearing by himself or his counsel for that purpose; and a copy of the petition will be furnished to any creditor or contributory of the said company requiring the same by the undersigned on payment of the regulated charge for the same.

The petitioner's address is 447 Collins-street, Melbourne.

The petitioner's solicitor is Messrs. Middletons, of 457 Little Collins-street, Melbourne.

MIDDLETONS.

NOTE.—Any person who intends to appear on the hearing of the said petition must serve on or send by post to the above-named firm of Messrs. Middletons, solicitors, notice in writing of his intention so to do. The notice must state the name and address of the person or, if a firm, the name and address of the firm and must be signed by the person

or firm, or his or their solicitor (if any), and must be served or, if posted, must be sent by post in sufficient time to reach the above named not later than 4 o'clock in the afternoon of the 23rd day of October, 1973 (the day before the day appointed for the hearing of the Petition). 4611

Trustee Act 1958.

NOTICE TO CLAIMANTS.

Pursuant to the Trustee Act 1958, creditors next of kin and all other persons having claims in respect of the estate of any deceased person named below are required to send particulars to the legal personal representative or representatives at the addresses stated, after which date the representatives will distribute the assets, having regard only to the claims of which notice has been received:—

William Armstrong Edwards, late of 38 Charles-street, Ascot Vale, retired flour miller, deceased, died on the 31st day of July, 1973.—Claims to the executor, Ronald William Edwards, of 25 Marshall-street, Flemington, meat worker, care of John F. Carroll, of 4 Paisley-street, Footscray, solicitor, by the 28th day of November, 1973. John F. Carroll, LL.B., solicitor, 4 Paisley-street, Footscray. 4641

Thomas Brooks, late of 11 Bolton-street, Spotswood, retired carpenter, deceased, died on the 20th day of April, 1973.—Claims to the executor, Norman Stanley Brooks, of 60 The Avenue, Spotswood, carpenter, care of John F. Carroll, of 4 Paisley-street, Footscray, solicitor, by the 28th day of November, 1973. John F. Carroll, LL.B., solicitor, 4 Paisley-street, Footscray. 4642

Creditors, next of kin and others having claims in respect of the estate of Mollie Berenice Barrie, late of 9 Bertram-street, Elsternwick, married woman (who died on the 9th day of July, 1973), are to send particulars of their claims to the executor, Desmond Russell Gleisner, care of the undersigned, by the 3rd December, 1973, after which date he shall commence to distribute the assets, having regard only to the claims of which he then has notice.

RENNICK & GAYNOR, solicitors, 481-Riversdale-road, Hawthorn East. 4615

JEAN PRISCILLA WELSH, late of 127 Rankins-road, Kensington, in the State of Victoria, married woman, DECEASED, intestate.

Creditors, next of kin and others having claims in respect of the estate of the deceased (who died on the 15th day of May, 1972), are required by the administrator, Leonard James Welsh, of the above address, postal employee, to send particulars to him, care of the under-mentioned solicitor, by the 10th day of December, 1973, after which date he will distribute the assets, having regard only to the claims of which he then has notice.

JOHN D. MULCAHY, solicitor, 169 Park-drive, Parkville. 4616

The Equity Trustees, Executors and Agency Company Limited, whose registered office is situate at 472 Bourke-street, Melbourne, in the State of Victoria, the executor of the will of Margaret Amelia Littlewood, late of Engles-road, Berwick, in the said State, married woman (who died on the 15th day of May, 1973), require all creditors, next of kin and others having claims against the estate of the said deceased, to send to the said company, on or before the 30th day of November, 1973, particulars, in writing, of such claims, after which date it will convey or distribute the assets to or among the persons entitled thereto, having regard only to the claims of which the said company shall have had notice.

Dated the 17th day of September, 1973.

BOOTHBY & BOOTHBY, solicitors, 883 Dandenong-road, Caulfield East. 4647

RODERICK WILLIAM JOSEPH PRITCHARD, late of Vinifera, in the State of Victoria, orchardist, DECEASED.

Creditors, next of kin and other persons having claims against the estate of the said deceased (who died on the 30th day of May, 1973), are required to send particulars of same to the executrix, Margaret Ruth Pritchard, in care of the undersigned, on or before the 30th day of November, 1973, after which date she will distribute the assets, having regard only to the claims of which she then has notice.

DELANY & DWYER, barristers and solicitors, 201 Campbell-street, Swan Hill. 4613



Creditors, next of kin and others having claims in respect of the estate of Ethel Frances Burton, formerly of 49 Christowel-street, Camberwell, in the State of Victoria, but late of Flat 2, 9 Mont Albert-road, Canterbury, in the said State, married woman, deceased, (who died on the 10th October, 1972), are to send particulars of their claims to the Executor, The Union-Fidelity Trustee Company of Australia Limited, of 100 Exhibition-street, Melbourne, in the said State by the 30th December, 1973, after which date they will distribute the assets of the estate, having regard only to the claims of which they then have notice.

HALL & WILCOX, solicitors, of 20 Queen-street, Melbourne. 4627

Creditors, next of kin and others having claims in respect of the estate of Edeley Joseph Treloar, late of 3 Hugh-street, Hawthorn East, gentleman, deceased (who died on the 22nd day of June, 1973), are to send the particulars of their claims to The Union-Fidelity Trustee Company of Australia Limited of 100 Exhibition-street Melbourne, by the 30th day of November, 1973, after which date the said company will distribute the assets, having regard only to the claims of which it then has notice.

Dated the 21st day of September, 1973.

MADDEN BUTLER ELDER & GRAHAM, solicitors, 500 Collins-street, Melbourne. 4622

MELLICENT MARY STRACHAN-SMITH, formerly of 15 Rockley-road, South Yarra, and 83 Cromwell-road, South Yarra, but late of St. Alfred Private Hospital, 51 Mathoura-road, Toorak, spinster, DECEASED.

Creditors, next of kin and others having claims against the estate of the said deceased (who died on the 20th June, 1973), are to send particulars of their claims to The Equity Trustees Executors and Agency Company Limited, care of 472 Bourke-street, Melbourne, by the 3rd day of December, 1973, after which date it will distribute the assets, having regard only to the claims of which it then has notice.

BLAKE & RIGGALL, solicitors, 140 William-street, Melbourne. 4621

EDITH JESSIE HUGHES, formerly of 25 Nott-street, East Malvern, in the State of Victoria, married woman, but late of Princess-street, Kew, in the said State, widow, DECEASED.

Creditors, next of kin and others having claims in respect of the estate of the deceased (who died on the 22nd day of May, 1973), are required by the personal representative, The Trustees Executors and Agency Company Limited, of 401 Collins-street, Melbourne, in the said State, to send particulars to it by the 30th day of November, 1973, after which date it will distribute the assets, having regard only to the claims of which it then has notice.

E. P. JOHNSON & DAVIES, solicitors, 339 Collins-street, Melbourne. 4620

Creditors, next of kin and others having claims in respect of the estate of Ewen Ridley Tolmie, late of Bald Hill, Beveridge, grazier, deceased (who died on the 18th June, 1973), are to send particulars of their claims to The Union-Fidelity Trustee Company of Australia Limited, and John Watson McCallum, care of the company's registered office, situate at 100 Exhibition-street, Melbourne, by the 29th November, 1973, after which date they will distribute the assets, having regard only to the claims of which they then have notice.

COOK & McCALLUM, solicitors, 422 Collins-street, Melbourne. 4619

Creditors, next of kin and others having claims in respect of the estate of Cecelia Alice Quinn, formerly of "Plympton", Kardinia-road, Glen Iris, but late of 56 Cloris-avenue, Beaumaris, married woman (who died on 2nd May, 1973), are required by the administrator, with the will annexed, of her estate, National Trustees Executors and Agency Company of Australasia Limited, of 95 Queen-street, Melbourne, to send particulars to the said company by the 27th day of November, 1973, after which date the said company may convey or distribute the assets, having regard only to the claims of which it then has notice.

MOLOMBY & MOLOMBY, solicitors, 411 Collins-street, Melbourne. 4618

Creditors, next of kin and others having claims in respect of the estate of Jean Stokes, late of Southways, Burkes-crescent, Beaconsfield, Buckinghamshire, in the United Kingdom, widow, deceased (who died on the 25th January, 1973), are to send particulars of their claims to The Trustees Executors and Agency Company Limited, of

401 Collins-street, Melbourne (the duly constituted attorneys of Peter Maurice Barclay, and Geoffrey William Rowlands, the proving executors of the will of the said deceased), by the 1st day of December, 1973, after which date the said company will distribute the assets in the said estate, having regard only to the claims of which it then has notice.

ARTHUR ROBINSON & CO., solicitors, 447 Collins-street, Melbourne. 4617

Creditors, next of kin and others having claims in respect of the estate of Herbert Roche Savage, formerly of "Meander", Meadow Creek, Bobinawarra, but late of "Angleside", Moyhu, in Victoria, farmer, deceased (who died on the 19th day of December, 1972), are required by the executors, John Roche Savage, of 18 Farnham-avenue, Mulgrave, in Victoria, trainee sales representative, and Gillian Mary Challis, of "Ballan Valley", Moyhu, in Victoria, married woman, to send particulars of their claims to them, care of the under-mentioned solicitors, by the 30th day of November, 1973, after which date they will distribute the assets, having regard only to the claims of which they then have notice.

AITKEN, WALKER & STRACHAN, solicitors, 414 Collins-street, Melbourne. 4649

Creditors, next of kin and others having claims in respect of the estate of Bernard Edson, late of the Chevron Hotel, St. Kilda-road, Melbourne, in Victoria, manufacturer, deceased (who died on the 16th day of December, 1972), are required by the executor, John Norman Edson, of 515 Chapel-street, South Yarra, in Victoria, photographer, to send particulars to him care of the under-mentioned solicitors, by the 30th day of November, 1973, after which date he will distribute the assets, having regard only to the claims of which he then has notice.

AITKEN, WALKER & STRACHAN, solicitors, 414 Collins-street, Melbourne. 4650

HAROLD WILLIAM FORDER (also known as William Henry Porter and William Gaudin), late of 115 Fitzroy-street, Fitzroy, retired, DECEASED.

Creditors, next of kin and others having claims in respect of the estate of the deceased (who died on 20th December, 1972), are required by the administrator, Paul Forder, to send particulars to his solicitor, Miss Norma L. Jenkins, of 329 St. George's-road, North Fitzroy, by the 26th November, 1973, after which date the administrator will convey or distribute the assets, having regard only to the claims of which he then has notice. 4568

BERNARD EDWARD RICHARDSON, late of 8 Hopetoun-avenue, Reservoir, in the State of Victoria, guillotine operator, DECEASED.

Creditors, next of kin and others having claims in respect of the estate of the deceased (who died on the 25th day of October, 1971), are required by the administrator, Eileen Mary Richardson, of 8 Hopetoun-avenue, Reservoir, in the said State, to send particulars to her, care of her solicitor, James Kelleher, 20 Bank-place, Melbourne aforesaid, by the 10th day of December, 1973, after which date the administrator may convey or distribute the assets, having regard only to the claims of which she then has notice.

Dated the 19th day of September, 1973. 4577

OLIVE JOYCE MARTIN, formerly of Lake Boga, in the State of Victoria, but late of Swan Hill aforesaid, married woman, DECEASED.

Creditors, next of kin and others having claims in respect of the estate of the deceased (who died on the 1st day of November, 1972), are required by the executor, Alexander Donald Martin, of Swan Hill aforesaid, to send particulars to him, care of the undersigned, by the 28th day of November, 1973, after which date the executor may convey or distribute the assets, having regard only to the claims of which he then has notice.

ALEC M. HAYES, solicitor, 148 Campbell-street, Swan Hill. 4562

Creditors, next of kin and others having claims in respect of the estate of Ruby Myrtle Gromann, late of 458 South-road, Moorabbin, widow, deceased (who died on the 25th day of May, 1973), are required by the administratrix, Denise Ruby Date, of 458 South-road, Moorabbin, aforesaid, married woman, to send particulars of their claims to her, in care of the under-mentioned solicitors, by the 28th day of November, 1973, after which date she will distribute the assets, having regard only to the claims of which she then has notice.

McCAY & THWAITES, solicitors, 374 Little Collins-street, Melbourne. 4614



Creditors, next of kin and others having claims in respect of the estate of Mary Josephine Dowling, late of 1 Little Boundary-street, South Melbourne, home duties, deceased (who died on the 18th April, 1973), are to send particulars of their claims to the executor, The National Trustees, Executors and Agency Company of Australasia Limited, of 95 Queen-street, Melbourne, care of the under-mentioned solicitors, by the 27th November, 1973, after which date it will distribute the assets, having regard only to the claims of which it has notice.

J. W. McCLUSKY, WILCZEK & CO., solicitors, 169 Bay-street, Port Melbourne. 4578

PERCY THOMAS BYRNES, of Swan Hill, in the State of Victoria, farmer, DECEASED.

Creditors, next of kin and others having claims in respect of the estate of the deceased (who died on the 4th day of March, 1973), are required by the executors, Noel Murdoch Byrnes, of Woorinen, and John Gordon Kimberley, of 29 Rosedale-road, Glen Iris aforesaid, to send particulars to them care of the undersigned by the 28th day of November, 1973, after which date the executors may convey or distribute the assets, having regard only to the claims of which they then have notice.

ALEC M. HAYES, solicitor, 148 Campbell-street, Swan Hill. 4590

EDITH JOAN AMOS, late of 82 Arnold-street, Bendigo, married woman, DECEASED.

Creditors, next of kin and others having claims in respect of the estate of the deceased (who died on the 22nd day of April, 1973), are required by Sandhurst and Northern District Trustees, Executors and Agency Company Limited, of View-street, Bendigo, to send particulars to the said company by the 29th day of November, 1973, after which date it may convey or distribute the assets, having regard only to the claims of which it then has notice.

ERNEST S. CAHILL & SON, solicitors, 16 View-street, Bendigo. 4593

Creditors, next of kin and others having claims against the estate of Peter Lang Nash, late of 69 Albert-street, Warragul, retired dairyman (who died on the 24th day of August, 1972), are requested to send particulars of their claims to Patricia Aileen Redden, of 69 Albert-street, Warragul, married woman, the executor appointed by the deceased's will, in care of the undersigned, by the 28th day of December, 1973, after which date she will distribute the assets, having regard only to the claims of which she then shall have had notice.

M. DAVINE & CO., solicitors, Warragul. 4600

CHARLES LAWRENCE MARTIN, late of Bath-street, Swan Hill, in the State of Victoria, farmer, DECEASED (who died on the 3rd April, 1973).

Creditors, next of kin and all other persons having claims against the estate of the deceased are required by the executors of the will, Margaret Ann Martin, Alexander Donald Martin and Vernon James Martin to send particulars to them, care of the undersigned, on or before the 18th day of December, 1973, after which date they will distribute the assets, having regard only to the claims of which they then have notice.

GARDEN & GREEN, solicitors, 4 McCallum-street, Swan Hill. 4567

Creditors, next of kin and others having claims in respect of the estate of Charles Patrick McCarthy, late of Flat 5, 18 William-street, Brighton, in the State of Victoria, retired engineer (who died on the 3rd day of May, 1973), are required by the executrix, Mary Florence McCarthy, to send particulars of their claims to her, care of the under-mentioned solicitors, by the 5th December, 1973, after which date the executrix will distribute the assets, having regard only to the claims of which she then has notice.

F. J. CORDER & CO., solicitors, 258 Little Bourke-street, Melbourne. 4610

LEONARD ARTHUR BUZZA, late of Bright-court, Drouin, farmer, DECEASED.

Creditors, next of kin and others having claims in respect of the estate of the said deceased (who died on the 31st May, 1972), are required by the trustee, Eric Victor Buzza, to send particulars of their claims to him, care of the undersigned solicitors, by the 30th November, 1973, after which date the trustee may convey or distribute the assets, having regard only to the claims of which he then has notice.

GRAY, FRIEND & LONG, solicitors, Warragul. 4604

No. 93.—8910/73.—5

GWENDOLINE APPLEBY, late of 94 Queen-street, Maffra, married woman, DECEASED.

Creditors, next of kin and others having claims in respect of the estate of the deceased (who died on the 4th day of June, 1973), are required by The Perpetual Executors and Trustees Association of Australia Limited, of 50 Queen-street, Melbourne, and Rex Roderick Appleby, of 84 Johnson-street, Maffra, authorized newsagent, the applicants for a grant of probate to send particulars of their claims to the said applicants in the care of the said company by the 31st day of December, 1973, after which date they will convey or distribute the assets, having regard only to the claims of which they then have notice.

4601

Creditors, next of kin and others having claims in respect of the estate of Frederick Peter Wilson, late of 1286 Dandenong-road, Murrumbena, retired builder, deceased (who died on the 26th day of October, 1972), are requested to send particulars of their claims to Dorothy Clyde Turner and Ivy Muriel McMahon, the executrices of the estate of the will of the said deceased, in care of the under-mentioned solicitors, by the 15th day of December, 1973, after which date the executrices will distribute the assets, having regard only to the claims of which they have notice.

CLEMENTS, MOTT & BETT, solicitors, 253-255 Glen-huntly-road, Elsternwick. 4633

Creditors, next of kin and others having claims in respect of the will of John Henry Willcocks, late of 4 George-street, Surrey Hills, retired (who died on the 16th day of July, 1973), are requested to send particulars of their claims to the executrix, May Beatrice Willcocks, care of the under-mentioned solicitor, by the 12th day of December, 1973, after which date she will distribute the assets, having regard only as to the claims of which she then has notice.

EDWARD CURMI, of 440 Victoria-street, North Melbourne. 4639

TERRENCE JOSEPH CORRIGAN, late of 1B Vancouver-street, Mornington, gentleman, DECEASED.

Creditors, next of kin and others having claims in respect of the estate of the deceased (who died on the 3rd day of April, 1973), are required by Kathleen Fowles, of Saint James, married woman, and Eileen Mary Jew, of 213 Highfield-road, Hartwell, married woman, to send particulars of their claims to the said Kathleen Fowles and Eileen Mary Jew, by the 16th day of November, 1973, after which date they will convey or distribute the assets, having regard only to the claims of which they have notice.

P. L. McCULLOUGH PRESTON & CO., solicitors, of 159 Main-street, Mornington. 4643

PHILLIP FREDRICK JAGER, late of 44 Bayview-road, Glenroy, retired, DECEASED.

Creditors, next of kin and others having claims in respect of the estate of the deceased (who died on 1st April, 1973), are required by the executrices, Pamela Denise Moffit, of 9 Catania-street, Mentone, and Lindsay Van Jager, of 50 Bridport-street, Albert Park, to send particulars to them by the 23rd day of November, 1973, after which date the executrices will distribute the assets, having regard only to the claims of which they then have notice.

SLATER & GORDON, solicitors, 60 Market-street, Melbourne, 3000. 4644

Creditors, next of kin and others having claims in respect of the estate of Verne Grantley Cowan, late of P.N.G. Training Depot, Goldie River, Papua New Guinea, army officer, deceased, intestate (who died on the 15th day of May, 1973), are required by the administrator, John Edward Chancellor, of 13 Rostrevor-parade, Mont Albert, regional manager, to send particulars of their claims to him, in care of the undermentioned solicitors, prior to the 5th December, 1973, after which date the said administrator will distribute the assets of the deceased, having regard only to the claims of which he then shall have had notice.

ROGERS & GAYLARD, solicitors, 51 Queen-street, Melbourne. 4645

Creditors, next of kin and others having claims in respect of the estate of Robert Lewis Bell, late of "Yulong", Barwon Heads, in Victoria, retired grazier, deceased (who died on the 24th day of January, 1973), are required by the executors, James Ford Strachan and Ross Gibson MacFarlan, both of 414 Collins-street, Mel-

bourne, in Victoria, solicitors, to send particulars to them, care of the under-mentioned solicitors, by the 30th day of November, 1973, after which date they will distribute the assets, having regard only to the claims of which they then have notice.

AITKEN, WALKER & STRACHAN, solicitors, of 414 Collins-street, Melbourne. 4648

In the Supreme Court of the State of Victoria.  
SALE BY THE SHERIFF.

On Friday, the 9th of November, 1973, at 2 p.m. at the Police Station, Rosebud (unless process be stayed or satisfied):—

All the estate and interest (if any) of B. E. Joyce and M. E. Joyce, shown on certificate of title as Brian Edward Joyce, transport operator, and Mavis Elaine Joyce, married woman, both of 12 Clovelly-avenue, Rosebud, as joint proprietors of an estate in fee-simple in the land described in certificate of title, volume 8795, folio 310, upon which is erected a two-storey asbestos cement dwelling, known as No. 12 Clovelly-avenue, Rosebud.

Registered mortgage No. E.879408 affects the said estate and interest.

Terms: Cash only.

DOUGLAS S. HALL, Sheriff's Officer.

26th September, 1973. 4652

In the Supreme Court of the State of Victoria.  
SALE BY THE SHERIFF.

On Friday, the 2nd of November, 1973, at 10 a.m., at the Police Station, Ferntree Gully (unless process be stayed or satisfied):—

All the estate and interest (if any) of Ernest Edward Pearson, plumber, of 46 Clematis-avenue, Ferntree Gully, as proprietor of an estate in fee-simple in the land described in certificate of title, volume 6406, folio 161, upon which is erected a brick dwelling, known as No. 46 Clematis-avenue, Ferntree Gully.

Registered mortgage No. E.219549 and caveat E.717800 affect the said estate and interest.

Terms: Cash only.

H. BUETTNER, Sheriff's Officer.

26th September, 1973. 4653

**IMPOUNDINGS**

BUSHFIELD.—Impounded in Bushfield Pound.

1 Jersey heifer, approx. 12 months old, notch out bottom of left ear, tattoo right ear 2 M 6, no visible brand

If not claimed and expenses paid, to be sold on 26th September, 1973.

4595—\$2.45 L. M. BARBER, Poundkeeper.

NAGAMBIE.—Impounded in the Shire of Goulburn Pound at Nagambie, at 9.30 a.m., on Tuesday, 25th September, 1973, from Old Ruffly-road, Ruffly.

17 Hereford heifers, various ear marks (approx. 15 months) 1 N° with 1 red and 1 yellow sheep ear tags; 3 N° with 1 red sheep ear tag; 11 N° with horns and 6 N° without horns, no visible brand

2 roan heifers, with horns and ear marks (approx. 15 months), no visible brand

1 black faced baldy heifer, no horns, with ear marks (approx. 15 months), no visible brand

If not claimed and expenses paid, to be sold on 19th October, 1973.

4654—\$5.25 M. MASON, Poundkeeper.

RUSHWORTH.—Impounded in Rushworth Pound, from Murchison.

1 Friesian cow, ear tag T/7, calf at foot, no visible brand

If not claimed and expenses paid, to be sold on 11th October, 1973.

4582—\$2.45 G. ROBERTS, Poundkeeper.

SHEPPARTON.—Impounded in Shepparton Pound.

1 bay gelding, two white hind feet, indistinct brand on near shoulder

1 Dorset crossbred lamb, notch out of point of off ear, no visible brand

If not claimed and expenses paid, to be sold on 11th October, 1973.

4655—\$3.15 A. MURPHY, Acting Poundkeeper.

SWAN HILL.—Impounded in Swan Hill Pound, on Monday, 24th September, 1973, from the Lake Boga Area.

1 black cow and calf, no visible brand  
1 dehorned black heifer with nicks from left ear, no visible brand

If not claimed and expenses paid, to be sold on 15th October, 1973.

4657—\$3.15 F. G. BLAIR, Poundkeeper.

SWAN HILL.—Impounded in Swan Hill Pound, from the property of Mr. R. V. Trebilcock, Kerang, on Friday, 22nd September, 1973, the following cattle:—

4 red with white face, no visible brand  
4 black and white (2 polled), no visible brand  
2 grey and white, no visible brand  
2 Poll brindle, no visible brand  
2 brindle-horned, no visible brand  
1 red freckled face, no visible brand  
1 Black Poll steer, no visible brand  
11 calves of assorted colouring, no visible brand

If not claimed and expenses paid, to be sold on 15th October, 1973.

4656—\$5.25 F. G. BLAIR, Poundkeeper.

*Subordinate Legislation Act 1962.*

**NOTICE OF MAKING OF STATUTORY RULES.**

In pursuance of the provisions of the *Subordinate Legislation Act 1962* and the Regulations made thereunder, notice is given of the making of the following statutory rules:—

No.	Local Government Act 1958.	Price.
246/1973.	Uniform Building (Amendment) Regulations 1973, No. 4	15c
	<i>Explosives Act 1960.</i>	
247/1973.	Classification of Explosives (Amendment No. 2) Order 1973	10c
	<i>Strata Titles Act 1967.</i>	
248/1973.	Strata Titles (Fees) Regulations 1973	10c
	<i>Sale of Land Act 1962.</i>	
249/1973.	Sale of Land (Fees) Regulations 1973	10c
	<i>Health Act 1958.</i>	
250/1973.	Food and Drug Standards (Amendment) Regulations 1973	15c
	<i>Apprenticeship Act 1958.</i>	
251/1973.	Apprenticeship (Vehicle Trades) (Amendment) Regulations 1973	10c
	<i>Apprenticeship Act 1958.</i>	
252/1973.	Apprenticeship (Aircraft Trades) (Amendment) Regulations 1973	10c
	<i>Police Regulation Act.</i>	
253/1973.	Police (Authorized Strength No. 5) Regulations 1973	10c
	<i>Private Agents Act 1966.</i>	
254/1973.	Private Agents (Fees) Regulations 1973	10c
	<i>Melbourne Harbor Trust Act 1958.</i>	
255/1973.	Melbourne Harbor Trust Regulations (Amendment No. 2/73)	10c
	<i>State Savings Bank Act 1958.</i>	
256/1973.	State Savings Bank (Interest Rates Amendment No. 2) General Order 1973	10c

Copies of these statutory rules may be purchased at the Sale of Publications Section of the Government Printing Office, located at 7A Parliament-place, Melbourne, 3002. If ordered by mail, remittance should be addressed to "The Government Printer, Box 203, P.O., North Melbourne, 3051", and should include 7c extra for postage. If a credit account is held at this office, no remittance is required with the mail order.

The annual subscription rate for Statutory Rules (including Bound Volumes) is \$25, payable in advance. The subscription year commences on 1st January.

C. H. RIXON, Government Printer.

**STATE ACTS, 1972**

Copies of the following Acts of Parliament of Victoria may be obtained at the Government Printing Office, Sale of Publications Branch, off Parliament-place, Melbourne, phone 63 0321, extension 6181, or from any accredited agent, at the price set opposite to each (these prices do not include postage).

The annual subscription for State Acts 1972 et seq. is \$12.50 payable in advance.

Bound Volumes of State Acts are also available on a subscription basis of \$17.50 per annum.

No.	Price.
8242. Seamen's (Amendment) ..	\$0.10
8243. Land (Greyhound Racing) ..	\$0.10
8244. Melbourne Land (Royal Melbourne Institute of Technology) ..	\$0.10
8245. Adoption of Children (Amendment) ..	\$0.10
8246. Disposal of Uncollected Goods (Amendment) ..	\$0.15
8247. Crimes (Powers of Arrest) ..	\$0.15
8248. Trustee Companies (Sandhurst and Northern District Trustees Executors and Agency Company Limited) ..	\$0.10
8249. Victorian Arts Centre ..	\$0.10
8250. Road Traffic (Amendment) ..	\$0.10
8251. Trustee Companies (National Trustees) ..	\$0.10
8252. Game Act ..	\$0.10
8253. Vermin and Noxious Weeds (Allowances) ..	\$0.10
8254. Leo Cussen Institute for Continuing Legal Education ..	\$0.15
8255. Revocation and Excision of Crown Reservations ..	\$0.10
8256. Dookie Agricultural College Land ..	\$0.15
8257. Country Fire Authority (Amendment) ..	\$0.15
8258. Select Committee (Ansett Transport Industries) ..	\$0.10
8259. Legal Profession Practice (Amendment) ..	\$0.15
8260. Mt. Hotham Alpine Resort ..	\$0.20
8261. Nurses (Amendment) ..	\$0.10
8262. Films (Amendment) ..	\$0.10
8263. County Court (Jurisdiction) ..	\$0.10
8264. Soldier Settlement (Amendment) ..	\$0.10
8265. Government Buildings Advisory Council ..	\$0.10
8266. Poisons (Amendment) ..	\$0.10
8267. Police Offences ..	\$0.10
8268. Public Service (Amendment) ..	\$0.10
8269. Racing (Totalizator Commissions) ..	\$0.10
8270. Stamps (Bookmakers' Statements) ..	\$0.10
8271. Workers Compensation ..	\$0.10
8272. Liquor Control (Amendment) ..	\$0.15
8273. Archaeological and Aboriginal Relics Preservation ..	\$0.20
8274. Taxation Appeals ..	\$0.30
8275. Justices ..	\$0.20
8276. Consumer Protection ..	\$0.60
8277. Environment Protection (Amendment) ..	\$0.15
8278. Coal Mines (Pensions) ..	\$0.10
8279. Motor Car (Amendment) ..	\$0.15
8280. Crimes (Amendment) ..	\$0.15
8281. Melbourne and Metropolitan Board of Works (Reconstitution) ..	\$0.10
8282. Supply (Supplementary Estimates) ..	\$0.10
8283. Victoria Institute of Colleges (Affiliated Colleges) ..	\$0.10
8284. Supreme Court (Civil Appeals) ..	\$0.10
8285. Tattersall Consultations (Amendment) ..	\$0.10
8286. Parliamentary Committees (Take-over Offers) ..	\$0.15
8287. Dentists ..	\$0.40
8288. Firearms (Amendment) ..	\$0.30
8289. Sports Promotion ..	\$0.15
8290. Western Port (Steel Works) ..	\$0.10
8291. Local Government ..	\$0.30
8292. Supply (July to September) ..	\$0.10
8293. Marine ..	\$0.15
8294. Supply (October to December) ..	\$0.10
8295. Albert Park Land ..	\$0.10
8296. Yarraville (Recreation Ground) Lands (Amendment) ..	\$0.10
8297. Summer Time ..	\$0.10
8298. Co-operative Housing Societies ..	\$0.10
8299. State Rivers and Water Supply Commission (Special Projects) ..	\$0.10
8300. Limitation of Actions (Personal Injuries) ..	\$0.10
8301. Montrose Land ..	\$0.10
8302. Registration of Birth Deaths and Marriages ..	\$0.10
8303. State Electricity Commission (Borrowing Powers) ..	\$0.10
8304. Land (Residence Areas) ..	\$0.15
8305. Attorney-General and Solicitor-General ..	\$0.10
8306. Supreme Court (Judges) ..	\$0.10
8307. Constitutional Convention ..	\$0.10

**STATE ACTS, 1972—continued:**

No.	Price.
8308. The Constitution Act Amendment (Conjoint Elections) ..	\$0.10
8309. Ringwood (Recreation Reserve) Land ..	\$0.10
8310. Land (Jetties and Marinas) ..	\$0.15
8311. Sandringham (Beach Oval) Land ..	\$0.10
8312. Mental Health (Admissions) ..	\$0.10
8313. Opticians Registration (Amendment) ..	\$0.10
8314. Superannuation ..	\$0.20
8315. Crown Grants (Removal of Conditions) ..	\$0.15
8316. Coal Mines (Pensions Increase) ..	\$0.10
8317. Sewerage Districts (Amendment) ..	\$0.10
8318. Gas and Fuel Corporation ..	\$0.10
8319. Boilers and Pressure Vessels (Registration) ..	\$0.10
8320. Lifts and Cranes (Amendment) ..	\$0.10
8321. Volunteer Civil Defence Workers Compensation ..	\$0.10
8322. Footscray (Bailey Reserve) Land ..	\$0.10
8323. Mildura Irrigation and Water Trusts (Amendment) ..	\$0.10
8324. Clean Air (Amendment) ..	\$0.10
8325. State Forests Works and Services ..	\$0.10
8326. Geelong Land Exchange ..	\$0.10
8327. Evidence ..	\$0.15
8328. State Electricity Commission (Dartmouth Hydro-Electric Power Station) ..	\$0.10
8329. State Electricity Commission (Yallourn W Power Station) ..	\$0.10
8330. Wrongs ..	\$0.10
8331. Crown Reservations (Revocation and Excision) ..	\$0.10
8332. Road Traffic ..	\$0.10
8333. Geelong Waterworks and Sewerage (Amendment) ..	\$0.20
8334. Navigable Waters (Oil Pollution) (Amendment) ..	\$0.20
8335. Melbourne College of Divinity ..	\$0.15
8336. Education (Amendment) ..	\$0.10
8337. Mines (Amendment) ..	\$0.10
8338. Crimes ..	\$0.10
8339. Housing Ministry ..	\$0.15
8340. National Gallery of Victoria ..	\$0.10
8341. The Constitution Act Amendment (Disqualification) ..	\$0.10
8342. River Improvement (Amendment) ..	\$0.10
8343. Health (Amendment) ..	\$0.30
8344. Youth, Sport and Recreation ..	\$0.30
8345. Motor Car (Learner Drivers' Permits) ..	\$0.15
8346. Veterinary Research Institute ..	\$0.10
8347. Cattle Compensation (Amendment) ..	\$0.10
8348. The Constitution Act Amendment (Appropriations) ..	\$0.10
8349. Motor Car (Miscellaneous Provisions) ..	\$0.10
8350. Victoria Conservation Trust ..	\$0.10
8351. Second-hand Dealers (Charitable Collectors) ..	\$0.10
8352. St. Vincent's Private Hospital (Guarantees) ..	\$0.10
8353. Railways (Amendment) ..	\$0.50
8354. Railway Works and Services ..	\$0.10
8355. Chiropodists (Amendment) ..	\$0.10
8356. Public Service (Appeals) ..	\$0.10
8357. Ministry for the Arts ..	\$0.15
8358. Wheat Marketing (Over-quota Wheat) ..	\$0.10
8359. Criminal Injuries Compensation ..	\$0.30
8360. The Constitution Act Amendment (Qualifications Joint Select Committee) ..	\$0.10
8361. Appropriation ..	\$2.20
8362. Water Supply Works and Services ..	\$0.30
8363. Surrender of Land ..	\$0.20
8364. Ministry for Conservation ..	\$0.15
8365. Public Works and Services ..	\$0.15
8366. Dental Technicians ..	\$0.30
8367. Land (Crown Bailiffs) ..	\$0.10
8368. Weights and Measures (Amendment) ..	\$0.20
8369. Metric Conversion (Agricultural Chemicals) ..	\$0.10
8370. Farm Produce Merchants and Commission Agents (Amendment) ..	\$0.10
8371. Milk and Dairy Supervision (Amendment) ..	\$0.10
8372. Pesticides (Amendment) ..	\$0.20
8373. Housing (Amendment) ..	\$0.10
8374. Local Government (Leases) ..	\$0.10
8375. Country Roads (Amendment) ..	\$0.10
8376. State College of Victoria ..	\$0.40
8377. State Electricity Commission (Amendment) ..	\$0.10
8378. Educational Grants ..	\$0.10
8379. Land Conservation (Vehicle Control) ..	\$0.10
8380. Town and Country Planning (Amendment) ..	\$0.40
8381. Land Tax ..	\$0.10
8382. Consumer Protection (Amendment) ..	\$0.15
8383. Decentralized Industry Incentives (Pay-roll Tax Rebates) ..	\$0.15
8384. Labour and Industry (Amendment) ..	\$0.15

C. H. RIXON,  
Government Printer.

**STATE ACTS, 1973**

Copies of the following Acts of Parliament of Victoria may be obtained at the Government Printing Office, Sale of Publications Branch, off Parliament-place, Melbourne, phone 63 0321, extension 6181, or from any accredited agent, at the price set opposite to each (these prices do not include postage).

The annual subscription for State Acts 1972 et seq. is \$12.50 payable in advance.

Bound Volumes of State Acts are also available on a subscription basis of \$17.50 per annum.

No.	Price.
8385. The Constitution Act Amendment (Qualifications)	\$0.10
8386. Hungarian Reformed Church of Australia (Victoria District) Incorporation	\$0.20
8387. Melbourne Family Care Organization	\$0.10
8388. Gas and Fuel Corporation (Colonial Gas Holdings Limited)	\$0.10
8389. Boilers and Pressure Vessels	\$0.10
8390. State Electricity Commission (Yallourn Council)	\$0.10
8391. Home Finance (Amendment)	\$0.10
8392. Zoological Gardens (Amendment)	\$0.10
8393. Melba Trust Fund	\$0.10
8394. Hospitals and Charities (Guarantee)	\$0.10
8395. Water (Amendment)	\$0.15
8396. Geelong Harbor Trust (Lands)	\$0.10
8397. Latrobe Valley (Amendment)	\$0.10
8398. Maryborough Land	\$0.10
8399. The Constitution Act Amendment (Presiding Officers)	\$0.10
8400. Constitutional Convention (Alternate Members)	\$0.10
8401. Ballarat (Sovereign Hill) Land	\$0.15
8402. Taxation Appeals (Commencement)	\$0.10
8403. Patriotic Funds (Amendment)	\$0.10
8404. Abattoir and Meat Inspection	\$0.40
8405. Valuation of Land (Valuers)	\$0.20
8406. Egg Industry Stabilization	\$0.40
8407. Recreation Vehicles	\$0.15
8408. Motor Car Traders	\$0.50
8409. Decentralized Industry (Housing)	\$0.15
8410. Crimes (Amendment)	\$0.10
8411. Cattle Compensation	\$0.10
8412. Victorian Inland Meat Authority (Amendment)	\$0.10
8413. Bendigo Aerodrome	\$0.10
8414. Ombudsman	\$0.30
8415. Public Service (Amendment)	\$0.10
8416. Coal Mines (Pensions Increase)	\$0.10
8417. Workers Compensation	\$0.10
8418. Public Records	\$0.20
8419. Joint Select Committee (Osteopathy, Chiropractic and Naturography)	\$0.10
8420. Marketing of Primary Products (Citrus Fruit)	\$0.10
8421. Barley Marketing (Amendment)	\$0.10
8422. Margarine	\$0.10
8423. Metric Conversion	\$0.10
8424. Medical Practitioners (Amendment)	\$0.15
8425. Crimes (Theft)	\$0.30
8426. Social Welfare (Amendment)	\$0.20
8427. Magistrates' Courts (Jurisdiction)	\$0.60

STATE ACTS, 1973—continued.

No.	Price.
8428. Victorian Development Corporation	\$0.40
8429. Motor Accidents	\$0.80
8430. Motor Car (Amendment)	\$0.15
8431. Teaching Service	\$0.10
8432. Lands Compensation	\$0.15
8433. Police Offences (Publications)	\$0.15
8434. The Constitution Act Amendment (Responsible Ministers)	\$0.10
8435. Supply (July to October)	\$0.10
8436. Supply (Supplementary Estimates)	\$0.10
8437. Joint Select Committee (Meat Industry)	\$0.10
8438. Joint Select Committee (Road Safety)	\$0.10
8439. Joint Select Committee (Osteopathy, Chiropractic and Naturography) Amendment	\$0.10
8440. Public Works Committee	\$0.10
8441. The Constitution Act Amendment (Qualifications Joint Select Committee)	\$0.10
8442. Ministry of Consumers Affairs	\$0.10
8443. Ministry for Planning	\$0.10

C. H. RIXON,  
Government Printer.

**CONTENTS**

**PAGE**

Acts of Parliament on Sale at the Government Printing Office	3365
Appointments	3327
Companies Act 1961—Notice	3302
Contracts	3326
Country Roads Board	3307
Estates of Deceased Persons	3324
Government Notices	3302
Holiday—Royal Agricultural Show	3302
Impoundings	3364
Lands	3347
Mining	3324
Notice to attend for Radiological Examination	3320
Notice of Making of Statutory Rules	3364
Orders in Council—	
Acts—Forests; Country Roads; Superannuation; Road Traffic; Land; Motor Car; Melbourne Underground Rail Loop; Electric Light and Power; Boiler and Pressure Vessels; Local Government; Housing; Medical Practitioners; Motor Car; Sewerage Districts.	3328 et seq
Private Advertisements	3353
Proclamations	3299
Public Service Notices	3352
Resignations	3328
Tenders	3350
Transport Regulation Board—Public Hearings	3303