



[789]

PUBLISHED BY AUTHORITY

Victoria Government Gazette

No. 37—Wednesday, 13 April 1983

PROCLAMATIONS

Land Act 1958
ROADS PROCLAIMED

PROCLAMATION

By His Excellency the Governor of the State of Victoria, and its Dependencies in the Commonwealth of Australia, &c., &c., &c.
I, the Governor of the State of Victoria, in the Commonwealth of Australia, by and with the advice of the Executive Council of the said State, pursuant to the provisions of section 25 (3) (c) of the Land Act 1958, doth hereby proclaim as roads the Crown lands hereinafter described, viz.:

Parish of Teddywaddy, being the lands indicated by hatching on plans hereunder — (T235(6)(L6-1549))

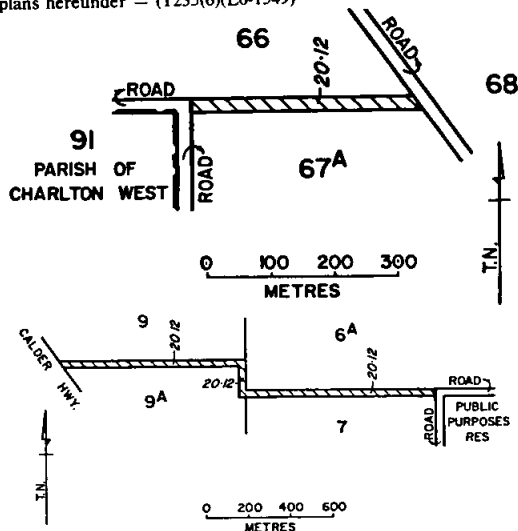

Given under my Hand and the Seal of the State of Victoria aforesaid, at Melbourne, this seventh day of April, in the year of our Lord One thousand nine hundred and eighty-three and in the thirty-second year of the reign of Her Majesty Elizabeth the Second, Queen of Australia.

(L.S.)

B. S. MURRAY

By His Excellency's Command

R. A. MACKENZIE
Minister of Lands

God Save the Queen!

Land Act 1958
ROAD PROCLAIMED

PROCLAMATION

By His Excellency the Governor of the State of Victoria, and its Dependencies in the Commonwealth of Australia, &c., &c., &c.

I, the Governor of the State of Victoria, in the Commonwealth of Australia, by and with the advice of the Executive Council of the said State, pursuant to the provisions of section 25 (3) (c) of the Land Act 1958, doth hereby proclaim as road the Crown land hereinafter described, viz.:

Parish of Mocamboro, being the land indicated by hatching on plan hereunder — (M214(6) (L2-403))

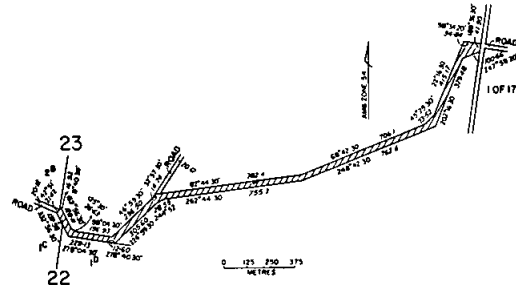

Given under my Hand and the Seal of the State of Victoria aforesaid, at Melbourne, this seventh day of April, in the year of our Lord One thousand nine hundred and eighty-three and in the thirty-second year of the reign of Her Majesty Elizabeth the Second, Queen of Australia.

(L.S.)

B. S. MURRAY

By His Excellency's Command

R. A. MACKENZIE
Minister of Lands

God Save the Queen!

ACTS OF PARLIAMENT

PROCLAMATION

By His Excellency the Governor of the State of Victoria and its Dependencies in the Commonwealth of Australia, &c., &c., &c.

I, the Governor of the State of Victoria, in the Commonwealth of Australia, do hereby declare that I have this day assented, in Her Majesty's name, to the Bills passed by the Parliament of the said State, the titles whereof are hereunder set forth, together with the short titles, that is to say:

No. 9867. "An Act to amend the *Motor Accidents Act 1973* to extend the provisions of the Act to motor accidents occurring outside Victoria involving motor cars registered in Victoria, to provide for the entering into of agreements between the Motor Accidents Board and other similar authorities in the Commonwealth of Australia, and for other purposes." (*Motor Accidents (Amendment) Act 1983.*)

No. 9868. "An Act to amend the *Motor Car Act 1958* to extend and improve training of Learner Drivers, to make provision for Learner's Endorsements, and for other purposes." (*Motor Car (Learner Drivers) Act 1983.*)

Given under my Hand and the Seal of the State of Victoria aforesaid, at Melbourne, this twelfth day April, in the year of our Lord One thousand nine hundred and eighty-three and in the thirty-second year of the reign of Her Majesty Queen Elizabeth II.

(L.S.)

B. S. MURRAY

By His Excellency's Command,

JOHN CAIN
Premier

GOD SAVE THE QUEEN!

NOTE—No. 9867. This Act shall be deemed to have come into operation on 15 December 1982.

No. 9868. This Act shall come into operation on a day to be fixed by proclamation of the Governor in Council published in the *Government Gazette*.

GOVERNMENT NOTICES

**Country Roads Board
RESOLUTIONS OF THE COUNTRY ROADS BOARD**

The Country Roads Board, in pursuance of the provisions of the *Country Roads Act 1958*, has passed Resolutions the dates whereof and the terms of which are scheduled hereunder:

**SCHEDULE
Main Roads**

Resolution dated 8 February 1983, made pursuant to Sections 21 and 58 of the *Country Roads Act 1958* declaring the deviation from Ameys Track in the Shire of South Gippsland as indicated by diagonal hatching on plans numbered G.P. 15356A, G.P. 15356B and G.P. 15357 hereunder to be part of a main road within the meaning and for the purposes of the said Act, and also declaring that such deviation shall be in lieu of the existing road or part thereof indicated by cross hatching on plans numbered G.P. 15356A and G.P. 15356B and horizontal hatching on plan numbered G.P. 15356A which part indicated by cross hatching on plans numbered G.P. 15356A and G.P. 15356B shall be discontinued.

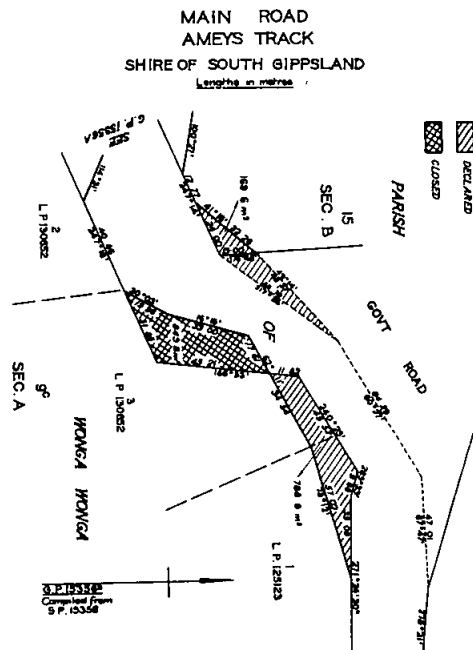
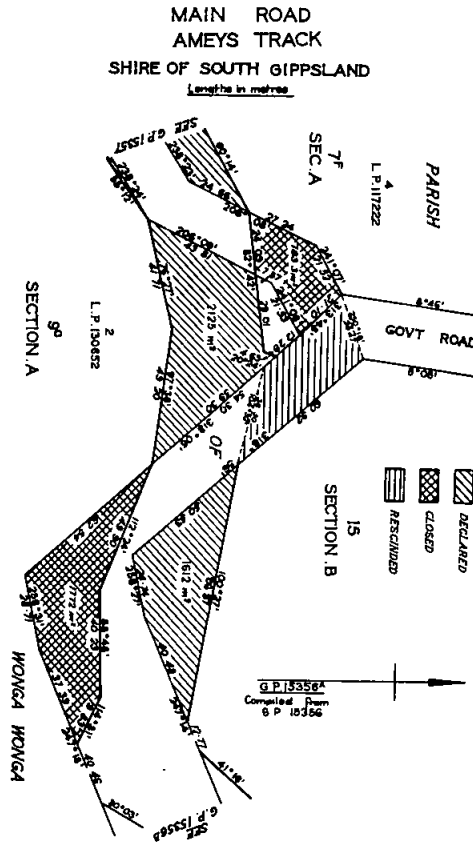
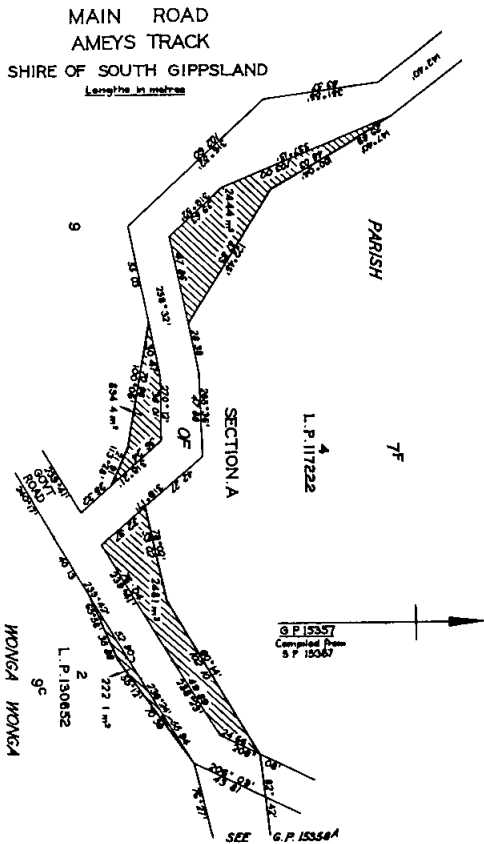

Resolution dated 18 March 1983, made pursuant to Sections 21 and 58 of the *Country Roads Act 1958*, declaring the deviation from the Albert River-Welshpool Road in the Shire of Alberton as indicated by diagonal hatching on plan numbered G.P. 15720 hereunder to be part of a main road within the meaning and for the purposes of the said Act, and also declaring that such deviation shall be in lieu of the existing road or part thereof indicated by cross hatching on the said plan and that such part of the said existing road shall be discontinued.

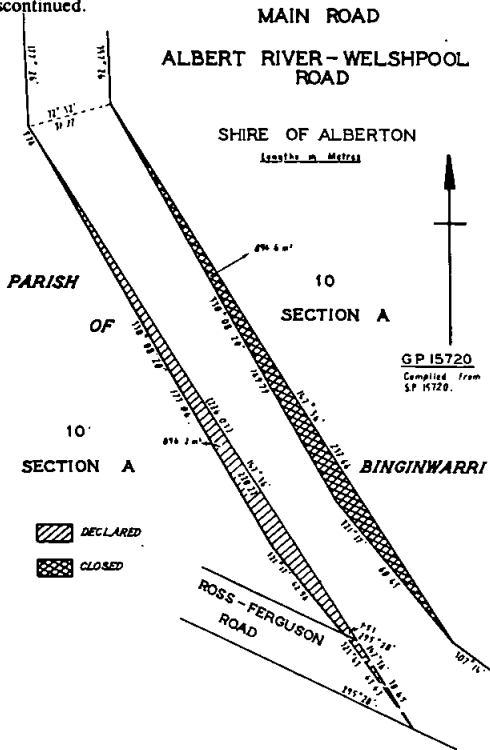

Resolution dated 18 March 1983 made pursuant to Section 21 of the *Country Roads Act 1958*, declaring the widening of the Heidelberg-Doncaster Road in the City of Doncaster & Templestowe as shown hatched on plans numbered G.P. 14668A, G.P. 14668B, G.P. 14668C, G.P. 14669A, G.P. 14669B AND G.P. 14669C hereunder to be part of a main road within the meaning and for the purposes of the said Act.

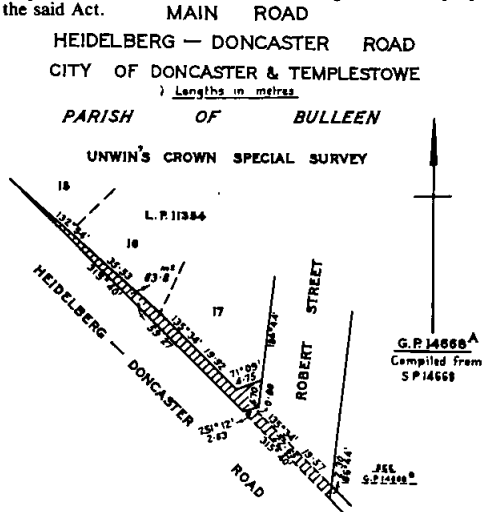

MAIN ROAD
HEIDELBERG - DONCASTER ROAD

CITY OF DONCASTER & TEMPLESTOWE

Lengths in metres

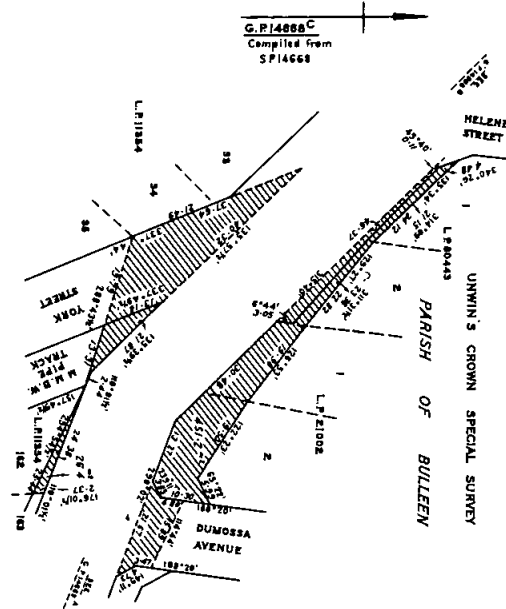

MAIN ROAD
HEIDELBERG - DONCASTER ROAD

CITY OF DONCASTER & TEMPLESTOWE

Lengths in metres

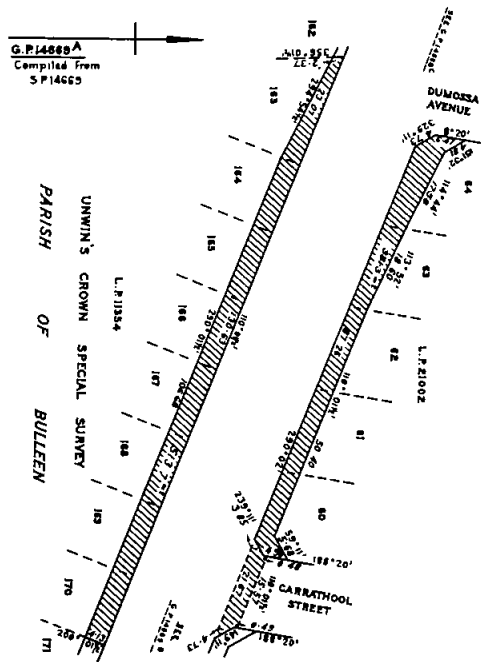

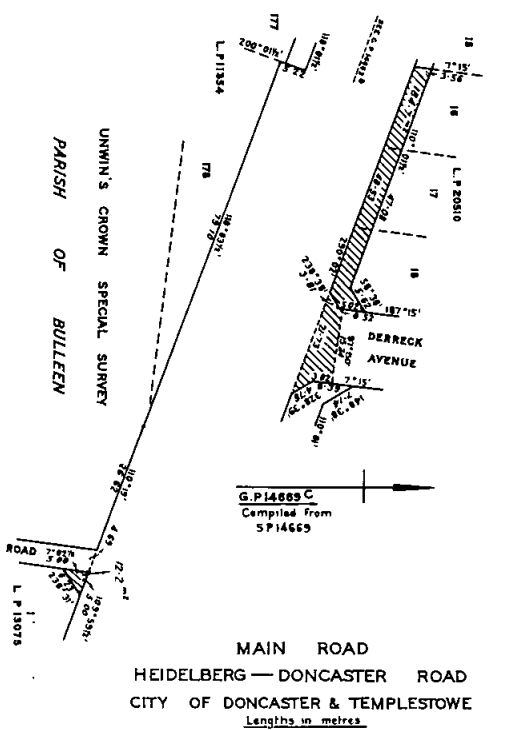
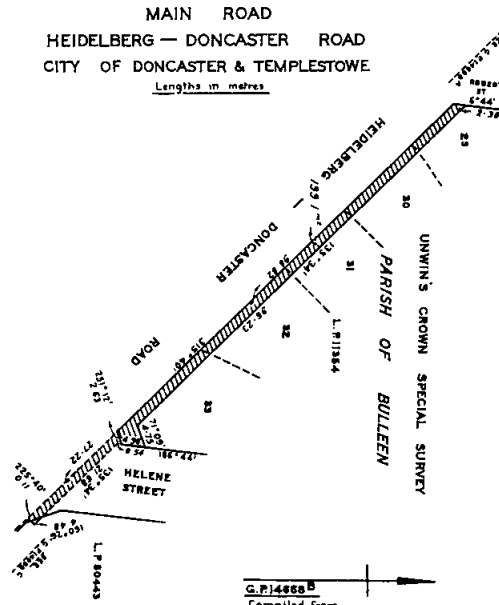
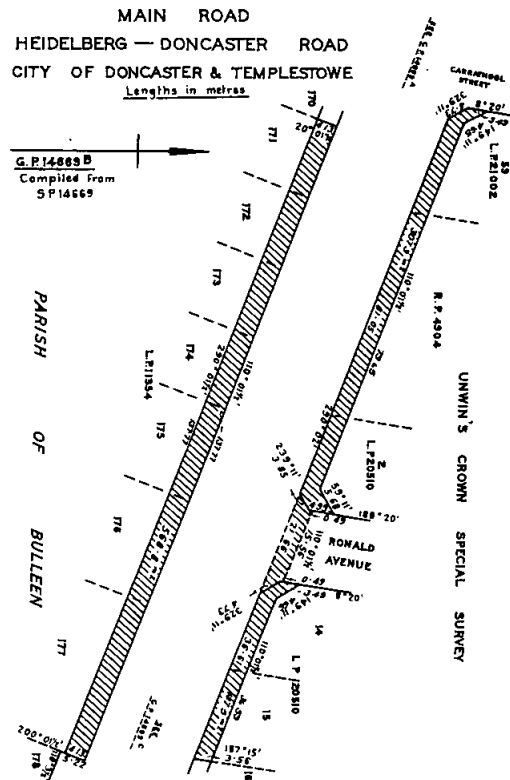

Resolution dated 18 March 1983 made pursuant to Section 21 of the *Country Roads Act 1958*, declaring the widening of the Murtoa-Minyip Road in the Shire of Dunmunkle as shown hatched on plans numbered G.P. 15706A and G.P. 15706B hereunder to be part of a main road within the meaning and for the purposes of the said Act.

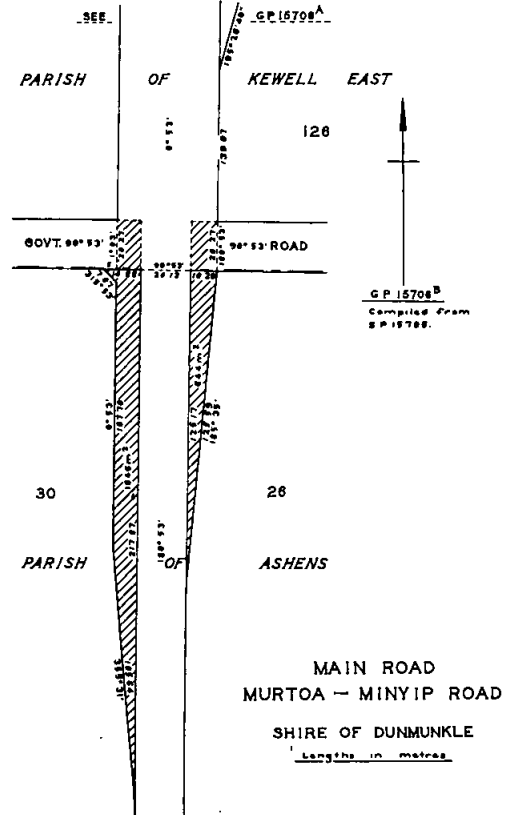

MAIN ROAD
MURTOA — MINYIP ROAD
SHIRE OF DUNMUNKLE
Lengths in metres.

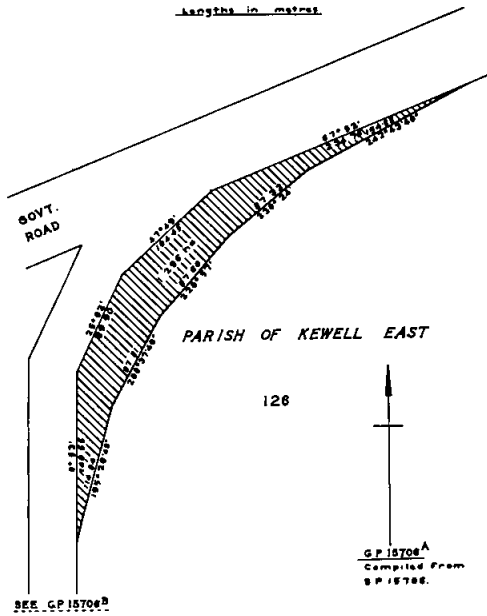

Resolution dated 18 March 1983 made pursuant to Section 21 of the *Country Roads Act 1958*, declaring the widening of Tyers Road in the Shire of Morwell as shown hatched on plans numbered G.P. 15428 and G.P. 15109B hereunder to be part of a main road within the meaning and for the purposes of the said Act.

MAIN ROAD
TYERS ROAD
SHIRE OF MORWELL
Lengths in metres.

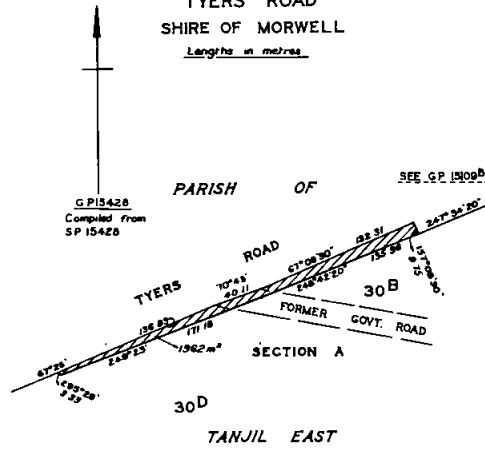

Resolution dated 18 March 1983 made pursuant to Section 21 of the *Country Roads Act 1958*, declaring the widening of Redesdale Road in the Shire of Kyneton as shown hatched on plan numbered G.P. 15418A hereunder to be part of a main road within the meaning and for the purposes of the said Act.

MAIN ROAD
REDESDALE ROAD
SHIRE OF KYNETON
Lengths in metres.

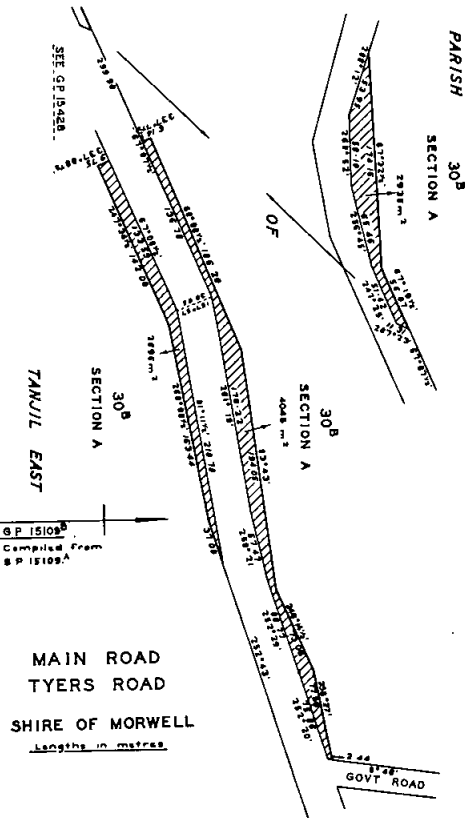
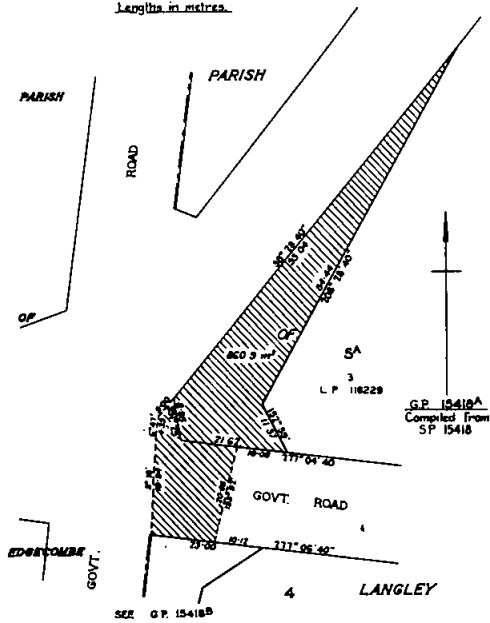

Resolution dated 18 March 1983 made pursuant to Section 21 of the *Country Roads Act 1958*, declaring the widening of the Tarwin Lower Road in the Shire of Woorayl as shown hatched on plan numbered 15392 hereunder to be part of a main road within the meaning and for the purposes of the said Act.

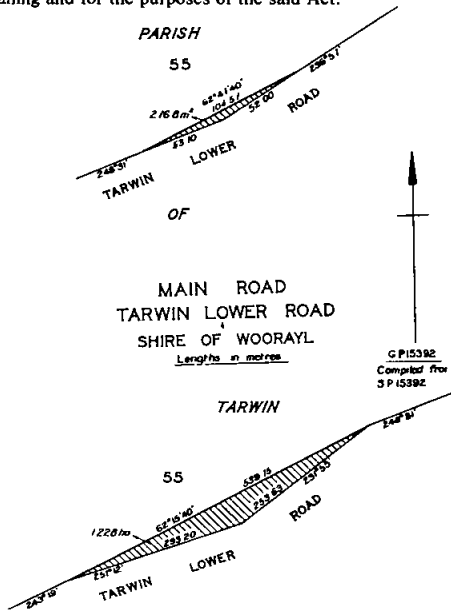

Resolution dated 18 March 1983 made pursuant to Sections 21 and 110 of the *Country Roads Act 1958* declaring the road in the Shire of Morwell as shown hatched on plans numbered G.P. 15216A and G.P. 15442 hereunder to be a road (Commercial Road) within the meaning and for the purposes of the said Act.

ROAD
COMMERCIAL ROAD
SHIRE OF MORWELL
Lengths in metres

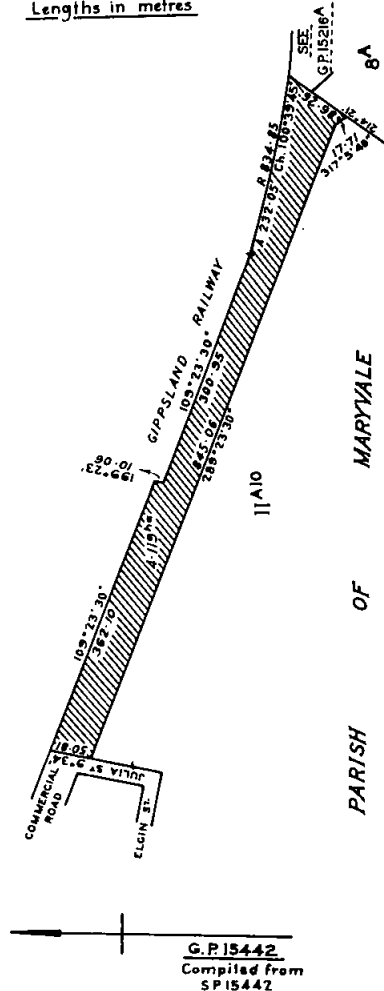

Unclassified Roads

Resolution dated 18 March 1983 made pursuant to Sections 21 and 110 of the *Country Roads Act 1958*, declaring the widening of a road in the Shire of Kyneton as shown hatched on plan numbered G.P. 15418B hereunder to be part of a road within the meaning and for the purposes of the said Act.

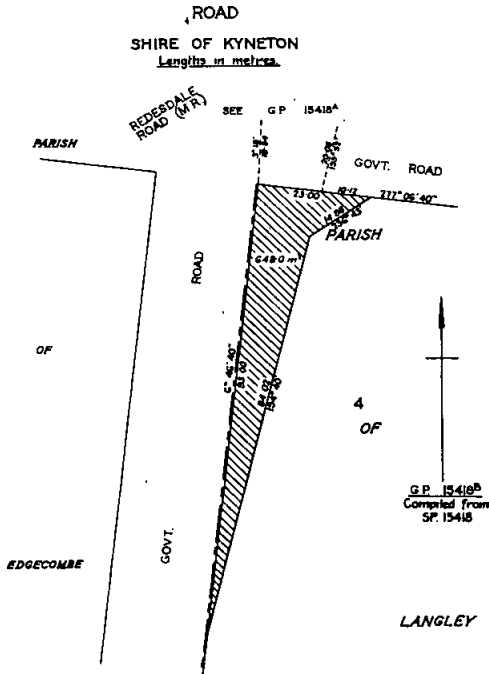

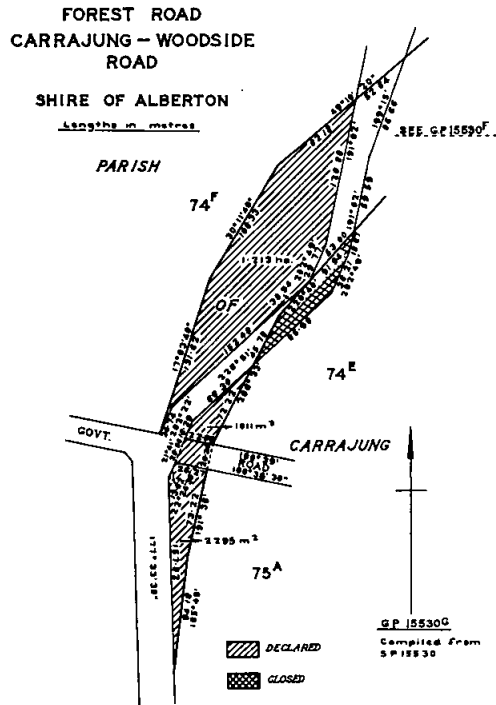
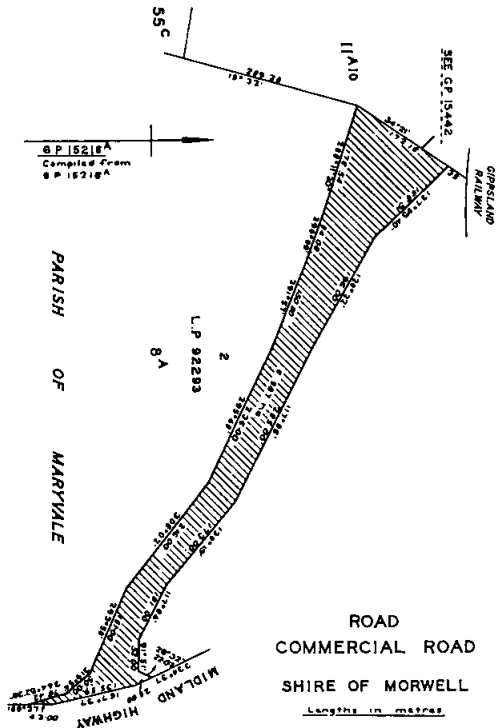

Forest Road
 Resolution dated 18 March 1983, made pursuant to Sections 21, 58 and 94 of the *Country Roads Act 1958*, declaring the deviation from the Carrajung-Woodside Road in the Shire of Alberton as indicated by diagonal hatching on plans numbered G.P. 15108B, G.P. 15108C, G.P. 15530A, G.P. 15530E, G.P. 15530F and G.P. 15530G hereunder to be part of a forest road within the meaning and for the purposes of the said Act and also declaring that such deviation shall be in lieu of the existing road or part thereof indicated by cross hatching on plans numbered G.P. 15108B, G.P. 15530E, G.P. 15530F and G.P. 15530G and vertical hatching on plans numbered G.P. 15108B, G.P. 15108C and G.P. 15530A which part indicated by cross hatching on plans numbered G.P. 15108B, G.P. 15530E, G.P. 15530F and G.P. 15530G shall be discontinued.

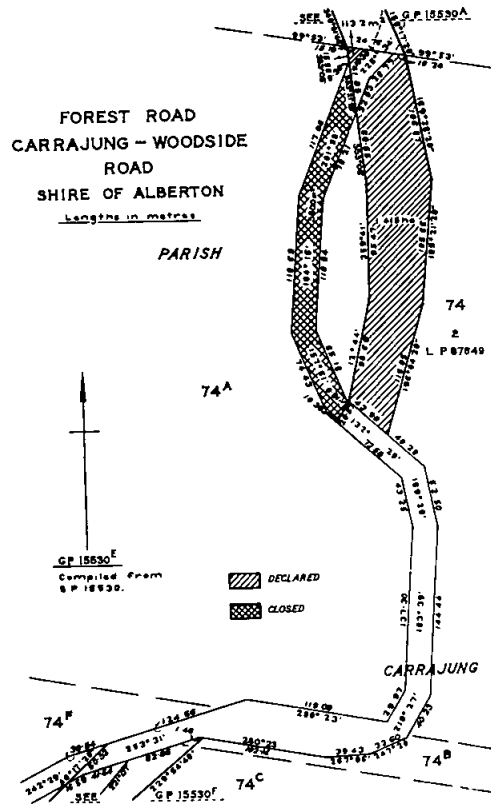
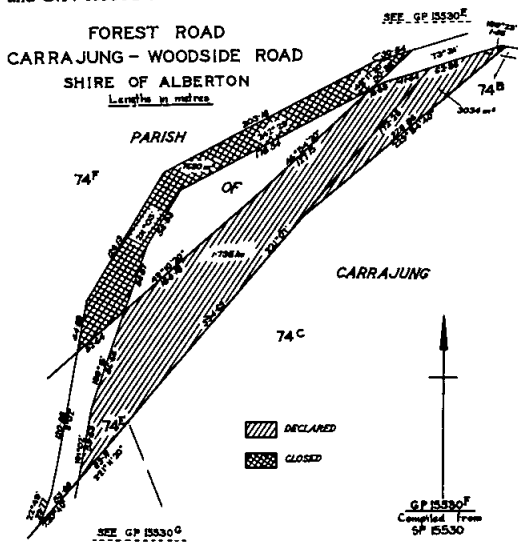

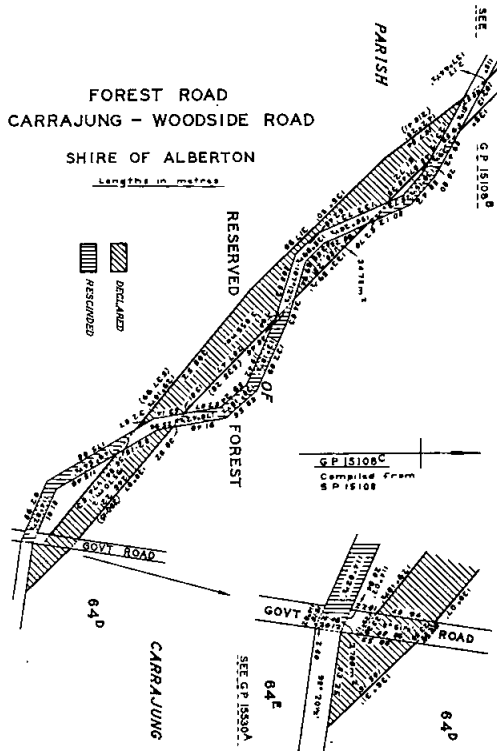
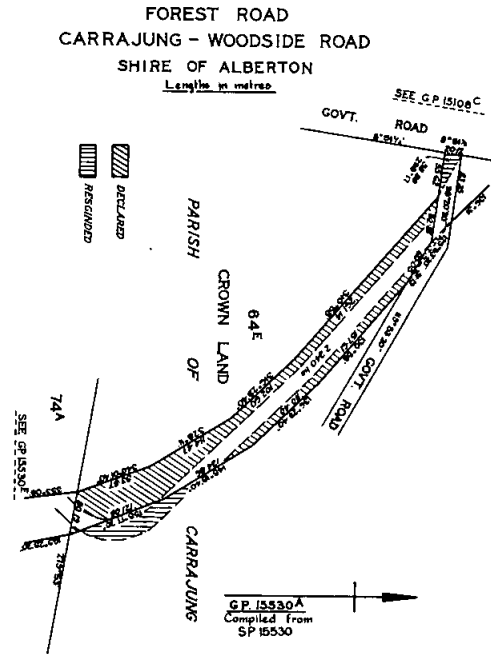
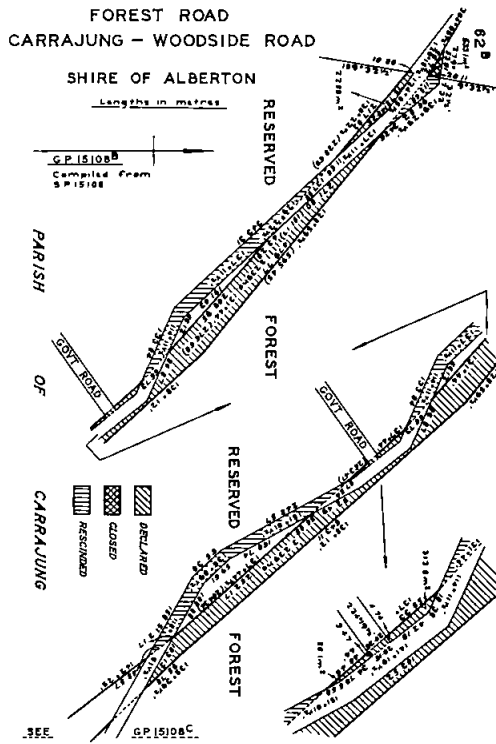

Main Roads
Resolution dated 22 March 1983 made pursuant to Section 21 of the *Country Roads Act 1958*, declaring the widening of the Red Hill-Shoreham Road in the Shires of Hastings and Flinders as shown hatched on plan numbered G.P. 8870 hereunder to be part of a main road within the meaning and for the purposes of the said Act.

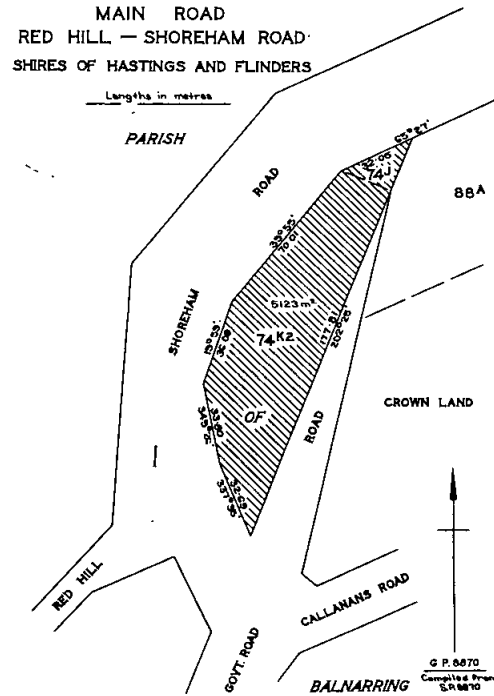

Resolution dated 22 March 1983 changing the name of a section of main road in the City of Moe as shown hatched on plan numbered G.P. 1235P2 hereunder from Moe-Yallourn Road to Haunted Hills Road.

**MAIN ROAD
HAUNTED HILLS ROAD
CITY OF MOE**

 RENAMED FROM MOE-YALLOURN ROAD

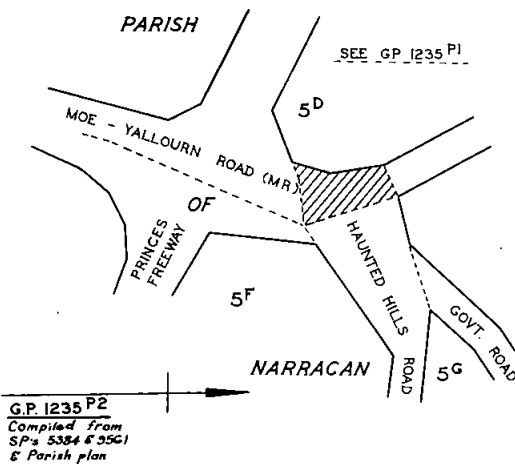

G.P. 1235 P2
Compiled from
SP's 5384 & 5561
& Parish plan

Resolution dated 22 March 1983 made pursuant to Sections 21 and 101 of the *Country Roads Act 1958*, declaring the widening of the Western Freeway in the Shires of Buninyong and Ballan as shown hatched on plan numbered G.P. 13956C hereunder to be part of a freeway within the meaning and for the purposes of the said Act.

**FREEWAY
WESTERN FREEWAY
SHIRES OF BUNINYONG & BALLAN**
Lengths in metres

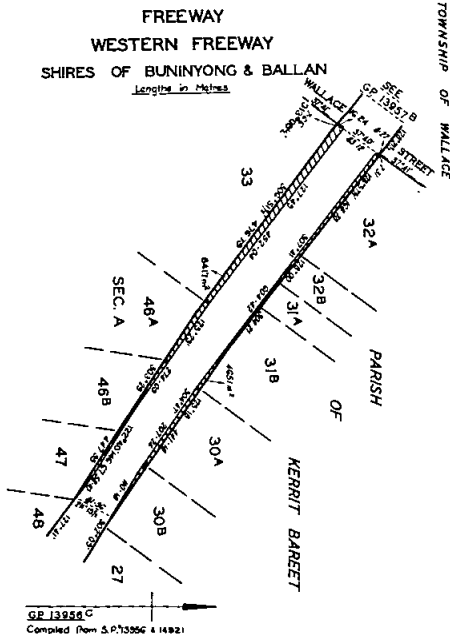

GP 13956 C
Compiled from SP's 13956 & 14921

Resolution dated 22 March 1983 varying the declaration of the Eastern Freeway in the City of Collingwood by the exclusion of the area shown hatched on plan numbered G.P. 14552C below.

**FREEWAY
EASTERN FREEWAY
CITY OF COLLINGWOOD**

Lengths in metres

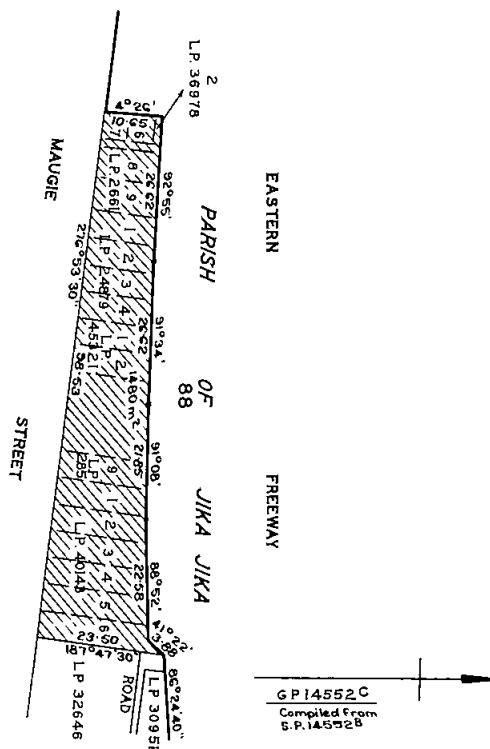

G.P. 14552 C
Compiled from
S.P. 14552 B

25 March 1983

P. J. McCULLOUGH
Acting Secretary

State Electricity Commission Act 1978
**ELECTION OF EMPLOYEES' REPRESENTATIVE OF THE
STATE ELECTRICITY COMMISSION**

Pursuant to Regulation 7 of the *State Electricity Commission Employees' Representative Regulations 1983* I hereby give notice that for the purpose of the election of the employee to be the Employees' Representative of the State Electricity Commission in accordance with the provisions of Section 4 (3) (b) (iv) of the *State Electricity Commission Act 1958* for the period of two years from the date of the declaration of the results of the election, the following dates are fixed, namely—

Nomination Day—29 April 1983

Polling Day—3 June 1983

And I further give notice that Peter Barry Allen is appointed as the Returning Officer to conduct the said elections and that he will receive nominations at his office in the Internal Audit Department of the State Electricity Commission of Victoria, 5th Floor, 60 Market Street, Melbourne 3000, not later than four o'clock in the afternoon on Nomination Day.

Prescribed forms of nomination may be obtained from the Returning Officer.

DAVID WHITE
Minister for Minerals and Energy

Liquor Control Act 1968
Liquor Control (Orderly Marketing) Act 1976
DETERMINATION OF LIQUOR CONTROL COMMISSION
No. 1 of 1983

The Liquor Control Commission, pursuant to powers conferred upon it by Section 11A *Liquor Control Act 1968* as amended, hereby determines the prices below which licensed persons may not sell and dispose of packaged beer to unlicensed persons in the State of Victoria.

By this determination the Liquor Control Commission determines different prices for packaged beer according both to the type, description or brand of the beer and the type, description or size of package in which the beer is to be sold or disposed of and also different prices at which packaged beer may be sold in different parts of Victoria, all as specified in the table hereunder. The different parts of Victoria in respect of which different prices are hereby determined are referred to as "Metropolitan Area", "Country Areas" Groups 1, 2, 3, 4 and 5 and "Special Area Group 1", respectively, in the said table. Except where otherwise defined, the areas referred to in the said table are defined by reference to municipal districts or subdivisions within the meaning of the *Local Government Act 1958* as amended.

"Metropolitan Area" means the municipal districts of Altona, Box Hill, Brighton, Broadmeadows, Brunswick, Bulla, Camberwell, Caulfield, Chelsea, Coburg, Collingwood, Croydon, Dandenong, Diamond Valley, Doncaster and Templestowe, Eltham, Essendon, Fitzroy, Footscray, Hawthorn, Heidelberg, Keilor, Kew, Knox, Malvern, Melbourne, Melton, Moorabbin, Mordialloc, Northcote, Nunawading, Oakleigh, Port Melbourne, Prahran, Preston, Richmond, Ringwood, Sandringham, South Melbourne, Springvale, St Kilda, Sunshine, Waverley, Whittlesea, Williamstown, the subdivisions of the municipal district of Werribee known as the East Riding and that portion of the municipal district of Lillydale within the area bounded as follows:

Commencing at the intersection of Colchester Road and the Dandenong Creek; thence south-easterly, southerly and easterly by the Dandenong Creek to Liverpool Road, thence northerly by Liverpool Road to Mount Dandenong Road; thence north-easterly by Mount Dandenong Road to Duram Road; thence north-easterly and easterly by Durham Road to Cambridge Road; thence north-westerly by Cambridge Road to Pembroke Road; thence north-north easterly by Pembroke Road to Taylor Road; thence westerly and south-westerly and west-north-westerly by Taylor Road to Hull Road; thence north-easterly by Hull Road to Ellen Road; thence north-westerly by Ellen Road to the railway line; thence south-westerly by the railway line to Manchester Road; thence northerly by Manchester Road to Diane Crescent; thence westerly by Diane Crescent to the Brushy Creek; thence southerly by the Brushy Creek to Sherlock Road; thence westerly by Sherlock Road to Newman Road; thence southerly by Newman Road to Lincoln Road; thence easterly by Lincoln Road and Cambridge Road to Hawthory Road; thence southerly by Hawthory Road to Mount Dandenong Road; thence westerly by Mount Dandenong Road to Colchester Road and thence southerly by Colchester Road to the point of commencement.

Insofar as the above-mentioned description relates to the municipal district of Lillydale and where the boundaries described run along a road, street, concourse, crescent, creek or railway line, the centre of such road, street, concourse, crescent, creek or railway line shall be taken to be the boundary line.

"Country Area Group One" means the municipal districts of Bacchus Marsh, Bannockburn, Berwick, Broadford, Corio, Cranbourne, Frankston, Geelong, Geelong West, Gisborne, Kilmore, Lillydale, save and except that portion thereof which is earlier described as situate in the Metropolitan area, Mornington, Newham and Woodend, Newtown, Pakenham, Romsey, Sherbrooke, Upper Yarra and Werribee, save and except the subdivision of the municipal district of Werribee known as the East Riding.

"Country Area Group Two" means the municipal districts of Ballan, Ballaarat City, Bendigo, Barrabool, Bass, Bellarine, Buln Buln, Castlemaine, Colac, Colac City, Daylesford and Glenlyon, Eaglehawk Borough, Euroa, Flinders, Goulburn, Hastings, Healesville, Korumburra, Kyneton, Mclvor, Maldon, Maryborough City, Metcalfe, Moe, Morwell, Narracan, Newstead, Phillip Island, Pyalong, Queenscliffe Borough, Ripon, Seymour, South Barwon, Strathfieldsaye, Talbot and Clunes, Traralgon, Traralgon City, Tullaroop, Violet Town, Warragul, Wonthaggi Borough, Winchelsea, Yallourn and Yea.

"Country Area Group Three" means the municipal districts of Alberton, Alexandra, Ararat, Ararat City, Avon, Bairnsdale, Bairnsdale Town, Ballarat, Beechworth, Belfast, Benalla, Benalla City, Bet Bet, Bright, Bungaree, Buninyong, Camperdown Town, Charlton, Chiltern, Cobram, Cohuna, Creswick, Deakin, Donald, Dunmunkle, East Loddon, Echuca City, Gordon, Grenville, Hamilton City, Hampden, Heytesbury, Horsham City, Huntly, Kara Kara, Kerang, Kerang Borough, Koroit Borough, Korong, Kyabram Town, Leigh, Lexton, Maffra, Marong, Minhamite, Mirboo, Mortlake, Mt. Rouse, Myrtleford, Nathalia, Numurkah, Otway, Oxley, Port Fairy Borough, Rochester, Rodney, Rosedale, Rutherglen, St. Arnaud Town, Sale City, Sebastopol Borough, Shepparton, Shepparton City, South Gippsland, Stawell, Stawell Town, Tungamah, Wangaratta, Wangaratta City, Waranga, Warrnambool, Warrnambool City, Wimmera, Wodonga, Woorayl, Yarrawonga, and that part of the municipal district of Arapiles which is within the Parish of Bungally.

"Country Area Group Four" means the municipal district of Arapiles except that part of the said municipal district which is within the Parish of Bungally, the municipal districts of Avoca, Birchip, Dimboola, Dundas, Glenelg, Kaniva, Karkaroo, Lowan, Mansfield, Portland, Town of Portland, Swan Hill, Swan Hill City, Tambo, Wannon, Warracknabeal, Wycheproof and Yackandandah.

"Country Area Group Five" means the municipal districts of Kowree, Omeo, Orbost, Tallangatta, Upper Murray and Walpeup.

"Special Area Group One" means the municipal districts of Mildura and Mildura City.

The Table referred to

Minimum retail prices for single units of packaged beer determined by the Liquor Control Commission

Part (A)—All packaged beer with an alcoholic content of more than 3·8 per centum by volume at a temperature of 20°C save and except such packaged beer as is listed in Part (C) hereof.

| | Country Areas Group | | | | | Special Area Group 1 | |
|----------------|---------------------|-----------|-----------|-----------|-----------|----------------------|-----------|
| | Metropolitan Area | 1 | 2 | 3 | 4 | | 5 |
| Bottles—750 ml | \$ c 1.12 | \$ c 1.14 | \$ c 1.15 | \$ c 1.16 | \$ c 1.17 | \$ c 1.18 | \$ c 1.17 |
| Bottles—375 ml | .63 | .65 | .66 | .67 | .68 | .69 | .68 |
| Cans—750 ml | 1.18 | 1.20 | 1.21 | 1.22 | 1.23 | 1.24 | 1.23 |
| Cans—375 ml | .64 | .66 | .67 | .68 | .69 | .70 | .69 |

Part (B)—All packaged beer with an alcoholic content of not more than 3·8 per centum by volume at a temperature of 20°C save and except such packaged beer as is listed in Part (D) hereof.

| | Country Areas Group | | | | | Special Area Group 1 | |
|----------------|---------------------|-----------|-----------|-----------|-----------|----------------------|-----------|
| | Metropolitan Area | 1 | 2 | 3 | 4 | | 5 |
| Bottles—750 ml | \$ c 1.06 | \$ c 1.08 | \$ c 1.09 | \$ c 1.10 | \$ c 1.11 | \$ c 1.12 | \$ c 1.11 |
| Bottles—375 ml | .60 | .62 | .63 | .64 | .65 | .66 | .65 |
| Cans—375 ml | .61 | .63 | .64 | .65 | .66 | .67 | .66 |

Part (C)

| | Metropolitan Area | Country Areas Group | | | | | Special Area Group |
|--|-------------------|---------------------|------|------|------|------|--------------------|
| | | 1 | 2 | 3 | 4 | 5 | 1 |
| | \$ c | \$ c | \$ c | \$ c | \$ c | \$ c | |
| Crown Lager Reschs Premier Reschs Lager Bottles—375 ml | .79 | .81 | .82 | .83 | .84 | .85 | .84 |
| Mildura Bitter Mildura Lager Mildura Draught Bottles—750 ml | 1.08 | 1.10 | 1.11 | 1.12 | 1.13 | 1.14 | 1.08 |
| Bottles—375 ml | .62 | .64 | .65 | .66 | .67 | .68 | .62 |

Part (D)

| | Metropolitan Area | Country Areas Group | | | | | Special Area Group |
|-------------------------------------|-------------------|---------------------|------|------|------|------|--------------------|
| | | 1 | 2 | 3 | 4 | 5 | 1 |
| | \$ c | \$ c | \$ c | \$ c | \$ c | \$ c | |
| Reschs Premier LA Bottles—375 ml | .79 | .81 | .82 | .83 | .84 | .85 | .84 |

The Commission hereby authorises a licensee to offer or give to any unlicensed person any or all of the following considerations, benefits and advantages in connection with or in consideration of the purchase of packaged beer by any unlicensed person, namely, free chilling of packaged beer, free delivery of packaged beer, free wrapping of packaged beer, loan of glasses free of charge, credit, and return of unopened bottles.

This determination replaces No. 3 of 1982.

Dated 8 April 1983

JUDGE M. C. KIMM (Additional Chairman)
COMMISSIONER L. S. BROKENSHIRE
COMMISSIONER E. J. BOND

CONTRACTS ACCEPTED—(Series 1983-84)

FLOOR COVERINGS—CARPET

Schedule No. 1/51

Contract from 1 April 1983 to 31 March 1984

1983/5—Myer Teale Group, 60-66 Leicester Street, Fitzroy. Telephone 417 2191

All supplies under this Schedule will be ordered by the Chief Supply Officer, Public Works Department and must be delivered as directed by him.

| Item No. | Description | Rate | Name of Contractor |
|----------|--|---------------------------|--------------------------|
| | | \$ | |
| | Floor Coverings—Carpet | | |
| | <i>Carpet—Supply, Make and Lay on Underfelt and Carpet Gripper</i> | | |
| 1 | Needleweave Tufted, Wool, 969 g per m ² 'Landau'— | | |
| | (a) Within 45 kms of G.P.O., Melbourne | per m ² 16.18* | |
| | (b) Beyond 45 kms and within 120 kms of G.P.O., Melbourne | .. 16.43* | |
| | (c) Beyond 120 kms of G.P.O., Melbourne and within State of Victoria | .. 16.68* | |
| 2 | Needleweave Tufted, Wool, 1220 g per m ² , 'Landau'— | | |
| | (a) Within 45 kms of G.P.O., Melbourne | per m ² 18.10* | Myer Teale Group |
| | (b) Beyond 45 kms and within 120 kms of G.P.O., Melbourne | .. 18.35* | |
| | (c) Beyond 120 kms of G.P.O., Melbourne and within State of Victoria | .. 18.60* | |
| 3 | Needleweave Tufted, Synthetic (Acrylic), 969 g per m ² 'Landau Acrylic'— | | |
| | (a) Within 45 kms of G.P.O., Melbourne | per m ² 12.05* | |
| | (b) Beyond 45 kms and within 120 kms of G.P.O., Melbourne | .. 12.30* | |
| | (c) Beyond 120 kms of G.P.O., Melbourne and within State of Victoria | .. 12.55* | |
| 4 | Needleweave Tufted, Synthetic (Acrylic), 1220 g per m ² , 'Landau Acrylic'— | | |
| | (a) Within 45 kms of G.P.O., Melbourne | per m ² 12.55* | |
| | (b) Beyond 45 kms and within 120 kms of G.P.O., Melbourne | .. 12.30* | Purchase (Regulation 84) |
| | (c) Beyond 120 kms of G.P.O., Melbourne and within State of Victoria | .. 12.30* | |
| 5 | Edge Stripping (Naplock)— | | |
| | (a) for use with Item 1 and 2 above 'Roberts' | per metre 3.30* | Myer Teale Group |
| | (b) for use with Item 3 and 4 above 'Roberts' | .. 3.00* | |

Approved—R. A. JOLLY, Treasurer—7 April 1983

*Rates less 2½% settlement discount, 30 days.

STATE TENDER BOARD—CONTRACTS ACCEPTED

| AMENDMENTS | | | | Schedule Number | Item Number | New Rate \$ | Effective Date |
|--|--------------------|---|-----------------------|--|----------------|----------------|-------------------|
| <i>Schedule Number</i> | <i>Item Number</i> | <i>New Rate</i> | <i>Effective Date</i> | <i>Provisions—Ararat District (Series 1982-83)</i> | | | |
| | | | | 2/06(4) | 1 | 1.74 | 1.4.83 |
| | | | | | 8 | 18.05 | |
| | | | | | 10 | 9.21 | |
| | | | | | 13 | 1.09 | |
| | | | | | 17 | 4.28 | |
| | | | | | 23 | 3.02 | |
| | | | | | 26 | 1.81 | |
| | | | | | 33 | 25.05 | |
| | | | | | 34 | 23.56 | |
| | | | | | 35 | 23.56 | |
| | | | | | 37 | 18.35 | |
| | | | | | 38 | 23.56 | |
| | | | | | 39 | 18.12 | |
| | | | | | 40 | 16.99 | |
| | | | | | 41 | 16.99 | |
| | | | | | 50 | 2.50 | |
| | | | | | 52 | 0.94 | |
| | | | | | 55 | 0.94 | |
| | | | | | 56 | 0.94 | |
| | | | | | 62 | 1.95 | |
| | | | | | 68 | 0.37 | |
| | | | | | 71 | 1.03 | |
| | | | | | 86 | 13.51 | |
| | | | | | 88 | 16.93 | |
| | | | | <i>Provisions—Ballarat District (Series 1982-83)</i> | | | |
| | | | | 2/07(4) | 1 | 1.74 | 1.4.83 |
| | | | | | 9 | 1.31 | |
| | | | | | 24 | 18.05 | |
| | | | | | 25 | 8.43 | |
| | | | | | 26 | 8.89 | |
| | | | | | 27 | 19.28 | |
| | | | | | 28 | 1.09 | |
| | | | | | 34 | 20.39 | |
| | | | | | 35 | 1.81 | |
| | | | | | 44 | 3.02 | |
| | | | | | 47 | 3.01 | |
| | | | | | 51 | 1.81 | |
| | | | | | 60 | 23.24 | |
| | | | | | 63 | 25.48 | |
| | | | | | 65 | 27.89 | |
| | | | | | 67 | 25.05 | |
| | | | | | 68 | 23.56 | |
| | | | | | 69 | 23.56 | |
| | | | | | 71 | 18.85 | |
| | | | | | 72 | 23.56 | |
| | | | | | 73 | 18.12 | |
| | | | | | 74 | 16.99 | |
| | | | | | 75 | 16.99 | |
| | | | | | 77 | 36.94 | |
| | | | | | 78 | 22.25 | |
| | | | | | 84 | 2.50 | |
| | | | | | 88 | 0.94 | |
| | | | | | 89 | 0.94 | |
| | | | | | 94 | 3.91 | |
| | | | | | 98 | 1.95 | |
| | | | | | 107 | 3.51 | |
| | | | | | 108 | 0.37 | |
| | | | | | 113 | 1.03 | |
| | | | | | 114 | 11.19 | |
| | | | | | 123 | 14.96 | |
| | | | | | 131 | 13.51 | |
| | | | | | 134 | 0.77 | |
| | | | | <i>Provisions—Bendigo District (Series 1982-83)</i> | | | |
| | | | | 2/09(4) | 2 | 1.74 | 1.4.83 |
| | | | | | 11 | 1.31 | |
| | | | | | 25 | 18.05 | |
| | | | | | 26 | 9.21 | |
| | | | | | 29 | 19.28 | |
| | | | | | 38 | 1.81 | |
| | | | | | 39 | 4.28 | |
| | | | | | 51 | 3.01 | |
| | | | | | 54 | 1.08 | |
| | | | | | 55 | 1.81 | |
| | | | | | 73 | 25.05 | |
| | | | | | 74 | 23.56 | |
| | | | | | 75 | 23.56 | |
| | | | | | 77 | 18.85 | |
| | | | | | 79 | 23.56 | |
| | | | | | 80 | 0.76 | |
| <i>Protective Clothing, Uniforms and Safety Equipment (Series 1981-83)</i> | | | | | | | |
| 1/14 | 18 | 9.75 | 1.4.83 | | | | |
| <i>Fasteners (Series 1982-84)</i> | | | | | | | |
| 1/26 | 41-43 | Sidney Cooke List 581 less 42½% | 25.3.83 | | | | |
| | 45 | Sidney Cooke List 581 less 42½% | | | | | |
| <i>Piping and Fittings (Series 1982-84)</i> | | | | | | | |
| 1/34 | 1,2 | T.O.A. Ltd. List 14.3.83 less 21%* | 16.3.83 | | | | |
| | 6,7 | Crane Enfield Metals Pty. Ltd. List 104 February '83 less 15% | 10.3.83 | | | | |
| | 8 | Ryemetal Wholesale Price List March 1983 nett | 1.4.83 | | | | |
| * Trading terms unchanged | | | | | | | |
| <i>Steel—Mild (Series 1982-84)</i> | | | | | | | |
| 1/35 | 3 | T.O.A. Ltd. List 14.3.83 less 21%* | 16.3.83 | | | | |
| * Trading terms unchanged | | | | | | | |
| <i>Motor Spirit, Kerosene, Fuel Oils and Lubricants (Series 1982-83)</i> | | | | | | | |
| <i>Petrol Outlets:</i> | | | | | | | |
| Add: Caltex—Gordon Stephens Motors Pty. Ltd. | | | | | | | |
| Conness Street, Chiltern | | | | | | | |
| Trading Hours: Mon-Fri. 8.30 a.m. to 5.30 p.m. | | | | | | | |
| Sat. 9.30 a.m. to 12.30 p.m. | | | | | | | |
| Sun. 10 a.m. to 12 p.m. | | | | | | | |
| <i>Hand Tools—General (Series 1982-84)</i> | | | | | | | |
| 1/56 | 55 | 4.77(16oz)* | 6.4.83 | | | | |
| | | 4.88(20oz)* | | | | | |
| | 232 | 1.55† | 25.3.83 | | | | |
| | 233 | 1.55† | | | | | |
| | 240 | 4.90† | | | | | |
| | 241 | 5.13† | | | | | |
| | 242 | 5.35† | | | | | |
| | 243 | 5.81† | | | | | |
| | 244 | 0.96† | | | | | |
| | 245 | 0.81† | | | | | |
| | 246 | 0.94† | | | | | |
| | 247 | 1.16† | | | | | |
| | 250 | 2.33† | | | | | |
| | 251 | 2.67† | | | | | |
| | 252 | 2.87† | | | | | |
| | 253 | 3.51† | | | | | |
| | 254 | 4.11† | | | | | |
| | 258 | 2.85† | | | | | |
| | 266 | 3.48† | | | | | |
| | 267 | 4.39† | | | | | |
| * Delete: Purchase (Regulation 84) | | | | | | | |
| Add: Eliza Tinsley (Aust.) Pty. Ltd. | | | | | | | |
| † Trading terms unchanged. | | | | | | | |
| <i>General Stationery and School Requisites (Series 1982-83)</i> | | | | | | | |
| 1/64 | 31 | 0.27* | 22.3.83 | | | | |
| | 38,39 | † | 1.4.83 | | | | |
| * Trading terms unchanged | | | | | | | |
| † Orders should be directed to: Derite Pty. Ltd. | | | | | | | |
| P.O. Box 43 | | | | | | | |
| Port Melbourne 3207 | | | | | | | |
| Telephone: 645 1877 | | | | | | | |

| Schedule Number | Item Number | New Rate | Effective Date | Schedule Number | Item Number | New Rate | Effective Date |
|--|-------------|---------------------|----------------|--|-------------|---------------------|----------------|
| | | \$ | | | | \$ | |
| <i>Provisions—Bendigo District (Series 1982-83) —continued</i> | | | | <i>Provisions—Langi Kal Kal (Series 1982-83)—continued</i> | | | |
| | 81 | 0.73 | | 85 | 13.51 | | |
| | 84 | 36.94 | | 87 | 29.13 | | |
| | 85 | 22.25 | | 89 | 16.93 | | |
| | 108 | 0.69 | | 90 | 22.20 | | |
| | 109 | 3.91 | | | | | |
| | 112 | 2.27 | | <i>Provisions—Pleasant Creek, Stawell (Series 1982-83)</i> | | | |
| | 115 | 1.95 | | 2/22(4) | 1 | 1.74 | 1.4.83 |
| | 125 | 0.37 | | | 3 | 1.31 | |
| | 126 | 4.09 | | | 13 | 18.05 | |
| | 132 | 11.19 | | | 14 | 9.21 | |
| | 133(b) | 1.03 | | | 15 | 1.09 | |
| | 162 | 13.51 | | | 23 | 3.01 | |
| | 167 | 16.93 | | | 25 | 9.99 | |
| | | | | | 30 | 28.21 | |
| <i>Provisions—Castlemaine Gaol (Series 1982-83)</i> | | | | | 33 | 25.05 | |
| 2/10(4) | 1 | 1.74 | 1.4.83 | | 34 | 23.56 | |
| | 9 | 18.05 | | | 35 | 23.56 | |
| | 10 | 9.21 | | | 36 | 18.85 | |
| | 11 | 10.91 | | | 37 | 23.56 | |
| | 13 | 8.89 | | | 38 | 18.12 | |
| | 14 | 1.09 | | | 39 | 16.99 | |
| | 18 | 4.28 | | | 40 | 16.99 | |
| | 32 | 3.14 | | | 42 | 36.94 | |
| | 33 | 3.93 | | | 52 | 1.95 | |
| | 42 | 2.50 | | | 56 | 3.51 | |
| | 46 | 3.91 | | | 57 | 4.09 | |
| | 48 | 1.95 | | | 66 | 13.51 | |
| | 53 | 3.51 | | | 67 | 16.93 | |
| | 58 | 5.38 | | <i>Provisions—Traralgon (Series 1982-83)</i> | | | |
| | 73 | 13.51 | | 2/24(4) | 10 | 20.57 | 23.3.83 |
| | 75 | 16.93 | | | 11 | 22.26 | |
| <i>Provisions—Colac Training Centre (Series 1982-83)</i> | | | | | 18 | 5.06 | |
| 2/11(4) | 1 | 1.74 | 1.4.83 | | 19 | 6.61 | |
| | 7 | 1.31 | | | 24 | 1.67 | |
| | 11 | 18.05 | | | 27 | 4.55 | |
| | 13 | 8.89 | | | 32 | 1.45 | |
| | 14 | 1.09 | | | 37 | 3.45 | |
| | 19 | 20.39 | | | 43 | 5.04 | |
| | 26 | 1.81 | | | 44 | 3.43 | |
| | 32 | 23.24 | | | 51 | 3.00 (Marmalade) | |
| | 34 | 25.48 | | | | 3.12 (Plum) | |
| | 35 | 28.21 | | | | 4.04 (Rasp./Straw.) | |
| | 37 | 25.05 | | | 56 | 12.90 | |
| | 38 | 23.56 | | | 67 | 4.75 | |
| | 39 | 23.56 | | | 71 | 15.84 | |
| | 40 | 18.85 | | | 72 | 15.73 | |
| | 41 | 23.56 | | | | | |
| | 43 | 36.94 | | | | | |
| | 44 | 22.25 | | | | | |
| | 51 | 2.50 | | | | | |
| | 53 | 2.77 (Apricot/Plum) | | | | | |
| | | 2.67 (Marmalade) | | | | | |
| | | 3.60 (Rasp./Straw.) | | | | | |
| | 56 | 3.91 | | | | | |
| | 62 | 0.37 | | | | | |
| | 63 | 4.09 | | | | | |
| | 65 | 1.03 | | | | | |
| | 74 | 13.51 | | | | | |
| | 75 | 16.93 | | | | | |
| <i>Provisions—Langi Kal Kal (Series 1982-83)</i> | | | | | | | |
| 2/15(4) | 8 | 2.73 | 1.4.83 | | | | |
| | 9 | 20.78 | | | | | |
| | 11 | 0.81 | | | | | |
| | 12 | 1.11 | | | | | |
| | 18 | 17.11 | | | | | |
| | 20 | 14.27 | | | | | |
| | 27 | 25.05 | | | | | |
| | 28 | 23.56 | | | | | |
| | 29 | 23.56 | | | | | |
| | 30 | 23.56 | | | | | |
| | 32 | 23.56 | | | | | |
| | 34 | 36.94 | | | | | |
| | 38 | 2.50 | | | | | |
| | 50 | 21.07 | | | | | |
| | 56 | 0.37 | | | | | |
| | 57 | 4.09 | | | | | |
| | 58 | 7.96 | | | | | |
| | 62 | 11.19 | | | | | |

J. M. PAWSON, Secretary to the Tender Board

CONTRACTS ACCEPTED — (SERIES PUBLIC WORKS)

His Excellency the Governor of the State of Victoria by and with the advice of the Executive Council thereof has by Order made on 7 April 1983 approved of the acceptance by the Minister of Public Works of the under-mentioned offers without public tenders being invited, viz.:

| | |
|--|--------------|
| Offers at the amounts shown for professional services at Glen Waverley Police Training Academy—109743-2. | |
| R. S. DEMAINE, RUSSELL, TRUNDLE, ARM-STRONG & ORTON (Architectural) | \$120 000.00 |
| STEVAN TEODOROVIC & ASSOCIATES (Mechanical & Electrical) | \$17 500.00 |
| OVE ARUP & PARTNERS (Structural) | \$45 000.00 |
| RIDER HUNT & PARTNERS (Quantity Surveyors) | \$75 000.00 |

Offers at the amounts shown for professional services at Bendigo Police Station—PN.44771,16
 KEITH REID & JOHN READ
 (Architectural) \$60 000.00
 CROOKS MICHELL PEACOCK STEWART PTY. LTD.
 (Electrical Mechanical Hydraulics & Civil Engineering) \$23 000.00
 W. P. BROWN & PARTNERS PTY. LTD.
 (Structural Engineering) \$28 000.00
 R. J. NAGEL & ASSOCIATES
 (Quantity Surveying) \$39 000.00

TOM FORRISTAL
 Clerk of the Executive Council

At the Executive Council Chamber
 Melbourne, 7 April 1983

Police Offences Act 1958, No. 6337
 DIVISION 1A—STATE CLASSIFICATION OF
 PUBLICATIONS BOARD

Take note that the State Classification of Publications Board has classified the following publications in accordance with the provisions of Section 180H (1) of the Police Offences Act 1958.

Each publication shall be subject to the following restrictions:

- It shall not be offered for sale, sold or delivered to any person under the age of 18 years;
- It shall not be made available for inspection or perusal by any person under the age of 18 years.

Schedule of Publications

| Title | Distributor |
|-----------------------------------|---------------------|
| The Best of Men Only, No. 10 | Gordon & Gotch Ltd. |
| Club International, Vol. 12 No. 4 | Gordon & Gotch Ltd. |
| Hustler Sex Play, April 1983 | Gordon & Gotch Ltd. |
| Mandate, March 1983 | Gordon & Gotch Ltd. |
| Sexology Today, April 1983 | Gordon & Gotch Ltd. |

J. ROGERSON, Secretary
 State Classification of Publications Board

Police Offences Act 1958, No. 6337
 DIVISION 1A—STATE CLASSIFICATION OF
 PUBLICATIONS BOARD

Take note that the State Classification of Publications Board has classified the following publications in accordance with the provisions of Section 180H (1) of the Police Offences Act 1958.

Each publication shall be subject to the following restrictions:

- It shall not be offered for sale, sold or delivered to any person under the age of 18 years;
- It shall not be made available for inspection or perusal by any person under the age of 18 years;
- It shall not be exhibited or displayed in any place to which persons under the age of 18 years have access or so that it is visible from any such place.

Schedule of Publications

| Title | Distributor |
|---------------------------------|--|
| Aggressive Women, Vol. 4 No. 11 | Claredale Holdings Pty. Ltd. |
| Barbara | Claredale Holdings Pty. Ltd. |
| Beloved Bonds | Claredale Holdings Pty. Ltd. |
| Bondage From Europe | Claredale Holdings Pty. Ltd. |
| Dominatrix Domain, No. 16 | Claredale Holdings Pty. Ltd. |
| Enslave, Vol. 2 No. 1 | Claredale Holdings Pty. Ltd. |
| Gentleman's Pleasure, No. 2 | Media Distributors of Victoria Pty. Ltd. |
| Hogtie | Claredale Holdings Pty. Ltd. |
| Human Digest, May 1983 | Gordon & Gotch Ltd. |
| Latent Image, Vol. 5 No. 11 | Claredale Holdings Pty. Ltd. |
| The Seigneury, Vol. 2 | Claredale Holdings Pty. Ltd. |
| Sharon | Claredale Holdings Pty. Ltd. |
| She-Fights! Vol. 1 No. 7 | Claredale Holdings Pty. Ltd. |
| Stalked! Vol. 1 No. 5 | Claredale Holdings Pty. Ltd. |
| Then and Now, Vol. 1 No. 1 | Claredale Holdings Pty. Ltd. |

J. ROGERSON, Secretary
 State Classification of Publications Board

Police Offences Act 1958, No. 6337
 DIVISION 1A—STATE CLASSIFICATION OF
 PUBLICATIONS BOARD

Take note that the State Classification of Publications Board has classified the following publications in accordance with the provisions of Section 180H (1) of the Police Offences Act 1958.

Each publication shall be subject to the following restrictions:

- It shall not be offered for sale, sold or delivered to any person under the age of 18 years;
- It shall not be made available for inspection or perusal by any person under the age of 18 years;
- It shall not be exhibited or displayed in any place to which persons under the age of 18 years have access or so that it is visible from any such place;
- It shall not be advertised in any manner whatsoever.

Schedule of Publications

| Title | Distributor |
|------------------------------|------------------------------|
| Bondage Cinema, Vol. 1 No. 7 | Claredale Holdings Pty. Ltd. |
| Breast Bondage, Vol. 1 No. 5 | Claredale Holdings Pty. Ltd. |
| Captured! Vol. 2, No. 1 | Claredale Holdings Pty. Ltd. |
| Kidnaped! Vol. 1 No. 9 | Claredale Holdings Pty. Ltd. |

J. ROGERSON, Secretary
 State Classification of Publications Board

Public Records Act 1973
 DECLARATION OF RECORDS NOT AVAILABLE FOR
 PUBLIC INSPECTION

Whereas section 10 (1) of the *Public Records Act 1973* provides, inter alia, that—"The Minister by notice in the Government Gazette may—(a) declare that any specified records or records of any specified class shall not be available for public inspection for a period of five years after the date of their transfer to the Public Record Office";

I, John Hamilton Simpson, Minister for Property and Services, do now by this notice declare the records listed on the Schedule shall not be available for public inspection for a period of five (5) years after the date of their transfer to the Public Record Office.

Schedule

| Series No. | Description of Records | Date of Transfer |
|------------|---|------------------|
| 2327 | Department of Crown Lands and Survey—Surveyor's Plans and Fieldnotes: Microfilm Security Copies | 24/3/1983 |

JACK SIMPSON, M.P.
 Minister for Property and Services

Community Welfare Services Act 1970
 DECLARATION OF AN INSTITUTION AS AN APPROVED
 CHILDREN'S HOME

In pursuance of the powers conferred by Section 29 (1) (b) of the *Community Welfare Services Act 1970*, I do hereby declare the premises at 143 Patterson Road, Moorabbin, operated by The Victorian Deaf/Blind and Rubella Children's Association, as an Approved Children's Home for the purpose of the said Act.
 30 March 1983

PAULINE TONER
 Minister

LICENCE DECLARED TO BE FORFEITED

His Excellency the Governor of the State of Victoria, by and with the advice of the Executive Council thereof, has declared to be forfeited the grazing licence issued pursuant to Section 130 of the *Land Act 1958* to L. B. Vail in respect of certain Crown land south-west of and adjoining Allotments 10H, 10J, and 10K, Section 4 in the Parish of Freeburgh for non-compliance with the conditions of the said licence—(808/130 Wangaratta).

TOM FORRISTAL
 Clerk of the Executive Council

At the Executive Council Chamber
 Melbourne, 7 April 1983

Private Agents Act 1966

NOTICE OF RECEIPT OF APPLICATIONS FOR LICENCES UNDER THE PROVISIONS OF THE PRIVATE AGENTS ACT 1966

The Clerk(s) of the Magistrates' Court(s) as listed hereunder hereby give notice that applications, as under, have been lodged for hearing by the said Court(s) on the date(s) specified.

Any person desiring to object to any of such applications must—

- (a) lodge with the respective Clerk of the Magistrates' Court a notice in the prescribed form of his objection and of the grounds thereof;
- (b) cause a copy of such notice to be served personally or by post upon the applicant at least three days before the hearing of the application; and
- (c) send or deliver—
 - (i) where the objection is not made by the officer in charge of the police district in which the Court is situated—a copy of the notice to such officer; and
 - (ii) where the objection is not made by the Registrar or Deputy Registrar—a copy to the Registrar.

| <i>Full Name of Applicant*</i> | <i>Place of Abode of Applicant or Nominee</i> | <i>Name of Firm or Corporation</i> | <i>Address for Registration</i> | <i>Type of Licence</i> | <i>Date of Hearing</i> |
|---|---|---|---------------------------------|------------------------|------------------------|
| MAGISTRATES' COURT, BENDIGO | | | | | |
| Cousins, Denis Mervyn | Lot 8, Howard St, Epsom | Bendigo Investments Ltd. | Abel St, Bendigo | Watchman | 22.4.83 |
| Dated at Bendigo 31 March 1983 R. N. HOLLIS, Clerk of the Magistrates' Court | | | | | |
| MAGISTRATES' COURT, PRAHRAN | | | | | |
| Whitehead, Anthony John | 1 Mackie Rd, Mulgrave | Mayne Nickless Ltd. | 390 St. Kilda Rd, Melbourne | Watchman | 29.4.83 |
| Dated at Prahran 31 March 1983 V. J. ARDLIE, Clerk of the Magistrates' Court | | | | | |
| MAGISTRATES' COURT, BALLARAT | | | | | |
| Young, Maxwell David | 202 Barkly St, Ballarat | Ray Goldings Ballarat Security Services | 423 Cobden St, Ballarat | Watchman | 21.4.83 |
| Dated at Ballarat 30 March 1983 D. CROFT, Clerk of the Magistrates' Court | | | | | |
| MAGISTRATES' COURT, MORWELL | | | | | |
| Van Der Veen, Tamme | 66 Duke St, Rosedale | | Lot 2, Toners Lane, Morwell | Watchman | 29.4.83 |
| Dated at Morwell 28 March 1983 R. R. BOURKE, Clerk of the Magistrates' Court | | | | | |
| MAGISTRATES' COURT, GEELONG | | | | | |
| Knox, Diane Marie | 14 Cornish Ave, Belmont | | 390 St. Kilda Rd, Melbourne | Watchman | 2.5.83 |
| Dated at Geelong 28 March 1983 A. R. DUNLOP, Clerk of the Magistrates' Court | | | | | |
| MAGISTRATES' COURT, SPRINGVALE | | | | | |
| Palmer, Colin Leon | 48 Elsie St, Boronia | Maioir Lisa Pty Ltd, (trading as) Security Group Industries | 18 Balmoral Ave, Springvale | Watchman | 29.4.83 |
| Dated at Springvale 29 March 1983 G. K. EBERT, Clerk of the Magistrates' Court | | | | | |
| MAGISTRATES' COURT, BENDIGO | | | | | |
| Stone, Anthony William | 11 Battery St, Long Gully | Philip Norman Woods | 13 Battery St, Long Gully | Watchman | 18.4.83 |
| Dated at Bendigo 28 March 1983 R. N. HOLLIS, Clerk of the Magistrates' Court | | | | | |
| MAGISTRATES' COURT, SPRINGVALE | | | | | |
| Palmer, Colin Leon | 48 Elsie St, Boronia | Maioir Lisa Pty Ltd, (trading as) Security Group Industries | 18 Balmoral Ave, Springvale | Watchman | 29.4.83 |
| Dated at Springvale 29 March 1983 G. K. EBERT, Clerk of the Magistrates' Court | | | | | |

* Or in the case of a firm or corporation, of the Nominee

PRIVATE AGENTS—continued

| Full Name of Applicant* | Place of Abode of Applicant or Nominee | Name of Firm or Corporation | Address for Registration | Type of Licence | Date of Hearing |
|---|--|-------------------------------|-------------------------------------|----------------------------|-----------------|
| MAGISTRATES' COURT, SOUTH MELBOURNE | | | | | |
| Towner, Leslie Wayne | 52 Stanley St, Glenroy | Security Protection Pty Ltd | 165 Moray St, Sth Melbourne | Watchman | 31.5.83 |
| Jones, Ronald | 3 Parnell Cres, Tullamarine | " " | " " | " | " |
| Hutton, David John | 843 Calder Hwy, Keilor | " " | " " | " | " |
| Dated at South Melbourne 29 March 1983 R. J. McHUGH, Clerk of the Magistrates' Court | | | | | |
| MAGISTRATES' COURT, FITZROY | | | | | |
| Dingovski, Dragan | 141/90 Brunswick St, Fitzroy | | 141/90 Brunswick St, Fitzroy | Process Server, Individual | 18.4.83 |
| " " | " " | | " " | Guard Agent, Individual | " |
| " " | " " | | " " | Inquiry Agent, Individual | " |
| Dated at Fitzroy 28 March 1983 G. A. SHARKEY, Clerk of the Magistrates' Court | | | | | |
| MAGISTRATES' COURT, SUNSHINE | | | | | |
| Obrenovic, Stepan | 12 Maxweld St, Ardeer | | 12 Maxweld St, Ardeer | Watchman | 27.4.83 |
| Dated at Sunshine 28 March 1983 J. ISAACS, Clerk of the Magistrates' Court | | | | | |
| MAGISTRATES' COURT, PORT MELBOURNE | | | | | |
| Allan, Stephen J. | 4/579 Dandenong Rd, Armadale | Armaguard | 633 Queensberry St, North Melbourne | Watchman | 14.4.83 |
| Dated at Port Melbourne 24 March 1983 S. BRYANT, Clerk of the Magistrates' Court | | | | | |
| MAGISTRATES' COURT, SPRINGVALE | | | | | |
| Mort, Anthony Edward | 28 Redfern Cres, Mulgrave | Force One Security | 28 Redfern Cres, Mulgrave | Guard Agent Firm | 29.4.83 |
| Dated at Springvale 28 March 1983 G. EBERT, Clerk of the Magistrates' Court | | | | | |
| MAGISTRATES' COURT, CAMBERWELL | | | | | |
| Klemm, Jeffrey Michael | 19 Primrose Cres, East Brighton | J. R. N. Investments Pty Ltd. | 1214 Toorak Rd, Hartwell | Watchman | 29.4.83 |
| Dated at Camberwell 31 March 1983 P. M. PATTISON, Clerk of the Magistrates' Court | | | | | |
| MAGISTRATES' COURT, FITZROY | | | | | |
| Syleman, Gyrkay | 102/12 Holland Crt, Flemington | Roden Security Services | 136 Johnston St, Fitzroy | Watchman | 2.5.83 |
| Sovil, Joe | 75/90 Brunswick St, Fitzroy | " " | " " | " | " |
| Dated at Fitzroy 29 March 1983 G. A. SHARKEY, Clerk of the Magistrates' Court | | | | | |
| MAGISTRATES' COURT, MARYBOROUGH | | | | | |
| Haddon, John Leonard | 174 Railway St, Maryborough | " " | 174 Railway St, Maryborough | Guard Agent | 28.4.83 |
| Dated at Maryborough 28 March 1983 R. A. ISON, Clerk of the Magistrates' Court | | | | | |
| MAGISTRATES' COURT, CRANBOURNE | | | | | |
| Mair, Robert James | 18 Mountain Gate Dve, Ferntree Gully | | 14 Robjant St, Hampton Park | Watchman | 20.4.83 |
| Dated at Cranbourne 30 March 1983 B. M. FOGARTY, Clerk of the Magistrates' Court | | | | | |

* Or in the case of a firm or corporation, of the Nominee

PRIVATE AGENTS—continued

| Full Name of Applicant* | Place of Abode of Applicant or Nominee | Name of Firm or Corporation | Address for Registration | Type of Licence | Date of Hearing |
|---|--|-----------------------------|----------------------------------|------------------------|-----------------|
| MAGISTRATES' COURT, SPRINGVALE | | | | | |
| Henderson, Robert Stephen | 9 Chloris Cres, Sth Caulfield | | 173 Springvale Rd, Springvale | Watchman | 29.4.83 |
| Bol, Adrian Hearicus Johannes | 1/54 Elowera Rd, No- ble Park | | 23 Buckley St, Noble Park | Process Server | " |
| " " | " " | | " " | Inquiry Agent | " |
| " " | " " | | " " | Commercial S/ Agent | " |
| Dated at Springvale 30 March 1983 G. K. EBERT, Clerk of the Magistrates' Court | | | | | |
| MAGISTRATES' COURT, FOOTSCRAY | | | | | |
| Reid, Andrew John | 3/14 Minogue Cres, Hoppers Crossing | | 121 Droop St, Footscray | Inquiry Agent | 20.4.83 |
| Bryce, Henry John | 25 Alexander St, Footscray | | 25 Alexander St, Footscray | Inquiry Agent | 19.4.83 |
| " " | " " | | " " | Guard Agent | " |
| Dated at Footscray 31 March 1983 G. WILLIAMSON, Clerk of the Magistrates' Court | | | | | |
| MAGISTRATES' COURT, WARRNAMBOOL | | | | | |
| Young, Roland George | 24 Examiner Cres, Warrnambool | | Wangoom Rd, Wangoom | Watchman | 19.4.83 |
| Dated at Warrnambool 29 March 1983 P. LIVINGSTONE, Clerk of the Magistrates' Court | | | | | |
| MAGISTRATES' COURT, FITZROY | | | | | |
| Smit, John David | 2 Edith Crt, Dande- nong | | 136 Johnston St, Fitzroy | Watchman | 2.5.83 |
| Dated at Fitzroy 30 March 1983 G. A. SHARKEY, Clerk of the Magistrates' Court | | | | | |
| MAGISTRATES' COURT, SUNSHINE | | | | | |
| Aquilina, Peter Jack | 131 Hertford Rd, Sunshine | | 131 Hertford Rd, Sunshine | Process Server | 27.4.83 |
| " " | " " | | " " | Inquiry Agent | " |
| Mason, Geoffrey Francis | Lot 11 Harpers Rd, Woodend | | 2 McDonald Rd, Brooklyn | Watchman | " |
| Dated at Sunshine 31 March 1983 J. ISAACS, Clerk of the Magistrates' Court | | | | | |
| MAGISTRATES' COURT, COBURG | | | | | |
| Hopkins, Maxwell | 47 Liston Ave, Keon Park | Armaguard (Coburg) | Bakers Rd, Nth Coburg | Watchman | 26.4.83 |
| Dated at Coburg 30 March 1983 P. WENDEN, Clerk of the Magistrates' Court | | | | | |
| MAGISTRATES' COURT, DANDENONG | | | | | |
| Blumfield, Keith Leonard | 1/5 Sutherland Rd, Dandenong | Paraguard Security | 1/5 Sutherland Rd, Dandenong | Guard Agent | 22.4.83 |
| " " | " " | " " | " " | Inquiry Agent | " |
| Dated at Dandenong 29 March 1983 D. J. GEAR, Clerk of the Magistrates' Court | | | | | |
| MAGISTRATES' COURT, CAMPERDOWN | | | | | |
| Lucas, Allan George | Princes Hwy, Terang | | Princes Hwy, Terang | Watchman | 28.4.83 |
| Dated at Camperdown 29 March 1983 R. HAMMETT, Clerk of the Magistrates' Court | | | | | |

* Or in the case of a firm or corporation, of the Nominee

Police Regulation Act 1958
VICTORIA POLICE FORCE

Determination No. 385 of the Police Service Board

The Police Service Board, in pursuance of the powers in that behalf conferred by the *Police Regulation Act 1958*, hereby makes the following Determination (that is to say):

1. The Determination No. 179 of the Police Service Board of 14 December 1971, and published in the *Government Gazette* of 25 January 1972, as amended, is hereby further amended as follows:

1.1 In sub-paragraph 12 (f)(i) by deleting the expression "Senior Sergeant Policewoman in Charge, Police Women Russell Street \$1.65" and substituting therefore the following new expression "Senior Sergeant in Charge Community Policing Squad \$1.37".

2. Having considered the opinion of the Police Service Board delivered to me pursuant to Section 69 (2AD) of the *Police Regulation Act 1958* that the amendment made in the sub-paragraph of this Determination 385 shown in Column (1) hereunder to the reference to and paragraph of Determination 179 shown in Column (2) should have effect from 1 February, 1982.

| (1) Determination 385 | (2) Determination 179 | (3) Date of Operation |
|--------------------------|--------------------------|--------------------------|
| Sub-paragraph — 1.1 | Paragraph — 12 (f)(i) | 1.2.82 |

Now I, pursuant to Section 69 (2AE) of the said Act, hereby authorize the Police Service Board to make the said paragraph as amended effective on and from the date respectively set out in the Column (3) above.

Dated 22nd March 1983.

RACE MATHEWS
 Minister for Police and Emergency Services

3. Pursuant to the authority now vested in the Police Service Board by the Minister for Police and Emergency Services, as endorsed above the Board who determines that the amendment made in the sub-paragraph of this Determination shown in Column (1) to the reference to and paragraph of Determination 179 shown in Column (2) shall come into operation on and from the date shown, respectively, in Column (3) as follows:

| (1) Determination 385 | (2) Determination 179 | (3) Date of Operation |
|--------------------------|--------------------------|--------------------------|
| Sub-paragraph — 1.1 | Paragraph — 12 (f)(i) | 1.2.82 |

Dated 22 March, 1983.

T. B. SHILLITO
 A Judge of the County Court of Victoria,
 Chairman and Member of the Police Service Board
G. DAVIDSON
 Member of the Police Service Board
F. J. LESLIE
 Member of the Police Service Board

Police Regulation Act 1958
VICTORIA POLICE FORCE

Determination No. 384 of the Police Service Board

The Police Service Board, in pursuance of the powers in that behalf conferred by the *Police Regulation Act 1958*, hereby makes the following Determination (that is to say):

1. The Determination No. 179 of the Police Service Board of 14 December 1971, and published in the *Government Gazette* of 25 January 1972, as amended, is hereby further amended as follows:

1.1 By deleting sub-paragraph 11 (e) and substituting therefore the following new sub-paragraph:—

“(e) *Communications District*

There shall be paid to a member while holding the rank and position specified in the first column hereunder, an allowance at the rate set forth in the second column hereunder:—

| First Column Rank or Position | Second Column Daily Allowance \$ |
|--|--|
| Chief Superintendent in Charge | 2.79 |
| Chief Inspector — Deputy to the Chief Superintendent | 2.72 |
| Chief Inspector — Operations | 2.72” |

1.2 In sub-paragraph 13 (b) by deleting the expressions “Superintendent in Charge \$2.63” and “Chief Inspector — Deputy to Superintendent \$2.63” and substituting therefore the following new expressions “Chief Superintendent in Charge \$2.63” and “Chief Inspector — Deputy to the Chief Superintendent \$2.63”.

1.3 In sub-paragraph 14 (c)(v) by inserting immediately after the expression “Chief Inspector in Charge \$2.72” the following new expression “Inspector \$2.63”.

2. This Determination shall come into operation on and from 20 March, 1983.

Dated 15 March 1983.

T. B. SHILLITO
A Judge of the County Court of Victoria,
Chairman and Member of the Police Service Board

G. DAVIDSON
Member of the Police Service Board

F. J. LESLIE
Member of the Police Service Board

Nurses Act 1958

Notice is hereby given, in pursuance of the *Nurses Act 1958*, and Regulations thereunder, that an election will be held on 19 August 1983 for the appointment as members of the Victorian Nursing Council of—

- six registered general nurses;
- two State enrolled nurses;
- one registered midwife;
- one registered psychiatric nurse or mental retardation nurse; and
- one mothercraft nurse.

Persons nominated for election must hold the appropriate current annual practising certificate.

The Returning Officer appointed for such election is Joseph Anthony Busuttill.

Nominations, for which forms may be obtained from the Returning Officer, must be lodged with the Returning Officer by 12 noon on 30 June 1983.

Written requests to the Returning Officer for nomination forms should be directed to:—

P.O. Box 4932,
Central Mail Exchange 3001
or alternatively may be obtained from his office on the
13th Floor,
555 Collins Street,
Melbourne.

TOM ROPER
Minister of Health

Police Regulation Act Section 122
SALE OF UNCLAIMED MOTOR CYCLE

An owner is required for a green Suzuki Motor Cycle, former Registration No. HK 142.

The vehicle came into possession of Police late in 1977, and if not claimed, will be sold by public auction at the Police Complex, 119-123 Wellington Street, Collingwood, 3066 on Tuesday 26 April 1983 at 10.00 a.m.

J. R. HALL
Acting Chief Commissioner of Police

STOCK DISEASES ACT 1968

In pursuance of section 32 (1) of the *Stock Diseases Act 1968* the name and address of owners of properties, together with the name and location of properties within the footrot control area which are at present under quarantine restrictions because of footrot, are listed below.

| Name | Address | Farm Location |
|---|--------------------------------------|---------------------|
| Bramall, W. L. | "Yering", Digby | Digby Dartmoor Road |
| Cameron, J. & E. & J. | Toolondo | Toolondo |
| Collie, E. J. | Box 38, Dartmoor | Dartmoor |
| Degaris, S. A. | Wallacedale | Wallacedale |
| Dyson, S. R. (Estate of) | P.O. Dartmoor | Digby Dartmoor Road |
| Guthrie & Williams | Chetwyn | Chetwyn |
| Kobo Investments P/L | Box 798, Portland | Portland |
| Lewis, D. L. & J. L. | Dunkeld Road, Cavendish | Woohipooper |
| Loats Family Farm | RSD 208, Hamilton | Yulecart |
| Loats, N. J., A. J. & R. E. & Executors of O. G. & B. A. Loats | RSD 208, Hamilton | Yulecart |
| Longbottom, C. N. | Langkoop | Langkoop |
| Nossack, R. | P.O. Box 68, Nhill | Kinamakataka |
| Patzel, I. | "Bamboa", Strathdownie | Strathdownie |
| Pettingill & Higgs | "Palpara 9B", Box 22, Mt. Gambier | Palpara |
| Russell, I. M. & J. M. | "Carmona", Balmoral | Balmoral |
| Russell, J. B. & G. E. | RMB 5434, Horsham | Nurrabiel |
| Tobin & Healy | 54 Valda Avenue, North Box Hill | Tahara |
| Tuloona Pastoral Services | Harrow | Harrow |

The following is a list of those properties within the footrot control area which have been released or recommended to be released from quarantine or restriction since 1 December 1982.

| Name | Address | Farm Location |
|-------------------------------------|-----------------------------|------------------|
| Beaton, N. D. | Gritjurk via Coleraine | Gritjurk |
| Dixon, K. J. | Mt. Napier via Penshurst | Mt. Napier |
| Frost, I. M. & A. D. | RSD Condah | Wallacedale |
| Hartwich, L. H. & S. | RSD 401, Hamilton | Hamilton |
| Hartwich, R. L. & N. V. | RSD 401, Hamilton | Hamilton |
| Howell, B. J. | Valley Road, Dunkeld | Dunkeld |
| Jolliffe, S. J. & T. W. (Estate of) | Box 93, Merino | Merino |
| Lewis, D. L. & J. L. | Dunkeld Road, Cavendish | Karabeal |
| Rothwell & Sons | RMB 5432, Horsham | Nurrabiel |
| Shoebidge, E. B. | Box 17, Merino | Tahara |
| Stevens, H. A. & M. | "Yangoora", Balmoral | Balmoral |
| Weckert, Est. H. W. | Box 78, Apsley | Mundarra |
| Woods, M. C. & M. J. | Mt. Napier via Penshurst | Mt. Napier |
| Wurst, S. P. & D. J. | Apsley | Bringalbert Road |

Dated 1 March 1983

D. E. KENT, Minister of Agriculture

**BOORT WATERWORKS TRUST
FIXING THE LIMIT OF BANK OVERDRAFT**

His Excellency the Governor of the State of Victoria by and with the advice of the Executive Council thereof has by Order made on 7 April 1983, fixed the total amount of the sums which the Boort Waterworks Trust may owe at any one time in respect of moneys borrowed by overdraft of current account pursuant to the provisions of Section 286 of the *Water Act 1958*, at Forty Five Thousand dollars (\$45 000).

TOM FORRISTAL
Clerk of the Executive Council

At the Executive Council Chamber
Melbourne, 7 April 1983

**BROADFORD SEWERAGE AUTHORITY
Fixing the Limit of Bank Overdraft**

His Excellency the Governor of the State of Victoria by and with the advice of the Executive Council thereof has by Order made on 7 April 1983 fixed the total amount of the sums which the Broadford Sewerage Authority may owe at any one time in respect of moneys borrowed by overdraft of current account pursuant to the provisions of Section 79A of *Sewerage Districts Act 1958*, at Seventy thousand dollars (\$70 000).

TOM FORRISTAL
Clerk of the Executive Council

At the Executive Council Chamber
Melbourne, 7 April 1983

**SHIRE OF MANSFIELD SEWERAGE AUTHORITY
Rating By-Law 1983**

The Shire of Mansfield Sewerage Authority pursuant to and in exercise of the power and authorities conferred on it by the *Sewerage Districts Act*, and of any and every other power of Authority in any wise enabling it in that behalf doth hereby make and prescribe the following By-Law, that is to say:—

(1) The Authority makes and levies a rate in respect of all lands and tenements with the Shire of Mansfield Sewerage District of six cents in the dollar on the Net Annual Valuation set out in the valuation at present in force of such lands and tenements for the purpose of the Municipal Rate of the Shire of Mansfield which is hereby adopted as the Valuation of such lands and tenements respectively.

(2) Such rate shall be made and levied upon the occupiers and owners of such lands and tenements for the year commencing on 1 January 1983, and shall be payable on 1 March 1983 at the office of the said Authority.

(3) In no case shall the amount of the rate payable in respect of any tenements (other than land on which there is no dwelling) be less than one hundred dollars (\$100.00).

(4) In no case shall the amount of the rate payable in respect of any land on which there is no dwelling be less than ninety dollars (\$90.00).

This By-Law was made and passed by the Shire of Mansfield Sewerage Authority on 23 February 1983 and confirmed on 9 March 1983.

G. D. PAYNE, Secretary
B. P. CUMMINS, Chairman
H. A. NIX, Member

Approved 31 March 1983—D. R. WHITE, Minister of Water Supply.

Local Government Act 1958

NOTICE OF CONFIRMATION OF AN ORDER OF THE COUNCIL OF THE SHIRE OF BELLARINE ADOPTING A PROPOSAL FOR THE CLOSURE OF STREETS TO THROUGH TRAFFIC

Pursuant to the provisions of section 539C of the *Local Government Act 1958*, the Governor in Council, on 7 April 1983 confirmed an order of the Council of the Shire of Bellarine made on 22 April 1982 adopting a proposal for the closure of Clifton Street and Clear-water Drive, Clifton Springs to through traffic by the erection of barriers at the locations shown on the plan hereunder.

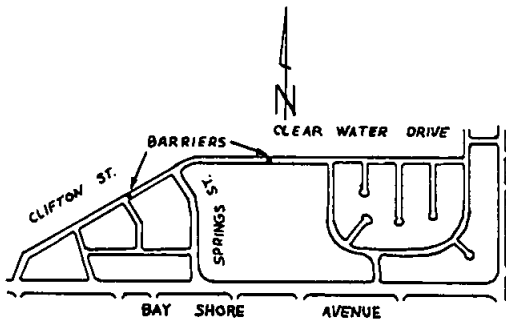

TOM FORRISTAL
Clerk of the Executive Council

Local Government Department
Melbourne (82/4554)

NOTICE TO MARINERS

[No. 12T of 1983]

AUSTRALIA—VICTORIA

Port of Corner Inlet and Port Albert
Approach Buoys Unlit, off Station

1. Corner Inlet Approach:
 - (a) No. 1 buoy (Lat. 38°51'·1"S., Long. 146°35'·7"E approx.) is reported unlit and 800 metres west of position.
 - (b) No. 5 buoy (Lat. 38°50'·6"S., Long. 146°33'·4"E approx.) is reported unlit.
 2. Port Albert:
 - Fairway buoy (Lat. 38°46'·5"S., Long. 146°42'·1"E approx.) is reported bearing 250° distance 800 metres from position.
- Further notice will issue.
Charts temporarily affected: AUS 801, AUS 357.

A. J. WAGGLEN
Port Officer

Public Works Department
Ports and Harbors Division
168 Exhibition Street
Melbourne 3000
30 March 1983

NOTICE TO MARINERS

[No. 13 of 1983]

AUSTRALIA—VICTORIA

Corner Inlet

1. Port Welshpool — Extension of Pier, alteration of pier light.
 2. Latrobe (Big Snake) Island — Establishment of Jetty and Jetty Light.
- Reference Position: Barry Point Light (Lat. 38°43'·0"S, Long. 146°23'·3"E approx.)

Details:—

1. Port Welshpool Shipping Pier:
 - (a) Former Notice No. 50T of 1981 refers and is cancelled. The pier has been extended 60 metres in a 254°35' direction.
 - (b) Former Notice No. 23T of 1982 refers and is cancelled. On or about 7 April 1983 the existing pier head light (Fl 6s) will be expunged and a new light, fixed red, will be established on the pier head bearing 078·6° distance 5200 metres (2.81 miles) from reference position.
2. Latrobe (Big Snake) Island:

A Jetty has been established on the North West corner of the Island bearing 094·6° distance 9876 metres (5·33 miles) from reference position. The jetty projects in a 312° direction and is 51 metres in length. On or about 7 April 1983 a light, flashing white every 10 seconds, will be established on the jetty head.

Elevation: 1(b): 10 metres; 2: 5 metres.

Visibility: 1(b): 3 miles; 2: 2 miles.

Abridged Description: 1(b): F.R. 10m 3M; 2: Fl. 10s 5m 2M.

Publication Affected: Sailing Directions, Victoria 1970, pages 458, 462 and 665.

A. J. WAGGLEN
Port Officer

Public Works Department
Ports and Harbors Division
168 Exhibition Street
Melbourne 3000
31 March, 1983

NOTICE TO MARINERS

[No. 14 of 1983]

AUSTRALIA—VICTORIA

Port Phillip

Removal of Mussel Culture Rafts

Former Notice: No. 21T of 1982 is cancelled.
Mussel culture rafts referred to in the above notice have been removed.

A. J. WAGGLEN
Port Officer

Public Works Department
Ports and Harbors Division
168 Exhibition Street
Melbourne 3000
31 March, 1983

Local Government Act 1958

NOTICE OF CONFIRMATION OF AN ORDER OF THE COUNCIL OF THE CITY OF SPRINGVALE ADOPTING A PROPOSAL FOR THE CLOSURE OF RACECOURSE ROAD, NOBLE PARK TO THROUGH TRAFFIC

Pursuant to the provisions of section 539C of the *Local Government Act 1958*, the Governor in Council, on 7 April 1983 confirmed an order of the Council of the City of Springvale made on 20 December 1982 adopting a proposal for the closure of Racecourse Road north of Ambrie Crescent, Noble Park to through traffic by the erection of a barrier at the location shown on the plan hereunder.

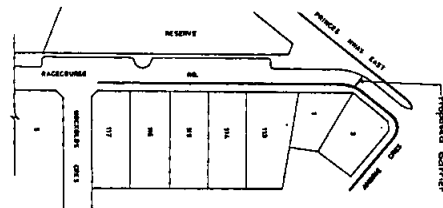
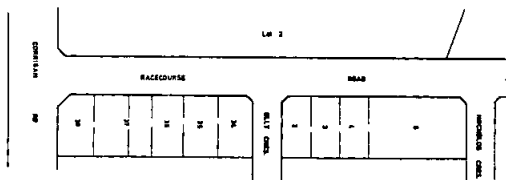

TOM FORRISTAL
Clerk of the Executive Council

Local Government Department
Melbourne (82/5910)

Transport Regulation Act
TRANSPORT REGULATION BOARD
 Hearing of Applications

Notice is hereby given that the following applications will be considered by the Transport Regulation Board on 26 April 1983.

ABB Printing Pty. Ltd., Melbourne — Application for two Special Purpose Vehicle licences in respect of a 1952 Jaguar sedan and a 1956 Jaguar sedan, each with a seating capacity for 4 persons, to operate from 121 Flinders Lane, Melbourne for the carriage of passengers for wedding parties.

Bransgrove C. F., Wangaratta — Application for variation of the conditions of licence TO 167, which authorises various tours from Euroa and Wangaratta to operate as follows:—

(a) delete tour No. 9 prescribed in the applicant's licence document and instead operate — Introduction to Nordic Skiing & Snow Camping Adventures. Depart Wangaratta Sunday afternoon for Mt. Beauty via Bright. Overnight at Cedar Lodge, Mt. Beauty for Sunday, Monday and Tuesday nights. Day trips to Falls Creek or Mt. Buffalo. Wednesday and Thursday nights to camp out on the Bogong High Plains beyond Falls Creek. Friday return to Cedar Lodge then to Wangaratta arriving at 8.00 p.m.

Note: (i) Vehicle to be stationed at Windy Corner, Falls Creek. (ii) Maximum group size — 9 persons.

(b) delete tours No. 1, 2 and 7 prescribed in the applicant's licence conditions document and instead operate the following day trips — (i) Horse Riding in Kelly Country. Depart Wangaratta for Boweya via Glenrowan. If group from Melbourne, pick up from Glenrowan. Days ride around Boweya. Return to Wangaratta via Glenrowan. (ii) Brown Brothers, Bikes and Alternative Technology. A day's cycling with use of support vehicle. Route — Wangaratta to Milawa and Brown Brothers, then along Snow Road to Oxley and return to Wangaratta via Oxley/Wangaratta Road. (iii) Rutherglen Wineries by Bicycle. A day's cycling with use of a support vehicle. Route — Rutherglen to St. Leonards on the Murray River via the Murray Valley Highway and the Corowa/Wangaratta Road. Drivers are ferried back to their cars at Rutherglen in the vehicle. (iv) Nordic Skiing for Novices. Depart Wangaratta for Mt. Buffalo via Porepunkah returning the same day. (v) Introduction to Bushwalking in the Strathbogies. Depart from Euroa Railway Station, via Strathbogies Road to Mt. Wombat Road. Leave walkers approximately 400 metres from Mt. Wombat summit returning to Polly McQuinns. Returning to Euroa via Merton/Euroa Road.

(c) Operate Weekend Tours. (i) Snow Shoeing Ascent of Mt. Bogong. Depart Wangaratta Saturday morning for Mountain Creek Road at Tawonga via Myrtleford. Return on Sunday afternoon. (ii) Snow Shoeing Ascent of Mt. Feathertop. Depart Wangaratta Saturday morning for Harriettville. Return on Sunday afternoon. (iii) Horse Riding along the Murray River. Commencing from Wangaratta, to Bruces Bend 6 km down stream on the Murray River from Yarrowonga. (iv) Horse Riding in Kelly Country. Commencing from Wangaratta to Boweya.

(d) Operate extended tours. (i) History and Huts of the High Plains. Depart Wangaratta for Mt. Hotham via Bright, Omeo, Falls Creek and Beechworth. Returning to Wangaratta — 4 days. (ii) Camping, Pubs and the Great Outdoors. Depart Wangaratta to explore the north east of Victoria, visit Mt. Buffalo National Park, Bright, Beechworth and Yackandandah and the valleys of the Lang, Ovens and Keiwa Rivers. Returning to Wangaratta — 4 days. (iii) Trekking on the Bogong High Plains. Depart Wangaratta to Falls Creek. Two nights accommodation at a lodge at Falls Creek and two nights camp out. Return to Wangaratta — 5 days. Fares: To be determined.

Eddebuttel J. B., Dandenong West — Application for one Special Purpose Vehicle licence in respect of a 1967 Mercedes Benz sedan with seating capacity for 4 persons, to operate from 78-80 Railway Parade, Dandenong West for the carriage of passengers for wedding parties and special promotion work.

Kollasets Pty. Ltd., Warburton — Application to licence one commercial passenger vehicle with seating capacity for 41 persons, to operate as follows:—

(a) For the carriage of school children between Woori Yallock and the Upper Yarra High-Technical School under temporary contract to the Education Department.

(b) Under charter conditions from within a 20 km pick-up radius of Warburton.

The vehicle to be licensed will hold a 1 star rating for charter purposes.

Nugent D. J. & J. E., Box Hill — Application to license one commercial passenger vehicle with seating capacity for 45 persons, to operate as a Metropolitan Special Service Omnibus.

Pilla I. & J. Bono, Cheltenham — Application to licence a required number of commercial passenger vehicles with large seating capacities, to operate as Metropolitan Stage Omnibuses between Hampton Railway Station and Southland Shopping Centre as follows:—

Route: Depart Hampton Railway Station via Willis Lane, Willis Street, Hampton Street, Ludstone Street, Bluff Road, Wickham Road, Spring Road, Carrington Street, Keiller Street, Henrietta Street, Exley Road, Spring Road, Wickham Road and Nepean Highway to Southland Shopping Centre. Returning via the reverse of the above route.

Timetable: Monday to Thursday, 6.16 a.m. to 8.05 p.m. — 20 minute frequency. Friday, 6.15 a.m. to 9.35 p.m. — 20 to 30 minute frequency. Saturdays, 6.35 a.m. to 8.00 p.m. — 15 to 30 minute frequency.

Sections and Fares: To be determined.

This application is subject to the cancellation of existing MO licences authorising operations on Route 638 (Hampton-Moorabbin) and Route 639 (Hampton-Southland).

Sanfilippo R. & M. Jovanovic, Southern Cross Hotel, Melbourne — Application for eight Special Purpose Vehicle licences in respect of 4 Bentley sedans (1949, 1951, 1954, 1961), 2 Rolls Royce sedans (1956, 1965), a 1950 Jaguar sedan and a 1964 Daimler sedan, each with a seating capacity for 4 persons, to operate from Shop 9, Lower Plaza, Southern Cross Hotel, Melbourne for the carriage of passengers for wedding parties.

Walton R. & L., Mulgrave — Application for two Special Purpose Vehicle licences in respect of a 1962 Rolls Royce sedan and a 1965 Rolls Royce sedan, each with a seating capacity for 6 persons, to operate from 9 Plato Crescent, Mulgrave for the carriage of passengers for wedding parties, advertising and special promotion work.

Application for renewal of licences as shown by the persons listed hereunder to operate under the same terms and conditions.

Baker R. W., North Essendon — TS 460, TS 595 and TS 954.

Handley J. E. & L. E., Rosebud — TS 725.

Ventura Motors Pty. Ltd., South Oakleigh — MC 51 and MC 52.

Notice of any objections should be forwarded to reach the Secretary of the Board not later than 22 April 1983.

Interested parties advised that it will not be necessary to appear on the hearing date specified, unless advised in writing by the Board. 8 April 1983

C. J. V. SMITH, Secretary

TRANSPORT REGULATION ACT
TRANSPORT REGULATION BOARD
 Hearing of Applications

Notice is hereby given that the following applications will be considered by the Transport Regulation Board on 3 May 1983.

Cardwell, L. G., H. T. & R. G., Numurkah — Application to license one commercial passenger vehicle with seating capacity for 18 persons, to operate in substitution for, but not in addition to, existing TS licences at present in the name of the applicant.

No charter rights are sought in this application.

T. S. Chilton & R. R. Hargreaves, Jeparit — Application for variation of the conditions of licence TS 598, which authorises an Education Department school contract service between Lake Hindmarsh and Rainbow, to undertake charter hirings from within a 20km pick-up radius of Jeparit.

The licensed vehicle holds a 2 star rating for charter purposes. This application is subject to the cancellation of charter rights from within a 20km pick-up radius of Rainbow which are presently attached to the licence.

Greek Orthodox Parish of Oakleigh & District, Oakleigh — Application to license one commercial passenger vehicle with seating capacity for 22 persons to operate for the carriage of students attending "St. Anargyroi", Oakleigh Greek Orthodox College between their homes and the College, as follows:—

Route

Commencing in Balaclava Road, East St Kilda, via Balaclava Road, Orrong Road, Malvern Road, Burke Road, Kyarra Road, York Road, Wills Street, High Street, Morris Street, Closter Avenue, Harold Street, High Street, Huntingdale Road, Gillard Street, Burwood Highway, Elgar Road, Neville Street, Frank Street, Riversdale Road, Station Street, Leonard Street, Finch Street, Cypress Avenue, Spark Avenue, Highbury Road, Crow Street, Mudgee Street, Benwerrin Drive, Highbury Road, Blackburn Road, Waverley Road, Glenwood Avenue, Monterey Avenue, Kauri Avenue, Fraser Street, Winmalee Drive, Springvale Road, Kemp Street, Govt Street, Dandenong Road, Elonera Road, Jacksons Road, Mulgrave Freeway, Forster Road, Ferntree Gully Road, Clayton Road, Dandenong

Road, Warrigal Road, Castle Bar Road, Arcadia Avenue, Woodlands Grove, Castle Bar Road, Dandenong Road, Alma Street, Fenwick Street, Chadstone Road, Poath Road and Willesden Road to the College.

Timetable: Monday to Friday

Depart East St Kilda 7.15 a.m.; Depart College 3.45 p.m.

Shave Bus Services Pty. Ltd., Mt Waverley—Application to license one commercial passenger vehicle with seating capacity for 35 persons to operate as a Metropolitan Stage Omnibus under the same terms and conditions as existing "MO" licences in the name of the applicant.

Application for renewal of licences as shown by the persons listed hereunder to operate under the same terms and conditions.

Cunningham, R. A., Niddrie—MO 109, MO 263, MO 264, MO 596, MO 675 and MC 91.

Mylon's Motorways Pty. Ltd., Wodonga—CO 46.

Notice of any objections should be forwarded to reach the Secretary of the Board not later than 27 April 1983.

Interested parties are advised that it will not be necessary to appear on the hearing date specified, unless advised in writing by the Board. Dated 13 April 1983

C. J. V. SMITH, Secretary

Melbourne and Metropolitan

BOARD OF WORKS

General Notice

The Melbourne and Metropolitan Board of Works having made provision for carrying off the sewage of each and every property which or any part of which is situate in the Sewerage Areas hereinafter described doth hereby declare that on and after the eighteenth day of April 1983 each and every property so situate shall be deemed to be a sewered property within the meaning of the *Melbourne and Metropolitan Board of Works Act 1958*.

The Sewerage Areas hereinbefore referred to are:—

Sewerage Area No. 4481

Shire of Sherbrooke—Commencing at the junction of Centre Road and Glenfern Road, thence northerly along Glenfern Road, easterly along the northern boundaries of that piece of land described on Certificate of Title Volume 7437 Folio 353 and lot 1 Clifford Grove, generally easterly along the Tecoma-Melbourne Railway Line, southerly along Burnham Road, easterly along McNicol Road, generally south-westerly along McNicol Road, north-easterly along the eastern boundaries of lot 133 McNicol Road and lot 82 Hazel Vale Road, south-westerly along Hazel Vale Road, northerly along Fairy Dell Road, westerly along the southern boundary of lot 2 Fairy Dell Road, northerly along the western boundaries of lot 2 and portion of lot 1 Fairy Dell Road, westerly along the southern boundary of lot 19 Centre Road, northerly and westerly along Centre Road to the commencing point.

Sewerage Area No. 4482

Shire of Sherbrooke—Commencing at the junction of McNicol Road and Station Street, thence westerly along McNicol Road, northerly along Burnham Road, easterly along the Tecoma-Belgrave Railway Line, southerly along portion of the Railway Reserve, south-westerly along Minter Street, easterly along Station Street, southerly and south-westerly along Grey Street, northerly along the western boundary of lot 87 Grey Street, north-westerly along the western boundary of lot 93 McNicol Road and north-easterly along McNicol Road to the commencing point.

Sewerage Area No. 4484

Shire of Sherbrooke—Commencing at the junction of Benson Street and Minter Street, thence north-easterly along Minter Street, northerly along portion of the Railway Reserve, easterly and north-easterly along the Melbourne-Belgrave Railway Line, south-easterly along Bayview Road, southerly along the eastern boundaries of lot 10 Bayview Road, lots 9 and 8 Heathermont Avenue and lots 1 to 4 Belgrave-Emerald Road, westerly along Belgrave-Emerald Road, southerly along Belgrave-Hallam Road and westerly along Benson Street to the commencing point.

Sewerage Area No. 4542

City of Doncaster and Templestowe—This area comprises all lots in Laviah Court and Derrance Place, lots 74 to 68, 59, 60, 66 and 67 Clontarf Crescent, lots 17 to 14 and 9 to 13 Templemore Drive, a portion of a Tree Reserve abutting Blackburn Road and Laviah Court.

Sewerage Area No. 4552

City of Knox—This area comprises lots 111, 110 and 242 Tamboon Road, lots 302 to 293, 292 to 284 and an Electricity Reserve Cooper Road, lots 283 and 282 Goulburn Drive.

Sewerage Area No. 4556

City of Knox—This area comprises all lots in Newbury Court, Avonwood Close, Raven Hill Way and Huntingdon Drive, lots 152, 153, 204 to 206, 213, 214, 182, 183, 2, 229, 228, 225 to 215 and a Drainage, Sewerage and Recreational Reserve Tyner Road, lots 184 to 187, 1, a further lot 1 and lots 1 to 3 Riddell Road, that piece of land described on Plan of Consolidation No. 107055 abutting Burwood Highway, Riddell Road and High Street Road, a Tree Reserve abutting High Street Road and Raven Hill Way, a further Tree Reserve abutting High Street Road, Raven Hill Way and Riddell Road.

Sewerage Area No. 4564

City of Croydon—This area comprises all lots in Nuraylia Avenue, Astor Court, Timms Court, Ray Street and Kurrajong Avenue, lots 2, 63, that piece of land described on Registered Plan No. 6177, lots 2, 1, 2 and 1 Jarvis Avenue, lots 1, 2, 59 to 62, 89 to 91, 11 to 13, 14 to 16, 1, 2, 81 to 85 and 30 to 32 Timms Avenue, lots 33 to 35, 40, 41, 48, 49 and 71 to 68 Ervin Road, lots 1, 77 and 16 to 11 Marion Avenue, that piece of land described on Registered Plan No. 10163, lot 1, that piece of land described on Certificate of Title Volume 7463 Folio 050, lot 1, those pieces of land described on Certificates of Titles Volume 7605 Folio 033 and Volume 8117 Folio 290, that piece of land described on Letter Plan R-526, lots 1 and 7 to 3 Hull Road, lots 35 to 25, 19, 20, 7 to 10 and 80 to 77 Alamein Avenue, lots 24, 23, 76, a Reserve, lots 73, 72, 47 to 42, 22, 21, 18 and 17 Kiloran Avenue, a Reserve abutting Hull Road and Kurrajong Avenue, a Reserve abutting Kurrajong Avenue and Kiloran Avenue.

Sewerage Area No. 4569

City of Doncaster and Templestowe—This area comprises all lots in Reddington Terrace, lots 288 to 291, lot N, a Reserve, lots 307 to 310, 311 to 317, 318, 319, a Reserve and lots 340 to 343 Landscape Drive, lots 333 to 339, 326 to 332 Catherine Avenue and lots 320 to 325 Andersons Creek Road, a Reserve abutting Landscape Drive and Reddington Terrace, a Reserve abutting Catherine Avenue and Landscape Drive.

Sewerage Area No. 4572

City of Broadmeadows—This area comprises all lots in International Drive, lots 1 to 4 Hillcrest Drive, lots 5 to 9, that piece of land described on Certificate of Title Volume 5768 Folio 498, that piece of land described on Letter Plan B-913, lots 10 to 6, 5 to 3, those pieces of land described on Letter Plans D-867, B-909 and S-634, lots B, 1 and A Mickleham Road, a Plantation Reserve abutting International Drive and Mickleham Road.

Sewerage Area No. 4576

City of Keilor—This area comprises all lots in Susan Court and Nicola Court, lots 2 to 6, 20 to 23, 39 to 62, 89, 90 and 38 to 24 Rachele Road, lot 1 Keilor Road, Essendon Grammar School abutting Keilor Road and Rachele Road, a Reserve abutting Keilor Road and Rachele Road.

Sewerage Area No. 4579

City of Sunshine—This area comprises that piece of land described on Plan of Consolidation No. 151443, lots 2, 1, 2 and that piece of land described on Plan of Consolidation No. 108368 Wright Street, those pieces of land described on Plan of Consolidation No. 154258 and 106993, lots 49, 48, those pieces of land described on Certificates of Title Volume 9444 Folio 035 and Volume 8367 Folio 585 and that piece of land described on Plan of Consolidation No. 106175 Hampton Avenue, lots 27 and 28 Patterson Avenue, those pieces of land described on Certificates of Title Volume 9004 Folio 542, Volume 9004 Folio 541 and Volume 9358 Folio 699 abutting Kororoit Creek.

Sewerage Area No. 4580

City of Croydon—This area comprises lots 74, 73, those pieces of land described on Certificates of Title Volume 8061 Folio 449, Volume 6936 Folio 036, Volume 8146 Folio 137 and Volume 8162 Folio 859, lot 67, that piece of land described on Certificate of Title Volume 5918 Folio 515 and lot 64 Dorset Road, lots 63 to 54 Dixon Avenue, the Monkami Training Centre abutting Dixon Avenue Lincoln Road and Dorset Road.

Sewerage Area No. 4581

City of Knox—This area comprises all lots in Foster Crescent, lots 603 to 595 Allister Avenue, lots 593, 594, 75 to 77, 95 to 97, 216 to 218 and 236 to 238 Phillip Road, lots 30, 2, 1, 2, 1, 33 to 35, 1 to 4, 41, 1, 2, 1, 2, 1, 2, 1 and 2 Kathryn Road, lots 2, 1, 49, 47, 46, 2, 1, 2 and 1 Valetta Crescent, a Reserve abutting Wallace Road and Allister Avenue.

Sewerage Area No. 4603

City of Keilor—This area comprises all lots in Walton Street, those pieces of land described on Certificates of Title Volume 8769 Folio 538, Volume 5928 Folio 482 and Volume 9420 Folio 999, lots 822 to 825, that piece of land described on Certificate of Title Volume 8498 Folio 708, lots 828, 829, a Drainage Reserve, lot 830, that piece of land described on Certificate of Title Volume 8416 Folio 719, lots 798, 804 to 808 and that piece of land described on Plan of Consolidation No. 102944 Webb Road, lots 777 to 774 Howes Street.

Sewerage Area No. 4607

City of Mordialloc—This area comprises lot 54 Lower Dandenong Road.

Sewerage Area No. 4608

City of Sunshine—This area comprises lots 1, 2 and 1 Sunshine Road.

Sewerage Area No. 4609

Shire of Diamond Valley—This area comprises lots 3 to 5 and 7 Ramptons Road.

Sewerage Area No. 4613

City of Knox—This area comprises all lots in Mahonia Court and Manna Gum Road, lots 33 to 30, 20 to 17, 8 and 7 McMahons Road, lot 6, that piece of land described on Plan of Consolidation No. 101071, lots 3 to 1, 1 to 6, 7 to 18 and 77 to 84 Burwood Highway, lots 85 and 86 Applegum Crescent, lots 87 to 90, 22 to 31, 36 to 39, 12 to 9, 16 to 13, 40 to 43 and 48 to 56 Cinerea Avenue, lots 61 to 68, 73 to 76, 24 to 21, 29 to 25, 445 to 441 and 436 to 429 Piperita Road, lots 92, 91, 19 to 21, 57 to 60, 427, 428, 460 and 461 Lightwood Drive, lots 459 to 454, 450 to 446 and 38 to 34 Bursaria Avenue.

Sewerage Area No. 4616

Shire of Cranbourne—This area comprises lots 2 and 198 Cairns Road.

Sewerage Area No. 4617

Cities of Ringwood and Doncaster and Templestowe—This area comprises lots 33 to 37 Giana Court, lots 38 and 39 Cantala Crescent, lots 46 to 48 Nicholas Court, lots 49, 3 and 164 to 168 Kubba Road, lots 169 to 173, 128 to 132, 2, 134 to 137, that piece of land described on Plan of Consolidation No. 10314 and a Reserve Felix Crescent, lots 143 to 147, 2, 1, a Reserve, lots 1, 152 to 162, 2, 1, 18, 12 to 1, 2 and 3 Glenvale Road, lots 2 and 8 to 13 Craig Road.

Sewerage Area No. 4619

City of Keilor—This area comprises lots 111 and 112 Errington Road.

Sewerage Area No. 4620

City of Nunawading—This area comprises lots 120 to 117 Stanley Road.

Sewerage Area No. 4621

City of Nunawading—This area comprises lots 4, 1, 2, a further lot 2, lots 3 and 4 George Road.

Sewerage Area No. 4625

City of Altona—This area comprises lots 31 and 32 Chambers Road.

Sewerage Area No. 4627

City of Sunshine—This area comprises lots 42 and 43 Judge Street.

Sewerage Area No. 4637

City of Knox—This area comprises lots 18 to 25 Fuschia Street, lots 11 to 7 Gibbs Road, lots 4 to 6 Bourke Road.

Sewerage Area No. 4638

City of Doncaster and Templestowe—This area comprises all lots in Saville Court, Montclair Court, Selwyn Court, Elsa Street and Kelvinside Drive, lots 70, 48, 47, 37 to 33, 30 to 28, 24 to 27 and 82 to 78 Dellfield Drive, lots 1 to 9, 16 and 20 to 23 Colonsay Street, lots 1, 14, 15, 1, 2 and 1 Serpells Road, lots 2 to 6 and 13 Duxson Drive, Tree Reserves abutting Foote Street, Elsa Street and Serpells Road, a Drainage and Sewerage Reserve abutting Foote Street and Dellfield Drive.

Sewerage Area No. 4640

City of Altona—This area comprises all lots in Pyramus Place, Ocean Court, Piri Grove and Calcutta Close, lots 142 to 148, 205, 206, 214, 215, 204 to 202 and 188 to 179 Rebecca Crescent.

Sewerage Area No. 4642

City of Doncaster and Templestowe—This area comprises lots 32 to 27 and 37 Dellfield Drive.

Sewerage Area No. 4643

City of Doncaster and Templestowe—This area comprises lots 55, 56 and portion of a Melbourne and Metropolitan Board of Works Pipe Track Warrandyte Road.

By order of the Board

H. G. FORD, Acting Director of Administration
12 April 1983
625 Little Collins Street
Melbourne, Vic. 3000.

PUBLIC TRUSTEE ACT 1958, SECTION 17

I hereby give notice that on 24 March 1983 the Public Trustee filed an Election to Administer the following deceased person's estate in accordance with Section 17 of the *Public Trustee Act 1958*:

Hocking, Lillian May, late of Mont Park, widow, died 11 January 1983.

I hereby give notice that on 28 March 1983 the Public Trustee filed Elections to Administer the following deceased persons' estates in accordance with Section 17 of the *Public Trustee Act 1958*:

Harper, Edward John, late of 59 Ovens Street, Yarraville, pensioner, died 25 January 1983.

Lacy, Edith Constance, late of 42 Hammond Street, Thornbury, widow, died 28 March 1983.

Marotte, John Charles, late of 364 Howe Parade, Garden City, gentleman, died 3 February 1983.

Ryan, James William, late of Judge Book Memorial Village, Eltham, retired, died 1 February 1983.

Saleh, Cholid Nangmuk, late of Flat 6, 1802 Dandenong Road, Clayton, died 7 January 1983.

6 April 1983

168 Exhibition Street, Melbourne 3000

P. T. SPENCER
Public Trustee

Creditors, next of kin and others having claims against the estate of any of the under-mentioned deceased persons are required to send particulars of their claims to the Public Trustee, 168 Exhibition Street, Melbourne, Victoria 3000, the personal representative, on or before 20 June 1983, after which date the Public Trustee may convey or distribute the assets having regard only to the claims of which the Public Trustee then has notice:—

Dale, James Richard Lougheed, late of 3 Twisden Road, Bentleigh, retired gardener, died 6 January 1983.

Firth, Margaret Ruby, formerly of "Otle", 2 Fernhill Road, Sandringham, but late of 22 Marine Parade, St. Kilda, home duties, died 29 September 1982.

Harper, Edward John, late of 59 Ovens Street, Yarraville, pensioner, died 25 January 1983.

Hocking, Lillian May, late of Mont Park, widow, died 11 January 1983.

Lacy, Edith Constance, late of 42 Hammond Street, Thornbury, widow, died 28 March 1983.

Marotte, John Charles, 364 Howe Parade, Garden City, gentleman, died 3 February 1983.

Martin, Violet, formerly of 32 Sussex Street, Yarraville, but late of 309 Somerville Road, West Footscray, widow, died 31 December 1982.

Moore, Edward Vernon, formerly of 15 Mackay Street, East Prahran, but late of 71 Woomack Road, Murrumbena, estimator, died 4 June 1955.

Paterson, James, late of 16A Daisy Street, Essendon, pensioner, died 17 January 1983.

Ryan, James William, late of Judge Book Memorial Village, Eltham, retired, died 1 February 1983.

Saleh, Cholid Nangmuk, late of Flat 6, 1802 Dandenong Road, Clayton, student, died 7 January 1983.

Thomas, William Thomas (in the will called William Thomas), late of 5 Lowther Street, Alphington, retired, died 21st December 1982. Melbourne 6 April 1983

P. T. SPENCER
Public Trustee

Town and Country Planning Act 1961
CITY OF MILDURA PLANNING SCHEME

Amendment No. 50
Notice of Approval

In pursuance of the powers conferred by the *Town and Country Planning Act 1961*, The Governor in Council on 7 April 1983 amended the abovementioned scheme in respect of the municipal district of the City of Mildura and for which the Council of the City of Mildura is the Responsible Authority.

The scheme comes into operation on the date this Notice is published in the *Government Gazette*.

The scheme includes provisions relating to the erection of a country dwelling and construction of access above natural ground level in the Agricultural A Zone.

A copy of the documents may be inspected free of charge, during office hours at the office of the Department of Planning (Plan Inspection Section), 5th Floor, 235 Queen Street, Melbourne, and at the office of the Council of the City of Mildura, Civic Buildings, Mildura.

DAVID YENKEN
Secretary for Planning

Town and Country Planning Act 1961
CITY OF SHEPPARTON PLANNING SCHEME 1953

Amendment No. 65
Notice of Approval

In pursuance of the powers conferred by the *Town and Country Planning Act 1961*, The Governor in Council on 7 April 1983 amended the abovementioned scheme in respect of the municipal district of the City of Shepparton and for which the Council of the City of Shepparton is the Responsible Authority.

The scheme comes into operation on the date this Notice is published in the *Government Gazette*.

The scheme includes the rezoning to Residential 'B' of land at 57-63 Wyndham Street, Shepparton, more particularly described as Part of CA 16, Parish of Shepparton and presently reserved for Public Open Space.

A copy of the documents may be inspected free of charge, during office hours, at the office of the Department of Planning (Plan Inspection Section), 5th Floor, 235 Queen Street, Melbourne, and at the office of the Council of the City of Shepparton, Municipal Offices, Civic Centre, Shepparton.

DAVID YENKEN
Secretary for Planning

Town and Country Planning Act 1961
WARRAGUL PLANNING SCHEME 1954

Amendment No. 44, 1982
Notice of Approval

In pursuance of the powers conferred by the *Town and Country Planning Act 1961*, The Governor in Council on 7 April 1983 amended the abovementioned scheme in respect of the municipal district of the Shire of Warragul and for which the Shire of Warragul is the Responsible Authority.

The scheme comes into operation on the date this Notice is published in the *Government Gazette*.

The scheme includes alterations to the provisions of the Planning Scheme Ordinance relating to the Commercial 'A' and Commercial 'B' Zones to achieve consistency in development controls relating to Commercial land.

A copy of the documents may be inspected free of charge, during office hours, at the office of the Department of Planning (Plan Inspection Section), 5th Floor, 235 Queen Street, Melbourne, and at the office of the Shire of Warragul.

DAVID YENKEN
Secretary for Planning

Town and Country Planning Act 1961
SHIRE OF BASS PLANNING SCHEME

Amendment No. 8
Notice of Approval

In pursuance of the powers conferred by the *Town and Country Planning Act 1961*, The Governor in Council on 7 April 1983 amended the abovementioned scheme in respect of the municipal district of the Shire of Bass and for which the Shire of Bass is the Responsible Authority.

The scheme comes into operation on the date this Notice is published in the *Government Gazette*.

The scheme affects Crown Allotments 10B, 10C and 11, Township of San Remo and reserves the land for Proposed Main Road Widening for the purposes of allowing the widening of Phillip Island Tourist Road on the outskirts of San Remo.

A copy of the documents may be inspected free of charge, during office hours, at the office of the Department of Planning (Plan Inspection Section), 5th Floor, 235 Queen Street, Melbourne, and at the office of the Council of the Shire of Bass, Shire Offices, Archies Creek.

DAVID YENKEN
Secretary for Planning

Town and Country Planning Act 1961
MELBOURNE METROPOLITAN PLANNING SCHEME

Amendment No. 190, Part 1
Notice of Approval

In pursuance of the powers conferred by the *Town and Country Planning Act 1961*, The Governor in Council on 7 April 1983 amended the abovementioned scheme in respect of various municipal districts for which the Melbourne and Metropolitan Board of Works is the Responsible Authority.

The scheme comes into operation on the date this Notice is published in the *Government Gazette*.

The scheme includes variations and amendments to maps in the Principal Scheme which are predominantly either routine or have arisen in order to correct minor anomalies, at the request of Councils, the Melbourne and Metropolitan Board of Works, owners or applicants.

A copy of the Planning Scheme as approved may be inspected free of charge, during office hours, at the office of the Department of Planning (Plan Inspection Section), 5th Floor, 235 Queen Street, Melbourne, and at the office of the Melbourne and Metropolitan Board of Works, 625 Little Collins Street, Melbourne.

DAVID YENKEN
Secretary for Planning

Town and Country Planning Act 1961
MELBOURNE METROPOLITAN PLANNING SCHEME

Amendment No. 187, Part 2
Notice of Approval

In pursuance of the powers conferred by the *Town and Country Planning Act 1961*, the Governor in Council on 29 March 1983, approved the abovementioned scheme in respect of the municipal districts of the Cities of Malvern and South Melbourne and for which the Melbourne and Metropolitan Board of Works is the Responsible Authority.

The scheme comes into operation on the date this Notice is published in the *Government Gazette*.

The scheme includes the rezoning of land at Nos. 135-151 Darling Road, Malvern from Service Business to Residential 'C' Zone and land at No. 119 Danks Street, Albert Park, from Local Business to Residential 'C' Zone.

A copy of the Planning Scheme as approved may be inspected free of charge, during office hours, at the office of the Department of Planning (Plan Inspection Section), 5th Floor, 235 Queen Street, Melbourne, and at the office of the Melbourne and Metropolitan Board of Works, 625 Little Collins Street, Melbourne.

DAVID YENKEN
Secretary for Planning

Town and Country Planning Act 1961
MELBOURNE METROPOLITAN PLANNING SCHEME

Amendment No. 191, Part 1
Notice of Approval

In pursuance of the powers conferred by the *Town and Country Planning Act 1961*, the Governor in Council on 29 March 1983, approved the abovementioned scheme in respect of various municipal districts for which the Melbourne and Metropolitan Board of Works is the Responsible Authority.

The scheme comes into operation on the date this Notice is published in the *Government Gazette*.

The scheme includes variations and amendments to maps in the Principal Scheme which are predominantly either routine or have arisen in order to correct minor anomalies, at the request of Councils, the Melbourne Metropolitan Board of Works, owners or applicants.

A copy of the Planning Scheme as approved may be inspected free of charge, during office hours, at the office of the Department of Planning (Plan Inspection Section), 5th Floor, 235 Queen Street, Melbourne, and at the office of the Melbourne and Metropolitan Board of Works, 625 Little Collins Street, Melbourne.

DAVID YENKEN
Secretary for Planning

Town and Country Planning Act 1961
CITY OF MELBOURNE (CENTRAL CITY)
INTERIM DEVELOPMENT ORDER

Amendment No. 9
Notice of Amendment

In pursuance of the powers conferred by the *Town and Country Planning Act 1961*, the Governor in Council on 12 April 1983 amended the abovementioned Order in respect of land known as No. 1 Spring Street, Melbourne and for which the Minister for Planning is the Responsible Authority.

The amendment comes into operation on the date this Notice is published in the *Government Gazette*.

The amendment enables the consideration of a permit application for a major office development at No. 1 Spring Street, Melbourne.

A copy of the documents may be inspected free of charge, during office hours at the office of the Department of Planning (Plan Inspection Section), 5th Floor, 235 Queen Street, Melbourne, and at the office of the Council of the City of Melbourne, 200 Little Collins Street, Melbourne.

DAVID YENKEN
Secretary for Planning

Town and Country Planning Act 1961
CITY OF MELBOURNE (CENTRAL CITY)
INTERIM DEVELOPMENT ORDER

Amendment No. 6
Notice of Amendment

In pursuance of the powers conferred by the *Town and Country Planning Act 1961*, the Governor in Council on 12 April 1983, amended the abovementioned Order in respect of land known as 535-549 Little Lonsdale Street and 540-550 Lonsdale Street, Melbourne, and for which the Minister of Planning is the Responsible Authority.

The amendment comes into operation on the date this Notice is published in the *Government Gazette*.

The amendment allows the abovementioned land to be used and developed for an eleven storey car park and a fifteen storey office building.

A copy of documents may be inspected free of charge, during office hours at the office of the Department of Planning (Plan Inspection Section), 5th floor, 235 Queen Street, Melbourne, and at the office of the Council of the City of Melbourne, 200 Little Collins Street, Melbourne.

DAVID YENKEN
Secretary for Planning

Town and Country Planning Act 1961
CITY OF MELBOURNE (CENTRAL CITY)
INTERIM DEVELOPMENT ORDER

Amendment No. 7
Notice of Amendment

In pursuance of the powers conferred by the *Town and Country Planning Act 1961*, the Governor in Council on 12 April 1983 amended the abovementioned Order in respect of land known as 471-485 Collins Street and 448-458 Flinders Lane, Melbourne and for which the Minister for Planning is the Responsible Authority.

The amendment comes into operation on the date this Notice is published in the *Government Gazette*.

The amendment allows for the use and development of the abovementioned land for the purpose of a 27 storey office building and associated facilities.

A copy of the documents may be inspected free of charge, during office hours at the office of the Department of Planning (Plan Inspection Section), 5th Floor, 235 Queen Street, Melbourne, and at the office of the Council of the City of Melbourne, 200 Little Collins Street, Melbourne.

DAVID YENKEN
Secretary for Planning

Town and Country Planning Act 1961
SHIRE OF HEALESVILLE INTERIM DEVELOPMENT
ORDER

Amendment No. 7

Notice of Amendment

In pursuance of the powers conferred by the *Town and Country Planning Act 1961*, The Governor in Council on 7 April 1983 amended the abovementioned Order in respect of land described as Crown Allotment 147, Parish of Gracedale and located on the south-west corner of Mt Riddell Road and Airlie Road, Healesville and for which the Shire of Healesville is the Responsible Authority.

The amendment comes into operation on the date this Notice is published in the *Government Gazette*.

The amendment varies the Ordinance of the Scheme to enable the abovementioned land to be subdivided into two lots.

A copy of the documents may be inspected free of charge, during office hours at the office of the Department of Planning (Plan Inspection Section), 5th Floor, 235 Queen Street, Melbourne, and at the office of the Council of the Shire of Healesville, Shire Office, 231 Maroondah Highway, Healesville.

DAVID YENKEN
Secretary for Planning

Town and Country Planning Act 1961
SHIRE OF BULLA PLANNING SCHEME 1959

Amendment No. 89, 1982

Notice of Approval

In pursuance of the powers conferred by the *Town and Country Planning Act 1961*, The Governor in Council on 7 April 1983 amended the abovementioned scheme in respect of the municipal district of the Shire of Bulla and for which the Shire of Bulla is the Responsible Authority.

The scheme comes into operation on the date this Notice is published in the *Government Gazette*.

The scheme includes ordinance changes introducing controls over "Massage Parlour" and "Adult Sex Book and Sex Aid Establishment" throughout the Planning Area.

A copy of the Planning Scheme as approved may be inspected free of charge, during office hours, at the office of the Department of Planning (Plan Inspection Section), 5th Floor, 235 Queen Street, Melbourne, and at the office of the Shire of Bulla, Municipal Offices, Macedon Street, Sunbury.

DAVID YENKEN
Secretary for Planning

Town and Country Planning Act 1961
GEELONG REGIONAL PLANNING SCHEME

Amendment No. 56, Part 1

Notice of Approval

In pursuance of the powers conferred by the *Town and Country Planning Act 1961*, The Governor in Council on 7 April 1983 amended the abovementioned scheme in respect of the municipal districts of the Shires of Bannockburn and Barrabool and for which the Geelong Regional Commission is the Responsible Authority.

The scheme comes into operation on the date this Notice is published in the *Government Gazette*.

The scheme includes two (2) map amendments, realigning a road reservation for a proposed by-pass road at Meredith, Shire of Bannockburn and zoning land used by the Gnawarre Tennis Club, to Rural (General Farming), Shire of Barrabool.

A copy of the documents may be inspected free of charge, during office hours, at the office of the Department of Planning (Plan Inspection Section), 5th Floor, 235 Queen Street, Melbourne, and at the office of the Geelong Regional Commission, Geelong Public Offices, Corner Little Malop and Fenwick Streets, Geelong.

DAVID YENKEN
Secretary for Planning

Town and Country Planning Act 1961
GEELONG REGIONAL PLANNING SCHEME

Amendment No. 56, Part 2

Notice of Approval

In pursuance of the powers conferred by the *Town and Country Planning Act 1961*, The Governor in Council on 7 April 1983 amended the abovementioned scheme in respect of the municipal district of the City of South Barwon and for which the Geelong Regional Commission is the Responsible Authority.

The scheme comes into operation on the date this Notice is published in the *Government Gazette*.

The scheme includes a map amendment to reserve Pioneer Road, Grovedale, City of South Barwon and its extension to link with South Valley Road as Existing and Proposed Arterial Road, respectively.

A copy of the documents may be inspected free of charge, during office hours, at the office of the Department of Planning (Plan Inspection Section), 5th Floor, 235 Queen Street, Melbourne and at the office of the Geelong Regional Commission, Geelong Public Offices, Corner Little Malop and Fenwick Streets, Geelong.

DAVID YENKEN
Secretary for Planning

Town and Country Planning Act 1961
CITY OF HORSHAM PLANNING SCHEME
Amendment No. 73, 1982

Notice of Approval

In pursuance of the powers conferred by the *Town and Country Planning Act 1961*, The Governor in Council on 7 April 1983 amended the abovementioned scheme in respect of the municipal district of the City of Horsham and for which the City of Horsham is the Responsible Authority.

The scheme comes into operation on the date this Notice is published in the *Government Gazette*.

The scheme rezones land situated on the eastern side of Firebrace Street between McLachlan Street and Roberts Avenue encompassing an area of approximately 340 square metres from Existing Public Purposes Reserve (32—Shire of Wimmera) to Commercial A Zone.

A copy of the documents may be inspected free of charge, during office hours, at the office of the Department of Planning (Plan Inspection Section), 5th Floor, 235 Queen Street, Melbourne, and at the office of the Council of the City of Horsham, Civic Centre, Urquhart Street, Horsham.

DAVID YENKEN
Secretary for Planning

Town and Country Planning Act 1961
MELBOURNE METROPOLITAN PLANNING SCHEME
Amendment No. 172 Part 2A

Notice of Approval

In pursuance of the powers conferred by the *Town and Country Planning Act 1961*, The Governor in Council on 7 April 1983 amended the abovementioned scheme in respect of various municipal districts of the Melbourne Metropolitan Planning Area and for which the Melbourne and Metropolitan Board of Works is the Responsible Authority.

The scheme comes into operation on the date this Notice is published in the *Government Gazette*.

The scheme includes various rezoning items in the metropolitan area.

A copy of the documents may be inspected free of charge, during office hours, at the office of the Department of Planning (Plan Inspection Section), 5th Floor, 235 Queen Street, Melbourne, and at the office of the Melbourne and Metropolitan Board of Works, 625 Little Collins Street, Melbourne.

DAVID YENKEN
Secretary for Planning

Town and Country Planning Act 1961
SHIRE OF SHERBROOKE PLANNING SCHEME 1979
(RURAL AREAS)

Amendment No. 11A

Notice of Amendment

In pursuance of the powers conferred by the *Town and Country Planning Act 1961*, The Governor in Council on 7 April 1983 amended the abovementioned scheme in respect of the municipal district of the Shire of Sherbrooke and for which the Council of the Shire of Sherbrooke is the Responsible Authority.

The amendment comes into operation on the date this Notice is published in the *Government Gazette*.

The amendment corrects a typographical error made in the documents approved as Amendment No. 11 to the above scheme.

A copy of the documents may be inspected free of charge, during office hours, at the office of the Department of Planning (Plan Inspection Section), 5th Floor, 235 Queen Street, Melbourne and at the office of the Council of the Shire of Sherbrooke, Shire Offices, Glenfern Road, Upwey.

DAVID YENKEN
Secretary for Planning

Town and Country Planning Act 1961
MELBOURNE METROPOLITAN INTERIM DEVELOPMENT
ORDER

Urban Conservation Areas

Notice of Approval

In pursuance of the powers conferred by the *Town and Country Planning Act 1961*, The Governor in Council on 7 April 1983 amended the abovementioned Order in respect of the Cities of Brunswick, Collingwood, Fitzroy, Melbourne, Port Melbourne, Richmond, South Melbourne, St. Kilda and Williamstown, and for which the Melbourne and Metropolitan Board of Works is the Responsible Authority.

The Order comes into operation on the date this Notice is published in the *Government Gazette*.

The Order provides appropriate controls over proposed urban conservation areas in inner Melbourne pending the processing of Amendment No. 224 to the Melbourne Metropolitan Planning Scheme.

A copy of the documents may be inspected free of charge, during office hours at the office of Planning the Department of Planning (Plan Inspection Section), 5th Floor, 235 Queen Street, Melbourne, and at the office of the Melbourne and Metropolitan Board of Works, 625 Little Collins Street, Melbourne.

DAVID YENKEN
Secretary for Planning

Town and Country Planning Act 1961
SEYMOUR PLANNING SCHEME

Amendment No. 70

Notice of Amendment

In pursuance of the powers conferred by the *Town and Country Planning Act 1961*, The Governor in Council on 7 April 1983 amended the abovementioned scheme in respect of the municipal district of the Shire of Seymour and for which the Shire of Seymour is the Responsible Authority.

The amendment comes into operation on the date this Notice is published in the *Government Gazette*.

The amendment includes the rezoning of part of Crown allotments 14, 15, 16, and 17, Section C, Township of Seymour from "Residential" to Public Purposes Reserve (Municipal Purposes).

A copy of the documents may be inspected free of charge, during office hours, at the office of the Department of Planning (Plan Inspection Section), 5th Floor, 235 Queen Street, Melbourne and at the office of the Shire of Seymour, Tallarook Street, Seymour.

DAVID YENKEN
Secretary for Planning

Town and Country Planning Act 1961
SHIRE OF UPPER YARRA INTERIM DEVELOPMENT
ORDER

Amendment No. 79

Notice of Amendment

In pursuance of the powers conferred by the *Town and Country Planning Act 1961*, The Governor in Council on 7 April 1983 amended the abovementioned Order in respect of land described as Crown Allotment 22, Parish of Warburton and located in Lowes Road, Wesburn and for which the Shire of Upper Yarra is the Responsible Authority.

The amendment comes into operation on the date this Notice is published in the *Government Gazette*.

The amendment varies the ordinance of the Scheme to enable the erection of a dwelling on the abovementioned land.

A copy of the documents may be inspected free of charge, during office hours at the office of the Department of Planning (Plan Inspection Section), 5th Floor, 235 Queen Street, Melbourne, and at the office of the Council of the Shire of Upper Yarra, Shire Offices, Main Road, Yarra Junction.

DAVID YENKEN
Secretary for Planning

Town and Country Planning Act 1961
CITY OF ARARAT PLANNING SCHEME

Amendment No. 31

Notice of Approval

In pursuance of the powers conferred by the *Town and Country Planning Act 1961*, The Governor in Council on 7 April 1983 amended the abovementioned scheme in respect of the municipal district of the City of Ararat and for which the City of Ararat is the Responsible Authority.

The scheme comes into operation on the date this Notice is published in the *Government Gazette*.

The scheme includes an Ordinance amendment affecting subdivision provisions in the Rural Residential A and B Zones.

A copy of the documents may be inspected free of charge, during office hours, at the office of the Department of Planning (Plan Inspection Section), 5th Floor, 235 Queen Street, Melbourne, and at the office of the Council of the City of Ararat, Municipal Offices, Ararat.

DAVID YENKEN
Secretary for Planning

Town and Country Planning Act 1961
GEELONG REGIONAL PLANNING SCHEME
Amendment No. 69
Notice of Amendment

In pursuance of the powers conferred by the *Town and Country Planning Act 1961*, The Governor in Council on 7 April 1983 amended the abovementioned scheme in respect of the municipal district of the Shire of Bellarine and for which the Geelong Regional Commission is the Responsible Authority.

The amendment comes into operation on the date this Notice is published in the *Government Gazette*.

The amendment establishes and includes land to the north-west of the Geelong-Portarlington Road between Point Richards Road and Spray Farm Lane, Portarlington within the Shire of Bellarine in a Port Bellarine Resort Development Zone and allows for a wide range of uses which may be related to tourist development.

A copy of the documents may be inspected free of charge, during office hours, at the office of the Department of Planning (Plan Inspection Section), 5th Floor, 235 Queen Street, Melbourne, and at the office of the Geelong Regional Commission, Geelong Public Offices, Corner Little Malop and Fenwick Streets, Geelong.

DAVID YENKEN
Secretary for Planning

Industrial Relations Act 1979
NOTICE OF APPLICATION FOR RECOGNITION AS AN ASSOCIATION

Notice is hereby given that the Victorian Employers Federation has filed an application to be recognized as an association under the *Industrial Relations Act 1979* with respect to the trade or trades for which the Racecallers Conciliation and Arbitration Board has been appointed.

Pursuant to regulation 33 (5) of the Industrial Regulations any recognized association or person interested may on or before 12 May 1983 file in the Registry (9th Floor, 271 William Street, Melbourne) an objection to the application.

The objection shall be in, or to the effect of Form 9 prescribed by the Regulations.

A. S. DOWLING, Deputy Registrar
Industrial Relations Commission of Victoria

APPOINTMENTS AND RESIGNATIONS

APPOINTMENTS

His Excellency the Governor of the State of Victoria by and with the advice of the Executive Council thereof has by Orders made on 7 April 1983 been pleased to make the undermentioned appointments, viz:

Department of Community Welfare Services
Honorary Probation Officers

Burdett, John, 1/208 St. Georges Road, Shepparton 3630; Cornell, Lina, 22 Maude Street, Shepparton 3630; Cornell, Neil, 22 Maude Street, Shepparton 3630; Derrick, Marie, 55 Echuca Road, Mooropna 3629; Impey, Denise, 3/28 Maude Street, Shepparton 3630; Poort, Hetty, Church Street, Girgarre 3624; Pratt, Philomena, 25 McIntosh Street, Echuca 3625; Russ, Tony, 8 Scobie Street, Kyabram 3620; Thomas, Esther, 16 Poplar Street, Echuca 3625; Thomson, Bruce, 4 Oomlim Avenue, Kyabram 3620; Wilson, Claire, 18 Mackenzie Street, Numurkah 3636 to be Honorary Probation Officers for all Adult and Children's Courts in the State of Victoria pursuant to the provisions of Section 507 (2) of the *Crimes Act 1973* and Section 9 of the *Children's Court Act 1973*.

Department of Crown Lands and Survey
Bailiff of Crown Lands

Alexander Peter Godfrey-Smith, an officer of the Department of Crown Lands and Survey, to be a bailiff of Crown lands pursuant to the provisions of section 30 of the *Land Act 1958* in respect of all Crown lands in the State of Victoria, and with authority to discharge and exercise all the duties and powers of bailiffs of Crown lands.

Health Commission

Members of the Committee of Management of Hospitals

Leighton Smith to be a member of the Committee of Management of the Mildura Base Hospital pursuant to the provisions of Section 63F (1) of the *Hospitals and Charities Act 1958* for the period of office expiring on 31 August 1983.

Member of the Specialist Practitioners Qualifications Committee
Elsdon Storey and John Dawkins as Members of the Specialist Practitioners Qualifications Committee pursuant to the provisions of Section 28A (2) of the *Dentists Act 1972* for a period of three years commencing 20 April 1983.

TOM FORRISTAL
Clerk of the Executive Council

At the Executive Council Chamber
Melbourne 7 April 1983

Liquor Control Act 1958

APPOINTMENT OF LICENSING INSPECTORS

In accordance with the authority conferred upon me by Section 6 of the *Police Regulation Act 1958*, I, Eric Thomas Millar, Deputy Commissioner of Police, do hereby appoint under sub-section (1) of Section 22 of the *Liquor Control Act 1968*, the following Officers of Police as Licensing Inspectors for the Divisions of the Police Districts as shown:—

| Division Number | Police District | Rank and Name |
|-----------------|-----------------|---|
| 1 | Altona | Inspector Lawrence Dillon, No. 13836 (from 30.3.83 to 30.4.83). |
| 3 | Altona | Inspector Gary Arthur Logan, No. 14031 (from 3.4.83 to 23.4.83). |
| 4 | Altona | Inspector Albert Maxwell Newell, No. 12762 (from 27.2.83 to 16.4.83). |

7.4.1983
E. T. MILLAR
Deputy Commissioner

Liquor Control Act 1968

APPOINTMENT OF LICENSING INSPECTORS

In accordance with the authority conferred upon me by Section 6 of the *Police Regulation Act 1958*, I, Eric Thomas Millar, Deputy Commissioner of Police, do hereby appoint under sub-section (1) of Section 22 of the *Liquor Control Act 1968*, the following Officers of Police as Licensing Inspectors for the Divisions of the Police Districts as shown:—

| Division Number | Police District | Rank and Name |
|-----------------|-----------------|---|
| 1 | Altona | Inspector Keith Charles MacDonald, No. 12024 (vice Chief Inspector Bloomcamp, No. 11965). |
| 4 | Altona | Inspector Daryl Campbell Payne, No. 12003 (vice Chief Inspector Hickman, No. 11643). |
| 2 | Moonee Ponds | Inspector Walter Ian Griffiths, No. 13734 (from 10.4.83 to 7.5.83). |
| 4 | Moonee Ponds | Inspector Ronald James Stone, No. 13871 (from 23.3.83 to 13.4.83). |
| 4 | Moonee Ponds | Inspector John Stuart Bateman, No. 12305 (vice Chief Inspector Woodcock, No. 10773). |
| 2 | Prahran | Inspector Graeme Francis Crawford, No. 12564 (from 3.4.83 to 30.4.83). |
| 2 | Prahran | Inspector Rex Albert Painter, No. 12077 (vice Chief Inspector Phelan, No. 12128). |

31.3.1983
E. T. MILLAR
Deputy Commissioner

National Parks Act 1975
AUTHORIZED OFFICERS

In accordance with section 9 (2) of the *National Parks Act 1975*, I, Donald Sydney Saunders, Director of National Parks, hereby appoint the following persons to be Authorized Officers for the purposes of the Act.

These Authorizations are to remain in effect until revoked or until the appointee ceases to be employed by the National Parks Service.

Name; Area of Appointment

- Peter Rennick; All Parks
- Graeme Richard McGill; All Parks
- Andrew Charles Miller; All Parks
- Stephanie Ailsa Knox; All Parks
- Jerome John O'Neill; All Parks
- Denis Leslie Rose; All Parks
- Raymond Lawrence Leivers; All Parks
- Louise Brickley; Wilsons Promontory National Park

D. S. SAUNDERS
 Director of National Parks

Shrine of Remembrance Trustees
APPOINTMENT OF CHAIRMAN

His Excellency the Governor of the State of Victoria, in the Commonwealth of Australia, by and with the advice of the Executive Council of the said State, pursuant to section 3 (2) of the *Shrine of Remembrance Act 1978*, has been pleased to make the undermentioned appointment, viz.:

Wing Commander Peter Isaacson, D.F.C., A.F.C., D.F.M. as Chairman of the Shrine of Remembrance Trustees in the place of Colonel Sir Alfred N. Kemsley, C.M.G., C.B.E., M.S.M., E.D., who has resigned as Chairman.—(Rs.4333)

TOM FORRISTAL
 Clerk of the Executive Council

At the Executive Council Chamber
 Melbourne, 7 April 1983

APPOINTMENTS

His Excellency the Governor of the State of Victoria by and with the advice of the Executive Council thereof has by Orders made on 12 April 1983 been pleased to make the undermentioned appointments, viz:

Department of Property and Services
Returning Officer

Noelle Elizabeth Holmes to be Returning Officer for the Legislative Assembly Electoral District of Swan Hill, vice W. Norton resigned.

TOM FORRISTAL
 Clerk of the Executive Council

At the Executive Council Chamber
 Melbourne 12 April 1983

RESIGNATIONS

His Excellency the Governor of the State of Victoria by and with the advice of the Executive Council thereof has by Orders made on 7 April 1983 accepted the resignations of the persons named hereunder of the Offices mentioned, viz:

Health Commission

Members of the Committee of Management of Hospitals

Colin James Clark, as a Member of the Committee of Management of the Essendon and District Memorial Hospital as from 2 February 1983; Kenneth Claude Ward, as a Member of the Committee of Management of the Maroondah Hospital as from 21 March 1983; Noel Howard Webster, as a Member of the Committee of Management of the Maroondah Hospital as from 25 March 1983; Stanley Kevin Clarke, as a Member of the Committee of Management of the Ovens District Hospital as from 11 January 1983; Graeme John Bailey, as a Member of the Committee of Management of the Ovens District Hospital as from 20 January 1983; Wendy Ryan, as a Member of the Committee of Management of Tawonga District General Hospital as from 8 March 1983.

These resignations are in accordance with the provisions of Section 63G (1) of the *Hospitals and Charities Act 1958*.

TOM FORRISTAL
 Clerk of the Executive Council

At the Executive Council Chamber
 Melbourne 7 April 1983

ORDERS IN COUNCIL

LAND ACT 1958

At the Executive Council Chamber, Melbourne, the twenty-ninth day of March, 1983

Present:

His Excellency the Governor of Victoria
 Mr Jolly | Mr Kent
 Mr White

UNUSED ROADS CLOSED

His Excellency the Governor of the State of Victoria, in the Commonwealth of Australia, by and with the advice of the Executive Council of the said State, pursuant to the provisions of section 349 of the *Land Act 1958* and with the concurrence in writing of the council of the municipality concerned and that of any adjoining land owners, doth hereby close the unused roads hereinafter described, viz.:

Municipal District of the City of Colac—

Township of Colac, being the road indicated by hatching on plan hereunder—(C 279⁹) (L.I-640)

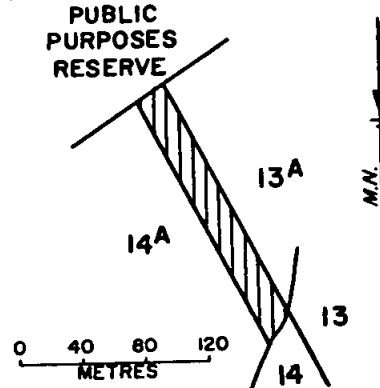

Municipal District of the Shire of Euroa—

Parish of Wondoomarook, being the road indicated by hatching on plan hereunder—(W347⁹) (Rs.12298).

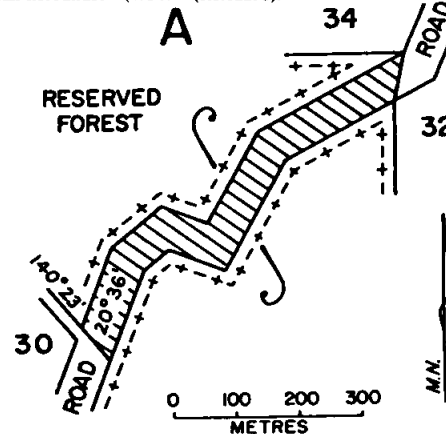

And the Honourable Roderick Alexander Mackenzie, Her Majesty's Minister of Lands for the State of Victoria, shall give the necessary directions herein accordingly.

TOM FORRISTAL
 Clerk of the Executive Council

This order replaces the order appearing in *Government Gazette* No. 34 dated 8 April 1983 on page 767.

CROWN LAND (RESERVES) ACT 1978

*At the Executive Council Chamber, Melbourne, the
twenty-ninth day of March, 1983*

Present:

His Excellency the Governor of Victoria

Mr Jolly
Mr White

Mr Kent

CROWN LANDS TEMPORARILY RESERVED

His Excellency the Governor of the State of Victoria, in the Commonwealth of Australia, by and with the advice of the Executive Council of the said State, pursuant to the provisions of sections 4 and 7 of the *Crown Lands (Reserves) Act 1978*, and being of the opinion that the Crown lands concerned are required for the public purposes respectively mentioned, doth hereby temporarily reserve and also except from prospecting or from occupation for mining purposes under any miner's right, the Crown lands hereinafter described, viz.:

Ballarat East—For Health Commission purposes—976 square metres, being Crown allotment 22^A, section 59, Township of Ballarat East, as shown on Certified Plan No. 101249 lodged in the Central Plan Office—(B 128⁽⁴¹⁾) (Rs. 11838).

Barrarbool—For Health Commission purposes—1065 square metres, being Crown allotment 9^A, Parish of Barrarbool, as indicated by hatching on plan hereunder—(Parish 2083) (Rs. 12171).

Borong—For Police purposes—2129 square metres, being Crown allotment 10^B, section 5, Parish of Borong, as indicated by hatching on plan hereunder—(B 89⁽¹⁰⁾) (Rs. 12259).

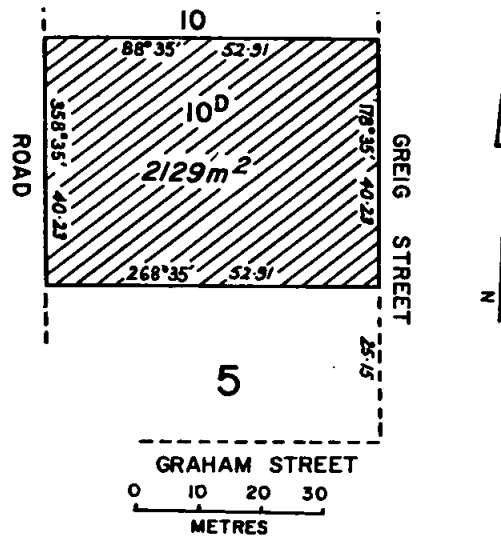
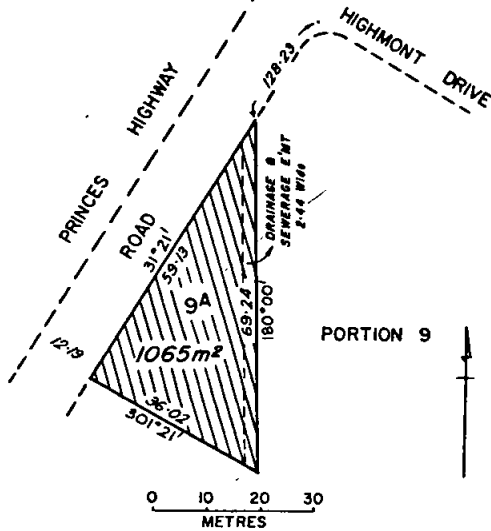

And the Honourable Roderick Alexander Mackenzie, Her Majesty's Minister of Lands for the State of Victoria, shall give the necessary directions herein accordingly.

TOM FORRISTAL
Clerk of the Executive Council

This order replaces the order appearing in *Government Gazette* No. 34 dated 8 April 1983 on page 767.

Forests Act 1958

*At the Executive Council Chamber, Melbourne, the
seventh day of April, 1983*

Present:

His Excellency the Governor of Victoria

Mr Simpson
Mr White

Mr Kent

EXCHANGE OF FOREST AREAS FOR CROWN LANDS

In pursuance of the provisions of Section 49 of the *Forests Act 1958*, No. 6254 His Excellency the Governor of the State of Victoria, by and with the advice of the Executive Council, doth hereby order that the areas of reserved forest described in the accompanying Excision Schedule No. 196 and comprising 7607 hectares, more or less, be excised from the Forest Reserves and that the areas of unoccupied Crown lands described in the accompanying Dedication Schedule No. 262 and comprising 14 624 hectares, more or less, be dedicated as reserved forest in lieu thereof.

EXCISION SCHEDULE No. 196

Seven thousand six hundred and seven hectares (7607 ha), more or less, of reserved forest comprising the areas tabulated hereunder and shown by cross hatched lines in diagrams 1461 to 1466, inclusive on the accompanying plans A, B and C.

| Diagram | Correspondence No. | | Parish | Plan No. | County | Area |
|---------|--------------------|------------------|---------------|----------|------------|---------|
| | Forests | Lands | | | | |
| 1461 | 81/2860 | L1-1526 | Irrewillipe | 2776 | Polwarth | 3070 ha |
| 1462 | 81/2860 | L1-1526 | Natte Murrang | 3286 | Polwarth | 2107 ha |
| | | | | 30 | | |
| 1463 | 81/2860 | J28459 J28765 | Gerangamete | 194 | Heytesbury | 38 ha |
| | | | | 499A | | |
| 1464 | 81/2860 | L1-1221 | Timboon | 3595 | Heytesbury | 275 ha |
| 1465 | 81/2860 | L1-1526 | Gerangamete | 194 | Polwarth | 621 ha |
| | | | | 528A | | |
| 1466 | 81/2860 | L1-1526 | Barwon Downs | 34 | Polwarth | 1496 ha |

DEDICATION SCHEDULE No. 262

Fourteen thousand, Six hundred and twenty-four hectares (14 626 ha), more or less of unoccupied Crown lands comprising the areas tabulated hereunder and shown by diagonal hatched lines in diagrams 1142 to 1169, inclusive, on the accompanying plans A, B, C, D, E, F, G, H, I and J.

| Diagram | Correspondence to | | Parish | Plan No. | County | Area |
|---------|--------------------|------------------|---------------|----------|------------|---------|
| | Forests | Lands | | | | |
| 1142 | 80/2314 | G72975 | Wensleydale | 3793 | Polwarth | 783 ha |
| | 81/2860 | X398R L1-1186 | Yan Yan Gurt | Cty 28 | | |
| 1143 | 81/2860 | X398R L1-1186 | Wensleydale | 3793 | Polwarth | 63 ha |
| 1144 | 81/2860 | X398R L1-1341 | Bambra | 20 | Polwarth | 93 ha |
| 1145 | 81/2860 | X398R L1-1341 | Lorne | 284A | Polwarth | 152 ha |
| 1146 | 81/2860 | L1-1341 | Bambra | 20 | Polwarth | 103 ha |
| 1147 | 81/2860 | X398R | Weeaprouinah | 485D | Polwarth | 51 ha |
| | | C89616 | | | | |
| 1148 | 81/2860 | X398R L1-1343 | Kaanglang | 239 | Polwarth | 236 ha |
| 1149 | 81/2860 | X398R L1-1303 | Yaugher | 528A | Polwarth | 11 ha |
| 1150 | 81/2860 | X398R | Yaugher | 528A | Polwarth | 496 ha |
| | | L1-1303 | | | | |
| 1151 | 81/2860 | X398R | Barramunga | 32 | Polwarth | 1132 ha |
| | | L1-1304 | | | | |
| 1152 | 81/2860 | X398R | Moorabool | 3168 | Polwarth | 193 ha |
| | | L1-1343 | | | | |
| 1153 | 81/2860 | X398R | Yaugher | 528A | Polwarth | 124 ha |
| | | L1-1303 | | | | |
| 1154 | 81/2860 | X398R | Barramunga | 32 | Polwarth | 500 ha |
| | | L1-1304 | | | | |
| 1155 | 81/2860 | X398R | Krambruk | 268A | Polwarth | 165 ha |
| | | L1-1301 | | | | |
| 1156 | 81/2860 | X398R | Krambruk | 268B | Polwarth | 98 ha |
| | | L1-1301 | | | | |
| 1157 | 81/2860 | X398R | Moorbanool | 3168 | Polwarth | 1393 ha |
| | | L1-1305 | | | | |
| 1158 | 80/2301 81/2860 | X398R | Weeaprouinah | 485D | Heytesbury | 115 ha |
| | | L1-1345 | | | | |
| 1159 | 81/2860 | X398R | Jancourt | 2781 | Heytesbury | 54 ha |
| | | J28765 | | | | |
| 1160 | 81/2860 | X398R | Wiridjil | 499A | Heytesbury | 54 ha |
| | | C89616 | | | | |
| 1161 | 81/2860 | X398R | Wyelangta | 519 | Polwarth | 135 ha |
| | | C89616 | | | | |
| 1162 | 81/2860 | X398R | Aire | 2 | Polwarth | 1290 ha |
| | | L1-1305 | | | | |
| 1163 | 81/2860 | X398R | Wyelangta | 519 | Polwarth | 616 ha |
| | | C89616 | | | | |
| 1164 | 81/2860 | X398R | Barwongemoong | 34A | Polwarth | 1592 ha |
| | | L1-1305 | | | | |
| 1165 | 81/2860 | X398R | Moomowroong | 314B | Polwarth | 2150 ha |
| | | L1-1305 | | | | |
| 1166 | 81/2860 | X398R | Wangerrip | 485D | Heytesbury | 1297 ha |
| | | L1-1344 | | | | |
| 1167 | 81/2860 | X398R | La Trobe | Cty 20 | Heytesbury | 1155 ha |
| | | L1-1344 | | | | |
| 1168 | 81/2860 | X398R | Wiridjil | 499A | Heytesbury | 230 ha |
| | | J28765 | | | | |
| 1169 | 81/2860 | X398R | Wiridjil | 499A | Heytesbury | 230 ha |
| | | J28765 | | | | |

Such excision and dedications to take effect on the fourteenth day after publication of this order in the *Government Gazette*.

EXCISION SCHEDULE N° 196 PLAN A

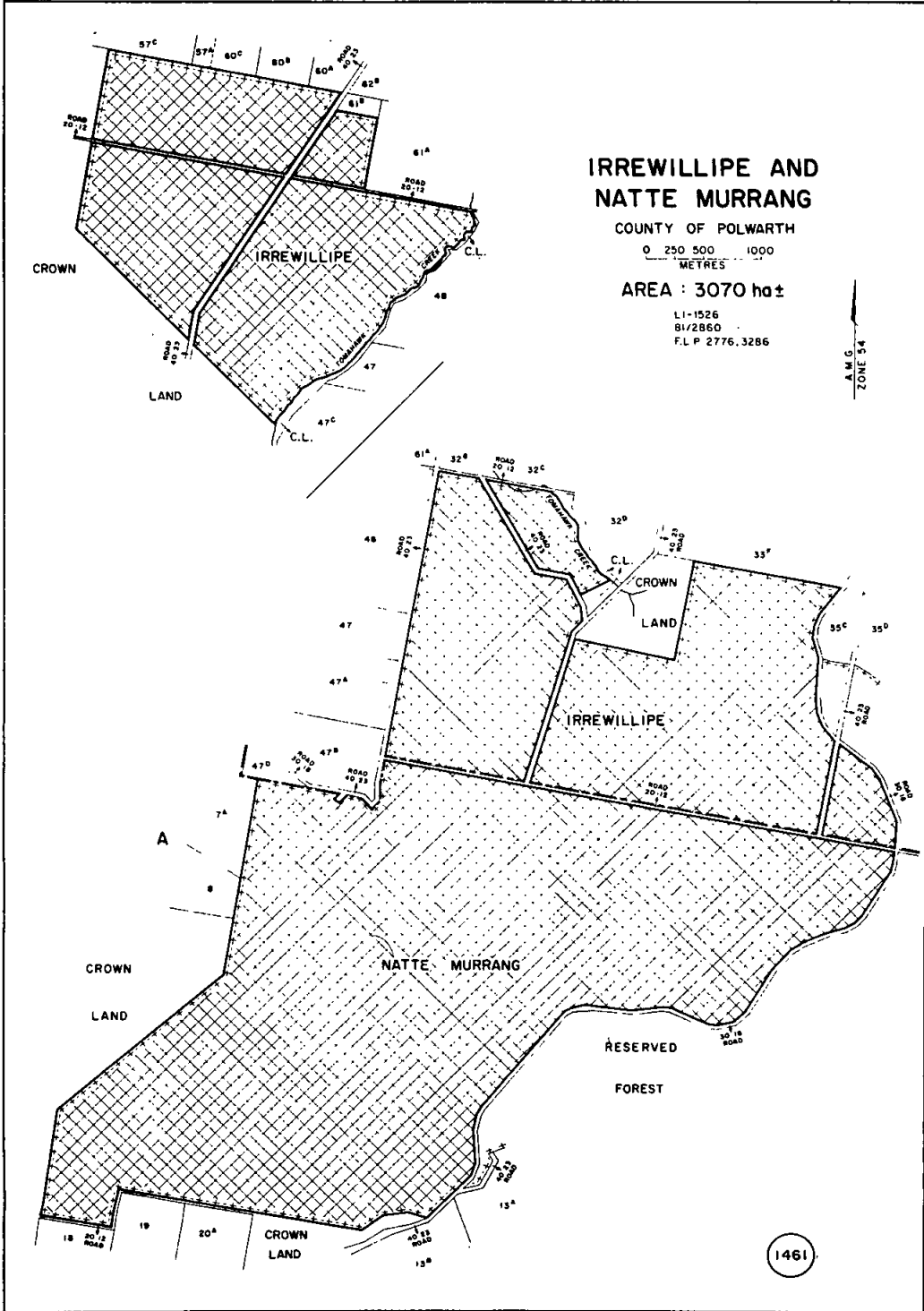

EXCISION SCHEDULE N° 196 PLAN B

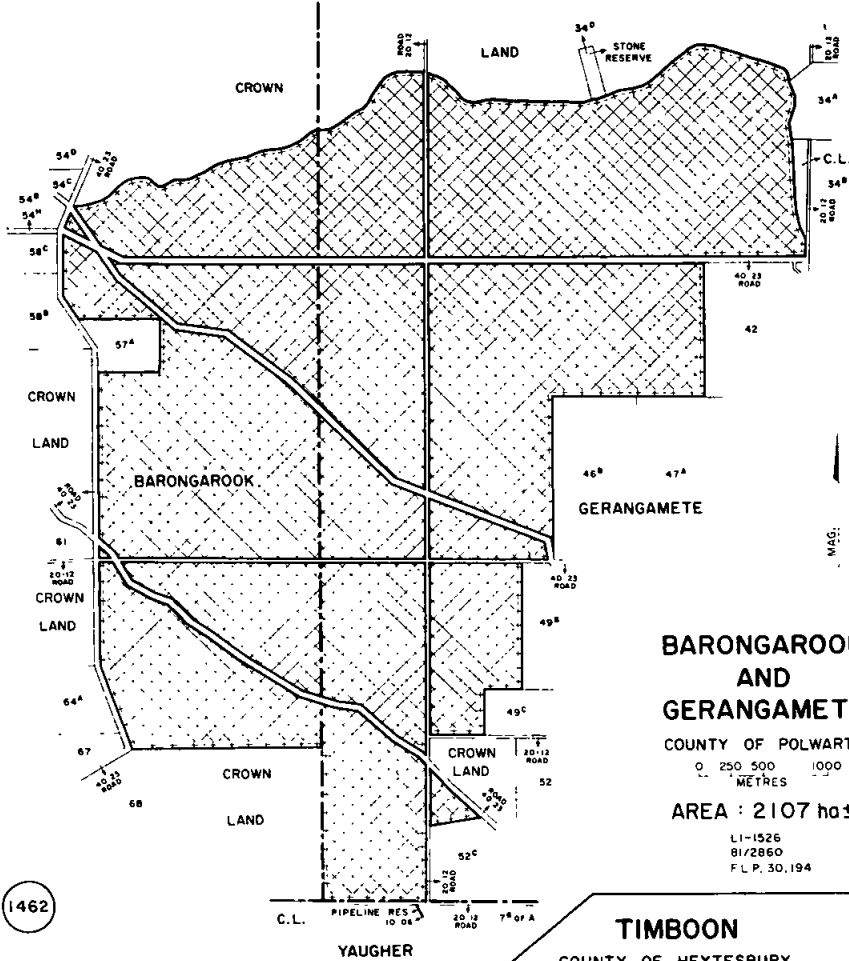

BARONGAROOK AND GERANGAMETE

COUNTY OF POLWARTH

0 250 500 1000 METRES

AREA : 2107 ha±

L1-1526
81/2860
F.L.P. 30,194

1462

TIMBOON

COUNTY OF HEYTESBURY

0 250 500 1000 METRES

AREA : 275 ha±

L1-1221
81/2860
F.L.P. 3595

WIRIDJIL

COUNTY OF HEYTESBURY

0 250 500 1000 METRES

AREA : 38 ha±

J28459, J28765
81/2860
F.L.P. 499A

SUBJECT TO SURVEY

MAG

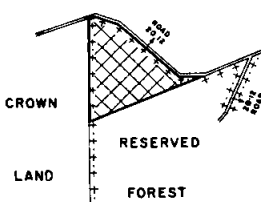

1463

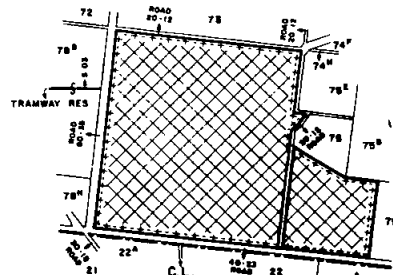

PAARATTE

1464

EXCISION SCHEDULE N° 196 PLAN C

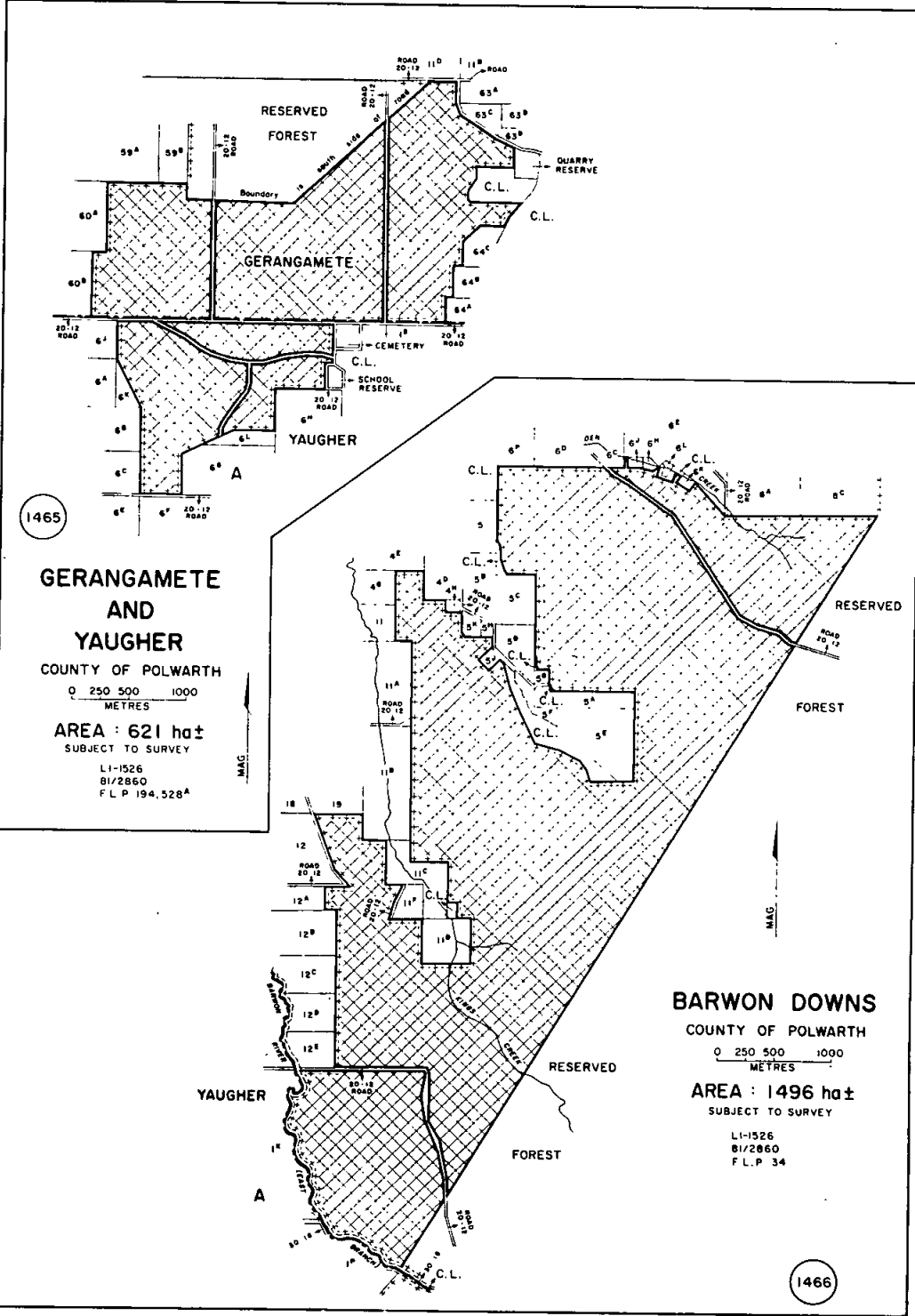

1465

GERANGAMETE AND YAUGHER

COUNTY OF POLWARTH
0 250 500 1000
METRES

AREA : 621 ha ±
SUBJECT TO SURVEY
L1-1526
81/2860
F.L.P. 194, 528^A

BARWON DOWNS

COUNTY OF POLWARTH
0 250 500 1000
METRES

AREA : 1496 ha ±
SUBJECT TO SURVEY
L1-1526
81/2860
F.L.P. 34

1466

DEDICATION SCHEDULE N° 262 PLAN A

WENSLEYDALE AND YAN YAN GURT

COUNTY OF POLWARTH

0 250 500 1000
METRES

AREA : 783 ha±

G72975, X398^h, LI-1186
80/2314, 81/2860
F.L.P. 3793, CTY 28

MAG.

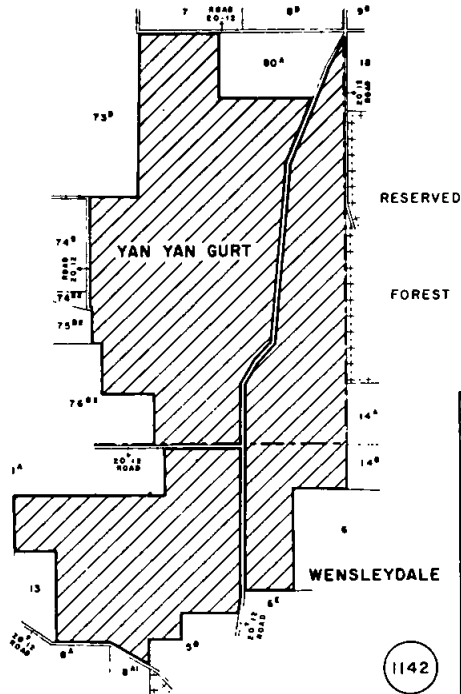

WENSLEYDALE

COUNTY OF POLWARTH

0 250 500 1000
METRES

AREA : 63 ha±

X398^h, LI-1186
81/2860
F.L.P. 3793

MAG.

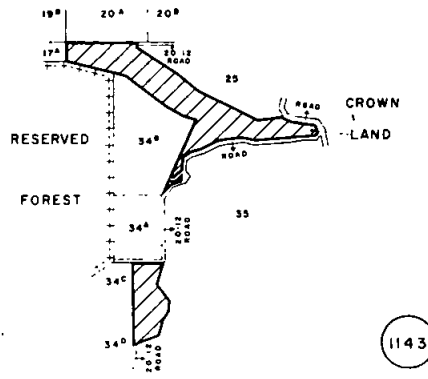

LORNE

COUNTY OF POLWARTH

0 100 200 400
METRES

AREA : 152 ha±

X398^h, LI-1341
81/2860
F.L.P. 284^A

MAG.

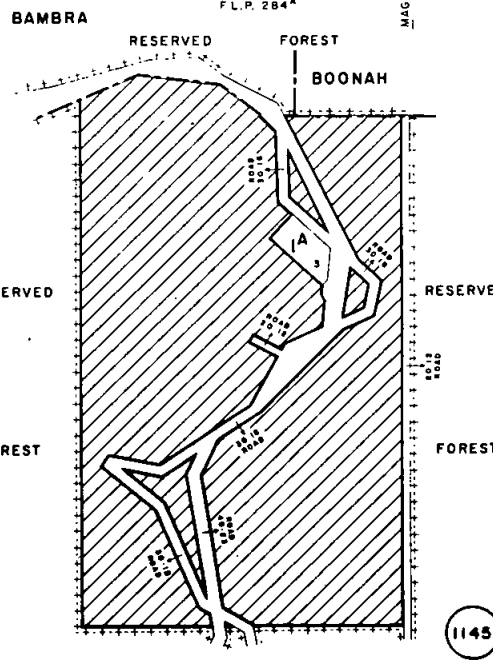

BAMBRA

COUNTY OF POLWARTH

0 250 500 1000
METRES

AREA : 93 ha± SUBJECT TO SURVEY

X398^h, LI-1341
81/2860
F.L.P. 20

MAG.

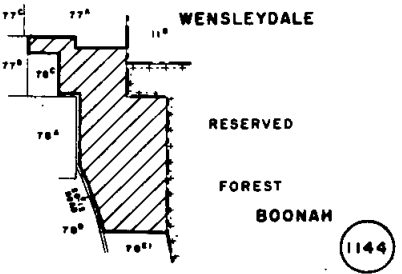

DEDICATION SCHEDULE N° 262 PLAN B

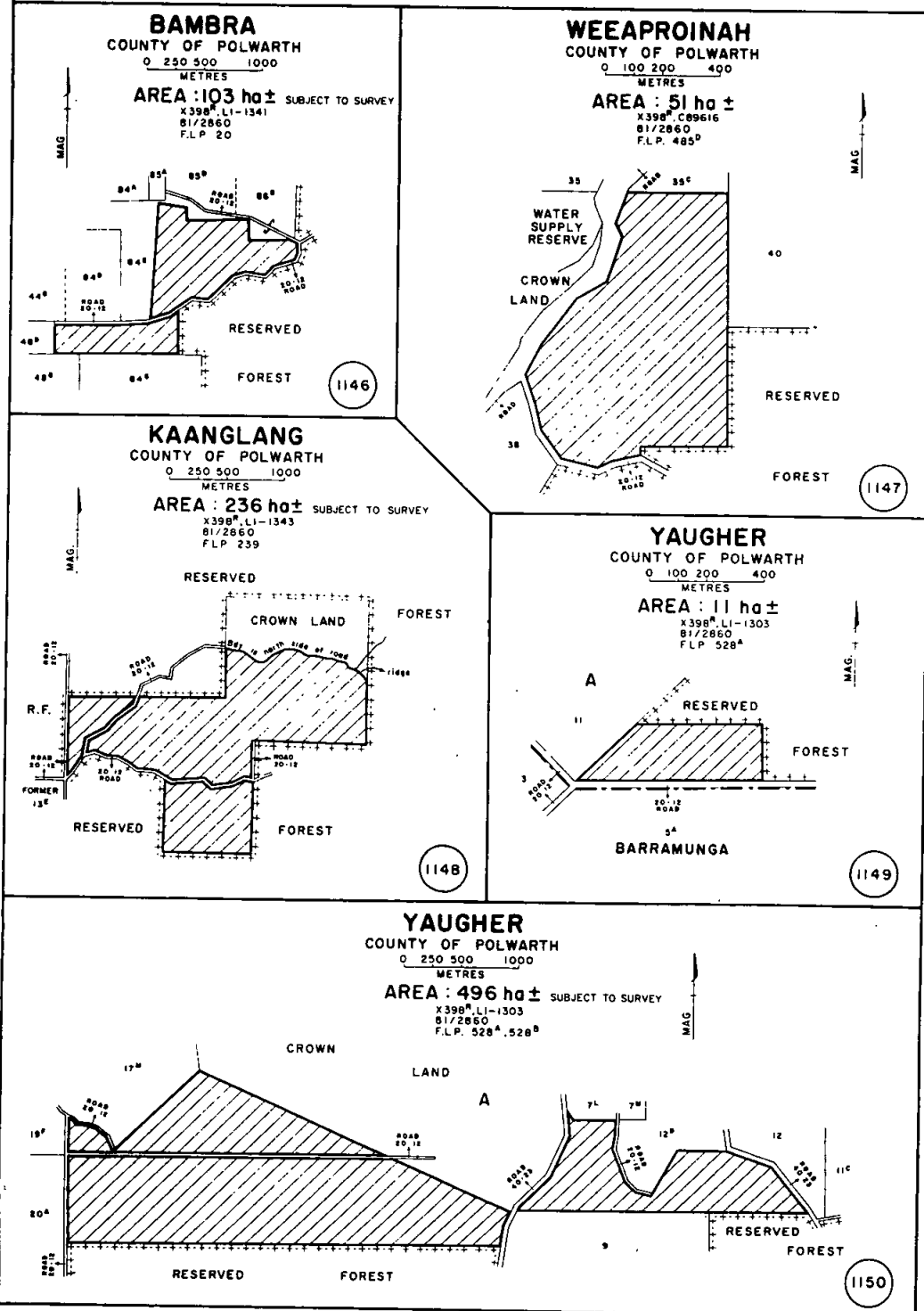

DEDICATION SCHEDULE N°262 PLAN C

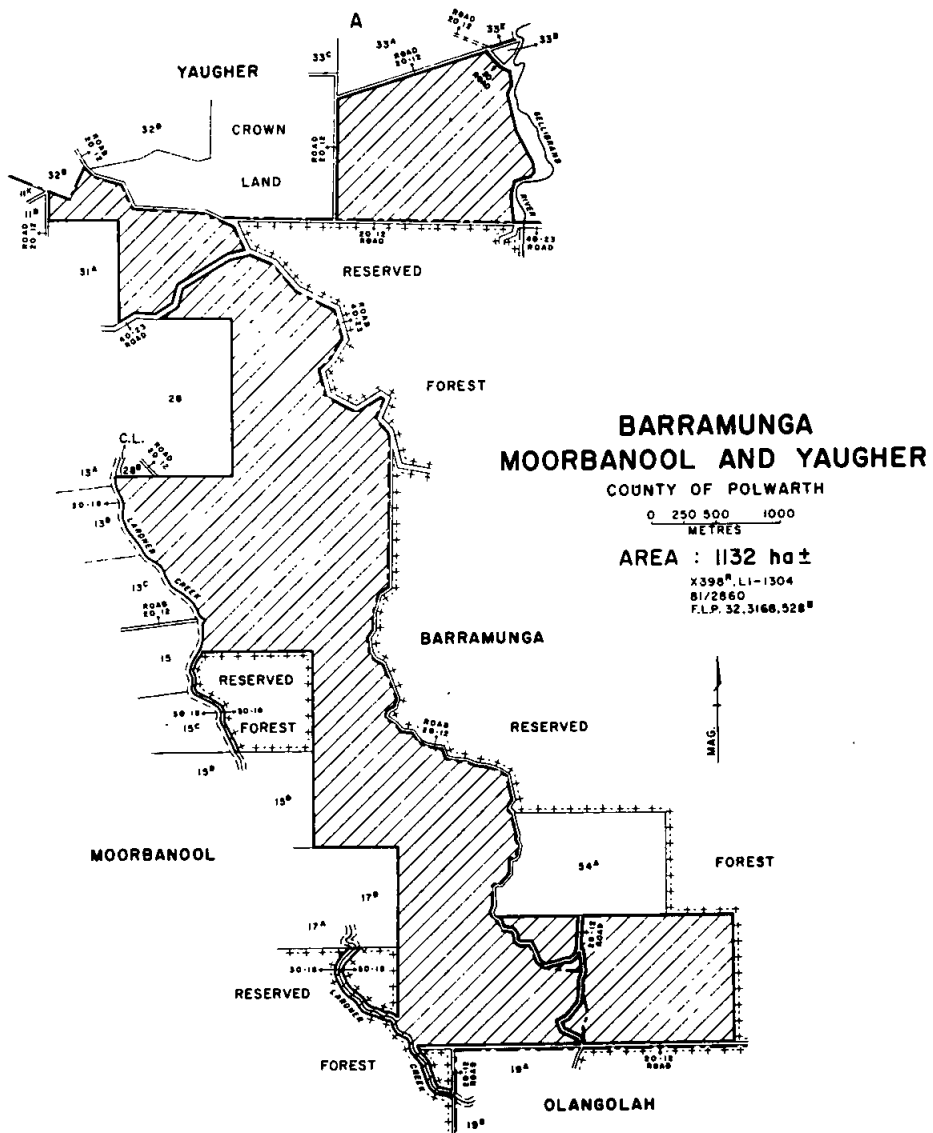

DEDICATION SCHEDULE N° 262 PLAN D

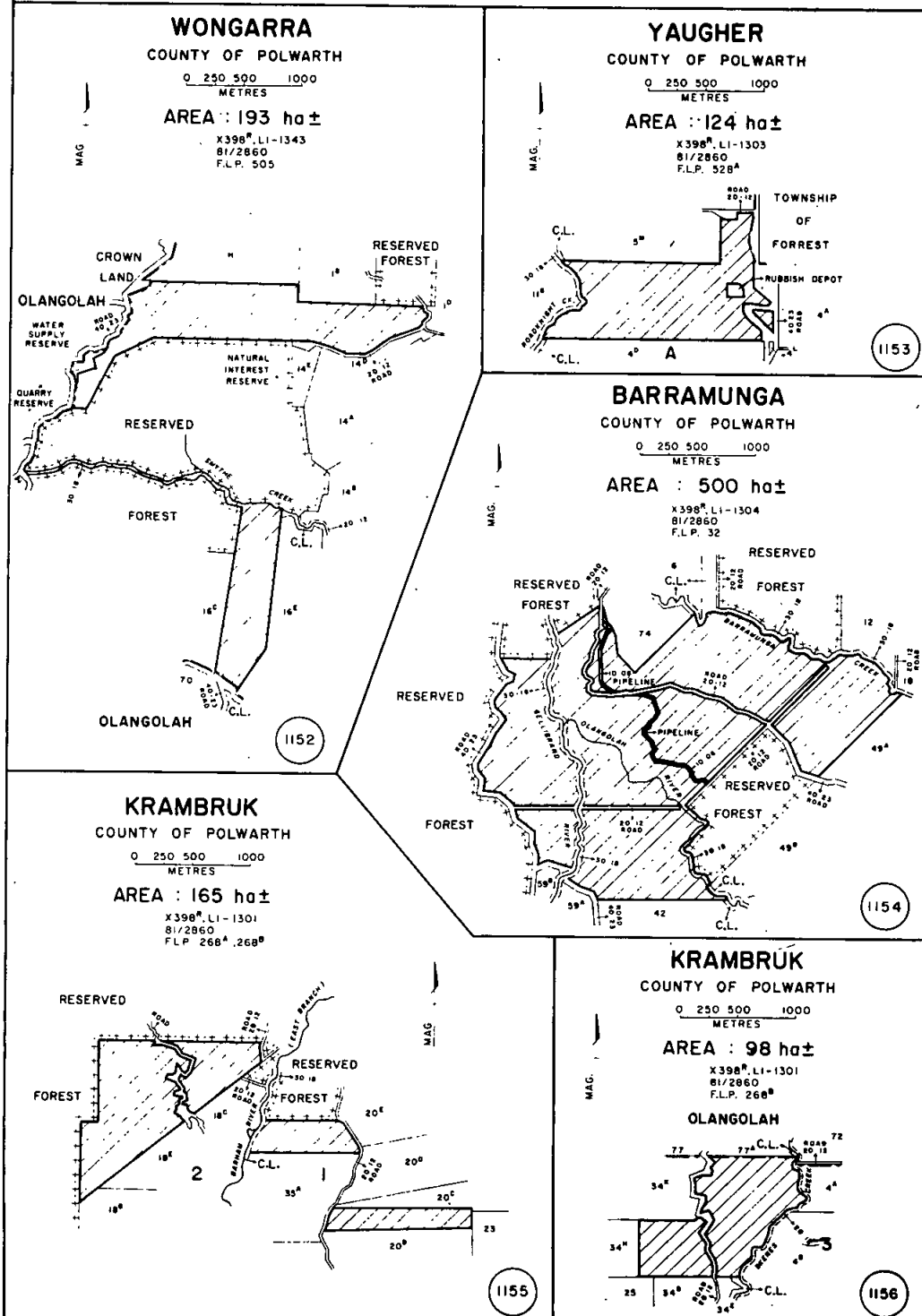

DEDICATION SCHEDULE N° 262 PLAN E

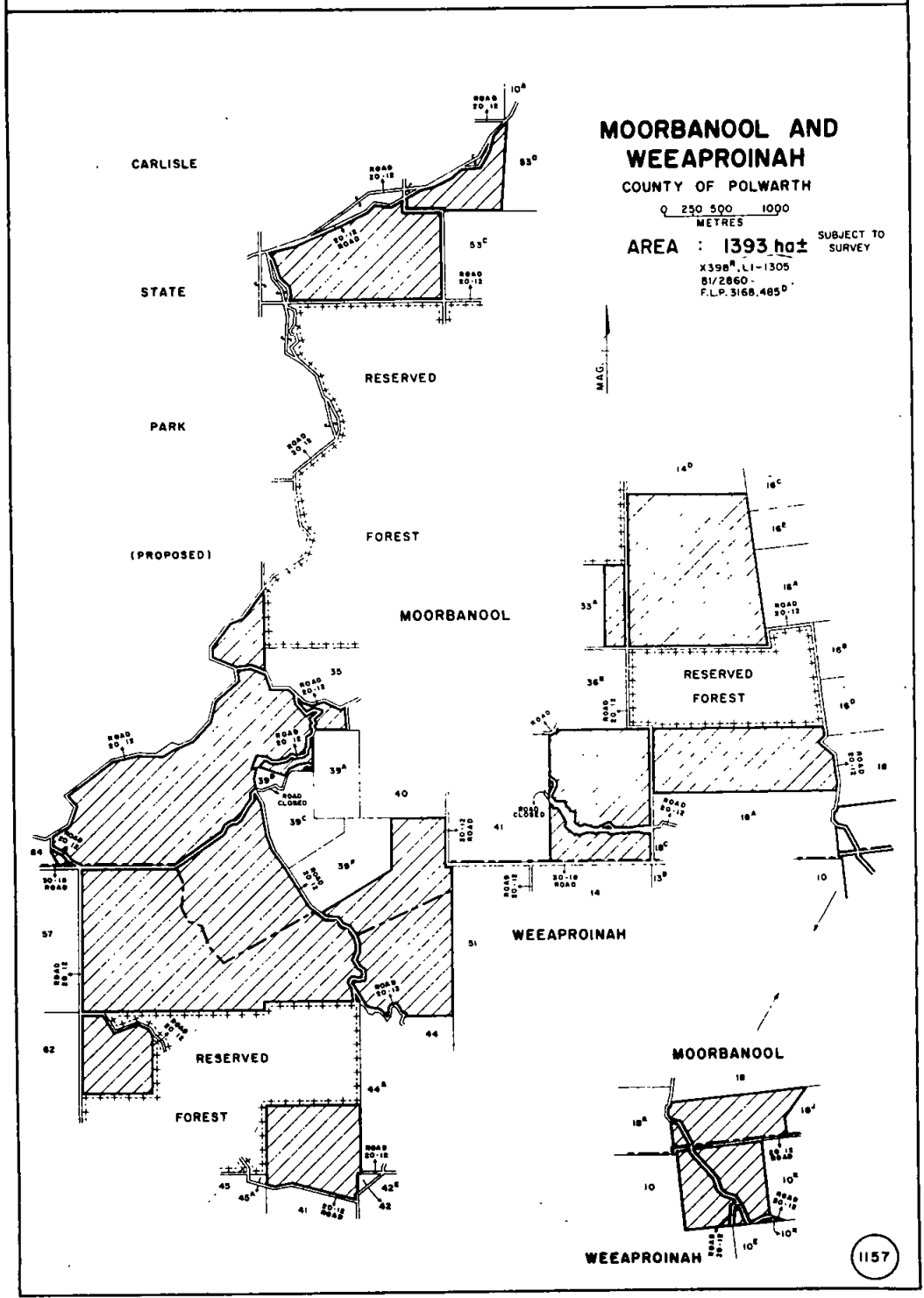

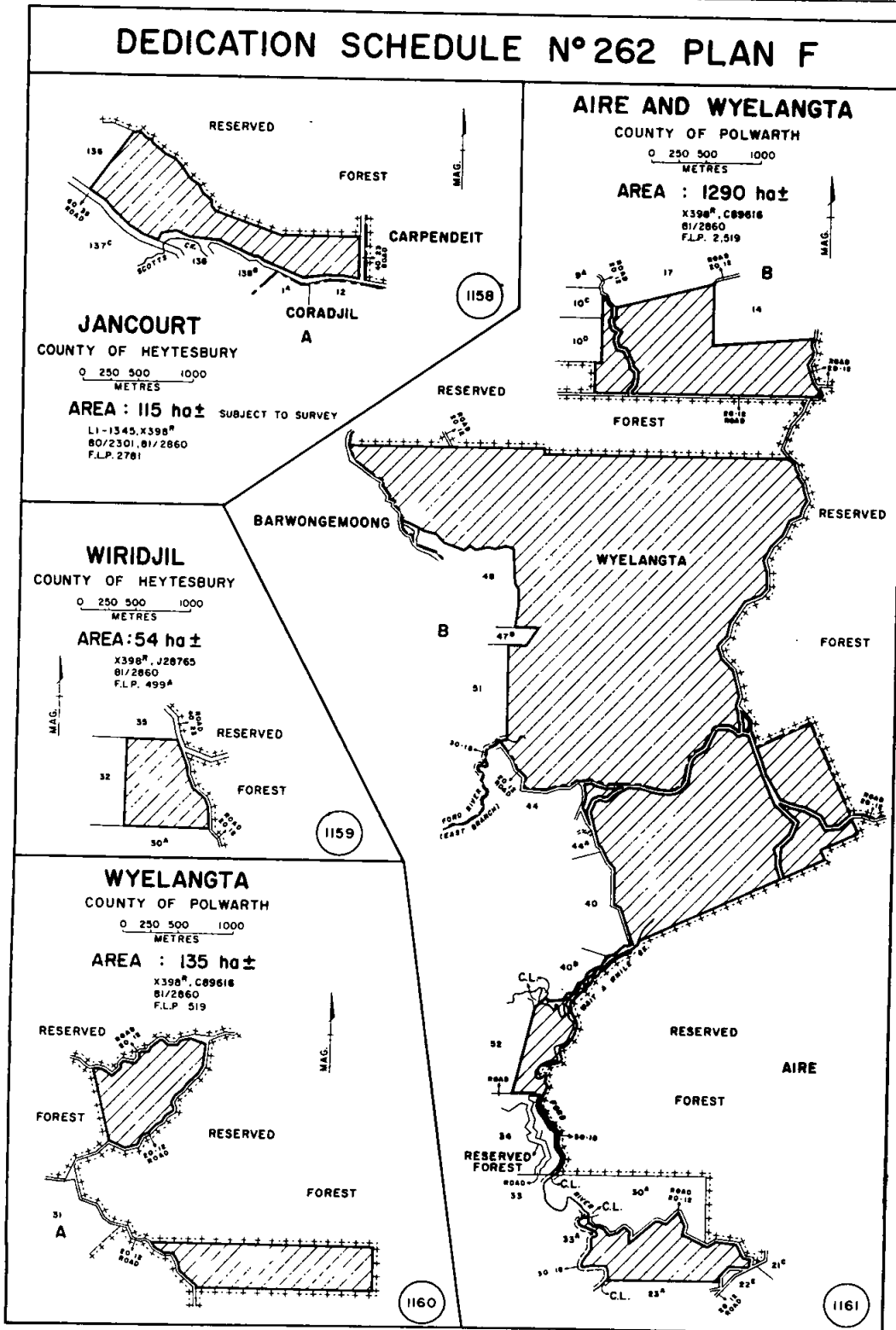

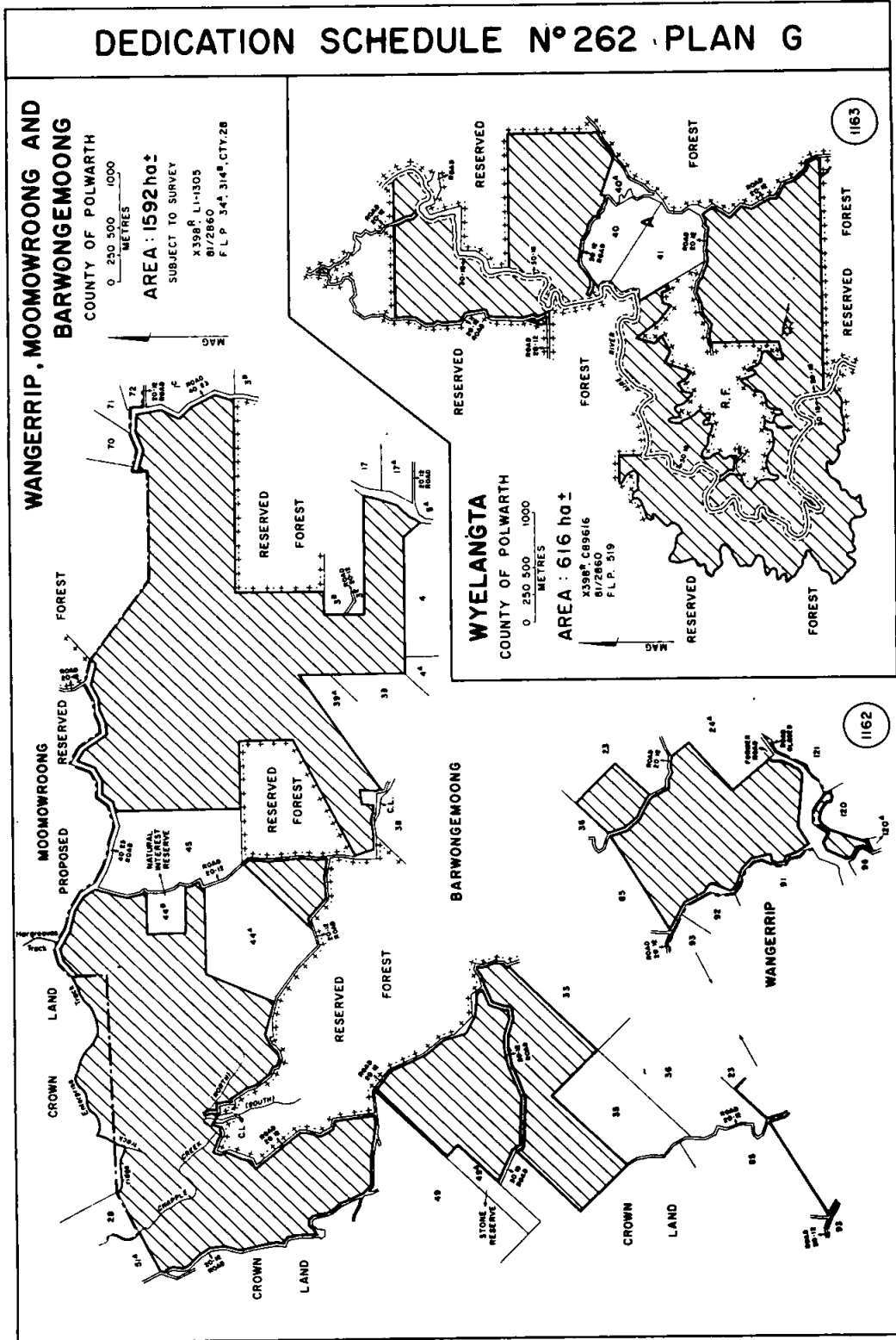

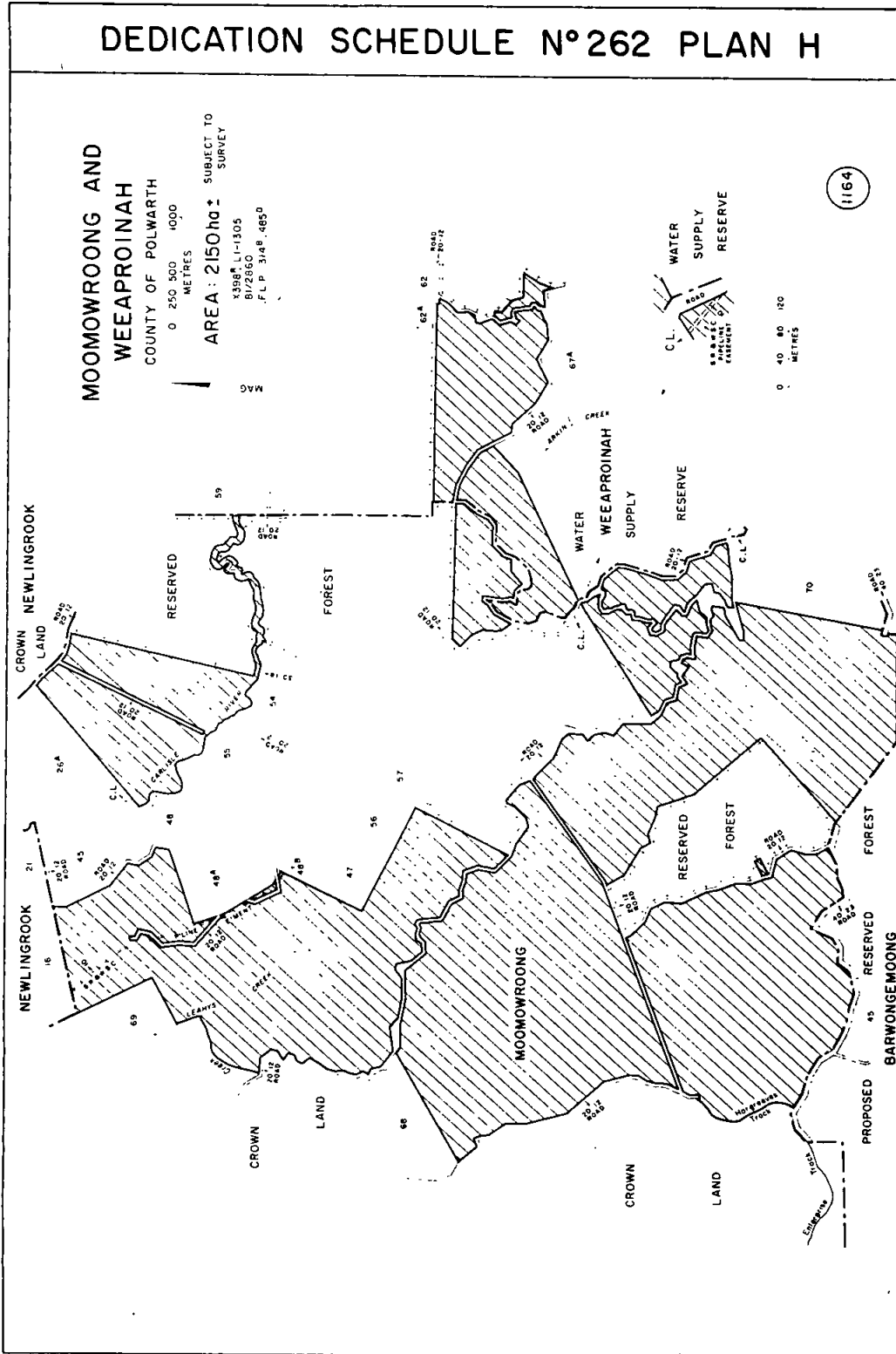

DEDICATION SCHEDULE N°262 PLAN I

**WAARRE, WIRIDJIL
AND
LA TROBE**
COUNTY OF HEYTESBURY
0 250 500 1000
METRES
AREA : 1297 ha±
X398, LI-1344
81/2860
F.L.P. 3690-2,499A,CTY 20

OLANGOLAH
COUNTY OF POLWARTH
0 250 500 1000
METRES
AREA : 167 ha±
X398, LI-1304
81/2860
F.L.P. 373

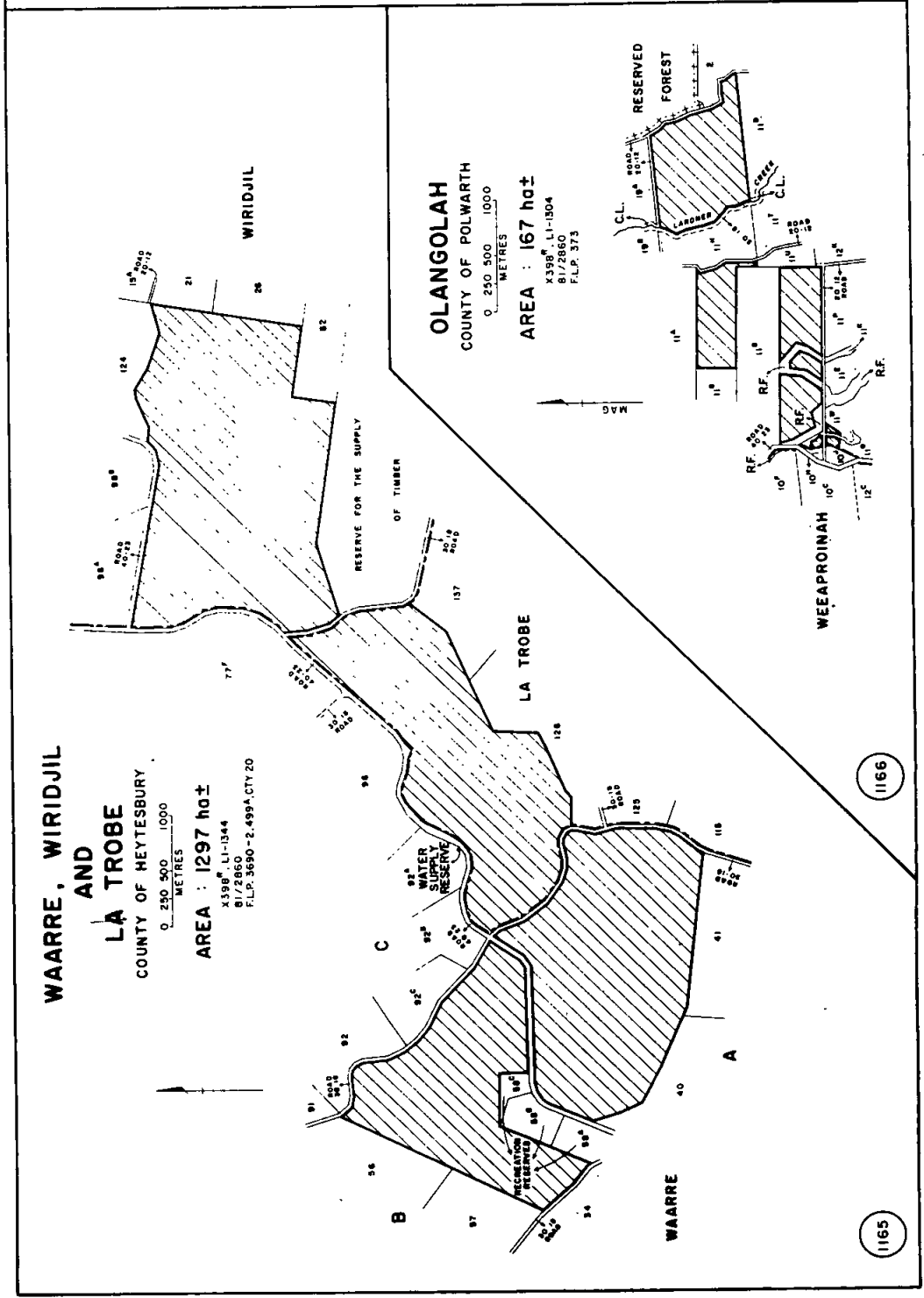

1165

1166

DEDICATION SCHEDULE N° 262 PLAN J

WIRIDJIL AND LA TROBE

COUNTY OF HEYTESBURY

0 250 500 1000
METRES

AREA : 1155 ha± SUBJECT TO SURVEY

X398^R LI-1344
81/2860
F.L.P. 499^A CTY 20

NOTE : THE GELLIBRAND RIVER ROAD IS EXCLUDED FROM THE DEDICATION

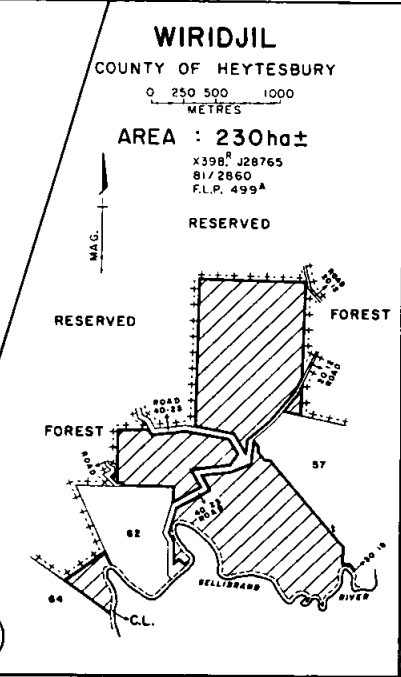
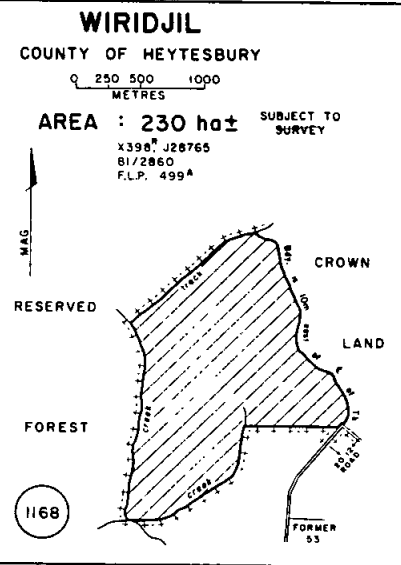
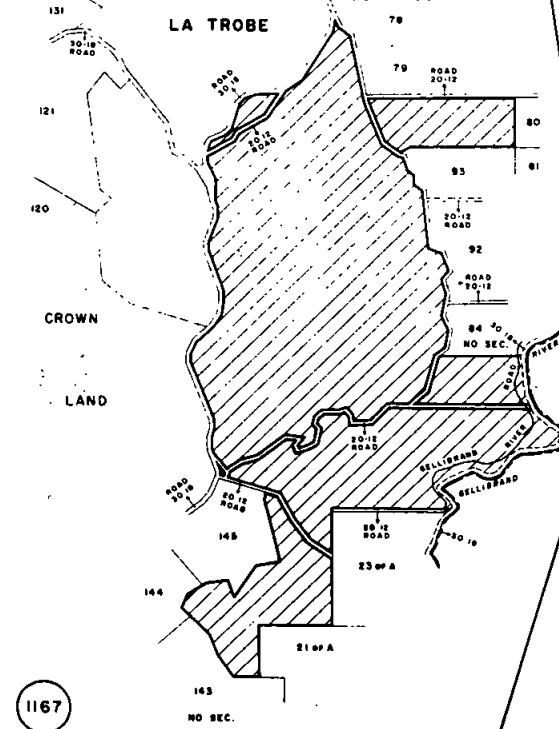
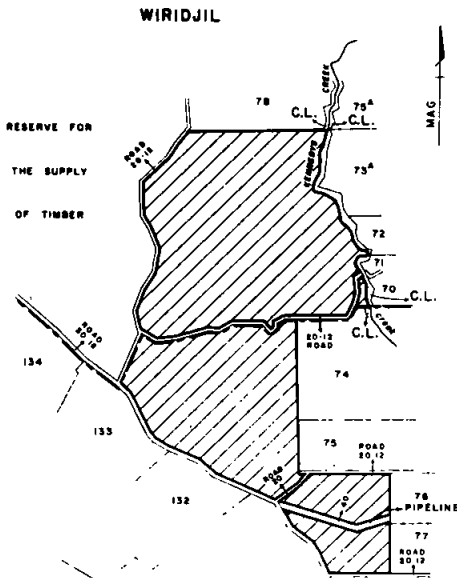

1167

1169

And the Honourable Roderick Alexander Mackenzie, Her Majesty's Minister of Forests for the State of Victoria, shall give the necessary directions herein accordingly.

TOM FORRISTAL
Clerk of the Executive Council

SUPERANNUATION ACT 1958

At the Executive Council Chamber, Melbourne, the seventh day of April, 1983

Present:
His Excellency the Governor of Victoria
Mr Simpson | Mr Kent
Mr White

Pursuant to the powers conferred by the provisions of paragraph (ja) of subsection (1) of Section 3 of the *Superannuation Act 1958*, His Excellency the Governor of the State of Victoria, by and with the advice of the Executive Council thereof doth by this Order declare that the provisions of the *Superannuation Act* shall apply to the officers named in the schedule set out hereunder.

Schedule

- Meehan, Margaret Imelda, Ballarat College of Advanced Education.
- Buchanan, Garry Andrew, Bendigo College of Advanced Education.
- Poustie, Murray James, Bendigo College of Advanced Education.
- Ratneyeke, Cynthia Dorothy, Bendigo College of Advanced Education.
- Roberts, Amanda Jane, Bendigo College of Advanced Education.
- Stuchbery, David John, Bendigo College of Advanced Education.
- Hennessy, Mark Edward, Lincoln Institute of Health Sciences.
- Gillies, Lois Eleanor, Victorian Institute of Secondary Education.
- Leong, Kin Ling, Victorian Institute of Secondary Education.
- Shaw, Bernard George, Warrnambool Institute of Advanced Education.

And the Honourable Robert Allen Jolly, Her Majesty's Treasurer for the State of Victoria, shall give the necessary directions herein accordingly.

TOM FORRISTAL
Clerk of the Executive Council

Local Government Act 1958

At the Executive Council Chamber, Melbourne, the seventh day of April, 1983

Present:
His Excellency the Governor of Victoria
Mr Simpson | Mr Kent
Mr White

ROAD DISCONTINUED — CITY OF BROADMEADOWS

Whereas it is provided in section 528 (2) of the *Local Government Act 1958*, that where a road (whether or not a public highway but not being a road set out on land of the Crown) or any part thereof is not required for public use, the Governor in Council on the request of the council of the municipality in which such road is situated made not less than one month after publishing in a newspaper generally circulating in the district and posting to the registered proprietor (if any) of the land and the owners and occupiers (if any) of lands abutting or immediately adjacent to the road notice of intention to make such a request may by Order published in the *Government Gazette* direct that such road or part shall be discontinued and thereupon such road or part shall be discontinued accordingly.

And whereas the Council of the City of Broadmeadows has requested that the Governor in Council direct that part of a road off Hermione Avenue, Oak Park be discontinued and not less than one month previously has published in a newspaper generally circulating in the district and posted to the registered proprietor of the land in the road and to the owners and occupiers of lands abutting or immediately adjacent to the road notice of intention to make such a request.

Now therefore, His Excellency the Governor of the State of Victoria, by and with the advice of the Executive Council thereof, hereby directs:—

- (a) that the said part of a road which is shown by hatching on the plan hereunder shall be discontinued;

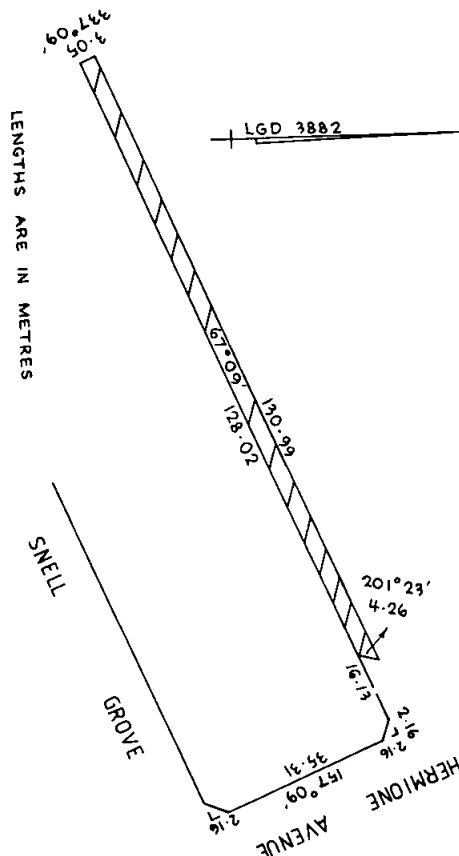

- (b) that notwithstanding such discontinuance the Melbourne and Metropolitan Board of Works shall continue to have and possess the same right title power authority or interest in or in relation to the whole of the land shown by hatching on the said plan as it had or possessed prior to such discontinuance with respect to or in connection with any drains or pipes laid or erected in on or over such land for the purposes of drainage or sewerage;
- (c) that, subject to any such right title power authority or interest the land in the said part of a road may be sold by the Council of the City of Broadmeadows by agreement.

And the Honourable Frank Noel Wilkes, Her Majesty's Minister for Local Government for the State of Victoria, shall give the necessary directions herein accordingly.

TOM FORRISTAL
Clerk of the Executive Council

Local Government Act 1958

At the Executive Council Chamber, Melbourne, the seventh day of April, 1983

Present:
His Excellency the Governor of Victoria
Mr Simpson | Mr Kent
Mr White

ROAD DISCONTINUED — TOWN OF BAIRNSDALE

Whereas it is provided in section 528 (2) of the *Local Government Act 1958*, that where a road (whether or not a public highway but not being a road set out on land of the Crown) or any part thereof

is not required for public use, the Governor in Council on the request of the council of the municipality in which such road is situated made not less than one month after publishing in a newspaper generally circulating in the district and posting to the registered proprietor (if any) of the land and the owners and occupiers (if any) of lands abutting or immediately adjacent to the road notice of intention to make such a request may by Order published in the *Government Gazette* direct that such road or part shall be discontinued and thereupon such road or part shall be discontinued accordingly:

And whereas the Council of the Town of Bairnsdale has requested that the Governor in Council direct that part of a road off Wallace Street, Bairnsdale be discontinued and not less than one month previously has published in a newspaper generally circulating in the district and posted to the registered proprietor of the land in the road and to the owners and occupiers of lands abutting or immediately adjacent to the road notice of intention to make such a request.

Now therefore, His Excellency the Governor of the State of Victoria, by and with the advice of the Executive Council thereof, hereby directs:—

(a) that the said part of a road which is shown by hatching and cross hatching on the plan hereunder shall be discontinued;

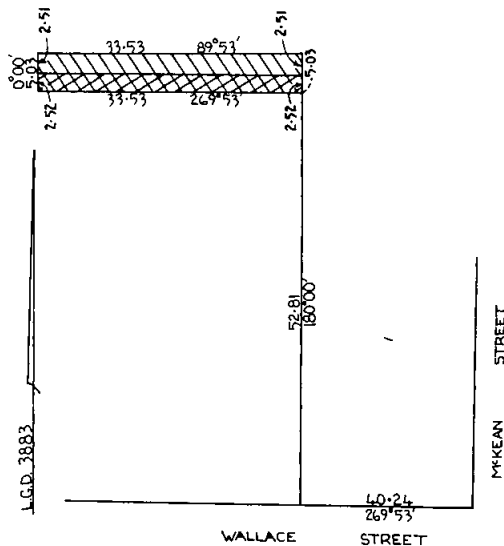

(b) that notwithstanding such discontinuance the Bairnsdale Sewerage Authority shall continue to have and possess the same right title power authority or interest in or in relation to the whole of the land shown by cross-hatching on the said plan as it had or possessed prior to such discontinuance with respect to or in connection with any drains or pipes laid or erected in on or over such land for the purposes of sewerage.

(c) that, subject to any such right title power authority or interest the land in the said part of a road may be sold by the Council of the Town of Bairnsdale by agreement.

And the Honourable Frank Noel Wilkes, Her Majesty's Minister for Local Government for the State of Victoria, shall give the necessary directions herein accordingly.

TOM FORRISTAL
Clerk of the Executive Council

MYRTLEFORD WATERWORKS TRUST

At the Executive Council Chamber, Melbourne, the seventh day of April, 1983

Present:

His Excellency the Governor of Victoria
Mr Simpson | Mr Kent
Mr White

WATER RESTRICTIONS

Whereas the supply of water available to the Myrtleford Waterworks Trust, an Authority constituted under the *Water Act 1958*, has fallen short of the quantity required to supply all entitlements proportionately in sufficient quantity to be of practical service; and

Whereas the *Water Act* provides that the Governor in Council may by Order regulate the order of priority in which the quantities with which the various bodies and persons so entitled to water shall be entitled to be supplied.

Now therefore, under the powers conferred by the *Water Act 1958*, and all other powers enabling him in that behalf, His Excellency the Governor of Victoria, by and with the advice of the Executive Council of the said State, hereby declares, orders and directs that:

Water supplied by the Myrtleford Waterworks Trust shall be used only as follows:

1. Occupiers of private residential properties shall be entitled to use a maximum of 60 litres per person resident on each day for domestic purposes.

2. Occupiers of other than private residential properties shall be entitled to use a maximum quantity in accordance with the nature of occupation of such property as specified hereunder:

| Nature of Occupation | Maximum Quantity of Water |
|---|---|
| Shops | |
| — Grocers, drapers, hardware, newsagents, service stations, garages, supermarkets and the like. | 15 litres per employee on each day. |
| — Milk bars, cafes, sandwich bars, butchers, delicatessens, fishmongers and the like. | 30 litres per employee on each day; and 75 litres on each day in respect of food preparation. |
| Public Residential | |
| — Hotels, Motels, Private hotels, Board houses and the like. | 40 litres per resident on each day; and 30 litres per employee on each day; and 1500 litres on each day in respect of each bar or kitchen or like on such premises. |
| Offices | |
| — Banks, legal, real estate, stock agents, police stations, and the like. | 15 litres per employee on each day. |
| Meeting Places | |
| — Public halls, club houses, church halls, churches and the like. | 200 litres on each day. |
| Schools and Kindergartens | |
| | 75 litres per pupil or employee in attendance on each day. |
| Golf Club | |
| | 30 litres per employee per day and 60 litres for club premises per day and 100 litres on each day in respect of each bar, kitchen or the like on such premises. |
| Hospital | |
| | 75 litres per person resident on each day; and water as required for medical/surgical purposes. |
| Industrial | |
| Bynon Soft Drink Pty. Ltd. | 5000 litres per week for the purpose of manufacturing soft drink. |
| Snow Valley Laundry | 5000 litres per day. |
| Valley Linen Hire | 5000 litres per day. |
| Laundrette | 6000 litres per day. |
| Australian Forrest Industries Ltd. | 700 000 litres per day. |
| Myrtleford Abbatoirs Pty. Ltd. | 150 000 litres per day. |

And the Honourable David Ronald White, Her Majesty's Minister of Water Supply for the State of Victoria, shall give the necessary directions herein accordingly.

TOM FORRISTAL
Clerk of the Executive Council

**WATER ACT 1958
STATE RIVERS AND WATER SUPPLY COMMISSION**

At the Executive Council Chamber, Melbourne, the seventh day of April, 1983

Present:

His Excellency the Governor of Victoria
Mr Simpson | Mr Kent
Mr White

GOULBURN-MURRAY IRRIGATION DISTRICT — DISTRICT EXTENDED — PORTION EXCISED — SHEPPARTON IRRIGATION AREA — BOUNDARIES VARIED

Under the powers conferred by the *Water Act 1958* and all other powers enabling him in that behalf, His Excellency the Governor of the State of Victoria, with the advice of the Executive Council of the said State, on the recommendation of the State Rivers and Water Supply Commission, doth hereby declare, order, and direct as follows:—

1. That as on and from 1 May 1983 the Goulburn-Murray Irrigation District shall be extended and the boundaries of the Shepparton Irrigation Area shall be varied by adding to the said District and Area the land shown by blue colour on a plan approved by the Governor in Council and deposited in the office of the State Rivers and Water Supply Commission, at 590 Orrong Road, Armadale (Corr. No. 63/3015); and

2. That as on and from 30 April 1983 there shall be excised from the Goulburn-Murray Irrigation District that portion of the same shown by green colour on the aforementioned plan and the boundaries of Shepparton Irrigation Area shall be varied to excise from the said Area the land coloured green on the said plan.

And the Honourable David Ronald White, Her Majesty's Minister of Water Supply for the State of Victoria, shall give the necessary directions herein accordingly.

TOM FORRISTAL
Clerk of the Executive Council

ARARAT CITY COUNCIL—LOCAL GOVERNING BODY

At the Executive Council Chamber, Melbourne, the seventh day of April, 1983

Present:

His Excellency the Governor of Victoria
Mr Simpson | Mr Kent
Mr White

APPROVAL TO SITE OF STORAGE AND ACQUISITION OF LAND FOR STORAGE

Under the powers conferred by the *Water Act* and all other powers enabling him in that behalf, His Excellency the Governor of the State of Victoria, by and with the advice of the Executive Council of the said State, doth hereby approve of the site required for the construction of a water storage and the acquisition of the land on which the storage is to be located as shown by red border and brown colour respectively on the plan approved by the Governor in Council and deposited in the office of the State Rivers and Water Supply Commission, Melbourne (Corr. No. 82/2929/25).

And the Honourable David Ronald White, Her Majesty's Minister of Water Supply for the State of Victoria, shall give the necessary directions herein accordingly.

TOM FORRISTAL
Clerk of the Executive Council

HEYTESBURY SEWERAGE AUTHORITY

At the Executive Council Chamber, Melbourne, the seventh day of April, 1983

Present:

His Excellency the Governor of Victoria
Mr Simpson | Mr Kent
Mr White

EXTENT OF SIMPSON SEWERAGE DISTRICT INCREASED

Under the powers conferred by the *Sewerage Districts Act* and all other powers enabling him in that behalf, His Excellency the Governor of the State of Victoria, by and with the advice of the Executive Council of the said State, doth hereby declare, order and direct that the extent of the Simpson Sewerage District of the Heytesbury Sewerage Authority be increased by adding thereto the lands

shown by red border on the plan approved by the Governor in Council, by and with this Order and deposited in the office of the State Rivers and Water Supply Commission, Melbourne (Corr. No. 79/2653/19) and as on and from the date hereof the extent of such district shall be and be deemed to be increased accordingly.

And the Honourable David Ronald White, Her Majesty's Minister of Water Supply for the State of Victoria, shall give the necessary directions herein accordingly.

TOM FORRISTAL
Clerk of the Executive Council

**GEELONG WATERWORKS AND SEWERAGE TRUST
Consent to Borrowing \$93 700**

At the Executive Council Chamber, Melbourne, the seventh day of April, 1983

Present:

His Excellency the Governor of Victoria
Mr Simpson | Mr Kent
Mr White

Under the powers conferred by the *Geelong Waterworks and Sewerage Act* and all other powers enabling him in that behalf, His Excellency the Governor of the State of Victoria, by and with the advice of the Executive Council of the said State, hereby consents to the Geelong Waterworks and Sewerage Trust borrowing the sum of Ninety three thousand seven hundred dollars (\$93 700) to meet the cost of conversion of Loan No. X.10.

And the Honourable David Ronald White, Her Majesty's Minister of Water Supply for the State of Victoria, shall give the necessary directions herein accordingly.

TOM FORRISTAL
Clerk of the Executive Council

LAND ACT 1958

At the Executive Council Chamber, Melbourne, the seventh day of April, 1983

Present:

His Excellency the Governor of Victoria
Mr Simpson | Mr Kent
Mr White

UNUSED ROADS CLOSED

His Excellency the Governor of the State of Victoria, in the Commonwealth of Australia, by and with the advice of the Executive Council of the said State, pursuant to the provisions of section 349 of the *Land Act 1958* and with the concurrence in writing of the council of the municipality concerned and that of any adjoining land owners, doth hereby close the unused roads hereinafter described, viz.:

Municipal District of the Shire of Orbost—Parish of Orbost East, being the roads indicated by hatching on plans hereunder—(0 23¹¹) (Rs. 11485)

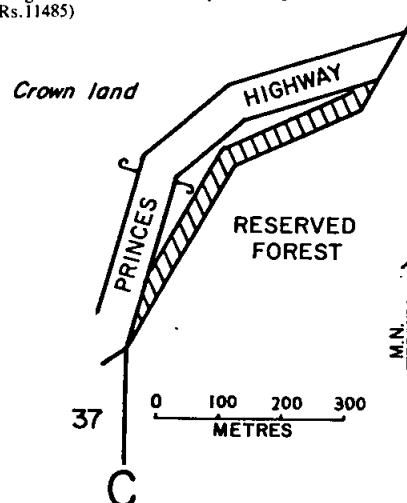

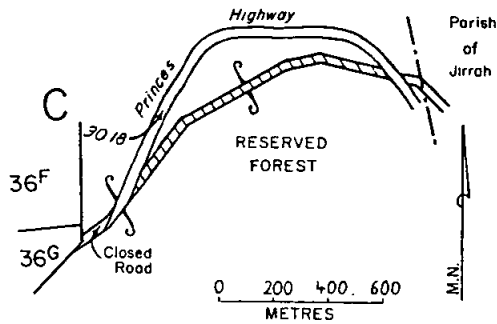

Municipal District of the Shire of Oxley—Parish of Greta, being the road indicated by hatching on plan hereunder—(G131¹⁰) (L8-915)

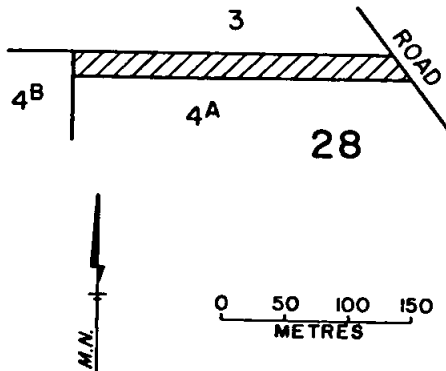

And the Honourable Roderick Alexander Mackenzie, Her Majesty's Minister of Lands for the State of Victoria, shall give the necessary directions herein accordingly.

TOM FORRISTAL
Clerk of the Executive Council

CROWN LAND (RESERVES) ACT 1978

At the Executive Council Chamber, Melbourne, the seventh day of April, 1983

Present:

His Excellency the Governor of Victoria
Mr Simpson Mr White Mr Kent

REVOCATION OF TEMPORARY RESERVATIONS OF LANDS BY ORDERS IN COUNCIL

His Excellency the Governor of the State of Victoria, in the Commonwealth of Australia, by and with the advice of the Executive Council of the said State, pursuant to the provisions of section 10 of the *Crown Land (Reserves) Act 1978*, doth hereby revoke the temporary reservations of lands by Orders in Council hereinafter described, viz.:

MANANGATANG—The temporary reservation by Order in Council of 20 October 1914 of 1.596 hectares of land in the Township of Manangatang (in section 4) as a site for a State School, revoked as to part by various Orders, so far as the balance containing 8519 square metres, more or less, is concerned—(M571¹⁰) (Rs.211)

WONTHAGGI—The temporary reservation by Order in Council of 1 March 1977 of 6783 square metres of land in the Township of Wonthaggi (being Crown allotment 34, section 54^A) as a site for Hospital purposes, as defined by description and hatching on plan published in the *Government Gazette* dated 16 March 1983—(W345¹⁷) (Rs.949)

And the Honourable Roderick Alexander Mackenzie, Her Majesty's Minister of Lands for the State of Victoria, shall give the necessary directions herein accordingly.

TOM FORRISTAL
Clerk of the Executive Council

CROWN LAND (RESERVES) ACT 1978

At the Executive Council Chamber, Melbourne, the seventh day of April, 1983

Present:

His Excellency the Governor of Victoria
Mr Simpson Mr White Mr Kent

CROWN LANDS TEMPORARILY RESERVED

His Excellency the Governor of the State of Victoria, in the Commonwealth of Australia, by and with the advice of the Executive Council of the said State, pursuant to the provisions of sections 4 and 7 of the *Crown Land (Reserves) Act 1978*, and being of the opinion that the Crown lands concerned are required for the public purposes respectively mentioned, doth hereby temporarily reserve and also except from prospecting or from occupation for mining purposes under any miner's right, the Crown lands hereinafter described, viz.:

KANGERONG—For Health Commission purposes—1185 square metres, being Crown allotment 11A, section 1, Parish of Kangerong, as indicated by hatching on plan hereunder—(K7(4) (Rs.12327)

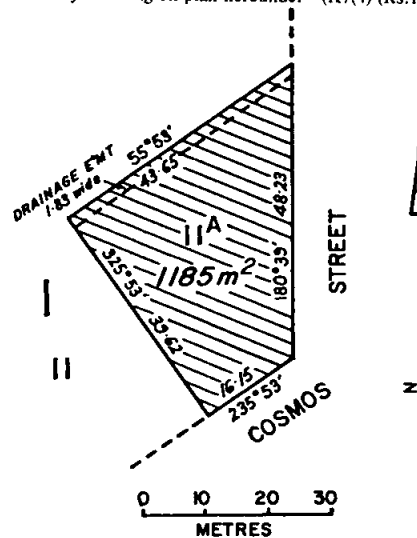

KORUMBURRA—For Departmental Residence—1030 square metres, being Crown allotment 33A, section 7, Township of Korumburra, as indicated by hatching on plan hereunder—(K172(12) (Rs.12214)

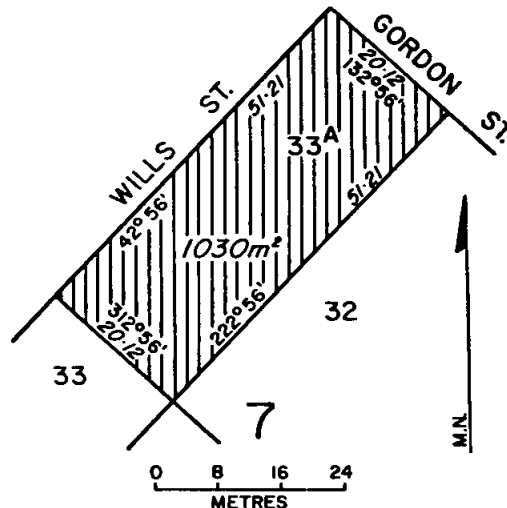

MOE—For Health Commission purposes—1172 square metres, being Crown allotment 36A, section 1, Township of Moe, as indicated by hatching on plan hereunder—(M498(10) (Rs.12269)

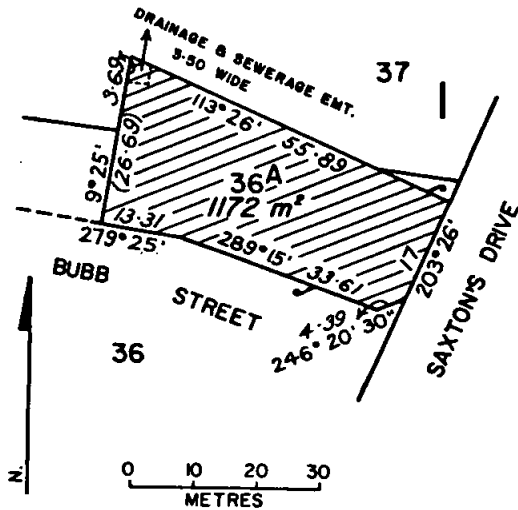

CROWN LAND (RESERVES) ACT 1978

At the Executive Council Chamber, Melbourne, the seventh day of April, 1983

Present:

His Excellency the Governor of Victoria
Mr Simpson | Mr Kent
Mr White

CROWN LANDS TEMPORARILY RESERVED

His Excellency the Governor of the State of Victoria, in the Commonwealth of Australia, by and with the advice of the Executive Council of the said State, pursuant to the provisions of sections 4 and 7 of the *Crown Land (Reserves) Act 1978*, and being of the opinion that the Crown Lands concerned are required for the purposes respectively mentioned, doth hereby temporarily reserve and also except from prospecting or from occupation for mining purposes under any miner's right, the Crown lands hereinafter described, viz.:

BRIGHT—For Infant Welfare Centre—194 square metres, being Crown allotment 15, section E, Township of Bright, as indicated by hatching on plan hereunder—(B573(5)(Rs.8086)

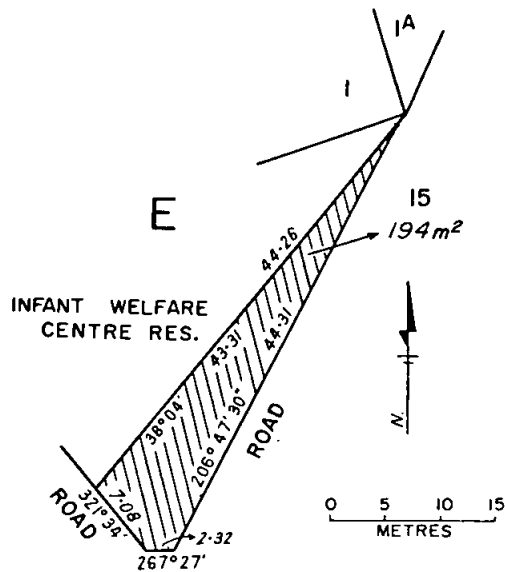

WANGARATTA SOUTH—For Health Commission purposes—1011 square metres, being Crown allotment 1A, section 4, Parish of Wangaratta South, as indicated by hatching on plan hereunder—(W85(9) (Rs.12247)

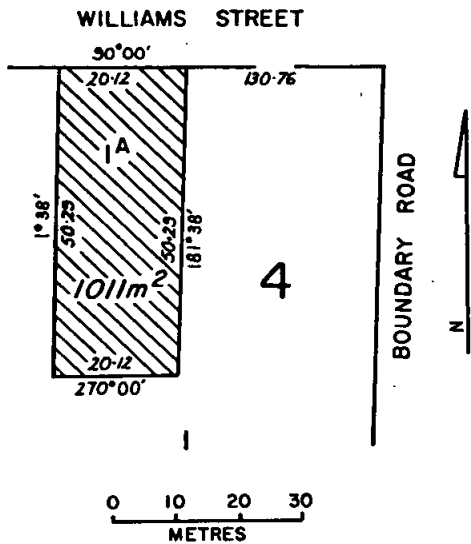

GOORAM GOORAM GONG—For Conservation of an Area of Natural Interest—48 hectares, more or less, being Crown allotment 41E, section A, Parish of Gooram Gooram Gong, as indicated by hatching on plan hereunder—(G149(3) (Rs.12182)

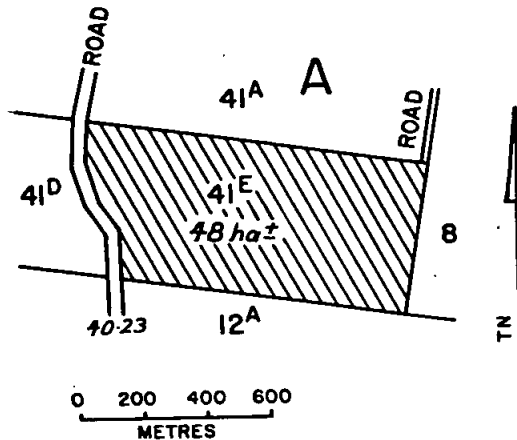

And the Honourable Roderick Alexander Mackenzie, Her Majesty's Minister of Lands for the State of Victoria, shall give the necessary directions herein accordingly.

TOM FORRISTAL
Clerk of the Executive Council

MARENGO—For Ornamental Plantation—2663 square metres, being Crown allotment 9, section 3, Township of Marengo, as shown on Certified Plan No. 106226 lodged in the Central Plan Office—(M611(2) (Rs.12396)

SEBASTOPOL—For Public Recreation—1.765 hectares, being Crown allotment 3, section 40, Township of Sebastopol, as shown on Certified Plan No. 106350 lodged in the Central Plan Office—(S353(9) (Rs.12039)

BALLARAT EAST—For Education purposes—942 square metres, being Crown allotment 20B, section L, Township of Ballarat East, as indicated by hatching on plan hereunder—(B128(47) (Rs.2789)

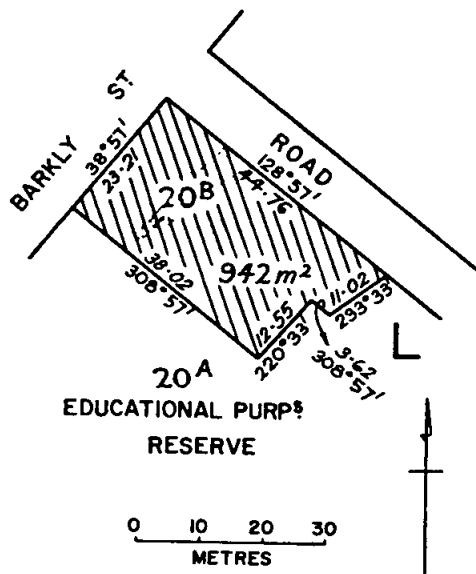

And the Honourable Roderick Alexander Mackenzie, Her Majesty's Minister of Lands for the State of Victoria, shall give the necessary directions herein accordingly.

TOM FORRISTAL
Clerk of the Executive Council

CROWN LAND (RESERVES) ACT 1978

At the Executive Council Chamber, Melbourne, the seventh day of April, 1983

Present:

His Excellency the Governor of Victoria
Mr Simpson | Mr Kent
Mr White

CROWN LAND PLACED UNDER THE CONTROL AND MANAGEMENT OF THE FORESTS COMMISSION

His Excellency the Governor of the State of Victoria, in the Commonwealth of Australia, by and with the advice of the Executive Council of the said State, pursuant to the provisions of section 18 (1) of the *Crown Land (Reserves) Act 1978*, doth hereby place the Crown land hereinafter described under the control and management of the Forests Commission, viz:

NARREE WORRAN—The land comprising 1.965 hectares, being Crown allotment 113A, Parish of Narree Worrان permanently reserved for Public Park by Order in Council of 21 December 1982 (see *Government Gazette* dated 5 January 1983)—(Rs.11403)

And the Honourable Roderick Alexander Mackenzie, Her Majesty's Minister of Lands for the State of Victoria, shall give the necessary directions herein accordingly.

TOM FORRISTAL
Clerk of the Executive Council

CROWN LAND (RESERVES) ACT 1978

At the Executive Council Chamber, Melbourne, the seventh day of April, 1983

Present:

His Excellency the Governor of Victoria
Mr Simpson | Mr Kent
Mr White

CROWN LAND PERMANENTLY RESERVED

His Excellency the Governor of the State of Victoria, in the Commonwealth of Australia, by and with the advice of the Executive Council of the said State, pursuant to the provisions of sections 4 and 7 of the *Crown Land (Reserves) Act 1978*, and being of the opinion that the Crown land concerned is required for the purpose mentioned, doth hereby permanently reserve and also except from prospecting or from occupation for mining purposes under any miner's right, the Crown land hereinafter described, viz.:

PORTLAND (LAWRENCE ROCKS)—For Management of Wildlife—Crown allotment 90, section 13, Parish of Portland, as indicated by hatching on plan hereunder—(Parish 3414) (Rs.8243)

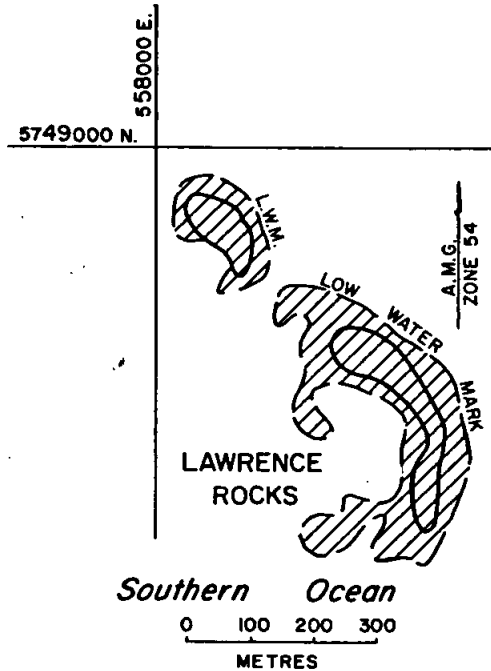

AREA HATCHED: Allot. 90 Sec. 13

And the Honourable Roderick Alexander Mackenzie, Her Majesty's Minister of Lands for the State of Victoria, shall give the necessary directions herein accordingly.

TOM FORRISTAL
Clerk of the Executive Council

CROWN LAND (RESERVES) ACT 1978

At the Executive Council Chamber, Melbourne, the seventh day of April, 1983

Present:

His Excellency the Governor of Victoria
Mr Simpson | Mr Kent
Mr White

CROWN LAND PERMANENTLY RESERVED

His Excellency the Governor of the State of Victoria, in the Commonwealth of Australia, by and with the advice of the Executive Council of the said State, pursuant to the provisions of sections 4 and 7 of the *Crown Land (Reserves) Act 1978*, and being of the opinion

that the Crown land concerned is required for the purpose mentioned, doth hereby permanently reserve and also except from prospecting or from occupation for mining purposes under any miner's right, the Crown land hereinafter described, viz.:

LAURISTON—For Cemetery—1 440 hectares, being Crown allotment 39^A, Parish of Lauriston, as shown on Certified Plan No. 105997 lodged in the Central Plan Office—(L32⁰¹¹) (Rs.12256)

And the Honourable Roderick Alexander Mackenzie, Her Majesty's Minister of Lands for the State of Victoria, shall give the necessary directions herein accordingly.

TOM FORRISTAL
Clerk of the Executive Council

**RAILWAY CONSTRUCTION AND PROPERTY BOARD ACT
1979**

*At the Executive Council Chamber, Melbourne, the
seventh day of April, 1983*

Present:

His Excellency the Governor of Victoria
Mr Simpson | Mr Kent
Mr White

DEVELOPMENT OF RAILWAY LAND

Whereas it is provided by Section 21 (1) of the *Railway Construction and Property Board Act 1979* that the Board shall manage and control land vested in it.

And whereas it is provided by Section 21 (1) (e) of the said Act that with the consent of the Governor in Council, the Board may sell the whole or any part of the land in respect of which the Board has a freehold title.

Now therefore, His Excellency the Governor of the State of Victoria by and with the advice of the Executive Council thereof doth hereby consent to the sale of the land comprising 1388 sq. metres being the land in the Parish of Corio and being the whole of the land shown by hatching on the attached plan and being part of the land described in Certificate of Title Volume 1421 Folio 113.

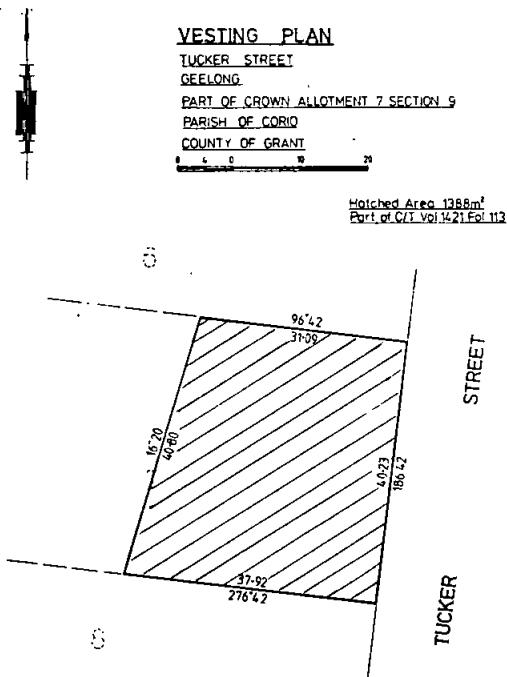

And the Honourable Steven Marshall Crabb, M.L.A., Her Majesty's Minister of Transport for the State of Victoria, shall give the necessary directions therein accordingly.

TOM FORRISTAL
Clerk of the Executive Council

**RAILWAY CONSTRUCTION AND PROPERTY BOARD ACT
1979**

*At the Executive Council Chamber, Melbourne, the
seventh day of April, 1983*

Present:

His Excellency the Governor of Victoria
Mr Simpson | Mr Kent
Mr White

DEVELOPMENT OF RAIL LAND

Whereas it is provided by Section 20 (4) of the *Railway Construction and Property Board Act 1979* that the Railway Construction and Property Board may make recommendations to the Minister for or with respect to the use or development of railway land.

And whereas it is provided by Section 20 (5) of the said Act that where the Board has made recommendations to the Minister under Section 20 (4) the Minister may submit the recommendations to the Governor in Council for approval.

And whereas the Board has made the following recommendation in respect of Railway land situated at Game Street, Merbein.

Recommendation

That the land which is surplus to railway requirements be used for industrial purposes.

Now therefore His Excellency the Governor of the State of Victoria by and with the advice of the Executive Council thereof, doth hereby approve of the foregoing recommendation.

And the Honourable Steven Marshall Crabb, Her Majesty's Minister of Transport for the State of Victoria, shall give the necessary directions therein accordingly.

TOM FORRISTAL
Clerk of the Executive Council

**RAILWAY CONSTRUCTION AND PROPERTY BOARD ACT
1979**

*At the Executive Council Chamber, Melbourne, the
seventh day of April, 1983*

Present:

His Excellency the Governor of Victoria
Mr Simpson | Mr Kent
Mr White

DEVELOPMENT OF RAIL LAND

Whereas it is provided by Section 20 (4) of the *Railway Construction and Property Board Act 1979* that the Railway Construction and Property Board may make recommendations to the Minister for or with respect to the use or development of railway land.

And whereas it is provided by Section 20 (5) of the said Act that where the Board has made recommendations to the Minister under Section 20 (4) the Minister may submit the recommendations to the Governor in Council for approval.

And whereas the Board has made the following recommendation in respect of Railway land situated at Bell Street, Bell.

Recommendation

That the land which is surplus to railway requirements be used for road widening purposes.

Now therefore His Excellency the Governor of the State of Victoria by and with the advice of the Executive Council thereof, doth hereby approve of the foregoing recommendation.

And the Honourable Steven Marshall Crabb, Her Majesty's Minister of Transport for the State of Victoria, shall give the necessary directions therein accordingly.

TOM FORRISTAL
Clerk of the Executive Council

**RAILWAY CONSTRUCTION AND PROPERTY BOARD ACT
1979**

*At the Executive Council Chamber, Melbourne, the
seventh day of April, 1983*

Present:

His Excellency the Governor of Victoria
Mr Simpson | Mr Kent
Mr White

DEVELOPMENT OF RAIL LAND

Whereas it is provided by Section 20 (4) of the *Railway Construction and Property Board Act 1979* that the Railway Construction and

Property Board may make recommendations to the Minister for or with respect to the use or development of railway land.

And whereas it is provided by Section 20 (5) of the said Act that where the Board has made recommendations to the Minister under Section 20 (4) the Minister may submit the recommendations to the Governor in Council for approval.

And whereas the Board has made the following recommendation in respect of Railway land situated at Wodonga.

Recommendation

That the land which is surplus to railway requirements be used for the purposes of an extension of the Returned Servicepersons Club.

Now therefore His Excellency the Governor of the State of Victoria by and with the advice of the Executive Council thereof, doth hereby approve of the foregoing recommendation.

And the Honourable Steven Marshall Crabb, Her Majesty's Minister of Transport for the State of Victoria, shall give the necessary directions therein accordingly.

TOM FORRISTAL
Clerk of the Executive Council

RAILWAY CONSTRUCTION AND PROPERTY BOARD ACT
1979

At the Executive Council Chamber, Melbourne, the seventh day of April, 1983

Present:

His Excellency the Governor of Victoria
Mr Simpson Mr Kent
Mr White

DEVELOPMENT OF RAIL LAND

Whereas it is provided by Section 20 (4) of the *Railway Construction and Property Board Act 1979* that the Railway Construction and Property Board may make recommendations to the Minister for or with respect to the use or development of railway land.

And whereas it is provided by Section 20 (5) of the said Act that where the Board has made recommendations to the Minister under Section 20 (4) the Minister may submit the recommendations to the Governor in Council for approval.

And whereas the Board has made the following recommendation in respect of Railway land situated at Leitchville being Railway Lot 12.

Recommendation

That the land which is surplus to railway requirements be used for industrial purposes.

Now therefore His Excellency the Governor of the State of Victoria by and with the advice of the Executive Council thereof, doth hereby approve of the foregoing recommendation.

And the Honourable Steven Marshall Crabb, Her Majesty's Minister of Transport for the State of Victoria, shall give the necessary directions therein accordingly.

TOM FORRISTAL
Clerk of the Executive Council

RAILWAY CONSTRUCTION AND PROPERTY BOARD ACT
1979

At the Executive Council Chamber, Melbourne, the seventh day of April, 1983

Present:

His Excellency the Governor of Victoria
Mr Simpson Mr Kent
Mr White

DEVELOPMENT OF RAIL LAND

Whereas it is provided by Section 20 (4) of the *Railway Construction and Property Board Act 1979* that the Railway Construction and Property Board may make recommendations to the Minister for or with respect to the use or development of railway land.

And whereas it is provided by Section 20 (5) of the said Act that where the Board has made recommendations to the Minister under Section 20 (4) the Minister may submit the recommendations to the Governor in Council for approval.

And whereas the Board has made the following recommendation in respect of Railway land situated at Lake Boga.

Recommendation

That the land which is surplus to railway requirements be used for the purposes of a salt extraction plant.

Now therefore His Excellency the Governor of the State of Victoria by and with the advice of the Executive Council thereof, doth hereby approve of the foregoing recommendation.

And the Honourable Steven Marshall Crabb, Her Majesty's Minister of Transport for the State of Victoria, shall give the necessary directions therein accordingly.

TOM FORRISTAL
Clerk of the Executive Council

RAILWAY CONSTRUCTION AND PROPERTY BOARD ACT
1979

At the Executive Council Chamber, Melbourne, the seventh day of April, 1983

Present:

His Excellency the Governor of Victoria
Mr Simpson Mr Kent
Mr White

DEVELOPMENT OF RAIL LAND

Whereas it is provided by Section 20 (4) of the *Railway Construction and Property Board Act 1979* that the Railway Construction and Property Board may make recommendations to the Minister for or with respect to the use or development of railway land.

And whereas it is provided by Section 20 (5) of the said Act that where the Board has made recommendations to the Minister under Section 20 (4) the Minister may submit the recommendations to the Governor in Council for approval.

And whereas the Board has made the following recommendation in respect of Railway land situated at Everton.

Recommendation

That the land which is surplus to railway requirements be used for rural purposes.

Now therefore His Excellency the Governor of the State of Victoria by and with the advice of the Executive Council thereof, doth hereby approve of the foregoing recommendation.

And the Honourable Steven Marshall Crabb, Her Majesty's Minister of Transport for the State of Victoria, shall give the necessary directions therein accordingly.

TOM FORRISTAL
Clerk of the Executive Council

RAILWAY CONSTRUCTION AND PROPERTY BOARD ACT
1979

At the Executive Council Chamber, Melbourne, the seventh day of April, 1983

Present:

His Excellency the Governor of Victoria
Mr Simpson Mr Kent
Mr White

DEVELOPMENT OF RAIL LAND

Whereas it is provided by Section 20 (4) of the *Railway Construction and Property Board Act 1979* that the Railway Construction and Property Board may make recommendations to the Minister for or with respect to the use or development of railway land.

And whereas it is provided by Section 20 (5) of the said Act that where the Board has made recommendations to the Minister under Section 20 (4) the Minister may submit the recommendations to the Governor in Council for approval.

And whereas the Board has made the following recommendation in respect of Railway land situated at Camms Road, Cranbourne.

Recommendation

That the land which is surplus to railway requirements be used for residential purposes.

Now therefore His Excellency the Governor of the State of Victoria by and with the advice of the Executive Council thereof, doth hereby approve of the foregoing recommendation.

And the Honourable Steven Marshall Crabb, Her Majesty's Minister of Transport for the State of Victoria, shall give the necessary directions therein accordingly.

TOM FORRISTAL
Clerk of the Executive Council

RAILWAY CONSTRUCTION AND PROPERTY BOARD ACT 1979

At the Executive Council Chamber, Melbourne, the seventh day of April, 1983

Present:
His Excellency the Governor of Victoria
Mr Simpson | Mr Kent
Mr White

DEVELOPMENT OF RAIL LAND

Whereas it is provided by Section 20 (4) of the *Railway Construction and Property Board Act 1979* that the Railway Construction and Property Board may make recommendations to the Minister for or with respect to the use or development of railway land.

And whereas it is provided by Section 20 (5) of the said Act that where the Board has made recommendations to the Minister under Section 20 (4) the Minister may submit the recommendations to the Governor in Council for approval.

And whereas the Board has made the following recommendation in respect of Railway land situated at Bridge Street, Korumburra.

Recommendation

That the land which is surplus to railway requirements be used for the purposes of the Korumburra Sewerage Authority.

Now therefore His Excellency the Governor of the State of Victoria by and with the advice of the Executive Council thereof, doth hereby approve of the foregoing recommendation.

And the Honourable Steven Marshall Crabb, Her Majesty's Minister of Transport for the State of Victoria, shall give the necessary directions therein accordingly.

TOM FORRISTAL
Clerk of the Executive Council

RAILWAY CONSTRUCTION AND PROPERTY BOARD ACT 1979

At the Executive Council Chamber, Melbourne, the seventh day of April, 1983

Present:
His Excellency the Governor of Victoria
Mr Simpson | Mr Kent
Mr White

DEVELOPMENT OF RAIL LAND

Whereas it is provided by Section 20 (4) of the *Railway Construction and Property Board Act 1979* that the Railway Construction and Property Board may make recommendations to the Minister for or with respect to the use or development of railway land.

And whereas it is provided by Section 20 (5) of the said Act that where the Board has made recommendations to the Minister under Section 20 (4) the Minister may submit the recommendations to the Governor in Council for approval.

And whereas the Board has made the following recommendation in respect of Railway land situated at the corner of Beachley Street and Turner Crescent, Braybrook.

Recommendation

That the land which is surplus to railway requirements be used for residential purposes.

Now therefore His Excellency the Governor of the State of Victoria by and with the advice of the Executive Council thereof, doth hereby approve of the foregoing recommendation.

And the Honourable Steven Marshall Crabb, Her Majesty's Minister of Transport for the State of Victoria, shall give the necessary directions therein accordingly.

TOM FORRISTAL
Clerk of the Executive Council

HOUSING ACT 1958

At the Executive Council Chamber, Melbourne, the twelfth day of April, 1983

Present:
His Excellency the Governor of Victoria
Mr. Roper | Mr. Trezise
Mr. Spyker

CLOSURE OF A PORTION OF ROAD—SHIRE OF MORWELL

Whereas by virtue and in exercise of the powers contained in the *Housing Act 1958* (No. 6275) Housing Commission has recommended to the Governor in Council that the portion of road described in the Schedule hereto be closed.

Now therefore His Excellency the Governor of the State of Victoria in the Commonwealth of Australia by and with the advice of the Executive Council of the said State, doth in pursuance of the powers conferred by the said Act and upon such recommendation, consent and by this Order hereby close such portion of road.

Schedule

The portion of road delineated and hachured on the plan hereunder

PART OF CROWN ALLOTMENT 74

PARISH OF MARYVALE

COUNTY OF BULN BULN

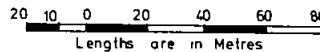

L.P. 58879

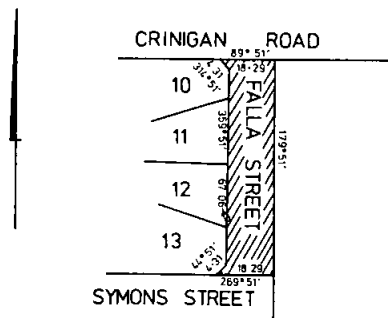

And the Honourable Ian Robert Cathie, Her Majesty's Minister of Housing for the State of Victoria shall give the necessary directions herein accordingly.

TOM FORRISTAL
Clerk of the Executive Council

PUBLIC SERVICE ACT 1974

At the Executive Council Chamber, Melbourne, the twelfth day of April, 1983

Present:
His Excellency the Governor of Victoria
Mr. Roper | Mr. Trezise
Mr. Spyker

APPOINTMENT OF DEPUTY MEMBER OF THE PUBLIC SERVICE BOARD

Whereas by an Order in Council dated 30 November 1982, made in pursuance of section 12 of the *Public Service Act 1974*, Maurice Colin Keppel was appointed as Deputy Member of the Public Service

Board for the period during which the office of Member made vacant by reason of the resignation of Kevin Laurence Hayes remains vacant unless such appointment by further Order should be earlier terminated:
 Now therefore, in pursuance of section 12 of the *Public Service Act 1974*, His Excellency the Governor of the State of Victoria, by and with the advice of the Executive Council thereof, doth by this Order:—

- (i) revoke the appointment of the said Maurice Colin Keppel as Deputy Member of the Public Service Board, and
- (ii) appoint James William McLaughlin as Deputy Member of the Public Service Board for the period from the date of this Order to 9 May 1983 (both dates inclusive) unless this appointment by further Order be earlier terminated.

And the Honourable John Cain, Her Majesty's Premier for the State of Victoria, shall give the necessary directions herein accordingly.

TOM FORRISTAL
 Clerk of the Executive Council

VICTORIA CONSERVATION TRUST ACT 1972

At the Executive Council Chamber, Melbourne, the seventh day of April, 1983

Present:

His Excellency the Governor of Victoria
 Mr Simpson | Mr Kent
 Mr White

APPOINTMENT OF MEMBERS OF THE VICTORIA CONSERVATION TRUST

In pursuance of the powers contained in the *Victoria Conservation Trust Act 1972*, and all other powers him thereunto enabling, His Excellency the Governor of the State of Victoria, by and with the advice of the Executive Council thereof doth by this Order:

- 1. Reappoint Carmen Sandra Carnegie, (John) Michael Avison Parker and John Melvin Swan to be members of the Victoria Conservation Trust, and
- 2. Appoint H. Norman B. Wettenhall, and David L. Bremer, to be members of the Victoria Conservation Trust for a period of five years.

And the Honourable Evan Walker, Her Majesty's Minister for Conservation for the State of Victoria shall give the necessary directions herein accordingly.

TOM FORRISTAL
 Clerk of the Executive Council

THE CONSTITUTION ACT AMENDMENT ACT 1958

At the Executive Council Chamber, Melbourne, the twelfth day of April, 1983

Present:

His Excellency the Governor of Victoria
 Mr. Roper | Mr. Trezise
 | Mr. Spyker

APPOINTMENT OF POLLING PLACE

Pursuant to the provisions of *The Constitution Act Amendment Act 1958*, and all other powers him thereunto enabling, His Excellency the Governor of the State of Victoria, by and with the advice of the Executive Council thereof doth hereby appoint Kerang North as a polling place within and for the Kerang Subdivision of the Electoral District of Swan Hill and of the North Western Province, the Chief Electoral Officer having certified that it is necessary to appoint such polling place.

And the Honourable John Hamilton Simpson, Her Majesty's Minister for Property and Services for the State of Victoria, shall give the necessary directions herein accordingly.

TOM FORRISTAL
 Clerk of the Executive Council

THE CONSTITUTION ACT AMENDMENT ACT 1958

At the Executive Council Chamber, Melbourne, the twelfth day of April, 1983

Present:

His Excellency the Governor of Victoria
 Mr. Roper | Mr. Trezise
 | Mr. Spyker

REVOCATION OF APPOINTMENT OF POLLING PLACES FOR THE ELECTORAL DISTRICT OF SWAN HILL AND THE NORTH WESTERN PROVINCE

Pursuant to the provisions of *The Constitution Act Amendment Act 1958*, and all other powers him thereunto enabling, His Excellency the Governor of the State of Victoria, by and with the advice of the Executive Council thereof, doth hereby revoke the appointment of Bolton and Willangie East as polling places within and for the Robinvale and Wycheproof Subdivisions respectively of the Electoral District of Swan Hill and the North Western Province, the Chief Electoral Officer having certified that it is necessary to revoke the appointment of such polling places.

And the Honourable John Hamilton Simpson, Her Majesty's Minister for Property and Services for the State of Victoria, shall give the necessary directions herein accordingly.

TOM FORRISTAL
 Clerk of the Executive Council

LANDS DEPARTMENT
 NOTICES

APPROACHING LAND SALES

Sale of Crown Land, will be held at the under-mentioned places and dates, viz.:

| | No. of Gazette |
|--------------------------------------|----------------|
| Box Hill—Saturday, 16 April 1983 | 25 |
| Ballarat—Thursday, 5 May 1983 | 19 |
| Murrayville—Friday, 10 June 1983 | 28 |
| Yackandandah—Thursday, 14 April 1983 | 25 |

SALE OF CROWN LAND BY AUCTION

The land will be offered for sale subject to the provision of the Land Act and Regulations thereunder.

The upset price is the sum at which bidding will start, and no bid below that sum can be accepted. The highest bidder at or above that sum shall be the purchaser, subject to signature of contract and any necessary payment.

Terms:

A deposit of at least 12½% of the purchase price must be paid at the sale, either in cash or by cheque.

The residue is payable in 2 instalments as follows or may be paid off at any earlier time.

12½% of residue payable on 17 November 1983. Balance payable on 17 May 1984.

Interest at the rate of 14% per annum is payable with final payment of residue, and is computed on the unpaid balance at any time. Additional interest is charged if any instalment is not paid on or before the due date.

If paid off within 30 days of sale, no interest is payable.

Fees, etc.

Survey fee is payable at the sale.

Payable with balance of purchase money—

Crown Grant fee—\$41.00.

Assurance contribution—One cent in every Five dollars or part thereof of purchase price. (This is to guarantee the validity of freehold titles.)

Transfer of interest prior to completion of payment may be allowed on payment of the prescribed fee and subject to stamp duty.

If unable to attend personally, a prospective purchaser may arrange for another person to bid as his agent.

Attention is drawn to section 95, *Land Act 1958*, which provides that the purchaser shall be deemed to be the owner, for the purposes

of other Acts; also to an amendment to the Local Government Act providing for Government roads, in certain circumstances, to be declared "private streets", thus making the purchaser liable to contribute to the cost of street construction.

R. A. MACKENZIE
Minister of Lands

Department of Crown Lands and Survey
Melbourne

WAHGUNYAH—Sale (No. 12390) of Crown land, by auction, will be held at the Wahgunyah School of Arts Hall, Foord Street, Wahgunyah on Tuesday, 17 May 1983 at 2 o'clock p.m. To be conducted by F. F. Holt, Regional Land Officer, Wangaratta.

Lot 1—Parish of Carlyle—Being former Viticultural Purposes Reserve adjoining the Murray River on western fringe of Wahgunyah township.

Upset price \$98 500.00 the lot. Survey fee \$1400.00. Area 50.22 hectares more or less — subject to survey. Allotment 5C of Section A.

Improvements comprise coolstore and grafting shed; glass house; controlled temperature and humidity shed all in fair condition.

Special Conditions—Until the purchase money has been paid in full the following Special Conditions shall apply—

- (i) The purchaser shall at his own expense maintain the property in good order and repair and keep all improvements thereon insured against fire, storm and tempest in the name of the Secretary for Lands.
- (ii) A cover note for such insurance shall be lodged in the Department of Crown Lands and Survey, by the purchaser within one week of the date of sale, and the policy shall be lodged immediately on issue.
- (iii) The purchaser shall not remove or make any alterations to the improvements on the site without prior consent of the Secretary for Lands.

Enquiries—Regional Land Officer, Wangaratta. Phone (057) 21 5144.—(L8-1744)

MELBOURNE SOUTH (ST. KILDA)—The temporary reservation by Order in Council of 14 August 1956 of 9713 square metres of land in the Parish of Melbourne South as a site for Public Recreation, so far only as the portions thereof containing 2242 square metres, as indicated by hatching on plan hereunder, are concerned—(S226^v) (Rs.50)

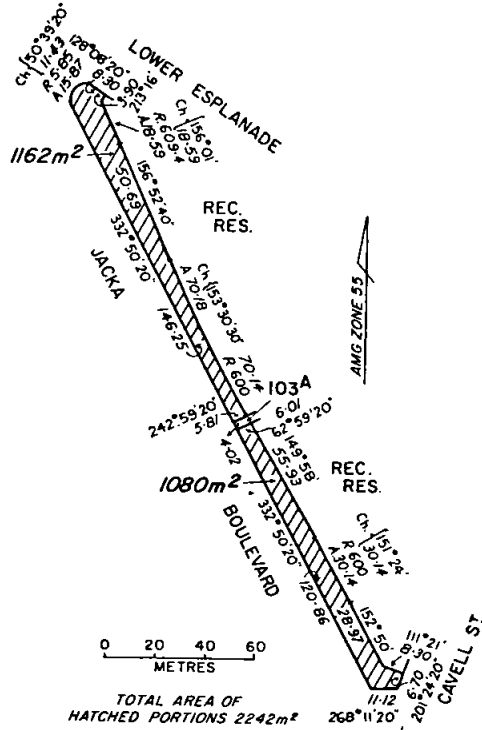

PROPOSED REVOCATION OF TEMPORARY RESERVATION OF LAND BY ORDER IN COUNCIL

In pursuance of the provisions of section 10 of the *Crown Land (Reserves) Act 1978*, notice is hereby given that it is the intention of the Governor in Council to revoke the temporary reservation of land by Order in Council hereunder referred to, viz.:

MELBOURNE SOUTH (ST. KILDA)—The temporary reservation by Order in Council of 5 June 1906 of 7.942 hectares of land in the Parish of Melbourne South as a site for the Recreation, Convenience and Amusement of the People, revoked as to part by various Orders, so far only as the portion thereof containing 1200 square metres, more or less, as indicated by hatching on plan hereunder, is concerned—(M333²²⁵) (Rs.50)

MELBOURNE SOUTH (ST. KILDA)—The temporary reservation by Order in Council of 28 November 1887 of 1543 square metres of land in the Parish of South Melbourne as a site for an Ornamental Plantation, so far only as the portion thereof containing 75 square metres, as indicated by hatching on plan hereunder, is concerned—(M333²²²) (Rs.5742)

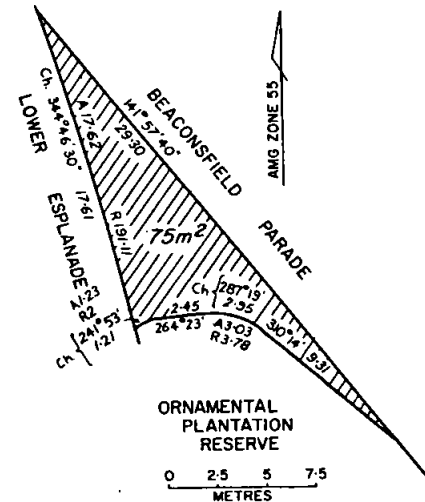
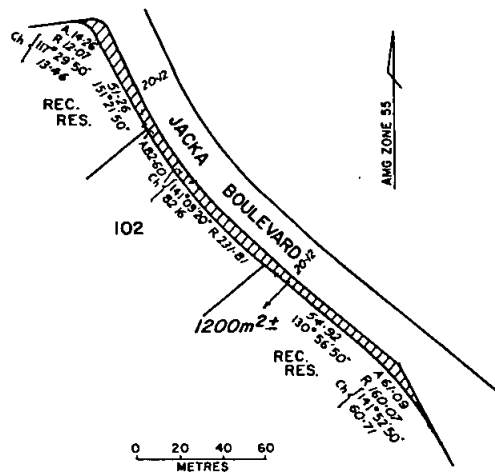

ELMORE—The temporary reservation by Order in Council of 23 November 1868 of land comprised within the line of railway from Melbourne to Echuca, for Railway purposes, so far only as the portion thereof in the Township of Elmore containing 3298 square metres, as indicated by hatching on plan hereunder, is concerned—(E38⁵¹) (L6-1951)

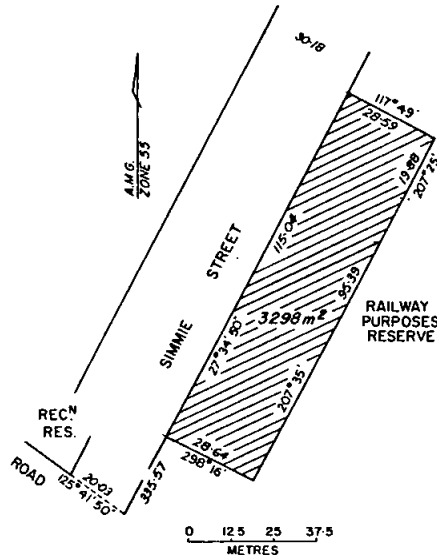

MANSFIELD—The temporary reservation by Order in Council of 10 April 1979 of 1214 square metres of land in the Parish of Mansfield (being Crown allotment 23H) for Public Buildings—(M35⁵¹) (Rs. 10573)

MANSFIELD—The temporary reservation by Order in Council of 10 February 1862 of 8094 square metres of land in the Parish of Mansfield (adjoining allotment 23A) as a site for a Public Pound, revoked as to part by Order of 22 November 1966, so far as the balance thereof containing 6880 square metres, is concerned—(M35⁵¹) (Rs. 5430)

R. A. MACKENZIE
Minister of Lands

Department of Crown Lands and Survey
Melbourne

LOCAL LAND BOARD

In pursuance of the provisions of section 34 of the *Land Act* 1958 notice is hereby given that a public hearing at the following place and time will be conducted by the person mentioned, being duly appointed in that behalf.

Place—Land Inspector's Office, State Public Offices, Colac.
Time—10.00 a.m. Wednesday, 27 April 1983.
Member—D. O'Connor.

R. A. MACKENZIE
Minister of Lands

TENDERS

PUBLIC WORKS DEPARTMENT

Tenders are invited for the purposes indicated hereunder and will be received at 2 Treasury Place, Melbourne, 3002, until TWO p.m. on dates shown.

Tenders must be addressed to the Minister of Public Works with the envelope endorsed "Tender for

Hand-delivered tenders must be placed in the Department's tender box in foyer, Ground Floor, 2 Treasury Place, Melbourne.

Tenders documents are available from the Contracts Office, Room 29, 2 Treasury Place, Melbourne and where indicated, at offices of Inspectors of Works.

★Tenders for works identified with star (★) will only be considered from Contractors qualified for repairs and painting works. Any Tenderers wishing to qualify may obtain the application form from the Contracts Office.

Wednesday, 20 April

Building, Electrical and Mechanical Works

BAIRNSDALE—Fencing, Lands Depot. (W.O. Bairnsdale, Traralgon.)

ORBOST—Fencing, Lands Depot. (W.O. Bairnsdale, Traralgon.)

Wednesday, 27 April 1983

Building, Electrical and Mechanical Works

ALTONA—Installation of Mechanical Services, Primary School.

BAIRNSDALE—New Depot, Crown Lands. (W.O. Bairnsdale.)

★BAIRNSDALE—Internal and external renovations to main building, C.G.I. clad buildings, woodwork block, Technical School. (W.O. Bairnsdale)

BENDIGO—Upgrade of Administration Offices—Psychiatric Centre, Health. (W.O. Bendigo.)

DOOKIE—Erection of New Steel Framed Agricultural Workshop, TAFE College. (W.O. Shepparton.)

MELBOURNE—Erection of New Store, Communicable Diseases Centre, Health Commission.

MORWELL PARK—Alterations to Existing Classrooms to provide a new Art and Craft Facility and Cyclic Maintenance, Primary School. (W.O. Traralgon.)

MOUNT BAW BAW—(Re-advertisement) New Building and Alteration to Existing to provide Visitor Centre Facility. (W.O. Waragul.) Alpine Reserve.

★MT. BEAUTY—External and Internal Renovations, Primary School. (W.O. Wangaratta, Benalla.)

★MURCHISON—Internal and external alterations and repairs, and painting, cyclic maintenance 1982/83, Primary School No. 1126. (W.O. Shepparton, Benalla, Alexandra and Wangaratta.)

ORBOST—New Depot, Crown Lands. (W.O. Bairnsdale.)

ROYAL PARK—Modifications to Control of Heating System, Psychiatric Hospital.

ROYAL PARK—Modifications to Central Heating System, Psychiatric Hospital

SOUTH MELBOURNE—Retiling of Shower recesses, Police Hospital, Police and Emergency Services.

TOORA—Provision of new relocatables and associated walkways and galleries and conversion of existing LTC to staff (Administration Facility), Primary School. (W.O. Traralgon.)

VARIOUS—Installation and collection of Sanitary Disposal Units, Various Schools.

★VERMONT—External cyclic maintenance to all buildings, internal cyclic maintenance to toilet blocks and breeze-ways, High School.

★WONTHAGGI—Cyclic maintenance, Court House, (W.O. Korumburra.)

Siteworks

MONT PARK—Renewal of Water Supply, Wards F12, and MF3, Mental Hospital.

WESTMEADOWS—Siteworks for Stage I, relocatables, Police Driving School, Police and Emergency Services.

Miscellaneous

COLLINGWOOD—Maintenance cleaning—period 1.6.83 to 31.5.86, Court House and Police Station.

DANDENONG—Maintenance Cleaning, 1.6.83 to 31.5.86, Police Station.

EAST MELBOURNE—Maintenance cleaning, Police Station.

GIPPSLAND LAKES—Reeves Channel Protection Works, supply and cartage of rock, Ports and Harbors Division. (W.O. Bairnsdale.)

MACLEOD—Supply and delivery of one (1) X-Ray Unit, State Forensic Science Laboratory, Police and Emergency Services.

MACLEOD—Supply and delivery of one (1) Surgical Operating Microscope, State Forensic Science Laboratory, Police and Emergency Services.

PRESTON EAST—Maintenance cleaning, 1.6.83 to 31.5.86, Police Station.

YARRAM—Maintenance cleaning, 1.4.83 to 31.3.86, Court House and Office. (Yarram Court House.)

SHEPPARTON—Maintenance cleaning, 1.6.83 to 31.5.86, State Development, Decentralization, Tourism. 23 Nixon St. (W.O. Shepparton.)

WARRANTDYTE—Maintenance cleaning, 1.7.83 to 30.6.86, Police Station.

JACK SIMPSON
Minister of Public Works

Public Works Department
Melbourne, 12 April 1983

Wednesday, 4 May 1983

Building, Electrical and Mechanical Works

BAIRNSDALE—Female toilet block, additions (brick veneer) to existing building, Technical School. (W.O. Bairnsdale.)

BEECHWORTH—Supply and installation personal Duress Alarm System, Training Prison.

*BLACKBURN—"Readvertisement"—Cyclic maintenance, High School.

BLACKBURN—Auto Practice Annex (Building Works), Technical School.

BROADMEADOWS—Boys and girls toilet upgrade, High School.

*CASTLEMAINE—External and part internal repairs and painting, Court House. (W.O. Kyneton and Bendigo.)

*COBRAM—Interior and exterior renovations, Consolidated School. (W.O. Shepparton.)

DANDENONG—Mechanical services—Smoke spill system to Security Wards, Psychiatric Centre.

DARTMOOR—Construction of Police Residence, Police Residence. (W.O. Warnambool.)

DEVON MEADOWS—New toilet block, Primary School.

ENDEAVOUR HILLS—New building—Auto Practice Annex, Technical School.

*ESSENDON—Cyclic maintenance—internal and external, Technical School.

*MORDIALLOC—Internal, external repairs and painting, Police Station.

NUMURKAH—Science rooms upgrade, High School. (W.O. Shepparton.)

*NUMURKAH—Cyclic maintenance—internal and external repairs and painting, Primary School. (W.O. Shepparton and Wangaratta.)

PARKVILLE—Provision of new store room, Baltara Reception Centre.

RINGWOOD—Auto Practice Annex, Technical School.

SOUTH YARRA—Safety structure for the testing of milk tank wagons, Weights and Measures Office.

STAWELL—Construction of Covered Way, High School. (W.O. Horsham.)

VARIOUS—Supply, delivery and erection of Covered Ways, At Rates 1983/84, Modular Buildings, (W.O. Geelong, Bendigo, Ballarat, Shepparton and Traralgon.)

*YUNDOOL—Internal and external repairs and painting and minor electrical and mechanical works, Primary School. (W.O. Benalla, Shepparton and Wangaratta.)

Siteworks

BRAYBROOK—Renewal of fire and cold water service, High School.

Miscellaneous

BELGRAVE—Maintenance cleaning, 1.7.83 to 30.6.86, Police Station. (Police Station.)

FOOTSCAY—Maintenance cleaning, 1.6.83 to 31.5.86, Court House.

HEALESVILLE—Maintenance cleaning, 1.7.83 to 30.6.86, Police Station. (Healesville Police Station.)

STATE TENDER BOARD

Schedule No. 1/61

Printing Paper, Writing Paper, etc.

Tenders will be received until 8.30 a.m. on 6 May 1983 from persons willing to supply, at Melbourne, Paper for the Victorian Government, as per schedule, in the quantities as may be required by the Government Printer from time to time.

Preference will be given to a tender received from a de-centralized industry approved by the Minister for Economic Development.

Forms of tender, conditions of tendering, schedule, conditions of contract, and samples may be obtained on application to the Secretary to the Tender Board, 3rd Floor, 49 Spring Street, Melbourne, Victoria 3000.

Tenders enclosed in the envelope provided, must be deposited in the tender-box at the Tender Board Offices, Third Floor, 49 Spring Street, Melbourne 3000, or if sent by post, postage must be prepaid and the tenders addressed to the Chairman of the Tender Board, Tender Board Offices, 49 Spring Street, Melbourne 3000, which Office they must reach not later than by first post on the date of closing of tenders. Under no circumstances will tender details be accepted by telephone.

J. M. PAWSON
Secretary to the Tender Board

PRIVATE ADVERTISEMENTS

CITY OF BENALLA

Loan No. 56

Notice of Intention to Borrow

Notice is hereby given that the Council of the City of Benalla proposes to borrow the principal sum of \$84 000 secured by a charge over the general rates of the municipality, such sum to be raised by the grant of a mortgage in accordance with the provisions of the *Local Government Act 1958*.

1. The maximum rate of interest that may be paid is 15.5 per cent per annum.

2. The purpose for which the loan is to be applied is to liquidate the principal moneys owing on Loan No. 39.

3. The period of the loan shall be 10 years.

4. The moneys borrowed shall be repayable by providing out of the municipal fund half-yearly instalments of \$8397.04 each including principal and interest on 1 December and 1 June during the currency of the loan. The first instalment shall be payable on 1 December 1983.

5. Such moneys shall be repayable to the Local Authorities Superannuation Board, Rigny House, 15 Queens Road, Melbourne, or such other place or places as the Board from time to time may require.

6217

JOHN F. SHAW, Town Clerk

CITY OF BRIGHTON

Notice is hereby given that the Municipality of the City of Brighton in its capacity as committee of management of various Crown Reserves hereby appoints Senior Sergeant Peter Brian Nancarrow No. 15360 replacing Senior Sergeant Melvin John Clement McKay No. 14164 as Prosecuting Officer to take legal proceedings on behalf of the Council for and in connection with breaches and non-observance of the Local Government Act or any other Act which the Council from time to time is empowered to enforce and any by-laws, rules and regulations made under such Acts.

Municipal Offices, Boxshall Street, Brighton, Victoria 3186.

6280

V. L. FARAVONI, Town Clerk

CITY OF SPRINGVALE

Loan No. 199

Notice of Intention to Borrow the Sum of \$150 000 for Permanent Works and Undertakings

Notice is hereby given that the Council of the City of Springvale proposes to borrow the principal sum of \$150 000 secured by a charge over the general rates of the municipality, such sum to be raised by the grant of a mortgage in accordance with the provisions of the *Local Government Act 1958*.

1. The maximum rate of interest that may be paid is 15.5 per cent per annum.
2. The purpose for which the loan is to be applied is:—
To liquidate Loan No. 175 — final instalment of principal due for repayment 1 June 1983.
3. The period of the loan shall be ten years.
4. The loan is to be liquidated by a sinking fund which shall be created in accordance with the provisions of the *Local Government Act* by the half-yearly investment of such amount as the Auditor-General certifies will be sufficient to repay the principal moneys secured by the mortgage within the currency of the loan in such manner as the Treasurer of Victoria shall direct.

The plans and specifications and the estimate of the cost of such works and a statement showing the proposed expenditure of the moneys to be borrowed are open for inspection by ratepayers, during office hours, at the City Offices, Civic Centre, Springvale Road, Springvale, for one month after the publication of this notice.

6219

K. D. MOODY, Town Clerk

SHIRE OF BUNINYONG

Loan No. 39

Notice of Intention to Borrow the Sum of \$50 000 for Permanent Works and Undertakings

Notice is hereby given that the Council of the Shire of Buninyong proposes to borrow the principal sum of \$50 000 secured by a charge over the general rates of the municipality, such sum to be raised by the grant of a mortgage in accordance with the provisions of the *Local Government Act 1958*.

1. The maximum rate of interest that may be paid is 15.0 per centum per annum.
2. The purpose for which the loan is to be applied is:—

| | |
|---|--------|
| | \$ |
| (a) Magpie Road—bridge reconstruction. Council share of joint project | 15 000 |
| (b) Pryor's Road—construction of one culvert at 45kls from Sand Road junction | 15 000 |
| (c) Wiggins Road—reconstruction southerly of previous treatment | 10 000 |
| (d) Coulsens Road—reconstruction westerly from S.E.C. Road | 10 000 |
3. The period of the loan shall be 4 years.
4. The moneys borrowed will be repayable by providing out of the Municipal Fund seven (7) half-yearly instalments of \$5469.56 each, including principal and interest on 1 June and 1 December during the currency of the loan and a final instalment of \$37 506.40 which will be the subject of negotiation of a further loan to liquidate this balance. The first instalment is to be repayable on 1 December 1983.

5. Such moneys shall be repayable to the National Australia Bank, Melbourne.

6. The plans and specifications and the estimates of the cost of the proposed works and a statement showing the proposed expenditure of the moneys to be borrowed are open for inspection at the office of the Council of the Shire of Buninyong, Learmonth Street, Buninyong.

Dated 7 April 1983

6281

A. F. HELYAR, Shire Secretary

SHIRE OF CRANBOURNE

Notice of Intention to Acquire Land Compulsorily

Notice is given that the Council of the Shire of Cranbourne deems it expedient to exercise its powers in taking land compulsorily for the purpose of a Drainage Inlet Structure in connection with the Pearce Dale Drainage Scheme and that in the opinion of Council, such compulsory taking of land is necessary and desirable.

Council intends to acquire land described as Part Crown Portion 83, situated on the corner of Baxter-Tooradin Road and Colley Street, measuring 14m x 40m, Parish of Langwarrin, County of Mornington.

The Council has caused to be prepared maps and other papers showing the general description of the said land and the exact site and measurements thereof, together with the names of the owners,

or reputed owners, lessees or reputed lessees, mortgagees or occupiers of those lands as far as these names can be ascertained by the Council.

The said maps and other papers are deposited at the Shire Office, Cranbourne, and shall be kept open for inspection by all persons interested at all reasonable hours for a space of 40 clear days after publication of this notice in the *Government Gazette* on Wednesday, 13 April 1983.

All persons affected by the proposed taking of the land are hereby called to set forth, in writing, addressed to the Council or Shire Secretary of Shire of Cranbourne, within forty (40) clear days of the publication of this notice in the *Government Gazette*, all objections which they may have to the taking of the said land.

Dated 13 April 1983

By Order of the Council

6218

T. VICKERMAN, Shire Secretary

SHIRE OF MOUNT ROUSE

PROSECUTING OFFICER

Notice is given that Senior Constable Andrew Robert Inglis No. 16583 has been appointed Prosecuting Officer for the Municipality in lieu of Senior Constable Leslie William Hyde, transferred.

6282

K. N. WILSON, Shire Secretary

SHIRE OF WERRIBEE

Shire of Werribee—Loan Number 119

Notice of Intention to Borrow the Sum of \$150 000 to Liquidate Portion of the Principal Moneys Owning by the Municipality on Account of a Previous Loan

Notice is hereby given that the Council of the Shire of Werribee proposes to borrow the principal sum of \$150 000 secured by a charge over the general rates of the Municipality such sum to be raised by the grant of a mortgage in accordance with the provisions of the *Local Government Act 1958*.

1. The maximum rate of interest that may be paid is 15.5% per annum.
2. The purpose for which the loan is to be applied is a partial re-financing of Shire of Werribee Loan Number 119.
3. The period of the loan shall be 10 years.
4. The money borrowed shall be repayable by providing out of the Municipal Fund half yearly instalments of \$11 625.00 being interest only with the principal sum being repayable in full on maturity. In addition to the interest payments half yearly instalments of \$4301.90 will be paid into a Sinking Fund for the term of the loan to provide for the repayment of the principal monies upon expiry of the loan period.
5. Such money shall be repayable to the Insurance Commissioner, State Insurance Office, 480 Collins Street, Melbourne.

6220

J. T. KERR, Shire Secretary

Water Act 1958

TRAFALGAR WATERWORKS TRUST

Water Restrictions

Notice is hereby given that By-law No. 3 for the purpose of restricting the use of water within the Trafalgar Waterworks Trust District has been made by the Trafalgar Waterworks Trust and approved by the Governor in Council on 22 March 1983.

This By-law empowers the Trust to implement at any time any of the eight stages of water restrictions in any special part or parts of districts as the Trust deems necessary by notice published in a local newspaper.

A copy of By-law No. 3 may be inspected at the office of the Trust, Municipal Offices, Trafalgar during normal office hours.

6284

W. F. NELSON, Secretary

WARRAGUL WATERWORKS TRUST

Water Restrictions

Notice is hereby given that By-Law No. 78 for the purpose of restricting the use of water within the Warragul Waterworks Trust District has been made by the Warragul Waterworks Trust and approved by the Governor in Council on 22 March 1983.

This By-Law—

- (a) empowers the Trust to implement at any time any of the 8 stages of water restriction in any special part or parts of districts as the Trust deems necessary by notice published in a local newspaper.
- (b) repeals By-Law Nos. 70, 71, 72, 73 and 77.

A copy of By-Law No. 78 may be inspected at the office of the Trust, Civic Place, Warragul, free of charge during office hours.

6250

B. G. ELKIN, Secretary/Manager

Water Act 1958
WESTERNPORT WATERWORKS TRUST
Water Restrictions

Notice is hereby given that By-Law No. 37 for the purpose of restricting the use of water within the Waterworks Trust District has been made by the Waterworks Trust and approved by the Governor in Council on 15 February 1983.

This By-Law—

- (a) empowers the Trust to implement at any time any of the 8 stages of water restrictions in any special part or parts of districts as the Trust deems necessary by notice published in a local newspaper.
- (b) repeals By-Laws 35 and 36.

A copy of By-Law No. 37 may be inspected at the Office of the Trust at 8 Findlay Street, Cowes, free of charge during normal office hours.

6251 C. F. BEASLEY, Secretary

Water Act 1958
THORPDAL WATERWORKS TRUST
Water Restrictions

Notice is hereby given that By-law No. 1 for the purpose of restricting the use of water within the Thorpdale Waterworks Trust District has been made by the Thorpdale Waterworks Trust and approved by the Governor in Council on 22 March 1983.

This By-law empowers the Trust to implement at any time any of the eight stages of water restrictions in any special part or parts of districts as the Trust deems necessary by notice published in a local newspaper.

A copy of the By-law No. 1 may be inspected at the office of the Trust, Municipal Offices, Trafalgar during normal office hours.

6283 W. F. NELSON, Secretary

BELLARINE SEWERAGE AUTHORITY
General Notice

The abovementioned Sewerage Authority having made provision for carrying off the sewage from each and every property which is within the sewerage area hereinafter described doth hereby declare that on and after 13 April 1983, each and every property which or any part of which is within the said sewerage area shall be deemed to be a seweraged property within the meaning of the *Sewerage Districts Act 1958*.

Portarlington Sewerage District Sewerage Area No. 6

The boundaries of the sewerage area hereinbefore referred to are as indicated on a plan which is available for inspection at the Authority's Office, being the Municipal Office, Collins Street, Drysdale.

By order of the said Sewerage Authority
L. PEARCE, Secretary
E. L. TEW, Chairman

6249G.

FIRST SCHEDULE

Notice is hereby given that the partnership heretofore subsisting between William Paul Alexander of 103A Rowell Avenue, Camberwell, and Jeffrey Whyatt of 5 Haileybury Court, Wantirna, carrying on business as Drycleaners under the registered business name of "Signet Drycleaners" has been dissolved by mutual consent as of 31 March 1983 and all debts due and owing by the said Signet Drycleaners as at 31 March 1983 will be received and paid by Jeffrey Whyatt.

JEFFREY WHYATT
WILLIAM PAUL ALEXANDER

6252

Notice is hereby given that the partnership between Mary Anne O'Callaghan and Dennis Charles O'Callaghan trading as Dennis Cleaning Service of 5 Bardia Avenue, Ashburton, was dissolved on 3 June 1982. 6290

BARKROY INVESTMENTS PTY. LIMITED (IN LIQUIDATION)
MEMBERS VOLUNTARY LIQUIDATION

Notice is hereby given that at a General Meeting of the above-named Company duly convened and held at 35 Alban Street, Taree on 28 March 1983 the following special resolution was duly passed:—

"That the Company be wound up voluntarily." It was also resolved:— "To appoint Alan Russell Cowan of Cowan, Walker & Lynch of Taree as liquidator."

Dated 28 March 1983

6274 S. A. BARNES, Secretary

In the Supreme Court of Victoria, C.O. 13014—In the matter of the Companies (Victoria) Code; and in the matter of T. Matthews Pty. Ltd.

Notice is hereby given that an Application for the winding up of the abovenamed company by the Supreme Court was on 17 February 1983 presented by the Company and that the said Application is directed to be heard before the Court sitting at the Practice Court Law Courts, Lonsdale Street, Melbourne at the hour of 10.30 o'clock in the forenoon on 19 May 1983 and any creditor or contributory of the said Company desiring to support or oppose the making of an order on the said Application may appear at the time of hearing by himself or his Counsel for the purpose; and a copy of the said Application will be furnished to any creditor or contributory of the said Company requiring the same by the undersigned on payment of the regulated charge for the same.

The Applicant's official address is 47 Bull Street, Bendigo.

The Applicant's Solicitors are Messrs. Cornwall Stodart & Co. of 63 Exhibition Street, Melbourne.

CORNWALL STODART & CO.

Note—Any person who intends to appear on the hearing of the said Application must serve on or send by post to the abovenamed Cornwall Stodart & Co., notice in writing of his intention so to do. The notice must state the name and address of the person, or, if a firm, the name and address of the firm, and must be signed by the person or his or their solicitor (if any), and must be served or, if posted, must be sent by post in sufficient time to reach the abovenamed not later than 4.00 o'clock in the afternoon on 18 May 1983. 6221

In the Supreme Court of Victoria, C.O. 13013—In the matter of the Companies (Victoria) Code; and in the matter of Matthews Transport Pty. Ltd.

Notice is hereby given that an Application for the winding up of the abovenamed company by the Supreme Court was on 17 February 1983 presented by the Company and that the said Application is directed to be heard before the Court sitting at the Practice Court Law Courts, Lonsdale Street, Melbourne at the hour of 10.30 o'clock in the forenoon on 19 May 1983 and any creditor or contributory of the said Company desiring to support or oppose the making of an order on the said Application may appear at the time of hearing by himself or his Counsel for the purpose; and a copy of the said Application will be furnished to any creditor or contributor of the said Company requiring the same by the undersigned on payment of the regulated charge for the same.

The Applicant's official address is 47 Bull Street, Bendigo.

The Applicant's Solicitors are Messrs. Cornwall Stodart & Co. of 63 Exhibition Street, Melbourne.

CORNWALL STODART & CO.

Note—Any person who intends to appear on the hearing of the said Application must serve on or send by post to the abovenamed Cornwall Stodart & Co., notice in writing of his intention so to do. The notice must state the name and address of the person, or, if a firm, the name and address of the firm, and must be signed by the person or his or their solicitor (if any), and must be served or, if posted, must be sent by post in sufficient time to reach the abovenamed not later than 4.00 o'clock in the afternoon on 18 May 1983. 6222

The Companies Act 1961

ANTRIM INTERIORS PTY. LTD. (IN LIQUIDATION)
NOTICE CONVENING FINAL MEETING PURSUANT TO SECTION 272

Notice is hereby given that a special meeting of Creditors and members of the above company will be held at the Victorian Club, 141 Queen Street, Melbourne in the first floor board room on 12 May 1983 at 10.30 in the forenoon for the purpose of having an account laid before them showing the manner in which the winding up has been conducted and the property of the Company disposed of and of hearing of any explanation that may be given by the liquidator.

Dated 5 April 1983

6227

C. P. STEPHENS, Liquidator

In the Supreme Court of Victoria, C.O. 13018—In the matter of the Companies (Victoria) Code; and in the Matter of Davmar Enterprises Pty. Ltd. Notice of Winding-Up Order

Winding-Up Order: Made 7 April 1983.

Name and address of the liquidator: Ernest Harding Neimann, 80 Collins Street, Melbourne.

PHILIP E. FOX, solicitor for the petitioner, 367 Collins Street, Melbourne 3000. 6295

Unclaimed Moneys Act 1962

Register of Unclaimed Moneys held by the—

| Name of Owner on Books and Last Known Address | Total Amount Due to Owner | Description of Unclaimed Money | Date when Amount first became Payable |
|--|---------------------------|--------------------------------|---------------------------------------|
| \$ | | | |
| ICI AUSTRALIA LIMITED | | | |
| Hamilton-Gibbs, Dr. John S., 34 Homewood Ave, Karori, Wellington, N.Z. | 21.25 | Dividend | 31.7.81 |
| Percival, Thomas A., 65 Pembroke St, Hamilton, N.Z. | 12.75 | " | " |
| Wilbur-Ham, Dr. Brian L., 3 Balfour St, Toorak. | 21.70 | " | " |
| Djurasevich, Danica, 154 Brighton Rd, Somerton Park, S.A. | 10.00 | " | 31.1.82 |
| Percival, Thomas A., 65 Pembroke St, Hamilton, N.Z. | 12.75 | " | " |
| Pettit, Ethel M., 39 Clifford St, Warragul. | 10.00 | " | " |
| Wilbur-Ham, Dr. Brian L., 3 Balfour St, Toorak. | 21.70 | " | " |
| Adamson, Charles W., 7 Stirling St, Rosedale, Qld. | 17.50 | " | 31.5.81 |
| Andrew, Rodney W., 6 Leist St, Weston, A.C.T. | 35.00 | " | " |
| Ansombe, Alma L. M., (estate of), c/o William N. A. Latchford, "Meadowbank" Grants Rd, Whittlesea | 101.25 | " | " |
| Bagot, Margaret E., 12 Park Tce, Gilberton, S.A. | 125.00 | " | " |
| Bailey, Vera D., 233 Gale Rd, Maroubra, N.S.W. | 112.00 | " | " |
| Brooks, Leah M., 20 Craiglands Ave, Gordon, N.S.W. | 196.25 | Interest | " |
| Bruce, David R., 1 Grandview St, Pymble, N.S.W. | 36.25 | " | " |
| Denkbar Pty. Ltd., c/o H. R. Schlapp, 37 Swanston St, Melbourne | 280.00 | " | " |
| Jeeves, Deirdre J., 4/21 Essex Rd, Surrey Hills | 21.75 | " | " |
| Jullyan, Ross D., and Lillian D. A., 1/28 Northcote Ave, Balwyn | 14.40 | " | " |
| Kerr, Kathleen A., 26 Warwick St, Killara, N.S.W. | 35.00 | " | " |
| Kilsby, William M., 5 Ajax Cr, Para Vista, S.A. | 18.13 | " | " |
| Laing, Evelyn F., 55 St. Georges Rd, Toorak | 32.50 | " | " |
| Old Scotch Collegians' Association, c/o F. Crawford, c/o Scotch College, Glenferrie Rd, Hawthorn | 65.00 | " | " |
| R. I. M. Pty. Ltd., c/o J. Mandleson, 19 Olive St, Paddington, N.S.W. | 42.00 | " | " |
| Sibley, Neville V., 45 Greenbank St, Marrickville, N.S.W. | 130.63 | " | " |
| Thompson, George, 35 Scott St, Elwood | 38.00 | " | " |
| Whittakers, Wanda G. (estate of), c/o Alison A. Christie, 18 Dwyer St, Macleod | 10.50 | " | " |
| Whittney, Evelyn F., 82 Wellington St, Deniliquin, N.S.W. | 39.88 | " | " |
| Williams, Violette M., "Opononui", 106 Gregory St, Ballarat | 36.00 | " | " |
| Bastin, Constance S. N., "Somerset", Brewster Rd, Ararat | 60.00 | " | 31.7.81 |
| Westrate, Dorothy B., 100 Harakeke St, Christchurch, N.Z. | 27.00 | " | " |
| Adamson, Charles W., 7 Stirling St, Rosedale, Qld. | 17.50 | " | 30.11.81 |
| Andrew, Rodney W., 6 Leist St, Weston, A.C.T. | 35.00 | " | " |
| Barta, Joseph and Barta, Catherine M. O., 133 Nelson Rd, Mount Nelson, Tas. | 25.25 | " | " |
| Bartlow, Claude B., 5a Russell Ave, Wahroonga, N.S.W. | 54.38 | " | " |
| Boyd, Thelma L., 38 Boomerang St, St. Lucia, Qld. | 35.00 | " | " |
| Chabot, Charles J., (estate of), c/o Burnand and Burnand, 4 Aldsworth Pde, Goring Way/Goring-By-Sea, Worthing West, U.K. | 68.17 | " | " |
| Foulsham, Pamela M. J., Aigua Blava, 15b Coolong Rd, Vaucluse, N.S.W. | 140.00 | " | " |
| Higgs, Elizabeth M., 4 Albany Pl, Bulleen | 162.50 | " | " |
| Hill, Jean G., 13 Merchiston Gve, Strathmore | 64.38 | " | " |
| Kerr, Kathleen A., 26 Warwick St., Killara, N.S.W. | 35.00 | " | " |
| Kilsby, William K., 5 Ajax Cr, Para Vista, S.A. | 18.13 | " | " |
| Laing, Evelyn F., 55 St. Georges Rd, Toorak | 32.50 | " | " |
| Makinson, Kathleen I., 4 Russell St, Wollstonecraft, N.S.W. | 31.88 | " | " |
| Sibley, Neville V., 45 Greenbank St, Marrickville, N.S.W. | 130.63 | " | " |
| Thompson, George, 35 Scott St, Elwood | 38.00 | " | " |
| Thompson, Mark R., 35 Grove Rd, Wamberal, N.S.W. | 59.50 | " | " |
| Weston, David L., 25 Military Rd, Tennyson, S.A. | 13.00 | " | " |
| Whittakers, Wanda G., (estate of), c/o Alison A. Christie, 18 Dwyer St, McLeod | 10.50 | " | " |
| Cowdell, Barry G., GPO Box 1457N, Melbourne | 90.00 | Interest A/C No. 39 | 31.1.82 |
| Andrew, Donald, Tiroiti, Hyde Central, Otago, N.Z. | 10.17 | Dividend | 2.3.81 |
| Arana, Antonio and Arana, Antonio T., Box 380, Ayr, Qld. | 18.81 | " | " |
| Bartier, William J., 13 Maxwell Rd, Austinmer, N.S.W. | 13.86 | " | " |
| Battersby, Paula F., 36 Bay View Tce, Wellington C4, N.Z. | 208.16 | " | " |
| Biondo, Sam and Biondo, Domenica, 123 Synott St., Werribee | 16.74 | " | " |
| Blackmore, Stephen G., 25 Kenilworth St., Bondi Junction, N.S.W. | 16.74 | " | " |
| Bosworth, Herbert R., PO Box 23 Victoria Estate, Ingham, Qld. | 16.20 | " | " |
| Brabant, Archibald E. D. M., 41 Newcastle St, Fairfield, Qld. | 11.97 | " | " |
| Britten, Desmond J., 36 Tio-Tio Rd, Strathmore, Wellington, N.Z. | 10.17 | " | " |
| Brown, Peter R. C., "Pengwyn", Symonds Yat East Nr. Ross-on-Wye, Herefordshire HR96JL, U.K. | 91.80 | " | " |
| Bundesen, Donald and Bundesen Pamela G., Bow 186, Yeppoon, Qld. | 11.97 | " | " |
| Byrne, Gerald F., c/o Byrne, Margaret M., 3/24 Parnell St, Elsternwick | 209.97 | " | " |
| Cameron, Hugh L., 16 Skene St, Newtown, Geelong | 184.77 | " | " |
| Cameron, Leith R., 2171 Stedcombe St, Alawa, Darwin, N.T. | 23.94 | " | " |
| Campbell, James R., 73 Station Rd, Deer Park | 17.01 | " | " |
| Carroll, Hazel D., c/o PO Box 4311, Melbourne | 47.97 | " | " |
| Clarry, David W., c/o 345 M/S, Mundubbera, Qld. | 17.64 | " | " |
| Claussen, Olive V. D., c/o Rees and Rees, GPO Box 121, Brisbane, Qld. | 12.60 | " | " |
| Clayton, Charles D., 51 Reilleys Rd, Winston Hills, N.S.W. | 59.94 | " | " |
| Cosatto, Paul J., Box 29, Dimbulah, Qld. | 10.53 | " | " |
| Crabbe, Heather A., 9 Murdoch St, Cremorne, N.S.W. | 33.57 | " | " |
| Crisp, Digby D., 37 Power St, Balwyn | 11.97 | " | " |
| Crisp, Maxwell B., 34 Rich St, Higgins, A.C.T. | 11.97 | " | " |

Unclaimed Moneys Act 1962

Register of Unclaimed Moneys held by the—

| Name of Owner on Books and Last Known Address | Total Amount Due to Owner | Description of Unclaimed Money | Date when Amount first became Payable |
|--|------------------------------------|-----------------------------------|--|
| \$ | | | |
| ICI AUSTRALIA LIMITED—continued | | | |
| De Campo, Ethel C. M. and De Campo, Francis J. Grand Central Hotel, Srina, Qld. | 26.37 | Dividend | 2.3.81 |
| Dellanoce, Anna V., "Westwood", Heatherlands Rd, Chilworth, Hants, U.K. | 109.09 | " | " |
| De Meyrick, Anthony, 9 Glen Carron Ave, Mosman, N.S.W. | 59.94 | " | " |
| Dunn, Howard S., 34 Alambie La, Upper Ross River, Townsville, Qld. | 26.46 | " | " |
| Eidsvold Station Holdings Pty Ltd, Eidsvold Station, Eidsvold, Qld. | 39.06 | " | " |
| Epstein, Martin T., 12 Burwood Rd, Whitebridge, N.S.W. | 11.97 | " | " |
| Ferrero, Elmo, Box 555, Ingham, Qld. | 10.26 | " | " |
| Foley, David J., PO Box 76, Warra, Qld. | 27.81 | " | " |
| Fracchia, Bruno, PO Box 490, Ingham, Qld. | 11.34 | " | " |
| Gabiola, Pascasio, Feluga Via Tully, Qld. | 13.50 | " | " |
| Galloway, Alexander N., Wagga Rd, Lavington, N.S.W. | 61.38 | " | " |
| Ghidella, Lorenzo, M/S 102, Ingham, Qld. | 13.05 | " | " |
| Gould, Phyllis M., Suriside Motel, 12 Anzac Pde, Yeppoon, Qld. | 38.88 | " | " |
| Grant, Peter D. and Grant, Malcolm J., c/o Hjooring Tait and Farrell, Box 10, Oamaru, N.Z. | 174.73 | " | " |
| Grenfell, Nicholas, 29 Fairdale Gdns, Putney, London, SW15, U.K. | 42.00 | " | " |
| Grotherr, Mervyn R., Sharon via Bundaberg, Qld. | 19.26 | " | " |
| Handbury, Alan J., c/o Carricks, Level 7/60 Albert Rd, South Melbourne | 72.00 | " | " |
| Hargrave, Sheila, 1693 Malvern Rd, Glen Iris | 23.94 | " | " |
| Hartwell, Clarence E. and Hartwell, Robert W., PO Box 614, Ayr, Qld. | 17.82 | " | " |
| Hassed, Ritchie D., 6 Hawtree Tce, Johnstonville, Wellington, N.Z. | 39.93 | " | " |
| Hewett, Leonard E. A., c/o Hewett Constructions, 53 Bishops Place, Kensington, S.A. | 14.40 | " | " |
| Hinchliffe, Desmond W., M/S 763 Pialba, Qld. | 11.61 | " | " |
| Holovsky, Milos and Holovsky, Mary J., PO Box 1162, Boroko, PNG | 10.17 | " | " |
| Huddy, Victor, 20 Davidson St, Ingham, Qld. | 23.40 | " | " |
| Ioannou, Aristotelis, 31 Ongar Rd, London, SW6 U.K. | 15.30 | " | " |
| Jackson, Anthony C. B., c/o Jackson Heyes and Wilson, 167 Macquarie St, Sydney, N.S.W. | 23.94 | " | " |
| Jason, Phyllis A., c/o Riversdale Private Hospital, 65 Riversdale Rd, Hawthorn | 94.32 | " | " |
| Johnstone, Isabel M., 265 Drummond St, Carlton | 11.97 | " | " |
| Jordan, Juliet M., Flat 4/6 Denbigh Rd, Armadale | 141.57 | " | " |
| Kelly, Kevin H., PO Box 36, El Arish, Qld. | 11.97 | " | " |
| Knowles, James, D., 9 Ballarat St, Queenstown, Otago, N.Z. | 40.77 | " | " |
| Laurie, Kathleen M., 56 Alfred Rd, Glebe, N.S.W. | 21.78 | " | " |
| Lea, Henry, Box 2747, Auckland, C1, N.Z. | 23.64 | " | " |
| Lee, Hung N., 16 Mathieson St, Highett | 11.97 | " | " |
| Le Galley, Ray E., 20 Spinkbrae, Fig Tree Pocket, Qld. | 11.97 | " | " |
| Leslie, Heather M., 15 Scales Parade, Balgowlah, N.S.W. | 50.40 | " | " |
| Luff, Genefer A., 30 Virginia St, Kensington, N.S.W. | 11.97 | " | " |
| McCook, Cyril L., Tucker St, Yeppoon, Qld. | 34.20 | " | " |
| McLaughlin, James J. A., Marsden Valley, Nelson, N.Z. | 11.78 | " | " |
| Manassero, Pierino and Manassero, Delia M., Abergowrie PO, Qld. | 12.42 | " | " |
| Marbelli, Ernesto and Marbelli, Enrica, PO Box 61, Halifax, Qld. | 23.49 | " | " |
| Mitchell, Margaret J., 802 Maraekakaho Rd, Hastings, N.Z. | 33.05 | " | " |
| Mulherin, Thomas G. B., 4 New Farm Rd, West Pennant Hills, N.S.W. | 11.25 | " | " |
| Munro, Janice L., 117 Clausen St, Mt. Gravatt, Qld. | 27.90 | " | " |
| Muscat, James, Racecourse via Mackay, Qld. | 15.84 | " | " |
| Newman, William A., Post Office, Mena Creek, Qld. | 16.02 | " | " |
| North, Earl A. C., 20 Roskilda Cres, Taradale, Napier, N.Z. | 36.87 | " | " |
| Parker, Bryan S. and Parker, Merle D., Lindemans Rd, Moore Park, Gooburum, Qld. | 11.97 | " | " |
| Paterson, John D., 24 Tawa Rd, Onehynga, Auckland, N.Z. | 152.23 | " | " |
| Player, Anthony J. F., 91 Factory Rd, Mosgiel, Otago, N.Z. | 10.17 | " | " |
| Poggioli, Norma, Toiga Rd, Kairi, Qld. | 10.17 | " | " |
| Poli, S. Davide, Poli, Gino and Poli, Alfonso, Box 67, Home Hill, Qld. | 10.26 | " | " |
| Previll, Fay M., 203 Eastern Valley Rd, Middle Cove, N.S.W. | 27.81 | " | " |
| Quong Chong, Ida P., 84 Milton St, Ashfield, N.S.W. | 21.33 | " | " |
| Reade, Paul A., Flat 205 Central Park Flats, Brooklyn, Wellington, N.Z. | 10.17 | " | " |
| Rice, Ian H., c/o Rice Bros, Fowler St, Moe | 11.97 | " | " |
| Robb, Heather I., Gin Gin, Qld. | 26.28 | " | " |
| Robb, Roy D., Newhaven, Gin Gin, Qld. | 10.26 | " | " |
| Rockey, Jeanne M., 22 Drumalbyn Rd, Bellevue Hill, N.S.W. | 36.00 | " | " |
| Rudd, Sheila A., 5 Karrakatta St, Black Rock | 23.94 | " | " |
| Schnackenberg, Peter J., 'Bromdevi' Frankford, Tas. | 16.74 | " | " |
| Sherwood, Ray, PO Box 315, Hastings, N.Z. | 30.60 | " | " |
| Silberman, Joseph, c/o Smartfit Pty Ltd, 68 Wentworth Ave, Sydney, N.S.W. | 83.97 | " | " |
| Smith, Harold G. and Smith, Robert G., PO Box 839, Ayr, Qld. | 19.53 | " | " |
| Smith, Margaret J., c/o Dalgety New Zealand Loan, Berridale, N.S.W. | 23.94 | " | " |
| Stone, Minnie, 76 Tilehurst Rd, Reading, Berks, U.K. | 28.53 | " | " |
| Sugden, Arthur E., PO Box 508, Port Louis, Mauritius, Indian Ocean | 41.96 | " | " |
| Swanson, Dr Andrew, 3 Rowallan Court, North Balwyn | 23.94 | " | " |
| Taylor, Donald D., Wallum Downs, Isis Junction, Qld. | 11.97 | " | " |

Unclaimed Moneys Act 1962

Register of Unclaimed Moneys held by the—

| Name of Owner on Books and Last Known Address | Total Amount Due to Owner | Description of Unclaimed Money | Date when Amount first became Payable |
|--|------------------------------------|-----------------------------------|--|
| ICI AUSTRALIA LIMITED—continued | | | |
| \$ | | | |
| Teate, Michael R., Box 30, Frances, S.A. | 36.00 | Dividend | 2.3.81 |
| Tonion, Giulio G., Box 489, Ingham, Qld. | 10.98 | " | " |
| Vardy, Terence C., 59 Station St, Currumbin, Qld. | 19.44 | " | " |
| Venables, Norma J., M/S 102, Ingham, Qld. | 15.84 | " | " |
| Walsh, James, (estate of), c/o Rope, Douglas B., Glenmore Rd, Pakaronga, N.Z. | 33.81 | " | " |
| Ward, Grahame R., c/o PO Box 4311, Melbourne | 11.97 | " | " |
| Warner, Edwin A., 103 Springdale Rd, Killara, N.S.W. | 73.44 | " | " |
| Wearne, Howard R., 16 Harcourt Ave, Caulfield | 131.94 | " | " |
| Wells, Bernhard J., c/o Bank of N.S.W. Nominees Pty Ltd, GPO Box 7026, Sydney, N.S.W. | 68.94 | " | " |
| Westcott, Charles A. H., Sunnyside, Homebush via Mackay, Qld. | 11.97 | " | " |
| Westcott, Charles A. H., Westcott, Warrick H. and Westcott, Charles E., Sunnyside via Mackay, Qld. | 11.97 | " | " |
| Whitley, Carey, Flat 4/183 Romford Rd, Stratford E15, 4JO, U.K. | 14.23 | " | " |
| Wilcox, Gavin G., 15 Kiamala Cres, Killara, N.S.W. | 18.00 | " | " |
| Willett, Leonard A., Willett, Maureen, Bromley, Helena G., Glen Bar, Warwick, Qld. | 11.97 | " | " |
| Williams, Christine I., 7 Swallow St, Slade Point, Mackay, Qld. | 12.06 | " | " |
| Adamson, Flora, 14 Warrall St, Croydon | 134.40 | " | 1.9.81 |
| Baird, John H., 28 Woolwich Rd, Hunters Hill, N.S.W. | 92.88 | " | " |
| Biondo, Sam and Biondo, Domemica, 123 Synott St, Werribee | 11.16 | " | " |
| Bramley Investment Co. Pty Ltd, c/o W. R. Worley and Co, Yandilla St, Pittsworth, Qld. | 53.64 | " | " |
| Brasch, Charles O. and Fels Peter W., (estate of), c/o Webb Brash Ward and Co, PO Box 11, Dunedin, N.Z. | 67.83 | " | " |
| Broad, Muriel M., 3 Heron Ave, Mermaid Beach, Qld. | 33.60 | " | " |
| Browne, Maxwell S., Villa 3, 36 Archibald Ave, Brighton, Le Sands, N.S.W. | 22.38 | " | " |
| Byrne, Gerald F., (estate of), c/o Byrne, Margaret M., 3/24 Parnell St, Elsternwick | 139.98 | " | " |
| Cameron, Leith R., 2171 Stedcombe St, Alawa, Darwin, N.T. | 15.96 | " | " |
| Campbell, James R., 73 Station Rd, Deer Park | 11.34 | " | " |
| Carroll, Hazel E., c/o PO Box 4311, Melbourne | 31.98 | " | " |
| Chabot, Charles J., (estate of), c/o Burnand and Burnand, 4 Aldsworth Pde, Goring Way, Goring-By-Sea, Worthing West, Sussex, BN12, 4UA, U.K. | 47.58 | " | " |
| Cotzell, Helen M., 46 Brighton St, Flemington | 55.98 | " | " |
| Crabbe, Heather A., 9 Murdoch St, Cremorne, N.S.W. | 22.38 | " | " |
| Curwood, Sylvia M., Flat 2, 15 Bulla Rd, North Essendon | 15.96 | " | " |
| Cvjetanovic, Radinko, Up River, Home Hill, Qld. | 10.80 | " | " |
| Cvjetanovic, Radinko and Cvjetanovic, Peter T., Box 239, Home Hill, Qld. | 12.36 | " | " |
| Darken, John H. M., 56 Loughnans Rd, Ringwood | 158.88 | " | " |
| Dellanoce, Anna V., "Westwood" Heatherlands Rd, Chilworth, Hants, U.K. | 72.73 | " | " |
| De Meyrick, Anthony, 9 Glen Carron Ave, Mosman, N.S.W. | 39.96 | " | " |
| Denman, Robert E., M/S 656, Etowri via Mackay, Qld. | 15.12 | " | " |
| Dunn, Howard S., 34 Alambie, La Upper Ross River, Townsville, Qld. | 17.64 | " | " |
| Ede, Henry J., Mourilyan, Qld. | 10.08 | " | " |
| Elms, Diana J., 80 Hackthorne Rd, Christchurch, N.Z. | 13.57 | " | " |
| Finger Investments Pty Ltd, 12 Pring St, Ipswich, Qld. | 35.10 | " | " |
| Firkin Holdings Pty Ltd, 11 Longworth Ave, Wallsend, N.S.W. | 55.98 | " | " |
| Foley, David J., PO Box 76, Warra, Qld. | 18.54 | " | " |
| Fox, Mary E., M/S 305, Barolin via Bundaberg, Qld. | 20.28 | " | " |
| Grenfell, Nicholas, 29 Fairdale Gdns, Putney, London, SW15, U.K. | 28.00 | " | " |
| Grotherr, Mervyn R., Sharon via Bundaberg, Qld. | 12.84 | " | " |
| Grove, Harry R., PO Box 889, Ingham, Qld. | 13.80 | " | " |
| Handbury, Alan J., c/o Carricks Level 7, 60 Albert Rd, South Melbourne | 48.00 | " | " |
| Hargrave, Sheila, 1693 Malvern Rd, Glen Iris | 15.96 | " | " |
| Hassed, Ritchie D., 6 Hawtry Tce, Johnsonville, Wellington, N.Z. | 26.62 | " | " |
| Herbert, Helene A., 17 Kipling Ave, Epsom, Auckland 3 N.Z. | 13.57 | " | " |
| Huddy, Victor, 20 Davidson St, Ingham, Qld. | 15.60 | " | " |
| Ioannou, Aristotelis, 32 Ongar Rd, London, SW6, U.K. | 10.20 | " | " |
| Irwin, Lillian E., Weston, Thomas R., Weston, Joyce D., Cordalba, Qld. | 17.52 | " | " |
| Iwanek, Hilary, Llys Tryfan University College of North Wales, Menai Ave, Bangor Gwynedo, Wales, U.K. | 22.13 | " | " |
| Jackson, David C., "Irak", Maroona | 60.00 | " | " |
| Jordan, Juliet M., Flat 4, 6 Denbigh Rd, Armadale | 94.38 | " | " |
| Kendall, Leslie J., PO Box 233 Auckland C1 N.Z. | 42.28 | " | " |
| Kirchner, Margarete H., Bundaberg, Qld. | 14.28 | " | " |
| Knowles, James D., 9 Ballarat St, Queenstown, Otago, N.Z. | 27.18 | " | " |
| Kraegen, John F., 37 Woodland St, Balgowlah, N.S.W. | 31.98 | " | " |
| Laurie, Kathleen M., 5 Alfred Rd, Glebe, N.S.W. | 14.52 | " | " |
| Lea, Henry, Box 2747, Auckland, C1 N.Z. | 15.76 | " | " |
| Leslie, Heather M., 15 Scales Pde, Balgowlah, N.S.W. | 33.60 | " | " |
| Lloyd, Ronald E., 556 Whinray Cres, Albury, N.S.W. | 79.98 | " | " |
| Longmore, Charles J. N. and Jackson, Susan A., c/o Lloyds Bank Ltd 115 Commercial Rd, Portsmouth/Hants, U.K. | 48.55 | " | " |

Unclaimed Moneys Act 1962

Register of Unclaimed Moneys held by the—

| Name of Owner on Books and Last Known Address | Total Amount Due to Owner | Description of Unclaimed Money | Date when Amount first became Payable |
|---|---------------------------|--------------------------------|---------------------------------------|
| \$ | | | |
| ICI AUSTRALIA LIMITED—continued | | | |
| Lunney, David J., 98 Madison Drive, Adamstown Heights, N.S.W. | 22.38 | Dividend | 1 9. 81 |
| McCallum, Victoria D., Bomana Police College, Free Bag, Boroka, Port Moresby, P.N.G. | 20.40 | " | " |
| McGregor, John M., PO Box 314, Bundaberg, Qld. | 13.68 | " | " |
| McLaughlin, Mary J., 18 Yabba St, Ascot, Qld. | 27.96 | " | " |
| Margrie, Charles G., Redvale M/S, Yarram, Qld. | 78.54 | " | " |
| Montgomery, Annie G., 323 Withells Rd, Christchurch, N.Z. | 32.33 | " | " |
| Munro, Janice L., 117 Clausen St, Mt Gravatt, Qld. | 18.60 | " | " |
| Newman, William A., Post Office, Mena Creek, Qld. | 10.68 | " | " |
| North, Earl A. C., 20 Roskilda Cres, Taradale, Napier, N.Z. | 22.29 | " | " |
| Parker, Wylie, CML Building, 110 Hunter St, Newcastle, N.S.W. | 139.74 | " | " |
| Peters, William M. and Peters, Aileen C., 58 Keats St, Sunnybank, Qld. | 11.16 | " | " |
| Phillips, John W., PO Box 16, Holbrook, N.S.W. | 63.96 | " | " |
| Previll, Fay M., 203 Eastern Valley Rd, Middle Cove, N.S.W. | 18.54 | " | " |
| Quong Chong, Ida P., 84 Milton St, Ashfield, N.S.W. | 14.22 | " | " |
| Robb, Heather I., Gin Gin, Qld. | 17.52 | " | " |
| Rudd, Sheila, A., 5 Karrakatta St, Black Rock | 15.96 | " | " |
| Schnackenberg, Peter J., "Bromdevi" Frankford, Tas. | 11.16 | " | " |
| Silberman, Joseph, c/o Smartfit Pty Ltd, 68 Wentworth Ave, Sydney, N.S.W. | 55.98 | " | " |
| Smith, Harold G. and Smith, Robert G., PO Box 839, Ayr, Qld. | 13.02 | " | " |
| Spinks, Dr Betty B., 14 St Andrews St, Brighton | 11.16 | " | " |
| Stone, Minnie, 76 Tilehurst Rd, Reading, Berks, U.K. | 19.02 | " | " |
| Store, Nigel J., 31 Abbey Park Rd, Grimsby, Lincolnshire, U.K. | 34.78 | " | " |
| Sugden, Arthur E., (estate of) PO Box 508, Port Louis, Mauritius, Indian Ocean | 27.97 | " | " |
| Swanson, Andrew B., 3 Rowallan Court, North Balwyn | 15.96 | " | " |
| Swift, Loris N., PO Box 70, Hunters Hill, N.S.W. | 111.96 | " | " |
| Taifalos, Nicholas J., PO Box 43, Silkwood, Qld. | 12.30 | " | " |
| Taylor, Ian M., 15 Hopetoun Rd, Toorak | 26.16 | " | " |
| Taylor, Judith A., 9 Smugglers Way, Rhu Dumbartonshire, Scotland | 17.80 | " | " |
| Thornton, Patricia L., c/o Thornton, S. G., 24 Hanslope Ave, Alphington | 16.18 | " | " |
| Venables, Norma J., M/S Ingham, Qld. | 10.56 | " | " |
| Waldie, Ian H., 32 Boundary St, Roseville, N.S.W. | 11.16 | " | " |
| Walsh, James, (estate of), c/o Rope, Douglas B., Glenmore Rd, Pakaronga, N.Z. | 22.54 | " | " |
| Walter Steiner Pty Ltd, 4th Floor, 537 George St, Sydney, N.S.W. | 130.32 | " | " |
| Warner, Edwin A., 103 Springdale Rd, Killara, N.S.W. | 48.96 | " | " |
| Wearne, Howard R., 16 Harcourt Ave, Caulfield | 87.96 | " | " |
| Williams, Irene L., 31 Taylor St, Darlinghurst, N.S.W. | 11.16 | " | " |
| Wilson, Anthony Q. V., "Mangatapu" Wilsons Rd, No.9 RD Palmerston North, N.Z. | 18.36 | " | " |
| Woods, Alex K., 20 Clee St, McKinnon | 11.16 | " | " |
| Dann, Cyril G., (estate of), c/o Tyson and Tyson, 59 Cameron St, Launceston, Tas. | 97.65 | Dividend | 2.3.81 |
| Lawler, Thomas R. and Lawler, Ellen M., PO Box 167, Darwin, N.T. | 11.97 | " | " |
| Burden, Bessie H. K., 107 Swaine Ave, Toorak Gardens, S.A. | 700.00 | Unclaimed | 30.11.81 |
| Craven, Horace S., (estate of), c/o George A. Raves and Poole, PO Box 531, Artarmon, N.S.W. | 1000.00 | " | " |
| Faviell, David W. C., 32 Beach Rd, Collaroy, N.S.W. | 2000.00 | " | " |
| Kilsby, William M., 5 Ajax Court, Para Vista, S.A. | 500.00 | " | " |
| Ross, Aurea, (estate of), c/o Purves Moodie and Storey, GPO Box 119, Sydney, N.S.W. | 1000.00 | " | " |
| Smith, Vera, 6 Dick St, Wodonga | 100.00 | " | " |
| Westrup, Ernest, (estate of), c/o David Roe Treatt and Watts, PO Box 410, Gosford, N.S.W. | 1400.00 | " | " |
| Whitney, Evelyn F., 82 Wellington St, Deniliquin, N.S.W. | 1100.00 | " | " |
| Barry, Norah E. C., (estate of), c/o R. J. Darton and Co, 471 Marrickville Road, Dulwich Hill, N.S.W. | 1000.00 | " | " |
| Henderson, Allan H., Shepherds Flat, Daylesford | 1000.00 | " | " |
| May, Geoffrey B., CO PO 13 Buderim, Qld. | 2000.00 | " | " |
| 5671 | | | |
| MOBIL OIL AUSTRALIA | | | |
| Ski Lift Engineering, 2 Tyne Crt, Frankston | 45.00 | Cheque | 26.3.81 |
| Siemans Metal, Dartmouth | 240.00 | " | 30.4.81 |
| Westfield, Westall Rd, Clayton | 90.00 | " | 23.9.81 |
| Monitto, G. A., 87 Gamon St, Yarraville | 15.00 | " | 21.12.81 |
| Woorayl District Hospital, Leongatha | 56.78 | " | 22.12.81 |
| Cameron, D. J., 5 Hisken St, Sorrento | 57.89 | " | 23.12.81 |
| Watkins, Ronald A., 1 Wilkinson St, East Burwood | 149.40 | " | 30.9.81 |
| William and Douglas, Federation St, Ascot Vale | 25.62 | " | 22.12.81 |
| Beard, L. U., 154 Toorak Rd, South Yarra | 67.35 | " | 27.8.81 |
| Wallace Recreation Centre, c/o Bungaree Shire, Bungaree | 79.20 | " | 16.10.81 |
| 5664 | | | |

Unclaimed Moneys Act 1962

Register of Unclaimed Moneys held by the—

| Name of Owner on Books and Last Known Address | Total Amount Due to Owner | Description of Unclaimed Money | Date when Amount first became Payable |
|---|------------------------------------|-----------------------------------|--|
| \$ | | | |
| A.C.I. INTERNATIONAL LIMITED | | | |
| Ahern, Margaret F., 76 Old Burleigh Rd, Surfers Paradise, Qld. | 22.50 | Dividend | 26.2.82 |
| Akers, Agnes A., 916 Pittwater Rd, Dee Why, N.S.W. | 26.03 | " | 29.8.81 |
| Alcock, G. M. A., Piggott, J. B. and Morton, J. N., "G Account", 122 Collins St, Hobart, Tas. | 33.75 | " | " |
| Allen, Sydney J., c/o 79 Nelson St, Opotiki, N.Z. | 573.76 | " | " |
| Anderson, Ross S., G.P.O. Box 246, Charlestown, N.S.W. | 127.13 | " | 26.2.82 |
| Antonieson, Herman P., 86 Fitzpatrick Cres, Casula, N.S.W. | 22.50 | " | 29.8.81 |
| Arkins, Margaret V., 46 Baringa Road, North Bridge, N.S.W. | 43.88 | " | 26.2.81 |
| Arlescote Pty. Ltd., c/o A.E. Dry P.O. Box 166, Perth, W.A. | 1109.52 | " | 31.7.81 |
| Arnott, Gwynth V., 4 Russell St, Balgowlah, N.S.W. | 25.66 | " | 29.8.81 |
| Arthur, Rita M., "Tralee", Temora, N.S.W. | 23.40 | " | " |
| Baird, John H., 28 Woolwich Rd, Hunters Hill, N.S.W. | 776.40 | " | 29.8.81 |
| Baird, Moira J., 28 Woolwich Rd, Hunters Hill, N.S.W. | 115.73 | " | 26.9.82 |
| Baker, Ian H., 66 Chelmsford Av, Epping, N.S.W. | 18.76 | " | 29.8.81 |
| Balfour, Phyllis M., Vernon 4, R.D., Blenheim, N.Z. | 72.00 | " | 31.7.81 |
| Barclay, Miles, "T" Account, P.O. Box 160, Double Bay, N.S.W. | 735.38 | " | 29.8.81 |
| Bardon, Ines D., 117 East Tamaki Rd, Papatoetoe, N.Z. | 16.58 | " | " |
| Barnett, Peter, 11/28 Selwyn Ave, Elwood | 15.98 | " | " |
| Barrell, Peter H. R., 1/6 Grange Rd, Toorak | 375.00 | " | " |
| Bayles, Bruce T., Darlington Park Cressy, Tas. | 3158.82 | " | 31.7.81 |
| Bell, Ross J., 7 Berwick St, Dunedin, N.Z. | 51.71 | " | 26.2.82 |
| Berry, Dr. Paul R., c/o Acute Respiratory Unit, Auckland Hospital, Auckland, N.Z. | 34.44 | " | 29.8.81 |
| Bett, Dr. John H. N. and Cleaver, Abigail, Flat 20, 29 Upton Rd, Windsor | 150.00 | " | " |
| Betty, David J., 27 Braeside St, Wahroonga, N.S.W. | 28.13 | " | " |
| B. and G. Securities Pty. Ltd., Shellslear Trust, PO Box 44 | 165.60 | " | 31.7.81 |
| Blakeney, John S. c/o Manager, ANZ Banking Group Ltd., cnr. King and George Sts, Sydney, N.S.W. | 30.00 | " | 29.8.81 |
| Blanks, Dr. Ernest E., 3 Miller Place, Booragoon, W.A. | 11.25 | " | 26.2.82 |
| Blunt, Robert, 6 Croker St, West Newport | 37.90 | " | 29.8.81 |
| Bolling, Fred, 15/7 Dowling St, Kensington, N.S.W. | 18.76 | " | " |
| Bonnington, Valmai S. B., c/o A. Mitchell and Assoc. PO Box 49, Crows Nest, N.S.W. | 204.53 | " | 26.2.82 |
| Bossong, Hans, 512 Elgar Rd, Box Hill | 26.70 | " | 29.8.81 |
| Bowden, Robert C., 40 The Grove, Mosman, N.S.W. | 408.18 | " | 31.7.81 |
| Bowker, Dr. Stanley B. L. and Jean M., 95 Wairere Road, Gisborne, N.Z. | 304.43 | " | " |
| Boyden, Patricia B., "Denshans" Chagford, Devon, England | 11.93 | " | 29.8.81 |
| Bradford, Irene S., 4 Elm Cres, East Ivanhoe | 350.13 | " | 31.7.81 |
| Brasch, Charles O., PO Box 11, Dunedin, N.Z. | 200.10 | " | 31.7.81 |
| Brewer, Robert, 5 Pacific Blvd, Beaumaris | 452.76 | " | " |
| Bullock, Heather K., 208 Greenhill Rd, Eastwood, S.A. | 175.73 | " | 29.8.81 |
| Buckingham, David A., 10 O'Shanassy St, Curtin, A.C.T. | 46.80 | " | " |
| Bryers, Vaughan T., 8/3 Thorpe St, Clovelly, N.S.W. | 37.50 | " | 26.2.82 |
| Brunen, Harry, 93 Military Rd, Dover Heights, N.S.W. | 59.27 | " | 31.7.81 |
| Browne, Jessie, Unit 15, Frederick and Dural St, Hornsby, N.S.W. | 16.80 | " | 26.2.82 |
| Brown, David G., 1/48 Albert St, Hornsby, N.S.W. | 26.26 | " | 29.8.81 |
| Brown, Andrew F., 9 Sirius Cove Rd, Mosman, N.S.W. | 11.25 | " | " |
| Britten-Gerger, Beverley, 139 Fowler Rd, Illawong, N.S.W. | 15.00 | " | " |
| Bristow, John M., 68 Boundary Rd, Wahroonga, N.S.W. | 112.50 | " | " |
| Brennan, Eileen W., 311 Kent St, Falls Church, Virginia, U.S.A. | 11.17 | " | 26.2.82 |
| Braund, Harold C., (estate of) 16 Sorrett Avenue, Malvern | 525.78 | " | 31.7.81 |
| Burley, Heather W., Ormiston Rd, Manurewa Manurewa Rd, Auckland, N.Z. | 262.08 | " | " |
| Burn, Anthony R. | 108.21 | " | " |
| Burns, Donald M., 14 Wallace St, Burwood, N.S.W. | 42.00 | " | 29.8.81 |
| Burns, Gregory J., 14 Wallace St, Burwood, N.S.W. | 21.08 | " | " |
| Burns, John H., 1018 Frederick St, Hastings, N.Z. | 38.70 | " | 31.7.81 |
| Burton, Charles D. (estate of) GPO Box 2819A, Melbourne | 16 651.08 | " | " |
| Bushby, Philip A. and John D. S. Hooks, 60 Bellevue Rd, Bellevue Hill, N.S.W. | 219.02 | " | " |
| Cadmore, F. N. E. (estate of) 32 Clive St, Shepparton | 135.68 | " | 26.2.82 |
| Campbell, Jack D. and Janice M. 32 Kay St, Carlingford, N.S.W. | 214.78 | " | 31.7.81 |
| Carlile, Anne Penelope and Roberts, George V. and Peter A., PO Box 1003, Townsville | 256.88 | " | 26.2.82 |
| Caswell, Peter R. | 46.80 | " | 29.8.81 |
| Cathie, Ronald J., 102 Polaris Drive, East Doncaster | 1322.04 | " | 31.7.81 |
| Catlow, Warren R. and Margot E., 10 Baudelaire Avenue, Wantirna | 18.75 | " | 26.2.82 |
| Cawdle, Robert F., 29 Dallass St, Mt. Waverley | 30.00 | " | 29.8.81 |
| Champion, Beryl, 102 Livingstone Ave, Pymble, N.S.W. | 124.10 | " | 31.7.81 |
| Chandler, Ronald S., "Rowan Cottage" 142 Swithland Lane, Rothley, Leicestershire, U.K. | 16.27 | " | 26.2.82 |
| Chapman, Pauline K., 45 Ronald Ave, Greenwick, N.S.W. | 37.50 | " | 29.8.81 |
| Charlton, Elaine W., 32 Brunswick St, Fitzroy | 20.70 | " | 31.7.81 |
| Clapin, William D. c/o Wiclappin and Son, 300 George St, Sydney, N.S.W. | 788.40 | " | " |
| Clarke, Sir Rupert W. J. and Lady Kathleen and Rupert, G. A., 56 Avoca St, South Yarra | 31.05 | " | 26.2.82 |

Unclaimed Moneys Act 1962

Register of Unclaimed Moneys held by the—

| Name of Owner on Books and Last Known Address | Total Amount Due to Owner | Description of Unclaimed Money | Date when Amount first became Payable |
|--|---------------------------|--------------------------------|---------------------------------------|
| \$ | | | |
| A.C.I. INTERNATIONAL LIMITED—continued | | | |
| Clarkson, Raymond J., 28 Cruickshank Cres, Invercargill, N.Z. | 12.75 | Dividend | 26.2.82 |
| Cleland, Kenneth W., c/o Dept. of Histology, University of Sydney, Sydney, N.S.W. | 59.63 | " | 29.8.81 |
| Cloake, William, c/o D. V. Walton, PO Box 218, Pymble, N.S.W. | 94.73 | " | 26.2.82 |
| Cohen, Maxine, c/o G. M. Cohen, 19th Floor, 109 Pitt St, Sydney, N.S.W. | 238.74 | " | 31.7.81 |
| Collicot, Keith A., 51 St. Kinnord St, Essendon | 45.54 | " | " |
| Copland, Patricia M. c/o M. Donohue, 2/11 Osbourne Rd, Manly, N.S.W. | 35.10 | " | 29.8.81 |
| Cook, Gerrard G., 163 Riverside Drive, Lower Hutt, N.Z. | 80.64 | " | 31.7.81 |
| Cook, Hilda M., Unit 79, 17 Pyne St, South Caulfield | 1043.28 | " | " |
| Cowling, Edna M., 191 Bexley Rd, Earlwood, N.S.W. | 179.55 | " | 26.2.82 |
| Croft, Ivan F., c/o T. F. Croft, 2/11 Parnell St, Strathfield, N.S.W. | 92.03 | " | " |
| Cross, Geoffrey C. and Beighley, Jane G. 342 Cascades Drive, Fairay California, U.S.A. | 23.86 | " | " |
| Croswell, Charles, (estate of), c/o Ewart and Ewart, PO Box 488, Parramatta, N.S.W. | 448.26 | " | 31.7.81 |
| Cullen, Jean C. Currajugg RMB 127, Clyde Mountaine, Briardwood, N.S.W. | 145.13 | " | " |
| Curtis, Norma R., cnr. B'Field Pde, and Nimmo St, Albert Park | 37.50 | " | 29.8.81 |
| Darby, John J., 131 Armagh St, Christchurch, N.Z. | 15.96 | " | " |
| Darken, John H., 56 Loughnan Rd, Ringwood | 659.56 | " | " |
| Davey, Pringle N., 5 Buckneth St, Christchurch 4, N.Z. | 38.26 | " | " |
| Davies, Alfred C., Unit 2/34 Second St, Black Rock | 116.10 | " | 31.7.81 |
| Davies, Frances W., 4 Durness St, Kinmore, Qld. | 21.75 | " | 29.8.81 |
| Davies, Robert C., 6 Martin St, Crows Nest, N.S.W. | 69.30 | " | 31.7.81 |
| Davies, Ruby E., (estate of) P.O. Box 10, Wollongong, N.S.W. | 1077.78 | " | " |
| Davis, Jennifer L. | 51.00 | " | 29.8.81 |
| David, Robert W. and Robin, G.P.O. Box 4708, Darwin, N.T. | 75.00 | " | 26.2.82 |
| Davis, Roger, Rinder Box Rd, Piersons Point, Tas. | 14.03 | " | 29.8.81 |
| Dixon, Bruce C. | 11.48 | " | " |
| Dobson, Michael, 4/187 McKean St, North Fitzroy | 75.00 | " | 26.2.82 |
| Dolley, Lois, 68 Almorah Rd, Epsom, Auckland, N.Z. | 233.40 | " | " |
| Donald, John H., 2 Hawkswood Pl, Christchurch 4, N.Z. | 13.14 | " | " |
| Donohue, Margaret K., 454 Edgecliff Rd, Edgecliff, N.S.W. | 89.64 | " | 31.7.81 |
| Doran, Gordon, Wynde Heights, Woomelang | 178.02 | " | " |
| Dowling, Clifford E., 61E Chatswood Road, Silverstream, Upper Hutt, N.Z. | 104.43 | " | 26.2.82 |
| Downing, Margaret E., c/o N.W. Forrester, 22 Gilles Rd, Woodley, S.A. | 127.20 | " | 29.8.81 |
| Doyle, Harold M. c/o Macquarie Private Hotel, National Circuit, Barton, A.C.T. | 60.53 | " | " |
| Drake, David J., 153 Campbell St, Surry Hills, N.S.W. | 15.00 | " | " |
| Drake, Hugh H., 6 Hume St., Wollstonecraft, N.S.W. | 10.28 | " | " |
| Drewe, Margaret, 52 Bennington St, Ascot, Qld. | 172.92 | " | 31.7.81 |
| Duggan, Patrick W., 11 Inglewood Rd, Grays Pt, N.S.W. | 37.50 | " | 29.8.81 |
| Duncan, Max C. 6 Stanley St, Darlinghurst, N.S.W. | 52.65 | " | " |
| Dunn, Gwenda, Stonehaven via Geelong | 16.50 | " | " |
| Dye, Bruce H., 185 Arthur St, Grafton, N.S.W. | 11.70 | " | 26.2.82 |
| Dynes, Robert J., 75 Lochich Ave, Edithvale | 153.00 | " | 31.7.81 |
| Early, Alfred, 21 Tirotai Cres, Westmere, Auckland, N.Z. | 46.03 | " | 29.8.81 |
| Eccleston, Doris | 10.50 | " | " |
| Eddy, David R., 37 Myrtle Rd, Seachill, S.A. | 12.83 | " | " |
| Edgecombe, James D., P.O. Box 9029, Hamilton, N.Z. | 1585.62 | " | 31.7.81 |
| Egel, Peter, 49 Womarah Ave, Potts Pt, N.S.W. | 15.00 | " | 26.2.82 |
| Elliott, Winifred M., 2 Clovelly Pde, Seaford | 13.95 | " | " |
| Ellis, Edward C., 111 Clausen St, North Fitzroy | 102.30 | " | 29.8.81 |
| Ellis, Elizabeth M., 8 Fenton Ave, Kew | 27.90 | " | 31.7.81 |
| Ellis, Martyn P., 2/21A Bondi Rd, Bondi Junction, N.S.W. | 30.00 | " | 26.2.82 |
| Errey, Ian D. and Barbara A., Box 214, Portland | 81.90 | " | " |
| Evans, Joyce M. F., Flat 3, 42 Broadway, Nedlands, W.A. | 65.78 | " | " |
| Farkell, Rosemary A., 36 Matlock St, Canterbury | 140.27 | " | 31.7.81 |
| Farlou, Colin, Cometrowe St, Drummoyne, N.S.W. | 18.76 | " | 29.8.81 |
| Farrington, Mavis L., 7 Oxford St, East Brighton | 16.80 | " | 26.2.82 |
| Ferrall, Peter, 217B Invermay Rd, Launceston, Tas. | 16.80 | " | 29.8.81 |
| F. and J. Tyson Pty. Ltd., 3 Wells Street, Surrey Hills | 45.00 | " | 26.2.82 |
| Fleming, John M., Foursteel Rd, Hamilton | 18.76 | " | 29.8.81 |
| Fooke, Lorna I., 8 Stawell St, Beaumaris | 196.26 | " | 31.7.81 |
| Foord, Janet M., 14 Margaret Ave, Port Lincoln, S.A. | 154.80 | " | " |
| Ford, Richard G. M., P.O. Box 20, Gordon, N.S.W. | 68.88 | " | " |
| Formby, Irene J., c/o H. K. Formby, 89 Galston Rd, Hornsby, N.S.W. | 293.01 | " | " |
| Foster, John E., Flat 10, 4 Maree Rd, One Tree Hill, Auckland, N.Z. | 25.50 | " | 29.8.81 |
| Fox, Leslie, c/o War Veterans Home, 59 Ferguson Ave, Myrtlebank, S.A. | 46.80 | " | " |
| Francis, Judith B., "Tramella" Baden Powell Drive, Mt. Eliza | 108.76 | " | " |
| Fry, Derek G., 60 Bulls Rd, St. Johns Park, N.S.W. | 22.50 | " | 31.7.81 |
| Fry, William H., Lower Wonga, via Woolooga, Qld. | 102.00 | " | 29.8.81 |
| Galbraith, David F., P.O. Box 255, Castle Hill, N.S.W. | 65.51 | " | 31.7.81 |
| Gargard, Giacomo, 122 Banksia St, Heidelberg | 150.00 | " | 26.2.82 |
| Garner, Sybil, 756 Jones St, Albury, N.S.W. | 108.00 | " | 31.7.81 |
| Garratt Harden Pty. Ltd., "Garratt" Harden, N.S.W. | 11.10 | " | 26.2.82 |
| Gerathy, James S., 23/1 Spains Wharf Rd, Neutral Bay, N.S.W. | 75.00 | " | " |

Unclaimed Moneys Act 1962

Register of Unclaimed Moneys held by the—

| Name of Owner on Books and Last Known Address | Total Amount Due to Owner | Description of Unclaimed Money | Date when Amount first became Payable |
|---|------------------------------------|-----------------------------------|--|
| A.C.I. INTERNATIONAL LIMITED—continued | | | |
| Gibson, Norma, 9/23 Auburn Grove, Hawthorn | 24.08 | Dividend | 29.8.81 |
| Glossop, Lilian E., Unit 78/42-44 Cliff Rd, Wollongong, N.S.W. | 149.18 | " | 26.2.82 |
| Goodall, Donald D. W., Mossburn No. 2 R.D. Southland, N.Z. | 38.25 | " | 29.8.81 |
| Gordon, Alexander D. D. 30 Driveway Gardens, Reid, A.C.T. | 11.51 | " | 31.7.81 |
| Gouldern, Wendy M. E. c/o M. A. Mathers, 6 Tarella Dve, Mt. Waverley | 34.06 | " | 29.8.81 |
| Garden, Valerie, M. R., 6 Rodney St, Kanganui, N.Z. | 48.24 | Capital | 31.7.81 |
| Graham, Laurel C., 5/21 Bridge St, Epping, N.S.W. | 23.40 | Dividend | " |
| Graham, Robert A., P.O. Box 207, Woolahra, N.S.W. | 153.60 | " | " |
| Greenwood, Brett T., 19 Avbray Rd, Northbridge N.S.W. | 22.50 | " | " |
| Grevis, Enid D., (estate of) c/o Messrs Sly & Russell, G.P.O. Box 3872, Sydney, N.S.W. | 289.53 | " | " |
| Griffiths, Robert G., Nariel via Cudgewa | 120.00 | " | 26.2.82 |
| Grigg, Bertha E., c/o Francis Grill & Co., 6-10 O'Connell St, Sydney, N.S.W. | 36.23 | " | 29.8.81 |
| Gurson, Allan L., "Altrea", Common St, Goulburn, N.S.W. | 52.65 | " | 26.2.82 |
| Gurson, Joan T., "Altrea", Common St, Goulburn, N.S.W. | 146.48 | " | " |
| Gupta, Ray, R., 16 Tragorr Rd, Cantonment, Kanpur, India | 275.64 | " | 29.8.81 |
| Hall, Clive J. D., 46 Fulton Rd, Mount Eliza | 52.50 | " | 26.2.82 |
| Hall, Grace P., 2 Ashwood Crt, Fountain Gate Estate, Narre Warren | 14.03 | " | " |
| Hamilton, Bryan V., P.O. Box 18-148, Armagh, Christchurch, N.Z. | 32.92 | " | 31.7.81 |
| Handbury, Peter J. (estate of), and William G., P.O. Box 187, Mount Eliza | 20.48 | " | 26.2.82 |
| Hanson, Roderick A. D., 5 Shakespeare Gve, Hawthorn | 51.68 | " | 29.8.81 |
| Harper, Leslie A. T., (estate of) c/o I. and B.L. Harper, 14 Malmsbury St, Kew | 2644.08 | Capital | 31.7.81 |
| Harris, Kenneth E., (estate of), c/o Farry Wylie and Aage, P.O. Box 3246, Wellington, N.Z. | 690.00 | " | " |
| Harris, Stuart M., 8/39 Mascoty Dve, Eastlakes, N.S.W. | 30.00 | Dividend | 29.8.81 |
| Harrison, Brian A., 196 Raglan St, Mosman, N.S.W. | 46.58 | " | 26.2.82 |
| Harrison, Iona P., 171 Forest Rd, Arncliffe, N.S.W. | 11.25 | " | " |
| Hart, Edward T., 20 Davidson Rd, Attadale, W.A. | 506.26 | " | 29.8.81 |
| Hart, Edward W. P., 100 Williamsons Rd, Doncaster | 45.90 | Capital | 31.7.81 |
| Hart, Norman, 19 Saliva Ave, Bankstown, N.S.W. | 52.97 | Dividend | " |
| Hay, Thelma M., (estate of), c/o Pennington & Pennington, Provident Building, 263 George St, Sydney, N.S.W. | 11.26 | " | 29.8.81 |
| Hayes, Christopher J., "Winlavra" RMB 2460, Benalla | 20.40 | " | 26.2.82 |
| Hayes, James R., 2/89 Church St, Geelong West | 14.03 | " | " |
| Heapy, George T., 498 Nassim Rd, Tanglin, Singapore, 10 | 25.50 | " | 29.8.81 |
| Hefren, Anita L., 112 Avondale Rd, Couranbog, N.S.W. | 276.00 | Capital | 31.7.81 |
| Herring, John M., P.O. Box 50, Margaret River, W.A. | 225.00 | Dividend | 26.2.82 |
| Hilderbrand, Victoria J., 41 Cratloc Rd, Mt. Waverley | 27.30 | " | 29.8.81 |
| Hill, Barbara, 332 Military Rd, Vaucluse, N.S.W. | 37.50 | " | " |
| Hill, John D., Yandaran, Qld | 15.00 | " | " |
| Hindson, Jessie M., 23 Harrowdale Dve, Christchurch, 4, N.Z. | 131.78 | " | " |
| Hipwell, Freda G., 4 Casey Ave, Sunbury | 22.50 | " | " |
| Holdern, Josephine G., 17 Sackville St, Kew | 24.76 | " | " |
| Holden, Raymond A., 125 Bent St, Northcote | 276.00 | Capital | 31.7.81 |
| Holland, Ivan, 14 Sepentine Pde, Vaucluse, N.S.W. | 16.67 | Dividend | " |
| Hourane, Pamela, 1 Ulladulla Place, Kareela, N.S.W. | 30.46 | " | 29.8.81 |
| Howden, Conrad G., 41 Light St, Bar Beach, N.S.W. | 37.50 | " | " |
| Howden, David T., No. 1 R.D., Ashburton, N.Z. | 18.00 | Capital | 31.7.81 |
| Howse, John B., G.P.O. Box 2, Canberra, A.C.T. | 21.60 | " | " |
| Hoy, Bruce D., P.O. Box 2067, Konedobu, Papua New Guinea | 19.89 | Dividend | 26.2.82 |
| Hubbard, Charles G., P.O. Box 103, Palmerston North, N.Z. | 96.91 | " | 31.7.81 |
| Huckstepp, R. L., (estate of), c/o Travers Bizannes & Solomon, P.O. Box 358, Strathfield, N.S.W. | 176.93 | " | 29.8.81 |
| Hude, Valerie, 81/2 Parkes St, Kirribilli, N.S.W. | 531.30 | Capital | 31.7.81 |
| Hudson, Harold R., 37 Telegraph Rd, Pymble, N.S.W. | 636.18 | " | " |
| Hughes, Douglas W., 9 Tilshoad Close, Druids Heath, Maypole, Birmingham, England | 76.50 | Dividend | 29.8.81 |
| Huletti, Anthony J. & Paul M., 24 Howard St, Glen Iris | 15.00 | " | 26.2.82 |
| Hunter, Eileen J., P.O. Box 274, Christchurch, N.Z. | 96.01 | " | " |
| Hynes, Dr James V., 2 Dart St, Auchenflower, Qld. | 56.34 | Capital | 31.7.81 |
| Ingersoll, John K., c/o 46 Terrace Rd, Dulwich Hill, N.S.W. | 37.50 | Dividend | 29.8.81 |
| Insch, John P., 85 Cameron Rd, Hamilton, N.Z. | 63.75 | " | " |
| Ives, Irene M., 34 Wilson Rd, Wangaratta | 710.70 | Capital | 31.7.81 |
| Jackson, Peter A. & Driver, Robert F., c/o A. E. McIntosh & Anderson, 185 Elizabeth St, Sydney, N.S.W. | 18.76 | Dividend | 29.8.81 |
| Janke, Gunter, 103 Berry Ave, Edithvale | 23.40 | " | " |
| Jansen, Frederick W., P.O. Box 46, Burnside, S.A. | 10.83 | " | 31.7.81 |
| Johnson, Virginia N., M.T. Torlesse, Springfield, N.Z. | 99.06 | Capital | " |
| Johnstone, Wilson P., 27 McDonald St, Colac | 75.18 | " | " |
| Jones, Keith, Private Bag 513, Horsham | 36.83 | Dividend | 26.2.82 |
| Jones, Roslyn M., 13 Blossom Crt, Doncaster West | 116.10 | Capital | 31.7.81 |
| Jonston, Clytie L., 15 Carroll St, North Melbourne | 22.50 | Dividend | 29.8.81 |
| Jonston, Mavis E., 15 Carroll St, North Melbourne | 11.25 | " | " |
| Jungwirth, George, 4 Cannan St, Sunshine | 22.50 | " | " |
| Junior, Malcolm J. E., R.S.D Kialla | 175.40 | " | 31.7.81 |

Unclaimed Moneys Act 1962

Register of Unclaimed Moneys held by the—

| Name of Owner on Books and Last Known Address | Total Amount Due to Owner | Description of Unclaimed Money | Date when Amount first became Payable |
|--|------------------------------------|-----------------------------------|--|
| \$ | | | |
| A.C.I. INTERNATIONAL LIMITED— <i>continued</i> | | | |
| Kalaru Pty. Limited, 65 Clifton St, Malvern, S.A. | 123.84 | Capital | 31.7.81 |
| Kear, Rosie, (estate of), 479 Henley Beach Rd, Lockleys, S.A. | 206.56 | Dividend | 26.2.82 |
| Keenan, Judith R., 44 Leonard St, Upwey | 13.13 | " | 29.8.81 |
| Kelly, Martin, 310 Payneham Rd, Marden, S.A. | 18.76 | " | " |
| Kelmscott (Management) Pty. Ltd., c/o 239 Melbourne St, North Adelaide, S.A. | 450.00 | " | " |
| Kennedy, Scott W., 419 Dunoon St, Murrumbidgee | 54.00 | " | 31.7.81 |
| King, Louise S., 2/100 South Rd, Brighton | 37.50 | " | 26.2.82 |
| King, Marisa, "McKenzie Farm", Pittown Rd, McGraths Hill, N.S.W. | 375.00 | " | 29.8.81 |
| Kirkby, John H. W., c/o Rennie Cox & Garlick, P.O. Box 6647, Auckland, N.Z. | 318.76 | " | 26.2.82 |
| Kitchen, Frederick W., Ihu High School, I.H.U. P.O. Box Gulf Province, Papua New Guinea | 79.69 | " | 26.2.82 |
| Kneeshaw, Robert J., Werneth | 206.10 | " | 31.7.81 |
| Komodromoo, Kypros, 12 Russell St, Springvale | 359.64 | Capital | 26.2.82 |
| Kotz, Rolf, c/o Mrs J. Niven, 15 Milfred Gve, North Clayton | 40.95 | Dividend | 29.8.81 |
| Kurop, Chaja L., Unit 6, 74 Hawthorn Rd, Caulfield | 11.70 | " | 31.7.81 |
| Lake, Crompton C., Otorohanga, N.Z. | 85.99 | " | " |
| Lambert, June I. P., 4 Onehika Rd, Lower Hutt, N.Z. | 440.22 | Capital | 29.8.81 |
| Larcombe, Denise E., 617 Morton St, Wollstonecraft, N.S.W. | 18.76 | Dividend | 26.2.82 |
| Latham, Lynette M., 43 Derinya Dve, Frankston | 36.08 | " | 29.8.81 |
| Lawson, Phillip D., 918 Bowen St, Chatswood, N.S.W. | 66.30 | " | 31.7.81 |
| Leeming, Mary L., Southern Brook, Northam, W.A. | 352.44 | Capital | 26.2.82 |
| Lemin, Patricia H., 43 Nell St, Greensborough | 10.13 | Dividend | 29.8.81 |
| Lenaghan, Richard, c/o National Bank of A'sia, 22 Lansdowne St, East Melbourne | 13.13 | " | " |
| Leslie, Heather M., 15 Seales Pde, Balgowlah, N.S.W. | 93.76 | " | 31.7.81 |
| Lewis, Jean, 2 Mewhere Ave, Sandy Bay, Tas. | 1497.18 | Capital | 26.2.82 |
| Lilley, William Bruce, P.O. Box 169, Taupo, N.Z. | 86.94 | " | 31.7.81 |
| Little, Elly, Unit 7, 19 Church St, Randwick, N.S.W. | 120.00 | Dividend | 29.8.81 |
| Little, Keith L., 45 Garrick St, Coolangatta, Qld. | 36.00 | Capital | 31.7.81 |
| Luck, Ronald K., 34 Issaac St, Blakehurst, N.S.W. | 78.00 | Dividend | 29.8.81 |
| Luker, Winifred, M. 28 Beach Rd, Collaroy, N.S.W. | 86.88 | " | 31.7.81 |
| Lupton, John S., 27 Womerah St, Turramurra, N.S.W. | 19.32 | Capital | 29.8.81 |
| Lush, Jennifer, 37 Rochester Rd, Canterbury | 14.03 | Dividend | " |
| Mack, Ulrich, 7 Cara Rd, Highton | 18.76 | " | " |
| Mackay, Hector J., "Barr Creek", via Jandowae, Qld. | 28.06 | " | 26.2.82 |
| Maitland, Gus C., Easter Meadow, West Hill, Braunton, North Devon, England | 42.97 | " | 29.8.81 |
| Major, Dinah K., 42 Toronto Ave, Cromer, N.S.W. | 65.93 | " | 31.7.81 |
| Malcolm, Eileen E., 15 Moora St, Chester Hill, N.S.W. | 68.63 | " | 26.2.82 |
| Manderson, Alexander & Marjorie, P.O. Box 1232, Canberra City, A.C.T. | 45.00 | " | 29.8.81 |
| Mangan, Rodney, 401 Moorabool St, Geelong | 37.50 | " | " |
| Mansour, Timothy F. A., P.O. Box 9305, Queen Victoria Buildings, York St, Sydney, N.S.W. | 28.06 | " | 29.8.81 |
| Manuel, Lynn A., 9/11 Cope Street, Lane Cove, N.S.W. | 45.00 | " | 26.2.82 |
| Manzie, Harold C., Boyd St, Wourim, Bribie Island, Qld. | 132.84 | Capital | 31.7.81 |
| Marsden, Arnold, 4 Murray St, Mentone | 23.40 | Dividend | 29.8.81 |
| Maskell, Harold J. M., Flat 5/27 Billyard Ave, Elizabeth Bay, N.S.W. | 150.00 | " | " |
| Matthews, Adeline T., (estate of), 67 Lennox St, Rockdale, N.S.W. | 24.30 | " | " |
| Maunsell, John, Albion Hotel, Parramatta, N.S.W. | 46.80 | " | " |
| Maynes, Edwin C., 59 Cambridge St, Paddington, N.S.W. | 21.90 | " | " |
| Mealy, Harry, 10 Hodgson St, Heidelberg | 13.13 | " | " |
| Mercer, Julian F. B., 15 Glenard Dve, Heidelberg | 35.64 | Capital | 31.7.81 |
| Merritt, Elizabeth B., 10 Church St, Morningson | 298.28 | Dividend | 29.8.81 |
| Middleton, Percy E., c/o Cameron & Middleton, 400 St. Kilda Rd, Melbourne | 386.25 | " | 26.2.82 |
| Millar, Brigid, 28 Rangitoto Tce, Milford, Auckland, N.Z. | 73.08 | " | 29.8.81 |
| Miller, Patricia, 6 Bickleigh St, Ashwood | 10.50 | " | 26.2.82 |
| Mitchell, Ross I., 46 Cobham Ave, West Ryde, N.S.W. | 64.35 | " | 31.7.81 |
| Montgomery, Anne, 15 Masefield Ave, East Sandringham | 58.98 | Capital | 26.2.82 |
| Moreton, Owen N., P.O. Box 187, Greymouth, N.Z. | 19.13 | Dividend | 29.8.81 |
| Moriarty, Mary R., The Vineyard, P.O. Box 279, Nowra, N.S.W. | 56.10 | " | 29.8.81 |
| Morley, Ian H. & Kenneth H., P.O. Box 27/240, Mt. Roskill, N.Z. | 41.40 | Capital | 31.7.81 |
| Morris, Julie M., (estate of), c/o Cater & Blumer, P.O. Box 479A, Griffith, N.S.W. | 19.32 | " | " |
| Muers, Joan R., 7 Lucknow Tce, Khandallah, Wellington, N.Z. | 39.85 | Dividend | 29.8.81 |
| Muspratt, Elizabeth B., 47 Dominion Circuit, Forrest, A.C.T. | 35.10 | " | " |
| McCloy, Myce, 29 Abbott St, Forbes, N.S.W. | 157.76 | " | 31.7.81 |
| McCooke, Annabel H., Flat 6, 58 Windsor Cres, Mont Albert | 56.26 | " | 29.8.81 |
| McGifford, Noeleen M., 101 Daffodil St, Titirangi, Auckland, 7, N.Z. | 15.30 | " | 26.2.82 |
| McGrane, Joyce F., P.O. Box 3036, Port Moresby, P.N.G. | 25.45 | " | " |
| McInerney, Ellen V., 3/13 Bay Rd, Five Dock, N.S.W. | 10.02 | Capital | 31.7.81 |
| McIntosh, Betty J., 503 Fullarton Rd, Highgate, S.A. | 694.00 | Dividend | 29.8.81 |
| McKinnon, Elizabeth M., 100 Collins Rd, St. Ives, N.S.W. | 38.70 | " | 29.8.81 |
| McLaghlin, James A., Merryanbone North, Warren, N.S.W. | 203.52 | Capital | 31.7.81 |
| McLean, Donald R., (estate of), Main North Rd, Amberley, N.Z. | 19.13 | Dividend | 29.8.81 |

Unclaimed Moneys Act 1962

Register of Unclaimed Moneys held by the—

| Name of Owner on Books and Last Known Address | Total Amount Due to Owner | Description of Unclaimed Money | Date when Amount first became Payable |
|---|---------------------------|--------------------------------|---------------------------------------|
| A.C.I. INTERNATIONAL LIMITED—continued | | | |
| McLeod, Ronald D., 20 Narelle Ave, Castle Hill, N.S.W. | 17.78 | Dividend | 26.2.82 |
| McMillan, Yvonne M., (estate of), c/o R. F. Gutman, 82 Ackland St, St. Kilda | 1556.68 | " | 31.7.81 |
| McNamara, John W., 66 Parrinini Rd, Mosman, N.S.W. | 950.56 | " | " |
| Nankervis, John M., 31 The Crescent, Roseneath, Wellington 3, N.Z. | 47.82 | " | 26.2.82 |
| Nash, Jessie A., No. 9 "New Ambassador", 134 Nilson Rd, Cremorne, N.S.W. | 37.88 | " | " |
| Nicholls, Donald F., 18 George St, Miranda, N.S.W. | 36.00 | Capital | 31.7.81 |
| Niepel, Hans, 19 Marden St, Georges Hall, N.S.W. | 30.00 | Dividend | 26.2.82 |
| North, Dr Raymond, AMP Building, Victoria St, Hamilton, N.Z. | 80.14 | " | " |
| Odd Lot Nominees Pty. Ltd., G.P.O., Box 4423, Sydney | 76.73 | " | " |
| O'Driscoll, Desmond, 28 Daymar Pl, Castle Cove, N.S.W. | 56.25 | Dividend | 26.2.82 |
| O'Dwyer, Rosemary, 3 Borg St, Vincent, Townsville, Qld. | 31.74 | Capital | 31.7.81 |
| O'Halloran, Ellen, 2 Churchill St, Ringwood. | 26.33 | Dividend | 26.2.82 |
| Okkerse, Michael J. S., P.O. Box 2421, Wellington, N.Z. | 13.68 | " | 31.7.81 |
| Pakes, Ethel T., 3 Marlborough Rd, Flemington, N.S.W. | 281.52 | Capital | " |
| Palfreyman, John R., c/o Thos. Borthwick & Sons, G.P.O. Box 172a, Melbourne. | 300.00 | Dividend | 29.8.81 |
| Palfreyman, John R., 61 Cadosaw Pl, London, SW1, England. | 130.06 | " | 29.8.81 |
| Paltie, Sadie, 623 New South Head Rd, Rose Bay, N.S.W. | 17.10 | " | 29.8.81 |
| Parish, Enid A. (estate of), Unit 1, 5 The Avenue, Surrey Hills. | 117.30 | Capital | 31.7.81 |
| Parkinson, Helen O., 80 Goboion St, Wellington, N.S.W. | 494.10 | Dividend | 31.7.81 |
| Parsons, Rosamund Westcliff, c/o P.O. Box Marino, S.A. | 93.76 | " | 29.8.81 |
| Passlow, Christopher J., 10 Wade St, Adamstown Heights, N.S.W. | 11.25 | " | 29.8.81 |
| Patterson, Charles A., 35 Bunarba Rd, Gynea, N.S.W. | 432.26 | " | 31.7.81 |
| Pearson, Dawn E., 1 Brewster Pl, Duffy, N.S.W. | 22.50 | " | 29.8.81 |
| Pickell, Isabella A., 13 Purli St, Chevron Island, Qld. | 18.00 | Capital | 31.7.81 |
| Pie, Robert B. & David A., P.O. Box 48, Geebung, Qld. | 40.40 | Dividend | 31.7.81 |
| Pilcher, Norman G., (estate of) 25 Westbourne Rd, Remuera, Auckland, N.Z. | 350.22 | " | 31.7.81 |
| Pill, Leslie, 13 Picton St, Mascot, N.S.W. | 45.00 | " | 29.8.81 |
| Plant, Nelson C., (estate of) c/o Williams, Winter & Higgs, P.O. Box Queen St, Melbourne. | 1486.26 | Capital | 31.7.81 |
| Poppins, Anne, 40 Bena St, Yarraville. | 177.84 | " | 31.7.81 |
| Poskitt, Eric J., 3 Ascot Ave, Christchurch, 7, N.Z. | 193.05 | Dividend | 31.7.81 |
| Precians, Lyndall, Fernlea, Blacksprings, N.S.W. | 124.20 | Capital | 31.7.81 |
| Pullman, Simon C., 2/263 Victoria Rd, Drummoyne, N.S.W. | 30.00 | Dividend | 26.2.82 |
| Rae, James, (estate of), 12 Firth St, Cobden, Greymouth, N.Z. | 630.66 | Capital | 31.7.81 |
| Ramsey, Michael J., c/o 210 York Pl, Dunedin, N.Z. | 76.89 | Dividend | 29.8.81 |
| Randolfi, Victor, 508 Roman Rd, Bow, London, E3, England. | 12.76 | " | 29.8.81 |
| Rew, Kenneth T., P.O. Box 1936, Wellington, N.Z. | 34.20 | Capital | 31.7.81 |
| Richard, Kay G., 34 Ku-Ring-Gai Ave, Turramurra, N.S.W. | 62.55 | Dividend | 26.2.82 |
| Richardson, Barbara G., Flowerdale, via Forbes, N.S.W. | 33.44 | " | 31.7.81 |
| Ritchie, Phillip L., 3/67 Ocean Ave, Double Bay, N.S.W. | 102.76 | " | 29.8.81 |
| Roberts, Ann H., c/o P.O. Box 217, P.O. Malvern. | 15.60 | " | " |
| Robinson, Ingrid, 23 Sherwood Ave, Teatatu, Auckland, N.Z. | 47.84 | " | " |
| Rogers, Patricia M., (estate of) c/o M. A. Bradshaw & Co. 302 Penshurst St, Willoughby North, N.S.W. | 140.63 | " | 26.2.82 |
| Rogers, Dr. Peter H., 32 Patterson St, Concord, N.S.W. | 23.40 | " | 29.8.81 |
| Rosanove, Elizabeth, "Eyre Court", P.O. Box 4, Berwick. | 11.70 | " | " |
| Rose, Griselda Mary, Boulder Farm, Ebenezer, N.S.W. | 54.96 | " | 31.7.81 |
| Rosen, Henry, 6/33 Kimberley St, Vaucluse, N.S.W. | 41.94 | Capital | " |
| Ross, Dorothy, 111 Forest Rd, Miranda, N.S.W. | 30.00 | Dividend | 29.8.81 |
| Ross, Francis R., P.O. Box 3917, Auckland, N.Z. | 80.64 | Capital | 31.7.81 |
| Ross, Harold, 39 Masters St, South Caulfield | 12.63 | Dividend | " |
| Rossell, Elizabeth A., 47 View Hill Cres, Eltham. | 112.50 | " | 29.8.81 |
| Rothwell, William T. & Peter A. & Bauld, Welwyn A. S., Henrietta, Tas. | 590.63 | " | " |
| Rouch, David C., 143 Lower Heidelberg Rd, Ivanhoe. | 30.27 | " | 31.7.81 |
| R.P. Toojay Pty. Ltd., 8 Allan St, Edwardstown, S.A. | 75.83 | " | 26.2.82 |
| Rudge, Anna E., 9 William Edward St, Longueville, N.S.W. | 44.64 | Capital | 31.7.81 |
| Rutledge, Maureen E., c/o Barclays Bank Limited, 19 High St, Ascot, Berks., SL57JG, U.K. | 12.75 | Dividend | 26.2.82 |
| Rutter, Gerald A., (estate of), c/o Bells Eagle Chambers, 16-18 Eden St, Kingston-upon-Thames, Surrey, KT1, 1RO, U.K. | 120.94 | " | " |
| Ryder-Barnwell, Elaine, 87 Wilkinson Ave, Somerton, S.A. | 187.50 | " | " |
| Saint, Harold F., 10 Wilkinson Ave, Somerton, S.A. | 135.00 | " | " |
| Sanderson, Patricia A., "Allawa", Walgett, N.S.W. | 22.50 | " | " |
| Schaffe, John R., (estate of), Kickerbell, Quirindi, N.S.W. | 466.68 | Capital | 31.7.81 |
| Schank, Edwin A., 24 Gunyah St, Toogoolawah, Qld. | 12.15 | Dividend | 29.8.81 |
| Schofield, James C., c/o Gillfillan, Gentles & Steen, Box 1584, Auckland, N.Z. | 47.82 | " | 26.2.82 |
| Schoning, Moira, "Mulgrave", 8 Yarra Rd, Croydon. | 1089.00 | " | " |
| Scott, Judith A., 148 Windsor St, Paddington, N.S.W. | 103.43 | " | 29.8.81 |
| Scott, Robert H., 75 Brisbane St, East Maitland, N.S.W. | 22.50 | " | " |
| Sculley, Edward S., 8th Floor, 23 Berry St, North Sydney, N.S.W. | 19.50 | " | " |
| Seloer, Raymond T., c/o Shield Life Assur. Ltd., G.P.O. Box 1399, Sydney, N.S.W. | 124.20 | Capital | 31.7.81 |
| Sellow, David D., 304 Cooden St, Box-Hill-on-Sea, Sussex, England. | 90.00 | " | " |
| Sharpe, Valerie, Mount Eden, Auckland, N.Z. | 16.45 | Dividend | 26.2.82 |

Unclaimed Moneys Act 1962

Register of Unclaimed Moneys held by the—

| Name of Owner on Books and Last Known Address | Total Amount Due to Owner | Description of Unclaimed Money | Date when Amount first became Payable |
|---|---------------------------|--------------------------------|---------------------------------------|
| \$ | | | |
| A.C.I. INTERNATIONAL LIMITED—continued | | | |
| Shaw, Felicity L., Lisnacpieve, Cowperave, Mt. Macedon. | 157.56 | Capital | 31.7.81 |
| Shield Life Assurance Ltd., and Spratt, Albert E., P.O. Box 1399, North Sydney, N.S.W. | 31.58 | Dividend | 26.2.82 |
| Shine, William B., & Denis J., Shines Cres, Brunswick Junction, W.A. | 17.10 | " | " |
| Singleton, Owen P., Flat 30, 202 The Avenue, Parkville. | 392.86 | " | 31.7.81 |
| Skiba, Tabeusz, 4 Gellibrand St, Campbell, A.C.T. | 18.51 | " | " |
| Smith, Gregory W. & Neil R., 1/129 Burns Bay Rd, Lane Cove, N.S.W. | 23.40 | " | 29.8.81 |
| Smith, Guy W., (estate of), c/o Coplice & Kelly, 28 Cambridge St, Epping, N.S.W. | 120.27 | " | 31.7.81 |
| Smith, Louis L., (estate of), c/o Blanford & Robbie, P.O. Box 2, Bega, N.S.W. | 748.00 | " | " |
| Smith, Penelope M. M. (estate of), Breadalbank, Elphinston. | 97.98 | Capital | " |
| Smith, Vera L., Qld. | 18.30 | Dividend | 29.8.81 |
| Smithers, Hartley G., 2 Kjolsten Ave, Turramurra, N.S.W. | 138.00 | Capital | 31.7.81 |
| Southwell-Keeley, Peter T., 46 The Crescent, Vaucluse, N.S.W. | 186.78 | " | " |
| Spry, Berna I., & Watkins, Marjorie J., 9 Korangi Ave, St. Ives, N.S.W. | 118.06 | Dividend | 29.8.81 |
| St. Clair, Jean A., (estate of), 2/18 Wolsley Gve, Brighton. | 187.50 | " | " |
| Stephenson, Justin, 24 Northern Dve, North Rocks, N.S.W. | 13.50 | " | " |
| Stevenson, Graham R., (estate of), c/o Stevenson, Keith c., 4/32 Tranmere Ave, Carnegie. | 73.66 | " | " |
| Story, Elaine M., 10 Buller Rd, Ariarmon, N.S.W. | 18.90 | Capital | 31.7.81 |
| Strickland, Catherine A., 5 Peter St, Attadale, W.A. | 11.25 | Dividend | 29.8.81 |
| Stuart, Christopher C., 30 Wright Ave, Swanbourne, W.A. | 37.50 | " | " |
| Sturgess, Steven G., 288 Enmore Rd, Marrickville, N.S.W. | 15.00 | " | " |
| Sutherland, Hugh D., (estate of), c/o McLarty, Archer & Co., P.O. Box 159, Hamilton. | 107.90 | " | 31.7.81 |
| Swain, Ross B., 5 Harmony Rd, Huntington, N.Y. 11743, U.S.A. | 25.50 | " | 29.8.81 |
| Swan, Herbert N. B., Unit 20, Harbison Homes, Charlotte St, Burradoo, N.S.W. | 683.80 | " | 31.7.81 |
| Swift, Sydney H. (estate of), c/o Hunton and Gargot, Richmond, Nth. Yorkshire DL10 4JL England. | 146.70 | " | 29.8.81 |
| Tait, Lady Viola W., 106 Leopold Street, South Yarra | 738.54 | Capital | 31.7.81 |
| Talbot, Hilary L., 28 Repton Street, Merivale, Christchurch, N.Z. | 164.86 | Dividend | 26.2.82 |
| Taylor, Carolyn E., 62 Bruce Street, Nedlands, W.A. | 33.75 | " | 26.2.82 |
| Taylor, Kenneth J., 64 Tuckfield Street, Fremantle, W.A. | 293.94 | Capital | 31.7.81 |
| Taylor, Letitia J., "Jemalong", Patrick Estate, Lowood, Qld. | 14.03 | Dividend | 29.8.81 |
| Taylor, Valerie B., 2 Lakeview St, Boolaroo, N.S.W. | 28.06 | " | " |
| Tharmaratnam, Konagasabai, 36 Lorne Rd, Singapore, 1129 | 1518.00 | Capital | 31.7.81 |
| Thew, Edna, G., P.O. Box 238, Wahroonga, N.S.W. | 31.74 | " | " |
| Thornton, Lloyd C., 24 Rickard Ave, Mosman, N.S.W. | 16.80 | Dividend | 26.2.82 |
| Thornycroft, Robert, 62 Wilson St, North Carlton | 18.76 | " | 29.8.81 |
| Todoka Pty. Limited, c/o 4 Loloma Cr, Burwood | 112.20 | " | " |
| Torrance, Clifford, 183 Muller Rd, Boondall Heights, Qld. | 26.48 | " | 26.2.82 |
| Tretchikoff, Dimitri M., Unit 3, 22 Read St, Waverley, N.S.W. | 15.00 | " | 29.8.81 |
| Tretter, Anna M., Hotel Elizabeth Park, Alt Aussee, Steelmark, Austria | 32.76 | " | " |
| Trust, Betty and Loretta, 52 Bilsen Rd, Wavell Heights, Qld. | 16.80 | " | " |
| Turner, Marion L., Flat 2, 255 Sandgate Rd, Albion, Qld. | 18.76 | " | " |
| Tyler Arthur G., Flat 17, 160 Grange Rd, Glenhuntly | 75.00 | " | 26.2.82 |
| Vasta, Margaret E., 136 The Boulevard, Strathfield, N.S.W. | 18.75 | " | 29.8.81 |
| Vaughan, Terrence J., 48 McKimmie St, Palmyra, W.A. | 30.00 | " | " |
| Veneziano, Franco, 80 Moore St, Coburg | 40.20 | " | 26.2.82 |
| V.J. Gay, Pty. Limited, P.O. Box 47, Crows Nest, N.S.W. | 211.62 | Capital | 31.7.81 |
| Vormister, Maynard, 13 Girston Cres, Corrimal, N.S.W. | 56.58 | " | " |
| Waldie, Ian H., 32 Bundry St, Roseville, N.S.W. | 60.90 | Dividend | 29.8.81 |
| Walker, John W., P.O. Box 34, Wingham, N.S.W. | 101.76 | " | 31.7.81 |
| Wallman, Elizabeth A., 95 Church Terrace, Walkerville, S.A. | 145.28 | " | 29.8.81 |
| Walter, Kenneth G., 4 Auvergne Ave, New Town, Tas. | 21.76 | " | " |
| Walter Steiner Pty. Ltd., 4th Floor, 537 George St, Sydney, N.S.W. | 489.00 | " | " |
| Wardlaw, Andrew D., 882 Whitehorse Rd, Box Hill | 436.08 | Capital | 31.7.81 |
| Warne, Peter H., 18 Robert St, Willoughby, N.S.W. | 90.00 | Dividend | 29.8.81 |
| Warrick, Susan M., Pinegrove, Armidale, N.S.W. | 18.60 | " | 26.2.82 |
| Waterhouse, Ashleigh G., c/o Gowrie Private Hotel, Northbourne Ave, Canberra City, A.C.T. | 18.76 | " | 29.8.81 |
| Watson, Ernst F., 5 Austral Av, Beecroft, N.S.W. | 827.52 | " | 31.7.81 |
| Watson, Florence D., 132 Strangways Tce, North Adelaide, S.A. | 234.96 | Capital | " |
| Webb, Doris, G., 464 Glenhuntly Rd, Elsternwick | 2725.01 | Dividend | " |
| Webber, Albert R., 1/587 Glenferrie Rd, Hawthorn | 22.50 | " | 26.2.82 |
| Weinberg, Isabella G., c/o ANZ Banking Grp. Ltd, King and George Sts, Sydney, N.S.W. | 94.13 | " | 29.8.81 |
| Weir, Edwin E. (estate of), 338 Stuart St, Longueville, N.S.W. | 240.78 | " | 31.7.81 |
| Weldon B. Gibson Trust, 593 Gekona Rd, Stamford, California, U.S.A., 94305 | 4830.00 | Capital | " |
| Wentworth, Janet, Traminer Pl, Eagle Vale, N.S.W. | 22.50 | Dividend | 26.2.82 |
| White, Janice, R., c/o Colin White & Co., P.O. Box 303, Wagga Wagga, N.S.W. | 37.50 | " | " |
| Whitehead, Christine M., and Dixon, Davas M., Chisbury, nr. Marlborough, Wiltshire, England | 13.66 | " | 29.8.81 |
| Whyns, Leigh, 3 Aloha St, Mascot, N.S.W. | 35.64 | Capital | 31.7.81 |

Unclaimed Moneys Act 1962

Register of Unclaimed Moneys held by the—

| Name of Owner on Books and Last Known Address | Total Amount Due to Owner | Description of Unclaimed Money | Date when Amount first became Payable |
|--|---------------------------|--------------------------------|---------------------------------------|
| A.C.I. INTERNATIONAL LIMITED—continued | | | |
| Wiggins, Lesley, A., 35 Awakino Rd, Te Kuiti, N.Z. | 19.13 | Dividend | 26.2.82 |
| Wilkinson, Ethel M. E. (estate of), 5 Reed St, Cremorne, N.S.W. | 16.88 | " | " |
| Williams, Alan R., 103 Mt. Eden Rd, Auckland, N.Z. | 131.46 | Capital | 31.7.81 |
| Williams, Colin E., 26 Cliff Rd, Epping, N.S.W. | 17.10 | Dividend | 26.2.82 |
| Williams, John E., 18 Lochlan Ave, Sylvania Waters, N.S.W. | 18.00 | Capital | 31.7.81 |
| Williams, Virginia B., 19 Papanui Rd, Christchurch, N.Z. | 22.39 | Dividend | 26.2.82 |
| Willingham, Leslie N. (estate of), 4 Lilydale Rd, East Ringwood | 51.15 | " | " |
| Wilson, Beverley I., P.O. Box 253, Gisborne, N.Z. | 84.86 | " | 29.8.81 |
| Wilmot, William, 34 Fitzroy St, Geelong | 132.84 | Capital | 31.7.81 |
| Wilpat Pty., Limited, 49 Greendale Ave, St. Ives, N.S.W. | 22.50 | Dividend | 29.8.81 |
| Wilson, David L., Yarraman Station, Quirindi, N.S.W. | 28.06 | " | " |
| Wilson, Elizabeth A., 24 Ormond Street, Ascot, Qld. | 15.36 | Capital | 31.7.81 |
| Wilson, K. P. and Carnachan, I. D., c/o P.O. Box 140, Auckland, N.Z. | 346.08 | " | " |
| Winter, Ruth M., 41A Tomes Road, Christchurch 5, N.Z. | 55.08 | Dividend | 29.8.81 |
| Wise, Kenneth C., 34 Holack Street, Mackay, Qld. | 84.02 | " | 31.7.81 |
| Wonham, Laurence G. and Roberts, Doreen V., Acland, Qld. | 19.02 | Capital | " |
| Wood, Shirley, Awapapa, Private Bag, Havelock North, N.Z. | 93.84 | " | " |
| Woodward, John L., 91 Dyers Pass Road, Christchurch, N.Z. | 36.00 | " | " |
| Worley, Felicia M., 27 Arney Road, Auckland 5, N.Z. | 39.85 | Dividend | 26.2.82 |
| Worsop, Katherine H., Box 479, Waipukurau, N.Z. | 115.16 | " | 29.8.81 |
| Wright, Brian D., P.O. Box 100, Waimate, N.Z. | 361.30 | " | 31.7.81 |
| Wrigley, Natalie B., c/o Post Office, Upper Hutt, N.Z. 5933 | 17.34 | " | 29.8.81 |
| NATIONAL MUTUAL LIFE NOMINEES LIMITED | | | |
| Ames, Richard M., Box 23a Route 1 Littlerock California 93543 U.S.A. | 40.42 | Proceeds | 16.6.81 |
| Buchanan, Robert J., 13514 Southfield Detroit 48223 Michigan U.S.A. | 72.76 | " | " |
| McKinney, William G., c/o 26421 Wilson Los Molinos California 96055 U.S.A. | 40.42 | " | " |
| Parmalee, Marcus, 243 Suffolk Dr, San Leandro California U.S.A. | 16.65 | " | " |
| Salmon, Coral L., 200 Radnor Chester Rd, Villanova, 19085 Pennsylvania, U.S.A. 5667 | 90.39 | " | " |
| FROZEN FOOD INDUSTRIES OF AUSTRALIA LIMITED | | | |
| Bladen, Edith, 6 Cliff St, Torquay | 117.00 | Takeover | 4.11.76 |
| Carmon, Joyce, 89 Springbank Rd, Clapham, S.A. | 540.00 | " | " |
| Douglas, Gillespie W. A., 474 Glenferrie Rd, Hawthorn | 1 783.00 | " | " |
| Felstead, Stephen, c/o Esso Standard Oil, Longreach Control, Sale | 48.60 | " | " |
| Hube Pty. Ltd., 11/28 Victoria Pde, Manly, N.S.W. | 396.00 | " | " |
| Matear, Virginia M., 21 Huntingtower Rd, Armadale | 16.20 | " | " |
| O'Connor, Shirley M., c/o G. W. A. Douglas, 474 Glenferrie Rd, Hawthorn | 280.80 | " | " |
| Pattinson, Noel J. L., Railway, Table Top, N.S.W. | 495.00 | " | " |
| Richard, Judith M., c/o 125a Droop St., Footscray | 43.20 | " | " |
| Watson, Nigel, 8 Cook St, Caringbah, N.S.W. | 16.20 | " | " |
| Wisely, John, 53 Kennealy St, Surrey Hills | 28.80 | " | " |
| McGinn, Noel, c/o Provincial Bank of Ireland, Eyre Square, Galway, Ireland, Eire | 70.20 | " | " |
| Sedgewick, Cabot, Sante Fe Ranch, Nogales, Arizona, 85621, U.S.A. 5668 | 396.00 | " | " |
| MAYNE NICKLESS LIMITED | | | |
| Beaton, Allan William, 37 Driscolls Rd, Kealba | 35.75 | Dividend | 31.10.81 |
| Head Chief Hammer Deroburt, Nauru Island, Central Pacific | 39.86 | " | " |
| Fraser, Graeme George, 5 Brinawa Dr, Greensborough | 71.50 | " | " |
| McNIGHT, Wayne, 32 Allawoona Street, Redbank Plains, Qld. | 35.75 | " | 30.4.81 |
| Taylor, Thomas Kenneth (estate of), c/o H. L. Davies, 10 Hastings Crt, Heidelberg | 54.08 | " | " |
| Bailey, James William, 12 Stirgess Ave, Harbord, N.S.W. | 95.28 | " | " |
| Coffey, Michael Francis, and Baine, Anthony, 30 Cherrybrook Road, Cabramatta, N.S.W. | 21.58 | " | " |
| Simpson, Frederick William, 225 St Georges Tce, Perth, W.A. | 242.84 | " | " |
| Speers, John Crispin, c/o National Bank of A'asia Ltd. 48 St George's Tce, Perth, W.A. | 58.24 | " | " |
| Fisher, Richard Welby, c/o Lloyds Bank Limited, Belgrave Road Branch, 68 Warwick Square, London, SW1V 2AS | 152.49 | " | 31.10.81 |
| Flaherty, Elizabeth Ann, 6 Ringwood St, Durack, Qld. | 37.50 | " | " |
| Harvey, Margaret, 22 High St, London, England, U.K. | 32.32 | " | " |
| Dandreis, Lihana, 16 Laurel Ave, Linden Park, S.A. 5669 | 19.76 | Interest | 30.9.81 |
| J. P. SAGE PTY. LTD. | | | |
| Dalton, David, 4/16 Daley St, Elwood | 70.00 | Deposit | 1979 |
| Mercer, Mr and Mrs, 21 Wilson St, Brighton 5670 | 50.00 | " | 1974 |

Unclaimed Moneys Act 1962

Register of Unclaimed Moneys held by the—

| Name of Owner on Books and Last Known Address | Total Amount Due to Owner | Description of Unclaimed Money | Date when Amount first became Payable |
|--|------------------------------------|-----------------------------------|--|
| S | | | |
| AMALGAMATED CO-OPERATIVE MARKETERS (AUSTRALIA) LIMITED | | | |
| Allen, John S., Capeen via Old Bonalbo, N.S.W. | 24.00 | Dividend | 8.12.81 |
| Aubedal Pty. Ltd., Melbourne | 12.00 | " | " |
| Aurisch, Clarence A., Yinnar | 12.00 | " | " |
| Austin, Frank, address unknown | 12.00 | " | " |
| Bailey, Robert G., address unknown | 24.00 | " | " |
| Beckham, William J. T., address unknown | 24.00 | " | " |
| Bolding, Graham J., Hazelwood North | 12.00 | " | " |
| Bond, George L., Yinnar | 24.00 | " | " |
| Brennan, Kevin F. N., address unknown | 12.00 | " | " |
| Brose, Frederick B., Kyabram | 12.00 | " | " |
| Brown, Robert J., Mudgegonga | 24.00 | " | " |
| Cahill, Edmund (estate of), Briagolong | 12.00 | " | " |
| Cameron, Angus (estate of), Dandenong | 12.00 | " | " |
| Cardwell, Leslie M., Wodonga | 18.00 | " | " |
| Child, Jessie, address unknown | 10.80 | " | " |
| Chislett, Leslie A., Warrnambool | 48.00 | " | " |
| Clark, William G. (estate of), address unknown | 12.00 | " | " |
| Coles, Frederick J., Apollo Bay | 48.00 | " | " |
| Crofts, Samuel T., address unknown | 12.00 | " | " |
| Cross, George (estate of), address unknown | 13.20 | " | " |
| Crutchfield, Erskine M. (estate of), address unknown | 24.00 | " | " |
| Cumming, Roy, Trafalgar | 12.00 | " | " |
| Cumming, Wilfred H. (estate of), Middle Brighton | 24.00 | " | " |
| Davis, Kelvin W. S., Yarram | 30.00 | " | " |
| Davis, Emily F., address unknown | 12.00 | " | " |
| Dehnert, Norman C. and Frank A. (estate of), address unknown | 24.00 | " | " |
| Dick, Dr Donald L., address unknown | 12.00 | " | " |
| Dickson, Charles S. (estate of), address unknown | 14.40 | " | " |
| Dore, Thomas M., address unknown | 10.80 | " | " |
| Dunlop, Albert, Tatura | 12.00 | " | " |
| Dunn, Norman A., address unknown | 12.00 | " | " |
| Farrell, Annie, address unknown | 12.00 | " | " |
| Ford, George G., address unknown | 10.80 | " | " |
| Frayne, William (estate of), address unknown | 12.00 | " | " |
| French, John B., address unknown | 24.00 | " | " |
| Gange, Clement C., address unknown | 12.00 | " | " |
| Gardiner, Kenneth G., Yannathan South | 12.00 | " | " |
| Gardiner, Stanley D. (estate of), Stanhope | 14.40 | " | " |
| Gillies, Christopher N., address unknown | 12.00 | " | " |
| Green, Maurice (estate of), address unknown | 12.00 | " | " |
| Griffin, Michael A. and Ellen P., Fish Creek | 12.00 | " | " |
| Hanna, Mary G. C., address unknown | 24.00 | " | " |
| Henry, Alan W. T., Dockers Plains | 18.00 | " | " |
| Hill, Thomas J., and Aimee, address unknown | 12.00 | " | " |
| Huggins, Charles F., address unknown | 30.00 | " | " |
| Johnston, Allen H., Mirboo North | 48.00 | " | " |
| Johnston, G. and L. and T. J. and H., address unknown | 12.00 | " | " |
| Johnston, May (estate of), Dandenong | 46.80 | " | " |
| Keily, Marie T., address unknown | 30.00 | " | " |
| Kerr, Robert T. (estate of), and Thomas, C. M. address unknown | 24.00 | " | " |
| Kirkham, Stanley J. (estate of), Frankston | 24.00 | " | " |
| Land, Stanley B. (estate of), address unknown | 12.00 | " | " |
| Langshaw, William H. (estate of), address unknown | 12.00 | " | " |
| Lewis, John J. (estate of), address unknown | 12.00 | " | " |
| Linke, Angus T., address unknown | 12.00 | " | " |
| Loader, Albert H. and Joan U. (estate of), Hoddle | 24.00 | " | " |
| Lyne, Thomas (estate of), Fish Creek | 24.00 | " | " |
| Macarthur, Claude V. (estate of), address unknown | 12.00 | " | " |
| Macdonald, Mary F., Deniliquin, N.S.W. | 18.00 | " | " |
| Macleod, Annie K., address unknown | 12.00 | " | " |
| McAlpine, Edward A., Moorabbin | 12.00 | " | " |
| McAuliffe, George E. and Noel A., Lavington, N.S.W. | 12.00 | " | " |
| McConachy, Edward G., Winchelsea | 12.00 | " | " |
| McCrorey, James (estate of), address unknown | 13.20 | " | " |
| McGuffie, William R., Myrtleford | 24.00 | " | " |
| McIlraith, Norman A., Wangaratta | 60.00 | " | " |
| McKee, Alan E. and Diana E., Mirboo North | 12.00 | " | " |
| McKenney, Don, Toongabbie | 12.00 | " | " |
| McRae, Bruce W. and John J. Mount Waverley | 72.00 | " | " |
| Micallef, Paul, address unknown | 12.00 | " | " |
| Morant, Edith A., Tallangatta Valley | 12.00 | " | " |
| Morris, Donald C., Yarram | 12.00 | " | " |
| Napier, Thomas G. (estate of), address unknown | 19.20 | " | " |
| Neill, James S. B., Clyde | 126.00 | " | " |

Unclaimed Moneys Act 1962

Register of Unclaimed Moneys held by the—

| Name of Owner on Books and Last Known Address | Total Amount Due to Owner | Description of Unclaimed Money | Date when Amount first became Payable |
|--|------------------------------------|-----------------------------------|--|
| \$ | | | |
| AMALGAMATED CO-OPERATIVE MARKETERS (AUSTRALIA) LIMITED— <i>continued</i> | | | |
| Norden, Frans A. L. (estate of), Denison | 18.00 | Dividend | 8.12.81 |
| Paten, Thomas E. (estate of), address unknown | 12.00 | " | " |
| Pattison, Dr Grant, Wangaratta | 12.00 | " | " |
| Peacock, Stewart A., address unknown | 48.00 | " | " |
| Peluso, Vittoria, Glen Waverley | 12.00 | " | " |
| Pendergast, William J. C., Benambra | 24.00 | " | " |
| Petty, Leslie (estate of), address unknown | 12.00 | " | " |
| Preston, Robert, address unknown | 14.40 | " | " |
| Rahley, Jacqueline C., address unknown | 48.00 | " | " |
| Rathjen, Aloine (estate of), Woodglen | 12.00 | " | " |
| Ray, William J. T., address unknown | 12.00 | " | " |
| Rentsch, Olga, Goroke | 48.00 | " | " |
| Richie, William J. (estate of), Cobram | 12.00 | " | " |
| Roberts, Morris H., Lake Boga | 12.00 | " | " |
| Ross, Jean A., Warrnambool | 12.00 | " | " |
| Rowan, John G. and James S., Colac | 28.80 | " | " |
| Sadler, Frederick G. (estate of), Terang | 12.00 | " | " |
| Sargent, Harry C., address unknown | 14.40 | " | " |
| Schroeter, Kathleen M. C. and Smith, Elizabeth G., Carnegie | 12.00 | " | " |
| Schulz, Kelvin R., Jindera, N.S.W. | 12.00 | " | " |
| Smallman, John G. and Fay, Mardan via Leongatha | 12.00 | " | " |
| Soutter, Douglas L., address unknown | 14.40 | " | " |
| Speer, William (estate of), Corop | 12.00 | " | " |
| Stillard, William K. (estate of), West Dandenong | 24.00 | " | " |
| Stoney, Christopher, address unknown | 14.40 | " | " |
| Sweeney, Terence J., Yarram | 12.00 | " | " |
| Symons, George (estate of), Vermont | 12.00 | " | " |
| Taylor, William, Kingston | 24.00 | " | " |
| Thomson, Roy W. and Sylvia J., Wangaratta | 12.00 | " | " |
| Turner, Albert J., address unknown | 24.00 | " | " |
| Underwood, Thomas R., Newfield | 96.00 | " | " |
| Vanstan, Florinda C., Eltham | 24.00 | " | " |
| Wachter, Karl C. (estate of), address unknown | 12.00 | " | " |
| Wain, Florence R., address unknown | 18.00 | " | " |
| Wallace, Harold G., address unknown | 16.80 | " | " |
| Wallis, Graeme and Beverley, Leongatha South | 39.60 | " | " |
| Wanliss, Ewen (estate of), Mortlake | 24.00 | " | " |
| Waters, Colin W., address unknown | 12.00 | " | " |
| Watt, Gladys M., Mirboo North | 30.00 | " | " |
| Weller, Gordon T., Bookar | 19.20 | " | " |
| Williams, Frederick J., address unknown 5712 | 12.00 | " | " |
| J. E. ABEL REAL ESTATE PTY. LTD. | | | |
| Kennedy, R. J., Linvingstone, R. M., Forward, B. A., Browne, C. and M. A., 33 Dandenong Rd, Frankston | 28.57 | Bond | 23.10.81 |
| Barrett, A. M., 14 Naranga Cres, Frankston 5665 | 253.00 | " | 24.2.82 |
| VEALLS SECURITIES AND FINANCE LIMITED | | | |
| Scott, V. E., 29a Glen Ebor Ave, Blackburn | 35.00 | Dividend | 30.4.81 |
| Scott, V. E., 29a Glen Ebor Ave, Blackburn | 500.00 | Return | 29.5.81 |
| Scott, V. E., 29a Glen Ebor Ave, Blackburn | 17.50 | Dividend | 31.10.81 |
| Haines, E. M., 12 Field St, Llangeftni, Anglesey, U.K. 5666 | 17.50 | Return | 29.5.81 |
| FITWEAR LIMITED | | | |
| Black, R. G., 18 Landcox Cl, East Brighton | 12.50 | Dividend | 26.11.81 |
| Brown, F. E., (estate of), c/o Polkinghorne & Webb, P.O. Box 16, Hampton | 12.50 | " | " |
| Brown, N., c/o N. B. Marsden, 15 Charles St, Maffra | 31.25 | " | " |
| Chandler, V. E., 8 Denmark Hill Rd, Hawthorn East | 25.94 | " | " |
| Coates, P. M., Walbundry Ave, Ferntree Gully | 125.00 | " | " |
| Deville, E. L., 2025 Malvern Rd, East Malvern | 12.50 | " | " |
| Miller, T. (estate of), c/o Norman Shankly & Hamilton, 406 Lonsdale St, Melbourne | 34.38 | " | " |
| McArthur, M. C., 226 Inkeram St, St. Kilda | 17.31 | " | " |
| Read, C. S., 4/7 Coppins Gve, Hawthorn | 18.75 | " | " |
| Taylor, J. (estate of), 8 White St, Beaumaris | 12.50 | " | " |
| Woods, R. E., 33 Weir St, Balwyn 5662 | 37.50 | " | " |

Unclaimed Moneys Act 1962

Register of Unclaimed Moneys held by the—

| Name of Owner on Books and Last Known Address | Total Amount Due to Owner | Description of Unclaimed Money | Date when Amount first became Payable |
|---|------------------------------------|-----------------------------------|--|
| \$ | | | |
| NYLEX CORPORATION LIMITED | | | |
| Agean Investments Pty. Ltd., 2 Young St, Kew | 203.54 | Dividend | 27.11.81 |
| Barton, Dennis E., 15 Rainer St, Karrinyup, W.A. | 28.27 | " | 1.5.81 |
| Bell, Stephen A., Box 9514, Newmarket, Auckland, N.Z. | 118.49 | " | 27.11.81 |
| Brown, Samuel R., 32 Shakespeare Rd, Wanganui, N.Z. | 15.43 | " | 1.5.81 |
| Browning, Rev. Ronald M., 21 Wight St, Kensington | 14.04 | " | 27.11.81 |
| Bruechle, Peter C., 237 St. George's Tce, Perth, W.A. | 17.82 | " | " |
| Cameron, Gweneth M., 16 Skene St, Newtown, Geelong | 52.80 | " | 1.5.81 |
| Campbell, Dr. George J., c/o Trustees Executors and Agency Co. Ltd., G.P.O. Box 1336, Brisbane. | 90.00 | " | 27.11.81 |
| Cook, Bernard G., (estate of), c/o Phoenix Walters and Co. 14 and 15 The Parade, Cardiff, CF2 3TR, U.K. | 72.93 | " | 27.11.81 |
| Cusack, Margaret A., c/o P.O. Box 159, Nowra, N.S.W. | 21.06 | " | 27.11.81 |
| Davidson, Margaret D., c/o P.O. Box 327, Woolloongabba, Qld. | 27.60 | " | 1.5.81 |
| Donaldson, Marcia L., 70 Erlunda Circuit, Hawker, A.C.T. | 110.00 | " | " |
| Doolley, David R., 15 William St, Melbourne | 34.82 | " | 27.11.81 |
| Fletcher, Cyril C., c/o Nylex Corporation Ltd., 10 Queens Rd, Melbourne | 45.00 | " | " |
| French Dr. Alastair J., c/o Dr. W Bonner., P.O. Box 9, Dubbo, N.S.W. | 17.82 | " | " |
| French, Helen A., 3 Monmouth Ave, Killara, N.S.W. | 12.47 | " | " |
| Gibson, Ann E., "Rockview", Blakney Creek, via Dalton, N.S.W. | 14.52 | " | 1.5.81 |
| Grant, Peter D., and Grant, Malcolm J., c/o Berry Alty and Neil, Box 10, Oamaru, N.Z. | 25.24 | " | 27.11.81 |
| Halsall, May S., 20 Slater Ave, Blackburn | 11.72 | " | 1.5.81 |
| Harris, Bessie M. G., c/o Michael Sutton, 43 Lydiard St, South, Ballarat | 50.82 | " | " |
| Harvey, Heath., 44 Boomerang St, Turramurra, N.S.W. | 77.22 | " | 27.11.81 |
| Homer, Trevor W. B., 12 Maythorn Gardens, Tettenhall, Wolverhampton, West Midlands, U.K. | 14.96 | " | 1.5.81 |
| Hopkins, Marjory I., 6/8 Wirreanda Ct, Blackburn | 15.44 | " | 27.11.81 |
| Irvine, Dr. Allan F., 9/539 Pacific Hwy, Killara, N.S.W. | 51.40 | " | 1.5.81 |
| Irvine, Laird F., 9/539 Pacific Hwy, Killara, N.S.W. | 114.71 | " | 27.11.81 |
| Julian, Trevor D., 775 Whitehorse Rd, Mont Albert | 13.50 | " | " |
| Kaufmann, George A., 3/147 Curzon St, North Melbourne | 10.53 | " | " |
| Kenny, Ellen F., c/o Nylex Corporation Ltd., Box 846J, Melbourne | 40.00 | " | 1.5.81 |
| Lang, William O., 46 McComb Blvd, Frankston | 15.44 | " | 27.11.81 |
| Lee, Marjorie, 53 Gostwyck St, Toowoomba, Qld. | 194.91 | " | 1.5.81 |
| Mitchell, Greta B. (estate of), c/o John P. B. Vincent, 1 Manning Rd, Mosman Park, W.A. | 53.01 | " | 27.11.81 |
| Morrison, Denis B. B., 187 Douglas St., Taimaru, N.Z. | 13.46 | " | 1.5.81 |
| Morrison, Marian F., 187 Douglas St, Taimaru, N.Z. | 13.46 | " | 27.11.81 |
| Morton, Jenifer A., 25 Bella Vista Rd, Glen Iris | 52.80 | " | " |
| Partridge, Frederic A., "Burnlea", Exeter, Tas. | 29.70 | " | " |
| Peach, Ivor A., 76 Durham Rd, Surrey Hills | 37.73 | " | 1.5.81 |
| Powis, Joan C., 14 Harvic St, Glen Waverley | 77.00 | " | 27.11.81 |
| Prior, Patricia S., 7 Montgomery Ave, Syndal | 148.56 | " | " |
| Robinson, Alan K., 2/148 Malabar Rd, South Coogee, N.S.W. | 17.82 | " | 27.11.81 |
| Rowley, Suzanne, 10 Etham Ave, Darling Point, N.S.W. | 84.70 | " | 1.5.81 |
| Russell, James, Carngham | 50.00 | " | 27.11.81 |
| Saunders, Godfrey G., 135 Lower Heidelberg Rd, Ivanhoe | 52.80 | " | " |
| Scott, Kenneth W., and Haigh, Muriel and Knight, Betty, c/o Wilson Bishop Boves and Craig, 271 William St, Melbourne | 75.46 | " | " |
| Scott, Kenneth W. and Norgate, Raymond H. and Mynott, R. J., c/o Wilson Bishop Boves and Craig, 271 William St, Melbourne | 34.31 | " | " |
| Shankland, Estella A., 88 Glass St, Essendon | 32.67 | " | " |
| Shaw, Margery E. M., 4 Heol Hiraethlyn, Eglwysbach, near Colwyn Bay, North Wales, U.K. | 33.47 | " | 1.5.81 |
| Shepherd, Malcolm A. L., 1/10 Bruce St, Toorak | 363.00 | " | " |
| Simpson, Ian C., 11 Wolseley Gve, Brighton Beach | 18.15 | " | " |
| Skreiner, Klaus M., Apartment 3A, 404 North Munroe St, Media PA 19063, Philadelphia, U.S.A. | 10.56 | " | 27.11.81 |
| Smith, Margaret, Penrose Cottage, Charmouth Rd, Lyme Regis, Dorset, England | 16.04 | " | 1.5.81 |
| Smith, William G., 91 Breed St, Traralgon | 36.00 | " | 27.11.81 |
| Steer, Stafford E., c/o Patrick Grimes and Co., P.O. Box 261, Lane Cove, N.S.W. | 15.44 | " | " |
| Stevens, Judith A., 19 Kynance St, Leichhardt, Qld. | 26.40 | " | 1.5.81 |
| Summons, Elizabeth M. D., 72 Caroline St, South Yarra | 110.00 | " | " |
| Taylor, Elsie S., (estate of), c/o Taylor, Harry B., Somerville House, Yelvertoft, Northamptonshire, U.K. | 26.13 | " | 27.11.81 |
| Taylor, John G., 56 Hillborough Rd, South Hobart, Tas. | 24.75 | " | " |
| Travers, Clement T., Elimatta Lodge, 45 Alexander Dve, Mt. Lawley, W.A. | 433.08 | " | " |
| W. E. Spencer Pty. Ltd., 99 Whitehorse Rd, Croydon | 47.19 | " | 1.5.81 |
| Webster, Andrew, c/o Midland Bank Ltd., 83 High St, Mexborough, Yorks, U.K. | 12.62 | " | 27.11.81 |
| Wilkinson, Kenneth, O., (estate of), c/o National Trustees, 95 Queen St, Melbourne 5877 | 1007.81 | Unsecured Deposit and Interest | 31.1.81 |

Unclaimed Moneys Act 1962

Register of Unclaimed Moneys held by the—

| Name of Owner on Books and Last Known Address | Total Amount Due to Owner | Description of Unclaimed Money | Date when Amount first became Payable |
|---|---------------------------|--------------------------------|---------------------------------------|
| \$ | | | |
| FORD CREDIT AUSTRALIA LIMITED | | | |
| Walsh, W. F., 299 Kooyong Rd, Caulfield | 36.87 | Refund | 29.7.80 |
| Economon, S., 472 Mountain Hwy, Wantirna | 14.66 | " | 27.5.80 |
| Vann-ragg, 26 High St, Harmion, S.A. | 44.62 | " | 11.8.80 |
| Guy, D. K., c/o H.M.A.S. Derwent, G.P.O. Melb. | 101.50 | " | 27.3.81 |
| Kayne, P. W., 12 Holden Way, Mt Pleasant Hill, 20 Patterson St, Carlton | 117.61 | " | 31.3.81 |
| Precision Pipe, 35 Alex Drive, Moorabbin | 45.81 | " | 16.2.81 |
| Warrensmith, D. H., 749 Canterbury Rd, Richmond | 121.80 | " | 20.2.81 |
| Warrensmith, D. H., 749 Canterbury Rd, Richmond | 25.80 | " | 3.3.81 |
| Yenice, M., 1/50 Lower Dandenong Rd, Mentone | 120.00 | " | 9.4.81 |
| McKenzie, P. A., 25 Brinawa Ave, Greensborough | 37.74 | " | 2.1.81 |
| Parry, R., 2 Ferguson St, Kendale | 54.95 | " | 9.6.80 |
| Brown, A., 71 Woodward St, Parkes | 101.52 | " | 6.5.81 |
| Beckman, J., 317 Adderstone Ave, N. Sydney | 20.06 | " | 16.3.81 |
| Traynor, D., 3136 Alston Ave, Como | 50.19 | " | 16.3.81 |
| Oldfield, G., 13-702 Barrenjoey Rd, Avalon | 47.55 | " | 25.3.81 |
| Pearce, K. W., Bernard House St, Johns Cr, Rivervale | 168.87 | " | 5.1.81 |
| A vant Grade Photography, 246 William St, Kings Cross | 45.00 | " | 14.6.81 |
| Gnjec, M., 16 Wilfred Rd, Langford | 10.67 | " | 26.8.81 |
| Lilley, L. S., 31405 Bevan St, Laverton | 72.50 | Overpayment | 7.7.80 |
| Dahlia Nominees P/L, 4 Pengana St, Sunny Bank | 18.87 | " | 11.11.81 |
| Brown, H. F., 42 Hampshire St, Victoria Park | 214.25 | " | 9.7.81 |
| Smith, I. S., 2 Squadron R.A.A.F. Base, Amberely | 10.00 | " | 25.9.81 |
| Fuller, S., 1/220 Warrigal Rd, Burwood | 23.06 | " | 3.12.81 |
| Morris, L. S., 86 Astley St, Gosnells | 11.37 | " | 13.11.81 |
| Burgess, A., 30 Tate St, South Perth | 12.71 | " | 16.3.82 |
| Wilson, N. R., The Caves via Rockhampton | 108.34 | " | 16.3.82 |
| Choung, I. Y., 2/23 Park St, Campsie | 35.74 | " | 16.11.81 |
| Jasch, R., 213 King St, Newton | 15.80 | " | 18.3.82 |
| Brodie, J. P., 360 Collins St, Melbourne | 51.07 | " | 29.3.82 |
| Hardie, T., P.O. Box 288, Prahran | 68.38 | Interest | 30.6.80 |
| Hardie, J., P.O. Box 288, Prahran | 347.17 | " | 30.6.80 |
| Woodridge, B. P., Wembley Rd, Woodridge | 116.45 | " | 30.9.80 |
| Morgan, S. M., 10 Huntingford Rd, Toorak | 56.11 | " | 30.12.80 |
| Morrison, J. M., 41 Mathoura Rd, Toorak | 56.11 | " | " |
| Osmond, S. O., 3/79 Bowen St, Camberwell | 158.97 | " | 30.6.81 |
| Paton, S., 4A Fairview St, Hawthorn | 111.28 | " | " |
| Norgate, B. A., 7 Pisa Cr, Bundall Waters, Surfers Paradise | 19.95 | " | " |
| Young, P. C., "Cowl Cowl", Hillston, N.S.W. | 26.47 | " | 13.3.78 |
| Young, P. C., "Cowl Cowl", Hillston, N.S.W. | 11.84 | " | 30.6.78 |
| Bray, E. J., 28 Belmont Ave, Kew | 11.88 | " | 21.9.78 |
| Ping Lin Low, 1/28 Coppin Gvc, Hawthorn | 10.19 | " | 26.10.79 |
| Young, P. C., "Cowl Cowl", Hillston, N.S.W. | 18.84 | " | 23.1.79 |
| Taylor, O. H., 1/8 Park Ave, Glenhuntly | 11.88 | " | 15.2.79 |
| Koci, B. F. 2/4 Charles St, St. Kilda | 33.75 | " | 30.3.79 |
| Hayward, F. J., 1320 Plenty Rd, Bundoora | 44.38 | " | 11.5.79 |
| Young, P. C. "Cowl Cowl", Hillston, N.S.W. | 39.45 | " | " |
| Lenny, B. I. and E. A., 14/3 Bellevue Park Rd, Bellevue Hill, N.S.W. | 11.88 | " | 30.6.79 |
| Clayton, C. A., 88A Mathoura Rd, Toorak | 151.88 | " | 29.6.79 |
| Clayton, C. A., 88A Mathoura Rd, Toorak | 60.00 | " | 29.6.79 |
| Westriem, G. F., 3 Martindale Ave, Baulkham Hills, N.S.W. | 60.00 | " | 28.9.79 |
| Birch, D. C., 51 Beresford Rd, Thornleigh | 31.50 | " | 28.12.79 |
| Parker, J. D., 40 Lansell Rd, Toorak | 11.88 | " | " |
| Shields, L. O., 34 Bruarong Cres, Frankston | 160.00 | " | " |
| Rawlings, A. K., 11 Cooper St, Nedlands | 156.25 | " | " |
| Delroit Pty. Ltd., c/o Houston & Brown, N.S.W. | 55.00 | " | " |
| Brown, E. N., 7 Cremorne St, Balwyn | 31.07 | " | " |
| Lawman, F. H., Bellbrook via Kempsey, N.S.W. | 25.64 | " | 16.10.79 |
| Fergus, H. C., 1/37 Kingsville St, West Footscray | 28.77 | " | 7.11.79 |
| Bailey, M. N., 4 Harden Cres, Georges Hall, N.S.W. | 17.52 | " | " |
| McDonald, A. W., Suite 4316 Australia Sq, Sydney, N.S.W. | 21.37 | " | " |
| Creswick, J. F., 6/18 Belmont St, Arncliffe | 18.00 | " | 30.11.79 |
| Birch, D. C., 51 Beresford Rd, Thornleigh, N.S.W. | 15.88 | " | 31.3.80 |
| Newman, B. C., 30 Strathalbyn St, East Kew | 11.88 | " | " |
| Beard, E. V., 49 Forbes St, Hawthorne | 156.75 | " | " |
| Tsangaris, G. P., 11/50 Sutherland Rd, Armadale | 16.00 | " | 31.3.80 |
| Pedder, J. A. A., 25 Britannia St, Geelong West | 41.42 | " | " |
| Birch, D. C., 51 Beresford Rd, Thornleigh, N.S.W. | 82.19 | " | 24.4.80 |
| Lydspcr, F. D., 15 Lockhart St, Caulfield | 12.50 | " | 30.6.80 |
| Rouse, K. D., P.O. Box 193, Canberra | 100.00 | " | " |
| Clayton, W. S. and P. J., P.O. Box 152, Nelsons Bay | 13.12 | " | " |
| Anderson, C., 10 Bamfield Cl, Templestowe | 26.25 | " | 30.9.80 |
| Chatterton, H. M., 308 Raymond St, Sale | 78.75 | " | " |
| Sanderson, J. M. E., 5 Freyer St, North Williamstown | 10.27 | " | 15.10.80 |
| | 41.10 | " | " |

Unclaimed Moneys Act 1962

Register of Unclaimed Moneys held by the—

| Name of Owner on Books and Last Known Address | Total Amount Due to Owner | Description of Unclaimed Money | Date when Amount first became Payable |
|--|------------------------------------|-----------------------------------|--|
| \$ | | | |
| FORD CREDIT AUSTRALIA LIMITED—continued | | | |
| Castres, R. R. and J. M., 1169 Sturt St, Ballarat | 68.75 | Interest | 30.12.80 |
| Daniels, G. F. and N. K., 111 Arden St, North Melbourne | 47.25 | " | 30.3.81 |
| Powell, A. W., 287 St. Kilda St, Brighton | 86.25 | " | " |
| Vines, H. C., 50 Sussex St, Middle Brighton | 15.68 | " | 30.6.81 |
| Cassar, M. C. and C. M., 84 Madden Gve, Richmond | 16.56 | " | " |
| Fowler, F. A., 23 Tormey St, North Balwyn | 355.72 | " | " |
| Wallace, J. R., 12 Glenroy Ave, Middle Cove | 31.25 | " | 30.9.81 |
| O'Gorman, B. K., 16/26 Pacific St, Manly | 17.38 | " | 4.8.81 |
| Dickenson, J. J. and A. M., 8/408 Bay St, Brighton | 28.00 | " | 30.9.81 |
| Welch, N. K. and D. R., 23 Troy St, Applecross | 84.00 | " | " |
| De La Pierre, J. M., 15 Fernvale Cres, Mulgrave | 37.50 | " | 31.12.81 |
| Smith, G. B., 37 Graham Ave, Wangaratta | 50.63 | " | " |
| Rees, G. V., c/o Commonwealth Savings Bank, Neutral Bay, N.S.W. | 72.25 | " | " |
| Vines, H. C., 50 Sussex Street, Middle Brighton | 18.07 | " | 30.12.81 |
| Rowlands Hance and Co., 114 William St, Melbourne | 12.50 | " | 10.7.81 |
| Vines, H. C., 50 Sussex St, Middle Brighton, 5713 5713 | 17.55 | " | 30.9.81 |
| HECLA ROWE LTD. | | | |
| Alcedo Pty. Ltd., c/o N. V. Nixon, 50 Stawell St, Kew | 40.00 | Dividend | 10.12.81 |
| Beaumont, E. A., 46 National Circuit, Forrest, A.C.T. | 18.00 | " | " |
| Billiald, T. G., P.O. Box 83, Rosebud | 20.00 | " | " |
| Cadd, M. D., 29 Linum St, Blackburn | 21.06 | " | " |
| Chapman, E. M., 16A Wellington St, Brighton | 11.24 | " | " |
| Coldwell, S. J., 14 Deutscher St, Avondale Heights | 300.00 | " | " |
| Downie Group Industries Pty. Ltd., 7-11 Regent St, Redfern, N.S.W. | 39.74 | " | " |
| Eldridge, W. C., c/o Blynton and Perkins, G.P.O. Box 144B, Hobart, Tas. | 13.50 | " | " |
| Furnell, L., (estate of), Address Unknown | 24.00 | " | " |
| Greer, D. R., 28 Water St, Old Noarlunga, S.A. | 40.00 | " | " |
| Griffiths, G. V., 16 Tower Hill Rd, Frankston | 10.10 | " | " |
| Hollingworth, C. S., 426 Chapel St, South Yarra | 18.00 | " | " |
| Hopkins R. G., (estate of), Address Unknown | 90.00 | " | " |
| Kerr, M. M. E., 23 Chopin Rd, Somerton Park, S.A. | 20.00 | " | " |
| Legg, Dr. J., 21 Hopetoun Ave, Canterbury | 36.00 | " | " |
| May, D. J., Blampied via Creswick | 10.10 | " | " |
| Mayer, J. M., 18 Stevenson St, Kew | 25.26 | " | " |
| Nicholls, M., Lot 18, Gulls Way, Frankston | 12.00 | " | " |
| O'Callaghan Nominees Pty. Ltd., 47 Wakefield St, Adelaide, S.A. | 40.00 | " | " |
| Rawber, J. D., 89 Gould St, Frankston | 20.00 | " | " |
| Shannon, K. A., 2 Bradshaw St, Ballarat | 20.00 | " | " |
| Singleton, D., P.O. Box 1226, Rockhampton, Qld. | 20.00 | " | " |
| Crabb, J. T., (estate of), Address Unknown | 10.50 | " | " |
| Thearle, P. F., 112 New Ballina Cutting, Lismore Heights, N.S.W. | 10.00 | " | " |
| Ulmer, R. A., 133 Grandview Gve, McLeod West | 10.00 | " | " |
| Whitbourne, P. W., 14 Pacific Blvd, Beaumaris | 10.00 | " | " |
| Dunbar, S. F., 6/3 Wreford Rd, Blackburn | 10.00 | " | " |
| Hawkins, T. G., P.O. Box 321, Kenmore, Qld. | 10.00 | " | " |
| Hazell, A. E., 49 Park Cres, Fairfield 5672 | 10.00 | " | " |
| ACTROL LIMITED | | | |
| Clark, John S., (estate of), c/o B. J. Clark, P.O. Box 555, Launceston, Tas. | 41.56 | Dividend | 31.3.81 |
| Floyd, David A., 14 Duxford St, Paddington, N.S.W. | 66.19 | " | 26.11.81 |
| Maxwell, Jean M., c/o Central Share Registry of Australia P/L, P.O. Box 45, Collins St., Melbourne. | 109.75 | " | 26.11.81 |
| May, Jean M., P.O. Box 5, Canterbury | 109.75 | " | 31.3.81 |
| Webster, Senator James J., Murrungowar, Yuroke | 441.56 | " | " |
| Kereszturi Kay, 1/10 Alcock St, Mt. Wellington, Auckland N.Z. | 10.62 | " | " |
| Kivell, Margaret E., 141 Beerescourt Rd., Hamilton, N.Z. | 12.86 | " | " |
| Ransom, Audrey A. J., 19 Eastwood Rd., Goodmayes, Ikford, Essex, U.K. | 10.52 | " | " |
| Ransom, Audrey A. J., 19 Eastwood Rd., Goodmayes, Ikford, Essex, U.K. 5673 | 10.52 | " | 26.11.81 |
| HECRON LIMITED | | | |
| Clan Ross Enterprises Pty. Ltd., 27 Arden Street, North Melbourne | 40.00 | Dividend | 17.12.81 |
| Guthrie, G. A. K., 62 Mills Street, Albert Park | 40.00 | " | " |
| Jaffe, P., G.P.O. Box 4603, Melbourne | 15.00 | " | " |
| Joyce, C., 55 St. George's Terrace, Perth, W.A. | 25.00 | " | " |
| Marks, J. B., 708 Toorak Road, Malvern | 100.00 | " | " |
| W. E. & J. M. Gardner Holdings Pty. Ltd., 12 Denham Avenue, Batehaven, N.S.W. 5674 | 10.00 | " | " |

Unclaimed Moneys Act 1962

Register of Unclaimed Moneys held by the—

| Name of Owner on Books and Last Known Address | Total Amount Due to Owner | Description of Unclaimed Money | Date when Amount first became Payable |
|---|---------------------------|--|---------------------------------------|
| \$ | | | |
| OLIVER J. NILSEN (AUSTRALIA) LIMITED | | | |
| Shankly, Norman John (estate of), 406 Lonsdale Street, Melbourne 5678 | 101.60 | Dividend | 8.5.81 |
| ICI AUSTRALIA LIMITED | | | |
| Dineen, Frank H. (estate of), c/o John F. Dineen, 40 Kitchener St, Trafalgar | 1000.00 | Cheques | 30.11.80 |
| Sibley, Neville V., 45 Greenbank St, Marrickville, N.S.W. | 1000.00 | " | " |
| Ashton, Elsie C. (estate of), c/o Brian Hunter, G.P.O. Box 165 Adelaide S.A. | 800.00 | " | " |
| Eyles, Noel A., David Hill Rd, Monbulk | 200.00 | " | " |
| Gray, Kenneth A., 91 Western Hwy., Blaxland, N.S.W. | 400.00 | " | " |
| Barry, Norah E. C. (estate of), c/o R. J. Darton & Co., 471 Marrickville Rd, Dulwich Hill, N.S.W. | 1600.00 | " | " |
| Gibson, Janet E., 5 Warde St, Bairnsdale | 100.00 | " | " |
| Gray, Kenneth A., 91 Western Hwy, Blaxland, N.S.W. 5679 | 100.00 | " | " |
| G. J. COLES & COY. LIMITED—STAFF SUPERANNUATION FUND | | | |
| Pelligrin, M., 1/2a Wattlevalley Road, Canterbury | 203.44 | Superannuation | 26.5.81 |
| Lawrence, H. K., 6/30 Eldridge Street, Footscray | 20.00 | " | 29.5.81 |
| Skinner, T., 26 Mincha Street, West Brunswick | 31.80 | " | 12.11.81 |
| Lidsey, S. M., 15 Agathea Court, Frankston 5676 | 144.10 | " | 30.7.81 |
| COMMERCIAL UNION ASSURANCE COMPANY OF AUSTRALIA LIMITED | | | |
| Yeo Crostwaite & Co. P/L, 108 Queen Street, Melbourne | 69.23 | Claim | 7.1.81 |
| Dale, M. P. c/o Mrs. Duffy, 2/6 Burwood Street, Parkdale | 10.65 | Return | 3.2.81 |
| Oliver Davey Glass, 194 Canterbury Road, Bayswater | 64.89 | Storm Damage | 3.2.81 |
| Carney, M. J., 1/3 May Street, Elwood | 150.00 | Claim | 4.2.81 |
| Bond, D. H., 63 Watson Street, Murchison | 80.03 | Return | " |
| Austin, N., 6/5 Powell Street, South Yarra | 10.24 | " | " |
| Conroy, A. and J., 64 Stanley Street, Black Rock | 70.00 | Claim | 5.2.81 |
| Gummoni, R. S., 9 Wilson Ave, Montmorency | 30.00 | " | 12.2.81 |
| Corp. B. 8893, c/o A. & S. Real Estate, 341 Smith Street, Fitzroy | 85.00 | " | 12.2.81 |
| Figgins, R. D., 38 Carmichael Road, Oakleigh | 59.50 | " | 23.2.81 |
| Prosmitrelis, A. S., 10 Bent Street, Northcote | 77.00 | " | 23.2.81 |
| Hassan, V. 86 Cooloongatta Rd, Beverly Hills, N.S.W. | 225.00 | " | 24.2.81 |
| Styles, Peter, 36 LaTrobe Street, Mentone | 60.00 | Storm Damage | 6.3.81 |
| Koleich, D. S., 3/334 Nicholson St, Yarraville | 360.00 | Lost Chain | 4.3.81 |
| Largis, E. and A. T., 168 Darebin Rd, Northcote | 172.00 | Claim | 25.2.81 |
| Woodward, K. and G., c/o A. O'Neill, 11/82 Park St, St Kilda | 33.00 | Return | 12.3.81 |
| Stilo, S. and Corallo, S. F., 95 Nelson Rd, Box Hill | 24.00 | " | 24.3.81 |
| Seriotis, C. H., 50 Albert St, Port Melbourne | 62.00 | " | 12.3.81 |
| Breen, UP/M. T., 89 Middleborough Rd, East Burwood | 35.15 | Claim | 19.3.81 |
| McCusker, M., 20 Boyd St, Albert Park | 74.00 | Return | 23.3.81 |
| Williams, T. S. and D. B., 3 Petronella Ave, Wheelers Hill | 58.00 | Claim | 29.4.81 |
| Eldred, F. G., Moolap RMD Mail Centre, Geelong | 165.00 | Lost Ring | 5.5.81 |
| Richardson, B. S., 27 Shakespeare Rd, Hawthorn | 21.00 | Claim | 18.5.81 |
| Swan Hill Chiropractic Service, Cnr. McCrae and Splatt Sts, Swan Hill | 21.00 | R. A. Keating, Med. P. Bevendge, Ref. 21 | 26.5.81 |
| Bruhin, P., 16 Finlayson St, Malvern | 41.07 | Claim | " |
| Baillie, B. and H., c/o Paul Cyrostellems, P.O. Box 300, Traralgon | 40.70 | Return | 28.5.81 |
| Barawowski, G. and Bond, G., 10/14 Nash St, Glen Iris | 25.00 | " | 24.6.81 |
| Chen, S. and N., c/o Roger Yelland & Co, 159a Glenferrie Rd, Malvern | 34.00 | " | 25.6.81 |
| Dickinson, F. A., c/o B. McIntyre, 4th Floor, N.M.L.A., Melbourne | 44.21 | " | 24.6.81 |
| Nichol, F., c/o N.M.L.A., 414 St Kilda Rd, Melbourne | 33.00 | Claim | 19.6.81 |
| Kennedy, H., c/o Wilson Inss, P.O. Box 55, East Bentleigh | 152.00 | " | 25.6.81 |
| Stambanis, A., 1/11 Chalayben St, Preston | 12.30 | " | 23.6.81 |
| Silverman, K., 41 Jupiter St, Caulfield | 82.50 | " | 24.6.81 |
| Usher, D. and F., 1039 High St, Armadale | 18.33 | Return | 1.7.81 |
| Michelle and Cullen, c/o N.M.P.B.S., 470 Collins St, Melbourne | 49.73 | " | 21.7.81 |
| Flew, R. and J., 223 Blackburn Rd, South Blackburn | 16.29 | " | 7.7.81 |
| Golquhoun, P. M., 91 Manning Village, Robinson Rd, Baxter | 69.22 | " | 23.7.81 |
| Scanlon, B., 7 Mile Rd, Nar Nar Goon | 30.00 | " | 13.7.81 |
| Judy Pengly Real Estate, c/o Steeves Agnew (Aust) Pty Ltd, 530 Lt Collins St, Melbourne | 84.00 | " | 13.7.81 |
| Munro, L. I., 14 Hughes St, Burwood | 45.00 | " | 21.7.81 |
| Cole, T., 16 Punt Rd, Barwon Heads | 20.00 | Claim | 24.7.81 |
| Mackay, R. and J. E., 33 Starold St, Glenroy | 76.40 | " | 28.7.81 |
| Constantine, A., 10 Gordon Gve, Malvern | 120.00 | " | 28.7.81 |
| Rapsey, D., 2A Warsaw Cres, Wondonga | 251.50 | Water Damage | 18.8.81 |
| Rapsey, D., 2A Warsaw Cres, Wodonga | 25.20 | Claim | 18.8.81 |
| Taularidis, A., 2 Henty St, Reservoir | 45.00 | " | " |
| Trueman, W., 11/15 Cucklewod Ave, Frankston | 50.31 | " | 20.8.81 |
| Osborough, G. R. and A. F. K., c/o R. J. Martin, 100 Exhibition St, Melbourne | 20.28 | Return | 12.8.81 |
| Lyrie, L. and Killern, J., c/o D. A. Jones, 26 Greeves St, Fitzroy | 33.75 | " | " |

Unclaimed Moneys Act 1962

Register of Unclaimed Moneys held by the—

| Name of Owner on Books and Last Known Address | Total Amount Due to Owner | Description of Unclaimed Money | Date when Amount first became Payable |
|---|------------------------------------|--|--|
| \$ | | | |
| COMMERCIAL UNION ASSURANCE COMPANY OF AUSTRALIA LIMITED—continued | | | |
| Peters Hydrojet Carpet, 1 Glenbrook Ave | 27.00 | Invoice 3684—Palide Family Trust | 3.9.81 |
| Saudel Constructions, c/o Marshall Golding & Adams, P.O. Box 288, South Melbourne | 25.06 | Return | 23.10.81 |
| Adam, A., 42 Coghlan St, Niddrie | 10.00 | Claim | 20.10.81 |
| BCSP Finlayson Street, 2/16 Finlayson St, Malvern | 25.00 | " | 23.10.81 |
| Rapsey, D., 2A Warsaw Cr, Wodonga | 86.70 | " | 26.10.81 |
| Silvester, D., 44 Purches St, Mitcham | 37.10 | Claim | 1.10.81 |
| Karayannis, S., 1 Maribymong Rd, Ascot Vale | 77.05 | Claim | 13.10.81 |
| Joinery, F. and M., 216 White Rd, Wonthaggi | 29.12 | " | 28.10.81 |
| Healey, A., 20A Union St, Essendon | 300.00 | " | 10.11.81 |
| Moisisdis, J. and G., 58 Avocado St, Mildura | 18.00 | " | 16.11.81 |
| Zass, S. J., 35 View St, Bendigo | 20.55 | Commission | 17.11.81 |
| Bolugh, G. and Y., c/o Mrs Kennedy, P.O. Box 23, Brighton | 23.59 | Return | 4.12.81 |
| Stattery, M. A., Myrtle Bank, via Sale | 21.00 | " | 25.11.81 |
| Butera, D. and G., 10 Hay St, Reservoir | 31.47 | Claim | 27.11.81 |
| Organ, J. H., 351-353 Warrandyte Rd, Ringwood | 44.40 | Return | 1.12.81 |
| Houssos, J. C. and N. V., 193 Palmerston Ave, Dromana | 15.00 | " | 9.12.81 |
| Fabrizio, A. and E., 13 Alfred Crs, North Fitzroy | 16.00 | Claim | 9.12.81 |
| Healy, M. A., 117 Collins St, Melbourne | 300.00 | " | 7.12.81 |
| F. A. Peluso & Co, 136 Johnson St, Collingwood | 39.07 | Commission | 9.12.81 |
| E. A. Ward & Co, Woorinen | 350.55 | Claim | 21.12.81 |
| Ruthenia Court Pty Ltd, 5/5 Westbury Gve, East St Kilda | 70.00 | " | 23.12.81 |
| P. G. & N. V. McAllister Pty Ltd, 70 Campbell St, Swan Hill | 26.00 | " | 5.1.82 |
| Bridgeman, M. O. and M. C., 155 Greenwood Dve, Bundoora | 35.00 | " | 30.12.81 |
| Ellinson, R. A., 69 Orrong Rd, Toorak | 11.16 | Return | 29.12.81 |
| Drs F. S. Braithwaite & Linguish, P.O. Box 112, Corio | 22.80 | Claim | 12.1.82 |
| Thirty Third Newcomers, 29 Fitzroy St, Fitzroy | 13.00 | " | 12.1.82 |
| Gardiner, J. G., Bulgoo, Cobarr, N.S.W. | 130.19 | Balance | 14.1.82 |
| Antolovich, L., 23 St Andrews Crs, Bulleen | 44.99 | Commission | 12.1.82 |
| Gadd, G. R. and J., Tangambalanga | 27.85 | Claim | 14.1.82 |
| Gunzberg, J. C. and J. E., 26 Stutt Ave, Doncaster 5935 | 48.64 | Lost Items | 21.1.82 |
| NATIONAL CONSOLIDATED LIMITED | | | |
| Laughlin, Heather May, 95 Hunter Street, Deniliquin, N.S.W. | 14.40 | Dividend | 28.4.81 |
| Shankly, Elizabeth Agnes Dalton, Norman S. and Roy B., c/o H. Shankly & Shankly, 406 Lonsdale Street, Melbourne | 77.76 | " | " |
| Shankly, Norman J., (estate of), c/o H. Shankly & Shankly, 406 Lonsdale Street, Melbourne | 259.20 | " | " |
| Karimui, Caroline Jane Hide, c/o Dept. of Primary Industry, via Kundiawa Chimbu Province, Papua New Guinea | 12.09 | " | " |
| Warr, Glennis Joyce, P.O. Box 623, Potts Point, N.S.W. | 21.60 | " | " |
| Kingston, James Russell Bruce and Hurley, Ray Watson, P.O. Box 6448, Auckland, N.Z. | 18.36 | " | " |
| Trengrove, Robert Roff, 18 Alice Street, Turramurra, N.S.W. | 44.52 | " | 13.11.81 |
| Darken, John Henry, 56 Loghnan Road, Ringwood | 27.78 | " | " |
| Darken, John Henry Macarthur, 56 Loghnan Road, Ringwood | 92.64 | " | " |
| Marks, Jennifer Ann, 30 Gladstone Avenue, Armadale | 224.64 | " | " |
| Taylor, Graeme John, Barastock Farm, Central Ave., Croydon | 16.20 | " | " |
| Whippy, Denby James, 76 Hilton Avenue, Lakemba, N.S.W. | 30.80 | " | " |
| Wilkens, Erica Rutherford, Malunga, Lara | 10.80 | " | " |
| Winn, Neelia Henriette Gertrude, 37 Brown Street, Paddington, N.S.W. | 12.60 | " | " |
| Barnier, Neville Kenneth, 289 Gallipoli Road, Carina Heights, Qld. | 39.00 | " | " |
| Carter, Ida Vera, c/o Coopers & Lybrand, G.P.O. Box 2650, Sydney, N.S.W. | 64.30 | " | " |
| Petford, Esma Raphael, Taldora 11 Nelson Street, Corinda, Brisbane, Qld. | 123.70 | " | " |
| Sanson, Alison Ruth, 290 Hampden Street, Hokitika, N.Z. | 43.73 | " | " |
| UNION ASSURANCE SOCIETY OF AUSTRALIA LIMITED | | | |
| Sentile, M. R. P.O., Box 299, Irymple | 14.02 | Claim | 19.3.81 |
| Beck, M., 2/7 Halley Ave, Camberwell 5934 | 26.88 | Refund | 14.9.81 |
| J. B. WERE & SON | | | |
| Heinrich, Fred, H., 99 Meller St, O'Connor, A.C.T. | 4223.05 | Sale Proceeds, 3000 Kitchener Mining, Un- presented Cheque | 12.3.80 |
| 5878 | | | |
| ANDREW LAMBERT (HOLDINGS) PTY. LTD. | | | |
| Cannon, Reginald Holden Bertram, 70 Bathurst St, Sydney, N.S.W. | 26.40 | Dividend | 21.9.81 |
| 5663 | | | |

Unclaimed Moneys Act 1962

Register of Unclaimed Moneys held by the—

| Name of Owner on Books and Last Known Address | Total Amount Due to Owner | Description of Unclaimed Money | Date when Amount first became Payable |
|---|------------------------------------|-----------------------------------|--|
| \$ | | | |
| BATTEN & PERCY PTY. LTD. | | | |
| McCauley, Wendy, 1/8 Firth St, Doncaster. (Address unknown) | 179.00 | Bond | 15.1.81 |
| Mildren, M., 41 Liddiard St, Hawthorn 5871 | 194.30 | " | " |
| COMMERCIAL AND GENERAL ACCEPTANCE LIMITED | | | |
| Latter R. and L. Contractors Pty. Ltd., 388 Boronia Rd, Boronia 5872 | 153.77 | Refund | 29.4.81 |
| H. J. HEINZ COMPANY AUSTRALIA LTD. | | | |
| Fishlock, B. F. (Address unknown) | 1938.35 | Long Service Leave and Wages | — 2.82 |
| Nojak, J. V., Eden | 71.01 | " | — 4.81 |
| Lewis, A., Eden | 53.52 | " | " |
| Dundord, R., Eden | 21.24 | " | " |
| Stewart, O., Eden | 26.81 | " | — 5.81 |
| Thurling, P., Eden | 126.00 | " | " |
| Aldridge, S., Eden | 134.00 | " | — 6.81 |
| McDonald, R., Eden | 172.44 | " | " |
| Larritt, J., Eden | 155.22 | " | — 8.81 |
| Dadd, A., Eden | 114.00 | " | — 9.87 |
| Anderson, T., Eden | 65.56 | " | " |
| Lyon, G., Eden | 131.42 | " | — 11.81 |
| Kirby, Eden | 24.00 | " | " |
| Schumann, M., Eden | 25.82 | " | " |
| Moore, A., Eden | 34.91 | " | " |
| Fletcher, D., Eden | 18.99 | " | " |
| Morris, C., Eden | 48.40 | " | " |
| Abbey, L., Eden | 12.36 | " | " |
| Thomsen, K., Eden | 21.74 | " | " |
| Grenenger, F., Eden | 26.81 | " | " |
| Ingram, P., Eden 5873 | 24.56 | " | " |
| JULIUS MARLOW | | | |
| Heggarty, D. P., 56 Chaucer St, Moorooka, Qld | 16.26 | Dividend | 9.4.81 |
| Lawrence, S., 59 Ocean St., Woollahra, N.S.W. | 12.50 | " | " |
| Watson, D. B. H., 6 Brooke St, South Melbourne | 12.50 | " | " |
| Lew, W. H. C., 65 Tooronga Rd., East Hawthorn 5874 | 12.50 | " | " |
| MILDURA GRAND HOTEL LIMITED | | | |
| Smith, James Henry, E14 Glenmore Hostel, Tokorda, N.Z. 5875 | 44.83 | Dividend | 2.1.81 |
| MOORABBIN HOTEL PTY. LTD. | | | |
| Cook, C. E. 5941 | 20.40 | Wages | 28.2.82 |
| MIDDLESEX HOTEL PTY. LTD.—GOWERVILLE | | | |
| Harris, J. R., 18 Princes St, Watsonia 5942 | 83.10 | Wages | 4.4.82 |
| EDINBURGH HOTEL PTY. LTD. | | | |
| Young, K. A. | 19.70 | Wages | 20.12.80 |
| Saynor, S. N. | 21.80 | " | 27.9.81 |
| Morand, M. P. 5943 | 26.10 | " | 6.9.81 |
| DERRIMUT HOTEL PTY. LTD. | | | |
| Gallia, A. 5944 | 365.90 | Wages | 6.2.82 |
| T. AND A. TESS PTY LTD | | | |
| Laing, J. | 40.00 | Dividend | 11.6.81 |
| Grouch, H. and B. | 20.90 | " | 9.6.81 |
| Bain, R. | 15.90 | " | 18.5.81 |
| Moss, B. and P. | 15.53 | " | " |
| Sharp, W. E. | 260.00 | " | 26.6.81 |
| Mai, I. and N. 5945 | 16.80 | " | 31.12.81 |
| OLIVER HUME (SOUTHERN) PTY. LTD. | | | |
| Grant, D. J. and S. M. White, 4/10 Daly St, East Oakleigh 5946 | 500.00 | Deposit | 18.3.81 |

Unclaimed Moneys Act 1962

Register of Unclaimed Moneys held by the—

| Name of Owner on Books and Last Known Address | Total Amount Due to Owner | Description of Unclaimed Money | Date when Amount first became Payable |
|--|------------------------------------|-----------------------------------|--|
| \$ | | | |
| THE NATIONAL MUTUAL LIFE ASSOCIATION OF AUSTRALIA LTD. | | | |
| Mundy, J. F., 47 Holborow St, Croydon | 63.65 | Superannuation Benefits | 13.10.80 |
| Pagett, E. V., 6/12 Victoria Ave, Mitcham | 101.43 | Premium Refund | 6.11.80 |
| Egan, G., Shoalhaven Willows Caravan Park, Nowra, N.S.W. | 10.03 | Superannuation Benefits | 11.11.80 |
| Van der Wgen, C., 4/49 Imperial Ave, Bondi, N.S.W. | 25.78 | " " | 19.11.80 |
| Galvin, J. A., 86 Bentons Rd., Mornington | 24.38 | Premium Refund | 25.11.80 |
| McAllister, M., 91 Sladden St., Cranbourne | 72.00 | " " | 1.12.80 |
| Brooks, A. T., P.O. Box 124, Lakes Entrance | 23.05 | " " | 9.12.80 |
| Drew, G. I., Eramosa Rd, Somerville | 69.57 | " " | 4.1.80 |
| Birkeit, S. J., 2/33 Albion St, Sebastopol | 79.37 | " " | 17.12.80 |
| Bernhardt, G. L., Manifold St., Nathalia | 45.89 | " " | 24.12.80 |
| Bett, G., (address unknown) | 120.35 | Superannuation Benefits | .12.80 |
| Fleet, A. C., 6 Abor Court, Karingal | 28.69 | Premium Refund | 14.1.81 |
| Watts, J. W., (address unknown) | 62.71 | Superannuation Benefits | .7.78 |
| Tappai, E., (address unknown) | 49.97 | " " | .9.79 |
| Jeffrey, D., (address unknown) | 294.58 | " " | .11.79 |
| Parr, C. (address unknown) | 63.38 | " " | .1.80 |
| McPherson, P. W., (address unknown) | 24.57 | " " | .3.80 |
| Falshaw, V. (address unknown) | 40.00 | " " | .12.79 |
| Murray, W. L., (address unknown) | 33.33 | " " | .4.80 |
| Ettia, L. (address unknown) | 50.30 | " " | " |
| Challender, P. H. (address unknown) | 43.81 | " " | " |
| Dunn, K. J., (address unknown) | 43.86 | " " | " |
| Inati, D. (address unknown) | 41.55 | " " | " |
| Casey, S. M., (address unknown) | 59.89 | " " | .5.80 |
| Lees, S. W., (address unknown) | 29.78 | " " | .6.80 |
| Jefferies, R. H., (address unknown) | 157.58 | " " | .7.80 |
| Swann, N., (address unknown) | 13.86 | " " | .7.80 |
| Hensgen, K. W., P.O. Nichols Point | 20.82 | Premium Refund | 10.2.81 |
| Brown, M. W., 3/58 Rankins Rd, Kensington | 15.00 | " " | 30.10.80 |
| Orvad, C. R., 3 Lambassa Gve, Keon Park | 31.29 | " " | 16.3.81 |
| McMahon, C. S., 309 Humffray St., North Ballarat | 23.63 | " " | 2.4.81 |
| Steiner, V., 25 Brighton St, Richmond | 173.00 | Superannuation Benefits | 29.4.81 |
| Lord, I R. and Y., 4/801 Princes Hwy, Springvale | 13.96 | Premium Refund | 15.5.81 |
| Blackley, R., 6 Dion St., Burwood | 16.57 | " " | 5.6.81 |
| Read, K. J., 41 Forest St, Yarra Glen | 15.20 | " " | 11.6.81 |
| Liepa, Y., Hastings St, Newry | 19.84 | " " | 23.6.81 |
| Lal, R., 120 Wells St, Newtown, N.S.W. | 39.93 | Superannuation Benefits | 20.7.81 |
| Turner, C. A., 33 Glen Rd, Belgrave Heights | 113.28 | Premium Refund | 20.7.81 |
| Dunrabin, C. H., 37 Scanlan Rd., Berwick | 12.74 | " " | 29.7.81 |
| Nelson, J., 250 Barkers Rd, Hawthorn | 10.00 | " " | 2.9.81 |
| Vassallo, J., 4/15 Cleveland St, St. Albans | 105.57 | " " | 4.9.81 |
| Elder, S. M., 53 Richards Ave, Knoxfield | 45.06 | " " | 9.9.81 |
| Sherrard, F. W., 9 Gareth Ave, Beaumaris | 13.00 | " " | 9.9.81 |
| Cachia, N., 42 Barnes Way, Bundoora | 272.36 | Superannuation Benefits | 28.9.81 |
| Izlemer, C. L. M., 117 Hawkers St., Ivanhoe | 21.22 | Premium Refund | 11.5.81 |
| Barry, A., 74 Bishop St, Yarraville | 24.79 | Disability Premium Refund | 26.6.81 |
| Cannon, M. H. L., 31 High St, Kangaroo Flat 5876 | 59.44 | Premium Refund | 19.1.81 |
| MIDDLESEX HOTEL PTY. LTD.—BAYSWATER | | | |
| Handley, G., 408 Mt Dandenong Rd, Kilsyth 5940 | 47.00 | Wages | 31.3.81 |
| KRAFT FOODS LIMITED | | | |
| Bray, J. C., Murrabit | 69.66 | Cheque Unpresented | 18.4.81 |
| " " | 69.66 | " " | 16.6.81 |
| Byrne, P. G., 22/7 Alfred Square, St. Kilda | 279.60 | Unclaimed Wages | 29.3.81 |
| McKenzie, C. A., 4/318 Beaconsfield Pde., St. Kilda | 121.20 | Cheque Unpresented | 22.3.81 |
| Gramptsas, T., 29 Fenton Street, Ascot Vale | 12.65 | Unclaimed Wages | 29.11.81 |
| McDowell, S. D., 182 Brunswick Road, Brunswick | 14.47 | Cheque Unpresented | 12.6.81 |
| Butler, C. J., Strathmerton | 119.82 | Unclaimed Wages | 14.12.81 |
| Howard, D. L., P.O. Box 123, Cohuna | 143.18 | Cheque Unpresented | 10.6.81 |
| Raper, K. L., c/o Scipio Primas, Torrumbury Estate, Torrumbury | 15.49 | " " | 10.8.81 |
| Andrew, N. J. & M. I., River Road, Murchison 5675 | 17.26 | " " | " |

Unclaimed Moneys Act 1962

Register of Unclaimed Moneys held by the—

| Name of Owner on Books and Last Known Address | Total Amount Due to Owner | Description of Unclaimed Money | Date when Amount first became Payable |
|--|---------------------------|--------------------------------|---------------------------------------|
| \$ | | | |
| NATIONAL COMMERCIAL UNION LIMITED | | | |
| Anderson, Lindsay N. J., G.P.O., Box 441, Sydney, N.S.W. | 12.00 | Dividend | 11.11.81 |
| Barrett, Katherine E., 18 Clutha Place, South Hobart, Tas. | 54.00 | " | " |
| Beanvee Pty Limited, 459 Little Collins St, Melbourne | 24.00 | " | " |
| Blyth, James F., c/o Commonwealth Savings Bank, Box 2718, Sydney, N.S.W. | 60.00 | " | " |
| Borland, Raymond A., 26 Clermont Ave, North Strathfield, N.S.W. | 48.00 | " | " |
| Callen, Colleen J., and Callen, Sheila V., c/o A. C. Boyle Neilson & Co., 65 York Street, Sydney, N.S.W. | 12.00 | " | " |
| Clarke, Doris M., 4 Dine St, Randwick, N.S.W. | 15.00 | " | " |
| Cookes, William H., (estate of) care of Leslie A. Brumby, 64 Elizabeth St, Melbourne | 18.00 | " | " |
| Crawford, Florence A., 21 Francis Ave, Brighton-Le-Sands, N.S.W. | 13.52 | " | " |
| Curwen, Isla M., 4 Nyora Ave, The Basin | 12.00 | " | " |
| Dugald Pty Limited, G.P.O. Box 3579, Sydney, N.S.W. | 24.00 | " | " |
| Hall Effie E. C. M., 41 Elphin St, Ivanhoe | 12.00 | " | " |
| Hayden, Barbara, Flat 4, 15 Kinkora Rd, Hawthorn | 10.00 | " | " |
| Hindmarsh, Barbara D., 28 Hakea Ave, Frenchs Forest, N.S.W. | 30.00 | " | " |
| Jenkinson, Michael J. T. and John A. Spenceley c/o 6 Cleveland St, Wahroonga, N.S.W. | 19.00 | " | " |
| Ling, Betty L., RMB 270, Inglewood | 80.00 | " | " |
| Lutshetshko, Myron and Irina Lutshetshko, 43 Hanley St, Narre Warren | 40.00 | " | " |
| Madill, Floyd D. J. and Judith M. Madill, c/o Commercial Bank of Aust Ltd, Caboolture, Qld. | 12.00 | " | " |
| Mayne, Dr Lewis H., P.O. Box 385, Ipswich, Qld. | 48.00 | " | " |
| Nicholas, David W., 25 Burns Rd, Wahroonga, N.S.W. | 20.00 | " | " |
| P. F. W. Investments Pty Ltd c/o P. F. Williams, 7 Gawith Crt, Toorak | 26.68 | " | " |
| Payne, John H., 64 Butler St, Inverell, N.S.W. | 40.00 | " | " |
| Ritter, Richard E. L., Unit 3, 35 Stanhope Crt, Camberwell | 27.00 | " | " |
| Saunders, Nellie L., 2 Lewis St, Epping, N.S.W. | 45.00 | " | " |
| a-Tripet, Ernest, 9 Lumeah St, Punchbowl, N.S.W. | 27.00 | " | " |
| Watson, Amy Elizabeth, 31/40 Gerard St, Cremorne, N.S.W. | 12.00 | " | " |
| Williams, Christine L., 7 Swallow St, Slade Point, via Mackay North, Qld. | 12.00 | " | " |
| Young, William A., G.P.O. Box M948, Perth, W.A. 5936 | 30.00 | " | " |
| COURT HOUSE HOTEL PTY. LTD. | | | |
| Watson, C. L., 41 Coolgardie St, Frankston | 44.00 | Wages | 28.6.81 |
| Wilson, H. E., 3/32 Jasper Tee, Frankston | 11.20 | " | " |
| Williams, M., 1/34 Nepean Hwy, Aspendale | 48.90 | " | 23.2.81 |
| Kilbourne, F. A. | 40.60 | " | 6.12.81 |
| Lindley, R. 5937 | 33.50 | " | 21.2.82 |
| ROYARC PTY. LTD. | | | |
| Wright, L., 73 Glenferrie Rd, Hawthorn | 28.50 | Wages | 6.12.81 |
| Donahue, M., 138 Power Ave, Chadstone 5938 | 45.20 | " | 21.2.82 |
| CORNER PTY. LTD. | | | |
| Bugg, R. M., 123 Rosslyn Ave, Seaford | 18.00 | Wages | 15.11.81 |
| O'Neil, T. A., 1 Sundowner Ave, Clayton 5939 | 30.20 | " | 4.4.82 |
| AUSTRALIAN GLASS MANUFACTURERS COMPANY | | | |
| Rybicki, K., 3/171 Albert St, Brunswick | 28.11 | Wages | 8.8.81 |
| Adams, J., c/o 23 Bladin St, Laverton | 33.50 | " | 6.8.81 |
| Stojanovski, S., 56 Hanson St, West Newport | 44.10 | " | 7.10.81 |
| Ranca, L. I., 2/7 Truman St, Spotswood | 204.90 | " | " |
| Bodas, S., 164 Amer Er Stavrou, Kavala, Greece 5930 | 27.30 | " | 13.12.81 |
| A.C.I. LIQUITAINERS | | | |
| Jansen, M., 5 Rutherglen Rd, Vermont | 44.46 | Wages | 18.4.81 |
| Costanzo, T., 5/39 Sherwood Ave, Chelsea 5931 | 95.40 | " | 23.9.81 |
| A.C.I. GROUP EMPLOYEES' SUPERANNUATION FUND | | | |
| Karakasidis, E., 264 Warrigal Rd, Oakleigh | 26.28 | Refund | 2.6.80 |
| Emms, K., N.S.W. | 19.04 | " | 9.6.80 |
| Eskilsson, J. P., 3/23 Edmonstone St, West End, Qld. | 168.48 | " | 12.8.80 |
| Bajgerytch, J., 11 Berwyn Rd, Girrawheen, W.A. | 104.28 | " | 9.8.80 |
| Fisher, K. J., 10 Tentori Crt, Rochdale, Qld. | 10.73 | " | 23.7.80 |
| Brodtko, G., 26 Magga Dan Ave, Tregear, Mt. Druitt, N.S.W. 5932 | 42.84 | " | 10.9.80 |

Unclaimed Moneys Act 1962

Register of Unclaimed Moneys held by the—

| Name of Owner on Books and Last Known Address | Total Amount Due to Owner | Description of Unclaimed Money | Date when Amount first became Payable |
|---|---------------------------|--------------------------------|---------------------------------------|
| SINGER AUSTRALIA LIMITED | | | |
| | \$ | | |
| Suckling, B. D. | 12.39 | Salary | — . 74 |
| Trevisiol, B. T. | 27.38 | " | " |
| Kalweit, E. | 75.33 | " | " |
| Spefilly, C. 5972 | 31.31 | " | — . 75 |
| R.V.B. LTD. | | | |
| Brown, James D. and Lorraine M., 32 Hilltop Ave, Glen Iris | 15.00 | Dividend | 22.5.81 |
| Leggo, Jack F., Illawong Jesmond Rd, Fig Tree Pocket, Qld. | 30.00 | " | " |
| Young, Wilhelmina, c/o Public Trustee, 19 O'Connell St, Sydney | 31.03 | " | " |
| Jones, Rosa M., 38 Irymple Ave, East Kew | 24.35 | " | 20.11.81 |
| Woolley, Ernest, The Retreat, Esplanade, Mooloolaba, Qld. 5973 | 15.35 | " | " |
| MARSHALL WHITE & CO. PTY. LTD. | | | |
| Thorpe, L. A., 421 Hawthorn Rd, Caulfield | 21.76 | Stamp Duty | 8.3.79 |
| Irving, D., 23 Houson St, Malvern | 15.00 | Rent | 24.8.79 |
| Fraser, M., 17/631 Punt Rd, South Yarra | 23.00 | " | 1.9.79 |
| Petch, D., 5 Stanhope St, Malvern | 22.90 | " | 31.5.79 |
| Wallace, G., 17 Waitle Gve, Malvern | 13.20 | Stamp Duty | 9.5.79 |
| Morrison, G., 14/10-16 White St, Malvern | 15.60 | " | 28.9.79 |
| Kenyon, L. J., 4/10-16 White St, Malvern | 16.70 | " | 7.11.79 |
| Burke, R., 42 Kooyong Rd, Armadale | 25.10 | " | 15.5.80 |
| Mortenson, P. J., 21 Park St, South Yarra | 17.90 | " | 4.6.80 |
| Rundle, L., 10 Shipley St, South Yarra | 22.70 | " | 31.1.80 |
| Swallow R. J., 377 Alma Rd, Caulfield | 22.80 | " | 18.5.80 |
| Grissell, D. J., 9 Faircraft Ave, Glen Iris | 24.00 | Rent | 18.2.80 |
| Loton, A., 27 Inverness Ave, Armadale | 44.10 | " | 29.6.79 |
| Wixey, D., 3 Erica St, Prahran | 13.10 | Stamp Duty | 13.8.81 |
| Nellis, J., 9/8 Washington St, Toorak | 49.50 | " | 23.1.80 |
| Dent, R. W., 601 High St, Armadale | 66.50 | Rent | 1.3.79 |
| Gleadow, J., 31A Winter St, Malvern | 65.34 | " | 19.10.79 |
| Babington, J., 16/K1-K5 Raleigh St, Windsor | 14.90 | Stamp Duty | 17.6.81 |
| Bennett, C. L., 25 Rueban Rd, Toorak | 14.90 | " | " |
| Porteous, A., 7/27 Tintern Ave, Toorak | 20.90 | " | 1.10.80 |
| Campbell, N., 59 Chomley St, Prahran | 11.83 | Rent | 13.8.81 |
| Dorffer, M., 173 Finch St, East Malvern | 18.20 | " | 16.6.81 |
| Timms, M. B., 31 Glassford St, Armadale | 13.50 | Stamp Duty | 13.8.81 |
| Hunt, J., 4/494 Glenferrie Rd, Hawthorn | 13.08 | " | " |
| Angliss, S. E., 23 Johnstone St, Malvern | 31.60 | " | 6.7.81 |
| Robins, P., 12 Kooyong Rd, Armadale | 10.78 | Rent | 13.8.81 |
| Desouza, V., 80 Nicholson St, South Yarra | 19.77 | " | " |
| Dungan, W. T., 2/3 Osborne Ave, Glen Iris | 10.68 | " | 7.8.81 |
| Lie, R., 3 Glassford St, Armadale | 20.90 | Stamp Duty | 24.8.81 |
| Lewis, J., 12/88 Victoria Rd, Hawthorn | 19.02 | Rent | 25.11.81 |
| Gallou, R., 19/K1-K5 Raleigh St, Windsor | 15.50 | Stamp Duty | 13.8.81 |
| Hodgens, F. R., 21/88 Victoria Rd, Hawthorn | 20.60 | " | " |
| Name and address not known | 240.00 | Money Order | 8.12.80 |
| Name and address not known 5974 | 38.00 | Cheque | " |
| NESTLE AUSTRALIA LTD. | | | |
| Goodyear Tyre Service, Heyington Rd, Thomastown | 22.20 | Refund | 26.10.81 |
| Elcheikh, G., Shopping Centre, Chirnside Park | 11.64 | " | 14.10.81 |
| Coles, G. J., Garfield St, Launceston, Tas. | 347.23 | Payment | 22.12.81 |
| Sam's Cut Prices | 20.00 | " | — . 11.81 |
| Australia Post, G.P.O. Box 2020 S, Melbourne 5978 | 10.66 | " | 4.3.82 |
| STERLING PROPERTIES LIMITED | | | |
| Beresford, Dr Thomas J., 634 Toorak Rd, Toorak | 166.00 | Dividend | 30.4.82 |
| Graham, Mary M., c/o Murray & Cudmore, 44 Pirie St | 16.20 | " | " |
| Ninth Nadula Pty. Ltd., "Woodside", Bonds Rd, Lower Plenty | 42.00 | " | " |
| Seventh Hi Breeze Pty. Ltd., "Woodside", Bonds Rd, Lower Plenty 5976 | 60.00 | " | " |
| JOE WHITE MALTINGS LIMITED | | | |
| Drummond, Isabel M., Glenhuntly | 153.12 | Payable | 28.10.81 |
| Price, Margaret M., Hobart, Tas. | 105.13 | " | " |
| Ottesen, Olav G., South Melbourne | 75.40 | " | " |
| Houston, Vida M., Wodonga | 62.78 | " | " |
| Hall, Clive J. D., Mt Eliza 5977 | 78.00 | " | 28.4.82 |

Unclaimed Moneys Act 1962

Register of Unclaimed Moneys held by the—

| Name of Owner on Books and Last Known Address | Total Amount Due to Owner | Description of Unclaimed Money | Date when Amount first became Payable |
|--|---------------------------|--------------------------------|---------------------------------------|
| \$ | | | |
| HUYCK AUSTRALIA PTY. LIMITED | | | |
| Fraser, Malcolm Lawson, 22 Grandview Pde, Drumconda 5975 | 153.40 | Wages | 25.5.82 |
| LUCAS INDUSTRIES AUSTRALIA LIMITED | | | |
| Mathan, K., 266 Station St, Box Hill | 37.50 | Wages | 3.5.81 |
| Haveron, A., 266 Station St, Moorabbin | 48.60 | " | 20.9.81 |
| Butterworth, R. T., 1/49 Wilson St, Cheltenham | 105.20 | " | 17.5.81 |
| Sylvia, D. M., 13/34 Nepean Hwy, Spendale | 171.20 | " | 12.7.81 |
| Mallows, B., 1 Gairloch Dr, Frankston 5979 | 127.70 | " | 17.9.81 |
| CONTAINERS LIMITED | | | |
| Bielby, Joseph W., Flat 9/6 Dorothy St, Brunswick | 15.01 | Dividend | 30.4.81 |
| Bradd, Enid B., 13/15 Burton St, Concord, N.S.W. | 15.01 | " | " |
| Byrne, Margaret M., 3/24 Parnell St, Elsternwick | 18.62 | " | " |
| Candy, Marjorie C., 69 Keppler St, Warrnambool | 20.90 | " | " |
| Cockburn, Robert F., 63 Millewa Ave, Chadstone | 41.04 | " | " |
| Fielder, Joyce M., 29 Queensbury Rd, Padstow Heights, N.S.W. | 15.01 | " | " |
| Gregory, Gwendoline H., 12 Gordon Crt, 65A Werona Ave, Gordon, N.S.W. | 37.62 | " | " |
| Nairon Pty. Ltd., c/o F. Howe Talbot and Co., 28-24 O'Connell St, Sydney, N.S.W. | 507.68 | " | " |
| Naughton, Claude B., Box 315, Surfers Paradise, Qld. | 37.62 | " | " |
| Nussey, Mary A. M., Lot 70, View St, South Coogee, W.A. | 195.61 | " | " |
| Shankly, Norman J. (estate of), c/o 38 Manning Rd, East Malvern | 102.22 | " | " |
| Turnbull, Elizabeth J., 3/589A Toorak Rd, Toorak | 246.24 | " | " |
| Wilbur-Ham, Brian L., 3 Balfour St, Toorak | 54.91 | " | " |
| Wall, Lena L., 21A Adelaide St, Launceston, Tas. | 136.80 | " | " |
| Barnes, William K., c/o Rushcutters Bond, P.O. Box 2, Edgecliff, N.S.W. | 45.13 | " | " |
| Kirke, Lesley P., Unit 12, 5/13 Belgrave St, Cremorne, N.S.W. | 58.14 | " | " |
| Lindsay, Margot K., 33 Verbrugghen St, Melba, N.S.W. | 75.24 | " | " |
| Stapleton, Katherine M., 14 Greendale St, Greenwich, N.S.W. | 188.10 | " | " |
| Frasers Nominees Ltd., Union Building, Singapore | 86.25 | " | " |
| Honeywell, Ida G. (estate of), c/o Messrs Tozers, 2/4 Orchard Gardens, Teignmouth, Devon, U.K. | 127.91 | " | " |
| Thong, Sing Ching-John, 8 Pulasan Rd, Singapore 15 | 22.29 | " | " |
| Burns, Joanna C., 34 Commercial Rd, Hyde Park, S.A. | 18.75 | Interest | 29.5.81 |
| Porker, Eric J., 8 Florence Tce, Rosewater, S.A. | 26.25 | " | " |
| Northcote, Mark J., 18 Claude St, Chatswood, N.S.W. | 11.25 | " | " |
| Northcote, William E. M., 18 Claude St, Chatswood, N.S.W. 5980 | 11.25 | " | " |
| STIRLING REAL ESTATE PTY. LTD. | | | |
| Moloney, T., 12/9 Denbigh Rd, Armadale | 23.12 | Refund | 23.10.79 |
| Hanson, Noel, 44 Horace St, Malvern | 81.00 | Creditor | 30.6.80 |
| Casset, J., 9/67 Lang St, South Yarra | 56.62 | Refund | 27.11.80 |
| Moffat, L., 4/7 Southey Crt, Elwood | 28.69 | " | 9.12.80 |
| Fiorella, V., 9/458 St Kilda Rd, Melbourne | 28.69 | " | 25.2.81 |
| Bannum Pty. Ltd., c/o Rigby and Fielding, 4 Bank Pl, Melbourne | 131.49 | " | 31.8.81 |
| Shipman, C., Room 24, 2nd Floor, 113 Swanston St, Melbourne | 744.00 | " | 31.12.81 |
| Cantwell, I., 21 Beach Ave, Elwood 5981 | 363.94 | " | 2.3.82 |

Companies (Victoria) Code 1981, Section 398 (1)

CORONET CARAVAN (HOLDINGS) PTY. LIMITED

At an extraordinary meeting of members of Coronet Caravan (Holdings) Pty. Limited convened and held at the offices of Deloitte Haskins & Sells, 6th Floor, 461 Bourke Street, Melbourne on 29 March 1983, the following Special Resolution was passed:—

"That it has been proved to the satisfaction of this meeting of members of Coronet Caravan (Holdings) Pty. Limited that the company cannot by reason of its liabilities continue in business and it is advisable to wind-up same, and accordingly, that the company be wound-up voluntarily and that Mr A. S. Home of Deloitte Haskins & Sells, 461 Bourke Street, Melbourne be appointed Liquidator of the company for the purpose of the winding-up."

Dated 29 March 1983

6224

I. FARREN, Director

WINDOURAN PASTORAL CO. PTY. LIMITED

Pursuant to Section 83 (3) (b) of the Companies Code 1981 notice is hereby given to Creditors that application is to be made to transfer the State of Incorporation from Victoria to New South Wales as the management and operations of the Company are resident in New South Wales.

The proposed Registered Office of the Company is C/- Thompson Douglass & Co., 21 Floor, 1 York Street, Sydney, 2000.

A Special Resolution dated 21 January 1983 authorising the Transfer has been passed by the Company's Directors. Any objections to this Transfer are to be promptly lodged with the Victorian Corporate Affairs Commission.

By Order of the Board

Dated 7 April 1983

6297

G. B. CRAWFORD, Director

NOTICE OF FINAL MEETING IN VOLUNTARY WINDING UP

Euroa No. 2 Co-operative Housing Society Limited (in Liquidation)

Take notice that the affairs of the abovenamed Society are now fully wound up and that in pursuance of Section 272 (1) of the *Companies Act 1961* and of the *Co-operative Housing Societies Act 1958*, a General Meeting of the Society will be held at Binney Street, Euroa, on 5 May 1983 at 2 p.m. for the purposes of—

- (i) laying before it an account showing how the winding up has been conducted and the property of the Society disposed of and giving any explanations thereof; and
- (ii) passing a resolution that the books and papers of the said Society and of the Liquidator relevant to the affairs of the Society be destroyed after a period of twelve months from the date of the meeting.

Dated 6 April 1983

6223

PETER MALY, Liquidator

Companies Act, 1961, Section 272 (2)

M.C.B. (LIDCOMBE NO. 2) PTY. LIMITED

Notice is hereby given that an Extra-Ordinary General Meeting of the members of the abovenamed Company will be held at 9.00 on Thursday, 28 April 1983 at 5th Floor, 71 Queens Road, Melbourne 3004 for the purpose of receiving and adopting the Liquidators Account detailing the manner in which the winding up of the Company has been conducted and the manner in which the property of the Company has been disposed of.

Dated 7 April 1983

6225

J. A. SANTA MARIA, Liquidator(s)

Companies Act 1961

Section 272 (2)

M.H. SUPERANNUATION PTY. LIMITED

Notice is hereby given that an Extra-Ordinary General Meeting of the members of the abovenamed Company will be held at 9.15 a.m. on Thursday, 28 April 1983 at 5th Floor, 71 Queens Road, Melbourne 3004 for the purpose of receiving and adopting the Liquidators Account detailing the manner in which the winding up of the Company has been conducted and the manner in which the property of the Company has been disposed of.

Dated 7 April 1983

6226

J. A. SANTA MARIA, Liquidator(s)

The Companies Act 1961

IN THE MATTER OF NEWBOROUGH HOTELS PTY. LTD.
(IN LIQUIDATION)

NOTICE OF MEETING OF CREDITORS AND MEMBERS

Pursuant to Section 272

Notice is hereby given that a final meeting of creditors and members of the abovenamed company will be held at the offices of Bentley, Smith & Wits, 130 Commercial Road, Morwell on Wednesday, 18 May 1983 at 2.15 o'clock in the afternoon for the purpose of laying before the meeting the liquidator's final account and report and giving any explanation thereof.

Dated 6 April 1983

6296

R. D. M. SMITH, Liquidator

In the Supreme Court of Victoria, C.O. 13045—In the matter of the Companies (Victoria) Code; and in the matter of Victoria Solid Plasterers Pty. Ltd. Notice of Winding-Up Order
Winding-Up Order: Made 7 April 1983.

Name and address of liquidator: David Alexander Crawford, Peat Marwick Mitchell & Co., 500 Bourke Street, Melbourne, Victoria 3000.

B. J. O'DONOVAN, Crown Solicitor for the Commonwealth and Solicitor for the Petitioner. 6294

Companies (Victoria) Code

JENNER TRANSPORT PTY. LTD. (IN VOLUNTARY LIQUIDATION)

Notice is hereby given in accordance with Section 392(2) of the Companies (Victoria) Code that at an extraordinary general meeting of the members of the abovementioned Company, duly convened and held on 6 April 1983 the following special resolution was passed:

That the Company be wound up voluntarily.

Dated 6 April 1983.

6258

T. C. BIGNELL, Secretary

Companies Code, Section 411

NOTICE OF FINAL MEETING OF CREDITORS AND MEMBERS—CANBERRA TELEVISION DISTRIBUTORS PTY. LTD. (IN LIQUIDATION)

Notice is hereby given that a meeting of the creditors and members of Canberra Television Distributors Pty. Limited (In Liquidation) will be held at 5th Floor, 301 Castlereagh Street, Sydney on 12 May 1983 at 10.00 a.m.

Agenda

To lay before the meeting the Liquidator's account showing how the winding up has been conducted and the property of the company has been disposed of and to give any explanation of the account which may be required.

Dated 30 March 1983

6273

C. K. DICKENS, Liquidator

In the Supreme Court of Victoria, C.O. 13098—In the matter of the Companies (Victoria) Code; and in the matter of Alex Johnson (Epping) Pty. Ltd.

Notice is hereby given that a petition for the winding up of the abovenamed Company by the Supreme Court was on 7 April 1983 presented by the Commonwealth of Australia and that the said petition is directed to be heard before the Court sitting at the Fifteenth Court, Law Courts, Lonsdale Street, Melbourne at the hour of 10.30 o'clock in the forenoon on 5 May 1983 and any creditor or contributory of the said company desiring to support or oppose the making of an order on the said petition may appear at the time of hearing by himself or his Counsel for the purpose; and a copy of the said petition will be furnished to any creditor or contributory of the said company requiring the same by the undersigned on payment of the regulated charge for the same.

The Petitioner's official address is 99 Queen Street, Melbourne.

The Petitioner's Solicitor is B. E. McMillan, Acting Deputy Crown Solicitor for the Commonwealth of 99 Queen Street, Melbourne.

B. E. McMILLAN

Note—Any person who intends to appear on the hearing of the said petition must serve on or send by post to the abovenamed B. E. McMillan notice in writing of his intention so to do. The notice must state the name and address of the person, or, if a firm, the name and address of the firm, and must be signed by the person or firm, or his, or their solicitor (if any), and must be served, or, if posted, must be sent by post in sufficient time to reach the abovenamed not later than 4.00 in the afternoon of 4 May 1983. 6257.

In the Supreme Court of Victoria, C.O. 13045—In the matter of the Companies (Victoria) Code; and in the matter of Victoria Fibrous Plaster Manufacturers Pty. Ltd. Notice of Winding-Up Order
Winding-Up Order: Made 7 April 1983.

Name and address of liquidator: Bruce Edward Fordham, Fordham Williams & Co., 521 Toorak Road, Toorak.

B. J. O'DONOVAN, Crown Solicitor for the Commonwealth and Solicitor for the Petitioner. 6291

In the Supreme Court of Victoria, C.O. 13003—In the matter of the Companies (Victoria) Code; and in the matter of Abbey Lodge Pty. Ltd. Notice of Winding-Up Order

Winding-Up Order: Made 7 April 1983.

Name and address of liquidator: Robert Arthur Waters, Orr Martin & Waters, 460 Bourke Street, Melbourne.

B. J. O'DONOVAN, Crown Solicitor for the Commonwealth and Solicitor for the Petitioner. 6292

Companies (Victoria) Code

NOTICE INVITING FORMAL PROOF OF DEBT OR CLAIM
DUTY FREE STORES PTY. LTD. (RECEIVERS & MANAGERS APPOINTED) (in liquidation)

Take notice that creditors of the company, whose debts or claims have not already been admitted, are required on or before 29 April 1983 to prove their debts or claims and to establish any title they may have to priority by delivering or sending through the post to me at my address a formal proof of debt or claim in accordance with Form 131 or 132 containing their respective debts or claims. In default they will be excluded from the benefit of a first and final distribution made before their debts or claims are proved or their priority is established and from objecting to the distribution.

Form of proof may be obtained from me.

Dated 13 April 1983.

A. M. HORSBURGH, Official Liquidator, 499 St. Kilda Road, Melbourne, Victoria 3004. 6359

*Companies Act 1961***J. & M. J. GREIG PTY. LTD. (IN LIQUIDATION)**

Notice is hereby given that as liquidator of the abovenamed company, I have fixed Thursday 21 April 1983 as the day on or before which creditors of the company are to prove their debts or claims and to establish any title they may have to priority under Section 292 or be excluded from the benefit of a second and final distribution made before such debts are proved or as the case may be from objecting to such distribution.

Dated 31 March 1983.

V. R. DYE, Liquidator

V. R. DYE & CO., Chartered Accountants, 159 Springvale Road, Nunawading 3131. 6260

In the Supreme Court of Victoria, C.O. 13075—In the matter of the Companies (Victoria) Code; and in the matter of Doug Bennett Nominees Pty. Ltd.

Notice is hereby given that a Petition for the Winding-up of the abovenamed Company was on 21 March 1983 presented by Nevig Pty. Ltd. and that the said Petition is directed to be heard before the Supreme Court sitting at the Practice Court, Law Courts, Lonsdale Street, Melbourne at the hour of 10.30 o'clock in the forenoon on 19 May 1983. Any Creditor or contributory of the said Company desiring to support or oppose the making of an Order on the said Petition may appear at the time of hearing by himself or his Counsel for the purpose; and a copy of the Petition will be furnished to any creditor or contributory of the said Company requiring the same by the undersigned upon payment of the regulated charge for the same.

The Petitioner's official address is 60 Albert Road, South Melbourne.

The Petitioner's Solicitors are Messrs. Tolhurst Druce & Emmerson of 389 Lonsdale Street, Melbourne.

TOLHURST DRUCE & EMMERSON

Note—Any person who intends to appear on the hearing of the said Petition must serve or send by post to the abovenamed Solicitors, Tolhurst Druce & Emmerson notice in writing of his intention so to do. The notice must state the name and address of the person, or if a firm, the name and address of the firm, and must be signed by the person or firm, or his or their Solicitor (if any) and must be served, or if posted must be sent by prepaid post in sufficient time to reach the abovenamed not later than 4.00 o'clock in the afternoon of 15 May 1983. 6288

In the Supreme Court of Victoria, C.O. 13057—In the matter of the Companies (Victoria) Code; and in the matter of Simit Pty. Ltd.

Notice is hereby given that a Petition for the Winding-Up of the abovenamed Company was on 21 March 1983 presented by Alan Nance and that the said Petition is directed to be heard before the Supreme Court sitting at the Practice Court, Law Courts, Lonsdale Street, Melbourne at the hour of 10.30 o'clock in the forenoon on 19 May 1983. Any creditor or contributory of the said Company desiring to support or oppose the making of an Order on the said Petition may appear at the time of hearing by himself or his Counsel for the purpose; and a copy of the Petition will be furnished to any creditor or contributory of the said Company requiring the same by the undersigned upon payment of the regulated charge for the same.

The Petitioner's official address is 372 Canning Street, North Carlton.

The Petitioner's Solicitors are Messrs. Tolhurst Druce & Emmerson of 389 Lonsdale Street, Melbourne.

TOLHURST DRUCE & EMMERSON

Note—Any person who intends to appear on the hearing of the said Petition must serve or send by post to the abovenamed Solicitors, Tolhurst Druce & Emmerson notice in writing of his intention so to do. The notice must state the name and address of the person, or if a firm, the name and address of the firm, and must be signed by the person or firm, or his or their Solicitor (if any) and must be served, or if posted must be sent by prepaid post in sufficient time to reach the abovenamed not later than 4.00 o'clock in the afternoon of 15 May 1983. 6289

Notice is hereby given that pursuant to Section 272 of the Companies Act the Final Meeting of Creditors and Members of Hollyford Hotel Pty. Ltd. (In Vol. Liq.) will be held at 2nd Floor, 335 Flinders Lane, Melbourne, on 16 May 1983 at 11.00 a.m. for the purpose of laying before the Meeting the account of the winding up and any explanation thereof.

Dated 6 April 1983

DAVID H. ENGLAND, Liquidator, 335 Flinders Lane, Melbourne, Victoria 3000. 6264

Companies Act 1961—Section 291 & Rule 99

In the matter of Mira Barbara Nominees Pty. Ltd. (In liquidation).

Take notice that as Joint Liquidator of the abovenamed Company, I have fixed Wednesday 27 April 1983 as the day on or before which creditors of the Company are to prove their debts or claims and to establish any title they may have to priority under Section 292 or be excluded from the benefit of a final distribution made before such debts are proved or as the case may be from objecting to such distribution.

Dated 13 April 1983.

A. M. HORSBURGH, Joint Liquidator

WALLACE, McMULLIN & SMAIL, Chartered Accountants, 499 St. Kilda Road, Melbourne, Victoria 3004. 6261

In the Supreme Court of Victoria, C.O. 13048—In the matter of the Companies (Victoria) Code; and in the matter of Andor Services Pty Ltd. Notice of Winding-Up Order

Winding-Up Order: Made 7 April 1983.

Name and address of liquidator: David Carl Christensen, Coopers & Lybrand, 461 Bourke Street, Melbourne, Victoria 3000.

B. J. O'DONOVAN, Crown Solicitor for the Commonwealth and Solicitor for the Petitioner. 6293

Companies (Victoria) Code, Companies Form 142

**NOTICE OF INTENTION TO DECLARE A DIVIDEND—
CARTER ADAMS TRUEMAN PTY. LIMITED**

A first dividend is to be declared on 3 May 1983 in respect of the company.

Creditors whose debts or claims have not already been admitted are required on or before 26 April 1983 formally to prove their debts or claims. In default, they will be excluded from the benefit of the dividend.

Dated 30 March 1983

M. J. HUMPHRIES, Liquidator

DUESBURYS, Chartered Accountants, 114 William Street, Melbourne, Victoria 3000. 6265

*Companies Act 1961—Section 271***AIC CONSTRUCTIONS PTY. LTD. (IN LIQUIDATION)****NOTICE OF FINAL MEETING OF MEMBERS AND
CREDITORS**

Notice is hereby given that a general meeting of the members and creditors of AIC Constructions Pty. Ltd. (In Liquidation) will be held at the offices of V. R. Dye & Co., Chartered Accountants, 159 Springvale Road, Nunawading on Wednesday 27 April 1983 at 11.30 a.m. to receive an account of my acts and dealings and of the conduct of the winding up during the year ended 23 March 1983.

Dated 5 April 1983

V. R. DYE, Liquidator

V. R. DYE & CO., Chartered Accountants, 159 Springvale Road, Nunawading 3131. 6262

In the Supreme Court of Victoria, C.O. 13099—In the matter of the Companies (Victoria) Code; and in the matter of Sacaya Pty. Ltd.

Notice is hereby given that a petition for the winding up of the abovenamed Company by the Supreme Court was on 7 April 1983 presented by Eric John Unger Deputy Commissioner of Taxation of the Commonwealth of Australia and that the said petition is directed to be heard before the Court sitting at the Fifteenth Court, Law Courts, Lonsdale Street, Melbourne at the hour of 10.30 o'clock in the forenoon on 5 May 1983 and any creditor or contributory of the said company desiring to support or oppose the making of an order on the said petition may appear at the time of hearing by himself or his Counsel for the purpose; and a copy of the said petition will be furnished to any creditor or contributory of the said company requiring the same by the undersigned upon payment of the regulated charge for the same.

The Petitioner's official address is 350 Collins Street Melbourne.

The Petitioner's Solicitor is B. J. O'Donovan, Crown Solicitor for the Commonwealth of 99 Queen Street Melbourne.

B. J. O'DONOVAN

Note—Any person who intends to appear on the hearing of the said petition must serve or send by post to the abovenamed B. J. O'Donovan notice in writing of his intention so to do. The notice must state the name and address of the person, or, if a firm, the name and address of the firm, and must be signed by the person or firm, or his, or their solicitor (if any), and must be served, or, if posted, must be sent by post in sufficient time to reach the abovenamed not later than 4.00 in the afternoon of 4 May 1983. 6254.

Companies Act 1961—Section 271

VAN LEEUWEN BORING CO. PTY. LTD. (IN LIQUIDATION)

NOTICE OF MEETING OF MEMBERS AND CREDITORS

Notice is hereby given that a general meeting of the members and creditors of Van Leeuwen Boring Co. Pty. Ltd. (In Liquidation) will be held at the offices of V. R. Dye & Co., Chartered Accountants, 159 Springvale Road, Nunawading on Wednesday 27 April 1983 at 10.00 a.m., to receive an account of my acts and dealings and of the conduct of the winding up during the year ended 1 April 1983.

Dated 6 April 1983

V. R. DYE, Liquidator

V. R. DYE & CO., Chartered Accountants, 159 Springvale Road, Nunawading 3131. 6263

Companies (Victoria) Code, Section 411 (2); Registered No. 102659-K

TEREK PTY. LTD. (IN LIQUIDATION) (FORMERLY AMMERAAL AUST. PTY. LTD.)

NOTICE CONVENING FINAL MEETING OF MEMBERS AND CREDITORS

Notice is hereby given pursuant to Section 411 (2) of the Companies (Victoria) Code that a meeting of the Members and Creditors of the abovenamed company will be held at the office of Nelson Wheeler, Chartered Accountants, 430 William Street, Melbourne on Wednesday 11 May 1983 at noon, for the purpose of having an account laid before them showing the manner in which the winding up has been conducted and the property of the company disposed of and of hearing any explanations that may be given by the Liquidator.

Dated 6 April 1983

6228

B. K. SIMMONS, Liquidator

In the Supreme Court of Victoria, C.O. 13100—In the matter of the Companies (Victoria) Code; and in the matter of Bonzopane Pty. Ltd.

Notice is hereby given that a petition for the winding up of the abovenamed Company by the Supreme Court was on 7 April 1983 presented by Eric John Unger Deputy Commissioner of Taxation of the Commonwealth of Australia and that the said petition is directed to be heard before the Court sitting at the Fifteenth Court, Law Courts, Lonsdale Street, Melbourne at the hour of 10.30 o'clock in the forenoon on 5 May 1983 and any creditor or contributory of the said company desiring to support or oppose the making of an order on the said petition may appear at the time of hearing by himself or his Counsel for the purpose; and a copy of the said petition will be furnished to any creditor or contributory of the said company requiring the same by the undersigned on payment of the regulated charge for the same.

The Petitioner's official address is 350 Collins Street, Melbourne.

The Petitioner's Solicitor is B. J. O'Donovan, Crown Solicitor for the Commonwealth of 99 Queen Street, Melbourne.

B. J. O'DONOVAN

Note—Any person who intends to appear on the hearing of the said petition must serve on or send by post to the abovenamed B. J. O'Donovan notice in writing of his intention so to do. The notice must state the name and address of the person, or, if a firm, the name and address of the firm, and must be signed by the person or firm, or his, or their solicitor (if any), and must be served, or, if posted, must be sent by post in sufficient time to reach the abovenamed not later than 4.00 in the afternoon of 4 May 1983. 6255.

In the Supreme Court of Victoria, C.O. 13084—In the matter of the Companies (Victoria) Code; and in the matter of Clarke's Stone Crushing Works Pty. Ltd.

Notice is hereby given that a petition for the winding up of the abovenamed Company by the Supreme Court was on 24 March 1983 presented by Eric John Unger Deputy Commissioner of Taxation of the Commonwealth of Australia and that the said petition is directed to be heard before the Court sitting at the Fifteenth Court, Law Courts, Lonsdale Street, Melbourne at the hour of 10.30 o'clock in the forenoon on 21 April 1983 and any creditor or contributory of the said company desiring to support or oppose the making of an order on the said petition may appear at the time of hearing by himself or his Counsel for the purpose; and a copy of the said petition will be furnished to any creditor or contributory of the said company requiring the same by the undersigned on payment of the regulated charge for the same.

The Petitioner's official address is 350 Collins Street, Melbourne.

The Petitioner's Solicitor is B. J. O'Donovan, Crown Solicitor for the Commonwealth of 99 Queen Street, Melbourne.

B. J. O'DONOVAN

Note—Any person who intends to appear on the hearing of the said petition must serve on or send by post to the abovenamed B. J. O'Donovan notice in writing of his intention so to do. The notice must state the name and address of the person, or, if a firm, the name and address of the firm, and must be signed by the person or firm, or his, or their solicitor (if any), and must be served, or, if posted, must be sent by post in sufficient time to reach the abovenamed not later than 4.00 in the afternoon of 20 April 1983. 6256.

NOTICE INVITING PROOF OF DEBT OR CLAIM

In the matter of Antipodes Pty. Ltd. (In Liquidation) and in the matter of the Companies Act 1981.

The creditors of the abovenamed company are required on or before 1 June 1983 to prove their debts or claims and to establish any title they may have to priority by delivering or sending through the post to the liquidator at the undermentioned address an affidavit verifying their respective debts or claims. In default they will be excluded from the benefit of any distribution made before such debts or claims are proved or such priority is established and from objecting to any such distribution. Form of proof may be obtained from the liquidator at the address shown below.

Dated 9 April 1983

D. L. ACKLAND, Liquidator, C/- Lindsay Iles & Co., 4th Floor, 4 Bank Place, Melbourne, Victoria 3000. 6253

In the Supreme Court of Victoria—Co. No. 13039—In the matter of the Companies (Victoria) Code; and in the matter of Maldon Developments Pty. Ltd. Company No. C 96954; and in the matter of a Petition dated 7 March 1983.

Notice is hereby given that a Petition presented by George Frew Director of and on behalf of Electricaire Holdings Pty. Ltd. and that the said Petition is directed to be heard before the Court sitting at the Fifteenth Court, Law Courts, Lonsdale Street, Melbourne at the hour of 10.30 o'clock in the forenoon on 5 May 1983 and any Creditor or contributory of the said Company desiring to support or opposing the making of an Order on the said Petition may appear at the time of hearing by himself or his Counsel for that purpose and a copy of the said Petition will be furnished to any Creditor or contributory of the said Company requiring the same by the undersigned in payment of the regulated charge for the same.

The Petitioner's official address is 123 Bamfield Road, Heidelberg in the State of Victoria.

The Petitioner's Solicitors are Messrs Sewell King & Hedstrom of 454 Collins Street, Melbourne.

Note—Any person who intends to appear on the hearing of the said Petition must serve on or send by post to the abovenamed, Messrs Sewell King & Hedstrom, Solicitors notice in writing of his intention to do so. The notice must state the name and address of the person, or if a firm, the name and address of the firm and must be signed by the person or firm, or his or their Solicitor (if any) and must be served, or if posted must be sent by post in sufficient time to reach the abovenamed not later than 4.00 p.m. in the afternoon of 4 May 1983. 6272

In the Supreme Court of Victoria, C.O. 13101—In the matter of the Companies (Victoria) Code; and in the matter of Devonian Slate Co. (Aust.) Pty. Limited

Notice is hereby given that a Petition for the winding-up of the above named Company by the Supreme Court was, on 7 April 1983, presented by Associated Marble Products Pty. Ltd. and that the said Petition is directed to be heard before the court sitting at Melbourne at the hour of 10.30 o'clock in the forenoon on Thursday, 12 May 1983 and any creditor or contributory of the said company desiring to support or oppose the making of an order on the said Petition may appear at the time of hearing himself or his counsel for the purpose; and a copy of the petition will be furnished to any creditor or contributory of the said company requiring the same by the undersigned on payment of the regulated charge for same.

The Petitioner's address is 100 Victoria Road, Drummoyle, New South Wales.

The Petitioner's Solicitors are Messrs. Allan Moore & Co., 140 Queen Street, Melbourne.

ALLAN MOORE & CO.

Note—Any person who intends to appear on the hearing of the said Petition must serve on or send by post to the abovenamed solicitors notice in writing of his intention to do so. The notice must state the name and address of the person or firm, or his, or their solicitor (if any) and must be served, or if posted, must be sent by post in sufficient time to reach the abovenamed not later than 4 o'clock in the afternoon of 11 May 1983. 6285

Creditors, next of kin and others having claims against the Estate of Constance Rose Burkett, late of 5 Ridge Road, Greensborough, widow, deceased (who died on 25 October 1982) are required by Patrick Francis Toohey the Executor of the Will of the said deceased to send to him care of the undersigned Solicitors particulars thereof by 21 June 1983 after which date he will distribute the assets having regard only to the claims of which he shall then have notice.

GAVAN DUFFY & KING, solicitors, 95 Queen Street, Melbourne. 6229

Creditors, next of kin and others having claims in respect of the estate of Aubrey Dale Edwards, late of Walmsley Village, Greaves Drive, Kilsyth, retired, deceased, who died on 30 January 1982 are to send particulars of their claims to The Union-Fidelity Trustee Company of Australia Limited of 100 Exhibition Street, Melbourne by 22 June 1983, after which date the said Union-Fidelity Trustee Company of Australia Limited will distribute the assets having regard only to the claims of which it shall then have notice.

GREENING JOHNSON & GILBERT, solicitors, 37 Queen Street, Melbourne. 6230

ELLEN CONNELLAN, late of Watchem in the State of Victoria, widow, deceased

Creditors, next of kin and others having claims in respect of the estate of the abovenamed deceased who died on 27 January 1983 are hereby required by David John English, Margaret Anne O'Donnell and Winifred O'Loughlin the Executors of the Will of the abovenamed deceased to send particulars to the said Executors care of the undermentioned Solicitors by 22 June 1983 after which date they will convey or distribute the assets having regard only to the claims of which they then have notice.

OAKLEY THOMPSON & CO., solicitors, 24 Cumming Avenue, Birchip 3483 (and at 205 King Street, Melbourne). 6231

JOHN WILLIAM TIERNEY, late of Birchip in the State of Victoria, farmer, deceased

Creditors, next of kin and others having claims in respect of the estate of the abovenamed deceased who died on 31 January 1983 are hereby required by Leslie Robert Tierney and Rex Tierney the Executors of the Will of the abovenamed deceased to send particulars to the said Executors care of the undermentioned Solicitors by 22 June 1983 after which date they will convey or distribute the assets having regard only to the claims of which they then have notice.

OAKLEY THOMPSON & CO., solicitors, 24 Cumming Avenue, Birchip 3483 (and at 205 King Street, Melbourne.) 6232

ANNIE CATHERINE CONNELLAN, late of Birchip in the State of Victoria, married woman, deceased

Creditors, next of kin and others having claims in respect of the estate of the abovenamed deceased who died on 6 December 1982 are hereby required by Desmond Vincent Cain and Cyril John O'Connor, the Executors of the Will of the abovenamed deceased, to send particulars to the said Executors care of the undermentioned Solicitors by 22 June 1983 after which date they will convey or distribute the assets having regard only to the claims of which they then have notice.

OAKLEY THOMPSON & CO., solicitors, 24 Cumming Avenue, Birchip 3483 (and at 205 King Street, Melbourne.) 6233

ELEF JORGENSEN, late of 567 Main Road, Belgrave in the State of Victoria, medical practitioner, deceased

Creditors, next of kin and others having claims in respect of the estate of the deceased who died on 25 March 1981 are required by Michael Jorgensen of 506 Station Street, North Carlton in the said State, architect, and Jenny Margaret Teichman, of 3 Derby Street, Newnham, Cambridge in the United Kingdom, lecturer the Executors of the said estate to send particulars of their claims to the said Executors care of Oakley Thompson & Co., of 205 King Street, Melbourne, Solicitors, by 24 June 1983 after which date the executors may convey or distribute the assets having regard only to the claims of which they then have notice.

OAKLEY THOMPSON & CO., solicitors, 205 King Street, Melbourne 3000. 6234

LEO BILLS, late of 18 O'Neill's Road, Melton in the State of Victoria, contractor, deceased

Creditors, next of kin and others having claims in respect of the Estate of the deceased who died on 24 August 1982 are required by Helen Henderson Bills, of 18 O'Neill's Road, Melton in the said

State, home duties, and Noel Bills, of McLeod Street, Orbost in the said State, retired contractor, the Executors to whom Probate of the Will of the said deceased was granted by the Supreme Court of Victoria to send particulars to them by 15 June 1983 after which date the said Executors may convey or distribute the assets having regard only to the claims of which they then have notice.

PATRICK J. CANNON, TESTRO & COBURN, solicitors, 117 Durham Road, Sunshine 3020. 6235

MARGARET ELIZABETH INGLIS, late of Carnsworth Garoopna, 18 Barry Street, Kew, spinster, deceased

Creditors, next of kin and others having claims in respect of the estate of the abovenamed deceased who died on 1 February 1983 are required by John Cadwallader Jones of 257 Collins Street, Melbourne, Solicitor, and Peter Andrew Paton, of "Ardonochie", Macarthur, grazier, the executors of the Will of the said deceased to send particulars of their claims to the said executors in the care of the undernamed solicitors by 17 June 1983 after which date the executors will convey or distribute the assets having regard only to the claims of which they then have notice.

RUSSELL, KENNEDY & COOK, solicitors, 257 Collins Street, Melbourne. 6270

In the will of RONALD FRANK MATHIESON HAMILTON, of Unit 1, 23 Carramar Avenue, Camberwell in the State of Victoria, gentleman, deceased

Creditors, next of kin and others having claims in respect of the estate of the above named deceased, who died on 26 January 1983 are required by The Perpetual Executors and Trustees Association of Australia Limited of 50 Queen Street, Melbourne, to send particulars of their claims to the said Company on or before 30 June 1983 after which date it will convey or distribute the assets, having regard only to the claims of which it then has notice.

BEST HOOPER RINTOUL & SHALLARD, solicitors, 400 Little Collins Street, Melbourne 3000. 6275

EMILY ELLEN CLARK, late of Lot 303 Scenic Drive, Cowes, retired, deceased

Creditors, next of kin and others having claims in respect of the estate of the abovenamed deceased who died on 17 January 1983 are required by Beryl Ivy Hazell of "Witherow", Limorite Road, Boolarra, Administrator and John Cadwallader Jones of 257 Collins Street, Melbourne, Solicitor, the executors of the Will of the said deceased to send particulars of their claims to the said executors in the care of the undernamed solicitors by 17 June 1983 after which date the executors will convey or distribute the assets having regard only to the claims of which they then have notice.

RUSSELL, KENNEDY & COOK, solicitors, 257 Collins Street, Melbourne. 6269

MURIEL MARY MCGILL, late of 11/25 Adams Street, South Yarra, home duties, deceased

Creditors, next of kin and others having claims in respect of the estate of the abovenamed deceased who died on 31 August 1982 are required by James Kenneth Aitken and Nancy Beatrice Dowdle, both of 257 Collins Street, Melbourne, Solicitors, the executors of the Will of the said deceased to send particulars of their claims to the said executors in the care of the undernamed solicitors by 17 June 1983 after which date the executors will convey or distribute the assets having regard only to the claims of which they then have notice.

RUSSELL, KENNEDY & COOK, solicitors, 257 Collins Street, Melbourne. 6268

Creditors next of Kin and others having claims in respect of the estate of Marie Louise Pridham late of 82 Richardson Street Essendon widow who died on 14 February 1983 are to send the particulars of their claims to The Equity Trustees Executors and Agency Company Limited of 472 Bourke Street, Melbourne 3000 by 14 June 1983 after which date it will distribute the assets having regard only to the claims of which it then has notice.

RYLAH & RYLAH, solicitors, 191 Queen Street, Melbourne. 6266

ROBERT ALEXANDER SIMPSON, late of 19 Tyrone Street, Hartwell, retired, deceased.

Creditors, next of kin and others having claims in respect of the Estate of the deceased (who died on 11 November 1982) are required by The Perpetual Executors and Trustees Association of Australia Limited of 50 Queen Street, Melbourne to send particulars of their claims to the said Company by 20 June 1983 after which date it will convey or distribute the assets, having regard only to the claims of which the Company then has notice.

CORR & CORR, solicitors, 350 William Street, Melbourne. 6267

Creditors, next of kin and others having claims in respect of the Estate of Maxwell Thomas Austin Umphelby, late of Flat 7, 2 King William Street, Fitzroy, clerk, deceased, who died on 13 December 1982 are to send particulars of their claims to the Executor Ian Geoffrey Middleton of 140 William Street, Melbourne, Solicitor, by 14 June 1983 after which date he will distribute the assets having regard only to the claims of which he then has notice.

MIDDLETONS, OSWALD BURT & CO., solicitors, 140 William Street, Melbourne. 6286

DORIS JULIA MURPHY, late of 14 Cuming Street, Yarraville in the State of Victoria, widow, deceased

Creditors, next of kin and others having claims in respect of the Estate of the deceased, who died on 1 January 1983 are required by Nancy Isabel Ryan of 51 Benjamin Street, Sunshine in the said State, nursing sister, the Executrix to whom Probate of the Will of the said deceased was granted by the Supreme Court of Victoria to send particulars to her care of the undersigned by 27 June 1983 after which date the said Executrix may convey or distribute the assets having regard only to the claims of which she then has notice.

PATRICK J. CANNON, TESTRO & COBURN, solicitors, 117 Durham Road, Sunshine 3020. 6287

Creditors, next of kin and others having claims in respect of the Estate of Kenneth Gidney Allen, late of 613 Waverley Road, Chadstone in the State of Victoria, manufacturer, deceased, who died on 20 January 1983 are to send particulars of their claims to J. & S. Shatin & Bernstein, Solicitors, of 224 Queen Street, Melbourne in the said State, the Solicitors for the Executors appointed by the Will of the deceased, by 20 June 1983.

J. & S. SHATIN & BERNSTEIN, solicitors, of 224 Queen Street, Melbourne. 6240

HANNAH JOSEPHINE COLEMAN, late of 1 Trafalgar Street, Mont Albert in the State of Victoria, widow, deceased

Creditors, next of kin and others having claims in respect of the estate of the deceased (who died on 2 August 1982) are required by the Executor Wellesley Arthur Coleman, of 107 Orient Avenue, Mitcham in the said State, gentleman to send particulars to him care of the undermentioned solicitors by 14 June 1983 after which date the Executor may convey or distribute the assets having regard only to the claims of which he then has notice.

SLATER & GORDON, solicitors, 636 Bourke Street, Melbourne. 6299

ISABEL HELEN MARGET JORDAN, usually known as Isabel Margaret Jordan or Isabel Nellie Margaret Jordan, late of 397 Nott Street, Port Melbourne, spinster, deceased

Creditors, next of kin and other persons having claims in respect of the Estate of the deceased, who died on 16 January 1983, are requested by the trustee Thomas Malcolm Stirling, of 51 Queen Street, Melbourne, Solicitor to send particulars to him by 10 June 1983 after which date the trustee may convey or distribute the assets having regard only to the claims of which he then has notice.

RIVERS DICKINSON STIRLING & MUNZ, 51 Queen Street, Melbourne, solicitors. 6300

HOWARD GEORGE HENRY SAUER, late of 25 George Street, Bacchus Marsh, retired mail officer, deceased

Creditors, next of kin and others having claims in respect of the estate of the deceased who died on 10 November 1982 are required by National Trustees Executors and Agency Company of Australasia Limited of 95 Queen Street, Melbourne, the Executors to whom Probate of the Will of the said deceased was granted by the Supreme Court of Victoria to send particulars to it by 20 June 1983 after which date the said Executor may convey or distribute the assets having regard only to the claims of which it then has notice.

PATRICK J. CANNON, TESTRO & COBURN, solicitors, 117 Durham Road, Sunshine. 6236

STANLEY BONE, late of 15 Alice Street, Yarraville, unmarried man, deceased

Creditors, next of kin and others having claims in respect of the estate of the deceased who died on 16 September 1982 are required by the Administratrixes Ivey May Michell of 20 Hillcrest Avenue, Eltham in the said State, widow, and Myrtle Emmaline Collins of 35 Pembroke Street, Surrey Hills in the said State, married woman to send particulars to the undermentioned firm by 16 June 1983 after which date the said Administratrixes may convey or distribute the assets having regard only to the claims of which notice has by then been given.

SETON WILLIAMS & SMYTH, solicitors, 408 Collins Street, Melbourne. 6238

JAN VAN DER WOLDE, late of 1 Larch Crescent, Diamond Creek, cleaning contractor, deceased

Creditors, next of kin and others having claims in respect of the estate of the deceased who died on 9 February 1983 are required by the Executrix Jantje Van Der Wolde, of 1 Larch Crescent, Diamond Creek, widow to send particulars to the undermentioned firm by 7 July 1983 after which date the said Jantje Van Der Wolde may convey or distribute the assets having regard only to the claims of which notice has by then been given.

SETON WILLIAMS & SMYTH, solicitors, 408 Collins Street, Melbourne. 6239

Creditors, next of kin and others having claims in respect of the Estate of Leslie James Eades, late of Flat 8, 32 Wellington Street, St Kilda, retired, who died on 1 April 1983, are to send the particulars of their claims to The Trustees Executors and Agency Company Limited of 401 Collins Street, Melbourne, by 17 June 1983 after which date it will distribute the assets having regard only to the claims of which it then has notice. 6298

GEORGE WILLIAM REID, late of 520 Armstrong Street, North Ballarat, gentleman, deceased, who died on 9 November 1982

Creditors, next of kin and all other persons having claims against the estate of the said deceased are required by the Executor, The Union-Fidelity Trustee Company of Australia Limited of 100 Exhibition Street, Melbourne to send detailed particulars of their claims in respect of the said property to the said Executor care of the said company at 101 Lydiard Street North, Ballarat, on or before 13 June 1983 after which date it will proceed to distribute the estate having regard only to the claims of which it then has notice.

Dated 13 April 1983

RAMSAY, GAUNT & FRASER, solicitors, of 41 Lydiard Street South, Ballarat. 6237

In the Supreme Court of the State of Victoria
SALE BY THE SHERIFF

On 26 May 1983 at 2.30 p.m. at the Sheriff's Office, Writs & Warrants Division, 2nd Floor, 241 William Street, Melbourne at the best price offered (unless process be stayed or satisfied).

All the Estate and Interest (if any) of Mrs M. P. Geappen (shown on Certificate of Title as Mary Patricia Geappen) of Flat 1, 208 Tennyson Street, St. Kilda as proprietor of an estate in fee simple in the lands described in Certificates of Title Volume 9110 Folios 779 and 787 upon which is erected a Strata Title Unit and an Accessory Unit containing a garage known as Flat 1, 208 Tennyson Street, St. Kilda.

Registered Mortgage No. G231826 affects the said estate and interest.

Terms—Cash only—To be sold to the highest bidder—No reserve set. Office No. S82/40332

6271 R. J. MARTIN, Sheriff's Officer

INSOLVENCY NOTICE

The Bankruptcy Act 1966, Part X

Re: KEVIN WALTER JOHN NICOLLS, No. 062 of 1983

Notice is hereby given that the abovementioned Debtors have signed an Authority under Section 188 (1) of the Act authorising Clive Henry Morris to take over control of their property and further take notice that a Meeting of Creditors will be held at 60 Market Street, Melbourne on the 21st Floor, on Friday 22 April 1983 at 11.30 a.m.

Dated 8 April 1983

CLIVE MORRIS & STAFF, Public Accountants, 177 Eley Road, Blackburn South, Victoria 3130. 6301

**NOTICE OF MAKING OF
STATUTORY RULES
WHICH ARE NOT YET
AVAILABLE**

Notice is given of the making of the following Statutory Rules:

No. Health Act 1958
55/1983. Health (Nightsoil and Sewage Land)
(Amendment) Regulations 1983

| | |
|----------|---|
| No. | <i>Marine Act 1958</i> |
| 64/1983. | Marine (Rolls of Electors and Elections) Regulations 1983 |
| | <i>Racing Act 1958</i> |
| 65/1983. | Racing (Harness Racing Board) Regulations 1983 |
| | <i>Road Traffic Act 1958</i> |
| 66/1983. | Road Traffic (M.G. Car Club) Regulations 1983 |
| | <i>Motor Car Act 1958</i> |
| 67/1983. | Motor Car (Preliminary Breath Test Devices) Regulations 1983 |
| | <i>Motor Boating Act 1961</i> |
| 68/1983. | Motor Boating (Port of Gippsland Lakes Speed Restrictions) Regulations 1983 |
| | <i>Motor Car Act 1958</i> |
| 69/1983. | Motor Car (Eighty-seventh Schedule Amendment) Regulations 1983 |
| | <i>Industrial Training Act 1975</i> |
| 70/1983. | Industrial Training (Pastrycooking Trade Apprenticeship) (Amendment) Regulations 1983 |
| | <i>Industrial Training Act 1975</i> |
| 71/1983. | Industrial Training (Horticultural Trades Apprenticeship and Adult Training) (Amendment) Regulations 1983 |
| | <i>Industrial Training Act 1975</i> |
| 72/1983. | Industrial Training (Textile Mechanics Trade Apprenticeship) Regulations 1983 |
| | <i>State Electricity Commission Act 1958</i> |
| 73/1983. | State Electricity Commission Employees' Representative Regulations 1983 |
| | <i>Industrial Training Act 1975</i> |
| 74/1983. | Industrial Training (Furniture Trades Apprenticeship) Regulations 1983 |
| | <i>Fisheries Act 1968</i> |
| 75/1983. | Fishing (Scallop) (Amendment No. 1) Regulations 1983 |
| | <i>Health Act 1958</i> |
| 76/1983. | Food and Drug Standards (Amendment No. 31) Regulations 1983 |

Copies of these Statutory Rules are available and may be purchased at the Victorian Government Bookshop, located at 41 St. Andrews Place, East Melbourne (formerly 7A Parliament Place, Melbourne, 3002). If ordered by mail, remittance should be addressed to "The Government Printer, Box 203, North Melbourne, 3051", and should include 50c delivery and handling fee.

The annual subscription rates for Statutory Rules for the year commencing 1 January 1982, payable in advance are as follows:

*Statutory Rules (other than Public Service Determinations), Pamphlet copies only \$55.00
Public Service Determinations \$33.00

*The Bound Volume of Statutory Rules is not included in the subscription rate.

F. D. ATKINSON
Government Printer

CONTENTS

| | Page |
|--|--------|
| Acts of Parliament | 789 |
| Appointments | 816 |
| Contracts | 799 |
| Country Roads Board | 790 |
| Estates of Deceased Persons | 812 |
| Government Notices | 790 |
| Insolvency Notice | 875 |
| Lands | 842 |
| Melbourne and Metropolitan Board of Works—Notice | 811 |
| Notice to Mariners | 809 |
| Notice of Making of Statutory Rules | 784 |
| Orders in Council— | |
| Acts—Land; Crown Land (Reserves); forests; | 817 |
| Superannuation; Local Government; | et seq |
| Water; Sewerage Districts; Geelong | |
| Waterworks and Sewerage; Land; Crown | |
| Land (Reserves); Railway Construction | |
| and Property Board; Housing; Public | |
| Service; Victoria Conservation Trust; The | |
| Constitution Act Amendment | |
| Police Sale | 807 |
| Private Advertisements | 845 |
| Proclamations | 789 |
| Regulations— | |
| Act—Police | 806 |
| Resignations | 817 |
| Tenders | 844 |
| Transport Regulation Board—Public Hearings | 810 |
| Waterworks Trust | 808 |