

PUBLISHED BY AUTHORITY



Victoria Government Gazette

No. 21—Wednesday, 2 April 1986

PROCLAMATIONS

ACTS OF PARLIAMENT

PROCLAMATION

By His Excellency the Governor of the State of Victoria and its Dependencies in the Commonwealth of Australia, &c., &c., &c.

I, the Governor of the State of Victoria, in the Commonwealth of Australia, do hereby declare that I have this day assented, in Her Majesty's name, to the Bills passed by the Parliament of the said State, the titles whereof are hereunder set forth, together with the short titles, that is to say:

No. 2/1986. *Administrative Law (University Visitor) Act 1986.*

No. 3/1986. *Adoption (Amendment) Act 1986.*

No. 4/1986. An Act to amend section 32 of the *Interpretation of Legislation Act 1984* and for other purposes.

Interpretation of Legislation (Amendment) Act 1986.

No. 5/1986. *Melbourne Sailors' Home Act 1986.*

No. 6/1986. *State Relief Committee Act 1986.*

No. 7/1986. *Transfer of Land (Share Interests) Act 1986.*

Given under my Hand and the Seal of the State of Victoria aforesaid, at Melbourne, this twenty-fifth day of March in the year of our Lord One thousand nine hundred and eighty-six and in the thirty-fifth year of the reign of Her Majesty Queen Elizabeth the Second, Queen of Australia.

(L.S.) J. DAVIS McCAUGHEY

By His Excellency's Command

JOHN CAIN
Premier

GOD SAVE THE QUEEN!

No. 2/1986. This Act comes into operation on a day to be proclaimed.

No. 3/1986. This Act comes into operation on a day to be proclaimed.

No. 4/1986. This Act shall come into operation on the day on which it receives the Royal Assent.

No. 5/1986. This Act comes into operation on the 28th day after the day on which it receives the Royal Assent.

No. 6/1986. This Act comes into operation on the day on which it receives the Royal Assent.

No. 7/1986. This Act comes into operation on the day on which it receives the Royal Assent.

Magistrates (Summary Proceedings) Act 1975

DECLARATION UNDER SECTION 107

PROCLAMATION

By His Excellency the Governor of the State of Victoria and its Dependencies in the Commonwealth of Australia, &c., &c., &c.

Pursuant to section 107 of the *Magistrates (Summary Proceedings) Act 1975*, I, the Governor of Victoria, by and with the advice of the Executive Council of Victoria, do by this Proclamation declare:

1. The State of South Australia being a State or Territory having laws providing for enforcement in that State or Territory of a fine payable under a conviction or order of a Magistrates' Court or other Court having a summary jurisdiction in Victoria against a body corporate in that State or Territory, to be a reciprocating State or Territory for the purpose of the enforcement in Victoria of a fine payable under a conviction or order of a Court having summary jurisdiction in the other State or Territory against a body corporate in Victoria; and

2. Every Court of Summary Jurisdiction in the State of South Australia to be a reciprocating Court for the purposes of the enforcement in Victoria of a fine payable under a conviction or order of that Court against a body corporate in Victoria.

Given under my Hand and the Seal of the State of Victoria aforesaid, at Melbourne, this twenty-fifth day of March in the year of our Lord One thousand nine hundred and eighty-six and in the thirty-fifth year of the reign of Her Majesty Queen Elizabeth the Second, Queen of Australia.

(L.S.) J. DAVIS McCAUGHEY

By His Excellency's Command

J. H. KENNAN
Attorney-General

GOD SAVE THE QUEEN!

GOVERNMENT NOTICES

Co-operation Act 1981

F.I.T. Sports Club Co-operative Limited
The Legend Park Tennis Club Co-operative
Society Limited

Watsonia Sporting Club Co-operative Limited

Notice is hereby given in pursuance of section 192 (8) of the *Co-operation Act 1981* and section 459 (2) of the Companies (Victoria) Code, that, at the expiration of three months from the date hereof, the names of the aforementioned societies will, unless cause is shown to the contrary, be struck off the register and the societies will be dissolved.

Dated at Melbourne 24 March 1986

W. J. KILPATRICK

Registrar of Co-operative Societies

Co-operation Act 1981

1st Lower Plenty Boy Scout Co-operative Limited
Lang Lang Community Co-operative Limited
Olympus Co-operative Limited

Victorian Air Rescue Service Co-operative
Limited

Victorian Co-operative Locum Service Limited

Notice is hereby given in pursuance of section 192 (8) of the *Co-operation Act 1981* and section 459 (2) of the Companies (Victoria) Code, That, at the expiration of three months from the date hereof, the names of the aforementioned societies will, unless cause is shown to the contrary, be struck off the register and the societies will be dissolved.

Dated at Melbourne 24 March 1986

W. J. KILPATRICK

Registrar of Co-operative Societies

Co-operation Act 1981

5th Box Hill Boy Scouts Co-operative Limited
11th Waverley Scout Group Co-operative Limited
Heathmont State School Co-operative Limited
Horsham High School Co-operative Limited
Nindethana Aboriginal Theatre Co-operative
Limited

Notice is hereby given in pursuance of section 192 (8) of the *Co-operation Act 1981* and section 459 (2) of the Companies (Victoria) Code, that, at the expiration of three months from the date hereof, the names of the aforementioned societies will, unless cause is shown to the contrary, be struck off the register and the societies will be dissolved.

Dated at Melbourne 24 March 1986

W. J. KILPATRICK

Registrar of Co-operative Societies

Co-operation Act 1981

Leongatha Apex Co-operative Society Limited

Notice is hereby given in pursuance of section 192 (8) of the *Co-operation Act 1981* and section 459 (2) of the Companies (Victoria) Code, that, at the expiration of three months from the date hereof, the name of the aforementioned society will, unless cause is shown to the contrary be struck off the register, and the society will be dissolved.

Dated at Melbourne 24 March 1986

W. J. KILPATRICK

Registrar of Co-operative Societies

Co-operation Act 1981

F.P.U.A. (VICTORIA) CREDIT CO-
OPERATIVE LIMITED

Notice is hereby given in pursuance of section 192 (8) of the *Co-operation Act 1981* and section 459 (2) of the Companies (Victoria) Code, that, at the expiration of three months from the date hereof, the name of the aforementioned society will, unless cause is shown to the contrary be struck off the Register, and the society will be dissolved.

Dated at Melbourne 24 March 1986

W. J. KILPATRICK

Registrar of Co-Operative Societies

Co-operation Act 1981

Council of Aboriginal and Island Women Co-
operative Limited

Notice is hereby given in pursuance of section 192 (8) of the *Co-operation Act 1981* and section 459 (2) of the Companies (Victoria) Code, that, at the expiration of three months from the date hereof, the name of the aforementioned society will, unless cause is shown to the contrary be stuck off the register, and the society will be dissolved.

Dated at Melbourne 24 March 1986

W. J. KILPATRICK

Registrar of Co-operative Societies

Co-operation 1981

CHANGE OF NAME OF A SOCIETY

Notice is hereby given that Portarlington Sailing Club Co-operative Limited which was incorporated as a Community Advancement Society under the abovenamed Act on 4 September 1972, has registered a change of its name and is now incorporated under the name of Point Richards Co-operative Limited under the said Act.

Dated at Melbourne 6 March 1986

D. F. HENRY

Acting Deputy Registrar of Co-operative Societies

Co-operation Act 1981

BACCHUS MARSH WEST GOLF CO-OPERATIVE LIMITED
 CATJUMP KINDERGARTEN CO-OPERATIVE LIMITED
 CHELSEA YACHT CLUB CO-OPERATIVE LIMITED
 1st SYNDAL BOY SCOUT CO-OPERATIVE LIMITED
 LILYDALE WEST STATE SCHOOL CO-OPERATIVE LIMITED

Notice is hereby given in pursuance of section 192 (8) of the *Co-operation Act 1981* and section 459 (2) of the *Companies (Victoria) Code*, that, at the expiration of three months from the date hereof, the names of the aforementioned societies will, unless cause is shown to the contrary, be struck off the register and the societies will be dissolved.

Dated at Melbourne 14 March 1986

W. J. KILPATRICK
 Registrar of Co-operative Societies

Industrial Relations Act 1979

INDUSTRIAL RELATIONS COMMISSION OF VICTORIA

Certificate of Recognition as an Association

Notice is hereby given that an application has been made for a change in the name on the Certificate of Recognition issued to the Country Fire Authority Officers' Association to reflect the change in the name of that association to the "Country Fire Authority Employees' Association".

Notice is also given that this matter is listed for hearing before the Industrial Relations Commission of Victoria in Full Session at 10.00 a.m. on Tuesday, 15 April 1986 in Hearing Room No. 1, Level 18, Nauru House, 80 Collins Street, Melbourne.

A. S. DOWLING, Deputy Registrar
 Industrial Relations Commission of Victoria

Department of Industry, Technology and Resources

MINING LEASE GRANTED

No. 1051; Ando Gold NL; 105.8 ha, Parishes of Moolerr and Carapooee.

INTENTION TO RENEW MINING LEASE

No. 179-1; P. L. Poole, E. Poole and B. Prothero; 31.28 ha, Parish of Kevington.

MINING LEASE TRANSFERRED

No. 845; From Central Victorian Gold Mines NL to Central Victorian Gold Mines NL and Western Mining Corporation Limited

INTENTION TO GRANT PROSPECTING AREA LICENCE

No. 70; Dargo Gold NL; 230 ha, Parishes of Graham and Cooma

TAILINGS REMOVAL LICENCE GRANTED

No. 5138; W. J. & M. J. Kiel; to remove tailings from the "Moon and Catherine Dumps" in the Parish of Sandhurst

EXPLORATION LICENCES EXTENDED AND AREAS RELINQUISHED

No. 1275—3; CRA Exploration Pty Ltd; area retained 416.75 km², area relinquished 148.5 km², Counties of Gladstone, Bendigo and Talbot

The above relinquished area will become available again for Exploration Licence on 14 March 1986.

No. 1394—1; D. R. Brown and B. W. Cuffley; area retained 4 km², area relinquished nil, Parishes of Beechworth and Everton.

APPLICATIONS FOR EXPLORATION LICENCES TRANSFERRED

Nos. 1501 and 1522; Central Victorian Gold Mines NL to Western Mining Corporation Limited and Central Victorian Gold Mines NL

EXTRACTIVE INDUSTRY LEASES GRANTED

No. 333; City of Frankston; 5.5 ha, Parish of Frankston

EXTRACTIVE INDUSTRY LICENCE GRANTED

No. 981; William E. Burdett and Raynar J. Phersson; 6.4 ha, Parish of Langwarrin

R. C. FORDHAM
 Minister for Industry, Technology and Resources

Occupational Health and Safety Act 1985

APPROVAL OF A COURSE IN TRAINING IN OCCUPATIONAL HEALTH AND SAFETY

On 13 March 1986, the Victorian Occupational Health and Safety Commission decided to withdraw their approval for the occupational health and safety course conducted by the Clothing and Allied Trades Union which had been granted at its meeting on 12 December 1985. This decision is effective from 31 March 1986. Also on 13 March 1986, the commission granted approval for the following course of training for purposes of section 31 (2) (D) of the *Occupational Health and Safety Act 1985*:

Clothing and Allied Trades Union	The Occupational Health and Safety Course of Training for Health and Safety Representatives
----------------------------------	---

For enquiries, telephone Victorian Occupational Health and Safety Commission, 602 8111.

CAROLYN INGVARSON
 Secretary, Victorian Occupational Health and Safety Commission

Private Agents Act 1966

NOTICE OF RECEIPT OF APPLICATIONS FOR LICENCES UNDER THE PROVISIONS OF THE PRIVATE AGENTS ACT 1966

The Clerk(s) of the Magistrates' Court(s) as listed hereunder hereby give notice that applications, as under, have been lodged for hearing by the said Court(s) on the date(s) specified.

Any person desiring to object to any of such applications must—

- (a) lodge with the respective Clerk of the Magistrates' Court a notice in the prescribed form of his objection and of the grounds thereof;
- (b) cause a copy of such notice to be served personally or by post upon the applicant at least three days before the hearing of the application; and
- (c) send or deliver—
 - (i) where the objection is not made by the officer in charge of the police district in which the Court is situated—a copy of the notice to such officer; and
 - (ii) where the objection is not made by the Registrar or Deputy Registrar—a copy to the Registrar.

<i>Full Name of Applicant*</i>	<i>Place of Abode of Applicant or Nominee</i>	<i>Name of Firm or Corporation</i>	<i>Address for Registration</i>	<i>Type of Licence</i>	<i>Date of Hearing</i>
MAGISTRATES' COURT, SPRINGVALE					
Aspinal, Phillip Brain	38 Springvale Rd, Glen Waverley			Process Server	27.3.86
Baldwinson, Frederick John	204 Cranbourne Rd, Frankston			"	"
Barron, Alfred Allan	Adelaide St, Chewton			"	"
Bell, Allan Vernard	14 kincumber Dr. Glen Waverley			"	"
Bell, Kevin John	Queenscliff Rd, Portarlington			"	"
Bell, Stephen Andrew	53 Old Orchard Drive, Wantirna South			"	"
Blake, Ronald Elliot	172 Barkly St, Mornington			"	"
Brand, Kenneth John	16 Conoon Crt, Hamilton			"	"
Britton, Peter Charles	8/282 Nepean Hwy, Seaford			"	"
Buck, Alan Edwin	103 Foote St, Lwr Templestowe			"	"
Beuttner, Hartmutt	"Benaroon Park" Dalry Rd, Healesville			"	"
Burland, John	402 Huntingdale Rd, South Oakleigh			"	"
Cameron, Robert James	30 Erin St, West Preston			"	"
Cartwright, Jeffrey Noel	Lot 7 Traralgon- Balook Rd, Traralgon			"	"
Chenwell, Micheal Dewaney	5 Princess St, Warrnambool			"	"
Crandell, John	5 Sunline Ave, Noble Park			"	"

*Or in the case of a firm or corporation, of the Nominee

PRIVATE AGENTS—continued

<i>Full Name of Applicant*</i>	<i>Place of Abode of Applicant or Nominee</i>	<i>Name of Firm or Corporation</i>	<i>Address for Registration</i>	<i>Type of Licence</i>	<i>Date of Hearing</i>
MAGISTRATES' COURT, SPRINGVALE					
Curtis, Grahame Robert	P.O. Box 2823 Mildura			Process Server	27.3.86
De Pasavale, Luciano	4 Norfolk Crt, Fawkner			"	"
Dixon, Ian Robert	Lot 25 Cradock Rd, Kyabram			"	"
Pockray, Alan	35 Freemans Rd, North Alrona			"	"
Dunlop, Rodney Glenn	20 Lemal Ave, Wantirna			"	"
Farrugia, Alfred	4 Everitt St, Glenroy			"	"
Fordyce, Bruce Kemplay	38 Callanan Dr, Melton South			"	"
Frappell, Kenneth B.	6 Beddoe Ave, East Bentleigh			"	"
Furst, Christof M.	3 Sabre Crt, Ferntree Gully			"	"
Gawler, John W.	12 Klilliaro Rd, Croydon			"	"
Goudie, Peter A.	10 Risdon Dr, Notting Hill			"	"
Griffiths, George F.	P.O. Box 28, Wahgunyah			"	"
Halliday, William J.	3 Tawunda St, Vermont South			"	"
Harbour, Russell G.	32 Houston St, Bendigo			"	"
Hayen, Hajo B.	61 King Pde, Knoxfield			"	"
Howes, Denis E.	21 Paxton St, Malvern East			"	"
Hutchinson, Peter R.	93 Eley Rd, Box Hill			"	"
Ierardo, Vincent N.	74 Queen St, Regent			"	"
Jackson, Francis B.	20 Judkins Ave, Hoppers Crossing			"	"
Jeffries, Brian E. H.	100A Oban Rd, Ringwood North			"	"
Lever, Ross A.	Camms Rd, Monbulk			"	"
Lewis, Ronald A.	50 Central Ave, Boronia			"	"
Limpens, Theodorus A.	33 Lower Dandenong Rd, Mentone			"	"
Livingston, Wilfred G.	11 Gardeners Rd, East Bentleigh			"	"
Koniczka, George J.	14 Correa Cl, Corio			"	"
Mansfield, Lynn M.	6 Atkins Ave, Greensborough			"	"

*Or in the case of a firm or corporation, of the Nominee

PRIVATE AGENTS—continued

<i>Full Name of Applicant*</i>	<i>Place of Abode of Applicant or Nominee</i>	<i>Name of Firm or Corporation</i>	<i>Address for Registration</i>	<i>Type of Licence</i>	<i>Date of Hearing</i>
MAGISTRATES' COURT, SPRINGVALE					
Martin, Keith R.	20 Verene Ave, Lower Templestowe			Process Server	27.3.86
Maus, Stephen W.	2A McKenna Rd, Forest Hills			"	"
McGinn, Ralph	13 Judkins Ave, Hoppers Crossing			"	"
Nicholls, Terence M.	48 Wallace Ave, Murrumbeena			"	"
Olsen, Rodney G.	8 The Avenue, Hampton			"	"
Parker, Arthur J.	Morison's Rd, Mangalore West			"	"
Purvis, Peter R.	22 Anthony St, Dandenong North			"	"
Riccio, Assunta	42 Laura St, Brunswick			"	"
Rountree, Leslie J.	4 Genevieve Crt, Ferntree Gully			"	"
Schubert, Dennis J.	RMB T416, Horsham			"	"
Sims, Jillian M.	70 Queens St, Ararat			"	"
Smith, Albert R.	13 Patern St, Highton			"	"
Smith, Eric A.	6 Jessop Crt, Tullamarine			"	"
Smith, John W.	15 Bamboo Crt, Doveton			"	"
Stanley, Albert J.	10 Cavalier St, Doncaster East			"	"
Stapleton, Peter J.	24 Wills St, Wangaratta			"	"
Talbot, Peter G.	22 Bendle St, Geelong East			"	"
Taylor, David J.	2 Amanda Crt, Melton			"	"
Tolomeo, Joseph N.	12 Travers St, Thomastown			"	"
Walker, Michael R.	12 Battalion Crt, Boronia			"	"
Wenker, Geoffrey N.	RMB 4619, Bairnsdale			"	"
West, Graham	6 Blackwood Crt, Werribee			"	"
Wren, Dianne J.	99 Victoria St, Kerang			"	"
Wright, Wesley	48 Long St, Langwarrin			"	"
Yole, David L.	102 Outhwaite Rd, Heidelberg Heights			"	"

Dated at Springvale 17 March 1986
B. LAWRENCE, Clerk of the Magistrates' Court

*Or in the case of a firm or corporation, of the Nominee

PRIVATE AGENTS—continued

<i>Full Name of Applicant*</i>	<i>Place of Abode of Applicant or Nominee</i>	<i>Name of Firm or Corporation</i>	<i>Address for Registration</i>	<i>Type of Licence</i>	<i>Date of Hearing</i>
	MAGISTRATES' COURT, SPRINGVALE				
Watson, Noel R.	214 Skeane St, Cockatoo		39 Fairview St, Springvale	Watchman	17.4.86
	Dated at Springvale 13 March 1986 B. LAWRENCE, Clerk of the Magistrates' Court				
	MAGISTRATES' COURT, BOX HILL				
McOrmond, Shane	1 Ursula St, Box Hill			Watchman	21.4.86
	Dated at Box Hill 24 March 1986 , Clerk of the Magistrates' Court				
	MAGISTRATES' COURT, HEIDELBERG				
Newnham, David P.	1/102 Church Rd, Doncaster	Alexander George Ibbotson	15 Tarakan St, West Heidelberg	Watchman	9.5.86
	Dated at Heidelberg 21 March 1986 , Clerk of the Magistrates' Court				
	MAGISTRATES' COURT, CAMBERWELL				
Mannix, Geoffrey J.	14 Grandview Ave, Pascoe Vale		114 Winfield Rd, North Balwyn	Watchman	16.4.86
	Dated at Camberwell 20 March 1986 , Clerk of the Magistrates' Court				
	MAGISTRATES' COURT, NORTHCOTE				
Mineo, Vincenzo	19 Martin St, Thornbury		Guard Agent		21.4.86
	Dated at Northcote 17 March 1986 R. J. MALONEY, Clerk of the Magistrates' Court				
	MAGISTRATES' COURT, FRANKSTON				
Penhale, Anthony John	8 Lorraine Cl, Mt. Eliza		76 Bellbird Rd, Mt. Eliza	Commercial Sub-Agent	16.4.86
	Dated at Frankston 17 March 1986 J. T. FERGUSON, Clerk of the Magistrates' Court				
	MAGISTRATES' COURT, BROADMEADOWS				
Raffone, Gaztano	54 Woodburn Crt, Coolaroo	G. & A. Security Services	54 Woodburn Crt, Coolaroo	Guard Agent	11.4.86
	Dated at Broadmeadows 17 March 1986 F. MORTIMER, Clerk of the Magistrates' Court				
	MAGISTRATES' COURT, SPRINGVALE				
Ley, Nicholas Diefier	28 Koonalda Ave, Glen Waverley		28 Koonalda Ave, Glen Waverley	Guard Agent	10.4.86
	Dated at Springvale 14 March 1986 B. LAWRENCE, Clerk of the Magistrates' Court				

*Or in the case of a firm or corporation, of the Nominee

PRIVATE AGENTS—continued

Full Name of Applicant*	Place of Abode of Applicant or Nominee	Name of Firm or Corporation	Address for Registration	Type of Licence	Date of Hearing
MAGISTRATES' COURT, MORWELL					
Rayson, Gary Neil	13 Alfred Drive, Yinnar		390 St Kilda Rd, Melbourne	Watchman	17.4.86
Dated at Morwell 20 March 1986 K. G. McMAHON, Clerk of the Magistrates' Court					
MAGISTRATES' COURT, MORWELL					
Gannon, Kevin William	15 Bennett St, Moe		390 St Kilda Rd, Melbourne	Watchman	17/4/86
Ketelaar, Theodore	43 Wirraway St, Moe		Lot 2 Toners Lane, Morwell		"
Darby, Paul John Edward	3 Mimosa Cres, Churchill		"	"	"
Dated at Morwell 19 March 86 K. G. McMAHON, Clerk of the Magistrates' Court					
MAGISTRATES' COURT, OAKLEIGH					
Carroll, Bruce Evan	18 Waratah St, South Oakleigh		18 Waratah St, South Oakleigh	Inquiry Agent	18.4.86
Dated at Oakleigh 19 March 1986 W. BYRNE, Clerk of the Magistrates' Court					
MAGISTRATES' COURT, WANGARATTA					
Sirianni, Orsola Lina	30 Rowan St, Wangaratta	George Lauren (NE) Pty. Ltd.	27 Ely St, Wangaratta	Commercial Sub-Agent	14.4.86
Dated at Wangaratta 19 March 1986 K. W. LEWIS, Clerk of the Magistrates' Court					
MAGISTRATES' COURT, HASTINGS					
Orr, Bernard Joseph	64 Reid Pde, Hastings		64 Reid Pde, Hastings	Guard Agent (Indiv)	23.4.86
Dated at Hastings 19 March 1986 I. F. CAIN, Clerk of the Magistrates' Court					
MAGISTRATES' COURT, FERNTREE GULLY					
Bridge, Peter Michael	F1/7 Violen St, Bayswater		F1/7 Violen St, Bayswater	Guard Agent	15.4.86
Pryor, Phillip John	3 Pleasant Rd, Ferntree Gully		3 Pleasant Rd, Ferntree Gully	Process Server	11.4.86
Dated at Ferntree Gully 18 March 1986 R. O'KEEFE, Clerk of the Magistrates' Court					
MAGISTRATES' COURT, HEIDELBERG					
Coffey, Allan, Griffyth	Stoney Ridge Valley Road Wattle Glen	Burson Security	13 Bainbridge Drive, Eltham	Watchman	21.4.86
Dated at Heidelberg 17 March 1986 J. ISAACS, Clerk of the Magistrates' Court					
MAGISTRATES' COURT, LILYDALE					

*Or in the case of a firm or corporation, of the Nominee

Transport Act 1983

ROAD TRAFFIC AUTHORITY

Commercial Passenger Vehicle Applications

Notice is hereby given that the following applications will be considered by the Road Traffic Authority on 22 April 1986.

Notice of any objections should be forwarded to reach the Manager Vehicle Licensing Branch or any Regional Office of the Road Traffic Authority not later than 16 April 1986.

It will not be necessary for interested parties to appear on the hearing date specified, unless advised in writing by the Authority.

Notification of the date for consideration of applications which are objected to and which require determination by the Road Transport Licensing Tribunal will be published by further notice in this Gazette.

H. A. Beames, Morwell. Application to license two commercial passenger vehicles to be purchased both with seating capacity for 45 passengers to operate under charter conditions from within a 20 km pick-up radius of the Post Office at Morwell. *Note:* The vehicles to be licensed would hold 5 star ratings for charter purposes.

M. J. P. Bristow, South Yarra. Application to license one commercial passenger vehicle in respect of a 1958 Rolls Royce sedan with seating capacity for 5 passengers to operate as a special purpose vehicle from 5 Howard Street, South Yarra for the carriage of passengers for wedding parties.

S. H. Elder, Greensborough. Application to license one commercial passenger vehicle in respect of a 1938 Plymouth sedan with seating capacity for 4 passengers to operate as a special purpose vehicle from 94 Diamond Creek Road, Greensborough for the carriage of passengers for wedding parties within the Melbourne metropolitan area.

M. Jovanovic & R. Sanfilippo, Melbourne. Application to license five commercial passenger vehicles in respect of a 1948 Bentley sedan, a 1961 Rolls Royce sedan and three Jaguar sedans (1974, 1979, 1980) each with a seating capacity for 4 passengers to operate as special purpose vehicles from shop 9, Lower Plaza, Southern Cross Hotel, Melbourne for the carriage of passengers for wedding parties within the Melbourne metropolitan area.

McHarry's Buslines Pty. Ltd., Geelong West. Application to license one commercial passenger vehicle with seating capacity for 49 passengers to operate under charter conditions from within a 20 km pick-up radius of the Post Office at Geelong.

Note: 1. The vehicle to be licensed would hold a 3 star rating for charter purposes.

2. The applicant is currently seeking approval to operate the vehicle to be licensed as a public commercial passenger vehicle.

A. T. Tea, Springvale. Application to license one commercial passenger vehicle with seating capacity for 14 passengers to operate for the carriage of farm workers between Springvale and the Sunny Ridge Strawberry Farm located at Flinders Road, Main Ridge. *Timetable:* Morning—Depart Westall Road, Springvale 6.15 a.m. Depart corner of Balmoral and Albert Avenues, Springvale 6.25 a.m. Depart corner of Balmoral Avenue and Springvale Road, Springvale 6.30 a.m. Arrive Sunny Ridge Strawberry Farm, Flinders Road, Main Ridge 7.30 a.m. *Afternoon* Depart Sunny Ridge Strawberry Farm, Flinders Road, Main Ridge 6.00 p.m. Arrive corner Springvale Road and Balmoral Avenue, Springvale 7.00 p.m. Arrive corner Balmoral and Albert Avenues, Springvale 7.10 p.m. Arrive Westall Road, Springvale 7.15 p.m. *Fares:* \$3.00 per person return. *Note:* Service to operate October to April/May, 7 days a week.

Tendico Pty. Ltd., Warragul. Application for variation of the conditions of licences CT 436, CT 437, CT 468, CT 794 and CT 860 which authorize taxi operations from within a 9 km radius of the Post Office at Warragul and permit the licensed vehicles to stand at approved stands in Warragul and the conditions of licence CT 852 which authorize taxi operations from within a 9 km radius of the Post Office at Yarragon and permit the licensed vehicle to stand at approved stands in Trafalgar and Yarragon, to extend the licensed pick-up area to include that area East of a North South line through Robinhood, West of a North South line through Westbury, South of an East West line through Rokeby and North of an East West line through Allambee and to permit the licensed vehicles to stand at designated standing places in Warragul, Yarragon and Trafalgar. *Note:* This application replaces a previous application published in the *Victoria Government Gazette* No. 13 dated 5 March 1986.

G. Zovko, Bell Park. Application for variation of the conditions of licence SV 537 which authorizes the carriage of farm labourers between the City of Geelong and surrounding areas and farms located within the Shires of Ballan, Bannockburn, Buninyong and Corio to include the Shires of Werribee and Bacchus March. *Timetable:* As and when required. *Fares:* To be determined.

Dated 2 April 1986

G. J. MENARY
Group Manager
Licensing and Research

STATE TRANSPORT AUTHORITY

Notice Pursuant to Schedule 3, Clause 4 of the
Transport Act 1983

The State Transport Authority of 589 Collins Street, Melbourne, pursuant to Schedule 3, Clause 4 of the *Transport Act 1983*, No. 9921 and with the approval of the Minister for Transport dated 24

March 1986, hereby declares that the level crossing specified hereunder shall be closed from the date as is specified hereunder whereupon the rights of the public to use the level crossing shall cease and determine and the land over which the crossing is constructed shall be freed from all rights, easements or privileges existing or claimed as regards that land either in the public or by any person or body of persons whomsoever or whatsoever as incident to any past dedication or supposed dedication thereof or by virtue of any past user thereof or by any fiction of law and the land shall be vested in the Authority.

The said level crossing at Vallence Road, Bacchus Marsh is situated between Bacchus Marsh and Parwan at a point 50.203 kilometres from Melbourne on the Melbourne-Ballarat rail line.

The date of closure is 30 April 1986.

HEALTH DEPARTMENT VICTORIA

Health (Radiation Safety) (Computer Tomography Scanners) Regulations 1986

The Minister for Health intends to make the above Regulations and invites public comment on the Regulations.

The objectives of the proposed Regulations are to amend the Principal Regulations—

- (i) to ensure an equitable distribution of CT Scanners in Victoria;
- (ii) to ensure that the distribution of CT Scanners should not result in more than adequate facilities becoming available in Victoria as required by the Act.

The Regulations are made pursuant to the *Health Act 1958*.

A Regulatory Impact Statement has been prepared in accordance with the provisions of the *Subordinate Legislation Act 1962* setting out the anticipated impact of the regulations.

Copies of the Statement may be obtained from the Legislation Officer, Department of Health, 21st Floor, Enterprise House, 555 Collins Street, Melbourne, 3000. (Phone 616 7281 during business hours.)

Submissions in response to the Regulatory Impact Statement should be sent to the Legislation Officer at the above address and quoting reference number CA 10/124 within 21 days of the date of publication of this notice.

Any enquiries regarding this Statement or the proposed Regulations should be made on 616 8177, during business hours.

LEON M. L'HUILLIER
Chief General Manager
Department of Health, Victoria

HEALTH (TOBACCO PACKAGES — WARNINGS) REGULATIONS 1986

The Minister for Health intends to make the above Regulations and invites public comment on the Regulations.

The objective of the proposed regulations is to prescribe the warning labels which must be attached to or printed on packages of tobacco and tobacco products by manufacturers or importers of these products.

The Regulations are made pursuant to the *Health Act 1958*.

A Regulatory Impact Statement has been prepared in accordance with the provisions of the *Subordinate Legislation Act 1962* setting out the anticipated impact of the Regulations.

The Statement indicates that health warnings are an efficient way of reaching smokers and that the maintenance of the warnings for 5 years ensures a reasonable period for defraying of costs.

Copies of the Statement may be obtained from the Legislation Officer, Department of Health, 21st Floor, Enterprise House, 555 Collins Street, Melbourne, 3000 (Phone 616 7281 during business hours).

Submissions in response to the Regulatory Impact Statement should be sent to the Legislation Officer at the above address and quoting reference number CA 10/125 within 21 days of the date of the date of publication of this notice.

LEON M. L'HUILLIER
Chief General Manager
Department of Health, Victoria

Forests Act 1958, No. 6254

REVOCATION OF PROHIBITED PERIOD

In pursuance of the powers conferred by section 3 of the *Forests Act 1958*, I, Joan E. Kirner, Her Majesty's Minister for Conservation, Forests and Lands in the State of Victoria hereby vary the Declaration of a Prohibited Period previously made by me in the *Victoria Government Gazette* No. 125 dated 18 December 1985 insofar as it refers to the municipalities specified hereunder, and by this notice declare that in the specified municipalities the Prohibited Period in respect to any fire protected area (other than a State forest, national park or protected public land) shall end as specified hereunder.

Schedule 1

The Prohibited Period shall end at midnight between 4 and 5 April 1986 in the municipalities shown hereunder:

The Shires of Alberton and Morwell.

The Cities of Sale and Traralgon.

Dated 27 March 1986

JOAN E. KIRNER
Minister for Conservation, forests and Lands

Country Fire Authority Act 1958

VARIATION OF FIRE DANGER PERIOD

In pursuance of the powers conferred by section 4 of the *Country Fire Authority Act 1958*, I, Charles Race Thorson Mathews, Minister for Police and Emergency Services, after consultation with the Minister for Conservation, Forests and Lands hereby vary the declaration of fire danger periods previously published in the *Government Gazette* by declaring that such fire danger periods shall end in respect of the under-mentioned municipalities or parts of municipalities specified:

From and inclusive of Monday 7 April 1986:

Town of St. Arnaud
Shire of Kara Kara
Shire of Korong
Shire of Bet Bet
Shire of Huntly
Shire of Marong
Shire of Strathfieldsaye
City of Bendigo
Borough of Eaglehawk

C. R. T. MATHEWS

Minister for Police and Emergency Services
Ministry for Police and Emergency Services
Melbourne, 2 April 1986

NOTICE TO MARINERS

No. 17 T of 1986

Australia—Victoria
PORT PHILLIP
Sorrento, Frankston
Oyster Culture Rafts

Oyster culture rafts have been established in positions:

- (i) 103°; 3250 metres (1.8 miles) from Sorrento Pier Light (Lat. 38° 20.2'S., Long. 144° 44.7'E. approx.).
- (ii) 305°; 500 metres (0.3 miles) from Wooleys Reef Isolated Danger mark (Lat. 38° 09.5'S., Long. 145° 05.4'E. approx.).

Each position is marked by a yellow buoy with an "X" shaped topmark displaying a flashing yellow light every 5 seconds.

Abridged Description: Fl. Y. 5s.

Further Notice will issue.

Charts Affected: Aus. 158, Aus. 143.

Publication Affected: *Sailing Directions, Victoria* 1970 Pages 192, 284, 600 and 602.

R. M. PERRY
Port Officer
Port of Port Phillip

Ports and Harbors Division
168 Exhibition Street
Melbourne 3000, 20 March 1986

NOTICE TO MARINERS

No. 16 T of 1986

Australia—Victoria
CORNER INLET
Lewis Channel

Nos. 10 and 12 Pile Lights—Construction

Date: On or about 3 April 1986

Details: (a) Construction of a new Lewis Channel No. 10 pile light will commence in a position 130°; 65 metres (approx.) from the existing No. 10 pile light (Lat. 38° 43.1'S., Long. 146° 25.6'E. approx.) which will be extinguished.

During construction a red buoy emitting a flashing red light every 2 seconds will be established close South East of the new structure.

Abridged Description: Fl. R. 2s.

(b) Construction of a new Lewis Channel No. 12 pile light will commence in a position adjacent to the existing structure (Lat. 38° 42.7'S., Long. 146° 26.1'E. approx.).

The existing No. 12 pile light characteristics will remain unchanged during construction.

A pile driving barge will be moored in the locality. The barge and the incomplete structures will display flashing yellow lights at night.

Mariners are advised to proceed at a minimum speed consistent with safe navigation when passing the construction areas.

Further Notice will issue.

Chart Affected: Aus. 182

Publication Affected: *Sailing Directions, Victoria* 1970 Pages 466 and 665.

R. M. PERRY
Port Officer

Port of Corner Inlet and Port Albert

Ports and Harbors Division
168 Exhibition Street
Melbourne 3000, 20 March 1986.

Education Act 1958

NOTICE OF THE MAKING OF AN ORDER UNDER SECTION 13 (4) OF THE ACT

Pursuant to section 13 of the *Education Act 1958* I hereby give notice that Orders of the Governor in Council were made on 25 March 1986 under subsection (4) of the said Act amending certain provisions relating to the State School Councils listed below:

3173 Strath Creek Primary
3641 Youanmite Primary
3684 Clifton Creek Primary
5053 Karingal Heights Primary
7366 Swinburne Technical

I. R. CATHIE
Minister for Education

Barley Marketing Act 1958
**BARLEY MARKETING (ELECTIONS)
 REGULATIONS 1975**

Appointment of Polling Day and Nomination Day
 for Election of One Elective Member of the
 Australian Barley Board

In accordance with the provisions of Sub-Regulation (1) of Regulation 3 of the Barley Marketing (Elections) Regulations 1975, I hereby appoint Wednesday, 13 August 1986, for the holding of an election of one representative of Victorian growers of barley to be an elective member of the Australian Barley Board. I have appointed Tuesday, 27 May 1986, as the day for nominations of candidates of such election.

Nominations in the prescribed form will close at noon on Nomination Day with Mr. D. L. Burrows, Returning Officer, Australian Barley Board Election, P.O. Box 400, East Melbourne 3002. Nominations may be hand-delivered to the Returning Officer, 9th floor, Department of Agriculture and Rural Affairs, 166 Wellington Parade, East Melbourne, prior to the closing time for nominations.

Nomination forms are obtainable from the Returning Officer at the above postal address or location (telephone 651 7721).

E. H. WALKER
 Minister for Agriculture and Rural Affairs

**THE AUSTRALIAN BARLEY BOARD
 ELECTION**

I hereby appoint Duncan Lithgow Burrows as Returning Officer for the poll of Victorian growers of barley to be taken on Wednesday, 13 August 1986, for the Election of one representative of growers, to be an elective member of the Australian Barley Board constituted under the *Barley Marketing Act 1958*.

E. H. WALKER
 Minister for Agriculture and Rural Affairs

Barley Marketing Act 1958
**BARLEY MARKETING (ELECTIONS)
 REGULATIONS 1975**

Election Notice
 Australian Barley Board

Pursuant to the provisions of Regulation 3 (3) of the Barley Marketing (Elections) Regulations 1975, I hereby give notice that I have appointed Wednesday, 23 April 1986, as the date for the purpose of calculating the eligibility of Victorian growers of barley to vote at an election to be held on Wednesday, 13 August 1986, for the election of one representative of such growers to be an elective member of the Australian Barley Board.

E. H. WALKER
 Minister for Agriculture and Rural Affairs

**CONTRACTS ACCEPTED—(Series 1986-87)
 PUBLIC WORKS**

Kew City—Steam heated roll ironer and folder, Kew, Willsmere Psychiatric Hospital—\$174 187.00—Hardie Trading Ltd., Cheltenham.

Melbourne City—Installation of emergency lighting, Melbourne 555 Collins St. (Health)—\$72 501.00—State Superannuation Board of Vic., Melbourne.

Nunawading City—Staff admin. upgrade, Mirrabooka Primary School—\$78 350.00—D. P. & B. Cullen, Montrose South.

Preston City—Extend cleaner's room and remodel bathrooms, Kingsbury Training Centre—\$450 918.00—A. J. Richardson & Son Pty. Ltd., Reservoir.

Tallangatta Shire—New station and residence, Walwa Police Station—\$251 662.00—Roy D. Tobias, Wangaratta.

Tambo Shire—Fire restoration, Lakes Entrance Post Primary School—\$56 395.00—H. N. Olver Pty. Ltd., Bairnsdale.

Werribee Shire—Construction of new primary school, Bellbridge Primary School—\$2 422 045.00—J. C. Taylor & Sons (Aust.) Pty. Ltd., South Melbourne.

Waverley City—Education centre/admin. building, Glen Waverley State School Nursery—\$1 294 424.00—Dura (Australia) Constructions, Clayton.

Dated 27 March 1986

D. J. LITTLE
 Director-General of Public Works

ASSOCIATIONS IN CORPORATION ACT 1981

Notice is hereby given that in accordance with sub-section 36 (2) of the *Associations Incorporation Act 1981*, the incorporation of Children Services Group Inc., Essential Infant Formulae Association Inc., Melbourne Soccer Club Inc., Sculpture '85 Inc., Shangria La Awareness Foundation Inc., and Trade Union and Community Media Services Inc., were cancelled on 4 March 1986.

JOHN B. KING
 Registrar of Incorporated Associations

ASSOCIATIONS INCORPORATION ACT 1981

Notice is hereby given that in pursuance of sub-section 10 (4) of the *Associations Incorporation Act 1981* a certificate of incorporation was granted to Redlight Monitoring Service Co-operative Limited on 5 March 1986.

JOHN B. KING
 Registrar of Incorporated Associations

Town and Country Planning Act 1961
SHIRE OF CRANBOURNE (WESTERN PORT)
PLANNING SCHEME

Amendment No. 37
Notice of Approval

In pursuance of the powers conferred by the *Town and Country Planning Act 1961*, the Governor in Council on 25 March 1986, approved the abovementioned scheme in respect of the municipal district of the Shire of Cranbourne and for which the Shire of Cranbourne is the Responsible Authority.

The scheme comes into operation on the date this Notice is published in the *Government Gazette*.

The scheme includes part C.A. 43B, south-west corner of Ballarto and Koo-wee-rup/Longwarry Roads, Bayles within the Rural Residential 1 Zone.

A copy of the documents may be inspected free of charge, during office hours, at the office of the Ministry for Planning and Environment (Plan Inspection Section), The Olderfleet Buildings, 477 Collins Street, Melbourne and at the office of the responsible authority, Shire of Cranbourne Council, Shire Office, Sladen Street, Cranbourne.

DAVID YENCKEN
Secretary for Planning and Environment

Town and Country Planning Act 1961
CITY OF HORSHAM PLANNING SCHEME

Amendment No. 79
Notice of Approval

In pursuance of the powers conferred by the *Town and Country Planning Act 1961*, the Governor in Council on 25 March 1986, approved the abovementioned scheme in respect of the municipal district of the City of Horsham and for which the City of Horsham is the Responsible Authority.

The scheme comes into operation on the date this Notice is published in the *Government Gazette*.

The scheme includes rezoning and renaming numerous industrial zones throughout the City in accordance with the recommendations of the City of Horsham Industrial Land-Use Study.

A copy of the documents may be inspected free of charge, during office hours, at the office of the Ministry for Planning and Environment (Plan Inspection Section), The Olderfleet Buildings, 477 Collins Street, Melbourne and at the office of the responsible authority City of Horsham, Civic Centre, Horsham.

DAVID YENCKEN
Secretary for Planning and Environment

Town and Country Planning Act 1961
MELBOURNE METROPOLITAN PLANNING
SCHEME

Amendment No. 337
Notice of Amendment

In pursuance of the powers conferred by the *Town and Country Planning Act 1961*, the Governor in Council on 25 March 1986, amended the abovementioned scheme in respect of part of the municipal districts of the Cities of Caulfield and Malvern and for which the Minister for Planning and Environment is the Responsible Authority.

The amendment comes into operation on the date this Notice is published in the *Government Gazette*.

The amendment includes the reservation of land in the vicinity of Princes Highway East, Caulfield and Malvern between Malvern Grove and Tooronga Road, for Proposed Main Road Widening and Proposed Public Open Space.

A copy of the documents may be inspected free of charge, during office hours, at the office of the Ministry for Planning and Environment, The Olderfleet Buildings, 477 Collins Street, Melbourne.

DAVID YENCKEN
Secretary for Planning and Environment

PROPOSED REVOCATION OF TEMPORARY
RESERVATION OF LAND BY ORDER IN
COUNCIL

In pursuance of the provisions of section 10 of the *Crown Land (Reserves) Act 1978*, notice is hereby given that it is the intention of the Governor in Council to revoke the temporary reservation of land by Order in Council hereunder referred to, viz:

Tandarook—The temporary reservation by Order in Council of 24 April 1888 of 9637 square metres of land in the Parish of Tandarook as a site for State School. L1/740.

Meredith—The temporary reservation by Order in Council of 23 November 1868 for railway purposes of lands comprised within the line of railway from Melbourne to Ballarat so far only as the portion thereof in the Parish of Meredith containing 2503 square metres. Certified Plan 107807. L1/1646.

Kangeraar—The temporary reservation by Order in Council of 2 December 1870 of 4.046 hectares of land in the Parish of Kangeraar as a site for watering purposes. Rs. 12909.

Bendigo—The temporary reservation by Order in Council of 23 November 1868 for Railway Purposes and lands comprised within the limits of the surveyed line from Melbourne to Echuca so far only as the portion thereof at Bendigo in the Parish of Sandhurst containing 1.426 ha. Certified Plan 107684. L6/1959.

J. E. KIRNER
Minister for Conservation, Forests and Lands

Police Regulation Act, Section 122

SALE OF UNCLAIMED MOTOR VEHICLE

An owner is required for a blue XW Ford Falcon.

The vehicle came into possession of Police on 16 March 1983, and if not claimed, will be sold by public auction at the Traffic Branch, 20 Dawson Street, Brunswick, on Tuesday, 29 April 1986, at 10.00 a.m.

S. I. MILLER
Chief Commissioner

APPOINTMENTS

Liquor Control Act 1968

APPOINTMENT OF LICENSING INSPECTORS

In accordance with the authority conferred upon me by section 6 of the *Police Regulation Act 1958*, I, Eric Archibald Mudge, Deputy Commissioner of Police, do hereby appoint under sub-section (1) of section 22 of the *Liquor Control Act 1968*, the following Officers of Police as Licensing Inspectors for the divisions of the Police Districts as shown:

<i>Division Number</i>	<i>Police District</i>	<i>Rank and Name</i>
1	Dandenong	Inspector Robert Noel Hogan, 11963 (from 16.3.86 to 12.4.86)
3	Dandenong	Inspector Robert John Royce White, 13104 (from 19.2.86 to 28.3.86)
4	Dandenong	Inspector Denis Francis Elliott, 11707 (from 27.2.86 to 31.3.86)
2	Prahran	Inspector Quentin Andrew Pritchard, 14485 (from 9.3.86 to 5.4.86)
1	Upper Murray	Senior Sergeant Ralph Dewhurst, 13801 (from 9.3.86 to 29.3.86)

Dated 21 March 1986

E. A. MUDGE
Deputy Commissioner (Administration)

APPOINTMENTS

His Excellency the Governor of the State of Victoria by and with the advice of the Executive Council thereof has by Order made on 25 March 1986 been pleased to make the undermentioned appointments, viz:

Law Department

Commissioners for Taking Affidavits

Geoffrey William SHELTON, Coroner's Court, Flinders Street Extension, Melbourne

Anthea Eileen MACTIERNAN, Accident Compensation Tribunal, 570 Bourke Street, Melbourne

Gordon John PRATT, Accident Compensation Tribunal, 570 Bourke Street, Melbourne

Michaelina Maria VENNIX, Accident Compensation Tribunal, 570 Bourke Street, Melbourne

Russell James WICKING, Accident Compensation Tribunal, 570 Bourke Street, Melbourne

John Francis D'ORIVAL, 5 Albion Street, Kennington

Louise IZATT, 104 Bell Street, Coburg

Sandra ADMINIS, Accident Compensation Tribunal 570 Bourke Street, Melbourne

Allan Murray COULTHARD, Accident Compensation Tribunal, 570 Bourke Street, Melbourne

Ian McClure CRAWFORD, Accident Compensation Tribunal, 570 Bourke Street, Melbourne

Jennifer Elizabeth EASTICK, Accident Compensation Tribunal, 570 Bourke Street, Melbourne

Ian JONES, Accident Compensation Tribunal, 570 Bourke Street, Melbourne and

Richard William LEE, Accident Compensation Tribunal, 570 Bourke Street, Melbourne

to be Commissioners for taking Affidavits under the *Evidence Act 1958*.

L. G. HOUSTON

Clerk of the Executive Council

At the Executive Council Chamber
Melbourne, 25 March 1986

ORDERS IN COUNCIL

LAND ACT 1958

At the Executive Council Chamber, Melbourne, the twenty-fifth day of March 1986

PRESENT:

His Excellency the Governor of Victoria

Mr Cathie

Mr Wilkes

Mr Jolly

UNUSED ROAD CLOSED

His Excellency the Governor of the State of Victoria in the Commonwealth of Australia by and with the advice of the Executive Council of the said State, pursuant to the provisions of section 349 of the *Land Act 1958* and with the concurrence in writing of the council of the municipality concerned and that of any adjoining land owners doth hereby close the unused road hereunder described viz:

Municipal District of the Shire of Walpeup—Parish of Boolungal being the road indicated by hatching on plan hereunder. (B 789 (1)) (L5-3020).

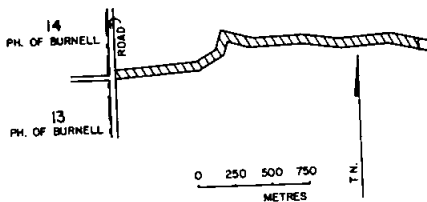

And the Honourable Joan Elizabeth Kirner, Her Majesty's Minister for Conservation, Forests and Lands for the State of Victoria, shall give the necessary directions herein accordingly.

L. G. HOUSTON
Clerk of the Executive Council

GEELONG WATERWORKS AND SEWERAGE ACT 1958

At the Executive Council Chamber, Melbourne, the twenty-fifth day of March 1986

PRESENT:

His Excellency the Governor of Victoria
Mr Cathie | Mr Wilkes
Mr Jolly

GEELONG AND DISTRICT WATER BOARD—EXTENT OF DRAINAGE AREA INCREASED

Under the powers conferred by the *Geelong Waterworks and Sewerage Act 1958* and all other powers enabling him in that behalf, His Excellency the Governor of the State of Victoria, by and with the advice of the Executive Council of the said State, doth hereby declare, order and direct that the extent of the Drainage Area of the Geelong and District Water Board be increased by adding thereto the lands shown by pink colour on the plan approved by the Governor in Council, by and with this Order and deposited in the Office of the Department of Water Resources, Melbourne (Corr. No. 79/2661/P86/31) and as on and from the date hereof the extent of such area shall be and be deemed to be increased accordingly.

And the Honourable Andrew McCutcheon, Her Majesty's Minister for Water Resources for the State of Victoria, shall give the necessary directions herein accordingly.

L. G. HOUSTON
Clerk of the Executive Council

CROWN LAND (RESERVES) ACT 1978

At the Executive Council Chamber, Melbourne, the twenty-fifth day of March 1986

PRESENT:

His Excellency the Governor of Victoria
Mr Cathie | Mr Wilkes
Mr Jolly

CROWN LAND TEMPORARILY RESERVED

His Excellency the Governor of the State of Victoria, in the Commonwealth of Australia by and with the advice of the Executive Council of the said State, pursuant to the provisions of sections 4 and 7 of the *Crown Land (Reserves) Act 1978* and being of the opinion that the Crown land concerned is required for the purposes mentioned hereby temporarily reserves and also exempts from prospecting or from occupation for mining purposes under any miners right the Crown land hereinafter described viz:

Municipal district of the Shire of Lexton—Evansford—for a public hall—1.078 hectares being Crown Allotment 81A Township of Evansford, Parish of Caralulup, County of Talbot as indicated by hatching on plan hereunder. (E 106 (2)) (Rs.12942).

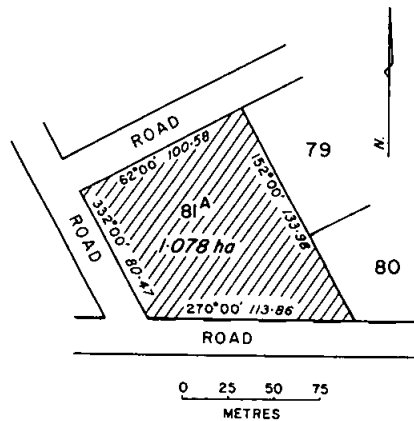

And the Honourable Joan Elizabeth Kirner, Her Majesty's Minister for Conservation, Forests and Lands for the State of Victoria, shall give the necessary directions herein accordingly.

L. G. HOUSTON
Clerk of the Executive Council

CROWN LAND (RESERVES) ACT 1978

At the Executive Council Chamber, Melbourne, the
twenty-fifth day of March 1986

PRESENT:

His Excellency the Governor of Victoria
Mr Cathie | Mr Wilkes
Mr Jolly |

CROWN LAND TEMPORARILY RESERVED

His Excellency the Governor of the State of Victoria, in the Commonwealth of Australia by and with the advice of the Executive Council of the said State, pursuant to the provisions of sections 4 and 7 of the *Crown Land (Reserves) Act 1978* and being of the opinion that the Crown land concerned is required for the purposes mentioned hereby temporarily reserves and also excepts from prospecting or from occupation for mining purposes under any miners right the Crown land hereinafter described viz:

Municipal district of the City of Ballarat—Ballarat—for public purposes—6.8 hectares being Crown allotment 3A Section 119A—Township of Ballarat East, Parish of Ballarat, as indicated by hatching on plan hereunder. (B 128 (52)) (Rs.3775).

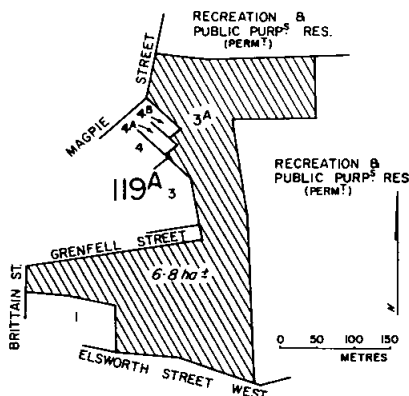

And the Honourable Joan Elizabeth Kirner, Her Majesty's Minister for Conservation, Forests and Lands for the State of Victoria, shall give the necessary directions herein accordingly.

L. G. HOUSTON
Clerk of the Executive Council

WATER AND SEWERAGE AUTHORITIES
(RESTRUCTURING) ACT 1983

WATER ACT 1958

At the Executive Council Chamber, Melbourne, the
twenty-fifth day of March 1986

PRESENT:

His Excellency the Governor of Victoria
Mr Cathie | Mr Wilkes
Mr Jolly |

NHILL WATER BOARD
APPROVAL TO SITE OF BORE No. 8

Under the powers conferred by the *Water and Sewerage Authorities (Restructuring) Act 1983*, the *Water Act 1958* and all other powers enabling him in that behalf, His Excellency the Governor of the State of Victoria, by and with the advice of the Executive Council of the said State, doth hereby approve of the site of bore No. 8 as shown by pink colour on the plan approved by the Governor in Council by and with this Order and deposited in the office of the Department of Water Resources, Melbourne—(Corr. No. 81/2583/104).

And the Honourable Andrew McCutcheon, Her Majesty's Minister for Water Resources for the State of Victoria, shall give the necessary directions herein accordingly.

L. G. HOUSTON
Clerk of the Executive Council

WATER AND SEWERAGE AUTHORITIES
(RESTRUCTURING) ACT 1983

WATER ACT 1958

At the Executive Council Chamber, Melbourne, the
twenty-fifth day of March 1986

PRESENT:

His Excellency the Governor of Victoria
Mr Cathie | Mr Wilkes
Mr Jolly |

MANSFIELD DISTRICT WATER BOARD
MERRIJIG URBAN DISTRICT REVOKED
EXTENT OF SHIRE OF MANSFIELD
WATERWORKS DISTRICT
INCREASED AND DIMINISHED

Whereas by an Order in Council dated 4 May 1982, made under the provisions of the *Water Act 1958* and published in the *Government Gazette* on 12 May 1982, the Governor in Council approved of the proclamation of the Merrijig Urban District as required by the former Shire of Mansfield Waterworks Trust as shown by red border on the plan approved by the Governor in Council—(Corr. No. 82/956/2).

And whereas the Merrijig Urban District as delineated on the plan (Corr. No. 82/956/2) is now considered to be unsuitable, the Governor in Council by Order doth hereby revoke the said Urban District as described in the Order made on 4 May 1982.

Now therefore, under the provisions of the *Water and Sewerage Authorities (Restructuring) Act 1983*, and all other powers enabling him in that behalf, His Excellency the Governor of the State of Victoria, by and with the advice of the Executive Council of the said State doth hereby declare, order and direct that the extent of the Shire of Mansfield Waterworks District of the Mansfield District Water Board be diminished and increased by excising therefrom those lands shown by green border and adding thereto those lands shown by red border on the plan approved by the Governor in Council and deposited in the Office of the Department of Water Resources, Melbourne (Corr. No. L86/20/1); and as on and from the date hereof the extent of such District shall be and be deemed to be diminished and increased accordingly.

And the Honourable Andrew McCutcheon, Her Majesty's Minister for Water Resources for the State of Victoria, shall give the necessary directions herein accordingly.

L. G. HOUSTON
Clerk of the Executive Council

**WATER AND SEWERAGE AUTHORITIES
(RESTRUCTURING) ACT 1983**

*At the Executive Council Chamber, Melbourne, the
twenty-fifth day of March 1986*

PRESENT:

His Excellency the Governor of Victoria
Mr Cathie Mr Wilkes
Mr Jolly

**MACALISTER WATER BOARD
Amendment of Order**

Under the powers conferred by the *Water and Sewerage Authorities (Restructuring) Act 1983*, and all other powers enabling him in that behalf, His Excellency, the Governor of the State of Victoria by and with the advice of the Executive Council of the said State doth hereby amend as follows the Order in Council which constituted the Macalister Water Board and appointed the interim members thereto; such Order being made on 30 October 1984, and published in the *Victoria Government Gazette*, of 7 November 1984.

Under Section 2H appointing the Interim Members:

—“For the name Jim Kelly substitute the name John Spinner”

And the Honourable Andrew McCutcheon, Her Majesty's Minister for Water Resources shall give the necessary directions herein accordingly.

L. G. HOUSTON
Clerk of the Executive Council

**WATER AND SEWERAGE AUTHORITIES
(RESTRUCTURING) ACT 1983**

*At the Executive Council Chamber, Melbourne, the
twenty-fifth day of March 1986*

PRESENT:

His Excellency the Governor of Victoria
Mr Cathie Mr Wilkes
Mr Jolly

**BENALLA WATER BOARD
Amendment of Constituting Order**

Under the powers conferred by the *Water and Sewerage Authorities (Restructuring) Act 1983*, and all other powers enabling him in that behalf, His Excellency the Governor of the State of Victoria, by and with the advice of the Executive Council of the said State, doth hereby amend the Order in Council of 27 September 1983, such Order constituting the Benalla Water Board, as follows:

Section I of the Order shall be deleted and the following Section I shall be substituted.

1. The members of the Board shall comprise: six members elected by persons whose names are enrolled on the voters roll for the Electoral District of the Benalla Water Board, one member appointed by the Minister for Water Resources.

And the Honourable Andrew McCutcheon, Her Majesty's Minister for Water Resources for the State of Victoria shall give the necessary directions herein accordingly.

L. G. HOUSTON
Clerk of the Executive Council

Water Act 1958
RURAL WATER COMMISSION OF VICTORIA

*At the Executive Council Chamber, Melbourne, the
twenty-fifth day of March 1986*

PRESENT:

His Excellency the Governor of Victoria
Mr Cathie Mr Wilkes
Mr Jolly

**WARANGA BASIN RECREATIONAL AREA
BOUNDARIES VARIED**

Under the powers conferred by the *Water Act 1958* and all other powers enabling him in that behalf, His Excellency the Governor of the State of Victoria, with the advice of the Executive Council

of the said State, on the recommendation of the Rural Water Commission of Victoria, doth hereby declare, order and direct that the boundaries of the Waranga Basin Recreational Area be varied by adding to the said Area the land shown by green colour on a plan numbered 6148B approved by the Governor in Council and lodged in the Plan Room of the Rural Water Commission of Victoria, at 590 Orrong Road, Armadale, and as on and from the date hereof, the boundaries of such Area shall be so varied.

And the Honourable Andrew McCutcheon, Her Majesty's Minister for Water Resources for the State of Victoria, shall give the necessary directions herein accordingly.

L. G. HOUSTON
Clerk of the Executive Council

Audit Act 1958
TREASURY REGULATIONS 1981

*At the Executive Council Chamber, Melbourne, the
twenty-fifth day of March 1986*

PRESENT:

His Excellency the Governor of Victoria	
Mr Cathie	Mr Wilkes
Mr Jolly	

Where proviso (a) of Regulation 71 (2) of the Treasury Regulations 1981 provides that Regulation 71 shall not apply in respect of the invitations of tenders to expenditure specifically authorized by the Governor in Council on the recommendation of the Treasurer.

And whereas the Treasurer has recommended that the expenditure detailed hereunder be specifically authorized by the Governor in Council.

Now therefore, pursuant to the powers conferred on him by the Treasury Regulations 1981 and all other powers enabling him in that behalf, His Excellency the Governor of the State of Victoria, by and with the advice of the Executive Council thereof, does hereby authorize the expenditure of an amount not exceeding six thousand dollars (\$6000) by payment to Rider Hunt and Partners for the provision of services as for Evaluation of Construction Programme for the National Tennis Centre.

And the Honourable Neil Benjamin Trezise, Her Majesty's Minister for Sport and Recreation for the State of Victoria, shall give the necessary directions herein accordingly.

L. G. HOUSTON
Clerk of the Executive Council

Audit Act 1958
TREASURY REGULATIONS 1981

*At the Executive Council Chamber, Melbourne, the
twenty-fifth day of March 1986*

PRESENT:

His Excellency the Governor of Victoria	
Mr Cathie	Mr Wilkes
Mr Jolly	

Where proviso (a) of Regulation 71 (2) of the Treasury Regulations 1981 provides that Regulation 71 shall not apply in respect of the invitations of tenders to expenditure specifically authorized by the Governor in Council on the recommendation of the Treasurer.

And whereas the Treasurer has recommended that the expenditure detailed hereunder be specifically authorized by the Governor in Council.

Now therefore, pursuant to the powers conferred on him by the Treasury Regulations 1981 and all other powers enabling him in that behalf, His Excellency the Governor of the State of Victoria, by and with the advice of the Executive Council thereof, does hereby authorize the expenditure of an amount not exceeding nine hundred thousand dollars (\$900 000) by payment to Civil and Civic Pty. Ltd. for the provision of services as Project Manager for the National Tennis Centre.

And the Honourable Neil Benjamin Trezise, Her Majesty's Minister for Sport and Recreation for the State of Victoria, shall give the necessary directions herein accordingly.

L. G. HOUSTON
Clerk of the Executive Council

**PRIVATE
ADVERTISEMENTS**

CITY OF CAMBERWELL
Road Discontinuance

Pursuant to section 528 (2) of the *Local Government Act 1958*, the Council of the City of Camberwell has resolved that part of a road abutting 5 Meldreth Street and 6 Shepreth Street, Surrey Hills which is shown by hatching on the plan herewith, and which has been closed under the City of Camberwell Local Development Scheme approved on 3 April 1985 be discontinued subject to:

- (a) the Melbourne and Metropolitan Board of Works continuing to have and possess the same right, title, power, authority or interest in or in relation to the whole of the land shown by hatching on the said plan as it had or possessed prior to such discontinuance with respect to or in connection with any

- drains or pipes laid or erected in on or over such land for the purposes of drainage or sewerage;
- (b) the City of Camberwell continuing to have and possess the same right, title, power, authority or interest in or in relation to the whole of the land shown by hatching on the said plan as it had or possessed prior to such discontinuance with respect to or in connection with any drains or pipes laid or erected in on or over such land for the purposes of drainage or sewerage;
 - (c) the land in the said road subject to any such right, title, power, authority or interest vesting in the municipality to be retained by it until sold by private treaty.

Location—From the intersection of Peppertree Lane with Baillie Street in a northerly direction for 130 metres to where the Lane turns East.

2221 R. A. MARSHALL, Town Clerk

CITY OF MARYBOROUGH

Closure of Road to Traffic

Notice is hereby given that the City of Maryborough has adopted an Order pursuant to the Local Government Act, section 539 C for the closure of Crimea Street to through vehicular traffic by erection of barriers and further that the Order shall come into operation on Wednesday, 9 April 1986.

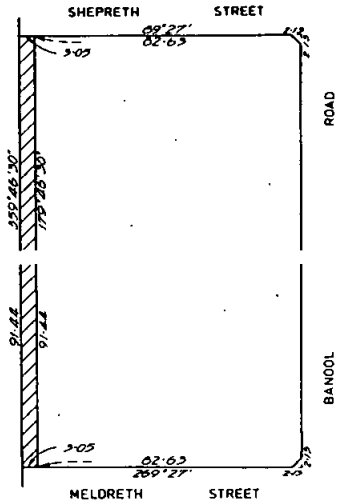

— POW to be closed with Council and RUDW, retaining existing rights

2220 MARTIN VERHOEVEN
Chief Executive Officer and Town Clerk

CITY OF HORSHAM

Notice of Change in Street Name

Notice is hereby given that in pursuance of powers conferred by the *Local Government Act 1958*, the Council of the City of Horsham at a meeting held on 17 February 1986, resolved to make the following name change:

Old Name—Peppertree Lane
New Name—Trinity Drive

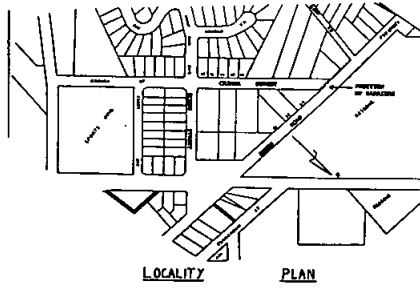

2235 RICHARD J. PEKIN, Town Clerk

CITY OF RICHMOND

By-Law No. 196

Blasting Operations

Notice is hereby given that the Council of the City of Richmond, pursuant to section 197 of the *Local Government Act 1958* (as amended), has made and passed a By-Law entitled the 'Blasting Operations By-Law' and numbered By-Law No. 196 for the purposes of: prohibiting, regulating or controlling blasting operations elsewhere than in any mine, quarry, clay pit, gravel pit or sandpit within the municipal district.

The Resolution for passing this By-Law was agreed to by the Council on Tuesday, 25 February 1986, and confirmed on Monday, 24 March 1986.

A copy of this By-Law is available for inspection without fee by any person during office hours at the Town Hall, Bridge Road, Richmond, 3121.

2237 D. G. WILLIAMS, Town Clerk

Form 2.1

Town and Country Planning Act 1961

CITY OF SALE PLANNING SCHEME 1975

Notice that a Planning Scheme has been Prepared and is Available for Inspection

Amendment No. 30, 1986

Notice is hereby given that the City of Sale in pursuance of its powers under the *Town and Country Planning Act 1961*, has prepared a scheme to:

- (a) Rezone land to "Public Open spaces Municipal Purpose" and "Residential Low Density B" in Frith Street, Bennison Drive area, Sale.
- (b) Modify sections "b" and "j" of the interpretation of "Home Occupation" under Clause 4 of the City of Sale Planning Scheme Ordinance.

A copy of the scheme has been deposited at the Council Chambers, 82-88 Macalister Street, Sale, and at the office of the Department of Planning (Plan Inspection Section), Ground Floor, of the Olderfleet Buildings, 477 Collins Street, Melbourne, and will be open for inspection during office hours by any person, free of charge.

Any persons affected by the scheme are required to set forth in writing any submission they may wish to make with respect to the scheme, addressed to the Town Clerk, City of Sale, P. O. Box 506, Sale Vic. 3850 by 3 July 1986 and state whether they wish to be heard in respect of their submission.

2222 J. L. LOW, Town Clerk

CITY OF SOUTH MELBOURNE

By-Law No. 457

Notice is hereby given that in pursuance of the powers conferred by the *Local Government Act 1958*, the Council of the City of South Melbourne has made a By-Law numbered 457 for the purpose of—

- (i) preventing and extinguishing fires;
- (ii) suppressing nuisances;
- (iii) regulating the times during which incinerators may be used wholly or partly for residential purposes.

Resolution for passing this By-Law was agreed to by the Council of the City of South Melbourne on 24 February, 1986 and confirmed on 24 March, 1986.

A copy of the By-Law is open for inspection, free of charge, at the office of the Council of the City of South Melbourne at the Town Hall, Bank Street, during office hours.

2249 NOEL F. KROPP
Chief Executive Officer and Town Clerk.

CITY OF SOUTH MELBOURNE

Road Discontinuance

Notice is hereby given that in accordance with the provisions of section 528 (2) (a) of the *Local Government Act 1958*, the Council of the City of South Melbourne on 24 March 1986, resolved as follows:

- (a) That Right-of-Way No. 605 located at the rear of 552-554 City Road, as shown hatched on the plan hereunder, is not reasonably required as a road for public use.
- (b) That the said Right-of-Way be discontinued upon publication of this resolution in the *Government Gazette*.
- (c) That the land in the said Right-of-Way shall vest in the City of South Melbourne until sold by private treaty to the abutting owner(s).

PLAN OF
PART OF CROWN ALLOTMENT 4 SECTION 51
CITY OF SOUTH MELBOURNE
PARISH OF MELBOURNE SOUTH
COUNTY OF BOURKE

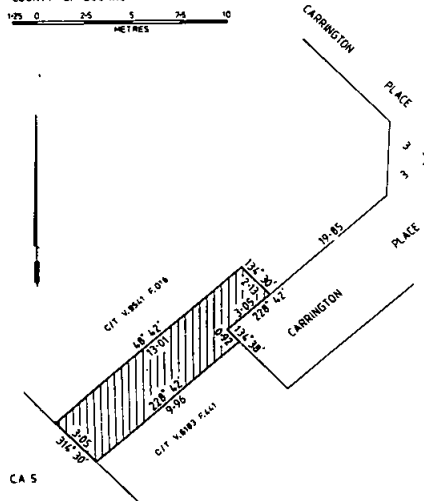

2223 NOEL F. KROPP
Chief Executive Officer and Town Clerk

CITY OF SUNSHINE

Road Discontinuance

Pursuant to section 528 (2) of the *Local Government Act 1958*, the Council of the City of Sunshine passed the following resolution at its Ordinary Meeting held on 18 March 1986:

This Council, being of the opinion that the part of the road shown enclosed by continuous thick lines on the plan hereunder is not reasonably

required as a road for public use, having consulted with any relevant public statutory authority, having published and given the notices required by section 528 (2) of the *Local Government Act 1958* and having considered any objections to the proposal, does hereby resolve and direct that:

- (a) such part be discontinued;
- (b) publication of this resolution be effected in the *Government Gazette*; and
- (c) thereafter, the said part be sold to abutting owners by private treaty.

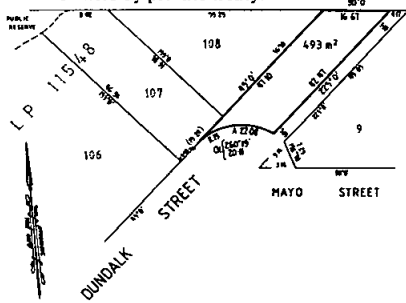

2224

G. S. PEARSON, Town Clerk

BOROUGH OF WONTHAGGI
By-Law No. 72

Caravans on Private Property

A By-law of the Borough of Wonthaggi made under the provisions of the *Local Government Act 1958* and numbered 72 for the purpose of amending By-law No. 57 relating to prohibiting or regulating placing of caravans on private property.

In pursuance of the powers conferred by section 197 (i) (xxxi) (g) of the *Local Government Act*, and of any and every other power it thereunto enabling the Mayor, Councillors and Burgesses of the Borough of Wonthaggi order as follows:

1. Clause 1 (c) of By-law No. 57 is to be and is hereby amended by the addition of the following expression after the word "thereto"—"and any free standing tent or toilet enclosure".

2. This By-law shall apply to and have operation throughout the whole of the Municipal District.

This By-law was made and passed by the Council of the Borough of Wonthaggi on 20 January 1986, and confirmed on 17 March 1986.

In witness of the foregoing, the common seal of the Mayor, Councillors and Burgesses of the Borough of Wonthaggi was hereunto affixed 17 March 1986, in the presence of:

D. BIGGS, Mayor
J. NELSON, Councillor
A. A. N. DEED, Town Clerk

2240

SHIRE OF LILLYDALE

Discontinuance and Sale of Government Road

Pursuant to section 528 (2) of the *Local Government Act 1958*, the Shire of Lillydale, being of the opinion that the government road abutting Lots 1-6, LP 4955, Lot Part Section 5, Part Crown Allotments B and C, Parish of Yering, County of Evelyn, is not reasonably required as a road for public use, has consulted with the appropriate public statutory authorities, has considered the objection to the proposal to discontinue the road, resolved on 11 March 1986 to discontinue the road and that the road be sold by private treaty to M. W. and E. F. Pyle at a price to be fixed by the Shire Valuer.

Dated 17 March 1986

W. I. HEINE

2225 Acting Chief Executive Officer

STAWELL WATER BOARD

Notice of Commencement of Construction of Sewerage Works

Pursuant to section 119 (2) of the *Sewerage Districts Act 1958* notice is hereby given of the intention to construct a sewer for the property situated in the following area at least 30 days after the date of this notice.

Hawthorn Street, Lot 1 on Plan of Subdivision 200670 Parish of Stawell and more particularly as shown on plans which are open for inspection at the office between the hours of 8.30 a.m. and 5.15 p.m. Monday to Friday inclusive.

2226 N. R. ILLIG, Secretary

I, Helen Wilma Forbs of Unit 2, 27 Manifold Street, Manifold Heights in the State of Victoria, food services assistant, heretofore called and known by the name of "Helena Poltarzycki" hereby give public notice that a Deed Poll dated 21 February 1986, and deposited with the Registrar General on 12 March 1986, Numbered M119287 I formerly and absolutely renounce and abandon the said christian name of "Helena" and the said surname of "Poltarzycki" and declare that I have resumed and intended henceforth upon all occasions what ever to use and subscribe the christian name of "Helen" and the middle name of "Wilma" and the surname of "Forbs" instead of the said christian name of "Helena" and the said surname of "Poltarzycki" and so as to be at all times thereafter called, known and described by the name of "Helen Wilma Forbs."

Dated 25 March, 1986

HELEN WILMA FORBS

Ingpen & Bent, Solicitors, 95 Yarra Street, Geelong

2234

PARTNERSHIP ACT 1958, SECTION 41

Take notice that the partnership of Alfreda Nominees Pty. Ltd. and Adrian Richard Griffin (trading as Frankston Air Conditioning) was dissolved on 21 March 1986.

ROBERT M. PHELAN & Co., "Moncroft House", 93-97 Rose Street, Essendon. Phone: 337 0444 solicitors for Adrian Richard Griffin. 2250

Notice is hereby given that the partnership heretofore subsisting between Bill Deliyiannis and Con Deliyiannis both of 59 Kareella Road, Frankston in the State of Victoria carrying on business as Fish Shop Proprietors at 59 Kareela Road, Frankston has been dissolved on 11 March 1986.

CON DELIYIANNIS
BILL DELIYIANNIS
2251

NOTICE OF DISSOLUTION OF PARTNERSHIP

C. F. Bell and L. C. Bell trading as "Belcon Industries" of 17 Yuilles Street, Mornington

Take notice that the above partnership has been dissolved with effect from 1 July 1985. The business of "Belcon Industries" shall be continued by C. F. Bell alone trading from 17 Yuilles Street, Mornington.

McCULLOUGH KOLLIAS & CO., solicitors for L. C. Bell 2257

Notice is hereby given that the partnership heretofore subsisting between John Arthur William Guthrie, Ian Andrew Ness, John Frederick Henry and Carlo Anthony Massola, carrying on business as Solicitors at 12 Batman Street, Melbourne under the style or firm of Turner Ness & Davis has been dissolved as from 31 March 1986 so far as concerns the said John Arthur William Guthrie who retires from the said firm.

Dated 1 April 1986

J. GUTHRIE
IAN NESS
J. F. HENRY
C. MASSOLA
2241

Take notice that the carpentry business trading under the name of L. J. & M. L. Shortis was never and is not now a partnership. 2228

DISSOLUTION OF PARTNERSHIP

Notice is hereby given that the partnership of Lines, MacFarlane & Marshall of Suite 4, 19 Carpenter Street, Brighton carrying on the business of architects was dissolved as from 1 July 1985.

2238

In the Supreme Court of Victoria 1986 Co. No. 130—In the matter of the Companies (Victoria) Code; and in the matter of Donegan Potato Packers Pty. Ltd.—Advertisement of Application.

Notice is hereby given that an application for the winding up of the abovenamed company by the Supreme Court was on 5 March 1986 filed by the Applicant, Colac Producer Company Pty. Ltd. and that the said Application is directed to be heard before the Court in the Seventh Court at 10.30 a.m. Law Courts, Lonsdale Street, Melbourne on 16 April 1986.

The Liquidator whose appointment is sought is Alan M. Holsburgh of 499 St. Kilda Road, Melbourne.

And any creditor or contributory of the company desiring to support or oppose the making of an order on the Application may appear at the time of hearing by himself or his Counsel for that purpose; and a copy of the said Application will be furnished by the undersigned to any creditor or contributory of the said company requiring the same by the undersigned on payment of the regulated charge for same.

The applicant's official address is: 67 Bruce Street, Colac.

The applicant's Solicitors are: Messrs. Henty, Jepson & Kelly of 1051-1053 Burwood Highway, Ferntree Gully.

Note: Any person who intends to appear on the hearing of the said application must serve on or send by post to the abovenamed Henty, Jepson & Kelly, notice in writing of his intention to do so. The notice must state the name and address of the person, or if a firm, the name and address of the firm; and must be signed by the person or firm, or his, or their solicitors (if any) and must be served, or if posted, must be sent in sufficient time to reach the abovenamed not later than 4.00 p.m. on 15 April 1986. 2227

**DEAKIN No. 2 CO-OPERATIVE HOUSING SOCIETY LIMITED
(In Liquidation)**

Take notice that the affairs of the abovenamed Society are now fully wound up and that pursuant to section 411 of the Companies (Victoria) Code and the *Co-operative Housing Societies Act 1958*, a General Meeting of the Society will be held at the office of the Liquidator, 464A Lower Heidelberg Road, Heidelberg, on Wednesday, 23 April 1986, at 4.30 p.m. for the purpose of—

1. Laying before it an account showing how the winding up has been conducted and the property of the Society disposed of and giving any explanations thereof; and

2. Passing a resolution that the books and papers of the said Society and of the Liquidator relevant to the affairs of the Society be destroyed after a period of twelve months from the date of the meeting.

Dated 20 March 1986

2242 **GEOFFREY PURVIS**
Liquidator

Companies Form 130
Companies (Victoria) Code
Supreme Court Rule 99 (2)

Notice Inviting Formal Proof of Debt or Claim
LONGLEIGH PTY. LTD.

Take notice that creditors of the company, whose debts or claims have not already been admitted, are required on or before 10 April 1986 to prove their debts or claims and to establish any title they may have to priority by delivering or sending through the post to me at my address a formal proof of debt or claim in accordance with Form 131 or 132 containing their respective debts or claims. In default they will be excluded from the benefit of any distribution made before their excluded from the benefit of any distribution made before their debts or claims are proved or their priority is established and from objecting to the distribution.

Form of proof may be obtained from me.

Dated 19 March 1986

A. M. HORSBURG
Official Liquidator
Duesburys Chartered Accountants, 499 St Kilda
Road, Melbourne Vic. 3004 2243

Companies Form 78
Notice of Appointment of Receivers and Manager
of

TRIAD CONSTRUCTIONS (AUST.) PTY. LTD.

National Australia Bank Limited of 28th Floor, 500 Bourke Street, Melbourne gives notice that on 19 March 1986 it appointed Michael James Humphris and Douglas Orson Oldfield, Chartered Accountants of Ernst & Whinney of 35 Collins Street, Melbourne jointly and severally as Receivers and Managers of the property of the Company specified in the Schedule under the powers contained in an instrument dated 18 October 1985 being a Debenture registered number 54328.

Schedule

The whole of the property assets and undertaking of the Company whatsoever and wheresoever both present and future including its uncalled and called but unpaid capital and the whole of the property and assets whatsoever and wheresoever both present and future held by the Company as trustee of the Trust Fund referred to in Clause 36 of the said Debenture.

Dated 20 March 1986

Executed by National Australia Bank Limited by being signed sealed and delivered in Victoria by its Attorney Graeme Henry Roberts under Power of Attorney dated 24/10/85 (a certified copy of which is filed in Permanent Order Book) who declares that he holds the office in the Bank indicated under his signature in the presence of:

J. WILLIAMS

2244 **G. R. ROBERTS**
Regional Manager

**SYMPOSIA INTERNATIONAL PTY. LTD., (In
Voluntary Liquidation)**

Notice is hereby given that at an Extraordinary General meeting of the above-named company, held on 24 March 1986, it was resolved by Special Resolution:

“That the company be wound up voluntarily and that John Francis Murdoch of 11 Banksia Court, Croydon, be and is hereby appointed liquidator of the Company.”

2252 **JOHN F. MURDOCH, Liquidator**

Companies (Victoria) Code
Sub-section 411 (2)

**A.J.C. INVESTMENT CO. PTY. LTD. (In
Voluntary Liquidation)**

Notice of Final Meeting

Notice is hereby given that pursuant to sub-section 411 of the Companies (Victoria) Code a final general meeting of the members of A.J.C. Investment Co. Pty. Ltd. will be held at 860 Glenferrie Road, Hawthorn on Thursday 7 May 1986 at 10.00 a.m.

The purpose of the meeting is to lay accounts before it showing the manner in which the winding up has been conducted and the property of the company disposed of and of hearing any explanation that may be given by the liquidator.

Dated 25 March 1986

J. C. BENZIES Liquidator
J. C. Benzies, 860 Glenferrie Road, Hawthorn,
3122 2258

Companies Act 1961
**RE: GRANT BARNETT & CO. (AUST.) PTY.
LTD.**

(In Liquidation)

Notice is hereby given that a third and final dividend is intended to be declared in the above matter. Creditors who have not proved their debt by 25 April 1986, will be excluded from the dividend.

Dated 26 March 1986

**R.D. WIDDOWS, Liquidator, 703 South Road,
Moorabbin. Tel: 555 7422 2259**

Creditors, next of kin and others having claims in respect of the estate of Hedley Gerrard Doran late of 30 Dorothy Avenue, Glenhuntly in the State of Victoria Horse Trainer deceased who died on 14 September 1985, are required to send particulars of their claims to the Executrix Janice Ann Wade care of her Solicitor, Peter J. Walsh of 95 Queen Street, Melbourne by 11 June 1986, after which date the Executrix will distribute the assets having regard only to the claims of which she then has had notice.

2245

NORMAN LEE RIGG, late of 63 Hopetoun Road, Toorak, gentleman, deceased

Creditors, next of kin and others having claims against the Estate of the said deceased who died on 15 July 1985 are to send particulars of their claims to May Frazer Rigg Norma Lee Wiltshire and Kenneth James Russell c/o Messrs Blake & Riggall solicitors 140 William Street Melbourne by 2 July 1986 after which date they will distribute the assets having regard only to the claims of which they then have notice.

2246

Creditors, next of kin and others having claims in respect of the Estate of Queenie Rose Salmon late of Flat B1 "Sylvan Glades" Silvan Road, Monbulk in the State of Victoria Gentlewoman deceased who died on 22 October 1985, are required to send particulars of their claims to the Executor National Trustees Executors and Agency Company of Australasia Limited of 95 Queen Street, Melbourne by 11 June 1986, after which date the Executor will distribute the assets having regard only to the claims of which it then has notice.

PETER J. WALSH, solicitor, 95 Queen Street, Melbourne 2247

JOAN MARIE STANBOROUGH, late of

35 Ashburton Drive, Mitcham librarian, deceased

Creditors, next of kin and others having claims in respect of the estate of the deceased who died on 31 October 1985 are required by Julie Ann Jacks of 6 Thompson Street, Essendon, computer systems officer, Jennifer Maree Stanborough of 35 Ashburton Drive Mitcham, teacher librarian and David Hilton Stanborough of Unit 1 No. 19 Balllater Street, Essendon, state insurance broker the Executors to whom Probate of the Will of the said deceased was granted by the Supreme Court of Victoria to send particulars care of the undersigned by 23 June 1986 after which date the said Executors may convey or distribute the assets having regard only to the claims of which they then have notice.

PATRICK J. CANNON, COBURN & ASSOCIATES, solicitors, 205 Hampshire Road, Sunshine 2232

MARJORIE MONTROSE MUNRO, late of
Flat 3, 25 North Road, Brighton

Creditors, next of kin and others having claims in respect of the estate of the deceased (who died on 19 August 1985) are required by Helen Eugenie Graham to send particulars of their claims to her C/o Read & Read 422 Collins Street, Melbourne, by 3 June 1986 after which date she will convey or distribute the assets having regard only to the claims of which she as Executrix then has notice. 2229

GERTRUDE ALICE JEAN GRAHAM, late of
45 Albion Road, Glen Iris

Creditors next of kin and others having claims in respect of the estate of the deceased, who died on 28 October 1985, are required by Arthur James Downing of Read & Read, 422 Collins Street, Melbourne to send particulars of their claims to him by 3 June 1986 after which date he will convey or distribute the assets having regard only to the claims of which he as Executor then has notice.

2230

VERA EMILY EDWARD, late of Mayflower Home for Aged People, 7 Centre Road, Brighton East in the State of Victoria, widow, deceased

Creditors, next of kin, and others having claims in respect of the estate of the deceased, who died on 15 January 1986 are required by Robert Andrew Green of 549 Hampton Street, Hampton in the said State of Victoria, to whom probate of the will dated 28 November 1985 of the said deceased was granted by the Supreme Court of Victoria on 25 February 1986 to send particulars to him by 30 May 1986 after which date the said Robert Andrew Green may convey or distribute the assets, having regard only to the claims of which he then has notice.

Dated 24 March 1986

ROBERT A. GREEN LL.B., solicitor, 549 Hampton Street, Hampton Victoria. 2231

SUSAN SHEA LEE HANNAKER (otherwise known as Susan Shea Hannaker), late of Unit 2, No. 20 Seaview Crescent, Black Rock, widow, deceased

Creditors, next of kin and others having claims in respect of the estate of the deceased who died on 15 February 1986 are required by the personal representatives John Maxwell Hannaker of 34 Mernda Avenue Carrum and Elizabeth Clare Scott of 29 Hourigan Avenue Clayton to send particulars to them care of the undermentioned solicitors by 10 June 1986 after which date the personal representatives may convey or distribute the assets having regard only to the claims of which they then have notice.

AITKEN, WALKER & STRACHAN, solicitors, 114 William Street, Melbourne 2236

Creditors, next of kin and others having claims in respect of the Estate of Dorothy Lilian Coats late of 27 McArthur Street, Moorabbin in the State of Victoria Married Woman deceased who died on 2 November 1985 are to send particulars of their claims to Frederick Howard Coats of 27 McArthur Street, Moorabbin in the said State Public Servant care of the undermentioned Solicitors by 2 June 1986 after which date he will distribute the assets having regard only to the claims to which he then has notice.

REGINALD C. BUTLER & CO., solicitors, 312 Centre Road, Bentleigh 2253

CHARLES CLIFFORD GILL, late of Guildford, pensioner, deceased, intestate

Creditors, next of kin and others having claims in respect of the estate of the deceased who died on 27 August 1985 are required by the Administratrix Ruth Vida Carter of Ballarat Street, Guildford to send particulars to her by 15 May 1986 care of the undermentioned Solicitors after which date the Administratrix may convey or distribute the assets, having regard only to the claims of which she then has notice.

H. S. W. LAWSON & CO., solicitors, 38 Lyttleton Street, Castlemaine 2254

In the Will of EMILY LOUISA HUNTER, late of 44 Evans Street, Brunswick in the State of Victoria, pensioner

Creditors, next of kin and any persons having an interest and others having claims in respect of the estate of the deceased, who died on 4 October 1985 are required by the trustees of the estate and Executors of her Will made 20 April 1982, namely, Alan George West of 59 Oakover Road, Preston in the State of Victoria, retired engineer, and Carl Michael Soccio of 260 Albert Street, Brunswick in the State of Victoria, Solicitor, to send particulars to them by 16 June 1986 after which date the trustees abovementioned may convey or distribute the assets, having regard only to the claims of which they then have notice.

Dated 24 March 1986

SOCCIO & ZITO, solicitors, 260 Albert Street, Brunswick 2239

ALICE LOUISA HUSKINSON MITCHELL, late of 236 Bridge Street, Port Melbourne

Creditors, next of kin and others having claims in respect of the estate of the deceased (who died on 23 December 1985) are required by The Perpetual Executors and Trustees Association of Australia Limited of 50 Queen Street, Melbourne, to send particulars of their claims to the said Company by 31 May 1986 after which date it will convey or distribute the assets, having regard only to the claims of which the Company then has notice. 2256

MAXWELL ROY GLEN, late of 72 Rutherford Street, Swan Hill in the State of Victoria, Rural Water Commission Employee, deceased (who died on 11 December 1985)

Creditors next of kin and all other persons having claims against the estate of the deceased are required by the Executrix of the Will, Dorothy Pearl Glen, to send particulars to her care of the undersigned on or before 27 May 1986, after which date she will distribute the assets having regard only to the claims of which she then has notice.

GARDEN & GREEN, solicitors, 4 McCallum Street, Swan Hill 2260

Creditors next of kin and all other persons having claims against the estate of Ralph Ellery Madder late of 11 Boyanda Road, Glen Iris, deceased who died on 12 February 1986 are required by the Executors Philip Gough Madder of 21 Karina Street, Frankston South, Retired, Geoffrey Ralph Madder of 103 Hill Road, North Balwyn, Finance Manager, Beatrice Esther Bewley of 20 Glyndebourne Avenue, Toorak, Married Woman and Dorothea Patricia Davis of 290 Walsh Street, South Yarra, Married Woman to send particulars of their claims to them care of the undersigned solicitors by 2 June 1986 after which date they may convey or distribute the assets having regard only to the claims of which they then have notice.

COHENS, FRENKEL BERKOVITCH KEFFORD & NEW, solicitors of 114 William Street, Melbourne 2261

STELLA IRENE MAY WITHERS, late of 440 Camberwell Road Camberwell Retired Salvation Army Officer Deceased

Creditors, next of kin and others having claims in respect of the estate of the deceased who died on 24 September 1985 are required by the legal personal representative Keith Ernest Reynolds of 4 Athelston Road Camberwell Salvation Army Officer to send particulars to him by 7 June 1986 after which date he will distribute the assets having regard only to the claims of which he has notice.

E. P. JOHNSON & DAVIES of 257 Collins Street, Melbourne 2248

Creditors next of kin having claims against the estate of Catherine McMahon late of Karinya Nursing Home, 32 Kangerong Road, Box Hill who died on 12 October 1985 are to send particulars of their claims to National Trustees Executors and Agency Company of Australasia Limited of 95 Queen Street, Melbourne before 1 June 1986 after which date it will distribute the assets of the estate having regard to the claims only of which it then has notice.

JOHN F. CARROLL, solicitor, 95 Queen Street, Melbourne 2263

Creditors next of kin and all other persons having claims against the estate of Alpha Roseanna Taylor late of 106 Victoria Street, Coburg, deceased who died on 15 December 1985 are required by the Executors Shirley Amelia Mitchell and William Mitchell both of 3 Irvin Court, Moomba Park, Fawkner, Home Duties and Electrician respectively, to send particulars of their claims to them care of the undersigned solicitors by 2 June 1986 after which date they may convey or distribute the assets having regard only to the claims of which they then have notice.

COHENS, FRENKEL BERKOVITCH
KEFFORD & NEW, solicitors of 114 William
Street, Melbourne 2262

WILLIAM JAMES DUNT, late of 21 Solar Drive
Whittington, wool scourer, deceased, intestate

Creditors, next of kin and others having claims in respect of the estate of the abovementioned deceased who died on 7 August 1985 are required by Elder Hazel Dunt of care of L. J. Reaburn, solicitor, 112 Market Square Mall Geelong, the administratrix of the abovementioned estate to send particulars to her at the above address by 1 June 1986 after which date she may convey or distribute the assets having regard only to the claims of which she then has notice.

L. J. REABURN, solicitor, 112 Market Square
Mall, Geelong 2233

Creditors, next of kin and others having claims in respect of the estate of Harold Norman Harris late of 925 Nepean Highway, Mornington in the State of Victoria Gentleman deceased who died on 1 November 1985 are to send particulars of their claims to Lawrence Adrian Harris of 177 Derby Street, Pascoe Vale in the said State invalid pensioner care of the undermentioned Solicitors by 2 June 1986 after which date he will distribute the assets having regard only to the claims to which he then has notice.

REGINALD C. BUTLER & CO., solicitors, 312
Centre Road, Bentleigh 2255

**NOTICE OF MAKING OF
STATUTORY RULES
WHICH ARE NOT YET
AVAILABLE**

Notice is given of the making of the following Statutory Rules:

No.	<i>Health Act 1958</i>
48/1986	Health (Indoor Heating Appliances) (Revocation) Regulations 1986
	<i>Port of Melbourne Authority Act 1958</i>
59/1986	Port of Melbourne Authority (Superannuation) (Optional Early Retirement) Regulations 1986
	<i>Health Act 1958</i>
64/1986	Health (Animal Food) (Revocation) Regulations 1986
	<i>Stamps Act 1958</i>
67/1986	Stamps (Amendment) Regulations 1986
	<i>Business Franchise (Tobacco) Act 1974</i>
68/1986	Business Franchise (Tobacco and Petroleum Products) (Amendment) Regulations 1986
	<i>Teaching Service Act 1981</i>
69/1986	Teaching Service (Appeals Boards, Chairman—Remuneration) (Amendment No. 19) Regulations 1986

Publications Availability

Publications may be purchased from the
Victorian Government Bookshop
 41 St Andrews Place East Melbourne
 (PO Box 203 North Melbourne 3051)
 Telephone Inquiries (03) 320 0299

Mail Orders and Postage

A postage and packaging fee must be added to the cost of the requested publication using the table of rates below. Remittances should be made payable to the 'Victorian Government Printing Office'.

Bankcard

Purchases may be made using Bankcard facilities in the Bookshop and by mail order. Bankcard mail orders require the Bankcard number, expiry date, name, address and signature of customer to be supplied. (Minimum purchase of \$5.00 applies).

Total Price of Publications	Postage Packaging Fee
\$ 0.00 to \$ 2.00	\$ 0.80
\$ 2.05 to \$ 5.00	\$ 1.10
\$ 5.05 to \$ 25.00	\$ 2.50
\$ 25.05 to \$ 75.00	\$ 3.00
\$ 75.05 to \$125.00	\$ 3.50
\$125.05 to \$200.00	\$ 4.00
\$200.05 and over	at cost

General Information

The following guidelines should be followed for the publication of official material in the *Victoria Government Gazette*.

Publication of official material

- Duplicate copies should be submitted for the use of the Gazette Officer.
- Material submitted to the Executive Council for Gazettal will normally be published in the next week's issue.
- Where urgent gazettal is required, special arrangements should be made with the:
 Gazette Officer
 Department of the Premier and Cabinet
 Government Branch
 2nd Floor, 1 Treasury Place
 Melbourne 3000
 Telephone Inquiries (03) 651 5153

Publication of other material

- All other material authorized by a responsible officer should be forwarded to the Gazette Officer no later than 9.30 a.m. on Tuesday.
- Lengthy or complicated notices should be forwarded several days before publication.
- Proofs will be supplied only when requested or at the direction of the Gazette Officer. They should be returned quickly to avoid delay in publication.
- No additions or amendments to material for publication will be accepted by telephone.

Late Copy

Copy received after 3.30 p.m. on the day prior to publication at the Victorian Government Printing Office will be placed in the following issue of the *Victoria Government Gazette*, irrespective of any date/s mentioned in the copy.

— Publication Details —

The *Victoria Government Gazette* is published every Wednesday, unless otherwise advertised.

Copy Deadline

Private advertisements will be accepted by:

Gazette Advertising

Victorian Government Printing Office

PO Box 203 North Melbourne 3051, no later than 1 p.m. on the day before publication.

Advertising Rates

Single column × cm/part cm	..	\$3.60
Double column × cm/part cm	..	\$7.20
Full page	..	\$151.00

Ordinary rates will apply to material submitted for publication before 1 p.m. Tuesday. Double rates will apply for material submitted between 1 p.m. and 3.30 p.m. Tuesday.

Advertisers should note:

- There are approximately 30 words to each column centimetre depth;
- Signatures (in particular) and proper names must be written clearly in the text;
- Advertising material should be double-spaced and confined to ONE SIDE ONLY of each sheet of paper
- Documents NOT CLEARLY PREPARED will be returned to the sender, unpublished.

Correspondence

All correspondence should be addressed to:

Gazette Advertising

Victorian Government Printing Office

PO Box 203 North Melbourne 3051

Telephone Inquiries (03) 320 0100

Agents

The following have been appointed agents to receive advertisements for the *Victoria Government Gazette*:

- Armstrong's Communications Pty Ltd
191 Queen Street Melbourne 3000
- Blane's Authorized Newsagents 162
Murray Street Colac 3250
- Cornell R G 126 Eighth Street Mildura
3500
- Franks H and Co 184 Ryrie Street Geelong
3220
- Gordon and Gotch Australasia Ltd
25-37 Huntingdale Road Burwood 3125
- Harston, Partridge & Co. Pty Ltd 455
Little Collins Street Melbourne 3000
- Kyneton Guardian Pty Ltd PO Box 18
Kyneton 3444
- The Mercantile Exchange 108 Queen
Street Melbourne 3000
- Bridgemall Newsagency 63 Bridgemall
Road Ballarat 3350
- McGill's Authorized Newsagency
183-185 Elizabeth Street Melbourne 3000
- McNaughton P R and L A 112-114
Gray Street Hamilton 3300
- Powney's Authorized Newsagency 293
Hargreaves Street Bendigo 3550
- Purdie J & Co. 138 Moorabool Street
Geelong 3220
- Vernons of Richmond 261 Bridge Road
Richmond 3121

CONTENTS

	Page
Acts of Parliament	815
Appointments	829
Contracts	827
Government Notices	816
Melbourne and Metropolitan Board of Works	823
Notice to Mariners	826
Notice of Making of Statutory Rules	841
Orders in Council—	
Acts—Land; Geelong Waterworks and Sewerage; Crown Land (Reserves); Water and Sewerage Authorities (Restructuring); Water; Audit	829 et seq
Police Sale	829
Private Advertisements	833
Proclamations	815

