

# VICTORIA GOVERNMENT G A Z E T T E

No. G 25 Wednesday 6 July 1988

By Authority Jean Gordon Government Printer Melbourne

**GENERAL**

## Gazette Services

The *Victoria Government Gazette* (VGG) is published by VGPO for the State of Victoria and is produced in three editions.

VGG **General** is published each Wednesday and provides information regarding Acts of Parliament and their effective date of operation; Government notices; requests for tenders; as well as contracts and contracts accepted. Private notices are also published.

VGG **Special** is published any day when required for urgent or special Government notices. VGG Special is made available automatically to subscribers of VGG General.

VGG **Periodical** is published on Monday when required and includes specialised information eg. Medical, Dental, Pharmacist's Registers, etc.

## Government Advertising

### Publishing Details

The following Guidelines should be followed to ensure publication of Government material in the *Victoria Government Gazette*.

- Duplicate copies should be submitted for use by the Gazette Officer.
- Material submitted to the Executive Council for gazettal will normally be published in the following week's issue.
- Where urgent gazettal is required, contact:  
Gerd Gaspar  
Gazette Officer  
Department of the Premier and Cabinet  
2nd Floor 1 Treasury Place  
Melbourne 3000  
Telephone Inquiries (03) 651 5153
- Government advertising other than material for the consideration of the Executive Council should be forwarded to the Gazette Office no later than 9.30 am on Tuesday.
- Lengthy or complicated notices should be forwarded several days before publication.
- Proofs will be supplied only when requested or at the direction of the Gazette Officer.
- No additions or amendments to material for publication will be accepted by telephone.
- Double rates for advertising in the Special Gazette will apply.

## Private Advertising

### Publishing Details. Send copy to:

VGG Coordinator  
Gazette Advertising  
VGPO  
66-112 Macaulay Road  
North Melbourne  
(PO Box 203 North Melbourne 3051)  
Telephone inquiries (03) 320 0100  
Fax No. (03) 329 2696

### Advertising Rates and Payment

Single column × cm/part cm \$3.85  
Double column × cm/part cm \$7.70  
Full page \$161.70

All private advertising **MUST** be paid for in advance, prior to any gazettal. Cheques should be made payable to 'VGPO'.

### Advertisers should note:

- There are approximately 20 words to each column centimetre depth.
- Signatures (in particular) and proper names must also be in block letters.
- All material should be double spaced.
- Advertisements can be faxed, and a cover sheet should be used, marked to the attention of the Gazette Coordinator.
- Documents not clearly prepared and in the exact format for gazettal will be returned to the sender unpublished.
- Late copy received at VGPO after 3.30 pm Tuesday will be placed in the following issue of VGG, irrespective of any date/s mentioned in the copy (unless otherwise advised).

### Copy Deadline

11.00 am Tuesday (Normal Rates)  
3.30 pm Tuesday (Double Rates)

## Subscriptions

VGG is available by three subscription services:

General and Special—\$106 each year  
General, Special and Periodical—\$122 each year  
Periodical—\$64 each year

Subscriptions are payable in advance and accepted for a period of one year. All subscriptions are on a firm basis and refunds for cancellations will not be given.

All payments should be made payable to VGPO.

Subscription inquiries: (03) 320 0217

Bookshop Inquiries: (03) 663 3760

1986 G 25 6 July 1988

**PROCLAMATION**

*Land Act 1958*

**PROCLAMATION OF ROAD**

I, J. Davis McCaughey, Governor of Victoria acting with the advice of the Executive Council and under section 25 (3) (c) of the *Land Act 1958* proclaim as road the following land:

**MUNICIPAL DISTRICT OF THE SHIRE OF ORBOST**

TABBARA—being the land in the Parish of Tabbara shown as Crown Allotments 28A, 30B and 30C section A on Certified Plan Nos. 108968, 108969 and 108970 lodged in the Central Plan Office—(L9-3759).

Given under my hand and the seal of Victoria on 28 June 1988

(L.S.) J. DAVIS McCAUGHEY

By His Excellency's Command

J. E. KIRNER

Minister for Conservation, Forests and Lands

*Victoria Government Gazette*

**GOVERNMENT NOTICES**

I hereby give notice that on 15 June 1988, the State Trust Corporation filed an election to administer the following deceased person's estate in accordance with section 22 of the *State Trust Corporation Act 1987*.

Mitchell, George, late of Kew, pensioner, died 19 June 1987.

Dated 29 June 1988

W. J. KILPATRICK

Managing Director  
State Trust Corporation

Creditors, next of kin, and others having claims against the estate of any of the undermentioned deceased persons are required to send particulars of their claims to the State Trust Corporation of Victoria, 168 Exhibition Street, Melbourne, Vic. 3000, the personal representative, on or before 7 September 1988, after which date the State Trust Corporation may convey or distribute the assets having regard only to the claims of which the State Trust Corporation then has notice:

Evans, George Edward Charles, also known as George Evans, late of 207 Tyler Street, East Preston, retired plumber, died 17 January 1988.

Hussen, Edith Stella, Flat 11/20 Shirley Court, Shirley Grove, East St. Kilda, pensioner, died 4 December 1987.

King, Ronald Leslie Arthur, late of 65 Southampton Street, Footscray, gentleman, died 21 December 1987.

Mitchell, George, later of Kew, pensioner, died 19 June 1987.

Muller, Wilfred August Carl, late of 48 Russell Place, North Williamstown, retired crane driver, died 25 February 1988.

Raila, Elena, formerly of Flat 22, 36 Dalgety Street, St. Kilda but late of Dromara House, 1 Enfield Street, St. Kilda, widow, died 3 November 1987.

Rickaby, Kathleen May, late of 22 Munro Street, East Hawthorn, widow, died 25 January 1988.

Dated Melbourne 29 June 1988

W. J. KILPATRICK

Managing Director  
State Trust Corporation

## Private Agents Act 1966

NOTICE OF RECEIPT OF APPLICATIONS FOR LICENCES UNDER THE PROVISIONS OF  
THE PRIVATE AGENTS ACT 1966

The Clerk(s) of the Magistrates' Court(s) as listed hereunder hereby give notice that applications, as under, have been lodged for hearing by the said Court(s) on the date(s) specified.

Any person desiring to object to any of such applications must—

- (a) lodge with the respective Clerk of the Magistrates' Court a notice in the prescribed form of his objection and of the grounds thereof;
- (b) cause a copy of such notice to be served personally or by post upon the applicant at least three days before the hearing of the application; and
- (c) send or deliver—
  - (i) where the objection is not made by the officer in charge of the police district in which the Court is situated—a copy of the notice to such officer; and
  - (ii) where the objection is not made by the Registrar or Deputy Registrar—a copy to the Registrar.

Full Name of Applicant*	Place of Abode of Applicant or Nominee	Name of Firm or Corporation	Address for Registration	Type of Licence	Date of Hearing
<b>MAGISTRATES' COURT, HEALESVILLE</b>					
Scales, Graham John	Lot 10, Fleay Rd, Healesville		Lot 10, Fleay Rd, Healesville	Process Server	10.8.88
" "	"		"	Inquiry Agent	"
Dated at Healesville, 22 June 1988 MICHAEL A. JONES, Clerk of the Magistrates' Court					
<b>MAGISTRATES' COURT, BRUNSWICK</b>					
Talbot, George William	213 Coburns Rd, West Melton	Night Watch Security Services, Pty Ltd	158 Sydney Rd, Coburg	Guard Agent	20.7.88
Dated at Brunswick, 27 June 1988 B. P. REGAN, Clerk of the Magistrates' Court					
<b>MAGISTRATES' COURT, OAKLEIGH</b>					
Ashton, Ann Louise	13 Lord St, Glenhuntly		13 Lord St, Glenhuntly	Inquiry Agent	26.7.88
Dated at Oakleigh, 28 June 1988 S. DOBSON, Clerk of the Magistrates' Court					
<b>MAGISTRATES' COURT, NORTHCOTE</b>					
Dawson, Paul Anthony	29 Tanner Gve, Northcote		29 Tanner Gve, Northcote	Inquiry Agent	5.8.88
Dated at Northcote, 24 June 1988 L. BARILLARD, Clerk of the Magistrates' Court					

\*Or in the case of a firm or corporation, of the Nominee

## PRIVATE AGENTS—continued

<i>Full Name of Applicant*</i>	<i>Place of Abode of Applicant or Nominee</i>	<i>Name of Firm or Corporation</i>	<i>Address for Registration</i>	<i>Type of Licence</i>	<i>Date of Hearing</i>
Carretero, Jose	MAGISTRATES' COURT, BROADMEADOWS 3 Stanlake St, Footscray		3 Stanlake St, Footscray	Watchman	26.7.88
			Dated at Broadmeadows, 28 June 1988 Clerk of the Magistrates' Court		
Irwin, Frederick William	MAGISTRATES' COURT, FERNTREE GULLY 80 Willow Ave, Rowville		118 Mountain Gate Shopping Centre	Inquiry Agent	4.8.88
			Dated at Ferntree Gully, 28 June 1988 A. J. CALDWELL, Clerk of the Magistrates' Court		
May, Terrence Andrew	MAGISTRATES' COURT, BENDIGO 24 Hercules St, Long Gully		Abel St, Bendigo	Watchman	22.7.88
			Dated at Bendigo, 28 June 1988 Clerk of the Magistrates' Court		
Hubbard, Jeff John	MAGISTRATES' COURT, MARYBOROUGH RMB 2457 Natte Yallock Rd, Alma		Lot 13 Taggart Dve, Daisy Hill	Watchman	22.7.88
			Dated at Maryborough, 28 June 1988 RUSSELL ISON, Clerk of the Magistrates' Court		
Pitts, Geoffrey Raymond Gollop, Ken William	MAGISTRATES' COURT, RINGWOOD 5/28 Burwood Rd, Hawthorn 10 Julie Rd, Croydon		634 Grattan St, Melbourne " "	Watchman " "	2.8.88 " "
			Dated at Ringwood, 28 June 1988 D. REES, Clerk of the Magistrates' Court		
Kerr, Craig Stephen	MAGISTRATES' COURT, MILDURA 16 Noyce Crt, Mildura		16 Noyce Crt, Mildura	Watchman	19.7.88
			P. J. KELLOW, Clerk of the Magistrates' Court		
Drake, Fay	MAGISTRATES' COURT, OAKLEIGH 256 Koornang Rd, Carnegie	Individual		Process Server	21.7.88
			Dated at Oakleigh 28 June 1988 W. WARD, Clerk of the Magistrates' Court		

\*Or in the case of a firm or corporation, of the Nominee

## PRIVATE AGENTS—continued

Full Name of Applicant*	Place of Abode of Applicant or Nominee	Name of Firm or Corporation	Address for Registration	Type of Licence	Date of Hearing
<b>MAGISTRATES' COURT, FERNTREE GULLY</b>					
Lee, Noel Albert Winston	24 Judith Ave, Boronia		24 Judith Ave, Boronia	Inquiry Agent	5.8.88
Dated at Ferntree Gully, 28 June 1988 A. J. CALDWELL, Clerk of the Magistrates' Court					
<b>MAGISTRATES' COURT, MELBOURNE</b>					
Balabin, Alexander	32 Watford Rd, St. Albans		32 Watford Rd, St. Albans	Inquiry Agent	22.7.88
Soriano, Rocco	155 Farrell St, Port Melbourne		155 Farrell St, Port Melbourne	Process Server	"
" "	"		"	Guard Agent	"
" "	"		"	Inquiry Agent	"
Leary, Timothy Nicholas	75 Stanhope St, West Footscray	Wormald Security	87 Racecourse Rd, North Melbourne	Watchman	"
Lichfield-Bennett, Stephanie	31 Vermont St, Glen Waverley	"	"	"	"
Luu, Minh Khoa	98 Francis St, Ascot Vale	"	"	"	"
Morgan, Jodie	3 Robin Pde, Healesville	"	"	"	"
Fogarty, Mark Allan	123 Roberts St, Essendon	TNT Security Pty. Ltd.	54 Racecourse Rd, North Melbourne	"	"
Costa, Dean John	29 Kitson Rd, Clayton South	"	"	"	"
Dated at Melbourne, 28 June 1988 W. BYRNE, Clerk of the Magistrates' Court					
<b>MAGISTRATES' COURT, NORTHCOTE</b>					
Lapierre, Patrick Dario	14/1 Collins St, Thornbury		14/1 Collins St, Thornbury	Inquiry Agent	5.8.88
Dated at Northcote, 30 June 1988 L. BARILLARO, Clerk of the Magistrates' Court					

\*Or in the case of a firm or corporation, of the Nominee

*Building Societies Act 1986*

## NOTICE OF CHANGE OF NAME

Notice is hereby given that Colonial Mutual Permanent Building Society which was on 4 September 1888 incorporated as a permanent building society, and is now duly incorporated under the provisions of the *Building Societies Act 1986*, has registered a change of name to Southern Permanent Building Society.

Given under my hand and seal at Melbourne  
22 June 1988

R. C. TREVETHAN  
Registrar of Building Societies

*Building Societies Act 1986*

## NOTICE OF CHANGE OF NAME

Notice is hereby given that Greater Melbourne Building Society which was on 22 July 1958 incorporated as a permanent building society, and is now duly incorporated under the provisions of the *Building Societies Act 1986*, has registered a change of name to Central Building Society.

Given under my hand and seal at Melbourne  
22 June 1988

R. C. TREVETHAN  
Registrar of Building Societies

1990 G 25 6 July 1988

**VICTORIAN GOVERNMENT MAJOR  
PROJECTS UNIT**

I, Evan Walker, Minister Responsible for Major Projects, hereby state that:

1. In relation to Major Project Control as referred to in the Administration of Acts Supplement to the General Order of 29 April 1986, dated 13 February 1987, and published in the *Government Gazette* on 18 February 1987, in addition to its existing responsibilities, the following major State project is the responsibility of the independent major projects unit known as the Victorian Government Major Projects Unit:

Redevelopment of the existing State Library and Museum and the development of the Queen Victoria Hospital site.

2. For the purposes of section 4 (1) (c) of the *Urban Land Authority Act 1979*, I have directed Maxwell Brian Roger and Richard William Parker, as delegates of the Urban Land Authority in relation to Major Project Control, and their successors, to assist in the implementation of State urban planning policies and major State projects through the acquisition, development and sale of land relating to the said projects.

Dated 27 June 1988

**EVAN WALKER**  
Minister Responsible for Major Projects

*Police Regulation Act Section 122*

**SALE OF UNCLAIMED MOTOR VEHICLE**

An owner is required for a 1972 Fiat Sedan, white colour, Registration No. ANN-083.

The vehicle came into possession of Police on 6 December 1987, and if not claimed, will be sold by public auction at the Port Melbourne Police Station, Cnr. Bay and Graham Streets, Port Melbourne, on Wednesday, 14 September 1988, at 10.00 a.m.

**K. GLARE**  
Chief Commissioner of Police

*Cemeteries Act 1958*  
**RULES AND REGULATIONS—BULLA  
PUBLIC CEMETERY**

In pursuance of the powers conferred upon them by the *Cemeteries Act* the Trustees of the Bulla Public Cemetery hereby make the following Regulation which shall come into operation upon publication in the *Government Gazette*.

Approval is required for the erection on a grave site of any structure whatsoever. Only memorials and surrounds constructed of permanent type

*Victoria Government Gazette*

materials (not including wood) will be approved. Furthermore any monument, headstone or grave surround erected after 1 June 1988 without the permission of the Bulla Cemetery Trust will be removed by the Order of the Trustees, if the unauthorised structure is not removed within 14 days of notification to the relevant party that the structure has been erected without permission.

JOHN MCKENZIE, Trustee  
IAN SOUTER, Trustee  
COLIN ROBERTSON, Trustee  
DONALD IRWIN, Trustee

Approved by the Governor in Council, 28 June 1988—LAWRENCE A. FISHER, Clerk of the Executive Council

*Cemeteries Act 1958*  
**RULES AND REGULATIONS—MILDURA  
PUBLIC CEMETERY**

In pursuance of the powers conferred upon them by the *Cemeteries Act* the Trustees of Mildura Cemetery hereby make the following Regulations which shall come into operation upon publication in the *Government Gazette*:

*Conditions regarding memorial works:*

- (a) A permit is to be submitted for approval of the Trust.
- (b) This approved permit will be directed to the Sexton.
- (c) The monumental mason must contact the Sexton prior to the commencement of works so that an exact grave site location can be given.
- (d) The hours for memorial works to be performed is limited to normal working hours, 8 a.m. to 5 p.m., Monday to Friday, subject to (e) below.
- (e) No works or after hours memorial work will be allowed without good reason and without the prior consent of the Sexton. If a grave site location is required outside normal working hours then an extra fee of \$25.00 is payable.

J. W. BLAIN, Trustee  
K. J. AVERY, Trustee  
A. R. BURR, Trustee  
R. A. ROGERS, Assistant Secretary

Approved by the Governor in Council, 28 June 1988—LAWRENCE A. FISHER, Clerk of the Executive Council

## TRAVEL AGENTS LICENSING AUTHORITY

The Travel Agents Licensing Authority hereby publishes two lists, namely:

- (i) A list of the holders of travel agents licences;
- (ii) A list of persons and corporations who are currently deemed to be the holders of travel agents' licences.

Suppliers of travel services should not deal with a person or corporation not included on either of the lists, unless that person or corporation is able to produce a travel agent's licence or can satisfy the supplier that he or she or it is exempt from being required to hold a licence.

SUE ALLEN, Registrar  
Travel Agents Licensing Authority

## LIST OF LICENSED TRAVEL AGENTS

Date of preparation: 30 June 1988

Date list comes into force: 6 July 1988

Date list ceases to be in force: 6 September 1988

<i>Name under which business conducted</i>	<i>Licensee</i>	<i>Licence Number</i>
602 Travel Agency	Connolly, Mollie Eileen	30530
A.A.T. Kings Tour Pty. Ltd.	A.A.T. Kings Tour Pty. Ltd.	30123
A.B.A.S. Travel Pty. Ltd.	A.B.A.S. Travel Pty. Ltd.	30450
A.L.M.S. Travel	Day, Owen Leonard	30753
A.L.M.S. Travel	Richardson, Bruce	30754
A.N.A. Travel Service	Trustees of the Australian Natives Association	30565
A.P.I. Travel Pty. Ltd.	A.P.I. Travel Pty. Ltd.	30118
A.R.E. Travel Service	Association of Railway Enthusiasts Ltd.	30535
Abelair Travel Centre	De Chalain, Elizabeth June	30256
Acland Travel Agency	Your Travel Agent Pty. Ltd.	30016
Acropolis Travel Agency	Hermes Overseas Baggage Agency Pty. Ltd.	30202
ACS Travel Pty. Ltd.	ACS Travel Pty. Ltd.	30271
Advance Tours and Travel	Advance Tours Pty. Ltd	31027
Adventure World Pty. Ltd.	Adventure World Pty. Ltd.	30114
African Dreams	Mariole, Herve Joseph Raymond	30769
African Dreams	Mariole, Lyziane	30961
Air Adventure Australia Pty. Ltd.	Air Adventure Australia Pty. Ltd.	30941
Air India	Air India	30596
Air New Zealand Ltd.	Air New Zealand Ltd.	30879
Airline Reservations Service	Ametco Travel Pty. Ltd.	30095
Alan Valpied Travel Pty. Ltd.	Alan Valpied Travel Pty. Ltd.	30442
Alfy Travel Agency	Alfy, Abdelmonei Ahmed	30555
ALIA—The Royal Jordanian Airline	ALIA—The Royal Jordanian Airline	30397
Alisons International Travel	Ali, Hassan Resa	30956
Alisons International Travel	Ali, Hassan Zulfaquar	30957
Alitalia	Alitalia Linee Aeree Italiane S.p.A	30925
All About Travel	Pojer, Peter Michael	30466
All Around Travel Service	Mirringle Promotions Pty. Ltd.	30609
All Coach Booking Centre	Forbes, Ronald McEwan	30419
All Coach Booking Centre	Makrikostas, Patricia Ray	30955
All Seasons Travel	O'Donnell, Raymond	30432
All World Travel	Sargut Pty. Ltd.	30285
Allaround Travel Service	Allaround Travel (Australia) Pty. Ltd.	30125
Allways Tours	Lockwood, Neil	30524

<i>Name under which business conducted</i>	<i>Licensee</i>	<i>Licence Number</i>
Allways Tours	Skinner, Geoffrey James	30525
Allways Tours	Neofitou, Anthony	30526
Allways Tours	Todaro, Antonio	30527
Allways Travel Service	Lockwood, Neil	30524
Allways Travel Service	Skinner, Geoffrey James	30525
Allways Travel Service	Neofitou, Anthony	30526
Allways Travel Service	Todaro, Antonio	30527
Alma Travel Service	Alma Travel Service Pty. Ltd.	30612
Alpine Travel and Shipping Agency	Jamapel Pty. Ltd.	31079
AM/PM Travel	Bennett, Joseph Laurence Alan	30826
Ambassador Travel Service (Melb.) Pty. Ltd.	Ambassador Travel Service (Melb.) Pty. Ltd.	30301
Ambassador Travel Service Pty. Ltd.	Ambassador Travel Service Pty. Ltd.	31014
American Express Travel Agency	American Express International Inc.	30233
American Express Travel Service	American Express International Inc.	30233
Ametco Travel Pty. Ltd.	Ametco Travel Pty. Ltd.	30095
Andes Pacific Travel Service	Andes Pacific Travel Service Pty. Ltd.	30647
Angeren Travel Service	Van Angeren, Albertus Antonius	30437
Angeren Travel Service	Van Angeren, Mavis Isabella	30438
Anke Travel Service	Anke Nominees Pty. Ltd.	30012
Anne M. Scerri (AMS) Travel Agent	Anne Scerri	30262
Ansett Airlines of Australia	Ansett Transport Industries (Operations) Pty. Ltd.	30170
Ansett International Travel	Ansett Transport Industries (Operations) Pty. Ltd.	30170
Ansus Travel Service Pty. Ltd.	Ansus Travel Service Pty. Ltd.	30134
ANZ Travel	Australia and New Zealand Banking Group Limited	30457
Apple Travel Pty. Ltd.	Apple Travel Pty. Ltd.	30165
Aquarius Travel Service	A.I.T. Holdings Pty. Ltd.	30385
Archivel Pty. Ltd.	Archivel Pty. Ltd.	31085
Archer Edney Travel Pty. Ltd.	Archer Edney Travel Pty. Ltd.	30516
Argonaut—E.M. Travel (Vic.) Pty. Ltd.	Argonaut—E.M. Travel (Vic.) Pty. Ltd.	30890
Argonaut Travel Service Pty. Ltd.	Argonaut Travel Service Pty. Ltd.	30357
Arizona Travel	Korn, Margit	30729
Arizona Travel	Korn, Leslie	30730
Arizona Travel	Edale Pty. Ltd.	30731
ARJ Travel Services	Stewart Moffat Travel Australia Pty. Ltd.	31012
Arjenta Travel	Arjenta Pty. Ltd.	30540
Around Australia Travel Pty. Ltd.	Around Australia Travel Pty. Ltd.	30920
Around Trip Travel Service	Logiudice, Vanda	30884
Around Trip Travel Services	Logiudice, Vincenzo	30185
Ashburton Travel Centre	First Mount Cope Pty. Ltd.	30027
Asian Dreams Holidays Pty. Ltd.	Asian Dreams Holidays Pty. Ltd.	30230
Asian Explorer Holidays Pty. Ltd.	Asian Explorer Holidays Pty. Ltd.	30776
Asian Travel Centre Pty. Ltd.	Asian Travel Centre Pty. Ltd.	30775
Assist Travel	Assist Personnel Services Pty. Ltd.	30915
Associated Promotions	W. J. Bashfield and Associates Pty. Ltd.	30337



<i>Name under which business conducted</i>	<i>Licensee</i>	<i>Licence Number</i>
Astjet Air Service Pty. Ltd.	Astjet Air Services Pty. Ltd.	30573
Astoria Travel Agency	Kyriacopoulos, Basil	30188
Astoria Travel Agency	Kyriacopoulos, Dimitra	30189
Astron Travel	Di Battista, Robert	30099
Astron Travel	Di Battista, Louise	30100
Astron Travel	Formica, Julie	30101
Astron Travel	Formica, Vince	30102
Atlas Travel Service Pty. Ltd.	Atlas Travel Service Pty. Ltd.	30221
Aupal Travel Agency	Slutzki, Leon	30693
AUS. Sail Australia	Aisha Nominees Pty. Ltd.	30672
Aussie Travel Centre	O'Donnell, Annette Mary	30433
Australasian Bird Tours	Doughty, Christopher John	30687
Australasian Bird Tours	Doughty, Christine Elaine	30931
Australian Church Travel Service	Stewart Moffat Travel Australia Pty. Ltd.	31012
Australian Coach Travel Pty. Ltd.	Australian Coach Travel Pty. Ltd.	30757
Australian Discovery Bicycle Touring Pty. Ltd.	Australian Discovery Bicycle Touring Pty. Ltd.	31017
Australian Farmers Travel	V.P. Travel Pty. Ltd.	30019
Australian Island Holidays	Stockdale Travel Pty. Ltd.	30790
Australian Pacific Tours Pty. Ltd.	Australian Pacific Tours Pty. Ltd.	30112
Australian Pacific World Travel	Australian Pacific Tours Pty. Ltd.	30112
Australian Tours Management Pty. Ltd.	Australian Tours Management Pty. Ltd.	30698
Australian Vintage Travel Agency Pty. Ltd.	Australian Vintage Travel Agency Pty. Ltd.	30836
Australian Wilderness Expeditions	A. J. Fraser & B. A. Galbally Pty. Ltd.	30927
Avgo Travel	Vandenham, Pamela Dawn	30485
Avgo Travel	Vandenham, Arnold Herman	30486
B.R. Travel Centre Pty. Ltd.	B.R. Travel Centre Pty. Ltd.	30127
Balaclava International Travel Pty. Ltd.	Balaclava International Travel Pty. Ltd.	30881
Balcombe Travel & Tours Pty. Ltd.	Balcombe Travel & Tours Pty. Ltd.	30747
Bali Tours Indonesian Specialists	Indonesia House Pty. Ltd.	30815
Bali Unlimited Centre	City Travel Centre Pty. Ltd.	30619
Balmoral Travel	Havegun Travel Pty. Ltd.	30761
Balnarring Travel Pty. Ltd.	Balnarring Travel Pty. Ltd.	30032
Barry McNaught Travel	Zana Fifty-Three Pty. Ltd.	30663
Bayview Travel	Murphy, David F.	30608
Beaumaris Travel Centre	Melranrod Pty. Ltd.	30626
Bellarine Travel	Benders Diesel Service Pty. Ltd.	30192
Bells Travel Service	Bell, Raymond Louis	30390
Bells Travel Service	Bell, Allan Douglas	30391
Belmont Centreway Travel	Paton, John Ronald	30400
Belmont Centreway Travel	Paton, Judith Lindsay	30821
Belmore Travel	Brian Campbell Travel Pty. Ltd.	30154
Benjamin, Darell Henry	Benjamin, Darell Henry	31062
Bentleigh Travel Centre	Bentleigh Travel Centre Pty. Ltd.	30798
Bentmore United Travel Pty. Ltd.	Bentmore United Travel Pty. Ltd.	30852
Bentours International Pty. Ltd.	Bentours International Pty. Ltd.	30620
Berwick Travel Pty. Ltd.	Berwick Travel Pty. Ltd.	30464
Best Travel Service	A.J.M. Enterprises Pty. Ltd.	30578

<i>Name under which business conducted</i>	<i>Licensee</i>	<i>Licence Number</i>
Biljana Travel Service	Kalincev, Mara	30396
Bill Healy Travel	Bill Healy Travel Pty. Ltd.	30414
Binalong Trekking	Kruize, Stephanie Ann	30973
Blackburn Travel	Thompson, Peter Howard	30917
Blackburn Travel	Thompson, Jenny Maree	30940
Blue Sapphire Travel Pty. Ltd.	Blue Sapphire Travel Pty. Ltd.	30487
Boronia Travel Centre	Malura Pty. Ltd.	31037
Bottom Line Discount Travel	Balaclava International Travel Pty. Ltd.	30881
Brandon Park Travel Agency Pty. Ltd.	Brandon Park Travel Agency Pty. Ltd.	30156
Breakaway International Travel Pty. Ltd.	Breakaway International Travel Pty. Ltd.	30014
Brian Campbell Travel Pty. Ltd.	Brian Campbell Travel Pty. Ltd.	30154
Brian Devlin's Travel Centre	Fara Quinta Nominees Pty. Ltd.	30522
Bright Chalet	O'Sullivan, Michael Francis	30381
Bright Chalet	O'Sullivan, Athalie Leonette	30382
Brighton Travelworld (Aust.) Pty. Ltd.	Brighton Travelworld (Aust.) Pty. Ltd.	30316
Britannia Travel Service	Haines, Brettwell Charles	30595
Bruce Shaw Travel Pty. Ltd.	Bruce Shaw Travel Pty. Ltd.	30380
Bruno D'Aprano Travel Pty. Ltd.	Bruno D'Aprano Travel Pty. Ltd.	30386
Bulleen Travel	Andrew Bonello Pty. Ltd.	30130
Bus Australia Holidays	Bus Australia Limited	31071
Bus Booking Centre	Imajolly Pty. Ltd.	30044
Business & Leisure Travel	Fleck, Laurette Marie Therese	30347
Business Holiday Travel (Australia) Pty. Ltd.	Business Holiday Travel (Australia) Pty. Ltd.	30560
Butterfly Travel Service Pty. Ltd.	Butterfly Travel Service Pty. Ltd.	30408
C-Mor Travel Services	C-Mor Travel Services Pty. Ltd.	30329
C.B.L. Tours	Castlemaine Bus Lines Pty. Ltd.	30210
C.D.M. Travel	De Marco, Coralie Rosenfield	30122
C.J. Travel	Johnston, Christine Suzanne	30637
C.P. Travel Pty. Ltd.	C.P. Travel Pty. Ltd.	30715
Camberwell Travel Service	Jaeggi, Othmar	30004
Camberwell Travel Service	Jaeggi, Angela Elma	30005
Camperdown Travel	Hillman, Jennifer Maree	30214
Canadian Airlines International	Canadian Pacific Air Lines Ltd.	30552
Capricorn Travel Pty. Ltd.	Capricorn Travel Pty. Ltd.	30194
Caras International Tours Pty. Ltd.	Caras International Tours Pty. Ltd.	30010
Caras Tours Pty. Ltd.	Caras Tours Pty. Ltd.	30011
Cardwell's Coach Travel	Cardwell, Gordon Lindsay	30030
Carefree Bali Holidays	Carefree Holidays Pty. Ltd.	30445
Carlton Travel Service Pty. Ltd.	Carlton Travel Service Pty. Ltd.	30313
Cathay Pacific Airways Ltd.	Cathay Pacific Airways Ltd.	30375
Caulfield Travel Agency	Massie, Janet Sarah	30778
Cedar Jet Travel & Insurance Service	Khoury, George Youssef	30109
Centralian Holidays Pty. Ltd.	Centralian Holidays Pty. Ltd.	30026
Centreway Travel	Liparota, Domenica	30885
Cerberus Travel	Dennis, Robert John	30216
Chaffey's World Wide Travel Service	R. H. Chaffey & Co. Pty. Ltd.	30031

<i>Name under which business conducted</i>	<i>Licensee</i>	<i>Licence Number</i>
Charter World Pty. Ltd.	Charter World Pty. Ltd.	30745
Cheltenham Travel Centre	Statewide Holiday Marketing Pty. Ltd.	30607
China Today	Panda Tours Pty. Ltd.	30762
Choice Travel Agency	Choice Travel Agency Pty. Ltd.	30306
Chris's Coaches Pty. Ltd.	Chris's Coaches Pty. Ltd.	30048
Christians Travel	W. Christian and Co. Pty. Ltd.	30520
CIT Australia Pty. Ltd.	CIT Australia Pty. Ltd.	30854
City Travel Centre	City Travel Centre Pty. Ltd.	30619
Claude Brown Travel	Brown, Claude Aloysius	30022
Clifton's Leisure Holidays Pty. Ltd.	Clifton's Leisure Holidays Pty. Ltd.	30229
Club Filipino	Wellington, Wayne Stanley	30168
Club Mediterranee (Australia) Pty. Ltd.	Club Mediterranee (Australia) Pty. Ltd.	30279
Co-Operative Tours	V. P. Travel Pty. Ltd.	30019
Co-Ordinated Travel	Glenister, Aldene Lesley	30490
Coburg Travel Centre	International Holiday Marketing Pty. Ltd.	30513
Cohuna Skyhigh Travel	Graham, Esmee Ann	30181
Colac Travel Service	K.J. Trav Pty. Ltd.	30066
Combined Associated Travel Services Limited	Combined Associated Travel Services Limited	30368
Compass Travel Pty. Ltd.	Compass Travel Pty. Ltd.	30494
Concept Tours	Teoh, Chye Hean	30206
Concept Tours	Teoh, Remedios Azucena	30519
Concorde Coach Tours	E. D. Kosloof & Son Pty. Ltd.	30477
Concord International Travel Pty. Ltd.	Concorde International Travel Pty. Ltd.	30204
Conference Associates	Australian Associates Pty. Ltd.	30264
Connection Holidays	French Caledonia Travel Service Pty. Ltd.	30717
Connection Travel	B.B.S. Travel Service Pty. Ltd.	30950
Conquest Tours	Bridgford, John Noel	30664
Consolidated Air Services Pty. Ltd.	Consolidated Air Services Pty. Ltd.	30572
Consolidated Travel	Parthenon Travel Service Pty. Ltd.	30195
Contal Travel Pty. Ltd.	Contal Travel Pty. Ltd.	30611
Contiki Travel (Australia) Pty. Ltd.	Contiki Travel (Australia) Pty. Ltd.	30997
Contours Travel Pty. Ltd.	Contours Travel Pty. Ltd.	30145
Convention Travel International	Beovich, Beverley	30436
Cook & Cook Travel	Cook, Geoffrey Haydon	30128
Cook & Cook Travel	Cook, Betty Lorraine	30261
Cooper Prince Travel	Cooper Prince Travel Pty. Ltd.	30002
Corner Exchange Travel	Benders Diesel Service Pty. Ltd.	30192
Corona Travel Pty. Ltd.	Corona Travel Pty. Ltd.	30695
Country Estate Tours Pty. Ltd.	Country Estate Tours Pty. Ltd.	30968
Countrywide Travel Pty. Ltd.	Countrywide Travel Pty. Ltd.	30937
Courtesy Travel Pty. Ltd.	Courtesy Travel Pty. Ltd.	30255
Cowes Travel Centre	Excell, Helen Margaret	30080
Cranbourne Travel Service	C-Mor Travel Services Pty. Ltd.	30329
Creative Tours Pty. Ltd.	Creative Tours Pty. Ltd.	30017
Croydon Flight Centre	Travelrite International Pty. Ltd.	30858
Croydon Travel Centre	Destination Holidays Pty. Ltd.	30298

<i>Name under which business conducted</i>	<i>Licensee</i>	<i>Licence Number</i>
Cruises Unlimited Centre	City Travel Centre Pty. Ltd.	30619
Cruising Australia	Stockdale Travel Pty. Ltd.	30790
CTC Cruises	C.T.C. Package Holidays Pty. Ltd.	30777
CTC Travel	C.T.C. Package Holidays Pty. Ltd.	30777
Custodian Travel Advisors	Edwards, Jennifer Anne	30297
Cyprus Enterprises Pty. Ltd.	Cyprus Enterprises Pty. Ltd.	30143
Darebin Travel Pty. Ltd.	Darebin Travel Pty. Ltd.	30176
D.J. Travel	Eganette Pty. Ltd.	31042
D.M. Travel	Wilson, Cornelia	30153
D.Q. International Travel Service P/L	D.Q. International Travel Service Pty. Ltd.	30224
Dalma Travel Service	Bakhsh, Robert	30989
Dalma Travel Service	Przastek, Rashida	30990
Dalma Travel Service	Przastek, Zbigniew	30991
Dalma Travel Service	Hart, Pamela Irene	30992
Dalma Travel Service	Hart, Graham John	30993
Danube Travel	Nagy-Drda, Margaret	30363
Deer Park Travel	Solomon, Graeme Robert	30676
Deer Park Travel	McNamara, John Patrick	30923
Dependable Travel Service	Harmon, Ingrid Verbinia	30302
Destination Holidays	Destination Holidays Pty. Ltd.	30298
Destiny Travel	V.P. Travel Pty. Ltd.	30019
Diamond Creek Travel	Bath, Gail Susan	30558
Diamond Creek Travel	James Avery and Associates Pty. Ltd.	30829
Diamond Valley Travel	Tim Hakins Travel Pty. Ltd.	30643
Dickies World Travel Centre	Dickie, Vance Charles Richard	30344
Dickies World Travel Centre	Dickie, Georgina Staniforth	30801
Direct Travel Service Pty. Ltd.	Direct Travel Service Pty. Ltd.	30724
Distinct Travel	Cardariu, Christina	31052
Distinct Travel	Ionescu, Eugen	31040
Dive Travel Australia	A.I.T. Holdings Pty. Ltd.	30385
Dominique Voyage Servis	Fernandez, Maxwell Valentine	30932
Doncaster Travel Agency	W.T. Travel Pty. Ltd.	30250
Donvale Travel Service	Gregorich, Eric Ivan	30218
Door Way Travel	Chambers, Graham Lytton	30654
Door Way Travel	Chambers, Betty May	30859
Drake Travel	Drake Personnel Limited	31007
Driver Coaches	Driver Bus Lines Pty. Ltd.	30935
Eaglemont Travel	Eaglemont Travel and Tours Pty. Ltd.	30193
East Burwood Travel Pty. Ltd.	East Burwood Travel Pty. Ltd.	30257
East End Travel Pty. Ltd.	East End Travel Pty. Ltd.	30317
East Gippsland Insurance and Orbost Travel Centre	Fatchen, Darryl William	30875
East-West World Travel	East-West Airlines (Operations) Limited	30040
Eastern Hill Travel Centre	Chalmers, Margaret May	30504
Eastern Hill Travel Centre	Cook, Michele Ann	30908
Easybudget Educational Tours Pty. Ltd.	Easybudget Educational Tours Pty. Ltd.	30599
Easybudget Tours	Easybudget Educational Tours Pty. Ltd.	30599

<i>Name under which business conducted</i>	<i>Licensee</i>	<i>Licence Number</i>
Echuca Holiday World	Makepeace, Roger Winston	30115
Echuca Holiday World	Makepeace, Lynette	30283
Echuca Sunshine Villas	Yakooli Nominees Pty. Ltd.	30291
Echuca Travel Centre	Yakooli Nominees Pty. Ltd.	30291
Ed Travel Pty. Ltd.	Ed Travel Pty. Ltd.	30444
Edgley Voyager Travel Pty. Ltd.	Edgley Voyager Travel Pty. Ltd.	30541
Edwards & White Travel Service Pty. Ltd.	Edwards & White Travel Service Pty. Ltd.	30029
Elders IXL Travel	Ansett Transport Industries (Operations) Pty. Ltd.	30170
Eliza Travel Pty. Ltd.	Eliza Travel Pty. Ltd.	30534
Eltham Travel	Pearson, Ian Victor	30324
Eltham Travel	Pearson, Visnja	30496
Energy Travel	Stewart Moffat Travel Australia Pty. Ltd.	31012
Entertainment Travel Services	Michael Edgley Holdings Limited	30723
Equatorial Travel	Chin Keong Pty. Ltd.	30606
Esplanade Travel, Lakes Entrance	Guillot, Cheryl Anne	30023
Esta Cardwell Numurkah Travel	Cardwell, Esta May	30556
Eurasia Travel	Gan, Lawrence	30589
Eurasia Travel	Gan, Stella	30928
Euroa Travel Service	Dewan, John Anthony	30500
Euroa Travel Service	Dewan, Helen Mary	30501
Europacific Travel Pty. Ltd.	Europacific Travel Pty. Ltd.	30461
European Travel Office Pty. Ltd.	European Travel Office Pty. Ltd.	30424
Everest Trekking Pty. Ltd.	Everest Trekking Pty. Ltd.	30498
Everything Travel	Travel Focus Australia Pty. Ltd.	30632
Exact Travel	F.M.A.H. Pty. Ltd.	30918
Exodus Travel Agency Pty. Ltd.	Exodus Travel Agency Pty. Ltd.	30684
Exotic Travel Service	Meyisti Pty. Ltd.	30407
Experience Tours Australia Pty. Ltd.	Experience Tours Australia Pty. Ltd.	31051
Explorer Travel Services Pty. Ltd.	Explorer Travel Services Pty. Ltd.	30773
Expo Adventure	Expo Adventure Pty. Ltd.	30068
Expo Travel Services	Expo Adventure Pty. Ltd.	30068
Expojet Travel Pty. Ltd.	Expojet Travel Pty. Ltd.	30828
Fairley's Travel World	James Fairley Pty. Ltd.	30374
Far and Near Travel Services	Salgram Nominees Pty. Ltd.	30217
Fare Deal Flights & Travel	Imajolly Pty. Ltd.	30044
Fargo Travel	Dekretser, Allan Rodney	30563
Fasciale Travel Services	Joe Fasciale & Associates Pty. Ltd.	30614
Fetco Travel	Stewart Moffat Travel Australia Pty. Ltd.	31012
Firmstone Tours	International Holiday Marketing Pty. Ltd.	30513
Five Star Travel	Five Star Travel (International) Pty. Ltd.	31033
Five Star Travel (International) Pty. Ltd.	Five Star Travel (International) Pty. Ltd.	31033
Flight Director	Flight Director Pty. Ltd.	30521
Fly High—Peacock	Szlamowicz, Suzanne	30865
Fly Outback Australia Pty. Ltd.	Fly Outback Australia Pty. Ltd.	31011
Fords Coach Travel Pty. Ltd.	Fords Coach Travel Pty. Ltd.	30728
Forest Hill Travel Service	Hickcox, Warren Stickel Pty. Ltd.	30389
Foster Travel Service	Davis and Linton Real Estate Pty. Ltd.	30328

<i>Name under which business conducted</i>	<i>Licensee</i>	<i>Licence Number</i>
Fountain Gate Travel Agency Pty. Ltd.	Fountain Gate Travel Agency Pty. Ltd.	30328
Four Corners Travel Service Pty. Ltd.	Four Corners Travel Service Pty. Ltd.	30327
Four Sea Travel Agency	Cathay Viceo Pty. Ltd.	30904
Frank Ford Travel	Richardson, Ian Francis Charles	30505
Frank Ford Travel	Richardson, Marjorie Lois	30900
Frankston Travel Pty. Ltd.	Frankston Travel Pty. Ltd.	30539
Fraser's Travel Service	Fraser, Hida May	30107
Fraser's Travel Service	Fraser, John	30108
French Caledonia Travel Service Pty. Ltd.	French Caledonia Travel Service Pty. Ltd.	30717
Friendly Travel Service Pty. Ltd.	Friendly Travel Service Pty. Ltd.	30251
G & R Giurco Travel Agency Pty. Ltd.	G & R Giurco Travel Agency Pty. Ltd.	30284
G.E.T. Educational Tours Pty. Ltd.	G.E.T. Educational Tours Pty. Ltd.	30137
G.E.T. Travel Service	Gippsland Educational Tours Hostel Pty. Ltd.	30138
G.S.T. Travel Services	Travel Service Excellence Pty. Ltd.	30656
Gadabout Holidays	Travelgroup Enterprises Pty. Ltd.	30862
Garrard Travel Service	Garrard, Edward Henry	30171
Garuda Indonesia	Garuda Indonesia	31025
Gateway Management Pty. Ltd.	Gateway Management Pty. Ltd.	30689
Geelong Travel Bureau Pty. Ltd.	Geelong Travel Bureau Pty. Ltd.	30472
Gem Tours and Travel Service	McQuade, Maurice Edwin	30749
Gem Tours and Travel Service	McQuade, Ida May	30916
General Sales Agents International Pty. Ltd.	General Sales Agents International Pty. Ltd.	30748
Geoff Broome's Travelworld	Travelgroup Enterprises Pty. Ltd.	30862
Geoffrey Rooks Travel	Rooks, Geoffrey Charles	30429
Geotravel International	Lesit Shipping International Pty. Ltd.	30051
Geraldine Dillon Tours—International	Dillon, Geraldine Anne	30312
German Travel Service	Jaeggi, Othmar	30004
German Travel Service	Jaeggi, Angela Elma	30005
Gilchrist's Terang Travel Service	T.T.S. Tours Pty. Ltd.	30163
Gippsland Travel Centre	Turner, Jacqueline	31045
Gippsland Travel Centre	Turner, Robert Stanley	31046
Gippsland World Travel	Thos Standing and Co Promotions Pty. Ltd.	30509
Giramondo Travel Agency	Giramondo, Luigi	30792
Giramondo Travel Agency	Giramondo, Maria	30910
Gisborne Travel Centre	Quaife, Glenys Mary	30198
Glenhantly Travel Agency	G.T.A. Nominees Pty. Ltd.	30228
Glenway Travel Centre	Ramnai Nominees Pty. Ltd.	30334
Glenwood Travel Pty. Ltd.	Glenwood Travel Pty. Ltd.	30628
Globus Tours	Contal Travel Pty. Ltd.	30611
Go Easy Travel	Edgley Voyager Travel Pty. Ltd.	30541
Go Travel	Motortramp Pty. Ltd.	30537
Goldair (Victoria) Pty. Ltd.	Goldair (Victoria) Pty. Ltd.	30091
Golden City World Travel	Baloo Pty. Ltd.	30398
Golden Globe Travel Service	Jaworski, Krystyna	30043
Golden Globe Travel Service	Jaworski, John	31029
Golden Wheels Travel	Centralian Holidays Pty. Ltd.	30026
Goldfields Travel	Stephens, Angela Elizabeth	30212
Gold Pass Travel Pty. Ltd.	Gold Pass Travel Pty. Ltd.	30827

<i>Name under which business conducted</i>	<i>Licensee</i>	<i>Licence Number</i>
Gordon Tours Australia	Hayfam (Australia) Pty. Ltd.	30639
Grampians Travel Centre	Sovereign Group Agents Pty. Ltd.	30439
Graphic Tours Pty. Ltd.	Graphic Tours Pty. Ltd.	30660
Great Journeys	Sorenson, Ingrid Alice	30369
Great Southern Travel Services	Travel Service Excellence Pty. Ltd.	30656
Great Wall Travel	Jet Stream Travel Pty. Ltd.	30759
Grecian Tours Pty. Ltd.	Grecian Tours Pty. Ltd.	30007
Group Speciality Travel	Dixon, Karen Aurelia	30247
Guildford Travel Service	Sinclair, Robyn Joy	30658
Gull Travel Pty. Ltd.	Gull Travel Pty. Ltd.	31048
Haere-Ra Travel Booking Agency	Waite, Graeme Patrick Allan	30736
Hales Travel	Thirty-Third Sward Pty. Ltd.	30564
Hallmark International Travel Pty. Ltd.	Hallmark International Travel Pty. Ltd.	30857
Hamilton Island Travel Pty. Ltd.	Hamilton Island Travel Pty. Ltd.	31035
Harp Travel	Gaist, Janet Kim	30463
Harvey World Travel (Sandringham)	Smith, Lynette Ann	30085
Hastings Travel	Rodwell, Victor Charles	30409
Hastings Travel	Rodwell, Glenda Marelyn	30410
Hawthorn Travel Pty. Ltd.	Hawthorn Travel Pty. Ltd.	30356
Hearn's Travel Service	Leisure Promotions Pty. Ltd.	30570
Heathmont Travel Service	Platt, James Campbell	30876
Heathmont Travel Service	Platt, Margaret Elaine	30967
Hegarty Travel	Hegarty, Shirley Josephine	30590
Heidelberg Travel Service Pty. Ltd.	Heidelberg Travel Service Pty. Ltd.	30434
Hemisphere Travel Pty. Ltd.	Hemisphere Travel Pty. Ltd.	30033
Herald Sun Travel Pty. Ltd.	Herald Sun Travel Pty. Ltd.	30280
Hermes Travel Agency Pty. Ltd.	Hermes Travel Agency Pty. Ltd.	30208
Hesters World Travel Service	Hester, William Andrew	30037
Highton Travel Pty. Ltd.	Highton Travel Pty. Ltd.	31043
Himalayan Odyssey Pty. Ltd.	Himalayan Odyssey Pty. Ltd.	30653
Holiday Asia	Majub Pty. Ltd.	30354
Holiday Club International Pty. Ltd.	Holiday Club International Pty. Ltd.	30768
Holiday Corner Pty. Ltd.	Holiday Corner Pty. Ltd.	30370
Holiday Makers	Holidaymakers Pty. Ltd.	30270
Holiday World Travel	Bevan, Robyn Gail	30557
Holland Gateway Tours	Muskens Bourke Travel Pty. Ltd.	30763
Holland Gateway Tours	Van Angeren, Albertus Antonius	30437
Holland Gateway Tours	Van Angeren, Mavis Isabella	30438
Honeymoon World	Sovereign Group Agents Pty. Ltd.	30439
Horsham Travel Centre	Olsen, Brian Charles	30276
Horsham Travel Centre	Carter, John Bertram	30869
Horsham Travel Centre	Carter, Neil	30870
Horsham Travel Centre	Pouliot, Ronald E.	30871
Horsham Travel Centre	Pouliot, Lynette Ann	30872
Houldens Tours Pty. Ltd.	Houldens Tours Pty. Ltd.	30841
House of Holidays Pty. Ltd. (The)	House of Holidays Pty. Ltd. (The)	30006
Howick Travel	Howick Travel Pty. Ltd.	31070

<i>Name under which business conducted</i>	<i>Licensee</i>	<i>Licence Number</i>
Hoy's Bon Accord (Harrierville)	Raymond Jennifer	31036
Hoy's Bon Accord (Harrierville)	Raymond, Kevin Francis	30800
Hoy's Tourist Service	Raymond, Jennifer	31036
Hoy's Tourist Service	Raymond, Kevin Francis	30800
Hua's Travel Centre	Chiu, Tyrone	30350
I.O.O.F. Travel	Matsam Pty. Ltd.	30222
I.T.B. International Travel Bonus	Business Holiday Travel (Australia) Pty. Ltd.	30560
Inflight Travel Service	Astawayne Pty. Ltd.	30384
Ian Nethersole Travel Pty. Ltd.	Ian Nethersole Travel Pty. Ltd.	30499
Impex International Travel Pty. Ltd.	Impex International Travel Pty. Ltd.	30428
Impulse Travel	Pearse, Malcolm Davidson	30996
In Vogue Travel Service	Number Two Janminga Pty. Ltd.	30147
In-Depth Tours	Worldvision Travel Pty. Ltd.	30034
Incentive Associates	Australian Associates Pty. Ltd.	30264
Ingall Marketing Group Pty. Ltd.	Ingall Marketing Group Pty. Ltd.	30616
Instant Travel	The Travel Bag Pty. Ltd.	30559
Intair	Wright, Geoffrey Clyde	30727
Inter Pacific Travel Pty. Ltd.	Inter Pacific Travel Pty. Ltd.	30586
International Sporting Tours Pty. Ltd.	International Sporting Tours Pty. Ltd.	30764
Interes	Business Holiday Travel (Australia) Pty. Ltd.	30560
International Community Travel	Kelly, Moira Bernadette	30746
International Community Travel	Rae, Clidna	30943
International Convention Management Services	Markey, Barrie James	30532
International Convention Management Services	Markey, Suzanne Elizabeth	30905
International Travel Alliance Limited	International Travel Alliance Limited	30164
Into Sport Australia Travel	Mort, Irene Beverley	31055
Intravel	Destination Holidays Pty. Ltd.	30298
Investour Travel Pty. Ltd.	Investour Travel Pty. Ltd.	30988
Ivanhoe Travel & Tours	Benders Diesel Service Pty. Ltd.	30192
J. Nakich Travel Agency	Nakic, Jakov	30479
J. C. Tours	Tanvale Pty. Ltd.	30045
Jacque Towers Connection Service	Towers, Jacque	30895
Jan Cameron Travel	Cameron, Jeanette Anne	30655
Janjet Tours & Cruises	Rollo, Janet Elizabeth	30352
Japan Air Lines Company Ltd.	Japan Air Lines Company Ltd.	30629
Japan Travel Bureau Australia Pty. Ltd.	Japan Travel Bureau Australia Pty. Ltd.	30281
JCT Australia Pty. Ltd.	JCT Australia Pty. Ltd.	30638
Jeff Cole's Travel Centre	Cole's Coaches Pty. Ltd.	30351
Jemison Rentals Pty. Ltd.	Jemison Rentals Pty. Ltd.	30475
Jet America Travel Service	Garabelli, Alberto	30335
Jet America Travel Service	Garabelli, Cristina	30901
Jet International Travel	Bacash, Karl Andrew	30889
Jet-Stream Travel	Jet Stream Travel Pty. Ltd.	30759
Jetabout	Q H Tours Limited	30480
Jetaround Travel Pty. Ltd.	Jetaround Travel Pty. Ltd.	30797
Jetset Tours Pty. Ltd.	Jetset Tours Pty. Ltd.	30597



<i>Name under which business conducted</i>	<i>Licensee</i>	<i>Licence Number</i>
Jetset Tours (Balaclava) Pty. Ltd.	Jetset Tours (Balaclava) Pty. Ltd.	30577
Jetset Tours (Coburg) Pty. Ltd.	Jetset Tours (Coburg) Pty. Ltd.	30148
Jetset Tours (Doncaster) Pty. Ltd.	Jetset Tours (Doncaster) Pty. Ltd.	30613
Jetset Tours (Footscray) Pty. Ltd.	Jetset Tours (Footscray) Pty. Ltd.	30411
Jetset Travel (Hawthorn) Pty. Ltd.	Jetset Travel (Hawthorn) Pty. Ltd.	30140
Jetset Tours (South Yarra) Pty. Ltd.	Jetset Tours (South Yarra) Pty. Ltd.	30732
Jetspace International Travel Agency	Affi, Mohamed	30481
Jetworld Air Services Pty. Ltd.	Jetworld Air Services Pty. Ltd.	30571
Jim Doumtses Travel Agency	Doumtses, Jim	30741
Jo Travel	Angost Pty. Ltd.	30349
John Marsh Australian Inbound Tours	John Marsh Travel Pty. Ltd.	30758
John Marsh Holiday Travel	John Marsh Travel Pty. Ltd.	30758
John Marsh Travel Management Services	John Marsh Travel Pty. Ltd.	30758
John Marsh Travel Pty. Ltd.	John Marsh Travel Pty. Ltd.	30758
John O. Lorry Pty. Ltd.	John O. Lorry Pty. Ltd.	30951
John Wharf Travel	Wharf, John Wason	30542
John Wharf Travel	Wharf, Mary Therese	30924
Jordan Travel	Stryker, Marilyn Ridsen	30116
J.R. Travel & Tours	Haltan Holdings Pty. Ltd.	30994
J.S. Travel	Alfalfa Pty. Ltd.	30104
Juanita Scott Travel Pty. Ltd.	Juanita Scott Travel Pty. Ltd.	30211
Just Flights	Imajolly Pty. Ltd.	30044
Just Fun Tours	Johns, Carolyn Joy	30220
Just Fun Tours	Johns, Ian	30784
K. Charles Travel Pty. Ltd.	K. Charles Travel Pty. Ltd.	30079
K. L. Kent Travel Affair Pty. Ltd.	K. L. Kent Travel Affair Pty. Ltd.	30592
KLM Royal Dutch Airlines	Koninklijke Luchtvaart Maatschappij N.V.	30718
Kangaroo Club Travel	Promco International Corporation Pty. Ltd.	30642
Kangaroo Flat Bus Lines Pty. Ltd.	Kangaroo Flat Bus Lines Pty. Ltd.	30945
Kangaroo Travel	Gordon, Michael	30774
Kenair Travel	Kenair Pty. Ltd.	30310
Kerang Skyhigh Travel	Graham, Alistair Hamish	30209
Kerang Skyhigh Travel	Graham, Lynn Maree	30820
Kevin J. Wickham Pty. Ltd.	Kevin J. Wickham Pty. Ltd.	30287
Kilsyth Montrose Travel Pty. Ltd.	Kilsyth Montrose Travel Pty. Ltd.	30071
Kingston Educational Travel	The Kingston Group Pty. Ltd.	30722
Kingston's Travel Pty. Ltd.	Kingston's Travel Pty. Ltd.	30806
Kirra Tours Limited	Kirra Tours Limited	30235
Korea Travel Service	Kim, Stephen	30770
Korea Travel Service	Yoon, Seong Ju	30771
Kronos Travel Service Pty. Ltd.	Kronos Travel Service Pty. Ltd.	30074
Kyneton Travel Centre	Peucker, James Henry	30393
Kyneton Travel Centre	Peucker, Nancy Elizabeth	30394
Lang Lang Travel	Westernport Roadlines Pty. Ltd.	30392
Langdons Travel Service	Langdon, Paul Arthur	30422
Langdons Travel Service	Langdon, Gregory William	30911
Langtree International Travel	Haenan, Wendy Margaret	30273

<i>Name under which business conducted</i>	<i>Licensee</i>	<i>Licence Number</i>
Langtree International Travel	Haenan, Peter Jacobus	30274
Langtree International Travel	Stewart Wilkinson Nominees Pty. Ltd.	30275
Lara Travel Pty. Ltd.	Lara Travel Pty. Ltd.	30515
Laros Travel Service Pty. Ltd.	Laros Travel Service Pty. Ltd.	30190
LAS—Administrative, Trade, Travel and Interpreting Centre	Stojanovski, Alex	30455
LAS—Administrative, Trade, Travel and Interpreting Centre	Stojanovski, Lilian	30975
Laser Travel	Innovation Marketing Finance Pty. Ltd.	30780
Latrobe Valley Travel	Firmin, Stanley William	30236
Leambe Travel Pty. Ltd.	Leambe Travel Pty. Ltd.	31069
Le Fils	China Safari Tours Pty. Ltd.	30268
Lemons Travel	Lemon, Doreen Frances	30075
Lemons Travel	Lemon, John Graeme	30244
Lensar Travel	Riversdale Manufacturing Company (Victoria) Pty. Ltd.	30376
Leongatha Travel and Stationery	Gray, David Allan	30665
Liaise Travel	Ausliday Travel Pty. Ltd.	30703
Lighthouse Travel	Ormond Pines Pty. Ltd.	30670
Lilydale Travel Centre	D. and R. Wyatt Pty. Ltd.	30296
Lombard Travel Agency	Pham, Duc Thien	31002
Lombard Travel Agency	Pham, Thi Thuy Duong	31003
London Walkabout Travel Centre	Kiplee Pty. Ltd.	30813
Lufthansa German Airlines	Deutsche Lufthansa Aktiengesellschaft	30959
Luv To Travel	White, David Miles	30240
Luv To Travel	White, Jo-Ellen	30938
M.I.T. Business Travel	Majestic International Travel Service Pty. Ltd.	30186
MA Promotions	Anderson, Margaret Ann	30399
Main Street Travel Agency (Mornington) Pty. Ltd.	Main Street Travel Agency (Mornington) Pty. Ltd.	30627
Major's Travel Service Australia	Marsalar Pty. Ltd.	30365
Malaysian Airline System	Malaysian Airline System	30929
Malta Travel Service	Ciantar Bros. Pty. Ltd.	30067
Malvern International Travel	Lang, Margaret Pamela	30465
Manila Group Airfares	Wellington, Wayne Stanley	30168
Manlius Travel Service Pty. Ltd.	Manlius Travel Service Pty. Ltd.	30793
Manning Travel	Manning, Roy James	30587
Mansfield Travel Service	Smith, Leslie Alfred	30289
Mansfield Travel Service	Smith, Doreen Sylvia	30493
Maren Evans	Evans, Maren	30719
Margaret Gurry Travel Pty. Ltd.	Margaret Gurry Travel Pty. Ltd.	30120
Market Travel	Varga, Eileen	30855
Market Travel	Pongrac, Tony	30856
Martens Travel Service	Martens, Susan Mary	30512
Martine's Travel World	Casey, Mark James	31005
Martine's Travel World	Williamson, Martine	31006
Maryborough Travel Service	R. J. Whitmore Pty. Ltd.	30395
Mastroianni's Travel Bureau	O'Meara Real Estate Pty. Ltd.	30295

<i>Name under which business conducted</i>	<i>Licensee</i>	<i>Licence Number</i>
Mauritius Affairs & Tours	Mariole, Herve Joseph Raymond	30769
Mauritius Affairs & Tours	Mariole, Lyziane	30961
M.B. Travel	Muskens Bourke Travel Pty. Ltd.	30763
McInnes Travel Centre	Farmair Pty. Ltd.	30265
McKenzie's Tourist Services Pty. Ltd.	McKenzie's Tourist Services Pty. Ltd.	30343
McKerlie's Travelfriends	McKerlie, Rev. Darrell John	30843
McKerlie's Travelfriends	McKerlie, Pamela Ruth	30844
Meadowvale Travel	Francis, Robert William	30456
Meadowvale Travel	Francis, Leanne Joy	30971
Melbourne Flight Centre Pty. Ltd.	Melbourne Flight Centre Pty. Ltd.	30136
Melton Traveland	Marvos Pty. Ltd.	30443
Mercantile Travel Pty. Ltd.	Mercantile Travel Pty. Ltd.	30489
Mercury World Travel	Gordon and Gotch Ltd.	30028
Meridian Travel Pty. Ltd.	Meridian Travel Pty. Ltd.	30038
Merlin Travel Service Pty. Ltd.	Merlin Travel Service Pty. Ltd.	30601
Mettravel Tours	Majestic International Travel Service Pty. Ltd.	30186
Mettravel Tours	Metro Friendly Society	30309
Metro Travel	Mrksa, Harry	30106
Metro Travel	Mrksa, Michael	30866
Metro Travel	Mrksa, Kris	30867
Metro Travel	Mrksa, Olga	30868
Midway Travel	Bennett, Joseph Laurence Alan	30826
Mildura Travel	Howick Travel Pty. Ltd.	31070
Minna Travel	Conte, Marina	30303
Mirabella Travel Pty. Ltd.	Mirabella Travel Pty. Ltd.	30267
Mirama Travel Service	Mirama Travel Service Pty. Ltd.	30047
ML Tours	ML Travel (Aust.) Pty. Ltd.	30677
ML Travel	ML Travel (Aust.) Pty. Ltd.	30677
M.M. Travel & Tours	Mauceri, Michael	31026
Modica Travel Service Pty. Ltd.	Modica Travel Service Pty. Ltd.	30179
Monahan International Tours	Monahan, Robert Peter	30502
Mondo Travel Agency	Garland Court Pty. Ltd.	30511
Monty Travel Centre	Mosbury Investments Pty. Ltd.	30574
Moonee Ponds Travel Agency	Caoustos, Basil	30415
Moonee Ponds Travel Agency	Mayrias, Denis	30416
Moonee Ponds Travel Agency	Trion Holdings Pty. Ltd.	30417
Mordialloc Travel	Wells, Kevin Lindsay	30084
Mordialloc Travel	Wells, Lila Louise	30150
Moreland Bus Lines Pty. Ltd.	Moreland Bus Lines Pty. Ltd.	30146
Morning Star International Travel	Network Court Pty. Ltd.	30985
Mornington Peninsula Travel Centre	Arthur, Lewis Paul	30025
Morrissey Tours and Travel	Sarraville Pty. Ltd.	30336
Mountain District Travel Centre Pty. Ltd.	Mountain District Travel Centre Pty. Ltd.	30348
Mt Pleasant Travel	Biviano, Domenico	30254
MTS International Tours	Modica Travel Service Pty. Ltd.	30179
Mulgrave Travel Service	Cullen, Robyn Ann	30630
Multinational Travel	Multinational Travel Pty. Ltd.	30330

<i>Name under which business conducted</i>	<i>Licensee</i>	<i>Licence Number</i>
Murray Valley Travel Pty. Ltd.	Murray Valley Travel Pty. Ltd.	30682
Muskens Bourke Travel Pty. Ltd.	Muskens Bourke Travel Pty. Ltd.	30763
Mylons Motorways Pty. Ltd.	Mylons Motorways Pty. Ltd.	30625
N.T.—Territory Holidays	Investnorth Management Pty. Ltd.	30966
National Australia Bank Limited	National Australia Bank Limited	30307
Navini Holidays	Deerah Holdings Pty. Ltd.	30213
Neale Hann Travel	Hann, Peter Frederick	30288
Neale Hann Travel	Stone, Ronald Allen	30893
Nepean Travel Centre	Nepean International Travel Pty. Ltd.	30426
Neptune Tourist and Travel Bureau	Gentiluomo, Flavia	30052
Neptune Tourist and Travel Bureau	Gentiluomo, Giovanni	30053
Neptune Tourist and Travel Bureau	Gentiluomo, Thomas Gaetano	30054
Neptune Tourist and Travel Bureau	Nazzari, Francesco	30055
Network Travel Marketing	Alimbin Pty. Ltd.	30805
New Zealand Tourist & Publicity Travel Office	New Zealand Tourist & Publicity Travel Office	30699
Nicholas Travel Consultants	Krestina Pty. Ltd.	30377
Noble Park Travel Centre	Page, Walter Thornton	30319
Noble Park Travel Centre	Page, Sue	30320
Noonan's There & Back Travel Agency	Magden Pty. Ltd.	30787
Norm McMillan Stock and Travel Agency	McMillan, Norman Murray	30231
Norm McMillan Stock and Travel Agency	McMillan, Joan Mary	30232
North End Travel	Marragata Pty. Ltd.	30379
North West Travel Centre	E. D. Kosloof & Son Pty. Ltd.	30477
Nova Travel	Edgley Voyager Travel Pty. Ltd.	30541
Novelty Tours	Darrington, Pamela Marjorie	30580
O.S. Ski Tours	O'Sullivan, Michael Francis	30381
O.S. Ski Tours	O'Sullivan, Athalie Leonette	30382
Oakleigh Travel Agency	Tubid Pty. Ltd.	30201
Oberon Travel	Barnett, George William	30799
Ocean Air Ticket Centre	Miltur Pty. Ltd.	30197
Ocean Grove Travel Pty. Ltd.	Ocean Grove Travel Pty. Ltd.	30514
Odra Travel Service (Aust.) Pty. Ltd.	Odra Travel Service (Aust.) Pty. Ltd.	30919
Olympic Airways S. A.	Olympic Airways S. A.	30282
Omega Travel	Skyrider International Pty. Ltd	30788
Orbit Travel Services Pty. Ltd.	Orbit Travel Services Pty. Ltd.	30538
Orchid Travel Pty. Ltd.	Orchid Travel Service Pty. Ltd.	30321
Organ's Bus Service Pty. Ltd.	Organ's Bus Service Pty. Ltd.	30508
Orient Express Travel Service Pty. Ltd.	Orient Express Travel Service Pty. Ltd.	30059
Orient Pacific Travel	Orient Pacific Holidays Pty. Ltd.	30063
Orientours Co.	Thompson, Graeme DeCastro	30304
Orrong Travel	The African Centre Pty. Ltd.	30680
Outback Downunder	Jonatee Pty. Ltd.	31074
Outdoor Travel Centre (Australia) P/L	Outdoor Travel Centre (Australia) Pty. Ltd.	30603
Ovens Valley Travel Services	Kukulka, Halina	30046
Owen Vollmer Travel	Vollmer, Owen Maxwell	30372
Oz International Travel Centre	Ayranci, Durdu Mehmet Ozdemir	30666

<i>Name under which business conducted</i>	<i>Licensee</i>	<i>Licence Number</i>
P.K. Travel Service	Kalliakoudis Peter	30345
P.C. Travel Pty. Ltd.	P.C. Travel Pty. Ltd.	30473
Pacesetter Travel Service	Volda Travel Pty. Ltd.	30358
Pacific Island Holidays Pty. Ltd.	Pacific Island Holidays Pty. Ltd.	31068
Pakenham Travel Agency	Webster, Rodney Charles	30650
Pakenham Travel Agency	Webster, Rosemary	30930
Pan Australian Wandana Travel Pty. Ltd	Pan Australian Wandana Travel Pty. Ltd.	31015
Panda Tours Pty. Ltd.	Panda Tours Pty. Ltd.	30762
Paramount Travel Service	Paramount Travel Service Pty. Ltd.	30081
Parkmore Travel Centre	Page, Walter Thornton	30319
Parkmore Travel Centre	Page, Sue	30320
Passport Europe	Curnow Holdings Pty. Ltd.	30850
Passport Travel	McCunn, Brent Alexander	31054
Pat & Rons Tours	Forbes, Ronald McEwan	30419
Paxton Travel	The Incentive Consultants Pty. Ltd.	30359
Pat & Rons Tours	Makrikostas, Patricia Ray	30955
PBE Travel	Ginn, Dennis Reginald	30851
Peden's (Vic.) Pty. Ltd.	Peden's (Vic.) Pty. Ltd.	30553
Pelagonia Tourist	Spasov, Trajan	30849
Pelagonia Tourist	Spasov, Milica	30921
Pellegrino Travel Agency (Ringwood)	Pellegrino, Maria	30958
Pelligrino Travel Agency (Ringwood)	Pelligrino, Charles	30492
Penny Broome Travel	Broome, Penelope Clare	30982
Peregrine Adventures	Adventure Centre Pty. Ltd.	31009
Peregrine International Pty. Ltd.	Peregrine Internation Pty. Ltd.	30789
Peter Daniels & Company	Tirpkou, Peter Daniel	30979
Phar Lap Travel	Saville, Susan Ann	30952
Phar Lap Travel	Russell, John Michael	30953
Pharmacy Travel Service	Stewart Moffat Travel Australia Pty. Ltd.	31012
Phil Australia Travel	Vargas, Ricardo	30913
Philippine Airlines Inc.	Philippine Airlines Inc.	30227
Philippine Promotion Centre	Majub Pty. Ltd.	30354
Philippine Tours	Villager Pty. Ltd.	30126
Philippine Travel Agency	Direct Travel Service Pty. Ltd.	30724
Philomena's Travel Service	Miriad Travel Centres Pty. Ltd.	31058
Pivot Travel	Debromel Pty. Ltd.	30634
Pivot Travel	Malviste, Heinz Helmut	30633
Pivot Travel	Malviste, Nola Joy	31030
Pivot Travel	Solomons Pty. Ltd.	30635
Plain Flying Pty. Ltd.	Plain Flying Pty. Ltd.	30431
Plaza Travel	ACTA Pty. Ltd.	30277
Portland Coach Company Pty. Ltd.	Portland Coach Company Pty. Ltd.	30133
Portland Travel Pty. Ltd	Portland Travel Pty. Ltd.	30378
Portside Travel Pty. Ltd.	Portside Travel Pty. Ltd.	30491
Postup Ukrainian Co-operative Trading Society Ltd.	Postup Ukrainian Co-operative Trading Society Ltd.	30018
Prahran Travel Service Pty. Ltd.	Prahran Travel Service Pty. Ltd.	30207

<i>Name under which business conducted</i>	<i>Licensee</i>	<i>Licence Number</i>
Preferred Travel Services	P.T.S. Pty. Ltd.	30497
Premium Tours Pty. Ltd.	Premium Tours Pty. Ltd.	31024
Preston Travel Service Pty. Ltd.	Preston Travel Service Pty. Ltd.	30162
Preston Travel Westfield Pty. Ltd.	Preston Travel Westfield Pty. Ltd.	30838
Prima Holidays Ltd.	Prima Holidays Ltd.	30049
Priority Travel Pty. Ltd.	Priority Travel Pty. Ltd.	30974
Promco Travel Agency	Promco International Corporation Pty. Ltd.	30642
Promotivation Australia	Asian Dreams Holidays Pty. Ltd.	30230
P. R. Tours	Rickard, Pauline	31066
Putnik Travel Agency Pty. Ltd.	Putnik Travel Agency Pty. Ltd.	30249
Pyramid Travel	Farrow Travel Agency Pty. Ltd.	30064
Qantas Airways Limited	Qantas Airways Limited	30362
Quinces International Tours	Quinces Scenicruisers Pty. Ltd.	30568
R.J. Travel	R. J. Travel Pty. Ltd.	30688
R.J. Travel Pty. Ltd.	R.J. Travel Pty. Ltd.	30688
RACV Travel Service	Royal Automobile Club of Victoria	30752
Rainwood Pty. Ltd.	Rainwood Pty. Ltd.	30825
Ram Travel Service Pty. Ltd.	Ram Travel Service Pty. Ltd.	30986
Rapid Travel Pty. Ltd.	Rapid Travel Pty. Ltd.	30942
Rapitravel Pty. Ltd.	Rapitravel Pty. Ltd.	31010
Rathdowne Travel and Tours	Travelmaster Australia Pty. Ltd.	30469
Real Holidays Pty. Ltd.	Real Holidays Pty. Ltd.	30340
Rechner's Travel	Rechner, Janice Margaret	30245
Rechner's Travel	Rechner, Colin James	30371
Red & Black Travel Service Pty. Ltd.	Mijobi Travel Pty. Ltd.	31049
Red Carpet Travel Service	R.C.T.S. Travel Pty. Ltd.	30243
Redi Travel	Dandenong Credit Union Cooperative Ltd.	30402
Regency Travel Pty. Ltd.	Regency Travel Pty. Ltd.	30008
Regis E. Masset & Associates Travel Consultants	Masset, Regis Emmanuel	30088
Regis E. Masset & Associates Travel Consultants	Masset, Gisela Marie	30152
Reho Travel (Australia) Pty. Ltd.	Reho Travel (Australia) Pty. Ltd.	30878
Reliance Travel Australia	Chow, Helen Kineng	30474
Rex Hunt Fishing World Travel	Rex Hunt Fishing World Travel Pty. Ltd.	31053
RHSV Tours	Council of the Horticultural Societies and Clubs of Victoria (Inc.)	31041
Richmond Travel Brokers	Lockyer, Leah Ellen	30864
Right Connections Travel	Hartney, Gloria Margaret	30373
Riviera International Travel	Meilak, Elizabeth	30880
Riveria International Travel	Meilak, Margaret	30926
Road Runner Travel Pty. Ltd.	Road Runner Travel Pty. Ltd.	30786
Road Tours Australia Pty. Ltd.	Road Tours Australia Pty. Ltd.	30998
Ron's Tourist Centre Mildura	Price, Ronald James	30318
Ron's Tourist Centre Mildura	Price, Mary Jacinta	30605
Rose City Travel Centre	Marril Pty. Ltd.	30139
Rose Travel Service	Parkes, Rose	30087
Rosebud Travel House	Arthur, Lewis Paul	30025

<i>Name under which business conducted</i>	<i>Licensee</i>	<i>Licence Number</i>
Ross Hallam Travel (Wholesale) Pty. Ltd.	Ross Hallam Travel (Wholesale) Pty. Ltd.	30528
Round Travel	Vavala, Maria	30582
Roundworld Travel	Roundworld Holdings Pty. Ltd.	31000
Royal Nepal Holidays	Roka, Gopi Bahadur	31018
Russell Travel and Tours International	Cacoyiannis, Dinos	30667
Rye Travel	Greentown Pty. Ltd.	30360
S.C. Travel	Brasier, Sandra joy	30155
S. M. Tours	Stewart Moffat Travel Australia Pty. Ltd.	31012
Safeway Travel	Malawi Pty. Ltd.	30459
Samlor Adventure Tours	Alma Travel Service Pty. Ltd.	30612
San Michele Travel Pty. Ltd	San Michele Travel Pty. Ltd	30710
Sanford Travel	Indigoday Pty. Ltd.	30412
Sandringham Travel	Woodward, Francis Maclean	30292
Sandringham Travel	Brown, Maureen	30488
SAS Scandinavian Airlines	Scandinavian Airlines System	30495
Seaford Travel Pty. Ltd.	Seaford Travel Pty. Ltd.	30404
Select Travel	Golden Tours & Travel (Australia) Pty. Ltd.	30458
Sevastopoulos Travel Service	Sevastopoulos, Haralambous	30711
Seven Seas International Travel	Bauer, Yvonne	30506
Seymour Travel Centre	Crowther, Helen Mary	30976
Seymour Travel Centre	Crowther, Rodney	30984
Shangri-La Holidays	Good Harvest Pty. Ltd.	30914
Sheeran's Australian Colonial Travel	Mulomme Pty. Ltd.	30760
Shepparton Travel Centre	Hainsworth, Carl John	30451
Shepparton Travel Centre	O'Connor, Brian Francis	30452
Shepparton Travel Centre	Hainsworth, Jennifer May	30453
Shepparton Travel Centre	O'Connor, Maureen Therese	30454
Shipjet	Stewart Moffat Travel Australia Pty. Ltd.	31012
Ships and Trips	Smith, Margery May	30366
Short Cut Travel Pty. Ltd.	Short Cut Travel Pty. Ltd.	30470
Showgrounds Travel	S.R.S. Sprinklers Pty. Ltd.	30668
Sierra Holiday Travel International	Brown, Ruth Margaret	30584
Sierra Holiday Travel International	Brown, John Arthur	30765
Signature Travel	J.R. & B.L. Young Pty. Ltd.	30708
Signature Travel	W.R. & J.L. Metcalfe Pty. Ltd.	30944
Silver Tours and Travel	The Alternative Travel Specialist Pty. Ltd.	30837
Singapore Airlines Limited	Singapore Airlines Ltd.	30624
Sitmar Cruises Ltd.	Sitmar Cruises Ltd.	30058
Skylords' Travel Service	Jaric, Phillip	30387
Skyrider—Omega Travel	Skyrider International Pty. Ltd.	30788
Skyrider International Pty. Ltd.	Skyrider International Pty. Ltd.	30788
Skyrider Travel Elsternwick	Skyrider International Pty. Ltd.	30788
Skyrider Travel Malvern	Skyrider International Pty. Ltd.	30788
Skyway Travel International Pty. Ltd.	Skyway Travel International Pty. Ltd.	31001
Skyworld Travel Service	Kabella Pty. Ltd.	31039
Small World Travel Pty. Ltd.	Small World Travel Pty. Ltd.	30242
Snow Ski Travel	J.E.H. Computer Management Service Pty. Ltd.	30949

<i>Name under which business conducted</i>	<i>Licensee</i>	<i>Licence Number</i>
Snowfun Holidays	Short, Frank Harry	30842
South Caulfield Travel Service	Patience, Geoffrey Simon	30737
South Gippsland Tourist Agency Pty. Ltd.	South Gippsland Tourist Agency Pty. Ltd.	30070
South Yarra Travel	Rogers, Bruce Ellison	30215
South Yarra Travel	Rogers, Paul Adrian	31031
South Yarra Travel	Rogers, Norma Joan	31032
Southwest Travel Service	Matheson, Ian	30346
Southwest Travel Service	Matheson, Patricia Ann	30818
Sovereign World Travel	Sovereign Group Agents Pty. Ltd.	30439
Special Gippsland Tour Departures	Turner, Jacqueline	31045
Special Gippsland Tour Departures	Turner, Robert Stanley	31046
Special Interest Tours & Travel	McMaster, Hugh Theodore John	30476
Special Interest Tours & Travel	McMaster, Lorraine Lillian	30903
Sports Extra Travel	Dragica, Cirkovic	30546
Springvale Flight & Travel Centre	Imajolly Pty. Ltd.	30044
Springvale Flight Centre	Imajolly Pty. Ltd.	30044
Springvale Travel Centre	Imajolly Pty. Ltd.	30044
S.T.A. Travel	Student Travel Australia Pty	30808
St. Arnaud Travel Centre	Sampson, Janice Lorraine	30326
St. Kilda Road Travel	Asian Dreams Holidays Pty. Ltd.	30230
Standard Travel Pty. Ltd.	Standard Travel Pty. Ltd.	30086
Stewart Moffat Travel Australia Pty. Ltd.	Stewart Moffat Travel Australia Pty. Ltd.	31012
Stockdale Travel Pty. Ltd.	Stockdale Travel Pty. Ltd.	30790
Stojan Photo Studio & Kompas Travel	Dongovski, Stojan	30252
Stojan Photo Studio & Kompas Travel	Dongovski, Anna	30253
Stork Travel	Gadecki, Christopher	30579
Stotts Travel Services	Stotts Correspondence College Pty. Ltd.	30807
Strathmore Travel Centre	Watson, Marlene	30041
Strathmore Travel Centre	Watson, Michael John	30042
Sue Leitz Travel	Leitz, Susan Wayne	30965
Sue Wood & Associates Pty. Ltd.	Sue Wood & Associates Pty. Ltd.	30972
Sun Centre Tourism Company	Sun Centre Tourism Company	30361
Sunbird Travel Services	Sunbird Travel Services Pty. Ltd.	30073
Sunbury Travel	L. & C. Birch Nominees Pty. Ltd.	30462
Suncity Tourist Office	Kalms, Laurence Frederick	30742
Suncity Tourist Office	Kalms, Norma Elizabeth	30906
Sundowners Travel Centre Pty. Ltd.	Sundowners Travel Centre	30093
Sunny Adriatic Travel	Committed Pty. Ltd.	30644
Sunshine Travel Service Pty. Ltd.	Sunshine Travel Service Pty. Ltd.	30286
Supareps Australia	Asian Dreams Holidays Pty. Ltd.	30230
Superior Travel Service	Brooks, William Elliott	31021
Superior Travel Service	Brooks, Jennifer	31022
Supertravel	Super Travel Pty. Ltd.	30121
Surfers Paradise Booking Service	Innovation Marketing Finance Pty. Ltd.	30780
Surfers Paradise Holidays & Accommodation Pty. Ltd.	Surfers Paradise Holidays & Accommodation Pty. Ltd.	30057
Susan's Travel Service	Gimesy, Susan Barbara	30441



<i>Name under which business conducted</i>	<i>Licensee</i>	<i>Licence Number</i>
Swiss Travel Centre	Jaeggi, Othmar	30004
Swiss Travel Service	Jaeggi, Angela Elma	30005
Swissair Pty. Ltd.	Swissair Pty. Ltd.	30446
T. & A. Wings Away Travel Services	Rogers, Elizabeth Anne	30467
T. & A. Wings Away Travel Services	Rogers, Barry Anthony	30894
T. & S. International Travel Service	Saliba, Antonio	30076
T. & S. International Travel Service	Regan, Susan Mary	30077
Tailor Made Travel	Peddle, Rosemary Anne	30478
Tailored Tours	Rubens, Paul	30543
Tailored Tours	Dean, Norman Frederick	30544
Taking Off Tours Pty. Ltd.	Taking Off Tours Pty. Ltd.	30305
Talk About Travel	McGorlick, Bente	30124
Talk About Travel	McGorlick, Kerry Graham	31013
Tapa Tours	Business Holiday Travel (Australia) Pty. Ltd.	30560
Tara International Travel Pty. Ltd.	Tara International Travel Pty. Ltd.	31078
Telstar Travel	Stewart Moffat Travel Australia Pty. Ltd.	31012
Thai Airways International Ltd.	Thai Airways International Ltd.	30585
The Alfred's Travel Service	Eaglemont Travel & Tours Pty. Ltd.	30193
The Australian Outback Travel Company Pty. Ltd.	The Australian Outback Travel Company Pty. Ltd.	31057
The Australian Travel Exchange Pty. Ltd.	The Australian Travel Exchange Pty. Ltd.	30094
The Cruise Shop	Debromel Pty. Ltd.	30634
The Cruise Shop	Malviste, Heinz Helmut	30633
The Cruise Shop	Malviste, Nola Joy	31030
The Cruise Shop	Solomons Pty. Ltd.	30635
The Fares Factory	Houghton, Elizabeth Thackray	30794
The Flight Brokers	McCracken, Robert Anthony	30083
The Flight Shop Pty. Ltd.	The Flight Shop Pty. Ltd.	30009
The Holiday Booking Office	Holiday Booking Office Pty. Ltd.	30322
The Missing Link Travel Service	Griffiths, David James	30795
The Pioneer Store	Carsad Pty. Ltd.	30278
The Pioneer Store	Shanceh Industries Pty. Ltd.	31047
The Ticket Shop	McDonald, Brenda Kathleen	30078
The Ticket Shop	Ellis, Norma Frances	30103
The Travel Bag Pty. Ltd.	The Travel Bag Pty. Ltd.	30559
The Travel Bug Pty. Ltd.	The Travel Bug Pty. Ltd.	30483
The Travel Factory	Clift, Anthony Joseph	30651
The Travel Factory	Clift, Diana Mary	30652
The Travel Professionals Pty. Ltd.	The Travel Professionals Pty. Ltd.	30098
Thomas Cook State Bank Travel	Thomas Cook Pty. Ltd.	30050
Thomas Cook Travel	Thomas Cook Pty. Ltd.	30050
Thomson Professional Travel Service	Thomson, Graeme DeCastro	30304
Thornbury Travel Agency	De Vincentis, Rocco	30241
Thornbury Travel Agency	De Vincentis, Ercole	30898
Tip Top Travel	Kamusinski, Barbara	30646
Tip Top Travel	Kamusinski, Wladyslaw	30981
Tishler Travel Service	Tishler, Deborah	30423

<i>Name under which business conducted</i>	<i>Licensee</i>	<i>Licence Number</i>
Tivoli Travel	Benders Diesel Service Pty. Ltd.	30192
Tony Marino Insurance and Travel Agency	Marino, Antonio	30934
Tony Marino Insurance and Travel Agency	Marino, Maria Teresa	30947
Top Deck Travel	Top Deck Travel Pty. Ltd.	30135
Top Travel Service	Ghezzi, Luigi	30177
Top Travel Service	Ghezzi, Mary	30694
Torquay Travel	Barmby, Garry Cecil Bryce	30263
Torquay Travel	Seidel, Gavin Munro	30418
Torre Travel	Torre, Charles	30234
Total Travel Pty. Ltd.	Total Travel Pty. Ltd.	30645
Tour and Travel Plan	Kyriacopoulos, Nicholas	30405
Tour and Travel Plan	Kyriacopoulos, Magdalena	30406
Tourist Express Travel Agency	Dudic, Natalija	30259
Tourmakers	Van Den Berg, Helen Margot	30510
Tourmakers	Van Den Berg, Jack	30978
Townhouse Travel	Barmby, Garry Cecil Bryce	30263
Townhouse Travel	Seidel, Gavin Munro	30418
Trade Centre Travel Pty. Ltd.	Trade Centre Travel Pty. Ltd.	30636
Tradewinds Travel Pty. Ltd.	Tradewinds Travel Pty. Ltd.	30832
Trans Otway Travel	Trans Otway Travel Pty. Ltd.	30720
Trans World Travel Pty. Ltd.	Trans World Travel Pty. Ltd.	30178
Trans-Universe Travel Agency	Butt, Thomas Man-Chat	30707
Travel and Conventional Management	Remington Travel Group Pty. Ltd.	30733
Travel and Tour Corporation of Australia Pty. Ltd.	Travel and Tour Corporation of Australia Pty. Ltd.	30588
Travel Associates Pty. Ltd.	Travel Associates Pty. Ltd.	30421
Travel Centre Bendigo Pty. Ltd.	Travel Centre Bendigo Pty. Ltd.	30460
Travel Desk International Pty. Ltd.	Travel Desk International Pty. Ltd.	30169
Travel Discounters	Candela Nita Nominees Pty. Ltd.	30246
Travel First (Australia)	Potter, John Stephen Lockyer	30738
Travel Forum (Vic) Pty. Ltd.	Travel Forum (Vic) Pty. Ltd.	30060
Travel Grant Australia	Height Rowley & Associates Pty. Ltd.	30315
Travel Life	Aisha Nominees Pty. Ltd.	30672
Travel Now Pty. Ltd.	Travel Now Pty. Ltd.	30468
Travel Plus Travel Service	Daniels, John William	30549
Travel Plus Travel Service	Daniels, Moira Frances	30550
Travel Quest Pty. Ltd.	Travel Quest Pty. Ltd.	30659
Travel Scene Pty. Ltd.	Travel Scene Pty. Ltd.	30618
Travel Time	Ancar Australia Pty. Ltd.	30671
Travel Trend International Pty. Ltd.	Travel Trend International Pty. Ltd.	30669
Travel Wings Pty. Ltd.	Travel Wings Pty. Ltd.	30594
Travel World Travel Service Pty. Ltd.	Travel World Travel Service Pty. Ltd.	30683
Travelaire Intercontinental Tour Pty. Ltd.	Travel Intercontinental Tour Pty. Ltd.	30662
Traveland At Carlton Place	C.G.B. Investments Pty. Ltd.	30311
Traveland Pty. Ltd.	Traveland Pty. Ltd.	30591
Travelbound—Balwyn	Mowat, John Geoffrey	30962
Travelcade of Bayswater	Alburnam Pty. Ltd.	30196

<i>Name under which business conducted</i>	<i>Licensee</i>	<i>Licence Number</i>
Traveldale Warragul Pty. Ltd.	Traveldale Warragul Pty. Ltd.	30174
Traveze Pty. Ltd.	Traveze Pty. Ltd.	30341
Travellers Unanimous	Van Der Berg, Helen Margot	30510
Travellers Unanimous	Van Der Berg, Jack	30978
Travelmakers Pty. Ltd.	Travelmakers Pty. Ltd.	30191
Travelmart International	Travelmart International Pty. Ltd.	30810
Travelmaster Australia Pty. Ltd.	Travelmaster Australia Pty. Ltd.	30469
Travelplan Australia Pty. Ltd.	Travelplan Australia Pty. Ltd.	30167
Travelrite Croydon	Travelrite International Pty. Ltd.	30858
Travelrite International	Travelrite International Pty. Ltd.	30858
Travelscope	Bennett, Lorraine Isabel	30704
Travelstrength Limited	Travelstrength Limited	30161
Travman	Panda Tours Pty. Ltd.	30762
Trekset (Aust) Pty. Ltd.	Trekset (Aust) Pty. Ltd.	30896
Trevor Lloyd Travelling Centre	Lloyd, Frederick Trevor	30184
Triandos Transport and Travel Pty. Ltd.	Triandos Transport and Travel Pty. Ltd.	30072
Trident Travel	Belfalas Pty. Ltd.	30180
Trish Stamp Travel	Stamp, Patricia Brenda	30200
Tsitsanis Travel	Tsitsanis, Andreas	30151
Tsitsanis Travel	Tsitsanis, Agoritsa	30816
Tura Travel	Guler, Tulay	30440
Turkair Travel Service	Gurpinar, Kemal Howard	30886
Tut Travel	Morcos, Bassilios Aziz	30661
Tut Travel	Morcos, Amira	30946
Tyam Travel & Tours	Tyam Pty. Ltd.	31020
United Air Lines Inc.	United Air Lines Inc.	30766
United Kingdom Settlers Association	United Kingdom Settlers Association	30290
United Travel Agencies	Aust-Franc Trade Pty. Ltd.	31065
Unitours	Unitours (Vic) Pty. Ltd.	30089
UTA (Union De Transports Aeriens)	UTA (Union De Transports Aeriens)	30239
V. G. Travel	Gigliotti, Vittorio	30575
V. P. Travel Pty. Ltd.	V. P. Travel Pty. Ltd.	30019
Vacations International	Viva! International Pty. Ltd.	30062
Venture Holidays	Jaces Pty. Ltd.	30631
Vermont South Travel	Nicholson, Kenneth Alan	30172
Vermont South Travel	Nicholson, Veronica Marian	30173
Via International Travel Pty. Ltd.	Via International Travel Pty. Ltd.	30860
View Point Travel	Van Cooten, Graham Thomas	30403
View Point Travel	Van Cooten, Elspeth Merle	30980
Viva Holidays	Viva! International Pty. Ltd.	30062
Wallaby Tours	Barkla, Harold Thomas	30960
Walter Travel Service	Roski Pty. Ltd.	30673
Wandana Travel Pty. Ltd.	Wandana Travel Pty. Ltd.	30159
Wandana Travel (Armadale) Pty. Ltd.	Wandana Travel (Armadale) Pty. Ltd.	30157
Wandana Travel (Eastern) Pty. Ltd.	Wandana Travel (Eastern) Pty. Ltd.	30158
Wandana Travel (Southern) Pty. Ltd.	Wandana Travel (Southern) Pty. Ltd.	30160
Wanderers Ski Holidays and Travel	Fox, David Harcourt	30367

<i>Name under which business conducted</i>	<i>Licensee</i>	<i>Licence Number</i>
Wanderlust Travel Service	Slutzkin Robert Eliot	30065
Wanderlust Travel Service	Cohen, Beverley Ann	30187
Wandin Travel Service	Salgram Nominees Pty. Ltd.	30217
Wangaratta Tourist & Travel Bureau	R. D. & R. B. Graham Holdings Pty. Ltd.	30090
Wannon Travel Services	Howick Investments Pty. Ltd.	30725
Wannon Travel Services	Howick Travel Pty. Ltd.	21070
Wannon-Mildura Travel World	Howick Investments Pty. Ltd.	30725
Warburton Travel Agency	Stewart, Nola Mary	30755
Warburton Travel Agency	Stewart, Larry Victor	30756
Weber World Travel Pty. Ltd.	Weber World Travel Pty. Ltd.	30069
Werribee Travel Service	Todlock Pty. Ltd.	30015
Westernport Travel	Rodwell, Victor Charles	30409
Westernport Travel	Rodwell, Glenda Marelyn	30410
Westgate Travel	J.H.J. Pty. Ltd.	30615
Westpac Travel	Westpac Banking Corporation	30333
Westside Travel World	Farmair Pty. Ltd.	30265
Westworld Travel Centre	Westworld Travel Centre Pty. Ltd.	30175
Whight's Tourist Bureau Pty. Ltd.	Whight's Tourist Bureau Pty. Ltd.	30622
Wildlife Safaris	African Wildlife Safaris Pty. Ltd.	30248
Willco Travel	Belt, William Ernest	30199
Willco Travel	Belt, Kathleen Winifred	30817
Williamstown Travel Centre (Vic) Pty. Ltd.	Williamstown Travel Centre (Vic) Pty. Ltd.	30551
Wilshire James Travel Pty. Ltd.	Wilshire James Travel Pty. Ltd.	30110
Wiltrans Agency Pty. Ltd.	Wiltrans Agency Pty. Ltd.	30082
Wimmera World Travel Pty. Ltd.	Wimmera World Travel Pty. Ltd.	30853
Windsor International Travel & Tourist	Skliwas, John	30020
Windsor International Travel & Tourist	Skliwas, Julie	30021
Wings Abroad	Wings Over Australia Pty. Ltd.	31019
Wodonga Travel Centre	Losite Pty. Ltd.	30484
Wonderworld Travel	Manett Holdings Pty. Ltd.	30111
Woodrow Travel	Woodrow, Colin Francis	30523
World Alpine Tours	Tait, John James	30783
World Aviation Systems (Australia) Pty. Ltd.	World Aviation Systems (Australia) Pty. Ltd.	30203
World Beater Travel	Allan Low Tours Pty. Ltd.	30554
World Card Travel Pty. Ltd.	World Card Travel Pty. Ltd.	31059
World Connection	Duerden, Frederick	30448
World Connection	Duerden, Susan Ann	30933
World Expeditions	Australian Himalayan Expeditions Pty. Ltd.	30969
World Express Pty. Ltd.	World Express Pty. Ltd.	30342
World Travel Headquarters Pty. Ltd.	World Travel Headquarters Pty. Ltd.	30812
World Wide Travel (South Yarra) Pty. Ltd.	World Wide Travel (South Yarra) Pty. Ltd.	30003
World-Wise-Travel	J. E. H. Computer Management Service Pty. Ltd.	30949
Worldvision Travel	Worldvision Travel Pty. Ltd.	30034
Xclusive Tours (Aust) Pty. Ltd.	Xclusive Tours (Aust) Pty. Ltd.	30105
Yarraville World Travel Centre	Dean, Jeanette	30205
Yarrowonga Tours & Travel	Thomson, Janette Maree	30781
Yarrowonga Tours & Travel	Thomson, Joseph Lawrence	30782

<i>Name under which business conducted</i>	<i>Licensee</i>	<i>Licence Number</i>
Yeti Travels	Roka, Gopi Bahadur	31018
YHA Travel (Victoria)	Youth Hostels Association of Victoria	30258
YNCA Dorado Travel Services	Barra, Pablo	30697
York Travel Service	W. J. Bashfield and Associates Pty. Ltd.	30337
Your Travel Agent Pty. Ltd.	Your Travel Agent Pty. Ltd.	30016
Yugoslav Airlines	Yugoslav Airlines	30269
Zion Travel and Tours	Zion Enterprises Pty. Ltd.	30675

## LIST OF DEEMED LICENSED TRAVEL AGENTS

Date of preparation: 28 April 1988

Date list comes into force: 4 May 1988

Date list ceases to be in force: 5 July 1988

<i>Name under which business conducted</i>	<i>Deemed Licensee</i>
ACTS—A.C. Travel Services	Chaudhri, Dr Mohammad Anwar
Air Nauru	Nauru Corporation (Victoria) Pty. Ltd.
All Aussie Tours	Monocord Pty. Ltd.
All Club Tours	Monocord Pty. Ltd.
All Points Travel	Compass Building Society
Ansett Pioneer	Pioneer Tourist Industries Pty. Ltd.
Banninks World Tours	Travel Management Pty. Ltd.
British Airways Plc	British Airways Plc
Carden International Travel	Essendon Travel Centre Pty. Ltd.
CBMC Travel	The Travel Option Pty. Ltd.
Centralian Pty. Ltd.	Centralian Pty. Ltd.
Chaudhri, Dr Mohammed Anwar	Chaudhri, Dr Mohammed Anwar
Continental Airlines Inc.	Continental Airlines Inc.
Continental Pacific Travel (Australia) Pty. Ltd.	Continental Pacific Travel (Australia) Pty. Ltd.
Dimension Travel	Corvasce, Suzanne Margaret
Ersu Travel Agency	Akguner, Mustafa Galip
Ersu Travel Agency	Akguner, Nurcan
Evergreen Tours Pty. Ltd.	Evergreen Tours Pty. Ltd.
French Cottages & Travel	Villaworld Travel Pty. Ltd.
G.E.T. Travel Service Yarram	Compass Building Society
Greenline Travel Pty. Ltd.	Greenline Travel Pty. Ltd.
Holmesglen Travel Services	Rackley, John David
Intercontinental Travel Pty. Ltd.	Intercontinental Travel Pty. Ltd.
Jettrail Travel Agency	O'Day, Garry John
Jettrail Travel Agency	O'Day, Lynette Mary
Kilmore Travel	Kilkenny Real Estate Pty. Ltd.
Lyn McNaught Mooroopna Travel	McNaught, Lynette Joyce
Lyn McNaught Mooroopna Travel	David Keele Nominees Pty. Ltd.
Maureen Kelly Travel	Nankervis, Andreas
Maureen Kelly Travel	Kelly, Maureen
Melbright Coaches Pty. Ltd.	Melbright Coaches Pty. Ltd.
Monarch International Travel	Fyna Foods (Vic) Pty. Ltd.
Nauru Air & Shipping Agency	Nauru Corporation (Victoria) Pty. Ltd.

<i>Name under which business conducted</i>	<i>Deemed Licensee</i>
Panorama Tours	Executive Travel Pty. Ltd.
Pascoe Vale Travel Services	Kingston Court Pty. Ltd.
Performax	Performance Marketing Pty. Ltd.
Salisan Park Travel Agent	Parker, John Douglas
Terra Travel	Nagy Nominees Pty. Ltd.
The Tour Company Pty. Ltd.	The Tour Company Pty. Ltd.
The Travel Option Pty. Ltd.	The Travel Option Pty. Ltd.
The Travel Organisers	Brown, Simon Leonard McInnes
Travel Now Pty. Ltd.	Travel Now Pty. Ltd.
Travel Spot International Pty. Ltd.	Travel Spot International Pty. Ltd.
Travel Vision Holdings Pty. Ltd.	Travel Vision Holdings Pty. Ltd.
Village Travel Centre	Executive Travel Pty. Ltd.
Villaworld Travel	Villaworld Travel Pty. Ltd.
Walshes World	Rodney Walshe Australia Pty. Ltd.
Waverley Travel	Travel Management Pty. Ltd.
Yarraville World Travel Centre	Dowling, Kenneth William

Department of Industry, Technology and  
Resources

APPLICATIONS FOR MINING LEASES  
TRANSFERRED

Nos. 1434 and 1435; From Drummond Ridge  
P/L to Drummond Ridge P/L, Paget Gold  
Mining Company Ltd and R. Sargent.

APPLICATION FOR RENEWAL OF  
MINING LEASE DECLARED ABANDONED

No. 512-1; A. J. Mahoney, P. Higgins &  
Reamway P/L; 1.4757 ha, Parish of  
Blackwood.

INTENTION TO GRANT A PROSPECTING  
AREA LICENCE

No. 209; Kinex P/L; 248 ha, Parish of Craigie.

PROSPECTING AREA LICENCE GRANTED

No. 336; G. M. Proctor and N. M. Higgins; 200  
ha, Parish of Boola Boloke.

APPLICATION FOR PROSPECTING AREA  
LICENCE WITHDRAWN

No. 467; F. E. Evans; 186 ha, Parish of Byawatha.

TAILINGS REMOVAL LICENCE EXPIRED

No. 5160; G. B. Wallace; to remove tailings from  
the "Central Ajax Mine" situated in the Parish  
of Wombat.

APPLICATION FOR TAILINGS  
TREATMENT LICENCE WITHDRAWN

No. 457; J. C. Hedley; 10.29 ha, Parish of  
Harrietteville.

EXPLORATION LICENCES GRANTED

No. 1897; Titan Resources Ltd; 5 km<sup>2</sup>; Shire of  
Bet Bet.

No. 2005; CRA Exploration P/L; 125 km<sup>2</sup>; Shire  
of Dunmunkle, Kara Kara and Stawell.

No. 2014; Noble Resources NL; 39.5 km<sup>2</sup>; Shire  
of Korung.

APPLICATIONS FOR EXPLORATION  
LICENCES REFUSED

No. 1820; CRA Exploration P/L; 1320.5 km<sup>2</sup>;  
Goschen area.

No. 1877; Bendigo Gold Associates P/L; 54 km<sup>2</sup>;  
Shire of Orbost.

No. 2054; Bach Holdings P/L; 59.5 km<sup>2</sup>;  
Wandiligong.

No. 2144; CRA Exploration P/L; 195 km<sup>2</sup>;  
Chandler's Creek.

No. 2199; Sipvill P/L; 292.5 km<sup>2</sup>; Tallangatta.

No. 2231; KTM Gold Ltd; 11.25 km<sup>2</sup>; Shire of  
Mansfield.

No. 2238; Holdvale P/L; 50 km<sup>2</sup>; Charlton.

No. 2312; Xenolith Gold Ltd; 27 km<sup>2</sup>; Cann  
Valley.

No. 2353; N. T. Motton; 182.5 km<sup>2</sup>; Ballarat.

APPLICATIONS FOR EXPLORATION  
LICENCE DECLARED ABANDONED

Nos. 2250 and 2251; Connaught Gold  
Exploration Ltd; 9.5 and 3 km<sup>2</sup>; Shire of  
Strathfieldsaye.

EXPLORATION LICENCES EXTENDED

No. 1360-4; BHP Gold Mines Ltd; 53 km<sup>2</sup>;  
County of Wonnangatta.

No. 1504-1; KTM Gold Ltd; 40.75 km<sup>2</sup>; Parish  
of Tarnagulla.

No. 1623-1; B. R. and D. R. McLean; 15 km<sup>2</sup>,  
Shire of Daylesford and Glenlyon.

**APPLICATIONS FOR EXTENSION OF  
EXPLORATION LICENCES REFUSED**

No. 1286-4; New Resources P/L; 73 km<sup>2</sup>,  
Dunolly.

No. 1325-2; Jupiter Mining P/L 165.5 km<sup>2</sup>,  
County of Grant.

No. 1463-2; Tallangalook P/L; Ghana Gold  
P/L, Strategic Finance P/L; 33 km<sup>2</sup>,  
Tallangatta.

**EXPLORATION LICENCES EXPIRED**

No. 1286-3; New Resources P/L; 73 km<sup>2</sup>,  
Dunolly.

The above expired area will become available  
again for Exploration Licence on 9 August 1988.

No. 1463-1; Tallangalook P/L; Ghana Gold  
P/L, Strategic Finance P/L; 33 km<sup>2</sup>,  
Tallangatta.

The above expired area will become available  
again for Exploration Licence on 7 September  
1988.

**EXTRACTIVE INDUSTRY LICENCE  
GRANTED**

No. 942; Featherock Quarries P/L; 60.03 ha,  
Parish of Anakie.

**ROBERT FORDHAM**  
Minister for Industry, Technology and Resources

**STATE TENDER BOARD  
CONTRACTS ACCEPTED  
Amendments**

Schedule Number	Item Number	New Rate	Effective Date
		\$	
	<b>Hose (Garden) and Polythene Bags</b>		
1/08	4	0.74	29.6.88
	5	3.10	
	6	1.18	
	7	4.96	
	8	2.48	
	9	12.40	
	10	0.62	
	11	6.20	
	12	0.74	
	13	8.06	
	14	0.89	
	15	8.93	
	16	1.76	
	17	17.61	
	18	3.10	
	19	31.00	
	20	2.73	
	21	27.28	

**Passenger Sedans and Station Wagons**

1/58 1A 9 261.00\* 30.6.88

**Optional Equipment—**

Auto Transmission 569.00

Air Conditioning 1 074.00

Tow pack and socket 152.00

2A 8 913.00†

**Optional Equipment—**

Auto Transmission 569.00

Air Conditioning 1 074.00

Tow pack and socket 171.00

\*Delete: Colt GL Sedan Model No. RD5H41

†Delete: Colt GLX Sedan Model No. RESH41

†Delete: Colt GL Hatch Model No. RD5H44

Add: Colt GLX Hatch Model No. RESH44

**Light Commercial Motor Vehicles**

1/59B 4C 14 637.66\* 4.7.88

\*Delete: Model No. E22C5VSDX

Add: Model No. E22D5VSDX

**Provisions**

2/01A 103 0-4447 1.5.88

104 0-6717

105 1-3252

106 0-6387

**Passenger Sedans and Station Wagons**

1/58 4B 11 024.00 29.6.88

5B 11 764.00

6B 11 803.00

**Optional Equipment—**

Air Conditioning 5B 773.00 1.5.88

**General Stationery**

1/64 69 0.41\* 24.5.88

\*Delete: Wilson Penney (Victoria) Pty. Ltd.

Add: James King Enterprises Pty. Ltd.

**J. M. PAWSON**  
Secretary to the Tender Board

**Subordinate Legislation Act 1962**

**State Electricity Commission Act 1958**

**PROPOSED STATE ELECTRICITY  
COMMISSION (ENERGY EFFICIENCY  
LABELLING) (REFRIGERATIVE AIR  
CONDITIONERS) REGULATIONS 1988**

It is proposed that State Electricity Commission (Energy Efficiency Labelling) (Refrigerative Air Conditioners) Regulations 1988 be made in furtherance of the existing energy efficiency labelling of proclaimed electrical appliances scheme which commenced in Victoria in 1987.

The purpose of these Regulations is to ensure that information on energy consumption and energy efficiency of refrigerative air conditioners is available to consumers at the point of sale.

A Regulatory Impact Statement has been prepared and this concludes that the preferred method of achieving the objective is to make regulations.

2016 G 25 6 July 1988

Comments and submissions are invited from the public and will be received up to 21 days from the publication of this advertisement. Copies of the Regulatory Impact Statement are available from: The Manager, Energy Conservation Programs, Energy Services Department, State Electricity Commission of Victoria, 12th Floor, Monash House, 15 William Street, Melbourne 3000. Telephone: Mr P. Richards, (03) 691 4501.

**JIM SMITH**  
Chief General Manager  
State Electricity Commission of Victoria

*Subordinate Legislation Act 1962*  
*State Electricity Commission Act 1958*  
**PROPOSED STATE ELECTRICITY  
COMMISSION (ENERGY EFFICIENCY  
LABELLING) (DISHWASHERS FOR  
DOMESTIC USE) REGULATIONS 1988**

It is proposed that State Electricity Commission (Energy Efficiency Labelling) (Dishwashers for Domestic Use) Regulations 1988 be made in furtherance of the existing energy efficiency labelling of proclaimed electrical appliances scheme which commenced in Victoria in 1987.

The purpose of these Regulations is to ensure that information on energy consumption and energy efficiency of dishwashers for domestic use is available to consumers at the point of sale.

A Regulatory Impact Statement has been prepared and this concludes that the preferred method of achieving the objective is to make regulations.

Comments and submissions are invited from the public and will be received up to 21 days from the publication of this advertisement. Copies of the Regulatory Impact Statement are available from: The Manager, Energy Conservation Programs, Energy Services Department, State Electricity Commission of Victoria, 12th Floor, Monash House, 15 William Street, Melbourne 3000. Telephone: Mr P. Richards, (03) 691 4501.

**JIM SMITH**  
Chief General Manager  
State Electricity Commission of Victoria

*Transport Act 1983*  
**VARIATIONS OF DECLARATIONS AND  
DEDICATIONS OF ROADS**

The Road Construction Authority, in pursuance of the powers conferred by the *Transport Act 1983*, varies the declarations of roads as described below; and further declares that any new roads, deviations or widenings made by the Authority and included in such variations are fit to be used as public highways:

*Victoria Government Gazette*

29/88—By including in the declaration of the Glenelg Highway in the Shire of Ararat the land shown hatched on plan numbered GP17215 and excluding from the said declaration the land shown cross hatched on the said plan.

30/88—By excluding from the declaration of the Hume Highway in the Shires of Benalla and Violet Town and the City of Benalla the land shown hatched and cross hatched on plans numbered GP16133C, GP244053A, GP244054A and GP244055A.

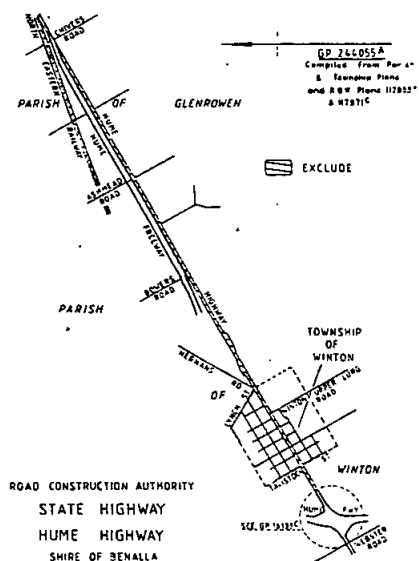
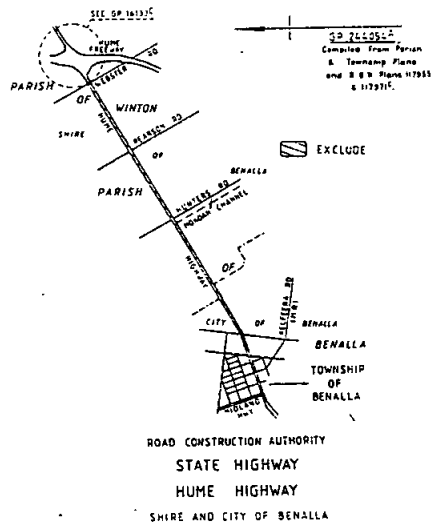



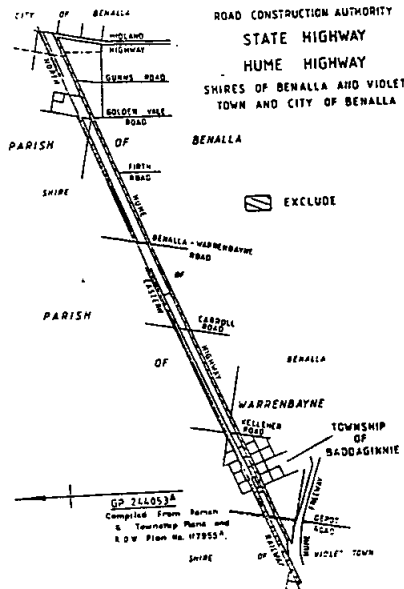
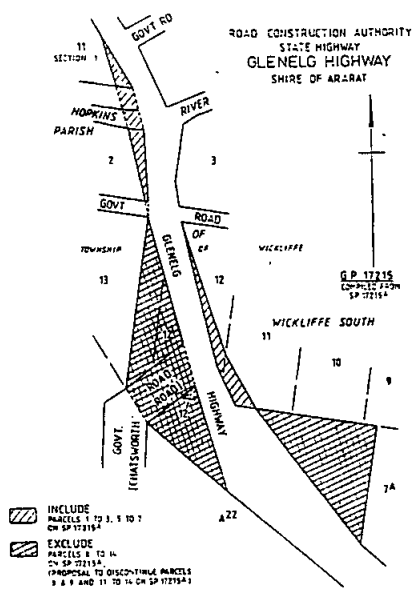

In accordance with the provisions of Clause 2 (2), Schedule 5 of the *Transport Act 1983*, the new roads, deviations or widenings made by the Authority shall, upon the publication of this notice in the *Government Gazette*, become and be absolutely dedicated to the public as a public highway within the meaning of any law now or hereafter in force.

Dated 29 June 1988

IAN F. X. STONEY  
Managing Director  
Road Construction Authority

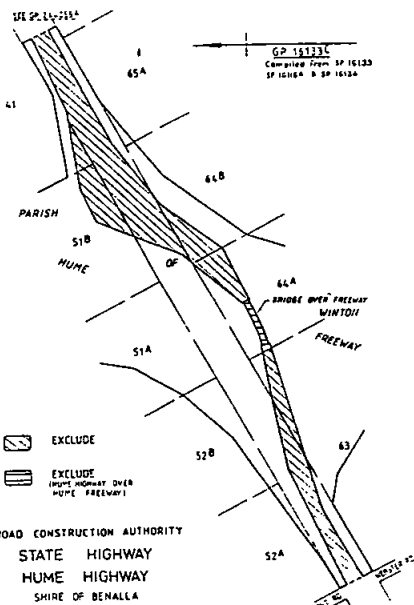

*Transport Act 1983*  
DECLARATIONS AND DEDICATIONS OF  
ROADS

The Road Construction Authority, in pursuance of the powers conferred by the *Transport Act 1983*, declares the roads or parts of roads or any deviation from or widenings of roads to be described below; and further declares that any such new roads, deviations or widenings made by the Authority are fit to be used as public highways:

27/88—The widening of the Maroona—Glenthompson Road in the Shire of Ararat shown hatched on plan numbered GP17082.

28/88—An existing road (Baddaginnie—Benalla Road) in the Shire of Benalla and the City of Benalla shown hatched on plan numbered GP244053B.

2018 G 25 6 July 1988

29/88—An existing road (Benalla-Winton Road) in the Shire of Benalla and the City of Benalla shown hatched on plans numbered GP16133D and GP244054B.

30/88—By renaming that section of the Hume Highway in the City of Benalla shown by heavy line on plan numbered GP244052A to be part of the Midland Highway.

Victoria Government Gazette

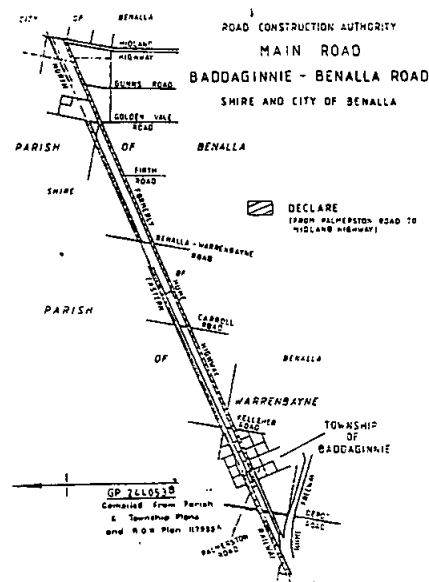
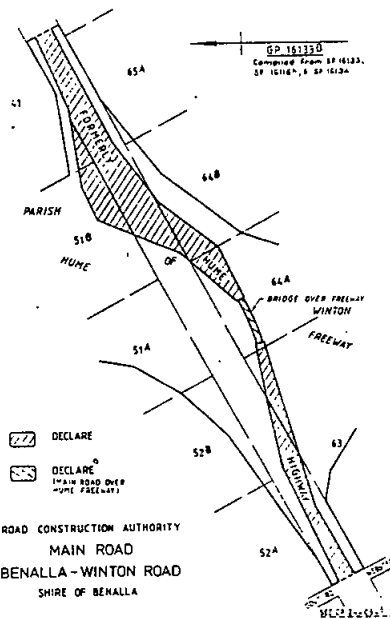
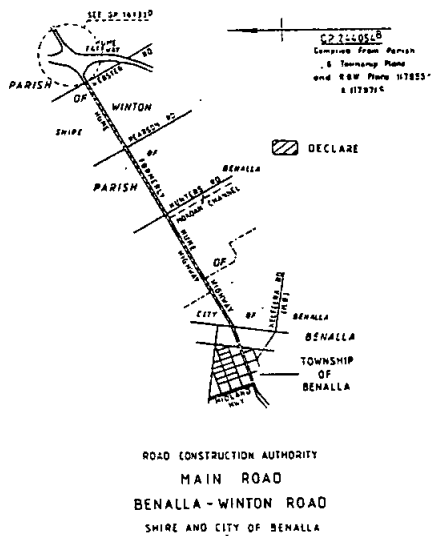
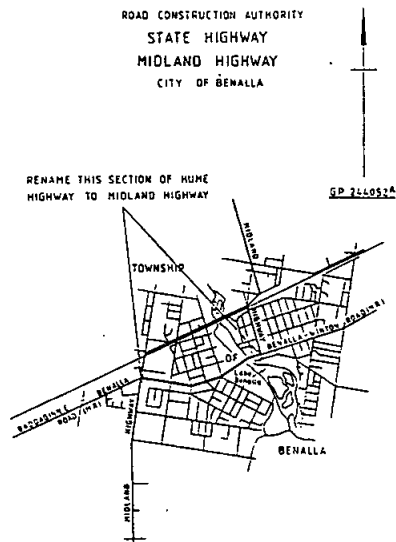

*Victoria Government Gazette*

ROAD CONSTRUCTION AUTHORITY

MAIN ROAD  
MAROONA — GLENTHOMPSON  
ROAD

SHIRE OF ARARAT

PARISH OF WILLAURA

31<sup>B</sup>

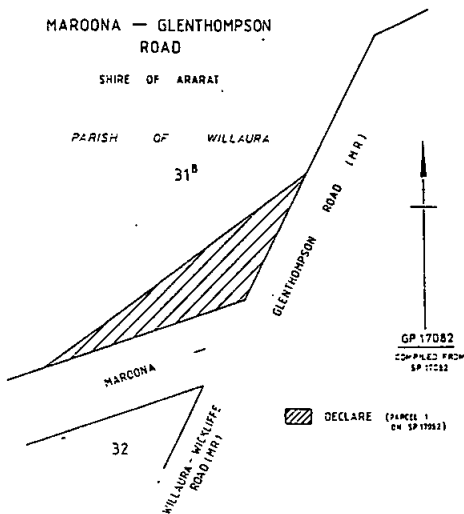

In accordance with the provisions of Clause 2 (2), Schedule 5 of the *Transport Act 1983*, the new roads, deviations or widenings made by the Authority shall, upon the publication of this notice in the *Government Gazette*, become and be absolutely dedicated to the public as a public highway within the meaning of any law now or hereafter in force.

Dated 29 June 1988

IAN F. X. STONEY  
Managing Director  
Road Construction Authority

G 25 6 July 1988 2019

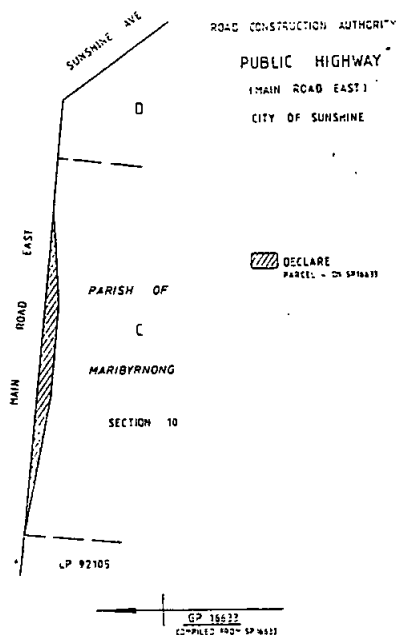

In accordance with the provisions of Clause 2 (2), Schedule 5 of the *Transport Act 1983*, the widenings shall, upon the publication of this notice in the *Government Gazette*, become and be absolutely dedicated to the public as public highways within the meaning of any law now or hereafter in force.

Dated 29 June 1988

IAN F. X. STONEY  
Managing Director  
Road Construction Authority

*Transport Act 1983*  
**NOTICE DECLARING THE WIDENINGS  
OF EXISTING ROADS TO BE FIT TO BE  
USED AS PUBLIC HIGHWAYS**

The Road Construction Authority is of the opinion that the widenings of the existing roads as set out below are fit to be used as public highways—

The widening of an existing road (Main Road East) in the City of Sunshine shown hatched on plan numbered GP16633.

*Planning and Environment Act 1987*  
**BASS PLANNING SCHEME**  
Notice of Approval of Amendment  
Amendment L2

The Minister for Planning and Environment has approved Amendment L2 to the Bass Planning Scheme.

The amendment comes into operation on the date this notice is published in the *Government Gazette*.

The amendment rezones 27 ha of land at Coronet Bay to Future Residential (21 ha) and Proposed Public Purposes—Municipal Purposes (6 ha) and an Ordinance amendment to allow for the future residential expansion of Coronet Bay.

2020 G 25 6 July 1988

A copy of the amendment can be inspected, free of charge, during office hours, at the offices of the Shire of Bass, Shire Office, Archies Creek, and at the Ministry for Planning and Environment, 477 Collins Street, Melbourne.

GEOFF CODE, Manager  
Planning Co-ordination Branch

*Planning and Environment Act 1987*  
**LILLYDALE PLANNING SCHEME**  
Notice of Approval of Amendment  
Amendment L21

The Minister for Planning and Environment has approved Amendment L21 to the Lillydale Planning Scheme.

The amendment comes into operation on the date this notice is published in the *Government Gazette*.

The amendment rezones 2 ha of surplus Ministry of Education land on the Warburton Highway, Seville East, to General Farming 2.

A copy of the amendment can be inspected, free of charge, during office hours, at the offices of the Shire of Lillydale, Anderson Street, Lillydale, and at the Ministry for Planning and Environment, 477 Collins Street, Melbourne

GEOFF CODE, Manager  
Planning Co-ordination Branch

*Planning and Environment Act 1987*  
**MELBOURNE PLANNING SCHEME**  
Notice of Approval of Amendment  
Amendment L11

The Minister for Planning and Environment has approved Amendment L11 to the Melbourne Planning Scheme.

The amendment comes into operation on the date this notice is published in the *Government Gazette*.

The amendment rezones 0.2 ha of surplus STA land generally between Ratcliffe Street and Railway Place, Flemington, to General Industrial.

A copy of the amendment can be inspected, free of charge, during office hours, at the offices of the City of Melbourne, 200 Little Collins Street, Melbourne, and at the Ministry for Planning & Environment, 477 Collins Street, Melbourne.

GEOFF CODE, Manager  
Planning Co-ordination Branch

*Victoria Government Gazette*  
*Planning and Environment Act 1987*  
**NOTICE OF AMENDMENT TO THE  
GEELONG REGIONAL PLANNING  
SCHEME**

**Amendment No. R10**

The Geelong Regional Commission has prepared Amendment No. R10 to the Geelong Regional Planning Scheme.

The Amendment proposes to change the Regional Section of the Planning Scheme by:

Item 1 Rezoning land known as the St. Augustine's Boys Home, generally located between Thornhill Road and South Valley Road, south of Gwyther Road, Highton from Special Uses -7- Private Educational and Religious Institutions or Establishments and Public Purposes (Existing) Reservation -4- Water Works and Sewerage Authorities to Reserved Residential zone, and a rezoning from Reserved Residential to Special Uses -7-.

Item 2 Rezoning of a single allotment located on the south west corner of Burdoo Drive and Heyers Road Grovedale from Residential A zone to the Local Business zone.

Item 3 Rezoning of land located north of the Geelong-Portarlington Road between Buckley Grove and Hermsley Road between Leopold and Moolap from Proposed Arterial Road Reserve to Existing Arterial Road Reserve.

Item 4 Rezoning of a single allotment, 19 Lelean Street, Ocean Grove from Special Uses -6- Caravan Park zone to Residential A Zone.

Item 5 Rezoning of land located on the north side of McKillop Street west of Yarra Street, Geelong from Special Uses -7- Private Educational and Religious Institutions or Establishments to Public Purposes (Existing) Reservation -24, - State Government Other.

Item 6 Rezoning Nos. 47-49 Station Lake Road and No. 20 Flinders Avenue, together with Council-owned land between the flood levee and the south bank of Hovells Creek, in that section of the creek lying between Station Lake Road and Flinders Avenue from Rural Floodland Zone to part Residential A Zone, and part Public Open Space (Existing) Reservation - A, Foreshore and Streamside Reserve.

Item 7 Rezoning land on the north east corner of Forest Road and Darcy Street adjoining Lara Lake Primary School from Residential A Zone to Public Purpose (Existing) Reservation - 11, Education Department.

Item 8 Introducing a new sub-clause in the Planning Scheme Ordinance which will place controls over extensions to buildings or works which have existing use rights and which would normally require a permit to be developed under the present Planning Scheme provisions.

Victoria Government Gazette

G 25 6 July 1988 2021

Item 9 Introducing a new use, "Indoor Sports Centre", in the Special Uses—2 zone.

Item 10 Amending the Ordinance provisions for Industrial zones by introducing noise level standards which are compatible with similar State Environment Protection Policy standards.

Item 11 Including an Ordinance Amendment which places a limit on the developable area of retail floorspace at the shopping centre located on the south west corner of Burdoo Drive and Heyers Road, Grovedale.

The Amendment can be inspected at:

Geelong Regional Commission, Fifth Floor, State Government Offices, Cnr Fenwick and Lt Malop Streets, Geelong 3220; Ministry for Planning and Environment, The Olderfleet Buildings, 477 Collins Street, Melbourne 3000.

The offices of:

- (i) The Borough of Queenscliffe
- (ii) The City of Geelong
- (iii) The City of Geelong West
- (iv) The City of Newtown
- (v) The City of South Barwon
- (vi) The Shire of Bannockburn
- (vii) The Shire of Barrabool
- (viii) The Shire of Bellarine
- (ix) The Shire of Corio

Submissions about the Amendment must be sent to the Secretary, Geelong Regional Commission, P.O. Box 770, Geelong 3220, by Monday, 8 August 1988.

G. R. COWLING, Secretary  
Geelong Regional Commission

*State Electricity Commission Act 1958*  
STATE ELECTRICITY COMMISSION OF  
VICTORIA

Electrical Approvals Board

In accordance with the requirements of the Electrical Approvals Board Regulations 1984, the State Electricity Commission of Victoria hereby gives notice that the following appointments have been made pursuant to the provisions contained in section 51 of the *State Electricity Commission Act 1958*, and the said Regulations, viz:

Henry Dennis HAVIS as representing the interests of manufacturers of electrical goods in Victoria; and

Maxwell Bevan HODGES as representing the interests of the electricity supply undertakers in Victoria;

to be members of the said Board to hold office until 30 June 1991.

Dated 30 June 1988

J. HORGAN, Secretary

*Stamps Act 1958 (No. 6375)*

NOTICE UNDER SECTION 115

Notice is hereby given that the Comptroller of Stamps has approved, pursuant to section 115 (1) (a) of the *Stamps Act 1958*, for the purposes of Subdivision (12) of Division 3 of Part II of the *Stamps Act 1958*, the following equipment by which bets may be recorded and betting-tickets issued:

TURFTALK System, distributed by C. C. Hincksman, J. C. Smith and M. Wenham trading as Turf Talk.

Stamp Duties Office, Melbourne

SUSAN BATH  
Comptroller of Stamps

*County Court Act 1958*

ADDITIONAL COUNTY COURT SITTING  
1988

Notice is given that an additional sitting of the County Court of Victoria will be held at Colac on Monday, 1 August 1988.

J. R. O'SHEA  
Acting Chief Judge of the County Court of  
Victoria

*Water Act 1958*

RURAL WATER COMMISSION OF  
VICTORIA

Confirmation of Minister's Direction

In accordance with section 26 (1) of the *Water Act 1958*, confirmation of my Direction of 31 March 1988 to Rural Water Commission is hereby published:

(1) that from 31 March 1988 until 15 May 1988 water from the Thompson Dam shall be purchased from the Melbourne and Metropolitan Board of Works and to be offered for sale to irrigators in the Macalister Irrigation District for use during the 1987-88 Irrigation season;

(2) that the water is to be offered to Right Holders under normal sales conditions at a price of \$40/ML.

FRANK WILKES  
Minister for Water Resources

STATE TRUST CORPORATION OF  
VICTORIA—SECTION 23

Notice is hereby given that the State Trust Corporation of Victoria intends administering the estate of Grace Woodward, late of Ravenswood Court, 15A Tovey Street, Reservoir in the State of Victoria, widow who died on 15 March 1988.

2022 G 25 6 July 1988

Creditors, next of kin and others having claims against this estate are required pursuant to section 33 of the *Trustee Act 1958* to send particulars of their claims against the above-mentioned estate to the State Trust Corporation of Victoria, 168 Exhibition Street, Melbourne, Victoria, 3000 on or before 7 September 1988 after which date the State Trust Corporation of Victoria may convey or distribute the assets of the above-mentioned estate having regard only to the claims of which it then has notice.

*Industrial Relations Act 1979*

**INDUSTRIAL RELATIONS COMMISSION  
OF VICTORIA**

**Appeal against a variation of the Commercial  
Clerks Award**

Notice is hereby given that an appeal has been lodged on behalf of the Victorian Automobile Chamber of Commerce against the decision of the Commercial Clerks Conciliation and Arbitration Board on 1 June 1988 to insert supplementary payments into the Commercial Clerks Award.

Notice is also given that this matter is listed for mention before the Industrial Relations Commission of Victoria in Full Session at 10.00 a.m. on Tuesday, 5 July 1988, in Hearing Room No. 1, Level 18, Nauru House, 80 Collins Street, Melbourne.

**A. S. DOWLING**  
Deputy Registrar

**Industrial Relations Commission of Victoria**

*Industrial Relations Act 1979*

**INDUSTRIAL RELATIONS COMMISSION  
OF VICTORIA**

**Application for a Declaration of the True Intent  
and Effect of the Social and Community  
Services Award**

Notice is hereby given that the Australian Conservation Foundation Inc. has lodged an application for a declaration of the true intent and effect of Part IV of the Social and Community Services Award, No. 2 of 1988, made 21 January 1988.

The applicant seeks a declaration for the true intent and effect of the following provisions of the Award:

- (a) A declaration as to whether work performed by Project Officers, Librarian/Information Officers, Membership and Fund Raising Officers or Development Officers employed by the Australian Conservation Foundation Inc. is community development work within the meaning of the Award.

*Victoria Government Gazette*

- (b) A declaration as to whether persons performing the duties of Project Officers, Librarian/Information Officers, Membership and Fund Raising Officers or Development Officers of the Australian Conservation Foundation Inc. are validly described as Community Development Workers within the meaning of the Award.

- (c) Alternatively, if the said Award does purport to apply to the employment by the Australian Conservation Foundation Inc. of Project Officers, Librarian/Information Officers, Membership and Fund Raising Officers or Development Officers (which is denied), a declaration that to that extent, it is an Award which has no effect.

Notice is also given that this matter is listed for mention before the Industrial Relations Commission of Victoria in Court session at 9.30 a.m. on Tuesday, 5 July 1988 in Hearing Room No. 2, Level 18, Nauru House, 80 Collins Street, Melbourne.

**A. S. DOWLING**  
Deputy Registrar

**Industrial Relations Commission of Victoria**

**ORDERS IN COUNCIL**

*Cemeteries Act 1958*  
**SCALES OF FEES FOR PUBLIC  
CEMETERIES**

The Governor in Council under section 17 of the *Cemeteries Act 1958* consents to the making of the attached Scales of Fees in respect of:

**SCALE OF FEES OF THE DARGO PUBLIC  
CEMETERY**

In pursuance of the powers conferred upon them by the *Cemeteries Act* the trustees of the Dargo Public Cemetery hereby make the following scale of fees, which shall come into operation upon publication in the *Government Gazette*, and from and after such publication every scale of fees heretofore made by the said trustees shall be and is hereby rescinded to the extent to which it conflicts with this scale.

	\$
<i>Public Graves</i>	
Interment in grave without exclusive right—Stillborn child	50.00
Interment in grave without exclusive right—Others	80.00
Number peg or label	20.00

*Private Graves*

Land, 2.44 m × 1.22 m	120.00
Own selection of land (extra)	60.00
<i>Sinking Charges for Private Graves</i>	
Sinking grave 1.83 m deep contract price + 10%	
Each additional 0.3 m	50.00
Sinking oversize grave	50.00
Cancellation of order to sink (if commenced)	50.00
Re-opening grave (no cover)	160.00
Re-opening grave (with cover)	170.00

*Miscellaneous Charges*

Interment fee	60.00
Interment outside prescribed hours, or on Saturdays, Sundays or Public Holidays or without due notice	120.00
Certificate of Right of Burial	20.00
Number plate or brick	20.00
Permission to erect a headstone or monument; permission to construct a brick grave or to erect any stone kerb, brick tile-work or concrete—10% of cost with a minimum of \$50.00	

Exhuming the remains of a body (when authorised)	400.00
Interment of ashes in a private grave	60.00
Memorial wall niche and plaque	150.00
Search fee per request	15.00

G. HUTCHISON, Trustee  
J. KINGLEY, Trustee  
V. PHELAN, Trustee  
B. WEBSDALE, Trustee

**SCALE OF FEES OF THE DIGBY PUBLIC  
CEMETERY**

In pursuance of the powers conferred upon them by the *Cemeteries Act* the trustees of the Digby Public Cemetery hereby make the following scale of fees which shall come into operation upon publication in the *Government Gazette*, and from and after such publication every scale of fees heretofore made by the said trustees shall be and is hereby rescinded to the extent to which it conflicts with this scale.

	\$
<i>Interments: Adults</i>	
Children	16.00
J. BURGESS, Trustee R. DUNN, Trustee B. FIDLER, Trustee	

**SCALE OF FEES OF THE TALLANGATTA  
PUBLIC CEMETERY**

In pursuance of the powers conferred upon them by the *Cemeteries Act* the trustees of the Tallangatta Public Cemetery hereby make the following scale of fees which shall come into operation upon publication in the *Government Gazette*, and from and after such publication every scale of fees heretofore made by the said trustees shall be and is hereby rescinded to the extent to which it conflicts with this scale.

Land 2.44 m × 1.22 m	80.00
V. T. LEY, Trustee J. MERBACH, Trustee J. NICHOLSON, Trustee	

**SCALE OF FEES OF THE BULLA PUBLIC  
CEMETERY**

In pursuance of the powers conferred upon them by the *Cemeteries Act* the trustees of the Bulla Public Cemetery hereby make the following scale of fees which shall come into operation upon publication in the *Government Gazette*, and from and after such publication every scale of fees heretofore made by the said trustees shall be and is hereby rescinded to the extent to which it conflicts with this scale.

2024 G 25 6 July 1988

Victoria Government Gazette

	\$		\$
<i>Public Graves</i>		<i>Private Graves</i>	
Interment in grave without exclusive tight—Stillborn child	100.00	Land 2.43 m × 1.219 m (8' × 4')	40.00
Interment in grave without exclusive right—Others	100.00	<i>Extra Charges</i>	
Number peg or label	20.00	Interment not in the prescribed hours or on Saturday, Sunday or Public Holidays	100.00
<i>Private Graves</i>		<i>Miscellaneous Charges</i>	
Land 2.44 m × 1.22 m	450.00	Interment fee	30.00
Own selection of site (extra)	50.00	Certificate of right of burial	5.00
<i>Sinking Charges for Private Graves</i>		Interment of ashes in a private grave	35.00
Sinking grave 1.8 m deep	225.00	<i>Memorial Wall</i>	
Each additional 0.3 m	40.00	Wall niche (with memorial plaque)	120.00
Sinking oversized grave	70.00	Wall reservations	30.00
Cancellation of order to sink (if commenced)	50.00	J. CURKPATRICK, Trustee M. LYNCH, Trustee D. STANFORD, Trustee	
Re-opening grave (no cover)	200.00		
Re-opening grave (with cover or kerb)	225.00		

**SCALE OF FEES OF THE WERONA KOOROOCHANG PUBLIC CEMETERY**

In pursuance of the powers conferred upon them by the Cemeteries Act, the trustees of the Werona Kooroocheang Public Cemetery hereby make the following scale of fees which shall come into operation upon publication in the *Government Gazette*, and from and after such publication every scale of fees heretofore made by the said trustees shall be and is hereby rescinded to the extent to which it conflicts with this scale.

	\$
<i>Miscellaneous Charges</i>	
Interment fee	40.00
Interment outside prescribed hours, or on Saturdays, Sundays or Public Holidays or without due notice	50.00
Late fee (per half-hour or part thereof in excess of first fifteen minutes)	20.00
Certificate of right of burial	10.00
Number plate or brick	10.00
Permission to construct a brick grave or to erect any stone kerb, brick tilework or concrete	40.00
Grave renovations or additional inscription	20.00
Exhuming the remains of a body (when authorised)	400.00
Interment of ashes in a private grave	75.00
J. McKENZIE, Trustee I. SOUTER, Trustee C. ROBERTSON, Trustee D. IRWIN, Trustee	

**SCALE OF FEES OF THE NHILL PUBLIC CEMETERY**

In pursuance of the powers conferred upon them by the Cemeteries Act the trustees of the Nhill Public Cemetery hereby make the following scale of fees which shall come into operation upon publication in the *Government Gazette*, and from and after such publication every scale of fees heretofore made by the said trustees shall be and is hereby rescinded to the extent to which it conflicts with this scale.

	\$
<i>Public Graves</i>	
Interment of an adult	70.00
Interment of a stillborn child	20.00
<i>Private Graves</i>	
Land 2.44 m × 1.22 m	125.00
<i>Sinking or Re-opening Graves</i>	
Sinking or re-opening of graves	125.00
<i>Miscellaneous Fees</i>	
Burial on Saturday or gazetted holiday	50.00
Burial of ashes in grave	25.00
Sinking or re-opening oversized grave	40.00
Exhumation of body (when authorised)	495.00
Additional charge for opening sealed grave	20.00
Permission to erect a headstone or monument—5% of cost, minimum charge \$20.00	
D. HEPBURN, Trustee R. ROBINSON, Trustee J. N. GERVASONI, Trustee	



Victoria Government Gazette

G 25 6 July 1988 2025

**SCALE OF FEES OF THE QUEENSCLIFFE  
PUBLIC CEMETERY**

In pursuance of the powers conferred upon them by the Cemeteries Act, the trustees of the Queenscliffe Public Cemetery hereby make the following scale of fees which shall come into operation upon publication in the *Government Gazette*, and from and after such publication every scale of fees heretofore made by the said trustees shall be and is hereby rescinded to the extent to which it conflicts with this scale.

	\$
<i>Private Graves</i>	
Land 2.44 m × 1.22 m	100.00
Own selection of site (extra)	25.00
<i>Miscellaneous Charges</i>	
Interment fee	40.00
Interment not in the prescribed hours or on Saturdays, Sundays or Public Holidays or without due notice	50.00
Permission to erect a headstone or monument—5% of cost with a minimum of \$20.00	
Permission to construct a brick grave or to erect any kerb, brick tilework or concrete	30.00
Interment of ashes in a private grave	40.00
<i>Lawn Section</i>	
Land—First burial, including plaque	450.00
Second burial (includes interment fee and plaque)	200.00
C. BRYANT, Trustee P. McDONALD, Trustee B. GOODWIN, Trustee F. HEWESTON, Trustee	

Dated 28 June 1988

Responsible Member:

DAVID RONALE WHITE  
Minister for Health

LAWRENCE A. FISHER  
Clerk of the Executive Council

Dated 28 June 1988

Responsible Minister:

D. R. WHITE  
Minister for Health

LAWRENCE A. FISHER  
Clerk of the Executive Council

*Crown Land (Reserves) Act 1978*  
**CROWN LANDS TEMPORARILY  
RESERVED**

The Governor in Council under sections 4 and 7 of the *Crown Land (Reserves) Act 1978* temporarily reserves for the purposes mentioned and also excepts from prospecting or from occupation for mining purposes under any miners right the following Crown lands:

**MUNICIPAL DISTRICT OF THE SHIRE OF  
STAWELL**

ILLAWARRA—Conservation of an area of natural interest, 3.569 hectares being Crown Allotment 249C, Parish of Illawarra as indicated by hatching on plan hereunder—(2771) (Rs 13767).

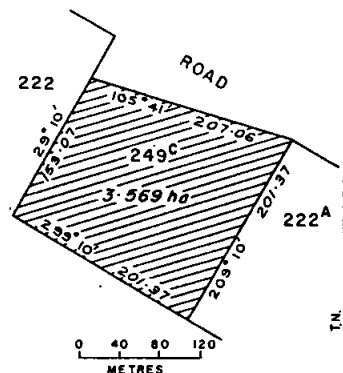

*Cemeteries Act 1958*  
**APPOINTMENT OF TRUSTEES OF PUBLIC  
CEMETERIES**

The Governor in Council under section 3 (1) of the *Cemeteries Act 1958* makes the following appointments of trustees of public cemeteries:

Name	Public Cemetery
Helen Margaret RAPSEY	Tallangatta Public
Jacqueline Anne CRITCHLEY	Williamstown and The Memorial Park

**MUNICIPAL DISTRICT OF THE SHIRE OF  
EAST LODDON**

MITIAMO—Public Hall, 661 square metres being Crown Allotment 1G, Parish of Mitiamo—(Rs 13764).

**MUNICIPAL DISTRICT OF THE TOWN OF  
STAWELL**

STAWELL—Public Recreation, 374 square metres being Crown Allotment 12A, section 24, Parish of Stawell as indicated by hatching on plan hereunder—(3499-5) (Rs 2088).

2026 G 25 6 July 1988

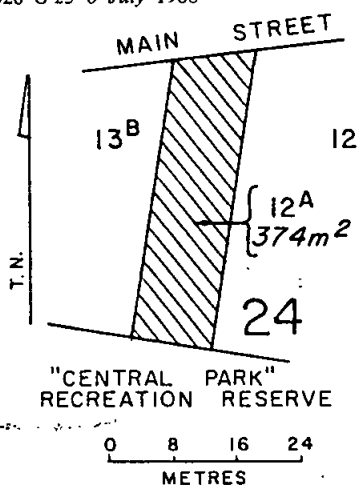

**MUNICIPAL DISTRICT OF THE TOWN OF STAWELL**

STAWELL—Public Recreation, 1528 square metres being Crown Allotment 24A, section 24, Parish of Stawell as shown on Certified Plan No. 108932 lodged in the Central Plan Office—(Rs 2088).

Dated 28 June 88

Responsible Minister:

JOAN E. KIRNER

Minister for Conservation, Forests and Lands

LAWRENCE A. FISHER

Clerk of the Executive Council

*Crown Land (Reserves) Act 1978*

**APPOINTMENT OF TRUSTEE**

Masonic Charitable Institution Site at South Melbourne

The Governor in Council, under section 12 of the *Crown Land (Reserves) Act 1978* appoints:

William Anthony TOPE

as a trustee of the land in the Parish of South Melbourne permanently reserved as a site for Masonic Charitable Institutions by Order in Council of 30 December 1867 in the place of:

Charles Roger DARVALL, (Retired)

Rs 1188

Dated 28 June 1988

Responsible Minister:

JOAN E. KIRNER

Minister for Conservation, Forests and Lands

LAWRENCE A. FISHER

Clerk of the Executive Council

*Victoria Government Gazette*

*Crown Land (Reserves) Act 1978*

**NOTICE OF INTENTION**

The Governor in Council under section 10 of the *Crown Land (Reserves) Act 1978*, gives notice of intention to revoke the following temporary reservations:

**BALLARAT**—The temporary reservation by Order in Council of 5 April 1892, of 14.16 hectares of land in the Township of Ballarat and Ballarat East and the Parish of Ballarat as a site for Public purposes, revoked as to part by various orders, so far only as the portion in the Township of Ballarat containing 1600 square metres, more or less, as indicated by hatching on plan hereunder—(B128(73)) (Rs 5114).

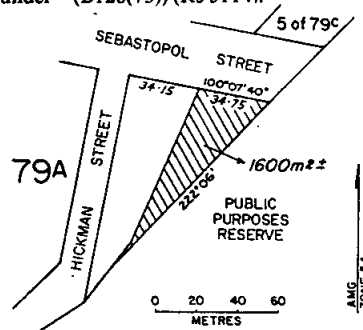

**BRIAGOLONG**—The temporary reservation by Order in Council of 13 April 1886, of 1.36 hectares of land in the Parish of Briagolong as a site for road purposes—(L9-2289).

**CASTLEMAINE**—The temporary reservation by Order in Council of 16 April 1985 of 49.70 hectares of land being Crown allotment 8 section B4 Parish of Castlemaine as a site for Prison purposes so far only as the portion containing 114 square metres shown as Crown allotment 8A section B4 Parish of Castlemaine on Certified Plan No. 108798 lodged in the Central Plan Office—(Rs 11508).

**KILCUNDA**—The temporary reservation by Order in Council of 8 October 1901 of 2023 square metres of land in section 2, Township of Kilcunda as a site for a Mechanics Institute and Free Library—(Rs 3158).

**LEEOR**—The temporary reservation by Order in Council of 22 September 1890, of 60.7 hectares of land in the Parish of Leeor as a site for Water Supply purposes, revoked as to part by Orders of 24 April 1928 and 15 March, 1978, so far only as the areas of 1.602 hectares and 1108 square metres shown as Crown Allotments 12G and 12J, respectively, section 6, Parish of Leeor on Certified Plan No. 108979 lodged in the Central Plan Office—(Rs 10481).

*Victoria Government Gazette*

**WOMBELANO**—The temporary reservation by Order in Council of 17 January 1882, of 48.56 hectares of land in the Parish of Wombelano as a site for the Conservation of Water—(L4-1556).

Dated 28 June 1988

Responsible Minister:

**JOAN E. KIRNER**

Minister for Conservation, Forests and Lands

**LAWRENCE A. FISHER**

Clerk of the Executive Council

*Crown Land (Reserves) Act 1978*

**APPOINTMENT OF TRUSTEES**

Newstead Racecourse and Recreation Reserve  
The Governor in Council, under section 12 of the *Crown Land (Reserves) Act 1978* appoints:

James Francis **EBERY**,

Harold Thomas **BARKLA**,

Robert Charles William **WARD**,

Dennis Arthur **TICKELL**

as trustees of the land being Crown Allotment 9, section C, Township of Newstead, Parish of Strangways permanently reserved for a Racecourse and other purpose of Public Recreation by Order in Council of 16 July 1888 in the place of:

Francis Charles **HALL**, (Deceased),

Andrew MacIntosh **HURSE**, (Deceased),

Alister Ian **MACLAREN**, (Deceased),

James Henry **BUTLER**, (Deceased),

Dugald McInnis **CAMERON** (Deceased)

Rs. 1030

Dated 28 June 1988

Responsible Minister:

**JOAN E. KIRNER**

Minister for Conservation, Forests and Lands

**LAWRENCE A. FISHER**

Clerk of the Executive Council

*Crown Land (Reserves) Act 1978*

**CROWN LAND PERMANENTLY RESERVED**

The Governor in Council under sections 4 and 7 of the *Crown Land (Reserves) Act 1978* permanently reserves for the purpose mentioned and also excepts from prospecting or from occupation for mining purposes under any miners right the following Crown land:  
**MUNICIPAL DISTRICT OF THE SHIRE OF STAWELL**

**MALAKOFF**—Conservation of an area of natural interest, 8.094 hectares being Crown Allotment 134C, Parish of Malakoff as indicated by hatching on plan hereunder—(M454(2)) (Rs 504).

G 25 6 July 1988 2027

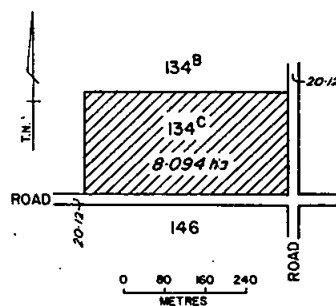

Dated 28 June 1988

Responsible Minister:

**JOAN E. KIRNER**

Minister for Conservation, Forests and Lands

**LAWRENCE A. FISHER**

Clerk of the Executive Council

*Land Act 1958*

**UNUSED ROAD CLOSED**

The Governor in Council under section 349 of the *Land Act 1958* and with the consent in writing of the municipality concerned and the adjoining owners closes the following unused road:

**MUNICIPAL DISTRICT OF THE SHIRE OF WALPEUP**

**BOULKA**—The road in the Parish of Boulka shown by hatching on plan hereunder—(B768<sup>(2)</sup>) (L5-3166).

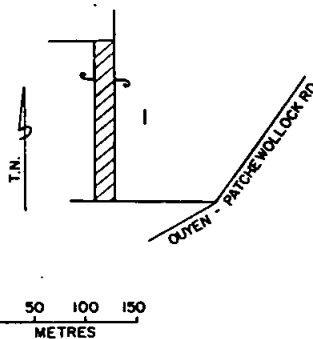

Dated 28 June 1988

Responsible Minister:

**JOAN E. KIRNER**

Minister for Conservation, Forests and Lands

**LAWRENCE A. FISHER**

Clerk of the Executive Council

2028 G 25 6 July 1988

*Land Act 1958*  
**UNUSED ROAD CLOSED**

The Governor in Council under section 349 of the *Land Act 1958* and with the consent in writing of the municipality concerned and the adjoining owner closes the following unused road:

**MUNICIPAL DISTRICT OF THE SHIRE OF MAFFRA**

**BRIAGOLONG**—The road in the Parish of Briagolong as indicated by hatching on plan hereunder—(B97(6))(L9-2289).

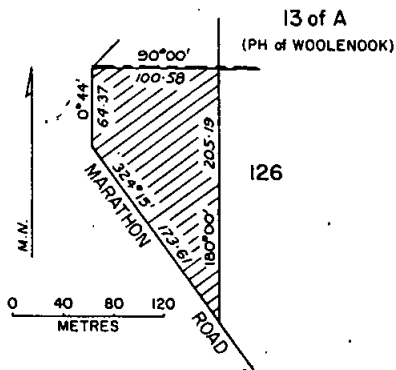

Dated 28 June 1988

Responsible Minister:

**JOAN E. KIRNER**

Minister for Conservation, Forests and Lands

**LAWRENCE A. FISHER**

Clerk of the Executive Council

*The Constitution Act Amendment Act 1958*

**APPOINTMENT OF MELBOURNE POLLING PLACE**

The Governor in Council under section 148 (4) of *The Constitution Act Amendment Act 1958* and all other available powers, appoints the Melbourne polling place for the purpose of taking votes at the election for the Legislative Assembly Electoral District of Ballarat North to be held on 23 July 1988.

Dated 28 June 1988

Responsible Minister:

**PETER SPYKER**

Minister for Property and Services

**LAWRENCE A. FISHER**

Clerk of the Executive Council

*Victoria Government Gazette*

*Water and Sewerage Authorities (Restructuring) Act 1983*

*Sewerage Districts Act 1958*  
**DAYLESFORD WATER BOARD**

**Acquisition of Land Approved**

The Governor in Council under the provisions of the *Water and Sewerage Authorities (Restructuring) Act 1983* and the *Sewerage Districts Act 1958* approves of the acquisition of the following parcel of land by the Daylesford Water Board to increase the extent of its sewage treatment works.

**Parcel of land:**

Crown allotments 1 and 2, section 6, Parish of Franklin, County of Talbot and being more particularly described on Certificate of Title Volume 9784 Folio 332.

Dated 21 June 1988

Responsible Minister:

**FRANK WILKES**

Minister for Water Resources

**LAWRENCE A. FISHER**

Clerk of the Executive Council

*Local Government Act 1958*

**APPOINTMENT OF MEMBERS AND DEPUTY-MEMBERS OF MUNICIPAL VALUATION FEES COMMITTEE**

The Governor in Council, under section 254 (6A and 6AB) of the *Local Government Act 1958*, appoints the following persons as Members and Deputy Members of the Municipal Valuation Fees Committee, for the period from 24 June 1988 to 24 June 1991.

*Members*

**Peter G. CLEARY,**

**Graeme FRECKER**

*Deputy Members*

**Ann F. FREEMAN,**

**Athol ATTWATER**

Dated 28 June 1988

Responsible Minister:

**PETER SPYKER**

Minister for Property and Services

**LAWRENCE A. FISHER**

Clerk of the Executive Council

**PRIVATE  
ADVERTISEMENTS**

*Planning and Environment Act 1987*  
**NOTICE OF AMENDMENT TO A  
PLANNING SCHEME**

The City of Altona has prepared Amendment No. L1 to the Altona Planning Scheme. The amendment affects land at the north west corner of Blyth Street and Bent Street, Altona, being described as part Crown Allotment A, section 8 in the Parish of Truganina.

The amendment proposes to change the scheme by rezoning the land from Residential 'C' to Restricted Business. The amendment can be inspected at the offices of the:

City of Altona, 115 Civic Parade, Altona 3018;  
Ministry for Planning and Environment, Ground Floor, The Olderfleet Buildings, 477 Collins Street, Melbourne 3000.

Submissions about the amendment must be sent to: Chief Executive Officer/Town Clerk, City of Altona, P.O. Box 21, Altona 3018.

Dated 8 August 1988

**JOHN F. SHAW**  
1799 Chief Executive Officer/Town Clerk

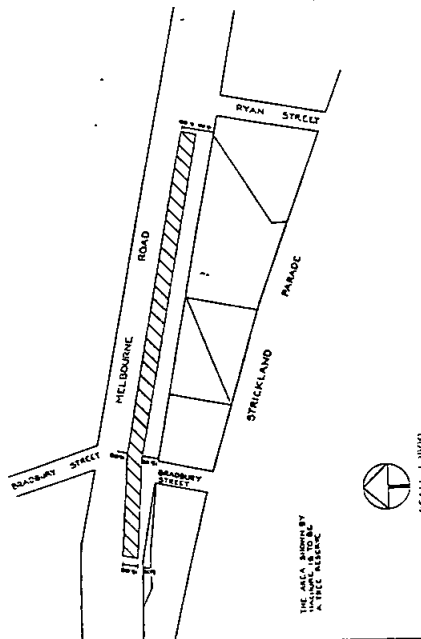

Dated 28 June 1988

**DAVID R. PEILE**  
1776 Chief Executive Officer

City of Ballarat  
**SHOPPING MALL ORDER**

(Section 539b (10) Local Government Act)

The Council of the City of Ballarat hereby advises that at its meeting on 20 June 1988, it did adopt the proposal dated 22 September 1986 without modification and formally declares that the area of Armstrong Street South, Ballarat between the north building line of Chancery Lane and the south building line of Bath Street (commonly known as Bath Lane) be a shopping mall.

The Council has further resolved to fix 1 July 1988 as the date upon which the order as adopted shall come into operation.

**D. R. PEILE**  
1768 Chief Executive Officer

**CITY OF BALLARAT**  
Tree Reserve

(Section 557 (1) Local Government Act)

The Council of the City of Ballarat hereby advises that at its meeting on 22 February 1988, it did order that the area of the Old Melbourne Road shown by hachure on the plan hereunder shall be a tree reserve.

Local Government Act  
**CITY OF BRIGHTON**

Road Discontinuance Resolution

Whereas it is provided in section 528 (2) of the above Act (as amended) that where a road whether or not a public highway (but not being required as a road for public use) the council of the municipality in which such a road is situated may not less than one month after publishing a public notice in a newspaper generally circulated in the municipal district and giving written notice to the registered proprietor (if any) of any land abutting or immediately adjacent to the road of its intention to make a resolution published in the *Government Gazette* direct that such a road or part of the road shall be discontinued accordingly:

And whereas the Council of the above municipality hereby resolves that the right of way off the south side of Harwood Street, and rear of 33-39 Drake Street, be discontinued and not less than one month previously has published a public notice in a newspaper generally circulated in the municipal district and has given notice to the last registered owner of the land in

2030, G 25 6 July 1988

the roads and to the owners and occupiers of land abutting or immediately adjacent to the right of way of its intention to make this Resolution and has considered all objections received within 14 days of publication of the public notice aforesaid:

Now therefore the Council of the City of Brighton hereby directs:

- (a) That the section of the right of way shown hatched on the enclosed plan herewith shall be discontinued upon publication of this Resolution in the *Government Gazette*.
- (b) That the land in the said roads shall vest in the municipality to be retained by it until it is sold by private treaty.

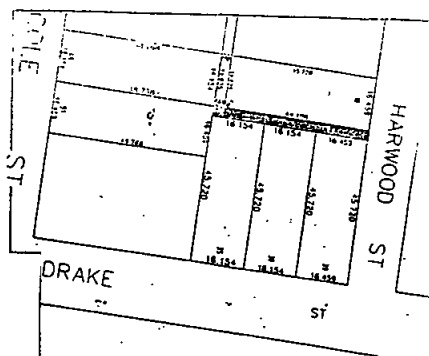

V. L. FARAVONI  
Town Clerk

1790

Local Government Act  
CITY OF BRIGHTON  
Road Discontinuance Resolution

Whereas it is provided in section 528 (2) of the above Act (as amended) that where a road whether or not a public highway (but not being required as a road for public use) the council of the municipality in which such a road is situated may not less than one month after publishing a public notice in a newspaper generally circulated in the municipal district and giving written notice to the registered proprietor (if any) of any land abutting or immediately adjacent to the road of its intention to make a resolution published in the *Government Gazette* direct that such a road or part of the road shall be discontinued accordingly:

*Victoria Government Gazette*

And whereas the Council of the above municipality hereby resolves that the right of way abutting 16 York Street, be discontinued and not less than one month previously has published a public notice in a newspaper generally circulated in the municipal district and has given notice to the last registered owner of the land in the roads and to the owners and occupiers of land abutting or immediately adjacent to the right of way of its intention to make this Resolution and has considered all objections received within 14 days of publication of the public notice aforesaid:

Now therefore the Council of the City of Brighton hereby directs:

- (a) That the section of the right of way shown hatched on the enclosed plan herewith shall be discontinued upon publication of this Resolution in the *Government Gazette*.
- (b) That the land in the said roads shall vest in the municipality to be retained by it until it is sold by private treaty.
- (c) That notwithstanding such discontinuance the Melbourne and Metropolitan Board of Works shall continue to have and possess the same right, title, power, authority or interest in or relation to the whole of the land shown by hachure on the said plans as it had or possessed prior to such discontinuance with respect to or in connection with any drains or pipes laid or erected in or over such land.

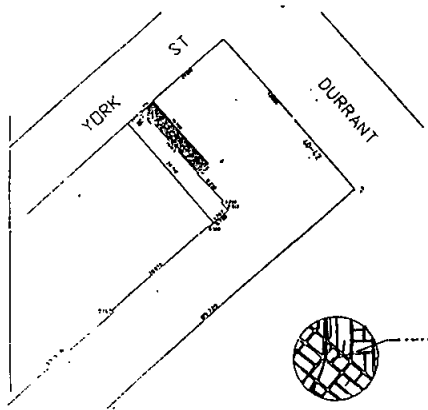

V. L. FARAVONI  
Town Clerk

1791

**CITY OF CAMBERWELL**  
Road Discontinuance

Pursuant to section 528 (2) of the *Local Government Act 1958*, the Council of the City of Camberwell has resolved that part of a road rear of Martin Road and Staughton Road and abutting Valley Parade, Glen Iris which is shown by hatching on the plan herewith, and which has been closed per Amendment 408, Melbourne Metropolitan Planning Scheme, gazetted 25 June 1986 be discontinued subject to:

- (a) the Melbourne and Metropolitan Board of Works continuing to have and possess the same right, title, power, authority or interest in or in relation to the whole of the land shown by hatching on the said plan as it had or possessed prior to such discontinuance with respect to or in connection with any drains or pipes laid or erected in on or over such land for the purposes of drainage or sewerage;
- (b) the land in the said road subject to any such right, title, power, authority or interest vesting in the municipality to be retained by it until sold by private treaty.

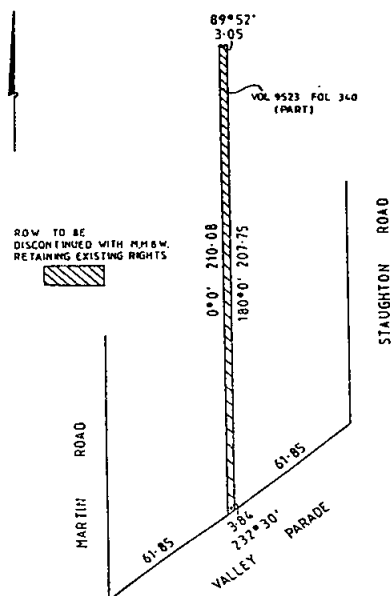

1804 **MARTIN VERHOEVEN**  
Chief Executive Officer and Town Clerk

**CITY OF COLAC**  
Road Discontinuance

Pursuant to section 528 (2) of the *Local Government Act 1958*, the Council of the City of Colac at its ordinary meeting of Council held on 22 June 1988 resolved that the road shown hatched on the plan below be discontinued and sold by private treaty.

That notwithstanding such discontinuance the Colac District Water Board shall continue to have and possess the same right, title, power, authority or interest in or in relation to the whole of the land shown by hatching on the said plan as it has possessed prior to such discontinuance with respect to or in connection with any drains or pipes laid or erected in or over such land for sewerage purposes.

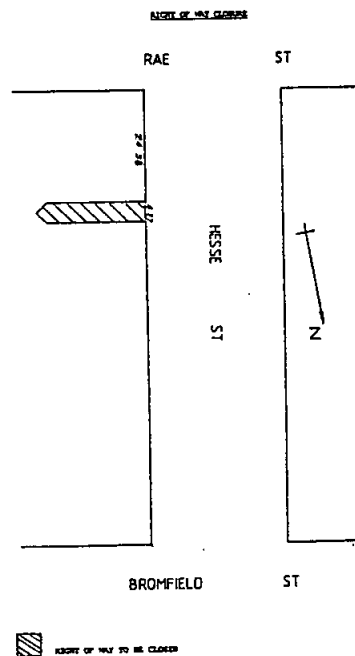

1803 **B. KANE**  
Acting Town Clerk

2032 G 25 6 July 1988

CITY OF ESSENDON  
Right-of-Way No. 184

Whereas it is provided in section 528 (2) (a) of the *Local Government Act 1958*, that where a road (whether or not a public highway but not being a road set out on land of the Crown) or any part thereof is not required for public use of the Council of the municipality in which such road is situated made not less than one month after publishing in a newspaper generally circulating in the district and posting to the registered proprietor (if any) of the land and to the owners and occupiers (if any) of lands abutting or immediately adjacent to the road notice of intention to pass such a resolution may by resolution published in the *Government Gazette* direct that such a road or part shall be discontinued and thereupon such road or part shall be discontinued accordingly.

And whereas the Council of the City of Essendon on 22 February 1988 resolved that the road be discontinued and not less than one month previously has published in a newspaper generally circulating in the district and posted to the registered proprietors of the land in the roads and to the owners and occupiers of lands abutting or immediately adjacent to the roads notice of intention to make such a resolution.

Now therefore the Mayor, Councillors and Citizens of the City of Essendon by resolution dated 22 February 1988—

- (a) that the said road which is shown by hatching on the plan hereunder, shall be discontinued;
- (b) that notwithstanding such discontinuance the Melbourne and Metropolitan Board of Works and the Mayor, Councillors and Citizens of the City of Essendon shall continue to have and possess the same right, title, power, authority or interest in or in relation to the whole of the land shown by hatching on the said plan as they had or possessed prior to such discontinuance with respect to or in connection with any drains or pipes laid or erected in, on, or over such land for the purposes of drainage or sewerage; and
- (c) that, subject to any such right, title, power, authority or interest the land in the said roads may be sold by the Council of the City of Essendon by agreement.

Victoria Government Gazette

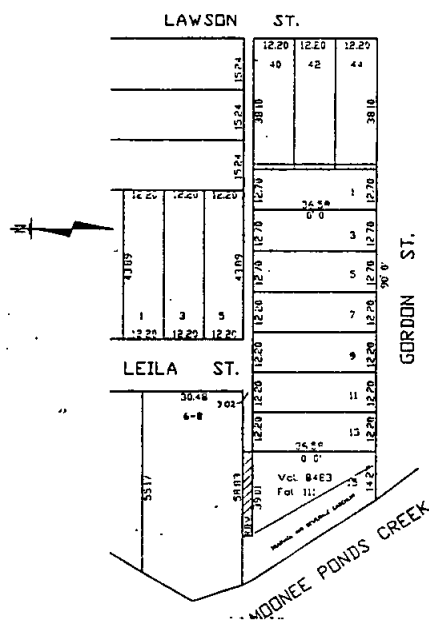

1805

P. SEAMER  
City Manager

CITY OF ESSENDON  
Right-of-Way No. 229

Whereas it is provided in section 528 (2) (a) of the *Local Government Act 1958*, that where a road (whether or not a public highway but not being a road set out on land of the Crown) or any part thereof is not required for public use of the Council of the municipality in which such road is situated made not less than one month after publishing in a newspaper generally circulating in the district and posting to the registered proprietor (if any) of the land and to the owners and occupiers (if any) of lands abutting or immediately adjacent to the road notice of intention to pass such a resolution may by resolution published in the *Government Gazette* direct that such a road or part shall be discontinued and thereupon such road or part shall be discontinued accordingly.

And whereas the Council of the City of Essendon on 27 June 1988 resolved that the road be discontinued and not less than one month previously has published in a newspaper generally circulating in the district and posted to the registered proprietors of the land in the roads and to the owners and occupiers of lands abutting or immediately adjacent to the roads notice of intention to make such a resolution.



Victoria Government Gazette

Now therefore the Mayor, Councillors and Citizens of the City of Essendon by resolution dated 27 June 1988—

- (a) that the said road which is shown by hatching on the plan hereunder, shall be discontinued;
- (b) that notwithstanding such discontinuance the Melbourne and Metropolitan Board of Works and the Mayor, Councillors and Citizens of the City of Essendon shall continue to have and possess the same right, title, power, authority or interest in or in relation to the whole of the land shown by hatching on the said plan as they had or possessed prior to such discontinuance with respect to or in connection with any drains or pipes laid or erected in, on, or over such land for the purposes of drainage or sewerage; and
- (c) that, subject to any such right, title, power, authority or interest the land in the said roads may be sold by the Council of the City of Essendon by agreement.

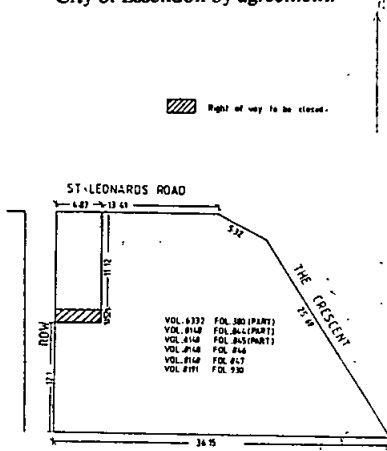

1806

P. SEAMER  
City Manager

City of Hawthorn  
DISCONTINUANCE OF ROAD

Pursuant to section 528 (2) of the *Local Government Act 1958*, the Council of the City of Hawthorn after consultation with public authorities and the advertising of its intention and notification to the registered proprietor of the land and owners of any land abutting or immediately adjacent to the road, has resolved at an ordinary meeting held on 14 June 1988, as follows:

G 25 6 July 1988 2033

- (a) That the Council pursuant to section 528 (2) (a) of the *Local Government Act 1958*, resolves to close the road on the west side of Elphin Grove commencing 45.72 m south of Barkers Road and terminating 47.34 m west of the west building line of Elphin Grove, and contained in Certificate of Title Volume 1596, Folio 002, and that the land thereof be sold by private treaty.
- (b) The entire area of land contained in the discontinued road be encumbered with sewerage rights in favour of the Melbourne and Metropolitan Board of Works.
- (c) The land contained in the discontinued road be offered for sale by private treaty to the abutting owners.
- (d) A copy of this resolution be published in the *Government Gazette*.

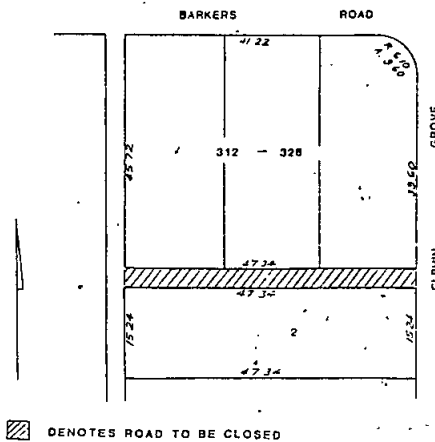

1767

B. C. SMITH, Town Clerk

CITY OF MELBOURNE  
Partial Street Closure

Notice is hereby given that the Council of the City of Melbourne, pursuant to the provisions of section 539c (10) of the *Local Government Act 1958*, on 20 June 1988, resolved to vary by Order, the Order made on 20 May 1985 under section 539c (5) of the Act for the closure to through traffic of part of the width of Canning Street, North Melbourne, at its intersection with Macaulay Road, by deleting the existing barriers over portion of Canning Street and substituting the barriers as shown in the diagram below.

2034 G 25, 6 July 1988

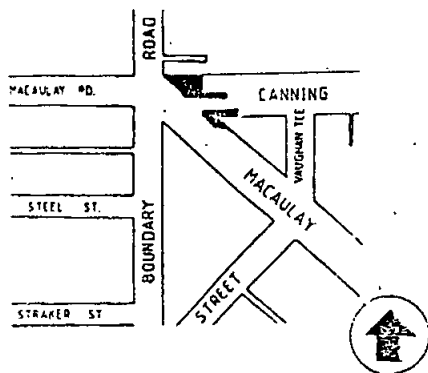

D. N. BETHKE  
1800 Chief Executive Officer and Town Clerk

**CITY OF NUNAWADING**  
Road Discontinuance

Pursuant to section 528 (2) of the *Local Government Act 1958*, the Council of the City of Nunawading, after consultation with public authorities and the advertising of its intention and notification to the registered proprietor and occupiers of the land, has by resolution of its ordinary meeting held on 20 June 1988, resolved that the area shown by hatching on the plan below and known as the Esplanade Mitcham is:

- (a) in the opinion of Council not reasonably required for public use, and shall be discontinued;
- (b) that the land shall vest in Council until sold by private treaty.

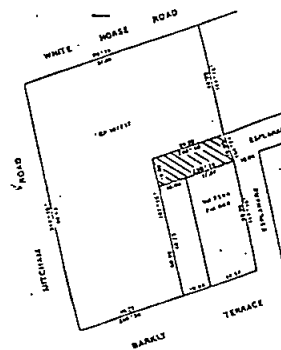

L. FELL  
1792 Chief Executive

*Victoria Government Gazette*

**CITY OF SPRINGVALE**  
Closure of Road to Traffic

Notice is hereby given that the City of Springvale has adopted an Order pursuant to the *Local Government Act*, section 539c, for the closure of Bowen Road, Mordialloc, to vehicular traffic, by the erection of a permanent barrier located at the bend in Bowen Road and further that the Order shall come into operation on Wednesday, 6 July 1988.

I. J. TATTERSON  
1802 Chief Executive Officer

**SHIRE OF BANNOCKBURN**  
Renaming of Road

Section 535 (4) *Local Government Act*

Notice is hereby given that at a meeting held on 11 June 1987, the Council of the Shire of Bannockburn formally resolved to change the name of the road known as Durdidwarrah-Beremboke Road to Stony Creek Road.

The subject road extends from the Geelong-Ballan Road in a northerly direction along the eastern boundary of the Water Reserve and Crown Allotment number 28A in the Parish of Moreep and into the Parish of Beremboke.

E. J. DIXON  
1807 Shire Secretary

**SHIRE OF BANNOCKBURN**  
Renaming of Road

Section 535 (4) *Local Government Act*

Notice is hereby given that at a meeting held on 11 June 1987, the Council of the Shire of Bannockburn formally resolved to change the name of the road known as Bamganie-Lethbridge Road to Lower Plains Road.

The subject road extends from the Midland Highway in a westerly direction to the Meredith-Shelford Road along the southern boundaries of Crown Allotment Numbers E and G, section 2, A, B, D, section 3, 7, 7B, 7H, 10, 17, 18, no section, Parish of Coolebarghurk.

E. J. DIXON  
1808 Shire Secretary

**SHIRE OF BANNOCKBURN**  
Renaming of Road

Section 535 (4) *Local Government Act*

Notice is hereby given that at a meeting held on 11 June 1987, the Council of the Shire of Bannockburn formally resolved to change the name of the road known as Slabik Road to Duggan Road.

Victoria Government Gazette

The subject road extends in a southerly direction from Steiglitz Road along the eastern boundaries of Crown Allotment numbers 26, 26A, 26B, 27B, 27C, in the Parish of Durdidwarrah.

1809 E. J. DIXON  
Shire Secretary

**SHIRE OF BANNOCKBURN**

Renaming of Road

Section 535 (4) Local Government Act

Notice is hereby given that at a meeting held on 11 June 1987, the Council of the Shire of Bannockburn formally resolved to change the name of the road known as "Off Loves Lane" to Galatea Mine Road.

The subject road extends in a westerly direction from Loves Lane along the northern boundaries of Crown Allotment numbers B23, 40G, 40J, in the Parish of Durdidwarrah.

1810 E. J. DIXON  
Shire Secretary

**SHIRE OF BET BET**

Naming of Road

Notice is hereby given pursuant to the provisions of the *Local Government Act 1958*, as amended, that the Council of the Shire of Bet Bet resolved at its ordinary meeting held on 22 June 1988, to assign the following name to the Government Road as stated hereunder:

Name; Location

Crystal Hill Road; unnamed road lane located between Crown Allotments 1 and 2 of section 14B Township of Tarnagulla.

Dated 28 June 1988

1778 J. A. THOMPSON  
Shire Secretary

**SHIRE OF DIMBOOLA**

Notice of Amendment to a Planning Scheme

The Shire of Dimboola has prepared Amendment L2 to the Shire of Dimboola Planning Scheme.

The Amendment affects land at:

Land on the South Eastern corner of the New Dimboola By-pass and the realigned Borung Highway, Dimboola being Crown Allotment 163M, Parish of Dimboola.

Land in Station Street, Rainbow being Crown Allotment 4, section 1, Township of Rainbow and Lots 1, 2 on LP 63548.

The Amendment proposes to change the Planning Scheme by allowing Council to consider a permit application for:

G 25 6 July 1988 2035

A Motor workshop on CA 163M, Parish of Dimboola.

A Gas refuelling station in Station Street, Rainbow being CA4, section 1, Township of Rainbow and Lots 1, 2 on LP 63548.

The Amendment can be inspected at the:

Shire Office, Roy Street, Jeparit.

Old Shire Hall, Lloyd Street, Dimboola

Ministry for Planning and Environment (Plan Inspection) Ground Floor, The Olderfleet Buildings, 477 Collins Street, Melbourne.

Submission about the amendment must be sent to the Shire of Dimboola, PO Box 186, Jeparit, on or before 9 August 1988.

Dated 28 June 1988

1777 M. B. MOLONEY  
Shire Secretary

*Land Acquisition and Compensation Act 1986*

GEELONG AND DISTRICT WATER

BOARD

Form 7

Notice of Acquisition

Compulsory Acquisition of Interest in Land from Gordon John Holland, Florence Amy Holland and Graeme John Holland

Geelong and District Water Board (herein called "the Authority") declares that by this Notice it acquires the legal and equitable estates in the fee simple of all that piece of land containing 18.93 hectares delineated and enclosed by continuous lines on plan reference number 9-2981 (which is available for inspection at the Authority's office at 61-67 Ryrie Street, Geelong) being Crown Allotments 7, 8, 9, 10, 11, 12, 13 and 13A Section One and Crown Allotments 5, 6, 7, 8 and 11 and part of Allotments 9 and 10 Section 2 Township of Wurdi Boluc and Crown Allotment 7B and part of Crown Allotment 7A Section 4 Parish of Tutegong and being the lands referred to in Certificates of Title Volume 8850 Folios 847 and 848 and Crown Grant Volume 8274 Folio 929.

Published with the authority of Geelong and District Water Board.

1825 I. G. ZIERK, Acting Secretary

*Land Acquisition and Compensation Act 1986*

GEELONG AND DISTRICT WATER

BOARD

Form 7

Notice of Acquisition

Compulsory Acquisition of Interest in Land from William Meredith Johnson, Esther Jean Johnson and National Australia Bank Limited

2036 G 25 6 July 1988

Geelong and District Water Board (herein called "the Authority") declares that by this Notice it acquires the legal and equitable estates in the fee simple of all that piece of land delineated and shown with an area of 4.810 hectares on plan reference number 9-2992 (which is available for inspection at the Authority's office at 61-67 Ryrie Street, Geelong) being part of Crown Allotment 4, Section One, Parish of Tutegong and being part of the land referred to in Mortgage No. 718 Book 741.

Published with the authority of Geelong and District Water Board.

1826 I. G. ZIERK, Acting Secretary

*Land Acquisition and Compensation Act 1986*  
**LAND ACQUISITION AND  
COMPENSATION REGULATIONS 1987**  
Form 7, S21 Reg. 16  
Notice of Acquisition  
**COMPULSORY ACQUISITION OF  
INTEREST IN LAND**

The Dandenong Valley Authority declares that by this notice it acquires an interest as owner in fee simple in all that piece of land delineated on the plan below and being part of the land described in Certificates of Title Volume 8681 Folios 026 and 027 and Volume 8744 Folios 586 and 587.

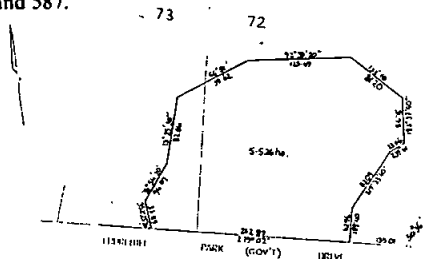

Published with the authority of the Dandenong Valley Authority.  
Dated 20 June 1988

1793 SECRETARY  
Dandenong Valley Authority

**BENDIGO WATER BOARD**  
General Notice

The abovementioned Water Board having made provision for carrying off the sewage from each and every property which or any part of which is within the sewerage area hereinafter described doth hereby declare that on and after 1 July 1988 each and every property which or any part of which is within the said sewerage area shall be deemed to be a seweraged property within the meaning of the *Sewerage Districts Act 1958*.

*Victoria Government Gazette*

The boundaries of the sewerage areas herein referred to are delineated on the plans, copies of which may be inspected at the office of the Board, 34 Mundy Street, Bendigo, or at the Department of Water Resources, 35 Spring Street, Melbourne.

The sewerage areas referred to are:

- 507 Taylor Street
- 508 Stringybark Court
- 509 Golden Gully Road
- 510 Ham Street
- 511 Sherwood Drive
- 512 Shelton Road
- 513 Miller Court
- 514 Plumridge Street
- 515 Lethebys Road
- 516 Clarcoll Crescent
- 517 Strickland Street
- 518 Jackass Flat

By Order of the said Water Board 28 June 1988

C. M. NANKERVIS, Chairman  
J. A. BOWLES, Member  
1811 M. W. BROWN, Secretary

**LANG LANG WATER BOARD**  
General Notice

The Lang Lang Water Board, having made provision for carrying off the sewage from each and every property which, or any part of which, is within the Sewerage Area hereinbefore described, doth hereby declare that on, or after 1 July 1988 each and every property which, or any part of which is within the said Sewerage Area, shall be deemed to be a seweraged property within the meaning of the *Sewerage Districts Act*.

*Sewerage Area No. 5*

Lots 1-49 James Street, Lang Lang (7.31 hectares).

By Order of the said Water Board

K. KITCHIN, Chairman  
1812 R. J. PERCY, Secretary

*Land Act 1958*  
**SECTION 134**

Notice is hereby given that Maffra Bowls Recreation Inc. has applied for a lease under section 134 of the *Land Act 1958* for a term of 21 years of Crown allotment 3, section 42, Township of Maffra, containing 7025 m<sup>2</sup> and situated on the corner of Princess and John Streets, Maffra as a site for Amusement and Recreation (Bowling Club).

1772 COLIN LESTRANGE  
Honorary Secretary

**DISSOLUTION OF PARTNERSHIP**

Take notice that the partnership between Peter Tzavaras and Shirley Anne Tzavaras being carried on under the business name of The Beaufort Fish Shop at 70 Neill Street, Beaufort in the State of Victoria has as and from 23 May 1988 being dissolved. Peter Tzavaras will continue to carry on the business at the same address but Shirley Anne Tzavaras will not be entitled to any of the income or be responsible for any debts incurred by the business after 23 May 1988 without her written consent.

**RAMSAY, GAUNT & FRASER, Solicitors,**  
41 Lydiard Street South, Ballarat 3350 1769

**NOTICE FOR DISSOLUTION OF  
PARTNERSHIP**

Notice is hereby given that the Partnership of John Grant Wilson, Debbie Ann Wilson (nee Evans), Warren Mark Winkler and Deborah Joy Winkler carrying on business as Discovery Homes at 6 Belt Terrace, Endeavour Hills has been dissolved at and from 30 April 1988. John Grant Wilson and Trevor John Holland will continue to carry on the said business.

**S. R. LEIGHTON, Shop 7, Endeavour Hills  
Shopping Centre, Heatherton Road, Endeavour  
Hills 1770**

**NOTICE OF DISSOLUTION OF  
PARTNERSHIP**

Notice is hereby given that the Partnership of Derick Francis Fernandez and Cynthia Joan Fernandez carrying on business as Soap Cleaning Service at 42 Mildura Crescent, Endeavour Hills has been dissolved as and from 31 May 1988. Derick Francis Fernandez will continue to carry on the said business.

**S. R. LEIGHTON, Shop 7, Endeavour Hills  
Shopping Centre, Heatherton Road, Endeavour  
Hills 1771**

**NOTICE PURSUANT TO SECTIONS 40  
AND 41 OF THE PARTNERSHIP ACT 1958**

To All Persons

Please take note that as at 17 April 1988 the Partnership between Peter Thurlow and Corinne Thurlow both of R.S.D. 72 Three Bridges, Victoria and Steve Theiler and Suzanne Theiler both of 70 Deering Avenue, Healesville has now been dissolved. A new partnership between Steve and Suzanne Theiler both of 70 Deering Avenue, Healesville are now conducting the business of "Homegrown Organic Produce" at Shop 3, 90 Melbourne Hill Road, Warrandyte. 1781

**VICTORIAN TEACHERS' UNION No. 3  
CO-OPERATIVE HOUSING SOCIETY  
LIMITED**

(In Liquidation)

Take notice that the affairs of the abovenamed Society are now fully wound up and that pursuant to section 411 of the Companies (Victoria) Code and the *Co-operative Housing Societies Act 1958*, a General Meeting of the Society will be held at the office of the Liquidator, 464A Lower Heidelberg Road, Heidelberg, on Monday, 1 August 1988, at 12 noon for the purpose of—

1. Laying before it an account showing how the winding up has been conducted and the property of the Society disposed of and giving any explanation thereof; and

2. Passing a resolution that the books and papers of the said Society and of the Liquidator relevant to the affairs of the Society be destroyed after a period of twelve months from the date of the meeting.

Dated 4 July 1988

**GEOFFREY PURVIS**

1841

Liquidator

Notice is hereby given that an Extraordinary General Meeting of Polwarth Knitting Mills Pty. Ltd. will be held at 197-199 Riversdale Road, Hawthorn at 10.00 on 27 June 1988 for the purpose of considering and if thought fit passing with or without amendments the following resolution as a Special Resolution:

"That the Company be wound up voluntarily, and that Leslie Newman be and is now appointed liquidator of the Company."

Dated 17 June 1988

**S. SPITALNIC**

1779

Director

**GUNN'S CONSTRUCTIONS PTY.LTD.**

(In Voluntary Liquidation)

At an Extraordinary General Meeting of Members of the above Company, duly convened and held at Suite 2, 368 Hawthorn Road, Caulfield South Victoria on 17 June 1988, the following special resolution was duly passed:

"That the company be wound up by voluntary winding up and that Alexander Darvas of Suite 2, 368 Hawthorn Road, Caulfield South be appointed as Liquidator for the purpose of winding up the affairs and distributing the property of the company."

Dated 23 June 1988

**ALEXANDER DARVAS**

1780

Liquidator

## Unclaimed Moneys Act 1962

## Register of Unclaimed Moneys held by the

<i>Name of Owner on Books and Last Known Address</i>	<i>Total Amount Due to Owner</i>	<i>Description of Unclaimed Money</i>	<i>Date when Amount first became Payable</i>
\$			
NATIONAL AUSTRALIA BANK LTD			
Ainsworth, James, PO Box 770, Mount Isa, Qld	447.50	Cheque	
Allen, Barbara M, c/o 23 Thorne St, Edgecliff, NSW	121.51	"	
Andrew Potter Productions Pty, PO Box 187, Balmain, NSW	43.50	"	
Archer, Zoe FR, 29 Skene St, Hamilton	145.00	"	
Archibald, John G and Donald C Scott, c/o L H Halliday Hook & Co, PO Box 1, Scone, NSW	279.56	"	
Arnold, Jane V, 15 Wellington St, Kew	106.44	"	
Atkinson, Betty L M, 2 Gregory St, Fannie Bay, NT	123.25	"	
Bagnell, David A, c/o "Oorawilly", via Walcha, NSW	66.70	"	
Baird, Maxwell, Geoffrey Clark and Keith Sharkie, 235 St Helena Rd, Greensborough	68.00	"	
Baker, Edward A (estate of), 85 Findon Rd, Worthing, West Sussex, England	91.80	"	
Bakewell, Ann-Marie, 3/131 Young St, Neutral Bay, NSW	725.00	"	
Balmain, Nanette E, c/o Allens Private Hotel, 28 Lower Wycombe Rd, Neutral Bay, NSW	429.20	"	
Bellm, Genevieve J, 123 Old Mount Barker Rd, Stirling, SA	43.79	"	
Bennett, Jeanie J, 37 Farm Ave, North Harrow, Middlesex, England	256.11	"	
Bergman, Patricia E, 35 Addison Rd, Graceville, Qld	61.78	"	
Bills, Ruth A, Unit 11, 230 Gover St, North Adelaide, SA	30.89	"	
Bishop, Dorothy, 16 Ocean St, Woolahra, NSW	350.90	"	
Bock, Kevin, c/o Commercial Hotel, 52 Wentworth St, Port Kembla, NSW	290.00	"	
Borzell, Lilian M (estate of), c/o Adrian Borzell, PO Box 443, Potts Point, NSW	49.88	"	
Bosher, Arthur ET, c/o ANZ Banking Group, 2748 Goldcoast Hwy, Broadbeach, Qld	42.63	"	
Bowring, Timothy J, 22 Kiata Dve, Mildura	115.57	"	
Boyle, Margaret K L, Yew Tree, Sophurst La, Matfield, Tonbridge, Kent, UK	30.60	"	
Bragg, Damien J, PO Box 899, Wagga Wagga, NSW	396.50	"	
Brand, Ronald M G, 17 Luxton Tce, Seaford	29.00	"	
Britt, Robyn A, c/o R A Neilson, Flat 23, 17 Meadow Cres, Meadowbank, NSW	58.00	"	
Brown, Charles L and Valeriee, c/o H Brown, 31 Charmaine St, Moorooka, Qld	52.50	"	
Burgess, David L, 22 Adelaide Ave, East Lindfield, NSW	31.90	"	
Cary, Ronald A, 11 Junction St, Ryde, NSW	34.00	"	
Chu, Eileen, 436 Glenmore Rd, Edgecliff, NSW	17.00	"	
Clark, Alistair W, c/o N F Clark, 431 McIvor Rd, Bendigo	166.39	"	
Classen, Dieter M and Cornelia U, 245 South Spruce Ave, South San Francisco, California, USA	17.75	"	
Coastal Nominees Ltd, 91 Account, Gerrard House, Gresham St, London, UK	12.45	"	

## Unclaimed Moneys Act 1962

## Register of Unclaimed Moneys held by the

<i>Name of Owner on Books and Last Known Address</i>	<i>Total Amount Due to Owner</i>	<i>Description of Unclaimed Money</i>	<i>Date when Amount first became Payable</i>
--	--	---	--

\$

## NATIONAL AUSTRALIA BANK LTD—continued

Cochrane, Robert M, 111 King Rd, Harkaway	47.13	Cheque	
Connor, Gillian L, 107 Fotheringay Rd, Glasgow, UK	30.60	"	
Cooke, Edward W (estate of), The Cottage, 32 Lewisham Rd, Windsor	262.74	"	
Cottier, Susan B, 218 La Perouse St, Red Hill, ACT	17.00	"	
Coventry, William R (estate of), c/o Ashton Tod McLaren, 13 Castle St, Liverpool, UK	69.02	"	
Creswick, John F, PO Box 288, Fairfield, NSW	51.00	"	
Cruickshank, Margery (estate of), c/o Mary Ireland, 7 Aubrey Cres, Coffs Harbour, NSW	495.18	"	
Dennison, Noel C, Charlotte G and F R (estate of), 33 Ramshana Rd, Christchurch, NZ	98.60	"	
Dixon, Agnes B (estate of), c/o Hill Thomson & Sullivan, 58 Pitt St, Sydney, NSW	68.00	"	
Dixon, John E M, 84 Eastern Rd, Turramurra, NSW	174.00	"	
Doak, Drena F M, 9 Eric Ave, Lower Templestowe	66.99	"	
Douglas, Ivy L, 76 Cutler Rd, Clontarf, NSW	131.23	"	
Douglass, Ivy L, 31/21 Fairlight Cres, Fairlight, NSW	64.53	"	
Downie, Maxine, 39 Carlton St, Harbord, NSW	58.00	"	
Elliott, Susan G, 21 Baynes St, Mount Druitt, NSW	14.50	"	
ERH Pty Ltd, 73 Clanville Rd, Roseville, NSW	383.53	"	
Feldstein, Beatrice, c/o Albert B Feldstein, PO Box 307 Wellers Bridge Rd, Roxbury, Ct, USA	11.09	"	
Fitts, Leslie W J, c/o P I Meredith, 15 Halley St, Blackburn	29.00	"	
Fletcher, Cynthia D H (estate of), c/o Whitehead Monckton & Co, 72 King St, Maidstone, Kent, UK	30.60	"	
Fogarty, Barbara T, PO Box E-137, Canberra, ACT	145.00	"	
Foletta, Henry G, 34 Georges Rd, Toorak	1879.20	"	
Foster, Margaret A (estate of) and John A Chester, c/o Archer Bushby, PO Box 1004, Launceston, Tas	329.15	"	
Frank, Audrey L, 1 Verulam Buildings, Grays Inn, London, England	15.30	"	
French, Alistair J, c/o W Bonner, PO Box 9, Dubbo, NSW	52.20	"	
GK Goh Securities (Pte), 180 Cecil St, Bangkok Building, Singapore	30.60	"	
GL Nominees Ltd, c/o Le Mare Martin & Co, 4th Floor, 39-45 Finsbury Sq, London, UK	1297.33	"	
Gamoty, Gwennyth K (estate of), 22 Mona Rd, Darling Point, NSW	15.23	"	
Gaw, Peter A, 23 Princess St, Taringa, Qld	82.95	"	
George Orwell Productions Ltd (in voluntary liquidation), c/o Philip R Rhodes, 186 City Rd, London, UK	616.25	"	
Gibbs, Sheila M N, 1 Portland Cl, Penarth, South Glam, UK	550.18	"	
Gifford, James D, Flat 8, No. 15 Sir Fred Schonell Dve, St Lucia, Qld	21.75	"	

2040 G 25 6 July 1988

Victoria Government Gazette

## Unclaimed Moneys Act 1962

## Register of Unclaimed Moneys held by the

<i>Name of Owner on Books and Last Known Address</i>	<i>Total Amount Due to Owner</i>	<i>Description of Unclaimed Money</i>	<i>Date when Amount first became Payable</i>
\$			
NATIONAL AUSTRALIA BANK LTD—continued			
Gilder, Robert Jnr, "Glenfalloch", via Licola	145.00	Cheque	
Gordon, Adam McK S, The Garage Flat, Remony House, Kenmore By Aberfeldy, Perthshire, Scotland	616.24	"	
Gray, Grizel, c/o Raphael Zorn, 10 Throgmorton Ave, London, UK	18.61	"	
Greene, Julius D, Unit 2, 29 Archer St, Toowong, Qld	246.50	"	
Greenland, Richard, 5 Page Ave, Wahroonga, NSW	14.50	"	
Grey, Catherine M, 110 Bambra Rd, Caulfield South	130.50	"	
Guthrie, Bronwyn M, c/o IBM, GPO Box 435, Brisbane, Qld	16.24	"	
Hacon, Peter E, Granada, Cloncurry, Qld	73.08	"	
Hadrill, Ian M and Hugh F, 2 Park Dve, Ambelside, East Devonport, Tas	20.45	"	
Hansell, Frank W, The Croft, Muthill Crieff, Perthshire, Scotland, UK	76.41	"	
Hayes, Valmai O, 1 Avanti St, Mermaid Waters, Qld	145.00	"	
Henderson, David McA and Judith M, c/o Argyle Offices, PO Box 357, Albion, Qld	29.00	"	
Herd, Katherine, "Corinna", Catani Boulevard, Kangaroo Ground	41.76	"	
Holland, Anne H, Flat 2, 601 Manukau Rd, Epsom, Auckland, NZ	254.14	"	
Hughes, Winsome M, 47 Simpson St, Bondi, NSW	785.61	"	
Humphris, Ethel M, 15 Dallas St, Mount Waverley	72.50	"	
Hunt, Hamlyn R, Flat 41, 341 Bowen Tce, New Farm, Qld	559.12	"	
Inverarity, Fiona J, 8 Ocean View Pde, Mount Ousley, NSW	21.76	"	
Jackel, Richard W, 45 Skyview Oval, Tappan, New York, USA	54.98	"	
Janson, Ian and Rachel N, Wincomlee Colemans Rd, Breachwood Green, Hitchin, Herts, UK	72.75	"	
Jenkins, Robin P, 336 Macquarie St, Dubbo, NSW	54.38	"	
Jennings, Mary F, 28 London Rd, Hailsham, Sussex, UK	30.60	"	
Johnson, Andrew, 39 Rangers Ave, Cremorne, NSW	217.50	"	
Johnson, William A, Flat 901, 5 Jersey Rd, Artarmon, NSW	72.50	"	
Keong, John, Post Office, Jonoaryan, Qld	29.00	"	
Kesend, Estelle L, 1025 Fifth Ave, New York, NY, USA	110.92	"	
King, Annette (estate of), c/o Walker Gibbs & King, PO Box 8, Cooma, NSW	3357.34	"	
Klein, Abe, Monroe Towers Apartment 1N, 610 Sewall Ave, Asbury Park, New Jersey, USA	24.65	"	
Lai, Kuat S and Ong, Jin H, 2/4 La Frank St, Burwood	3697.50	"	
Lang, Bruce G, 2 Dickens St, Blackburn	17.00	"	
Largo Pty Ltd, c/o Beekays Super Fund, c/o Arthur Young & Co, GPO Box 2646, Sydney, NSW	34.00	"	
Law, Peter, 5 Killara Ave, Killara, NSW	250.56	"	



## Unclaimed Moneys Act 1962

## Register of Unclaimed Moneys held by the

<i>Name of Owner on Books and Last Known Address</i>	<i>Total Amount Due to Owner</i>	<i>Description of Unclaimed Money</i>	<i>Date when Amount first became Payable</i>
\$			
NATIONAL AUSTRALIA BANK LTD—continued			
Lea, Constance M, 3 Bank Mews, Bank House La, Helsby, Warrington, Cheshire, UK	15.30	Cheque	
Lees, Anthony H, 22 Albert St, Edgecliff, NSW	192.13	"	
Lockley, Louise M (estate of), Post Office, Berrima, NSW	153.41	"	
Longolucco, Frances A, 82 East Ave, Westerley, Rhode Island, USA	11.09	"	
Ludowici, Geoffrey R, PO Box 640, Castle Hill, NSW	91.64	"	
Lukins, Janet, 25 Darling St, Moonee Ponds	17.00	"	
Lunda, Margaret D, 9 Coutman St, West Kempsey, NSW	21.75	"	
Mackay, Charles R (deceased), Flat 24, 748 High Street Rd, Glen Waverley	47.56	"	
Maddocks, Susan E, c/o Susan E Kennedy, 28 Coleridge St, Kew	84.10	"	
Maitland, Walter Y, 24A Cooper Pl, Beaumont, SA	68.15	"	
Majid, Aljafei A, Flat 5, 22 Westbury St, East St Kilda	58.00	"	
May, Neil, 8/386 Trower Rd, Tiwi, NT	313.49	"	
Mayes, Nicholas J, 39 Amelia Ave, Wheelers Hill	14.50	"	
McConachy, Reginald J and Bell, John S, 7 Stradbroke Ave, East Brighton	23.20	"	
McCosh, Vera E, 11A Riverview St, South Perth, WA	397.30	"	
McElhone, Barbara, 1211 Bayview Street, McMahons Point, NSW	203.00	"	
McHugh, Thomas, 14 Bromley Ave, Pymble, NSW	362.50	"	
McMahon, Brett S, 1 Grafton St, Woollahra, NSW	29.00	"	
McRae, Cherrie A, 43A Napier St, Freemans Bay, Auckland, NZ	290.00	"	
Meikle, Janet C, 30 Warslap Ave, Arbroath Angus, UK	61.20	"	
Menchan Developments Pty Ltd, 5 Killara Ave, Killara, NSW	375.84	"	
Metcalf, Shirley, c/o Lionel Hauritz, 12 McLeod St, Toowoomba, Qld	34.80	"	
Mikus, Ann B, 22 Woolem Cres, Biloela, Qld	74.82	"	
Miller, Lance H, 10 Mitchell Tce, Port Augusta, SA	145.00	"	
Mitchell, Ross I, 46 Cobham Ave, West Ryde, NSW	58.00	"	
M M Woodlock Pty Ltd, 'Kilpenora', Warren, NSW	208.80	"	
Moden, Florence H W (estate of), c/o HSW Lawson Hughes & Co, 254 Spring St, Reservoir	34.00	"	
Morley, Wilfred J, c/o Moore & Schley Cameron Co, 45 Broadway, New York, NY, USA	140.74	"	
Morrison, Joan A, 14 Kirval Crt, West Hobart, Tas	32.77	"	
Morton, Graeme H, Woodhouse, via Glenthompson	17.00	"	
Mundy, Hilda M, c/o The Perpetual Executors and Trustees Association of Australia Ltd, 50 Queen Street, Melbourne	170.00	"	
Nevitt, Caroline J, Flat 3, 25 Belgrave Rd, Newcastle-Under- Lyme, Staffs, UK	71.48	"	
Noble, Jock W, "Little Farm", Linwood Rd, Seville	58.00	"	

## Unclaimed Moneys Act 1962

## Register of Unclaimed Moneys held by the

<i>Name of Owner on Books and Last Known Address</i>	<i>Total Amount Due to Owner</i>	<i>Description of Unclaimed Money</i>	<i>Date when Amount first became Payable</i>
\$			
NATIONAL AUSTRALIA BANK LTD—continued			
Nordstrom, Marie J, 17 Fourth Ave, Roseland, New Jersey, USA	14.67	Cheque	
Norric, Janette E, PO Box 162, Umina, NSW	87.00	"	
Notares, Irene, 17 Rodney St, Dover Heights, NSW	290.00	"	
Ober, Steven J, 17 Bartholomew Ave, Loberthal, SA	17.00	"	
O'Neill, Nance M (estate of), c/o Bell, Shop 6, Thomas Drive, Chevron Island, Qld	365.40	"	
Ong, Soo K, c/o Osk & Partners, Sdn Lee Wah Bank Bldg, 6th Floor Medan Pasar, Kuala Lumpur, Malaysia	738.64	"	
O'Rourke, Stephanie E, Flat 3, 29 Baxter Ave, Kogarah, NSW	17.40	"	
Otto, Heather, 10 Brookside Rd, Springfield, SA	72.50	"	
Perrers, Elizabeth L, 4 Mona Rd, Woodford, NSW	123.26	"	
Perrett, Arthur A, "Orange Grove", Gunnedah, NSW	58.00	"	
Perrett, Nance R B, "Orange Grove", Gunnedah, NSW	29.00	"	
Phillips, Anita M, PO Box 3481, Beaudesert, Qld	62.35	"	
Pickworth, Margaret, 86 Bridge Street, Port Melbourne	36.25	"	
Pilkington, John P, Lot 77, The Wridgeway, Mount Evelyn	17.00	"	
Pitman, Jane M, 2 King Ave, Balgowlah, NSW	130.50	"	
Podbury, Murray B, 5 Vanessa Crt, Frankston	14.50	"	
Power, Jason McC, 5/23 The Avenue, Rose Bay, NSW	290.00	"	
The Public Trustee of NZ, I M Kidson Account, PO Box 5024, Wellington, NZ	425.00	"	
Quinn, Bertha A, Fairy Bower Rd, Gracemere, Qld	137.76	"	
Rae, Ann, 15 Brisbane St, Goondiwindi, Qld	204.45	"	
Ramsden, Robert M, Broom House, Flanchford Rd, Reigate, Surrey, UK	30.60	"	
Rayment Enterprises Pty Ltd, 27 Waratah St, Queanbeyan, NSW	253.76	"	
Rixon, Irene, c/o Hotel Francis, 383 Lonsdale St, Melbourne	43.50	"	
Robinian Pty Ltd, PO Box 349, Ballina, NSW	14.50	"	
Rodd, Ida (estate of), c/o Mr J H Rodd, 15 Kandoona Ave, St Ives, NSW	145.00	"	
Roget, Elsie M (estate of), c/o Mr R. Wilson-Reid, 1742 Malvern Road, Glen Iris	133.40	"	
Ryan, Edna M, Alex A Jackson and Kathleen J Drabsch, c/o R M Ewing, PO Box 3 Guyra, NSW	191.40	"	
Schmitter, Magdalene, Vereinsweg 23, 3012 Berne, Switzerland	785.72	"	
Scott, Julie Monica, 7 Coorabin Rd, Northbridge, NSW	116.00	"	
Semmel, Robert A O H and Sheila M Currie, c/o 20 Gardenia Rd, Gardenvale	23.06	"	
Shields, Margaret L, 20 Roborough Av, Mt Eliza	361.34	"	
Simpson, James E I, 76 Williams Rd, Blackburn	42.92	"	
Slade, Julian P, 3 Priory Walk, London, UK	45.90	"	
Smith-Elson, A M, 2/2 Stinton Av, Newtown	313.20	"	
Smith, Andrew W H and Dennis V Arrowsmith, 7 Clwyd St, Rhyl, Clwyd, UK	326.37	"	

## Unclaimed Moneys Act 1962

## Register of Unclaimed Moneys held by the

<i>Name of Owner on Books and Last Known Address</i>	<i>Total Amount Due to Owner</i>	<i>Description of Unclaimed Money</i>	<i>Date when Amount first became Payable</i>
\$			
NATIONAL AUSTRALIA BANK LTD—continued			
Smith, Ann P S, 14 Winslow St, Milsons Point, NSW	328.43	Cheque	
Smith, Dorothy E (estate of), c/o C E Smith, 1/40 North St, Tamworth, NSW	145.00	"	
Smith, Martha E, Unit 4, 37 Belgrave Rd, East Malvern	117.02	"	
Sparrow, Zoe A (estate of), c/o S C Inglis, 164 Martin St, Gardenvale	204.74	"	
Spenthorn Nominees Ltd, Warnford Court, 29 Throgmorton St, London, UK	209.52	"	
St Hildas College, University of Melbourne, Parkville	680.00	"	
Stephens, Peter J, 4 Lake Terrace, Mt Gambier, SA	34.00	"	
Stout, Dorothy L, 75A Grant Rd, Thornden, Wellington, NZ	68.04	"	
Sutton, Victoria, Shop 34, Australian Sq, Sydney, NSW	174.00	"	
Swanson, Cora M, Unit 1, 80 Coonanbarra Rd, Wahroonga, NSW	137.72	"	
Swinerton, Robert C F, c/o Williams & Glyns Bank Ltd, 359-363 Goswell Rd, Islington, UK	28.10	"	
Talbot, Leo E, 1 Bracken Street, Mittagong, NSW	34.00	"	
Talitis Pty Ltd, PO Box 188, Mudgee, NSW	34.50	"	
Tandy, Muriel A (estate of), c/o Ian M Thorpe & Co, MLC Centre, 19 Martin Pl, Sydney, NSW	97.44	"	
Taylor, Bessie M, 69 The Esplanade, Cronulla, NSW	165.88	"	
Taylor, Louise E, Tarcoola Quarry St, Deniliquin, NSW	219.24	"	
Thistlethwayte, Arnold B, 8 Kennedy Rd, Austinmer, NSW	34.00	"	
Thomas, Maureen H, 57 Derwent Terrace, New Norfolk, Tas	36.25	"	
Thomas, Rowan H R, "The Pocket", Knoll Rd, North Tamborine, Qld	51.04	"	
Thompson Mary J, c/o Bank of New South Wales, PO Box 33, Indooroopilly, Qld	82.36	"	
Turner, John E and Lorraine C Tsaoussi, Unit 5, 1-7 Barry St, Mentone	34.00	"	
Vergara, Andres, 84 Queens Pde, Newport, NSW	58.00	"	
Walden, Garry W, Lot 6, Greendale Rd, Bringelly, NSW	34.00	"	
Walsh, John W and Carol A Sec., 29 Tallawong St, Dapto, NSW	154.28	"	
Webb, Alan D, 118 Bishopsgate St, Carlisle, WA	24.07	"	
Webster, Eric, 3 Yvonne Pl, Castle Hill, NSW	32.20	"	
West, Robert, 124 Holt Av, Cremorne Junction, NSW	28.42	"	
Wheese Nominees Pty Ltd, Warnford Crt, Throgmorton St, London, UK	1499.21	"	
Whitehouse, Robert P and Stephen W Hewer, 24 Murray St, Hobart, Tas	195.75	"	
Whitley, Carey B E, 2 Brooksby St, London, UK	809.50	"	
Whittmore, Rev Fr Paul F, 26 Arnold Sq, Carlton, NSW	69.31	"	
Wildman, Katherine E, c/o National Westminster Bank Ltd, Caxton House, Westminster, 6 Tothill St, London, UK	959.26	"	

## Unclaimed Moneys Act 1962

## Register of Unclaimed Moneys held by the

<i>Name of Owner on Books and Last Known Address</i>	<i>Total Amount Due to Owner</i>	<i>Description of Unclaimed Money</i>	<i>Date when Amount first became Payable</i>
--	--	---	--

\$

## NATIONAL AUSTRALIA BANK LTD—continued

Williams, Dorothy McA, 11 Princess St, North Coburg	71.70	Cheque	
Williams, Jean M, 6 Short St, Balmain, NSW	46.98	"	
Wilson, Reginald E, 12 Strachans Rd, Mornington	18.85	"	
Wiselaw Nominees Pty Ltd, 459 Little Collins St, Melbourne	106.79	"	
Worley, Bevan R, 16 Burford Pl, Howick, Auckland, NZ	12.32	"	
Yates, Gwen, Flat 12, 27 Gillies Av, Wollstonecraft, NSW	49.88	"	
Zeban Nominees Ltd, 'BHA Account', Ebbgate Lane, 2 Swan St, London, UK	231.10	"	
Zeban Nominees Ltd, 'BMJ Account' Ebbgate House, 2 Swan St, London, UK	231.10	"	
Zeban Nominees Ltd, 'CDC Account' Ebbgate House, 2 Swan St, London, UK	286.93	"	
Zeban Nominees Ltd, 'BAF Account' Ebbgate House, 2 Swan St, London, UK	423.98	"	
Zeban Nominees Ltd, 'CDC Account' Ebbgate House, 2 Swan St, London, UK	21.20	"	
Zeban Nominees Ltd, 'EVC Account' Ebbgate House, 2 Swan St, London, UK	293.96	"	
Zorn Nominees Ltd, c/o Raphael Zorn, 10 Throgmorton Av, London, UK	236.15	"	

## MOORE BUSINESS SYSTEMS AUSTRALIA LIMITED

Brown, Peter R, 4/21 Gosport St, Cronulla, NSW	11.95	Cheque	18.4.84
Gibbons, Catherine H, 8/20 Valentine Gve, Armadale	26.00	"	"
Merison, John H, c/o Greig Fester Ltd, 52 Lime St, London, UK	26.52	"	"
Williamson, Norman B, 17 Sinns Ave, Werribee	10.27	"	"
Howden, Conrad, 332 Victoria St, Darlinghurst, NSW	50.00	"	28.9.84
Newton, Eric, Kingston	10.00	"	"
Alderson, Dorothy A (estate of), c/o Rankin, M A, Spring Beach, Orford, Tas	119.85	"	16.4.85
Howden, Conrad, 332 Victoria St, Darlinghurst, NSW	150.00	"	"
Merison, John H, c/o Greig Fester Ltd, 52 Lime St, London, UK	30.60	"	"
Williamson, Norman B, 17 Sinns Ave, Werribee	11.85	"	"
Saunders, James L, 50 Lawrence Cres, Toronto, Ontario, Canada	25.50	"	"
Howden, Conrad, 332 Victoria St, Darlinghurst, NSW	50.00	"	27.9.85
Merison, John H, c/o Greig Fester Ltd, 52 Lime St, London, UK	10.20	"	"
Howden, Conrad, 332 Victoria St, Darlinghurst, NSW	150.00	"	24.4.86
Merison, John H, c/o Greig Fester Ltd, 52 Lime St, London, UK	30.60	"	"
Saunders, James L, 50 Lawrence Cres, Toronto, Ontario, Canada	25.50	"	"
Williamson, Norman B, 17 Sinns Ave, Werribee	11.85	"	"

Victoria Government Gazette

In the Supreme Court of Victoria—1988 Co. No. 421—In the Matter of the Companies (Victoria) Code and in the matter of L. G. Williams (Australia) Pty. Ltd.

**ADVERTISEMENT OF NOTICE OF MOTION FOR WINDING UP**

Notice is hereby given that a notice of motion for the winding up of the abovementioned Company by the Supreme Court was on 8 June 1988 issued by Hunt Engineering Pty Ltd. The motion is to be heard before the Court sitting in the 7th Court Law Courts, Lonsdale Street, Melbourne at the hour of 10.30 a.m. on 27 July 1988.

The Liquidator whose appointment is sought is Michael James Humphries of the firm, Messrs. Ernst & Whinney of 35 Collins Street, Melbourne.

Any creditor or contributory of the said company desiring to support or oppose the making of an Order on the said motion may appear at the time of hearing by himself or his Counsel for that purpose and a copy of the Notice of Motion will be furnished to any creditor or contributory of the said Company requiring the same by the undersigned on payment of the regulated charge for the same.

The applicant's address is: c/o Messrs. Lilley Brereton, 13th Floor, 114 William Street, Melbourne 3000.

The applicant's solicitors are Messrs. Lilley Brereton.

**LILLEY BRERETON**

Note: Any person who intends to appear on the hearing of the said motion must serve on or send by post to the abovenamed solicitor notice in writing of his intention to do so. The notice must state the name and address of the person or if a firm, the name and address of the firm and must be signed by the person or firm, or his or their solicitor (if any), and must be served, or, if posted, must be sent by post in sufficient time to reach the abovenamed not later than 4.00 p.m. on 26 July 1988.

In the matter of the *Co-operative Housing Societies Act 1958* and the Companies (Victoria) Code 1981 and in the matter of Commercial No. 3 Co-operative Housing Society Limited.

All persons having any claims against the above Society are required to send particulars of their claims in writing to 414 Lonsdale Street, Melbourne on or before 8 August 1988.

Dated 6 July 1988

**H. C. HOLMÉS  
R. J. ANDERSON  
P. L. HARRISON**

1794

Joint or several liquidators

G 25 6 July 1988 2045

**COMMERCIAL No. 3 CO-OPERATIVE HOUSING SOCIETY LIMITED**

(In Liquidation)  
Special Resolution

At a special general meeting of the abovenamed Society duly convened and held at the Society's Office, 414 Lonsdale Street, Melbourne on 27 June 1988 at 5.00 p.m. the subjoined special resolution was duly passed:

1. That the Society having successfully completed its objectives forty-seven months ahead of its expected term be wound up voluntarily and that Mr Hay Charles Holmes, Mr Richard John Anderson and Mrs Pauline Lorraine Harrison all of 4th Floor, 414 Lonsdale Street Melbourne be appointed joint or either liquidators for the purpose of the winding up.

**R. G. McNISH, Chairman  
P. L. HARRISON, Secretary**  
1795

*Co-operative Housing Societies Act 1958*

**HEIDELBERG DISTRICT (No. 4)  
CO-OPERATIVE**

**HOUSING SOCIETY LIMITED**

Notice is hereby given that at a special meeting of the abovenamed society duly convened and held at 126 Wellington Parade, East Melbourne, on 1 July 1988 at 12.30 p.m. the following special resolution was duly passed:

"That the Society having successfully completed its objectives 48 months ahead of its expected term be wound up voluntarily, and that John Patrick Chaundy, of 126 Wellington Parade, East Melbourne, be appointed liquidator for the purposes of the winding up."

Dated 1 July 1988

**R. A. LANGLEY, Chairman  
J. P. CHAUNDY, Secretary**  
1814

In the Supreme Court of Victoria at Melbourne—1988 No. Co. 396—In the Matter of the Companies (Victoria) Code, and in the matter of Corpivic (No. 31) Pty. Limited—Advertisement of Application for Winding Up

Notice is hereby given that an application for the winding up of the abovenamed company by the Supreme Court of Victoria was on 1 June 1988 filed by Viscount Consolidated Industries Pty. Ltd. The application is to be heard before the Court in the 7th Court, Law Courts, Lonsdale Street, Melbourne at 10.30 a.m. on 20 June 1988.

The liquidator whose appointment is sought is Graham John Clark of the firm of Neville Bird Clark & Co. of 499 St. Kilda Road, Melbourne.

Any creditor or contributory of the company desiring to support or oppose the making of an order on the application may appear at the time

2046 G 25 6 July 1988

of hearing by himself or his counsel for that purpose. A copy of the application will be finished by the undersigned to any creditor or contributory of the company requiring it on payment of the regulated charge.

The applicant's address is 234-238 Boundary Road, Braeside.

The applicant's solicitors are Holding Redlich of 478 Albert street, East Melbourne.

**HOLDING REDLICH**  
Solicitors for the Applicant

Note—Any person who intends to appear on the hearing of the application must serve on or send by post to the abovenamed Solicitor notice in writing of his intention so to do. The notice must state the name and address of the person or, if a firm, the name and address of the firm, and must be signed by the person or firm, or his or their solicitor (if any) and must be served or, if posted, must be sent by post in sufficient time to be received not later than 4.00 o'clock in the afternoon of 19 July 1988. 1838

**PIZZINI, RINALDO FAUSTO** (deceased), late of 9 Glenaplin Avenue, Tarragindi, Qld, died on 1 May 1988.

Any persons claiming to be dependant upon the deceased are requested to send particulars of their claims to "Life Claims Department, Australian Eagle Ins. Co. Ltd., GPO Box 1883R, Melbourne, 3001", within two months of the date of this notice, after which the date the deceased's entitlement will be distributed in accordance with the provisions of the Eagle Retirement Fund Trust Deed, having regard only to the claims which have been notified. 1801

**ALEXIS WILLIAM STEIN**, late of Unit 20, 203 Clarke Street, Northcote, in the State of Victoria, gentleman, deceased

Creditors, next of kin and others having claims against the estate of the said deceased who died on 23 December 1985 and Letters of Administration in respect of whose estate were granted by the Supreme Court of Victoria in its Probate Jurisdiction on 13 April 1988 to Margaret Kathleen Saunders of 68 Bondi Road, Bonbeach in the said State, filing clerk, the daughter of the deceased are required to send particulars of their claims to the said Administratrix care of G. S. Baker, solicitor of 422 Collins Street, Melbourne by 14 September 1986 after which date the said Administratrix will distribute the assets of the estate with regard only to the claims of which she then has notice.

**G. S. BAKER**, solicitors, of 422 Collins Street, Melbourne 1829

*Victoria Government Gazette*

**DAVID WILLIAM RADLEY**, late of Leitchville, in the State of Victoria, pensioner, deceased

Creditors, next of kin and all other persons having claims against the Estate of the said deceased are required by Allison Elizabeth Baker of Leitchville aforesaid Married Woman, the Executrix of the Estate to send particulars of such claims to her in care of the undermentioned solicitors on or before 5 September 1988 after which date she will distribute the assets having regard only to the claims of which she then has notice.

**WILLAN & MCKENZIE**, solicitors, Box 299, Cohuna 1819

**EDGAR IGOR GALAVIN**, late of Lot 17, Royle Avenue, Kallista, in the State of Victoria, gentleman, deceased

Creditors, next of kin and others having claims in respect of the estate of the deceased are required to send particulars of their claims to the Executrix, Gloria Tobin, care of the undersigned Solicitors by 6 September 1988, after which date the said Executrix will proceed to distribute the estate having regard only to the claims of which she then has notice.

**ARMSTRONG, SINGER & ROSS**, solicitors, 647A Main Street, Belgrave 1820

**PETER GRAVATT PURDY**, late of 39 Through Road, Ringwood, in the State of Victoria, auctioneer, deceased

Creditors, next of kin and others having claims in respect of the estate of the deceased who died on 18 August 1987, are required by the trustee Patricia Mary Purdy of 39 Through Road, Ringwood, widow, to send particulars thereof to her care of the undermentioned solicitors by 16 September 1988, after which date the trustee may convey or distribute the assets having regard only to the claims of which he then has notice.

**MOORES**, solicitors, of 9 Prospect Street, Box Hill 1821

Creditors, next of kin and others having claims in respect of the estate of Maurice Peel, late of 31 Seves Street, Altona, retired clerk, deceased who died on 23 April 1988 are required by the Executor William Andrew Thwaites of 6/394 Collins Street, Melbourne, solicitor to send particulars of their claims to him at the undermentioned address by 30 September 1988 after which date he will distribute the assets having regard only to the claims of which he then has notice.

**W. ANDREW THWAITES**, solicitor, 6/394 Collins Street, Melbourne 3000 1833

*Victoria Government Gazette*

Creditors, next of kin or others having claims in respect of the estate of Gerard Devereaux late of 29 Gordon Street, Traralgon, retired State Electricity Commission employee, deceased who died on 24 June 1988 are to send particulars of their claims to the executrix Pauline Elizabeth Smales care of the undermentioned solicitors by 7 September 1988 after which date the executrix will distribute the assets having regard only to the claims of which she then has notice.

D. C. DAVINE, EDMUNDS & Co., solicitors  
of 39 Breed Street, Traralgon 3844 1823

MYRTLE LAWRENCE, late of 23 Golightly Street, Port Lonsdale in the State of Victoria, spinster, deceased

Creditors, next of kin and others having claims in respect of the estate of the abovenamed deceased who died on 14 May 1988 are required by the trustee Joy Briggs of 6 Lemmon Street, Williamstown in the said State, home duties, to send particulars of their claims to the Trustee care of the undermentioned solicitors by 27 August 1988, after which date the Trustee may convey or distribute the assets having regard only to the claims of which she then has notice.

INGPEN & BENT, solicitors, 95 Yarra Street,  
Geelong, solicitors for the trustees 1824

Creditors, next of kin and others claims in respect of the estate of James Hugh Bowring late of Lot 2, Flora Avenue, Mildura, horticulturist, deceased who died on 22 May 1988 are requested to send particulars of their claims to the executor, Anthony Thomas Rogers care of the undermentioned solicitors on or before 7 September 1988 after which date he will distribute the assets having regard only to the claims of which he then has notice.

McKEAN & PARK, solicitors, 405 Little  
Bourke Street, Melbourne 1827

JOHN JAMES GEORGE, late of 40 Dorking Road, Box Hill, in the State of Victoria, retired gentleman, deceased

Creditors, next of kin and others having claims in respect of the estate of the deceased who died on 27 February 1988, are required by the trustee, The Union-Fidelity Trustee Company of Australia Ltd., of 100 Exhibition Street, Melbourne to send particulars thereof to them care of the undermentioned solicitors by 8 September 1988, after which date the trustee may convey or distribute the assets having regard only to the claims of which he then has notice.

MOORES, solicitors, of 9 Prospect Street, Box  
Hill 1822

*G 25 6 July 1988 2047*

Creditors, next of kin and others having claims in respect of the estate of Gladys Ethel Mary Lewis late of 3 Marlborough Avenue, Camberwell in the State of Victoria, retired, who died on 27 October 1987 are to send particulars of their claims to ANZ Executors and Trustee Company Limited of 94 Queen Street, Melbourne by 6 September 1988 after which date it will distribute the assets of the deceased having regard only to the claims of which it then has notice.

DUDLEY TREGENT & CO., solicitors, 422  
Collins Street, Melbourne, solicitors for the  
applicant 1788

LILIAN BLANCHE HARLAND, formerly of  
"Pleasant Lodge", 12 Mount Pleasant Road,  
Nunawading, but late of Avonsleigh Terrace,  
41-43 Robe Street, St. Kilda, widow, deceased

Creditors, next of kin and others having claims in respect of the deceased who died on 26 March 1988 are required by the trustee National Mutual Trustees Limited of 419 Collins Street, Melbourne to send particulars to it at such address by 15 September 1988 after which date the trustee may convey or distribute the assets having regard only to the claims of which it then has notice.

PHILLIPS & WILKINS, solicitors, 823 High  
Street, Thornbury 1789

DANIEL McINNENY, formerly of Swan Hill,  
in the State of Victoria, but late of 9 Hallam  
Street, Bendigo, in the said State, pensioner,  
deceased (who died on 25 December 1987)

Creditors, next of kin and all other persons having claims against the estate of the deceased are required by the Executrices of the Will, Margaret Sylvia Bridgland and Joan Marie Tolley, to send particulars to them care of the undersigned on or before 1 September 1988 after which date they will distribute the assets having regard only to the claims of which they then have notice.

GARDEN & GREEN, solicitors, 4 McCallum  
Street, Swan Hill 1796

Creditors, next of kin and others having claims in respect of the estate of Ethel Susan Rawlings, late of Unit 111, St. Laurence Court, Upper Road, California Gully widow, deceased who died on 18 February 1988 are required to send particulars of their claims to the Executor National Mutual Trustees Limited of 46 Queen Street, Bendigo on or before 13 September 1988 after which date it will distribute the assets having regard only to the claims of which it then has notice.

ROGERS & EVERY, solicitors, 71 Bull Street,  
Bendigo 1797

2048 G 25 6 July 1988

**YEULETT SPENCER PEDDER**, late of Mansfield Caravan Park, Ultimo Street, Mansfield, caretaker

Creditors, next of kin and others having claims in respect of the deceased who died on 19 December 1987 are required by his Trustee Dorothy Irene Pedder of 19 Melbourne Road, Yeâ to send particulars to her care of the undermentioned firm of solicitors by 20 September 1988 after which date the Trustees may convey and distribute the assets having regard only to the claims of which they then have notice.

**MAL RYAN, JACKSON & GLEN**, 9 High Street, Mansfield 1816

Creditors, next of kin and others having claims in respect of the estate of Dean Adam Di Marzo, late of 11 Maine Court, Corio, Cleaning Contractor deceased who died on 5 April 1985 are required to send particulars of their claims to the Administratrix Lexie June Di Marzo care of the undersigned solicitors before 7 September 1988 after which date the assets of the estate will be distributed having regard only to the claims of which the Administratrix then has notice.

**HARWOOD & PINCOTT**, solicitors, 83 Moorabool Street, Geelong 1817

Creditors, next of kin and others having claims in respect of the Estate of Catherine Hope Brown, late of 50 North Valley Road, Highton, Home Duties, deceased, who died on 9 December 1987 are required to send particulars of their claims to the Executor Andrew Hume Brown, care of the undersigned solicitors before 7 September 1988 after which date the assets of the estate will be distributed having regard only to the claims of which the Executor then has notice.

**HARWOOD & PINCOTT**, solicitors, 83 Moorabool Street, Geelong 1818

**SAUNDERS, MARY ALICE**, spinster, late of St Leeor Nursing Home, 31 Thanet Street, Malvern, Victoria, who died on 9 April 1988

Notice is hereby given pursuant to the *Trustee Act* 1936 as amended, the *Inheritance (Family Provision) Act* 1972-1975 and the *Family Relationships Act* 1975, that all creditors beneficiaries and other persons having claims against any of the abovenamed estates are directed to send full particulars of such claims to the undersigned on or before 12 August 1988 otherwise they will be excluded from the distribution of the said estates.

**EXECUTOR TRUSTEE & AGENCY COMPANY OF S.A. LTD**, 22 Grenfell Street, Adelaide 1787

*Victoria Government Gazette*

**LORNA MABLE ROBERTSON**, late of 6 Philip Street, Manifold Heights, home duties, deceased

Pursuant to the *Trustee Act* 1958 notice is hereby given that all persons having claims against the estate of the abovenamed deceased who died on 27 April 1988 and probate of whose will was granted by the Supreme Court Probate Jurisdiction on 22 June 1988 to Jeffrey Winston Lempriere Hogg of 114 Main Street, Pakenham, solicitor, hereby required to send particulars of such claims to the said executor at his abovenamed address on or before 31 August 1988 after which date the said executor will proceed to distribute the assets of the estate which have come to his hands amongst the persons entitled thereto having regard only to the claims which he shall then have had notice. And notice is hereby further given that the said executor will not be liable for the assets so distributed or any part thereof to any person of whose claim he shall not have had notice as aforesaid.

Dated 27 June 1988

**MACPHERSON & KELLEY**, 114 Main Street, Pakenham, solicitors for the executor

1782

**AMY McINTYRE**, formerly of Market Street, Yarragon but late of 13 Campbell Street, Yarragon, retired nursing sister, deceased

Creditors, next of kin and others having claims in respect of the estate of the deceased who died on 6 March 1988 are required by the Trustees Donald Walter Graydon, Kenneth George Graydon and Olwyn Amy McDonald to send particulars of their claims to them care of the undersigned solicitors by 14 September 1988 after which date the Trustees may convey or distribute the assets having regard only to the claims of which they then have notice.

**GRAY, FRIEND & LONG**, solicitors, Warragul 1783

**JANET MARGERIE JAMIESON**, late of Flat 3/ 35 Walsh Street, South Yarra, widow, deceased

Creditors, next of kin and others having claims in respect of the estate of the deceased who died on 10 April 1988, are required by the executor The Perpetual Executors and Trustees Association Limited of 50 Queen Street, Melbourne, to send particulars to it by 9 September 1988 after which date the executor may convey or distribute the assets having regard only to the claims of which it then has notice.

**ARTHUR ROBINSON & HEDDERWICKS**, solicitors, 535 Bourke Street, Melbourne 3000

1828



Creditors, next of kin and others having claims in respect of the estate of James Hugh Bowring, late of Lot 2, Flora Avenue, Mildura, Horticulturalist, deceased, who died on 22 May 1988 are requested to send particulars of their claims to the Executor, Anthony Thomas Rogers, care of the undermentioned solicitors on or before 7 September 1988 after which date he will distribute the assets having regard only to the claims of which he then has notice.

**McKEAN & PARK**, solicitors, 405 Little Bourke Street, Melbourne 1839

Creditors, next of kin and others, having claims against the estate of Irene Gladys Gowans, late of The Mount Eliza Centre, Jacksons Road, Mt Eliza in the State of Victoria, widow, deceased, who died on 15 November 1987 are requested to send particulars of their claims to Irene Lillian Little of 11 Roseline Avenue, Mt Waverley in the said State, married woman, the Executrix of the said estate care of the belowmentioned solicitors by 14 September 1988 after which date she will then distribute the assets having regard only to the claims of which she then has notice.

**PURVES & PURVES**, solicitors of 121 William Street, Melbourne 1840

**JOHN JAMES COOPER**, late of 3 Maverston Street, Burwood, in the State of Victoria, retired hardware merchant, deceased

Creditors, next of kin and others having claims in respect of the estate of the deceased who died on 25 February 1988 are required by The Equity Trustees Executors and Agency Company Limited of 472 Bourke Street, Melbourne aforesaid and applicant for a grant of Administration, to send particulars of their claims applicant in the care of the said company by 15 September 1988 after which date it will convey or distribute the assets having regard only to the claims of which it then has notice.

**FREEHILL HOLLINGDALE & PAGE**, solicitors, 140 William Street, Melbourne 1832

Creditors, next of kin and others having claims in respect of the estate of Mary Dorothea Hart, late of Unit 1, 9 Highfield Road, Canterbury, trained nurse, deceased (who died on 15 November 1986) are required by John Stanley Hart and Rita Maud Green the executors of the will of the said deceased to send to them care of the undermentioned solicitors particulars thereof by 14 September 1988, after which date they will distribute the assets of the deceased having regard only to the claims of which they then have notice.

**MAHONY & GALVIN**, solicitors, 343 Little Collins Street, Melbourne 1835

**ESTATE OF LILIAN MARY CARR  
DECEASED**

Pursuant to the *Trustees Act* 1958 as amended, notice is hereby given regarding the Estate of Lilian Mary Carr late of Heath Road, Healesville, gentlewoman. Probate was granted by the Supreme Court of Victoria in the Probate Jurisdiction in the said State on 17 May 1988, to William De Graaf of 234 Maroondah Highway, Healesville, solicitor.

Creditors, next of kin and others having claim in respect of the Estate of the deceased who died on 15 January 1988, are hereby required to send particulars in writing of such claims to him care of the office hereinafter mentioned, on or before 16 September 1988 after which date the Executor may convey or distribute the assets having regard only to the claims of which he then has notice.

Dated 27 June 1988

**CRILLY & DE GRAAF**, solicitors, 234 Maroondah Highway, Healesville. Solicitors for the Estate of Lilian Mary Carr Deceased. 1774

**ARNOLD RUSSELL RAINES**, late of Unit 3/98 Bruce Street, Preston in the State of Victoria, machinist, deceased

Creditors, next of kin and others having claims in respect of the estate of the deceased who died on 23 May 1988 are requested to send particulars of their claims to the executrix Cheryl Margaret Raines care of the undersigned solicitor by 7 September 1988, after which date the said executrix will proceed to distribute the estate having regard only to the claims of which she then has notice.

**MARJORY C. COATES**, 422 Collins Street, Melbourne 3000 1834

**JESSIE VIOLA MAY PRESTON**, formerly of 51 Settlement Road, Belmont, Geelong but late of Trethowan Private Hospital, 98 McKillop Street, Geelong, widow, deceased

Creditors, next of kin and others having claims in respect of the estate of the abovenamed deceased who died on 14 February 1988 are required by Jack Athol Crawcour of 2 Morven Court, Highton, Geelong, retired solicitor, the Executor to whom has been granted Probate of the Will of the said deceased to send particulars of their claims to him care of the undermentioned Solicitors on or before 14 September 1988 after which date the said Executor will distribute the assets having regard only to the claims of which he then has notice.

**CRAWCOUR & FIKKERS**, solicitors, 87 Yarra Street, Geelong 1815

2050 G 25 6 July 1988

**ESTATE OF CHARLES ORD GILBERT  
COLLIS DECEASED**

Pursuant to the "Trustees Act 1958 as amended, notice is hereby given regarding the estate of Charles Ord Gilbert Collins late of 22 Crowley Road, Healesville, retired gentleman. Letters of Administration were granted by the Supreme Court of Victoria in the Probate Jurisdiction in the said State on 25 May 1988 to Frederick Charles Melvyn Drakeford of 22-107 Andersons Creek Road, Doncaster East, retired gentleman.

Creditors, next of kin and others having claims in respect of the estate of the deceased who died on 14 February 1988 are hereby required to send particulars in writing of such claims to him care of the office hereinafter mentioned, on or before 28 August 1988 after which date the Administrator may convey or distribute the assets having regard only to the claims of which he then has notice.

Dated 28 June 1988

**CRILLY & DE GRAAF**, solicitors, 234 Maroondah Highway, Healesville, solicitors for the Estate of Charles Ord Gilbert Collins deceased. 1773

**ADAM POTTS FLEMING**, formerly of 11 Marraboer Street, Swan Hill, in the State of Victoria but late of Alcheringa, Stewart Street, Swan Hill in the said State, pensioner, deceased (who died on 31 December 1987)

Creditors, next of kin and all other persons having claims against the estate of the deceased are required by the Executrices of the Will, Dorothy Ruth Pata, and Esma Rhoda Jewson, to send particulars to them care of the undersigned on or before 1 September 1988, after which date they will distribute the assets having regard only to the claims of which they then have notice.

**GARDEN & GREEN**, solicitors, 4 McCallum Street, Swan Hill 1785

**MARION MITCHELL YUNCKEN**, formerly of "Birkenmoor" Bonds Road, Lower Plenty but late of Surrey Hills Nursing Home, 18 Florence Road, Surrey Hills in the State of Victoria, widow, deceased

Creditors, next of kin and others having a claim in respect of the estate of the deceased who died on 29 October 1987 are required by National Mutual Trustees Limited of 46 Queen Street, Bendigo to send particulars to it by 1 August 1988 after which date the trustee may convey or distribute the assets having regard only to the claims of which it then has notice.

**PETER CAHILL**, solicitor, 45 Bull Street, Bendigo 1786

*Victoria Government Gazette*

**MINNIE LEONE FAIRLEY** (usually known as **MINETA LENORE FAIRLEY**), late of Tarcoola Retirement Village, The Boulevard, Shepparton, Victoria, widow, deceased

Creditors, next of kin and others having claims in respect of the estate of the deceased who died on 18 March 1988 are required by The Perpetual Executors and Trustees Association of Australia Limited of 50 Queen Street, Melbourne and John Horace Mott of 13 Atkinson Street, Templestowe the applicants for a grant of administration to send particulars of their claims to the said applicants in the care of the said company by 10 September 1988 after which date they will convey or distribute the assets having regard only to the claims of which they then have notice.

**ARTHUR ROBINSON & HEDDERWICKS**, solicitors, 535 Bourke Street, Melbourne 1830

**GRACIE AUGUSTA KEDDIE**, late of 15 McIvor Street, Reservoir, in the State of Victoria, widow, deceased

Creditors, next of kin and others having claims in respect of the estate of the deceased who died on 14 May 1988 are requested to send particulars of their claims to the executrix Marlene Joan Minogue care of the undersigned solicitor by 7 September 1988, after which date the said executrix will proceed to distribute the estate having regard only to the claims of which she then has notice.

**MARJORY C. COATS**, 422 Collins Street, Melbourne, 3000 1831

Creditors next of kin and others having claims against the estate of George Alfred Meeking late of 7 Parkstone Avenue, Pascoe Vale South, deceased who died on 7 April 1988 and Probate of whose will was granted by the Supreme Court of Victoria in its Probate jurisdiction on 16 June 1988 are required to send particulars of their claims to the Executors care of Minter Ellison of 40 Market Street, Melbourne by 7 September 1988 after which date the Executors will distribute the assets of the estate having regard only to the claims of which they shall then have had notice.

**MINTER ELLISON**, solicitors of 40 Market Street, Melbourne 1775

Creditors, next of kin and others having claims in respect of the estate of Mary Joyce Williamson late of Unit 4, 10 Rosedale Avenue, Glenhuntingly in the State of Victoria, widow, deceased who died on 14 February 1988 are required to send particulars of their claims to the executor care of the undermentioned solicitors by 27 August 1988 after which date we will distribute the assets having regard only to the claims for which notice has been received.

**BORCHARD & MOORE**, solicitors of 44 Douglas Street, Noble Park 1784

In the Supreme Court of the State of Victoria  
**SALE BY THE SHERIFF**

On 25 August 1988 at 2.30 p.m. at the Police Station, Bendigo (unless process be stayed or satisfied).

All the estate and interest (if any) of N. C. Grinton shown on Certificate of Title as Noreen Walsh of 17 Kirily Court, White Hills, Bendigo as joint proprietor with Robert Grinton of an estate in fee simple in the land described in Certificate of Title Volume 9258 Folio 761 upon which is erected a brick veneer dwelling known as 17 Kirily Court, White Hills, Bendigo.

Registered Mortgage No. J800887 affects the said estate and interest.

Terms—Cash only.

1836 H. BUETTNER  
 Sheriff's Officer

In the Supreme Court of the State of Victoria  
**SALE BY THE SHERIFF**

On 11 August 1988 at 2.30 p.m. at the Sheriff's Office, 287 Springvale Road, Glen Waverley (unless process be stayed or satisfied).

All the estate and interest (if any) of Aggeliki Nicolas also known as Angeliki Nicolas shown on Certificate of Title as Ageliki Nicolas of 25 Picadilly Street, South Oakleigh as joint proprietor with Sam Nicolas of an estate in fee simple in the land described shown on Certificate of Title Volume 9428 Folio 811. All that piece of land being 118.5 hectares of land situated on Government Road, Dimboola on the south side of the road commencing at a point 603.38 metres east of the eastern boundary of Stringy Bark Road and having a frontage to Stringy Bark Road 615.6 metres to Government Road. The land has a farm house and out buildings constructed thereon and developed as an Olive Oil Farm.

Mortgage No. K49977 affects the said estate and interest.

Terms—Cash only.

1837 H. BUETTNER  
 Sheriff's Officer

**NOTICE OF MAKING OF  
 STATUTORY RULES  
 WHICH ARE NOT YET  
 AVAILABLE**

Notice is given of the making of the following Statutory Rules:

*Trustee Act 1958*  
 202/1988 Trustee (Unit Trust)  
 Regulations 1988

*Trustee Act 1958*  
 203/1988 Trustee (Approved  
 Corporation)  
 Regulations 1988

*Trustee Act 1958*  
 204/1988 Trustee (Mortgage  
 Investment Certificate)  
 Regulations 1988

*Drugs, Poisons and  
 Controlled Substances Act  
 1981*

206/1988 Drugs, Poisons and  
 Controlled Substances  
 (Hypodermic Needles  
 and Syringes)  
 Regulations 1988

*State Electricity  
 Commission Act 1958*  
 209/1988 Approval of Electrical  
 Equipment  
 (Amendment)  
 Regulations 1988

*Racing Act 1958*  
 211/1988 Racing (Plumpton  
 Coursing Matches  
 Permits) Regulations  
 1988

*Dandenong Valley  
 Authority Act 1958*  
 216/1988 Dandenong Valley  
 Authority (Patterson  
 River Recreational Area)  
 Regulations 1988

*Water Act 1958*  
 218/1988 Water (Derrinal  
 Recreational Area)  
 Regulations 1988

2052 G 25 6 July 1988

Victoria Government Gazette

	<i>Water Act 1958</i>		<i>Appeal Costs Act 1964</i>
219/1988	Water (Green's Lake Recreational Area) Regulations 1988	237/1988	Appeal Costs Regulations 1988
	<i>Water Act 1958</i>		<i>Second-hand Dealers Act 1988</i>
220/1988	Water (Kimbolton Recreational Area) Regulations 1988	238/1988	Second-hand Dealers (General Exemption) Regulations 1988
	<i>River Improvement Act 1958</i>		<i>Second-hand Dealers Act 1958</i>
223/1988	River Management Boards (Long Service Leave) Regulations 1988	239/1988	Second-hand Dealers (Exemption No. 2) Regulations 1988
	<i>Magistrates' Courts Act 1971</i>		<i>Sale of Land Act 1962</i>
224/1988	Magistrates' Courts (Fees) Rules 1988	240/1988	Sale of Land (General Law Subdivision) Regulations 1988
	<i>County Court Act 1958</i>		<i>State Electricity Commission Act 1958</i>
225/1988	County Court (Civil Costs) Rules 1988	242/1988	Electrical Works Protection Regulations 1988
	<i>Aerial Spraying Control Act 1966</i>		<i>Pipelines Act 1967</i>
230/1988	Aerial Spraying Control Regulations 1988	243/1988	Pipelines Regulations 1988
	<i>Dried Fruits Act 1958</i>		<i>Drainage Areas Act 1958</i>
231/1988	Dried Fruits Regulations 1988	244/1988	Drainage Areas (Advisory Committee) Regulations 1988
	<i>Fruit and Vegetables Packing Act 1958</i>		<i>Hawkers and Pedlers Act 1958</i>
232/1988	Fruit and Vegetables Packing Regulations 1988	245/1988	Hawkers and Pedlers (Forms of Applications, Notices and Licences) Regulations 1988
	<i>Poultry Processing Act 1968</i>		<i>Environment Protection Act 1970</i>
233/1988	Poultry Processing Regulations 1988	246/1988	Environment Protection (Prescribed Waste) (Amendment) Regulations 1988
	<i>Stock Diseases Act 1988</i>		<i>Building Control Act</i>
234/1988	Stock Diseases Regulations 1988	247/1988	Building Control (Accreditation) (Fees) (Amendment) Regulations 1988
	<i>Veterinary Surgeon Act 1958</i>		<i>Building Control Act 1981</i>
235/1988	Veterinary Surgeons Regulations 1988	248/1988	Building Control (Fees) (Amendment) Regulations 1988
	<i>Legal Profession Practice Act 1958</i>		
236/1988	Solicitors (Trust Accounts Instruction) Regulations 1988		

*Victoria Government Gazette*

G 25 6 July 1988 2053

	<i>Planning and Environment Act 1987</i>		<i>State Electricity Commission Act 1958</i>
249/1988	Planning and Environment (Fees) (Amendment No. 1) Regulations 1988	260/1988	Electricity Supply and Construction Regulations 1988
	<i>Metropolitan Fire Brigades Act 1958</i>		<i>Valuation of Land Act 1960</i>
250/1988	Metropolitan Fire Brigades Board (Contributions) Regulations 1988	261/1988	Valuation of Land (Oath of Fidelity and Secrecy) Regulations 1988
	<i>Survey Co-ordination Act 1958</i>		<i>The Constitution Act Amendment Act 1958</i>
251/1988	Place Names Committee (Members' Fees and Travelling Allowances) Regulations 1988	262/1988	Electoral Rolls Regulations 1988
	<i>Sport and Recreation Act 1972</i>		<i>Strata Titles Act 1967</i>
252/1988	Sport and Recreation (Council Fees and Allowances) (Amendment) Regulations 1988	263/1988	Strata Titles (Re-development and Conversion) Regulations 1988
	<i>Professional Boxing Control Act 1985</i>		<i>Medical Practitioners Act 1970</i>
253/1988	Professional Boxing Control Board (Fees and Allowances) (Amendment) Regulations 1988	264/1988	Medical Practitioners Regulations 1988
	<i>Racing Act 1958</i>		<i>Occupational Health and Safety Act 1985</i>
254/1988	Racing (Greyhound Registration) Regulations 1988	266/1988	Occupational Health and Safety (Explosive-powered Tools) Regulations 1988
	<i>Transport Accident Act 1986</i>		<i>Lifts and Cranes Act 1967</i>
255/1988	Transport Accident (Impairment) Regulations 1988	267/1988	Cranes Regulations 1988
	<i>Road Safety Act 1986</i>		<i>Occupational Health and Safety Act 1985 Health Act 1958</i>
256/1988	Road Safety (Vehicles) (Amendment) Regulations 1988	268/1988	Occupational Health and Safety (Lead Control) Regulations 1988
	<i>Murray-Darling Basin Act 1982</i>		<i>Occupational Health and Safety Act 1985</i>
257/1988	Murray-Darling Basin (River Traffic) Regulations 1988	269/1988	Occupational Health and Safety (General Safety) (Amendment) Regulations 1988
	<i>Extractive Industries Act 1986</i>		<i>Occupational Health and Safety Act 1985</i>
259/1988	Extractive Industries Regulations 1988	270/1988	Occupational Health and Safety (Factory Registration) Regulations 1988

2054 G 25 6 July 1988

- Dangerous Goods Act 1985*  
271/1988 Dangerous Goods  
(Flammable Liquids)  
Storage Regulations 1988
- Dangerous Goods Act 1985*  
272/1988 Dangerous Goods  
(Explosives) Regulations  
1988
- Lifts and Cranes Act 1967*  
273/1988 Lifts Regulations 1988
- Accident Compensation Act  
1985*  
274/1988 Accident Compensation  
(Bonus Fund)  
Regulations 1988
- Supreme Court Act 1986*  
275/1988 General Order made  
Pursuant to the Supreme  
Court Act 1986
- Local Government Act 1958*  
276/1988 Building Qualification  
Board (Building  
Surveyors) Regulations  
1988
- Port of Melbourne Authority  
Act 1958*  
277/1988 Port of Melbourne  
Authority Regulations  
1988

Victoria Government Gazette

**NOTICE OF MAKING  
AND AVAILABILITY OF  
STATUTORY RULES**

In pursuance of the provisions of the *Subordinate Legislation Act 1962* and the Regulations made thereunder notice is given of the making and availability of the following Statutory Rules:

Note: The date specified after each Statutory Rule is the date it was first obtainable from—

- Bookshop  
Information Victoria  
318 Lt Bourke Street, Melbourne
- Building Control Act 1981*  
143/1988 Victoria Building  
(Amendment)  
Regulations 1988, No. 6  
30 May 1988 \$1.00
- Racing Act 1958*  
163/1988 Racing (Totalizator Agency  
Board) (Members' Fees)  
Regulations 1988  
2 June 1988 40c
- Tobacco Act 1987*  
174/1988 Tobacco (Vending  
Machines) Regulations  
1988  
22 June 1988 40c
- Farm Produce Merchants  
and Commission Agents  
Act 1965*  
188/1988 Farm Produce Merchants  
and Commission Agents  
Regulations 1988  
1 July 1988 \$2.10
- Public Authorities Marks  
Act 1958*  
200/1988 By-Law No. 240:  
Approving and Stamping  
of Materials  
5 July 1988 40c
- State Electricity  
Commission Act 1958*  
207/1988 State Electricity  
Commission (Cathodic  
Protection) Regulations  
1988  
4 July 1988 70c

Victoria Government Gazette

G 25 6 July 1988 2055

	<i>State Electricity Commission Act 1958</i>		<i>Water Act 1958</i>	
208/1988	State Electricity Commission Wiring Regulations 1988		Water (Lake Glenmaggie Recreational Area) Regulations 1988	
1 July 1988	\$1.00	1 July 1988		\$1.00
	<i>Gas and Fuel Corporation Act 1958</i>		<i>State Bank Act 1988</i>	
210/1988	Gas and Fuel Corporation (Supply) Regulations 1988	226/1988	State Bank (Amendment No. 4) General Orders 1988	
1 July 1988	70c	1 July 1988		40c
	<i>Lotteries Gaming and Betting Act 1966</i>		<i>Melbourne and Metropolitan Board of Works Act 1958</i>	
212/1988	Lotteries Gaming and Betting (Amusement Machines) Regulations 1988	227/1988	By-Law No. 238: Water Supply	
1 July 1988	70c	1 July 1988		40c
	<i>Lotteries Gaming and Betting Act 1966</i>		<i>Melbourne and Metropolitan Board of Works Act 1958</i>	
213/1988	Lotteries Gaming and Betting (Raffles and Bingo Permits) (Amendment) Regulations 1988	228/1988	By-Law No. 248: Water Supply	
1 July 1988	70c	1 July 1988		40c
	<i>Land Tax Act 1958</i>			
214/1988	Land Tax Regulations 1988			
4 July 1988	\$1.00			
	<i>Mildura Irrigation Trusts and Sunraysia Water Board Act 1958</i>			
215/1988	Mildura Irrigation Trusts and Sunraysia Water Board (Long Service Leave) Regulations 1988			
1 July 1988	70c			
	<i>Water Act 1958</i>			
217/1988	Water (Lake Eildon Recreational Area) Regulations 1988			
4 July 1988	\$1.70			
	<i>Water Act 1958</i>			
221/1988	Water (Metcalf Recreational Area) Regulations 1988			
1 July 1988	\$1.00			

**CONTENTS**

	Page
Cemeteries—Scale of Fees	1990
Contracts Accepted—Amendments	2015
Estates of Deceased Persons	1986
Government Notices	1986
Notice of Making of Statutory Rules	2051
Orders in Council—	
Acts—Cemeteries; Crown Land (Reserves); Land; The Constitution Act Amendment; Water and Sewerage Authorities (Restructuring); Local Government	2023
Police Sale	1990
Private Advertisements	2029
Proclamation	1986
Rural Water Commission	2021

**No. G 25—General Government Gazette**

A Victorian Government Publication

Published by VGPO  
Melbourne Victoria Australia

© State of Victoria

This publication is copyright. No part may be reproduced by  
any process except in accordance with the provisions  
of the Copyright Act

Address all inquiries to the Government Printer  
for the State of Victoria  
PO Box 203 North Melbourne 3051 Victoria Australia  
ISSN 0819—5471

Further copies of this publication can be obtained from  
Bookshop  
Information Victoria  
318 Lt Bourke Street Melbourne  
Bookshop Inquiries: (03) 663 3760

By Authority Jean Gordon Government Printer Melbourne  
**Recommended Retail Price \$1.10**