



VICTORIA
GOVERNMENT GAZETTE.

Published by Authority.

[Registered at the General Post Office, Melbourne, for transmission by post as a newspaper.]

No. 605]

WEDNESDAY, AUGUST 16.

[1950

ACT OF PARLIAMENT.

PROCLAMATION

By His Excellency the Governor of the State of Victoria and its Dependencies in the Commonwealth of Australia, &c., &c., &c.

I, THE Governor of the State of Victoria, in the Commonwealth of Australia, do hereby declare that I have this day assented, in His Majesty's name, to the Bill passed by the Parliament of the said State, the title whereof is hereunder set forth, that is to say:—

No. 5454. "An Act to authorize The Marine Board of Victoria temporarily to exempt certain harbor construction contractors and their vessels and personnel from compliance with provisions of the Marine Acts and the Regulations thereunder, and for other purposes."

Given under my Hand and the Seal of the State of Victoria aforesaid, at Melbourne, this fifteenth day of August, in the year of our Lord One thousand nine hundred and fifty, and in the fourteenth year of the reign of His Majesty King George VI.

(L.S.)

DALLAS BROOKS.

By His Excellency's Command,

JOHN G. B. McDONALD,
Premier.

GOD SAVE THE KING!

PUBLIC HIGHWAY.—CITY OF MALVERN.

PROCLAMATION

By His Excellency the Governor of the State of Victoria and its Dependencies in the Commonwealth of Australia, &c., &c., &c.

WHEREAS by the *Local Government Act 1946* (No. 5203), section 518, it is amongst other things enacted that it shall be lawful for the Governor in Council at any time, and from time to time, upon the request of the council of any municipality, by notice in the *Government Gazette*, to declare any land reserved, used, or by purchase or exchange acquired for a street, road, highway, thoroughfare, bridge, square, court, alley, or right-of-way to be a public highway, and that such land shall thereupon and thenceforth from the date of such Proclamation become and be absolutely dedicated to the public as a public highway within the meaning of any law then or thereafter in force: And whereas the Council of the City of Malvern has requested that the land hereinafter

mentioned, which has been reserved for a street by the said Council within the said city, be so declared to be a public highway: Now therefore I, the Governor of the State of Victoria, in the Commonwealth of Australia, by and with the advice of the Executive Council of the said State, do by this Proclamation declare the land reserved for a street hereinafter described, and situated within the City of Malvern aforesaid, to be a public highway within the meaning of the said Act, viz.:—

PUBLIC HIGHWAY.—CITY OF MALVERN.

All that piece of land being part of Crown portion 183, Parish of Prahran, County of Bourke, bounded by a line commencing at a point on the east building line of Chadstone-road, 674 ft. 9 in. south of the intersection of the south building line of Abbotsford-avenue, with the east building line of Chadstone-road; thence bearing 149 deg. 8 min. for 17 ft. 2 in.; thence bearing 118 deg. 15 min. for 417 ft. 8 in.; thence bearing 90 deg. 20 min. for 434 ft. 9½ in.; thence bearing 222 deg. 7 min. for 67 ft. 0½ in.; thence bearing 270 deg. 20 min. for 402 ft. 6½ in.; thence bearing 298 deg. 15 min. for 403 ft. 2½ in.; thence bearing 239 deg. 8 min. for 10 ft. 3 in.; thence bearing 0 deg. 0 min. for 76 ft. 9 in. to the commencing point.

Given under my Hand and the Seal of the State of Victoria aforesaid, at Melbourne, this 8th day of August, in the year of our Lord One thousand nine hundred and fifty, and in the fourteenth year of the reign of His Majesty King George VI.

(L.S.)

DALLAS BROOKS.

By His Excellency's Command,

P. T. BYRNES,
Commissioner of Public Works.

GOD SAVE THE KING!

PUBLIC HIGHWAY.—SHIRE OF FERN TREE GULLY.

PROCLAMATION

By His Excellency the Governor of the State of Victoria and its Dependencies in the Commonwealth of Australia, &c., &c., &c.

WHEREAS by the *Local Government Act 1946* (No. 5203), section 518, it is amongst other things enacted that it shall be lawful for the Governor in Council at any time, and from time to time, upon the request of the council of any municipality, by notice in the *Government Gazette*, to declare any land reserved, used, or by purchase or exchange acquired for a street, road, highway, thoroughfare, bridge, square, court, alley, or right-of-way to be a public highway, and that such land shall there-

upon and thenceforth from the date of such Proclamation become and be absolutely dedicated to the public as a public highway within the meaning of any law then or thereafter in force: And whereas the Council of the Shire of Fern Tree Gully has requested that the land hereinafter mentioned, which has been used as a street by the said Council within the said shire, be so declared to be a public highway: Now therefore I, the Governor of the State of Victoria, in the Commonwealth of Australia, by and with the advice of the Executive Council of the said State, do by this Proclamation declare the land used as a street hereinafter described, and situated within the Shire of Fern Tree Gully aforesaid, to be a public highway within the meaning of the said Act, viz:—

PUBLIC HIGHWAY.—SHIRE OF FERN TREE GULLY.

St. Elmo-avenue.

Commencing at the southern corner of lot 1 on L.P. 6789; thence north 43 deg. 4 min. east 1,684 ft. 5½ in.; thence north 43 deg. 0 min. east 361 ft. 1 in. to a Government road; thence along the said Government road, south 17 deg. 51 min. west 120 ft., and south 43 deg. 0 min. west 252 ft. 6 in.; thence bearing south 43 deg. 4 min. west 1,749 ft. 6½ in.; thence by an arc of radius 1,486 ft. 10½ in., and length 52 ft. 7½ in. on a chord bearing north 32 deg. 41 min. west to the point of commencement.

Given under my Hand and the Seal of the State of Victoria aforesaid, at Melbourne, this 8th day of August, in the year of our Lord One thousand nine hundred and fifty, and in the fourteenth year of the reign of His Majesty King George VI.

(L.S.) DALLAS BROOKS.

By His Excellency's Command,
P. T. BYRNES,
Commissioner of Public Works.

GOD SAVE THE KING!

The Game Acts.

SANCTUARY FOR NATIVE GAME AT "POLLOCH,"
NAGAMBIE.

PROCLAMATION

By His Excellency the Governor of the State of Victoria and its Dependencies in the Commonwealth of Australia, &c., &c., &c.

I, THE Governor of the State of Victoria, in the Commonwealth of Australia, by and with the advice of the Executive Council of the said State, and in pursuance of the provisions of the Game Acts and all other powers me enabling in that behalf, do by this Proclamation revoke the Proclamation made the 22nd day of April, 1941, and published in the *Government Gazette* of the 23rd day of April, 1941, respecting a Sanctuary for Native Game at "Polloch," Nagambie, and direct that the parts of Victoria within the boundaries hereinafter described shall be localities in which, from the first day of January to the thirty-first day of December (both days inclusive) in each year, it shall be unlawful for any person to kill or destroy any native game included in the Third Schedule to the *Game Act 1928*.

PARTS OF VICTORIA REFERRED TO.

Parish of Baillieston, County of Rodney.—Commencing at the north-western angle of allotment 50A; thence southerly by the western boundary of that allotment to its south-western angle; thence westerly by the northern boundary of allotment 63A to its north-western angle; thence southerly by the western boundary of the said allotment, a line, and the western boundary of allotment 64A to the south-western angle of the last-mentioned allotment; thence generally easterly by the northern side of a 1½-chain road to the south-western angle of allotment 64B; thence north-easterly by the southern boundary of that allotment, the south-eastern boundaries of allotments 65 and 51, the eastern boundary of allotment 38AA, and a line in continuation thereof to the southern boundary of the Baillieston P.R.; thence easterly by a direct line and the southern boundary of the aforesaid P.R. to a fence distant 634 yds. (more or less); thence northerly by that fence to the eastern boundary of the Baillieston P.R.; thence generally northerly by the eastern boundary of the Baillieston P.R. to the northern boundary thereof; thence westerly by the said boundary and a line, and further westerly by the

aforesaid northern boundary of the Baillieston P.R. and the northern boundaries of allotments 50 and 50A to the point of commencement.

Given under my Hand and the Seal of the State of Victoria aforesaid, at Melbourne, this fifteenth day of August, in the year of our Lord One thousand nine hundred and fifty, and in the fourteenth year of the reign of His Majesty King George VI.

(L.S.) DALLAS BROOKS.

By His Excellency's Command,
K. DODGSHUN,
Chief Secretary.

GOD SAVE THE KING!

BANK HALF-HOLIDAYS.

PROCLAMATION

By His Excellency the Governor of the State of Victoria and its Dependencies in the Commonwealth of Australia, &c., &c., &c.

I, IN pursuance of the provisions of the Banks and Currency Acts, I, the Governor of the State of Victoria, in the Commonwealth of Australia, do by this my Proclamation appoint the days and dates named hereunder special days to be observed as Bank Half-Holidays at the places respectively mentioned, that is to say:—

Bank Half-Holidays from the Hour of Twelve o'clock noon:—

WEDNESDAY, THE 16TH DAY OF AUGUST, 1950, at Stawell.
THURSDAY, THE 7TH DAY OF SEPTEMBER, 1950, at Goroke.
WEDNESDAY, THE 23RD DAY OF AUGUST, 1950, at Birchop.

Given under my Hand and the Seal of the State of Victoria aforesaid, at Melbourne, this fifteenth day of August, in the year of our Lord One thousand nine hundred and fifty, and in the fourteenth year of the reign of His Majesty King George VI.

(L.S.) DALLAS BROOKS.

By His Excellency's Command,
K. DODGSHUN,
Chief Secretary.

GOD SAVE THE KING!

PUBLIC HOLIDAYS.

PROCLAMATION

By His Excellency the Governor of the State of Victoria and its Dependencies in the Commonwealth of Australia, &c., &c., &c.

I, IN pursuance of the provisions contained in Part III. of the *Public Service Act 1946* (10 Geo. VI. No. 5124), I, the Governor of the State of Victoria, in the Commonwealth of Australia, by and with the advice of the Executive Council of the said State, do by this my Proclamation appoint the days and dates hereunder mentioned to be observed as Public Holidays or Public Half-Holidays (as the case may be) at the places respectively specified, viz:—

Public Holidays:—

FRIDAY, THE 18TH DAY OF AUGUST, 1950, throughout the Underbool Riding of the Shire of Walpeup.

*THURSDAY, THE 31ST DAY OF AUGUST, 1950, throughout the Shire of Minhamite.

Public Half-Holidays from the Hour of Twelve o'clock noon:—

*THURSDAY, THE 7TH DAY OF SEPTEMBER, 1950, throughout the North and Central Ridings of the Shire of Kowree.

*WEDNESDAY, THE 18TH DAY OF OCTOBER, 1950, throughout the Shire of Cohuna.

*Agricultural Show.

Given under my Hand and the Seal of the State of Victoria aforesaid, at Melbourne, this fifteenth day of August, in the year of our Lord One thousand nine hundred and fifty, and in the fourteenth year of the reign of His Majesty King George VI.

(L.S.) DALLAS BROOKS.

By His Excellency's Command,
K. DODGSHUN,
Chief Secretary.

GOD SAVE THE KING!

APPOINTMENTS.

HIS Excellency the Governor of the State of Victoria, by and with the advice of the Executive Council thereof, has, by Orders made on the 8th day of August, 1950, been pleased to make the under-mentioned appointments, viz.:—

CHIEF SECRETARY'S DEPARTMENT.

Member of Committee of Management of Melbourne Sailors' Home.

ROBERT HAROLD OWEN,
pursuant to the provisions of section 8 of the *Melbourne Sailors' Home Act 1901*, to be a member of the Committee of Management of the Melbourne Sailors' Home, vice Angus McIntyre, resigned.

Probation Officer.

GEORGE WILLIAM FINNIE,
pursuant to the provisions of section 536 of the *Crimes Act 1928*, to be a Probation Officer for the purposes of the said Act, in Melbourne and suburbs.

Superintendent (Acting) of Reformatory Prison.

JOHN HENRY CHAPMAN,
pursuant to the provisions of the *Crimes Act 1928*, to be Superintendent (Acting) of the Reformatory Prison at French Island, from the 21st July, 1950, pending the appointment of a successor to Alan James Jack, deceased.

Registrar of Births and Deaths.

JAMES FRANCIS RYAN,
pursuant to the provisions of section 4 of the *Registration of Births Deaths and Marriages Act 1928*, to be Registrar of Births and Deaths at Kyneton, to date from commencement of duty, with fees, vice Donald Harold Gude, resigned.

DEPARTMENT OF CROWN LANDS AND SURVEY.

Inspector of Vermin and Noxious Weeds.

ALBERT SAMUEL HEPBURN, Inspector of Land Settlement,
to be also an Inspector under the provisions of section 4 of the *Vermin and Noxious Weeds Act 1949*, as from and inclusive of the 18th May, 1950. Published in lieu of the appointment of Alfred Samuel Hepburn appearing in the *Gazette* of the 26th July, 1950.

Manager of Common.

RUSSELL THOMAS WHITE, M.L.A.,
to be a Manager of the Ballarat West Town Common for the period ending the 31st December, 1951. Published in lieu of the notice appearing in the *Gazette* of the 26th July, 1950.

LAW DEPARTMENT.

Commissioners for Taking Declarations, &c.

GEORGE HENRY HOCKING, 208 Kangaroo-road, Oakleigh,
EDITH FLORENCE BROOKFIELD, 14 Derham-street, Spotswood,
COLIN ARTHUR COX, Yarram,
ROBERT HARVEY O'NEILL, Camperdown, and
JOHN JOSEPH BLACK, 251 York-street, South Melbourne,
to be Commissioners for taking Declarations and Affidavits, pursuant to the provisions of Division 8 of Part IV. of the *Evidence Act 1928*—to resign upon removing from the neighbourhood of the addresses stated.

Magistrates.

JOHN PITMAN CHARLES TRESISE, Serpentine,
to Keep the Peace in the Midland Bailiwick of the State of Victoria;
ALFRED THOMAS COATES, St. Arnaud,
to Keep the Peace in the Western Bailiwick of the State of Victoria;
JOHN STEPHEN LAWFORD, Barmah,
to Keep the Peace in the Northern Bailiwick of the State of Victoria;
HARRY EDWIN HOGUE, Staff Inspector, Department of the Army, Victoria Barracks, Melbourne,
to Keep the Peace in the Central Bailiwick of the State of Victoria; and
ARTHUR ALBERT WEBSTER, Inspecting Superintendent of Police, Melbourne,
to Keep the Peace in the Central, Northern, Southern, Eastern, Western, and Midland Bailiwicks of the State of Victoria.

Probation Officers.

MYLES DILLON O'CALLAGHAN, 9 Glen Vale-road, Glen Iris,
PATRICK MICHAEL BOURKE, 40 Rona-street, Regent,
FRANCIS GEORGE GWYNN, 735 Nepean Highway, East Brighton, and
JOSEPH CLEMENT CLACK, 27 Williamstown-road, Footscray,
to be Probation Officers, pursuant to the provisions of section 8 of the *Children's Court Act 1928*, for the Children's Courts at Malvern, Preston, Brighton, and Footscray, respectively.

Special Magistrate.

GERSHON LAPIN, 325 Orrong-road, East St. Kilda,
to be a Special Magistrate, pursuant to section 5 of the *Children's Court Act 1928*, for the Petty Sessions District of St. Kilda (that is to say): That continuous area made up of all places therein whereat any matter justiciable by a Court of Petty Sessions arising, the Court of Petty Sessions duly appointed to be held at St. Kilda aforesaid and there sitting would, were an information or complaint founded on such matter laid or made, be the proper Court to deal therewith by reason of such Court being holden at the place most easy of access from the place where the subject matter thereof arose.

DEPARTMENT OF WATER SUPPLY.

Waterworks Trust Commissioners.

JAMES HARPER HARVEY,
LANGTON HUGH MCKENZIE MCHARG, and
ROBERT JOHN WILLIAMS,
to be Commissioners of the Walwa Waterworks Trust for a period of four years from the date hereof, subject to the provisions of the Water Acts;
JOHN JAMES ROBERTS HEATH,
to be a Commissioner of the Port Fairy Waterworks Trust for a period of four years from the date hereof, subject to the provisions of the Water Acts;
ARTHUR WILLIAM ASMUS KINGSBURY,
to be a Commissioner of the Wangaratta Waterworks Trust for a period of four years from the date hereof, subject to the provisions of the Water Acts;
JOHN GORMAN MORRISON,
to be a Commissioner of the Longwood Waterworks Trust, vice Rowland G. Cox, deceased, and to hold office as such from the date hereof until the fourth Thursday in the month of October in the year 1950, subject to the provisions of the Water Acts; and
ROBERT MICHAEL WHELAN,
to be a Commissioner of the Apollo Bay Waterworks Trust for a period of two years from the date hereof, subject to the provisions of the Water Acts.

A. MAHLSTEDT,

Clerk of the Executive Council.

At the Executive Council Chamber,
Melbourne, 8th August, 1950.

RESIGNATIONS.

HIS Excellency the Governor of the State of Victoria, by and with the advice of the Executive Council thereof, has, by Orders made on the 8th day of August, 1950, accepted the resignations of the persons named hereunder of the offices mentioned, viz.:—

CHIEF SECRETARY'S DEPARTMENT.

ANGUS MCINTYRE, as a member of the Committee of Management of the Melbourne Sailor's Home.
DONALD HAROLD GUDE, as Registrar of Births and Deaths at Kyneton, to date from and inclusive of the 1st July, 1950.

LAW DEPARTMENT.

ARTHUR WOODSIDE, from the Commission of the Peace for the Northern Bailiwick.
ALAN JOHN DUFF, as a Commissioner for taking Declarations and Affidavits, pursuant to the provisions of the *Evidence Act 1928*.
CLARENCE WALTER PEDERSEN, as a Commissioner for taking Declarations and Affidavits, pursuant to the provisions of the *Evidence Act 1928*.

A. MAHLSTEDT,

Clerk of the Executive Council.

At the Executive Council Chamber,
Melbourne, 8th August, 1950.

CONTRACTS ACCEPTED.—(Series 1950-51.)

Contract No.	Particulars.	Amount.	Name of Contractor.	Charge against Vote or Fund.
	GOVERNMENT PRINTER— Supply and delivery of Printing Paper, Writing Paper, &c., required by the Government Printer for the year 1950-51— Schedule No. 1.—Printing Paper, Writing Paper, &c.			
1013	" " " "	Rates as per annex	B. J. Ball Ltd.	} Contingencies, 1950-51
1014	" " " "	"	Alex. Cowan and Sons Ltd.	
1015	" " " "	"	T. T. Eadie Pty. Ltd.	
1016	" " " "	"	Edwards Dunlop and Co. Ltd.	
1017	" " " "	"	Gordon and Gotch (Australasia) Ltd.	
1018	" " " "	"	Michaelis, Hallenstein and Co. Pty. Ltd.	
1019	" " " "	"	Sands and McDougall Pty. Ltd.	
1020	" " " "	"	Spicers (Australia) Ltd.	
1021	" " " "	"	L. A. Wade Pty. Ltd.	
1022	" " " "	"	Wiggins, Teape and Alex. Pirie (Export) Ltd.	
1023	" " " "	"	Max Wurcker (1930) Pty. Ltd.	

Approved—J. G. B. McDONALD, Treasurer. 14.8.50.

ANNEX TO CONTRACTS Nos. 1950/1013 TO 1950/1023.
Schedule No. 1.

PRINTING PAPER, WRITING PAPER, ETC.

- 1950/1013.—*B. J. Ball Ltd.* Security, £325.
- 1950/1014.—*Alex. Cowan and Sons Ltd.* Security, £390.
- 1950/1015.—*T. T. Eadie Pty. Ltd.* Security, £45.
- 1950/1016.—*Edwards Dunlop and Co. Ltd.* Security, £305.
- 1950/1017.—*Gordon and Gotch (Australasia) Ltd.* Security, £246.
- 1950/1018.—*Michaelis, Hallenstein and Co. Pty. Ltd.* Security, £19.
- 1950/1019.—*Sands and McDougall Pty. Ltd.* Security, £16.
- 1950/1020.—*Spicers (Australia) Ltd.* Security, £478.
- 1950/1021.—*L. A. Wade Pty. Ltd.* Security, £250.
- 1950/1022.—*Wiggins, Teape and Alex. Pirie (Export) Ltd.* Security, £985.
- 1950/1023.—*Max Wurcker (1930) Pty. Ltd.* Security, £85.

ADJUSTMENT OF CONTRACT RATES.

All rates are subject to adjustment in accordance with the special conditions of the respective contracts. Notification of such adjustments will be published in the *Government Gazette* as required.
Contracts for a number of items are subject to special conditions regarding availability of supplies, delivery dates, priority certificates, export and import licences, &c.

AGREEMENTS.

Where the name of the supplier opposite any item is shown in italics, with the sign (A), no contract has been executed no security lodged; requirements of such items are to be purchased from the supplier named, under Tender Board Agreement.

B. British. C. Commonwealth. F. Foreign.

Item No.	Description.	Quantity.	Rate.	Country of Origin.	Name of Contractor.
	WHITE OFFSET PRINTING PAPER.		£ s. d.		
8	<i>Sample No. 2—</i> Quadruple Crown, 90 lb., 30 in. x 40 in.	100 reams	per ream 3 16 6·084	C.	L. A. Wade Pty. Ltd.
	COLOURED PRINTING PAPER.				
11	<i>Sample No. 3—</i> Blue Quadruple Foolscap, 45 lb., 27 in. x 34 in.	75 reams	1 16 11	F.	Wiggins, Teape and Alex. Pirie (Export) Ltd.
	SUPER-CALENDERED PAPER.				
34	<i>Sample No. 6—</i> Double Demy, 48 lb., 22½ in. x 35 in.	500 reams	1 18 3·42	C.	Gordon and Gotch (Australasia) Ltd.
35	Double Royal, 60 lb., 25 in. x 40 in.	1,000 "	2 7 10·275	C.	Wiggins, Teape and Alex. Pirie (Export) Ltd.
36	Quadruple Crown, 72 lb., 30 in. x 40 in.	1,500 "	2 17 5·13	C.	B. J. Ball Ltd.
38	Reels, 39 in.	175,000 lb.	per lb. 0 0 9·319§	C.	Edwards Dunlop and Co. Ltd. Gordon and Gotch (Australasia) Ltd.

§ Rate subject to surcharge of 10s. per reel.

CONTRACTS ACCEPTED—continued.

Item No.	Description.	Quantity.	Rate.	Country of Origin.	Name of Contractor.
M.G. (LITHO.) PAPER.					
40A	Sample No. 7— Quadruple Crown, 80 lb., 30 in. x 40 in.	400 reams	£ s. d. per ton 110 0 0*	C.	Australian Paper Manufacturers Ltd. (A)
BLUE WOVE WRITING PAPER (STATIONERY).					
45	Sample No. 9— Quadruple Foolscap, 56 lb., 27 in. x 34 in.	150 reams	per ream 2 9 4.41†	C.	Gordon and Gotch (Australasia) Ltd.
46	Quadruple Foolscap, 44 lb., 27 in. x 34 in.	2,000 "	1 18 9.465†	C.	Alex. Cowan and Sons Ltd.
CREAM WOVE WRITING PAPER (STATIONERY).					
53	Sample No. 10— Double Large Post, 36 lb., 21 in. x 33 in.	150 reams	1 9 10.166†	C.	Gordon and Gotch (Australasia) Ltd.
TINTED BOND WRITING PAPER (STATIONERY).					
55B	Sample No. 12A— Pink Quadruple Foolscap, 40 lb., 27 in. x 34 in.	250 reams	3 14 3	B.	} Edwards Dunlop and Co. Ltd.
55H	Buff Quadruple Foolscap, 40 lb., 27 in. x 34 in.	150 "	3 14 3	B.	
HAND-MADE PAPER (STATIONERY).					
61	Sample No. 13— Blue Laid Double Foolscap, 30 lb., 17 in. x 27 in.	100 reams	8 3 10	B.	Wiggins, Teape and Alex. Pirie (Export) Ltd.
LEDGER PAPER.					
65	Sample No. 14— Double Medium, 68 lb., 22 in. x 35 in.	150 reams	5 18 6	B.	} Wiggins, Teape and Alex. Pirie (Export) Ltd.
66	Double Demy, 48 lb., 20 in. x 31 in.	200 "	4 3 8	B.	
CREAM LAID WRITING PAPER (STATIONERY).					
69B	Sample Nos. 15 and 16— Quadruple Foolscap, 63½ lb., 27 in. x 34 in.	300 reams	2 12 10.253†	C.	B. J. Ball Ltd.
70	Double Large Post, 48 lb., 21 in. x 33 in.	100 "	1 19 9.555†	C.	L. A. Wade Pty. Ltd.
72	Double Foolscap, 24 lb., 17 in. x 27 in., ruled faint lines	2,000 "	1 11 6†	C.	Spicers (Australia) Ltd.
CREAM WOVE BOND WRITING PAPER (STATIONERY).					
83	Sample No. 18— Quadruple Foolscap, 72 lb., 27 in. x 34 in.	150 reams	6 15 8	B.	} B. J. Ball Ltd.
84C	Double Medium, 42 lb., 23 in. x 36 in.	100 "	3 19 3	B.	
84A	Double Large Post, 36 lb., 21 in. x 33 in., surface sized	1,500 "	1 11 8.835†	C.	} Wiggins, Teape and Alex. Pirie (Export) Ltd.
84B	Quadruple Foolscap, 48 lb., 27 in. x 34 in.	4,000 "	2 2 3.78†	C.	
LOAN PAPER (STATIONERY).					
85	Sample No. 19— Medium, 34 lb., 17½ in. x 22½ in.	50 reams	8 15 1	B.	} Wiggins, Teape and Alex. Pirie (Export) Ltd.
85A	Double Large Post, 30 lb., 21 in. x 33 in.	50 "	8 0 8	B.	
86	Double Foolscap, 50 lb., 17 in. x 27 in.	100 "	12 6 1	B.	
CREAM WOVE BANK PAPER (STATIONERY).					
96	Sample No. 22— Quadruple Foolscap, 28½ lb., 27 in. x 34 in.	5,000 reams	1 9 4	F.	Wiggins, Teape and Alex. Pirie (Export) Ltd.
COLOURED BANK PAPER (STATIONERY).					
97	Sample No. 23— Pink Quadruple Foolscap, 28½ lb., 27 in. x 34 in.	750 reams	1 10 9	F.	} Wiggins, Teape and Alex. Pirie (Export) Ltd.
99	Old Gold Quadruple Foolscap, 28½ lb., 27 in. x 34 in.	600 "	1 10 9	F.	
99A	Buff Quadruple Foolscap, 28½ lb., 27 in. x 34 in.	100 "	1 11 0	F.	
100	Green Quadruple Foolscap, 28½ lb., 27 in. x 34 in.	400 "	1 10 9	F.	

† Rate subject to surcharge of £4 8s. 7.92d. per ton for packing in cases.
* Rate less maximum discount of £5 per ton.

CONTRACTS ACCEPTED—continued.

Item No.	Description.	Quantity.	Rate.	Country of Origin.	Name of Contractor.
CARTRIDGE PAPER (STATIONERY).					
<i>Sample No. 28—</i>					
108	Imperial, 60 lb., smooth, 22 in. x 30 in.	600 reams	£ s. d. per ream 2 11 0·056	C.	Edwards Dunlop and Co. Ltd. Purchase (Clause 62)
110	Double Demy, 77 lb., smooth, 22½ in. x 35 in.	75 „	..	C.	
MANILLA PAPER (STATIONERY).					
<i>Sample No. 29—</i>					
113	Double Crown, 120 lb., 20 in. x 30 in. (Long Grain)	400 reams	per ton 101 0 0†	C.	Australian Paper Manufacturers Ltd. (A)
BLOTTING PAPER (STATIONERY).					
<i>Sample No. 30—</i>					
115	White Demy, 38 lb., 17½ in. x 22½ in., flat	500 reams	per ream 1 14 8·349	C.	Alex. Cowan and Sons Ltd.
BROWN PAPER (STATIONERY).					
<i>Sample No. 31—</i>					
124	Kraft, 63 lb., 30 in. x 45 in., flat, M.G., No. 15687A	500 reams	per ton 95 0 0*	C.	} Australian Paper Manufacturers Ltd. (A)
124A	Kraft, 63 lb., 30 in. x 45 in., folded, M.F., No. 15501A	300 „	92 0 0*	C.	
124B	Kraft, 166 lb., 45 in. x 60 in., folded, M.F., No. 15501A	150 „	92 0 0*	C.	
COVER PAPER (STATIONERY).					
<i>Sample No. 32—</i>					
128	Green, 20½ in. x 30½ in., 60 lb.	50 reams	105 0 0	C.	} Australian Paper Manufacturers Ltd. (A)
129	Wedgwood Blue, 20½ in. x 30½ in., 60 lb.	150 „	105 0 0	C.	
140	Cream, 23 in. x 36 in., 80 lb.	50 „	105 0 0	C.	
COPYING TISSUE (STATIONERY).					
<i>Sample No. 33—</i>					
141	Double Crown White, 7 lb., 20 in. x 30 in.	100 reams	per ream 0 18 4	B.	Edwards Dunlop and Co. Ltd.
DRAWING PAPER (STATIONERY).					
<i>Sample No. 34—</i>					
143	Imperial (hot-pressed), 72 lb., 22½ in. x 30½ in.	2 reams	18 8 3	B.	} Wiggins, Teape and Alex. Pirio (Export) Ltd.
144	Double Elephant (hot-pressed), 28½ in. x 40 in.	2 „	34 0 3	B.	
DUPLICATING PAPER (STATIONERY).					
<i>Sample No. 35—</i>					
147	White Wove Double Large Post, 33 lb., 21 in. x 33 in.	500 reams	1 8 8·943	C.	Spicers (Australia) Ltd.
PASTEBOARDS (STATIONERY).					
<i>Sample No. 38—</i>					
155	Royal, 4-sheet, 20 in. x 25 in., 21 lb., per 100 boards	20,000 boards	..	C.	Purchase (Clause 62)
156	Mottled, 4-sheet, 25½ in. x 30½ in., 44 lb., per gross	4,500 gross	per ton 108 0 0	C.	Australian Paper Manufacturers Ltd. (A)
156B	Royal, 8-sheet, 20 in. x 35 in., 38 lb., per 100 boards	20,000 boards	..	C.	Purchase (Clause 62)

* Rate less maximum rebate of £2 per ton. || Rate plus £2 per ton for folding.
 † Rate plus £4 14s. per ton loss of deckle charge.

CONTRACTS ACCEPTED—continued.

Item No.	Description.	Quantity.	Rate.	Country of Origin.	Name of Contractor.
SYSTEM BOARDS (STATIONERY).					
<i>Sample No. 42—</i>					
			per 100		
167	Buff, 25½ in. x 30½ in., 6-sheet, 44 lb. per 100 boards ..	10,000 boards	3 0 6	B.	} Alex. Cowan and Sons Ltd.
168	Blue, 25½ in. x 30½ in., 6-sheet, 44 lb. per 100 boards ..	3,000 "	3 0 6	B.	
175	Blue, 25½ in. x 30½ in., 4-sheet, 28 lb. per 100 boards ..	10,000 "	1 18 6	B.	
176	Green, 25½ in. x 30½ in., 4-sheet, 28 lb. per 100 boards ..	10,000 "	1 18 6	B.	
177	Pink, 25½ in. x 30½ in., 4-sheet, 28 lb. per 100 boards ..	5,000 "	1 18 6	B.	
178	Fawn, 25½ in. x 30½ in., 4-sheet, 28 lb. per 100 boards ..	6,000 "	1 18 6	B.	
180	White, 25½ in. x 30½ in., 4-sheet, 28 lb. per 100 boards ..	50,000 "	1 17 9	B.	
181	White, 27 in. x 34 in., 3-sheet, 28 lb. per 100 boards ..	10,000 "	1 17 9	B.	
183A	Buff, 25½ in. x 30½ in., 3-sheet, 22 lb. per 100 boards ..	5,000 "	1 10 3	B.	
183c	White, 25½ in. x 30½ in., 3-sheet, 22 lb. per 100 boards ..	10,000 "	1 9 6	B.	
STRAWBOARDS.					
<i>Sample No. 43—</i>					
			per ton		
187	Imperial, 20-oz., 22½ in. x 32 in., 45 boards, 56 lb. ..	40 bundles	56 0 0*	C.	} Australian Paper Manufacturers Ltd. (A)
188	Imperial, 24-oz., 22½ in. x 32 in., 38 boards, 56 lb. ..	50 "	55 0 0*	C.	
189	Imperial, 32-oz., 22½ in. x 32 in. ..	70 "	55 0 0*	C.	
192	Extra Royal, 16-oz., 21½ in. x 27 in., 64 boards, 56 lb. ..	60 "	54 0 0*	C.	
198	Royal, 16-oz., 20½ in. x 27 in., 71 boards, 56 lb. ..	40 "	54 0 0*	C.	
204	Large Middle, 16-oz., 18½ in. x 23½ in., 92 boards, 56 lb. ..	40 "	54 0 0*†	C.	
207	Large Middle, 32-oz., 18½ in. x 23½ in. ..	60 "	55 0 0*†	C.	
210	Double Crown, 16-oz., 20 in. x 30 in., 65 boards, 56 lb. ..	60 "	54 0 0*	C.	
211	Double Crown, 20-oz., 20 in. x 30 in., 53 boards, 56 lb. ..	60 "	56 0 0*	C.	
213	Double Crown, 32-oz., 20 in. x 30 in. ..	50 "	55 0 0*	C.	
215	Double Foolscap, 12-oz., 18 in. x 27 in., 111 boards, 56 lb. ..	40 "	50 0 0*†	C.	
216	Double Foolscap, 16-oz., 18 in. x 27 in., 80 boards, 56 lb. ..	60 "	54 0 0*†	C.	
217	Double Foolscap, 20-oz., 18 in. x 27 in., 68 boards, 56 lb. ..	60 "	56 0 0*†	C.	
218	Double Foolscap, 24-oz., 18 in. x 27 in., 56 boards, 56 lb. ..	40 "	55 0 0*†	C.	
STATIONERY.					
			per roll		
248A	Tracing Paper, 30 in. x 50 yards (Arcus No. 309) ..	400 rolls	1 15 0	B.	Max Wurcker (1930) Pty. Ltd.
ENVELOPES.					
			per 1,000		
249	Demy, 10½ in. x 4½ in., Kraft Brown, Banker's, gummed ..	500,000	1 7 6	C.	Alex. Cowan and Sons Ltd.
257	10½ in. x 7½ in., Kraft Brown, Pocket, gummed ..	100,000	2 0 0	C.	} Spicers (Australia) Ltd.
258	15 in. x 6 in., pocket, gummed, Kraft, brown ..	20,000	2 10 0	C.	
259	15 in. x 11 in., pocket, gummed, Kraft, brown ..	50,000	4 17 6	C.	} T. T. Eadie Pty. Ltd.
260	12 in. x 6 in., Kraft Brown, Pocket, gummed ..	20,000	3 12 0	C.	
261	16 in. x 11 in., Kraft Brown, Pocket, gummed ..	20,000	7 0 0	C.	} Spicers (Australia) Ltd.
262	7 in. x 5 in., Manilla, Pocket, gummed ..	200,000	1 6 0	C.	
263	9 in. x 4 in., pocket, gummed, Manilla ..	300,000	1 3 6	C.	} Purchase (Clause 62)
264	5½ in. x 3½ in., pocket, gummed, Manilla ..	550,000	0 15 0	C.	
265	5½ in. x 3½ in., Window Face, secretive, Bankers, gummed ..	1,000,000	
266	9 in. x 4 in., Window Face, secretive, Bankers, gummed ..	1,000,000	
267	6½ in. x 3½ in., Window Face, secretive, Bankers, gummed ..	500,000	
268	9 in. x 4 in., Blue Wove, secretive, Pocket, gummed ..	500,000	
BOOKBINDERS' LEATHER.					
			per doz. skins		
271	Calf, Law, smooth, 29 in. x 19½ in. ..	24 skins	5 9 6§	..	} Michaelis, Hallenstein and Co. Pty. Ltd.
272	Calf, Super Royal, rough, 36 in. x 24 in. ..	240 "	5 19 0§	..	
273	Basil, red, 30 in. x 27 in. ..	72 "	} Purchase (Clause 62)
275	Basil, black, 30 in. x 27 in. ..	48 "	
276	Basil, blue, 30 in. x 27 in. ..	24 "	
277	Sheep, rough, 30 in. x 27 in. ..	360 "	
279	Roan, red, straight-grained, 30 in. x 27 in. ..	120 "	
280	Roan, brown, straight-grained, 30 in. x 27 in. ..	84 "	
281	Roan, green, straight-grained, 30 in. x 27 in. ..	72 "	
282	Roan, blue, straight-grained, 30 in. x 27 in. ..	96 "	
283	Roan, purple, straight-grained, 30 in. x 27 in. ..	144 "	
287	Skiver, purple paste grained, 30 in. x 27 in. ..	72 "	
MANILLA TAGS.					
			per 1,000		
314	5N (in gangs of 4) ..	200,000	0 7 6	C.	} Sands and McDougall Pty. Ltd.
315	6N (in gangs of 4) ..	200,000	0 8 6	C.	

* Rate less maximum rebate of £2 per ton. † Rate plus cutting charge of £2 per ton.
 § Rate subject to surcharge of 37 per cent.

CONTRACTS ACCEPTED.—(Series 1950-51.)

VICTORIAN RAILWAYS.

9. Electric motor bogie axles, at £35 sterling each (Contract 57988).—Commonwealth Steel Co. Ltd. 10. Light furnace oil, at rates (Contract 58248).—The Commonwealth Oil Refineries Ltd. 11. Radial drilling machine, at £1,361 each (Contract 58250).—Gilbert-Lodge and Co. Ltd. 12. Excavation and removal of ash deposit, Newport Power Station, at 5s. 5d. per cubic yard (Contract 58379).—Roche Bros. Pty. Ltd.

By order of the Victorian Railways Commissioners,
N. QUAIL, Secretary. 11.8.50.

PUBLIC WORKS.

932. (2) Armadale, "Larnook" Domestic Arts Training Centre, supply and delivery of electrically-heated Bain Marie and hot press, £704.—L. J. Morgan.
933. (2) Armadale, "Trelowarren" After Care Home, installation of new toilet and enclosing balcony, £330.—F. B. Westwood.
934. (3) Ashburton, State School No. 4317, electrical installation, new wing, £135 11s.—J. G. Catterall.
935. (1) Ararat, Court House, extermination of white ants and repairs, £170.—Austral Pest Exterminating Co.
936. (1) Ballarat, Mental Hospital, replacement of lavatory hand basins, taps, and fittings, Wards F.1 and F.9, £183.—McLean and Boakes.
937. (1) Ballarat, Gaol, supply and installation of hot-water service, £686 13s.—McLean and Boakes.
938. (3) Bairnsdale, Assistant District Architect's residence, Public Works Department, electrical installation, £130 12s. 6d.—F. Geddes.
939. (3) Beechworth, Mental Hospital, supply and installation of electric refrigerator in Staff Mess Room, £158.—Rickards Bros. Pty. Ltd.
940. (1) Beechworth, Court House, provision of new garage, wood shed, and repairs, &c., £1,330 10s.—T. E. McGeehan.
941. (2) Beechworth, Mental Hospital, supply and installation of electric meat-cutting band saw, £270.—Butchers' Service Engineering Co.
942. (1) Bendigo, Country Roads Board Depot, supply and installation of hot-water service, Mess Room, £123 15s. 10d.—J. G. Hibberd.
943. (1) Bendigo, School of Mines, replacement of fencing, £182 10s.—R. Hinks.
944. (4) Bittern, State School No. 3933, repairs and painting, £353 5s.—M. J. L. Clota.
945. (1) Bundalong South, State School No. 2109, repairs, £152 10s.—J. Law and Son.
946. (1) Belmont, State School No. 26, repairs, &c., £152 10s.—C. J. Ash.
947. (2) Burnley, State School No. 2853, erection of new fence and renovations to caretaker's residence, £217 10s.—L. C. Wallis.
948. (1) Burnley, Horticultural College, supply and installation of bio-box ventilation, £166.—W. E. Tuck.
949. (1) Camperdown, State School No. 114, repairs and replacements, including provision of new bath, residence, £208 17s. 6d.—J. H. Pyke.
950. (1) Catani, State School No. 4154, internal repairs and painting, £137.—F. H. Smith.
951. (3) Carlton, Transport Regulation Board, Exhibition Building, internal renovations to four rooms, £130.—L. W. Friezer.
952. (3) Carlton, State School No. 2605, removal and re-erection of girls' shelter shed and erection of wood shed, £237.—G. Wood and Son.
953. (1) Coburg, Pentridge, supply and delivery of three tube lathes for wire netting factory, £562 10s.—Smith and Bate.
954. (2) Coburg, Pentridge, electrical installation in two residences, £190 4s.—A. C. Reid.
955. (1) Coleraine, Police Station, repairs and painting, £670.—C. Patterson.
956. (1) Drouin, State School No. 1924, supply and installation of kerosene hot-water system, teacher's residence, £161 10s.—J. L. Wilson.
957. (2) Drouin, State School No. 1924, provision and erection of sleepout, residence, £250.—G. R. Rodway.
958. (2) Freshwater Creek, State School No. 256, supply and installation of kerosene hot-water service to residence, £145 10s.—Petro Pump Service.
959. (1) Footscray, State School No. 1912, erection of a safety fence, £328.—Cyclone Company of Australia Ltd.
960. (1) Flagg Creek, State School No. 3453, repairs, &c., £129.—A. J. Warry.
961. (1) Glenrowan, State School No. 1742, installation of lights and power points in school and residence, £112 10s.—A. E. Webster.
962. (1) Glenrowan, Police Station, electrical installation, £121 12s. 9d.—A. E. Webster.
963. (1) Greenvale, Sanatorium, supply and installation of meat rails, racks, &c., in meat chamber, £152.—Butchers' Service Engineering Co.
964. (2) Garfield, Police Station, electrical installation, £160.—Swiggs and Bishop.
965. (1) Gormandale, State School No. 2482, supply and installation of kerosene hot-water service, teacher's residence, £157 7s. 7d.—A. C. Gange.
966. (1) Hughesdale, State School No. 4176, erection of tuck shop, £330.—F. W. Kahler.
967. (1) Hurstbridge, State School No. 3939, renovations to school and residence removed from Gobur, £1,620.—F. H. Smith.
968. (3) Heatherton, Sanatorium, electrical installation, Dining Room, New Nurses' Quarters, £225.—H. H. Rowell.
969. (1) Kew, Mental Hospital, supply and installation of boiler feed pump, Children's Cottages, £182 15s.—W. E. Tuck.
970. (1) East Loddon, Consolidated School, supply and installation of fuel hot-water service, teacher's residence, £157 10s.—J. G. Hibberd.
971. (1) East Loddon, Consolidated School, central heating and hot-water to Administration, Cookery, and Senior Wings, £2,028.—D. Smyth and Son.
972. (2) Mont Park, Gresswell Sanatorium, supply and installation of sawdust extraction system, £350 5s.—W. E. Tuck.
973. (1) Mont Park, Mental Hospital, supply and installation of three steam oven cookers for main kitchen, £1,079 10s.—Anderson and Ritchie Pty. Ltd.
974. (2) Mont Park, Mental Hospital, electric lighting in new covered way, Central Block, £168.—S. Pearce.
975. (1) Mont Park, Mental Hospital, supply and installation of electric lighting in driveway to Medical Superintendent's residence, £198.—S. Pearce.
976. (2) Meringur, State School No. 4357, erection of store shed, £108.—C. F. Bennett.
977. (2) Maribyrnong, State School No. 3736, erection of combined wood and tool shed, £140.—G. Wood and Son.
978. (1) Merino, Police Station, provision of wind mill, tank and stand, &c., £118 1s. 6d.—E. A. Deutscher.
979. (1) Muntham, State School No. 2112, provision of new floor to classroom, £150.—D. Heenan.
980. (1) Melbourne, Public Offices, Treasury Gardens, maintenance of lifts for a period from 1st July, 1950, to 30th June, 1951, £103 6s.—Johns and Waygood Limited.
981. (1) Melbourne, Taxation Offices, maintenance of lifts for a period from 1st July, 1950, to 30th June, 1951, £219 18s.—Johns and Waygood Limited.
982. (1) Melbourne, Parliament House, renovations to press rooms, £192.—L. W. Friezer.
983. (1) Melbourne, Parliament House, electrical installation, £377 18s. 3d.—J. P. Eva and Town.
984. (2) Melbourne, Old Treasury Building, improved lighting in vaults, Auditor-General's Department, £159 15s.—J. P. Wallish.
985. (4) Melbourne, 107 Russell-street, internal renovations to part of caretaker's quarters, &c., £150.—H. C. Goldberg.
986. (3) Melbourne, Government Printing Office, conversion of two hydraulic goods lifts to electric, £6,475.—Johns and Waygood Limited.
987. (1) Melbourne, Public Buildings, maintenance of hydraulic lifts for twelve months from 1st July, 1950, to 30th June, 1951, £192.—Johns and Waygood Limited.
988. (2) North Shore, State School No. 4301, making and fixing school cupboards and coat hooks and blackboards, £328.—W. Russell.
989. (5) Port Melbourne, Public Works Department Storeyard, dust extraction equipment for woodworking machines, £411.—Airtvent.
990. (1) Powelltown, State School No. 3957, renewing fencing and repairs, £125.—D. W. Bale.
991. (3) Port Melbourne, State School No. 2932, fencing, &c., £448.—R. Bryant.
992. (4) Pomborneit East, State School No. 4126, painting and repairs and new woodshed, £157 15s.—Rogers and Gribble.
993. (5) Ross Creek, State School No. 803, new teacher's residence in timber, £2,419 15s.—L. J. and K. C. Webb.
994. (3) Royal Park, Children's Welfare Depot, supply and installation of hot-water service, £315.—R. Ashby.
995. (1) Roslyn, State School No. 4663, provision of hat and coat hooks, blackboards with cupboards under, £164.—W. Russell.
996. (1) Sunnyclyffs, State School No. 4416, supply and installation of electric hot-water service, £130 10s. 6d.—Howie Bros.
997. (3) Sale, State School No. 545, provision of new soakage shaft, &c., £230.—H. J. Templeton and Sons.
998. (2) Sunshine East, State School No. 4909, supply and installation of central heating system, Infant School, £670.—W. E. Tuck.
999. (4) Sunshine, Technical School, supply and installation of heating stoves, £225.—Griffiths Bros.

1000. (3) South Yarra, Botanical Gardens, repairs and painting to out-offices, £196.—L. W. Friezer.

1001. (3) South Yarra, Observatory Grounds, Domain, "The Lodge," external renovations, £205.—F. E. Liston.

1002. (2) Springvale, State School No. 3507, repairs and painting, £1,111.—R. Bryant.

1003. (1) Traralgon, State School No. 4652, provision of water supply, drinking fixtures, out-offices, blackboards, cupboards, &c., £1,945.—A. F. Angus.

1004. (1) Traralgon, Higher Elementary School and State School No. 3584, provision of new out-office accommodation, £3,020.—J. W. Short and Co.

1005. (2) Various, Fisheries and Game Department, construction of four motor boats, £4,280.—J. C. Bull and C. C. Neill.

1006. (1) Various, Schools, supplying and fixing plaster to walls and ceilings of four residences, £740.—Fibro Walls and Ceilings Co.

1007. (3) Various, Prefabricated Schools, supplying and laying mastic floor tiles, in 40 schools, £7,650.—Dunlop Semtex Pty. Ltd.

1008. (3) Various, Prefabricated Schools, supplying and laying mastic floor tiles, twenty schools, £3,863 5s.—Picton Hopkins and Son Pty. Ltd.

1009. (3) Various, Prefabricated Schools, supplying and laying mastic floor tiles, 40 schools, £7,726 10s.—J. Murray More Pty. Ltd.

1010. (1) Warrnambool, Technical School, supply and installation of fuel hot-water system, £163 9s. 10d.—R. Turland.

1011. (1) Yallourn, High School, extension and restoration of building from Hillside State School No. 4, £1,056.—H. J. Spencer.

1012. (5) Yarra Park, State School No. 1406, internal renovations, £844.—R. J. Austin.

P. T. BYRNES, Commissioner of Public Works. 9.8.50.

ORDERS IN COUNCIL.—(Series 1949-50.)

FORESTS COMMISSION.

Loan Act No. 5333, Item 8—

6036. To the purchase of allotment 48, section A, Parish of Boodyarn, County of Buln Buln, containing 81 acres 0 roods 8 perches, for forest purposes, £81 1s.—Miss D. E. Bowden, of Won Wron.

Approved by the Governor in Council, 6th June, 1950.—A. MAHLSTEDT, Clerk of the Executive Council.

Loan Act No. 5333, Item 8—

6037. To the purchase of allotments 65b and 65c, Parish of Weeaprounah, County of Polwarth, containing 186 acres 3 roods 15 perches, for forest purposes, £500.—E. A. Minchinton, of Weeaprounah.

Approved by the Governor in Council, 27th June, 1950.—A. MAHLSTEDT, Clerk of the Executive Council.

ORDERS IN COUNCIL.—(Series 1950-51.)

DEPARTMENT OF EDUCATION.

931. One special motor-driven condensate extraction pump, two-stage with driving motor, on brass plate, complete with hot well, for School of Mines, Bendigo, £162.—K. L. Distributors Pty. Ltd., Melbourne.

Approved by the Governor in Council, 8th August, 1950.—A. MAHLSTEDT, Clerk of the Executive Council.

STATE ELECTRICITY COMMISSION.

1024. The supply of five special conveyor belts for Stahlbau overburden spreaders, Yallourn and Morwell Open Cuts, to Quotation No. 6357.—Continental Gummiwerke A. G.

1025. The supply of 100 22-kV, 25-kVA single-phase distribution transformers, to Specification No. 49-50/151.—E. S. Atholl Murray and Co. (as agents for Electritral S.A.R.L. of Italy).

Approved by the Governor in Council, 25th July, 1950.—A. MAHLSTEDT, Clerk of the Executive Council.

1026. The excavation of site and erection of five sanitary blocks and five mess buildings at Ridge Hostel, Morwell, to Specification No. 49-50/281.—T. R. and L. Cockram Pty. Ltd.

1027. The removal of a dwelling and outbuildings from the easement area forming part of Crown allotment 67, section A, Parish of Kinglake, such easement being held by the State Electricity Commission of Victoria, and their re-erection elsewhere.—Robert Keith Lister.

Approved by the Governor in Council, 1st August, 1950.—A. MAHLSTEDT, Clerk of the Executive Council.

1028. The supply of spart parts for Caterpillar tractors, Yallourn, to Quotation No. 6841.—William Adams and Co. Ltd.

1029. The supply of 58,165 super. feet air and part-seasoned hardwood, to Quotation No. 721.—Atkins Timber Co.

1030. The supply of 5 miles of galvanized wire rope, Kiewa-Melbourne transmission line, to Quotation No. 6524.—Australian Wire Rope Works Pty. Ltd.

1031. The supply of 1,000 cubic yards crushed aggregate for construction works, Yallourn and Morwell.—Bayview Quarries Pty. Ltd.

1032. The purchase of land, Morwell, containing 111 acres 1 rood 27 perches, being part of Crown allotment 49A, Parish of Maryvale, County of Buln Buln, together with dwellings and outbuildings erected thereon, for accommodation site, Morwell Project.—Eric Stanley Brinsmead.

1033. The installation of fire protection sprinkler systems in woolshed buildings, Fishermen's Bend and West Footscray, to Specification No. 49-50/343.—Central Automatic Sprinkler Co. Pty. Ltd.

1034. The supply of two Remington accounting machines for consumers' accounting, metropolitan area, to Quotation No. 259.—Chartres Pty. Ltd.

1035. The supply of two Bedford 3-ton chassis for fitting up as tipping trucks, to Quotation No. 230.—S. A. Cheney Pty. Ltd.

1036. The supply of 10,000 lineal feet of plastic piping for housing and accommodation projects, Kiewa Hydro-Electric Scheme, Yallourn and Morwell areas, to Quotation No. 405.—C.I.A. Associated Agencies.

1037. The supply of three second-hand Clarke mobile cranes mounted on Chevrolet chassis for handling of steel, metropolitan area, to Quotation No. 817.—Clarke Mobile Cranes.

1038. The installation of ventilation ducts to office buildings, Church-street, Richmond, to Quotation No. 818.—T. R. and L. Cockram Pty. Ltd.

1039. The supply of 440 tons gelignite and 40 tons monobel, Kiewa Hydro-Electric Scheme, to Quotation No. 5926.—Dalgety and Co. Ltd.

1040. The supply of two 5-ton portable double-drum winches, Morwell, to Quotation No. 720.—Department of Supply.

1041. The supply of three second-hand Mack prime movers and semi-trailers for transportation of heavy loads, to Quotation No. 788.—Department of Supply.

1042. The supply of forestry fire-fighting equipment during a period of more than three years ending 31st December, 1953.—Forests Commission of Victoria.

1043. The supply of twelve road-grader tires, to Quotation No. 7214A.—Goodyear Tyre and Rubber Co. (Aust.) Ltd.

1044. The supply of two forestry tractors, Kiewa Hydro-Electric Scheme, to Quotation No. 6986.—Hastings Deering Service Ltd.

1045. The supply of 1,100 effective lengths hollow hexagonal drill steels, Kiewa Hydro-Electric Scheme, to Quotation No. 6417.—Hastings Deering Pty. Ltd.

1046. The supply of one second-hand reconditioned 5-6 ton mobile crane for stores handling, metropolitan area.—Heavy Equipment Pty. Ltd.

1047. The hire of two only Ruston Bucyrus 3/8 cubic yard excavators with trencher equipment, Yallourn, to Quotation No. 5647A.—Highland Plant Pty. Ltd.

1048. The supply of 5,000 lineal feet of 6-in. unreinforced concrete sewerage pipes, Yallourn and Morwell, to Quotation No. 489.—Humes Ltd.

1049. The supply of six Malcolm Moore shovel loaders fitted with Fordson tractors, to Quotation No. 326.—Malcolm Moore Pty. Ltd.

1050. The supply of seven 400-volt three-phase air circuit breakers, Shepparton and Warrnambool Power Stations, to Quotation No. 4544.—Nilcrom Electrical Sales Pty. Ltd.

1051. The supply of spare parts for Gardner-Denver drifting drills, Kiewa Hydro-Electric Scheme, to Quotation No. 195.—Noyes Bros. (Melb.) Ltd.

1052. The supply of one evaporative cooler unit for transformer cooling, metropolitan sub-stations, to Quotation No. 255.—Perkins (Aust.) Pty. Ltd.

1053. The erection of twelve pre-cut houses at East Newborough, to Specification No. 49-50/320.—Prentice Builders Pty. Ltd.

1054. The supply of 20,000 super. feet of sawn jarrah and 6,000 super. feet of sawn kauri, to Quotation No. 387.—Ringwood Timber and Trading Co. Pty. Ltd.

1055. The supply of one suspension type electro magnet, complete with accessories, to extract tramp iron from black coal, Paisley Fuel Depot, to Quotation No. 5681.—H. A. Stanger.

1056. The purchase of land situate at the corner of Arden and Lloyd streets, West Melbourne, containing an area of 7 acres 2 roods 20 2/10 perches, being part of Crown allotment 17b, section 2, Parish of Doutta Galla, County of Bourke, for terminal station site.—Victorian Railways Commissioners.

1057. The supply of one diesel driven mobile crushing plant, with spare parts, Kiewa Hydro-Electric Scheme, to Specification No. 49-50/159.—Norton Tootill and Co. Pty. Ltd.

1058. The supply of two transportable diesel driven crushing plants, with spare parts, Kiewa Hydro-Electric Scheme, to Specification 49-50/159.—Victorian Industrial Sales and Service Pty. Ltd.

Approved by the Governor in Council, 8th August, 1950
—A. MAHLSTEDT, Clerk of the Executive Council.

4 GEORGE VI. No. 4755, SECTION 6.

I HEREBY give notice that on the 18th July, 1950, I filed an election to administer the following deceased person's estate, in accordance with section 6 of the *Public Trustee Act 1940*:—

PIDGEON, SUSAN, formerly of Glenhuntly-road, Caulfield, but late of 41 Mary-street, St. Kilda, widow, died 25th July, 1942, intestate.

I HEREBY give notice that on the 28th July, 1950, I filed an election to administer the following deceased person's estate, in accordance with section 6 of the *Public Trustee Act 1940*:—

*SCOTT, ELIZABETH EMELIA, also known as Emelia Elizabeth Scott and as Elsie Scott, formerly of 267 Little Collins-street, Melbourne, but late of 41 Collins-street, Melbourne, hairdresser, died 5th January, 1950.

* According to the provisions of the will.

I HEREBY give notice that on the 2nd August, 1950, I filed elections to administer the following deceased persons' estates, in accordance with section 6 of the *Public Trustee Act 1940*:—

*BARRAS, OWEN, late of 97A Park-street, Abbotsford, pensioner, died 28th June, 1950.

BATE, WILLIAM, late of Mount Royal, Parkville, pensioner, died 30th June, 1948, intestate.

BERTRAM, ALBERT EDWARD, late of 64 St. John-street, Prahran, textile worker, died 4th March, 1950, intestate.

*BOWERS-CHILTON, ELENA, formerly of Perseverance Hotel, Fitzroy, but late of "Villa Maria," Boronia, gentleman, died 22nd February, 1950.

BRADLEY, JOHN GREENWOOD, late of Bendigo Benevolent Home, pensioner, died 19th March, 1950, intestate.

HALE, GEORGE HENRY, late of 11 Dimboola-street, Kensington, South Australia, labourer, died 6th May, 1946, intestate.

HILL, CECILIA ELIZABETH ROSE, late of Benevolent Home, Cheltenham, pensioner, died 16th June, 1950, intestate.

HOOK, CHARLES HENRY, formerly of Elvina-street, Vaucluse, but late of Woolner's Arm, via Casino, both in the State of New South Wales, body builder, died 4th April, 1949, intestate.

MCKINNEY, CATHERINE, late of 34 Gore-street, Fitzroy, widow, died 24th February, 1949, intestate.

OWENS, DENIS WILLIAM, late of 7 Barry-street, Kew, clerk, died 19th May, 1950, intestate.

RICHTER, ALMA CLARE, late of 63 Kent-street, Ascot Vale, married woman, died 1st July, 1950, intestate.

STUCHBERY, MYRTLE MOIRA, late of St. Andrews, Scotland, married woman, died 18th September, 1949, intestate.

WOOD, PATRICK DENNISON, also known as Geoffrey Hosie, late of 483 Latrobe-street, Melbourne, labourer, died 14th February, 1950, intestate.

* According to the provisions of the will.

C. J. GARDNER,

Public Trustee.

412 Collins-street, Melbourne, C.1, 9th August, 1950.

NOTICE.

ADMINISTRATION of the estate of each of the under-mentioned deceased persons has been granted to me, and creditors, next of kin, and all others having claims against the estate of any of the persons so mentioned are required to send particulars of their claims to the Public Trustee, No. 412 Collins-street, Melbourne, on or before the 18th October, 1950, or they will be excluded from the distribution of the estate when the assets are being distributed:—

*BARRAS, OWEN, late of 97A Park-street, Abbotsford, pensioner, died 28th June, 1950.

BATE, WILLIAM, late of Mount Royal, Parkville, pensioner, died 30th June, 1948, intestate.

BERTRAM, ALBERT EDWARD, late of 64 St. John-street, Prahran, textile worker, died 4th March, 1950, intestate.

†BOOCOCK, EDWARD, late of Wellington, New Zealand, gentleman, died 11th December, 1949.

*BOWERS-CHILTON, ELENA, formerly of Perseverance Hotel, Fitzroy, but late of "Villa Maria," Boronia, gentleman, died 22nd February, 1950.

BRADLEY, JOHN GREENWOOD, late of Bendigo Benevolent Home, pensioner, died 19th March, 1950, intestate.

COHEN, ABRAHAM JOSEPH, also known as Abraham Cohen, late of Main-street, Rutherglen, watchmaker, died 11th August, 1949, intestate.

†CREAGH, ALBERT JOSEPH, late of Mosman, New South Wales, solicitor, died 5th January, 1946.

†DAVIS, WILLIAM HENRY, formerly of 31 Como-street, Alphington, but late of 15 View-street, Mornington, retired carpenter, died 12th May, 1950.

†GLEESON, MATTHEW, formerly of 5 Forster-street, Williamstown, but late of 8 Forster-street, Williamstown, railway employee, died 23rd May, 1950.

HALE, GEORGE HENRY, late of 11 Dimboola-street, Kensington, South Australia, labourer, died 6th May, 1946, intestate.

HILL, CECILIA ELIZABETH ROSE, late of Benevolent Home, Cheltenham, pensioner, died 16th June, 1950, intestate.

HOOK, CHARLES HENRY, formerly of Elvina-street, Vaucluse, but late of Woolner's Arm, via Casino, both in the State of New South Wales, body builder, died 4th April, 1949, intestate.

†LONG, LILLIAN, late of 142 Edwardes-street, Reservoir, widow, died 5th June, 1950.

†MATTHEWS, ERNEST EDWARD, late of 2 Violet-street, Essendon, retired railway employee, died 13th April, 1950.

†MOOG, ADOLPH, formerly of The Municipal Saleyards, Charleston-road, Bendigo, but late of 51 Collingwood-road, Newport, retired superintendent, died 15th May, 1950.

MCKINNEY, CATHERINE, late of 34 Gore-street, Fitzroy, widow, died 24th February, 1949, intestate.

NEWLAND, CHARLES ALFRED, late of 81 Waverley-parade, Pascoe Vale South, retired jockey, died 29th May, 1950, intestate.

OWENS, DENIS WILLIAM, late of 7 Barry-street, Kew, clerk, died 19th May, 1950, intestate.

RICHTER, ALMA CLARE, late of 63 Kent-street, Ascot Vale, married woman, died 1st July, 1950, intestate.

*SCOTT, ELIZABETH EMELIA, also known as Emelia Elizabeth Scott and as Elsie Scott, formerly of 267 Little Collins-street, Melbourne, but late of 41 Collins-street, Melbourne, hairdresser, died 5th January, 1950.

†SHUTE, HARRY, late of 11 Mater-street, Collingwood, pensioner, died 26th May, 1950.

STUCHBERY, MYRTLE MOIRA, late of St. Andrews, Scotland, married woman, died 18th September, 1949, intestate.

TRUSCOTT, CLARA, formerly of 27 Fairlie-street, Yarraville, but late of 23 Hamilton-street, Brunswick, widow, died 17th June, 1950, intestate.

†WATT, ETHEL BLANCHE, late of Melbourne Benevolent Asylum, Cheltenham, widow, died 18th March, 1950.

WOOD, PATRICK DENNISON, also known as Geoffrey Hosie, late of 483 Latrobe-street, Melbourne, labourer, died 14th February, 1950, intestate.

* According to the provisions of the will.

† With the will annexed.

C. J. GARDNER,

Public Trustee.

Melbourne, 9th August, 1950.

Motor Car (Third-Party Insurance) Act 1939.—Section 6.

EFFECTIVE DATE OF WITHDRAWAL BY AUTHORIZED INSURER.

WHEREAS, by notice in writing dated the second day of August, 1950, to me, Keith Dodgshun, the responsible Minister for the time being administering the *Motor Car (Third-Party Insurance) Act 1939*, the following authorized insurer under Part I. of the said Act, namely, the—

COMMONWEALTH GENERAL ASSURANCE CORPORATION LIMITED,

has withdrawn from insurance business in terms of the aforesaid Part: Now therefore I, the said Keith Dodgshun, in pursuance of the provisions of section 6 of the *Motor Car (Third-Party Insurance) Act 1939*, do hereby specify the thirtieth day of August, 1950, as the date upon which such notice of withdrawal shall have effect.

K. DODGSHUN,

Chief Secretary.

Chief Secretary's Office,
Melbourne, 8th August, 1950.

Transport Regulation Acts.

TRANSPORT REGULATION BOARD.

NOTICES OF PUBLIC HEARINGS.

NOTICE is hereby given that the applications made by the persons named below for licences to operate the commercial passenger vehicles on the route or routes, or in the manner set out opposite their names, will be heard at a time and place to be communicated to the parties:—

Name of Applicant; Nature of Application.

BRIDGES, O. J., 29 Florence-street, Mentone; application for variation of licences numbered A.1507, A.2493, and A.1674, to extend service between Mentone Railway Station and George-street, Mordialloc, from George-street, Mordialloc, to the Mordialloc Railway Station, via Como-parade and Nepean Highway.

CRANSTON, A. H., Maryvale-road, Morwell; 1 commercial passenger vehicle, with seating capacity for five persons, to be purchased, to operate as follows:—(a) at separate and distinct fares within a radius of 5 miles of Morwell, (b) under private hire conditions within a radius of 50 miles of Morwell.

GERRARD, A. J., 32 Hesse-street, Colac; 2 commercial passenger vehicles, each with a seating capacity for five persons, to operate as follows:—(a) at separate and distinct fares within a radius of 5 miles of Colac, (b) under private hire conditions within a radius of 50 miles of Colac (subject to the cancellation of licences numbered A.1412 and A.2380, at present held by K. S. T. Martin, Colac).

GRIBBEN, P. P., Merrigum; 1 commercial passenger vehicle, with seating capacity for four persons, to operate as follows:—(a) at separate and distinct fares within a radius of 5 miles of Merrigum, (b) under private hire conditions within a radius of 50 miles of Merrigum.

HANCOCK, F. M., & E. M., 31 Macarthur-street, Sale; 1 commercial passenger vehicle, with seating capacity for five persons, to be purchased, to operate as follows:—(a) at separate and distinct fares within a radius of 5 miles of Sale, (b) under private hire conditions within a radius of 50 miles of Sale (subject to the cancellation of licence numbered A.496, at present held by F. Henderson, Sale).

LING, A. H. (trading as Glenwaverley Taxi Service), Jordan-grove, Glen Waverley; 1 commercial passenger vehicle, with seating capacity for five persons, to operate as follows:—(a) at separate and distinct fares within a radius of 5 miles of Glen Waverley, (b) under private hire conditions within a radius of 50 miles of Glen Waverley (subject to the cancellation of licence numbered A.2951, at present held by H. J. Mason and A. H. Ling, Hawthorn.)

SCHRAM, S. W. (trading as Age Taxi Service), 48 Armstrong-street, Colac; 1 commercial passenger vehicle, with seating capacity for five persons, and 1 commercial passenger vehicle, with seating capacity for five persons, to be purchased, to operate as follows:—(a) at separate and distinct fares within a radius of 5 miles of Colac, (b) under private hire conditions within a radius of 50 miles of Colac (subject to the cancellation of licences numbered A.2392 and A.2393, at present held by E. C. Reid and G. V. Libbis, Colac).

WARRNAMBOOL BUS LINES, 273 Raglan-parade, Warrnambool; application for variation of licence numbered A.1911, as follows:—(a) to delete all rights at present held under this licence, (b) for the carriage only of school children between Dunmore Station and Hawkesdale State School, in accordance with the terms of a contract entered into with the Education Department, (c) under charter conditions within a radius of 30 miles of Hawkesdale, (d) interchangeably with other large seating capacity vehicles operated by the applicants.

YALLOURN PASSENGER SERVICE, 1 Southend-road, Yallourn; 1 commercial passenger vehicle, with seating capacity for 33 persons, to operate as an additional vehicle under the same terms and conditions as contained in applicant company's existing stage omnibus licences.

APPLICATIONS for licences to operate commercial passenger vehicles, each with seating capacity for five persons, for the carriage of passengers otherwise than at separate and distinct fares for each passenger throughout Victoria:—

ANDREA, A. J., 1 Yarra-street, Echuca.

COMATAS, A. J., Athens Cafe, Orbost.

EASTLAKE, A., Box 12, Corryong.

HANCOCK, F. M. & E. M., 31 Macarthur-street, Sale (subject to the cancellation of licence numbered PH.406, at present held by F. Henderson, Sale).

KINGSTON, F. C., Grampian House, Hall's Gap.

MANSFIELD, G. A., 12 Louisville-avenue, Pascoe Vale.

MARTIN, A. W., Tempy.

NOTICE is hereby given that the applications made by the persons named below for licences to operate the commercial goods vehicles on the route or routes, or in the manner set out opposite their names, will be heard at a time and place to be communicated to the parties concerned:—

Name and Address; Nature of Application.

BOLTON, A. W., Merbein; 1 commercial goods vehicle (10 cwt.) to operate within a radius of 100 miles of Merbein for sale to householders on behalf of J. R. Watkins Co.—goods manufactured by the said company.

HEWITT, W., Duverney; 1 commercial goods vehicle (80 cwt.) for the carriage of general goods between Geelong and Mortlake, via Inverleigh, Cressy, Lismore, Derrinallum, and Darlington.

LANGSKAILL BROS., Buchan; 1 commercial goods vehicle (84 cwt.) for the carriage of (a) general goods from and to Nowa Nowa to and from places on or reached from the road between Nowa Nowa and Wulgulmerang, (b) general goods from and to places situate on road as defined in paragraph (a) above to and from Bairnsdale and Orbost.

LENNEN, F., Stratford; 2 commercial goods vehicles (110 cwt. each) for the carriage of (a) general goods within a radius of 20 miles of Stratford, (b) road making plant and materials within a 50 miles radius of Stratford.

MCGINTY, L., Casterton; application to vary the terms of licences Nos. D.3684 and D.5657 to include the carriage of general goods between Casterton and Portland, via Merino and Heywood.

MCLEAN, G. H., 11 Grace-avenue, Warrnambool; 1 commercial goods vehicle (120 cwt.) for the carriage of (a) general goods within a radius of 20 miles of Warrnambool, (b) road making plant and materials within a radius of 50 miles of Warrnambool.

PEARL, W., 10 Woolton-avenue, Thornbury; 1 commercial goods vehicle (12 cwt.) for the carriage of (a) snowballs throughout the State of Victoria in the course of business as "confectionery distributor," (b) confectionery from the railway stations at Yallourn, Traralgon, Sale, Castlemaine, Rochester, Echuca, Cohuna, Colac, Terang, Warrnambool, Euroa, Wangaratta, and Swan Hill, to retailers tributary to such railway stations.

ROBERTS, L. F., 30 Bree-road, Hamilton; application to vary the terms of licence No. D.6009, to include the carriage of bricks, sewerage pipes, and tiles from Ballarat to Hamilton.

RUSSELL, E. J., 395 Murray-street, Colac; 2 commercial goods vehicles (100 and 80 cwt.) for the carriage of road contracting plant and materials throughout the State of Victoria.

BUSCALL, E. G. (trading as Rutherglen Gravel Supply), Rutherglen; 1 commercial goods vehicle (90 cwt.) for the carriage of gravel and screenings as follows:—(a) within a 30 miles radius of Rutherglen, (b) from Rutherglen to places on the Murray Valley Highway between Rutherglen and Cobram.

SANDHURST BRICK COMPANY LTD., View Point, Bendigo; 1 commercial goods vehicle for the carriage of (a) bricks within a radius of 40 miles of Bendigo, (b) general goods within a radius of 25 miles of the afore-mentioned city.

STACPOOLE, S. P., 21 Charles-street, Preston; 1 commercial goods vehicle (81 cwt.) for the carriage of road contracting plant and materials throughout the State of Victoria.

STEVENS, L. M., Old Melbourne-road, Rye; 1 commercial goods vehicle (100 cwt.) for the carriage of general goods between Melbourne, Dromana, Rosebud, Rye, Sorrento, and Portsea.

WORLD BRANDS PTY. LTD., 567 Spencer-street, West Melbourne; 2 commercial goods vehicles (21 cwt. each) for the carriage of tea in cartons on behalf of Lipton Pty. Ltd. for distribution to retailers only as listed hereunder:—

Vehicle 1: (a) within a radius of 50 miles from Melbourne, (b) Melbourne to Bendigo, via Bacchus Marsh, Daylesford, Castlemaine, and Maryborough, (c) Bendigo to Melbourne, via Gisborne, Macedon, Kyneton, and Sunbury, provided that all goods distributed on the routes detailed under paragraph (b) and (c) are picked up at railway stations situate on the said routes.

Vehicle 2: (a) within a radius of 50 miles from Melbourne, (b) from Melbourne to towns on or conveniently reached from the Prince's Highway East between Warragul and Bairnsdale, returning to Melbourne via Yarram, Leongatha, and Korumburra—deliveries pursuant to this paragraph are to be made from various railway stations situate on the said routes.

Notice of any objection should be forwarded to reach the Secretary of the Board not later than Wednesday, 30th August, 1950.

E. V. FIELD,
Secretary.

Exhibition Buildings, Rathdown-street, Carlton, N.3, 15th August, 1950.

MELBOURNE AND METROPOLITAN BOARD OF WORKS.

GENERAL NOTICE.

THE Melbourne and Metropolitan Board of Works, having made sewers for carrying off the sewage from each and every property which, or any part of which, abuts on the streets or parts of streets in which such sewers are laid, and which are included within the Sewerage Areas hereinafter described, doth hereby declare that, on and after the 16th day of September, 1950, each and every property which, or any part of which, abuts on the said streets or parts of streets, shall be deemed to be a sewered property within the meaning of the *Melbourne and Metropolitan Board of Works Act 1928*.

The Sewerage Areas hereinbefore referred to are—

Sewerage Area No. 1,297.

City of Coburg.—Commencing at the intersection of Reynard-street and Melville-road at the junction of Sewerage Areas Nos. 888 and 843; thence southerly, westerly, southerly, and westerly following Sewerage Areas Nos. 843, 874, 1,150, and 1,088, to the intersection of Ward-grove and Louisville-avenue, further westerly along Ward-grove, northerly along Rainer-street, westerly along the southern boundary of lot 78 Rainer-street, southerly along the eastern boundaries of properties on the east side of Langtree-avenue to the south-east corner of lot 1 Langtree-avenue, westerly along portion of the eastern boundary of the said lot 1, southerly along the eastern boundary of lot 13 Lothair-street, easterly and

south-easterly along Lothair-street, north-easterly along the northern boundaries of lot 27 Lothair-street and lot 51 Rainer-street, south-easterly along Rainer-street to the boundary of Sewerage Area No. 1,152, westerly and northerly following Sewerage Area No. 1,152 to the intersection of Coonans-road and Woodlands-avenue, easterly along Woodlands-avenue, northerly along Kathleen-street to the boundary of Sewerage Area No. 1,030, easterly, southerly, easterly, northerly, and easterly following Sewerage Areas Nos. 1,030 and 888 to the commencing point.

Sewerage Area No. 1,298.

City of Moorabbin.—Commencing at the intersection of Balcombe-road and Charman-road; thence northerly along Charman-road to a point 187 feet north of the north side of Rossmith-avenue, westerly by a line and the northern boundaries of lots 15 to 18 Rossmith-avenue, northerly and westerly along the eastern and northern boundaries of lot 21 Wallace-crescent, northerly and westerly along Wallace-crescent, further westerly along the northern boundary of lot 11 Wallace-crescent, northerly along portion of the eastern boundary of lot 91 Spicer-street, westerly along the northern boundary of the said lot 91, southerly along Spicer-street, easterly along Balcombe-road to the commencing point.

Sewerage Area No. 1,299.

Shire of Braybrook.—Commencing at the intersection of Havelock-street and Mitchell-street; thence westerly along Mitchell-street, southerly along the western boundary of lot 428 Mitchell-street, westerly along portion of the northern boundary of lot 445 Scovell-crescent, south-westerly along the western boundary of the said lot 445, generally southerly along Scovell-crescent to the boundary of Sewerage Area No. 943, easterly following Sewerage Area No. 943 to Havelock-street, northerly along Havelock-street to the commencing point.

Victoria Housing Commission Area.

Sewerage Area No. 1,300.

Shire of Braybrook.—Commencing at the intersection of Thompson-street and Suffolk-street; thence westerly along Suffolk-street, northerly along Gibb-street, westerly along Yardley-street, northerly along Deakin-avenue, easterly along Curtin-street, northerly along Commercial-street, easterly along Janson-street, northerly along the western boundaries of lot 411 Janson-street and lot 402 Argyle-street, easterly along Argyle-street, southerly along Richelieu-street, easterly along Hill-street, southerly along Thompson-street to the commencing point.

Victoria Housing Commission Area.

Further particulars regarding the streets or parts of streets in which sewers have been laid may be ascertained on inquiry at the Board's office.

By order of the Board,
CHAS. J. W. BRIGGS,
Secretary.

110 Spencer-street,
Melbourne, C.1,
15th August, 1950.

Marriage Act 1928.

MINISTERS OF RELIGION REGISTERED TO CELEBRATE MARRIAGES IN VICTORIA.

IT is hereby notified that in pursuance of the provisions of the *Marriage Act 1928*, 19 Geo. V. No. 3726, Section 11, the under-mentioned Officiating Ministers of Religion have been registered at this Office for the celebration of marriages in Victoria:—

Number in Register.	Name.	Designation.	Denomination.	Residence.	Date of Registration.
10279	Hamley, Donald George ..	Deacon ..	Church of England ..	St. John Baptist, Murrayville ..	4.7.50
10280	McCormack, Stephen ..	Priest ..	Roman Catholic ..	St. Dominic's, East Camberwell ..	4.7.50
10281	Jones, John Clark ..	Minister ..	Presbyterian ..	West Hawthorn ..	11.7.50
10282	Marion, Edwin Charles ..	Captain ..	Salvation Army ..	Citadel, Brighton ..	7.7.50
10283	O'Keefe, Francis ..	Priest ..	Roman Catholic ..	Xavier Chapel, Kew ..	12.7.50
10284	Gair, Thomas Albert ..	Priest ..	Church of England ..	22 Grandview-grove, Armadale ..	11.7.50
10285	Rutter, Arthur Percival Langley ..	Deacon ..	Church of England ..	Holy Trinity, Buninyong ..	10.7.50
10286	Cosgrave, Francis Xavier ..	Priest ..	Roman Catholic ..	Redemptorist Monastery, Kew ..	4.7.50
10287	Maas, Christianus Leonardus ..	Priest ..	Roman Catholic ..	St. Patrick's Cathedral, Melbourne ..	17.7.50
10288	Ridgway, Kingsley Mervyn ..	Elder ..	Wesleyan Methodist Church ..	Walhalla-street, Pascoe Vale South ..	14.7.50
10289	Geraghty, Joseph Declan ..	Priest ..	Roman Catholic ..	St. Dominic's, East Camberwell ..	20.7.50
10290	Mudford, John Isaac ..	Minister ..	Churches of Christ ..	Church of Christ, Kaniva ..	22.7.50
10291	Tyreus, Lage ..	Pastor ..	Swedish Church ..	Clarendon-street, South Melbourne ..	1.8.50
10292	Stevens, Alexander Thomas ..	Minister ..	Presbyterian ..	St. Paul's, Wangaratta ..	24.7.50
10293	Shadjko-Basilewitsch, Alexander ..	Priest ..	Russian Orthodox (Abroad)	Bonegilla ..	10.7.50

Office of the Government Statist,
Melbourne, 11th August, 1950.

O. GAWLER,
Government Statist.

MONEY LENDERS ACT 1938.

IN accordance with the provisions of the above-mentioned Act, the following is published for general information:—

List of Persons to whom Money Lenders' Licences have been issued for the Year ending 30th June, 1951.

Name.	Authorized Name.	Authorized Address.	Date of Issue.
A and B Investments Pty. Ltd. (J. L. Weir, appointee)	A and B Investments Pty. Ltd. ..	Metro House, 330 Flinders-lane, Melbourne	4.7.50
Abraham, Isaac Pty. Ltd. (S. E. Abraham, appointee)	Isaac Abraham Pty. Ltd. ..	211 Mair-street, Ballarat ..	1.7.50
Abraham, M. D.	M. D. Abraham, carrying on business as D. L. Abraham	44 Queen-street, Melbourne ..	1.7.50
Adams, Geo. Pty. Ltd. (C. J. Smith, appointee)	Geo. Adams Pty. Ltd. ..	89 North-street, Ascot Vale ..	1.7.50
Adams, Geo. Pty. Ltd. (G. M. Brooks, appointee)	Geo. Adams Pty. Ltd. ..	117 Pall Mall, Bendigo ..	3.7.50
Adams, Geo. Pty. Ltd. (J. N. Honey, appointee)	Geo. Adams Pty. Ltd. ..	304 Sydney-road, Brunswick ..	1.7.50
Adams, Geo. Pty. Ltd. (C. S. Jackson, appointee)	Geo. Adams Pty. Ltd. ..	351 Smith-street, Fitzroy ..	1.7.50
Adams, Geo. Pty. Ltd. (F. W. Brown, appointee)	Geo. Adams Pty. Ltd. ..	429 Chapel-street, South Yarra ..	1.7.50
Advance Providers Pty. Ltd. (H. Davis, appointee)	Advance Providers Pty. Ltd. ..	31 Leeds-street, Footscray ..	1.7.50
Advance Providers Pty. Ltd. (G. Thompson, appointee)	Advance Providers Pty. Ltd. ..	318 High-street, Northcote ..	1.7.50
Advance Providers Pty. Ltd. (J. Goodenday, appointee)	Advance Providers Pty. Ltd. ..	306 Little Collins-street, Melbourne	1.7.50
Amalgamated Cash Orders Pty. Ltd. (F. O. Reinhart, appointee)	Amalgamated Cash Orders Pty. Ltd. ..	255 Smith-street, Fitzroy ..	1.7.50
Amalgamated Cash Orders Pty. Ltd. (F. O. Reinhart, appointee)	Amalgamated Cash Orders Pty. Ltd. ..	40 Leeds-street, Footscray ..	1.7.50
Amalgamated Cash Orders Pty. Ltd. (F. O. Reinhart, appointee)	Amalgamated Cash Orders Pty. Ltd. ..	Cr. Malop and Moorabool streets, Geelong	1.7.50
Amalgamated Cash Orders Pty. Ltd. (F. O. Reinhart, appointee)	Amalgamated Cash Orders Pty. Ltd. ..	130-132 Bourke-street, Melbourne	1.7.50
Amalgamated Cash Orders Pty. Ltd. (F. O. Reinhart, appointee)	Amalgamated Cash Orders Pty. Ltd. ..	327 Bourke-street, Melbourne ..	1.7.50
Assignment Mortgage and Finance Co. Pty. Ltd. (J. E. Dimelow, appointee)	Assignment Mortgage and Finance Co. Pty. Ltd. ..	422 Collins-street, Melbourne ..	3.7.50
Associated Finance Pty. Ltd. (J. T. Milward, appointee)	Associated Finance Pty. Ltd. ..	451 Elizabeth-street, Melbourne ..	1.7.50
Atlas Loan and Finance Co. Pty. Ltd. (T. Marshall, appointee)	Atlas Loan and Finance Co. Pty. Ltd.	303-9 Collins-street, Melbourne ..	1.7.50
Australian Guarantee Corporation Ltd. (G. V. Beattie, appointee)	Australian Guarantee Corporation Ltd.	44 Queen-street, Melbourne ..	1.7.50
Australian Mont de Piete Loan and Deposit Co. Ltd. (A. J. Thaw, appointee)	Australian Mont de Piete Loan and Deposit Co. Ltd.	330 Little Collins-street, Melbourne	10.7.50
Autoterms Pty. Ltd. (A. Lewis, appointee)	Autoterms Pty. Ltd. ..	493 Elizabeth-street, Melbourne ..	1.7.50
Barnes, W. G.	W. G. Barnes	284 Plenty-road, Preston ..	1.7.50
Barnett, S.	S. Barnett, carrying on business as Henry Barrett	569 Swanston-street, Carlton ..	1.7.50
Booth, E. V.	E. V. Booth	497 Brunswick-street, North Fitzroy	1.7.50
Browne, C. Dennys	C. Dennys Browne	84 Collins-street, Melbourne ..	13.7.50
Bowring, C. B. O.	C. B. O. Bowring	100-4 Queen-street, Melbourne ..	1.7.50
Brighton, Investments Co. Pty. Ltd. (M. H. Joske, appointee)	Brighton Investments Co. Pty. Ltd. ..	305 Collins-street, Melbourne ..	1.7.50
Brooks, A.	A. Brooks, carrying on business as R.H.B. Cash Order Co.	99-109 Smith-street, Fitzroy ..	1.7.50
Burke, M. B.	M. B. Burke	234 Collins-street, Melbourne ..	1.7.50
Burroughs, J. R.	J. R. Burroughs, carrying on business as Uneeda Cash Order Co.	224 Camberwell-road, Hawthorn East	1.7.50
Caplan, N.	N. Caplan, carrying on business as Brunswick Loan Co.	365B Lygon-street, East Brunswick	1.7.50
Carrick, A.	A. Carrick, carrying on business as C. Finance and Cash Order Co.	183 Elgin-street, Carlton ..	1.7.50
Case, H. E.	H. E. Case, carrying on business as H. and M. Case	38 Osborne-street, Williamstown ..	1.7.50
Case, M. A.	M. A. Case, carrying on business as H. and M. Case	38 Osborne-street, Williamstown ..	1.7.50
Casper, Edward Pty. Ltd. (G. S. Cox, appointee)	Edward Casper Pty. Ltd. ..	272 Bourke-street, Melbourne ..	1.7.50
Cheney, E. A.	E. A. Cheney, carrying on business as F. and E. Cheney	146 Hopkins-street, Footscray ..	1.7.50
Cheney, J. F.	J. F. Cheney, carrying on business as F. and E. Cheney	146 Hopkins-street, Footscray ..	1.7.50
City Insurance Finance Corporation Pty. Ltd. (R. G. Pinsent, appointee)	City Insurance Finance Corporation Pty. Ltd.	105 Swanston-street, Melbourne ..	3.7.50
Clifford Cash Order Pty. Ltd. (A. H. Temple, appointee)	Clifford Cash Order Pty. Ltd. ..	225 Collins-street, Melbourne ..	1.7.50
Commercial Discounters (Victoria) Pty. Ltd. (E. H. Shaw, appointee)	Commercial Discounters (Victoria) Pty. Ltd.	325 Collins-street, Melbourne ..	14.7.50
Dennis, G. W.	G. W. Dennis	73 Nicholson-street, Footscray ..	1.7.50
Dickens, D. S.	D. S. Dickens, carrying on business as The Elsternwick Cash Order Co.	26 Riddell-parade, Elsternwick ..	1.7.50
Evans, J. W. H.	J. W. H. Evans	26 Holloway-road, Brunswick West	1.7.50
Everyone's Finance Co. Pty. Ltd. (H. L. Whykes, appointee)	Everyone's Finance Co. Pty. Ltd. ..	41 Lydiard-street south, Ballarat..	1.7.50

MONEY LENDERS ACT—continued.

Name.	Authorized Name.	Authorized Address.	Date of Issue.
Extension Agency Pty. Ltd. (A. Mather, appointee)	Extension Agency Pty. Ltd.	172a Flinders-street, Melbourne ..	3.7.50
Field, K. E.	K. E. Field, carrying on business as The Star Cash Order and Finance Co.	48 Leeds-street, Footscray ..	1.7.50
Field, K. E.	K. E. Field, carrying on business as The Star Cash Order and Finance Co.	441 Sydney-road, Brunswick ..	1.7.50
Fleming, M.	M Fleming, carrying on business as Archie Wells Finance and Cash Order Co.	17 The Centraway, Chapel-street, Prahran	1.7.50
Fowler, D. W.	D. W. Fowler, carrying on business as P.B. Supply and Finance Office	138 Bridport-street, Albert Park ..	1.7.50
Gates, L. E.	L. E. Gates	17 Osborne-street, Northcote ..	1.7.50
Grant, Geo. Pty. Ltd. (E. Jansen, appointee)	Geo. Grant Pty. Ltd.	33 Bridge-road, Richmond ..	1.7.50
Green, S.	S. Green	408 Collins-street, Melbourne	13.7.50
Hall, Harry Pty. Ltd. (T. C. Wood, appointee)	Harry Hall Pty. Ltd.	81 Nicholson-street, Footscray ..	1.7.50
Hall, Harry Pty. Ltd. (H. C. Duffield, appointee)	Harry Hall Pty. Ltd.	131 Ryrie-street, Geelong ..	1.7.50
Hall, Harry Pty. Ltd. (H. A. Phillips, appointee)	Harry Hall Pty. Ltd.	57 Swanston-street, Melbourne ..	1.7.50
Hall, Harry Pty. Ltd. (L. O. Worland, appointee)	Harry Hall Pty. Ltd.	389 Bridge-road, Richmond ..	1.7.50
Hall, J.	J. Hall	58 North-road, Newport ..	1.7.50
Harris, E. H.	E. H. Harris	285 Barkly-street, Footscray ..	1.7.50
Hastings, C. I.	C. I. Hastings, carrying on business as Quick Service Finance Co.	473 Bourke-street, Melbourne	1.7.50
Hocking, J. B.	J. B. Hocking	69 Ryrie-street, Geelong ..	1.7.50
Hore, D. E. A.	D. E. A. Hore, carrying on business as Horton Cash Order Co.	64 Elizabeth-street, Melbourne ..	1.7.50
Horsington, W. F.	W. F. Horsington, carrying on business as Aussie Finance Co.	6 Paisley-street, Footscray ..	1.7.50
Ireland, T. M.	T. M. Ireland	229 Collins-street, Melbourne ..	10.7.50
Irons, J. F.	J. F. Irons	1 Woodlawn-street, Richmond ..	1.7.50
Izzard, H. W.	H. W. Izzard	135 Woodlands-street, Essendon ..	19.7.50
James, S. L.	S. L. James	26 James-street, Box Hill ..	1.7.50
Johnson, E. E.	E. E. Johnson, carrying on business as Vestor Finance Co.	149a Pakington-street, Geelong West	1.7.50
Jones, Marcus, Pty. Ltd. (M. Southwick, appointee)	Marcus Jones Pty. Ltd.	49 Elizabeth-street, Melbourne ..	1.7.50
Jubilee Investments Pty. Ltd. (M. S. Sheezel, appointee)	Jubilee Investments Pty. Ltd.	Cr. Bourke and Russell-streets, Melbourne	1.7.50
K. and G. Business Finance Pty. Ltd. (G. A. Greenaway, appointee)	K. and G. Business Finance Pty. Ltd.	28 Elizabeth-street, Melbourne ..	1.7.50
Kendall, J. F.	J. F. Kendall	51 Leeds-street, Footscray ..	3.7.50
*Kiernan, E. L.	E. L. Kiernan, carrying on business as "K" Cash Order Co.	220-228 Smith-street, Collingwood	1.7.50
*Kiernan, E. L.	E. L. Kiernan, carrying on business as "K" Cash Order Co.	189 Bourke-street, Melbourne ..	21.7.50
Kiernan, F. A.	F. A. Kiernan, carrying on business as "K" Cash Order Co.	220-228 Smith-street, Collingwood	1.7.50
Kiernan, F. A.	F. A. Kiernan, carrying on business as "K" Cash Order Co.	189 Bourke-street, Melbourne ..	21.7.50
Kinder, M.	M. Kinder, carrying on business as H. S. Thompson and M. Kinder	282-4 Collins-street, Melbourne ..	7.7.50
Knibb, J. E.	James Knibb	80 Swanston-street, Melbourne ..	1.7.50
Lawson Trading Co. Pty. Ltd. (A. G. Maver, appointee)	Lawson Trading Co. Pty. Ltd.	230 Collins-street, Melbourne ..	1.7.50
Leon Finance Co. Pty. Ltd. (L. M. Sheezel, appointee)	Leon Finance Co. Pty. Ltd.	Cr. Bourke and Russell streets, Melbourne	1.7.50
Livingstone, L. A.	L. A. Livingstone, carrying on business as General Cash Order Co.	270 Bridge-road, Richmond ..	1.7.50
McKay, W.	W. McKay	327 Collins-street, Melbourne ..	10.7.50
McKeown, W. J.	The W. J. McKeown Finance and Cash Order Co.	548 Sydney-road, Brunswick ..	1.7.50
Madden, T. W.	T. W. Madden	495 Collins-street, Melbourne ..	13.7.50
Marshall, J. D.	J. D. Marshall	13 Millor-street, Thornbury ..	1.7.50
Mather, T. G.	T. G. Mather, carrying on business as Swanston Trading Agency	109 Swanston-street, Melbourne ..	1.7.50
Matthews, V. R.	V. R. Matthews, carrying on business as The Grattan Finance and Cash Order Co.	209 Lygon-street, Carlton ..	1.7.50
Mayer, H. E.	H. E. Mayer	349 Collins-street, Melbourne ..	1.7.50
Melbourne Finance and Cash Order Co. Pty. Ltd. (M. Southwick, appointee)	Melbourne Finance and Cash Order Co. Pty. Ltd.	49 Elizabeth-street, Melbourne ..	1.7.50
Mueller, C. F.	C. F. Mueller, carrying on business as C. F. Mueller, P. M. and E. M. O'Connor Mutual Finance Co. Pty. Ltd.	231 High-street, Echuca ..	11.7.50
Mutual Finance Co. Pty. Ltd. (E. Jansen, appointee)	Mutual Finance Co. Pty. Ltd.	57 Swanston-street, Melbourne ..	1.7.50
Mutual Traders Credits Pty. Ltd. (B. Redapple, appointee)	Mutual Traders Credits Pty. Ltd.	121-123 Johnston-street, Fitzroy ..	1.7.50
The New South Wales Monte de Pieta Deposit and Investment Co. Ltd. (A. T. Howe, appointee)	The New South Wales Monte de Pieta Deposit and Investment Co. Ltd.	309-11 Little Collins-street, Melbourne	1.7.50
The New South Wales Monte de Pieta Deposit and Investment Co. Ltd. (H. W. Stephenson, appointee)	The New South Wales Monte de Pieta Deposit and Investment Co. Ltd.	349 Swanston-street, Melbourne ..	1.7.50
New Trading Agency Pty. Ltd. (G. R. Angus, appointee)	New Trading Agency Pty. Ltd.	163 Swanston-street, Melbourne ..	1.7.50

* Licence for which no fee is payable.

MONEY LENDERS ACT—continued.

Name.	Authorized Name.	Authorized Address.	Date of Issue.
*O'Connor, E. M.	E. M. O'Connor, carrying on business as C. F. Muller, P. M. and E. M. O'Connor	231 High-street, Echuca	11.7.50
O'Connor, P. M.	P. M. O'Connor, carrying on business as C. F. Muller, P. M. and E. M. O'Connor	231 High-street, Echuca	11.7.50
Orr, F. H.	F. H. Orr	46 Lydiard-street south, Ballarat	1.7.50
Pitt, R. G.	R. G. Pitt	148 Swan-street, Richmond	1.7.50
Prahran Cash Order Pty. Ltd. (H. E. Goss, appointee)	The Prahran Cash Order Pty. Ltd.	26 The Centreway, Prahran	1.7.50
Rabinov, S.	S. Rabinov, carrying on business as Simplex Finance and Cash Order Co.	75 Crockford-street, Port Melbourne	1.7.50
Rechners Ltd. (R. B. Rechner, appointee)	Rechners Ltd.	245 Latrobe-street, Melbourne	1.7.50
Redapple, J.	J. Redapple, carrying on business as Footwear Distributors Co.	121-123 Johnston-street, Fitzroy	1.7.50
Reddan, A. A.	A. A. Reddan, carrying on business as "K" Cash Order Co.	220-8 Smith-street, Collingwood	1.7.50
Reddan, A. A.	A. A. Reddan, carrying on business as "K" Cash Order Co.	189 Bourke-street, Melbourne	21.7.50
Rosen, L.	L. Rosen, carrying on business as Roseen Cash Order Co.	666 Sydney-road, Brunswick	1.7.50
Rosen, L.	L. Rosen, carrying on business as Roseen Cash Order Co.	412 Brunswick-street, Fitzroy	1.7.50
Scates, R. P.	R. P. Scates, carrying on business as Assurance Cash Order Co.	16 Koornang-road, Carnegie	1.7.50
Searson, A. J., Estate of (W. T. Vickers, Trustee)	Estate of A. J. Searson, carrying on business as Harold Scott	296 Collins-street, Melbourne	1.7.50
Searson, A. J., Estate of (W. T. Vickers, Trustee)	Estate of A. J. Searson, carrying on business as Harold Scott	2a Centreway, Chapel-street, Prahran	1.7.50
Shepherd, J. C.	J. C. Shepherd	79 Speight-street, Thornbury	1.7.50
Adam Smith Pty. Ltd. (P. J. Kierce, appointee)	Adam Smith Pty. Ltd.	11 Elizabeth-street, Melbourne	1.7.50
Adam Smith Pty. Ltd. (P. J. Kierce, appointee)	Adam Smith Pty. Ltd.	619 High-street, Northcote	1.7.50
Smith, C. D. J.	C. D. J. Smith, carrying on business as The Smith Cash Order Co.	194 Bank-street, South Melbourne	1.7.50
Smith, D.	D. Smith	153 Chapel-street, St. Kilda	1.7.50
Steele, S. C.	S. C. Steele	57 Elizabeth-street, Melbourne	1.7.50
Steward, E. J.	E. J. Steward, carrying on business as Swanston Trading Agency	109 Swanston-street, Melbourne	1.7.50
Swan Cash Order Pty. Ltd. (F. L. Pearce, appointee)	Swan Cash Order Pty. Ltd.	383 Brunswick-street, Fitzroy	1.7.50
Swift's Pty. Ltd. (I. L. Schroeder, appointee)	Swift's Pty. Ltd.	257-9 Swanston-street, Melbourne	1.7.50
The Towns Supply Co. Pty. Ltd. (R. G. Pinsent, appointee)	The Towns Supply Co. Pty. Ltd.	105 Swanston-street, Melbourne	3.7.50
The Towns Supply Co. Pty. Ltd. (R. G. Pinsent, appointee)	The Towns Supply Co. Pty. Ltd.	216 Glenferrie-road, Glenferrie	1.7.50
Thompson, H. S.	H. S. Thompson, carrying on business as Murray Kinder and H. S. Thompson	282 Collins-street, Melbourne	7.7.50
Tomasi, A.	A. Tomasi	368-370 Lygon-street, Carlton	1.7.50
Traders Finance Corporation Ltd. (G. V. Beattie, appointee)	Traders Finance Corporation Ltd.	44-6 Queen-street, Melbourne	1.7.50
Universal Providers Pty. Ltd. (E. Greenberg, appointee)	Universal Providers Pty. Ltd.	306 Little Collins-street, Melbourne	1.7.50
Universal Shopping and Finance Co. Pty. Ltd. (C. A. Pitman, appointee)	Universal Shopping and Finance Co. Pty. Ltd.	327 Bourke-street, Melbourne	1.7.50
Watkins, W. E.	W. E. Watkins	317 Collins-street, Melbourne	1.7.50
Weir, J. L.	J. L. Weir	330 Flinders-lane, Melbourne	4.7.50
White, L. G.	L. G. White, carrying on business as Cleveland and Co.	94 Elizabeth-street, Melbourne	1.7.50
Wright, M. H.	M. H. Wright	138 Little Malop-street, Geelong	1.7.50

* Licence for which no fee is payable.

State Treasury,
Melbourne, 1st August, 1950.R. E. STAFFORD,
Registrar.JUSTICE OF THE PEACE EMPOWERED TO CONSENT
TO THE MARRIAGE OF MINORS.

HIS Honour the Chief Justice has been pleased to empower the under-mentioned Justice of the Peace to consent to the Marriage of Minors, under the provisions of the *Marriage Act 1928*.—

Name.	Residence.	Jurisdiction.
Mrs. Ethel Lillian Holmes	60 Spencer-street, Essendon	Within the Essendon district

Prothonotary's Office,
Melbourne, 11th August, 1950.R. D. McFARLANE,
Prothonotary.*Water Act 1928.*

CONSENT TO SALE OF LAND.

HIS Excellency the Governor of the State of Victoria, by and with the advice of the Executive Council thereof, doth by Order made on the 8th day of August, 1950, under the provisions of the *Water Act 1928*, consent to the sale of an area of 7 acres and 24 perches, being part of allotment 7, section E, Parish of Muntoona, County of Moira, and an area of 2 acres 0 roods 33 perches, being the whole of allotment 3A, section F, of the same parish and county, which land was purchased by or is vested in the State Rivers and Water Supply Commission.

A. MAHLSTEDT,
Clerk of the Executive Council.At the Executive Council Chamber,
Melbourne, the 8th August, 1950.

REAL ESTATE AGENTS ACTS.

IN accordance with the provisions of the above-mentioned Acts, the following is published for general information :—

(a) List of Real Estate Agents' Licences issued during the month of July, 1950, and prior months.

Name.	Principal Place of Business (Registered Office).	Name of Firm or Partnership.	Date from which Licence is Effective.
Bateman, P. L.	Lascelles		14.7.50
Bell, G. A.	Main-street, Lang Lang		12.7.50
Conallin, E. C. R.	491 High-street, East Prahran	Matthew Raymond and Co.	18.7.50
Crowder, J. G.	Hatherley Park, Baxter		4.7.50
Crouch, A. F.	Indi-avenue, Red Cliffs		27.7.50
Darwin, E. R. H.	Mirboo North		25.7.50
Eccles, P. M.	196 High-street, Kew		5.7.50
Flannagan, L. N.	63 Clarke-street, East Prahran		18.7.50
Gurry, A. B.	Elva-avenue, Hamilton		14.7.50
Hallam, R. B.	Camp-road, Anglesea	R. B. Hallam and Co.	19.7.50
Hooke, E.	2 Peel-street north, Ballarat	"Withams"	12.7.50
Hudgson, M. P.	High-street, Charlton		1.8.50
Hunt, J. B.	317 Collins-street, Melbourne		28.7.50
Jane, H. A.	3 Plant-street, Malvern		5.7.50
Jury, T. H.	Main-road, Selby	Jury and Nurse	7.7.50
L'Huillier, A. S. P.	272 Exhibition-street, Melbourne	Philip James and Co.	14.7.50
McEniry, M. E.	Williamson-street, Bendigo	Putnam and McEniry	11.7.50
MacFarlane, A. A.	Kepler-street, Warnambool	James MacFarlane and Sons	17.7.50
Malcolm, J. H.	"Holmwood," Worrall-street, Croydon	Harley Malcolm	4.7.50
Mason, A. M.	353 Swanston-street, Melbourne		20.7.50
Norris, J. B.	High-street, Koroit		14.7.50
Nurse, A. J. W.	Main-road, Selby	Jury and Nurse	7.7.50
Palmer, H. G. L.	13 Berkeley-street, Hawthorn		5.7.50
Pullen, N. T.	971 Nepean-highway, Moorabbin		21.7.50
Punshon, D. N.	20 Lydiard-street south, Ballarat	Punshon and Wilkie	27.7.50
Rice, J. P.	McDonald-street, Murtoa	Rice and Taylor	13.7.50
Rose, D. R.	76 Marshall-street, Ivanhoe	Donald Raymond and Co.	15.6.50
Scully, M. J.	491 High-street, East Prahran	Matthew Raymond and Co.	18.7.50
Seymour, L. T.	44 Koornang-road, Carnegie		4.7.50
Smith, C.	23 Buckley-street, Footscray	Claude Smith and Sons	31.7.50
Smith, S. B.	23 Buckley-street, Footscray	Claude Smith and Sons	31.7.50
Tobias, R. N.	Kyabram		3.7.50
Tobolowski, S.	259 Collins-street, Melbourne		21.7.50
Vains, S. D.	378 Hargreaves-street, Bendigo	E. M. Vains and Co.	20.7.50
West, B. M.	132 Little Malop-street, Geelong		4.7.50
Williams and Co. Pty. Ltd. (W. L. Cook, nominee)	157-159 Toorak-road, South Yarra		18.7.50
Woodrow, T. H.	488 Victoria-street, North Melbourne		5.7.50

(b) List of Real Estate Sub-Agents' Licences issued during the month of July, 1950, and prior months.

Name.	Registered Address.	Date from which Licence is Effective.	Name.	Registered Address.	Date from which Licence is Effective.
Benson, W. C.	31 Alma-road, St. Kilda	10.7.50	Lee, L. H.	595 Whitehorse-road, Surrey Hills	20.7.50
Bilcock, B. A.	Toorak-avenue, Croydon	11.7.50	Longley, L. F.	St. James-road, East Heidelberg	15.6.50
Byrne, R. D.	4 Airlie-avenue, East Prahran	18.7.50	MacLeod, L. W.	44 Hopetoun-avenue, Canterbury	13.7.50
Collie, D. P.	Mumbannar, via Heywood	6.7.50	Malcolm, J. B.	79 Ormond-road, Elwood	28.7.50
Drewitt, M. M.	Kepler-street, Warnambool	11.7.50	Morgan, J.	10 Abercrombie-street, Balwyn	10.7.50
Eddy, H. A.	Clarkmont-road, Sassafras	7.7.50	Nugent, J. K.	40 Fountein-street, Tottenham	12.7.50
Edwards, S. H.	91 Ireland-street, West Melbourne	30.6.50	O'Foole, G. J.	81 The Right, Eaglemont	15.6.50
Ellis, K. W.	7 Love-street, Black Rock	19.7.50	Phillips, N. O. L.	20 Kent-street, Kew	26.7.50
Gabbett, E. N.	Yarram	18.7.50	Pinkerton, R. R.	Hamilton	28.7.50
Gillespie - Jones, S. A.	Olinda	21.7.50	Pitt, W.	9 Aroona-road, Caulfield	21.7.50
Harold, T. J.	54 Alexander-street, East St. Kilda	31.7.50	Redman, G. A.	41 Princes-street, Fitzroy	24.7.50
Henderson, R. D.	43 Newcastle-street, Newport	2.5.50	Rees, H. E.	18 Harrow-street, Box Hill	6.7.50
Higgins, S. M.	19 Leonard-street, Preston	12.7.50	Spry, R. J.	10 Clendon Court, Toorak	13.7.50
Hodgetts, A. W.	7 Stevens-street, Queenscliffe	31.7.50	Tilley, A. H. H.	17 Camberwell-road, Camberwell	10.7.50
Hodgson, S. J.	20 Kensington-road, South Yarra	13.7.50	Turrall, E. C. F.	52 Cochrane-street, Brighton	18.7.50
Hunter, A. E.	10 Station-street, Moorabbin	28.7.50	Wheeler, M. J.	314 Windermere-street, South, Ballarat	11.7.50
Imray, A. B.	12 Wallace Court, 7 Wallace-avenue, Toorak	18.7.50	Willmore, L. J. D.	42 Fitzroy-street, St. Kilda	13.7.50
Law, W. O.	31 Wanda-road, Caulfield	4.7.50	Windridge, A. H.	Kelly-street, Pyramid	25.7.50
			Witham, A. F.	20 Sturt-street, Ballarat	12.7.50

The Treasury,
Melbourne, 10th August, 1950.

R. E. STAFFORD,
Registrar.

SUMMONING OFFICER.

I HEREBY appoint the under-mentioned person, under section 31 of the Education Act 1928, to summon parents within the State of Victoria:—

First Constable BRYAN McNULTY, No. 7630.

P. P. INCHBOLD,
Minister of Education.

Education Department,
Melbourne, 8th August, 1950.

AUCTION SALES ACT 1928.

BENALLA.—Notice is hereby given that a Special Meeting of Justices for the Licensing of Auctioneers will be held in the Court House, Benalla, on Monday, the 11th day of September, 1950, at the hour of Ten o'clock in the forenoon, to consider an application by John Gilbert Short, of 22 Goomalibee-street, Benalla, for an auctioneer's licence. Dated this 9th day of August, 1950.—V. A. PROPOSCH, Clerk of Petty Sessions.

AUCTION SALES ACT 1928.

LIST of persons to whom Auctioneers' Licences have been issued during the month of July, 1950.

Name.	Address.	Date of Issue.
Barley, A. J.	421-423 High-street, St. Kilda	5.7.50
Brennan, R. A.	16 Gladstone-parade, Glenroy	17.7.50
Cummins, J. P.	Wycheproof	12.7.50
Gibbs, A. W.	Main-road, Menzies Creek	28.7.50
McCunnie, J. L.	Camperdown	22.6.50
Mason, K. T.	Simpson-street, Carisbrook	10.7.50
Melgaard, W. C.	Lonsdale-street, Dandenong	3.7.50
Norgrove, R. A.	27 St. Helens-road, Hawthorn	19.7.50
Radford, C.	25 Charnwood-road, St. Kilda	5.7.50
*Salathiel, G.	578 Flinders-street, Melbourne	24.7.50
Sherlock, S. E.	2 Rooks-road, Mitcham	14.7.50
Taylor, W. T. C.	1490 Malvern-road, Gardiner	13.7.50
Turpie, R. D.	City Oval Hotel, Ballarat	7.7.50

* By transfer from T. E. Cleary.

The Treasury,
Melbourne, 10th August, 1950.A. T. SMITHERS,
Director of Finance.

BUSINESS AGENTS ACT 1950.

IN accordance with the provisions of the above-mentioned Act, the following is published for general information:—

(a) List of Business Agents' Licences issued during the month of July, 1950, and prior months.

Name.	Principal Place of Business (Registered Office).	Name of Firm or Partnership.	Date from which Licence is Effective.
Baglin, H. L.	330 Wyndham-street, Shepparton		27.7.50
Conallin, E. C. R.	491 High-street, East Prahran	Matthew Raymond and Co.	18.7.50
Crouch, A. F.	Red Cliffs		27.7.50
Crowder, J. G.	Hatherley Park, Baxter		4.7.50
Darwin, E. R. H.	Mirboo North		25.7.50
Eccles, P. M.	196 High-street, Kew		5.7.50
Flannagan, L. N.	63 Clarke-street, East Prahran		18.7.50
Gurry, A. B.	Elva-avenue, Hamilton		14.7.50
Hallam, R. B.	Camp-road, Anglesea	R. B. Hallam and Co.	19.7.50
Hooke, E.	2 Peel-street north, Ballarat	"Withams"	12.7.50
Jane, H. A.	3 Plant-street, Malvern		5.7.50
Kuchmar, N.	13 Grandview-terrace, North Kew	Pearlette Business Agency	12.7.50
McEniry, M. E.	Williamson-street, Bendigo	Putnam and McEniry	11.7.50
MacFarlane, A. A.	Kepler-street, Warrnambool	James MacFarlane and Sons	17.7.50
Mason, A. M.	353 Swanston-street, Melbourne		20.7.50
Norris, J. B.	Koroit		14.7.50
Punshon, D. N.	20 Lydiard-street south, Ballarat	Punshon and Wilkie	27.7.50
Rose, D. R.	76 Marshall-street, Ivanhoe	Donald Raymond and Co.	29.6.50
Scully, M. J.	491 High-street, East Prahran	Matthew Raymond and Co.	18.7.50
Seymour, L. T.	44 Koornang-road, Carnegie		4.7.50
Skinner, A. W. S.	358 Collins-street, Melbourne	I. A. Watt and Co.	7.7.50
Smith, C.	23 Buckley-street, Footscray	Claude Smith and Sons	31.7.50
Smith, S. B.	23 Buckley-street, Footscray	Claude Smith and Sons	31.7.50
Williams and Co. Pty. Ltd. (W. L. Cook, nominee)	157-159 Toorak-road, South Yarra		18.7.50
Woodrow, T. H.	488 Victoria-street, North Melbourne		5.7.50

(b) List of Business Sub-agents' Licences issued during the month of July, 1950, and prior months.

Name.	Registered Address.	Date from which Licence is Effective.	Name.	Registered Address.	Date from which Licence is Effective.
Byrne, R. D.	4 Airlie-avenue, East Prahran	18.7.50	Law, W. O.	31 Wanda-road, Caulfield	4.7.50
Casemore, H.	416 Toorak-road, Toorak	22.3.50	Redman, G. A.	4 Princes-street, Fitzroy	24.7.50
Collie, D. P.	Mumbannar, via Heywood	6.7.50	Tilley, A. H. H.	17 Camberwell-road, Camberwell	10.7.50
Della-Porta, P.	Surrey Lodge, Mitcham-road, Mitcham	4.7.50	Furrall, E. C. F.	52 Cochrane-street, Brighton	18.7.50
Imray, A. B.	12 Wallace Court, 7 Wallace-avenue, Toorak	18.7.50	Witham, A. F.	20 Sturt-street, Ballarat	12.7.50

The Treasury,
Melbourne, 10th August, 1950.
No. 605.—8220/50.—2R. E. STAFFORD,
Registrar.

Marine Act 1928.

AMENDMENT OF PILOTAGE RATES.

UNDER the powers in that behalf conferred by section 79 of the *Marine Act 1928* and under all other powers it in that behalf enabling, the Marine Board of Victoria, with the approval of His Excellency the Governor in Council, doth ordain and determine as follows:—

"That on and after the 17th day of August, One thousand nine hundred and fifty, the pilotage rate from without Port Phillip Heads to an anchorage or pier in Hobson's Bay or Corio Bay, or vice versa, for steamships and ships propelled by electricity or other mechanical power up to and including 6,000 tons of the vessel's burthen, shall be Three pence one farthing (3½d.) per ton, and for every additional ton over 6,000 tons One penny one half-penny (1½d.), calculated on the vessel's net registered tonnage, subject in any case to a minimum charge of Five pounds (£5) and a maximum charge of One hundred pounds (£100)."

The foregoing ordinance and determination was passed at a meeting of the Marine Board of Victoria, held on the 3rd day of August, in the year of our Lord One thousand nine hundred and fifty.

(SEAL) A. T. SMITHERS, Vice-President.
E. MASTERS, Member.
W. W. BERRY, Member.
A. A. WELCH, Acting Secretary.

Approved by the Governor in Council,
8th August, 1950.

A. MAHLSTEDT,
Clerk of the Executive Council.

The Fisheries Acts.

NOTICE OF INTENTION TO ALTER THE PROCLAMATIONS RESPECTING THE USE OF NETS AROUND PIERS AND JETTIES, INCLUDING KERFERD-ROAD JETTY AND ST. KILDA PIER.

IT is hereby notified for general information that it is intended, after the expiration of one month from the date of publication of this notice in the *Government Gazette*, to move His Excellency the Governor in Council to make a Proclamation to provide as follows:—

(a) Revoking the Proclamation made the 25th day of November, 1902, and published in the *Government Gazette* of the 3rd day of December, 1902, respecting prohibition of netting around piers.

(b) Revoking the Proclamation made the 6th day of June, 1912, and published in the *Government Gazette* of the 12th day of June, 1912, respecting prohibition of netting within 250 yards of the Kerferd-road jetty, South Melbourne.

(c) Revoking the Proclamations made the 1st day of June, 1926, and the 10th day of October, 1932, and published in the *Government Gazettes* of the 9th day of June, 1926, and the 12th day of October, 1932, respecting netting restrictions in the vicinity of the St. Kilda Pier.

(d) Prohibiting the use of any trammel, trawl, or other net or engine, whether fixed or unfixed, to be employed in fishing as follows:—

1. Within a distance of 100 feet of any part of any pier or jetty (except the Kerferd-road jetty and the St. Kilda Pier).

2. Within a distance of 250 yards of any part of the Kerferd-road jetty, South Melbourne, and 440 yards of any part of the St. Kilda Pier, provided that for the purposes of this Proclamation the undecked portion of the St. Kilda Pier shall not be considered as a part of the pier.

Provided further that the holder of a current professional fishing licence may use hoop nets not exceeding ten (10) feet in diameter for the purpose of taking pilchards, white-bait (anchovy), blue sprat, or any other clupeoid from any pier or jetty, whether in waters closed to netting or not, by any other Proclamation under the Fisheries Acts.

NOTE.—Privately-owned jetties shall not be considered "jetties" for the purpose of this Proclamation.

K. DODGSHUN,
Chief Secretary.
A. DUNBAVIN BUTCHER,
Director of Fisheries and Game.
Melbourne, 9th August, 1950.

The Fisheries Acts.

NOTICE OF INTENTION TO ALTER THE RESTRICTIONS ON THE USE OF CERTAIN NETS IN PORT PHILLIP BAY.

IT is hereby notified for general information that it is intended, after the expiration of one month from the date of publication of this notice in the *Government Gazette*, to make a Proclamation repealing the Proclamation made the 7th day of June, 1949, and published in the *Government Gazette* of the 8th day of June, 1949, regarding restrictions on the use of certain nets in Port Phillip Bay, and providing that the following restrictions shall apply to the use of nets for the purpose of taking fish in the waters of Port Phillip Bay (including Corio and Hobson's Bays):—

1. The use of "mesh" or "set" nets containing meshes measuring less than 5 inches is prohibited from the first day of November in each year to the thirty-first day of March next following (both days inclusive), provided that in the portion of Port Phillip Bay (including Corio Bay) lying to the westward of an imaginary line running from the Werribee Sand Spit to the West Channel Pile Light, and thence to Point King, near Sorrento, the use of such nets shall be prohibited from the first day of October in each year to the thirtieth day of April next following (both days inclusive).

2. The maximum length of any single "mesh" or "set" net shall not exceed forty-five (45) fathoms, and no person may use, assist in the use of, or have on board any boat at any one time more than thirty (30) such nets, provided that where two or more persons are working together as a crew in any boat the maximum number of any such "mesh" or "set" nets which such persons may together use or have on board any boat shall not exceed forty-five (45).

3. The use of "seine" nets measuring more than two hundred (200) fathoms in length is prohibited in the waters of Port Phillip Bay (including Corio Bay) lying to the westward of an imaginary line running from the Gellibrand Pile Light to the West Channel Pile Light, and thence to the seaward end of the fisherman's pier at Queenscliff, throughout the whole of each year.

K. DODGSHUN,
Chief Secretary.
A. DUNBAVIN BUTCHER,
Director of Fisheries and Game.
Melbourne, 9th August, 1950.

Victoria.

SHIRE OF FRANKSTON AND HASTINGS.

ORDER CONFIRMED SUBJECT TO A VARIATION.

PURSUANT to section 513 of the *Local Government Act 1946*, the Minister of the Crown administering the said Act on the 9th day of August, 1950, confirmed the Order of the Shire of Frankston and Hastings, made on the 10th day of February, 1950, for the purpose of providing an infant welfare centre, subject to the variation that the land to be compulsorily acquired under such Order shall be that described hereunder, such land being within the municipal district of the Shire of Frankston and Hastings:—

Lot 3 on the plan of subdivision lodged in the Office of Titles, and numbered 6572, being part of Crown allotment 80, Parish of Lyndhurst, County of Mornington.

P. T. BYRNES,
Commissioner of Public Works.

*Apprenticeship Acts.*APPRENTICESHIP COMMISSION OF VICTORIA.
AMENDMENT OF MOULDING TRADES REGULATIONS.*Corrigendum.*

IN Regulation 12 (Standard of Proficiency) of the Moulding Trades Apprenticeship Regulations published on page 4091 of the *Victoria Government Gazette* of 2nd August, 1950, for the phrase "not less than an average of 5 per cent. of the possible marks" read "not less than an average of 75 per cent. of the possible marks."

RAY H. BEERS,
Secretary for Labour.
Department of Labour,
14th August, 1950.

DEPARTMENT OF LAW.—SOLICITOR-GENERAL.
COURTS OF PETTY SESSIONS, BENDIGO.—
ADDITIONAL DAYS AND HOURS.

HIS Excellency the Governor of the State of Victoria, by and with the advice of the Executive Council thereof, doth by Order made on the 8th day of August, 1950, pursuant to the provisions of section 61 of the *Justices Act 1928*, appoint every fourth Friday at Ten o'clock a.m., as a day and hour for the holding of the Court of Petty Sessions at Bendigo, in addition to the days and hours heretofore appointed—to take effect as from and inclusive of the 25th August, 1950.

A. MAHLSTEDT,
Clerk of the Executive Council.

At the Executive Council Chamber,
Melbourne, the 8th August, 1950.

LAW DEPARTMENT.—ATTORNEY-GENERAL.
CURATOR OF CONVICT'S PROPERTY.

HIS Excellency the Governor of the State of Victoria, by and with the advice of the Executive Council thereof, doth, by Order made on the 8th day of August, 1950, pursuant to the provisions of section 576 of the *Crimes Act 1928*, direct that the custody and management of the property of the convict, James Raymond Augustine O'Keefe, be committed to Paul Connell Nunan, of 422 Little Collins-street, Melbourne, solicitor, as a curator hereby appointed in that behalf.

A. MAHLSTEDT,
Clerk of the Executive Council.

At the Executive Council Chamber,
Melbourne, the 8th August, 1950.

WATER ACTS.

At the Executive Council Chamber, Melbourne, the
eighth day of August, 1950.

PRESENT:

His Excellency the Governor of Victoria.
Mr. Inghbold | Mr. Brose
Mr. Fulton | Mr. Mitchell.

STATE RIVERS AND WATER SUPPLY COMMISSION.—
WONTHAGGI WATERWORKS DISTRICT—WON-
THAGGI URBAN DISTRICT—DISTRICTS EXTENDED.

UNDER the powers conferred by the Water Acts and all other powers enabling him in that behalf, His Excellency the Governor of the State of Victoria, with the advice of the Executive Council of the said State, on the recommendation of the State Rivers and Water Supply Commission, doth hereby declare, order, and direct as follows:—

That the Wonthaggi Waterworks District and the Wonthaggi Urban District be extended by adding to the same the lands set out and described in the Schedule hereto, and as on and from the date of this Order such districts shall be deemed to be so extended.

SCHEDULE.

Commencing at the south-eastern angle of lot 179, Block B on lodged plan of subdivision No. 5417, Parish of Wonthaggi; thence southerly by the western boundary of a road to a point distant 20 chains southerly from the north-eastern angle of allotment 26A; thence westerly by a line parallel to the northern boundary of that allotment to the Nyora to Wonthaggi railway; thence north-westerly by that railway to a point in line with the western boundary of Hull-street; thence north-easterly by a line and the last-mentioned street boundary and north-westerly by that street boundary to a point in line with the southern boundary of Alexander-road; thence north by a line a distance of about 1 chain to a point in line with the southern boundaries of lots 236 to 242, Block B; thence easterly by a line and the northern boundary of Alexander-road to the point of commencement.

The lands described in the foregoing Schedule are shown on a plan approved by the Governor in Council, and deposited in the office of the State Rivers and Water Supply Commission, Melbourne (Corres. 50/8014).

And the Honorable Richard Keats Brose, His Majesty's Minister of Water Supply for the State of Victoria, shall give the necessary directions herein accordingly.

A. MAHLSTEDT,
Clerk of the Executive Council.

BOORT WATERWORKS TRUST.

At the Executive Council Chamber, Melbourne, the
eighth day of August, 1950.

PRESENT:

His Excellency the Governor of Victoria.
Mr. Inghbold | Mr. Brose
Mr. Fulton | Mr. Mitchell.

ADDITIONAL LOAN OF £1,500.

UNDER the powers conferred by the Water Acts and all other powers enabling him in that behalf, His Excellency the Governor of the State of Victoria, by and with the advice of the Executive Council of the said State, doth hereby grant an additional loan of One thousand five hundred pounds (£1,500) to the Boort Waterworks Trust for improvements to reticulation, as set forth in the detailed statement bearing date the 2nd August, 1950, and verified under the seal of the State Rivers and Water Supply Commission.

The loan hereby granted shall be subject to the provisions of the Water Acts.

And the Honorable Richard Keats Brose, His Majesty's Minister of Water Supply for the State of Victoria, shall give the necessary directions herein accordingly.

A. MAHLSTEDT,
Clerk of the Executive Council.

CARISBROOK WATERWORKS TRUST.

At the Executive Council Chamber, Melbourne, the
eighth day of August, 1950.

PRESENT:

His Excellency the Governor of Victoria.
Mr. Inghbold | Mr. Brose
Mr. Fulton | Mr. Mitchell.

ADDITIONAL LOAN OF £500.

UNDER the powers conferred by the Water Acts and all other powers enabling him in that behalf, His Excellency the Governor of the State of Victoria, by and with the advice of the Executive Council of the said State, doth hereby grant an additional loan of Five hundred pounds (£500) to the Carisbrook Waterworks Trust for the purchase and installation of meters, as set forth in the detailed statement bearing date the 3rd August, 1950, and verified under the seal of the State Rivers and Water Supply Commission.

The loan hereby granted shall be subject to the provisions of the Water Acts.

And the Honorable Richard Keats Brose, His Majesty's Minister of Water Supply for the State of Victoria, shall give the necessary directions herein accordingly.

A. MAHLSTEDT,
Clerk of the Executive Council.

MOTOR OMNIBUS ACT 1928 (No. 3742).

At the Executive Council Chamber, Melbourne, the eighth day of August, 1950.

PRESENT:

His Excellency the Governor of Victoria.
 Mr. Inchbold | Mr. Brose
 Mr. Fulton | Mr. Mitchell.

AMENDMENTS OF PRESCRIPTIONS OF METROPOLITAN OMNIBUS ROUTES NUMBERS 32A AND 104A.

HIS Excellency the Governor of the State of Victoria, by and with the advice of the Executive Council thereof, and in pursuance of the powers conferred by the *Motor Omnibus Act 1928* (No. 3742), doth by this Order amend, as set out hereunder, the prescriptions of certain routes within the metropolitan area along which motor omnibuses for which "regular-service" licences are granted may ply for hire, viz.:—

Route No. 32A (Oakleigh-Bentleigh-Brighton).—Under the heading "Maximum number of motor omnibuses which may be licensed on route" amend "8" to read "9."

Route No. 104A (North Coburg-Broadmeadows).—Under the heading "Fares to be charged," amend "Section No. 6, 7d.," to read "Section No. 6, 6d."

Licensing Authority.—Pursuant to the provisions of section 15 (1) (c) of the said Act (No. 3742), the Governor in Council by this Order confers upon the Licensing Authority full power and authority for the carrying into effect by the said Licensing Authority of the foregoing provisions of this Order.

And the Honorable Percy Thomas Byrnes, His Majesty's Commissioner of Public Works for the State of Victoria, shall give the necessary directions herein accordingly.

A. MAHLSTEDT,
 Clerk of the Executive Council.

DEPARTMENT OF CROWN LANDS AND SURVEY.

At the Executive Council Chamber, Melbourne, the eighth day of August, 1950.

PRESENT:

His Excellency the Governor of Victoria.
 Mr. Inchbold | Mr. Brose
 Mr. Fulton | Mr. Mitchell.

REVOCATION OF TEMPORARY RESERVATION OF LAND BY ORDER IN COUNCIL.

HIS Excellency the Governor of the State of Victoria, by and with the advice of the Executive Council thereof, doth hereby, in pursuance of the provisions of the *Land Act 1928*, revoke the temporary reservation of land by Order in Council hereinafter referred to, viz.:—

BENJEROOP.—Order in Council of 12th March, 1883, of 2 acres of land in the Parish of Benjeroop, as a site for Public purposes (State School).—(W.66372.)

And the Honorable Albert Eli Lind, His Majesty's Commissioner of Crown Lands and Survey for the State of Victoria, shall give the necessary directions herein accordingly.

A. MAHLSTEDT,
 Clerk of the Executive Council.

DEPARTMENT OF CROWN LANDS AND SURVEY.

At the Executive Council Chamber, Melbourne, the eighth day of August, 1950.

PRESENT:

His Excellency the Governor of Victoria.
 Mr. Inchbold | Mr. Brose
 Mr. Fulton | Mr. Mitchell.

LANDS TEMPORARILY RESERVED FROM SALE.

HIS Excellency the Governor of the State of Victoria, by and with the advice of the Executive Council thereof, doth hereby, in pursuance of the provisions of the *Land Act 1928*, reserve, temporarily, and also except from occupation for mining purposes under any miner's right, the lands hereinafter described:—

RAYMOND ISLAND.—Site for Public purposes, 3 acres 1 rood 10 perches, more or less, Township of Raymond Island, Parish of Bairnsdale, County of Tanjil, as indicated by hachure on plan hereunder.—(R.82(1) (Rs.6571).

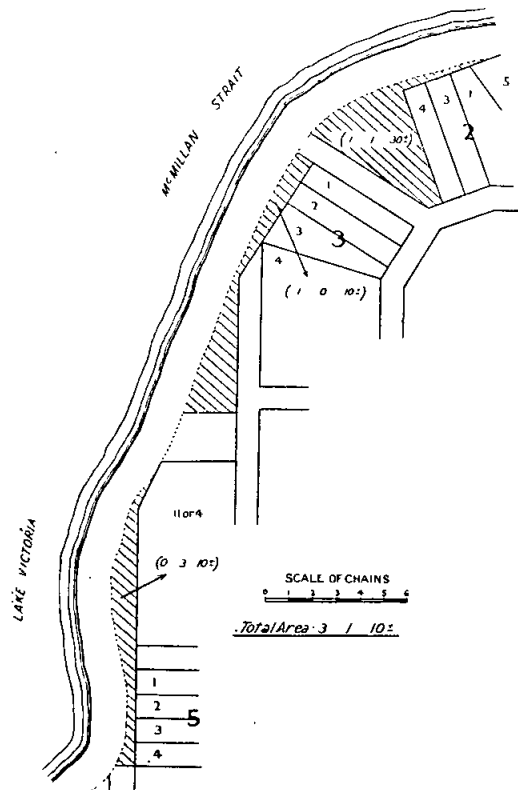

And the Honorable Albert Eli Lind, His Majesty's Commissioner of Crown Lands and Survey for the State of Victoria, shall give the necessary directions herein accordingly.

A. MAHLSTEDT,
 Clerk of the Executive Council.

DEPARTMENT OF CROWN LANDS AND SURVEY.

At the Executive Council Chamber, Melbourne, the eighth day of August, 1950.

PRESENT:

His Excellency the Governor of Victoria.
Mr. Inchbold | Mr. Brose
Mr. Fulton | Mr. Mitchell.

UNUSED AND UNMADE ROADS CLOSED.

HIS Excellency the Governor of the State of Victoria, by and with the advice of the Executive Council thereof, doth hereby direct that, in pursuance of the provisions of section 304 of the *Land Act 1928* (No. 3709), the unused and unmade roads referred to hereunder be closed, viz.:-

Parish of Warrenheip, County of Grant, being (1) the road between allotments 1N (northern portion), J, D¹, and D, and allotments 1N (southern portion), a road, 1E, a road, 1b, and 1c, section 18; (2) the road between allotment 1N (southern portion) and allotments 1E and 1F, section 18; (3) the road between allotments 1E and 1G and allotment 1b, section 18.—(W.8^(s)) (J.27474.)

Parish of Timboon, County of Heytesbury, being the road indicated by hachure on plan hereunder.—(T.182⁽⁷⁾) (C.90271).

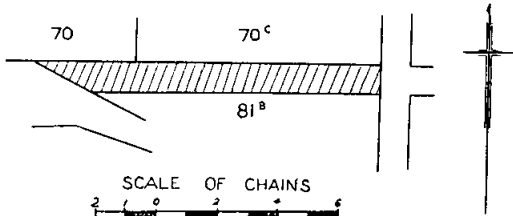

Parish of Holcombe, County of Talbot, being (1) the road between allotment 7K and allotment 7i; (2) the road between allotment 20E and allotment 20A.—(H.97⁽³⁾) (W.66507).

Parish of Glenlogie, County of Gladstone, being the road between allotments 164E² and 164E and allotment A¹⁴.—(G.65^(s)) (J.27601).

Parish of Campbelltown, County of Talbot, being the road between allotments 15A, 15A², 15B³, 43A, 40A, and 42, and allotments 40b and 41, section 2.—(C.364⁽⁴⁾) (J.27669).

Township of Bullumyaal, Parish of Bullumwaal, County of Dargo, being the roads indicated by hachure on plan hereunder.—(B.734^(c)) (H.018564).

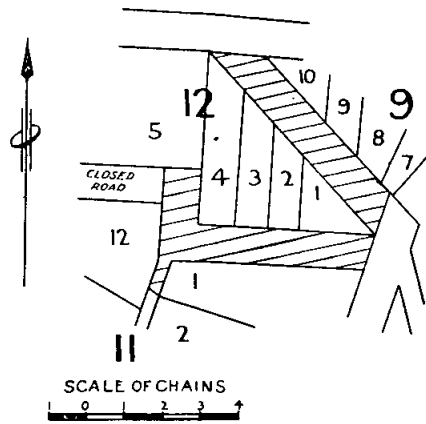

And the Honorable Albert Eli Lind, His Majesty's Commissioner of Crown Lands and Survey for the State of Victoria, shall give the necessary directions herein accordingly.

A. MAHLSTEDT,
Clerk of the Executive Council.

REAL ESTATE AGENTS ACT 1928.

At the Executive Council Chamber, Melbourne, the eighth day of August, 1950.

PRESENT:

His Excellency the Governor of Victoria.
Mr. Inchbold | Mr. Brose
Mr. Fulton | Mr. Mitchell.

EXEMPTION FROM HOLDING A LICENCE.

UNDER the powers conferred by section 4 (1) of the *Real Estate Agents Act 1928* (No. 3762), His Excellency the Governor of the State of Victoria, by and with the advice of the Executive Council, doth hereby exempt the Housing Commission, of 179 Queen-street, Melbourne, from holding a licence under the provisions of the *Real Estate Agents Act 1928* (No. 3762).

And the Honorable John Gladstone Black McDonald, His Majesty's Treasurer for the State of Victoria, shall give the necessary directions herein accordingly.

A. MAHLSTEDT,
Clerk of the Executive Council.

FACTORIES AND SHOPS ACTS.

At the Executive Council Chamber, Melbourne, the fifteenth day of August, 1950.

PRESENT:

His Excellency the Governor of Victoria.
Mr. Lind | Mr. Brose
Mr. Mitchell | Mr. Swinburne.

MOTOR DRIVERS BOARD—VARIATION OF APPOINTMENT ORDER.

WHEREAS, in pursuance of the provisions of the Factories and Shops Acts for the time being in force, the Governor in Council, did by Order appoint a Wages Board, described as the Motor Drivers Board, and did by further Orders extend the powers of the said Board: And whereas it is expedient to vary the powers of the said Board in the manner hereafter appearing: Now therefore His Excellency the Governor of the State of Victoria, by and with the advice of the Executive Council thereof, under the powers in that behalf conferred by the Factories and Shops Acts, doth hereby vary the Orders above mentioned so that in substitution for the powers thereby conferred, the said Motor Drivers Board shall be given the following powers, that is to say:—

To determine the lowest prices or rates which may be paid to persons employed—

- (a) driving mechanically-propelled vehicles hired or plying for hire;
- (b) cleaning or attending to the running requirements (not including repairs) of mechanically-propelled vehicles which are—
 - (i) hired, plying for hire, or used in connexion with a trade or business;
 - (ii) stalled in a public garage or in an engineer's workshop;
- (c) as conductors in connexion with mechanically-propelled passenger vehicles hired or plying for hire;
- (d) giving practical instruction in the driving of mechanically-propelled vehicles, but not including persons employed as instructor drivers in connexion with motor assembly works, warehouses or showrooms.

And the Honorable Trevor Harvey, His Majesty's Minister of Labour for the State of Victoria, shall give the necessary directions herein accordingly.

A. MAHLSTEDT,
Clerk of the Executive Council.

Apprenticeship Acts.

APPRENTICESHIP COMMISSION OF VICTORIA.

*At the Executive Council Chamber, Melbourne, the
fifteenth day of August, 1950.*

PRESENT:

His Excellency the Governor of Victoria.
Mr. Lind | Mr. Brose
Mr. Mitchell | Mr. Swinburne.

AMENDMENT OF AIRCRAFT TRADES REGULATIONS
(No. 1).

IN pursuance of the powers conferred by the Apprenticeship Acts and the Acts Interpretation Acts, His Excellency the Governor of the State of Victoria, by and with the advice of the Executive Council thereof, doth hereby rescind Regulation 9 of the Aircraft Trades Regulations (No. 1) as from the beginning of the first full pay period to commence in August, 1950, and doth hereby substitute therefor the following, that is to say:—

1. The rescission of any Regulations by these Regulations shall not affect any right accrued or accruing to any person or the liability of any person under such rescinded Regulations, where such right accrued or such liability was incurred prior to the coming into operation of these Regulations.

2. The minimum rates of pay to be paid as wages to apprentices in the said trades in each year of their apprenticeship course shall be as follows as from the beginning of the first full pay period to commence in August, 1950, on, from, and after which date all indentures of apprenticeship heretofore executed under the provisions of the Acts and of the Regulations made in respect of the aforesaid trades shall be deemed to be amended accordingly—

1st year—at the rate of 39s. 6d. per week.
2nd year—at the rate of 55s. 6d. per week.
3rd year—at the rate of 74s. 0d. per week.
4th year—at the rate of 117s. 0d. per week.
5th year—at the rate of 146s. 0d. per week.

AMENDMENT OF BOILERMAKING AND/OR STEEL
CONSTRUCTION TRADES REGULATIONS (No. 2).

IN pursuance of the powers conferred by the Apprenticeship Acts and the Acts Interpretation Acts, His Excellency the Governor of the State of Victoria, by and with the advice of the Executive Council thereof, doth hereby rescind Regulation 7 of the Boilermaking and/or Steel Construction Trades Regulations (No. 2) as from the beginning of the first full pay period to commence in August, 1950, and doth hereby substitute therefor the following, that is to say—

1. The rescission of any Regulations by these Regulations shall not affect any right accrued or accruing to any person or the liability of any person under such rescinded Regulations, where such right accrued or such liability was incurred prior to the coming into operation of these Regulations.

2. The minimum rates of pay to be paid as wages to apprentices in the said trades in each year of their apprenticeship course shall be as follows as from the beginning of the first full pay period to commence in August, 1950, on, from, and after which date all indentures of apprenticeship heretofore executed under the provisions of the Acts and of the Regulations made in respect of the aforesaid trades shall be deemed to be amended accordingly—

(a) With respect to the term of apprenticeship of five years—

1st year—at the rate of 39s. 6d. per week.
2nd year—at the rate of 55s. 6d. per week.
3rd year—at the rate of 74s. 0d. per week.
4th year—at the rate of 117s. 0d. per week.
5th year—at the rate of 146s. 0d. per week.

(b) With respect to the term of apprenticeship of four years—

1st year—at the rate of 45s. 0d. per week.
2nd year—at the rate of 73s. 6d. per week.
3rd year—at the rate of 117s. 0d. per week.
4th year—at the rate of 146s. 0d. per week.

AMENDMENT OF BOOT TRADES REGULATIONS.

IN pursuance of the powers conferred by the Apprenticeship Acts and the Acts Interpretation Acts, His Excellency the Governor of the State of Victoria, by and with the advice of the Executive Council thereof, doth hereby rescind Regulation 9 of the Boot Trades Regulations as from the beginning of the first full pay period to commence in August, 1950, and doth hereby substitute therefor the following, that is to say:—

1. The rescission of any Regulations by these Regulations shall not affect any right accrued or accruing to any person or the liability of any person under such rescinded Regulations, where such right accrued or such liability was incurred prior to the coming into operation of these Regulations.

2. The minimum rates of pay to be paid as wages to apprentices in the said trades in each year of their apprenticeship course shall be as follows as from the beginning of the first full pay period to commence in August, 1950, on, from, and after which date all indentures of apprenticeship heretofore executed under the provisions of the Acts and of the Regulations made in respect of the aforesaid trades shall be deemed to be amended accordingly—

(a) With respect to the term of apprenticeship of six years—

1st year—
1st six months—at the rate of 30s. 9d. per week.
2nd six months—at the rate of 35s. 9d. per week.
2nd year—
1st six months—at the rate of 42s. 0d. per week.
2nd six months—at the rate of 51s. 9d. per week.
3rd year—
1st six months—at the rate of 62s. 9d. per week.
2nd six months—at the rate of 82s. 9d. per week.
4th year—
1st six months—at the rate of 104s. 0d. per week.
2nd six months—at the rate of 117s. 3d. per week.
5th year—
1st six months—at the rate of 131s. 3d. per week.
2nd six months—at the rate of 134s. 9d. per week.
6th year—at the rate of 162s. 0d. per week.

(b) With respect to the term of apprenticeship of five years—

1st year—
1st six months—at the rate of 30s. 9d. per week.
2nd six months—at the rate of 35s. 9d. per week.
2nd year—
1st six months—at the rate of 42s. 0d. per week.
2nd six months—at the rate of 51s. 9d. per week.
3rd year—
1st six months—at the rate of 62s. 9d. per week.
2nd six months—at the rate of 82s. 9d. per week.
4th year—
1st six months—at the rate of 104s. 0d. per week.
2nd six months—at the rate of 117s. 3d. per week.
5th year—
1st six months—at the rate of 131s. 3d. per week.
2nd six months—at the rate of 134s. 9d. per week.

(c) With respect to the term of apprenticeship of four years—

1st year—
1st six months—at the rate of 35s. 3d. per week.
2nd six months—at the rate of 48s. 0d. per week.
2nd year—
1st six months—at the rate of 62s. 9d. per week.
2nd six months—at the rate of 82s. 9d. per week.

- 3rd year—
1st six months—at the rate of 104s. 0d. per week.
2nd six months—at the rate of 117s. 3d. per week.
- 4th year—
1st six months—at the rate of 131s. 3d. per week.
2nd six months—at the rate of 134s. 9d. per week.

(d) With respect to the term of apprenticeship of three years—

- 1st year—
1st six months—at the rate of 62s. 9d. per week.
2nd six months—at the rate of 82s. 9d. per week.
- 2nd year—
1st six months—at the rate of 104s. 0d. per week.
2nd six months—at the rate of 117s. 3d. per week.
- 3rd year—
1st six months—at the rate of 131s. 3d. per week.
2nd six months—at the rate of 134s. 9d. per week.

AMENDMENT OF THE BREAD MAKING AND BAKING TRADE REGULATIONS (No. 1).

IN pursuance of the powers conferred by the Apprenticeship Acts and the Acts Interpretation Acts, His Excellency the Governor of the State of Victoria, by and with the advice of the Executive Council thereof, doth hereby rescind Regulation 10 of the Bread Making and Baking Trade Regulations (No. 1) as from the beginning of the first full pay period to commence in August, 1950, and doth hereby substitute therefor the following, that is to say:—

1. The rescission of any Regulations by these Regulations shall not affect any right accrued or accruing to any person or the liability of any person under such rescinded Regulations, where such right accrued or such liability was incurred prior to the coming into operation of these Regulations.

2. The minimum rates of pay to be paid as wages to apprentices in the said trade in each year of their apprenticeship course shall be as follows as from the beginning of the first full pay period to commence in August, 1950, on, from, and after which date all indentures of apprenticeship heretofore executed under the provisions of the Acts and of the Regulations made in respect of the aforesaid trade shall be deemed to be amended accordingly—

(a) With respect to the term of apprenticeship of five years—

- 1st year—
1st six months—at the rate of 50s. 9d. per week.
2nd six months—at the rate of 55s. 10d. per week.
- 2nd year—
1st six months—at the rate of 60s. 11d. per week.
2nd six months—at the rate of 66s. 0d. per week.
- 3rd year—
1st six months—at the rate of 76s. 2d. per week.
2nd six months—at the rate of 86s. 4d. per week.
- 4th year—
1st six months—at the rate of 101s. 6d. per week.
2nd six months—at the rate of 116s. 9d. per week.
- 5th year—
1st six months—at the rate of 137s. 1d. per week.
2nd six months—at the rate of 157s. 4d. per week.

(b) With respect to the term of apprenticeship of four years—

- 1st year—
1st six months—at the rate of 60s. 11d. per week.

- 2nd six months—at the rate of 66s. 0d. per week.
- 2nd year—
1st six months—at the rate of 76s. 2d. per week.
2nd six months—at the rate of 86s. 4d. per week.
- 3rd year—
1st six months—at the rate of 101s. 6d. per week.
2nd six months—at the rate of 116s. 9d. per week.
- 4th year—
1st six months—at the rate of 137s. 1d. per week.
2nd six months—at the rate of 157s. 4d. per week.

AMENDMENT OF THE BRICKLAYING TRADE REGULATIONS (No. 1).

IN pursuance of the powers conferred by the Apprenticeship Acts and the Acts Interpretation Acts, His Excellency the Governor of the State of Victoria, by and with the advice of the Executive Council thereof, doth hereby rescind Regulation 10 of the Bricklaying Trade Regulations (No. 1) as from the beginning of the first full pay period to commence in August, 1950, and doth hereby substitute therefor the following, that is to say:—

1. The rescission of any Regulations by these Regulations shall not affect any right accrued or accruing to any person or the liability of any person under such rescinded Regulations, where such right accrued or such liability was incurred prior to the coming into operation of these Regulations.

2. The minimum rates of pay to be paid as wages to apprentices in the said trade in each year of their apprenticeship course shall be as follows as from the beginning of the first full pay period to commence in August, 1950, on, from, and after which date all indentures of apprenticeship heretofore executed under the provisions of the Acts and of the Regulations made in respect of the aforesaid trade shall be deemed to be amended accordingly—

- 1st year—at the rate of 40s. 6d. per week.
2nd year—at the rate of 54s. 0d. per week.
3rd year—at the rate of 74s. 0d. per week.
4th year—at the rate of 105s. 6d. per week.
5th year—at the rate of 137s. 0d. per week.

AMENDMENT OF BUTCHERING AND/OR SMALL GOODS MAKING TRADES REGULATIONS (No. 1).

IN pursuance of the powers conferred by the Apprenticeship Acts and the Acts Interpretation Acts, His Excellency the Governor of the State of Victoria, by and with the advice of the Executive Council thereof, doth hereby rescind Regulation 10 of the Butchering and/or Small Goods Making Trades Regulations (No. 1) as from the beginning of the first full pay period to commence in August, 1950, and doth hereby substitute therefor the following, that is to say:—

1. The rescission of any Regulations by these Regulations shall not affect any right accrued or accruing to any person or the liability of any person under such rescinded Regulations, where such right accrued or such liability was incurred prior to the coming into operation of these Regulations.

2. The minimum rates of pay to be paid as wages to apprentices in the said trades in each year of their apprenticeship course shall be as follows as from the beginning of the first full pay period to commence in August, 1950, on, from, and after which date all indentures of apprenticeship heretofore executed under the provisions of the Acts and of the Regulations made in respect of the aforesaid trades shall be deemed to be amended accordingly—

(a) With respect to the term of apprenticeship of five years—

- 1st year—at the rate of 46s. 0d. per week.
2nd year—at the rate of 61s. 0d. per week.
3rd year—at the rate of 90s. 6d. per week.
4th year—at the rate of 116s. 0d. per week.
5th year—at the rate of 151s. 6d. per week.

(b) With respect to the term of apprenticeship of four years—

- 1st year—at the rate of 53s. 6d. per week.
2nd year—at the rate of 76s. 0d. per week.
3rd year—at the rate of 116s. 0d. per week.
4th year—at the rate of 151s. 6d. per week.

AMENDMENT OF CARPENTRY AND JOINERY REGULATIONS (No. 1).

IN pursuance of the powers conferred by the Apprenticeship Acts and the Acts Interpretation Acts, His Excellency the Governor of the State of Victoria, by and with the advice of the Executive Council thereof, doth hereby rescind Regulation 9 of the Carpentry and Joinery Regulations (No. 1) as from the beginning of the first full pay period to commence in August, 1950, and doth hereby substitute therefor the following, that is to say:—

1. The rescission of any Regulations by these Regulations shall not affect any right accrued or accruing to any person or the liability of any person under such rescinded Regulations, where such right accrued or such liability was incurred prior to the coming into operation of these Regulations.

2. The minimum rates of pay to be paid as wages to apprentices in the said trades in each year of their apprenticeship course shall be as follows as from the beginning of the first full pay period to commence in August, 1950, on, from, and after which date all indentures of apprenticeship heretofore executed under the provisions of the Acts and of the Regulations made in respect of the aforesaid trades shall be deemed to be amended accordingly—

- 1st year—at the rate of 43s. 2d. per week.
- 2nd year—at the rate of 59s. 4d. per week.
- 3rd year—at the rate of 82s. 0d. per week.
- 4th year—at the rate of 116s. 2d. per week.
- 5th year—at the rate of 150s. 4d. per week.

AMENDMENT OF DENTAL MECHANIC TRADE REGULATIONS (No. 1).

IN pursuance of the powers conferred by the Apprenticeship Acts and the Acts Interpretation Acts, His Excellency the Governor of the State of Victoria, by and with the advice of the Executive Council thereof, doth hereby rescind Regulation 9 of the Dental Mechanic Trade Regulations (No. 1) as from the beginning of the first full pay period to commence in August, 1950, and doth hereby substitute therefor the following, that is to say:—

1. The rescission of any Regulations by these Regulations shall not affect any right accrued or accruing to any person or the liability of any person under such rescinded Regulations, where such right accrued or such liability was incurred prior to the coming into operation of these Regulations.

2. The minimum rates of pay to be paid as wages to apprentices in the said trade in each year of their apprenticeship course shall be as follows as from the beginning of the first full pay period to commence in August, 1950, on, from, and after which date all indentures of apprenticeship heretofore executed under the provisions of the Acts and of the Regulations made in respect of the aforesaid trade shall be deemed to be amended accordingly—

- 1st year—at the rate of 42s. 0d. per week.
- 2nd year—at the rate of 57s. 6d. per week.
- 3rd year—at the rate of 75s. 6d. per week.
- 4th year—at the rate of 118s. 0d. per week.
- 5th year—at the rate of 147s. 6d. per week.

AMENDMENT OF ELECTRICAL TRADES REGULATIONS (No. 1).

IN pursuance of the powers conferred by the Apprenticeship Acts and the Acts Interpretation Acts, His Excellency the Governor of the State of Victoria, by and with the advice of the Executive Council thereof, doth hereby rescind Regulation 9 of the Electrical Trades Regulations (No. 1) as from the beginning of the first full pay period to commence in August, 1950, and doth hereby substitute therefor the following, that is to say:—

1. The rescission of any Regulations by these Regulations shall not affect any right accrued or accruing to any person or the liability of any person under such rescinded Regulations, where such right accrued or such liability was incurred prior to the coming into operation of these Regulations.

2. The minimum rates of pay to be paid as wages to apprentices in the said trades in each year of their apprenticeship course shall be as follows as from the beginning of the first full pay period to commence in August, 1950, on, from, and after which date all indentures of apprenticeship heretofore executed under the provisions

of the Acts and of the Regulations made in respect of the aforesaid trades shall be deemed to be amended accordingly—

Within 20 miles of G.P.O., Melbourne, within 10 miles of G.P.O., Geelong, at Warrnambool, and within Mildura and Gippsland Districts.

- 1st year—at the rate of 39s. 6d. per week.
- 2nd year—at the rate of 55s. 6d. per week.
- 3rd year—at the rate of 74s. 0d. per week.
- 4th year—at the rate of 117s. 0d. per week.
- 5th year—at the rate of 146s. 0d. per week.

At Yallourn.

- 1st year—at the rate of 41s. 6d. per week.
- 2nd year—at the rate of 58s. 0d. per week.
- 3rd year—at the rate of 77s. 6d. per week.
- 4th year—at the rate of 122s. 6d. per week.
- 5th year—at the rate of 152s. 6d. per week.

Other Parts of Victoria where this Regulation Applies.

- 1st year—at the rate of 38s. 6d. per week.
- 2nd year—at the rate of 54s. 6d. per week.
- 3rd year—at the rate of 72s. 6d. per week.
- 4th year—at the rate of 114s. 6d. per week.
- 5th year—at the rate of 143s. 0d. per week.

AMENDMENT OF ENGINEERING TRADES REGULATIONS (No. 2).

IN pursuance of the powers conferred by the Apprenticeship Acts and the Acts Interpretation Acts, His Excellency the Governor of the State of Victoria, by and with the advice of the Executive Council thereof, doth hereby rescind Regulation 7 of the Engineering Trades Regulations (No. 2) as from the beginning of the first full pay period to commence in August, 1950, and doth hereby substitute therefor the following, that is to say:—

1. The rescission of any Regulations by these Regulations shall not affect any right accrued or accruing to any person or the liability of any person under such rescinded Regulations, where such right accrued or such liability was incurred prior to the coming into operation of these Regulations.

2. The minimum rates of pay to be paid as wages to apprentices in the said trades in each year of their apprenticeship course shall be as follows as from the beginning of the first full pay period to commence in August, 1950, on, from, and after which date all indentures of apprenticeship heretofore executed under the provisions of the Acts and of the Regulations made in respect of the aforesaid trades shall be deemed to be amended accordingly—

(a) With respect to the term of apprenticeship of five years—

- 1st year—at the rate of 39s. 6d. per week.
- 2nd year—at the rate of 55s. 6d. per week.
- 3rd year—at the rate of 74s. 0d. per week.
- 4th year—at the rate of 117s. 0d. per week.
- 5th year—at the rate of 146s. 0d. per week.

(b) With respect to the term of apprenticeship of four years—

- 1st year—at the rate of 45s. 0d. per week.
- 2nd year—at the rate of 73s. 6d. per week.
- 3rd year—at the rate of 117s. 0d. per week.
- 4th year—at the rate of 136s. 0d. per week.

The sum of 4s. 0d. per week shall be added to the above rates where the apprentice is in the trade of Pattern-making.

AMENDMENT OF ELECTROPLATING TRADE REGULATIONS (No. 1).

IN pursuance of the powers conferred by the Apprenticeship Acts and the Acts Interpretation Acts, His Excellency the Governor of the State of Victoria, by and with the advice of the Executive Council thereof, doth hereby rescind Regulation 9 of the Electroplating Trade Regulations (No. 1) as from the beginning of the first full pay period to commence in August, 1950, and doth hereby substitute therefor the following, that is to say:—

1. The rescission of any Regulations by these Regulations shall not affect any right accrued or accruing to any person or the liability of any person under such rescinded Regulations, where such right accrued or such liability was incurred prior to the coming into operation of these Regulations.

2. The minimum rates of pay to be paid as wages to apprentices in the said trade in each year of their apprenticeship course shall be as follows as from the beginning of the first full pay period to commence in August, 1950, on, from, and after which date all indentures of apprenticeship heretofore executed under the provisions of the Acts and of the Regulations made in respect of the aforesaid trade shall be deemed to be amended accordingly—

(a) With respect to the term of apprenticeship of five years—

- 1st year—at the rate of 39s. 6d. per week.
- 2nd year—at the rate of 55s. 6d. per week.
- 3rd year—at the rate of 74s. 0d. per week.
- 4th year—at the rate of 117s. 0d. per week.
- 5th year—at the rate of 146s. 0d. per week.

(b) With respect to the term of apprenticeship of four years—

- 1st year—at the rate of 45s. 0d. per week.
- 2nd year—at the rate of 73s. 6d. per week.
- 3rd year—at the rate of 117s. 0d. per week.
- 4th year—at the rate of 146s. 0d. per week.

AMENDMENT OF ENGINEERING TRADES REGULATIONS (No. 4).

IN pursuance of the powers conferred by the Apprenticeship Acts and the Acts Interpretation Acts, His Excellency the Governor of the State of Victoria, by and with the advice of the Executive Council thereof, doth hereby rescind Regulation 10 of the Engineering Trades Regulations (No. 4) as from the beginning of the first full pay period to commence in August, 1950, and doth hereby substitute therefor the following, that is to say:—

1. The rescission of any Regulations by these Regulations shall not affect any right accrued or accruing to any person or the liability of any person under such rescinded Regulations, where such right accrued or such liability was incurred prior to the coming into operation of these Regulations.

2. The minimum rates of pay to be paid as wages to apprentices in the said trades in each year of their apprenticeship course shall be as follows as from the beginning of the first full pay period to commence in August, 1950, on, from, and after which date all indentures of apprenticeship heretofore executed under the provisions of the Acts and of the Regulations made in respect of the aforesaid trades shall be deemed to be amended accordingly—

Within 10 miles of G.P.O., Geelong, at Warrnambool, and within Mildura and Gippsland Districts.

(a) With respect to the term of apprenticeship of five years—

- 1st year—at the rate of 39s. 6d. per week.
- 2nd year—at the rate of 55s. 6d. per week.
- 3rd year—at the rate of 74s. 0d. per week.
- 4th year—at the rate of 117s. 0d. per week.
- 5th year—at the rate of 146s. 0d. per week.

(b) With respect to the term of apprenticeship of four years—

- 1st year—at the rate of 45s. 0d. per week.
- 2nd year—at the rate of 73s. 6d. per week.
- 3rd year—at the rate of 117s. 0d. per week.
- 4th year—at the rate of 146s. 0d. per week.

At Yallourn.

(a) With respect to the term of apprenticeship of five years—

- 1st year—at the rate of 41s. 6d. per week.
- 2nd year—at the rate of 58s. 0d. per week.
- 3rd year—at the rate of 77s. 6d. per week.
- 4th year—at the rate of 122s. 6d. per week.
- 5th year—at the rate of 152s. 6d. per week.

(b) With respect to the term of apprenticeship of four years—

- 1st year—at the rate of 47s. 0d. per week.
- 2nd year—at the rate of 77s. 0d. per week.
- 3rd year—at the rate of 122s. 6d. per week.
- 4th year—at the rate of 152s. 6d. per week.

Other Parts of Victoria.

(a) With respect to the term of apprenticeship of five years—

- 1st year—at the rate of 38s. 6d. per week.
- 2nd year—at the rate of 54s. 6d. per week.
- 3rd year—at the rate of 72s. 6d. per week.
- 4th year—at the rate of 114s. 6d. per week.
- 5th year—at the rate of 143s. 0d. per week.

(b) With respect to the term of apprenticeship of four years—

- 1st year—at the rate of 44s. 0d. per week.
- 2nd year—at the rate of 72s. 0d. per week.
- 3rd year—at the rate of 114s. 6d. per week.
- 4th year—at the rate of 143s. 0d. per week.

The sum of 4s. 0d. per week shall be added to the above rates where the apprentice is in the trade of Pattern-making.

AMENDMENT OF FIBROUS PLASTERING TRADE REGULATIONS.

IN pursuance of the powers conferred by the Apprenticeship Acts and the Acts Interpretation Acts, His Excellency the Governor of the State of Victoria, by and with the advice of the Executive Council thereof, doth hereby rescind Regulation 9 of the Fibrous Plastering Trade Regulations as from the beginning of the first full pay period to commence in August, 1950, and doth hereby substitute therefor the following, that is to say:—

1. The rescission of any Regulations by these Regulations shall not affect any right accrued or accruing to any person or the liability of any person under such rescinded Regulations, where such right accrued or such liability was incurred prior to the coming into operation of these Regulations.

2. The minimum rates of pay to be paid as wages to apprentices in the said trade in each year of their apprenticeship course shall be as follows as from the beginning of the first full pay period to commence in August, 1950, on, from, and after which date all indentures of apprenticeship heretofore executed under the provisions of the Acts and of the Regulations made in respect of the aforesaid trade shall be deemed to be amended accordingly—

(a) With respect to the term of apprenticeship of six years—

- 1st year—at the rate of 49s. 6d. per week.
- 2nd year—at the rate of 64s. 6d. per week.
- 3rd year—at the rate of 84s. 6d. per week.
- 4th year—at the rate of 110s. 0d. per week.
- 5th year—at the rate of 153s. 0d. per week.
- 6th year—at the rate of 177s. 0d. per week.

(b) With respect to the term of apprenticeship of five years—

- 1st year—at the rate of 49s. 6d. per week.
- 2nd year—at the rate of 64s. 6d. per week.
- 3rd year—at the rate of 84s. 6d. per week.
- 4th year—at the rate of 110s. 0d. per week.
- 5th year—at the rate of 153s. 0d. per week.

AMENDMENT OF LADIES' AND/OR MEN'S HAIRDRESSING TRADES REGULATIONS (No. 1).

IN pursuance of the powers conferred by the Apprenticeship Acts and the Acts Interpretation Acts, His Excellency the Governor of the State of Victoria, by and with the advice of the Executive Council thereof, doth hereby rescind Regulation 10 of the Ladies' and/or Men's Hairdressing Trades Regulations (No. 1), as from the beginning of the first full pay period to commence in August, 1950, and doth hereby substitute therefor the following, that is to say:—

1. The rescission of any Regulations by these Regulations shall not affect any right accrued or accruing to any person or the liability of any person under such rescinded Regulations, where such right accrued or such liability was incurred prior to the coming into operation of these Regulations.

2. The minimum rates of pay to be paid as wages to apprentices in the said trades in each year of their apprenticeship course shall be as follows as from the beginning of the first full pay period to commence in August, 1950, on, from, and after which date all indentures of apprenticeship heretofore executed under the provisions of the Acts and of the Regulations made in respect of the aforesaid trades shall be deemed to be amended accordingly—

Ladies' Hairdressing.

- 1st year—at the rate of 29s. 9d. per week.
- 2nd year—at the rate of 41s. 3d. per week.
- 3rd year—at the rate of 62s. 3d. per week.
- 4th year—at the rate of 94s. 0d. per week.

Men's Hairdressing.

- 1st year—at the rate of 35s. 0d. per week.
- 2nd year—at the rate of 53s. 0d. per week.
- 3rd year—at the rate of 76s. 9d. per week.
- 4th year—at the rate of 120s. 6d. per week.

Ladies' and Men's Hairdressing.

- 1st year—at the rate of 35s. 0d. per week.
 2nd year—at the rate of 53s. 0d. per week.
 3rd year—at the rate of 76s. 9d. per week.
 4th year—at the rate of 120s. 6d. per week.
 5th year—at the rate of 150s. 0d. per week.

AMENDMENT OF MOTOR MECHANICS TRADES REGULATIONS.

IN pursuance of the powers conferred by the Apprenticeship Acts and the Acts Interpretation Acts, His Excellency the Governor of the State of Victoria, by and with the advice of the Executive Council thereof, doth hereby rescind Regulation 9 of the Motor Mechanics Trades Regulations, as from the beginning of the first full pay period to commence in August, 1950, and doth hereby substitute therefor the following, that is to say—

1. The rescission of any Regulations by these Regulations shall not affect any right accrued or accruing to any person or the liability of any person under such rescinded Regulations, where such right accrued or such liability was incurred prior to the coming into operation of these Regulations.

2. The minimum rates of pay to be paid as wages to apprentices in the said trades in each year of their apprenticeship course shall be as follows as from the beginning of the first full pay period to commence in August, 1950, on, from, and after which date all indentures of apprenticeship heretofore executed under the provisions of the Acts and of the Regulations made in respect of the aforesaid trades shall be deemed to be amended accordingly—

Within 20 miles of G.P.O., Melbourne, within 10 miles of G.P.O., Geelong, at Warrnambool, and within Mildura and Gippsland districts.

- (a) With respect to the term of apprenticeship of five years—
- 1st year—at the rate of 39s. 6d. per week.
 2nd year—at the rate of 55s. 6d. per week.
 3rd year—at the rate of 74s. 0d. per week.
 4th year—at the rate of 117s. 0d. per week.
 5th year—at the rate of 146s. 0d. per week.
- (b) With respect to the term of apprenticeship of four years—
- 1st year—at the rate of 45s. 0d. per week.
 2nd year—at the rate of 73s. 6d. per week.
 3rd year—at the rate of 117s. 0d. per week.
 4th year—at the rate of 146s. 0d. per week.

At Yallourn.

- (a) With respect to the term of apprenticeship of five years—
- 1st year—at the rate of 41s. 6d. per week.
 2nd year—at the rate of 58s. 0d. per week.
 3rd year—at the rate of 77s. 6d. per week.
 4th year—at the rate of 122s. 6d. per week.
 5th year—at the rate of 152s. 6d. per week.
- (b) With respect to the term of apprenticeship of four years—
- 1st year—at the rate of 47s. 0d. per week.
 2nd year—at the rate of 77s. 0d. per week.
 3rd year—at the rate of 122s. 6d. per week.
 4th year—at the rate of 152s. 6d. per week.

Other Parts of Victoria.

- (a) With respect to the term of apprenticeship of five years—
- 1st year—at the rate of 38s. 6d. per week.
 2nd year—at the rate of 54s. 6d. per week.
 3rd year—at the rate of 72s. 6d. per week.
 4th year—at the rate of 114s. 6d. per week.
 5th year—at the rate of 143s. 0d. per week.
- (b) With respect to the term of apprenticeship of four years—
- 1st year—at the rate of 44s. 0d. per week.
 2nd year—at the rate of 72s. 0d. per week.
 3rd year—at the rate of 114s. 6d. per week.
 4th year—at the rate of 143s. 0d. per week.

AMENDMENT OF MOULDING TRADES APPRENTICESHIP REGULATIONS.

IN pursuance of the powers conferred by the Apprenticeship Acts and the Acts Interpretation Acts, His Excellency the Governor of the State of Victoria, by and with the advice of the Executive Council thereof, doth hereby rescind Regulation 10 of the Moulding Trades

Apprenticeship Regulations, as from the beginning of the first full pay period to commence in August, 1950, and doth hereby substitute therefor the following, that is to say:—

1. The rescission of any Regulations by these Regulations shall not affect any right accrued or accruing to any person or the liability of any person under such rescinded Regulations, where such right accrued or such liability was incurred prior to the coming into operation of these Regulations.

2. The minimum rates of pay to be paid as wages to apprentices in the said trades in each year of their apprenticeship course shall be as follows as from the beginning of the first full pay period to commence in August, 1950, on, from, and after which date all indentures of apprenticeship heretofore executed under the provisions of the Acts and of the Regulations made in respect of the aforesaid trades shall be deemed to be amended accordingly—

- (a) With respect to the term of apprenticeship of five years—
- 1st year—at the rate of 39s. 6d. per week.
 2nd year—at the rate of 55s. 6d. per week.
 3rd year—at the rate of 74s. 0d. per week.
 4th year—at the rate of 117s. 0d. per week.
 5th year—at the rate of 146s. 0d. per week.
- (b) With respect to the term of apprenticeship of four years—
- 1st year—at the rate of 45s. 0d. per week.
 2nd year—at the rate of 73s. 6d. per week.
 3rd year—at the rate of 117s. 0d. per week.
 4th year—at the rate of 146s. 0d. per week.

AMENDMENT OF PAINTING, DECORATING, AND SIGNWRITING REGULATIONS (No. 2).

IN pursuance of the powers conferred by the Apprenticeship Acts and the Acts Interpretation Acts, His Excellency the Governor of the State of Victoria, by and with the advice of the Executive Council thereof, doth hereby rescind Regulation 8 of the Painting, Decorating, and Signwriting Regulations (No. 2), as from the beginning of the first full pay period to commence in August, 1950, and doth hereby substitute therefor the following, that is to say:—

1. The rescission of any Regulations by these Regulations shall not affect any right accrued or accruing to any person or the liability of any person under such rescinded Regulations, where such right accrued or such liability was incurred prior to the coming into operation of these Regulations.

2. The minimum rates of pay to be paid as wages to apprentices in the said trades in each year of their apprenticeship course shall be as follows as from the beginning of the first full pay period to commence in August, 1950, on, from, and after which date all indentures of apprenticeship heretofore executed under the provisions of the Acts and of the Regulations made in respect of the aforesaid trades shall be deemed to be amended accordingly—

- 1st year—at the rate of 43s. 2d. per week.
 2nd year—at the rate of 59s. 4d. per week.
 3rd year—at the rate of 82s. 0d. per week.
 4th year—at the rate of 116s. 2d. per week.
 5th year—at the rate of 150s. 4d. per week.

AMENDMENT OF PASTRYCOOKING TRADE REGULATIONS (No. 1).

IN pursuance of the powers conferred by the Apprenticeship Acts and the Acts Interpretation Acts, His Excellency the Governor of the State of Victoria, by and with the advice of the Executive Council thereof, doth hereby rescind Regulation 10 of the Pastrycooking Trade Regulations (No. 1), as from the beginning of the first full pay period to commence in August, 1950, and doth hereby substitute therefor the following, that is to say:—

1. The rescission of any Regulations by these Regulations shall not affect any right accrued or accruing to any person or the liability of any person under such rescinded Regulations, where such right accrued or such liability was incurred prior to the coming into operation of these Regulations.

2. The minimum rates of pay to be paid as wages to apprentices in the said trade in each year of their apprenticeship course shall be as follows as from the beginning of the first full pay period to commence in August, 1950, on, from, and after which date all indentures of apprenticeship heretofore executed under the provisions

of the Acts and of the Regulations made in respect of the aforesaid trade shall be deemed to be amended accordingly—

- (a) With respect to the term of apprenticeship of five years—
- 1st year—at the rate of 34s. 9d. per week.
 - 2nd year—at the rate of 48s. 0d. per week.
 - 3rd year—at the rate of 64s. 0d. per week.
 - 4th year—at the rate of 91s. 0d. per week.
 - 5th year—at the rate of 123s. 3d. per week.
- (b) With respect to the term of apprenticeship of four years—
- 1st year—at the rate of 48s. 0d. per week.
 - 2nd year—at the rate of 64s. 0d. per week.
 - 3rd year—at the rate of 91s. 0d. per week.
 - 4th year—at the rate of 123s. 3d. per week.

AMENDMENT OF PLASTERING REGULATIONS (No. 2).

IN pursuance of the powers conferred by the Apprenticeship Acts and the Acts Interpretation Acts, His Excellency the Governor of the State of Victoria, by and with the advice of the Executive Council thereof, doth hereby rescind Regulation 8 of the Plastering Regulations (No. 2); as from the beginning of the first full pay period to commence in August, 1950, and doth hereby substitute therefor the following, that is to say:—

1. The rescission of any Regulations by these Regulations shall not affect any right accrued or accruing to any person or the liability of any person under such rescinded Regulations, where such right accrued or such liability was incurred prior to the coming into operation of these Regulations.

2. The minimum rates of pay to be paid as wages to apprentices in the said trade in each year of their apprenticeship course shall be as follows as from the beginning of the first full pay period to commence in August, 1950, on, from, and after which date all indentures of apprenticeship heretofore executed under the provisions of the Acts and of the Regulations made in respect of the aforesaid trade shall be deemed to be amended accordingly—

- (a) With respect to the term of apprenticeship of six years—
- 1st year—at the rate of 43s. 2d. per week.
 - 2nd year—at the rate of 59s. 4d. per week.
 - 3rd year—at the rate of 82s. 0d. per week.
 - 4th year—at the rate of 116s. 2d. per week.
 - 5th year—at the rate of 150s. 4d. per week.
 - 6th year—at the rate of 183s. 0d. per week.
- (b) With respect to the term of apprenticeship of five years—
- 1st year—at the rate of 43s. 2d. per week.
 - 2nd year—at the rate of 59s. 4d. per week.
 - 3rd year—at the rate of 82s. 0d. per week.
 - 4th year—at the rate of 116s. 2d. per week.
 - 5th year—at the rate of 150s. 4d. per week.

AMENDMENT OF PLUMBING AND GASFITTING TRADES REGULATIONS.

IN pursuance of the powers conferred by the Apprenticeship Acts and the Acts Interpretation Acts, His Excellency the Governor of the State of Victoria, by and with the advice of the Executive Council thereof, doth hereby rescind Regulation 9 of the Plumbing and Gasfitting Trades Regulations, as from the beginning of the first full pay period to commence in August, 1950, and doth hereby substitute therefor the following, that is to say:—

1. The rescission of any Regulations by these Regulations shall not affect any right accrued or accruing to any person or the liability of any person under such rescinded Regulations, where such right accrued or such liability was incurred prior to the coming into operation of these Regulations.

2. The minimum rates of pay to be paid as wages to apprentices in the said trades in each year of their apprenticeship course shall be as follows as from the beginning of the first full pay period to commence in August, 1950, on, from, and after which date all indentures of apprenticeship heretofore executed under the provisions

of the Acts and of the Regulations made in respect of the aforesaid trades shall be deemed to be amended accordingly—

- (a) With respect to the term of apprenticeship of six years—
- 1st year—at the rate of 43s. 2d. per week.
 - 2nd year—at the rate of 59s. 4d. per week.
 - 3rd year—at the rate of 82s. 0d. per week.
 - 4th year—at the rate of 116s. 2d. per week.
 - 5th year—at the rate of 150s. 4d. per week.
 - 6th year—at the rate of 183s. 0d. per week.
- (b) With respect to the term of apprenticeship of five years—
- 1st year—at the rate of 43s. 2d. per week.
 - 2nd year—at the rate of 59s. 4d. per week.
 - 3rd year—at the rate of 82s. 0d. per week.
 - 4th year—at the rate of 116s. 2d. per week.
 - 5th year—at the rate of 150s. 4d. per week.

AMENDMENT OF PRINTING AND ALLIED TRADES REGULATIONS.

IN pursuance of the powers conferred by the Apprenticeship Acts and the Acts Interpretation Acts, His Excellency the Governor of the State of Victoria, by and with the advice of the Executive Council thereof, doth hereby rescind Regulation 9 of the Printing and Allied Trades Regulations as from the beginning of the first full pay period to commence in August, 1950, and doth hereby substitute therefor the following, that is to say:—

1. The rescission of any Regulations by these Regulations shall not affect any right accrued or accruing to any person or the liability of any person under such rescinded Regulations, where such right accrued or such liability was incurred prior to the coming into operation of these Regulations.

2. The minimum rates of pay to be paid as wages to apprentices in the said trades in each year of their apprenticeship course shall be as follows as from the beginning of the first full pay period to commence in August, 1950, on, from, and after which date all indentures of apprenticeship heretofore executed under the provisions of the Acts and of the Regulations made in respect of the aforesaid trades shall be deemed to be amended accordingly—

- (a) With respect to the term of apprenticeship of six years—
- 1st year—at the rate of 34s. 9d. per week.
 - 2nd year—at the rate of 46s. 6d. per week.
 - 3rd year—at the rate of 60s. 3d. per week.
 - 4th year—at the rate of 81s. 6d. per week.
 - 5th year—at the rate of 102s. 6d. per week.
 - 6th year—at the rate of 141s. 6d. per week.
- (b) With respect to the term of apprenticeship of five years—
- 1st year—at the rate of 46s. 6d. per week.
 - 2nd year—at the rate of 60s. 3d. per week.
 - 3rd year—at the rate of 81s. 6d. per week.
 - 4th year—at the rate of 102s. 6d. per week.
 - 5th year—at the rate of 141s. 6d. per week.

AMENDMENT OF PRINTING TRADES REGULATIONS (No. 1).

IN pursuance of the powers conferred by the Apprenticeship Acts and the Acts Interpretation Acts, His Excellency the Governor of the State of Victoria, by and with the advice of the Executive Council thereof, doth hereby rescind Regulation 11 of the Printing Trades Regulations (No. 1) as from the beginning of the first full pay period to commence in August, 1950, and doth hereby substitute therefor the following, that is to say:—

1. The rescission of any Regulations by these Regulations shall not affect any right accrued or accruing to any person or the liability of any person under such rescinded Regulations, where such right accrued or such liability was incurred prior to the coming into operation of these Regulations.

2. The minimum rates of pay to be paid as wages to apprentices in the said trades in each year of their apprenticeship course shall be as follows as from the beginning of the first full pay period to commence in August, 1950, on, from, and after which date all indentures of apprenticeship heretofore executed under the provisions

of the Acts and of the Regulations made in respect of the aforesaid trades shall be deemed to be amended accordingly—

- (a) With respect to the term of apprenticeship of six years—
- 1st year—at the rate of 34s. 9d. per week.
 - 2nd year—at the rate of 46s. 6d. per week.
 - 3rd year—at the rate of 60s. 3d. per week.
 - 4th year—at the rate of 81s. 6d. per week.
 - 5th year—at the rate of 102s. 6d. per week.
 - 6th year—at the rate of 141s. 6d. per week.
- (b) With respect to the term of apprenticeship of five years—
- 1st year—at the rate of 46s. 6d. per week.
 - 2nd year—at the rate of 60s. 3d. per week.
 - 3rd year—at the rate of 81s. 6d. per week.
 - 4th year—at the rate of 102s. 6d. per week.
 - 5th year—at the rate of 141s. 6d. per week.

AMENDMENT OF SHEET METAL TRADE REGULATIONS (No. 2).

IN pursuance of the powers conferred by the Apprenticeship Acts and the Acts Interpretation Acts, His Excellency the Governor of the State of Victoria, by and with the advice of the Executive Council thereof, doth hereby rescind Regulation 7 of the Sheet Metal Trade Regulations (No. 2) as from the beginning of the first full pay period to commence in August, 1950, and doth hereby substitute therefor the following, that is to say:—

1. The rescission of any Regulations by these Regulations shall not affect any right accrued or accruing to any person or the liability of any person under such rescinded Regulations, where such right accrued or such liability was incurred prior to the coming into operation of these Regulations.

2. The minimum rates of pay to be paid as wages to apprentices in the said trade in each year of their apprenticeship course shall be as follows as from the beginning of the first full pay period to commence in August, 1950, on, from, and after which date all indentures of apprenticeship heretofore executed under the provisions of the Acts and of the Regulations made in respect of the aforesaid trade shall be deemed to be amended accordingly—

- (a) With respect to the term of apprenticeship of five years—
- 1st year—at the rate of 39s. 6d. per week.
 - 2nd year—at the rate of 55s. 6d. per week.
 - 3rd year—at the rate of 74s. 0d. per week.
 - 4th year—at the rate of 117s. 0d. per week.
 - 5th year—at the rate of 146s. 0d. per week.
- (b) With respect to the term of apprenticeship of four years—
- 1st year—at the rate of 45s. 0d. per week.
 - 2nd year—at the rate of 73s. 6d. per week.
 - 3rd year—at the rate of 117s. 0d. per week.
 - 4th year—at the rate of 146s. 0d. per week.

AMENDMENT OF WATCH AND/OR CLOCK MAKING TRADES REGULATIONS (No. 1).

IN pursuance of the powers conferred by the Apprenticeship Acts and the Acts Interpretation Acts, His Excellency the Governor of the State of Victoria, by and with the advice of the Executive Council thereof, doth hereby rescind Regulation 9 of the Watch and/or Clock Making Trades Regulations (No. 1) as from the beginning of the first full pay period to commence in August, 1950, and doth hereby substitute therefor the following, that is to say:—

1. The rescission of any Regulations by these Regulations shall not affect any right accrued or accruing to any person or the liability of any person under such rescinded Regulations, where such right accrued or such liability was incurred prior to the coming into operation of these Regulations.

2. The minimum rates of pay to be paid as wages to apprentices in the said trades in each year of their apprenticeship course shall be as follows as from the beginning of the first full pay period to commence in August, 1950, on, from, and after which date all indentures of apprenticeship heretofore executed under the provisions

of the Acts and of the Regulations made in respect of the aforesaid trades shall be deemed to be amended accordingly—

- 1st year—at the rate of 37s. 0d. per week.
- 2nd year—at the rate of 47s. 6d. per week.
- 3rd year—at the rate of 66s. 6d. per week.
- 4th year—at the rate of 90s. 6d. per week.
- 5th year—at the rate of 120s. 0d. per week.
- 6th year—at the rate of 153s. 0d. per week.

And the Honorable Trevor Harvey, His Majesty's Minister of Labour for the State of Victoria, shall give the necessary directions herein accordingly.

A. MAHLSTEDT,
Clerk of the Executive Council.

LOCAL GOVERNMENT ACT 1946.

At the Executive Council Chamber, Melbourne, the fifteenth day of August, 1950.

PRESENT:

His Excellency the Governor of Victoria.
Mr. Lind | Mr. Brose
Mr. Mitchell | Mr. Swinburne.

EXTENSION OF HOURS FOR CLOSING POLL AT MUNICIPAL ELECTIONS.—SHIRE OF KERANG.

HIS Excellency the Governor of the State of Victoria, by and with the advice of the Executive Council thereof, and pursuant to the petition of the Council of the Shire of Kerang, doth, by this Order, under the provisions of section 134 of the Local Government Act 1946, direct that the hour for closing the poll at municipal elections for the said shire shall be six (6) o'clock in the afternoon.

And the Honorable Percy Thomas Byrnes, His Majesty's Commissioner of Public Works for the State of Victoria, shall give the necessary directions herein accordingly.

A. MAHLSTEDT,
Clerk of the Executive Council.

APPROACHING LAND SALES.

SALES of Crown lands, in fee-simple, will be held at the under-mentioned places and dates, viz.:—

	No. of Gazette.
Ararat.—Thursday, 17th August, 1950 ..	551
Melbourne.—Thursday, 17th August, 1950 ..	551
Omeo.—Tuesday, 29th August, 1950 ..	551

SALE BY AUCTION OF RIGHT TO LEASE CROWN ALLOTMENTS.

Melbourne.—Thursday, 17th August, 1950 .. 551

PROPOSED REVOCATION OF ORDER IN COUNCIL WITHHOLDING CERTAIN LAND FROM SALE, LEASING, AND LICENSING.

IN pursuance of the provisions of the Land Act 1928, notice is hereby given that it is the intention of the Governor in Council to revoke the withholding from sale, leasing, and licensing, by Order in Council of 8th April, 1878, of 46 acres 3 roods 5 perches of land in the Parish of Dartmoor, revoked as to part by Order of 12th October, 1936, so far only as the balance comprised within the boundaries as defined by technical description herewith, and containing 40 acres 3 roods 32 perches, is concerned:—

The following Notice was published 1^o on the 2nd August, 1950, pursuant to Order of the 25th July, 1950.

DARTMOOR.—The withholding from sale, leasing, and licensing, by Order in Council of the 8th April, 1878 (see Government Gazette of the 12th April, 1878, page 820), of 46 acres 3 roods 5 perches of land in the Parish of Dartmoor, being part of allotment 40, revoked as to part by Order of the 12th October, 1936, is hereby revoked so far as the balance thereof, containing 40 acres 3 roods 32 perches, is concerned.—(D.32(*) (C.53154).

A. E. LIND,
Commissioner of Crown Lands and Survey.

PROPOSED REVOCATIONS OF TEMPORARY RESERVATIONS OF LANDS BY ORDERS IN COUNCIL.

IN pursuance of the provisions of the *Land Act 1928*, notice is hereby given that it is the intention of the Governor in Council to revoke the temporary reservations of lands by the Orders in Council hereunder referred to, viz.:

The following Notices were published 1° on the 2nd August, 1950, pursuant to Orders of the 25th July, 1950.

DARTMOOR.—The temporary reservation, by Order in Council of the 19th February, 1913, of 10 acres of land in the Parish of Dartmoor, being part of allotment 40ii, as a site for Show Grounds and for Public Recreation, is about to be revoked.—(D.32⁽¹⁾) (C.53154).

GHERANG GHERANG.—The temporary reservation, by Order in Council of the 25th October, 1886 (see *Government Gazette* of the 29th October, 1886, page 3061), of 243 acres 2 roods 10 perches, more or less, of land in the Parish of Gherang Gherang, being allotments 69A, 71A, and 71B, as a site for Supply of Gravel for the use of the Railway Department, revoked as to part by various Orders, is about to be revoked so far as the balance thereof, containing 92 acres 3 roods 26 perches, more or less, is concerned.—(G.34⁽²⁾) (Rs.763).

KUNAT KUNAT.—The temporary reservation, by Order in Council of the 18th June, 1896 (see *Government Gazette* of the 19th June, 1896, page 2738), of 583 acres, more or less, of land in the Parish of Kunat Kunat as a site for Water Supply purposes and for affording a Supply of Timber, revoked as to part by Order of the 19th February, 1901, is about to be revoked so far only as the portion containing 4 acres 3 roods 10 perches, more or less, indicated by hachure on plan hereunder, is concerned.—(K.178⁽⁴⁾) (Rs.6560).

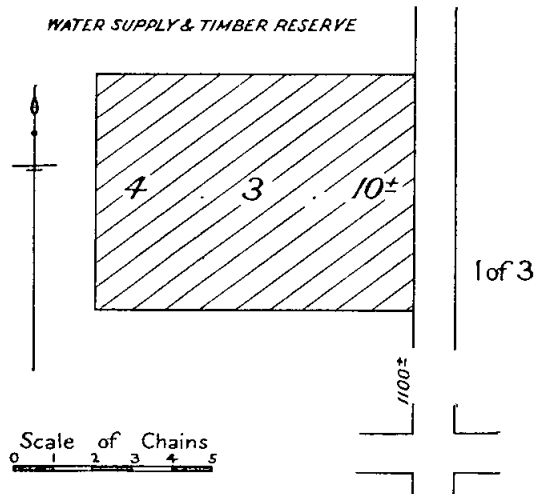

A. E. LIND,
Commissioner of Crown Lands and Survey.

to part by Order of the 9th October, 1917, is about to be further revoked so far as the balance thereof, containing 1 acre 0 roods 17 4/10 perches is concerned.—(K.163⁽²⁾) (Rs.1408).

KOONDROOK.—The temporary reservation by Order in Council of the 21st August, 1917, of 1 acre 8 4/10 perches of land in the Township of Koondrook, being allotment 13, section 19, as a site for Public purposes, is about to be revoked.—(K.163⁽²⁾) (Rs.1408).

MARYSVILLE.—The temporary reservation by Order in Council of the 7th June, 1949, of 33 perches of land in the Township of Marysville, as a site for an Infant Welfare Centre, is about to be revoked.—(M.431⁽³⁾) (Rs.6365).

STRANGWAYS.—The temporary reservation, by Order in Council of the 29th May, 1865, of 2 acres of land in the Parish of Strangways, County of Talbot, being part of allotment 4 of section 2A, as a site for a Pound, is about to be revoked.—(S.335⁽⁶⁾) (C.69614).

A. E. LIND,
Commissioner of Crown Lands and Survey.

PROPOSED REVOCATIONS OF TEMPORARY RESERVATIONS OF LANDS BY ORDERS IN COUNCIL.

IN pursuance of the provisions of the *Land Act 1928*, notice is hereby given that it is the intention of the Governor in Council to revoke the temporary reservations of lands by Orders in Council hereunder referred to, viz.:

The following Notices were published 1° on the 16th August, 1950, pursuant to Orders of the 8th August, 1950.

ASHENS.—The temporary reservation as a site for Racecourse and other purposes of Public Recreation, and the withholding from sale, leasing, and licensing, by Order in Council of the 9th August, 1881, of 111 acres 1 rood 21 perches of land in the Parish of Ashens, being part of allotment 163, is about to be revoked so far only as the portion containing 1 rood, more or less, indicated by hachure on plan hereunder, is concerned.—(A.168⁽⁶⁾) (Rs.1766).

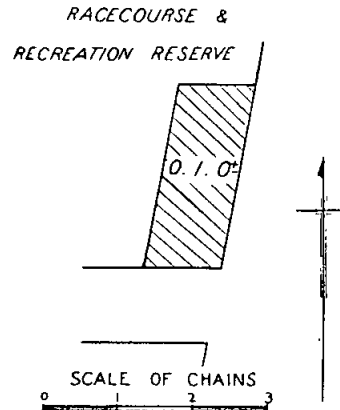

MARYSVILLE.—The temporary reservation, by Order in Council of the 27th December, 1865, of 3 roods 24 perches of land at Marysville as a site for Police purposes, is about to be revoked so far only as the portion containing 27 perches, more or less, indicated by hachure on plan hereunder, is concerned.—(M.431⁽³⁾) (Rs.5793).

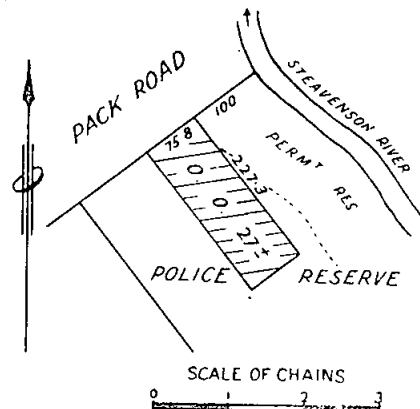

PROPOSED REVOCATIONS OF TEMPORARY RESERVATIONS OF LANDS BY ORDERS IN COUNCIL.

IN pursuance of the provisions of the *Land Act 1928*, notice is hereby given that it is the intention of the Governor in Council to revoke the temporary reservations of lands by the Orders in Council hereunder referred to, viz.:

The following Notices were published 1° on the 26th July, 1950, pursuant to Orders of the 18th July, 1950.

GLENLOTH.—The temporary reservation, as a site for Public purposes (State school), and the withholding from sale, leasing, and licensing, by Order in Council of the 30th June, 1879, of 5 acres of land in the Parish of Glenloth, being part of allotment 1 of section 4, revoked as to part by Order in Council of the 5th October, 1948, is about to be further revoked as regards the balance thereof, containing 3 acres 3 roods 10 perches, more or less.—(G.187⁽²⁾) (Rs.351).

KOONDROOK.—The temporary reservation, by Order in Council of the 21st June, 1913, of 2 acres 24 7/10 perches of land in the Township of Koondrook, being allotments 14 and 15, section 19, as a site for Public purposes, revoked as

HEPBURN.—The temporary reservation, by Order in Council of the 1st September, 1937, of 2 acres 1 rood 9 perches of land in the Township of Hepburn as a site for Public Park, in addition to and adjoining the site temporarily reserved therefor by Order in Council of the 1st September, 1926, is about to be revoked so far only as the portion containing 2 roods, more or less, indicated by hachure on plan hereunder, is concerned.—(H.118⁽⁴⁾) (Rs.3355).

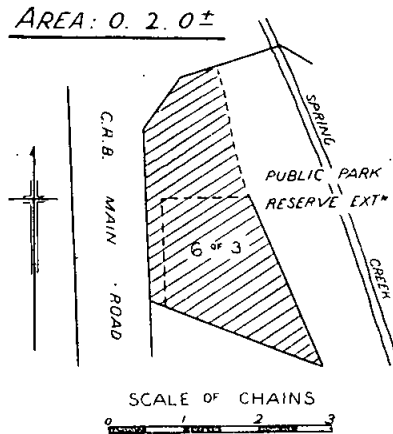

WODONGA.—The temporary reservation, by Order in Council of the 26th January, 1874, of 75 acres, more or less, of land in the Parish of Belvoir (now in the Town of Wodonga) as a site for Camping purposes, previously revoked as to part, is about to be revoked so far only as the portion containing 18 acres, more or less, indicated by hachure on plan hereunder, is concerned.—(W.308⁽⁵²⁾) (Rs.2122).

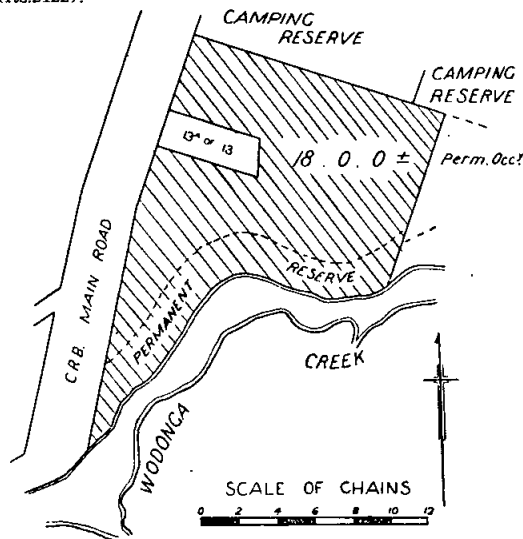

A. E. LIND,
Commissioner of Crown Lands and Survey.

correspondence Rs.5207, and known as the "Morrington Foreshore Reserves," hereinafter referred to as the "Reserves."

REGULATIONS.

1. The Reserves shall be open to the public at all times, free of charge, except on such days not exceeding twenty-six (26) in any one year as any portion of the Reserves, exclusive of the beach, may be set aside for purposes consistent with the reservation and with the consent of the Committee of Management.

2. No person shall enter or remain in the Reserves who may offend against decency as regards dress, language, or conduct.

3. No person shall enter or leave the Reserves except by means of the ramps or other openings provided, and no person shall climb the cliffs in the Reserves.

4. No person shall damage or interfere in any way with the trees, shrubs, marram grass, or flowers in the Reserves, nor shall fires be lighted therein except with the written consent of the Committee of Management.

5. No person shall in any way injure any of the buildings, fences, or seats in the Reserves, nor leave or deposit any glass, paper, or rubbish in the Reserves.

6. No person shall remove from the Reserves any gravel, stone, shellgrit, sand, or loam.

7. No person shall cut, saw, dig, move, or displace any tree, bough, live or dead timber, wood or other material which may be in or around the Reserves, without the consent in writing of the Committee of Management.

8. (a) No person shall, except as provided in the next succeeding sub-section, put or graze in the Reserves any cattle, goats, pigs, horses, sheep, or any other animals without the permission, in writing, of the Committee of Management, and on payment of such fees and subject to such conditions as the Committee of Management may determine.

(b) No person shall ride, drive, or lead any horse upon the Reserves except for the purpose of swimming or bathing the same in Port Phillip Bay, and then only in the mornings before 8 a.m., and upon such portions of the Reserves as shall be set apart for such purpose by the Committee of Management.

9. (i) No person, without the consent in writing of the Committee of Management, shall cause or suffer, or knowingly permit any dog belonging to him, or in his charge, to enter or remain in the Reserves, unless such dog be and continues to be under proper control on a chain, cord, or leash, and be effectively restrained from causing annoyance to any person, or from damaging or interfering in any way with the property of the said Committee of Management, or bring into the Reserves any dog for training or exercising for coursing, or other purposes of sport.

(ii) Any dog found in the Reserves, except as provided in these Regulations, shall be liable to be seized and/or destroyed by the Committee of Management, and the owner or any person having the custody of any dog so found shall be guilty of an offence against these Regulations, and may be required to make compensation for any damage done to the property of the said Committee of Management by such dog.

10. No person shall camp or erect any tent or other structure on any site on any portion of the Reserves, except on such portion or portions thereof as may be specially set apart for the purpose by the Committee of Management, and then only with the consent, in writing, of such Committee and on payment of such fees and subject to such conditions as such Committee may determine.

11. (a) No person shall drive on to the Reserves or park thereon any motor car or other vehicle except at such places as are set apart for this purpose by the Committee of Management.

(b) No person shall ride or drive upon the Reserves any bicycle, motor cycle, motor scooter, or like vehicle.

12. No person shall use the water closets or urinals in the Reserves or any portion of such water closets or urinals for any purpose other than that for which the same are constructed.

13. (a) No person shall erect any bathing box, boat-house, shed, or any other building, structure, erection, or booth on any site on the Reserves without the permission, in writing, of the Committee of Management first obtained, and such permission may be granted subject to such terms, fees, and conditions as may be deemed reasonable and advisable by the Committee of Management consistent with these Regulations, but no person shall use or cause to be used or knowingly permit to be used any such bathing box, boat-house, shed, or any other building, structure, erection, or booth for residential purposes.

(b) If the owner of any bathing box, boat-house, shed, or any other building, structure, erection, or booth erected on any site on the Reserves neglects for a period exceeding twelve months to pay to the Committee of Management the fee payable in respect thereof prescribed pursuant to the last preceding sub-section, then and in any such case it

REGULATIONS FOR THE CARE, PROTECTION, AND MANAGEMENT OF THE "MORNINGTON FORESHORE RESERVES."

WHEREAS by section 181 of the Land Act 1928, as re-enacted by section 9 of the Land Act 1941, power is given to the Board of Land and Works to make Regulations in respect of the care, protection, and management of any Crown land which has been reserved under the Land Acts for any public purpose whatsoever, and which has not been conveyed to or vested in trustees, and for the further purposes as enacted: Now therefore the Board of Land and Works, in pursuance of the powers conferred as aforesaid, doth hereby make the following Regulations in respect of the reserved Crown lands in the Town of Morrington and Parish of Moorooduc, as are indicated by red colour on plans marked M/27.4.31 and M/22.4.36 with Lands Department

shall be lawful for the Committee of Management in such manner as it thinks fit to sell such bathing box, boat-house, shed, or other building, structure, erection, or booth, and to recover from the proceeds of such sale the arrears of rent and the costs and expenses of such sale.

14. The Committee of Management shall have full power to order the removal from the Reserves of any bathing box, boat-house, shed, or any other building, structure, erection, or booth which has been placed, erected, or established without its consent, or which has not been properly erected or properly painted, or which in its opinion has not been satisfactorily maintained or kept in repair, or in respect of which the term of permission for the use of the site has expired or the permission to use the site for a building or buildings has expired or been withdrawn.

15. No person shall neglect or refuse to remove any bathing box, boat-house, shed, or other building, structure, erection, or booth erected or placed by him on any site in or on the Reserves within fourteen (14) days after the Committee of Management has sent by registered post to his last known address, a notice requiring such person to remove such bathing box, boat-house, shed, or any other building, structure, erection, or booth. Such notice may be signed by either the chairman or secretary for the time being of the said Committee of Management.

16. In the event of any such neglect or refusal as above-mentioned continuing after the expiration of the said fourteen (14) days, the Committee of Management may pull down and/or remove, and/or sell such bathing box, boat-house, shed, or any other building, structure, erection, or booth, and recover the costs and expenses thereof from the person so neglecting or refusing to remove the same but without prejudice to proceedings by way of information for breach of these Regulations being taken against such person so neglecting or refusing.

17. No person shall deposit or cause to be deposited waste paper, bottles, or any other litter on any part of the Reserves, except in the receptacles provided for the purpose.

18. No person shall bet publicly on any part of the Reserves, and every person infringing this Regulation shall be liable to expulsion from the enclosures and Reserves.

19. No person shall carry or discharge firearms or air-guns in the Reserves.

20. No person shall on any portion of the Reserves cause or permit any outcry, sound, or noise to be emitted from an amplifier, loud-speaker, public address system or like instrument without first obtaining the written permission of the Committee of Management, and such permission may be granted subject to such terms, conditions, and restrictions as may be imposed by the Committee of Management.

21. Persons renting or hiring any stand, building, erection, or enclosure on the occasions of any fêtes, sports, or holiday amusements may be required to deposit any sum which the Committee of Management may at any time determine, not exceeding £10, by way of guarantee that due care shall be taken of such stand, building, erection, or enclosure, and such Committee in its absolute discretion may make good any damage or injury sustained by such stand, building, erection, or enclosure, or anything contained therein, during such occupancy or hiring and deduct the cost of making good such loss or damage from the sum deposited by way of guarantee, and all persons so renting or hiring shall abide by these Regulations and by any order given by the Committee of Management.

22. No person shall play, practise, or engage in any organized game or sport within the Reserves, unless by consent of the Committee of Management.

23. Every person holding or purporting to hold any receipt or permission in writing issued by the Committee of Management shall, on demand by any member of the Committee of Management, or the properly appointed servant of such Committee of Management or any member of the Police Force, or any bailiff of Crown lands, produce such receipt or permission in writing.

Every person who contravenes or fails to comply with these Regulations shall, in accordance with the provisions of section 181 of the *Land Act 1928*, as re-enacted by section 9 of the *Land Act 1941*, for each offence be liable to a penalty of not more than Five pounds, and every person who contravenes or fails to comply with any such Regulation and who, after he has been warned by any bailiff of Crown lands or by any member of the Police Force, does not desist therefrom, may be forthwith apprehended by such bailiff or member of the Police Force and taken before some justice to be dealt with according to law, and shall be liable to a penalty of not more than Ten pounds.—(Corres. Rs.5207.)

The common seal of the Board of Land and Works was hereunto affixed this 10th day of August, 1950, in the presence of—

(SEAL) A. E. LIND, President.
W. M. CRAWFORD, Member.

REGULATIONS FOR THE CARE, PROTECTION, AND MANAGEMENT OF THE "MATTHEW BENNETT PARK," DROUIN.

WHEREAS by section 181 of the *Land Act 1928*, as re-enacted by section 9 of the *Land Act 1941*, power is given to the Board of Land and Works to make Regulations in respect of the care, protection, and management of any Crown land which has been reserved under the Land Acts for any public purpose whatsoever, and which has not been conveyed to or vested in trustees, and for the further purposes as enacted: Now therefore the Board of Land and Works, in pursuance of the powers conferred as aforesaid, doth hereby make the following Regulations in respect of the land in the Parish of Drouin West, temporarily reserved as a site for Racecourse and other purposes of Public Recreation, by Order in Council dated the 6th September, 1881, and for the additional purpose of an Agricultural Show Ground, by Order in Council dated the 7th June, 1949, and known as the "Matthew Bennett Park," hereinafter referred to as the "Reserve."

REGULATIONS.

1. The divisions into which the Reserve, with the buildings and other erections and fences thereon, is parcelled out are as follow:—

- (a) The portion of the Reserve on which is or shall be erected the secretary's office, jockeys' room, judge's box, horse stalls, and saddling paddock, race track proper and approaches, and members' car park.
- (b) Oval within race track proper, lawn and public grandstand thereon, sanitary conveniences, public car parking area and the outer enclosure comprising all the land other than those parts which are included under the before-mentioned clause (a).

2. The Reserve shall be open to the public free of charge from sunrise to sunset except when, as hereinafter provided, the Reserve may be set apart for horse races, cricket or football matches, fêtes, sports, agricultural shows or holding amusements, but nothing herein contained shall be construed so as to permit any conduct hereinafter forbidden.

3. The maximum scale of charges for admission to the Reserve and to any buildings, erections, or enclosures for the time being thereon on such days, not exceeding 26 in any one year, as the Reserve may be set apart for races, fêtes, sporting events, or holiday amusements shall be as follows:—

- (a) For the admission of every adult to the grandstand, saddling paddock, or any portion of the Reserve, such a charge as the Committee of Management or such body or persons as may be duly authorized by the Committee of Management may determine, not exceeding 20s., exclusive of entertainments tax.
- (b) For the admission of every saddled horse to the Reserve, exclusive of riders, such a charge as the Committee of Management or such body or persons as may be authorized by the said Committee may determine, not exceeding 2s.
- (c) For the admission to the Reserve of every carriage, cart, motor car, or other vehicle, such a sum as the said Committee or such body or persons as may be authorized by the said Committee may determine, not exceeding 2s.

4. Except when a race meeting is being held thereon, no person shall bring any racing horse or trotting horse on any part of the Reserve without the consent in writing of the said Committee or such body or persons as may be authorized for that purpose by the said Committee. When a race meeting is being held thereon, no person shall bring any racing horse or trotting horse without the consent in writing of the Committee of stewards of the body conducting galloping or trotting on the day, or some person duly authorized in writing by such Committee of stewards.

5. No person shall use the Reserve for the purpose of racing horses or for any other purpose whatsoever without the permission in writing of the Committee of Management being first obtained and then only on such terms and conditions as may be considered reasonable and consistent with these Regulations. Upon such person being duly authorized in writing by the Committee of Management the applicant shall pay a due proportion of the following fees:—

- (a) For each race meeting a fee not to exceed £25.
- (b) For each trotting meeting a fee not to exceed £25.
- (c) For any other sports, show, or holiday amusements a fee (if any) which the Committee of Management may fix, not to exceed £10 per day.

6. The fees for permission to exercise or train horses on the Reserve shall be £1 for each horse for each year or part thereof, and shall be payable to such body or persons as are duly authorized by the said Committee of Management to receive the same. Such permission to train or exercise horses shall not be unreasonably or arbitrarily withheld by the Committee of Management, or any body or persons duly authorized by the said Committee of Management, but such Committee, body, or persons may, by notice posted on the said Reserve, forbid the training or exercising of horses thereon on any day when, in the opinion of the said Committee or such body or persons, such use would be detrimental to the condition and maintenance of the training track or other improvements, or when the Reserve or part thereof is required for other purposes.

7. The moneys received as fees for the permission to train or exercise horses on the Reserve shall be applied in maintaining the said Reserve and course proper in a fit and proper condition and in otherwise rendering the said land suitable for racing and recreational purposes.

8. No person shall carry on the business or calling of a bookmaker except in and upon such portions of the Reserve as may be set aside for that purpose, and then only when he shall have complied with the following conditions:—

- (a) That he be registered as a bookmaker by such body or persons as are duly authorized in writing by the Committee of Management on payment of a fee not to exceed £5 for any race meeting or sporting event held in the Reserve.
- (b) That during the time he shall be in or upon the Reserve carrying on the business or calling of a bookmaker he shall wear a ticket supplied by the body or persons authorized by the Committee of Management which shall be visible to the public and shall have thereon his name.

9. The Committee of Management shall have full power and authority to enter into agreements with any racing club—

- (a) For granting to such racing club the right, whether exclusive of other racing clubs or not, to conduct race meetings on the Reserve during such limited number of days in each year as the Committee of Management and such racing club may agree and on such financial terms (comprising fees to be paid by such racing club to the Committee of Management, receipt by the racing club of admission fees, training fees, bookmakers' registration fees, &c.), and for such period of years as the Committee of Management and such racing club may agree;
- (b) for permission to such racing club to construct at its own expense buildings and other improvements on the Reserve for the purpose of race meetings and other incidental purposes and for giving such racing club such rights to remove the same as may be agreed; and
- (c) for such other purposes consistent with these Regulations as may be considered by the Committee of Management to be reasonable for the purpose of providing facilities for the holding of race meetings and for rendering the race track and appurtenances suitable and convenient therefor.

10. No person shall use the buildings, yards, or enclosures in the Reserve nor shall camp in the Reserve or in any buildings thereon, nor erect any booth or other structure without the permission in writing of the Committee of Management being first obtained.

11. No person shall enter or remain on the Reserve who may offend against decency as regards dress, language, or conduct.

12. No person shall damage in any way the trees, flowers, or shrubs in the Reserve, nor shall fires be lighted therein without the consent and by direction of the Committee of Management.

13. No person shall climb over the fences or gates, stick bills thereon or on any buildings, deface or damage fences, gates, or seats, or throw sticks, stones, or other missiles in the Reserve, or remove therefrom any sand or soil.

14. No person shall bring into the Reserve any horses, cattle, sheep, or other animals without the permission in writing of the Committee of Management.

15. No person shall bring into the Reserve any gun, rifle, or other firearm without the consent in writing of the Committee of Management being first obtained.

16. Persons renting or hiring any stand or building, erection or enclosure on the occasion of fêtes, sports, or holiday amusements or otherwise, may be required to deposit any sum which the Committee of Management may at any time determine, not exceeding £20, by way of guarantee that due care shall be taken of such stand, building, erection, or enclosure, and such Committee may in its absolute discretion make good any damage or other injuries sustained by such stand, building, erection, or enclosure, or anything contained therein during such occupancy or hiring, and deduct the cost of making good such loss or damage from the sum of money deposited by way of guarantee, and all persons so renting or hiring shall abide by these Regulations and by any order given by the Committee of Management. If no money is deposited as aforesaid or if the money deposited is insufficient to recompense the damage, the Committee of Management may recover the amount of the damage or the deficiency, as the case may be, from the person committing any such damage as aforesaid.

17. No person shall cross or trespass upon the course, or any part of it, during a race meeting or when the horses are prepared to start or are running for any race, or shall trespass upon the playing field during the progress of a cricket match, football match, or any sport or function.

Every person who contravenes or fails to comply with these Regulations shall, in accordance with the provisions of section 181 of the *Land Act* 1928, as re-enacted by section 9 of the *Land Act* 1941, for each offence be liable to a penalty of not more than Five pounds (£5), and every person who contravenes or fails to comply with any such Regulation and who, after he has been warned by any bailiff of Crown lands or by any member of the Police Force, does not desist therefrom may be forthwith apprehended by such bailiff or member of the Police Force and taken before some justice to be dealt with according to law, and shall be liable to a penalty of not more than Ten pounds (£10).

The common seal of the Board of Land and Works was hereunto affixed, this tenth day of August, 1950, in the presence of—

(SEAL) A. E. LIND, President.
W. M. CRAWFORD, Member.

The Reserve has been placed under the control of the Council of the Shire of Buln Buln as a Committee of Management thereof, with power and authority to enforce the foregoing Regulations.—(Rs.2948.)

REGULATION FOR THE CARE, PROTECTION, AND MANAGEMENT OF THE SWAN HILL SHOW GROUNDS AND RECREATION RESERVE.

WHEREAS by section 181 of the *Land Act* 1928, as re-enacted by section 9 of the *Land Act* 1941, power is given to the Board of Land and Works to make Regulations in respect of the care, protection, and management of any Crown land which has been reserved under the *Land Acts* for any public purposes whatsoever, and which has not been conveyed to or vested in trustees, and for the further purposes as enacted, and whereas by sub-section 1 (e) of the said section 181 of the *Land Act* 1928, power is given to the Board of Land and Works to apply all or any of the Regulations so made to any other land reserved as aforesaid and not conveyed to or vested in trustees, in any case where the persons, council, or body comprising the Committee of Management of such first-mentioned land are or is also appointed to be the Committee of Management of such other land: Now, therefore, the Board of Land and Works, in pursuance of the powers conferred, doth hereby make the following Regulation:—

“The Regulations made by the Board on 23rd December, 1940 (as notified in the *Government Gazette* of 3rd January, 1941), for the care, protection, and management of the land in the Township of Swan Hill, temporarily reserved by Orders in Council dated 29th November, 1897, and 18th January, 1949, as a site for Show Yards and Public Recreation, are hereby applied to the land in the Township of Swan Hill, temporarily reserved by Order in Council dated 27th June, 1950, as a site for Show Yards and Public Recreation in addition to and adjoining the first-mentioned site.”—(Rs.2474.)

The common seal of the Board of Land and Works was hereunto affixed this tenth day of August, 1950, in the presence of—

(SEAL) A. E. LIND, President.
W. M. CRAWFORD, Member.

COMMITTEES OF MANAGEMENT OF RESERVES.

APPOINTMENTS.

WHEREAS by section 184 of the *Land Act* 1928 it is provided that it shall be lawful for the Governor in Council or the Board of Land and Works to appoint and remove any number of persons, not less than three, or any municipal council, or the governing body of any corporation, to be a Committee of Management of any specified Crown land reserved either temporarily or permanently for any of the purposes set out in section 14 of the *Land Act* 1928, and not conveyed to or vested in trustees: Now therefore the Board of Land and Works doth hereby appoint the under-mentioned persons to be members of the Committee of Management of the Reserves named:—

"ALBERTON MECHANICS' INSTITUTE AND FREE LIBRARY RESERVE."

Harold Douglas Mowat, Albert Emerson Coulthard, Kenneth Ross Bell, Matthew Filex Knight, Stanley Johnstone Finlay, Albert Fredrick Howlett, George Finlay, Charles Tuckey, and John Niels Christensen as a Committee of Management for a period of three (3) years from 29th July, 1950, of the land permanently reserved on 25th November, 1889, as a site for a Mechanics' Institute and Free Library in the Township of Alberton, and known as the "Alberton Mechanics' Institute and Free Library Reserve."—(Corres. Rs.4077.)

"BADDAGINNIE RECREATION RESERVE."

Frederick Albert Cock, Rupert Charles Powell, Noel Henry Dosser, George Alec Merton Hill, Arthur James Cook, Allan Edwin Roy Croxford, John Patrick Mack, and Donald Francis McPherson as a Committee of Management for a period of three (3) years from 4th August, 1950, of the land temporarily reserved by Order in Council dated the 9th February, 1904, as a site for Public Recreation in the Town of Baddaginnie, and known as the "Baddaginnie Recreation Reserve."—(Corres. Rs.2252.)

"BENAMBRA HALL RESERVE."

Edwin A. Spencer as a member of the Committee of Management for a period ending 18th September, 1951, of the land permanently reserved by Order in Council dated 8th November, 1886, as a site for a Public Hall and Library in the Township of Benambra, and known as "Benambra Hall Reserve," in the place of John Miles Poulson, resigned.—(Corres. Rs.3029.)

"DOOKIE RACECOURSE AND RECREATION RESERVE."

Lancelot Symington Sim, William Ewart Fitz, Alexander John Gall, Albert Henry Hooper, and Thomas Ryan as a Committee of Management for the period of three (3) years from 19th July, 1950, of the remaining portion of the land temporarily reserved by Order in Council of the 6th October, 1873, as a site for Racing and General Recreation purposes in the Parish of Pine Lodge, and known as "Dookie Racecourse Reserve."—(Corres. Rs.741.)

"EAGLEHAWK RECREATION RESERVE."

The Council of the Borough of Eaglehawk as the Committee of Management of the land in the Borough of Eaglehawk, Parish of Sandhurst, temporarily reserved as a site for Public Recreation by Order in Council dated 9th May, 1950, and known as the "Eaglehawk Recreation Reserve."—(Corres. Rs.6530.)

"ESKDALE CAMPING AND WATER RESERVE."

Henry Francis Bock, John Wemyss Evans, William Raymond Swasbrick, Cecil John Bock, Robert Samuel Thorn Thompson, Kenneth John Kennedy, and William John Forster as a Committee of Management for a period ending the 27th January, 1953, of the land temporarily reserved by Order in Council dated the 4th July, 1950, as a site for Camping and Watering purposes in the Township of Eskdale.—(Corres. Rs.4198.)

"GREEN'S CREEK RACECOURSE RESERVE."

Edward Ernest Jones, Reginald John Parry, James Joseph Devery, John Parry, Henry Vincent Flynn, A. Kindred, Max G. Kindred, and Ray Stewart as a Committee of Management for a period of three (3) years from 1st August, 1950, of the land temporarily reserved by Order in Council dated 14th June, 1886, as a site for a Racecourse and other purposes of Public Recreation in the Town of Glynwylln, and known as the "Green's Creek Racecourse and Recreation Reserve."—(Corres. Rs.4771.)

No. 605.—8220/50.—3

"HODDLE'S CREEK RECREATION RESERVE."

Sidney Ernest Lacey, John Michael Kells, Alice Ethel Lacey, Joseph Whitehair, Alexander Francis Douth, Minnie Dufty, Edward Fall, George Robert Worley, Charles Mathers, and Arthur Thomas Willis as a Committee of Management for a period of three (3) years from 17th July, 1950, of the land permanently reserved by Order in Council dated the 6th February, 1929, as a site for Public Recreation in the Parish of Woori Yallock, and known as the "Hoddle's Creek Recreation Reserve."—(Corres. Rs.3796.)

"LAKE BOLAC FORESHORE RESERVE."

Leo John O'Rorke, Frederick Hewitt Moreton, Donald Keith Malcolm MacInnes, Stanley Herbert Moreton, Henry James McIntyre, and Henry Moreton Clarke as a Committee of Management for the period of three (3) years from 19th July, 1950, of the reserved Crown land in the Parish of Parupa, indicated in red colour on plans marked P/28.2.30 and P/3.11.49 with Lands Department correspondence file No. Rs.272, and known as the "Lake Bolac Foreshore Reserve."—(Corres. Rs.272.)

"LAKES ENTRANCE RECREATION RESERVE."

John Gerald Gray, in the place of Leonard Jack Anstee, resigned, as a member of the Committee of Management for a period ending 3rd December, 1951, of the land temporarily reserved by Orders in Council dated 18th November, 1889 and 3rd November, 1893, as sites for Public Recreation in the Township of Lakes Entrance, and known as the "Lakes Entrance Recreation Reserve."—(Corres. Rs.2251.)

"MANANGATANG RECREATION RESERVE."

Craig G. Sutton, John N. Dillon, and John Curran as additional members of the Committee of Management for a period ending 28th October, 1951, of the land temporarily reserved by Order in Council of 2nd March, 1922, as a site for Recreation purposes, and adjoining land temporarily reserved by Order in Council of 13th November, 1924, as a site for Public Recreation, both sites being in the Parish of Manangatang, and together known as the "Manangatang Recreation Reserve."—(Corres. Rs.2469.)

"MOORNGAG PUBLIC HALL AND RECREATION RESERVE."

George Ginnivan, F. R. McCauley, James Thomas Duffy, Frederick J. Horsburgh, K. W. McPherson, Dennis Keith McCauley, Daniel E. Ginnivan, L. Sawyer, William John Burns, Patrick Francis Burns, and James Reginald Patterson as a Committee of Management for the period of three (3) years from 12th July, 1950, of the land temporarily reserved by Order in Council dated 21st November, 1887, as a site for Public Recreation, and by Order in Council dated 7th September, 1948, as a site for additional purpose of a Public Hall in the Parish of Rothesay, and known as the "Moornag Public Hall and Recreation Reserve."—(Corres. Rs.2741.)

"MORTLAKE RACECOURSE RESERVE."

William Edward Rimmer, Thomas Clingan, John McKinnon, Godfrey McKinnon, Albert Peters, and Patrick Fitzgibbon as a Committee of Management for a period of three (3) years from 25th August, 1950, of the land permanently reserved by Order in Council dated 2nd March, 1892, as a site for Racecourse in the Parish of Connearren, and known as "Mortlake Racecourse Reserve."—(Corres. Rs.2143.)

"MT. DUNEED RECREATION RESERVE."

James Rainford, Patrick Feehan, Alfred E. Baulsh, Lawrence Charles Payne, John Jackson, John Wilfred White, and James Eustace Russell as a Committee of Management for a period of three (3) years from 28th June, 1950, of the land permanently reserved by Order in Council dated 8th February, 1886, as a site for Public Recreation in the Parish of Duneed, and known as "Mount Duneed Recreation Reserve."—(Corres. Rs.947.)

"OUYEN PLANTATION RESERVE."

The Council of the Shire of Walpeup as the Committee of Management of the land temporarily reserved as a site for Plantation purposes by Order in Council dated 25th July, 1950, and known as the "Ouyen Plantation Reserve."—(Corres. Rs.6553.)

"PATCHEWOLLOCK NORTH RECREATION AND PUBLIC HALL RESERVE."

William Bennetts, John Thomas Mackay, F. E. Clarke, Clarice Emily Ross, and Francis William Woollard as a Committee of Management for a period of three (3) years of the land temporarily reserved by Order in Council dated 13th March, 1935, as a site for Public Recreation and Hall in the Parish of Patchewollock North, and known as the "Patchewollock North Recreation and Public Hall Reserve."—(Corres. Rs.4441.)

"POUND BEND RESERVE," WARRANDYTE.

John Hutchinson, Roy Devan Christensen, John Ronald Golding, John Blair Hutchinson, Cyril Crompton Ardern, Mervyn Albert Naughton, and Henry Patrick Fitzherbert as a Committee of Management for a period of three (3) years from 8th June, 1950, of the land permanently reserved by Order in Council dated 11th July, 1932, as a site for a Public Park in the Parish of Warrandyte, and known as "Pound Bend Reserve," and of such portion of the Reserve for Public purposes (being a frontage to the Yarra River) in the Parish of Warrandyte, as is indicated by red colour on plan marked W/18.6.34 attached to Lands Department correspondence Rs.4212.—(Corres. Rs.4212.)

"RAYWOOD RECREATION RESERVE."

John Hugh Collins, Robert James Neighbour, Allan Samuel Dale, Jack Alexander Reid, Joseph Lewis Jones, Percy Hooper, and Ronald Arthur Ferguson West as a Committee of Management for a period of three (3) years from 25th July, 1950, of the land temporarily reserved by Order in Council dated 17th August, 1885, as a site for Public Recreation in the municipal district of Raywood, and known as the "Raywood Recreation Reserve."—(Corres. Rs.2377.)

"SALE RACECOURSE RESERVE."

John Gladstone Ryan, Oswald Abraham Ruff, James Alfred Armstrong, James Ernest Christie, and Eugene Michael Allman as a Committee of Management for the period of three (3) years from 1st August, 1950, of the land temporarily reserved by Order in Council dated 14th March, 1882, as a site for a Racecourse in the Parish of Sale, and known as the "Sale Racecourse Reserve."—(Corres. Rs.461.)

"SHELFORD RECREATION RESERVE."

James William Simpson, John Richard Heard, Harry McDonald Mohr, Joseph Edwin Challis, and Ray Edgar Heard as a Committee of Management for a period of three (3) years from 1st August, 1950, of the land temporarily reserved by Order in Council dated 14th December, 1906, as a site for Public Recreation in the Town of Shelford, and known as the "Shelford Recreation Reserve."—(Corres. Rs.4830.)

"TRAFALGAR RECREATION RESERVE."

William Riley, in place of Hector Thomas Lamont, resigned, as a member of the Committee of Management for the period ending 6th June, 1952, of the land temporarily reserved by Order in Council of 15th September, 1890, as a site for Public Recreation in the Parish of Yarragon, and known as the "Trafalgar Recreation Reserve."—(Corres. Rs.671.)

"UPPER BEACONSFIELD PUBLIC HALL AND CHILDREN'S PLAYGROUND RESERVES."

Percy Mansfield Hamilton, Donald James Sutherland, Greta I. Noblet, Gwendolyn Marjorie Kilvington, Trevor Basil Kilvington, Olive May Elliott, and Erin Sigrid Knapton as a Committee of Management for the period ending 31st January, 1951, of the land temporarily reserved by Orders in Council dated 29th July, 1940, and 23rd September, 1940, as sites for a Children's Playground and Public Hall, respectively, in the Parish of Gembrook, at Upper Beaconsfield, and known as "Upper Beaconsfield Children's Playground and Upper Beaconsfield Public Hall Reserves."—(Corres. Rs.5102 and Rs.5066.)

"UPPER PAKENHAM HALL AND PUBLIC LIBRARY RESERVE."

Edward Warner Nye, Bruce Henry Harvie, Andrew Brydie Warner, Joseph Taylor, Joseph Finn, Herbert Gordon Wollard, Albert James Andrew Nye, and Joseph Nye as a Committee of Management for a period of twelve (12) months from 31st July, 1950, of the land temporarily reserved by Order in Council dated the 2nd September, 1940, as a site for a Public Hall in the Parish of Gembrook, at Upper Pakenham, and known as the "Upper Pakenham Hall and Public Library Reserve."—(Corres. Rs.5083.)

"WALPEUP RACECOURSE RESERVE."

Leo Lawrence Murphy, Frank Joseph Glen, Michael F. Heffernan, John Henry Liles, William Henry Binns, William John Woodall, and Bertie Corbett as a Committee of Management for a period of three (3) years from 18th May, 1950, of the land temporarily reserved by Order in Council dated the 5th April, 1921, as a site for Racecourse and Recreation purposes in the Parish of Walpeup, and known as the "Walpeup Racecourse Reserve."—(Corres. Rs.3497.)

"WERRIBEE RACECOURSE AND RECREATION RESERVE."

Maurice Rushford, David Henry Macknamara, James Denis Canny, and Aloysius Joseph Louis Hayes (as representatives of the Werribee Racing Club), and James Herbert Wood, Thomas Beasley, Denis Phelan, and Joseph Lawrence Callanan as a Committee of Management for a period of three (3) years from the 9th June, 1950, of the land temporarily reserved by Order in Council dated the 22nd April, 1861, as a site for a Racecourse and General Recreation purposes in the Township of Wyndham (now Werribee), and known as the "Werribee Racecourse and Recreation Reserve."—(Corres. Rs.925.)

"WONGA WONGA HALL RESERVE."

Francis Leslie Cox and Samuel Riseley as members of the Committee of Management for the period ending 19th January, 1953, of the land temporarily reserved on 24th March, 1904, as a site for a Public Hall in the Parish of Wonga Wonga, and known as the "Wonga Wonga Public Hall Reserve," in the place of Vivian Percy Woodward and Edward Raymond Johns, both resigned.—(Corres. Rs.5863.)

In witness whereof the common seal of the Board of Land and Works was hereunto affixed this tenth day of August, One thousand nine hundred and fifty, in the presence of—

(SEAL) A. E. LIND, President.
W. M. CRAWFORD, Member.

Soldier Settlement Acts.
PRELIMINARY NOTICE OF COMPULSORY ACQUISITION.

TAKE notice that, by virtue of the powers contained in the Soldier Settlement Acts, the Governor in Council, by an Order made on the fifteenth day of August, 1950, a copy of which appears hereunder, directed that the land described in such Order be acquired compulsorily for the purposes of the said Acts.

Copy of Order of the Governor in Council made the fifteenth day of August, 1950:—

"DIRECTION FOR ACQUISITION OF LAND BY COMPULSORY PROCESS.

Whereas it is provided (*inter alia*) by the Soldier Settlement Acts that where it appears to the Governor in Council that any land proposed to be acquired for the purposes of such Acts cannot be acquired by agreement or cannot be so acquired at a reasonable price the Governor in Council may direct that such land be acquired compulsorily: And whereas by virtue of such Acts the Governor in Council has approved of the recommendation of the Soldier Settlement Commission that all those pieces of land comprising 333 acres, more or less, and being allotment 68A, Parish of Garvoc, the owners of which land are James Kelly, of Spring Gardens, Warrnambool, and the National Trustees, Executors, and Agency Company of Australasia Limited, of 95 Queen-street, Melbourne, should be acquired by the said Commission, pursuant to and in accordance with the Soldier Settlement Acts: And whereas by virtue of such Acts the Governor in Council directed the said Commission to negotiate for the acquisition of such land: And whereas it appears to the Governor in Council that the said land cannot be acquired by agreement: And whereas it is proposed that the said land be acquired for the purposes of the said Acts: Now therefore His Excellency the Governor of the State of Victoria by and with the advice of the Executive Council of the said State doth by this Order direct that the land described above be acquired compulsorily for the purposes of the said Acts.

A. MAHLSTEDT,
Clerk of the Executive Council."

Dated at Melbourne this fifteenth day of August, One thousand nine hundred and fifty.

E. SINGLETON, Secretary,
Soldier Settlement Commission.

THE CLOSER SETTLEMENT ACTS.

NOTICE is hereby given that the Board of Land and Works has accepted the surrender of the Leases mentioned in the Schedule hereunder for the reason specified.

LEASES UNDER THE CLOSER SETTLEMENT ACT 1938.

Corr.	District.	Lessee.	Allotment.	Section.	Parish.	Area.	Remarks.
						A. R. P.	
654/12	Mallee ..	Gardiner, E.	37 and 40	..	Koleya	1,011 2 18	The Lessees named have accepted compensation pursuant to the provisions of the <i>North-West Mallee Settlement Areas Act 1948</i> .
465/12	Mallee ..	Beckman, G. S. V.	15 and 18	..	Tunart	1,602 2 19	

W. M. CRAWFORD,
Acting Secretary for Lands.

10th August, 1950.

THE CLOSER SETTLEMENT ACTS.

NOTICE is hereby given that the Board of Land and Works has accepted the surrender of the Leases mentioned in the Schedule hereunder as from 28th February, 1950, for the reason specified.

LEASES UNDER THE CLOSER SETTLEMENT ACT 1938.

Corr.	District.	Lessee.	Allotment.	Section.	Parish.	Area.	Remarks.
						A. R. P.	
761/12	Mallee ..	Johnson, E. J. and S. N. K., Executors of N. Johnson, deceased	24	..	Yarrara	812 1 16	The Lessees named have been granted areas under perpetual lease pursuant to the provisions of the <i>North-West Mallee Settlement Areas Act 1948</i> and 1949.
674/12	Mallee ..	Gray, J. W.	21 and 22	..	Morkalla	2,732 1 0	

W. M. CRAWFORD,
Acting Secretary for Lands.

10th August, 1950.

Land Act 1928.

LEASES UNDER THE LAND ACTS 1915 AND 1928 DECLARED VOID.

NOTICE is hereby given that the Leases mentioned in the Schedule hereunder have been declared void by the Governor in Council for the reason specified in each case.

District.	Corr. No.	Name of Lessee.	Section of Land Act under which Leased.	Parish.	Allotment.	Area.	Class.	Annual Rental.	Reasons for Voiding.
						A. R. P.		£ s. d.	
Geelong ..	362/44	Gordon James Fisher	44	Durrid- warrarah	54D	163 0 0	3rd	4 1 6	Non-compliance with conditions.
Melbourne	0543/125	Barrett Brothers Proprietary Limited	125	Melbourne South, City of South Melbourne	16, 17, Section D	0 3 24	—	1,055 0 0	Lease expired—new lease to issue.
Geelong ..	194/44	Samuel William Richards	44	Carpendeit	44A	123 0 26	3rd	3 2 6	Non-compliance with conditions.

A. E. LIND,
Commissioner of Crown Lands and Survey,

Department of Lands and Survey,
Melbourne, 9th August, 1950.

LIST OF CROWN LANDS AVAILABLE.

THE under-mentioned areas are available for application as provided by various sections of the Land Act 1928, and all applications received on or before Wednesday, 13th September, 1950, will be deemed to have been simultaneously made, but any application lodged after such date may be considered if received in time for inclusion in the advertisement of the cases to be heard at the Local Land Board.

Applications on proper form, accompanied by 5s. duty stamp uncancelled (registration fee), may be delivered or forwarded by post to the Local Land Officer or to any Crown Lands Office in Victoria. Applicants may obtain from Local Land Officers, or the Lands Department, Melbourne, a certificate authorizing the issue by the Railway Department of a return ticket at concession fares to enable them to inspect available areas or to attend Local Land Boards. When an applicant is granted an allotment he may, if travelling by rail, obtain reduced fares for his family and also freight concessions in regard to some of his effects.

Subject to the approval of the Secretary for Lands, when the survey fee exceeds £25 but does not exceed £50, a deposit of £25 may be paid, and when the fee exceeds £50 a deposit of 60 per cent. of the fee, the balance in either case being payable over six years in half-yearly instalments.

Marked plans of any particular area, application forms, and any further information may be obtained from the Lands Department, Melbourne, and Land Officers, Ballarat and Stawell.

Department of Crown Lands and Survey,
Melbourne, 16th August, 1950.

A. E. LIND,
Commissioner of Crown Lands and Survey.

* Improvements may be subject to re-valuation after land has been granted to an applicant.

Local Land Office.	County.	Parish.	Allotment.	Section.	Area.	How Available.		Survey Fee.	Valuation of improvements (if any).	Location of Land, &c.	Nearest Railway Station or Township and Distance in miles therefrom.	How Accessible.	Water Supply.	General Description of Land—Soil, Timber, Suitability (Grazing, &c.).	
						Classification.	Value per Acre.								
						A. R. P.		£ s. d.							

AGRICULTURAL AND GRAZING LANDS—SELECTION PURCHASE ALLOTMENTS.

DIVISION 4, PART I., LAND ACT 1928.

Ballarat ..	Borong ..	Moyston ..	190K ..	242	1	12	2nd	To be valued			By road	By con-servation	Shallow soil; yellow box and red gum; suitable for cultivation. (107/121)
								4	0	0			

AVAILABLE UNDER SECTION 129, LAND ACT 1928.

Stawell (a)	Borong ..	Borough and Parish of Stawell	4	47A	0	0	26	Dwelling	Annual rental to be fixed			By road	To be con-served	Suitable for a dwelling. (Z.32858)
									5	10	0			

(a) Subject to survey.

PUBLIC SERVICE NOTICES.

PUBLIC SERVICE (PUBLIC SERVICE BOARD) REGULATION 36A.—RECLASSIFICATIONS.

THE Public Service Board has raised the classification of the under-mentioned offices as shown, and the Permanent Heads of the Departments have recommended the officers named for appointment.

Office and Present Classification.	Revised Classification.	Duties.	Qualifications.	Officer Recommended for Appointment.		
				Name.	Classification.	Date of Classification.

ADMINISTRATIVE DIVISION.

DEPARTMENT OF CHIEF SECRETARY.

State Motor Car Insurance Office.

Clerk, Class "C2"	Officer in Charge, Class "B"	To act as Officer in Charge of the State Motor Car Insurance Office	A specialized knowledge of Comprehensive and Statutory Motor Vehicle Insurance with practical experience in under-writing and settlement of claims; a thorough knowledge of the Motor Car and Motor Car (Third Party Insurance) Acts and the law relating to Insurance Contracts; to be able to direct and control staff	Dynon, J. P. . .	Clerk, Class "C2"	17.11.48
-------------------	------------------------------	---	--	------------------	-------------------	----------

DEPARTMENT OF LAW.

Office of the Public Trustee.

Clerk, Class "C1" (two offices)	Class "C2" (two offices)	To act as Trust Officer dealing with the estates of deceased persons and with agencies and trust estates	A thorough knowledge of the Public Trustee and other Acts and regulations there-under and the law affecting the administration of the estates of deceased persons and of agencies and trust estates; experience in the management and conduct of estates and businesses and in the interpretation of Wills and Agreements and a knowledge of real estate values	Harper, J. S. . .	Clerk, Class "C1"	28.2.49
				Day, T. G. . .	Clerk, Class "C1"	18.7.49
Clerk, Class "C" (two offices)	Class "C1" (two offices)	To act as Assistant Trust Officer dealing with the estates of deceased persons and with agencies and trust estates	A general knowledge of the Public Trustee and other Acts and regulations there-under and the law affecting the administration of the estates of deceased persons and of agencies and trust estates; experience in the management and conduct of estates under the supervision of Trust Officer	Woods, W. J. }	Clerk, Class "C"	23.12.48
				Halloran, K. }		

Appeals against such recommendations should be lodged with the Secretary to the Public Service Board not later than Saturday, the 26th August, 1950.

Office of the Public Service Board,
Melbourne, 15th August, 1950.

By order,
E. F. FITZGIBBON,
Secretary.

PUBLIC SERVICE (PUBLIC SERVICE BOARD) REGULATION 36A.—VACANCY.

THE Permanent Head of the Department shown has recommended the officer named hereunder for appointment to the under-mentioned vacancy.

Office and Classification.	Duties.	Qualifications.	Officer Recommended for Appointment.		
			Name.	Classification.	Date of Classification.

ADMINISTRATIVE DIVISION.

DEPARTMENT OF LABOUR.

Clerk, Class "C"	Under the direction of the Secretary to the Apprenticeship Commission, to act as Senior Industrial Clerk and to supervise the work of other Industrial Clerks, and also to answer enquiries and correspondence	To have a good knowledge of the Apprenticeship Acts and Awards; to possess approved ability to conduct correspondence and interviews and to be familiar with the practice and procedure of the Apprenticeship Commission	Thomas, E. F. . .	Clerk, Classes "E" and "D"	26.2.40
------------------	--	--	-------------------	----------------------------	---------

Appeals against such recommendation should be lodged with the Secretary to the Public Service Board not later than Saturday, the 26th August, 1950.

Office of the Public Service Board,
Melbourne, 15th August, 1950.

By order,
E. F. FITZGIBBON,
Secretary.

PUBLIC SERVICE BOARD OF VICTORIA.—VACANCIES.

APPLICATIONS will be received by the Public Service Board up to Wednesday, the 30th August, 1950, from persons employed in the Public Service of Victoria, who are eligible and qualified, for appointment to the under-mentioned positions.

ADMINISTRATIVE DIVISION.

Clerk, Class "C," Department of Lands and Survey.

Yearly Salary.—£462, minimum; £534, maximum.

Duties.—To notify lessees and licensees of Crown lands of amounts due; to issue authorities for and to record payments of rents and to certify that correct amounts have been paid for the issue of Crown grants.

Qualifications.—A good knowledge of the Land Acts, Part 48 of the Local Government Act and the Regulations thereunder, also the procedure with regard to the collection of departmental revenue.

Clerk, Class "C," Department of Public Works.

Yearly Salary.—£462, minimum; £534, maximum.

Duties.—To act as Secretary to the Motor Omnibus Advisory Committee and to undertake special duties as required; to assist in general administrative work.

Qualifications.—To have a knowledge of departmental organization and procedure; to possess tact and to have experience in dealing with the public and in the administration of legislation; to be capable of performing secretarial duties. Some knowledge of the transport systems of the metropolitan area is desirable. Ability to write shorthand would be an advantage.

PROFESSIONAL DIVISION.

Mechanical Engineer, Class "C2," Department of Water Supply.

Yearly Salary.—£631, minimum; £683, maximum.

Duties.—To be responsible for the acquisition, operation, and maintenance of Commission's motor transport, workshop equipment, and machine tools; to work in conjunction with the Manager, Central Plant Workshops, in repair of Commission's motor vehicles and plant generally.

Qualifications.—To possess a Degree or Diploma or similar qualification in Mechanical or Automotive Engineering, with extensive practical experience in the operation and maintenance of motor transport. Experience in selection and usage of workshop equipment and machine tools is required, and a knowledge of the mechanical operation of earth-moving and construction plant will be an advantage.

Assistant Surveyor, Class "D," Department of Water Supply.

Yearly Salary.—£325, minimum; £436, maximum.

Duties.—To assist in the carrying out of general engineering surveys, including investigation of channel systems and other water supply undertakings.

Qualifications.—To have passed—

1. (a) The School Leaving Examination, including English, Mathematics I, and Mathematics II; or
- (b) the School Intermediate Examination and, in addition, School Leaving English, Mathematics I, and Mathematics II; or
- (c) an equivalent Technical School Examination; and
2. To have had training or experience in survey work.

Draughtsman, Class "D," Department of Water Supply.

Yearly Salary.—£325, minimum; £436, maximum.

Duties.—To prepare compilation of maps and plans for record and reproduction, including the preparation of mosaics from air photographs.

Qualifications.—To have passed—

1. (a) The School Leaving Examination, including English, Mathematics I, and Mathematics II; or
- (b) the School Intermediate Examination and, in addition, School Leaving English, Mathematics I, and Mathematics II; or
- (c) an equivalent Technical School Examination; and
2. To have had training or experience in survey work.

TECHNICAL AND GENERAL DIVISION.

Assistant (Male), Grade I, Leasing Branch, Department of Mines.

Yearly Salary.—£390, minimum; £416, maximum.

Duties.—To make daily allotments of coal to consumers in the metropolitan area; to keep records relating to deliveries of black and brown coal; to answer inquiries made by the public concerning the supply of coal and keep records of the bulk stock of the Department's publications and plans and of their distribution to selling agents.

Qualifications.—To have a detailed knowledge of the work of the distribution of coal by the State Coal Committee and experience in the keeping of records in relation to coal rationing; to be familiar with the publications issued by the Department.

Senior Attendant, Venereal Diseases Clinic, General Health Branch, Department of Health.

Salary.—£377 a year.

Duties.—Under the Medical Officer in Charge to be responsible for the cleanliness and routine administration of the Prophylactic Centre, the rostering of the attendants, and the control of stores.

Qualifications.—To have had experience in the work of a Venereal Diseases Clinic and Prophylactic Centre.

Gardener, Ararat Mental Hospital, Department of Health. (Two vacancies.)

Salary.—£352 a year.

Duties.—To assist generally with general gardening work and maintenance of grounds of the hospital, particularly in regard to upkeep of lawns and flower gardens.

Qualifications.—A sound knowledge of gardening, including ability to raise seedlings.

General Assistant, Ararat Mental Hospital, Department of Health.

Yearly Salary.—£312, minimum; £338, maximum.

Duties.—To assist generally in the maintenance work of the hospital, including attention to drains and sewerage lines.

Qualifications.—To be capable of carrying out general maintenance work under direction of trained artisans.

Water Bailiff, Tongala Centre, Department of Water Supply.

Yearly Salary.—£305, minimum; £331, maximum.

Qualifications.—Ability to control and regulate the supply of water to irrigators; to keep the necessary records and to make arithmetical computations in connexion therewith; to possess a knowledge of water requirements for crop and grasses grown under irrigation, the methods of preparation of land for same, and methods of channel and drain construction and maintenance.

Tailoress, Mont Park Mental Hospital, Department of Health.

Yearly Salary.—£284, minimum; £297, maximum.

Duties.—To make up and repair male clothing, including coats, vests, and trousers, and to supervise patients working under her direction.

Qualifications.—To be a competent needlewoman and machinist, preferably with trade experience, and to be experienced in the care and management of mental patients.

Shorthand Writer and Typist (Female), Grade II, Taxation (Land Tax) Office, Department of Treasurer.

Yearly Salary.—£273, minimum; £286, maximum.

Duties.—To prepare correspondence from dictation and to compile letters from minutes, in accordance with the Land Tax Act and Regulations; to examine the work of the typing staff, and give guidance and direction in the interests of efficiency; to train additional staff and to be alert for methods of improvement in typing work.

Qualifications.—To be a competent typist and capable of writing shorthand at the rate of 100 words a minute; to be sufficiently experienced to allocate and supervise the work of the typing staff.

Shorthand Writer and Typist (Female), Grade II., Office of the Public Trustee, Department of Law.

Yearly Salary.—£273, minimum; £286, maximum.

Qualifications.—To be a competent typist with ability to write shorthand at the rate of 100 words a minute.

Typist (Female), Grade II., Motor Registration Branch, Office of the Chief Commissioner of Police, Department of Chief Secretary.

Yearly Salary.—£260, minimum; £273, maximum.

Duties.—To type registrations and licences for fees paid at country police stations, also forms for balance payments, duplicate plates and labels.

Qualifications.—To be a competent typist; to possess a knowledge of fees payable under the Motor Car Acts, premiums payable under the Motor Car (Third-Party Insurance) Act, and ability to assess pro rata payments.

Note.—In addition to the salary rates quoted, a cost of living adjustment (£132 a year for adult males, £88 a year for adult females, and £66 a year for minors), which varies in accordance with the rise or fall in the index number of the cost of living, is payable.

By order,

E. F. FITZGIBBON,
Secretary.

Office of the Public Service Board,
Melbourne, 15th August, 1950.

No. 824.

Public Service Act 1946, Section 39.

REGULATIONS—PART III.—SALARIES, INCREMENTS, AND ALLOWANCES.

THE Public Service Board, in pursuance of the powers conferred by the *Public Service Act 1946*, hereby amends its Regulations as shown below :—

FIRST SCHEDULE.
PROFESSIONAL DIVISION.
Offices and Rates of Salaries.

Office.	Yearly Rate of Salary.	
	Minimum.	Maximum.
DEPARTMENT OF STATE FORESTS.	£	£
CLASS "C."		
<i>Add—</i> Draughtsman	462	534

This Regulation shall have effect as on and from the 6th June, 1950.

D. D. PAINE, Chairman.
E. F. FITZGIBBON, Secretary.

Office of the Public Service Board,
Melbourne, 31st July, 1950.

No. 828.

Public Service Act 1946, Section 50.

REGULATIONS—PART III.—SALARIES, INCREMENTS, AND ALLOWANCES.

THE Public Service Board, in pursuance of the powers conferred by the *Public Service Act 1946*, hereby amends its Regulations as shown below :—

SECOND SCHEDULE.
TECHNICAL AND GENERAL DIVISION.
Offices and Rates of Salaries.

Department and Office.	Yearly Rate of Salary.	
	Minimum.	Maximum.
DEPARTMENT OF LANDS AND SURVEY.	£	£
<i>Add—</i> Foreman	338	351

D. D. PAINE, Chairman.
E. F. FITZGIBBON, Secretary.

Office of the Public Service Board,
Melbourne, 2nd August, 1950.

No. 827.

Public Service Act 1946, Section 50.

REGULATIONS—PART III.—SALARIES, INCREMENTS, AND ALLOWANCES.

THE Public Service Board, in pursuance of the powers conferred by the *Public Service Act 1946*, hereby amends its Regulations as shown below :—

SIXTH SCHEDULE.

TEMPORARY EMPLOYEES.

Designations of Positions and Rates of Salaries.

Department and Designation of Position.	Yearly Rate of Salary.		Increments (Annual).
	Minimum.	Maximum.	
DEPARTMENT OF CHIEF SECRETARY.	£	£	
FISHERIES AND GAME.			
<i>Delete—</i> Hatchery Assistant, Snob's Creek	299	312	..
<i>Add—</i> Hatchery Assistant, Snob's Creek	312	325	..

D. D. PAINE, Chairman.

E. F. FITZGIBBON, Secretary.

Office of the Public Service Board,
Melbourne, 7th August, 1950.

No. 825.

Public Service Act 1946, Section 39.

REGULATIONS—PART III.—SALARIES, INCREMENTS, AND ALLOWANCES.

THE Public Service Board, in pursuance of the powers conferred by the *Public Service Act 1946*, hereby amends its Regulations as shown below :—

FIRST SCHEDULE.

PROFESSIONAL DIVISION.

Offices and Rates of Salaries.

Office.	Yearly Rate of Salary.	
	Minimum.	Maximum.
DEPARTMENT OF AGRICULTURE.	£	£
CLASS "C1."		
<i>Add—</i> Senior Dairy Husbandry Officer	553	605
Supervisor of Herd Testing	553	605
CLASS "C."		
<i>Delete—</i> Dairy Science Officer	462	534
Supervisor of Herd Testing	462	534

D. D. PAINE, Chairman.

E. F. FITZGIBBON, Secretary.

Office of the Public Service Board,
Melbourne, 31st July, 1950.

No. 826.

Public Service Act 1946, Section 50.

REGULATIONS.—PART III.—SALARIES, INCREMENTS, AND ALLOWANCES.

THE Public Service Board, in pursuance of the powers conferred by the Public Service Act 1946, hereby amends its Regulations as shown below :—

SECOND SCHEDULE.

TECHNICAL AND GENERAL DIVISION.

Offices and Rates of Salaries.

Department and Office.	Yearly Rate of Salary.	
	Minimum.	Maximum.
DEPARTMENT OF CHIEF SECRETARY.	£	£
FISHERIES AND GAME.		
Delete— Hatchery Assistant, Snob's Creek ..	299	325
Add— Hatchery Assistant, Snob's Creek ..	312	338

D. D. PAINE, Chairman.

E. F. FITZGIBBON, Secretary.

Office of the Public Service Board,
Melbourne, 7th August, 1950.

No. 829.

Public Service Act 1946, Section 50.

REGULATIONS.—PART III.—SALARIES, INCREMENTS, AND ALLOWANCES.

THE Public Service Board, in pursuance of the powers conferred by the Public Service Act 1946, hereby amends its Regulations as shown below :—

SECOND SCHEDULE.

TECHNICAL AND GENERAL DIVISION.

Offices and Rates of Salaries.

Department and Office.	Yearly Rate of Salary.		Increments (Annual).
	Minimum.	Maximum.	
DEPARTMENT OF PUBLIC WORKS.	£	£	
Delete— Storeman and Caretaker, Storeyard, South Melbourne	364	416*	2 of £26
Add— Officer in Charge, South Melbourne Depot ..	423	475*	2 of £26

* With quarters.

D. D. PAINE, Chairman.

E. F. FITZGIBBON, Secretary.

Office of the Public Service Board,
Melbourne, 7th August, 1950.

TENDERS.

TENDERS will be received at this office until TEN A.M. on the days and for the purposes under mentioned.

Particulars may be learnt at this Office and also at places shown in parenthesis.

W.O. means Inspector of Works Office; P.S.—Police Station; T.S.—Technical School; H.E.S.—Higher Elementary School; S.S.—State School; H.S.—High School; P.D.—Preliminary deposit; F.D.—Final deposit.

The Board of Land and Works will not necessarily accept the lowest or any tender.

22nd August, 1950.

Balmoral.—Renovations, P.S. (W.O., Hamilton, Horsham; P.S., Balmoral.) P.D., £10. F.D., 2 per cent.

Bendigo North.—Erection of police building in timber, P.S. (W.O., Bendigo; P.S., Bendigo North.) P.D., £25. F.D., 2 per cent.

Buln Buln East.—Erection of new teacher's residence, S.S. No. 2435. (W.O., Traralgon; P.S., Warragul; S.S., Buln Buln East.) P.D., £15. F.D., 2 per cent.

Carisbrook.—Supply and installation of an electric hot-water service, teacher's residence, S.S. No. 1030. (W.O., Maryborough.) P.D., £2. F.D., 2 per cent.

Cheltenham.—Sewerage, superintendent's residence, Heatherton Sanatorium. P.D., £3. F.D., 2 per cent.

Cheltenham.—Supply and installation of dishwasher for new dining room for nurses, Heatherton Sanatorium. P.D., £10. F.D., 2 per cent.

Dartmoor.—Alterations, repairs, and renovations, S.S. No. 1035. (W.O., Hamilton, Warrnambool; P.S., Portland; S.S., Dartmoor.) P.D., £10. F.D., 2 per cent.

Dimboola.—Erection of two (2) timber residences for teachers, Memorial High School. (W.O., Warracknabeal; Assistant District Architect's Office, Horsham; Memorial High School, Dimboola.) P.D., £20. F.D., 2 per cent.

Dooen.—Additions to laundry, Longerenong Agricultural College. (W.O., Horsham; Longerenong Agricultural College, Dooen.) P.D., £5. F.D., 2 per cent.

Dooen.—Additions to Experimental Barn, Longerenong Agricultural College. (W.O., Horsham; Longerenong Agricultural College, Dooen.) P.D., £5. F.D., 2 per cent.

Echuca.—Replacement of flooring in classrooms, &c., H.S. (W.O., Shepparton; H.S., Echuca.) P.D., £5. F.D., 2 per cent.

Glenormiston North.—Internal and external painting, repairs, &c., S.S. No. 3207. (W.O., Camperdown; P.S., Terang; S.S., Glenormiston North.) Deposit, £4.

Hamilton.—Internal renovations, S.S. No. 295. (W.O., Hamilton; S.S., Hamilton.) P.D., £10. F.D., 2 per cent.

Healesville.—Provision of septic tank and new water service, re-erection of girls' out-offices and wood shed, S.S. No. 849. (W.O., Alexandra; S.S., Healesville.) P.D., £15. F.D., 2 per cent.

Melbourne.—Outside lighting installation, MacRobertson Girls' High School. P.D., £4. F.D., 2 per cent.

Mt. Clear.—Provision of new septic tank system and alterations to out-offices, S.S. No. 427. (W.O., Ballarat; S.S., Mt. Clear.) P.D., £5. F.D., 2 per cent.

Netherby.—Repairs and painting, school and residence, S.S. No. 2651. (W.O., Warracknabeal; P.S., Jeparit, Nhill; S.S., Netherby.) P.D., £5. F.D., 2 per cent.

Nhill.—Adaptation of huts into classrooms, S.S. No. 2411 (W.O., Horsham, Warracknabeal; S.S., Nhill.) P.D., £15. F.D., 2 per cent.

Northcote.—Electrical installation, H.S. Deposit, £5.

Portland.—Purchase and removal of blue-stone residence, H.S. (Assistant District Architect's Office, Warrnambool; P.S., Port Fairy, Portland.) Deposit, £25.

Richmond.—Renewal of urinal and screen fencing, Court House. P.D., £3. F.D., 2 per cent.

Snob's Creek (Thornton).—Completion of electrical reticulation, Fish Hatchery. P.D., £5. F.D., 2 per cent.

Stanley.—Erection of standard E.4.L. type residence, S.S. No. 550. (W.O., Wangaratta; P.S., Myrtleford; S.S., Stanley.) P.D., £15. F.D., 2 per cent.

Strathmerton.—Repairs and external painting, S.S. No. 2790. (W.O., Shepparton; S.S., Strathmerton.) P.D., £4. F.D., 2 per cent.

Tongala.—Provision of plaster sheeting, and internal painting, P.S. (W.O., Shepparton; P.S., Tongala.) Deposit, £5.

29th August, 1950.

Apollo Bay.—Removal, re-erection, alterations, and repairs to two class-rooms, shelter shed, and out-offices, Consolidated School. (W.O., Camperdown; P.S., Colac; Consolidated School, Apollo Bay.) P.D., £15. F.D., 2 per cent.

Barwon Heads.—Erection of timber residence for teacher, S.S. No. 1574. (W.O., Geelong; P.S., Barwon Heads; S.S., Barwon Heads.) P.D., £15. F.D., 2 per cent.

Birregurra.—Installation of septic tank system and alterations to out-offices, S.S. No. 723. (W.O., Geelong; S.S., Birregurra.) P.D., £5. F.D., 2 per cent.

Boisdale.—Electrical installation in Administration Wing, Consolidated School. (P.S., Boisdale, Maffra, Sale.) P.D., £10. F.D., 2 per cent.

Chiltern.—Erection of teacher's residence, S.S. No. 327. (W.O., Wangaratta; S.S., Chiltern.) P.D., £15. F.D., 2 per cent.

Donald.—Internal and external painting and repairs, H.E.S. No. 1465. (W.O., Maryborough; H.S., Donald.) P.D., £10. F.D., 2 per cent.

Forrest.—Erection of "A" type office, residence, and out-buildings, P.S. (W.O., Camperdown, Geelong; P.S., Colac, Forrest.) P.D., £20. F.D., 2 per cent.

Garfield.—Supply and installation of a briquette hot-water service, P.S. P.D., £4. F.D., 2 per cent.

Glenroy.—Erection of police station and residence, including cell, paths, and fencing, corner Pascoe Vale-road and Anselm-grove. P.D., £20. F.D., 2 per cent.

Hawthorn.—Supply and installation of two electric refrigerators, "Moorakyne" Girls' Hostel, 6 Lisson-grove. P.D., £5. F.D., 2 per cent.

Hoddle's Creek.—Erection of teacher's residence, S.S. No. 2541. (W.O., Alexandra; P.S., Lilydale; S.S., Hoddle's Creek.) P.D., £15. F.D., 2 per cent.

Horsham.—Erection of timber residence, Fisheries and Game Department. (W.O., Ballarat, Horsham.) P.D., £15. F.D., 2 per cent.

Kilmore.—Electrical installation, Court House. P.D., £4. F.D., 2 per cent.

Mentone.—Internal and external painting and repairs and extension to out-offices, S.S. No. 2950. (S.S., Mentone.) P.D., £15. F.D., 2 per cent.

Millgrove.—Erection of teacher's residence, S.S. No. 3655. (W.O., Alexandra; P.S., Warburton; S.S., Millgrove.) P.D., £15. F.D., 2 per cent.

Mont Park.—Installation of hot-water and central heating in extension to Nurses' Home, Mental Hospital. P.D., £20. F.D., 2 per cent.

Robinvale.—Conversion of school building removed from Mostank into Hostel for five teachers, Teachers' Hostel. (W.O., Swan Hill, Mildura; P.S., Ouyen.) P.D., £15. F.D., 2 per cent.

Sale.—Provision of new doorway and external escape staircase from first floor, S.S. No. 545. (W.O., Bairnsdale, Traralgon; S.S., Sale.) P.D., £5. F.D., 2 per cent.

Seymour.—Electrical installation, Court House. P.D., £4. F.D., 2 per cent.

Terip Terip.—Erection of teacher's residence, S.S. No. 3169. (W.O., Alexandra; S.S., Terip Terip.) P.D., £15. F.D., 2 per cent.

Williamstown.—Supply and delivery of 14-ft. motor boat, Marine Survey.

5th September, 1950.

Ararat.—Renovations of "J" Ward, Mental Hospital. (W.O., Ararat, Ballarat; Mental Hospital, Ararat.) P.D., £10. F.D., 2 per cent.

Badger Creek.—Additional class-room and alterations, S.S. No. 3309. (W.O., Alexandra; S.S. Badger Creek.) P.D., £15. F.D., 2 per cent.

Carlton.—Renovations, Motor Registration Branch, Exhibition Building. P.D., £15. F.D., 2 per cent.

Carlton.—Alterations and partitioning, Motor Registration Branch, Exhibition Building. P.D., £25. F.D., 2 per cent.

Cheltenham.—Erection of brick out-offices and connexion of all sanitary fittings to sewerage reticulation, S.S. No. 84. (S.S., Cheltenham.) P.D., £25. F.D., 2 per cent.

Foster.—Erection of three (3) residences, garages, out-buildings, &c., H.E.S. (W.O., Korumburra; H.E.S., Foster.) P.D., £25. F.D., 2 per cent.

Kyneton.—Erection of Nurses' Home, District Hospital. (W.O., Bendigo, Kyneton; District Hospital, Kyneton.) P.D., £50. F.D., 2 per cent.

Kyneton.—Supply and installation of mechanical services, new Nurses' Home, District Hospital. (W.O., Ballarat, Bendigo, Kyneton.) P.D., £20. F.D., 2 per cent.

Kyneton.—Electrical installation, new Nurses' Home, District Hospital. (W.O., Ballarat, Bendigo, Kyneton.) P.D., £20. F.D., 2 per cent.

Locksley.—Repairs and painting, school and residence, S.S. No. 2648. (W.O., Shepparton; S.S., Locksley.) P.D., £10. F.D., 2 per cent.

Preston.—Extensions to Boiler House, T.S. (T.S., Preston.) P.D., £5. F.D., 2 per cent.

Tenders to be addressed to the Honorable the Commissioner of Public Works, and envelope containing tender marked "Tender for _____ due _____"

P. T. BYRNES,
Commissioner of Public Works.

Melbourne, 15th August, 1950.

TENDERS FOR THE SERVICE, 1950-51.

PROVISIONS.

BUTTER AND CHEESE.

TENDERS will be received until Eleven o'clock a.m. on Friday, 8th September, 1950, from persons willing to furnish the under-mentioned supplies, in such quantities as may be ordered by the Victorian Government during the twelve months commencing on 1st October, 1950, as per Schedule No. 22—delivery to be made at the institutions at the under-mentioned places.

The places and supplies for which tenders will be received and the amount of the preliminary deposit required are as follows:—

Schedule No. 22.—Preliminary Deposit, £10.

Melbourne, Mont Park, Ararat, Ballarat, Beechworth, and Sunbury Districts—Butter and Cheese.

Greenvale Sanatorium and Pleasant Creek Special School, Stawell—Butter.

The prices tendered must not include sales tax.

Schedule as above, with full particulars, may be obtained from the Secretary to the Tender Board, and for the several districts, from the Medical Superintendent, Mental Hospital, at Ararat, Ballarat, Beechworth, Mont Park, and Sunbury, respectively; for Greenvale, from the Superintendent at the Sanatorium; for Stawell, from the Secretary, Special School, by whom also any information or explanation will be afforded to persons tendering.

Tenders must be accompanied by the preliminary deposit, as shown above, preferably by non-negotiable cheque payable to the order of the Secretary to the Tender Board. The amount and designation of the preliminary deposit enclosed must be clearly stated in the tender. Savings Bank deposit book, fixed deposit receipts, Commonwealth Treasury bonds, or reference to securities on existing contracts will in no case be received or entertained as preliminary deposits. Preliminary deposits will be returned within 30 days to unsuccessful tenderers on their application.

Security will be required either in Commonwealth Treasury Bonds, or approved bank guarantee, fixed deposit receipt, Savings Bank deposit book, or non-negotiable cheque in favour of the Secretary to the Tender Board, as the tenderer may elect.

The security must be completed and the contract signed within ten days of acceptance of the tender, failing which the contract may be again advertised, or another tender accepted.

The lowest or any tender will not necessarily be accepted.

In the event of tenderers withdrawing or attempting to withdraw their tenders before notification of acceptance of same, or failing to take up their accepted tenders within the prescribed period after notification of acceptance, the preliminary deposit will be forfeited and, in addition, they may be disqualified from tendering or holding any future contracts for Government supplies for a period of twelve months, such disqualification to date from the notification of acceptance of tender. It is also stipulated that, if a tenderer be a member of a firm and such firm be interested in the contract, the tender shall be in the name of the firm and not in that of the individual and that, for a breach of this condition, the preliminary deposit will be forfeited and the tender declared informal.

Tenders enclosed in a separate envelope, and having the words "Tender for _____ at _____" (as the case may be) written thereon, must be deposited in the Tender Box at the Tender Board Offices, Gisborne-street, Melbourne, or, if sent by post, postage must be prepaid, and the tenders addressed to the Chairman of the Tender Board, Tender Board Offices, Gisborne-street, Melbourne, C.2, which office they must reach not later than by first post on the date of closing of tenders.

The conditions of contract are those published in the Victoria Government Gazette, No. 298, dated 19th April, 1950, pages 2348 to 2350.

J. G. B. McDONALD,
Treasurer.

The Treasury,
Melbourne, 14th August, 1950.

TENDERS FOR THE SERVICE, 1950-51.

PROVISIONS—MEAT.

TENDERS will be received until Eleven o'clock a.m. on Friday, 8th September, 1950, from persons willing to furnish the under-mentioned supplies, in such quantities as may be ordered by the Victorian Government—delivery to be made at the under-mentioned places—during the three months commencing on 1st October, 1950.

The estimated quantities shown in the Schedules will be subject to variation in accordance with the requirements of any Regulations for the rationing of meat in force during the contract period.

The prices tendered must not include sales tax.

In all cases, the total cost of each item must be extended in the columns provided.

The places for which tenders will be received, the amount of the preliminary deposit, and the security required for the due fulfilment of each contract, are as follows:—

	Preliminary Deposit.	Security.
	£	£
Schedule No. 1.—Melbourne District—		
Meat—Kew Mental Hospital	2	35
.. Pentridge Penal Establishment, Female Penitentiary, and Metropolitan Gaol, Coburg	2	35
.. Children's Welfare Depot, Royal Park, and Police Hospital	1	8
.. Receiving House and Mental Hospital, Royal Park	1	10
Schedule No. 2.—Mont Park, Bundoora, Janesfield, and Gresswell—		
Meat	3	50
Schedule No. 3.—s.s. Rip and Dredges—		
Meat	1	5
Schedule No. 4.—Teachers' College, Carlton, and Travancore, Flemington—		
Meat	1	8
Schedule No. 5.—Ararat District—		
Meat	2	30
Schedule No. 6.—Ballarat District—		
Meat	2	35
Schedule No. 7.—Beechworth District—		
Meat	2	30
Schedule No. 8.—Castlemaine District—		
Meat	1	5
Schedule No. 9.—School of Forestry, Creswick—		
Meat	1	3
Schedule No. 10.—McLeod Settlement, French Island—		
Meat	1	6
Schedule No. 11.—Heatherton Sanatorium, Cheltenham—		
Meat	1	5
Schedule No. 12.—Sanatorium, Greenvale—		
Meat	1	7
Schedule No. 13.—Cooriemungle Prison Camp, Heytesbury Forest—		
Meat	1	4
Schedule No. 16.—Sale Gaol—		
Meat	1	3
Schedule No. 17.—Pleasant Creek Special School, Stawell—		
Meat	1	3
Schedule No. 18.—Sunbury District—		
Meat	2	40
Schedule No. 21.—Geelong District—		
Meat	1	5

Printed forms of tender and the conditions of contract may, in all cases, be obtained from the Secretary to the Tender Board, Gisborne-street, Melbourne, by whom also any information or explanation will be afforded to persons tendering.

Tenders must be accompanied by the preliminary deposit, as shown above, preferably by non-negotiable cheque payable to the order of the Secretary to the Tender Board. The amount and designation of the preliminary deposit enclosed must be clearly stated in the tender. Savings Bank deposit books, fixed deposit receipts, Commonwealth Treasury bonds, or reference to securities on existing contracts will in no case be received or entertained as preliminary deposits. Preliminary deposits will be returned within 30 days to unsuccessful tenderers on their application.

Security will be required either in Commonwealth Treasury Bonds, or approved bank guarantee, fixed deposit receipt, Savings Bank deposit book, or non-negotiable cheque in favour of the Secretary to the Tender Board, as the tenderer may elect.

The security must be completed and the contract signed within five days of acceptance of the tender, failing which the service may be again advertised, or another tender accepted.

The lowest or any tender will not necessarily be accepted.

In the event of tenderers withdrawing or attempting to withdraw their tenders before notification of acceptance of same, or failing to take up their accepted tenders within the prescribed period after notification of acceptance, the preliminary deposit will be forfeited and, in addition, they may be disqualified from tendering or holding any future contracts for Government supplies for a period of twelve months, such disqualification to date from the notification of acceptance of tender. It is also stipulated that, if a tenderer be a member of a firm and such firm be interested in the contract, the tender shall be in the name of the firm and not in that of the individual and that, for a breach of this condition, the preliminary deposit will be forfeited and the tender declared informal.

Tenders, enclosed in a separate envelope, and having the words "Tender for at" (as the case may be) written thereon, must be deposited in the Tender-box at the Tender Board Offices, Gisborne-street, Melbourne, or, if sent by post, postage must be prepaid, and the tenders addressed to the Chairman of the Tender Board, Tender Board Offices, Gisborne-street, Melbourne, C.2, which office they must reach not later than by first post on the date of closing of tenders.

CONDITIONS OF CONTRACT.

The conditions of contract are those published in the Victoria Government Gazette, No. 298, dated 19th April, 1950, pages 2348 to 2350.

J. G. B. McDONALD,

Treasurer.

The Treasury,

Melbourne, 14th August, 1950.

PRIVATE ADVERTISEMENTS.

Water Acts.

PROPOSED BARNAWARTHA WATERWORKS TRUST.

NOTICE is hereby given that the Chiltern Shire Council has made application to the Honorable the Minister of Water Supply for the constitution of a Waterworks Trust, and for the Proclamation of a waterworks district at Barnawartha, and the construction, maintenance, and continuance of water supply works within that district under the provisions of the Water Acts.

A general plan and description of the proposed works have been submitted with the application, and copies of same may be seen at municipal offices, at Chiltern.

Dated at Chiltern the 27th day of July, 1950.

3741

R. G. HATFIELD, Shire Secretary.

DANDENONG SEWERAGE AUTHORITY.

GENERAL NOTICE.

THE Dandenong Sewerage Authority, having made provision for the carrying off the sewage from each and every property within the Sewerage Area hereinafter described, doth hereby declare that on and after the 22nd day of August, 1950, each and every property which, or any part of which, is within the said Sewerage Area shall be deemed to be a sewered property within the meaning of the Sewerage Districts Act 1928.

Sewerage Area No. 10.

The Sewerage Area shall be the area comprised in lots 1, 2, 16, 15, 14, 13, block T, on lodged plan of subdivision numbered 3232.

By order of the said Authority,

VICTOR R. THARLE, Chairman.
C. H. MASTERS, Secretary.

OPTICIANS REGISTRATION ACT 1935.

LIST of alterations, additions, and removals made in the Register of Certified Opticians during the year 1949.

1. *Additions to the Register.*

- Ovenden, John Ambrose; Room 115, Capitol House, 109 Swanston-street, Melbourne; L.O.Sc.; 21st February, 1949; No. 384.
- Ovenden, George Vans; Room 115, Capitol House, 109 Swanston-street, Melbourne; L.O.Sc.; 21st March, 1949; No. 385.
- Conibear, Marcus Richard; 10 Ferndale-road, East Malvern; L.O.Sc.; 19th December, 1949; No. 389.
- Bennett, Richard Geoffrey; T. & G. Building, Liebig-street, Warrnambool; L.O.Sc.; 19th December, 1949; No. 387.
- Strachan, John Phillip Frith; 959 Canterbury-road, Box Hill; L.O.Sc.; 19th December, 1950; No. 386.
- Komesaroff, Tessa; 8 Duffy-avenue, Gardenvale; L.O.Sc.; 19th December, 1949; No. 388.

2. *Removals from Register.*

- Gaddes, Andrew Calvert; 97 Adelaide-street, Brisbane; No. 72.
- Maish, Samuel George; 10 Selwyn-avenue, Elwood; No. 193.
- Wood, William George Percy; 95 Elizabeth-street, Melbourne; No. 108.
- Sainken, Benjamin; c/o Metropole Hotel, Bourke-street, Melbourne; No. 376.

WM. J. CLARKE, Registrar.

Opticians Registration Board,
Melbourne, August, 1950. 3943

NOTICE OF INTENTION TO APPLY FOR A LICENCE TO DIVERT WATER AND CUT RACES FROM THE MURRAY RIVER, AT KARADOC.

I HEREBY give notice that I intend to apply for a licence empowering me to divert water for a term of (15) fifteen years to the extent of (9) nine acre-feet per annum at a maximum rate of 1 acre-foot per day of 24 hours for irrigation of 3 acres, being part of allotment A, Parish of Dewey, and to occupy certain Crown lands for works of storage and diversion, and to cut a race thereon.

Any objection to such application must be forwarded, in writing, to the State Rivers and Water Supply Commission, Melbourne, within 30 days of the date hereof.

MARTIN G. NIPPE.

Box 494, Redcliffs, 5th August, 1950. 3903

NOTICE OF INTENTION TO APPLY FOR A LICENCE TO DIVERT WATER AND CUT RACES FROM THE MURRAY RIVER, AT MILDURA.

I HEREBY give notice that I intend to apply for a licence empowering me to divert water for a term of 15 years to the extent of 100 acre-feet per annum at a maximum rate of 5 acre-feet per day of 24 hours for irrigation of 50 acres, being part of lots 5, 6, 7, 8, parts 16 and 17, section 9, Parish of Mildura, and to occupy certain Crown lands for works of storage and diversion, and to cut a race thereon.

Any objection to such application must be forwarded, in writing, to the State Rivers and Water Supply Commission, Melbourne, within 30 days of the date hereof.

THOMAS MAURICE DUNNE.

Box 593, Mildura, 9th August, 1950. 3904

NOTICE OF INTENTION TO APPLY FOR A LICENCE TO DIVERT WATER AND CUT RACES FROM THE LODDON RIVER, AT NEWBRIDGE.

I HEREBY give notice that I intend to apply for a licence empowering me to divert water for a term of 15 years to the extent of 100 acre-feet per annum at a maximum rate of 5 acre-feet per day of 24 hours for irrigation of 50 acres, being part of allotments 12, 13, 14, section 5, Parish of Tarnagulla, and to occupy certain Crown lands for works of storage and diversion, and to cut a race thereon.

Any objection to such application must be forwarded, in writing, to the State Rivers and Water Supply Commission, Melbourne, within 30 days of the date hereof.

ROY MAXWELL CLARK.

"Rhonda," Newbridge, 7th August, 1950. 3905

BOROUGH OF ST. ARNAUD.

NOTICE OF INTENTION TO BORROW THE SUM OF £1,000 FOR PERMANENT WORKS AND UNDERTAKINGS.

NOTICE is hereby given that the Council of the Borough of St. Arnaud proposes to borrow on the credit of the Mayor, Councillors, and Burgesses of the Borough of St. Arnaud the sum of One thousand pounds (£1,000), such sum to be raised by the issue of debentures, in accordance with the provisions of the *Local Government Act 1946*. The maximum rate of interest that may be paid is Three pounds six shillings and three pence per cent.

The moneys proposed to be borrowed are to be repayable at the National Bank, Melbourne, or the Council's bankers for the time being, by 60 half-yearly instalments, the first of which is to be paid six months after the date upon which such money is advanced to the municipality, and thereafter at the expiration of each succeeding six months in which manner the said loan is to be liquidated.

The purpose for which the loan is to be applied is—

Reconstruction of footpaths, Napier-street, St. Arnaud, at half cost to owners.

The estimate of costs of the works referred to above, and a statement showing the proposed expenditure of money to be borrowed, are open for inspection at the Town Hall, St. Arnaud, during office hours.

Dated this 9th day of August, 1950.

3908 F. E. BARTLETT, Town Clerk.

BOROUGH OF SWAN HILL.

BY-LAW No. 5.

A By-law of the Borough of Swan Hill made under the provisions of section 197 of the *Local Government Act 1946* and section 6 of the *Police Offences Act 1928*, and amendments thereof, and numbered 5, for the purpose of amending By-law No. 4 of the said Borough.

THE Mayor, Councillors, and Burgesses of the Borough of Swan Hill, in pursuance of the powers conferred by the *Local Government Act 1946* and section 6 of the *Police Offences Act 1928*, and every other power enabling them in that behalf, doth hereby make the By-law and order as follows:—

That By-law No. 4 of the said Borough be amended—

1. By repealing clause 10 and substituting therefor the following:—

"Every person parking a vehicle or leaving a vehicle standing attended or unattended in any street shall conform to the following Regulations:—

- (a) In all streets, excepting Curlewis-street and the section of Beveridge-street between McCallum-street and Pritchard-street and the section of McCrae-street between Beveridge-street and Splatt-street, cause such vehicle to be drawn up with the left or near front wheel as close as practicable to the kerb on his left or near side of the street, and as near as practicable at an angle of 45 degrees with the street, and when parking such vehicle or leaving the same stationary in any portion or section of the aforesaid streets where parking lines have been painted or indicated, or are painted or indicated at such time upon the street surface by the Council, cause the said vehicle to be parked within the limits and at the angle indicated by such parking lines. No person shall park any vehicle so that any portion of such vehicle or the load thereon, or any part of any trailer attached thereto, is of a distance greater than 16 feet from the kerb to which such vehicle is drawn up.
- (b) In Curlewis-street and the section of Beveridge-street between McCallum-street and Pritchard-street, and the section of McCrae-street between Beveridge-street and Splatt-street, cause such vehicle to be drawn up in such a position that the left or near side wheels are parallel with and as near as practicable to the kerb on his left or near side of such street, and that such vehicle is not less than 4 feet from any other vehicle.
- (c) In any section of any street in which there is a central reserve or plantation, vehicles shall be parked only on the near or building side of such streets, and excepting in the section of McCrae-street between Beveridge-street and Splatt-street referred to in sub-clause (b) hereof, as near as practicable to an angle of 45 degrees to the kerb, and in such position that the left or near front wheel is touching

the kerb, and so that no part of such vehicle is nearer than 3 feet to any other vehicle, or a distance greater than 16 feet from the kerb to which such vehicle is drawn up.

- (d) Curlewis-street and the section of Beveridge-street between McCallum-street and Pritchard-street (excepting any portion thereof reserved or set aside for other purposes as provided herein), shall be and are hereby appointed by the Council as a parking area for vehicles which, together with the load thereon, is of an overall length of more than 20 feet, or to which is attached any trailer, and a driver shall in such parking area park his vehicle as provided in sub-clause (b) hereof and in such manner as will enable him to take up or leave such position without disturbance to any other motor car or cars already parked, and also in such way as will permit the latter to leave their respective positions without difficulty, and not otherwise.
- (e) A driver shall not cause, allow, or permit a motor car or a motor car with an attached trailer of a greater overall length of 20 feet to be parked in any "parking area" in which angle parking is permitted, nor in any parking space defined by lines painted on the roadway of a length less than 20 feet."

2. This By-law shall come into operation and have effect immediately after its publication in the *Victoria Government Gazette*.

Resolution for passing this By-law No. 5 was agreed to by the Council of the Borough of Swan Hill on the 26th day of April, 1950, and confirmed on the 24th day of May, 1950.

The common seal of the Mayor, Councillors, and Burgesses of the Borough of Swan Hill was hereunto affixed the 24th day of May, 1950, in the presence of—

(SEAL) ALAN GARDEN, Mayor.
G. E. KURRELE, Councillor.
A. R. CONN, Town Clerk.

Approved by the Governor in Council, 18th July, 1950.—
A. MAHLSTEDT, Clerk of the Executive Council. 3927

SHIRE OF ALBERTON.

LOAN No. 6.

Notice of Intention to Borrow the Sum of Four Thousand Eight Hundred Pounds (£4,800) for Permanent Works and Undertakings in the Shire of Alberton.

TAKE notice that the Council of the Shire of Alberton proposes to borrow, on the credit of the President, Councillors, and Ratepayers of the said Shire, the sum of Four thousand eight hundred pounds (£4,800), such sum to be raised by the issue of debentures in accordance with the provisions of the *Local Government Act 1946*.

The rate of interest to be paid shall not exceed £3 7s. 6d. per centum per annum.

Such moneys shall be repayable by twenty equal half-yearly instalments, each including principal and interest, by providing out of the Municipal Fund such amounts on the 1st day of April and the 1st day of October in each respective year during the currency of the loan.

Such moneys shall be repayable at Melbourne at the Bank of Australasia, or at the Council's bankers for the time being in Melbourne.

The purpose for which the loan is to be applied is:—

Purchase of plant £4,800

The plans, specifications, and estimate of the cost of the works referred to above, and a statement showing the proposed expenditure of money to be borrowed, are open for inspection at the Shire Offices, Yarram.

Dated this 1st day of August, 1950.

3960 A. W. CURRY, Shire Secretary.

SHIRE OF STAWELL.

GLENORCHY WATER SUPPLY.

NOTICE is hereby given that the Council of the Shire of Stawell has made application to the Minister of Water Supply for the constitution of a Waterworks District to supply water to the Township of Glenorchy.

A general plan and description of the works has been forwarded with the application, and a copy may be inspected at the Shire Hall, Stawell.

3929 F. M. MORTYN, Shire Secretary.

SHIRE OF HAMPDEN.

APPOINTMENT OF PROSECUTING OFFICER, LISMORE.

NOTICE is hereby given that the Council of the Shire of Hampden, at its meeting held on the 4th instant, appointed James Norman Brewis, First Constable of Police, No. 7154, Prosecuting Officer at Lismore, in place of George Norman Hornsby, First Constable, who has resigned.

THOS. F. LITTLE, Shire Secretary.

Shire Office, Camperdown, 11th August, 1950. 3928

NOTICE OF DISSOLUTION OF PARTNERSHIP.

NOTICE is hereby given that the partnership heretofore subsisting between the undersigned Thomas Edward Busst, Edward James Busst, and Thomas William Busst, carrying on business as T. E. Busst and Sons, has been dissolved by mutual consent as from the 1st day of August, 1950. All debts due to and owing by the said late firm will be received and paid at the former place of business of the said firm.

Dated at Myrtleford this 8th day of August, 1950.

T. E. BUSST.
E. J. BUSST.
T. W. BUSST.

Witness to all signatures—J. E. DAILY. 3928

NOTICE is hereby given that the partnership heretofore subsisting between John Green, formerly of 8 Carrick-street, Mont Albert, in the State of Victoria, later care of 92 Coronation-parade, Enfield, in the State of New South Wales, engineer, but now of unknown address, and William Desmond Blake, formerly of 7 Buncle-street, North Melbourne, in the State of Victoria, but now of 34 Greville-street, North Essendon, in the State of Victoria, cartage contractor, carrying on business as motor vehicle distributing agents at 8 Carrick-street, Mont Albert aforesaid, under the style or name of Car Convoys, has been dissolved as from the 4th day of August, 1950.

Dated this 7th day of August, 1950.

W. D. BLAKE.

McCay and Thwaites, solicitors, Collins House, 360 Collins-street, Melbourne. 3961

NOTICE is hereby given that the partnership heretofore existing between Roy Stanley Arnel and William Henry Rice, carrying on business as public accountants at 290 Collins-street, Melbourne, under the name of Arnel and Rice, has been dissolved as from the 28th day of June, 1950.

Dated the 11th day of August, 1950.

3953 R. S. ARNEL.

NOTICE is hereby given that that partnership between Dawid Steinman and Leon Frank, carrying on business under the names of Sydmel Trading Company and Frank and Steinman, has been dissolved by mutual consent as at the 9th of August, 1950. All debts due and owing by the firm Sydmel Trading Company will be received and paid by the said Dawid Steinman, and all debts due and owing by the firm Sydmel Trading Company will be received and paid by the said Leon Frank.

DAWID STEINMAN.
LEON FRANK.

N. Jacobson, LL.B., solicitor, 330 Little Collins-street, Melbourne. 3957

NOTICE is hereby given that the partnership heretofore carried on at 9 Takapuna-street and at 49 Russell-street, Melbourne, by Thomas Joseph Holland and Leo Charles Coy, under the name of "Capital Motor School," has been dissolved. The business will be carried on under the same name by the said Thomas Joseph Holland.

Dated the 4th day of August, 1950.

3931

NOTICE is hereby given that the partnership heretofore subsisting between Frank Whistler Baker and Leonard Henry Gillam, carrying on business under the name of Durham Displays, as window dressers, ticket writers, and advertising contractors, at 69 Hardware-street, Melbourne, has been dissolved by mutual consent as at the 10th day of August, 1950. All debts due to and owing by the said late firm will be received and paid by the said Leonard Henry Gillam, who will continue to carry on the said business at the same address.

FRANK BAKER.
L. H. GILLAM.

Keith Hercules, LL.B., solicitor, 443 Little Collins-street, Melbourne. 3917

NOTICE is hereby given that the partnership heretofore subsisting between the undersigned James Arthur Wilkie and George Leopold Punshon, carrying on business as estate agents and auctioneers at, 20 Lydiard-street south, Ballarat, under the name of Punshon and Wilkie, has been dissolved by mutual consent as from the 30th day of June, 1950. All debts due to and owing by the said late firm will be received and paid by George Leopold Punshon, who will continue to carry on the business at the same place, in partnership with Donald Newton Punshon, under the name of Punshon and Wilkie.

Dated at Ballarat, the 1st day of July, 1950.

GEO. L. PUNSHON.
JAMES A. WILKIE.

Witness—W. H. HEINZ, solicitor, Ballarat. 3924

SCOTT & DUNBAR PROPRIETARY LIMITED.

AT an Extraordinary General Meeting of the above-named company, duly convened and held at 456 Little Collins-street, Melbourne, on Monday, the 7th day of August, 1950, the following Resolution was duly passed as a Special Resolution:—

“That the company be wound up voluntarily, and that Jean Mitchell Kerr, of 29 Dominic-street, Camberwell, clerk, be appointed liquidator for the purposes of such winding up.”

Dated the 10th day of August, 1950.

B. G. MEAGHER, Chairman.

Coltman, Wyatt, and Anderson, solicitors, 456 Little Collins-street, Melbourne. 3916

Companies Act 1938.

MADAME POMPADOUR PROPRIETARY LIMITED (IN VOLUNTARY LIQUIDATION).

NOTICE OF FINAL MEETING.

NOTICE is hereby given, in pursuance of section 236 of the *Companies Act 1938*, that a General Meeting of the members of the above-named company will be held at the office of the liquidator, at 68 Elizabeth-street, Melbourne, on Wednesday, the 20th day of September, 1950, at Three o'clock in the afternoon, for the purpose of having an account laid before them showing the manner in which the winding up has been conducted and the property of the company disposed of, and of hearing any explanation that may be given by the liquidator.

Dated this 10th day of August, 1950.

3909 G. G. MASON, Liquidator.

Form No. 49.

CORIO ENGINEERING COMPANY PROPRIETARY LIMITED.

SPECIAL RESOLUTION TO WIND UP, PURSUANT TO SECTION 226.

AT an Extraordinary General Meeting of the above-named company, duly convened and held at 55 Yarra-street, Geelong, on Thursday, the 10th day of August, 1950, the following Resolution was duly passed as a Special Resolution:—

“That the company be wound up voluntarily.”

And at such last-mentioned meeting, Eric Raymond Grills, of 55 Yarra-street, Geelong, was appointed liquidator for the purposes of the winding up.

Dated the 10th day of August, 1950.

3906 L. C. CROWLEY, Chairman.

In the matter of the *Companies Act 1938* and in the matter of SPEEDEX (AUSTRALIA) LIMITED (in Voluntary Liquidation).

AT an Extraordinary General Meeting of Speedex (Australia) Limited held at the registered office of the company on 9th August, 1950, the following Resolution was passed as a Special Resolution:—

“That since the company has ceased trading it is advisable to wind it up voluntarily, and that L. K. Cronin, chartered accountant (Aust.), of 252 Swanston-street, Melbourne, be and is hereby appointed liquidator for the purpose of such winding up.”

NOTE.—The above notice is given solely to comply with provisions of the *Companies Act 1938*. There are no trade creditors, and the whole of the assets are being acquired by Modern Office Equipment.

Dated at Melbourne this 10th day of August, 1950.

3901 L. K. CRONIN, Liquidator.

A. GERBES & SONS PTY. LTD.

SPECIAL RESOLUTION TO WIND UP, PURSUANT TO SECTION 226, COMPANIES ACT 1938.

AT an Extraordinary General Meeting of the above-named company, duly convened and held at the registered office of the company, Glass-street, Richmond, on Friday, the 4th day of August, 1950 the following Resolution was duly passed as a Special Resolution:—

“That the company be wound up voluntarily.”

At such last-mentioned meeting, Jack Crownson Harris, of Sherlock and Wilson, 352 Collins-street, Melbourne, was appointed liquidator for the purposes of winding up.

Dated this 7th day of August, 1950.

3963 W. M. GERBES, Chairman.

PETERSHAM COMPANY PROPRIETARY LIMITED.

NOTICE is hereby given that at an Extraordinary General Meeting of Petersham Company Proprietary Limited held at the office of Messrs. W. T. Forster and Germon, 5th Floor, 31 Queen-street, Melbourne, on Monday, 7th August, 1950, the following Special Resolution was duly passed:—

“That the company be wound up voluntarily, and that W. T. Forster, chartered accountant, 5th Floor, 31 Queen-street, Melbourne, be, and he is hereby appointed liquidator for the purposes of such winding up.”

W. T. FORSTER, Liquidator.

31 Queen-street, Melbourne, 9th August, 1950. 3899

Trustee Act 1928.

NOTICE TO CLAIMANTS.

PURSUANT to the *Trustee Act 1928*, creditors, next of kin, and all other persons having claims in respect of the estate of any deceased person named below are required to send particulars thereof to the legal personal representative or representatives at the address stated below, on or before the date stated, after which date the representative or representatives will distribute the assets, having regard only to the claims of which notice has been received:—

George Falconer, late of 90 Swanston-street, Geelong, in the State of Victoria, house decorator, died on the 26th day of June, 1950.—Claims to Norman George Falconer, Clifford Henry Falconer, and Harold Henry Wilks Russenberger, care of Doyle and Kerr, solicitors, Little Malop-street, Geelong, by the 1st of November, 1950. 3926

Frank Phillips (otherwise called Francis Charles Phillips), late of Irrewillipe East, farmer, died 10th May, 1950.—Claims to the executor, George Walter Phillips, of Irrewillipe East, farmer, by 16th October, 1950. Sewell and Sewell, solicitors, Colac. 3944

Emma Moore, late of Fairley, widow, died 11th April, 1950.—Claims to the administrator, David William Moore, care of Willan and McKenzie, solicitors, 46 Wellington-street, Kerang, by 19th October, 1950. 3935

John Henry Richard Broughton, generally known as John Henry Broughton, late of 25 Wills-street, Balwyn, retired farmer, deceased, died on 17th March, 1950.—Claims to the Union Trustee Company of Australia Limited, of Collins-street, Melbourne, by 17th October, 1950. 3920

Elizabeth Cairns Robinson, late of Princes Highway, Port Fairy, widow, deceased, died 22nd March, 1950.—Claims to the executrix, Margaret Wallace Robinson, of Port Fairy, spinster, care of J. W. Powling, solicitor, Port Fairy, by 2nd November, 1950. 3930

Thomas James Gibson, late of 32 Newcastle-street, East Preston, accountant, died 16th March, 1950.—Claims to the executor, The Equity Trustees, Executors, and Agency Company Limited, of 472 Bourke-street, Melbourne, by the 18th October, 1950. Maddock, Lonie, and Chisholm, solicitors, 339 Collins-street, Melbourne. 3910

Mary Gibson, late of 35 Davis-street, North Carlton, widow, died 1st February, 1950.—Claims to the administrator, The Equity Trustees, Executors, and Agency Company Limited, of 472 Bourke-street, Melbourne, by the 18th October, 1950. Maddock, Lonie, and Chisholm, solicitors, 339 Collins-street, Melbourne. 3911

CREDITORS, next of kin, and others having claims in respect of the estate of Joseph Robert Edge, late of 1 Franklin-street, Maryborough, of no occupation, deceased (who died on the 19th day of June, 1950), are to send the particulars of their claims to Harry Lloyd Bathurst, of Maryborough, solicitor, care of the undersigned solicitors, by the 25th day of October, 1950, after which date he will distribute the assets, having regard only to the claims of which he then has notice.

HERRING & BATHURST, solicitors, Maryborough.
3942

NOTICE TO CLAIMANTS.—RALPH JAMES KENNON, DECEASED.

CREDITORS, next of kin, and others having claims in respect of the estate of Ralph James Kennon, late of Moore-street, Hawthorn, in Victoria, gentleman, deceased (who died on the 14th day of May, 1950), are to send particulars of their claims to The Equity Trustees, Executors, and Agency Company Limited, at its registered office, No. 472 Bourke-street, Melbourne, by the 18th day of October, 1950, after which date the said company will distribute the assets, having regard only to the claims of which it then has notice.

Dated 10th day of August, 1950.

J. M. SMITH & EMMERTON, 480 Bourke-street, Melbourne, solicitors for the said company. 3945

NOTICE TO CREDITORS AND OTHERS.

PURSUANT to the *Trustee Act 1928*, notice is hereby given that all persons having claims against the estate of Arthur Stanley Turner, late of 40 Holyrood-street, Hampton, in the State of Victoria, traveller, deceased (who died on the 3rd day of April, 1950, and probate of whose will was granted by the Supreme Court of the State of Victoria, in its probate jurisdiction, on the 8th day of August, 1950, to Florence Jane Turner, of 40 Holyrood-street, Hampton, in the State of Victoria, widow of the said deceased, the executrix named in and appointed by the said will), are hereby required to send particulars, in writing, of such claims to the said Florence Jane Turner, at the office of her under-mentioned solicitors, on or before the 23rd day of October, 1950. And notice is hereby also given that after the last-mentioned date the said Florence Jane Turner will proceed to distribute the assets of the said Arthur Stanley Turner, deceased, amongst the persons entitled thereto, having regard only to the claims of which she shall then have had notice, and the said Florence Jane Turner will not be liable for the assets, or any part thereof, so distributed to any person of whose claim she shall not then have had notice.

Dated the 11th day of August, 1950.

A. L. C. FLINT & MARRIE, of 90 Queen-street, Melbourne, solicitors for the applicant. 3947

PURSUANT to the *Trustee Act 1928*, notice is hereby given that all persons having claims against the estate of Michael Finnigan, late of Cororooke, in the State of Victoria, farmer (who died on the 10th day of May, 1950, and probate of whose will was granted to Francis John Finnigan, farmer, and Eileen Margaret Willis, married woman, both of Cororooke aforesaid), are hereby required to send particulars, in writing, of such claims to the executors, care of the undersigned, on or before the 6th day of November, 1950, after which date the said executors will proceed to distribute the estate of the testator amongst the persons entitled thereto, having regard only to the claims of which they shall then have had notice, and will not be liable for the assets so distributed, or any part thereof, to any person of whose claim they shall not have had notice.

Dated 14th day of August, 1950.

CUNNINGHAM & LARKINS, of Murray-street, Colac, solicitors for the applicants. 3946

NOTICE TO CLAIMANTS.

CREDITORS, next of kin, and others having claims in respect of the estate of Dora Rosa Vosz McKernan, late of Euroa, in the State of Victoria, widow, deceased (who died on the 1st day of June, 1950), are to send the particulars of their claims to the National Trustees, Executors, and Agency Company of Australasia Limited, whose registered office is situate at 95 Queen-street, Melbourne, in the State of Victoria, by the 17th day of October, 1950, after which date it will distribute the assets, having regard only to the claims of which it then has notice.

J. J. TEHAN & KIRBY, Binney-street, Euroa, solicitors. 3948

CREDITORS, next of kin, and others having claims in respect of the estate of Walter Almond Cerini, late of 1514 High-street, Glen Iris, leather merchant (who died on the 28th day of April, 1950), are to send the particulars of their claims to The Trustees, Executors, and Agency Company Limited, of 401 Collins-street, Melbourne, by the 18th day of October, 1950, after which date it will distribute the assets, having regard only to the claims of which it then has notice.

RUSSELL, KENNEDY, & COOK, solicitors, 401 Collins-street, Melbourne. 3949

NOTICE TO CLAIMANTS.—In the estate of MARY HANNAH McLEOD, late of 341 High-street, Prahran, in the State of Victoria, widow, DECEASED.

PURSUANT to the *Trustee Act 1928*, all persons having claims against the estate of the above-named deceased (who died on the 13th day of April, 1950, and probate of whose will and codicil thereto was granted by the Supreme Court of Victoria, in its probate jurisdiction, on the 9th day of August, 1950, to Norman McLeod, of 341 High-street, Prahran, in the State of Victoria, medical practitioner, Maisie Buzzard, of Liebig-street, Warrnambool, in the said State, married woman, and The Equity Trustees, Executors, and Agency Company Limited, of 472 Bourke-street, Melbourne, in the said State, the executors and executrix appointed by the said will and codicil), are hereby required to send particulars, in writing, of such claims to the said The Equity Trustees, Executors, and Agency Company Limited, at its address aforesaid, on or before the 20th day of October, 1950, after which date the estate and assets of the said deceased will be distributed by the said executors and executrix, having regard only to the claims of which notice has then been received by the said The Equity Trustees, Executors, and Agency Company Limited.

Dated this 15th day of August, 1950.

J. H. S. CAMPBELL & SON, solicitors, 433 Little Collins-street, Melbourne. 3952

NOTICE TO CREDITORS.

PURSUANT to the *Trustee Act 1928*, notice is hereby given that all persons having claims against the estate of Albert Long, late of Denman-street, North Brunswick, accountant, deceased (who died on the 18th day of June, 1950), are hereby required to send particulars, in writing, of such claims to The National Trustees, Executors, and Agency Company of Australasia Limited, 95 Queen-street, Melbourne, and William Borthwick, of 56 Madeline-street, East Preston, dental technician, the executors of the will of the said deceased, to the care of the said National Trustees, Executors, and Agency Company of Australasia Limited, at its registered office at 95 Queen-street, Melbourne aforesaid, on or before the 23rd day of October, 1950, after which date the said National Trustees, Executors, and Agency Company of Australasia Limited and the said William Borthwick will proceed to distribute the assets of the said Albert Long, deceased, which shall have come to their hands, amongst the persons entitled thereto, having regard only to the claims of which they shall then have had notice. And notice is hereby further given that the said National Trustees, Executors, and Agency Company of Australasia Limited and the said William Borthwick will not be liable for the assets so distributed, or any part thereof, to any person of whose claim they shall not have had notice as aforesaid.

Dated this 14th day of August, 1950.

JOHN P. RHODEN, of 376 Collins-street, Melbourne, solicitor for the said executors. 3962

ALL persons having claims against the estate of Vincent Paul Williams, formerly of 41 Harcourt-street, Hawthorn, in the State of Victoria, but late of 157 Wattle Valley-road, East Camberwell, in the said State, chartered accountant, deceased (who died on the 27th day of May, 1950, and probate of whose will has been applied for by National Trustees, Executors, and Agency Company of Australasia Limited, whose registered office is 95 Queen-street, Melbourne, in the said State), are hereby required to send particulars, in writing, of such claims to the said company, at its registered address aforesaid, on or before the 17th day of October, 1950, after which last-mentioned date the said company will proceed to distribute the assets of the said deceased amongst the persons entitled thereto, having regard only to the claims of which it shall then have had notice, and will not be liable for the assets, or any part thereof, so distributed to any person of whose claim it shall not have had notice as aforesaid.

BERNARD NOLAN, solicitor, 408 Collins-street, Melbourne. 3951

CREDITORS, next of kin, and others having claims in respect of the estate of Julia Mary Stutt, late of 17 Simpson-street, East Melbourne, Victoria, deceased (who died on the 17th day of February, 1950), are to send particulars of their claims to National Trustees, Executors, and Agency Company of Australasia Limited, whose registered office is situate at 95 Queen-street, Melbourne, by the 23rd day of October, 1950, after which date it will distribute the assets, having regard only to the claims of which it then has notice.

GILLOTT, MOIR, & AHERN, solicitors, 95 Queen-street, Melbourne. 3955

ADA GRACE GOODWIN, late of Toongabbie, Gippsland, married woman, DECEASED.

CREDITORS, next of kin, and all other persons having claims against the estate of the above-named deceased are required by The Trustees, Executors, and Agency Company Limited, of 401 Collins-street, Melbourne, and Andrew Robert Theodore Goodwin, of Toongabbie, Gippsland, retired traveller, the executors of the will of the deceased, to send particulars of such claims to them, in care of the said company, on or before the 23rd day of October, 1950, after which date they will distribute the assets, having regard only to the claims of which they then have notice.

A. G. HALL & WILCOX, solicitors, 20 Queen-street, Melbourne. 3956

PURSUANT to the *Trustee Act* 1928, notice is hereby given that Vincent James Simpson, executor of the will of Teresa May Oliver (also known as Teresa Oliver), formerly of 6 Jolimont-street, Jolimont, and 109 Gardenvale-road, Gardenvale, married woman, and Albert Park Hotel, Dundas-place, Albert Park, but late of 7A Brook-street, Hawthorn, widow, deceased (who died on 26th June, 1950), intends to convey or distribute the estate of deceased to or among the persons entitled thereto, and requires all persons interested to send to the executor, care of G. A. Hilford, 19 Queen-street, Melbourne, on or before 25th October, 1950, particulars, in writing, of their claims against the said estate, after which date the executor may convey or distribute the said estate to or among the persons entitled thereto, having regard only to claims of which he then has notice.

G. A. HILFORD, solicitor, 19 Queen-street, Melbourne. 3950

MATILDA MCOWAN, late of Oxford Chambers, 473 Bourke-street, Melbourne, in the State of Victoria, widow, DECEASED (who died on 26th June, 1950).

CREDITORS, next of kin, and other persons having claims against the estate of the said deceased are required by John Allan Nixon, of 32 Braemar-street, Essendon, gentleman, Basil Allan Nixon, of 16 Locke-street, Essendon, bank officer, and Edgar Robert Marchant, of 164 Esplanade, Middle Brighton, accountant, all in the State of Victoria, the executors of the will of the said deceased, to send particulars of claims, in writing, to any one of the said executors, at their respective addresses aforesaid, on or before the 20th day of October, 1950, after which date the said executors will distribute the assets, having regard only to the claims of which they shall then have had notice.

MADDEN, BUTLER, ELDER, & GRAHAM, 406 Collins-street, Melbourne. 3959

STATUTORY NOTICE TO CREDITORS.

PURSUANT to the *Trustee Act* 1928, notice is hereby given that all persons having claims against the estate of Ann Macdonald, formerly of Cowley's Creek, in the State of Victoria, but late of 42 Shannon-avenue, Newtown, Geelong, in the said State, spinster, deceased (who died on the 9th day of September, 1949, and probate of whose will was granted by the Supreme Court of the said State, in its probate jurisdiction, on the 3rd day of April, 1950, to The Equity Trustees, Executors, and Agency Company Limited, of 472 Bourke-street, Melbourne, in the said State, and George Alexander Cameron, of Connewarre, in the said State, farmer), are hereby required to send particulars, in writing, of such claims to the said executors, in care of the undersigned, at their address hereunder mentioned, on or before the 20th day of October, 1950, after which date the said executors will proceed to distribute the assets of the said Ann Macdonald, deceased, which shall have come to their hands amongst the persons entitled thereto, having regard only to the claims of which they shall have had notice.

Dated the 4th day of August, 1950.

ARTHUR E. GEORGE & SONS, Curdie-street, Cobden. 3936

CREDITORS, next of kin, and others having claims in respect of the estate of Marion Griffith Baker, formerly of 14 Oban-street, Hawksburn, and 79 Hawksburn-road, South Yarra, but late of 19 Ludbrook-avenue, Caulfield, in Victoria, spinster, deceased (who died on the 25th April, 1950), are to send the particulars of their claims to The Perpetual Executors and Trustees Association of Australia Limited, of 100-104 Queen-street, Melbourne, in the said State, by the 18th day of October, 1950, after which date it will distribute the assets, having regard only to the claims of which it then has notice.

LUCAS & MUMME, 383 Little Flinders-street, Melbourne, proctors for the said company. 3958

WILLIAM COOK, formerly of 47 Doveton-street, Castle-maine, in the State of Victoria, but late of Woodvale, in the said State, retired farmer (who died on 25th February, 1950).

CREDITORS, next of kin, and all other persons having claims against the estate of the deceased are required by the executor of the will, William Maitland McLean Reid, of Malop-street, Geelong, in the State of Victoria, estate agent, to send particulars to him, care of the undersigned solicitor, on or before the 19th October, 1950, after which date he will distribute the assets, having regard only to the claims of which he then has notice.

ROY D. BIRDSEY, solicitor, Bank of New South Wales Building, Ryrie-street, Geelong. 3922

CREDITORS, next of kin, and others having claims against the estate of George William Watkins, late of Melbourne-road, Creswick, in the State of Victoria, pensioner, deceased (who died on the 8th day of April, 1950), are required to send particulars of their claims to the executor, Elliot Thomas Morris, of Creswick, care of the undersigned, by the 16th day of October, 1950, after which date he will distribute the assets, having regard only to the claims of which he then has notice.

NEVETT, NEVETT, & GLENN, 11 Lydiard-street south, Ballarat. 3923

BETSY CAMPBELL, late of "Dhachi," Macedon, in the State of Victoria, widow, DECEASED.

ALL creditors, next of kin, and others having claims upon the estate of the said deceased (who died on the 6th day of June, 1950, and probate of whose will was granted by the Supreme Court of Victoria, on the 18th day of July, 1950, to Maurice Hurry and Henry Bruce Stewart, both of Kyneton, in the said State, solicitors), are required to send particulars, in writing, of such claims to the said executors, at the office of the undersigned, at Kyneton, before the 31st day of October, 1950, after which date they will proceed to convey or distribute the said estate to or among the persons entitled thereto, having regard only to the claims, whether formal or not, of which they shall then have had notice.

H. HURRY & SON, solicitors, Kyneton, and at Woodend and Gisborne. 3925

CREDITORS, next of kin, and others having claims in respect of the estate of Amelia Waterhouse, formerly of 314 Lydiard-street north, Ballarat, in the State of Victoria, married woman, but late of 102 Ascot-street south, Ballarat aforesaid, widow, deceased (who died on the 7th day of April, 1950), are to send particulars of their claims to The Fidelity Trustee Company Limited (formerly The Ballarat Trustees, Executors, and Agency Company Limited), of 101 Lydiard-street north, Ballarat aforesaid, by the 18th day of October, 1950, after which date it will distribute the assets, having regard only to the claims of which it then has notice.

Dated the 8th day of August, 1950.

CUTHBERT, MORROW, MUST, & SHAW, solicitors, Lydiard-street, Ballarat. 3896

RACHEL LYNESS, late of Nelson-street, Colac, in the State of Victoria, widow, DECEASED (who died on 10th May, 1950).

CREDITORS, next of kin, and all others having claims against the estate of the above-named deceased are required by the executors, Thomas John Lyness, of Colac, farmer, William Lyness, of Carlisle River, farmer, and Queenie McCallum, of Rokewood Junction, married woman, to send particulars thereof to them, care of the under-mentioned solicitors, on or before 20th October, 1950, after which date they will distribute the assets of the said deceased, having regard only to the claims of which they shall then have had notice.

ST. JOHN CLARKE, MITCHELL, & BARWOOD, solicitors, 1 Murray-street, Colac. 3898

CREDITORS, next of kin, and others having claims in respect of the estate of John Lean, late of Maryborough, agent, deceased (who died on the 17th day of April, 1950), are to send the particulars of their claims to The Fidelity Trustee Company Limited, of 101 Lydiard-street north, Ballarat, by the 22nd day of October, 1950, after which date it will distribute the assets, having regard only to the claims of which it then has notice.

HERRING & BATHURST, solicitors, Maryborough. 3897

SINA ELIZA ALGIE, late of Swan Hill, in the State of Victoria, widow, DECEASED (who died on the 21st day of June, 1950).

CREDITORS, next of kin, and all other persons having claims against the estate of the deceased are required by the executrix of the will, Ina Mary Grace Brace, of Swan Hill aforesaid, widow, to send particulars to her, care of the undersigned, on or before the 8th day of November, 1950, after which date she will distribute the assets, having regard only to the claims of which she then has notice.

Dated the 8th day of August, 1950.

ALAN GARDEN & GREEN, solicitors, McCallum-street, Swan Hill. 3902

ALL persons having claims against the estate of Lillian Farley, late of 10 Emery-street, Preston, in Victoria, married woman, deceased (who died on the 26th day of June, 1950), are required to send particulars, in writing, of such claims to William Valentine Farley, the executor of her will, in care of the undersigned solicitor, on or before the 18th day of October, 1950, after which date the said executor will distribute the assets of the deceased, having regard only to the claims of which he shall then have had notice.

ERNEST ALLEN, solicitor, 443 Little Collins-street, Melbourne. 3915

FRED PARTRIDGE, formerly of Harcourt, orchardist and dairy farmer, but late of Thomastown, in the State of Victoria, grazier and dairy farmer, DECEASED (who died on the 2nd day of April, 1950).

CREDITORS, next of kin, and all other persons having claims against the estate of the said deceased are required by the sole executor, Farmers and Citizens Trustees Company Bendigo Limited, of Charing Cross, Bendigo, to send particulars thereof to it, on or before the 16th day of October, 1950; after which date it will distribute the assets, having regard only to claims of which it then has notice.

Dated the 8th day of August, 1950.

ERNEST S. CAHILL & SON, of A.M.P. Buildings, View Point, Bendigo, solicitors for the executor. 3907

CREDITORS, next of kin, and others having claims in respect of the estate of Elizabeth McBride, late of Commercial-street, Kaniva, in the State of Victoria, widow, deceased (who died on the 25th day of February, 1950), are to send the particulars of their claims to her executors, National Trustees, Executors, and Agency Company of Australasia Limited, at its registered office, situate at 95 Queen-street, Melbourne, in the said State (the applicant for a grant of probate herein), by the 26th day of October, 1950, after which date it will distribute the assets, having regard only to the claims of which it then has notice.

LUKE MURPHY & CO., 422 Bourke-street, Melbourne, solicitors for the said company. 3912

CREDITORS, next of kin, and others having claims in respect of the estate of Percy Richard Holmes Powlitch, late of 42 Breeze-street, Brunswick, cellarman, deceased (who died on the 21st day of December, 1949), are required to send particulars of their claims to the executor, Colin Keon-Cohen, on or before the 1st day of November, 1950, after which date he will distribute the assets, having regard only to the claims of which he then has notice.

Dated this 8th day of August, 1950.

COLIN KEON-COHEN, 472 Bourke-street, Melbourne, solicitor. 3913

CREDITORS, next of kin, and others having claims in respect of the estate of Elsie Lillian Millward, late of 63 Cromwell-street, South Yarra, in the State of Victoria, married woman, deceased (who died on the 27th December, 1949), are to send particulars of their claims to The Perpetual Executors and Trustees Association of Australia Limited and Charles George Millward, at the registered office of the said company, at 100-104 Queen-street, Melbourne, by the 20th day of October, 1950, after which date they will distribute the assets, having regard only to the claims of which they then have notice.

Dated the 9th day of August, 1950.

CORR & CORR, solicitors, 104 Queen-street, Melbourne. 3914

CREDITORS, next of kin, and others having claims in respect of the estate of Mercy Spencer, late of Portland, in the State of Victoria, widow, deceased (who died on the 7th day of June, 1950, and probate of whose will was granted by the Supreme Court of Victoria on the 28th day of July, 1950, to Stanley Edward Oakley, farmer, and James Valentine Hickey, mail contractor, both of Portland aforesaid), are hereby required to send particulars of such claims to the said executors, in care of the undersigned, on or before the 14th day of October, 1950, after which date the said executors will proceed to distribute the assets of the said deceased amongst the persons entitled thereto, having regard only to the claims of which they shall have then had notice.

Dated the 7th day of August, 1950.

HARRIS & WILLIAMSON, Portland, solicitors for the said executors. 3900

CREDITORS, next of kin, and others having claims in respect of the estate of Sydney Bateson Wright, late of 80 Shannon-street, Box Hill, Board of Works employee, deceased, intestate (who died 6th May, 1942, and letters of administration of whose estate were granted to Alice Jane Wright, of 80 Shannon-street, Box Hill, widow, the administratrix), are to send particulars of their claims to the said administratrix, care of the undersigned solicitors, on or before the 17th October, 1950, after which date the said administratrix will distribute the assets, having regard only to the claims of which notice has then been received.

E. A. ATKYNS & SON, 422 Little Collins-street, Melbourne. 3918

PURSUANT to the *Trustee Act 1928*, notice is hereby given that all creditors, next of kin, and others having claims against the property or estate of George Percival Chapman, late of 107 Thomson-street, Northcote, carrier, deceased (who died on the 9th day of April, 1950, and probate of whose will was granted by the Supreme Court of Victoria to the executors, Thelma Chapman, of 107 Thomson-street, Northcote, widow, and Arthur Gordon Lewis, of 11 Lumeah-road, Caulfield, traveller), are hereby required to forward particulars, in writing, of their claims to the said executors, in care of the undersigned solicitors, on or before the 20th day of October, 1950, after which date the said executors will convey or distribute such property or estate to or amongst the persons entitled, having regard only to those claims of which they shall then have had notice.

W. H. FLOOD & PERMEZEL, 379 Collins-street, Melbourne, solicitors for the executors. 3919

WILLIAM PROTHEROE, late of 93 Hope-street, Geelong West, Storeman, DECEASED.

NOTICE is hereby given that all persons having claims against the property or estate of William Protheroe, late of 93 Hope-street, Geelong West, storeman, deceased (who died on the 16th day of December, 1949, and letters of administration of whose estate were granted to Eustace Howard Wilson, of 51 Yarra-street, Geelong, solicitor), are hereby required to send, in writing, particulars of such claims to the said Eustace Howard Wilson, on or before the 20th day of October, 1950, after which date he will convey or distribute such property or estate to or among the persons entitled thereto, having regard only to the claims of which he shall then have had notice.

HARWOOD & PINCOTT, solicitors, 51 Yarra-street, Geelong. 3921

IMPOUNDINGS.

BALLARAT.—Impounded in the Ballarat Shire Pound.

1 Black Poll springer, no visible brand
 1 yellow cow, no visible brand, roan heifer at foot
 1 small red heifer, no visible brand
 1 small black heifer, no visible brand
 1 small white bull, no visible brand
 If not claimed and expenses paid, to be sold on 30th August, 1950.
 3941—9/2 H. WILSON, Poundkeeper.

COBRAM.—Impounded at Cobram, by E. C. Nunn.

1 small bay draught gelding, docked tail, large blaze on face, white legs, indistinct brand like O over M14 on off shoulder
 If not claimed and expenses paid, to be sold on 1st September, 1950.
 3965—7/4 L. G. HAMILTON, Poundkeeper.

COBURG.—Impounded at Coburg.

1 roan and white pony gelding, rope on neck, no visible brand
 If not claimed and expenses paid, to be sold on 30th August, 1950.
 3967—6/5 E. S. McNABB, Poundkeeper.

COLERAINE.—Impounded by Mrs. J. Arthur.

No. 44.—1 red yearling steer, white on forehead, slice bottom near ear, no visible brand
 If not claimed and expenses paid, to be sold on 2nd September, 1950.
 3933—6/5 S. R. DOLMAN, Poundkeeper.

DANDENONG.—Impounded from Dandenong Sale Yards, by Shire Ranger E. Osborne.

1 black and white heifer, no visible brand
 If not claimed and expenses paid, to be sold on 29th August, 1950.
 3937—6/5 A. WALKER, Poundkeeper.

DROMANA.—Impounded at Dromana.

1 bay gelding hack, white speck on forehead, no visible brand
 If not claimed and expenses paid, to be sold on 31st August, 1950.
 3939—6/5 J. A. McCUBBIN, Poundkeeper.

FOSTER.—Impounded from Toora Township.

1 bay and white horse, branded like C or G
 1 red and white heifer, no visible brand
 Impounded from O'Gradys Ridge-road.
 1 brown and white heifer, no visible brand
 1 blue roan heifer, no visible brand
 1 red heifer, white face, no visible brand
 1 red and white steer, no visible brand
 1 yellow and white cow, top off ear, no visible brand
 1 yellow and white cow, top out of ear, no visible brand
 If not claimed and expenses paid, to be sold on 1st September, 1950.
 3938—12/10 I. MORRIS, Poundkeeper.

HUNTLY.—Impounded at Huntly, by E. Morris.

1 white roan heifer, T on off rump
 If not claimed and expenses paid, to be sold on 31st August, 1950.
 3964—5/6 R. TANNOCK, Poundkeeper.

LARA.—Impounded by Road Ranger Hooper.

1 light-chestnut mare, white blaze on head, white hind fetlocks, no visible brand
 1 bay pony mare, no visible brand
 If not claimed and expenses paid, to be sold on 2nd September, 1950.
 3932—7/4 STEPHEN GROVES, Poundkeeper.

MILDURA.—Impounded at Lake Benetook (Mildura).

1 brown draught mare, blazed face, hind feet white, rope around neck, like W in diamond near shoulder
 1 brown draught mare, blazed face, near front and off hind foot white, no visible brand
 If not claimed and expenses paid, to be sold on 31st August, 1950.
 3966—8/3 S. C. JESSOP, Poundkeeper.

WODONGA.—Impounded at Wodonga, on 3rd August, 1950.

1 aged bay cart mare, small star on forehead, like T.G. near shoulder
 If not claimed and expenses paid, to be sold on 2nd September, 1950.
 3968—7/4 J. W. COLE, Poundkeeper.

YARRAGON.—Impounded at Yarragon.

1 dark-tan Jersey heifer, no visible brand
 If not claimed and expenses paid, to be sold on 30th August, 1950.
 3940—5/6 P. FLETCHER, Poundkeeper.

STATE ACTS, 1946.

COPIES of the following Acts of Parliament of Victoria may be obtained at the Government Printing Office, or from any bookseller, at the price set opposite to each:—

No.	Price.
	s. d.
5109. Geelong Land	0 6
5110. Transport Regulation (Amendment) .. .	0 6
5111. Factories and Shops (Annual Holidays) .. .	0 9
5112. Mornington Sewerage Authority (Validation) .. .	0 6
5113. Local Government (Emergency Housing Accommodation) Amendment .. .	0 6
5114. Housing (Commonwealth and State Agreement) .. .	1 0
5115. Factories and Shops (Early Closing) .. .	0 6
5116. Building Operations and Building Materials Control .. .	C 9
5117. Water (Levee Banks) .. .	0 9
5118. Co-operative Housing Societies .. .	0 6
5119. Local Government (Municipal Rolls) .. .	0 6
5120. Public Works Loan and Application .. .	0 6
5121. Totalizator (Charities) .. .	0 6
5122. Drought Relief .. .	0 6
5123. Taxation (Arrangements) .. .	0 6
5124. Public Service .. .	1 6
5125. Teaching Service .. .	1 3
5126. Police Regulation .. .	1 0
5127. Railways (Long Service) .. .	0 6
5128. Workers' Compensation .. .	1 6
5129. Sewerage Districts (Amendment) .. .	0 6
5130. Factories and Shops (Bread) .. .	0 6
5131. Crimes (Indeterminate Sentences) .. .	0 6
5132. Medical (Chemists' Apprentices) .. .	0 6
5133. Soldier Settlement (Amendment) .. .	0 6
5134. Consolidated Revenue .. .	0 6
5135. Consolidated Revenue .. .	0 6
5136. Apprenticeship .. .	0 6
5137. Consolidated Revenue .. .	0 6
5138. Consolidated Revenue .. .	0 6
5139. Consolidated Revenue .. .	0 6
5140. Nicholson-street Tramway Construction .. .	0 6
5141. Burke-road Tramway Construction .. .	0 6
5142. Ballarat Gas Company's .. .	0 6
5143. Melbourne and Metropolitan Board of Works (Contributions) .. .	0 6
5144. Stamps (Betting Tax) .. .	0 6
5145. Juries (Fees) .. .	0 6
5146. Cattle and Swine Compensation .. .	0 6
5147. Marine (Pilots and Pilotage Rates) .. .	0 6
5148. Patriotic Funds .. .	0 6

STATE ACTS, 1946—continued.

No.	Price.	s. d.	
		s.	d.
5149. Stock Foods (Amendment)	0	6	
5150. Municipal Endowment (Temporary Discontin- uance)	0	6	
5151. Medical Practitioners' Registration	0	6	
5152. Seeds	0	6	
5153. Water	0	6	
5154. Clifton Hill Land	0	6	
5155. Tobacco Sellers	0	6	
5156. Country Roads Board Fund (Amendment)	0	6	
5157. Moorpanyal Land	0	6	
5158. Factories and Shops (Annual Holidays) Amendment	0	6	
5159. Factories and Shops (Wages Board)	0	6	
5160. Melbourne and Metropolitan Tramways (Amendment)	0	6	
5161. Infectious Diseases Hospital (Borrowing)	0	6	
5162. University (Mildura Branch)	0	6	
5163. Farmers Protection (Amendment)	0	6	
5164. Forests (Exchange of Lands) Extension	0	6	
5165. Money Lenders (Cash Orders)	0	6	
5166. Local Government (Dandenong Street Con- struction)	1	0	
5167. Stamps (Increased Duty Continuance)	0	6	
5168. Land Tax	0	6	
5169. Cattle Breeding	0	6	
5170. Administration and Probate Duties	0	6	
5171. Co-operative Housing Societies (Guarantees)	0	6	
5172. Railways (Sick Leave)	0	6	
5173. Fruit and Vegetables	0	6	
5174. Farm Water Supplies and Drainage Advances	0	6	
5175. State Forests Loan and Application	0	6	
5176. Melbourne South Land	0	6	
5177. Agricultural Colleges (Amendment)	0	6	
5178. Drought Relief (Amendment)	0	6	
5179. Soldier Settlement	1	9	
5180. Free Library Service Board	0	6	
5181. Adult Education	0	6	
5183. Evidence	0	6	
5184. Housing (Discharged Servicemen)	0	6	
5185. Parliamentary Contributory Retirement Fund	0	6	
5186. Friendly Societies	0	6	
5187. Police Offences (Race-meetings)	0	6	
5188. Railways (Mont Park Siding)	0	6	
5189. Land (Grazing Licences)	0	6	
5190. Factories and Shops (Bread Carters)	0	6	
5191. Country Fire Authority	1	0	
5192. Supreme Court (Judges)	0	6	
5193. Railway Loan Application	0	6	
5194. Metropolitan Gas Company's	0	6	
5195. Railways (Temporary Employés)	0	6	
5196. Railways (State Coal Mine)	0	6	
5197. Licensing	0	6	
5198. Town and Country Planning	0	6	
5199. Public Works Loan and Application (No. 2)	0	6	
5201. Trotting Races	0	6	
5202. Economic Stability	0	6	
5204. Stamps	2	3	
5206. Melbourne and Metropolitan Tramways (Appeal Board)	0	6	

J. J. GOURLEY,
Government Printer.

STATE ACTS, 1947.

COPIES of the following Acts of Parliament of Victoria may be obtained at the Government Printing Office, or from any bookseller, at the price set opposite to each:—

No.	Price.	s. d.	
		s.	d.
5207. Consolidated Revenue	0	6	
5208. Custodian Trustee	0	6	
5209. Revocation and Excision of Crown Reserva- tions	0	9	
5210. Farmers Advances (Amendment)	0	6	
5211. Private Bill Committees	0	6	
5212. Health (Amendment)	0	6	
5213. Wills (Amendment)	0	6	
5214. Old Colonists' Association	0	6	
5215. Consolidated Revenue	0	6	
5216. Local Authorities Superannuation	1	0	
5217. Statute Law Revision	0	6	
5218. Motor Car (Registration Fees)	0	6	
5219. State Electricity Commission (Yallourn Area)	0	6	
5220. Transport Regulation (Licences and Fees)	0	6	

STATE ACTS, 1947—continued.

No.	Price.	s. d.	
		s.	d.
5221. Local Government (Private Street Construc- tion)	0	6	
5222. State Development (Amendment)	0	6	
5223. Coal Mine Workers Pensions	0	6	
5224. State Savings Bank	0	9	
5225. Drought Relief	0	6	
5226. Soil Conservation and Land Utilization	1	0	
5227. Consolidated Revenue	0	6	
5228. Consolidated Revenue	0	6	
5229. Consolidated Revenue	0	6	
5230. Municipal Endowment (Temporary Discon- tinuance)	0	6	
5231. Forests (Commissioners)	0	6	
5232. State Forests Loan and Application	0	6	
5233. Melbourne and Metropolitan Tramways (Amendment)	0	6	
5234. Auditor-General's Salary	0	6	
5235. Drought Relief (Amendment)	0	6	
5236. Wheat Marketing (Winding Up) Amendment	0	6	
5237. University (Mildura Branch)	0	6	
5238. Factories and Shops (Bread)	0	6	
5239. Water Supply Loan and Application	1	3	
5240. Public Works Loan and Application	0	6	
5241. Administration and Probate Duties	0	6	
5242. Land Tax	0	6	
5243. Country Roads Board Fund (Amendment)	0	6	
5244. Ballaarat Land	0	9	
5245. Stamps (Increased Duty Continuance)	0	6	
5246. Railway Loan Application	0	9	
5247. Sewerage Districts (Amendment)	0	6	
5248. State Electricity Commission (Financial)	0	6	
5249. Public Account Advances (Amendment)	0	6	
5250. Infectious Diseases Hospital (Amendment)	0	6	
5251. Public Works Loan and Application (Amend- ment)	0	6	
5252. Officials in Parliament	0	6	
5253. Water	0	6	
5254. Supreme Court (Judges Salaries)	0	6	
5255. Superannuation	0	9	
5256. Country Sewerage Loan and Application	0	6	
5257. Melbourne and Metropolitan Board of Works (Contributions)	0	6	
5258. Vegetation Diseases (Fruit Fly)	0	6	
5259. Building Operations and Building Materials Control (Amendment)	0	6	
5260. Police Regulation (Amendment)	0	6	
5261. Factories and Shops (Determinations)	0	6	
5262. Appropriation of Revenue	5	3	

J. J. GOURLEY,
Government Printer.

STATE ACTS, 1948.

COPIES of the following Acts of Parliament of Victoria may be obtained at the Government Printing Office, or from any bookseller, at the price set opposite to each:—

No.	Price.	s. d.	
		s.	d.
5263. Essential Services	0	9	
5264. Landlord and Tenant	2	6	
5265. Public Works Committee	0	6	
5266. Midwives (Amendment)	0	6	
5267. Carriers and Innkeepers	0	6	
5268. Camberwell Lands	0	9	
5269. Consolidated Revenue	0	6	
5270. Miners' Phthisis (Treasury Allowances) Amendment	0	6	
5271. Building Operations and Building Materials Control (Amendment)	0	6	
5272. State Electricity Commission	0	9	
5273. Town and Country Planning	0	6	
5274. Coranderrk Lands	0	9	
5275. Coroners (Medical Witnesses)	0	6	
5276. Vegetation Diseases (Fruit Fly)	0	6	
5277. Administration and Probate (Amendment)	0	9	
5278. Country Roads (Permanent Works)	0	6	
5279. Shrine of Remembrance Trustees	0	6	
5280. Non-Contributory State Pensions	0	6	
5281. Closer Settlement (Disposal of Land)	0	6	
5282. Melbourne North Land	0	6	
5283. Melbourne Harbor Trust (Chairman's Salary)	0	6	
5284. Police Offences (Race-meetings)	1	0	
5285. Statute Law Revision Committee	0	9	

STATE ACTS, 1948—continued.

No.	Price.
	s. d.
5286. Public Trustee	1 3
5287. Horse Breeding (Amendment) .. .	0 6
5288. Building Operations Control (Amendment) .. .	0 6
5289. Local Government (Streets) .. .	1 3
5290. Country Roads .. .	0 6
5291. Landlord and Tenant (Amendment) .. .	1 3
5292. Hepburn Springs Land .. .	0 6
5293. Gas Regulation (Amendment) .. .	0 6
5294. Commonwealth Transferred Officers .. .	0 6
5295. Forests (Amendment) .. .	0 6
5296. Parliamentary Salaries and Allowances .. .	0 9
5297. Farmers Debts Adjustment (Board) .. .	0 6
5298. Justices (Courts) .. .	0 6
5299. Local Authorities Superannuation (Amendment) .. .	0 6
5300. Hospitals and Charities .. .	2 3
5301. Health (Hospitals) .. .	0 9
5302. River Improvement .. .	1 9
5303. Geelong Harbor Trust (Land) .. .	0 6
5304. Stipendiary Magistrates .. .	0 6
5305. Consolidated Revenue .. .	0 6
5306. Consolidated Revenue .. .	0 6
5307. Local Government (Footscray Street Construction) .. .	0 6
5308. Teaching Service (Application of Enactments) .. .	0 6
5309. Parliamentary Contributory Retirement Fund .. .	0 6
5310. Prices Regulation .. .	2 0
5311. Marine (Pilotage Rates) .. .	0 6
5312. State Savings Bank .. .	0 6
5313. Coal Mine Workers Pensions .. .	0 9
5314. Transfer of Land (Acquisitions) .. .	0 6
5315. Workers' Compensation (Police Force) .. .	0 6
5316. Fire Brigades (Borrowing and Salaries) .. .	0 6
5317. Public Officers Salaries .. .	0 6
5318. Mildura Irrigation and Water Trusts (Amendment) .. .	0 6
5319. Thornbury Land .. .	1 0
5320. Barley Marketing .. .	1 0
5321. North-West Mallee Settlement Areas .. .	1 0
5322. Latrobe-street Tramway Construction .. .	0 6
5323. Gippsland Railway (Duplication and Re-grading) .. .	0 6
5324. Municipal Endowment (Temporary Discontinuation) .. .	0 6
5325. Stamps (Increased Duty Continuance) .. .	0 6
5326. Country Roads Board Fund (Amendment) .. .	0 6
5327. Land Tax .. .	0 6
5328. Housing .. .	1 0
5329. Master of the Supreme Court .. .	0 9
5330. Treasury Bonds .. .	0 6
5331. Statute Law Revision .. .	0 9
5332. Forests (Land Acquisition) .. .	0 6
5333. State Forests Loan and Application .. .	0 6
5334. Water Supply Loans Application .. .	1 3
5335. Country Roads (Works and Evidence) .. .	0 6
5336. Friendly Societies (War Service) Repeal .. .	0 6
5337. Teaching Service (Amendment) .. .	0 6
5338. Wheat Industry Stabilization .. .	0 9
5339. Administration and Probate Duties .. .	0 6
5340. Nurses (Registration) .. .	0 6
5341. Cancer Institute .. .	1 3
5342. Melbourne and Metropolitan Tramways (Financial) .. .	0 6
5343. Railways Standardization Agreement .. .	1 0
5344. Public Works Loan and Application (Amendment) .. .	0 6
5345. Alphington to East Preston Railway Construction .. .	0 9
5346. Public Works Loan and Application .. .	0 6
5347. Building Operations (Amendment) .. .	0 6
5348. Prices Regulation (Amendment) .. .	0 6
5349. Parliamentary Salaries and Allowances (No. 2) .. .	0 6
5350. Land (Leases) .. .	0 6
5351. Coal (Overseas Purchase) Loan and Application .. .	0 6
5352. Moe to Yallourn Railway Construction .. .	0 9
5353. Hide and Leather Industries .. .	1 0
5354. Revocation and Excision of Crown Reservations .. .	1 0
5355. Fern Tree Gully and Gembrook Railway (Reconstruction) .. .	0 9
5356. Railway Loan and Application .. .	1 0
5357. Co-operative Housing Societies .. .	0 9
5358. Hospital Benefits .. .	1 0
5359. Police Regulation (Amendment) .. .	0 6
5361. Railways (Amendment) .. .	0 9

J. J. GOURLEY,
Government Printer.

STATE ACTS, 1949.

COPIES of the following Acts of Parliament of Victoria may be obtained at the Government Printing Office, or from any bookseller, at the price set opposite to each:—

No.	Price.
	s. d.
5362. Miners' Phthisis (Treasury Allowances) .. .	0 5
Amendment .. .	0 6
5363. Country Roads (Financial) .. .	0 6
5364. Horsham Land .. .	0 6
5365. Mental Institution Benefits .. .	0 6
5366. Royal Commission (Communist Party) .. .	0 6
5367. Melbourne and Metropolitan Tramways (Chairman) .. .	0 6
5368. State Electricity Commission (Chairman) .. .	0 6
5369. River Murray Waters .. .	0 9
5370. Soldier Settlement .. .	0 9
5371. Consolidated Revenue .. .	0 6
5372. Agricultural Education .. .	0 9
5373. Forestry Pulp and Paper Company's Afforestation Contracts .. .	1 0
5374. Shearers Accommodation .. .	1 3
5375. Water .. .	0 9
5376. Consolidated Revenue .. .	0 6
5377. Mildura Irrigation and Water Trusts (Financial) .. .	0 6
5378. Collingwood (Unimproved Rating Poll) .. .	0 6
5379. Crimes .. .	1 3
5380. Governor's Salary .. .	0 6
5381. Consolidated Revenue .. .	0 6
5382. Wrongs (Tort-feasors) .. .	0 6
5383. State Development .. .	0 6
5384. Grain Elevators (Financial) .. .	0 6
5385. Imported Materials Loan and Application .. .	0 6
5386. Royal Commission (Communist Party) Amendment .. .	0 6
5387. Minister of Education .. .	0 6
5388. Municipal Endowment (Temporary Discontinuation) .. .	0 6
5389. Land Tax .. .	0 6
5390. Stamps (Increased Duty Continuance) .. .	0 6
5391. Railways (Long Service) .. .	0 6
5392. Williamstown Lands .. .	0 6
5393. Greta Lands Exchange .. .	0 6
5394. Consolidated Revenue .. .	0 6
5395. Superannuation (Amendment) .. .	0 6
5396. Mines (Amendment) .. .	1 0
5397. Coal (Overseas Purchase) Amendment .. .	0 6
5398. Country Roads Board Fund (Amendment) .. .	0 6
5399. Lancefield and Kilmore Railway (Disposal of Land) .. .	0 6
5400. Treasury Bonds .. .	0 6
5401. North-West Mallee Settlement Areas (Amendment) .. .	0 6
5402. Administration and Probate Duties .. .	0 6
5403. Judges Pensions .. .	0 9
5404. Town and Country Planning (Metropolitan Area) .. .	0 9
5405. State Forests Loan and Application .. .	0 6
5406. Legal Profession Practice .. .	0 6
5407. Forests (Exchange of Lands) Extension .. .	0 6
5408. Victorian Mining Accident Relief Fund (Winding-up) .. .	0 6
5409. Consolidated Revenue .. .	0 6
5410. Castlemaine Lands .. .	0 6
5411. Soil Conservation and Land Utilization .. .	0 9
5412. Public Account Advances (Amendment) .. .	0 6
5413. Mothercraft Nurses .. .	0 9
5414. Rural Finance Corporation .. .	2 0
5415. Co-operative Housing Societies .. .	0 6
5416. Latrobe Valley Development Loan and Application .. .	1 0
5417. Liquid Fuel .. .	0 6
5418. Water Supply Loan and Application .. .	1 3
5419. Fire Brigades (Appeal Tribunal) .. .	0 6
5420. Railway Loan Application .. .	1 0
5421. Local Authorities Superannuation (Amendment) .. .	0 9
5422. Public Works Loan and Application .. .	0 6
5423. Motor Car (Amendment) .. .	0 6
5424. Barwon River Improvement (Amendment) .. .	0 6
5425. Portland Harbor Trust .. .	1 9
5426. Land (Grants and Leases) .. .	0 6
5427. Geelong Waterworks and Sewerage .. .	0 9
5428. Metropolitan Gas Company's .. .	0 6
5429. Prices Regulation .. .	0 6
5430. Masseurs (Registration) .. .	0 6
5431. Vermin and Noxious Weeds .. .	1 9
5432. Health (Tuberculosis Arrangement) .. .	0 8
5433. Justices (Service of Process) .. .	0 6
5434. Police Offences (Amendment) .. .	0 6
5435. Revocation and Excision of Crown Reservations .. .	0 9

STATE ACTS, 1949—continued.

No.	Price.
	s. d.
5436. Coal Mine Workers Pensions (Amendment) ..	0 6
5437. Health (Cattle) ..	0 6
5438. Soldier Settlement (Amendment) ..	0 9
5439. Footwear Regulation (Amendment) ..	0 6
5440. Appropriation of Revenue, 1948-49 ..	4 3
5441. Croydon Fruit Cool Stores ..	0 5
5442. Licensing (Amendment) ..	0 6
5443. Local Government ..	1 6
5444. Milk Pasteurization ..	0 9
5445. Building Operations and Building Materials Control (Amendment) ..	0 9
5446. Tourists' Resorts Development (Financial) ..	0 6
5447. Public Library National Gallery and Museums ..	0 6
5448. Police Regulation (Amendment) ..	0 9
5449. Business Investigations ..	0 9
5450. Motor Car (Amendment) ..	1 6

J. J. GOURLEY,
Government Printer.

THE "VICTORIA GOVERNMENT GAZETTE."

SUBSCRIPTIONS.—The subscription, including postage, is £1 12s. 6d. per annum, 16s. 3d. half-yearly, or 8s. 2d. per quarter, payable in advance.

Subscriptions are required to commence and terminate with a month.

A lesser period than three months cannot be subscribed for.

Subscribers do not receive the Acts of Parliament with the GAZETTE.

ADVERTISEMENTS are charged at the rate of ELEVEN PENCE per line single column, and ONE SHILLING and TEN PENCE per line double column.

The title (£5 Reward, Dissolution of Partnerships, &c.) forms one or more lines as a heading.

On an average, ten words make a line.

Every signature must likewise be counted as a line.

The final words of a paragraph, though only portion of a line, must be counted as one line.

SIGNATURES (in particular) and proper names must be written very plainly in the text; ONE SIDE ONLY of each slip of paper should be WRITTEN UPON.

ALL COMMUNICATIONS should be addressed to "The Government Printer, Melbourne."

ALL DOCUMENTS illegibly written will be returned unpublished, and, where brands occur unprovided for by the ordinary letters of the alphabet, a worded explanatory description must be furnished.

THE VICTORIA GOVERNMENT GAZETTE is published on WEDNESDAY EVENING in each week, and Notices for insertion will be received by the Government Printer at or before Two p.m. at ordinary rates, and late advertisements between Two p.m. and Five p.m. at double rates on the day preceding the day of publication.

Single copies of the VICTORIA GOVERNMENT GAZETTE are Six pence, posted Eight pence, each.

No GAZETTES prior to January, 1939, in stock.

***ALL PAYMENTS ARE REQUIRED IN ADVANCE.—Remittances should be made by postal note, money order, or draft in favour of the Government Printer. Advertisements unaccompanied by a remittance sufficient to cover the cost of insertion will be returned unpublished.

PUBLICATION OF OFFICIAL MATTER.

ATTENTION is invited to the following procedure in relation to the publication of official matter in the Government Gazette:—

1. Matter submitted to the Executive Council.

Matter submitted to the Executive Council which requires gazettal will normally be published in the issue of the following week.

Where urgent gazettal is required, special arrangements should be made with the Gazette Officer.

Publication will be facilitated by the submission of carbon copies for the use of the Gazette Officer.

2. Other matter.

(a) All other matter duly certified by a responsible officer for publication should be lodged with the Gazette Officer not later than half-past Ten a.m. on Tuesday.

(b) Lengthy or involved notices should be forwarded several days before publication.

(c) Proofs, which will be supplied only when specifically requested or at the direction of the Gazette Officer, should be returned promptly to avoid delay in publication.

(d) No additions or amendments to matter for publication will be accepted by telephone.

AGENTS FOR THE "VICTORIA GOVERNMENT GAZETTE."

THE following have been appointed agents to receive Advertisements and Subscriptions for the Victoria Government Gazette:—

ARMSTRONG'S AGENCY, 143 Queen-street, Melbourne.

ARMSTRONG BROS., Kyneton.

MESSRS. ARNALL & JACKSON, 115 Barkly-street, West Brunswick.

MR. M. R. BADE, Tobacconist, Sturt-street, Ballarat.

MR. WM. DAVIS, Mildura.

A. J. DIGBY (B. S. and N. W. CASH), Main-street, Bairnsdale.

EDGAR'S NEWS AGENCY, Hargreaves-street, Bendigo.

EDGAR'S NEWS AGENCY, 53 Murphy-street, Wangaratta.

MESSRS. HENRY FRANKS & CO., Booksellers and Stationers, Market-square, Geelong.

MESSRS. GORDON & GOTCH, News Agents, 511 Little Collins-street, Melbourne; and corner Barrack and Clarence streets, Sydney.

W. GORDON HAMPTON, 243 Mitchell-street, Bendigo.

MESSRS. HARSTON, PARTRIDGE, & CO., 455 Little Collins-street, Melbourne.

MR. C. F. LATIMER, News Agent, Casterton.

MR. F. T. McCORMICK, Nunn-street, Benalla.

MESSRS. H. PAYNE & R. N. LOWE, 4 View Point, Bendigo.

MESSRS. R. H. & W. M. PETTY, News Agent, Wangaratta.

PIKE'S AUTHORIZED NEWS AGENCY, Sale.

J. PURDIE & CO., 138 Moorabool-street, Geelong.

MESSRS. A. S. RICHARDSON and T. C. GARDNER, trading as The Mercantile Exchange, 380 Collins-street, Melbourne.

ROBERTSON & MULLENS LTD., Elizabeth-street, Melbourne.

R. & A. SMALLMAN, News Agents, Toora.

MESSRS. SMITH & DUNNON, Hamilton.

TRAINOR & McBRIDE, 246 Wyndham-street, Shepparton.

A copy of the Gazette filed at each place for public reference.

CONTENTS.

	PAGE
Act of Parliament	4293
Acts of Parliament on sale at the Government Printing Office	4341
Appointments	4295
Auction Sales Act	4308
Bank Half-Holidays	4294
Business Agents Act 1930	4309
Contracts	4296
Courts	4311
Estates of Deceased Persons	4302
Government Notices	4302
Impoundings	4341
Lands	4320
Melbourne and Metropolitan Board of Works—Notice	4304
Ministers of Religion Registered to Celebrate Marriages in Victoria	4304
Money Lenders Act 1938	4305
Orders in Council	4311
Private Advertisements	4334
Proclamations	4293
Public Holidays	4294
Public Service Notices	4329
Real Estate Agents Act	4308
Resignations	4295
Tenders	4332
Transport Regulation Board—Public Hearings	4303



VICTORIA GOVERNMENT GAZETTE.

Published by Authority.

[Registered at the General Post Office, Melbourne, for transmission by post as a newspaper.]

No. 606]

WEDNESDAY, AUGUST 16.

[1950

Factories and Shops Acts.

DETERMINATION OF A WAGES BOARD ADJUSTED PURSUANT TO SECTION 21 OF THE FACTORIES AND SHOPS ACT 1934 (No. 4275).

I, Raymond Henry Beers, Secretary for Labour, in pursuance of the powers conferred by the Factories and Shops Acts, hereby make and issue the following adjusted Determination of the Wages Board referred to hereunder showing adjusted rates and prices to operate from the beginning of the first pay period to commence in August, 1950.

Dated at Melbourne, this
3rd day of August, 1950.

RAY. H. BEERS,
Secretary for Labour.

SHOPS BOARD No. 23 (ELECTRICAL AND RADIO GOODS).

Clause 2 of the Determination published in *Government Gazette* No. 284 of the 14th April, 1950, shall be replaced by the following clause:—

2. WAGES PER WEEK OF 40 HOURS.

Apprentices and Improvers.				Other Employees.										
				Within the Metropolitan District.		Outside the Metropolitan District wherever this Determination applies.								
MALES.				MALES.										
				s. d.		s. d.								
Under 16 years of age	37	0	(a) Person in charge of a shop Or, (b) Manager in charge of one or more persons in an electrical and/or radio department of a departmental store, the business of which is not confined to the sale of radio or electrical goods (c) Canvassers, travellers, collectors, installers, and all others who are in any way connected with the sale of goods on a merchant's premises, but excluding those selling off such premises if they are paid exclusively by commission and have the right to sell goods for more than one merchant	192	6	188	6				
16 years of age	49	6									
17	64	0									
18	89	0									
19	113	0									
20	138	6	177	0	173	0					
FEMALES.				FEMALES.										
Under 16 years of age	37	6					Females	141	6	137	6
16 years of age	47	6									
17	53	6									
18	62	0									
19	70	0									
20	80	0	PROPORTION (WITHIN ANY SHOP).								
Apprentices.				MALES.										
One male apprentice to every three or fraction of three workers receiving not less than 173s. per week.				FEMALES.										
One female apprentice to every three or fraction of three workers receiving not less than 137s. 6d. per week.				Improvers.										
MALES.				MALES.										
One male improver to every two or fraction of two workers receiving not less than 173s. per week.				FEMALES.										
One female improver to every two or fraction of two workers receiving not less than 137s. 6d. per week.														

Clauses, other than clause 2, of the said Determination shall remain in force.

By Authority: J. J. GOUBLEY, Government Printer, Melbourne.





VICTORIA
GOVERNMENT GAZETTE.

Published by Authority.

[Registered at the General Post Office, Melbourne, for transmission by post as a newspaper.]

No. 607]

WEDNESDAY, AUGUST 16.

[1950

Factories and Shops Acts.

DETERMINATION OF A WAGES BOARD ADJUSTED PURSUANT TO SECTION
21 OF THE FACTORIES AND SHOPS ACT 1934 (No. 4275).

I, Raymond Henry Beers, Secretary for Labour, in pursuance of the powers conferred by the Factories and Shops Acts, hereby make and issue the following adjusted Determination of the Wages Board referred to hereunder showing adjusted rates and prices to operate from the beginning of the first pay period to commence in August, 1950.

Dated at Melbourne, this
3rd day of August, 1950.

RAY. H. BEERS,
Secretary for Labour.

BOARDING SCHOOL EMPLOYEES BOARD.

Clause 2 of the Determination published in *Government Gazette* No. 89, of the 25th February, 1948, shall be replaced by the following clause:—

WAGES.

2.(a) Apprentices or Improvers.

Males.	Per Week.	Females.	Per Week.
	<i>s. d.</i>		<i>s. d.</i>
Under 17 years of age	75 6	Under 16 years of age	45 6
17 years of age and under 18	90 6	18 years of age and under 17	54 9
18 years of age and under 19	105 6	17 years of age and under 17½	63 9
19 years of age and under 20	120 9	17½ years of age and under 18	72 9
20 years of age and under 21	135 3	18 years of age and under 19	82 0
		and thereafter the minimum wage.	

Proportion (in any place).

Apprentices.—One apprentice to every four or fraction of four workers of either sex receiving not less than the minimum wage.

Improvers.—One improver to every four or fraction of four workers of either sex receiving not less than the minimum wage.

(b) *Other Employees.*

Males.	Per Week.	Females.	Per Week.
	£ s. d.		£ s. d.
First Cook, where the number of persons employed in the kitchen is		First Cook, where the number of persons employed in the kitchen is	
Eight or more	9 4 6	Eight or more	6 11 0
Five, six, or seven	8 19 6	Five, six, or seven	6 6 6
Four or less	8 14 6	Four or less	6 1 0
Cook employed alone	7 19 6	Cook employed alone	5 9 3
Second Cook, where the number of persons employed in the kitchen is		Second Cook, where the number of persons employed in the kitchen is	
Eight or more	8 9 6	Eight or more	5 16 6
Five, six, or seven	8 4 6	Five, six, or seven	5 10 6
Four or less	7 19 6	Four or less	5 5 6
Vegetable Cook	7 9 6	Vegetable Cook	4 18 3
Other Cooks	7 14 6	Other Cooks	5 1 9
Kitchenman, pantryman, houseman, or waiter	7 5 6	Head waitress	4 18 3
All others	7 5 6	Needlewoman or seamstress	4 18 3
		Kitchenmaid, pantrymaid, housemaid, or waitress	4 11 0
		All others	4 11 0

DEDUCTIONS FOR BOARD AND/OR BOARD AND LODGING.

(c) The amounts which may be deducted from the wages when an employee is provided with board only or board and lodging shall be:—

	Board Only.	Board and Lodging.
(i) <i>Apprentices or Improvers.</i>		
<i>Males.</i>		
	<i>s. d.</i>	<i>s. d.</i>
Under 17 years of age	7 6	10 0
17 years of age and under 18	9 0	12 0
18 years of age and under 19	10 6	14 0
19 years of age and under 20	12 0	16 0
20 years of age and under 21	13 6	18 0
<i>Females.</i>		
Under 16 years of age	7 6	10 0
16 years of age and under 17	9 0	12 0
17 years of age and under 17½	10 6	14 0
17½ years of age and under 18	12 0	16 0
18 years of age and under 19	13 6	18 0
(ii) <i>Other Employees.</i>		
Other employees	15 0	20 0

Clauses, other than clause 2, of the said Determination shall remain in force.



VICTORIA GOVERNMENT GAZETTE.

Published by Authority.

[Registered at the General Post Office, Melbourne, for transmission by post as a newspaper.]

No. 608]

WEDNESDAY, AUGUST 16.

[1950

Factories and Shops Acts.

DETERMINATION OF A WAGES BOARD ADJUSTED PURSUANT TO SECTION 21 OF THE FACTORIES AND SHOPS ACT 1934 (No. 4275).

I, Raymond Henry Beers, Secretary for Labour, in pursuance of the powers conferred by the Factories and Shops Acts, hereby make and issue the following adjusted Determination of the Wages Board referred to hereunder showing adjusted rates and prices to operate from the beginning of the first pay period to commence in August, 1950.

Dated at Melbourne, this
3rd day of August, 1950.

RAY. H. BEERS,
Secretary for Labour.

BUTTER FACTORIES BOARD.

Clause 2 of the Determination published in *Government Gazette* No. 475 of the 30th May, 1950, shall be replaced by the following clause:—

2.

APPRENTICES OR IMPROVERS.

JUVENILE WORKERS.

	Wages per Week.				Wages per Week.	
	Shift Workers.		Ordinary Workers.		Males.	Females.
	Where a Seven-day Week is Worked.	Where a Six-day Week is Worked.				
	s. d.	s. d.	s. d.	s. d.	s. d.	
Under 16 years	82 6	Under 16 years	89 9	65 6
16-17 years	98 9	16-17 years	78 3	73 6
17-18 "	109 0	17-18 "	96 9	81 6
18-19 "	142 3	138 6	123 0	18-19 "	106 6	95 6
19-20 "	154 6	150 6	139 0	19-20 "	124 3	104 3
20-21 "	162 3	158 6	148 3	20-21 "	142 3	115 3

PROPORTION (IN ANY PLACE).

Males.

One apprentice to every three or fraction of three workers receiving not less than 173s. per week.

One improver to every eight or fraction of eight workers receiving not less than 173s. per week.

Females.

One apprentice and one improver to every three or fraction of three workers receiving not less than 135s. per week.

OTHER EMPLOYEES.

	Wages per Week.		
	Shift Workers.		Ordinary Workers.
	Where a Seven-day Week is Worked.	Where a Six-day Week is Worked.	
	s. d.	s. d.	s. d.
Cream grader	203 0	200 0	192 0
Milk grader	202 0	199 0	191 0
Milk or cream tester	202 0	199 0	191 0
Creamery manager	197 0	194 0	186 0
Milk or cream neutralizer	195 6	192 6	184 6
Foreman of shift or department or casein plant	197 0	194 0	186 0
Butter-maker	202 0	199 0	191 0
Re-worker and/or processor (not requiring a buttermaker's certificate)	187 0	184 0	176 0
Operators of any of the following machines, viz :—			
Separator	185 0	182 0	174 0
Pasteurizer evacuator, or deodorizer	185 0	182 0	174 0
Weighing machine	185 0	182 0	174 0
Filling machine for tinning of butter when butter has not been milled	187 0	184 0	176 0
Filling machine for tinning of butter when butter has been milled	186 0	183 0	175 0
Storeman or packer in butter canning establishments	186 0	183 0	175 0
Other storeman or packers	185 0	182 0	174 0
Casein-maker	198 0	195 0	187 0
Assistant to casein-maker, casein dryers, and millers	186 6	183 6	175 6
Cheese-maker	202 0	199 0	191 0
Assistant to cheese-maker	186 6	183 6	175 6
Cheese storehand	188 0	185 0	177 0
Male adult washing or sterilizing cans or bottles	185 0	182 0	174 0
Operator of a fork lift truck	187 0	184 0	176 0
All other adult males	184 0	181 0	173 0
All other adult females	135 0

Washers and/or cleaners of any enclosed vat or tank fitted with a man hole, the height of which compels reaching overhead, shall be paid at the rate of 4s. per week in addition to their ordinary wage, whilst so engaged.

Clauses, other than clause 2, of the said Determination shall remain in force.



VICTORIA
GOVERNMENT GAZETTE.

Published by Authority.

[Registered at the General Post Office, Melbourne, for transmission by post as a newspaper.]

No. 609]

WEDNESDAY, AUGUST 16.

[1950

Factories and Shops Acts.

**DETERMINATION OF A WAGES BOARD ADJUSTED PURSUANT TO SECTION 21 OF THE
FACTORIES AND SHOPS ACT 1934 (No. 4275).**

I, Raymond Henry Beers, Secretary for Labour, in pursuance of the powers conferred by the Factories and Shops Acts, hereby make and issue the following adjusted Determination of the Wages Board referred to hereunder showing adjusted rates and prices to operate from the beginning of the first pay period to commence in August, 1950.

Dated at Melbourne, this
3rd day of August, 1950.

RAY. H. BEERS,
Secretary for Labour.

CANTEEN WORKERS BOARD.

Clause 2 of the Determination published in *Government Gazette* No. 463 of the 25th May, 1950, shall be replaced by the following clause:—

2.

WAGES.

(a)

*Improvers.**

Male.				Female.									
				£ s. d.									
Under 17 years	2	17	6	Under 17 years	3	2	3
17 and under 18 years	3	18	6	17 and under 18 years	3	12	3
18 and under 19 years	4	19	0	18 and under 19 years	3	17	9
19 and under 20 years	6	3	6	19 and under 20 years	4	13	0
20 and under 21 years	7	6	9	20 and under 21 years	4	18	3

Proportion:—One improver to every three or fraction of three workers receiving not less than the minimum wage.

* The Board has determined that no apprentice shall be taken to the trade.

(b)

Adults.

				Male.		Female.			
				£ s. d.		£ s. d.			
Cook (Grade 1)	9	7	0	7	4	9
Cook (Grade 2)	8	7	0	5	14	9
Cook working alone	8	12	0	6	5	3
Supervisor	5	14	9
Attendant	7	18	6	5	1	9

Clauses, other than clause 2, of the said Determination shall remain in force.

By Authority: J. J. GOURLEY, Government Printer, Melbourne.



VICTORIA GOVERNMENT GAZETTE.

Published by Authority.

[Registered at the General Post Office, Melbourne, for transmission by post as a newspaper.]

No. 610]

WEDNESDAY, AUGUST 16.

[1950

Factories and Shops Acts.

DETERMINATION OF A WAGES BOARD ADJUSTED PURSUANT TO SECTION 21 OF THE FACTORIES AND SHOPS ACT 1934 (No. 4275).

I, Raymond Henry Beers, Secretary for Labour, in pursuance of the powers conferred by the Factories and Shops Acts, hereby make and issue the following adjusted Determination of the Wages Board referred to hereunder showing adjusted rates and prices to operate from the beginning of the first pay period to commence in August, 1950.

Dated at Melbourne, this
9th day of August, 1950.

RAY H. BEERS,
Secretary for Labour.

HAIRDRESSERS BOARD.

Clause 2 of the Determination published in *Government Gazette* No. 1009 of the 29th November, 1949, shall be replaced by the following clause:—

2.

APPRENTICES AND IMPROVERS.

(a) Outside the Metropolitan District as defined in the Factories and Shops Acts.

	Wages per Week.			
	Apprentices.		*Improvers.	
	Males.	Females.	Males.	Females.
	<i>s. d.</i>	<i>s. d.</i>	<i>s. d.</i>	<i>s. d.</i>
1st year	24 9	21 0	136 6	82 9
2nd year	33 0	29 0		
3rd year	49 9	41 3		
4th year—				
1st six months ..	66 9	58 0		
2nd six months ..	66 9	66 9		
5th year—				
1st six months ..	82 9	66 9		
2nd six months ..	82 9	..		

(b) Within the Metropolitan District as defined in the Factories and Shops Acts—The wages payable shall be such rates as may be prescribed from time to time by the Apprenticeship Commission of Victoria.

Apprentices and improvers shall be subject to the number of hours per week as fixed for their respective sections.

PROPORTION (IN ANY SHOP OR PLACE).

Apprentices.

In Men's Hairdressing Saloons.

One male apprentice to every three or fraction of three male workers receiving not less than the minimum wage.

In Ladies' Hairdressing Saloons.

One apprentice to each female worker receiving not less than the wage of 12s. 6d. per week. Provided that a male working employer shall be entitled to an apprentice.

In Places where both Men's and Ladies' Hairdressing is Carried Out.

One apprentice to every three or fraction of three workers, male or female, receiving not less than the minimum wage if male, or 12s. 6d. per week if female.

Improvers.

One male improver to every fifteen male workers receiving not less than the minimum wage.

One female improver to every fifteen persons receiving not less than the minimum wage.

An amended indenture of apprenticeship prescribed by the Board was approved on 26th March, 1936.

JUVENILE WORKERS, i.e., females under 21 years of age employed solely as receptionists or females under 17 years of age employed solely as messengers—

Wages.

Receptionists 51s. 9d. per week of 40 hours.
Messengers 20s. 3d. per week of 40 hours.

PROPORTION (IN ANY SHOP OR PLACE).

One Juvenile Worker employed as a receptionist to every fifteen or fraction of fifteen persons receiving not less than the minimum wage.

In addition, one Juvenile Worker employed as a messenger in any shop or place where not less than four persons are employed.

* The employment, within the Metropolitan District, of any improver is illegal.

Other Employees.	Wages.	
	Within the Metropolitan District as defined in the Factories and Shops Acts; the Cities of Geelong, Geelong West, and Warrnambool; and the Town of Newtown and Chilwell.	All Other Parts of Victoria.
<i>Men's Hairdressing Saloons.</i>	<i>s. d.</i>	<i>s. d.</i>
Chair workers (male or female)	Per Week of 40 Hours. 179 0	Per Week of 40 Hours. 169 0
<p>Provided that any person appointed by his employer to be foreman of a saloon shall be paid 5s. extra per week if not more than five persons are employed, and if more than five persons are employed he shall be paid 1s. extra per week for each employee.</p>		
<i>Any Other Place.</i>		
Males engaged in—	Per Week of 40 Hours.	Per Week of 40 Hours.
Children's haircutting	179 0	169 0
Ladies' haircutting	188 6	185 6
All other males	198 6	195 6
Female window models	Per Week of 20 Hours. 194 6	Per Week of 20 Hours. 189 6
	Per Week of 40 Hours.	Per Week of 40 Hours.
Females engaged in haircutting	139 0	136 0
Female receptionists	70 9	70 9
All other females	126 9	124 6

Clauses, other than clause 2, of the said Determination shall remain in force.



VICTORIA GOVERNMENT GAZETTE.

Published by Authority.

[Registered at the General Post Office, Melbourne, for transmission by post as a newspaper.]

No. 611]

WEDNESDAY, AUGUST 16.

[1950

Factories and Shops Acts.

DETERMINATION OF A WAGES BOARD ADJUSTED PURSUANT TO SECTION 21 OF THE FACTORIES AND SHOPS ACT 1934 (No. 4275).

I, Raymond Henry Beers, Secretary for Labour, in pursuance of the powers conferred by the Factories and Shops Acts, hereby make and issue the following adjusted Determination of the Wages Board referred to hereunder showing adjusted rates and prices to operate from the beginning of the first pay period to commence in August, 1950.

Dated at Melbourne, this
14th day of August, 1950.

RAY. H. BEERS,
Secretary for Labour.

CONDENSERIES BOARD.

Clause 2 of the Determination published in *Government Gazette* No. 476 of the 30th May, 1950, shall be replaced by the following clause:—

2.

APPRENTICES OR IMPROVERS.				JUVENILE WORKERS.			
		Wages per Week.				Wages per Week.	
		Shift Workers.	All Others.			Males.	Females.
		<i>s. d.</i>	<i>s. d.</i>			<i>s. d.</i>	<i>s. d.</i>
Under 16 years	82 6	Under 16 years	69 3	66 9
16-17 years	96 0	16-17 years	78 0	73 0
17-18	109 9	17-18	96 0	82 3
18-19	143 6	124 0	18-19	106 6	97 3
19-20	155 0	139 0	19-20	124 3	104 9
20-21	163 6	147 9	20-21	142 3	116 6

PROPORTION (IN ANY PLACE).

Males.

One apprentice to every three or fraction of three workers receiving not less than 173s. per week.

One improver to every eight or fraction of eight workers receiving not less than 173s. per week.

Females.

One apprentice and one improver to every three or fraction of three workers receiving not less than 135s. per week.

Female juvenile workers operating the Majonnier tester shall be paid 9s. 3d. per week in addition to their ordinary wage.

Female juvenile workers employed in laboratories shall be paid 4s. 3d. per week in addition to their ordinary wage.

OTHER EMPLOYEES.

	Wages per Week.	
	Shift Workers.	All Others.
	s. d.	s. d.
Milk or cream grader or tester	202 0	191 0
Majonnier operator	202 0	191 0
Neutralizer	199 0	188 0
Foreman of shift or department	199 0	188 0
Operator of any of the following machines :—		
Milk drier (roller system)	192 0	181 0
Milk drier (spray system)	193 0	182 0
Assistant to milk drier (spray system)	192 0	181 0
Sugar boiler	187 0	176 0
Vacuum pan—condensery	194 0	183 0
Vacuum pan-dried milk	193 0	182 0
Vacuum pan-milk sugar	193 0	182 0
Evaporator	192 0	181 0
Homogenizer or visiolizer	190 6	179 6
Cream retort	188 0	177 0
Powder sifter	186 0	175 0
Tubular heater or ejector	187 0	176 0
Separator	185 0	174 0
Pasteurizer	185 0	174 0
Weighing machine (milk receiving)	192 0	181 0
Wire-hoopers, storeman, stackers or packers	186 0	175 0
Washers of vacuum pan, vacuum holding vats, or evaporator	187 0	176 0
Male adult washing or sterilizing cans or bottles	186 0	175 0
Operator of a fork lift truck	187 0	176 0
All other male adults	184 0	173 0
Headwoman, i.e., a person who has charge of employees under, and takes her instructions from, the foreman	135 0
Females operating dried milk automatic filler	135 0
All other females	135 0

Female workers operating the Majonnier operator shall be paid 9s. 3d. per week in addition to their ordinary wage.
 Female workers employed in laboratories shall be paid 4s. 3d. per week in addition to their ordinary wage.
 Persons employed clearing or cleaning horizontal drying boxes shall be paid 5s. per week for mid-clearance, or 3s. per week for morning clearance, in addition to their ordinary weekly wage.
 Persons operating more than two vacuum pans shall be paid 4s. per pan extra.
 Washers of vacuum pans, vacuum holding vats, or evaporators shall be allowed 3d. for each flying clean or 9d. for each full clean in addition to the ordinary weekly wage for the employee concerned.
 Persons employed cleaning milk tankers and vacuum pan vapour pipes, when the employee enters the latter, shall receive 9d. for each clean in addition to the ordinary weekly wage for the employee concerned.
 Persons employed on a Dennington Spray Control floor shall be paid 15s. per week additional to the rates for milk drier (spray system).
 Persons employed stacking tinplate or unloading tinplate from trucks shall be paid 2d. per hour in addition to their ordinary wage.
 Persons employed unloading or scooping briquettes shall be paid 3d. per hour in addition to their ordinary wage.
 Persons (other than regular loading gang hands) transporting complete stillages of tinplate shall receive 3s. per week in addition to the rate prescribed for storemen.
 Washers and/or cleaners of any enclosed vat or tank fitted with a man hole, the height of which compels reaching overhead, shall be paid at the rate of 4s. per week, in addition to their ordinary wage, whilst so engaged.
 Clauses, other than clause 2, of the said Determination shall remain in force.



VICTORIA GOVERNMENT GAZETTE.

Published by Authority.

[Registered at the General Post Office, Melbourne, for transmission by post as a newspaper.]

No. 612]

WEDNESDAY, AUGUST 16.

[1950

Factories and Shops Acts.

DETERMINATION OF A WAGES BOARD ADJUSTED PURSUANT TO SECTION 21 OF THE FACTORIES AND SHOPS ACT 1934 (No. 4275).

I, Raymond Henry Beers, Secretary for Labour, in pursuance of the powers conferred by the Factories and Shops Acts, hereby make and issue the following adjusted Determination of the Wages Board referred to hereunder showing adjusted rates and prices to operate from the beginning of the first pay period to commence in August, 1950.

Dated at Melbourne, this
14th day of August, 1950.

RAY H. BEERS,
Secretary for Labour.

CONFECTIONERS BOARD.

Clauses 2 and 3 of the Determination published in *Government Gazette* No. 294 of the 5th April, 1949, shall be replaced by the following clauses:—

2.

APPRENTICES AND IMPROVERS.

Wages.

Males.	Per Week.	Females.	Per Week.
<i>s. d.</i>		<i>s. d.</i>	
<i>(Assisting the Storeman and Packer.)</i>			
18 years of age and under 19 years	96 3	16 years of age and under ..	48 0
19 years of age and under 20 years	118 0	17 years of age	61 3
20 years of age and under 21 years	142 0	18 years of age	75 0
<i>All Other Males.</i>		19 years of age	88 6
16 years of age and under ..	61 0	20 years of age	102 6
17 years of age	74 9	PROPORTION.	
18 years of age	101 6	Three female juniors to every two female adults receiving not less than the adult minimum rate.	
19 years of age	116 0		
20 years of age	129 3		
PROPORTION.			
<i>(Assisting the Storeman and Packer.)</i>			
One male apprentice to every three or fraction of three male workers receiving not less than 170s. per week.			
One male improver to every four or fraction of four male workers receiving not less than 170s. per week.			
<i>Other Males.</i>			
Two male juniors to every three male adult workers receiving not less than the adult minimum rate.			

OTHER EMPLOYEES.

3.		Wages per Week.								
		Males.							s. d.	
Confectioners, Group 1.	182	0
Confectioners, Group 2.	176	0
Confectioners, Group 3.	170	0
Confectioners, Group 4.	164	0
Confectioners, Group 5.	158	0
Storeman or packer—										
(a) Who works singly	171	6
(b) Who supervises or directs the number of persons 18 years of age or over indicated hereunder, viz :—										
(i) 1, 2, 3, 4, 5 or 6 such persons	173	9
(ii) 7 or more such persons	187	9
Other storeman or packer engaged in the despatch or bulk receiving stores	167	0
All adult females	118	6

Clauses, other than clauses 2 and 3, of the said Determination shall remain in force.



VICTORIA GOVERNMENT GAZETTE.

Published by Authority.

[Registered at the General Post Office, Melbourne, for transmission by post as a newspaper.]

No. 613]

WEDNESDAY, AUGUST 16.

[1950

Factories and Shops Acts.

DETERMINATION OF A WAGES BOARD ADJUSTED PURSUANT TO SECTION 21 OF THE FACTORIES AND SHOPS ACT 1934 (No. 4275).

I, Raymond Henry Beers, Secretary for Labour, in pursuance of the powers conferred by the Factories and Shops Acts, hereby make and issue the following adjusted Determination of the Wages Board referred to hereunder showing adjusted rates and prices to operate from the beginning of the first pay period to commence in August, 1950.

Dated at Melbourne, this
14th day of August, 1950.

RAY. H. BEERS,
Secretary for Labour.

DENTAL MECHANICS BOARD.

Clause 2 of the Determination published in *Government Gazette* No. 219 of the 14th March, 1950, shall be replaced by the following clause:—

WAGES PER WEEK OF 40 HOURS.

* Dentist's Mechanic. (Apprentices.)	Dentist's Attendant. (Apprentices and Improvers.)	Other Employees.	Minimum Wage.
<i>s. d.</i>	<i>s. d.</i>		<i>s. d.</i>
1st year 42 0	1st year 53 6	Dentist's Surgical Assistant	272 0
2nd year 57 6	2nd year 74 6	Dentist's Mechanic	205 0
3rd year 75 6	3rd year 98 0	Dentist's Attendant	126 6
4th year 118 0			
5th year 147 6			
6th year 168 0			

Provided that no apprentice shall have his legal rate of payment as prescribed in the Determination hereby revoked reduced in consequence of the operation of this Determination.

*NOTE.—Clause 3. Special conditions regarding the employment of juniors.

And thereafter the minimum wage.

PROPORTION (IN ANY PLACE).

APPRENTICES.

One apprentice to every three or fraction of three workers receiving not less than the minimum wage.
An amended indenture of apprenticeship prescribed was approved on 3rd September, 1925.

IMPROVERS.
(Dentists' Attendants.)

One improver to every ten or fraction of ten workers receiving not less than the minimum wage.

Clauses, other than clause 2, of the said Determination shall remain in force.

By Authority: J. J. GOURLEY, Government Printer, Melbourne.



VICTORIA GOVERNMENT GAZETTE.

Published by Authority.

(Registered at the General Post Office, Melbourne, for transmission by post as a newspaper.)

No. 614]

WEDNESDAY, AUGUST 16.

[1950

Factories and Shops Acts.

DETERMINATION OF A WAGES BOARD ADJUSTED PURSUANT TO SECTION 21 OF THE FACTORIES AND SHOPS ACT 1934 (No. 4275).

I, Raymond Henry Beers, Secretary for Labour, in pursuance of the powers conferred by the Factories and Shops Acts, hereby make and issue the following adjusted Determination of the Wages Board referred to hereunder showing adjusted rates and prices to operate from the beginning of the first pay period to commence in August, 1950.

Dated at Melbourne, this
3rd day of August, 1950.

RAY. H. BEERS,
Secretary for Labour.

CEMENT BOARD.

Clause 2 of the Determination published in *Government Gazette* No. 9 of the 9th January, 1950, shall be replaced by the following clause:—

2.

WAGES.

APPRENTICES AND IMPROVERS.

	(a) CEMENT WORKS.		
	Wages per Week.		
	Adjustable Rate.	Plus War Loading (Non-adjustable).	Total Wage.
	<i>s. d.</i>	<i>s. d.</i>	<i>s. d.</i>
Under 16 years of age	60 0	2 0	62 0
Under 17 years of age	74 6	2 9	77 3
Under 18 years of age	85 9	3 3	89 0
Under 19 years of age	103 9	4 0	107 9
Under 20 years of age	117 0	4 3	121 3
Under 21 years of age	133 3	5 0	138 3

QUARRY.

(b) The wages for apprentices and improvers shall be the appropriate rates prescribed for cement works plus 7s. per week.

PROPORTION (in any factory or place).

Apprentices.

One apprentice to every three or fraction of three workers receiving not less than the minimum wage.

Improvers

One improver to every five or fraction of five workers receiving not less than the minimum wage.

OTHER EMPLOYEES (MALES).

(a)	Cement Works	Wages per Week.		
		Adjustable Rate.	Plus War Loading (Non-adjustable).	Total Wage.
		s. d.	s. d.	s. d.
	Cement Burner	178 0	6 0	184 0
	Tester on Slurry Controls	173 0	6 0	179 0
	Miller	170 6	6 0	176 6
	Coal Drier	170 6	6 0	176 6
	Potash plant attendant	169 0	6 0	175 0
	Loader in railway trucks at bagging sheds	175 0	6 0	181 0
	Machine Bag Filler	175 0	6 0	181 0
	Electrostatic Precipitator Attendant	165 6	6 0	171 6
	Pipe Line Attendant	158 0	6 0	164 0
	Slurry Tank Attendant	165 6	6 0	171 6
	Mammoth Crusher Attendant	178 6	6 0	184 6
	Mammoth Crusher Assistant	161 0	6 0	167 0
	Truck Trimmer	156 0	6 0	162 0
	Truck Cleaner	154 0	6 0	160 0
	Cleaner (other)	152 0	6 0	158 0
	Truck Tarper	158 0	6 0	164 0
	Mill Room Helper	157 0	6 0	163 0
	Centrefuge Operator	161 0	6 0	167 0
	Potash Residue Attendant	160 0	6 0	166 0
	Experienced Factory Operative	154 6	6 0	160 6
	Train Attendant	160 6	6 0	166 6
	All others	146 0	6 0	152 0

Female testers on slurry controls shall be paid 5½ per cent. of the gross male rate.

(b)	Quarries.	Adjustable Rate.	Plus War Loading (Non-adjustable).	Total Wage.
		s. d.	s. d.	s. d.
	Powder Monkey	185 0	6 0	191 0
	Jack Hammerman	185 0	6 0	191 0
	Platelayer	171 6	6 0	177 6
	Bankman	171 6	6 0	177 6
	Underground Drainer	204 0	6 0	210 0
	Underground Quarryman	183 0	6 0	189 0
	Pump Attendant	176 6	6 0	182 6
	Signal Attendant	163 0	6 0	169 0
	Leverman	160 6	6 0	166 6
	Dump Man	160 6	6 0	166 6
	String Puller	158 0	6 0	164 0
	Switch Attendant	158 0	6 0	164 0
	Dray Attendant	160 0	6 0	166 0
	All others	153 0	6 0	159 0

LEADING HANDS.

(c) In addition to the appropriate wages rate proscribed in sub-clauses (a) or (b) hereof a Leading Hand shall be entitled to the following allowance:—

- If in charge of 4 or less men 1/- per day.
- If in charge of 5 to 8 men 1/6 per day.
- If in charge of 9 men or more 2/- per day.

Clauses, other than clause 2, of the said Determination shall remain in force.



VICTORIA GOVERNMENT GAZETTE.

Published by Authority.

[Registered at the General Post Office, Melbourne, for transmission by post as a newspaper.]

No. 615]

WEDNESDAY, AUGUST 16.

[1950

Factories and Shops Acts.

DETERMINATION OF A WAGES BOARD ADJUSTED PURSUANT TO SECTION 21 OF THE FACTORIES AND SHOPS ACT 1934 (No. 4275).

I, Raymond Henry Beers, Secretary for Labour, in pursuance of the powers conferred by the Factories and Shops Acts, hereby make and issue the following adjusted Determination of the Wages Board referred to hereunder showing adjusted rates and prices to operate from the beginning of the first pay period to commence in August, 1950.

Dated at Melbourne, this

3rd day of August, 1950.

RAY H. BEERS,

Secretary for Labour.

CEMENT ARTICLES BOARD.

Clause 2 of the Determination published in *Government Gazette* No. 218 of the 14th March, 1950, shall be replaced by the following clause:—

2.				(b) OTHER EMPLOYEES.			
(a) APPRENTICES AND IMPROVERS.				(b) OTHER EMPLOYEES.			
Wages per Week of 40 Hours.				Wages per Week of 40 Hours.			
	Adjustable Rate.	Plus War Loading (Non-adjustable).	Total Wage.		Adjustable Rate.	Plus War Loading (Non-adjustable).	Total Wage.
	s. d.	s. d.	s. d.		s. d.	s. d.	s. d.
Under 16 years of age ..	44 6	0 9	45 3	Group No. 1.			
" 17 " " ..	59 6	1 0	60 6	Moulder on centrifugal or vibrator pipe machines	164 0	3 0	167 0
" 18 " " ..	74 6	1 6	76 0	Group No. 2.			
" 19 " " ..	93 6	1 9	95 3	Man operating a machine mixing cement or concrete	160 0	3 0	163 0
" 20 " " ..	108 0	2 0	110 0	Other moulder of cement or concrete articles, including operator of any machines not elsewhere included ..	160 0	3 0	163 0
" 21 " " ..	124 6	2 3	126 9	Repairer or renderer of cement or concrete articles	160 0	3 0	163 0
PROPORTION (in any Factory or Place).				Operator of machine making concrete or cinder-concrete blocks or bricks	160 0	3 0	163 0
<i>Apprentices.</i>				Crusher feeder or attendant where bricks are crushed	160 0	3 0	163 0
One apprentice to every three or fraction of three workers receiving not less than 155s. per week of 40 hours.				Hand Vibrator Attendant	160 0	3 0	163 0
An indenture of apprenticeship prescribed by the Board was approved on 30th July, 1930.				Group No. 3.			
<i>Improvers.</i>				Tile or ridge maker and the taker off of same	157 0	3 0	160 0
Cement Tilemakers' Section.				Other mixer of cement or concrete ..	157 0	3 0	160 0
Three improvers to four workers				Mould assembler	157 0	3 0	160 0
Four improvers to five or six workers				Operator of cement sprayer	157 0	3 0	160 0
Five improvers to seven workers				Other crusher feeder or attendant or mill feeder or attendant or crusher screen attendant, other than persons engaged in crushing spalls ..	157 0	3 0	160 0
Six improvers to eight workers, and thereafter one improver to every two workers ..				Stripper	157 0	3 0	160 0
Receiving not less than 155s. per week of 40 hours.				Pipe tester (i.e., person operating a pump or pressure apparatus) ..	157 0	3 0	160 0
All Other Sections.				Employee carrying away from any concrete or cinder-concrete block or brick-making machine	157 0	3 0	160 0
One improver to every three or fraction of three workers receiving not less than 155s. per week of 40 hours.				Where the load carried per man is of a greater average weight than 70 lb.:—			
Apprentices and improvers operating a cement sprayer shall be paid 1s. 6d. per week extra in addition to the prescribed rate.				(a) Lumper of cement or concrete articles (in and out of tanks) ..	157 0	3 0	160 0
				(b) Loader, unloader, or stacker (by hand) of cement or concrete articles	157 0	3 0	160 0
				Trucker or stacker of concrete or cinder-concrete blocks or bricks ..	157 0	3 0	160 0
				Person fabricating or preparing reinforcements for portable concrete products	157 0	3 0	160 0
				Group No. 4.			
				All others	152 0	3 0	155 0

NOTE.—"Renderer" means a skilled employee facing concrete articles with float and trowel. Clauses, other than clause 2, of the said Determination shall remain in force.

By Authority: J. J. GOURLY, Government Printer, Melbourne.



VICTORIA GOVERNMENT GAZETTE.

Published by Authority.

[Registered at the General Post Office, Melbourne, for transmission by post as a newspaper.]

No. 616]

WEDNESDAY, AUGUST 16.

[1950

Factories and Shops Acts.

DETERMINATION OF A WAGES BOARD ADJUSTED PURSUANT TO SECTION 21 OF THE FACTORIES AND SHOPS ACT 1934 (No. 4275).

I, Raymond Henry Beers, Secretary for Labour, in pursuance of the powers conferred by the Factories and Shops Acts, hereby make and issue the following adjusted Determination of the Wages Board referred to hereunder showing adjusted rates and prices to operate from the beginning of the first pay period to commence in August, 1950.

Dated at Melbourne, this

9th day of August, 1950.

RAY H. BEERS,

Secretary for Labour.

CHAFF-CUTTERS BOARD.

Clauses 2, 3, and 14 of the Determination published in *Government Gazette* No. 299 of the 7th April, 1949, shall be replaced by the following clauses:—

2.

Apprentices or Improvers.		Other Employees.	
Wages per week of 40 hours.		Wages per week of 40 hours.	
<i>Apprentices.</i>		CHAFF-CUTTING, CORN-CRUSHING, COMPRESSING FODDER, OR THRESHING.	
1st year	s. d. 83 0	Foreman (i.e., the man who gives instructions to, and is responsible for the work done by, 4 or more employees)	167 0
2nd	89 0	Drivers of Motor trucks—	
3rd	106 3	(a) having a carrying capacity of 25 cwt. or less ..	162 6
4th	117 6	(b) having a carrying capacity over 25 cwt. but not over 3 tons ..	168 6
5th	134 3	(c) over 3 tons but under 6 tons ..	171 0
<i>Improvers.</i>		Further tonnage—for each complete ton over 5, an extra 1/ per week.	
Under 17 years of age	83 0	Carter driving one horse	159 0
17 years of age	89 0	" two horses	165 0
18	106 3	" three horses	167 6
19	117 6	And 2s. 6d. extra per week for every additional horse.	
and thereafter the rate for "Other Employees".		Chaff-cutter feeders—	
PROPORTION (IN ANY PLACE).		(a) in stationary mills	164 6
<i>Apprentices.</i>		(b) on travelling plants	170 6
One apprentice to every three or fraction of three workers receiving not less than 155s. per week of 40 hours.		Stablemen	155 0
An indenture of apprenticeship, prescribed by the Board, was approved on 6th June, 1923.		All others—	
<i>Improvers.</i>		(a) in stationary mills	162 0
One improver to the first three or fraction of three workers, and thereafter one improver to every three workers receiving not less than 162s. per week of 40 hours.		(b) on travelling plants	168 0
		CORN-CLEANING OR CORN-GRADING.	
		Foreman (i.e., the man who gives instructions to, and is responsible for the work done by, 4 or more employees)	167 0
		All others	162 0

ALLOWANCES.

3. To the amounts otherwise prescribed in this Determination shall be added the following:—

- (a) Driver of a motor vehicle fitted and operated with a charcoal gas producer unit—for each day or portion thereof upon which he is called upon to drive such vehicle 1s. per day
- (b) Such driver for each day or portion thereof upon which he is called upon to clean the hopper and/or final filter of such unit An extra 1s.
- (c) Driver of a motor vehicle to which a trailer is attached—for each day or portion thereof upon which he is called upon to drive such vehicle 1s. per day
- (d) An allowance equivalent to double time or double rates, as the case may be, shall be paid to any employee whilst he is handling West Australian hay infested with mites (*Pediculus ventricosus*).

PIECE-WORK.

14. The lowest piece-work prices payable to any person employed on a travelling plant shall be—

(a)	Where three persons (including feeder, band cutter, pitcher, or baggers) are employed.	Where four persons (including feeder, band cutter, pitcher, or baggers) are employed.	Where five or six persons (including feeder, band cutter, pitcher, or baggers) are employed.	Where more than six persons (includ- ing feeder, band cutter, pitcher, or baggers) are employed.	Where more than four persons (including feeder, band cutter, pitcher, or baggers) are employed.
	PER TON. <i>s. d.</i>	PER TON. <i>s. d.</i>	PER TON. <i>s. d.</i>	PER TON. <i>s. d.</i>	PER TON. <i>s. d.</i>
Hay chaff-cutting, on machines with mouthpieces over 11 inches ..	4 1½	3 6½	2 11½	2 9½	..
Straw chaff-cutting, on machines with mouthpieces over 11 inches ..	5 3	4 4	3 10½	3 4	..
Hay chaff-cutting, on machines with mouthpieces 11 inches or under ..	4 6½	3 10½	3 10½
Straw chaff-cutting, on machines with mouthpieces 11 inches or under ..	5 3	4 4	3 10½

- (b) Baling sheaf hay, meadow hay and lucerne hay by any power-driven press *s. d.* 3 0½ per ton.
 Baling straw by any power-driven press { (i) Where up to and including four persons are employed .. 3 6½ per ton.
 (ii) Where more than four persons are employed .. 3 0½ per ton.

Clauses, other than clauses 2, 3, and 14, of the said Determination shall remain in force.



VICTORIA GOVERNMENT GAZETTE.

Published by Authority.

[Registered at the General Post Office, Melbourne, for transmission by post as a newspaper.]

No. 617]

WEDNESDAY, AUGUST 16.

[1950

Factories and Shops Acts.

DETERMINATION OF A WAGES BOARD ADJUSTED PURSUANT TO SECTION 21 OF THE FACTORIES AND SHOPS ACT 1934 (No. 4275).

I, Raymond Henry Beers, Secretary for Labour, in pursuance of the powers conferred by the Factories and Shops Acts, hereby make and issue the following adjusted Determination of the Wages Board referred to hereunder showing adjusted rates and prices to operate from the beginning of the first pay period to commence in August, 1950.

Dated at Melbourne, this
3rd day of August, 1950.

RAY. H. BEERS,
Secretary for Labour.

COAL AND COKE BOARD.

Clause 2 of Part 1 and clause 1 of Part 2 of the Determination published in *Government Gazette* No. 852 of the 23rd September, 1949, shall be replaced by the following clauses:—

PART I.—Persons OTHER THAN those employed in the process, trade, business, or occupation of burning, preparing, grinding, grading, or distributing charcoal in a form suitable for use in power-producing or heat-producing units; in the manufacture of explosives or in the manufacture, repair, or maintenance of gas masks or respirators.

2. (a)

Improvers.		Other Employees.	
WAGES PER WEEK.		WAGES PER WEEK.	
	s. d.		s. d.
Under 17 years of age	94 0	Persons trimming or spreading coal that is heated or on fire	253 0
17 years of age	110 9	Persons employed driving and/or operating power-driven coal-loading machines, i.e., persons riding on, driving and/or operating mechanical or other levers of such coal-loading machines	197 0
18 " "	127 9	Persons employed trimming coal and/or feeding coal to and from coal loaders	187 0
19 " " or over—the appropriate rate prescribed under the heading "other employees".		Persons trimming coal from the "Grab"	194 4
		Other coal trimmers	187 0
		Coal baggers or loaders	187 0
		Persons employed loading by shovel or fork loose coal from railway trucks to vehicles	187 0
		Persons employed loading by shovel or fork loose coal from vehicles to railway trucks	209 0
		Persons loading by shovel or fork loose coal from the ground into railway trucks	220 0
		Coke stackers at wharf coal yards	196 2
		Coke yard employees	157 8
		Carters driving one horse	163 6
		Carters driving two horses	171 6
		Carters driving three horses	176 0
		Carters driving four horses	179 0
		Carters driving five horses	180 6
		And 6d. extra per day for every additional horse.	
		Drivers of motor vehicle, including girlinger, having a maker's capacity of—	
		(a) 25 cwt. or less	171 6
		(b) Over 25 cwt., but not over 3 tons	177 6
		(c) Over 3 tons, but under 6 tons	182 0
		Further tonnage—for each complete ton over 5 an extra 1s. per week	
		All other coal yard employees	180 0

NOTE.—The Board has determined, in accordance with section 25 (1) of the *Factories and Shops Act* 1934, that the trade is an unskilled trade no apprentices shall be taken in the trade.

(b) Gas PRODUCER UNITS.—The following provisions shall apply to drivers of gas producer units:—

- (i) Driver of a motor vehicle fitted and operated with a charcoal gas producer unit for each day or portion thereof upon which he is called upon to drive such vehicle, 1s. extra.
- (ii) Such driver for each day or portion thereof upon which he is called upon to clean the hopper and/or final filter of such unit, 1s. extra.
- (iii) Suitable overalls and gloves shall be provided by employers for the employees mentioned in sub-clauses (i) and (ii) hereof
- (iv) Employers shall provide proper washing conveniences for such employees, and also hot water or some other efficient cleansing material.

PART 2.—Persons employed in the process, trade, business, or occupation of burning, preparing, grinding, grading, or distributing charcoal, in a form suitable for use in power-producing or heat-producing units; in the manufacture of explosives or in the manufacture, repair, or maintenance of gas masks or respirators.

1. (a)

Improvers.		Other Employees.	
WAGES PER WEEK OF 40 HOURS.		WAGES PER WEEK OF 40 HOURS.	
	<i>s. d.</i>		<i>s. d.</i>
Under 17 years of age	91 6	Wood cutters, using axe, power crosscut circular saw, or other method	167 8
17 years of age	107 3	Carters driving one horse	163 6
18 " "	122 3	Carters driving two horses	171 6
19 " " or over—the appropriate rate prescribed under the heading "other employees".		Carters driving three horses	176 0
		Carters driving four horses	179 0
		Carters driving five horses	180 6
		And 6d. extra per day for every additional horse	
		Drivers of vehicle (including girlinger) having maker's capacity of—	
		(a) 25 cwt. or less	171 6
		(b) Over 25 cwt., but not over 3 tons	177 6
		(c) Over 3 tons, but under 6 tons	182 0
PROPORTION (BY ANY EMPLOYER.)		Further tonnage—for each complete ton over 5 an extra 1s. per week.	
One improver to the first six workers, and thereafter one additional improver to every ten additional workers receiving not less than 163s. 6d. per week.		Charcoal burning by retorts, metal or brick kilns, or pits—	
		(a) Operator in charge of plant	182 8
		(b) All other employees, including persons employed in emptying, bagging, sewing, stacking, or loading	172 8
		Grinding or grading charcoal—	
		(a) Attendant in charge of plant—	
		(i) With four or more persons under his supervision	192 8
		(ii) With three or fewer persons under his supervision	188 8
		(b) All other persons, including those engaged in grinding, grading, or bagging charcoal or sewing bags	182 8

(b) GAS-PRODUCER UNITS.—The following provisions shall apply to drivers of gas-producer units:—

- (i) Driver of a motor vehicle fitted and operated with a charcoal gas-producer unit for each day or portion thereof upon which he is called upon to drive such vehicle, 1s. extra.
- (ii) Such driver for each day or portion thereof upon which he is called upon to clean the hopper and/or final filter of such unit, 1s. extra.
- (iii) Suitable overalls and gloves shall be provided by employers for the employees mentioned in sub-clauses (i) and (ii) hereof.
- (iv) Employers shall provide proper washing conveniences for such employees and also hot water or some other efficient cleansing material.

Clauses, other than clause 2 of Part 1 and clause 1 of Part 2, of the said Determination shall remain in force.



VICTORIA GOVERNMENT GAZETTE.

Published by Authority.

[Registered at the General Post Office, Melbourne, for transmission by post as a newspaper.]

No. 618]

WEDNESDAY, AUGUST 16.

[1950

Factories and Shops Acts.

DETERMINATION OF A WAGES BOARD ADJUSTED PURSUANT TO SECTION 21 OF THE FACTORIES AND SHOPS ACT 1934 (No. 4275).

I, Raymond Henry Beers, Secretary for Labour, in pursuance of the powers conferred by the Factories and Shops Acts, hereby make and issue the following adjusted Determination of the Wages Board referred to hereunder showing adjusted rates and prices to operate from the beginning of the first pay period to commence in August, 1950.

Dated at Melbourne, this
9th day of August, 1950.

RAY. H. BEERS,
Secretary for Labour.

BEDSTEADMAKERS BOARD.

Clauses 2 to 4 inclusive of the Determination published in *Government Gazette* No. 12 of the 9th January, 1950, shall be replaced by the following clauses:—

2.	Wages per week of 40 hours.	
	Within the Metropolitan District; the Cities of Geelong, Geelong West and the Town of Newtown and Chilwell and the City of Warrnambool.	Other Parts of Victoria where the Determination applies.
	<i>s.</i> <i>d.</i>	<i>s.</i> <i>d.</i>
Bedstead smith	165 0	162 0
Chill fitter called on to design and model	180 0	177 0
Other chill fitter	165 0	162 0
Machinist	162	159 0
Plater in charge	177 0	174 0
Plater's assistant	163 0	160 0
Polisher and grinder	164 0	161 0
Chipper and caster	161 0	158 0
Bedstead fitter and mounter	165 0	162 0
Employee engaged cutting, binding, straightening, drilling or squaring up parts of bedsteads and frame setter	164 0	161 0
Japanner and lacquerer	162 0	159 0
Other employees with not less than three months' experience in the industry	149 0	146 0
All others	143 0	140 0

SPECIAL RATES.

3. In addition to the wages prescribed in clause 2 hereof the following special rates and allowances shall be paid:—

- (a) Leading hands in charge of not less than three and not more than ten employees, including apprentices, 9s. per week extra; more than ten and not more than twenty employees, including apprentices, 18s. per week extra; more than twenty employees, including apprentices, 27s. per week extra.
- (b) Working in wet places, 1½d. per hour extra. Working in confined spaces, 3d. per hour extra.
- (c) Working for more than one hour in the shade in places where the temperature is raised by artificial means to between 115 and 130 degrees Fahrenheit, 1½d. per hour extra; in places where the temperature exceeds 130 degrees Fahrenheit, 3d. per hour extra. Where work continues for more than two hours in temperatures exceeding 130 degrees Fahrenheit, employees shall also be entitled to twenty minutes' rest after every two hours' work without deduction of pay. The temperature shall be decided by the foreman of the work after consultation with the employees who claim the extra rate.
- (d) Dirty work, i.e., work which a foreman and workman shall agree is of an unusually dirty or offensive nature, 1½d. per hour extra.
- (e) Compensation to the extent of the damage sustained shall be made for work in which clothing or tools are damaged or destroyed by the use of acids.
- (f) Where more than one of the disabilities entitling a workman to extra rates exist on the same job, the employer shall be bound to pay only one rate, viz., the highest for the disabilities so prevailing.

4.

JUNIOR MALE AND FEMALE LABOUR.

The following scale of wages shall apply to unapprenticed male junior labour and to female labour:—

	Percentage of Needs Basic Wage.	Adjustable Portion of Wage.	Loading (Constant).	Additional Amount.	Total Wage.
	Per Week.	Per Week.	Per Week.	Per Week.	Per Week.
<i>(a) Junior Males.</i>					
		<i>s. d.</i>	<i>s. d.</i>	<i>s. d.</i>	<i>s. d.</i>
Under 16 years of age		16 6	0 6	1 6	18 6
16 and under 17 years of age		46 3	0 9	2 6	49 6
17 and under 18 years of age		81 6	1 0	4 6	87 0
18 and under 19 years of age		101 6	2 0	6 0	109 6
19 and under 21 years of age		122 9	2 6	7 0	132 3
<i>(b) Adult Females.</i>					
If of less than 12 months' experience	65		3 0	6 0	96 0
Of 12 months' experience or more	75		3 0	7 0	110 6
<i>(c) Junior Females.</i>					
17 years of age and under	40		1 0	3 6	58 0
18 years of age	47½		1 3	4 0	69 0
19 years of age	55		1 6	4 6	79 6
20 years of age	62½		2 0	5 0	90 6

Females and unapprenticed male juniors may be employed on piece-work subject to clause 17 hereof. The wages of male juniors in receipt of 20s. per week or more shall be adjusted proportionately to adjustments of the needs basic wage in terms of clause 24 hereof, such adjustments to be made to the nearest 3d., half or less than half of 3d. to be disregarded. The wages of females shall be calculated to the nearest 6d., any broken part of 6d. in the result not exceeding 3d. to be disregarded.

Clauses, other than clauses 2 to 4 inclusive, of the said Determination shall remain in force.



VICTORIA GOVERNMENT GAZETTE.

Published by Authority.

[Registered at the General Post Office, Melbourne, for transmission by post as a newspaper.]

No. 619]

WEDNESDAY, AUGUST 16.

[1950

Factories and Shops Acts.

DETERMINATION OF A WAGES BOARD ADJUSTED PURSUANT TO SECTION 21 OF THE FACTORIES AND SHOPS ACT 1934 (No. 4275).

I, Raymond Henry Beers, Secretary for Labour, in pursuance of the powers conferred by the Factories and Shops Acts, hereby make and issue the following adjusted Determination of the Wages Board referred to hereunder showing adjusted rates and prices to operate from the beginning of the first pay period to commence in August, 1950.

Dated at Melbourne, this
14th day of August, 1950.

RAY. H. BEERS,
Secretary for Labour.

COAL MINERS BOARD.

Clauses (2) and (3) of the Determination published in *Government Gazette* No. 144 of the 17th July, 1943, shall be replaced by the following clauses:—

2.

WAGES.

Minors.				Adult Persons.				
Surface Workers.				Surface Workers.				
Age.	Per Day Shift.			All adults—*28s. 10d. per day shift.				
	Wages.	War-time Loading.	Total.	Underground Workers.				
	s. d.	d.	s. d.	Per Day Shift.				
				s. d.				
14 years	9 7	3	9 10	Shaft sinkers	33 1
15 "	11 11	4	12 3	Timber drawers	34 1
16 "	14 5	5	14 10	Shiftmen	31 10
17 "	17 7	6	18 1	Platmen	31 10
18 "	20 5	7	21 0	Assistant platmen	30 2
19 "	23 5	8	24 1	Set runners (riding or walking)	31 6
20 "	26 4	9	27 1	Jigmen	31 6
				Wheelers (hand wheeling or using one horse)	30 6
				Wheelers (using two horses)	32 1
				Examiners	34 1 *
				Contract miners' minimum wage	32 3
				Miners working on coal and/or brushing	32 3
				Persons employed in stone-drives	31 10
				Probationary miners	31 10
				Machine-men (including assistant)	33 7
				Shiftmen acting as examiners	32 10
				Ventilation stopping builders	32 10
				Ventilation stopping builders' assistants	30 6
				Persons not provided for otherwise	30 6

* Including 1/- war-time loading.

3. SHIFTS.—That work performed except on a day shift as defined in clause 16 herein shall be paid for at the rate prescribed for day-shift work, with the addition of 7½ per cent.

Clauses (4) to (18) inclusive of the Determination published in *Government Gazette* No. 144 of the 17th July, 1943, shall remain in force.

By Authority: J. J. GOUBLEY, Government Printer, Melbourne



VICTORIA GOVERNMENT GAZETTE.

Published by Authority.

[Registered at the General Post Office, Melbourne, for transmission by post as a newspaper.]

No. 620]

WEDNESDAY, AUGUST 16.

[1950

Factories and Shops Acts.

DETERMINATION OF A WAGES BOARD ADJUSTED PURSUANT TO SECTION 21 OF THE FACTORIES AND SHOPS ACT 1934 (No. 4275).

I, Raymond Henry Beers, Secretary for Labour, in pursuance of the powers conferred by the Factories and Shops Acts, hereby make and issue the following adjusted Determination of the Wages Board referred to hereunder showing adjusted rates and prices to operate from the beginning of the first pay period to commence in August, 1950.

Dated at Melbourne, this
9th day of August, 1950.

RAY. H. BEERS,
Secretary for Labour.

COMMERCIAL ARTISTS BOARD.

Clauses 2 and 3 of the Determination published in *Government Gazette* No. 883 of the 28th October, 1949, shall be replaced by the following clauses:—

WAGES (Adult Artists, other than Apprentices or Improvers).

2. All employees £10 7 0 per week of 40 hours.

JUNIORS.

3. (a) No person other than a senior artist shall be employed at any work covered by this Determination otherwise than—
(i) under a contract of apprenticeship as hereinafter provided;
(ii) those who prior to the 11th April, 1945, had been employed for at least six months in the trade; or
(iii) as a female improver.
(b) *Proportion.*—The proportion of apprentices or improvers in any place shall not exceed:—

Where the Number of Senior Artists Employed Is—	Number of Apprentices.	Number of Improvers.
One or Two	One	or One
Three or four	One Two	and One or and Nil
Five, six, or seven	Two Three Four	and Two or and One or and Nil
In excess of seven	One additional apprentice or improver for each two additional senior artists in excess of seven	

A senior artist is any adult employee other than an apprentice or an improver.

Notwithstanding anything contained in this Determination, any person who on the 11th April, 1945, was employed for not less than two months in the industry, and whose engagement or continued employment as an apprentice or as an improver, is by this Determination forbidden, shall be entitled to be employed, and shall be paid the scale of wages prescribed for an apprentice or improver of like experience.

(c) *Contract of Apprenticeship.*—Every contract of apprenticeship hereinafter made shall be on the form of indenture prescribed by the Commercial Artists Board.

No. 620.—7621/50.—PRICE 3D.

(d) *Period of Apprenticeship.*—The periods of apprenticeship shall be as follows :—

If the apprentice when indentured is under the age of 18 years—5 years, if over the age of 18 years—4 or 5 years, at the option of the contracting parties.

Provided that a person who has completed a full-time Commercial Art course of not less than three years at a school approved by the Wages Board shall be credited with one year of apprenticeship, and a person who has completed a full-time Commercial Art course of not less than four years at such a school shall be credited with two years' apprenticeship. For any such person the period of apprenticeship, including credit granted as above, shall not exceed five years, but may be of four years' duration at the option of the contracting parties.

(e) *Wages of Apprentices.*—The minimum weekly wages of apprentices shall be :—

	£	s.	d.
(i) Five-year term—			
First year	2	8	9
Second year	3	5	3
Third year	4	9	0
Fourth year	5	18	3
Fifth year	7	16	0

(ii) Four-year term—

First year	2	18	3
Second year	4	9	0
Third year	5	18	3
Fourth year	7	16	0

(f) *Wages of Improvers.*—The minimum weekly wages of improvers shall be :—

First year	2	8	9
Second year	3	5	3
Third year	4	9	0
Fourth year	5	18	3
Fifth year	7	16	0

Provided that a person who has completed a full-time Commercial Art course of not less than three years at a school approved by the Wages Board shall be credited with one year of service, and a person who has completed a full-time Commercial Art course of not less than four years at such a school, shall be credited with two years of service. This provision shall apply only to improvers engaged for the first time on or after the 1st September, 1946.

(g) *Probationary Period.*—Minors shall be apprenticed as from the date of commencing work with an employer, but notwithstanding anything contained elsewhere in this Determination the first nine months of service shall be deemed to be a probationary period, and the indenture may be terminated by any party thereto during such period of probation without any obligation to any other party or parties.

(h) *Attendance at Approved Art Schools.*—

(i) During the currency of the indenture an apprentice shall be permitted by the employer to absent himself during working hours for the purpose of attending art classes or examinations at a school approved by the Commercial Artists Board for a period or periods not exceeding in the aggregate four hours in any week.

(ii) The apprentice shall also attend evening classes at an Art school approved by the said Board on two evenings each week.

(iii) An apprentice attending a school or schools as prescribed in sub-clauses (i) and (ii) hereof and presenting reports of satisfactory progress and attendance, to his employer shall be reimbursed all fees paid for such tuition.

(iv) Until further order schools approved by the said Board shall be :—

Melbourne Technical College;
Swinburne Technical College, Glenferrie,
Gordon Institute of Technology, Geelong;
Prahran Technical School;
Technical Art School, Ballarat;
Caulfield Technical School.

(i) *Cancellation or Suspension of Indenture.*—Subject to the approval of the Secretary for Labour, but not otherwise, an indenture of apprenticeship may be suspended or cancelled—

(i) by mutual consent;

(ii) if through lack of orders or financial difficulties an employer is unable to find suitable employment for an apprentice and a transfer to another employer cannot be arranged;

(iii) if, in the opinion of the Secretary for Labour, circumstances exist which render such suspension or cancellation necessary or desirable.

Any covenant in an indenture inconsistent with the provisions of this clause shall be null and void and of no force or effect.

(j) *Lost Time.*—The apprentice at the end of the calendar period of any year in which he has actually given service to the master upon less than the ordinary working days prescribed in this Determination, or on which he has unlawfully absented himself without the master's consent shall, for every day short of the said number of working days, and for every day of such absence, serve one day, and the calendar period of the succeeding year of his service shall not be deemed to begin until the said additional day or days shall have been served.

Provided that in calculating the extra time to be so served, the apprentice shall be credited with time which he has worked during the relevant year in excess of his ordinary hours.

(k) *Prohibition of Premiums.*—An employer shall not, either directly or indirectly, or by any pretence or device receive from any person or require or permit any person to pay or give any consideration in the nature of a premium or bonus for the taking or binding of any probationer or apprentice.

(l) *Overtime.*—An apprentice under the age of eighteen years shall not be required to work overtime unless he so desires

(m) *Payment by Results.*—An apprentice or improver shall not work under any system of payment by results.

Clauses, other than clauses 2 and 3, of the said Determination shall remain in force.



VICTORIA GOVERNMENT GAZETTE.

Published by Authority.

[Registered at the General Post Office, Melbourne, for transmission by post as a newspaper]

No. 621]

WEDNESDAY, AUGUST 16.

[1950

Factories and Shops Acts.

DETERMINATION OF A WAGES BOARD ADJUSTED PURSUANT TO SECTION 21 OF THE FACTORIES AND SHOPS ACT 1934 (No. 4275).

I, Raymond Henry Beers, Secretary for Labour, in pursuance of the powers conferred by the Factories and Shops Acts, hereby make and issue the following adjusted Determination of the Wages Board referred to hereunder showing adjusted rates and prices to operate from the beginning of the first pay period to commence in August, 1950.

Dated at Melbourne, this
14th day of August, 1950.

RAY. H. BEERS,
Secretary for Labour.

CORDAGE BOARD.

Clause 2 of the Determination published in *Government Gazette* No. 101 of the 25th February, 1948, shall be replaced by the following clause:—

JUNIORS.

2. (a) The minimum rates of wages to be paid to junior employees shall be as follows:—

Age.	Males.			Females.		
	£	s.	d.	£	s.	d.
Under 16 years of age	2	12	3	2	13	0
16 years of age	3	0	3	2	19	6
16½ years of age	3	5	6	3	4	9
17 years of age	3	12	3	3	12	3
17½ years of age	3	19	0	3	19	0
18 years of age	4	6	6	4	5	0
18½ years of age	4	16	9	4	11	9
19 years of age	5	4	3	4	17	6
19½ years of age	5	19	3	5	0	6
20 years of age	6	6	9	5	4	3
20½ years of age	7	1	6	5	8	0

Provided that after a junior employee has had two years' experience in the industry he or she shall be paid, in addition to the above rates, the margins prescribed for adults in clause 29 of this Determination.

Provided also that a junior female after four years' experience in the industry shall be paid the rates prescribed for an adult female in the classification in which she is employed.

PROPORTION OF JUNIOR EMPLOYEES.

The proportion of junior employees, male and female, to adult male and female employees shall not exceed one junior to one employee receiving full adult male or female rates in the factory.

OTHER EMPLOYEES.

(b)

	Wages Per Week.		
	£	s.	d.
<i>Males.</i>			
First rope layer on heavy type 12 strand machine	8	16	0
Rope layer on heavy type 9 strand machine	8	11	0
Foreman in charge of spinning and preparing departments	8	12	0
Other rope layers in walk with travellers	8	7	0
Rope splicer on driving ropes and springs	8	6	0
Storeman in charge	8	4	0
Packer working press (hand or power) pressing over 28 lb. in weight	8	2	0
Rope house machinist making 2 inch up to and including 4 inch	8	2	0
Rope house machinist making over 4-inch	8	5	0
Power reeler or finisher in connexion with heavy type 12 strand machine	8	2	0
Feeder or first spreader	8	0	0
Traveller driver on heavy type 12 strand machine	8	0	0
Damp mixer or batcher	7	19	0
Feeder of softeners or batchers	7	19	0
Rope and binder twine packer	7	19	0
Winder and warper in tarring department	8	0	0
Winding oiling and tarring yarn	8	0	0
Oilier and/or belt repairer	8	0	0
Maker of rope fenders	8	0	0
Maker of pig nets	7	19	0
Maker of camouflage nets	7	17	0
Power reeler or finisher in walk	7	19	0
Other traveller drivers (except on light travellers for cords and lines not exceeding 1½ inches in circumference)	7	17	0
Layer of lines or cords in walk	8	3	0
Twister or layer of yarn in walk	7	19	0
Opening Manilla hemp	7	17	0
Scutcher	7	17	0
Lumping, loading or unloading hemp, flax or twine in store or factory	7	17	0
Feeder of tow breaker card	7	17	0
Lumping hemp flax or binder twine on wharf	8	0	0
Tacking and balling shop twine	7	19	0
Mat finisher	7	19	0
Maker of fishing lines	7	19	0
Hand reelers	7	17	0
Matting weavers	7	19	0
Drivers of motor waggons with capacity not exceeding 25 cwt.	8	4	0
Drivers of motor waggons with capacity exceeding 25 cwt. and not exceeding 3 tons	8	9	0
Drivers of motor waggons with capacity exceeding 3 tons	8	12	0
Employees pinning hackles, gills and card staves	7	17	0
Dye house and flax boiling department operatives	7	17	0
All other machine operators or employees feeding or taking from machines	7	17	0
All others	7	14	0
<i>Females.</i>			
Balling binder twine	6	0	0
Balling lashing	6	0	0
Bagging binder twine	5	19	0
Feeding breaker card with clock	6	0	0
Feeding spreaders	5	19	0
Feeding finisher cards (hemp)	5	19	0
Spinning	6	5	0
Wet spinning	6	6	0
Ring frame operative	6	0	0
All other machine operators or employees feeding or taking from machines	5	19	0
All others	5	16	0

Clauses, other than clause 2, of the said Determination shall remain in force.

[4377]



VICTORIA

GOVERNMENT GAZETTE.

Published by Authority.

[Registered at the General Post Office, Melbourne, for transmission by post as a newspaper.]

No. 622]

WEDNESDAY, AUGUST 16

[1950

Factories and Shops Acts.

DETERMINATION OF A WAGES BOARD ADJUSTED PURSUANT TO SECTION 21 OF THE
FACTORIES AND SHOPS ACT 1934 (No. 4275).

I, Raymond Henry Beers, Secretary for Labour, in pursuance of the powers conferred by the Factories and Shops Acts, hereby make and issue the following adjusted Determination of the Wages Board referred to hereunder showing adjusted rates and prices to operate from the beginning of the first pay period to commence in August, 1950.

Dated at Melbourne, this
14th day of August, 1950.

RAY H. BEERS,
Secretary for Labour.

CORK TRADE BOARD.

Clauses 2 (a) and 2 (b) of the Determination published in *Government Gazette* No. 563 of the 21st May, 1948, shall be replaced by the following clauses:—

2. (a) WAGES.

		Per Week.
		£ s. d.
<i>Adult Males.</i>		
Cork Cutting:—		
Rounding; drawing off; bench hand reclaiming waste and/or clean ending by hand—		
First six months	7 19 6
Thereafter	8 9 6
Feeders and/or operators of machines i.e., employees backing down; notching; boring; pressing; knurling; assembling; and/or capping or closing		
All others	7 17 6
All others	7 14 6
Cork Board:—		
Oven hand in charge (curing)	8 9 6
All others	7 14 6
Compressed Cork:—		
Oven hand in charge (curing)	8 9 6
Splitting with band knife and/or mixing granules with adhesive by machinery	8 2 6
All others	7 17 6
Fishing Requisites:—		
Rounding and/or drawing off—		
First six months	7 19 6
Thereafter	8 9 6
Employees notching; boring; threading; and/or attaching wire ferrules to sticks	7 17 6
All others	7 14 6
<i>Adult Females.</i>		
Under three months' experience	4 14 0
All others	5 8 0

(b) APPRENTICES OR IMPROVERS.

Males.				Per Week.	Females.				Per Week.
				£ s. d.					£ s. d.
Under 16 years of age	1 15 6	17 years of age and under	2 17 0
16 years of age	2 9 6	18 years of age	3 7 6
17 years of age	3 7 6	19 years of age	3 18 6
18 years of age	4 5 0	20 years of age	4 9 6
19 years of age	5 7 0					
20 years of age	6 8 0					

PROPORTION (in any place).

APPRENTICES.	IMPROVERS.
<i>Males.</i>	<i>Males.</i>
One male apprentice to every three or fraction of three male workers receiving not less than the minimum wage.	One male improver to every four or fraction of four male workers receiving not less than the minimum wage.
<i>Females.</i>	<i>Females.</i>
One female apprentice to every three or fraction of three female workers receiving not less than the minimum wage.	One female improver to every four or fraction of four female workers receiving not less than the minimum wage.

Clauses, other than clauses 2 (a) and 2 (b), of the said Determination shall remain in force.



VICTORIA GOVERNMENT GAZETTE.

Published by Authority.

[Registered at the General Post Office, Melbourne, for transmission by post as a newspaper.]

No. 623]

WEDNESDAY, AUGUST 16.

[1950

Factories and Shops Acts.

DETERMINATION OF A WAGES BOARD ADJUSTED PURSUANT TO SECTION 21 OF THE FACTORIES AND SHOPS ACT 1934 (No. 4275).

I, Raymond Henry Beers, Secretary for Labour, in pursuance of the powers conferred by the Factories and Shops Acts, hereby make and issue the following adjusted Determination of the Wages Board referred to hereunder showing adjusted rates and prices to operate from the beginning of the first pay period to commence in August, 1950.

Dated at Melbourne, this
14th day of August, 1950.

RAY H. BEERS,
Secretary for Labour.

CYCLE TRADE BOARD.

Clause 2 of the Determination published in *Government Gazette* No. 23 of the 13th January, 1950, shall be replaced by the following clause:—

2.

(a) *Apprentices.		(b) *Improvers.		(c) Other Employees.	
Weekly Wages.		Weekly Wages.		Weekly Wages Day Shift.	
s. d.		s. d.		s. d.	
1st year	36 3	1st year	35 6	Foremen, where over five adults are employed ..	197 6
2nd	44 9	2nd	43 3	Foremen, where five adults or fewer are employed	193 9
3rd	71 3	3rd	69 6	Lathe hands	192 0
4th	104 9	4th	101 3	Builders and repairers of motor cycle frames and frames other than cycle frames ..	178 3
5th	138 3	5th	135 0	Builders or repairers or brazers of cycle frames ..	177 0
And thereafter, until attaining the age of 21 years, four-fifths of the journeyman's rate.		And thereafter four-fifths of the journeyman's rate.		Other repairers of motor cycles (except lathe hands)	178 3
PROPORTION (IN ANY PLACE).		Provided that any improver who commences at the trade after attaining the age of 17 years shall be paid 20 per cent. in addition to the above rates.		Other repairers (except lathe hands)	177 0
One apprentice to every three or fraction of three persons receiving not less than 165s. per week.		PROPORTION (IN ANY PLACE).		Assemblers of motor cycles	177 0
		One improver to one person receiving not less than 165s. per week, two improvers to two or three such persons, thereafter two additional improvers to every three additional such persons.		Other assemblers	169 6
				Filers on motor and other cycles	169 6
				Wheel-builders on motor and other cycles ..	169 6
				Foremen in rim-making	181 6
				All others employed in rim-making	169 6
				Persons cleaning off joints by sand-blasting or by shot-blasting	169 6
				Handle-bar benders—	
				By the mandrel method	165 0
				By any other method	169 6
				Persons not provided for otherwise	159 0

* Except those covered by the Apprenticeship Act.

Clauses, other than clause 2, of the said Determination shall remain in force.

By Authority: J. J. GOUBLEY, Government Printer, Melbourne.





VICTORIA
GOVERNMENT GAZETTE.

Published by Authority.

[Registered at the General Post Office, Melbourne, for transmission by post as a newspaper.]

No. 624]

WEDNESDAY, AUGUST 16.

[1950

Factories and Shops Acts.

**DETERMINATION OF A WAGES BOARD ADJUSTED PURSUANT TO SECTION 21 OF THE
FACTORIES AND SHOPS ACT 1934 (No. 4275).**

I, Raymond Henry Beers, Secretary for Labour, in pursuance of the powers conferred by the Factories and Shops Acts, hereby make and issue the following adjusted Determination of the Wages Board referred to hereunder showing adjusted rates and prices to operate from the beginning of the first pay period to commence in August, 1950.

Dated at Melbourne, this
14th day of August, 1950.

RAY H. BEERS,
Secretary for Labour.

FROZEN GOODS BOARD.

Clause 2 of the Determination published in *Government Gazette* No. 859 of the 30th September, 1949, shall be replaced by the following clause:—

2.

WAGES.

Improvers and Juvenile Workers.					Other Employees.				
—	Weekly Rate.	*War Loading.	Total Weekly Wage.	Per Hour.	Per Week.				
					Weekly Rate.	*War Loading.	Total Weekly Wage.	Per Hour.	
	£ s. d.	s. d.	£ s. d.	s. d.	£ s. d.	s. d.	£ s. d.	s. d.	
16 years of age and under 17	3 15 9	0 11	3 16 8	1 11	10 19 6	4 0	11 3 6	5 7 ¹ / ₂₀	
17 " " " 18	4 4 1	0 11	4 5 0	2 1 ¹ / ₂					
18 " " " 19	4 19 0	1 10	5 0 10	2 6 ¹ / ₂					
19 " " " 20	5 16 6	1 10	5 18 4	2 11 ¹ / ₂					
20 " " " 21	7 5 7	2 9	7 8 4	3 8 ¹ / ₂	All others ..	10 6 10	4 0	10 10 10	5 3 ¹ / ₂

For definition of juvenile workers, see clause 11.

PROPORTION OF IMPROVERS.

One improver to every 25 or fraction of 25 workers receiving not less than the hourly rate herein prescribed for "all others".

Temporary workers shall be paid time and a half on the ordinary rates for work done during ordinary working hours. For work done outside those hours they shall receive ordinary overtime rates.

* The War Loading shall not be taken into account in the calculation of overtime and holiday rates.

NOTE.—The Wages Board has determined in accordance with section 25 (1) of the amended *Factories and Shops Act 1934* that the trade is so unskilful that no person should be taken as an apprentice to the trade.

Clauses, other than clause 2, of the said Determination shall remain in force.

By Authority: J. J. GOURLEY, Government Printer, Melbourne.



VICTORIA GOVERNMENT GAZETTE.

Published by Authority.

[Registered at the General Post Office, Melbourne, for transmission by post as a newspaper.]

No. 625]

WEDNESDAY, AUGUST 16.

[1950

Factories and Shops Acts.

DETERMINATION OF A WAGES BOARD ADJUSTED PURSUANT TO SECTION 21 OF THE FACTORIES AND SHOPS ACT 1934 (No. 4275).

I, Raymond Henry Beers, Secretary for Labour, in pursuance of the powers conferred by the Factories and Shops Acts, hereby make and issue the following adjusted Determination of the Wages Board referred to hereunder showing adjusted rates and prices to operate from the beginning of the first pay period to commence in August, 1950.

Dated at Melbourne, this
14th day of August, 1950.

RAY. H. BEERS,
Secretary for Labour.

FRUIT PACKING BOARD.

Clause 2 of the Determination published in *Government Gazette* No. 1119 of the 20th December, 1949, shall be replaced by the following clause:—

WAGES PER WEEK OF 40 HOURS.

2.

Improvers.	Citrus Fruit Packing Establishments.		Other Fruit Packing Establishments.*		Other Employees.
	Males.	Females.	Males.	Females.	
	<i>s. d.</i>	<i>s. d.</i>	<i>s. d.</i>	<i>s. d.</i>	<i>s. d.</i>
Under 16 years of age ..	51 3	51 3	51 3	51 3	Packers, graders or sizers of fruit by hand .. 176 0
16 to 17 years of age ..	62 9	62 9	62 9	62 9	Full cool store hands (i.e., persons who are engaged for at least 75 per cent. of their time each week in cool-store chambers).. 176 0
17 to 18 years of age ..	77 0	69 9	77 0	69 9	Persons bringing fruit from and putting fruit into cool-store chambers .. 171 0
18 to 19 years of age ..	102 3	100 0	102 3	100 0	Case ladders and nailers—machine .. 171 0
19 to 20 years of age ..	129 9	103 3	129 9	103 3	Case ladders and nailers—hand .. 171 0
20 to 21 years of age ..	151 0	114 6	151 0	114 6	Case wirers .. 171 0
					Persons stacking and unstacking cases of fruit, but not in cool chambers .. 166 0
					Persons feeding grading, washing, or sizing machines .. 166 0
					Empty case hands or case yardsmen .. 166 0
					Case labellers or persons engaged in branding and marking cases .. 166 0
					Persons loading or unloading any merchandise or material connected with the fruit packing industry .. 166 0
					Persons sweeping up and removing debris in or around a packing shed .. 166 0
					All others .. 153 0
					<i>Females.</i>
					Packers, graders or sizers of fruit by hand .. 176 0
					Graders of fruit which has already been subjected to grading pursuant to Regulations under the Commerce (Trade Descriptions) Act of the Commonwealth of Australia .. 123 9
					All others .. 118 6

* Provided that any improver engaged in packing fruit shall be paid the adult weekly wage or piecework prices.

Proportion (in any Place).

One improver to every two or fraction of two workers receiving not less than the minimum wage.

NOTE.—The Board determines that no person shall be employed as an apprentice.

Clauses, other than clause 2, of the said Determination shall remain in force, provided that to the weekly earnings of each pieceworker the sum of 15s. shall be added, provided that where less than 40 hours are worked in any week, a proportionate amount shall be added in lieu of such sum.

By Authority: J. J. GOURLEY, Government Printer, Melbourne.





VICTORIA
GOVERNMENT GAZETTE.

Published by Authority.

[Registered at the General Post Office, Melbourne, for transmission by post as a newspaper.]

No. 626]

WEDNESDAY, AUGUST 16.

[1950

Factories and Shops Acts.

**DETERMINATION OF A WAGES BOARD ADJUSTED PURSUANT TO SECTION
21 OF THE FACTORIES AND SHOPS ACT 1934 (No. 4275).**

I, Raymond Henry Beers, Secretary for Labour, in pursuance of the powers conferred by the Factories and Shops Acts, hereby make and issue the following adjusted Determination of the Wages Board referred to hereunder showing adjusted rates and prices to operate from the beginning of the first pay period to commence in August, 1950.

Dated at Melbourne, this
14th day of August, 1950.

RAY. H. BEERS,
Secretary for Labour

GAS WORKS BOARD.

Clauses 2 and 35 of the Determination published in *Government Gazette* No. 738 of the 25th August, 1949, shall be replaced by the following clauses:—

2. (a). Within the Localities Set Out in Note (a).

	Improvers.	Wages per Week of 40 Hours.		
		£	s.	d.
Under 15 years of age	0	15	6
15 years and under 16 years of age	0	19	0
16 " " " 17 " "	1	3	0
17 " " " 18 " "	1	11	0
18 " " " 19 " "	2	2	6
19 " " " 20 " "	2	13	6
20 " " " 21 " "	3	9	6

For shift work an extra rate of 3s. 6d. per week shall be paid, but no improver under eighteen years of age shall be employed upon night shift.

(b).

Adults.	Wages per Week of 40 Hours.	
	Within a Radius of 20 Miles of the G.P.O., Melbourne, 10 Miles of the G.P.O., Geelong, and the City of Warrnambool.	Within the Cities of Ballarat and Bendigo and the Borough of Castlemaine.
	£ s. d.	£ s. d.
Patching and scurfing retorts and cleaning flues—man continuously employed as such	8 15 0	8 12 0
Stoker in charge of gas or steam engine, or other works plant	8 15 0	8 12 0
Stoker, vertical retort	8 12 0	8 9 0
Stoking machine driver	8 12 0	8 9 0
Stoker, horizontal retort (machine)	8 9 0	8 6 0
Stoker, hand charging	8 7 0	8 4 0
Retort (vertical) operator	8 12 0	8 9 0
Operator vertical retort	8 12 0	8 9 0
Fireman retort house	8 12 0	8 9 0
Hydraulic and tar main attendant	8 11 0	8 8 0
Augerer and pipe jumper	8 6 0	8 3 0
Coke and coal conveyor attendant (day worker)	8 1 0	7 18 0
Greaser and oiler (in retort house)	8 9 0	8 6 0
Elevator and coal crusher attendant (day worker)	8 0 0	7 17 0
Elevator and coal crusher attendant (shift worker)	7 18 0	7 15 0
Coke and coal conveyor attendant (shift worker)	7 18 0	7 15 0
Oxide breaker—man attending and operating	8 1 0	7 18 0
Purifier—man opening up, or emptying	8 14 0	8 11 0
Purifier—man filling	7 15 0	7 12 0
All others	7 9 0	7 6 0

35.

Within the Localities Set Out in Note (b).

(a) Improvers.*	Wages per Week of 40 Hours.	(b) Other Employees.	Wages per Week of 40 Hours.
	£ s. d.		£ s. d.
Under 15 years of age	0 16 6	Stokers	8 6 0
15 years and under 16 years of age	1 0 6	All others	7 6 0
16 years and under 17 years of age	1 4 6		
17 years and under 18 years of age	1 13 6		
18 years and under 19 years of age	2 5 6		
19 years and under 20 years of age	2 17 6		
20 years and under 21 years of age	3 14 6		

* The Board has determined in accordance with section 25 (1) of the amended *Factories and Shops Act 1934*, that the process, trade, business, or occupation is so unskilled that no person shall be taken as an apprentice.

Clauses, other than clauses 2 and 35, of the said Determination, shall remain in force.



VICTORIA GOVERNMENT GAZETTE.

Published by Authority.

[Registered at the General Post Office, Melbourne, for transmission by post as a newspaper.]

No. 627]

WEDNESDAY, AUGUST 16.

[1950

Factories and Shops Acts.

DETERMINATION OF A WAGES BOARD ADJUSTED PURSUANT TO SECTION 21 OF THE FACTORIES AND SHOPS ACT 1934 (No. 4275).

I, Raymond Henry Beers, Secretary for Labour, in pursuance of the powers conferred by the Factories and Shops Acts, hereby make and issue the following adjusted Determination of the Wages Board referred to hereunder showing adjusted rates and prices to operate from the beginning of the first pay period to commence in August, 1950.

Dated at Melbourne, this
14th day of August, 1950.

RAY H. BEERS,
Secretary for Labour.

HORSEHAIR BOARD.

Clause 2 of the Determination published in *Government Gazette* No. 898 of the 14th November, 1949, shall be replaced by the following clause:—

2.

Apprentices.			Improvers and Juvenile Workers.			Other Employees.		
WAGES.			WAGES.			WAGES.		
		Per Week.			Per Week.			Per Week.
		<i>s. d.</i>			<i>s. d.</i>			<i>s. d.</i>
1st year	49 6	1st year	49 6	Person in charge of hair-washing machine	175 0
2nd year	61 9	2nd year	73 9	Persons engaged on hair-washing machines	168 0
3rd year	73 9	3rd year	123 0	Persons engaged on hair-drying machines	168 0
4th year	89 0	4th year	140 9	Persons who press washed and dried hair into bales	168 0
5th year	123 0				All others	164 0
PROPORTION (by any employer).			PROPORTION (by any employer).			Preparing any other kind of Hair.		
One apprentice to every three or fraction of three workers receiving not less than 164s. per week.			One improver to every five workers receiving not less than 164s. per week.			WAGES. Per Week		
			Juvenile Workers.			<i>s. d.</i>		
			One juvenile worker to every Hand Spinner.			Hand Spinners	181 0
						Machine Spinners—		
						1st year	171 0
						2nd year	177 0
						And thereafter	181 0
						Drafters	181 0
						Wet or dry hacklers	181 0
						Teasers and tail pullers	168 0
						Dyers or Scalders	165 0
						All others	164 0

Clauses, other than clause 2, of the said Determination shall remain in force, provided that, to the weekly earnings of each piece-worker shall be added the sum of twenty-seven shillings. Where less than forty hours is worked in any week by any piece-worker, a proportionate amount of such sum of twenty-seven shillings shall be added in lieu thereof.

By Authority: J. J. GOURLEY, Government Printer, Melbourne.

1
2

3

4

5

6

7



VICTORIA GOVERNMENT GAZETTE.

Published by Authority.

[Registered at the General Post Office, Melbourne, for transmission by post as a newspaper.]

No. 628]

WEDNESDAY, AUGUST 16.

[1950

Factories and Shops Acts.

DETERMINATION OF A WAGES BOARD ADJUSTED PURSUANT TO SECTION 21 OF THE FACTORIES AND SHOPS ACT 1934 (No. 4275).

I, Raymond Henry Beers, Secretary for Labour, in pursuance of the powers conferred by the Factories and Shops Acts, hereby make and issue the following adjusted Determination of the Wages Board referred to hereunder showing adjusted rates and prices to operate from the beginning of the first pay period to commence in August, 1950.

Dated at Melbourne, this
14th day of August, 1950.

RAY. H. BEERS,
Secretary for Labour.

HOSPITAL PHARMACISTS BOARD.

Clause 2 of the Determination published in *Government Gazette* No. 894 of the 7th November, 1949, shall be replaced by the following clause:—

2.

Apprentices.				Other Employees.			
WAGES PER WEEK OF 40 HOURS.				WAGES PER WEEK OF 40 HOURS.			
				£ s. d.			
1st year's experience	1	10	6	
2nd "	"	3	6	0	
3rd "	"	4	15	3	
4th "	"	6	3	3	
5th "	"	7	15	0	
PROPORTION.							
One apprentice to every three or fraction of three workers receiving not less than the minimum wage.							
Where the term of apprenticeship is four years, and the apprentice has not been successful in completing his examinations, he may, with the permission of the Secretary for Labour and the Pharmacy Board be bound for a further period not exceeding one year.							
				<i>Chief Pharmaceutical Chemist—</i>			
				(i.e. A pharmaceutical chemist in charge of the pharmacy department of a hospital.)			
				(a) Where four or more full time pharmaceutical chemists are normally employed			
				15 0 0			
				(b) Where two or three full time pharmaceutical chemists are normally employed			
				14 0 0			
				(c) Where he is the only pharmaceutical chemist employed			
				13 10 0			
				<i>Senior Pharmaceutical Chemist</i>			
				12 5 0			
				Where three or more full time pharmaceutical chemists are normally employed, one shall be a Senior Pharmaceutical Chemist, and shall take charge of the pharmacy department during the absence of the Chief Pharmaceutical Chemist			
				<i>Other Hospital Pharmaceutical Chemist</i>			
				1st year's experience as such			
				11 10 0			
				2nd " " " " " " " "			
				11 15 0			
				Thereafter " " " " " " " "			
				12 0 0			

Clauses, other than clause 2, of the said Determination shall remain in force.

By Authority: J. J. GOURLEY, Government Printer, Melbourne.

