



VICTORIA  
GOVERNMENT GAZETTE.

Published by Authority.

[Registered at the General Post Office, Melbourne, for transmission by post as a newspaper.]

No. 788]

WEDNESDAY, OCTOBER 4.

[1950

ACTS OF PARLIAMENT.

PROCLAMATION

By His Excellency the Governor of the State of Victoria and its Dependencies in the Commonwealth of Australia, &c., &c., &c.

I, THE Governor of the State of Victoria, in the Commonwealth of Australia, do hereby declare that I have this day assented, in His Majesty's name, to the Bills passed by the Parliament of the said State, the titles whereof are hereunder set forth, that is to say:—

- No. 5459. "An Act relating to Trade Descriptions of Textile Products."  
No. 5460. "An Act relating to Pensions of Members of the Police Force and their Widows, and for other purposes."  
No. 5461. "An Act to provide for the Closing of Bowen-street and part of an adjoining Lane in the City of Melbourne and to validate certain Crown Grants and Reservations, and for other purposes."  
No. 5462. "An Act relating to Newspaper Advertisements in Foreign Languages."  
No. 5463. "An Act to amend Section One hundred and fifty-two of the *Police Offences Act 1928*."  
No. 5464. "An Act to increase certain Non-Contributory State Pensions."

Given under my Hand and the Seal of the State of Victoria aforesaid, at Melbourne, this fourth day of October, in the year of our Lord One thousand nine hundred and fifty, and in the fourteenth year of the reign of His Majesty King George VI.

(L.S.)

DALLAS BROOKS.

By His Excellency's Command,

JOHN G. B. McDONALD,  
Premier.

GOD SAVE THE KING!

The Fisheries Acts.

PROHIBITION OF ALL FISHING IN THE GOULBURN RIVER, ETC., ABOVE ALEXANDRA.

PROCLAMATION

By His Excellency the Governor of the State of Victoria and its Dependencies in the Commonwealth of Australia, &c., &c., &c.

I, THE Governor of the State of Victoria, in the Commonwealth of Australia, by and with the advice of the Executive Council of the said State, and in pursuance of the provisions of the Fisheries Acts and all other powers me enabling in that behalf do by this my Proclamation:—

- (a) Vary the Proclamation made the 28th day of June, 1928, and published in the *Government Gazette* of the 4th day of July, 1928, respecting prohibition of fishing, by deleting therefrom the whole of paragraph five (5);  
(b) Revoke the Proclamation made the 27th day of August, 1934, and published in the *Government Gazette* of the 29th day of August, 1934, respecting the alteration of the area closed to fishing at Eildon Weir;  
(c) Vary the Proclamation made the 1st day of September, 1937, and published in the *Government Gazette* of the 8th day of September, 1937, respecting prohibition of fishing in certain streams, by deleting therefrom all reference to the Acheron River;  
(d) Revoke the Proclamation made the 21st day of August, 1939, and published in the *Government Gazette* of the 23rd day of August, 1939, respecting prohibition of fishing in portion of the Goulburn River below the Eildon Weir;  
(e) Revoke the Proclamation made the 2nd day of September, 1947, and published in the *Government Gazette* of the 3rd day of September, 1947, respecting prohibition of fishing in Jerusalem Creek and tributaries during the whole of each year;

(f) Prohibit all fishing in or the taking of fish from the following waters during the period set opposite the names of such waters:—

Waters referred to.	Period.
The Goulburn River and its tributaries above or upstream from the Riversdale-road bridge near Alexandra, and including the waters impounded by the Eildon Weir (excepting the following):—	From 1st May to 31st August (both days inclusive) in each year.
The Goulburn River at Eildon Weir between the weir wall and an imaginary line drawn between two posts situated respectively east and west of and in line with the south wall of the State Electricity Commission's Power House.	From 1st January to 31st December (both days inclusive) in each year.
The Goulburn River below Eildon Weir between an imaginary line drawn between two posts situated respectively east and west of and in line with the south wall of the State Electricity Commission's Power House, and the southern side of the bridge over the Goulburn River situated approximately 250 yards downstream from the Eildon Weir wall.	From 1st May to 31st October (both days inclusive) in each year.
Jerusalem Creek and its tributaries above or upstream from the Big River road bridge.	From 1st January to 31st December (both days inclusive) in each year.

Given under my Hand and the Seal of the State of Victoria aforesaid, at Melbourne, this twenty-sixth day of September, in the year of our Lord One thousand nine hundred and fifty, and the fourteenth year of the reign of His Majesty King George VI.

(L.S.)

DALLAS BROOKS.

By His Excellency's Command,

K. DODGSHUN,  
Chief Secretary.

GOD SAVE THE KING!

The Fisheries Acts.

**MINIMUM LENGTH FOR BREAM.**

**PROCLAMATION**

By His Excellency the Governor of the State of Victoria and its Dependencies in the Commonwealth of Australia, &c., &c., &c.

THE Governor of the State of Victoria, in the Commonwealth of Australia, by and with the advice of the Executive Council of the said State, and in pursuance of the provisions of the Fisheries Acts and all other powers me enabling in that behalf do by this my Proclamation substitute the length set out hereunder for the length of 10 inches set opposite the name of Bream in the Second Schedule to the Fisheries Act 1928:—

*Bream 10½ inches.*

Given under my Hand and the Seal of the State of Victoria aforesaid, at Melbourne, this twenty-sixth day of September, in the year of our Lord One thousand nine hundred and fifty, and in the fourteenth year of the reign of His Majesty King George VI.

(L.S.)

DALLAS BROOKS.

By His Excellency's Command,

K. DODGSHUN,  
Chief Secretary.

GOD SAVE THE KING!

Banks and Currency Acts.

**ALTERATION OF DAY APPOINTED FOR A BANK HOLIDAY AT SHEPPARTON AND MOOROOPNA.**

**PROCLAMATION**

By His Excellency the Governor of the State of Victoria and its Dependencies in the Commonwealth of Australia, &c., &c., &c.

WHEREAS by a Proclamation made on the 13th day of September, 1950, and published in the *Government Gazette* of the 13th day of September, 1950, Thursday, the 19th day of October, 1950, was appointed, under the provisions of section 14 of the *Banks and Currency Act 1928*, to be a bank holiday at Shepparton and Moorooopna: And whereas it is made to appear to the Governor in Council expedient that the said Thursday, the 19th day of October, 1950, should not be a bank holiday at Shepparton and Moorooopna: Now therefore I, the Governor of the State of Victoria, in pursuance of the provisions of the Banks and Currency Acts, do by this my Proclamation declare that the said Thursday, the 19th day of October, 1950, shall not be a bank holiday at Shepparton and Moorooopna, and appoint Friday, the 20th day of October, 1950, to be a bank holiday at Shepparton and Moorooopna.

Given under my Hand and the Seal of the State of Victoria aforesaid, at Melbourne, this third day of October, in the year of our Lord One thousand nine hundred and fifty, and in the fourteenth year of the reign of His Majesty King George VI.

(L.S.)

DALLAS BROOKS.

By His Excellency's Command,

K. DODGSHUN,  
Chief Secretary.

GOD SAVE THE KING!

**PUBLIC HOLIDAYS.**

**PROCLAMATION**

By His Excellency the Governor of the State of Victoria and its Dependencies in the Commonwealth of Australia, &c., &c., &c.

IN pursuance of the provisions contained in Part III. of the *Public Service Act 1946* (10 Geo. VI. No. 5124), I, the Governor of the State of Victoria, in the Commonwealth of Australia, by and with the advice of the Executive Council of the said State, do by this my Proclamation appoint the days and dates hereunder mentioned to be observed as Public Holidays or Public Half-Holidays (as the case may be) at the places respectively specified, viz.:—

*Public Holidays:—*

\*THURSDAY, THE 5TH DAY OF OCTOBER, 1950, throughout the Shire of Birchip.

\*WEDNESDAY, THE 11TH DAY OF OCTOBER, 1950, throughout the North-west Riding of the Shire of Tungamah.

FRIDAY, THE 20TH DAY OF OCTOBER, 1950, throughout the Shire of Chiltern.

\*FRIDAY, THE 27TH DAY OF OCTOBER, 1950, throughout that portion of the Shire of East Loddon lying south of the Prairie-Borong road.

\*WEDNESDAY, THE 8TH DAY OF NOVEMBER, 1950, throughout the Shire of McIvor.

WEDNESDAY, THE 22ND DAY OF NOVEMBER, 1950, throughout the City of Port Melbourne.

*Public Holidays from the Hour of Eleven o'clock in the forenoon:—*

\*SATURDAY, THE 21ST DAY OF OCTOBER, 1950, throughout the South and West Ridings of the Shire of Dimboola.

WEDNESDAY, THE 25TH DAY OF OCTOBER, 1950, throughout the South and Central Ridings of the Shire of Wycheproof.

SATURDAY, THE 11TH DAY OF NOVEMBER, 1950, throughout the South and West Ridings of the Shire of Dimboola.

\*WEDNESDAY, THE 29TH DAY OF NOVEMBER, 1950, throughout the Shire of Colac.

*Public Holiday from the Hour of half-past Eleven o'clock in the forenoon:—*

MONDAY, THE 9TH DAY OF OCTOBER, 1950, throughout the City of Ararat.

*Public Half-Holidays from the Hour of Twelve o'clock noon:—*

THURSDAY, THE 12TH DAY OF OCTOBER, 1950, throughout the North and Tyrrell Ridings of the Shire of Wycheproof.

\*THURSDAY, THE 19TH DAY OF OCTOBER, 1950, throughout the Shire of Lowan.

\*FRIDAY, THE 20TH DAY OF OCTOBER, 1950, throughout the Shire of Shepparton.

WEDNESDAY, THE 22ND DAY OF NOVEMBER, 1950, throughout the City of Bendigo.

\* Agricultural Show.

Given under my Hand and the Seal of the State of Victoria aforesaid, at Melbourne, this third day of October, in the year of our Lord One thousand nine hundred and fifty, and in the fourteenth year of the reign of His Majesty King George VI.

(L.S.) DALLAS BROOKS.

By His Excellency's Command,

K. DODGSHUN,  
Chief Secretary.

GOD SAVE THE KING!

BANK HOLIDAYS.

PROCLAMATION

By His Excellency the Governor of the State of Victoria and its Dependencies in the Commonwealth of Australia, &c., &c., &c.

IN pursuance of the provisions of the Banks and Currency Acts, I, the Governor of the State of Victoria, in the Commonwealth of Australia, do by this my Proclamation appoint the days and dates named hereunder special days to be observed as Bank Holidays or Bank Half-Holidays (as the case may be) at the places respectively mentioned, that is to say:—

*Bank Holidays:—*

WEDNESDAY, THE 18TH DAY OF OCTOBER, 1950, at Murtoa.  
FRIDAY, THE 20TH DAY OF OCTOBER, 1950, at Chiltern.

*Bank Half-Holidays from the Hour of Twelve o'clock noon:—*

MONDAY, THE 9TH DAY OF OCTOBER, 1950, at Ararat.  
THURSDAY, THE 12TH DAY OF OCTOBER, 1950, at Sea Lake.  
TUESDAY, THE 17TH DAY OF OCTOBER, 1950, at Rainbow.  
WEDNESDAY, THE 18TH DAY OF OCTOBER, 1950, at Cohuna.  
THURSDAY, THE 19TH DAY OF OCTOBER, 1950, at Newstead and Nhill.

WEDNESDAY, THE 25TH DAY OF OCTOBER, 1950, at Geelong and Leongatha.

WEDNESDAY, THE 8TH DAY OF NOVEMBER, 1950, at Kyneton.

Given under my Hand and the Seal of the State of Victoria aforesaid, at Melbourne, this third day of October, in the year of our Lord One thousand nine hundred and fifty, and in the fourteenth year of the reign of His Majesty King George VI.

(L.S.) DALLAS BROOKS.

By His Excellency's Command,

K. DODGSHUN,  
Chief Secretary.

GOD SAVE THE KING!

MELBOURNE CUP HOLIDAY.

NOTICE is hereby given that on—

TUESDAY, THE 7TH NOVEMBER, 1950,

the Public Offices in the municipalities hereunder will be closed, that day having been proclaimed by the Governor in Council, under the powers conferred by the *Public Service Act 1946*, to be observed as a holiday in the Public Offices:—

Bacchus Marsh, Berwick, Box Hill, Braybrook, Brighton, Broadmeadows, Brunswick, Bulla, Camberwell, Caulfield, Chelsea, Coburg, Collingwood, Cranbourne, Dandenong, Doncaster and Templestowe, Eltham, Essendon, Fern Tree Gully, Fitzroy, Footscray, Frankston and Hastings, Gisborne, Hawthorn, Heidelberg, Keilor, Kew, Lillydale, Malvern, Melbourne, Melton, Moorabbin, Mordialloc, Mornington, Mulgrave, Northcote, Nunawading, Oakleigh, Port Melbourne, Prahran, Preston, Richmond, Ringwood, Romsey, Sandringham, St. Kilda, South Melbourne, Werribee, Whittlesea, and Williamstown.

K. DODGSHUN,  
Chief Secretary.

Chief Secretary's Office,  
Melbourne, 13th September, 1950.

APPOINTMENTS.

HIS Excellency the Governor of the State of Victoria, by and with the advice of the Executive Council thereof, has, by Orders made on the 26th day of September, 1950, been pleased to make the under-mentioned appointments, viz.:—

CHIEF SECRETARY'S DEPARTMENT.

*Assistants to the Inspector of Fisheries.*

HENRY JAMES EVANS,  
JOHN MAXWELL TAYLOR,  
FREDERICK FRANCIS TOOMER,  
FRANK JONES,  
JOSEPH LINDSAY BOND,  
HUGHIE LINN DEWAR, and  
JOSEPH DAVIS,

pursuant to the provisions of the Fisheries Acts, to be Assistants to the Inspector of Fisheries.

*Licensing Inspector.*

WILLIAM GEORGE HOGG, Chief Inspector of Police, pursuant to the provisions of the Licensing Acts, to be a Licensing Inspector for each and every Licensing District in the State of Victoria, *vice* Augustus A. Charlesworth, resigned.

*Registrar of Births and Deaths.*

MARGARET MENTIPLAY, pursuant to the provisions of section 4 of the *Registration of Births Deaths and Marriages Act 1928*, to be Registrar of Births and Deaths at Hastings, with fees, *vice* Sydney Herbert Edwards, resigned.

DEPARTMENT OF CROWN LANDS AND SURVEY.

*Trustee of Site.*

CYRIL JUSTIN MCCARTHY to be a Trustee of the land permanently reserved on the 26th March, 1935, as a site for a Public Park and Recreation in the Parishes of Boroondara and Joka Joka, in the place of William Henry Schorey Dickinson, who has ceased to be a Councillor of the City of Kew; provided that the said Cyril Justin McCarthy shall hold office as a Trustee for so long only as he continues to be a Councillor and the elect of the City of Kew.

DEPARTMENT OF HEALTH.

*Trustees of Cemeteries.*

ROBERT LESLIE DYER,  
WILLIAM CALDOW,  
WILLIAM HENRY THOMAS BOWDEN,  
CYRIL HENRY JOHN CARTER,  
FREDERICK SMITH,  
RAYMOND GLASSON MITCHELL, and  
JOHN WILFRED MITCHELL,  
to be Trustees of the Karnak Public Cemetery;  
NORMAN WILLIAM FREETH and  
JOSEPH HUGH GAWITH  
to be Trustees of the Murtoa Public Cemetery, *vice* H. Pollock, resigned, and A. Wynne, resigned, respectively; and  
GORDON ERNEST BELL  
to be a Trustee of the Maryborough Public Cemetery.

LAW DEPARTMENT.

*Commissioners for Taking Declarations, &c.*

HILDA LANAGAN, Stewart-street, Rupanyup,  
REX HARLAND THOMAS, 1 Griffiths-street, Reservoir,  
GEORGE ALBERT JACKSON, 2 Gadd-street, Northcote,  
CHRISTOPHER ANDREW PATRICK COX, 45 Nimmo-street, Middle Park,  
JOHN JOSEPH CHARLES STRICKLAND, 91 Page-street, Middle Park,  
MELVILLE CHARLES HENWOOD, 205 Page-street, Middle Park, and  
GEORGE WILLIAM PERHAM, 87 Harold-street, Middle Park,  
to be Commissioners for taking Declarations and Affidavits, pursuant to the provisions of Division 8 of Part IV. of the *Evidence Act 1928*, to resign upon removing from the neighbourhood of the addresses stated; and  
MALCOLM JOHN AUGUSTUS ROSS, Manager, Broons and Sons, 28-36 Edward-street, East Brunswick, and  
ALEXANDER LOCKHART MUIR, Manager, E. S. and A. Bank, Belgrave,  
to be Commissioners for taking Declarations and Affidavits, pursuant to the provisions of Division 8 of Part IV. of the *Evidence Act 1928*, to resign upon ceasing to occupy their present positions.

*Magistrates.*

THOMAS EDWARD SOUTER, Centre Dandenong-road, Dingley,  
 PATRICK JOSEPH NORMOYLE, 52 Carrington-street, Pascoe Vale South,  
 ROBERT WALLACE, Warburton,  
 SYDNEY ROLLS, 41 Shakespeare-grove, Hawthorn,  
 HENRY CLYDESDALE, Seymour,  
 WALTER MARK BUTTERWORTH, Main-street, Greensborough,  
 LEONARD SAMUEL RALTON, 67 Church-street, Middle Brighton,  
 WILLIAM GEORGE MOODY, 173 Atherton-road, Oakleigh,  
 JOSCELYN DAVID LANGDON, 32 Young-street, Kew, and  
 GEORGE EDWARD CHANDLER, Belgrave,  
 to Keep the Peace in the Central Bailiwick of the State of Victoria.

*Official Liquidator.*

JOHN KENNETH HALL, 390 Little Collins-street, Melbourne,  
 to be an Official Liquidator, pursuant to the provisions of section 179 of the *Companies Act 1938*.

*Stipendiary Magistrate.*

JOHN DOWNEY,  
 to be a Stipendiary Magistrate, pursuant to the provisions of the *Justices Act 1928*, a Coroner for the State of Victoria, pursuant to the provisions of the *Coroners Act 1928*, and a Warden of the Goldfields in and for the State of Victoria, pursuant to the provisions of the *Mines Act 1928*.

PUBLIC WORKS DEPARTMENT.

*Wharf Manager.*

Sergeant JAMES LEWIS MCCOLL, No. 7501,  
 to be Wharf Manager at Sandringham, to carry out that portion of Part II. of the *Marine Act 1928* which relates to the management of public wharfs, and to be an officer under section 19 of such Act to levy and collect wharfage rates thereat; *vice* Sergeant Charles Edward Beames, transferred.

DEPARTMENT OF WATER SUPPLY.

*Waterworks Trust Commissioners.*

HUBERT STANER REILLY and  
 THOMAS PATRICK FLANAGAN  
 to be Commissioners of the Tatura Waterworks Trust for a period of four years from the date hereof, subject to the provisions of the Water Acts; and  
 THOMAS FRANCIS HAYES  
 to be a Commissioner of the Violet Town Waterworks Trust for a period of four years from the date hereof, subject to the provisions of the Water Acts.

A. MAHLSTEDT,  
 Clerk of the Executive Council.

At the Executive Council Chamber,  
 Melbourne, 26th September, 1950.

RESIGNATIONS.

HIS Excellency the Governor of the State of Victoria, by and with the advice of the Executive Council thereof, has, by Orders made on the 26th day of September, 1950, accepted the resignations of the persons named hereunder of the offices mentioned, *viz.*—

CHIEF SECRETARY'S DEPARTMENT.

SYDNEY HERBERT EDWARDS, as Registrar of Births and Deaths at Hastings, to date from and inclusive of the 31st March, 1950.

LAW DEPARTMENT.

OWEN HAROLD DIPROSE, from the Commission of the Peace for the Central Bailiwick.  
 FRANCIS ROBERT NELSON, from the office of Prosecutor for the King, as from and inclusive of the 17th September, 1950.

A. MAHLSTEDT,  
 Clerk of the Executive Council.

At the Executive Council Chamber,  
 Melbourne, 26th September, 1950.

STATE RIVERS AND WATER SUPPLY COMMISSION.

BY-LAW NO. 4540 PROHIBITING THE CLEARING OR FALLOWING OR BURNING OFF OF LANDS ADJACENT TO CHANNELS IN CERTAIN ALLOTMENTS WITHIN THE MILLEWA WATERWORKS DISTRICT.

THE State Rivers and Water Supply Commission, pursuant to and in exercise of the powers conferred by the Water Acts, doth hereby make the By-law following:—

1. The clearing or fallowing or burning off of any land within 3 chains of any channel under the control of the State Rivers and Water Supply Commission, within the allotments set out hereunder is prohibited—

*Parish of Merrinee.*

Allotments 39, 40.

*Parish of Tarrango.*

Allotments 13, 23.

*Parish of Yaramba.*

Allotments 7, 20.

2. Any person who clears or fallows, or burns off, or causes or permits to be cleared or to be fallowed or to be burnt off, any portion of such land within 3 chains of any channel under the control of the Commission (unless he has first obtained the written consent of the Commission or its authorized officer) shall be guilty of an offence against this By-law, and be liable to a penalty not exceeding Fifty pounds.

The foregoing By-law No. 4540 was made by the State Rivers and Water Supply Commission on the 18th day of September, 1950, and the common seal of the said Commission was hereunto affixed on the 2nd day of October, 1950, in the presence of—

(SEAL) L. R. EAST, Chairman.  
 H. W. McCAY, Commissioner.  
 J. A. AIRD, Commissioner.

Approved by the Governor in Council,  
 3rd October, 1950.

A. MAHLSTEDT,  
 Clerk of the Executive Council.

SUMMONING OFFICER.

I HEREBY appoint the under-mentioned person under section 31 of the *Education Act 1928*, to summon parents within the State of Victoria:—

First Constable G. W. Newton, No. 8333.

P. P. INCHBOLD,  
 Minister of Education.

Department of Education,  
 20th September, 1950.

LAW DEPARTMENT—SOLICITOR-GENERAL.

HAWKERS' AND PEDLERS' LICENCES—ALTERATION OF DAY AND HOUR FOR CONSIDERING APPLICATIONS.

HIS Excellency the Governor of the State of Victoria, by and with the advice of the Executive Council thereof, doth by Order made on the 26th day of September, 1950, pursuant to the provisions of section 6 of the *Hawkers and Pedlers Act 1928*, appoint in lieu of the days heretofore appointed, the day and hour set forth in the third column of the Schedule below for holding general meetings of Justices for the special purpose of taking into consideration applications for hawkers' and pedlers' licences at the Court named in the first column of such Schedule in the Police District indicated, to take effect as from and inclusive of the date shown.

SCHEDULE.

Court.	Police District.	Day Appointed.	Date of Commencement.
Ararat	Glenelg	Every Friday at 10 a.m.	6th October, 1950.

A. MAHLSTEDT,  
 Clerk of the Executive Council.

At the Executive Council Chamber,  
 Melbourne, the 26th September, 1950.

The Licensing Act 1928, Section 87.  
ANNUAL LICENSING COURTS, 1950.

NOTICE is hereby given that the Annual Sittings for the Licensing Court for the Licensing Districts herein named will be held as stated below:—

Court House.	Date of Sittings.	Hour.	Licensing Districts for which Courts are to be Held.
Ouyen .. .. .	Tuesday, 21st November .. .. .	10.30 a.m. .. .. .	Rainbow
Horsham .. .. .	Thursday, 30th November .. .. .	10 a.m. .. .. .	Borong

Dated at Melbourne, this 3rd day of October, 1950.

DIXON HEARDER,  
Chairman, Licensing Courts.

This notice amends notice given for the sittings of the above Licensing Courts as published in *Government Gazette* dated 27th September, 1950, No. 784 at page 5171.

DEPARTMENT OF MINES.

SUBJECT to any necessary excisions, &c., it is proposed to grant the following leases:—

- 8231, Beechworth; Tawonga Gold Mining Company N. L.; 15 acres 2 roods 14 perches, in the Parish of Mullindolingong.
- 9097, Castlemaine; Argus Hill Chewton Gold N. L.; 69 acres 1 rood 8 perches, in the Parish of Chewton.
- 11276, Bendigo; North Hustlers Gold Mining Company N. L.; 35 acres 2 roods 16 perches, in the Parish of Sandhurst.
- 7050, Maryborough; Edward McGurk; 27 acres 0 roods 36 perches, in the Parish of Wedderburne.
- 7200, Mineral; Standard Quarries Pty. Ltd.; 3 acres 0 roods 4 perches, in the Parish of Kangerong.
- 7207, Mineral; Bendigo Pottery Pty. Ltd.; 7 acres 2 roods 20 perches, in the Parish of Huntly.
- 7220, Mineral; South Costerfield Antimony and Gold Mining Company N. L.; 28 acres 0 roods 10 perches, in the Parishes of Costerfield and Heathcote.
- 7221, Mineral; Joseph Harry Jenkin, executor of the estate of Joseph Blight; 4 acres 3 roods 39 perches, in the Parish of Harcourt.

APPLICATIONS FOR MINING LEASES DECLARED ABANDONED.

- 9113, Ballarat; Victor Hughes and Jack Rowland Atcherley; 150 acres, south-west of Ballarat.
- 5537, Gippsland; Kenneth Munro; 200 acres, near Talbotville.
- 7169, Mineral; Great Eastern Brick Co. Ltd.; 15 acres, in the Parish of Numbruk.
- 7193, Mineral; Edward James Hansford; 40 acres, in the Parish of Traralgon.

APPLICATION FOR TAILINGS LICENCE REFUSED.

- 2200, Tailings Licence; Victorian Silica Brick Company; Parish of Smythesdale.

MINING LEASES GRANTED.

- 9065, Castlemaine; Wattle Gully Gold Mines N. L.; 85 acres 0 roods 9 perches, in the Parish of Chewton (in lieu of Lease No. 8840, Castlemaine, expired).
- 5530, Gippsland; Joseph Knapping; 21 acres 2 roods 21 perches, in the Parish of Toombon (in lieu of Lease No. 5275, Gippsland, expired).
- 7058, Maryborough; Christopher Joseph Grigg; 26 acres 0 roods 20 perches, in the Parish of Tarnagulla.
- 11281, Bendigo; South Nell Gwynne Gold Mining Co. N. L.; 2 acres 2 roods 24 perches, in the Parish of Sandhurst (in lieu of Lease No. 10878, Bendigo, expired).

TAILINGS LICENCES GRANTED.

- 2173, Tailing Licence; Alan Heywood Sutherland (in lieu of Tailings Licence No. 2173, expired).
- 2174, Tailings Licence; James W. Treacy.
- 2196, Tailings Licence; The President, Councillors and Ratepayers of the Shire of Avoca (in lieu of Tailings Licence No. 2138, expired).
- 2203, Tailings Licence; Guiseppe Mioni.

G. C. MOSS,  
Minister of Mines.

MINING LEASES DECLARED VOID.

- 8078, Beechworth; New Providence Gold Mine N. L.; 24 acres 3 roods 29 perches, in the Parish of Killingworth.
- 9074, Castlemaine; Leonard Wallace Roberts; 88 acres 0 roods 29 perches, in the Parish of Queenstown.
- 6807, Mineral; Stanley George Garrett; 72 acres 1 rood 16 perches, in the Parish of Redcastle.
- 7056, Mineral; Frederick Thomas McBride; 17 acres 2 roods 18 perches, in the Parish of Jumbunna East.

REX R. NEAL,  
Secretary for Mines.

Cemeteries Act 1928.

SCALE OF FEES OF THE ARARAT PUBLIC CEMETERY.

IN pursuance of the powers conferred upon them by the Cemeteries Acts, the Trustees of the Ararat Public Cemetery hereby make the following scale of fees, which will come into operation upon publication in the *Government Gazette*:—

Land for grave 8 ft. x 4 ft., together with sinking and number plate, in the west side of the Cemetery reserved for private graves purchased by the Public Trustee .. .. . £6 0 0

(One burial only to be allowed. Deed to be stamped, "Not to be issued.")

(SEAL) W. C. L. MILLER, Trustee.  
C. P. WALSH, Trustee.  
JOS. DAVIS, Trustee

Approved by the Governor in Council,  
26th September, 1950.

A. MAHLSTEDT,  
Clerk of the Executive Council.

Cemeteries Act 1928.

SCALE OF FEES OF THE CHILTERN PUBLIC CEMETERY.

IN pursuance of the powers conferred upon them by the Cemeteries Acts, the Trustees of the Chiltern Public Cemetery hereby make the following scale of fees, which shall come into operation upon publication in the *Government Gazette*, and from and after such publication, every scale of fees heretofore made by the said Trustees shall be and is hereby rescinded to the extent to which it conflicts with this scale:—

Private Graves.	£	s.	d.
Sinking a grave 6 feet .. .. .	4	0	0
Sinking a grave 7 feet .. .. .	4	10	0
Re-opening a grave .. .. .	3	10	0
Sinking a grave for a child under 12 years .. .. .	2	10	0
Sinking a grave for a stillborn child .. .. .	1	15	0

(SEAL) ROBERT SCOTT, Trustee.  
C. A. OATES, Trustee.  
M. BRANN, Trustee.

Approved by the Governor in Council,  
26th September, 1950.

A. MAHLSTEDT,  
Clerk of the Executive Council.

## RULES OF THE SUPREME COURT.

**I**N pursuance of the powers conferred by the Supreme Court Acts and of all other powers hereunto enabling, the following Rule is made and shall take effect from the date on which it is published in the *Government Gazette*:—

1. In Chapter I. the under-mentioned Orders, Rules, Forms, and Items are hereby amended as follows:—

- (a) In Rule 9 of Order XI the words "writ of summons" are hereby substituted for the words "writ or summons."
- (b) In Rule 9 (1) of Order XI. the expression "in Appendix K." is hereby inserted immediately after the expression "Form No. 37b."
- (c) In Rule 9 (4) of Order XI. the expression "Rule 9" is hereby substituted for the expression "Rule 15."
- (d) In Rule 10 of Order XI. the expression "Rule 9" is hereby substituted for the expression "Rule 11."
- (e) In Form No. 14 in Appendix F the words "or having failed to file the memorandum of the close of the proceedings within the prescribed time" are hereby repealed.
- (f) In Form No. 37D in Appendix K the expression "Rule 9" is hereby substituted for the expression "Rule 11" in note (c) thereto and the word "authority" is hereby added at the end of the said note (c).
- (g) In the following Rules and Forms the word "Master" is hereby substituted for the words "Chief Clerk," wherever occurring:—
  - (i) Rules 9 and 10 of Order XXXIII.
  - (ii) Rule 48 of Order XXXVI.
  - (iii) Rule 8 of Order XLI.
  - (iv) Rule 4 of Order XLV.
  - (v) Rule 14 of Order LII.
  - (vi) Rule 1A of Order LIV.
  - (vii) Rules 16, 17, 18, 24, 37, 46, 65, 66, 67, 69, 69A, 70, 70A, 70B, 70C, and 74 of Order LV.
  - (viii) Rule 31 of Order LXI.
  - (ix) Rules 1, 3, 4, 5, 6, 7, 9, 10, 11, 12, 13, 14, and 15 of Order LXII.
  - (x) Rules 27 (11) and 27 (22) of Order LXV.
  - (xi) Rule 2 of Order LXVI.
  - (xii) Form 34 in Appendix K.
  - (xiii) Forms 1, 2, 3, 4, 7, 8, 10, 15, 21, and 21A in Appendix L.
- (h) In the following Rules the word "Master's" is hereby substituted for the words "Chief Clerk's":—
  - (i) Rule 19 of Order XXXVI.
  - (ii) Rules 43 and 72 of Order LV.
  - (iii) Rule 10 of Order LXII.
- (i) In Rule 4 of Order XXXVIII. the words "Master of the Supreme Court" are hereby substituted for the word "Master-in-Equity."
- (j) In Order LV. the word "Master" is hereby substituted for the words "Chief Clerk" in the cross-heading immediately preceding Rule 16 and in the cross-heading immediately preceding Rule 65.
- (k) In Order LX. the following Rule is hereby substituted for Rule 2 thereof:—

*Absence of Prothonotary.*

2. In the absence of the Prothonotary from his office all acts which he is required or empowered to do may be done by such person as may be appointed for that purpose by the Judges of the Court or if no such person is appointed or available then by the first or second clerk in the office of the Prothonotary.

- (l) In Rule 25A of Order LXV. the word "Master" is hereby substituted for the words "Master-in-Equity, the Chief Clerk."

- (m) In Item 31 in the Ordinary Scale in Appendix N the word "Master" is hereby substituted for the words "Master-in-Equity or Master-in-Lunacy."
- (n) In Item 73 in the Ordinary Scale in Appendix N the words "Master or the Prothonotary" are hereby substituted for the words "Chief Clerk, the Prothonotary, the Master-in-Equity or Master-in-Lunacy."
- (o) In Item 74 in the Ordinary Scale in Appendix N the words "Chief Clerk" are hereby repealed.

2. In Chapter II. Rule 104 is hereby amended by substituting the word "Master" for the words "Chief Clerk" wherever occurring.

3. In Chapter III. the under-mentioned Rules and Forms are hereby amended as follows:—

- (a) In Rules 6, 21, 24, 28, 33, and 34 of Part I. the word "Master" is hereby substituted for the word "Master-in-Equity" wherever occurring.
- (b) In Rule 21 of Part I. the word "Master's" is hereby substituted for the word "Master-in-Equity's."
- (c) In Forms 1 and 2 the words "Master of the Supreme Court" are hereby substituted for the word "Master-in-Equity."

CHARLES J. LOWE, A.C.J.

C. GAVAN DUFFY, J.

NORMAN O'BRYAN, J.

JOHN V. BARRY, J.

ARTHUR DEAN, J.

R. R. SHOLL, J.

T. W. SMITH, J.

E. G. COPPEL, A.J.

E. H. HUDSON, A.J.

DEPARTMENT OF LABOUR.

DETERMINATION OF THE SHOPS BOARD, No. 16  
(HARDWARE.)

ATTENTION is drawn to the fact that notice of appeal to the Industrial Appeals Court has been lodged against certain parts of a Determination made by the Shops Board, No. 16 (Hardware) on the 6th September, 1950.

Section 22 (2) of the *Factories and Shops Act 1941* (No. 4874) provides that, when an appeal is made in accordance with that Act, the Determination, or part thereof appealed against, shall not come into operation until the appeal has been dealt with by the Court.

RAY H. BEERS,  
Secretary for Labour.

AUCTION SALES ACT 1928.

**BENALLA.**—Notice is hereby given that the Annual Meeting of Justices for the Licensing of Auctioneers will be held in the Court House at Benalla on Tuesday, the 28th day of November, 1950, at the hour of Ten o'clock in the forenoon. Dated this 2nd day of October, 1950.—V. A. PROPOSCH, Clerk of Petty Sessions.

**EUROA.**—Notice is hereby given that the Annual Meeting of Justices for the Licensing of Auctioneers will be held in the Court House at Euroa on Tuesday, the 28th day of November, 1950, at the hour of Ten o'clock in the forenoon. Dated this 2nd day of October, 1950.—V. A. PROPOSCH, Clerk of Petty Sessions.

**KYNETON.**—Notice is hereby given that a Special Meeting of Justices for the Licensing of Auctioneers will be held at the Court House, Kyneton, on Tuesday, the 24th day of October, 1950, at the hour of Ten o'clock in the forenoon to consider an application by Robert Athol Johnson Hand, of 95 High-street, Kyneton, for an Auctioneer's Licence. Dated at Kyneton this 29th day of September, 1950.—J. F. RYAN, Clerk of Petty Sessions.

CITY OF NEWTOWN AND CHILWELL.

ORDER CONFIRMED.

THE Minister of the Crown administering the *Local Government Act 1946*, on the 25th day of September, 1950, confirmed the Order hereinafter referred to, in pursuance of section 513 of the said Act, viz.:—

An Order of the Council of the City of Newtown and Chilwell, made on the 23rd day of August, 1950, for the purpose of providing a Maternity and Child Welfare Centre, and for acquiring for such purpose all that piece of land being lot 7 on plan of subdivision 20083 lodged in the Office of Titles, and being part of Crown allotment 3, section 10, Parish of Moorpanyal, County of Grant, such land being land within the municipal district of the said municipality.

P. T. BYRNES,  
Commissioner of Public Works.

CITY OF PRAHRAN.

ORDER CONFIRMED.

THE Minister of the Crown administering the *Local Government Act 1946*, on the 25th day of September, 1950, confirmed the Order hereinafter referred to, in pursuance of section 513 of the said Act, viz.:—

An Order of the Council of the City of Prahran, made on the 5th day of June, 1950, for the purpose of widening Hoddle-street (Punt-road) on the east side from Alexandra-avenue southwards to Shipley-street, South Yarra, and for acquiring certain land for such purpose, such land being that described in the Council's Notice of Intention to Acquire Land Compulsorily, published in the *Victoria Government Gazette* of the 13th July, 1949, at page 4087.

P. T. BYRNES,  
Commissioner of Public Works.

*Police Regulation Act 1946.*

## POLICE FORCE OF VICTORIA.

## DETERMINATION NO. 26 OF THE POLICE CLASSIFICATION BOARD.

THE Police Classification Board, in pursuance of the powers in that behalf conferred by the *Police Regulation Act 1946*, hereby makes the following Determination, that is to say:—

1. The Determination No. 6 of the Police Classification Board of the 19th September, as amended, is hereby further amended as follows:—

(a) In Clause 1, by—

deleting the words "Second Class Sergeant and First Class" and "Sub-inspector" where such occur;

inserting in the definition of "officer" the word "or" between the words "Chief Inspector, Inspector";

deleting in the definition of "sub-officer" the word "and" and substituting therefor the word "or".

(b) By deleting the existing amounts and substituting therefor the amounts as shown hereunder:—

In Clause 3 (2) (c) for "12s" substitute "12s. 6d."

In Clause 3 (2) (d) for "8s." substitute "8s. 6d."

In Clause 3 (2) (e) for "20s." substitute "21s."

In Clause 3 (2) (f) for "15s." substitute "16s."

In Clause 3 (3) (a) for "3s." substitute "3s. 6d."

In Clause 3 (3) (b) for "6s." substitute "7s."

In Clause 3 (3) (c) for "9s." substitute "10s. 6d."

In Clause 3 (3) (d) for "6s." substitute "7s."

In Clause 3 (3) (e) for "15s." and "8d." substitute "17s. 6d." and "9d."

In Clause 3 (3) (f) for "12s." and "6d." substitute "14s." and "7d."

In Clause 3 (5) for "8s." and "6s." substitute "8s. 6d." and "7s."

In Clause 5 for "3s." substitute "3s. 6d."

In Clause 6 (1) (a), (b), and (c) for "3s." substitute "3s. 6d."

In Clause 6 (2) for "3s." substitute "3s. 6d."

In Clause 7 (1) and (2) for "20s." substitute "30s."

2. This Determination shall come into operation on the 8th day of October, 1950.

Dated at Melbourne this second day of October, 1950.

G. L. DETHRIDGE,

A Judge of County Courts, Chairman and  
Member of the Police Classification Board.

S. R. MUDIE,

Member of the Police Classification Board.

E. C. J. JAMES,

Member of the Police Classification Board.



*Police Regulation Act 1946.*

## POLICE FORCE OF VICTORIA.

## DETERMINATION NO. 27 OF THE POLICE CLASSIFICATION BOARD.

THE Police Classification Board, in pursuance of the powers in that behalf conferred by the *Police Regulation Act 1946*, hereby makes the following Determination, that is to say:—

1. The Determination No. 1 of the Police Classification Board of the 13th November, 1946, and published in the *Government Gazette* on the 22nd November, 1946, as amended, is hereby further amended as follows:—

Division IV. of the said Determination is revoked and the following Division is substituted in its stead:—

## DIVISION IV.

## ALLOWANCE FOR UNIFORM.

Each member of the Police Force performing his duties in a uniform or who is required by the Chief Commissioner of Police to have and maintain a uniform in connexion with his duties shall be paid the following annual allowance:—

Rank or Position.	Annual Allowance.
	£
Officers . . . . .	20
Mounted Sub-Officers, First Constables, and Constables	19
Mounted Sub-Officers, First Constables, and Constables attached to the Police Depot, St. Kilda-road, Melbourne, and performing active mounted duty . . . . .	22
Sub-Officers, First Constables, and Constables . . . . .	17

2. This Determination shall come into operation from and inclusive of the 1st day of October, 1950.

Dated at Melbourne this 2nd day of October, 1950.

G. L. DETHRIDGE,

A Judge of County Courts, Chairman and Member of the Police Classification Board.

S. R. MUDIE,

Member of the Police Classification Board.

F. G. HOLLAND,

Deputy Member of the Police Classification Board.

*Police Regulation Act 1946.*

## POLICE FORCE OF VICTORIA.

## DETERMINATION NO. 28 OF THE POLICE CLASSIFICATION BOARD.

THE Police Classification Board, in pursuance of the powers in that behalf conferred by the *Police Regulation Act 1946*, hereby makes the following Determination, that is to say:—

1. The Determination No. 1 of the Police Classification Board of the 13th November, 1946, and published in the *Government Gazette* on the 22nd November, 1946, as amended, is hereby further amended as follows:—

In Division V., paragraph (iv) thereof, by deleting the word "male".

2. This Determination shall come into operation from and inclusive of the 1st day of October, 1950.

Dated at Melbourne this 2nd day of October, 1950.

G. L. DETHRIDGE,

A Judge of County Courts, Chairman and Member of the Police Classification Board.

S. R. MUDIE,

Member of the Police Classification Board.

E. C. J. JAMES,

Member of the Police Classification Board.

CONTRACTS ACCEPTED.—(Series 1950-51.)  
PROVISIONS.—MEAT.

No. of Contract.	Particulars of Each Tender Accepted.	Amount.	Name of Contractor.	Charge against Vote or Fund.
	<b>PROVISIONS—</b> Supply of Meat, in such quantities as may be ordered, from 1st October, 1950, to 31st December, 1950.			
1696	Schedule No. 1—Melbourne District— Kew Mental Hospital	Rates as per annex	F. Watkins Pty. Ltd.	Contingencies, 1950-51.
1697	Pentridge Penal Establishment, &c.	" "	F. Watkins Pty. Ltd.	
1698	Children's Welfare Depot, Royal Park, and Police Hospital	" "	J. H. Cooke Pty. Ltd.	
1699	Royal Park Mental Hospital and Receiving House	" "	J. H. Cooke Pty. Ltd.	
1700	Schedule No. 2—Mont Park; Sanatorium, Gresswell, &c.	" "	W. Angliss and Co. (Aust.) Pty. Ltd.	
1701	Schedule No. 3—s.s. Rip and Dredges	" "	J. H. Cooke Pty. Ltd.	
1702	Schedule No. 4—Teachers' College, Carlton, and Travancore Developmental Centre, Flemington	" "	J. H. Cooke Pty. Ltd.	
1703	Schedule No. 5—Ararat District	" "	A. Ahpee	
1704	Schedule No. 6—Ballarat District	" "	H. J. Symons Pty. Ltd.	
1705	Schedule No. 7—Beechworth District	" "	E. Spencer	
1706	Schedule No. 8—Castlemaine District	" "	Ewing's "W.K. and H.S."	
1707	Schedule No. 9—School of Forestry, Creswick	" "	H. J. Symons Pty. Ltd.	
1708	Schedule No. 10—McLeod Settlement, French Island	" "	L. G. Male	
1709	Schedule No. 11—Heatherton Sanatorium, Cheltenham	" "	W. Angliss and Co. (Aust.) Pty. Ltd.	
1710	Schedule No. 12—Sanatorium, Greenvale	" "	F. Watkins Pty. Ltd.	
1711	Schedule No. 13—Coorimungie Prison Camp	" "	Heytesbury Butchery	
1712	Schedule No. 16—Sale Gaol	" "	H. L. G. Laws	
1713	Schedule No. 17—Pleasant Creek Special School, Stawell	" "	A. J. Case	
1714	Schedule No. 18—Sunbury District	" "	F. Watkins Pty. Ltd.	
1715	Schedule No. 21—Geelong District	" "	O'Brien's Butchery	

Approved—J. G. B. McDONALD, Treasurer. 29.9.50.

ANNEX TO CONTRACTS.

SCHEDULE No. 1.—MELBOURNE DISTRICT.

ANNEX TO CONTRACT No. 1950/1696.

F. Watkins Pty. Ltd., 184 Bourke-street, Melbourne, C.I.

Sub-schedule No. 7.

MEAT FOR MENTAL HOSPITAL, KEW.

	£	s.	d.
Security, £35.			
1. Fresh Beef—Rolled Ribs, boneless .. per cntl.	7	10	0
2. " " Steak, Stewing .. per lb.	0	1	4
3. " " Minced .. do.	0	1	4
4. Corned Beef—Rolled or round, as ordered, without bone or cartilage .. do.	0	1	4
5. Fresh Mutton—(Whole Sheep) .. do.	0	0	10½
6. " " Forequarter Chops .. do.	0	0	10
7. Saveloys .. per doz.	0	1	0
8. Sausages—Mixed .. per lb.	0	1	0
9. Sausage—Belgium .. do.	0	1	0
10. Beef Loaf .. do.	0	1	9
11. Ham Loaf .. do.	0	3	6
12. Veal Loaf .. do.	0	2	0
13. Tripe, Fresh .. do.	0	0	6
14. Livers, Sheeps' .. do.	0	1	3
15. Brains, Sheeps' .. per set	0	0	4
16. Rabbits, Fresh .. per lb.	0	1	0

ANNEX TO CONTRACT No. 1950/1697.

F. Watkins Pty. Ltd., 184 Bourke-street, Melbourne, C.I.

Sub-schedule No. 8.

MEAT FOR PENAL ESTABLISHMENT (PENTRIDGE), FEMALE PENITENTIARY, AND METROPOLITAN GAOL (COBURG).

	£	s.	d.
Security, £35.			
1. Fresh Beef—Forequarters .. per lb.	0	0	10
2. Fresh Mutton (whole sheep) .. do.	0	0	10
3. Sausages—Mixed .. do.	0	1	0
4. Liver—Calves' .. do.	0	1	0
5. Fresh Suet—Kidney .. do.	0	0	6
6. Dripping—Beef .. do.	0	0	7
7. Sausage Meat .. do.	0	0	9
8. Tripe—Fresh .. do.	0	0	6
9. Beef—Minced .. do.	0	1	1

ANNEX TO CONTRACT No. 1950/1698.

J. H. Cooke Pty. Ltd., 378 Queen's-parade, Clifton Hill.

Sub-schedule No. 9.

MEAT FOR POLICE HOSPITAL, ST. KILDA-ROAD, CHILDREN'S WELFARE DEPOT, ROYAL PARK.

	£	s.	d.
Security, £8.			
1. Fresh Beef .. per cntl.	3	15	0
2. " Mutton .. do.	2	10	0
3. Steak—Rump .. per lb.	0	2	4
4. " Stewing .. do.	0	0	11
5. Beef—Corned Silverside .. do.	0	1	6
6. Fresh Mutton—Loin .. do.	0	0	10
7. " " Leg .. do.	0	1	0

Sub-schedule No. 9—continued.

MEAT FOR POLICE HOSPITAL, ST. KILDA-ROAD; CHILDREN'S WELFARE DEPOT, ROYAL PARK—continued.

	£	s.	d.
8. Fresh Mutton—Cutlets .. per lb.	0	1	0
9. Chops—Middle Loin .. do.	0	0	11
10. Shanks—Sheeps' .. each	0	0	4
11. Sausages—Mixed .. per lb.	0	0	10
12. Tripe—Fresh .. do.	0	0	6
13. Frys—Lambs' .. each	0	0	9
14. Liver—Calves' .. per lb.	0	0	9
15. Sausage—Beef, German .. do.	0	0	11
16. " Strasburg, Pork .. do.	0	1	6
17. Rabbits—Fresh .. do.	0	0	9½
18. Frankfurts .. do.	0	1	1
19. Brains—Sheeps' .. per set	0	0	4
20. Kidneys—Sheeps' .. per doz.	0	3	0

ANNEX TO CONTRACT No. 1950/1699.

J. H. Cooke Pty. Ltd., 378 Queen's-parade, Clifton Hill.

Sub-schedule No. 10.

MEAT FOR RECEIVING HOUSE AND MENTAL HOSPITAL, ROYAL PARK.

	£	s.	d.
Security, £10.			
1. Fresh Beef .. per cntl.	3	15	0
2. " " Buttocks .. do.	3	15	0
3. " Mutton .. per lb.	0	0	6
4. Corned Beef—Rolled or round, as ordered, without bone or cartilage .. do.	0	0	9
5. Fresh Suet—Kidney .. do.	0	0	5
6. Sausages—Mixed .. do.	0	0	10

SCHEDULE No. 2.—MONT PARK; SANATORIUM, GRESSWELL, ETC.

ANNEX TO CONTRACT No. 1950/1700.

W. Angliss and Co. (Aust.) Pty. Ltd., 42 Bourke-street, Melbourne, C.I.

Sub-schedule No. 4.

MEAT.\*

	£	s.	d.
Security, £50.			
1. Fresh Beef, Forequarters .. per cntl.	3	0	0
2. " " Hindquarters .. do.	4	0	0
3. " " Buttocks .. per lb.	0	1	0
4. " " Roast .. do.	0	1	0
5. Beef, Corned—Rolled or round, as ordered, without bone or cartilage .. do.	0	1	2
6. " " Silverside (Gresswell Sanatorium) .. do.	0	1	5
7. Mutton, Fresh .. do.	0	0	8½
8. Chops—Forequarter .. do.	0	0	7½
9. " Loin .. do.	0	0	11

\* Rates subject to variation in accordance with Determinations of Prices Decontrol Commissioner.

**Sub-schedule No. 4—continued.**

MEAT FOR MONT PARK; SANATORIUM, GRESSWELL, ETC.—continued.

	£	s.	d.
10. Suet—Beef .. .. .	per lb.	0	0 3½
11. Steak—Thick Flank .. .. .	do.	0	1 2
12. " Rump .. .. .	do.	0	1 11
13. " Minced .. .. .	do.	0	0 11
14. Sausage Meat .. .. .	do.	0	0 5
15. Sausages—Mixed .. .. .	do.	0	0 10
16. Shanks—Sheeps' .. .. .	each	0	0 3
17. Tripe—Fresh .. .. .	per lb.	0	0 4½
18. Brains—Sheeps' .. .. .	per set	0	0 4
19. Kidneys—Ox .. .. .	per lb.	0	1 2
20. Livers—Calves' .. .. .	do.	0	0 9
21. Sausage—Strasburg, Pork .. .. .	do.	0	1 3
22. Rabbits—Fresh .. .. .	do.	0	0 11½
23. Saveloys .. .. .	per doz.	0	1 5
24. Tongues—Ox .. .. .	per lb.	0	0 8
25. Ham Loaf .. .. .	do.	0	1 4
26. Pressed Veal and Pork Loaf .. .. .	do.	0	1 7
27. Frys—Lambs' .. .. .	each	0	0 6

**SCHEDULE No. 3.—S.S. RIP AND DREDGES.**

ANNEX TO CONTRACT No. 1950/1701.

*J. H. Cooke Pty. Ltd., 378 Queen's-parade, Clifton Hill.*

**Sub-schedule No. 3.**

MEAT.

(Delivery at River Yarra Wharfs.)

	Security, £5.	£	s.	d.
1. Fresh Beef—Roast .. .. .	per lb.	0	1 7	
2. Beef, Corned—Silverside .. .. .	do.	0	1 6	
3. " " Rolled .. .. .	do.	0	1 0	
4. Fresh Mutton—Forequarter .. .. .	do.	0	0 7	
5. " " Legs .. .. .	do.	0	1 1½	
6. Chops—Forequarter .. .. .	do.	0	0 7½	
7. " Loin .. .. .	do.	0	1 0	
8. Steak—Rump .. .. .	do.	0	2 4	
9. " Stewing .. .. .	do.	0	1 2	
10. " Topside .. .. .	do.	0	1 7½	
11. Sausages—Mixed .. .. .	do.	0	0 10	
12. Tripe—Fresh .. .. .	do.	0	0 7½	
13. Frys—Lambs' .. .. .	each	0	0 9	
14. Suet—Kidney .. .. .	per lb.	0	0 5	
15. Rabbits—Fresh .. .. .	do.	0	0 9½	
16. Ice .. .. .	per cwt.	0	3 6	

**SCHEDULE No. 4.—TEACHERS' COLLEGE, CARLTON, AND TRAVANCORE DEVELOPMENTAL CENTRE, FLEMINGTON.**

ANNEX TO CONTRACT No. 1950/1702.

*J. H. Cooke Pty. Ltd., 378 Queen's-parade, Clifton Hill.*

**Sub-schedule No. 3.**

MEAT.

Security, £8.

	£	s.	d.
1. Fresh Beef—Sirloin .. .. .	per lb.	0	1 5
2. Fresh Mutton—Cutlets .. .. .	do.	0	1 0
3. " " Chops—Mid. Loin .. .. .	do.	0	1 0
4. " " Forequarter .. .. .	do.	0	0 4
5. " " Legs .. .. .	do.	0	0 11
6. Beef—Corned—Silverside .. .. .	do.	0	1 6
7. Veal—Shoulder, Boned .. .. .	do.	0	0 4
8. Steak—Blade .. .. .	do.	0	1 5
9. " (when required, minced) .. .. .	do.	0	0 11
10. " Stewing .. .. .	do.	0	0 11
11. Mince Meat .. .. .	do.	0	0 11
12. Sausages—Mixed .. .. .	do.	0	0 10
13. Sausage Meat .. .. .	do.	0	0 7
14. " Beef, German .. .. .	do.	0	0 11
15. Frys—Lambs' .. .. .	each	0	0 9
16. Tripe—Fresh .. .. .	per lb.	0	0 6
17. Suet—Kidney .. .. .	do.	0	0 5
18. Bones—Soup .. .. .	do.	0	0 0½
19. Frankfurts .. .. .	do.	0	1 1
20. Black Puddings .. .. .	do.	0	0 8

**SCHEDULE No. 5.—ARARAT DISTRICT.**

ANNEX TO CONTRACT No. 1950/1703.

*A. Ahpee, 172 Barkly-street, Ararat.*

**Sub-schedule No. 4.**

MEAT.

Security, £30.

	£	s.	d.
1. Fresh Beef—Forequarters .. .. .	per cntl.	4	2 0
2. " " Hindquarters .. .. .	do.	4	2 0
3. " " Buttocks .. .. .	do.	4	2 0
4. " Mutton .. .. .	do.	4	3 4
5. Corned Beef—Rolled or round, as ordered, without bone or cartilage .. .. .	do.	4	2 0
6. Sausages—Mixed (summer months) .. .. .	per lb.	0	0 10
7. Sausage—Beef German (summer months) .. .. .	do.	0	1 3
8. Saveloys (winter months) .. .. .	per doz.	0	1 9

ANNEX TO CONTRACT No. 1950/1704.

*H. J. Symons Pty. Ltd., 1015 Macarthur-street, Ballarat.*

**Sub-schedule No. 4.**

MEAT.

Security, £35.

	£	s.	d.
1. Fresh Beef—Forequarters .. .. .	per cntl.	3	17 1
2. " " Hindquarters .. .. .	do.	4	9 7
3. " " Buttocks .. .. .	do.	4	11 8
4. Beef, Corned .. .. .	do.	5	0 0
5. Mutton, Fresh .. .. .	do.	3	10 10
6. Minced Meat .. .. .	per lb.	0	0 8
7. Sausages (April to September) .. .. .	do.	0	0 8
8. Sausage, Beef, German (October to March) .. .. .	do.	0	1 0
9. Saveloys (April to September) .. .. .	per doz.	0	1 0
10. Suet, Beef .. .. .	per lb.	0	0 7
11. Rabbits, Fresh (April to September) .. .. .	do.	0	0 9
12. Tripe .. .. .	do.	0	0 9
13. Ham Loaf (October to March) .. .. .	do.	0	1 10
14. Black Puddings .. .. .	do.	0	0 6

**SCHEDULE No. 7.—BEECHWORTH DISTRICT.**

ANNEX TO CONTRACT No. 1950/1705.

*E. Spencer, Camp-street, Beechworth.*

**Sub-schedule No. 4.**

MEAT.

Security, £30.

	£	s.	d.
1. Fresh Beef—Roast .. .. .	per cntl.	4	3 4
2. " " Buttocks .. .. .	do.	4	3 4
3. Corned Beef—Rolled .. .. .	do.	4	3 4
4. " Mutton .. .. .	per lb.	0	0 9½
5. Minced Meat .. .. .	do.	0	0 8
6. Sausages, Mixed .. .. .	do.	0	0 9
7. Sausage Meat .. .. .	do.	0	0 7½
8. Sausage—Beef, German .. .. .	do.	0	1 0
9. Suet—Kidney .. .. .	do.	0	0 6
10. Dripping—Beef .. .. .	do.	0	0 7
11. Ham and Beef Loaf .. .. .	do.	0	1 11
12. Saveloys .. .. .	per doz.	0	1 9

**SCHEDULE No. 8.—CASTLEMAINE DISTRICT.**

ANNEX TO CONTRACT No. 1950/1706.

*Ewing's "W.K. & H.S.", 91 Mostyn-street, Castlemaine.*

**Sub-schedule No. 2.**

MEAT.

Security, £5.

	£	s.	d.
1. Fresh Beef .. .. .	per lb.	0	0 11
2. Corned Beef—Rolled, or round, as ordered, without bone or cartilage .. .. .	do.	0	1 1
3. Fresh Mutton .. .. .	do.	0	0 8½
4. Sausages—Mixed .. .. .	do.	0	1 0
5. Sausage Meat .. .. .	do.	0	0 8

**SCHEDULE No. 9.—SCHOOL OF FORESTRY, CRESWICK.**

ANNEX TO CONTRACT No. 1950/1707.

*H. J. Symons Pty. Ltd., 1015 Macarthur-street, Ballarat.*

**Sub-schedule No. 4.**

MEAT.

Security, £3.

	£	s.	d.
1. Fresh Beef—Forequarters .. .. .	per lb.	0	1 1
2. " Mutton .. .. .	do.	0	0 11
3. Sausages—Mixed .. .. .	do.	0	0 11
4. Steak—Minced .. .. .	do.	0	0 8½
5. Frys—Lambs' .. .. .	each	0	0 6
6. Dripping—Beef .. .. .	per lb.	0	0 7

**SCHEDULE No. 10.—MCLEOD SETTLEMENT, FRENCH ISLAND.**

ANNEX TO CONTRACT No. 1950/1708.

*L. G. Male, Lang Lang.*

**Sub-schedule No. 3.**

MEAT.

Security, £5.

	£	s.	d.
1. Fresh Beef .. .. .	per lb.	0	0 10½
2. " Mutton .. .. .	do.	0	0 10½
3. Sausages .. .. .	do.	0	0 10

SCHEDULE No. 11.—HEATHERTON SANATORIUM,  
CHELTENHAM.

ANNEX TO CONTRACT No. 1950/1709.

W. Angliss and Co. (Aust.) Pty. Ltd., 42 Bourke-street,  
Melbourne, C.I.

Sub-schedule No. 3.

MEAT.*		Security, £3.	£	s.	d.
1. Beef—Fresh, Roast .. .. .	per lb.	0	1	0	
2. " " Corned—Silverside .. .. .	do.	0	1	5	
3. Mutton, Fresh .. .. .	do.	0	0	5	
4. Chops—Forequarter .. .. .	do.	0	0	5	
5. " " Middle Loin .. .. .	do.	0	1	0	
6. Veal—Leg .. .. .	do.	0	0	9	
7. Pork, Fresh—Loin .. .. .	do.	0	1	8	
8. Steak—Rump .. .. .	do.	0	2	0	
9. " " Blade Bone .. .. .	do.	0	1	3	
10. " " Minced .. .. .	do.	0	1	0	
11. " " Topside .. .. .	do.	0	0	9	
12. Tripe—Fresh .. .. .	do.	0	0	4	
13. Frys—Lambs' .. .. .	do.	0	0	6	
14. Sausages—Mixed .. .. .	do.	0	0	7	
15. Kidneys—Ox .. .. .	do.	0	1	2	
16. Tails—Ox .. .. .	do.	0	0	8	
17. Tongues—Ox .. .. .	do.	0	0	8	
18. " " Sheep's .. .. .	each	0	0	3	
19. Brains—Sheep's .. .. .	per set	0	0	4	
20. Ham Loaf .. .. .	pre lb.	0	1	4	
21. Fowls—First Quality .. .. .	do.	0	2	9	

SCHEDULE No. 12.—SANATORIUM, GREENVALE.

ANNEX TO CONTRACT No. 1950/1710.

F. Watkins Pty. Ltd., 184 Bourke-street, Melbourne, C.I.

Sub-schedule No. 3.

MEAT (cuts as ordered).		Security, £7.	£	s.	d.
1. Beef, Fresh—Roast .. .. .	per lb.	0	1	4½	
2. " " Topside .. .. .	do.	0	1	7½	
3. " " Rump .. .. .	do.	0	2	4	
4. " "—Corned, Silverside .. .. .	do.	0	1	6½	
5. Mutton, Fresh—Sides .. .. .	do.	0	0	11	
6. Cutlets—Mutton .. .. .	do.	0	1	0½	
7. Chops—Middle Loin .. .. .	do.	0	1	0½	
8. " " Leg .. .. .	do.	0	1	2½	
9. Steak—Minced .. .. .	do.	0	1	1	
10. Minced Meat .. .. .	do.	0	0	9	
11. Frys—Lambs' .. .. .	do.	0	1	3	
12. Pork, Fresh—Sides .. .. .	do.	0	2	2	
13. Tongues—Ox .. .. .	do.	0	0	8	
14. Sausages—Mixed .. .. .	do.	0	1	0	
15. " " Pork .. .. .	do.	0	1	4	
16. Sausage—Strasbourg, Pork .. .. .	do.	0	1	8	
17. Kidneys—Ox .. .. .	do.	0	1	6	
18. Rabbits—Fresh .. .. .	do.	0	1	1	
19. Fowls—First Quality .. .. .	do.	0	4	2	

SCHEDULE No. 13.—COORIEMUNGLE PRISON CAMP,  
HEYTESBURY FOREST.

ANNEX TO CONTRACT No. 1950/1711.

Heytesbury Butchery, Timboon.

Sub-schedule No. 3.

MEAT.		Security, £4.	£	s.	d.
1. Fresh Beef .. .. .	per lb.	0	1	4	
2. " " Mutton .. .. .	do.	0	1	1	
3. " " Cutlets .. .. .	do.	0	1	1	
4. Dripping—Beef .. .. .	do.	0	0	6	
5. Corned Beef—Rolled or round, as ordered, without bone or cartilage .. .. .	do.	0	1	1	
6. Minced Meat .. .. .	do.	0	0	10	

\* Rates subject to variation in accordance with Determinations of Prices Decontrol Commissioner.

SCHEDULE No. 16.—SALE GAOL.

ANNEX TO CONTRACT No. 1950/1712.

H. L. G. Laws, 111 Raymond-street, Sale.

Sub-schedule No. 2.

MEAT.		Security, £3.	£	s.	d.
1. Fresh Beef—Stewing .. .. .	per lb.	0	1	0	
2. Fresh Mutton .. .. .	do.	0	1	0	
3. Corned Beef—Rolled or round, as ordered, without bone or cartilage .. .. .	do.	0	1	0	
4. Cutlets—Mutton .. .. .	do.	0	1	0	

SCHEDULE No. 17.—PLEASANT CREEK SPECIAL SCHOOL,  
STAWELL.

ANNEX TO CONTRACT No. 1950/1713.

A. J. Case, Main-street, Stawell.

Sub-schedule No. 4.

MEAT.		Security, £3.	£	s.	d.
1. Fresh Beef—Prime ribs .. .. .	per lb.	0	1	3	
2. " " Sirloin .. .. .	do.	0	1	7	
3. " " " Stewing (minced when required) .. .. .	do.	0	1	2	
4. Beef—Corned, Silverside .. .. .	do.	0	1	5½	
5. Fresh Mutton—Chops (loin) .. .. .	do.	0	1	0½	
6. " " in sides .. .. .	do.	0	0	11½	
7. Sausages—Mixed .. .. .	do.	0	1	1	
8. Frys—Lambs' .. .. .	each	0	0	6	
9. Tripe—Fresh .. .. .	per lb.	0	0	9½	
10. Saveloys .. .. .	per doz.	0	2	2	
11. Tongues—Ox .. .. .	per lb.	0	0	8	

SCHEDULE No. 18.—SUNBURY DISTRICT.

ANNEX TO CONTRACT No. 1950/1714.

F. Watkins Pty. Ltd., 184 Bourke-street, Melbourne, C.I.

Sub-schedule No. 5.

MEAT.		Security, £40.	£	s.	d.
1. Fresh Beef—Forequarters .. .. .	per cntl.	4	7	6	
2. " " Buttocks .. .. .	per lb.	0	1	1	
3. " " Mutton .. .. .	do.	0	0	10½	
4. Corned Beef—Rolled or round, as ordered, without bone or cartilage .. .. .	do.	0	1	3	
5. Sausages—Mixed .. .. .	do.	0	1	0	

SCHEDULE No. 21.—GEEELONG DISTRICT.

ANNEX TO CONTRACT No. 1950/1715.

O'Brien's Butchery, 491 Moorabool-street, Geelong.

Sub-schedule No. 2.

MEAT.		Security, £10.	£	s.	d.
1. Fresh Beef .. .. .	per cntl.	3	15	0	
2. Corned Beef—Rolled or round, without bone or cartilage .. .. .	per lb.	0	0	8	
3. Fresh Mutton .. .. .	do.	0	0	8	

CONTRACTS ACCEPTED.—(Series 1950-51.)

Contract No.	Particulars.	Amount.	Name of Contractor.	Charge against Vote or Fund.
1716	PROVISIONS— Supply of Butter and Cheese, in such quantities as may be ordered, from 1st October, 1950, to 30th September, 1951	Rates as per annex	Melbourne Butter Supply Pty. Ltd.	Contingencies, 1950-51, 1951-52
1717	" " "	"	Holdenson and Nielson Fresh Food Pty. Ltd.	
1718	" " "	"	The Ararat and District Co-operative Butter Factory Co. Ltd.	

Approved—J. G. B. McDONALD, Treasurer. 29.9.50.

ANNEX TO CONTRACTS NOS. 1950/1716 TO 1950/1718.

Schedule No. 22.

PROVISIONS—BUTTER AND CHEESE.

CONTRACT FROM 1ST OCTOBER, 1950, TO 30TH SEPTEMBER, 1951.

1950/1716.—Melbourne Butter Supply Pty. Ltd. Security, £450.

1950/1717.—Holdenson and Nielson Fresh Food Pty. Ltd. Security, £200.

1950/1718.—The Ararat and District Co-operative Butter Factory Co. Ltd. Security, £80.

*Butter.*—To be first grade Creamery Butter, to score not less than 91 points Government Grade, Commerce Regulations Standard, the ruling market rate for which shall be deemed to be four shillings and eight pence per cwt. below the ruling market rate for Choicest Grade as published in the *Argus* newspaper on the first Tuesday or Wednesday, as the case may be, in each month.

*Cheese.*—To be first class quality, semi or fully matured, as ordered, and not less than three months old. If the quantity admits, it shall be boxed for transport.

Item No.	Particulars.	Rate.	Name of Contractor.
1	Melbourne District— Butter .. .. .	Per cwt.—Ruling market rate less 1%	Melbourne Butter Supply Pty. Ltd.
2	Cheese .. .. .	Per cwt.—£7 .. .. .	
3	Mont Park District— Butter .. .. .	Per cwt.—Ruling market rate less 1%	
4	Cheese .. .. .	Per cwt.—£7 .. .. .	
5	Ararat District— Butter .. .. .	Per cwt.—Ruling market rate .. .. .	The Ararat & District Co-operative Butter Factory Co. Ltd.
6	Cheese .. .. .	Per cwt.—£7 .. .. .	Melbourne Butter Supply Pty. Ltd.
7	Ballarat District— Butter .. .. .	Per cwt.—Ruling market rate, plus 2s. 4d.	Holdenson & Nielson Fresh Food Pty. Ltd.
8	Cheese .. .. .	Per cwt.—£7 .. .. .	Melbourne Butter Supply Pty. Ltd.
9	Beechworth District— Butter .. .. .	Per cwt.—Ruling market rate, plus 2s. 4d.	Holdenson & Nielson Fresh Food Pty. Ltd.
10	Cheese .. .. .	Per cwt.—£7 .. .. .	Melbourne Butter Supply Pty. Ltd.
11	Greenvale—Sanatorium— Butter .. .. .	Per cwt.—Ruling market rate less 1%	
12	Stawell—Pleasant Creek Special School— Butter .. .. .	Per cwt.—Ruling market rate, plus 2s. 4d.	Holdenson & Nielson Fresh Food Pty. Ltd.
13	Sunbury District— Butter .. .. .	Per cwt.—Ruling market rate, plus 2s. 4d.	Melbourne Butter Supply Pty. Ltd.
14	Cheese .. .. .	Per cwt.—£7 .. .. .	

CONTRACTS ACCEPTED.—(Series 1950-51.)

PUBLIC WORKS.

1771. (1) Ararat, Mental Hospital, erection of timber and brick storage sheds, £4,647.—J. H. Brown and Sons Pty. Ltd.

1772. (1) Ballarat, Mental Hospital, repairs and painting, senior gardener's quarters, £137 13s.—C. W. Pennant.

1773. (2) Blackburn, State School No. 2923, provision of blackboard cupboard, £105.—F. T. Pulling.

1774. (3) Blackburn, Police Station, erection of station and residence, £3,980.—F. W. Basing.

1775. (2) Boronia, State School No. 4081, erection of shelter sheds, £400.—L. C. Wallis.

1776. (2) Carlton, Exhibition Buildings, Motor Registration Branch, renovations, &c., £2,985 10s. 6d.—H. S. Bolger and Son.

1777. (4) Cheltenham, State School No. 84, erection of brick out-offices and connexion of all sanitary fittings to sewerage reticulation, £4,144.—D. S. Begg.

1778. (1) Dandenong, High School, enclosing of quadrangle to prevent vandalism, £156 16s. 6d.—Cyclone Co. of Australia Ltd.

1779. (1) Deans Marsh, State School No. 1642, repairs and alterations, £168 18s.—E. A. Rookes.

1780. (2) Eurack, State School No. 3448, repairs and painting, £309 18s.—R. H. Pyne.

1781. (2) Fitzroy, Correspondence School, Napier-street, supply and installation of gas hot water service, £116.—The Metropolitan Gas Co.

1782. (2) Footscray, Technical School, metallurgy laboratory, supply and installation of exhaust hood, £235.—Crockford and Robertson.

1783. (2) Glenferrie, Swinburne Technical College, wall benches and reagent shelving, £487.—J. R. and E. Seccull Pty. Ltd.

1784. (3) Glenroy, Police Station, erection of Police Station and residence, £5,224 10s.—F. Philip.

1785. (3) Hawthorn, "Moorakyne" Girls' Hostel, supply and installation of two electric refrigerators, £306.—Rickards Bros. Pty. Ltd.

1786. (1) Katunga, State School No. 2269, erection of new out-offices and woodshed for prefabricated classrooms, £486.—E. L. O'Donnell.

1787. (3) Kyneton, District Hospital, installation of steam generators and heating, &c., £4,296 10s. 6d.—Ross's Pty. Ltd.

1788. (3) Lima East, State School No. 2289, repairs, &c., prior to painting, £130 4s.—H. Cunningham Clarke.

1789. (1) Melbourne, Law Courts, cnr. Lonsdale and William streets, supplying and fixing rainwater heads and downpipes in galvanized iron, £223 5s.—W. J. Bugg.

1790. (2) Melbourne, Government Statist Office, 295 Queen-street, erection of an office in strong room, £190.—F. T. Pulling.

1791. (1) Mont Park, Mental Hospital, installation of hot water and central heating in extension to Nurses' Home, £3,386.—J. Wilson.

1792. (2) Morwell, State School M.A., Collins-street, provision of water service, drinking facilities, out-offices and sewerage, &c., "Bristol" prefabricated Schoolroom, £2,055 12s.—J. W. Short and Co.

1793. (4) Mt. Clear, State School No. 427, provision of new septic tank system and alterations to out-offices, £516 15s.—H. G. Feary.

1794. (1) Muckatah, State School No. 2496, provision of entrance porch to school and painting, £175.—C. C. Brereton.

1795. (1) Nilma, State School No. 2712, internal plaster work, residence, £192.—J. W. Short and Co.

1796. (1) Port Fairy, State School No. 1188, supply and installation of kerosene hot water service, residence, £167 6s.—J. J. McLaren.

1797. (3) Port Melbourne, Lands Department, Film Storage, electrical installation, £142 10s.—G. Wilkie Electrical Co.

1798. (1) Robinvale, Teachers' Hostel, re-erecting and painting, £2,860.—R. Maddy and Son.

1799. (1) Romsey, State School No. 366, repairs and painting, £199.—R. House.

1800. (1) Royal Park, Children's Welfare Depot, painting and repairs to building, Junior Boys, £2,225.—A. H. Philip.

1801. (2) Royal Park, Children's Welfare Depot, alterations, &c., to Nurses' Quarters, £203.—A. H. Philip.

1802. (2) Sale, Technical School, erection of two teachers' residences (labour only), £1,775.—A. C. Spruzen.

1803. (1) Sea Lake, Police Station, repairs to sergeant's residence, £138.—C. G. Tillig and Sons.

1804. (2) South Melbourne, Mines Department Drill Store, electrical installation, £157 10s.—Lecol Electrical Co.

1805. (1) Stawell East, Police Station, repairs, renovations, and painting, £550 18s. 9d.—W. C. Barker.

1806. (1) Tabilk, State School No. 951, renewal of paling fence, residence, £103.—E. L. O'Donnell.

1807. (1) Tylden, State School No. 621, repairs to school and residence, £159.—R. House.

1808. (1) Warracknabeal, High School, provision of tanks, tank stands, blackboards, cupboards, and hat and coat hooks, "Bristol" Prefabricated Schoolroom Unit, £268 17s.—J. G. Shaw and Son.

1809. (1) Willaura, State School No. 2662, drainage work, provision of cupboards, linen press, &c., £128 1s. 6d.—E. Martin.

1810. (1) North Wonthaggi, State School No. 3716, repairs to roof and spouting, £102 18s. 6d.—A. J. Avage and Sons.

1811. (1) Yin Barum, State School No. 2830, repairs to building, £180 15s.—H. Cunningham Clarke.

P. T. BYRNES, Commissioner of Public Works. 2.10.50.

#### ORDERS IN COUNCIL.—(Series 1950-51.)

##### EDUCATION DEPARTMENT.

1695. Two (2) only Hercules model "C" type 9-in. vee bed bench-type screwcutting lathes, with electric motors, for Preston Technical School, £207 11s.—McPherson's Limited, Melbourne.

Approved by the Governor in Council, 26th September, 1950.—A. MAHLSTEDT, Clerk of the Executive Council.

##### STATE ELECTRICITY COMMISSION.

1719. The complete overhaul of Caterpillar D.2 tractor, to Quotation No. 3409.—William Adams and Co. Pty Ltd.

1720. The supply of spare parts for Euclid trailers, Yallourn, to Quotation No. 636.—Blackwood Hodge (Aust.) Pty. Ltd.

1721. The supply of two 16,000 kW turbo-generators for No. 5 Power Station, Kiewa Hydro-Electric Scheme, to Specification No. 48-49/96.—Boving and Co. Ltd.

1722. The supply of eleven telephone cable loading coil pots, for telephone communications, Rubicon Hydro-Electric Scheme, to Quotation No. 5872.—British General Electric Co. Pty. Ltd.

1723. The supply of one oil fired hot water plant for temporary camp, Shepparton Power Station, to Quotation No. 1906.—Burnoil Pty. Ltd.

1724. The supply of two Pelton-driven pumping sets, piping and valves, for water cooling purposes, No. 4 Power Station, Kiewa Hydro-Electric Scheme, to Specification No. 49-50/209.—Coates and Co. Pty. Ltd.

1725. The supply of one-tracked tractor fitted with dozer blade attachments for construction of underground mains, to Quotation No. 5944.—Commando Industries Ltd.

1726. Repairs to diesel engine crankshaft, Hamilton Power Station, to Quotation No. 6544.—Commonwealth Government Marine Engine Works.

1727. The supply of 64 sheets of stabilized stainless steel for mess kitchen, Kiewa Hydro-Electric Scheme, to Quotation No. 7129.—Commonwealth Steel Co. Ltd.

1728. The supply and erection of wire fencing, Shepparton Power Station, to Specification No. 50-51/70.—Cyclone Co. of Aust. Ltd.

1729. The supply of 6,500 feet of galvanized chain wire for fencing of stores and housing boundaries, Rubicon, to Quotation No. 921.—Cyclone Co. of Aust. Ltd.

1730. The supply of 7,100 electric delay fuses, Kiewa Hydro-Electric Scheme, to Quotation No. 912.—Dalgety and Co. Ltd.

1731. The supply of four fuel oil pumps for Richmond Power Station, to Quotation No. 311.—Ebsray Distributors Pty. Ltd.

1732. The supply of 500 fuse cartridges and other attachments, Kiewa Hydro-Electric Scheme, to Quotation No. 812.—The English Electric Co. Ltd.

1733. The supply of approximately 4 miles of second-hand rail track for rail projects, Yallourn and Kiewa Hydro-Electric Scheme.—Forests Commission of Victoria.

1734. The supply of one universal high speed dial type milling machine, central base workshops, Yallourn, to Specification No. 50-51/22.—Gilbert Lodge and Co. Ltd.

1735. The supply of 70 "Y" type and 44 "I" type forged silicon chrome steel moulds for briquetting purposes, Briquette Factory, Yallourn, to Quotation No. 1558.—H. V. Hampton.

1736. The supply of 330 cast-iron fittings for fibrolite piping, for water supply purposes, Yallourn, to Quotation No. 1531.—James Hardie and Co. Pty. Ltd.

1737. The supply of 700 feet of 10-inch bore, flanged steel piping and fittings for drainage of Open Cut, Morwell Project, to Quotation No. 437.—Hume Steel Ltd.

1738. The supply of 489 drill wagon mountings, Kiewa Hydro-Electric Scheme, to Quotation No. 523.—Ingersoll-Rand (Aust.) Pty. Ltd.

1739. The supply of 2,500 feet 660 volt trailing cable for submersible pumps, Kiewa Hydro-Electric Scheme, to Quotation No. 1499.—Johnson and Phillips Ltd.

1740. The supply of structural steel headgate for No. 4 Head Race Tunnel, Kiewa Hydro-Electric Scheme, to Specification No. 50-51/16.—Johnson's Tyne Foundry Pty. Ltd.

1741. The supply of ten structures for North-east line carrier equipment, to Quotation No. 871.—Johns & Waygood Ltd.

1742. The supply of punched card type accounting system, to Quotation No. 1690.—Kalamazoo (Aust.) Ltd.

1743. The supply of spare parts for hammer drills, Kiewa Hydro-Electric Scheme, to Quotation No. 566.—K. L. Distributors Pty. Ltd.

1744. The supply of 16,550 feet of black steel wire rope for mechanical plant and earth-moving equipment.—Latch and Batchelor Ltd.

1745. The supply of two Johnson mud pumps and accessories for sewerage work, Morwell, to Quotation No. 1467.—O. T. Lempriere and Co. Ltd.

1746. The supply of 60,930 feet of standard steel scaffolding with fittings, Morwell, to Quotation No. 6887.—John Lysaght (Aust.) Pty. Ltd.

1747. The erection of six English pre-cut houses for housing of personnel, East Newborough, to Specification No. 49-50/320.—J. J. McCall.

1748. The supply of 30 heavy duty tipping bodies for fitment to Leyland "Beaver" chassis for use at Yallourn, Morwell, and Kiewa Hydro-Electric Scheme, to Quotation No. 528.—McGrath Trailer Equipment Pty. Ltd.

1749. The supply of six pneumatic impact wrenches, Kiewa Hydro-Electric Scheme, to Quotation No. 559.—McPherson's Ltd.

1750. The salvaging, carting and stacking of approximately 4 miles of rail track in the Erica Forest.—A. W. Maxwell.

1751. The supply of 2,000 feet of 4-in. x 3-in. steel bar for repairs to coal dredgers and overburden spreaders, Yallourn, to Quotation No. 844.—Melbourne Iron and Steel Mills Pty. Ltd.

1752. The supply of eight Ford V8 utility trucks for replacement purposes, to Quotation No. 1399.—Melford Motors Pty Ltd.

1753. The supply of five Commer 7-ton chassis complete with accessories, to Quotation No. 1445.—Neal's Motors Pty. Ltd.

1754. The supply of twenty 10-ply bar tread tires and 30 14-ply bar tread tires for motor trucks, to Quotation No. 1938.—The Olympic Tyre and Rubber Co. Ltd.

1755. The supply of two lathes and four sets of lathe tools, for workshop equipment, Shepparton and Warrnambool Power Stations, to Quotation No. 6727.—Qualos Sales Pty. Ltd.

1756. The supply of one diesel crawler tractor fitted with front end loader for constructional purposes, Metropolitan Area, to Quotation No. 231.—Queen's Bridge Motor and Engineering Co. Pty. Ltd.

1757. The supply and delivery of 2,000 cubic yards of ready mixed concrete for construction purposes, Metropolitan Area, to Quotation No. 1472.—Ready Mixed Concrete (Vic.) Pty. Ltd.

1758. The supply of 15,000 lineal feet of oregon timber for lining of tunnels, Kiewa Hydro-Electric Scheme, to Quotation No. 1667.—John Sharp and Sons Pty. Ltd.

1759. The supply of 580 extension ladders, to Quotation No. 1303.—A. B. Smith and Son.

1760. The supply of two pneumatic tire mounted light dumpers for constructional purposes, Metropolitan Area, to Quotation No. 863.—Stanhill Pty. Ltd.

1761. The cartage of timber and other merchandise, for a period of three months, from Ovens and Bright to Mt. Beauty, Kiewa Hydro-Electric Scheme, to Quotation No. 1930.—C. W. Stewart.

1762. The supply of spare parts for Tournapull and Allis Chalmers HD.14 tractors, to Quotation No. 2.—Tutt Bryant (Vic.) Pty. Ltd.

1763. The supply of 5,000 tons of granite spalls for construction work, Yallourn "C" Power Station, to Quotation No. 2089.—Tynong Granite Quarry.

1764. The supply of 30,000 insulator caps and pins for switchgear in rural substations, to Quotation No. 1355.—United Engineering and Malleable Co. Pty. Ltd.

1765. The supply of spare parts for International T.D.24 tractors, Yallourn, to Quotation No. 637.—Victorian Industrial Sales and Service Pty. Ltd.

1766. The supply of spare parts for International T.D.24 tractors, Yallourn and Kiewa Hydro-Electric Scheme, to Quotation No. 79.—Victorian Industrial Sales and Service Pty. Ltd.

1767. The supply of spare parts for International T.D.24 tractors, Yallourn, to Quotation No. 1098.—Victorian Industrial Sales and Service Pty. Ltd.

1768. The cutting of 40,000 super. feet of blue gum logs into crossarms for transmission and distribution lines.—Victorian Railways Commissioners.

1769. The supply of 600 bronze valves and cocks for general purposes, to Specification No. 49-50/338.—Bell's Asbestos and Engineering (Aust.) Ltd.

1770. The supply of 516 bronze valves and cocks for general purposes, to Specification No. 49-50/338.—M. B. John Ltd.

Approved by the Governor in Council, 26th September, 1950.—A. MAHLSTEDT, Clerk of the Executive Council.

#### QUEEN'S MEMORIAL INFECTIOUS DISEASES HOSPITAL BOARD.

##### TRIENNIAL ELECTIONS.

IN pursuance of the provisions of the *Infectious Diseases Hospital Act 1928* and of Regulations made thereunder, I hereby declare the following persons to be elected as members of the Queen's Memorial Infectious Diseases Hospital Board for three years, commencing on the 16th October, 1950.

Councillor Sir HAROLD GENGOULT SMITH, representing the City of Melbourne.

Councillor SAMUEL THEODORE EGERBERG, representing Group "A."

Councillor ALFRED ERNEST SHEPHERD, representing Group "B."

Councillor WILLIAM ALFRED KEMP, representing Group "C."

Councillor JOHN PATRICK BARRY, representing Group "D."

Councillor HERBERT CHARLES EDWARDS, representing Group "E."

GEORGE E. COLE,  
Returning Officer.

General Health Branch,  
Department of Health,  
Melbourne, C.1, 27th September, 1950.

#### The Fisheries Acts.

#### NOTICE OF INTENTION TO ALTER THE REGULATIONS RESPECTING LONG LINES IN WESTERN PORT BAY.

IT is hereby notified for general information that it is intended, after the expiration of one month from the date of publication of this notice in the *Government Gazette*, to move His Excellency the Governor in Council to make a Proclamation revoking the Proclamation made the sixteenth day of July, 1946, and published in the *Government Gazette* of the seventeenth day of July, 1946, respecting long lines in Western Port Bay, and prohibiting in the waters of Western Port Bay within or inside an imaginary line running from Shoreham to the Nobbies and an imaginary line running west north-west and east south-east through the flashing southern light of the inner passage, situated approximately 1,000 yards 60 degrees from the head of Newhaven Jetty, or of any river or creek flowing into such bay at any time during the period from the first day of November in each year to the thirty-first day of March next following, inclusive, any person having in his possession any long line in or upon the said waters, or within 200 yards thereof, or doing any or all of the following things:—

- Using or assisting in the use of a long line or the method of fishing known as "long lining";
- taking or assisting in the taking of a boat with a long line on board, or attached thereto, on to any of the said waters; permitting a long line to be on or attached to any boat on such waters; allowing a long line to be in or upon such waters, or within 200 yards thereof;
- using any fishing line, whether fixed or unfixed, having attached thereto more than three hooks or using or having in possession or control more than six such lines in or on the said waters;

and further prohibiting during the period in any year from the first day of April to the thirty-first day of October (both days inclusive) any person having in his possession more than one long line in or upon the said waters, or within 200 yards thereof, or a long line having attached thereto more than 500 hooks, or doing any or all of the following things:—

- Using or assisting in the use of more than one long line or a long line with more than 500 hooks attached thereto;
- permitting more than one long line or a long line with more than 500 hooks attached to be on or attached to any boat on such waters;
- taking or assisting in the taking of a boat having thereon, or attached thereto, more than one long line or a long line with more than 500 hooks attached on to the said waters; or allowing such a boat to be on the said waters;
- using or assisting in the use of a long line, or moving a boat with a long line on board, attached thereto, or in tow from any mooring, anchorage, wharf, or jetty during the period between noon on any Saturday and midnight on the following Sunday, or using any fishing line, whether fixed or unfixed, having attached thereto more than three hooks or using or having in possession or control more than six such lines during such period.

K. DODGSHUN,  
Chief Secretary.

A. DUNBAVIN BUTCHER,  
Director of Fisheries and Game.  
Melbourne, 29th September, 1950.

#### Co-operative Housing Societies Act 1944.

#### NOTICE OF CHANGE OF NAME OF SOCIETY.

NOTICE is hereby given that Kardinia Co-operative Housing Society Limited, which was incorporated as a co-operative housing society under the above-named Act on the 27th May, 1949, has registered a change of its name and is now incorporated under the name of Kardinia (No. 1) Co-operative Housing Society Limited, under the said Act.

Dated at Melbourne, this 25th day of September, 1950.

E. T. EBBELS,  
Registrar of Co-operative Housing Societies.

## 4 GEORGE VI. No. 4755, SECTION 6.

I HEREBY give notice that on the 18th September, 1950, I filed an election to administer the following deceased person's estate, in accordance with section 6 of the *Public Trustee Act 1940*:—

TAYLOR, HENRY CLIFFORD, also known as Henry Taylor, late of 117 Charles-street, Seddon, retired farm labourer, died 29th November, 1949, intestate.

I HEREBY give notice that on the 20th September, 1950, I filed elections to administer the following deceased persons' estates, in accordance with section 6 of the *Public Trustee Act 1940*:—

\*DODD, HERBERT SENIOR, late of 30 Ballarat-street, Yarraville, gentleman, died 2nd July, 1950.

ELLIS, MARY, late of Wales, United Kingdom, widow, died 27th March, 1919, intestate.

KING, ARTHUR CHARLES, late of Lake Goldsmith, via Beaufort, farm labourer, died 30th July, 1950, intestate.

MILES, GLORIA MARGARET, late of St. Leonards-road, Lilydale, widow, died 9th December, 1949, intestate.

MILLARD, CHARLES ARTHUR, late of 24 John-street, Oakleigh, plasterer, died 30th September, 1949, intestate.

\*MCCRIMMON, WILLIAM HECTOR, late of 18 Day-street, South Yarra, gardener, died 21st January, 1950.

MCLEAN, WILLIAM JOSEPH, also known as William McLean, formerly of 76 Heath-street, Port Melbourne, but late of 27 Market-street, South Melbourne, pensioner, died 20th July, 1947, intestate.

\* According to the provisions of the will.

I HEREBY give notice that on the 21st September, 1950, I filed elections to administer the following deceased persons' estates, in accordance with section 6 of the *Public Trustee Act 1940*:—

JONES, RICHARD, late of Wales, United Kingdom, bachelor, died 8th April, 1916, intestate.

ROBERTS, JOHN, late of Wales, United Kingdom, gentleman, died 30th January, 1942, intestate.

ROBERTS, WILLIAM, late of Wales, United Kingdom, gentleman, died 21st April, 1949, intestate.

I HEREBY give notice that on the 25th September, 1950, I filed elections to administer the following deceased persons' estates, in accordance with section 6 of the *Public Trustee Act 1940*:—

DIXON, ESTHER JEAN, late of 19 Nicholson-street, Essendon, married woman, died 9th August, 1950, intestate.

\*JONES, CLARA MAY, late of 7 Mair-street, Brighton Beach, spinster, died 11th July, 1950.

O'DEA, CATHERINE TERESA, late of 25 White-street, East Malvern, married woman, died 16th June, 1950, intestate.

\*ROUSE, MARY ANN, formerly of Daisy-street, Chatswood, but late of 18 Mabel-street, Willoughby, both in New South Wales, widow, died 29th December, 1949.

RUXTON, EVELYN FAY, late of Smith-street, Macedon, student, died 11th July, 1950, intestate.

SPOLSKI, JAN, late of Forests Commission Camp, Bullarto, labourer, died 24th June, 1950, intestate.

VITINS, NIKALAJA, late of Benalla, driver, died 29th April, 1950, intestate.

WHIGHTMAN, ALICE, late of 26 Westgarth-street, East Malvern, home duties, died 22nd August, 1950, intestate.

\* According to the provisions of the will.

I HEREBY give notice that on the 26th September, 1950, I filed an election to administer the following deceased person's estate, in accordance with section 6 of the *Public Trustee Act 1940*:—

MORONEY, JOHN STEPHEN, late of 23 Grosvenor-street, Balaclava, carpenter, died 15th May, 1949, intestate.

C. J. GARDNER,  
Public Trustee.

412 Collins-street, Melbourne, C.1, 27th September, 1950.

## NOTICE.

ADMINISTRATION of the estate of each of the under-mentioned deceased persons has been granted to me, and creditors, next of kin, and all others having claims against the estate of any of the persons so mentioned are required to send particulars of their claims to the Public Trustee, No. 412 Collins-street, Melbourne, on or before the 6th December, 1950, or they will be excluded from the distribution of the estate when the assets are being distributed:—

DIXON, ESTHER JEAN, late of 19 Nicholson-street, Essendon, married woman, died 9th August, 1950, intestate.

\*DODD, HERBERT SENIOR, late of 30 Ballarat-street, Yarraville, gentleman, died 2nd July, 1950.

ELLIS, MARY, late of Wales, United Kingdom, widow, died 27th March, 1919, intestate.

†GLENN, FLORENCE, late of 6 Normanby-street, Middle Brighton, widow, died 3rd July, 1950.

†GRAY, BENJAMIN WALTER, late of 1179 Burke-road, Kew, solicitor, died 14th March, 1949.

JOHNSTON, MARION ELSIE, late of 305 Barkly-street, Elwood, married woman, died 25th May, 1950, intestate.

\*JONES, CLARA MAY, late of 7 Mair-street, Brighton Beach, spinster, died 11th July, 1950.

JONES, RICHARD, late of Wales, United Kingdom, bachelor, died 8th April, 1916, intestate.

KING, ARTHUR CHARLES, late of Lake Goldsmith, via Beaufort, farm labourer, died 30th July, 1950, intestate.

†LANCASTER, MAUDE EUGENIE, late of Lower Hutt, New Zealand, spinster, died 4th March, 1950.

MARCHMENT, ADA ELLEN, late of 28 Argo-street, Prahran, spinster, died between 5th and 6th June, 1950, intestate.

MILES, GLORIA MARGARET, late of St. Leonards-road, Lilydale, widow, died 9th December, 1949, intestate.

MILLARD, CHARLES ARTHUR, late of 24 John-street, Oakleigh, plasterer, died 30th September, 1949, intestate.

†MORCOM, JACK HOWARD, formerly of the Second Australian Imperial Forces, soldier, but late of 28 Tovan-Akas-avenue, Bentleigh, clerk, died 26th June, 1950.

MORONEY, JOHN STEPHEN, late of 23 Grosvenor-street, Balaclava, carpenter, died 15th May, 1949, intestate.

\*MCCRIMMON, WILLIAM HECTOR, late of 18 Day-street, South Yarra, gardener, died 21st January, 1950.

MCLEAN, WILLIAM JOSEPH, also known as William McLean, formerly of 76 Heath-street, Port Melbourne, but late of 27 Market-street, South Melbourne, pensioner, died 20th July, 1947, intestate.

O'DEA, CATHERINE TERESA, late of 25 White-street, East Malvern, married woman, died 16th June, 1950, intestate.

\*QUINLIVAN, ANNIE VICTORIA, formerly of 148 Victoria-street, Footscray, but late of 9 Jean-street, West Essendon, married woman, died 2nd August, 1950.

REILLY, FRANCIS JOSEPH, also known as Francis Reilly, late of 190 Drummond-street, Carlton, labourer, died on or about 17th June, 1950, intestate.

ROBERTS, JOHN, late of Wales, United Kingdom, gentleman, died 30th January, 1942, intestate.

ROBERTS, WILLIAM, late of Wales, United Kingdom, gentleman, died 21st April, 1949, intestate.

\*ROUSE, MARY ANN, formerly of Daisy-street, Chatswood, but late of 18 Mabel-street, Willoughby, both in New South Wales, widow, died 29th December, 1949.

SPOLSKI, JAN, late of Forests Commission Camp, Bullarto, labourer, died 24th June, 1950, intestate.

TAYLOR, HENRY CLIFFORD, also known as Henry Taylor, late of 117 Charles-street, Seddon, retired farm labourer, died 29th November, 1949, intestate.

VITINS, NIKALAJA, late of Benalla, driver, died 29th April, 1950, intestate.

WAKELAN, WALTER JAMES, also known as Walter James Wakelam, late of 104 Wellington-parade, East Melbourne, gentleman, died 29th June, 1950, intestate.

†WALKER, JOHN, formerly of Civic Hotel, Inglewood, but late of Commercial Travellers' Club, Perth, both in Western Australia, traveller and retired business representative, died 26th August, 1949.

†WEBB, WILLIAM ARTHUR, formerly of 185 Stawell-street, Burnley, but late of 29 Auburn-grove, Auburn, retired winch driver, died 12th May, 1949.

WHIGHTMAN, ALICE, late of 26 Westgarth-street, East Malvern, home duties, died 22nd August, 1950, intestate.

\* According to the provisions of the will.

† With the will annexed.

C. J. GARDNER,  
Public Trustee.

Melbourne, 27th September, 1950.



Transport Regulation Act.  
TRANSPORT REGULATION BOARD.  
NOTICES OF PUBLIC HEARINGS.

NOTICE is hereby given that the applications made by the persons named below for licences to operate the commercial passenger vehicles on the route or routes, or in the manner set out opposite their names, will be heard at a time and place to be communicated to the parties:—

*Name of Applicant; Nature of Application.*

BURKE, B., Lees Café, Hume Highway, Seymour; 1 commercial passenger vehicle, with seating capacity for 6 persons, to operate for the carriage only of school children between Northwood and Seymour, in accordance with the terms of a contract entered into with the Education Department.

CALLANDER, H. F., 9 Union-street, Williamstown; 1 commercial passenger vehicle, with seating capacity for 19 persons, to operate as a special service omnibus (charter conditions) within a radius of 50 miles of General Post Office, Melbourne.

CUNNINGHAM, J., K. BROWN, & C. RUTZOW (trading as Mentone Bus Lines), 250 Balcombe-road, Mentone; 1 commercial passenger vehicle, with seating capacity for 21 persons, to operate as follows:—(a) As an additional vehicle, under the same terms and conditions as contained in applicants' existing stage omnibus licences, (b) under charter conditions within a radius of 50 miles of Mentone.

EDNEY, C., Bair-street, Leongatha; 1 commercial passenger vehicle, with seating capacity for 5 persons, to operate as follows:—(a) At separate and distinct fares within a radius of 5 miles of Leongatha, (b) under private hire conditions within a radius of 50 miles of Leongatha (subject to the cancellation of licence No. P.H.77, at present held by the applicant).

FORRESTER, J. A. MCR. (trading as Murray Valley Hire Cars), 13 McCallum-street, Swan Hill; 1 commercial passenger vehicle, with seating capacity for 5 persons, to be purchased, to operate as follows:—(a) At separate and distinct fares within a radius of 5 miles of Swan Hill, (b) under private hire conditions within a radius of 50 miles of Swan Hill. (This replaces application previously gazetted incorrectly in the name of J. A. McRae, trading as Murray Valley Hire Cars, on 13th September, 1950.)

MADSEN, A., Lavers Hill; 1 commercial passenger vehicle, with seating capacity for 18 persons, to operate as follows:—(a) For the carriage only of school children between Johanna River and Lavers Hill, in accordance with the terms of a contract entered into with the Education Department, (b) under charter conditions within a radius of 20 miles of Lavers Hill.

MARK, A. E., 119 Lydiard-street, Ballarat; 1 commercial passenger vehicle, with seating capacity for 5 persons, to operate from Ballarat to country race meetings, in accordance with the fixture published by the Victoria Racing Club.

ORTON, G. S., care of Box 20, Moe; 1 commercial passenger vehicle, with seating capacity for 5 persons, to be purchased, to operate as follows:—(a) At separate and distinct fares within a radius of 5 miles of Moe, (b) under private hire conditions within a radius of 50 miles of Moe.

PYLE, T. J., Tawonga Post Office; application for variation of licence No. A.2818, to include the ability to operate as follows:—

(a) Between the Co-operative Store at Mt. Beauty and the prefabricated area, via Mt. Beauty North—

*Mondays to Saturdays.*

Depart Co-operative Store, Mt. Beauty, 9.45 a.m., 11.30 a.m., 1.45 p.m., 3.30 p.m. Fares: 3d. single, 6d. return.

(b) Between Mt. Beauty and Tawonga—

*Mondays to Saturdays.*

Read Down. Read Up.

Depart—

2.00 p.m., 5.00 p.m. Mt. Beauty. 3.15 p.m., 6.15 p.m.  
2.15 p.m., 5.15 p.m. Tawonga. 3.00 p.m., 6.00 p.m.  
Fares: 1s. single, 2s. return.

(c) Between Bogong and Mt. Beauty—

*Tuesdays, Thursdays, and Saturdays only.*

Depart 8 a.m. Bogong.  
Depart 4 p.m. Mt. Beauty.

Fare: Bogong—Mt. Beauty—single, 2s.

ROBINSON, J., Yallourn North; 2 commercial passenger vehicles, each with seating capacity for 7 persons, to operate for the carriage of passengers, passengers' luggage, and parcels between Yallourn North and Melbourne, via Prince's Highway East, as follows:—

*Monday to Sunday inclusive.*

One vehicle.

Read Down.

Depart 7.30 a.m. Yallourn North  
Depart 7.40 a.m. Western Camp  
Depart 7.50 a.m. Yallourn Post Office  
Arrive 10.30 a.m. Melbourne

Read Up.

Arrive 9.30 p.m.  
Depart 9.20 p.m.  
Depart 9.10 p.m.  
Depart 6.30 p.m.

One vehicle.

Read Down.

Depart 7.30 a.m. Melbourne  
Depart 10.10 a.m. Yallourn Post Office  
Depart 10.20 a.m. Western Camp  
Arrive 10.30 a.m. Yallourn North

Read Up.

Arrive 9.30 p.m.  
Depart 6.50 p.m.  
Depart 6.40 p.m.  
Depart 6.30 p.m.

TRAHAIR, J. H. (executors of estate of the late), Prince-street, Myrtleford; 1 commercial passenger vehicle, with seating capacity for 5 persons, to operate for the carriage of passengers, mails, and parcels between Myrtleford and Rosewhite, via Barwidgee and Havilah, as follows:—

Read Down.

Tues. & Thurs.	Sat.	10.00 a.m. Myrtleford	10.40 a.m. Brown's resid.	10.55 a.m. Havilah	11.25 a.m. Rosewhite
Depart 4.00 p.m.	Depart 4.40 p.m.	Depart 4.45 p.m.	Arrive 6.25 p.m.	Arrive 6.40 p.m.	Arrive 6.10 p.m.

Read Up.

Tues. & Thurs.	Sat.	6.40 p.m.	6.10 p.m.	6.30 p.m.
Arrive 6.40 p.m.	Arrive 6.10 p.m.	Depart 5.30 p.m.	Depart 5.30 p.m.	Depart 5.30 p.m.

Fares: Myrtleford—Brown's—2s. single, 4s. return.

Myrtleford—Havilah—4s. single, 8s. return.

Myrtleford—Rosewhite—5s. single, 10s. return.

TRAHAIR, T. C., Prince-street, Myrtleford; application for variation of licence No. A.1930, to include the ability to carry passengers, mails, and parcels between Myrtleford and Dondangadale as follows:—

Read Down.

Tues. & Thurs.	Sat.	11.15 a.m. Myrtleford	12.45 p.m. Dondangadale
Depart 3.30 p.m.	Arrive 5.00 p.m.	Arrive 6.30 p.m.	Depart 5.05 p.m.

Read Up.

Tues. & Thurs.	Sat.	6.30 p.m.	2.00 p.m.	5.05 p.m.	12.50 p.m.
Arrive 6.30 p.m.	Depart 5.05 p.m.	Depart 5.05 p.m.	Depart 5.05 p.m.	Depart 5.05 p.m.	Depart 5.05 p.m.

Fares: Myrtleford—Pauls Corner—2s. single, 3s. 6d. return.

Myrtleford—Buffalo River South—3s. single, 6s. return.

Myrtleford—Fletchers Bridge—4s. 6d. single, 8s. return.

Myrtleford—Dondangadale—6s. single, 11s. return.

APPLICATIONS for licences to operate commercial passenger vehicles, with seating capacity for five persons, for the carriage of passengers otherwise than at separate and distinct fares for each passenger throughout Victoria:—

COLE, D. C., 45 Geelong-road, Barwon Heads.

FRANETOVICH, H., 54 Pascoe Vale-road, Moonee Ponds.

LACK, B. J., 10 Shasta-avenue, Middle Brighton.

NOTICE is hereby given that the applications made by the persons named below for renewal of licences to operate the commercial goods vehicles on the route or routes, or in the manner set out opposite their names, will be heard at a time and place to be communicated to the parties concerned:—

*Name and Address; Present Franchise; Licence No.; Date of Expiry.*

*Noojee Area.*

HUON CARTAGE COMPANY, corner of Connell-road and Edward-street, Oakleigh; (1) logs from any forest landing in the Upper Yarra forestry district—(a) to the railway station at Noojee, and to any mill or dump which is located within a radius of 20 miles of such landing or of the railway station at Noojee, (b) to any mill situated—(i) on or within 5 miles of the Prince's Highway East between Warragul and Berwick, (ii) south of the River Yarra within a radius of 25 miles but not within 8 miles of the G.P.O., Melbourne, (2) logs from such other area or to such other destinations as may be authorized, in writing, by the Board from time to time; T.T.D.1249; 14th November, 1950.

WILKINSON, R. H., PTY. LTD., 386 Spencer-street, Melbourne, C.1; (1) logs from any forest landing in the Upper Yarra forestry district—(a) to the railway station at Noojee, and to any mill or dump which is located within a radius of 20 miles of such landing or of the railway station at Noojee, (b) to any mill situated—(i) on or within 5 miles of the Prince's Highway East between Warragul and Berwick, (ii) south of the River Yarra within a radius of 25 miles but not within 8 miles of the G.P.O., Melbourne, (2) logs from such other area or to such other destinations as may be authorized, in writing, by the Board from time to time; T.T.D.1250; 14th November, 1950.

JOHNSTON, A. A., Noojee; sawn timber from W. Porta's sawmill at Tanjil Bren to the Noojee Railway Station or to any timber merchant or builder, if delivered *en route* to such railway station, or to a timber yard or building site located within a radius of 20 miles of such railway station; T.T.D.1240; 18th October, 1950.

FLEMING, J. R., Noojee; sawn timber from Singleton's mill at Vesper to the Noojee Railway Station or to any timber merchant or builder, if delivered *en route* to such railway station, or to a timber yard or building site located within a radius of 20 miles from such railway station; T.T.D.1241; 18th October, 1950.

#### Healesville Area.

CAMBARVILLE SAWMILLING CO., Cambarville, via Marysville; (1) logs from any forest landing in the Niagaroon and Upper Yarra forestry districts and the North Big River area—(a) to the railway station at Healesville, and to any mill or dump which is located within a radius of 20 miles of such landing or of the railway station at Healesville, (b) to any mill situated south of the River Yarra within a radius of 25 miles but not within 8 miles of the G.P.O., Melbourne, (2) logs from such other area or to such other destinations as may be authorized, in writing, by the Board from time to time, (3) sawn timber from own mill at Cambarville—(a) to the railway station at Healesville, (b) to any customer, if delivered within a radius of 20 miles of Healesville Railway Station, (c) to any merchant or builder, if delivered to a timber yard or direct on to a building site which is located south of the River Yarra within a radius of 25 miles but not within a radius of 8 miles of the G.P.O., Melbourne; T.T.D.1215; 18th December, 1950.

SUTTON, J. F., Healesville; (1) logs from any forest landing in the Niagaroon and Upper Yarra forestry district and the North Big River area—(a) to the railway station at Healesville, and to any mill or dump which is located within a radius of 20 miles of such landing or of the railway station at Healesville, (b) to any mill situated south of the River Yarra within a radius of 25 miles but not within 8 miles of the G.P.O., Melbourne, (2) logs from such other area or to such other destinations as may be authorized, in writing, by the Board from time to time, (3) sawn timber from G. Hubbard's mill at Yarra Glen—(a) to the railway station at Healesville, (b) to any customer, if delivered within a radius of 20 miles of Healesville Railway Station, (c) to any merchant or builder, if delivered to a timber yard or direct on to a building site which is located south of the River Yarra within a radius of 25 miles but not within 8 miles of the G.P.O., Melbourne; T.T.D.1261; 18th December, 1950.

#### Western Area.

BROWN, M. J. & L. R., St. Aidans-drive, Ballarat; logs from any forest landing within a radius of 60 miles from the Post Office at Stawell to Stawell Timber Industries Pty. Ltd., at Stawell; T.T.D.1259; 5th December, 1950.

HAMILL, S. J., Barramunga; (a) logs from any forest landing in the Barramunga area to holder's own mill at Barramunga, (b) palings and sawn timber from own mill at Barramunga to consignees at Colac, Camperdown, and Lismore, (c) palings and sawn timber from own mill at Barramunga to housing sites only within a radius of 10 miles of the chief post office at Geelong; T.T.D.1255; 5th December, 1950.

HYATT, S. G., Raglan-road, Beaufort; sawn timber from Mt. Cole Sawmilling Co. at Beaufort to consignees at Ararat, Stawell, Ballarat, Streatham, Colac, Derinallum, and Lismore; T.T.D.1238; 18th October, 1950.

PEARSE, F., Forrest; sawn timber from mills in the Otway area direct to Geelong building sites, in house lots only; T.T.D.1228; 18th October, 1950.

#### Central Area.

GREENOUGH, R., & J. FINN, Morrissions-road, Pakenham Upper; firewood, posts, and logs, being the property of the applicants, between own property situate at Morrissions-road, Pakenham Upper, and the City of Melbourne; T.T.D.1253; 14th November, 1950.

HUME & ISER PTY. LTD., 35-47 Charleston-street, Bendigo; sawn timber from Kyneton and within a radius of 60 miles from Bendigo, including Herrod and Maher's of Korweinguboorra, Friths of Bullarto, O'Hehir's of Trentham, Dwyers of Spargo Creek, Dwyers mill at Sailors Falls, and Evans Bros. mill at Echuca to own yards at Bendigo; T.T.D.1252; 14th November, 1950.

TURNER, E. B., 122 High-street, Kyneton; logs from any forest landing in the Metcalfe area direct to Evans Taylor Pty. Ltd. timber yards at Brighton and Boyd's timber yards at Preston; T.T.D.1245; 18th October, 1950.

#### North-East Area.

ANDREA, W. H., S.E.C. Sawmill, Tawonga; sawn timber from the State Electricity Commission at Tawonga to Mates timber yards at Albury, via Dederang, Kiewa, and Wodonga; T.T.D.1244; 18th October, 1950.

DUNSTAN, A., & SONS, 1-7 Tallangatta-road, Wodonga; (a) logs from any forest landing in the Glen Wills area to holder's mill at Eskdale to timber yards at Wodonga and Albury, (b) sawn timber from holder's mill at Eskdale to timber yards at Wodonga and Albury; T.T.D.1254; 5th December, 1950.

DUNSTAN, A., & SONS, 1-7 Tallangatta-road, Wodonga (two vehicles); (a) logs from the Forests Commission lease at Mt. Wills to A. Dunstan's sawmills at Eskdale, (b) sawn timber from A. Dunstan's sawmills at Eskdale to A. Dunstan's timber yards at Wodonga, and to the railway stations at Wodonga and Albury; T.T.D.1243, T.T.D.1242; 18th October, 1950.

#### Gippsland.

MILNER, HARRY, 15 Leila-road, Ormond (three vehicles); overlengh poles from any forest landing in the East Gippsland area, east of Berwick, to S.E.C. projects east of Berwick, as directed by an officer of the State Electricity Commission; T.T.D.1257, T.T.D.1258, T.T.D.1256; 5th December, 1950.

NOTICE is hereby given that the applications made by the persons named below for licences to operate the commercial goods vehicles on the route or routes, or in the manner set out opposite their names, will be heard at a time and place to be communicated to the parties concerned:—

#### Name and Address; Nature of Application.

ADAMS, H. P., 30 Park-crescent, Fairfield; 2 commercial goods vehicles (65 and 70 cwt.) for the carriage of (a) general goods within a radius of 25 miles from Melbourne, (b) sand from pits in the Frankston, Lyndhurst South, Somerville, and Cardinia areas to Melbourne.

BEER, F. F., 39 Annesley-street, Echuca; 1 commercial goods vehicle (84 cwt.) for the carriage of (a) general goods within a radius of 20 miles from Echuca, (b) road-making plant and materials within a radius of 50 miles from Echuca.

BENNIE, P. K. and B. J. (trading as Gippsland Tile Works), 94 Stawell-street, Sale; 2 commercial goods vehicles (100 cwt.) for the carriage of cement tiles in the course of trade as "cement tile manufacturers" within a radius of 70 miles from Sale and to Orbost. (These are applications for licences previously held by A. E. Rodda, the former owner of Gippsland Tile Works.)

BLACK, J. W. and D. W., 45 Edward-street, Elsternwick, S.4.; 1 commercial goods vehicle (112 cwt.) for the carriage of road-making plant and materials throughout the State of Victoria.

BLAKE, H. R., 2a High-street, Northcote; 1 commercial goods vehicle (60 cwt.) for the carriage of portable welding plant, tools of trade, and spare parts incidental to the repair of boilers and sawmilling machinery throughout the State of Victoria.

CARLILE BROS., Strickland-road, Bendigo; 1 commercial goods vehicle (100 cwt.) for the carriage of (a) wet sheep skins from Melbourne, Shepparton, and Ballarat to applicant's premises at Bendigo for treatment and packing, (b) export sheep skins in bales from Bendigo to wharves in Melbourne.

COATES, C., 32 Pender-street, Thornbury; 1 commercial goods vehicle (80 cwt.) for the carriage of marine stores in the course of business as "dealer" throughout the State of Victoria.

COKER-GODSON, B., 71 Nepean Highway, Seaford; 1 commercial goods vehicle (83 cwt.) for the carriage of building materials in the course of business as "building contractor" within a radius of 50 miles from Seaford.

EASTERN GIPPSLAND CONSTRUCTION CO. PTY. LTD., Dalmahoy-street, Bairnsdale; 1 commercial goods vehicle (100 cwt.) for the carriage of—(a) own goods in the course of business as "building contractors" within a radius of 20 miles from Bairnsdale, (b) building materials (i) from Bairnsdale to construction sites at Orbost, Maffra, and Sale, (ii) from Maffra to construction sites at Sale, (c) timber in connexion with own contracts from Bairnsdale to Omeo.

GEORGE, R. F., 32 College-street, Elsternwick; 1 commercial goods vehicle (30 cwt.) to operate as a display van and for the sale and delivery of drapery goods to householders in the course of business as "hawker" throughout the State of Victoria.

KELLAND, W. E., PTY. LTD., 107 Firebrace-street, Horsham; 1 commercial goods vehicle (12 cwt.) for the carriage of tires and tubes in the course of business as "tire retreaders" from and to Horsham to and from places within the Western District of Victoria.

OSBORNE, N. J., Marine-drive, Dromana; 1 commercial goods vehicle (97 cwt.) for the carriage of (a) general goods within a radius of 20 miles from Dromana, (b) road-making plant and materials within a radius of 50 miles from Dromana.

RAYMOND STORES PTY. LTD., 152 Raymond-street, Sale; 1 commercial goods vehicle (14 cwt.) for the carriage of (a) own goods in the course of business as "timber and hardware merchants" within a radius of 50 miles from Sale, (b) to operate in the course of trade as "funeral directors" throughout the State of Victoria.

REID, G. H., and SONS, 348 Sydney-road, Coburg; 1 commercial goods vehicle (100 cwt.) for the carriage of (a) general goods within a radius of 25 miles from Melbourne, (b) road-making plant and materials within a radius of 50 miles from Melbourne.

ROSS, G. L., 24 Burns-street, Maryborough; 4 commercial goods vehicles (94 to 190 cwt.) for the carriage of buildings, sheds, and equipment used in connexion with the removal of same in the course of business as "house remover" throughout the State of Victoria.

SHARP, J., Warragul; 1 commercial goods vehicle (237 cwt.) for the carriage of logs from any forest landing in the Upper Yarra Forestry District—(a) to the railway station at Noojee and to any mill or dump which is located within a radius of 20 miles of such landing, or of the railway station at Noojee, (b) to any mill situated (i) on or within 5 miles of the Prince's Highway East between Warragul and Berwick, (ii) south of the River Yarra within a radius of 25 miles but not within 8 miles of the G.P.O., Melbourne.

SLEIGHT, G. I., 38 William-street, Balaclava; 1 commercial goods vehicle (10 cwt.) for the carriage of drapery in the course of business as "hawker" throughout the State of Victoria.

TREW, W. G., Cowes, Phillip Island; 1 commercial goods vehicle (100 cwt.) for the carriage of—(a) general goods within a radius of 20 miles from Cowes, (b) road-making plant and materials within a radius of 50 miles from Cowes.

WEIRE, G. D., Stawell-street, Romsey; 3 commercial goods vehicles to operate as hereunder:—

A. Two vehicles (172 and 70 cwt.) for the carriage of general goods from and to Lancefield to and from Melbourne and towns *en route*.

B. One vehicle (60 cwt.) for the carriage of—(a) general goods within a radius of 20 miles from Romsey, (b) live stock and petroleum products between Romsey and Melbourne.

WRIGHT, L. G., Church-street, Stanhope; 1 commercial goods vehicle (100 cwt.) for the carriage of—(a) general goods within a radius of 20 miles from Stanhope, (b) road-making plant and materials within a radius of 50 miles from Stanhope.

Notice of any objection should be forwarded to reach the Secretary of the Board not later than Wednesday, 18th October, 1950.

E. V. FIELD,  
Secretary.

Exhibition Buildings, Rathdown-street, Carlton, N.3, 3rd October, 1950.

#### NOTICE TO MARINERS.

[No. 9 of 1950.]

TEMPORARY.

#### AUSTRALIA.—VICTORIA.

PORTLAND PIERS APPROACH.—DRILLING TOWER ESTABLISHED.

*Position.*—Flashing red light. New Pier Head. Lat. 38 deg. 21 min. S. Long. 141 deg. 37 min. E.

*Details.*—A movable steel-framed structure carrying drilling equipment is located within a circle of  $\frac{1}{2}$  mile radius with the above light as centre. Height above water varies from 25 to 35 feet, and at night a low-powered white light is exhibited, but this light being unattended cannot be implicitly relied upon.

*Caution.*—Mariners are warned to give this structure as wide a berth as possible, and to slow down to half speed when within  $\frac{1}{2}$  mile of structure.

*Chart Temporarily Affected.*—1062.

D. S. STEVENSON,  
Port Officer.

Ports and Harbors Branch,  
Department of Public Works,  
Melbourne, C.2, 29th September, 1950.

#### Apprenticeship Acts.

#### APPRENTICESHIP COMMISSION OF VICTORIA.

At the Executive Council Chamber, Melbourne, the thirteenth day of September, 1950.

#### PRESENT:

His Excellency the Governor of Victoria.	
Mr. Dodgshun	Mr. Lind
Mr. Inchbold	Mr. Brose
Mr. Fulton	Mr. Harvey.

#### AMENDMENT OF BUTCHERING AND/OR SMALL GOODS MAKING TRADES REGULATIONS (No. 1).

IN pursuance of the powers conferred by the Apprenticeship Acts and the Acts Interpretation Acts, His Excellency the Governor of the State of Victoria, by and with the advice of the Executive Council thereof, doth hereby rescind the Regulations mentioned in the First Schedule hereto, and doth hereby make the following Regulations, that is to say:—

#### Short Title.

1. These Regulations may be cited as the "Butchering Trades Apprenticeship Regulations."

2. The rescission of any Regulations by these Regulations shall not affect any right accrued or accruing to any person or the liability of any person under such rescinded Regulations where such right accrued or such liability was incurred prior to the coming into operation of these Regulations.

#### Interpretation.

3. In these Regulations—

"Acts" means the Apprenticeship Acts.

"Commission" means the Apprenticeship Commission of Victoria.

"Prescribed" means prescribed by an appropriate industrial authority or agreement, or by these Regulations, as the case may require.

"Probationer" means an applicant for apprenticeship employed on probation.

#### Application of Regulations.

4. These Regulations shall apply only with respect to the following apprenticeship trades, viz.:—

Butchering,  
Small Goods Making,  
Butchering and Small Goods Making,

so far as they are carried on within the metropolitan district.

#### Applicants for Apprenticeship to Apply for Certificate.

5. Applications by persons desiring to become apprentices in the said trades shall be in the form contained in the Third Schedule to General Regulations (No. 1) made under the Acts.

#### Applicants may be Examined—Exemptions.

6. Applicants for apprenticeship in the said trades may be required to submit themselves for examination at the time and place determined by the Commission to prove that they possess the preparatory educational qualifications required for entry into apprenticeship in such trades. Provided that any such applicant shall be exempted from such examination—

(a) If he possesses any one of the following educational qualifications, or, in the opinion of the Commission, the equivalent thereof:—

(i) The Intermediate Technical or Junior Technical Certificate of the Education Department of Victoria, the School Intermediate Certificate or equivalent qualifications approved by the Commission.

(ii) The satisfactory completion, as certified by the school authority and approved by the Commission, of a three years' course of study in a Junior Technical School, or equivalent qualifications approved by the Commission.

(iii) The satisfactory completion of the Eighth Grade course of study of the Elementary Schools of the Education Department of Victoria, or its equivalent, as certified by the school authority and approved by the Commission.

(b) If he satisfies the Commission, in accordance with sub-section (2) of section 18 of the Acts, that he has not had sufficient opportunity to obtain the preparatory educational qualifications prescribed for entry into the said trades.

*Minimum Age for Entry into Apprenticeship.*

7. The minimum age at which persons shall enter the said trades as apprentices or probationers shall be fifteen years, provided that for the period of one year from the 17th day of July, 1950, the minimum age at which persons shall enter the said trades as apprentices or probationers shall be fourteen and a half years.

*Term of Apprenticeship.*

8. The term of apprenticeship in the said trades shall be as follows:—

- (a) In the case of persons entering the said trades under the age of seventeen years, a term of five years.
- (b) In the case of persons entering the said trades at or above the age of seventeen years, a term of four years.

*Form of Indentures of Apprenticeship.—General Form.*

9. The standard form of indentures of apprenticeship in each of the said trades, and the terms, covenants, and conditions thereof, shall be in the form contained in the Second Schedule to General Regulations (No. 2) made under the Acts with the following additions thereto:—

*Additional Covenants, &c., to General Form of Indentures of Apprenticeship.***EMPLOYER'S COVENANTS.**

At the end of paragraph (c) (i) the following proviso shall be added:—

Provided that where he is temporarily unable to provide such work as will keep the apprentice fully employed during any ordinary working week or month, he may, with the approval of the Commission, employ the apprentice for such less time in any such week or month as may, on the application of the employer, be determined by the Commission, at wages proportionate to those which he is required, under the provisions of this paragraph, to pay to the apprentice when employed during the whole of any ordinary working week or month.

After paragraph (c) (ii) the following shall be added:—

- (c) (iii) Make no deduction from the wages of the apprentice in respect of any time lost by reason of compulsory attendance at classes for instruction in subjects of the apprenticeship course.
- (c) (iv) In the event of the employer being unable owing to lack of orders, or through financial difficulties, to find employment and training for the apprentice, or to arrange for the transfer of the apprentice to another employer, as provided for under the Acts, the Commission may, on application made in that behalf by the employer, and after satisfying itself that the circumstances justify such action, arrange for the suspension of the indentures for such period as it determines, or for the cancellation of the indentures.

After paragraph (e) the following shall be added:—

- (f) Not hold the apprentice responsible for any damage or injury done to materials, machinery, tools, or plant, other than wilful damage, or damage due to carelessness.
- (g) Provide the apprentice with all tools necessary for carrying out his work, excepting knives, steels, belt, and pouch.

*Apprentice and Parent or Guardian's Covenants.*

After paragraph (b) the following shall be added:—

- (c) At all times while in the employment of the employer, conduct himself in a courteous, obedient, and proper manner.

**MUTUAL AGREEMENTS.**

At the end of paragraph (3) the following provisos shall be added:—

Provided further—

- (i) that where the apprentice is required under the provisions of the proviso to paragraph (c) (i) hereof to work for less time than full time in any ordinary working week or month, or
  - (ii) that where the indentures of any apprentice are suspended for any period by the Commission—
- the total period of time not served by the apprentice by reason of either of the above-mentioned provisions shall,

at the option of the apprentice, be included in the term of his apprenticeship, or be added to the term of his apprenticeship. In the event of such period being added to the term of his apprenticeship the apprentice shall be paid for such period at the wages rates prescribed in respect to the last year of his apprenticeship.

After paragraph 9 the following shall be added:—

10. That the apprentice shall be paid the same allowances as are from time to time prescribed to be paid by the employer to journeymen in the same trade for meal money, fares, travelling time, country work, and other matters, or, where such allowances are proportionate to the minimum rates of wages prescribed to be paid to journeymen, the apprentice shall be paid only such proportion thereof as the prescribed minimum rates of wages of the apprentice bear to the prescribed minimum rates of wages of such journeymen.

11. That the apprentice will replace any of the tools supplied for his use as hereinbefore provided, if lost or broken through his own carelessness.

*Rates of Pay of Apprentices.*

10. The minimum rates of pay to be paid to apprentices as wages in each year of their apprenticeship course shall be as follows:—

- (a) With respect to the term of apprenticeship of five years—
  - 1st year—at the rate of 46s. 0d. per week.
  - 2nd year—at the rate of 61s. 0d. per week.
  - 3rd year—at the rate of 90s. 6d. per week.
  - 4th year—at the rate of 116s. 0d. per week.
  - 5th year—at the rate of 151s. 6d. per week.
- (b) With respect to the term of apprenticeship of four years—
  - 1st year—at the rate of 53s. 6d. per week.
  - 2nd year—at the rate of 76s. 0d. per week.
  - 3rd year—at the rate of 116s. 0d. per week.
  - 4th year—at the rate of 151s. 6d. per week.

*Rates for Overtime Worked.*

11. When an apprentice works under conditions for which, or at any time when, a journeyman employed at the aforesaid trades would be entitled to overtime or special rates for doing work under the same conditions, or at the same time, then such apprentice shall be paid by the employer for any such work at a rate or rates of wages which shall bear the same proportion to the prescribed minimum rate of wages of such apprentice as the wages of such journeyman for such work would bear to the prescribed minimum rate of wages of such journeyman.

*Standard of Proficiency.*

12. Should the apprentice in any year pass in the subjects prescribed for that year of his apprenticeship course and attain a standard as certified by the Commission of not less than an average of 75 per cent. of the possible marks allotted at the annual examinations approved by the Commission to the subjects of Trade Theory and Practice prescribed for that year of such course, he shall be deemed to have attained the standard of proficiency for such year.

*Increased Rates of Pay for Proficiency.*

13. When an apprentice attains in any year the standard of proficiency prescribed for that year of his apprenticeship course he shall for the next succeeding year of his apprenticeship course be paid the sum of 2s. per week in addition to the prescribed weekly wage.

*Proportion of Apprentices to Journeymen.*

14. The number of apprentices or probationers who may be employed in any shop, or shop and factory combined, by any employer at any time in the said trades shall not exceed the proportion of one apprentice or probationer to every three journeymen, or fraction of three journeymen, employed by such employer in such trades. For the purposes of this Regulation an employer working at the trades shall be deemed to be a journeyman and the number of journeymen employed at any time shall be deemed to be the average per working day of the number of journeymen employed in the said trades by such employer during the period of six months immediately preceding such time.

*Apprenticeship Course.—Classes for Instruction.*

15. The classes for instruction in the subjects of the apprenticeship course for the said trades shall be as set out in the Second Schedule hereto, but any apprentice or

probationer who has the necessary qualifications may, subject to the approval of the Commission, be permitted to enter the classes prescribed for any year of the said course.

*Standard of Education to be Attained by an Apprentice.*

16. The standard of education to be attained by an apprentice—

- (i) in the subjects of the first and second years of his apprenticeship course in order that he may qualify to proceed to the classes for instruction prescribed for the next succeeding year; and
- (ii) in the subjects of the third year of the apprenticeship course in order that he may qualify in respect to education for the "final certificate" of the Commission—

shall be not less than 50 per cent. of the possible marks allotted at the annual examinations approved by the Commission in each of the subjects prescribed for such year of the said course or such average percentage of marks in all of the said subjects deemed by the Commission to be equivalent thereto.

*Trade Experience Required of an Apprentice.*

17. The trade experience to be obtained by an apprentice in his apprenticeship course shall include gradual and complete instruction to the satisfaction of the Commission in the following processes (as the case may be):—

- (a) *Butchering.*—All phases of butchering and all things incidental thereto, including the correct methods of use of all tools and machines commonly used in connexion with the trade and also including: breaking up beef, mutton, lamb, pork, and veal; boning (as required in shop); method of hanging and treatment; cutting of orders and salesmanship; use of chilling room and arranging of meat therein; making pork and beef sausages; making of pickle; pumping meat; curing and rolling of spice beef; making of dripping; care and attention of shop; collecting and delivery of orders.
- (b) *Small Goods Making.*—All phases of small goods making and all things incidental thereto, including the correct methods of use of all tools and machines commonly used in connexion with the trade and also including: boning and slicing; curing and preparation of meat for chopping; cutting and seasoning; filling out; linking and tying; cooking; smoking; pressing.
- (c) *Butchering and Small Goods Making.*—All phases of butchering and small goods making and all things incidental thereto, as prescribed above—

and the employer shall, by the best means in his power, teach and instruct, or cause to be taught and instructed, the apprentice in the said processes.

*Payment of School Fees.*

18. (a) The school fees of apprentices and probationers for attendance at the prescribed classes for instruction shall be paid by such apprentices or probationers, but on the receipt by the employer of a report from the Commission that any such apprentice or probationer has secured during the period covered by the report a record of not less than 80 per cent. of the possible attendances at the prescribed day and evening classes respectively, the employer shall refund to the apprentice or probationer the school fees paid by him for such period of instruction. Provided, however, that if such report states that the apprentice or probationer has, in the opinion of the Commission, failed to be diligent or has behaved in an indecorous manner while in attendance at the prescribed classes for instruction during such periods, the employer shall not be required to make the refund as aforesaid.

(b) In cases where the apprentice or probationer is prevented from attendance at the said classes through illness or accident, such occasions shall not be included as possible attendances in determining the aforesaid percentage; provided that the employer may require the apprentice or probationer to produce a medical certificate as proof of such illness or accident, and in that case if the apprentice or probationer fails to produce such certificate, such occasions shall be included as possible attendances in determining the aforesaid percentage.

FIRST SCHEDULE.

Butchering and/or Small Goods Making Trades Regulations (No. 1) made by the Governor in Council on the 20th day of February, 1940, and published in the *Victoria Government Gazette* on the 21st day of February, 1940 (as amended from time to time).

SECOND SCHEDULE.

Classes for Instruction in the subjects of the Apprenticeship courses for the trades of Butchering and/or Small Goods Making.

	<i>Hours per week.</i>
<i>First Year—</i>	
Trade Theory and Practice .. Grade I. ..	} 4
English, Trade Mathematics, and Salesmanship .. .. Grade I. ..	
<i>Second Year—</i>	
Trade Theory and Practice .. Grade II. ..	} 4
English, Trade Mathematics, and Salesmanship .. .. Grade II. ..	
<i>Third Year—</i>	
Trade Theory and Practice .. Grade III. ..	} 4
English, Trade Mathematics, and Salesmanship .. .. Grade III. ..	

The detailed syllabus of the above-mentioned subjects shall be as determined by the Commission from time to time.

And the Honorable Trevor Harvey, His Majesty's Minister of Labour for the State of Victoria, shall give the necessary directions herein accordingly.

A. MAHLSTEDT,  
Clerk or the Executive Council.

Published in lieu of the Order appearing in the *Government Gazette* of the 13th September, 1950.

DEPARTMENT OF CROWN LANDS AND SURVEY.

At the Executive Council Chamber, Melbourne, the twenty-sixth day of September, 1950.

PRESENT:

- |  |              |
|--|--------------|
| His Excellency the Governor of Victoria. |              |
| Mr. Dodgshun                             | Mr. Lind     |
| Mr. Brose                                | Mr. Mitchell |
| Mr. Swinburne                            | Mr. Harvey.  |

PORTION EXCISED FROM ROAD.

HIS Excellency the Governor of the State of Victoria, by and with the advice of the Executive Council thereof, in pursuance of the provisions of section 3 of the *Land (Residence Areas) Act 1939* (No. 4697) and with the approval of the Council of the City of Bendigo, doth hereby order that the portion of the road in the City of Bendigo, Parish of Sandhurst, as is defined by description and shown by hachure on plan hereunder, be excised:—

City of Bendigo, Parish of Sandhurst, County of Bendigo, being the portion of Victoria-street indicated by hachure on plan hereunder.—(S.372(3)) (W.59540).

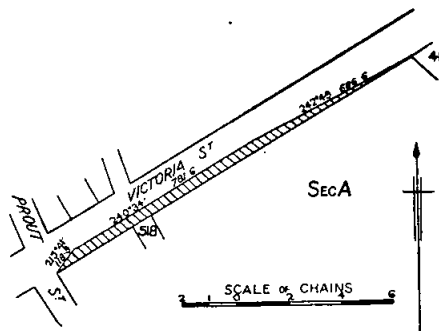

And the Honorable Albert Eli Lind, His Majesty's Commissioner of Crown Lands and Survey for the State of Victoria, shall give the necessary directions herein accordingly.

A. MAHLSTEDT,  
Clerk of the Executive Council.

DEPARTMENT OF CROWN LANDS AND SURVEY.

At the Executive Council Chamber, Melbourne, the twenty-sixth day of September, 1950.

PRESENT:

His Excellency the Governor of Victoria.	
Mr. Dodgshun	Mr. Lind
Mr. Brose	Mr. Mitchell
Mr. Swinburne	Mr. Harvey.

UNUSED AND UNMADE ROADS CLOSED.

HIS Excellency the Governor of the State of Victoria, by and with the advice of the Executive Council thereof, doth hereby direct that, in pursuance of the provisions of section 304 of the *Land Act 1928* (No. 3709), the unused and unmade roads referred to hereunder be closed, viz.:

Township of Elaine and Parish of Borhoneyghurk, County of Grant, being the roads indicated by hachure on plan hereunder.—(E.103(2) (B.406(3) (J.27363).

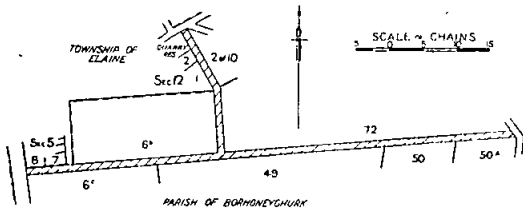

At Redcliffs, Parish of Mildura, County of Karkaroo, being the road indicated by hachure on plan hereunder.—(R.87(8) (K.5315).

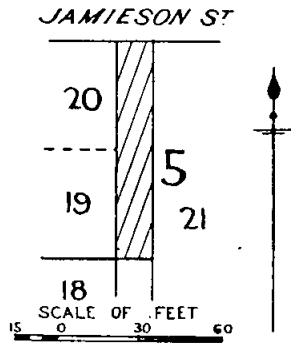

Parish of Nangana, County of Evelyn, being the roads indicated by hachure on plan hereunder.—(N.145(4) (F1) (Misc. 2395).

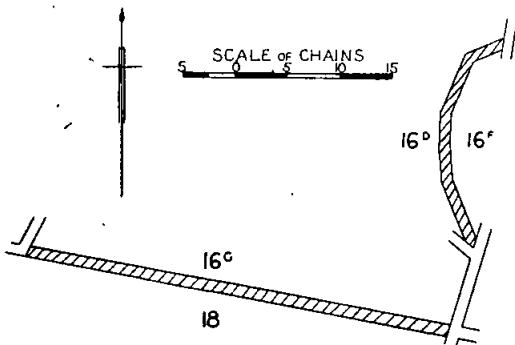

And the Honorable Albert Eli Lind, His Majesty's Commissioner of Crown Lands and Survey for the State of Victoria, shall give the necessary directions herein accordingly.

A. MAHLSTEDT,  
Clerk of the Executive Council.

DEPARTMENT OF CROWN LANDS AND SURVEY.

At the Executive Council Chamber, Melbourne, the twenty-sixth day of September, 1950.

PRESENT:

His Excellency the Governor of Victoria.	
Mr. Dodgshun	Mr. Lind
Mr. Brose	Mr. Mitchell
Mr. Swinburne	Mr. Harvey.

ROAD IN THE TOWN AND PARISH OF ARARAT.—  
REDUCED IN WIDTH.

HIS Excellency the Governor of the State of Victoria, by and with the advice of the Executive Council thereof, in accordance with the provisions of and in exercise of the powers conferred by the *Local Government Act 1946*, doth, by this Order, confirm the scheme for the reduction in width of the road in the Town and Parish of Ararat, in the County of Ripon, in the State of Victoria, as set out in an agreement deposited in the office of Lands and Survey, Melbourne, the said scheme being under the seal of the corporation of the Mayor, Councillors, and Ratepayers of the Town of Ararat of the first part, the seal of the Board of Land and Works of the second part, and under the hands and seals of the persons whose signatures are subscribed to the said scheme and who are called the parties of the third part.—(C.92134.)

And the Honorable Albert Eli Lind, His Majesty's Commissioner of Crown Lands and Survey for the State of Victoria, shall give the necessary directions herein accordingly.

A. MAHLSTEDT,  
Clerk of the Executive Council.

DEPARTMENT OF CROWN LANDS AND SURVEY.

At the Executive Council Chamber, Melbourne, the twenty-sixth day of September, 1950.

PRESENT:

His Excellency the Governor of Victoria.	
Mr. Dodgshun	Mr. Lind
Mr. Brose	Mr. Mitchell
Mr. Swinburne	Mr. Harvey.

LAND PERMANENTLY RESERVED.

HIS Excellency the Governor of the State of Victoria, by and with the advice of the Executive Council thereof, doth hereby, in pursuance of the provisions of the *Land Act 1928*, permanently reserve and except from occupation for mining purposes under any miner's right, the land hereinafter referred to, viz.:

SPERM WHALE HEAD.—Parish of Boole Poole, at Sperm Whale Head, as a site for a National Park, 441 acres 1 rood 10 perches of land comprised within the boundaries as defined by technical description and hachure on plan published in the *Government Gazette* of 30th August, 1950.—(Rs.3633.)

And the Honorable Albert Eli Lind, His Majesty's Commissioner of Crown Lands and Survey for the State of Victoria, shall give the necessary directions herein accordingly.

A. MAHLSTEDT,  
Clerk of the Executive Council.

## DEPARTMENT OF CROWN LANDS AND SURVEY.

## KING RIVER IMPROVEMENT TRUST.

At the Executive Council Chamber, Melbourne, the  
twenty-sixth day of September, 1950.

At the Executive Council Chamber, Melbourne, the  
twenty-sixth day of September, 1950.

## PRESENT:

His Excellency the Governor of Victoria.  
Mr. Dodgshun                      |                      Mr. Lind  
Mr. Brose                              |                      Mr. Mitchell  
Mr. Swinburne                        |                      Mr. Harvey.

## PRESENT:

His Excellency the Governor of Victoria.  
Mr. Dodgshun                      |                      Mr. Lind  
Mr. Brose                              |                      Mr. Mitchell  
Mr. Swinburne                        |                      Mr. Harvey.

## LOAN OF £2,000.

REVOCATION OF TEMPORARY RESERVATIONS OF  
LANDS BY ORDERS IN COUNCIL.

HIS Excellency the Governor of the State of Victoria, by and with the advice of the Executive Council thereof, doth hereby, in pursuance of the provisions of the *Land Act 1928*, revoke the temporary reservations of the lands by Orders in Council hereinafter referred to, viz.:—

WARRACKNABEAL.—Order in Council of 19th October, 1948, of 8 acres 1 rood 20 perches of land in the Town of Warracknabeal as a site for Educational purposes.—(Rs.3568.)

YALLOOK.—Order in Council of 17th August, 1874, of 5 acres of land in the Parish of Yallook as a site for State School purposes.—(Rs.5893.)

And the Honorable Albert Eli Lind, His Majesty's Commissioner of Crown Lands and Survey for the State of Victoria, shall give the necessary directions herein accordingly.

A. MAHLSTEDT,  
Clerk of the Executive Council.

UNDER the powers conferred by the Water Acts and all other powers enabling him in that behalf, His Excellency the Governor of the State of Victoria, by and with the advice of the Executive Council of the said State, doth hereby grant a loan of Two thousand pounds (£2,000) to the King River Improvement Trust for payment of preliminary expenses in connexion with the constitution of the Trust and the preparation of plans, specifications, and estimates of river improvement works on the King River within the King River Improvement District, as set forth in the detailed statement bearing the date of 20th September, 1950, and verified under the seal of the State Rivers and Water Supply Commission.

The loan hereby granted shall be subject to the provisions of the Water Acts.

And the Honorable Richard Keats Brose, His Majesty's Minister of Water Supply for the State of Victoria, shall give the necessary directions herein accordingly.

A. MAHLSTEDT,  
Clerk of the Executive Council.

## MILK AND DAIRY SUPERVISION ACT 1943 (No. 4997).

At the Executive Council Chamber, Melbourne, the  
twenty-sixth day of September, 1950.

## PRESENT.

His Excellency the Governor of Victoria.  
Mr. Dodgshun                      |                      Mr. Lind  
Mr. Brose                              |                      Mr. Mitchell  
Mr. Swinburne                        |                      Mr. Harvey.

## METROPOLITAN MILK SUPPLY REGULATIONS AMENDED.

IN pursuance of the powers conferred by Part I. of the *Milk and Dairy Supervision Act 1943*, His Excellency the Governor of the State of Victoria, by and with the advice of the Executive Council thereof, doth hereby amend the Metropolitan Milk Supply Regulations made on the 6th November, 1944, as follows (that is to say):—

After Regulation 27 the following Regulation shall be added:—

"28. The owner of a milk depot may receive milk from a factory the owner of which does not hold a milk depot permit, provided that such milk is used only for manufacture, and that subsequent to the receipt of such milk on any day, no milk is forwarded from the milk depot to the metropolis on the same day, and provided further that all equipment used for receiving and handling such milk is efficiently cleansed and sterilized before being again used for milk intended for the metropolis."

And the Honorable George Colin Moss, His Majesty's Minister of Agriculture for the State of Victoria, shall give the necessary directions herein accordingly.

A. MAHLSTEDT,  
Clerk of the Executive Council.

## COUNTRY ROADS BOARD.

At the Executive Council Chamber, Melbourne, the twenty-sixth day of September, 1950.

PRESENT:

His Excellency the Governor of Victoria.	
Mr. Dodgshun	Mr. Lind
Mr. Brose	Mr. Mitchell
Mr. Swinburne	Mr. Harvey.

## ORDER APPROVING OF A NEW STATE HIGHWAY IN THE SHIRE OF TULLAROOP.

WHEREAS the Country Roads Board constituted under the *Country Roads Act 1928* (No. 3662) has represented to His Excellency the Governor in Council that it appears to it desirable that the new Pyrenees Highway in the Shire of Tullaroop should be made by the said Board: And whereas the said Board in accordance with the requirements of section 19 of the said cited Act has caused to be prepared a map plan and estimate showing the points between which and on and through what land the said new highway is proposed to be made and the cost of acquiring the land and constructing the said new highway: And whereas on an inspection of the said map and plan and a consideration of the said estimate His Excellency the Governor in Council is satisfied that there are funds legally available for acquiring the land and constructing the said new highway: Now therefore be it known by this present Order that His Excellency the Governor of the State of Victoria with the advice of the Executive Council thereof doth hereby approve of the said highway being made, that is to say:—

All that piece of land in the Parish of Carisbrook, the boundaries of which are as follow:—Commencing at the south-eastern angle of Crown portion 31 of the said parish; thence by lines bearing respectively 291 deg. 55 min. 500 links, 100 deg. 57½ min. 981.8 links, and 270 deg. 0 min. 500 links to the point of commencement—which said piece of land is particularly delineated and shown coloured red on survey plan numbered 5248, lodged in the office of the Country Roads Board.

And the Honorable Percy Thomas Byrnes, His Majesty's Commissioner of Public Works for the State of Victoria, shall give the necessary directions herein accordingly.

A. MAHLSTEDT,  
Clerk of the Executive Council.

## COUNTRY ROADS BOARD.

At the Executive Council Chamber, Melbourne, the twenty-sixth day of September, 1950.

PRESENT:

His Excellency the Governor of Victoria.	
Mr. Dodgshun	Mr. Lind
Mr. Brose	Mr. Mitchell
Mr. Swinburne	Mr. Harvey.

## ORDER APPROVING OF A NEW MAIN ROAD IN THE SHIRE OF BENALLA.

WHEREAS the Country Roads Board constituted under the *Country Roads Act 1928* (No. 3662) has represented to His Excellency the Governor in Council that it appears to it desirable that the new Dookie-Devenish road in the Shire of Benalla should be made by the said Board: And whereas the said Board in accordance with the requirements of section 19 of the said cited Act has caused to be prepared a map plan and estimate showing the points between which and on and through what land the said new road is proposed to be made and the cost of acquiring the land and constructing the said new road: And whereas on an inspection of the said map and plan and a consideration of the said estimate His Excellency the Governor in Council is satisfied that there are funds legally available for acquiring the land and constructing the said new road: Now therefore be it known by this present Order that His Excellency the Governor of the State of Victoria with the advice of the Executive Council thereof doth hereby approve of the said road being made, that is to say:—

All that piece of land in the Parish of Devenish, the boundaries of which are as follow:—Commencing at a point on the western boundary of allotment 36B of the said parish distant 360 deg. 0 min. 89 links and 326 deg. 19 min. 111.1 links from the south-western angle of the said allotment; thence by lines bearing respectively 326 deg. 19 min. 249.9 links, 360 deg. 0 min. 115 links, 90 deg.

0 min. 33.5 links, and 161 deg. 59 min. 339.6 links to the point of commencement—which said piece of land is particularly delineated and shown coloured red on survey plan numbered 5241, lodged in the office of the Country Roads Board.

And the Honorable Percy Thomas Byrnes, His Majesty's Commissioner of Public Works for the State of Victoria, shall give the necessary directions herein accordingly.

A. MAHLSTEDT,  
Clerk of the Executive Council.

## COUNTRY ROADS BOARD.

At the Executive Council Chamber, Melbourne, the twenty-sixth day of September, 1950.

PRESENT:

His Excellency the Governor of Victoria.	
Mr. Dodgshun	Mr. Lind
Mr. Brose	Mr. Mitchell
Mr. Swinburne	Mr. Harvey.

## DECLARATION OF THE NEW CALDER HIGHWAY IN THE SHIRE OF METCALFE.

WHEREAS by sections 21 and 74 of the *Country Roads Act 1928* (No. 3662) it is amongst other things enacted that when the Country Roads Board under the provisions of the *Country Roads Act* has taken the land necessary for constructing a road or deviation it shall as soon as it thinks such road or deviation is fit to be used as a public highway by Resolution declare the road or deviation to be a State highway or part thereof and that upon publication in the *Government Gazette* of the Order of the Governor in Council confirming such Resolution such road or deviation shall thereupon be a State highway or part thereof within the meaning of the said Act: And whereas the said Board has by Resolution declared the road on the land described in the Schedule to such Resolution to be part of a State highway: Now therefore His Excellency the Governor of the State of Victoria by and with the advice of the Executive Council thereof doth hereby confirm the said Resolution.

*Resolution for Declaration of a New State Highway under the Country Roads Act.*

Whereas the land the site of the road the course of which is below set out was taken by the Board under the provisions of the *Country Roads Act* for the purpose of constructing such new road which new road has now been laid out and formed on the same: And whereas the said Board (being the Country Roads Board incorporated under the said Act) thinks that the road aforesaid is fit to be used as a public highway such Board at a meeting now holden acting under the authority conferred upon it by sections 21 and 74 of the *Country Roads Act 1928* doth hereby declare the said new road the course of which is described in the Schedule hereto with the commencing and terminating points thereof respectively specified to be part of a State highway within the meaning and for the purposes of the *Country Roads Act*.

## SCHEDULE.

*Shire of Metcalfe.*

3. *Calder Highway*.—All that piece of land in the Township of Taradale, Parish of Elphinstone, the boundaries of which are as follow:—Commencing at a point on the north-eastern boundary of allotment 14, section 9, of the said township, distant 327 deg. 13 min. 302.3 links from the south-eastern angle of that allotment; thence by lines bearing respectively 304 deg. 5 min. 662.8 links, 106 deg. 37 min. 400 links, and 147 deg. 13 min. 305.8 links to the point of commencement—which said piece of land is particularly delineated and shown coloured red on survey plan numbered 3312, lodged in the office of the Country Roads Board.

The common seal of the Country Roads Board was hereto affixed at Melbourne, this eighteenth day of September, One thousand nine hundred and fifty, in the presence of—

(SEAL)	D. V. DARWIN, Chairman.
	F. M. CORRIGAN, Member.
	W. H. NEVILLE, Secretary.

And the Honorable Percy Thomas Byrnes, His Majesty's Commissioner of Public Works for the State of Victoria, shall give the necessary directions herein accordingly.

A. MAHLSTEDT,  
Clerk of the Executive Council.



EXPLOSIVES ACT 1928.

At the Executive Council Chamber, Melbourne, the twenty-sixth day of September, 1950.

PRESENT:  
His Excellency the Governor of Victoria.  
Mr. Dodgshun                      Mr. Lind  
Mr. Brose                              Mr. Mitchell  
Mr. Swinburne                      Mr. Harvey.

CLASSIFICATION OF EXPLOSIVES.

HIS Excellency the Governor of the State of Victoria, by and with the advice of the Executive Council thereof, and in pursuance of the provisions of section 53 of the *Explosives Act 1928*, doth, by this Order, classify the under-mentioned explosives as follows:—

CLASS 2.—NITRATE MIXTURE.  
Nobel Delay Composition R.998.

CLASS 6.—AMMUNITION.  
Division 2.  
Prima Cord.

Division 3.  
Gasless Delay Detonators.

And the Honorable Keith Dodgshun, His Majesty's Chief Secretary for the State of Victoria, shall give the necessary directions herein accordingly.

A. MAHLSTEDT,  
Clerk of the Executive Council.

MOTOR OMNIBUS ACT 1928 (No. 3742).

At the Executive Council Chamber, Melbourne, the third day of October, 1950.

PRESENT:  
His Excellency the Governor of Victoria.  
Mr. Lind                              Mr. Byrnes  
Mr. Moss                              Mr. Brose.  
Mr. Harvey

AMENDMENT OF PRESCRIPTION OF METROPOLITAN MOTOR OMNIBUS ROUTE No. 102A (NORTH BRIGHTON—MOORABBIN).

HIS Excellency the Governor of the State of Victoria, by and with the advice of the Executive Council thereof, and in pursuance of the powers conferred by the *Motor Omnibus Act 1928* (No. 3742), doth by this Order amend, as set out hereunder, the prescription of a certain route, i.e., Route No. 102A (North Brighton—Moorabbin), within the metropolitan area along which motor omnibuses for which "regular service" licences are granted may ply for hire, viz.:—

Under the heading "Description of route, including commencing and terminal points," delete "by right-hand turns at corner of Asling and Bay streets," and in place thereof insert "in Asling-street, almost immediately north of Bay-street."

*Licensing Authority.*—Pursuant to the provisions of section 15 (1) (c) of the said Act (No. 3742), the Governor in Council by this Order confers upon the Licensing Authority full power and authority for the carrying into effect by the said Licensing Authority of the foregoing provisions of this Order.

And the Honorable Percy Thomas Byrnes, His Majesty's Commissioner of Public Works for the State of Victoria, shall give the necessary directions herein accordingly.

A. MAHLSTEDT,  
Clerk of the Executive Council.

APPROACHING LAND SALES.

SALES of Crown lands, in fee-simple, will be held at the under-mentioned places and dates, viz.:—

	No. of Gazette.
Bendigo.—Thursday, 5th October, 1950	728
Castlemaine.—Wednesday, 11th October, 1950	773
Daylesford.—Wednesday, 11th October, 1950	773
Murrayville.—Tuesday, 10th October, 1950	728

PROPOSED REVOCATIONS OF TEMPORARY RESERVATIONS OF LANDS BY ORDERS IN COUNCIL.

IN pursuance of the provisions of the *Land Act 1928*, notice is hereby given that it is the intention of the Governor in Council to revoke the temporary reservations of lands by the Orders in Council hereunder referred to, viz.:—

The following Notices were published 1° on the 13th September, 1950, pursuant to Orders of the 5th September, 1950.

**BERRIWILLOCK.**—The temporary reservation, by Order in Council of the 20th December, 1937, of 2 acres of land in the Parish of Berriwillock as a site for a State School, is about to be revoked.—(B.748(9) (Rs.4762).

**BANGERANG.**—The temporary reservation as a site for Conservation of Water, and the withholding from sale, leasing, and licensing, by Order in Council of the 22nd December, 1882, of 199 acres 3 roods 37 perches of land in the Parish of Bangerang, being allotment 33, revoked as to part by various Orders, is about to be revoked so far only as the portion containing 3 acres 0 roods 8 perches, indicated by hachure on plan hereunder, is concerned.—(B.658(4) (Rs.1891).

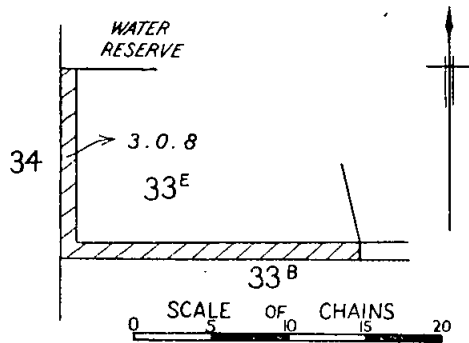

**BARAMBOGIE.**—The temporary reservation, by Orders in Council of the 27th February, 1865, and the 1st November, 1886 (see *Government Gazettes* of the 7th March, 1865, and the 5th November, 1886, pages 572 and 3119 respectively), of 3,788 acres of land in the Parish of Barambogie as a site for Water Supply purposes, revoked as to part by various Orders, is about to be revoked so far only as the portion containing 12 acres 1 rood, more or less, indicated by hachure on plan hereunder, is concerned.—(B.79(2) (Rs.6486).

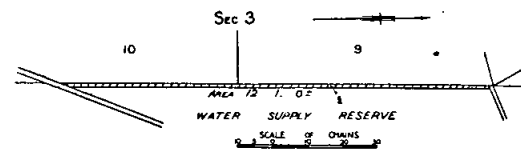

A. E. LIND,  
Commissioner of Crown Lands and Survey.

**RETIREMENT AND APPOINTMENT OF MANAGERS OF COMMONS.**

IT is hereby notified for the information of all persons entitled to depasture stock on commons that successors to the individual managers thereof, who will retire on the 31st December, 1950, should be elected before the close of the year by the persons interested, at public meetings duly convened for the purpose, by the president of the shire. The names, in full, of the gentlemen who may be elected for either one (1), two (2), or three (3) years, should be forwarded to the Department of Land and Survey.

A. E. LIND,  
Commissioner of Crown Lands and Survey.  
Department of Lands and Survey,  
Melbourne, C.2, 12th September, 1950.

**PROPOSED REVOCATION OF TEMPORARY RESERVATION OF LAND BY ORDER IN COUNCIL.**

IN pursuance of the provisions of the *Land Act 1928*, notice is hereby given that it is the intention of the Governor in Council to revoke the temporary reservation of land by Order in Council hereunder referred to, viz.:—  
*The following Notice was published 1° on the 20th September, 1950, pursuant to Order of the 13th September, 1950.*

**NILLUMBIK.**—The temporary reservation, by Order in Council of the 24th June, 1931, of 4 acres 20 perches of land in the Parish of Nillumbik as a site for Public purposes, is about to be revoked so far only as the portion containing 1 acre, more or less, indicated by hachure on plan hereunder is concerned.—(N.69<sup>(o)</sup>) (Rs.4050).

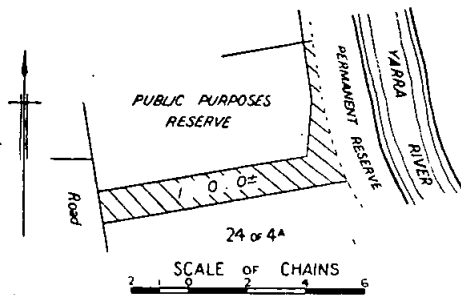

A. E. LIND,  
Commissioner of Crown Lands and Survey.

**PROPOSED REVOCATIONS OF TEMPORARY RESERVATIONS OF LANDS BY ORDERS IN COUNCIL.**

IN pursuance of the provisions of the *Land Act 1928*, notice is hereby given that it is the intention of the Governor in Council to revoke the temporary reservations of lands by the Orders in Council hereunder referred to, viz.:—

*The following Notices were published 1° on the 27th September, 1950, pursuant to Orders of the 19th September, 1950.*

**BELLAURA.**—The temporary reservation, by Order in Council of the 8th January, 1877 (see *Government Gazette* of the 12th January, 1877, page 46), of 5 acres of land in the Parish of Bellaura, being part of allotment 48B, as a site for Public purposes (State School), is about to be revoked.—(B.572<sup>(2)</sup>) (Z.22294).

**MERBEIN.**—The temporary reservation, by Order in Council of the 19th July, 1932, of 211 acres of land in the Parish of Merbein, as a site for the Supply of Gravel, is

about to be revoked so far only as the portion containing 135 acres 2 roods 31 perches, indicated by hachure on plan hereunder, is concerned.—(M.572<sup>(s)</sup>) (Rs.4227).

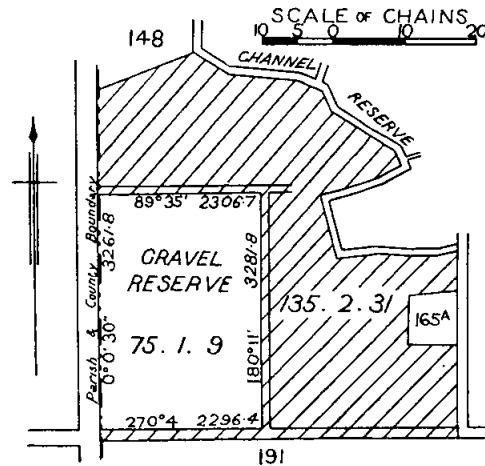

**LEONGATHA.**—The temporary reservation, by Order in Council of the 21st August, 1917, of 1 acre 1 rood 30 perches of land in the Township of Leongatha, as a site for a Public Garden, is about to be revoked so far only as the portion containing 3 roods 20 perches, indicated by hachure on plan hereunder, is concerned.—(L.167<sup>(o)</sup>) (Rs.1678).

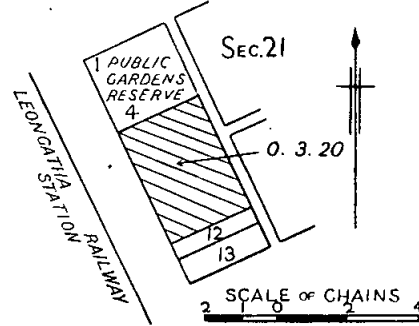

A. E. LIND,  
Commissioner of Crown Lands and Survey.

**PROPOSED REVOCATIONS OF TEMPORARY RESERVATIONS OF LANDS BY ORDERS IN COUNCIL.**

IN pursuance of the provisions of the *Land Act 1928*, notice is hereby given that it is the intention of the Governor in Council to revoke the temporary reservations of lands by the Orders in Council hereunder referred to, viz.:—

*The following Notices were published 1° on the 4th October, 1950, pursuant to Orders of the 26th September, 1950.*

**SALE.**—The temporary reservation, by Order in Council of the 8th April, 1941, of 1 acre 1 rood 21 perches of land in the Town of Sale, as a site for use by the Council of the Town of Sale for a Storage Depot, is about to be revoked.—(S.239<sup>(2)</sup>) (Rs.5177).

**STAWELL.**—The temporary reservation, by Order in Council of the 29th December, 1869 (see *Government Gazette* of the 7th January, 1870, page 13) of 10 acres of land in the Parish of Stawell at the Reefs, as a site for Powder-magazine purposes, is about to be revoked.—(S.329<sup>(10)</sup>) (C.92343).

**TIEGA.**—The temporary reservation, by Orders in Council of the 21st July, 1911, and the 14th September, 1920, of 5 acres 3 roods 4 9/10 perches of land in the Parish of Tiega, as a site for a State School, is about to be revoked.—(T.222<sup>(4)</sup>) (Rs.1994).

LILYDALE.—The temporary reservation, by Order in Council of the 3rd May, 1949, of 2 acres 20 perches of land in the Town of Lilydale, as a site for a Municipal Depot, is about to be revoked so far only as the portion containing 3 perches, more or less, indicated by hachure on plan hereunder is concerned.—(L.66(2) (Rs.4885).

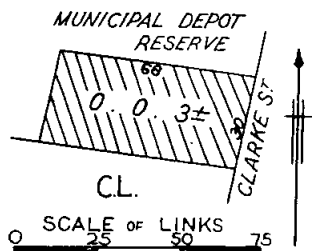

A. E. LIND,  
Commissioner of Crown Lands and Survey.

*Soldier Settlement Act 1946.*

REVOCATION OF ORDER DECLARING FARMING LAND SUITABLE FOR SOLDIER SETTLEMENT.

I, ALBERT ELI LIND, His Majesty's Commissioner of Crown Lands and Survey, do hereby declare that the Notice, made under the provisions of section 88 (1) of the Act, and published in the *Government Gazette* of the 13th September, 1950, whereby the land described in the Schedule hereto was declared to be land suitable for soldier settlement, shall no longer remain in force with respect to that land.

SCHEDULE.

All those pieces of land comprising 2,314 acres more or less, and being allotments 3, 4, 6, 7, 8, and 9, section 1, Parish of Byambynee; allotments 1 and 2 and part of allotments 3 and 14, section 18; allotments 6, 7, 8, and 9, section 19; allotment 7, section 20 and parts of section A, Parish of Braxholme—the whole being in the County of Normanby.

Signed at Melbourne this 2nd day of October, 1950.

A. E. LIND,  
Commissioner of Crown Lands and Survey.

LAND AVAILABLE UNDER THE SOLDIER SETTLEMENT ACT.

NOTIFICATION is hereby given in accordance with section 16 of the *Soldier Settlement Act 1946*, that the under-mentioned lots are available or are about to become available for settlement.

Any discharged soldier who has applied to the Commission on or before the 4th October, 1950, for classification in the required class or classes of primary production for which the lots are made available and whose application has been accepted but not necessarily finalized, or any discharged soldier who has been classified as suitable in such class or classes of primary production may apply on the prescribed form for settlement on any lot or lots, indicating where he applies in respect of more than one lot his order of preference therefor.

The prescribed application forms, plans and further particulars may be obtained from the Enquiry Branch, Soldier Settlement Commission, State Public Offices, Melbourne. The closing date for the receipt of completed applications for settlement on these holdings is the 30th October, 1950, such applications to be in the hands of the Secretary, Soldier Settlement Commission, on or before that date.

E. SINGLETON,  
Secretary.

Soldier Settlement Commission,  
Melbourne, C.2, 29th September, 1950.

SCHEDULE OF ALLOTMENTS.

SUBDIVISION OF "TRENTWOOD" ESTATE.

PARISH OF DEDERANG, COUNTY OF BOGONG.

*Suitable for Dairying and Mixed Farming.*

Lot number on Plan of Subdivision.	Approximate Area in Acres. (Subject to Survey).
1	246
2	286
3	262

TENDERS.

TENDERS will be received at this office until **TEN A.M.** on the days and for the purposes under mentioned.

Particulars may be learnt at this Office and also at places shown in parenthesis.

W.O. means Inspector of Works Office; P.S.—Police Station; T.S.—Technical School; H.E.S.—Higher Elementary School; S.S.—State School; H.S.—High School; P.D.—Preliminary deposit; F.D.—Final deposit.

The Board of Land and Works will not necessarily accept the lowest or any tender.

10th October, 1950.

Arcadia.—Supply and installation of a kerosene hot-water service, residence, S.S. No. 1880. (W.O., Benalla.) P.D., £2. F.D., 2 per cent.

Bairnsdale.—Supply and installation of kerosene hot-water service, residence, Assistant Divisional Engineer, Country Roads Board. (W.O., Bairnsdale.) P.D., £2. F.D., 2 per cent.

Baulkamaugh North.—Purchase and removal of school building, out-offices, tanks, &c., S.S. No. 2336. (W.O., Shepparton, Bendigo; P.S., Nathalia, Tatura.) Deposit, £2.

Beaconsfield Upper.—Erection of teacher's residence, including out-buildings, paths, and fencing, S.S. No. 2560. (W.O., Korumburra; S.S., Beaconsfield Upper.) P.D., £15. F.D., 2 per cent.

Boisdale.—Supply and installation of heating and hot-water equipment, Administration Block, Consolidated School. P.D., £5. F.D., 2 per cent.

Bruthen.—Supply and installation of a kerosene hot-water service, teacher's residence, S.S. No. 1141. (W.O., Bairnsdale.) P.D., £3. F.D., 2 per cent.

Camperdown.—Erection of brick offices, State Rivers and Water Supply Commission. (W.O., Camperdown; P.S., Colac.) P.D., £25. F.D., 2 per cent.

Cann River.—Supply and installation of hot-water service, residence, S.S. No. 3920. (W.O., Bairnsdale.) P.D., £2. F.D., 2 per cent.

Colac West.—Erection of fire-escape staircase, S.S. No. 4064. (W.O., Camperdown, Geelong; S.S., Colac West.) Deposit, £4.

Flora Hill (Bendigo).—Heating and ventilation equipment, S.S. No. 4667. (W.O., Bendigo.) P.D., £15. F.D., 2 per cent.

Geelong.—Additions, alterations, and renovations, "Lunan House," Teachers' Training College. (W.O., Geelong.) P.D., £25. F.D., 2 per cent.

Harston.—Provision of new out-offices and installation of septic-tank system, S.S. No. 1458. (W.O., Shepparton; P.S., Tatura; S.S., Harston.) P.D., £5. F.D., 2 per cent.

Hedley.—Erection of teacher's residence, S.S. No. 2773. (W.O., Korumburra; P.S., Yarram; S.S., Hedley.) P.D., £15. F.D., 2 per cent.

Locksley.—Repairs and painting, school and residence, S.S. No. 2648. (W.O., Shepparton; S.S., Locksley.) P.D., £10. F.D., 2 per cent.

Macarthur.—Alteration to school building, S.S. No. 1561. (W.O., Warrnambool, Hamilton; S.S., Macarthur.) P.D., £5. F.D., 2 per cent.

Melbourne.—Supply and installation of electric passenger lift, new Chemistry School, Technical College. P.D., £20. F.D., 2 per cent.

Melbourne.—Renovation of offices occupied by Stamp Controller, Titles Office, Queen-street. P.D., £5. F.D., 2 per cent.

Merino.—Alterations and additions, Consolidated School. (W.O., Hamilton, Warrnambool.) P.D., £20. F.D., 2 per cent.

Mont Park.—Lagging and renewal of piping on ironing machine, Mental Hospital. P.D., £2. F.D., 2 per cent.

Murrumbena.—Renovations, P.S. P.D., £5. F.D., 2 per cent.

Oakleigh.—Supply and installation of saw-dust extraction equipment, T.S. P.D., £10. F.D., 2 per cent.

Rosedale.—Supply and installation of an electric bath-heater residence, P.S. (W.O., Traralgon; P.S., Rosedale.) Deposit, £2.

Rupanyup.—Renovations, Police Station. (W.O., Horsham; P.S., Minyip, Murtoa, Rupanyup.) P.D., £5. F.D., 2 per cent.

Rutherglen.—Erection of mess hut for farm hands, Research Station. (W.O., Wangaratta; P.S., Wodonga; Research Station, Rutherglen.) P.D., £10. F.D., 2 per cent.

Seymour.—Supply and installation of hot-water service, residence, H.S. (W.O., Alexandra.)

Stawell.—Additions and remodelling, H.S. (W.O., Ararat, Ballarat, Horsham; H.S., Stawell.) P.D., £50. F.D., 2 per cent.

Traralgon.—Supply and installation of electric hot-water service, residence of Inspector of Works, Public Works Department. (W.O., Traralgon.) P.D., £2. F.D., 2 per cent.

Trentham.—Provision of new shelter shed with storage accommodation for firewood, tools, &c., S.S. No. 1588. (W.O., Kyneton; S.S., Trentham.) Deposit, £10.

Warracknabeal.—Supply and installation of mechanical services, District Hospital. (W.O., Ballarat, Bendigo, Warracknabeal.) P.D., £50. F.D., 2 per cent.

Williamstown.—Supply of one (1) only wireless broadcast receiver, together with two (2) only 7-in. loud speakers, Dredge *Matthew Flinders*, Ann-street.

Yarragon.—Supply and installation of a kerosene hot-water service, teacher's residence, S.S. No. 2178. (W.O., Traralgon.) P.D., £3. F.D., 2 per cent.

#### 17th October, 1950.

Ararat.—Extension to female teachers' room, H.S. (W.O., Ararat; P.S., Stawell; H.S., Ararat.) Deposit, £4.

Birregurra.—Installation of septic tank system and alterations to out-offices, S.S. No. 723. (W.O., Geelong; S.S., Birregurra.) P.D., £5. F.D., 2 per cent.

Echuca.—Replacement of flooring in classrooms, &c., H.S. (W.O., Shepparton; H.S., Echuca.) P.D., £5. F.D., 2 per cent.

Geelong.—Supply, delivery, and installation of heating piping and oil-fired boiler, Gordon Institute of Technology. (W.O., Geelong.) P.D., £15. F.D., 2 per cent.

Hartwell.—Internal and external painting and repairs, S.S. No. 4055. P.D., £15. F.D., 2 per cent.

Healesville.—Provision of septic tank and new water service, re-erection of girls' out-offices and wood shed, S.S. No. 849. (W.O., Alexandra; S.S., Healesville.) P.D., £15. F.D., 2 per cent.

Heidelberg West.—Supply and installation of central heating, Primary School, S.S. No. 4267. P.D., £10. F.D., 2 per cent.

Horsham.—Erection of new timber residence, Country Roads Board, Baillie-street. (W.O., Ararat; Assistant District Architect's Office, Horsham; P.S., Stawell.) P.D., £20. F.D., 2 per cent.

Lake Boga.—Erection of new boundary fencing, P.S. (W.O., Swan Hill; P.S., Lake Boga.) Deposit, £3.

Melbourne.—External repairs and painting and renewal of fencing, State Relief Committee, 145 King-street. P.D., £10. F.D., 2 per cent.

Melbourne.—Electrical installation in additional first floor, Physics School, University. P.D., £15. F.D., 2 per cent.

Moe.—Erection of an "A" type office with attached out-office, P.S. (W.O., Traralgon; P.S., Moe.) P.D., £10. F.D., 2 per cent.

Mont Park.—Supply and installation of kitchen fans, Gresswell Sanatorium. P.D., £3. F.D., 2 per cent.

Pakenham.—Supply and installation of heating and hot-water equipment, Cookery, Administration and Boiler House, Consolidated School. P.D., £15. F.D., 2 per cent.

Preston.—Supply and delivery of workshop equipment, T.S. P.D., £15. F.D., 2 per cent.

South Yarra.—External painting to Great Telescope House, Weights and Measures Office, Observatory Grounds, Domain. P.D., £5. F.D., 2 per cent.

Stanley.—Erection of standard E.4.L. type residence, S.S. No. 550. (W.O., Wangaratta; P.S., Myrtleford; S.S., Stanley.) P.D., £15. F.D., 2 per cent.

Thornton.—Erection of teacher's residence, S.S. No. 1371. (W.O., Alexandra; S.S., Thornton.) P.D., £15. F.D., 2 per cent.

Windsor.—Erection of station and residence, P.S. P.D., £20. F.D., 2 per cent.

Yallourn.—Additional staff room accommodation, H.E.S. (W.O., Bairnsdale; P.S., Sale, Warragul; H.E.S., Yallourn.) P.D., £10. F.D., 2 per cent.

#### 24th October, 1950.

Doncaster East.—Repairs and painting, school and residence, S.S. No. 2096. (S.S., Doncaster East.) P.D., £10. F.D., 2 per cent.

Dooen.—Erection of E.4 type residence, S.S. No. 1782. (W.O., Horsham; P.S., Murtoa; S.S., Dooen.) P.D., £15. F.D., 2 per cent.

Heathcote.—Repairs, renovations, and painting, Court House. (W.O., Bendigo; P.S., Heathcote.) P.D., £10. F.D., 2 per cent.

Hoddle's Creek.—Erection of teacher's residence, S.S. No. 2541. (W.O., Alexandra; P.S., Lilydale; S.S., Hoddle's Creek.) P.D., £15. F.D., 2 per cent.

Jancourt East.—Erection of new E.4 type residence, S.S. No. 3783. (W.O., Camperdown; P.S., Cobden; S.S., Jancourt East.) P.D., £15. F.D., 2 per cent.

Kilmore.—Repairs and painting, Court House. (W.O., Bendigo, Kyneton; P.S., Kilmore.) Deposit, £4.

King Valley.—Erection of teacher's residence, S.S. No. 2894. (W.O., Benalla; S.S., King Valley.) P.D., £15. F.D., 2 per cent.

Lockington.—Electrical installation, Senior Wing, Consolidated School. (W.O., Bendigo; P.S., Echuca, Lockington.) P.D., £10. F.D., 2 per cent.

Melbourne.—Supply and installation of electric passenger lift, new Court Chambers, Law Courts, William-street. P.D., £20. F.D., 2 per cent.

Sale.—Supply and installation of a gas hot-water service, teacher's residence, T.S. (W.O., Bairnsdale.) P.D., £3. F.D., 2 per cent.

Sea Lake.—Repairs and painting, Court House. (W.O., Swan Hill; P.S., Sea Lake.) P.D., £5. F.D., 2 per cent.

Shepparton Park.—Painting and repairs, S.S. No. 3264. (W.O., Shepparton.) P.D., £4. F.D., 2 per cent.

Timor.—Remodelling residence removed from Archdale, S.S. No. 1207. (W.O., Maryborough; P.S., Dunolly, St. Arnaud.) P.D., £10. F.D., 2 per cent.

Warburton.—Erection of residence, S.S. No. 1485. (W.O., Alexandra; S.S., Warburton.) P.D., £10. F.D., 2 per cent.

Williamstown North.—External renovations and painting, S.S. No. 1409. P.D., £15. F.D., 2 per cent.

#### 31st October, 1950.

Mitta Mitta.—Supply and installation of a fuel hot-water service, teacher's residence, S.S. No. 887. (W.O., Wangaratta.) P.D., £3. F.D., 2 per cent.

Tenders to be addressed to the Honorable the Commissioner of Public Works, and envelope containing tender marked "Tender for  
due

P. T. BYRNES,  
Commissioner of Public Works.

Melbourne, 3rd October, 1950.

## PUBLIC SERVICE NOTICES.

## PUBLIC SERVICE (PUBLIC SERVICE BOARD) REGULATION 36A.—RECLASSIFICATIONS.

THE Public Service Board has raised the classification of the under-mentioned offices as shown, and the Permanent Heads of the Departments have recommended the officers named for appointment.

Office and Present Classification.	Revised Classification.	Duties.	Qualifications.	Officer Recommended for Appointment.		
				Name.	Classification.	Date of Classification.

## ADMINISTRATIVE DIVISION.

## DEPARTMENT OF PREMIER.

*Audit Office.*

Office and Present Classification.	Revised Classification.	Duties.	Qualifications.	Name.	Classification.	Date of Classification.
Auditor, Grade I., Class "B" (three offices)	Senior Auditor, Class "B1" (three offices)	To act as Assistant Auditor of Railways Accounts, and to conduct audits and investigations as directed by the Auditor-General	To be a qualified Accountant; to have a thorough knowledge of the Audit Act and the regulations thereunder, the Railways Act, and of the Treasury and Railways systems of accounts	Kehoe, J. D. . .	Auditor, Grade I., Class "B"	6.9.48
		To audit the accounts of the Lands Department and of the Soldier Settlement Commission, and to conduct other audits and investigations, as directed by the Auditor-General	To be a qualified Accountant; to have a thorough knowledge of the Audit Act and the regulations thereunder, the Land Act, Soldier Settlement Acts, and of the system of accounts in the offices of the Lands Department	Gartner, J. F.	Auditor, Grade I., Class "B"	6.9.48
		To audit the accounts of the Melbourne and Metropolitan Board of Works, and to conduct other audits and investigations, as directed by the Auditor-General	To be a qualified Accountant; to have a thorough knowledge of the Audit Act and the regulations thereunder, the Melbourne and Metropolitan Board of Works Act, and of the system of accounts in operation at the offices of the Board	Simkin, L. G.	Auditor, Grade I., Class "B"	6.9.48

## DEPARTMENT OF EDUCATION.

*Reconstruction Training Branch.*

Office and Present Classification.	Revised Classification.	Duties.	Qualifications.	Name.	Classification.	Date of Classification.
Clerk, Class "C2"	Class "B"	Under the direction of the Regional Director (Industrial Training Division), to supervise the administration of the Commonwealth Reconstruction Training Branch of the Education Department; to act as certifying officer in relation to Commonwealth and State expenditure	Ability to control a large staff; a sound knowledge of accounting procedure and of the Public Accounts regulations; good organizing ability, and a knowledge of the conditions of the Commonwealth States Agreement, so far as it relates to the training of ex-Service personnel	Gardiner, C. A. T.	Clerk, Class "C2"	9.1.50

*Accounts Branch.*

Office and Present Classification.	Revised Classification.	Duties.	Qualifications.	Name.	Classification.	Date of Classification.
Clerk, Class "C2"	Class "B"	Under the direction of the Accountant, to supervise the staff engaged in the preparation of the pay roll; to prepare statements on special cases regarding salaries and allowances	A sound knowledge of the relevant portions of the Public Service, Teaching Services and Education Acts and the regulations thereunder; the regulations respecting public accounts; the Department's practice and procedure, and machine accounting; to be capable of controlling a staff	Boyce, J. H. . .	Clerk, Class "C2"	7.3.49

Appeals against such recommendations should be lodged with the Secretary to the Public Service Board not later than Saturday, the 14th October, 1950.

Office of the Public Service Board,  
Melbourne, 3rd October, 1950.

By order,  
E. F. FITZGIBBON,  
Secretary.

## PUBLIC SERVICE BOARD OF VICTORIA.—VACANCIES.

APPLICATIONS will be received by the Public Service Board up to Wednesday, the 18th October, 1950, from persons employed in the Public Service of Victoria, who are eligible and qualified, for appointment to the under-mentioned positions:—

## PROFESSIONAL DIVISION.

**Principal Research Officer, Class "A," Soil Conservation Authority, Department of Premier.**

*Yearly Salary.*—£900, minimum; £1,000, maximum.

*Duties.*—To be responsible to the Authority for the development, direction, and administration of the Research Division. The functions of this Division are:—the study of areas, primarily catchment areas, to determine the extent and kind of erosion that has taken place in relation to climate, soils, vegetation, and land-use; and to devise, in co-operation with officers of other Government Departments, modifications or changes in land-use required for conservation; to study the physical characteristics of soils which are important for erosion control, soil conservation, and reclamation; to make economic studies with respect to soil conservation.

*Qualifications.*—To possess a University Degree in Science or Agricultural Science, and considerable research experience in the fields of Ecology, Pedology, and Agronomy, with a knowledge of their application to soil conservation, and to have administrative ability.

**Chief Engineer, Class "A," Soil Conservation Authority, Department of Premier.**

*Yearly Salary.*—£900, minimum; £1,000, maximum.

*Duties.*—To be responsible to the Authority for the development, direction, and administration of the Engineering Division which is to provide the following functions:—the investigation of the hydraulic problems of soil conservation; the design of structures; construction of erosion prevention works; advisory service to public authorities on erosion control involving engineering works; modification of agricultural equipment for soil conservation; surveying; draughting; and the supervision and maintenance of the Authority's vehicles and mechanical equipment.

*Qualifications.*—To possess a University Degree in Civil Engineering or recognized equivalent engineering qualification; to have had extensive experience in construction and design of engineering works, including those for erosion control; experience in the control of drawing office and constructional staff, and to have administrative ability.

**Executive Engineer, Grade II., Class "A," Murray and Major Works Division (Tallangatta Township Removal), Department of Water Supply.**

*Yearly Salary.*—£900, minimum; £1,000, maximum.

*Duties.*—To be Resident Engineer in charge of the Tallangatta Township removal, and to supervise the planning and construction work connected therewith; to conduct negotiations with property owners and to control staff and operations on the works.

*Qualifications.*—To hold the recognized engineering qualification of Engineer of Water Supply under the Water Acts; to have had extensive practical experience in building construction and in civil engineering works, including water supply and other public services.

**Draughtsman, Class "D," Department of Water Supply.**

*Yearly Salary.*—£325, minimum; £436, maximum.

*Duties.*—To prepare compilation of maps and plans for record and reproduction, including the preparation of mosaics from air photographs.

*Qualifications.*—To have passed—

1. (a) the School Leaving Examination, including English, Mathematics I. and Mathematics II.; or
- (b) the School Intermediate Examination and, in addition, School Leaving English, Mathematics I. and Mathematics II.; or
- (c) an equivalent Technical School examination; and
2. to have had training or experience in survey work.

## TECHNICAL AND GENERAL DIVISION.

**Second Engineer, Government Printing Office, Department of Treasurer.**

*Salary.*—£480 a year.

*Qualifications.*—To be a first-class turner and fitter; to have an intimate knowledge of all classes of machinery used in the printing trade, and to be capable of installing new machinery when required.

**Assistant (Male), Grade I., Kew Mental Hospital, Department of Health.**

*Yearly Salary.*—£390, minimum; £416, maximum.

*Duties.*—To perform the statutory and other work relating to the records of patients in the Hospital; to keep the financial accounts of three messrooms, and to be responsible for the recording of, receipt, issue, and balance of all provisions for the Hospital, and the passing of accounts relative thereto; to compile salary sheets and to assist as required in the keeping of staff records and in the general administrative work of a Mental Hospital.

*Qualifications.*—To have a thorough knowledge of the Mental Hygiene Acts and Public Accounts Regulations, and to have had good experience of their application to the work of a Mental Hospital.

**Tutor Sister, Tuberculosis Branch, Department of Health.**

(Gresswell Sanatorium.—One vacancy.)

(Greenville Sanatorium.—One vacancy.)

*Yearly Salary.*—£383, minimum; £422, maximum, less deduction of £62 a year for quarters and rations.

*Duties.*—To undertake the organization of a system of training of nurse assistants in a State Sanatorium, and to lecture trained staff for the post-graduate Certificate in Tuberculosis Nursing.

*Qualifications.*—To be a general trained nurse registered in Victoria; experience in tutoring nursing staff desirable.

**Electrical Mechanic, Kew Mental Hospital, Department of Health.**

*Yearly Salary.*—£380, minimum; £393, maximum.

*Duties.*—Under the direction of the Engineer Mechanic, to maintain wiring and electrical machinery; to undertake minor electrical installations, and to assist the Engineer Mechanic in other work required.

*Qualifications.*—To possess an "A" grade wiring licence.

**Senior Ranger, Nyah West, Department of Water Supply.**

*Salary.*—£344 a year.

*Duties.*—Supervision of distribution of water and maintenance of channels in an area adjacent to Nyah West.

*Qualifications.*—Experience in distribution of water for domestic and stock purposes; capacity for handling men with horse teams on sand clearing, and for supervising gangs of men on channel maintenance and repair of structures; to be competent to measure up piecework and to perform clerical work in connexion with these duties.

**General Assistant, Kew Mental Hospital, Department of Health.**

*Yearly Salary.*—£312, minimum; £338, maximum.

*Duties.*—Under the direction of the Engineer Mechanic, to undertake such duties as the clearing of spoutings, downpipes, sewerage blocks, &c.; to generally assist the engineer, bricklayer, and other artisans if required.

*Qualifications.*—Ability to carry out general labouring work under the direction of artisans.

**Machinist (Female), Grade III., Office of the Chief Commissioner of Police, Department of Chief Secretary. (Two vacancies.)**

*Yearly Salary.*—£325, minimum; £338, maximum.

*Duties.*—To operate a Remington accounting machine and Remington cheque writer in the preparation of the Police and Public Service staff pay.

*Qualifications.*—To be capable of operating a Remington accounting machine, and to be a competent typist.

NOTE.—In addition to the salary rates quoted, a cost of living adjustment (£132 a year for adult males and £88 a year for adult females), which varies in accordance with the rise or fall in the index number of the cost of living, is payable.

By order,

E. F. FITZGIBBON,

Secretary.

Office of the Public Service Board,  
Melbourne, 3rd October, 1950.

PUBLIC SERVICE OF VICTORIA.  
COMPETITIVE EXAMINATION FOR ADMISSION TO  
THE PUBLIC SERVICE.  
(ADMINISTRATIVE DIVISION.)

AN examination of male candidates for appointment to the Administrative Division of the Public Service of Victoria will be held on the 16th December, 1950.

The examination is open to the persons who have or will, before the 31st January, 1951, have passed the School Intermediate Examination of the University of Melbourne, or an equivalent examination, and who—

- (a) on the 16th December, 1950, are not less than fifteen years of age; or
- (b) on the 3rd September, 1939, were under the age of 22 years, and who, having served in the Naval, Military, or Air Forces of the Commonwealth, the United Kingdom, or any other part of the British Dominions, were discharged from such Forces subsequent to the 16th December, 1947; or
- (c) are officers of the Technical and General Division of the Public Service of Victoria; or
- (d) are temporary employees in the Public Service of Victoria, and on the 16th December, 1950, will be under 46 years of age.

A candidate will be required to enter for competitive examination in English, General Intelligence, General Knowledge, and Handwriting.

The English paper will consist of an essay, and the General Knowledge paper will contain questions relating mainly to Australian affairs.

The maximum number of marks that may be awarded shall be—

English .. .. .	150
General Intelligence .. .	150
General Knowledge .. .	100
Handwriting .. .	80

Candidates, in order to qualify for appointment, must obtain at least 50 per centum of the total number of marks in English, General Knowledge, and Handwriting, and at least 100 marks in General Intelligence.

Appointments proposed to be made ..	150
Appointments reserved for officers of the Technical and General Division ..	30

A candidate (other than a discharged serviceman or a member of the Public Service) cannot be appointed before attaining sixteen years of age or after attaining 22 years of age.

The rates of salary (including adjustable cost of living allowance) for the Administrative Division are—

Age.	Yearly Rate.
	£
16 years .. .. .	209
17 years .. .. .	222
18 years .. .. .	248
19 years .. .. .	300
20 years .. .. .	326
21 years .. .. .	431

and rising thereafter, subject to prescribed conditions, by increments to £568 a year, the maximum of the automatic range: After appointment, officers giving satisfactory service will be eligible to receive promotion to higher grades, including eventual promotion to the principal administrative positions in the Public Service.

Entries for the examination must be lodged at the office of the Public Service Board, Public Offices, Treasury place, Melbourne, C.2 (where the prescribed forms are obtainable), on or before Friday, the 24th November, 1950.

Reasonable facilities will be provided for candidates residing in country districts to sit for the examination in local centres.

By order,  
E. F. FITZGIBBON,  
Secretary.

Office of the Public Service Board,  
Melbourne, 2nd October, 1950.

No. 867.

Public Service Act 1946, Section 50.

REGULATIONS—PART III.—SALARIES, INCREMENTS,  
AND ALLOWANCES.

THE Public Service Board, in pursuance of the powers conferred by the Public Service Act 1946, hereby amends the Public Service (Public Service Board) Regulations as follows:—

FIFTH SCHEDULE.

TEMPORARY EMPLOYEES.

DEPARTMENT OF HEALTH.

MENTAL HYGIENE.

Designations of Positions and Rates of Salaries.

Designation of Position.	Yearly Rate of Salary.		Increments (Annual).
	Minimum.	Maximum.	
<i>Delete the existing yearly rates of salary for the under-mentioned positions and insert the rates shown hereunder in lieu thereof:—</i>	£	£	
Assistant (Female)—			
Junior—			
Under 16 years of age .. .. .		91.	
At 16 years of age .. .. .		117	
At 17 years of age .. .. .		130	
At 18 years of age .. .. .		156	
At 19 years of age .. .. .		182	
At 20 years of age .. .. .		221	
Adult .. .. .	260	273*	
Shorthand Writer and Typist (Female)—			
Junior—			
Under 16 years of age .. .. .		130	
At 16 years of age .. .. .		156	
At 17 years of age .. .. .		169	
At 18 years of age .. .. .		182	
At 19 years of age .. .. .		221	
At 20 years of age .. .. .		247	
Adult .. .. .	273	299	
Typist (Female)—			
Junior—			
Under 16 years of age .. .. .		117	
At 16 years of age .. .. .		143	
At 17 years of age .. .. .		156	
At 18 years of age .. .. .		169	
At 19 years of age .. .. .		208	
At 20 years of age .. .. .		234	
Adult .. .. .	260	286	

\* Employees appointed prior to the 1st October, 1944, shall receive a further increment of £13 after twelve months' satisfactory service on the maximum rate of salary.

This Regulation shall have effect as on and from the 1st October, 1950.

D. D. PAINE, Chairman.

E. F. FITZGIBBON, Secretary.

Office of the Public Service Board,  
Melbourne, 26th September, 1950.

No. 862.

PUBLIC SERVICE ACT 1946.

THE Public Service Board, in pursuance of the powers conferred by the Public Service Act 1946, hereby amends the Public Service (Public Service Board) Regulations, as follows:—

SECOND AND SIXTH SCHEDULES.

DEPARTMENT OF PREMIER.

"Regional Planning and Decentralization Division" is substituted for "State Development Division."

D. D. PAINE, Chairman.

E. F. FITZGIBBON, Secretary.

Office of the Public Service Board,  
Melbourne, 18th September, 1950.

No. 865.

Public Service Act 1946, Section 50.

REGULATIONS.—PART III.—SALARIES, INCREMENTS, AND ALLOWANCES.

THE Public Service Board, in pursuance of the powers conferred by the Public Service Act 1946, hereby amends the Public Service (Public Service Board) Regulations as follows:—

SIXTH SCHEDULE.

TEMPORARY EMPLOYEES.

Designations of Positions and Rates of Salaries.

Department and Designation of Position.	Yearly Rate of Salary.		Increments (Annual).
	Minimum.	Maximum.	
	£	£	
<i>Delete the existing yearly rates of salary for the under-mentioned positions and insert the rates shown hereunder in lieu thereof:—</i>			
GENERAL.			
Assistant (Female)—			
Junior—			
Under 16 years of age ..	..	91	..
At 16 years of age ..	..	117	..
At 17 years of age ..	..	130	..
At 18 years of age ..	..	156	..
At 19 years of age ..	..	182	..
At 20 years of age ..	..	221	..
Adult ..	260	273*	..
Laboratory Assistant (Male)—			
Junior—			
Under 16 years of age ..	..	117	..
At 16 years of age ..	..	143	..
At 17 years of age ..	..	156	..
At 18 years of age ..	..	169	..
At 19 years of age ..	..	208	..
At 20 years of age ..	..	234	..
Adult ..	312	364	..
Machinist (Female)—			
Junior—			
Under 16 years of age ..	..	117	..
At 16 years of age ..	..	143	..
At 17 years of age ..	..	156	..
At 18 years of age ..	..	169	..
At 19 years of age ..	..	208	..
At 20 years of age ..	..	234	..
Adult ..	273	299	..
Shorthand Writer and Typist (Female)—			
Junior—			
Under 16 years of age ..	..	130	..
At 16 years of age ..	..	156	..
At 17 years of age ..	..	169	..
At 18 years of age ..	..	182	..
At 19 years of age ..	..	221	..
At 20 years of age ..	..	247	..
Adult ..	273	299	..
Telephonist (Female)—			
Junior—			
Under 16 years of age ..	..	117	..
At 16 years of age ..	..	143	..
At 17 years of age ..	..	156	..
At 18 years of age ..	..	169	..
At 19 years of age ..	..	208	..
At 20 years of age ..	..	234	..
Adult ..	260	286	..
Typist (Female)—			
Junior—			
Under 16 years of age ..	..	117	..
At 16 years of age ..	..	143	..
At 17 years of age ..	..	156	..
At 18 years of age ..	..	169	..
At 19 years of age ..	..	208	..
At 20 years of age ..	..	234	..
Adult ..	260	286	..

SIXTH SCHEDULE—TEMPORARY EMPLOYEES—continued

Department and Designation of Position.	Yearly Rate of Salary.		Increments (Annual).
	Minimum.	Maximum.	
	£	£	
DEPARTMENT OF CHIEF SECRETARY.			
PUBLIC LIBRARY, NATIONAL MUSEUM, MUSEUM OF APPLIED SCIENCE, AND NATIONAL GALLERY.			
Assistant (Female), Grade I.—			
Junior—			
Under 16 years of age ..	..	117	..
At 16 years of age ..	..	143	..
At 17 years of age ..	..	156	..
At 18 years of age ..	..	169	..
At 19 years of age ..	..	208	..
At 20 years of age ..	..	234	..
Adult ..	260	286	..
DEPARTMENT OF TREASURER.			
STAMP DUTIES.			
Embossor (Female)—			
Junior—			
Under 16 years of age ..	..	91	..
At 16 years of age ..	..	117	..
At 17 years of age ..	..	130	..
At 18 years of age ..	..	156	..
At 19 years of age ..	..	182	..
At 20 years of age ..	..	221	..
Adult ..	260	273	..
DEPARTMENT OF EDUCATION.			
Typist (Female), employed in Teachers' Colleges and Schools†—			
Junior—			
Under 16 years of age ..	..	110	..
At 16 years of age ..	..	135	..
At 17 years of age ..	..	147	..
At 18 years of age ..	..	159	..
At 19 years of age ..	..	196	..
At 20 years of age ..	..	221	..
Adult ..	245	271	..
DEPARTMENT OF LANDS AND SURVEY.			
BOTANIC GARDENS.			
Assistant Librarian (Female), National Herbarium—			
Junior—			
Under 16 years of age ..	..	117	..
At 16 years of age ..	..	143	..
At 17 years of age ..	..	156	..
At 18 years of age ..	..	169	..
At 19 years of age ..	..	208	..
At 20 years of age ..	..	234	..
Adult ..	260	286	..
DEPARTMENT OF AGRICULTURE.			
Insectary Assistant (Female), Plant Research Laboratory, Burnley ..	260	286	..
GENERAL.			
<i>Delete—</i>			
Laboratory Assistant (Female)—			
Junior—			
Under 16 years of age ..	..	104	..
At 16 years of age ..	..	117	..
At 17 years of age ..	..	130	..
At 18 years of age ..	..	143	..
At 19 years of age ..	..	182	..
At 20 years of age ..	..	208	..
Adult ..	234	260	..



SIXTH SCHEDULE—TEMPORARY EMPLOYEES—continued.

Department and Designation of Position.	Yearly Rate of Salary.		Increments (Annual).
	Minimum.	Maximum.	
	£	£	£
GENERAL—continued.			
<i>Add—</i>			
Laboratory Assistant (Female), Grade I.—			
Junior—		117	..
Under 16 years of age ..	..	143	..
At 16 years of age ..	..	156	..
At 17 years of age ..	..	169	..
At 18 years of age ..	..	208	..
At 19 years of age ..	..	234	..
At 20 years of age ..	260	286	..
Adult ..	..	..	..
Laboratory Assistant (Female), Grade II. ..	..	312	..
DEPARTMENT OF HEALTH.			
GENERAL HEALTH.			
<i>Delete—</i>			
Laboratory Assistant (Female), Grade II. ..	..	286	..
DEPARTMENT OF LABOUR.			
<i>Delete—</i>			
Assistant (Female), Boys' Employment Movement, Geelong—			
Junior—			
Under 16 years of age ..	..	104	..
At 16 years of age ..	..	117	..
At 17 years of age ..	..	130	..
At 18 years of age ..	..	143	..
At 19 years of age ..	..	169	..
At 20 years of age ..	..	195	..
Adult ..	..	234	..

\* Employees appointed prior to the 1st October, 1944, shall receive a further increment of £13 after twelve months' satisfactory service on the maximum rate of salary.

† Excluding Melbourne Teachers' College, Melbourne Boys' High School, MacRobertson Girls' High School, University High School, and the Correspondence School.

This Regulation shall have effect as on and from the 1st October, 1950.

D. D. PAINE, Chairman.  
E. F. FITZGIBBON, Secretary.

Office of the Public Service Board,  
Melbourne, 22nd September, 1950.

No. 871.

Public Service Act 1946, Section 39.

REGULATIONS—PART III.—SALARIES, INCREMENTS, AND ALLOWANCES.

THE Public Service Board, in pursuance of the powers conferred by the Public Service Act 1946, hereby amends its Regulations as shown below:—

FIRST SCHEDULE.

PROFESSIONAL DIVISION.

Offices and Rates of Salaries.

Office.	Yearly Rate of Salary.		Increments (Annual).
	Minimum.	Maximum.	
	£	£	
DEPARTMENT OF TREASURER.			
CLASS "C1."			
<i>Add—</i>			
Valuer, Housing Commission ..	..	553	605

D. D. PAINE, Chairman.  
E. F. FITZGIBBON, Secretary.

Office of the Public Service Board,  
Melbourne, 19th September, 1950.

No. 788.—10137/50.—3

No. 866.

Public Service Act 1946, Section 50.

REGULATIONS—PART III.—SALARIES, INCREMENTS, AND ALLOWANCES.

THE Public Service Board, in pursuance of the powers conferred by the Public Service Act 1946, hereby amends its Regulations as shown below:—

SEVENTH SCHEDULE.

TECHNICAL AND GENERAL DIVISION.

DEPARTMENT OF HEALTH—MENTAL HYGIENE.

Offices and Rates of Salaries.

Office.	Yearly Rate of Salary.		Increments (Annual).
	Minimum.	Maximum.	
	£	£	
GENERAL STAFF—FEMALES.			
<i>Delete the existing yearly rates of salary for the under-mentioned offices and insert the rates shown hereunder in lieu thereof:—</i>			
Shorthand Writer and Typist (Female), Grade I. ..	273	299*	..
Shorthand Writer and Typist (Female), Grade II. ..	209	312*	..
Shorthand Writer and Typist (Female), Grade III. ..	325	338*	..
Telephonist (Female), Grade I.—			
Junior—			
At 16 years of age ..	..	143	..
At 17 years of age ..	..	150	..
At 18 years of age ..	..	169	..
At 19 years of age ..	..	208	..
At 20 years of age ..	..	234	..
Adult ..	..	260	..

\* See Regulation 47A of the Public Service (Public Service Board) Regulations.  
This Regulation shall have effect as on and from the 1st October, 1950.

D. D. PAINE, Chairman.  
E. F. FITZGIBBON, Secretary.

Office of the Public Service Board,  
Melbourne, 26th September, 1950.

No. 870.

Public Service Act 1946, Section 50.

REGULATIONS—PART III.—SALARIES, INCREMENTS, AND ALLOWANCES.

THE Public Service Board, in pursuance of the powers conferred by the Public Service Act 1946, hereby amends its Regulations as shown below:—

SEVENTH SCHEDULE.

TECHNICAL AND GENERAL DIVISION.

DEPARTMENT OF HEALTH.

MENTAL HYGIENE.

Offices and Rates of Salaries.

Office.	Yearly Rate of Salary.		Increments (Annual).
	Minimum.	Maximum.	
	£	£	
GENERAL STAFF—MALES.			
<i>Add—</i>			
Supervisor of Catering, Grade I. (Kew, Mont Park, Sunbury)	436	462	1 of £26
Supervisor of Catering, Grade II. (Ararat, Ballarat, Beechworth)	410	436	1 of £26
ARTISANS AND SERVANTS—MALES.			
<i>Add—</i>			
General Assistant ..	..	312	338

D. D. PAINE, Chairman.  
E. F. FITZGIBBON, Secretary.

Office of the Public Service Board,  
Melbourne, 26th September, 1950.

No. 864.

Public Service Act 1946, Section 50.

REGULATIONS.—PART III.—SALARIES, INCREMENTS, AND ALLOWANCES.

THE Public Service Board, in pursuance of the powers conferred by the Public Service Act 1946, hereby amends the Public Service (Public Service Board) Regulations as follows:—

SECOND SCHEDULE.

TECHNICAL AND GENERAL DIVISION.

Offices and Rates of Salaries.

Department and Office.	Yearly Rate of Salary.		Increments (Annual).
	Minimum.	Maximum.	
<i>Delete the existing yearly rates of salary for the under-mentioned offices and insert the rates shown hereunder in lieu thereof:—</i>			
GENERAL.			
Assistant (Female), Grade I.—			
Junior—			
At 16 years of age .. .. .	..	117	..
At 17 years of age .. .. .	..	130	..
At 18 years of age .. .. .	..	156	..
At 19 years of age .. .. .	..	182	..
At 20 years of age .. .. .	..	221	..
Adult .. .. .	260	273	..
Assistant (Female), Grade II. ..	273	286	..
Assistant (Female), Grade III. ..	286	299	..
Assistant (Female), Grade IV. ..	312	325	..
Assistant (Female), Senior .. ..	338	351	..
Laboratory Assistant (Female),			
Grade I.—			
Junior—			
At 16 years of age .. .. .	..	143	..
At 17 years of age .. .. .	..	156	..
At 18 years of age .. .. .	..	169	..
At 19 years of age .. .. .	..	208	..
At 20 years of age .. .. .	..	234	..
Adult .. .. .	260	290	..
Laboratory Assistant (Female),			
Grade II. .. .. .	312	325	..
Machinist (Female), Grade I.—			
Junior—			
At 16 years of age .. .. .	..	143	..
At 17 years of age .. .. .	..	156	..
At 18 years of age .. .. .	..	169	..
At 19 years of age .. .. .	..	208	..
At 20 years of age .. .. .	..	234	..
Adult .. .. .	273	290	..
Machinist (Female), Grade II. ..	299	312	..
Machinist (Female), Grade III. ..	325	338	..
Machinist (Female), Senior .. ..	338	351	..
Shorthand Writer and Typist			
(Female), Grade I.—			
Junior—			
At 16 years of age .. .. .	..	156	..
At 17 years of age .. .. .	..	169	..
At 18 years of age .. .. .	..	182	..
At 19 years of age .. .. .	..	221	..
At 20 years of age .. .. .	..	247	..
Adult .. .. .	273	299*	..
Shorthand Writer and Typist			
(Female), Grade II. .. .. .	299	312*	..
Shorthand Writer and Typist			
(Female), Grade III. .. .. .	325	338*	..
Shorthand Writer and Typist			
(Female), Senior .. .. .	338	351	..
Shorthand Writer (Female),			
Licensed .. .. .	338	377*	1 of £13 and 1 of £26
Telephonist (Female), Grade I.—			
Junior—			
At 16 years of age .. .. .	..	143	..
At 17 years of age .. .. .	..	156	..
At 18 years of age .. .. .	..	169	..
At 19 years of age .. .. .	..	208	..
At 20 years of age .. .. .	..	234	..
Adult .. .. .	260	286	..
Typist (Female), Grade I.—			
Junior—			
At 16 years of age .. .. .	..	143	..
At 17 years of age .. .. .	..	156	..
At 18 years of age .. .. .	..	169	..
At 19 years of age .. .. .	..	208	..
At 20 years of age .. .. .	..	234	..
Adult .. .. .	260	286	..
Typist (Female), Grade II. ..	286	299	..
Typist (Female), Supervising ..	312	325	..

SECOND SCHEDULE—TECHNICAL AND GENERAL DIVISION—  
*continued.*

Department and Office.	Yearly Rate of Salary.		Increments (Annual).
	Minimum.	Maximum.	
	£	£	
DEPARTMENT OF EDUCATION.			
Typist (Female), employed in Teachers' Colleges and Schools†—			
Junior—			
At 16 years of age .. .. .	..	135	..
At 17 years of age .. .. .	..	147	..
At 18 years of age .. .. .	..	159	..
At 19 years of age .. .. .	..	196	..
At 20 years of age .. .. .	..	221	..
Adult .. .. .	245	271	..
DEPARTMENT OF PUBLIC WORKS.			
Telephonist (Female), Senior ..	325	338	..
Telephonist (Female), Grade II. ..	286	299	..
GENERAL.			
Add—			
Laboratory Assistant (Male)—			
Junior—			
At 16 years of age .. .. .	..	143	..
At 17 years of age .. .. .	..	156	..
At 18 years of age .. .. .	..	169	..
At 19 years of age .. .. .	..	208	..
At 20 years of age .. .. .	..	234	..
Adult .. .. .	312	377	3 of £13 and 1 of £26

\* See Regulation 47A.

† Excluding Melbourne Teachers' College, Melbourne Boys' High School, MacRobertson Girls' High School, University High School, and the Correspondence School.

*This Regulation shall have effect as on and from the 1st October, 1950.*

D. D. PAINE, Chairman.

E. F. FITZGIBBON, Secretary.

Office of the Public Service Board,  
Melbourne, 22nd September, 1950.

No. 863.

Public Service Act 1946, Section 50.

REGULATIONS.—PART III.—SALARIES, INCREMENTS, AND ALLOWANCES.

THE Public Service Board, in pursuance of the powers conferred by the Public Service Act 1946, hereby amends its Regulations as shown below:—

SIXTH SCHEDULE.

TEMPORARY EMPLOYEES.

Designations of Positions and Rates of Salaries.

Department and Designation of Position.	Yearly Rate of Salary.		Increments (Annual).
	Minimum.	Maximum.	
	£	£	
DEPARTMENT OF CHIEF SECRETARY.			
FISHERIES AND GAME.			
Add—			
Biologist (Female) .. .. .	462	514	2 of £26

D. D. PAINE, Chairman.

E. F. FITZGIBBON, Secretary.

Office of the Public Service Board,  
Melbourne, 22nd September, 1950.

No. 861.

*Public Service Act 1946, Section 39.*

REGULATIONS—PART III.—SALARIES, INCREMENTS, AND ALLOWANCES.

THE Public Service Board, in pursuance of the powers conferred by the *Public Service Act 1946*, hereby amends its Regulations as shown below :—

FIRST SCHEDULE.

PROFESSIONAL DIVISION.

*Offices and Rates of Salaries.*

Office.	Yearly Rate of Salary.	
	Minimum.	Maximum.
DEPARTMENT OF PREMIER. CLASS "C1."	£	£
<i>Delete—</i> Senior Investigation Officer, State Development Division .. .. .	553	605
<i>Add—</i> Senior Investigation Officer, Regional Planning and Decentralization Division	553	605

D. D. PAINE, Chairman.  
E. F. FITZGIBBON, Secretary.

Office of the Public Service Board,  
Melbourne, 18th September, 1950.

No. 868.

*Public Service Act 1946, Section 50.*

REGULATIONS.—PART III.—SALARIES, INCREMENTS, AND ALLOWANCES.

THE Public Service Board, in pursuance of the powers conferred by the *Public Service Act 1946*, hereby amends its Regulations as shown below :—

SECOND SCHEDULE.

TECHNICAL AND GENERAL DIVISION.

*Offices and Rates of Salaries.*

Department and Office.	Yearly Rate of Salary.		Increments (Annual).
	Minimum.	Maximum.	
DEPARTMENT OF HEALTH. GENERAL HEALTH. State Sanatoria—	£	£	
<i>Add—</i> Tutor Sister .. .. .	383	422	1 of £26 and 1 of £13

D. D. PAINE, Chairman.  
E. F. FITZGIBBON, Secretary.

Office of the Public Service Board,  
Melbourne, 25th September, 1950.

No. 860.

*Public Service Act 1946, Section 39.*

REGULATIONS—PART III.—SALARIES, INCREMENTS, AND ALLOWANCES.

THE Public Service Board, in pursuance of the powers conferred by the *Public Service Act 1946*, hereby amends its Regulations as shown below :—

FIRST SCHEDULE.

PROFESSIONAL DIVISION.

*Offices and Rates of Salaries.*

Office.	Yearly Rate of Salary.	
	Minimum.	Maximum.
DEPARTMENT OF LAW. CLASS "C."	£	£
<i>Delete—</i> Legal Assistant (Housing), Crown Solicitor's Office .. .. .	462	534
<i>Add—</i> Legal Assistant (Housing), Crown Solicitor's Office .. .. .	631	683

D. D. PAINE, Chairman.  
E. F. FITZGIBBON, Secretary.

Office of the Public Service Board,  
Melbourne, 18th September, 1950.

No. 869.

*Public Service Act 1946, Section 50.*

REGULATIONS—PART III.—SALARIES, INCREMENTS, AND ALLOWANCES.

THE Public Service Board, in pursuance of the powers conferred by the *Public Service Act 1946*, hereby amends its Regulations as shown below :—

SIXTH SCHEDULE.

TEMPORARY EMPLOYEES.

*Designations of Positions and Rates of Salaries.*

Department and Designation of Position.	Yearly Rate of Salary.		Increments (Annual).
	Minimum.	Maximum.	
DEPARTMENT OF WATER SUPPLY.	£	£	
<i>Delete—</i> Storeman, Assistant (Bendigo) Storeman, Assistant (Swan Hill)	312 312	325 325	.. ..
<i>Add—</i> Storeman, Assistant .. .. .	312	325	..

D. D. PAINE, Chairman.  
E. F. FITZGIBBON, Secretary.

Office of the Public Service Board,  
Melbourne, 25th September, 1950.

## PRIVATE ADVERTISEMENTS.

**I** TIMOTHY STREET, of "Eildon," Lismore, in Victoria, spinster, heretofore called and known by the name of Veronica Laura Street, hereby give public notice that by a Deed Poll dated the 29th day of September, 1950, duly executed and attested and deposited with the Registrar-General of the said State on the 29th day of September, 1950, I formally renounced and abandoned the said christian names of Veronica Laura, and declared that I had assumed and adopted and intended thenceforth in all reasons whatsoever to use and subscribe the christian name of Tim in lieu thereof, and so as to be at all times thereafter called, known, and described by the said christian name of Tim.

Dated the 29th day of September, 1950.

TIMOTHY STREET.

Witness—R. R. ATKEN, solicitor, Melbourne. 4542

**I** EDWARD PETERSON, of 44 Dundas-place, Albert Park, in the State of Victoria, labourer, heretofore called and known by the names of Edward Albert Jordan, hereby give public notice that by a deed poll dated 25th September, 1950, duly executed and attested and deposited with the Registrar-General of the said State on the 26th day of September, 1950, I formally and absolutely renounced and abandoned the said names of Edward Albert Jordan and declared that I had assumed and adopted and intended henceforth upon all occasions whatsoever to use and subscribe the names of Edward Peterson instead of the said names of Edward Albert Jordan, and so as to be at all times thereafter called, known, and described by the said names of Edward Peterson.

Dated the 26th day of September, 1950.

EDWARD PETERSON.

Witness—JOAN V. CLARK. 4506

NOTICE OF INTENTION TO APPLY FOR A LICENCE TO DIVERT WATER AND CUT RACES.

CORRECTION.

**I**N my Notice of Intention to apply for a Licence to Divert Water from the River Murray at Benjeroop, which appeared in the *Victoria Government Gazette* of 7th September, 1949, No. 807, page 5271, and the *Kerang New Times* of 2nd, 6th, and 9th September, 1949, the volume of water to be diverted was inadvertently stated as 20 acre-feet per annum for irrigation purposes in lieu of 40 acre-feet per annum.

Any objections to an amendment being made must be forwarded, in writing, to the State Rivers and Water Supply Commission, Melbourne, within 30 days of the date hereof.

Dated the 3rd October, 1950.  
4496

CYRIL G. STALEY.

NOTICE OF INTENTION TO APPLY FOR A LICENCE TO DIVERT WATER AND CUT RACES FROM THE LITTLE RIVER AT LITTLE RIVER.

**I** HEREBY give notice that I intend to apply for a licence empowering me to divert water for a term of fifteen years to the extent of 8 acre-feet per annum at a maximum rate of 4 acre-feet per day of 24 hours for irrigation of 4 acres, being part of allotments 12 and part 13, Parish of Bulban, and to occupy certain Crown lands for works of storage and diversion, and to cut a race thereon.

Any objection to such application must be forwarded, in writing, to the State Rivers and Water Supply Commission, Melbourne, within 30 days of the date hereof.

JOSSLYN BENJAMIN FINK.

Little River, 26th September, 1950. 4497

NOTICE OF INTENTION TO APPLY FOR A LICENCE TO DIVERT WATER AND CUT RACES FROM THE MURRAY RIVER AT YARRAWONGA.

**I** HEREBY give notice that I intend to apply for a licence empowering me to divert water for a term of fifteen years to the extent of 200 acre-feet per annum at a maximum rate of 10 acre-feet per day of 24 hours for irrigation of 100 acres, being part of allotments A6 and part 6, and allotments 7, 7A, and 7B, Parish of Yarrawonga, and to occupy certain Crown lands for works of storage and diversion, and to cut a race thereon.

Any objection to such application must be forwarded, in writing, to the State Rivers and Water Supply Commission, Melbourne, within 30 days of the date hereof.

JAMES BRUCE FORGE.

Yarrawonga, 30th September, 1950. 4498

NOTICE OF INTENTION TO APPLY FOR A LICENCE TO DIVERT WATER AND CUT RACES FROM THE LODDON RIVER AT SALISBURY WEST.

**I** HEREBY give notice that I intend to apply for a licence empowering me to divert water for a term of fifteen years to the extent of 100 acre-feet per annum at a maximum rate of 8 acre-feet per day of 24 hours for irrigation of 50 acres, being part of allotments 1, 2, 3, 4, and 5, section B, Parish of Salisbury West, and to occupy certain Crown lands for works of storage and diversion, and to cut a race thereon.

Any objection to such application must be forwarded, in writing, to the State Rivers and Water Supply Commission, Melbourne, within 30 days of the date hereof.

CHARLES ALBERT TRIPLETT.

Salisbury West, 25th September, 1950. 4499

NOTICE OF INTENTION TO APPLY FOR A LICENCE TO DIVERT WATER AND CUT RACES FROM THE LODDON RIVER AT BRIDGEWATER.

**I** HEREBY give notice that I intend to apply for a licence empowering me to divert water for a term of fifteen years to the extent of 40 acre-feet per annum at a maximum rate of 5 acre-feet per day of 24 hours for irrigation of 20 acres, being part of allotment 143, Parish of Derby, and to occupy certain Crown lands for works of storage and diversion, and to cut a race thereon.

Any objection to such application must be forwarded, in writing, to the State Rivers and Water Supply Commission, Melbourne, within 30 days of the date hereof.

THOMAS GILBERT LEARMONTH.

Bridgewater On Loddon, 20th September, 1950. 4500

NOTICE OF INTENTION TO APPLY FOR A LICENCE TO DIVERT WATER AND CUT RACES FROM THE LODDON RIVER, AT SALISBURY WEST.

**I** HEREBY give notice that I intend to apply for a licence empowering me to divert water for a term of 15 years to the extent of 40 acre-feet per annum at a maximum rate of 2 acre-feet per day of 24 hours for irrigation of 20 acres, being part of allotments 5L and 5M, section A, Parish of Salisbury West, and to occupy certain Crown lands for works of storage and diversion, and to cut a race thereon.

Any objection to such application must be forwarded, in writing, to the State Rivers and Water Supply Commission, Melbourne, within 30 days of the date hereof.

BRIDGET M. McLINDEN.

20 Stewart-street, Yarraville, W.13, 27th September, 1950. 4529

WARRNAMBOOL SEWERAGE AUTHORITY.

GENERAL NOTICE.

**T**HE above-mentioned sewerage authority, having made sewers for carrying off the sewage from each and every property which, or any part of which, abuts on the streets, or parts of streets, in which such sewers are laid, and which are included within the sewerage areas hereinafter described, doth hereby declare that, on and after the 1st day of October, 1950, each and every property which, or any part of which, abuts on the said streets, or parts of streets, shall be deemed to be a seweraged property within the meaning of the *Sewerage Districts Act 1928*.

The boundaries of the sewerage areas hereinbefore referred to are:—

Area No. 17.

Commencing at a point on the boundary of the existing seweraged area, being the north-west corner of Crown allotment 112, City of Warrnambool; thence easterly along the northern boundary of Crown allotments 112, 111, 110, 109, 108, and 107 to the north-east corner of Crown allotment 107; thence southerly along the east boundary of Crown allotment 107; thence westerly along the southern boundary of Crown allotments 107, 108, 109, 110, 111, and 112 to the south-west corner of Crown allotment 112; thence northerly to the starting point on the north-west corner of Crown allotment 112.

Area No. 18.

Commencing at a point on the boundary of the existing seweraged area, being a point on the north boundary of Crown allotment 311, City of Warrnambool, a distance of 75 links east of its western boundary; thence easterly along the northern boundary of Crown allotments 311, 312, 307, 309, 310, 313, 314, and 315 to the north-east boundary of Crown allotment 315 across Lava-street east to the north-west corner of Crown allotment 317; thence easterly to the most easterly corner of Crown allotment 317; thence westerly along the southern boundary of Crown

allotments 317, 318, across a lane, and 319 to the most southerly corner of Crown allotment 319; thence westerly along the southern boundaries of Crown allotments 319, 320, 321, 322, 323, 324, 325, 326, and across a lane to the south-east corner of Crown allotment 327, being a point on the boundary of the existing sewerage area; thence northerly, westerly, northerly, and easterly along the boundary of the existing sewerage area to the starting point.

*Area No. 19.*

Commencing at the most easterly point in the sewerage area No. 16, being the mid-point of Cramer-street on the prolongation of the south-western boundary of Crown allotment 174; thence along the centre line of Cramer-street to a point on the prolongation of the southern building line of Monash-avenue; thence north-westerly along the said building line to the most northern corner of allotment 14, Crown allotment 176, City of Warrnambool; thence westerly along the northern boundary of allotments 14 and 13 to the north-west corner of allotment 13; thence north-westerly along the northern boundary of allotment 12, Crown allotment 175, to its most northerly corner; thence south-westerly along the western boundary of the said allotment 12 to its most westerly corner; thence generally westerly along the southern boundary of allotments 11, 10, 9, 8, 7, 6, 5, Crown allotments 174 and 175, to the south-west corner of said allotment 5; thence northerly along the western boundary of said allotment 5 to its most westerly corner; thence westerly along the southern boundary of Crown allotment 182 to a point approximately 55 feet east of the western boundary of Crown allotment 182; thence northerly for 55 feet along the eastern boundary of the Kiama-avenue extension subdivision; thence westerly along the northern boundary of lot 14, part Crown allotments 182 and 183, to its north-west corner; and thence across Kiama-avenue to the south-east corner of allotment 2, Crown allotment 183; thence northerly to the north-east corner of allotment 3, Crown allotment 183; thence westerly along the northern boundary of said allotment to a point on the boundary of the existing sewerage area No. 16; thence southerly and generally south-easterly along the boundary of said area to the starting point.

By order of the said Sewerage Authority,

4507 J. D. E. WALTER, Chairman.  
K. L. ARNEL, Secretary.

CITY OF BENDIGO.

CHANGE OF NAME OF STREET.

NOTICE is hereby given that at a Meeting of the Council of the City of Bendigo, held on the 4th day of September, 1950, the said Council, in pursuance of the provisions of the *Local Government Act 1946*, did make an order changing the name of the street set out hereunder, that is to say:—

*Old name.*—Epsom-road.

*New name.*—Napier-street.

*Location.*—From Scott-street to the city boundary.  
4538 F. T. AMER, Town Clerk.

TOWN OF PORTLAND.

BY-LAW NO. 69.

A By-law of the Town of Portland, made under section 197 of the *Local Government Act 1946*, and numbered 69, for the adoption of certain provisions of the Fifteenth Schedule of the *Local Government Act 1946*.

IN pursuance of the powers conferred by the *Local Government Act 1946*, the Mayor, Councillors, and Burgesses of the Town of Portland order as follows:—

That sub-sections 3 to 7 (inclusive) and 9 to 12 (inclusive) of section 2 of Part IV. of the Fifteenth Schedule of the *Local Government Act 1946*, relating to public gardens, be adopted a By-law in and for the Town of Portland.

Resolution for passing this By-law agreed to by the Council the 25th day of August, 1950. Confirmed this 22nd day of September, 1950.

The common seal of the Town of Portland was hereunto affixed this 22nd day of September, 1950, in the presence of—

4491 (SEAL) P. HODGE, Councillor.  
ARTHUR J. THOMAS, Councillor.  
E. NOËL T. HENRY, Town Clerk.

SHIRE OF KYNETON.

LOAN No. 14.

*Notice of Intention to Borrow the Sum of Three Thousand Five Hundred Pounds (£3,500), under the Provisions of the Local Government Acts.*

NOTICE is hereby given that the Council of the Shire of Kyneton proposes to borrow the sum of Three thousand five hundred pounds (£3,500), on the credit of the President, Councillors, and Ratepayers of the Shire of Kyneton, by the issue of debentures, in accordance with the provisions of Part XV. of the *Local Government Act 1946*.

It is further provided:—

1. That the term of the loan shall be ten years.
2. The maximum rate of interest to be paid shall be Three pounds five shillings per centum per annum.
3. The sum borrowed shall be repayable by providing out of the municipal fund twenty half-yearly instalments, each of approximately £206 7s. 6d., and each including principal and interest, payable on 1st January and 1st July in each year, the first instalment to be payable on 1st July, 1951.
4. The money borrowed and the interest thereon shall be repayable at the Commercial Banking Co. of Sydney Ltd., Melbourne, or the Council's bankers for the time being in Melbourne.
5. The purposes for which the loan is to be applied are the purchase of a Roadmaster grader and a Bulldog ripper, as road-making plant for use in the Shire of Kyneton.
6. The plans and descriptions and the estimated cost of the road-making plant referred to, with a statement of the proposed expenditure of the money to be borrowed, are open for inspection at the Shire Office, Kyneton, during office hours.

GEO. SWANSON, Shire Secretary.  
Kyneton, 30th September, 1950. 4525

SHIRE OF NUMURKAH.

NOTICE is hereby given that James Ryan, Senior Constable of Police, No. 8243/430, has been appointed Prosecuting Officer for the Western and Moira Ridings of the Shire of Numurkah, *vice* Senior Constable R. H. Finlay.  
4495 J. K. DANCOCKS, Shire Secretary.

SHIRE OF ORBOST.

LOAN No. 10.

*Notice of Intention to Borrow the Sum of Four Thousand Pounds (£4,000) for Permanent Works and Undertakings.*

NOTICE is hereby given that the Council of the Shire of Orbost proposes to borrow the sum of Four thousand pounds (£4,000) on the credit of the President, Councillors, and Ratepayers of the Shire of Orbost, by the issue of debentures, in accordance with the provisions of Part XV. of the *Local Government Act 1946*.

It is further proposed that—

1. The period of the loan shall be ten years.
2. The maximum rate of interest to be paid shall be £3 5s. per centum per annum.
3. The money borrowed shall be repayable out of the Municipal Fund by twenty half-yearly instalments of approximately £235 17s. 6d. each, including principal and interest, on the 1st day of June and the 1st day of December in each year during the currency of the loan. The first instalment shall be payable on the 1st day of June, 1951.
4. The money borrowed, and the interest thereon, shall be payable at the Commercial Bank of Australia Limited, Melbourne, or at the Council's bankers for the time being in the City of Melbourne.
5. The purposes for which the loan is to be applied is for the purchase of road-making plant—crawler type tractor angle dozer.
6. The plans and specifications and estimate of the cost of the purchase of the plant referred to, with a statement of the proposed expenditure of the money to be borrowed, are open for inspection at the Shire Office, Orbost, during office hours.

Dated this 25th day of September, 1950.

4493 H. MCK. SILKE,  
Shire Secretary.

SHIRE OF PORTLAND.

LOAN No. 8.

Notice of Intention to Borrow the Sum of Four Thousand Pounds (£4,000) for Permanent Works and Undertakings in the Shire of Portland.

TAKE notice that the Council of the Shire of Portland proposes to borrow, on the credit of the President, Councillors, and Ratepayers of the said Shire, the sum of Four thousand pounds (£4,000), such sum to be raised by the issue of debentures, in accordance with the provisions of the Local Government Acts.

The maximum rate of interest that may be paid is £3 5s. per centum per annum.

Such moneys shall be repayable by twenty half-yearly instalments of approximately £236 each, including principal and interest, by providing out of the Municipal Fund such amounts on the 1st day of June and the 1st day of December in each respective year during the currency of the loan. The first instalment shall be payable on the 1st day of June, 1951.

Such moneys shall be repayable, at Melbourne, at the Commercial Bank of Australia Limited, or at the Council's bankers for the time being in Melbourne.

The purpose for which the loan is to be applied is:—

For the purchase of road-making and road maintenance plant . . . . . £4,000

The necessary specifications and estimates of cost, and a statement showing the proposed expenditure of money to be borrowed, are open for inspection at the Shire Office, Heywood.

Dated this 21st day of September, 1950.

M. D. ALLARDICE,  
Shire Secretary.

4492

SHIRE OF SOUTH BARWON.

NOTICE OF INTENTION TO BORROW £4,850 FOR PERMANENT WORKS AND UNDERTAKINGS IN THE SHIRE OF SOUTH BARWON.

NOTICE is hereby given that the Council of the Shire of South Barwon proposes to borrow on the credit of the Municipality the sum of £4,850, to be raised by the issue of debentures for such amount, in accordance with the provisions of Part XV. of the Local Government Act 1946.

- (a) The amount of the principal moneys which it is proposed to borrow is £4,850.
- (b) The maximum amount of interest that may be paid is £3 5s. per cent. per annum.
- (c) The term of the loan is for fifteen years, and is repayable at the Bank of New South, Melbourne, or at the Council's bankers for the time being in the City of Melbourne, by half-yearly payments on the 1st day of January and the 1st day of July in each year during the term of the loan—the first of such payments commencing on the 1st day of July, 1951:
- (d) The loan is to be applied for the purposes of:—

1. Wyuna-parade . . . . .	92
2. Marshall Hotel-road—seal towards Horse Shoe Bend . . . . .	150
3. Roberts-road—construct and seal . . . . .	500
4. Scenic-road . . . . .	200
5. Beach-road, Torquay—construction . . . . .	648
6. Horse Shoe Bend-road, north and south of lower Duneed-road—80 chains D.C. seal . . . . .	1100
7. Lake-road, Connemare—reseal . . . . .	850
8. Baby Health Centre, Torquay . . . . .	400
9. Bluestone School-road, Challis's corner towards Breamlea turn off . . . . .	460
10. Concrete mixer . . . . .	200
11. Office furniture and plant . . . . .	250
	£4,850

- (e) The manner in which the loan is to be liquidated is by providing out of the Municipal Fund thirty half-yearly payments of approximately £205 11s., including principal and interest, during the term of the loan.

The plans, specifications, and estimates of such works and undertakings and a statement of the proposed expenditure of the money to be borrowed are available and are open for inspection during office hours at the office of the Council, Shire Hall, Belmont.

Dated at Belmont this 26th day of September, 1950.

J. A. McCAY,  
Shire Secretary.

4494

Local Government Act 1946.

SHIRE OF WARRAGUL.

DECLARATION OF PRIVATE STREET AS PUBLIC HIGHWAY.

THE Council of the Shire of Warragul, having considered the application of the Housing Commission of Victoria, owners of property in Gloucester-place, being the owners of premises fronting on such street as in rateable value are a greater part of all the premises so fronting, which street is not less than 15 feet in width and is constructed to the satisfaction of the Council of the said Shire of Warragul, do hereby declare the said Gloucester-place hereinafter described to be a public highway within the meaning of the Local Government Act 1946, viz.:—

Gloucester-place, Warragul.

All that piece of land, being parts of Crown allotments 1, 2, 3, and 4, section 11, Town of Warragul, Parish of Drouin East, County of Buln Buln, known as Gloucester-place, Warragul: Commencing at a point on the south side of Sutton-street, Warragul, west of the north-east boundary of the aforesaid Crown allotment 4 a distance of 253 ft. 9½ in.; thence south-westerly by the arc of a circle of radius 30 feet a distance of 47 ft. 1½ in., the chord of which arc bears 234 deg. 25 min.; thence south along a bearing of 189 deg. 25 min. a distance of 46 feet; thence east along a line bearing 99 deg. 25 min. a distance of 10 feet, south along a line bearing 189 deg. 25 min. a distance of 60 feet; thence west along a line bearing 279 deg. 25 min. a distance of 10 feet; thence south-westerly by the arc of a circle of radius 186 feet a distance of 289 ft. 3 in., the chord of which arc bears 234 deg. 25 min. into Crown allotment 3, section 11, town, parish, and county aforesaid; thence west on a line bearing 279 deg. 25 min. a distance of 423 feet; thence south-westerly on a line bearing 234 deg. 34 min. a distance of 21 ft. 2 in.; thence north-westerly by the arc of a circle of radius 95 feet a distance of 153 ft. 9 in., the chord of which arc bears 324 deg. 25 min. through Crown allotment 1; thence north-easterly on a line bearing 53 deg. 47 min. a distance of 21 feet; thence north on a line bearing 9 deg. 25 min. a distance of 99 feet, west on a line bearing 279 deg. 25 min. a distance of 10 feet; thence north on a line bearing 9 deg. 25 min. a distance of 45 feet; thence east on a line bearing 99 deg. 25 min. a distance of 10 feet, north on a line bearing 9 deg. 25 min. a distance of 45 feet; thence north-westerly by the arc of a circle of radius 30 feet a distance of 47 ft. 1½ in., the chord of which arc bears 324 deg. 25 min. to a point on the south side of the aforesaid Sutton-street, Warragul; thence east by a line bearing 9 deg. 25 min. a distance of 110 feet; thence south-westerly by the arc of a circle of radius 30 feet a distance of 47 ft. 1½ in., the chord of which arc bears 234 deg. 25 min.; thence south along a line bearing 189 deg. 25 min. a distance of 45 feet; thence east by a line bearing 99 deg. 25 min. a distance of 10 feet, south by a line bearing 189 deg. 25 min. a distance of 61 feet, west by a line bearing 279 deg. 25 min. a distance of 10 feet, south by a line bearing 189 deg. 25 min. a distance of 106 feet; thence south-easterly by the arc of a circle of radius 30 feet a distance of 47 ft. 1½ in., the chord of which arc bears 144 deg. 25 min.; thence east along a line bearing 99 deg. 25 min. a distance of 400 feet through Crown allotment 2 into Crown allotment 3, section 11, town, parish, and county aforesaid; thence north along a line bearing 9 deg. 25 min. a distance of 10 feet; thence east along a line bearing 99 deg. 25 min. a distance of 34 ft. 6 in.; thence north-easterly by the arc of a circle of radius 126 feet a distance of 52 ft. 4½ in., the chord of which arc bears 87 deg. 30 min.; thence south-easterly by a line bearing 165 deg. 36 min. a distance of 10 feet; thence north-easterly by the arc of a circle of radius 136 feet a distance of 157 feet. 1 in., the chord of which arc bears 42 deg. 30½ min.; thence westerly on a line bearing 279 deg. 25 min. a distance of 10 feet; thence north along a line bearing 9 deg. 25 min. a distance of 60 feet, east on a line bearing 99 deg. 25 min. a distance of 10 feet, north along a line bearing 9 deg. 25 min. a distance of 46 feet; thence north-easterly by the arc of a circle of radius 30 feet a distance of 47 ft. 1½ in., the chord of which arc bears 324 deg. 25 min. to a point on the south side of the aforesaid Sutton-street, Warragul; thence easterly on a line bearing 99 deg. 25 min. a distance of 110 feet to the commencing point.

The common seal of the said Shire of Warragul was hereunto affixed, in pursuance of an Order of the Council made on the 9th day of May, 1950, in the presence of—

E. G. ROBERTS, President.  
MAC STEWARD, Councillor.  
L. A. HEMLEY, Shire Secretary.

(SEAL)

4523

## SHIRE OF WYCHEPROOF.

## BY-LAW No. 18.

A By-law of the Shire of Wycheproof, made under Part VII. of the *Local Government Act 1946*, for prohibiting cattle being allowed to graze or wander upon any land not enclosed by a substantial fence.

IN pursuance of the powers conferred by the Local Government Act, the President, Councillors, and Rate-payers of the Shire of Wycheproof order as follows:—

1. No person being the owner, hirer, drover, shepherd, or having the possession, care, charge, custody, control, or supervision of any cattle shall allow such cattle to graze or wander upon any land not enclosed by a substantial fence.

2. This By-law shall apply to and have operation throughout the whole of the Municipal District of the Shire of Wycheproof.

Resolution for the passing of this By-law No. 18 was agreed to by the Council of the Shire of Wycheproof on the 14th August, 1950.

Confirmed on the 11th September, 1950.

The common seal of the Shire of Wycheproof was hereunto affixed in pursuance of an order of the Council made this 11th day of September, 1950, in the presence of—

(SEAL) G. T. ALLAN, President.  
WILLIAM H. T. BATH, Councillor.  
R. K. SOULSBY, Secretary.

4524

NOTICE is hereby given that the partnership heretofore subsisting between the undersigned Reginald Joseph Perry and Reginald Austin Hodder, carrying on business as garage proprietors at Yinnar, under the name of "Main Garage, Yinnar," has been dissolved by mutual consent as from the 31st day of August, 1950. All debts due to and owing by the said late firm will be received and paid by Reginald Joseph Perry, who will continue to carry on the business at the same place.

Dated at Yinnar, the 31st day of August, 1950.

REGINALD JOSEPH PERRY.  
REGINALD AUSTIN HODDER.

Witness to both signatures—J. L. HAYDEN.

P. J. Wilson, M.A., LL.B., solicitor, Foster. 4532

NOTICE is hereby given that the partnership heretofore subsisting between Rudolph Alexander Arbuthnot and Lindsay Arbuthnot, in the business of bakers and pastry-cooks, carried on by them under the firm name or style of "Federal Bakery," at Nilma, has been dissolved by mutual consent as from the 1st day of March, 1950. All debts due and owing to the said late firm will be received and paid by the said Rudolph Alexander Arbuthnot, who will continue to carry on the said business on his own account at the same address, under the same firm name.

Dated this 27th day of September, 1950.

R. A. ARBUTHNOT.  
L. ARBUTHNOT.

Gray, Friend, and Moonie, solicitors, Warragul. 4526

NOTICE is hereby given that the partnership heretofore carried on by Claude Rupert Greville and Frederick William McKenna, in the business of "sign and showcard writing and reproduction," under the name or style of "Greville-McKenna," is dissolved by mutual consent as on the 30th day of September, 1950, from which date the said business shall be carried on by Claude Rupert Greville, the said Frederick William McKenna retiring from the firm. All debts owing to the late partnership should be paid to the said Claude Rupert Greville, who will satisfy all liabilities.

Dated this 30th day of September, 1950.

C. R. GREVILLE.  
F. W. MCKENNA.

Witness to both signatures—MALCOLM CLARKE, solicitor, Melbourne.

D. Bruce Tunnock and Clarke, solicitors, 87 Queen-street, Melbourne. 4508

NOTICE is hereby given that the partnership business of A. E. Cocks and Company, hitherto carried on by Henry Alexander Peel and Alan Edwin Cocks, at 323 Bourke-street, Melbourne, has been dissolved by mutual consent of the partners this 30th day of September, 1950, after which day Alan Edwin Cocks will carry on the business under the same name, at the same address.

Dated this 29th day of September, 1950.

A. E. COCKS.  
HENRY A. PEEL.

4545

## NOTICE OF DISSOLUTION OF PARTNERSHIP.

NOTICE is hereby given that the partnership heretofore subsisting between William Ian Potter, Henry Arthur Pitt, and James Hiers McColl, carrying on the business of stock and share brokers at 360 Collins-street, Melbourne, under the firm name of "Ian Potter and Company," has been dissolved by mutual consent as from the 30th day of September, 1950, by the retirement of James Hiers McColl from the said firm. William Ian Potter and Henry Arthur Pitt will continue to carry on the said business in partnership under the same firm name. All moneys due and becoming due to the said firm, and all debts and liabilities of the said firm will be received, paid, and discharged respectively by William Ian Potter and Henry Arthur Pitt.

Dated the 30th day of September, 1950.

W. I. POTTER.  
H. A. PITT.  
J. H. MCCOLL.

Malleson, Stewart and Company, solicitors, 46 Queen-street, Melbourne. 4568

## NOTICE OF DISSOLUTION OF PARTNERSHIP.

NOTICE is hereby given that the partnership heretofore subsisting between Murray Francis Buxton and Norman James Kennedy, carrying on business as tailors at 49 Elizabeth-street, Melbourne, under the name of "Murray F. Buxton and Norman J. Kennedy," has been dissolved as from the 17th day of May, 1950. Murray Francis Buxton is once again carrying on the business alone at the same place.

Dated the 27th day of September, 1950.

M. F. BUXTON.

Blake and Riggall, solicitors, 120 William-street, Melbourne. 4558

NOTICE is hereby given that the partnership heretofore subsisting between Douglas Wingfield Mathews, Theodore Kahanoff, and Gerald Shohet, carrying on business as a parcels delivery service at 46 William-street, Melbourne, under the firm name of "Ten Twelve Two Four Parcel Delivery," has been dissolved by mutual consent as from the 21st day of September, 1950, and that the said business has been acquired as from the 1st day of September, 1950, by J. R. Graham Proprietary Limited, of 16 Byron-street, North Melbourne, which will henceforth carry on the said business at the latter address under the same firm name.

Dated this 21st day of September, 1950.

DOUGLAS WINGFIELD MATHEWS.  
THEODORE KAHANOFF.  
GERALD SHOHET.

Witness to the above three signatures—J. JENKINS.

Signed for and on behalf of J. R. Graham Proprietary Limited, in the presence of R. BEBEND.—J. R. GRAHAM, Director. 4559

ON account of ill-health Mrs. Eve Sher will, as from the 8th of September, 1950, no longer be associated with the firm of "Central Luggage Shop," leather goods retailers, of 429 Bourke-street, Melbourne.

Leslie Cohen and Freadman, solicitors, 422 Collins-street, Melbourne, and 141A Chapel-street, St. Kilda. 4512

No. of company, 21208.

Form No. 40.

*Companies Act 1938.*

A. S. GUY PROPRIETARY LIMITED.

COPY OF RESOLUTIONS, PURSUANT TO SECTION 118.

AT a General Meeting of the members of A. S. Guy Proprietary Limited, duly convened and held at 40 Queen-street, Melbourne, on the 25th day of September, 1950, the following Special and Extraordinary Resolutions were duly passed:—

*Special Resolution.*

(1) "That the company be wound up voluntarily, and that Reginald Edward Victor Church, chartered accountant (Aust.), of 40 Queen-street, Melbourne, be and is hereby appointed liquidator for the purposes of such winding up at a remuneration of Fifty guineas."

*Extraordinary Resolution.*

(2) "That the liquidator be and is hereby authorized to exercise any of the powers given by paragraphs (b), (c), and (d) to sub-section (1) of section 191 of the *Companies Act 1938*, which a liquidator is authorized to exercise with the sanction of an Extraordinary Resolution."

Dated this 26th day of September, 1950.

4543

R. E. V. CHURCH, Secretary.

LANCE RAYMOND (VICTORIA) PROPRIETARY LIMITED.

SPECIAL RESOLUTION TO WIND UP, PURSUANT TO SECTION 226.

AT an Extraordinary General Meeting of the above-named company, duly convened and held at 131 Queen-street, Melbourne, on Monday, the 25th day of September, 1950, the following Resolution was duly passed as a Special Resolution:—

“That the company be wound up voluntarily.”

And at such last-mentioned meeting Donald Robertson Griffiths, chartered accountant (Aust.), of 131 Queen-street, Melbourne, was appointed liquidator for the purposes of the winding up.

Dated the 29th day of September, 1950.

4521 W. D. SYKES, Chairman.

ABERFELDIE INVESTMENT CO. PTY. LTD.  
(IN LIQUIDATION).

NOTICE CONVENING FINAL MEETING, PURSUANT TO SECTION 236.

NOTICE is hereby given, in pursuance of section 236 of the Companies Act 1938, that a General Meeting of the members of the above-named company will be held at the company's registered office, 403 Bourke-street, Melbourne, on Wednesday, the 29th day of November, at Three o'clock in the afternoon, for the purpose of having an account laid before them showing the manner in which the winding up has been conducted and the property of the company disposed of, and of hearing any explanation that may be given by the liquidator. 4515

Companies Act 1938.

THE DANDENONG RANGES PRESS PTY. LTD.  
(IN VOLUNTARY LIQUIDATION).

NOTICE OF FINAL MEETING OF COMPANY, PURSUANT TO SECTION 236.

NOTICE is hereby given that a Final General Meeting of the above company will be held at 10 a.m. on Monday, 6th of November, 1950, at the office of the liquidator, 443 Little Collins-street, Melbourne, for the purpose of having an account laid before it showing how the winding up of the company has been conducted and the property of the company has been disposed of.

Dated this 2nd day of October, 1950.

RONALD H. SULLIVAN, B.Com., A.C.A. (Aust.), chartered accountant (Aust.), 443 Little Collins-street, Melbourne, C.I. liquidator. 4546

Companies Act 1938.

VOGUE UTILITIES PROPRIETARY LIMITED  
(IN VOLUNTARY LIQUIDATION).

PURSUANT TO SECTION 245 (2).

NOTICE is hereby given to all shareholders of Vogue Utilities Proprietary Limited that a Final Meeting of the company will be held on Tuesday, the 14th November, 1950, at the office of Gandy and Skate, 44 Queen-street, Melbourne, at 9.15 a.m.:—

To place before the members an account showing how the winding up has been conducted and the property of the company has been disposed of.

Dated this 29th day of September, 1950.

J. W. GANDY, chartered accountant (Aust.), liquidator. 4547

Companies Act 1938.

THE GRANGE INVESTMENT COMPANY  
PROPRIETARY LIMITED.

NOTICE CONVENING FINAL MEETING OF MEMBERS, PURSUANT TO SECTION 245.

NOTICE is hereby given, in pursuance of section 245 of the Companies Act 1938, that a General Meeting of the members of the above-named company will be held on Tuesday, the 28th day of November, 1950, at Twelve o'clock noon, for the purpose of having an account laid before them showing the manner in which the winding up has been conducted and the property of the company disposed of, and of hearing any explanation that may be given by the liquidator.

Dated the 29th day of September, 1950.

4570 R. W. GRAHAM, Liquidator.

Companies Act 1938.

THE AUSTRALIAN JEWISH WELFARE SOCIETY  
(IN LIQUIDATION).

NOTICE is hereby given that the Final Meeting of shareholders of the above company, pursuant to section 236 of the Companies Act, will be held at the office of the liquidator, 108 Queen-street, Melbourne, on Wednesday, 8th November, at Two p.m.

Dated this 2nd day of October, 1950.

4539 R. J. SICREE, Liquidator.

STEWART DAWSON & CO. (VICTORIA) PTY.  
LIMITED.

AT an Extraordinary General Meeting of members of the above-mentioned company, duly convened and held at the offices of George C. Coburn and Co., 39 Martin-place, Sydney, on Thursday, the 21st day of September, 1950, the following Special Resolution was passed:—

“It was resolved that the company be wound up voluntarily.”

Dated at Sydney this 26th day of September, 1950.

4511 G. C. COBURN, Chairman.

MICHAEL PATRICK COONAN (sometimes known as Michael Patrick Joseph Coonan), late of Yea, in the State of Victoria, grazier, DECEASED.

CREDITORS, next of kin, and others having claims in respect of the estate of Michael Patrick Coonan (sometimes known as Michael Patrick Joseph Coonan), late of Yea, in the State of Victoria, grazier, deceased (who died on the 24th day of June, 1950), are to send particulars of their claims to the executors, care of R. G. Hoban, solicitor, Sydney-street, Kilmore, by the 7th day of December, 1950, after which date the executors will distribute the assets, having regard only to the claims of which they then have notice.

Dated the 26th day of September, 1950.

R. G. HOBAN, LL.B., solicitor, Sydney-street, Kilmore. 4531

CREDITORS, next of kin, and all others having claims against the estate of Charles Frederick Osborne, late of “St. Leonards,” 10 St. Leonards-avenue, St. Kilda, clerk, deceased (who died on the 25th day of June, 1950), are required by the sole executor of his will, Francis Read Monotti, of St. Arnaud, solicitor, to send particulars thereof to the said executor, care of the undersigned, on or before the 9th December, 1950, after which date the said executor will distribute the assets, having regard only to the claims of which he then has notice.

MITCHELL & MONOTTI, solicitors, St. Arnaud. 4528

CREDITORS, next of kin, and others having claims in respect of the estate of Richard Kelly, late of Shepparton, in the State of Victoria, Roman Catholic clergyman, deceased (who died on the 21st day of July, 1949), are to send particulars of their claims to the executor, Patrick O'Sullivan, care of his under-mentioned solicitor, on or before the 15th day of December, 1950, after which date the said Patrick O'Sullivan will proceed to distribute the assets of the said deceased, having regard only to the claims of which he then has notice.

JOHN F. RIORDAN, solicitor, of 45 Fryers-street, Shepparton. 4527

RE JAMES LYLE YOUNG, DECEASED.

PURSUANT to the provisions of the Trustee Act 1928, notice is hereby given that all persons having claims against the estate of James Lyle Young, formerly of 37 Park-street, St. Kilda, but late of 16 Selwyn-avenue, Elwood, in the State of Victoria, grazier, deceased (who died on the 3rd September, 1945, and probate of whose will was on the 8th October, 1945, granted by the Supreme Court of Victoria to Frank Newington Heathfield, of 230 Collins-street, Melbourne, solicitor, one of the executors appointed by the said will, are hereby required to send particulars, in writing, of such claims to the said executor, in the care of the under-mentioned solicitors, on or before 15th December, 1950, after which date the said executor will proceed to distribute the assets of the said deceased among the persons entitled thereto, having regard only to the claims of which he shall then have had notice in writing. And notice is hereby further given that the said executor will not be liable for the assets so distributed or any part thereof to any person or persons of whose claim he shall not then have had notice in writing, as aforesaid.

Dated this 2nd day of October, 1950.

SETON, WILLIAMS, & HEATHFIELD, solicitors, 230 Collins-street, Melbourne. 4553



**CREDITORS**, next of kin, and others having claims in respect of the estate of Thomas Leslie Cookson, late of 50 Clarendon-street, Thornbury, in the State of Victoria, printer, deceased (who died on 26th day of June, 1950), are to send particulars of their claims to Ivy Cookson, at the above address (or to the undersigned at his office hereunder mentioned), on or before the 30th day of November, 1950, after which date the said Ivy Cookson will proceed to distribute the assets of the said deceased, having regard only to the claims of which she then has notice.

ROYSTON T. CAHIR, solicitor, of 108 Queen-street, Melbourne. 4516

ALICE ELSEY BEGBIE, late of 316 McKinnon-road, McKinnon, widow (who died on 17th March, 1950).

**CREDITORS**, next of kin, and all others having claims in respect of the estate of the deceased are required by the executor, Vernon George Thurgood, of 20 Kingsley-street, Elwood, sales representative, to send to him particulars of such claims on or before the 20th December, 1950, after which date he will proceed to distribute the estate of the said deceased amongst the persons entitled thereto, having regard only to the claims of which he then has notice.

DAVIES, CAMPBELL, & PIESSE, solicitors, 401 Collins-street, Melbourne. 4513

**CREDITORS**, next of kin, and all others having claims against the estate of George Thomas Eaton, formerly of Bairnsdale, in the State of Victoria, mill manager, but late of 95 Easey-street, Collingwood, in the said State, tractor driver, deceased, intestate (who died on the 27th day of February, 1950), are requested to send particulars thereof, in writing, to The Union Trustee Company of Australia Limited, of No. 333 Collins-street, Melbourne, in the said State, on or before the 12th day of December, 1950, otherwise they may be excluded when the assets are being distributed.

Dated the 29th day of September, 1950.

Messrs. McLAUGHLIN, EAVES, & JOHNSTON, of 343 Little Collins-street, Melbourne, solicitors for the said company. 4510

SHIRLEY THORNTON MCKAY, formerly of 113 Grange-road, Toorak, but late of 6 Crocker-street, Ballarat, married woman, DECEASED (who died on the 5th day of July, 1950).

**CREDITORS**, next of kin, and all other persons having claims against the estate of Shirley Thornton McKay, formerly of 113 Grange-road, Toorak, but late of 6 Crocker-street, Ballarat, married woman, deceased, are required by the executors of the will, The Union Trustee Company of Australia Limited and James Watmough McKay to send particulars to them, care of The Union Trustee Company of Australia Limited, of 333 Collins-street, Melbourne, on or before the 8th day of December, 1950, after which date the said executors will distribute the assets, having regard only to the claims of which they then have notice.

MEARES, DUGAN, & HALL, solicitors, 339 Collins-street, Melbourne. 4509

FLORENCE MAY WHITE, of Warrenbayne, in the State of Victoria, married woman, DECEASED.

**CREDITORS**, next of kin, and all others having claims against the estate of the said deceased are required by Frederick Eden White, of Warrenbayne, farmer, the administrator of the estate of the said deceased, to send particulars of such claims to the said administrator, care of Hamilton, Clarke, and Clarke, 63 Nunn-street, Benalla, on or before the 5th day of December, 1950, after which date the said administrator will distribute the assets, having regard only to the claims of which he then has notice.

HAMILTON, CLARKE, & CLARKE, solicitors, 63 Nunn-street, Benalla. 4503

#### NOTICE TO CREDITORS.

**CREDITORS**, next of kin, and others having claims in respect of the estate of Edmund Withers Dawes, late of Bunyip, farmer, deceased (who died on 30th day of June, 1950), are to send particulars of their claims to the National Trustees, Executors, and Agency Company of Australasia Limited, the registered office of which is situate at 95 Queen-street, Melbourne, by the 12th day of December, 1950, after which date it will distribute the assets, having regard only to the claims of which it then has notice.

Dated the 2nd October, 1950.

M. DAVINE, solicitor, Warragul. 4504

No. 788.—10137/50.—4

**PURSUANT** to the *Trustee Act* 1928, all persons having claims against the estate of Robert Henry Luff, formerly of 246 Dorcas-street, South Melbourne, but late of 38 Burrindi-road, Caulfield, in the State of Victoria, retired carpenter, deceased (who died on the 23rd day of June, 1950, and probate of whose will was granted by the Supreme Court of Victoria on the 17th day of August, 1950, to John McDonald Martin, of 37 Queen-street, Melbourne, the executor appointed by the said will), are hereby required to send particulars of such claims to the said John McDonald Martin, care of the under-mentioned solicitors, on or before the 4th day of December, 1950, after which date the said executor will distribute the assets having regard only to the claims of which notice has then been received.

MARTIN & MARTIN, solicitors, 37 Queen-street, Melbourne. 4569

**PURSUANT** to the *Trustee Act* 1928, creditors, next of kin, and all other persons having claims in respect of the estate of Catherine Susan Matthews, late of 348 St. George's-road, North Fitzroy, in the State of Victoria, widow, deceased (who died on the 27th day of June, 1949, and probate of whose will was granted on the 16th day of March, 1950, to Gordon Kenneth Matthews, of 221 Nicholson-street, Carlton, driver, and Winifred Bailey, of 242 Blyth-street, East Brunswick, married woman), are hereby required to send particulars, in writing, of such claims to the said executors, care of the undersigned, at their office at the address mentioned hereunder, on or before the 15th day of December, 1950, after which date the said executors will proceed to distribute the assets of the said deceased, having regard only to the claims of which they shall then have had notice, and they will not be liable to any person of whose claim they shall not have then received notice.

SLATER & GORDON, solicitors, 422 Collins-street, Melbourne. 4520

**PURSUANT** to the *Trustee Act* 1928, creditors, next of kin, and all other persons having claims in respect of the estate of Arthur Smith, late of 52 Wantirna-road, Ringwood, in the State of Victoria, retired contractor, deceased (who died on the 9th day of December, 1949, and probate of whose will was granted on the 6th day of March, 1950, to Walter Frederick Smith, of 52 Narrawang-road, Caulfield, diver), are hereby required to send particulars, in writing, of such claims to the said executor, care of the undersigned, at their office at the address mentioned hereunder, on or before the 15th day of December, 1950, after which date the said executor will proceed to distribute the assets of the said deceased, having regard only to the claims of which he shall then have had notice, and he will not be liable to any person of whose claim he shall not have then received notice.

SLATER & GORDON, solicitors, 422 Collins-street, Melbourne. 4519

**PURSUANT** to the *Trustee Act* 1928, creditors, next of kin, and all other persons having claims in respect of the estate of Sarah Cook, late of 29 Prospect-street, Box Hill, in the State of Victoria, widow, deceased (who died on the 13th day of December, 1949, and probate of whose will was granted on the 20th day of June, 1950, to William Slater, of 422 Collins-street, Melbourne, solicitor), are hereby required to send particulars, in writing, of such claims to the said executor, care of the undersigned, at their office at the address mentioned hereunder, on or before the 15th day of December, 1950, after which date the said executor will proceed to distribute the assets of the said deceased, having regard only to the claims of which he shall then have had notice, and he will not be liable to any person of whose claim he shall not have then received notice.

SLATER & GORDON, solicitors, 422 Collins-street, Melbourne. 4518

JOSEPH PETER SCHEMBRI, late of Karadoc-avenue, Mildura, fruit grower, DECEASED (who died 23th May, 1950).

**CREDITORS**, next of kin, and all other persons having claims against the estate of deceased are required by The Fidelity Trustee Company Limited (formerly The Ballarat Trustees, Executors, and Agency Company Limited), of 101 Lydiard-street north, Ballarat, to send particulars to the company, on or before the 30th November, 1950, after which date it will distribute the assets, having regard only to the claims of which it then has notice.

PERCY T. PARK & HILLARD, solicitors, Mildura. 4501

*Trustee Act 1928.*

## NOTICE TO CLAIMANTS.

PURSUANT to the *Trustee Act 1928*, creditors, next of kin, and all other persons having claims in respect of the estate of any deceased person named below are required to send particulars thereof to the legal personal representative or representatives at the address stated below, on or before the date stated, after which date the representative or representatives will distribute the assets, having regard only to the claims of which notice has been received:—

Roy Gillett, late of Lara, farmer, died 29th April, 1950. —Claims to the applicant for letters of administration, James Thomas Gillett, of Lara, farmer, care of Wighton and McDonald, solicitors, 53 Yarra-street, Geelong, by 29th November, 1950. 4505

Henry Francis Bakker, late of St. Leonard's-road, Ascot Vale, Catholic clergyman, deceased, who died on the 8th June, 1950.—Claims to the executor, the Reverend Maurice Catarinich, care of M. Mornane, solicitor, 95 Queen-street, Melbourne, by the 7th December, 1950. 4548

Annie Louisa Batten, late of Langford-street, Moe, in the State of Victoria, married woman, deceased, who died on the 26th day of April, 1950.—Claims to the administrator, Eric Walter Batten, on or before the 4th day of December, 1950, care of Francis James Corder, of 108 Queen-street, Melbourne, solicitor. 4544

Mary Ann White, late of 33 Harold-street, Middle Park, in the State of Victoria, widow, deceased, who died on the 11th day of August, 1950.—Claims to the executrix, Mary Margaret Spriggins, on or before the 4th day of December, 1950, care of Francis James Corder, of 108 Queen-street, Melbourne, solicitor. 4517

CREDITORS, next of kin, and others having claims in respect of the estate of Ernest Ivan Williams, formerly of 9 Armillan-road, Moonee Ponds, but late of 20 Maniell-street, Moonee Ponds, in Victoria, draper, deceased (who died on the 12th day of July, 1950), are required by the executor of deceased's will, The Trustees, Executors, and Agency Company Limited, to send particulars of their claims to it, care of the under-mentioned solicitors, before the 8th day of December, 1950, after which date it will distribute the assets, having regard only to the claims of which it has then had notice.

C. J. McFARLANE & DOUGALL, 430 Little Collins-street, Melbourne. 4541

MARGARET JESSIE ALGIE, late of "Balgowan," Neerim South, widow, DECEASED.

CREDITORS, next of kin, and all other persons having claims against the estate of the said deceased are required by the executors of the will, Roderick Algie and David McCulloch Algie, both of Neerim South, graziers, to send particulars to them, care of the undersigned solicitors, on or before the 3rd day of December, 1950, after which date they will distribute the assets, having regard only to the claims of which they then have notice.

GRAY, FRIEND, & MOONIE, solicitors, Warragul. 4502

CREDITORS, next of kin, and others having claims in respect of the estate of Garnet Alfred Britter, late of 49 Spencer-street, St. Kilda, retired bank officer, deceased, intestate (who died on the 10th day of October, 1949), are to send particulars of their claims to the administratrix, Alma Augusta Britter, care of her under-mentioned solicitor, at his under-mentioned address, by the 5th day of December, 1950, after which date she will distribute the assets, having regard only to the claims of which she then has notice.

R. H. DUNN, solicitor, 421 Bourke-street, Melbourne. 4514

CREDITORS, next of kin, and others having claims against the estate of Euphemia McLean, formerly of Haines-street, Hawthorn, in the State of Victoria, but late of 451 Moreland-road, Moreland, in the said State, spinster, deceased (who died on 13th April, 1950), are to send particulars of their claims to The Union Trustee Company of Australia Limited, of 333 Collins-street, Melbourne, in the said State, by the 6th day of December, 1950, after which date it will distribute the assets, having regard only to the claims of which it then has notice.

MADDEN, BUTLER, ELDER, & GRAHAM, 406 Collins-street, Melbourne. 4567

CREDITORS, next of kin, and others having claims against the estate of Frances Alice Stevenson, late of 147 North-road, Gardenvale, in the State of Victoria, widow, deceased (who died on 31st July, 1950), are to send particulars of their claims to National Trustees, Executors, and Agency Company of Australasia Limited, of 95 Queen-street, Melbourne, in the said State, by the 6th day of December, 1950, after which date it will distribute the assets, having regard only to the claims of which it then has notice.

MADDEN, BUTLER, ELDER, & GRAHAM, 406 Collins-street, Melbourne. 4565

CREDITORS, next of kin, and others having claims against the estate of Helen Muirhead, late of 334 Albert-street, East Melbourne, in the State of Victoria, spinster, deceased (who died on 5th day of July, 1950), are to send particulars of their claims to The Union Trustee Company of Australia Limited, of 333 Collins-street, Melbourne aforesaid, by the 6th day of December, 1950, after which date it will distribute the assets, having regard only to the claims of which it then has notice.

MADDEN, BUTLER, ELDER, & GRAHAM, 406 Collins-street, Melbourne. 4566

ALFRED NUTTALL, late of 185 Waterdale-road, Ivanhoe, in the State of Victoria, accountant, DECEASED.

CREDITORS, next of kin, and others having claims against the estate of the above-named deceased are required by the executrix, Annie Helena Nuttall, to send particulars thereof to her, at the under-mentioned address, on or before the 15th day of December, 1950, after which date she will proceed to distribute the assets of the said deceased, having regard only to the claims of which she then has notice.

VROLAND, PEARCE, & WEBSTER, solicitors, of 430 Little Collins-street, Melbourne. 4577

LOUISA JANE RODDA, late of 18 Moonee-street, Ascot Vale, in Victoria, gentlewoman, DECEASED.

CREDITORS, next of kin, and others having claims against the estate of the above-named deceased (who died on the 26th day of February, 1950), are required by the executors, Herbert Foley Rodda and Charles Samuel Kent Rodda to send particulars thereof to them, care of C. S. K. Rodda, 18 Moonee-street, Ascot Vale, on or before the 15th day of December, 1950, after which date the executors will distribute the assets of the said deceased, having regard only to the claims of which they then have notice.

ROSE SPEARS, late of 13 Victoria-street, Preston, widow, DECEASED.

CREDITORS, next of kin, and others having claims in respect of the estate of the above-named deceased (who died on 15th June, 1950), are required to send the particulars of their claims to the executors, Henry Edmund Wright and Kenneth Roy Williams, care of the under-named solicitors, by the 6th day of December, 1950, after which date they will distribute the assets, having regard only to the claims of which they then have notice.

NORRIS, COATES, & HEARLE, solicitors, of 422 Collins-street, Melbourne. 4551

CREDITORS, next of kin, and others having claims in respect of Catherine Quinn, late of Brigidine Convent, Mentone, in the State of Victoria, spinster, deceased (who died on the 19th day of July, 1950, application for probate of whose will has been made by National Trustees, Executors, and Agency Company of Australasia Limited, whose registered address is 95 Queen-street, Melbourne, in the said State), are to send particulars, in writing, of their claims to the said company at its registered address aforesaid by the 5th day of December, 1950, after which date the said company will distribute the assets of the said deceased, having regard only to the claims of which it then has had notice.

BERNARD NOLAN, solicitor, 408 Collins-street, Melbourne. 4549

In the Supreme Court of the State of Victoria.—*Fi. Fa.*

NOTICE is hereby given that under and by virtue of a certain process issued out of the Supreme Court of the State of Victoria and directed to the Sheriff, requiring him to levy certain moneys of the real and personal estate of Robert Keith Ballantyne, of Buln Buln, in the State of Victoria, farmer, the said Sheriff will, on Thursday, the 9th day of November, 1950, at the hour of Two o'clock in the

afternoon, cause to be sold at the Police Station, Warragul (unless the said process shall have been previously satisfied or the said Sheriff be otherwise stayed):—

All the right, title, estate, and interest (if any) of the said Robert Keith Ballantyne, in and to firstly, all that piece of land containing 59 acres and 8 perches or thereabouts, being part of Crown allotment 35B, Parish of Drouin East, County of Buln Buln, being the whole of the land in certificate of title, volume 4781, folio 956130; secondly, insomuch and such parts as lie above the depth of 50 feet below the surface of all that piece of land containing 27 acres and 39 perches more or less, being allotments 14 and 14A of section B in the Parish of Neerim, County of Buln Buln, and being the whole of the land comprised in Crown grant volume 6382, folio 1276392.

N.B.—Terms: Cash. No cheques taken.

Dated at Warragul, this 2nd day of October, 1950.

4530 STANLEY FRANCIS BROWNE, Sheriff's Officer.

### MINING NOTICES.

#### CHEWTON GOLD MINES N. L.

NOTICE is hereby given that a Call (the 91st) of Three pence per share (making shares £1 6s. paid up) has been made upon the capital of the company, due and payable at the registered office of the company, 430 Little Collins-street, Melbourne, on Wednesday, the 11th day of October, 1950.

By order of the Board,

4564 A. E. LLEWELLYN, Manager.

#### ARDLETHAN TIN RESIDUES NO LIABILITY.

NOTICE is hereby given that a Call (No. 16) of Two shillings per share (making shares paid up to 18s.) has been made, and is due and payable to me at the registered office, 422 Collins-street, Melbourne, on Wednesday, 11th October, 1950.

By order of the Board,

4560 FRANK COOPER, Manager.

#### LADY CLAIRE GOLD No. 2 NO LIABILITY.

A CALL (the 2nd) of One shilling per share has been made on all the contributing shares recently issued in the capital of the company (making the shares paid to Four shillings each), due and payable at the company's registered office, 368 Collins-street, Melbourne, on Wednesday, 11th October, 1950.

4561 R. DOOLEY, Legal Manager.

#### ARGUS HILL CHEWTON GOLD NO LIABILITY.

NOTICE is hereby given that a Call (No. 82) of Three pence per share (making shares paid up to 23s.) has been made, and is due and payable to me at the registered office, 422 Collins-street, Melbourne, on Wednesday, 11th October, 1950.

By order of the Board,

4562 FRANK COOPER, Manager.

#### NORTH NELL GWYNNE GOLD MINES NO LIABILITY.

ALL shares upon which the 95th (September) Call of Three pence per share and previous Call remain unpaid are forfeited and will be sold by public auction at the Stock Exchange, Melbourne, on Thursday, 12th October, 1950, at Twelve noon, unless previously redeemed.

F. H. TADGELL, Manager.

Dickenson and Tadgell, chartered accountants (Aust.),  
46 Queen-street, Melbourne, C.1. 4563

#### NORTHERN STAR GOLD MINES NO LIABILITY.

NOTICE is hereby given that a Call (the 28th) of Four pence per share has been made upon all the contributing shares in the company, due and payable to the manager at the registered office, 140 Queen-street, Melbourne, on Wednesday, 11th October, 1950.

4555 F. L. SMYTH, Manager.

#### GOLDEN HIND MINING CO. NO LIABILITY.

NOTICE is hereby given that a Call (the 5th) of Six pence per share has been made on the capital of the company, due and payable on Wednesday, 11th October, 1950, at the registered office, 379 Collins-street, Melbourne.

By order of the Board,

4540 F. MATTHEWS, Manager.

#### BALLARAT SOUTH GOLDFIELDS N. L.

NOTICE is hereby given that a Call (No. 3) of One shilling per share (making shares paid up to 3s.) has been made on contributing shares in the above company, due and payable to me at the registered office, Sixth Floor, Temple Court, 422 Collins-street, Melbourne, on Wednesday, 11th October, 1950.

By order of the Board,

4550 JAMES L. MOORE, Manager.

#### NORTHERN STAR GOLD MINES NO LIABILITY.

NOTICE is hereby given that all shares forfeited for non-payment of the 27th (September) Call of Four pence per share will be sold by public auction at the Stock Exchange Hall, 428 Little Collins-street, Melbourne, on Thursday, 12th October, 1950, at Twelve o'clock noon, unless the shares be previously redeemed.

F. L. SMYTH, Manager.

Registered office: 140 Queen-street, Melbourne. 4556

#### SOUTH VIRGINIA GOLD MINING COMPANY NO LIABILITY.

NOTICE is hereby given that all shares forfeited for non-payment of the 48th (August) and 49th (September) Calls, each of Three pence per share, will be sold by public auction at the Stock Exchange Hall, 428 Little Collins-street, Melbourne, on Thursday, 12th October, 1950, at Twelve o'clock noon, unless the shares be previously redeemed.

F. L. SMYTH, Manager.

Registered office: 140 Queen-street, Melbourne. 4554

### IMPOUNDINGS.

#### ARARAT.—Impounded at Ararat.

1 Clydesdale gelding, white feet, blaze on face, aged, no visible brand

1 Jersey cow, one broken horn, no visible brand

If not claimed and expenses paid, to be sold on 18th October, 1950.

4522—7/4 D. J. BOWER,  
Poundkeeper.

#### CROYDON.—Impounded at Croydon.

1 light bay hack, blaze face, callous on fetlock, W near shoulder

If not claimed and expenses paid, to be sold on 21st October, 1950.

4533—6/5 E. MASON,  
Poundkeeper.

#### FERN TREE GULLY.—Impounded at Fern Tree Gully, by Shire Ranger.

1 chestnut gelding, about 14.2 hands, white hind feet, running star, no visible brand

1 bay gelding, about 14.2 hands, black points, star, no visible brand

If not claimed and expenses paid, to be sold on 19th October, 1950.

4571—9/2 A. DINSDALE,  
Poundkeeper.

#### HAMILTON.—Impounded at Hamilton, by the City Inspector.

1 brown gelding hack, 9 over 2 on off shoulder, 2 on near shoulder

If not claimed and expenses paid, to be sold on 19th October, 1950.

4535—7/4 R. J. WALTER,  
Poundkeeper.

#### SALE.—Impounded in the Sale Pound.

1 chestnut breedy type gelding, hind feet white, blaze both nostrils, no visible brand

If not claimed and expenses paid, to be sold on 10th October, 1950.

4534—6/5 G. CLARK,  
Poundkeeper.

**WANGARATTA.**—Impounded in Wangaratta Pound.  
 1 brown medium draught mare, aged, hind and near front feet white, no visible brand  
 If not claimed and expenses paid, to be sold on 19th October, 1950.  
 J. McDONNELL,  
 Poundkeeper.  
 4537—6/5

**WHITTLESEA.**—Impounded at Epping, by J. Hughes.  
 1 chestnut pony gelding, white star, no visible brand  
 If not claimed and expenses paid, to be sold on 19th October, 1950.  
 J. HERD,  
 Poundkeeper.  
 4536—5/6

MESSRS. GORDON & GOTCH, News Agents, 511 Little Collins-street, Melbourne; and corner Barrack and Clarence streets, Sydney.  
 W. GORDON HAMPTON, 243 Mitchell-street, Bendigo.  
 MESSRS. HARSTON, PARTRIDGE, & CO., 455 Little Collins-street, Melbourne.  
 MR. C. F. LATIMER, News Agent, Casterton.  
 MR. F. T. McCORMICK, Nunn-street, Benalla.  
 MESSRS. H. PAYNE & R. N. LOWE, 4 View Point, Bendigo.  
 MESSRS. R. H. & W. M. PETTY, News Agent, Wangaratta.  
 PIKE'S AUTHORIZED NEWS AGENCY, Sale.  
 J. PURDIE & CO., 138 Moorabool-street, Geelong.  
 MESSRS. A. S. RICHARDSON and T. C. GARDNER, trading as The Mercantile Exchange, 380 Collins-street, Melbourne.  
 ROBERTSON & MULLENS LTD., Elizabeth-street, Melbourne.  
 R. & A. SMALLMAN, News Agents, Toora.  
 MESSRS. SMITH & DUNNON, Hamilton.  
 TRAINOR & McBRIDE, 246 Wyndham-street, Shepparton.

A copy of the Gazette filed at each place for public reference.

THE "VICTORIA GOVERNMENT GAZETTE."

SUBSCRIPTIONS.—The subscription, including postage, is £1 12s. 6d. per annum, 16s. 3d. half-yearly, or 8s. 2d. per quarter, payable in advance.

Subscriptions are required to commence and terminate with a month.

A lesser period than three months cannot be subscribed for.

Subscribers do not receive the Acts of Parliament with the GAZETTE.

ADVERTISEMENTS are charged at the rate of ELEVEN PENCE per line single column, and ONE SHILLING and TEN PENCE per line double column.

The title (£5 Reward, Dissolution of Partnerships, &c.) forms one or more lines as a heading.

On an average, ten words make a line.

Every signature must likewise be counted as a line.

The final words of a paragraph, though only portion of a line, must be counted as one line.

SIGNATURES (in particular) and proper names must be written very plainly in the text; ONE SIDE ONLY of each slip of paper should be WRITTEN UPON.

ALL COMMUNICATIONS should be addressed to "The Government Printer, Melbourne."

ALL DOCUMENTS illegibly written will be returned unpublished, and, where brands occur unprovided for by the ordinary letters of the alphabet, a worded explanatory description must be furnished.

THE VICTORIA GOVERNMENT GAZETTE is published on WEDNESDAY EVENING in each week, and Notices for insertion will be received by the Government Printer at or before Two p.m. at ordinary rates, and late advertisements between Two p.m. and Five p.m. at double rates on the day preceding the day of publication.

Single copies of the VICTORIA GOVERNMENT GAZETTE are Six pence, posted Eight pence, each.

No GAZETTES prior to January, 1939, in stock.

\*\*\*ALL PAYMENTS ARE REQUIRED IN ADVANCE.—Remittances should be made by postal note, money order, or draft in favour of the Government Printer. Advertisements unaccompanied by a remittance sufficient to cover the cost of insertion will be returned unpublished.

AGENTS FOR THE "VICTORIA GOVERNMENT GAZETTE."

THE following have been appointed agents to receive Advertisements and Subscriptions for the Victoria Government Gazette:—

ARMSTRONG'S AGENCY, 143 Queen-street, Melbourne.  
 ARMSTRONG BROS., Kyneton.  
 MESSRS. ARNALL & JACKSON, 115 Barkly-street, West Brunswick.  
 MR. M. R. BADE, Tobacconist, Sturt-street, Ballarat.  
 MR. WM. DAVIS, Mildura.  
 A. J. DIGBY (B. S. and N. W. CASH), Main-street, Bairnsdale.  
 EDGAR'S NEWS AGENCY, Hargreaves-street, Bendigo.  
 EDGAR'S NEWS AGENCY, 53 Murphy-street, Wangaratta.  
 MESSRS. HENRY FRANKS & CO., Booksellers and Stationers, Market-square, Geelong.

PUBLICATION OF OFFICIAL MATTER.

ATTENTION is invited to the following procedure in relation to the publication of official matter in the Government Gazette:—

1. Matter submitted to the Executive Council.

Matter submitted to the Executive Council which requires gazettal will normally be published in the issue of the following week.

Where urgent gazettal is required, special arrangements should be made with the Gazette Officer.

Publication will be facilitated by the submission of carbon copies for the use of the Gazette Officer.

2. Other matter.

(a) All other matter duly certified by a responsible officer for publication should be lodged with the Gazette Officer not later than half-past Ten a.m. on Tuesday.

(b) Lengthy or involved notices should be forwarded several days before publication.

(c) Proofs, which will be supplied only when specifically requested or at the direction of the Gazette Officer, should be returned promptly to avoid delay in publication.

(d) No additions or amendments to matter for publication will be accepted by telephone.

CONTENTS.

	PAGE
Acts of Parliament .. .. .	5265
Appointments .. .. .	5267
Auction Sales Act .. .. .	5271
Bank Holidays .. .. .	5267
Cemetery—Scale of Fees .. .. .	5269
Contracts .. .. .	5274
Country Roads Board .. .. .	5288
Courts .. .. .	5268
Estates of Deceased Persons .. .. .	5280
Government Notices .. .. .	5268
Impoundings .. .. .	5307
Lands .. .. .	5289
Melbourne Cup Holiday .. .. .	5267
Mining .. .. .	5269, 5307
Notice to Mariners .. .. .	5283
Orders in Council .. .. .	5283
Private Advertisements .. .. .	5300
Proclamations .. .. .	5265
Public Holidays .. .. .	5266
Public Service Notices .. .. .	5293
Resignations .. .. .	5268
Rules of the Supreme Court .. .. .	5270
State Rivers and Water Supply Commission .. .. .	5268
Tenders .. .. .	5291
Transport Regulation Board—Public Hearings .. .. .	5281



VICTORIA  
GOVERNMENT GAZETTE.

Published by Authority.

[Registered at the General Post Office, Melbourne, for transmission by post as a newspaper.]

No. 789]

THURSDAY, OCTOBER 5.

[1950

Prices Regulation Acts.

PRICES REGULATION ORDER No. 180.

MILK—VICTORIA—COUNTRY AREAS.

IN pursuance of the powers conferred upon me by the Prices Regulation Acts, I, John Francis Waldron, Prices Decontrol Commissioner, hereby make the following Order:—

*Citation.*

1. This Order may be cited as Prices Regulation Order No. 180.

*Revocation.*

2. Prices Regulation Order No. 36, as amended by Prices Regulation Orders Nos. 84 and 141, is hereby revoked.

*Definitions and Interpretation.*

3. (1) In this Order, unless the contrary intention appears—
  - “By retail” or “by wholesale” means, in relation to any sale of milk, that such sale is a sale by retail or by wholesale, as the case may be, but is not a sale by semi-wholesale.
  - “By semi-wholesale” means, in relation to the sale of any milk—
    - (a) that such milk is sold by a retailer to a person to whom the retailer has, on the day of the sale, sold a quantity of milk (including that comprised in such first-mentioned sale) exceeding 2 gallons; or
    - (b) is a sale to a person who conducts a shop where milk is sold separately from any milk round.
  - “Central Area” means the area specified in Part I. of the Second Schedule to this Order.
  - “Gippsland Area” means the area specified in Part II. of the Second Schedule to this Order.
  - “Mallee Area” means the area specified in Part III. of the Second Schedule to this Order.
  - “Melbourne Milk Board Area” means the area which, at the date of this Order, constituted the Metropolis as defined for the purposes of the Milk Board Acts.
  - “North-Central Area” means the area specified in Part IV. of the Second Schedule to this Order.

"North-Eastern Area" means the area specified in Part V. of the Second Schedule to this Order.

"Northern Area" means the area specified in Part VI. of the Second Schedule to this Order.

"Treatment" includes the pasteurization, cooling, chilling, refrigerating of milk, and "treated" has a corresponding meaning.

"Western Area" means the area specified in Part VII. of the Second Schedule to this Order.

"Wimmera Area" means the area specified in Part VIII. of the Second Schedule to this Order.

(2) For the purpose of this Order, where any post office or principal post office of any place is situated less than 3 miles from any boundary line of any area defined in this Order, then all places within 3 miles of that post office, or principal post office, as the case may be, shall be deemed to be within the area in which that post office, or principal post office, is situated.

*Maximum Prices—Specified Areas.*

4. I fix and declare the maximum price at which milk may be sold for delivery in any of the areas specified in the first column of the First Schedule to this Order to be—

(a) in respect of sales to retailers (excluding semi-wholesale sales):

- (i) where delivery is taken at the retailer's premises—the price specified in the second column of that Schedule opposite to such area; or
- (ii) where delivery is taken at any other place—the price specified in sub-paragraph (i) of this paragraph less the cost which would be incurred in transporting the milk to the retailer's premises;

(b) in respect of sales by retail:

- (i) where such milk is not sold in a sealed container—
  - (A) the price specified in the fourth column of that Schedule opposite such area; or
  - (B) the price paid or payable by the retail seller for such milk plus an amount computed at the rate of 1s. 6½d. per gallon, plus any cost incurred in transporting that milk to his premises, whichever is the lesser;

or

- (ii) where such milk is sold in a sealed container—the price specified in sub-paragraph (i) of this paragraph, plus an amount computed at the rate of ¾d. per quart.

Provided that the maximum price for milk supplied to persons having milk delivered to them regularly in retail quantities of one pint or more per day shall be computed on a weekly basis by multiplying the total quartage delivered during such week by the maximum price per quart fixed by the foregoing provisions of this sub-paragraph.

(c) in respect of sales by semi-wholesale:

- (i) where such milk is not sold in a sealed container—
  - (A) the price specified in the third column of that Schedule opposite such area; or
  - (B) the price paid or payable for such milk by the semi-wholesaler plus an amount calculated at the rate of 9½d. per gallon, whichever is the lesser;

or

- (ii) where such milk is sold in a sealed container—the price specified in paragraph (i) of this paragraph, plus an amount computed at the rate of 3d. per gallon.

*Maximum Prices—Treatment Depots.*

5. Notwithstanding the foregoing provisions of this Order, I fix and declare the maximum price at which milk may be sold to any person (other than a retailer) for treatment in any area specified in the Schedules to this Order to be the maximum price for the sale of that milk to a retailer in that area less an amount computed at the rate of 1d. per gallon.

6. Notwithstanding the foregoing provisions of this Order, I fix and declare the maximum price at which milk may be sold to a retailer by any person who has purchased that milk and treated that milk in any area specified in the Schedules to this Order to be the maximum price fixed for the sale of that milk to a retailer in that area, plus an amount computed at the rate of 1d. per gallon.

*Fixation of Maximum Prices by Notice.*

7. Notwithstanding the foregoing provisions of this Order, I fix and declare the maximum price at which milk may be sold in any area specified in the Schedules to this Order by any person to whom a notice is given in pursuance of this clause to be the price fixed by the Prices Decontrol Commissioner by notice in writing to that person.

THE FIRST SCHEDULE.

First Column. Area.	Second Column.	Thrd Column.	Fourth Column.
	Sales to Retailers.	Sales by Semi-wholesale.	Sales by Retail.
	Per Gallon. s. d.	Per Gallon. s. d.	Per Quart. s. d.
Central Area .. .. .	1 9½	2 7	0 10
Gippsland Area .. .. .	1 9½	2 7	0 10
Western Area .. .. .	1 9½	2 7	0 10
North-Eastern Area .. .. .	1 9½	2 7	0 10
North-Central Area .. .. .	1 11½	2 9	0 10½
Northern Area .. .. .	1 11½	2 9	0 10½
Wimmera Area .. .. .	2 1½	2 11	0 11
Mallee Area .. .. .	2 3½	3 1	0 11½

THE SECOND SCHEDULE.

PART. I.

*Central Area.*

All that area of Victoria comprising the following shires and boroughs:—

Shires—

- |               |                |
|---------------|----------------|
| Bacchus Marsh | Cranbourne     |
| Ballan        | Gisborne       |
| Ballarat      | Healesville    |
| Bannockburn   | Melton         |
| Bass          | Phillip Island |
| Berwick       | Romsey         |
| Bungaree      | Upper Yarra    |
| Buninyong     |                |

Boroughs—

- |            |           |
|------------|-----------|
| Ballarat   | Wonthaggi |
| Sebastopol |           |

and all that part of the following shires outside the Melbourne Milk Board Area:—

- |              |            |
|--------------|------------|
| Braybrook    | Kellor     |
| Broadmeadows | Whittlesea |
| Bulla        |            |

PART II.

*Gippsland Area.*

All that area of Victoria comprising the following shires and borough:—

Shires—

- |            |                 |
|------------|-----------------|
| Alberton   | Omeo            |
| Avon       | Orbost          |
| Bairnsdale | Rosedale        |
| Buln Buln  | South Gippsland |
| Korumburra | Tambo           |
| Maffra     | Traralgon       |
| Mirboo     | Warragul        |
| Morwell    | Woorayl         |
| Narracan   |                 |

Borough—

- Sale

THE SECOND SCHEDULE—*continued.*

## PART III.

*Mallee Area.*

All that area of Victoria comprising the following shires and boroughs:—  
Shires—

Birchip	Swan Hill
Karkaroc	Walpeup
Mildura	Wycheproof

Boroughs—

Mildura	Swan Hill
---------	-----------

and all that area of Victoria within the following shires north of 36 degrees latitude:—

Dimboola	Lowan
Kaniva	

## PART IV.

*North-Central Area.*

All that area of Victoria comprising the following shires and boroughs:—  
Shires—

Alexandra	Metcalfe
Broadford	Newham and Woodend
Creswick	Newstead and Mt. Alexander
Glenlyon	Pyalong
Kilmore	Seymour
Kyneton	Talbot
Lexton	Tullaroop
Maldon	Yea

Boroughs—

Castlemaine	Daylesford
Clunes	Maryborough

## PART V.

*North-Eastern Area.*

All that area of Victoria comprising the following shires and boroughs:—  
Shires—

Beechworth	Rutherglen
Benalla	Towong
Bright	Violet Town
Chiltern	Wangaratta
Euroa	Wodonga
Goulburn	Upper Murray
Mansfield	Yackandandah
Oxley	

Borough—

Wangaratta
------------

## PART VI.

*Northern Area.*

All that area of Victoria comprising the following shires and boroughs:—  
Shires—

Cohuna	Rochester
Deakin	Rodney
East Loddon	Shepparton
Gordon	Tungamah
Kerang	Waranga
McIvor	Yarrowonga
Numurkah	

Boroughs—

Echuca	Shepparton
--------	------------

and all that part of the following shires outside the Melbourne Milk Board Area:—

Huntly	Strathfieldsaye
Marong	

## PART VII.

*Western Area.*

All that area of Victoria comprising the following shires and boroughs:—  
Shires—

Ararat	Minhamite
Belfast	Mortlake
Colac	Mt. Rouse
Dundas	Otway
Glenelg	Portland
Grenville	Ripon
Hampden	Wannon
Heytesbury	Warrnambool
Leigh	Winchelsea

Boroughs—

Colac	Port Fairy
Hamilton	Portland
Koroit	Warrnambool



THE SECOND SCHEDULE—*continued.*

PART VIII.

Wimmera Area.

All that area of Victoria comprising the following shires and boroughs:—

Shires—

Arapiles	Kara Kara
Avoca	Korong
Bet Bet	Kowree
Charlton	Stawell
Donald	Warracknabeal
Dunmunkle	Wimmera

Boroughs—

Ararat	St. Arnaud
Horsham	Stawell
Inglewood	

and all that area of Victoria within the following shires south of 36 degrees latitude:—

Dimboola	Lowan
Kaniva	

Dated this 27th day of September, 1950.

J. F. WALDRON,  
Prices Decontrol Commissioner.

Prices Regulation Acts.

PRICES REGULATION ORDER No. 181.

GROCERIES—RETAIL—VICTORIA.

IN pursuance of the powers conferred upon me by the Prices Regulation Acts, I, John Francis Waldron, Prices Decontrol Commissioner, hereby make the following Order:—

*Citation.*

1. This Order may be cited as Prices Regulation Order No. 181.

*Amendment.*

2. Prices Regulation Order No. 171 is hereby amended—
  - (a) by deleting from the Schedule thereto the items appearing in the First Schedule to this Order;
  - (b) by inserting in the Schedule thereto the items appearing in the Second Schedule to this Order.

THE FIRST SCHEDULE.

<i>Description.</i>	<i>Maximum Price.</i>
	<i>s. d.</i>
CHEESE—	
Danish Blue .. .. .	per lb. 7 10
DIABETIC FOODS—	
Biscuits—	
Goldberg .. .. .	1-lb. packet 1 8
Flour, Self-Raising—	
Goldberg .. .. .	1-lb. packet 1 6
Porridge—	
Goldberg .. .. .	1-lb. packet 1 6
OILS—	
Shell, Household .. .. .	4-oz. tin 0 10
Shell, Household .. .. .	8-oz. tin 1 2
SALT—	
Cerebos .. .. .	24-oz. tin 1 9
Cerebos, iodized .. .. .	24-oz. drum 1 9
Cerebos, plain .. .. .	3-lb. tin 3 3
Cerebos, iodized .. .. .	3-lb. tin 3 3
Cerebos .. .. .	28-lb. tin 17 8
Mary Baker, Onion .. .. .	cruet 0 8½
Mary Baker, Onion .. .. .	packet 0 7
Mary Baker, Celery .. .. .	cruet 0 9
Mary Baker, Celery .. .. .	packet 0 6
Saxa .. .. .	16-oz. packet 0 6
Saxa .. .. .	24-oz. drum 1 3
Saxa, iodized .. .. .	16-oz. packet 0 6
Saxa, iodized .. .. .	24-oz. drum 1 3
Saxa .. .. .	2-lb. drum 1 10

## THE FIRST SCHEDULE—continued.

Description.	Maximum Price.	
	s.	d.
SOAP, SAND—		
A.H.P. .. .. .	12-oz. cake	0 4
Clipper .. .. .	cake	0 3
Crofts .. .. .	cake	0 2
Eclipse .. .. .	12-oz. cake	0 5½
Federal .. .. .	cake	0 2½
Gem .. .. .	cake	0 4
Juvo .. .. .	cake	0 2
Lectric .. .. .	cake	0 4
McLeods .. .. .	12-oz. cake	0 5½
Medal .. .. .	small cake	0 2
Melray .. .. .	small cake	0 2
Melray .. .. .	large cake	0 3
Monkey .. .. .	5½-oz. cake	0 4½
Pearlite .. .. .	9-oz. cake	0 3½
Pearsons .. .. .	14-oz. cake	0 5½
Preservene .. .. .	12-oz. cake	0 5½
Valu .. .. .	cake	0 2
STARCH—		
White Ray .. .. .	12-oz. packet	1 0

## THE SECOND SCHEDULE.

CHEESE—		
Danish Blue, "Dana" Brand .. .. .	per lb.	7 0
Danish Blue, "Plumrose" Brand .. .. .	per lb.	7 10
Danish Camembert, "De Paradis" Brand .. .. .	5½-oz. portion	4 2
Girgarre Werder .. .. .	per lb.	2 6½
Gruyere (Swiss), "Rigi" Brand .. .. .	8-oz. box	6 5
CHEESE SPREAD—		
"Rex" Luncheon .. .. .	4-oz. cans	1 3½
DIABETIC FOODS—		
Biscuits—		
Goldberg Gluten .. .. .	per ½-lb. packet	2 2
Bread—		
Goldberg Gluten .. .. .	1-lb. loaf	1 8
Flour—		
Goldberg Plain .. .. .	1-lb. packet	1 10
Goldberg Self-Raising .. .. .	1-lb. packet	1 10
Porridge—		
Goldberg Diabetic .. .. .	1-lb. packet	1 10
FRUITS—CANNED—		
Apricots, "Croydon Brand" .. .. .	30-oz. tin	1 10½
Blackberries, "Norwood" Brand .. .. .	30-oz. tin	2 10
Cherries, "Croydon" Brand .. .. .	30-oz. tin	2 5½
Pears, "Croydon" Brand .. .. .	30-oz. tin	1 11
Peaches (Free stone), "Croydon" Brand .. .. .	30-oz. tin	1 9½
Plums, "Croydon" Brand .. .. .	30-oz. tin	1 8½
Quinces, "Norwood" Brand .. .. .	30-oz. tin	1 10½
Fruit Salad, "Barossa" Brand .. .. .	16-oz. tin	1 5½
INVALIDS' AND INFANTS' FOODS—		
Sanatogen, Size 1 .. .. .	per container	4 9
Sanatogen, Size 2 .. .. .	per container	8 1
Sanatogen, Size 3 .. .. .	per container	15 3
Sanatogen, Size 4 .. .. .	per container	25 2
JAMS AND JELLIES—		
W. A. Blake Pty. Ltd. ("Sundowner" Brand)—		
Apple Conserve .. .. .	24-oz. tin	1 5½
Apple Conserve .. .. .	5-lb. tin	4 7
Apple Jelly .. .. .	24-oz. tin	1 5½
Apple Jelly .. .. .	5-lb. tin	4 7
Apricot (Golden) .. .. .	24-oz. tin	1 6½
Apricot (Golden) .. .. .	5-lb. tin	4 10
Apricot and Pine .. .. .	24-oz. tin	1 8
Apricot and Pine .. .. .	5-lb. tin	5 1½
Blackberry .. .. .	24-oz. tin	1 10
Blackberry .. .. .	5-lb. tin	5 10
Blackcurrant .. .. .	24-oz. tin	2 1
Blackcurrant .. .. .	5-lb. tin	6 7½
Blackcurrant and Apple .. .. .	24-oz. tin	1 10½
Blackcurrant and Apple .. .. .	5-lb. tin	6 3½
Fig Conserve .. .. .	24-oz. tin	1 8
Gooseberry .. .. .	24-oz. tin	1 7½
Grape Conserve .. .. .	24-oz. tin	1 6½
Loganberry .. .. .	24-oz. tin	1 11½

## THE SECOND SCHEDULE—continued.

Description.	Maximum Price.	
	s.	d.
JAMS AND JELLIES—continued.		
W. A. Blake Pty. Ltd. ("Sundowner" Brand)—continued.		
Marmalade, Golden .. .. .	24-oz. tin	1 7
Marmalade, Golden .. .. .	5-lb. tin	4 11½
Marmalade, Grapefruit .. .. .	24-oz. tin	1 6½
Marmalade, Grapefruit .. .. .	5-lb. tin	4 9½
Marmalade, Sweet Orange .. .. .	24-oz. tin	1 7
Marmalade, Sweet Orange .. .. .	5-lb. tin	4 11½
Melon and Ginger .. .. .	24-oz. tin	1 6
Melon and Ginger .. .. .	5-lb. tin	4 7½
Melon Jelly .. .. .	24-oz. tin	1 6½
Melon and Lemon .. .. .	24-oz. tin	1 6
Melon and Lemon .. .. .	5-lb. tin	4 7½
Melon and Pine .. .. .	24-oz. tin	1 6½
Melon and Pine .. .. .	5-lb. tin	4 9½
Peach Conserve .. .. .	24-oz. tin	1 6
Peach Conserve .. .. .	5-lb. tin	4 8
Peach and Pine .. .. .	24-oz. tin	1 7
Peach and Pine .. .. .	5-lb. tin	4 11½
Plum, Gipsy .. .. .	24-oz. tin	1 5
Plum, Gipsy .. .. .	5-lb. tin	4 4
Plum, Fairy .. .. .	24-oz. tin	1 5
Plum, Fairy .. .. .	5-lb. tin	4 4
Plum and Raspberry .. .. .	24-oz. tin	1 7
Plum and Raspberry .. .. .	5-lb. tin	4 10½
Quince Conserve .. .. .	24-oz. tin	1 6
Quince Conserve .. .. .	5-lb. tin	4 8
Quince Jelly .. .. .	24-oz. tin	1 7
Quince Jelly .. .. .	5-lb. tin	4 11½
Raspberry .. .. .	24-oz. tin	2 0½
Raspberry .. .. .	5-lb. tin	6 6½
Raspberry and Apple .. .. .	24-oz. tin	1 10½
Redcurrant Jelly .. .. .	24-oz. tin	2 1
Strawberry .. .. .	24-oz. tin	2 8
Cottees Passiona Ltd.—		
Blackberry .. .. .	8-oz. carton	0 11
Blackberry .. .. .	8-oz. tumbler	1 6
Blackberry .. .. .	16-oz. jar	1 11½
Blackcurrant Jelly .. .. .	16-oz. jar	2 0
Raspberry Jelly .. .. .	8-oz. tumbler	1 7
Raspberry Jelly .. .. .	16-oz. jar	2 2
Strawberry Conserve .. .. .	8-oz. carton	1 1
Strawberry Conserve .. .. .	8-oz. tumbler	1 8½
Strawberry Conserve .. .. .	16-oz. jar	2 4
J. C. Mellor and Co. Pty. Ltd., "Wine Glo" Brand—		
Blackberry Jelly .. .. .	9½-oz. tumbler	1 7
Blackberry Jelly .. .. .	15-oz. jar	2 1½
Blackcurrant Jelly .. .. .	9½-oz. tumbler	1 7½
Blackcurrant Jelly .. .. .	15-oz. jar	2 2
Loganberry Jelly .. .. .	9½-oz. tumbler	1 7½
Loganberry Jelly .. .. .	15-oz. jar	2 2½
Raspberry Jelly .. .. .	9½-oz. tumbler	1 8
Raspberry Jelly .. .. .	15-oz. jar	2 3
"Croydon" Brand—		
Apricot .. .. .	24-oz. tin	1 8½
Imported—		
Marmalade, "Silver Shred" .. .. .	16-oz. jar	3 0
MARGARINE—		
Margarine (Cake), Wrapped .. .. .	1-lb. pat	1 0
Margarine (Pastry), Wrapped .. .. .	1-lb. pat	1 0
OILS—		
Shell Household .. .. .	4-oz. tin	1 1
Shell Household .. .. .	8-oz. tin	1 7
Shell Lighter Fluid .. .. .	4-oz. tin	1 2
Shell Lighter Fluid .. .. .	4-oz. bottle	0 11
Castor .. .. .	2-oz. bottle	0 10
Castor .. .. .	2½-oz. bottle	1 0
Castor .. .. .	4-oz. bottle	1 6
Castor .. .. .	5-oz. bottle	2 2½
Castor .. .. .	10-oz. bottle	3 4
Eucalyptus .. .. .	1-oz. bottle	1 0
Eucalyptus .. .. .	2-oz. bottle	1 5½
Eucalyptus .. .. .	3-oz. bottle	1 10
Eucalyptus .. .. .	4-oz. bottle	2 7½
Paraffin .. .. .	8-oz. bottle	1 5
Paraffin .. .. .	10-oz. bottle	1 8
Paraffin .. .. .	16-oz. bottle	2 5
Paraffin .. .. .	26-oz. bottle	3 4½
RICE—		
Rice Flour .. .. .	per lb.	0 5½

## THE SECOND SCHEDULE—continued.

Description.	Maximum Price. s. d.
<b>SALT—</b>	
Celery (Mary Baker) .. .. . per 3-oz. cruet	0 10
Celery (Mary Baker) .. .. . per 5-oz. packet	0 7
Onion (Mary Baker) .. .. . per 3-oz. cruet	1 0
Onion (Mary Baker) .. .. . per 5-oz. packet	0 11½
Cerebos, Plain or Iodized .. .. . 24-oz. tin	1 9½
Cerebos, Plain or Iodized .. .. . 3-lb. tin	3 4
Cerebos, Plain or Iodized .. .. . 28-lb. tin	17 9
Saxa, Plain or Iodized .. .. . 1-lb. packet	0 6½
Saxa, Plain or Iodized .. .. . 24-oz. packet	1 3½
<b>SOAP EXTRACTS—</b>	
Pental .. .. . per 12-oz. packet	0 11½
Sparkle .. .. . per 16-oz. packet	1 2
<b>SOAP, TOILET—</b>	
Christy's No. 134, Fancy Carton, Three Tablets .. .. . per carton	3 11
Christy's No. 234, Fancy Carton, Three Tablets .. .. . per carton	3 11
Christy's No. 334, Fancy Carton, Three Tablets .. .. . per carton	3 11
Christy's No. 301, Humpty Dumpty, One Tablet .. .. . per tablet	2 6
Christy's No. 302, Lemon Bucket, Three Tablets .. .. . per bucket	4 6
Christy's No. 303, Lemon Bon Bon, Two Tablets .. .. . per bon bon	2 3
Christy's No. 304, Lemon Bunch, Two Tablets .. .. . per bunch	2 3
Christy's No. 354, Fancy Cartons, Three Tablets .. .. . per carton	2 3
Christy's No. 306, Sambo, One Tablet ..	per tablet 2 6
Christy's No. 307, Old King Cole, One Tablet .. .. . per tablet	2 6
<b>STARCH—</b>	
White Ray .. .. . 12-oz. packet	1 2
<b>SUGAR-ICING MIXTURES—</b>	
Wilton King .. .. . per lb. carton	0 11
Others, Loose .. .. . per lb.	0 6½

Dated this 27th day of September, 1950.

J. F. WALDRON,  
Prices Decontrol Commissioner.

Prices Regulation Acts.

PRICES REGULATION ORDER No. 182.

ZINC.

IN pursuance of the powers conferred upon me by the Prices Regulation Acts, I, John Francis Waldron, Prices Decontrol Commissioner, hereby make the following Order:—

*Citation.*

1. This Order may be cited as Prices Regulation Order No. 182.

*Amendment.*

2. Prices Regulation Order No. 46 is hereby amended by omitting from paragraph 4 the words and figures "£40 per ton" and inserting in their stead the words and figures "£65 per ton".

Dated this 27th day of September, 1950.

J. F. WALDRON,  
Prices Decontrol Commissioner.

## Prices Regulation Acts.

## PRICES REGULATION ORDER No. 183.

## LEAD.

IN pursuance of the powers conferred upon me by the Prices Regulation Acts, I, John Francis Waldron, Prices Decontrol Commissioner, hereby make the following Order:—

*Citation.*

1. This Order may be cited as Prices Regulation Order No. 183.

*Amendment.*

2. Prices Regulation Order No. 47 is hereby amended by omitting from paragraph 4 the words and figures "£35 per ton" and inserting in their stead the words and figures "£65 per ton".

Dated this 27th day of September, 1950.

J. F. WALDRON,  
Prices Decontrol Commissioner.

## Prices Regulation Acts.

## PRICES REGULATION ORDER No. 184.

## SECOND-HAND BAGS AND SACKS.

IN pursuance of the powers conferred upon me by the Prices Regulation Acts, I, John Francis Waldron, Prices Decontrol Commissioner, hereby make the following Order:—

*Citation.*

1. This Order may be cited as Prices Regulation Order No. 184.

*Revocation.*

2. Prices Regulation Order No. 105, as amended by Prices Regulation Order No. 164, made under the Prices Regulation Acts, is hereby revoked.

*Definitions and Interpretations.*

3. (1) In this Order, unless the contrary intention appears—

"Cost of Transport" means, in relation to any sale of second-hand bags or sacks, the cost of transport (if any) incurred by the seller in transporting the goods from the point of delivery to his place of business and recorded on an invoice or docket delivered in relation thereto.

"Once Used" means, in relation to any sugar sack, wheat sack, barley sack, or rice sack, a sack which has been only once previously used as a container for sugar, wheat, barley, or rice, as the case may be, and has not been used for any other purpose.

"Point of Delivery" means, in relation to the sale of any second-hand bag or sack by any person, the place at which liability for payment of transport charges in conveying such bag or sack to his place of business passed to the seller from the person from whom he purchased it.

"Second-hand Bag or Sack" means a bag or sack which has been used at least once for the purpose of containing goods.

"'A' Licensee" means a person who was, prior to the 7th day of February, 1946, the holder of an "A" licence, issued pursuant to the Control of Second-hand Jute Goods Order, dated 26th September, 1942, and published in the *Commonwealth of Australia Gazette*, dated 9th October, 1942.

"'B' Licensee" means a person who was, prior to the 7th day of February, 1946, the holder of a "B" licence, issued pursuant to the Control of Second-hand Jute Goods Order, dated 26th September, 1942, and published in the *Commonwealth of Australia Gazette*, dated 9th October, 1942.

- (2) Any bag or sack sold by any person other than an "A" licensee, which when reconditioned would conform to any of the descriptions of bags or sacks specified in the Schedule to this Order, shall for the purpose of this Order be deemed to be of that description at the time of such sale.

4. (1) I fix and declare the maximum price at which any second-hand bag or sack of a description set out in the Schedule to this Order may be sold by any person to be the price specified in the second, third, or fourth columns of the said Schedule (as the case requires) according as the seller is an "A" licensee or a "B" licensee, or is a person not being either of such licensees.

(2) Notwithstanding anything contained in the last preceding sub-clause, I fix and declare the maximum price at which any second-hand bag or sack of a description set out in the said Schedule and which has been purchased by the seller from a person who is an "A" licensee may be sold to be the sum of—

- (i) the price paid or payable by the seller for that bag or sack or the maximum price specified in the fourth column of the said Schedule for the sale of that description of bag or sack by a person who is an "A" licensee, whichever is the lesser;
- (ii) cost of transport; and
- (iii) a margin at the rate of Six pence per dozen bags or sacks (as the case requires).

*Fixation of Maximum Prices by Notice.*

5. Notwithstanding the foregoing provisions of this Order, I declare the maximum price at which any second-hand bags or sacks specified in a notice given in pursuance of this paragraph may be sold by any person to whom such notice is given to be such price as is fixed by the Commissioner by notice in writing to that person.

*Delivery of Invoices.*

6. Every person who sells second-hand bags or sacks shall deliver with those goods an invoice or docket specifying the following particulars:—

- (a) Date of sale,
- (b) name of purchaser,
- (c) address of purchaser,
- (d) quantity of bags or sacks sold,
- (e) full description of bags or sacks sold,
- (f) price at which those goods are sold.

THE SCHEDULE.

Column 1. Description.	Column 2. Sales by any Person other than an "A" or "B" Licensee.	Column 3. Sales by "B" Licensee.	Column 4. Sales by "A" Licensee.
	Per Doz. s. d.	Per Doz. s. d.	Per Doz. s. d.
1. Once-used sugar sacks free from holes and repairs and not being brushed, washed, or mill marked sugar sacks .. .. .	31 6	32 3	34 9
2. Once-used wheat, barley, and rice sacks free from holes and patches .. .. .	29 6	30 3	32 3
3. Potato sacks free from holes and patches .. .. .	25 6	26 6	29 0
4. No. 1 flour sacks free from holes and patches .. .. .	25 6	26 6	29 0
5. Sugar sacks, mill marked, washed or brushed, free from holes and patches, not being sugar sacks of the kind referred to in item (1) of this Schedule .. .. .	26 0	27 0	28 9
6. Offal and oat sacks .. .. .	18 9	20 3	23 9
7. No. 1 four-bushel sacks free from holes and patches .. .. .	19 0	20 0	22 0
8. No. 2 four-bushel sacks .. .. .	14 9	16 0	19 0
9. Ash, coke, charcoal, or lime sacks, or sacks other than sacks of the kind referred to elsewhere in this Schedule .. .. .	11 9	13 0	16 6
10. No. 1 quality chaff or bran bags in sound order and condition .. .. .	23 9	25 0	27 6
11. No. 2 quality chaff or bran bags .. .. .	19 0	20 3	22 9
12. 70-lb. sugar bags .. .. .	6 6	7 6	8 6

Dated this 29th day of September, 1950.

J. F. WALDRON,  
Prices Decontrol Commissioner.

By Authority: J. J. GOURLEY, Government Printer, Melbourne.

**DETERMINATION OF THE SHOPS BOARD No. 16 (HARDWARE).**

---

**NOTE.**

A notice of appeal to the Industrial Appeals Court has been lodged against certain parts of the Determination.

Section 22 (2), Act 4874, provides that, when an appeal is made in accordance with that Act, the Determination or part thereof appealed against shall not come into operation until the Appeal has been dealt with by the Court.

9492/50.

**MEAL MONEY.**

5. Where overtime, as in the preceding clause, is performed on any day in the week, an allowance of 3s. 6d. shall be made for meal money, and shall be paid on the day when such work is performed.

**SUNDAYS AND HOLIDAYS.**

6. Double time shall be the rate for all work done on Sundays, New Year's Day, Australia Day, Labour Day, Good Friday, Easter Saturday, Easter Monday, King's Birthday, Christmas Day and Boxing Day, and within the Metropolitan District Melbourne Cup Day and after 12 noon on Melbourne Show Day. If any other day be by Act of Parliament or Proclamation substituted for any of the abovenamed holidays the rate shall be payable for work done only on the day so substituted. All employees shall be entitled to the abovenamed holidays without deduction of pay.

**TIME RATE.**

7. Any person employed on time wages for less than the number of hours fixed for an ordinary week's work shall for each hour worked up to 20 hours be paid—

(a) In any week in which two or more Public Holidays occur . . . . . At the ordinary wages rate with an addition of fifty per centum.

(b) In any other week . . . . . At the ordinary wages rate with an addition of thirty-three and one-third per centum.

and for each hour worked beyond the 20 hours aforesaid shall be paid the ordinary wages rate up to but not exceeding ordinary wages rates for an ordinary week's work.

Provided that an employer may deduct payment for any day an employee cannot be usefully employed because of any strike or through any breakdown of machinery or any stoppage of work by any other cause arising out of such strike and for which the employer cannot be held responsible. Provided further that any such time lost shall be counted as time worked in computing sick leave under this Determination.

**TERMINATION OF EMPLOYMENT.**

8. Except where the conduct of an employee justifies instant dismissal, seven days' notice of termination of employment shall be given by either employer or employee, or one week's wages shall be paid or forfeited in lieu thereof.

**PAY DAY.**

9. All wages, overtime, &c., shall be paid not later than Thursday of each week.

**NOTICE TO WORK OVERTIME.**

10. No employee shall be obliged to work overtime unless he has received at least 24 hours' notice of same.

**NOTICE OF INTENTION TO RATION.**

11. Where an employer owing to slackness of trade desires to ration his employees, he shall give seven days' notice to each employee of his intention to ration such employee.

**ANNUAL LEAVE.**

12. The annual holiday shall be as prescribed by the provisions of the *Factories and Shops (Annual Holidays) Act 1946* (No. 5111), and any amendments which may be made thereto from time to time.

(In his or her own interests each employer of labour should obtain a copy of the above Act, which may be purchased from the Government Printer, Melbourne, at a cost of 1s., plus postage.)

**SICK LEAVE.**

13. (a) Any employee who, having had at least three months' service with the same employer, is absent from duty as a result of personal ill health or accident shall be entitled to sick pay as follows:—

(i) During the first year—3½ hours' ordinary pay for each complete month of service.

(ii) During any subsequent year of service—40 hours' ordinary pay.

Provided that, in either case such employee produces or forwards within 48 hours of the commencement of such absence evidence satisfactory to the employer that his or her non-attendance was due to personal ill health or accident necessitating such absence.

(b) If the full period of sick leave as prescribed above is not taken in any year such portion as is not taken shall, provided an employee remains in the service of the one employer, or any successor of such employer, be cumulative from year to year. For the purposes of this sub-clause service prior to the 1st October, 1947, shall be disregarded.

**MEAL INTERVALS.**

14. One hour shall be given for a meal, between the hours of noon and 3 p.m.

NOTE.—Section 117 (3) of the *Factories and Shops Act 1928* (No. 3377) provides that no person shall be employed in any shop more than five hours without an interval for a meal

**BICYCLE ALLOWANCE.**

15. Where a bicycle is provided by an employee and is required to be used in connexion with his employer's business, an allowance of 6d. per day or part thereof for each day on which he is so required to use such bicycle, shall be paid by the employer.

**GARMENT ALLOWANCE.**

16. Any employee who is required to wear, when at work, a washable outer garment, dust coat, or overall, shall be paid 2s. 6d. per week in addition to the ordinary wage, unless the garment is both provided and laundered by the employer.

**REFERENCE.**

17. On an employee being dismissed or leaving his employment he shall be entitled to a reference showing his period of service and qualifications.

**TIME AND WAGES RECORDS.**

18. Time and wages records showing the name of each employee, the hours worked each week by, and the wages and overtime paid to, each employee, shall be kept by his employer and completed weekly. Such records shall be open for inspection by a duly accredited representative of the Shop Assistants and Warehouse Employees' Federation of Australia.

Provided that an inspection shall not be demanded unless the Secretary or other paid official of the Union suspects a breach of the Determination has been committed.

**REST PERIOD.**

19. A rest period of ten minutes each morning and afternoon shall be granted each employee, such periods are to be counted as time worked.

**DEFINITIONS.**

20. "Departmental manager" shall mean a person having the control of one or more salesmen, 21 years of age or over, notwithstanding he may be under the orders of a general manager.

"Branch manager" shall mean and include a person for the time being entrusted with the control or superintendence of a shop or of a branch shop (the proprietor of which is trading under his own or a different name), notwithstanding such manager may be under the orders of a superior who does not devote the whole of his time to the management of the said shop or branch shop.

"Outside salesman" shall mean an employee who for at least half the working hours in any week solicits or receives orders for goods while absent from the shop where he is employed, whether such goods are kept in stock or have to be procured in order to fulfil such orders.

"Assembler" shall mean an employee 21 years of age or over who is engaged in assembling goods for order and despatch from salesmen's and/or travellers' lists or invoices.



**DETERMINATION OF THE SHOPS BOARD No. 16 (HARDWARE).**

**NOTE.**

A notice of appeal to the Industrial Appeals Court has been lodged against certain parts of the Determination.

Section 22 (2), Act 4874, provides that, when an appeal is made in accordance with that Act, the Determination or part thereof appealed against shall not come into operation until the Appeal has been dealt with by the Court.

9492/50.

