



VICTORIA
GOVERNMENT GAZETTE.

Published by Authority.

[Registered at the General Post Office, Melbourne, for transmission by post as a newspaper.]

No. 540]

WEDNESDAY, JULY 15.

[1953

Land Act 1928.

AREAS OF LANDS COMPRISED IN CERTAIN CLASSES DIMINISHED OR INCREASED.

PROCLAMATION

By His Excellency the Administrator of the Government of the State of Victoria and its Dependencies in the Commonwealth of Australia, &c., &c., &c.

WHEREAS by the *Land Act 1928* it is amongst other things enacted that the Governor in Council, may, by Proclamation to be published in the *Government Gazette*, at any time diminish or increase the area of land comprised in any of the classes mentioned in Part I., Division 1, section 5, of the said *Land Act 1928*, but that the area of lands which may be sold by auction (Class 6) shall not be increased except as in certain cases in the said Act provided: Now therefore I, the Administrator of the Government of the State of Victoria, in the Commonwealth of Australia, by and with the advice of the Executive Council of the said State, and in accordance with the provisions of sections 94 and 117 of the *Land Act 1928* aforesaid, do hereby diminish or increase (as the case may be) the areas of Crown lands comprised in Classes 3, 6, and 7 of the classes mentioned in section 5 of the *Land Act 1928* aforesaid to the extent set forth in the subjoined Schedule (that is to say):—

Schedule referred to.

CLASSES DIMINISHED OR INCREASED.

| County. | Parish. | Allotment. | Section. | Area. | Diminished. | Increased. | Description. |
|--------------|----------------|------------|----------------|-----------------------------------|-------------|------------|------------------------------------|
| | | | | | Class. | Class. | |
| | | | | A. R. P. | | | |
| Bogong .. | Carlyle .. | Pt. 22B | 44 | 1 0 0 | .. | .. | In east of parish. (H.016453) |
| Gladstone .. | Salisbury West | 7K | C | 209 0 0 (Subject to survey) | 7 | 3 | In south-west of parish. (W.67676) |
| Talbot .. | Castlemaine .. | 145A | D ^o | 5 2 38 | 7 | 6 | Fronting Tomkies-street. (W.66012) |

Given under my Hand and the Seal of the State of Victoria aforesaid, at Melbourne, this eighth day of July, in the year of our Lord One thousand nine hundred and fifty-three, and in the second year of the reign of Her Majesty Queen Elizabeth II.

(L.S.)

CHARLES J. LOWE.

By His Excellency's Command,

R. W. HOLT,
Commissioner of Crown Lands and Survey.

GOD SAVE THE QUEEN!

Soldier Settlement Act 1946 (No. 5179).

ROADS CLOSED.

PROCLAMATION

By His Excellency the Administrator of the Government of the State of Victoria and its Dependencies in the Commonwealth of Australia, &c., &c., &c.

WHEREAS section 6 (1) of the *Soldier Settlement Act 1946 (No. 5179)* prescribes that where any road (whether used or unused and whether formed or unformed) forms part of or intersects any Estate and the Soldier Settlement Commission, after consultation with the Council or Councils of the Municipality or Municipalities concerned certifies that the said road is unsuited to the proper subdivision of the Estate:

And whereas the Soldier Settlement Commission, after consultation with the Councils of the Municipalities concerned has so certified:

Now therefore, I, the Administrator of the Government of the State of Victoria, in the Commonwealth of Australia, by and with the advice of the Executive Council of the said State, and in pursuance of section 6 of the *Soldier Settlement Act 1946 (No. 5179)* do by this my Proclamation direct that the roads, as described hereunder, be closed, that is to say:

Parish of Denison, County of Tanjil, being the road between subdivision A of allotment 4A, subdivision B of allotment 4A, section 12, and allotment 4D, section 12.—(D.48⁽²⁾) (G.N.7).

Parish of Eilyar, County of Hampden, being the road indicated by hachure on plan hereunder.—(E.20(A¹)) (D.9298).

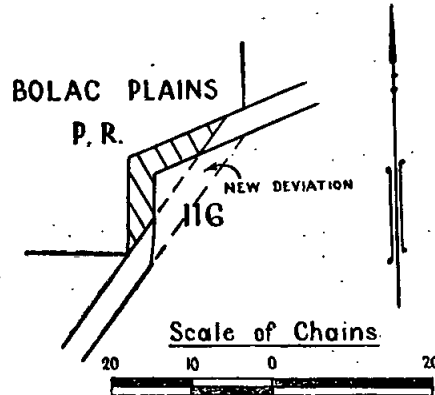

Parish of Marong, County of Bendigo, being the road indicated by hachure on plan hereunder.—(M.32⁽³⁾) (D.2618).

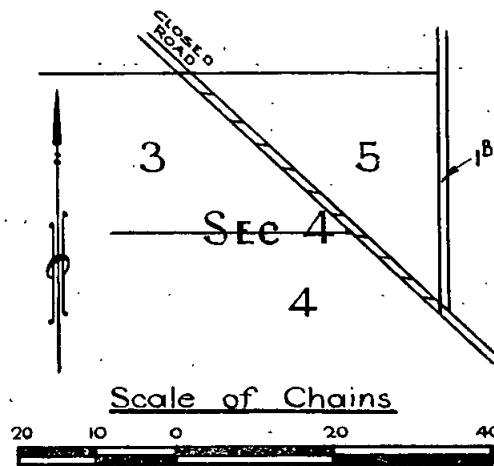

Parishes of Enuç and Mahkwallok, County of Ripon, being the roads indicated by hachure on plan hereunder.—(E.90(A¹) (M.401⁽²⁾) (D.13130).

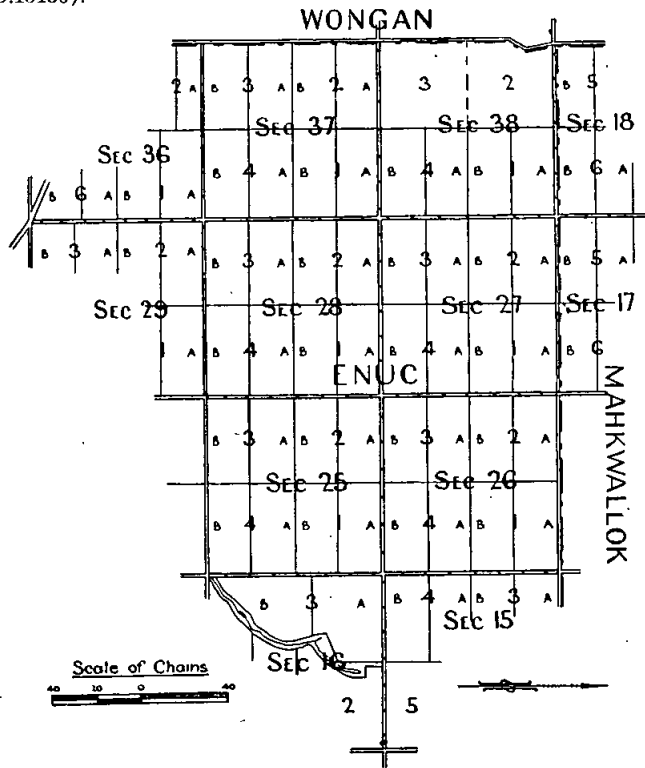

Parish of Wongan, County of Ripon, being the road indicated by hachure on plan hereunder.—(W.231⁽²⁾) (D.13130).

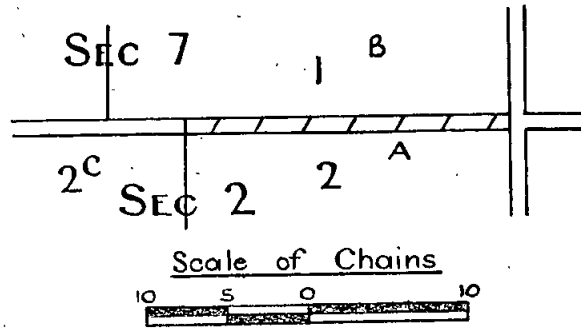

Parish of Kilnoorat, County of Hampden, being the road indicated by hachure on plan hereunder.—(K.53⁽²⁾) (D.5709).

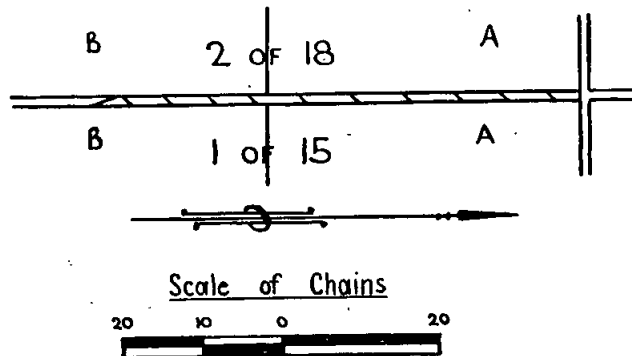

Parish of Wongan, County of Ripon, being the road indicated by hachure on plan hereunder.—(W.231⁽²⁾) (D.13130).

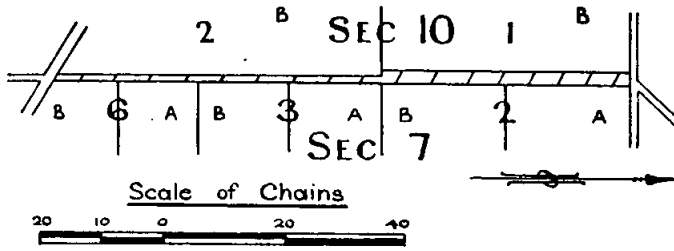

Parish of Wongan, County of Ripon, being the roads indicated by hachure on plan hereunder.—(W.231⁽²⁾) (D.13130).

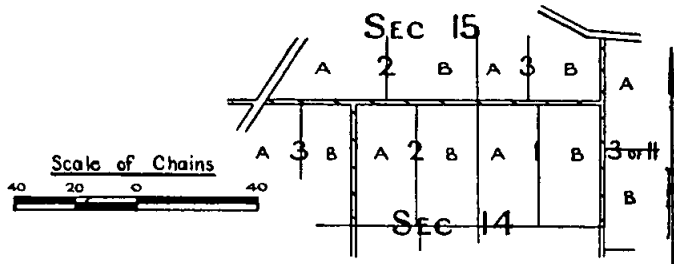

Parish of Mahkwallok, County of Ripon, being the road between subdivisions A and B of allotment 2, subdivisions A and B of allotment 5, section 13, and subdivision A of allotment 3, allotment 4, section 13.—(M.401⁽²⁾) (D.13130).

Parish of Gembrook, County of Evelyn, being the road indicated by hachure on plan hereunder.—(G.206⁽¹⁰⁾) (D.1363).

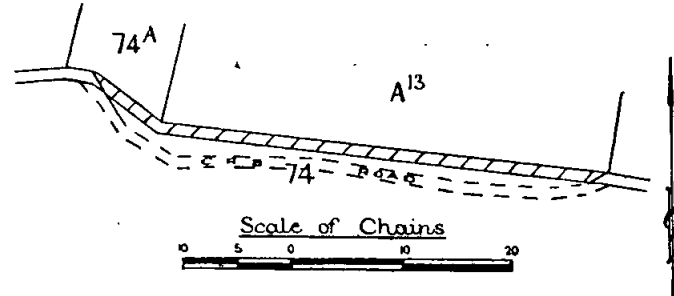

Parish of Gembrook, County of Evelyn, being the roads indicated by hachure on plan hereunder.—(G.206⁽¹⁰⁾) (D.1363).

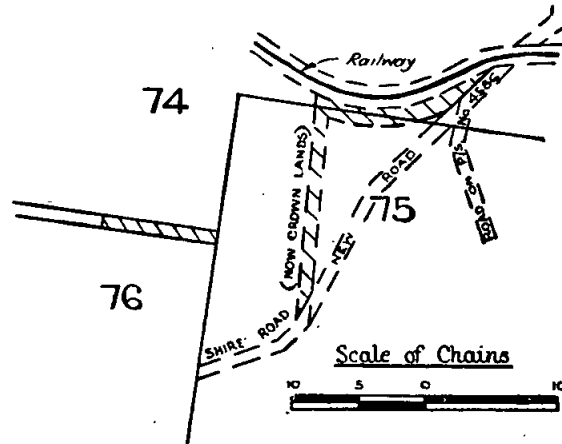

Parish of Kilnoorat, County of Hampden, being the roads indicated by hachure on plan hereunder.—(K.53⁽²⁾) (D.5709).

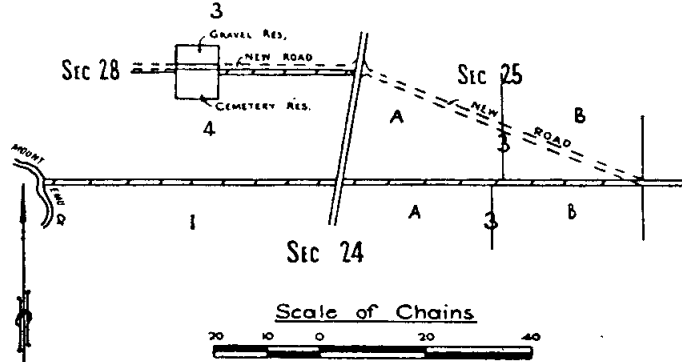

Parish of Kilnoorat, County of Hampden, being the road indicated by hachure on plan hereunder.—(K.53⁽²⁾) (D.5709).

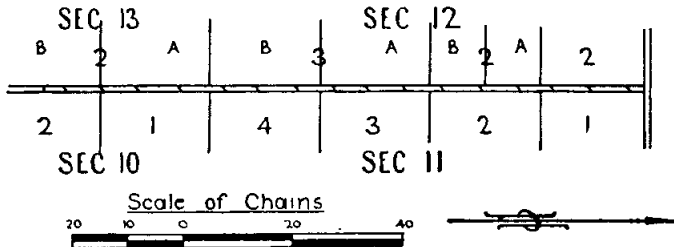

Parish of Pircarra, County of Hampden, being the road indicated by hachure on plan hereunder.—(P.122⁽²⁾) (D.5⁽⁴⁾) (D.5709).

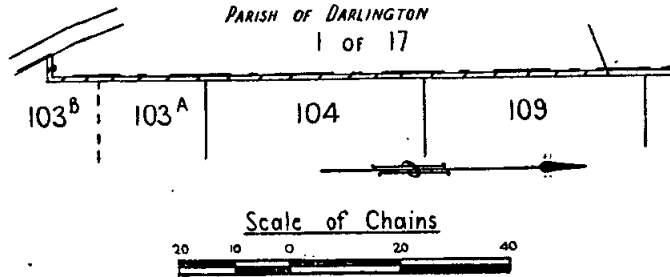

Parish of Pircarra, County of Hampden, being the road indicated by hachure on plan hereunder.—(P.122⁽²⁾) (D.5709) (D.16675).

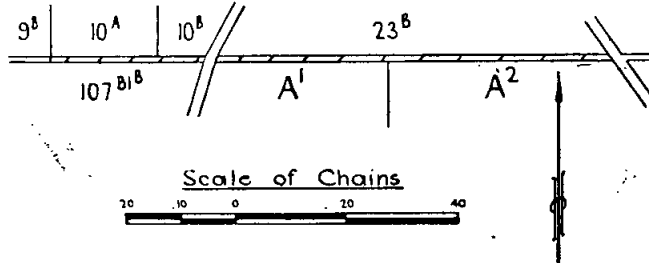

Parish of Pircarra, County of Hampden, being the road indicated by hachure on plan hereunder.—(P.122⁽²⁾) (D.16675).

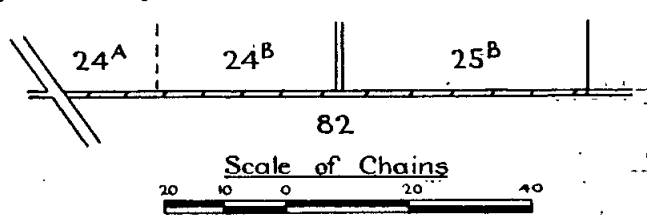

Parish of Pircarra, County of Hampden, being the road indicated by hachure on plan hereunder.—(P.122⁽²⁾) (D.5709).

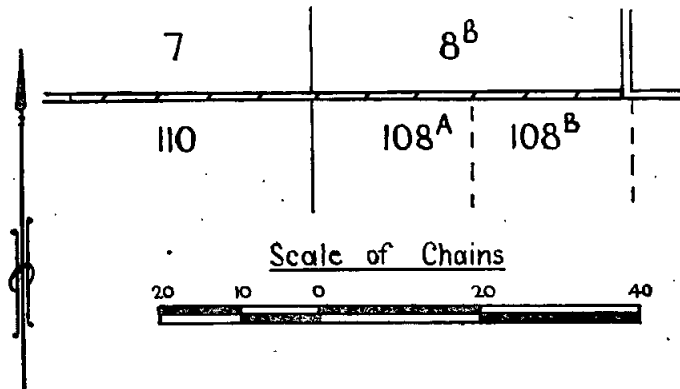

Parish of Mannibadar, County of Grenville, being the roads indicated by hachure on plan hereunder.—(M.90⁽²⁾) (D.21576).

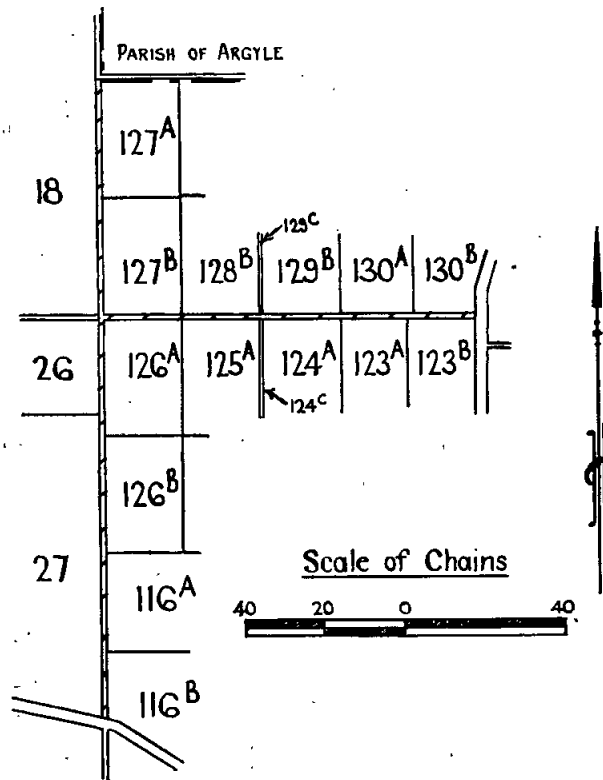

Township of Wonthaggi North, Parish of Wonthaggi North, County of Mornington, being the road indicated by hachure on plan hereunder.—(W.345⁽¹⁵⁾) (W.345⁽¹²⁾) (D.19786).

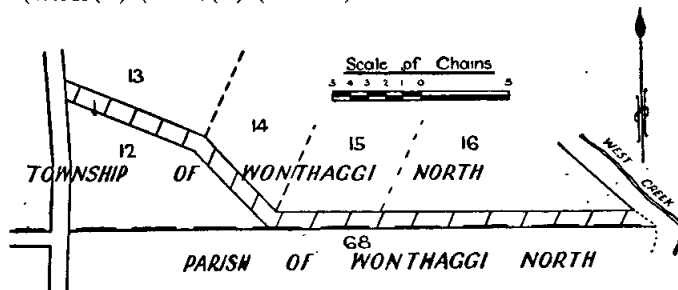

Parish of Woodstock, County of Bendigo, being the road indicated by hachure on plan hereunder.—(W.185⁽²⁾) (D.2618).

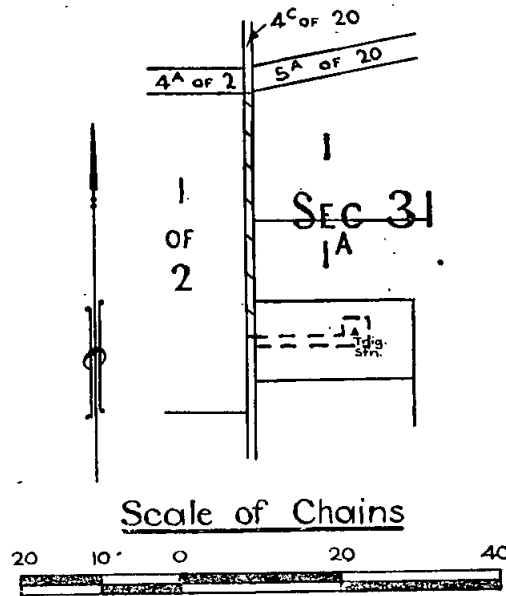

Parish of Neerim, County of Buln Buln, being the road indicated by hachure on plan hereunder.—(N.121⁽⁴⁾) (D.16958).

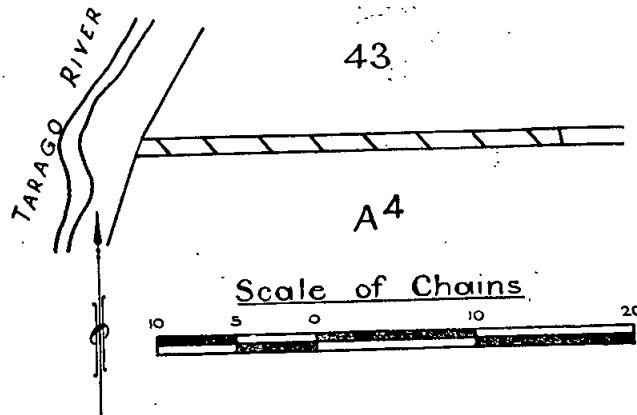

Parish of Yackandandah, County of Bogong, being the road between allotments 2C, 1B, 1A, section 7, and allotments 2D, 2C, 3A, 3B, section 8.—(Y.45⁽⁷⁾) (D.1565).

Parish of Yackandandah, County of Bogong, being the road between allotment 1A, section 8, and allotment 2A, section 8.—(Y.45⁽⁷⁾) (D.1565).

Given under my Hand and the Seal of the State of Victoria aforesaid, at Melbourne, the fourteenth day of July, in the year of our Lord One thousand nine hundred and fifty-three, and in the second year of the reign of Her Majesty Queen Elizabeth II.

(L.S.)

CHARLES J. LOWE.

By His Excellency's Command,

R. W. HOLT,

Commissioner of Crown Lands and Survey.

GOD SAVE THE QUEEN!

PUBLIC HIGHWAY.—CITY OF MOORABBIN.

PROCLAMATION

By His Excellency the Administrator of the Government of the State of Victoria and its Dependencies in the Commonwealth of Australia, &c., &c., &c.

WHEREAS by the *Local Government Act 1946* (No. 5203), section 518, it is amongst other things enacted that it shall be lawful for the Governor in Council at any time, and from time to time, upon the request of the council of any municipality, by notice in the *Government Gazette*, to declare any land reserved, used or by purchase or exchange acquired for a street, road, highway, thoroughfare, bridge, square, court, alley or right-of-way to be a public highway, and that such land shall thereupon and thenceforth from the date of such Proclamation become and be absolutely dedicated to the public as a public highway within the meaning of any law then or thereafter in force:

And whereas the Council of the City of Moorabbin has requested that the land hereinafter mentioned, which has been used for a street within the said City, be so declared to be a public highway:

Now, therefore, I, the Administrator of the Government of the State of Victoria in the Commonwealth of Australia, by and with the advice of the Executive Council of the said State, do by this Proclamation declare that all that piece of land in the municipal district of the City of Moorabbin described hereunder shall be a public highway within the meaning of the said Act, viz.:—

LAUREL-STREET.

Commencing at a point on the west street alignment of East Boundary-road a distance of 615 ft. 9 in. north of the intersection of the prolongation of the north street alignment of Centre-road and the prolongation of the west street alignment of East Boundary-road, thence north-westerly a distance of 9 ft. 11 in. on a bearing of 315 deg. 6 min., thence westerly a distance of 540 ft. 11 in. on a bearing of 270 deg. 13½ min., thence south-westerly a distance of 9 ft. 11 in. on a bearing of 225 deg. 6 min., thence northerly a distance of 57 feet on a bearing of 359 deg. 58 min., thence easterly a distance of 554 ft. 11 in. on a bearing of 90 deg. 13½ min., thence southerly a distance of 57 feet on a bearing of 179 deg. 58 min. back to the commencing point.

Given under my Hand and the Seal of the State of Victoria aforesaid, at Melbourne, this eighth day of July, in the year of our Lord One thousand nine hundred and fifty-three, and in the second year of the reign of Her Majesty Queen Elizabeth II.

(L.S.) **CHARLES J. LOWE.**

By His Excellency's Command,
S. MERRIFIELD,
Commissioner of Public Works.

GOD SAVE THE QUEEN!

PUBLIC HIGHWAY.—CITY OF OAKLEIGH.
KINRADE-STREET AND PART DALLAS-AVENUE.

PROCLAMATION

By His Excellency the Administrator of the Government of the State of Victoria and its Dependencies in the Commonwealth of Australia, &c., &c., &c.

WHEREAS by the *Local Government Act 1946* (No. 5203), section 518, it is amongst other things enacted that it shall be lawful for the Governor in Council at any time, and from time to time, upon the request of the council of any municipality, by notice in the *Government Gazette*, to declare any land reserved, used or by purchase or exchange acquired for a street, road, highway, thoroughfare, bridge, square, court, alley or right-of-way to be a public highway, and that such land shall thereupon and thenceforth from the date of such Proclamation become and be absolutely dedicated to the public as a public highway within the meaning of any law then or thereafter in force:

And whereas the Council of the City of Oakleigh has requested that the lands hereinafter mentioned, which have been used for streets within the said City, be so declared to be public highways:

Now, therefore, I, the Administrator of the Government of the State of Victoria in the Commonwealth of Australia, by and with the advice of the Executive Council of the said State, do by this Proclamation declare that all those

pieces of land used for streets and being the parts of Crown portion 85, Parish of Prahran, County of Bourke, indicated by hachure on the plan hereunder shall be public highways within the meaning of the said Act, viz.:—

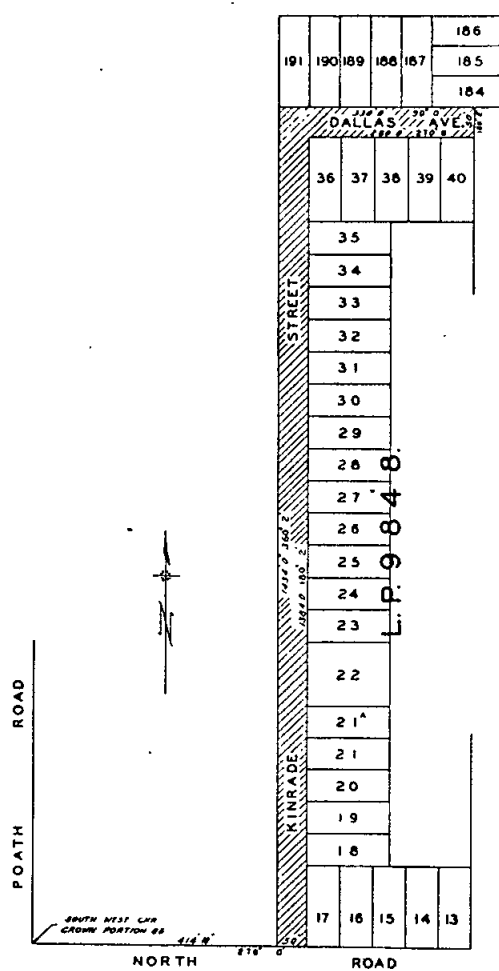

Given under my Hand and the Seal of the State of Victoria aforesaid, at Melbourne, this eighth day of July, in the year of our Lord One thousand nine hundred and fifty-three, and in the second year of the reign of Her Majesty Queen Elizabeth II.

(L.S.) **CHARLES J. LOWE.**

By His Excellency's Command,
S. MERRIFIELD,
Commissioner of Public Works.
GOD SAVE THE QUEEN!

Marketing of Primary Products Act 1935 (No. 4337).
DECLARATION THAT A BOARD SHALL BE CONSTITUTED IN RELATION TO SEED BEANS.

PROCLAMATION

By His Excellency the Administrator of the Government of the State of Victoria and its Dependencies in the Commonwealth of Australia, &c., &c., &c.

WHEREAS in accordance with sub-section (5) of section 6 of the *Marketing of Primary Products Act 1935*, more than sixty per centum of the producers of seed beans entitled to vote at a poll taken on the question whether a marketing board shall be constituted in relation to seed beans, voted thereat, and more than sixty per centum of the votes polled are in favour of the constitution of a board. Now therefore, I, the Administrator of the Government of the State of Victoria, in the Commonwealth of Australia, by and with the advice of the Executive Council

of the said State by this my Proclamation hereby declare that a marketing board shall be constituted in relation to seed beans and that the provisions of the said Act shall apply to seed beans.

Given under my Hand and the Seal of the State of Victoria aforesaid, at Melbourne, this eighth day of July, in the year of our Lord One thousand nine hundred and fifty-three, and in the second year of the reign of Her Majesty Queen Elizabeth II.

(L.S.) CHARLES J. LOWE.

By His Excellency's Command,
C. P. STONEHAM,
Minister of Agriculture.

GOD SAVE THE QUEEN!

Land Acts.

PROCLAMATION RESCINDED AND TOWNSHIP OF HEYFIELD PROCLAIMED.

PROCLAMATION

By His Excellency the Administrator of the Government of the State of Victoria and its Dependencies in the Commonwealth of Australia, &c., &c., &c.

I THE Administrator of the Government of the State of Victoria in the Commonwealth of Australia by and with the advice of the Executive Council of the said State and in pursuance of the provisions contained in section 25 of the *Land Act 1928* as amended by section 2 of the *Land Act 1933* do by this my Proclamation rescind the Proclamation dated 14th February 1882 defining a certain area of land as the Town of Heyfield (see *Government Gazette 1882* page 414) and in lieu thereof do hereby proclaim as a Township under the designation of Heyfield the area of land in the Parish of Tinamba, County of Tanjil within the boundaries indicated by conventional township sign on the plan hereunder.—(H.110(1) (T.147(4) (C.95176).

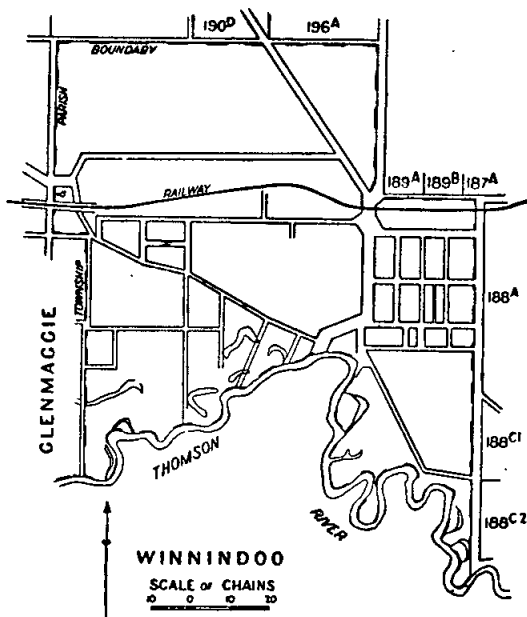

Given under my Hand and the Seal of the State of Victoria aforesaid, at Melbourne, this eighth day of July, in the year of our Lord One thousand nine hundred and fifty-three, and in the second year of the reign of Her Majesty Queen Elizabeth II.

(L.S.) CHARLES J. LOWE.

By His Excellency's Command,
R. W. HOLT,
Commissioner of Crown Lands and Survey.
GOD SAVE THE QUEEN!

Land Act 1928.

PROCLAMATION RESCINDED AND TOWNSHIP OF TOOLONDO PROCLAIMED.

PROCLAMATION

By His Excellency the Administrator of the Government of the State of Victoria and its Dependencies in the Commonwealth of Australia, &c., &c., &c.

I THE Administrator of the Government of the State of Victoria in the Commonwealth of Australia by and with the advice of the Executive Council of the said State and in pursuance of the provisions contained in section 25 of the *Land Act 1928* do by this my Proclamation rescind the Proclamation dated 12th November 1912 defining a certain area of land as the Township of Toolondo (see *Government Gazette 1912* page 4848) and in lieu thereof do hereby proclaim as a Township under the designation of Toolondo the area of land in the Parish of Toolondo, County of Lowan within the boundaries indicated by conventional township sign on the plan hereunder.—(T.187(2) (C.95358).

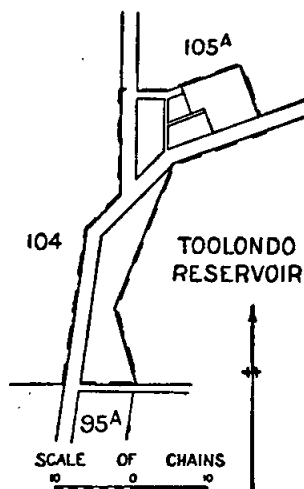

Given under my Hand and the Seal of the State of Victoria aforesaid, at Melbourne, this eighth day of July, in the year of our Lord One thousand nine hundred and fifty-three, and in the second year of the reign of Her Majesty Queen Elizabeth II.

(L.S.) CHARLES J. LOWE.

By His Excellency's Command,
R. W. HOLT,
Commissioner of Crown Lands and Survey.
GOD SAVE THE QUEEN!

PUBLIC HOLIDAYS.

PROCLAMATION

By His Excellency the Administrator of the Government of the State of Victoria and its Dependencies in the Commonwealth of Australia, &c., &c., &c.

IN pursuance of the provisions contained in Part III. of the *Public Service Act 1946*, I, the Administrator of the Government of the State of Victoria, in the Commonwealth of Australia, by and with the advice of the Executive Council of the said State, do by this my Proclamation appoint the days and dates hereunder mentioned to be observed as Public Holidays or Public Half-Holidays (as the case may be) at the places respectively specified, viz.:—

Public Holidays.

- WEDNESDAY, THE 5TH DAY OF AUGUST, 1953, throughout the Shire of Tungamah.
- *MONDAY, THE 10TH DAY OF AUGUST, 1953, throughout the Shire of Stawell.
- FRIDAY, THE 21ST DAY OF AUGUST, 1953, throughout the Underbool and Walpeup Ridings in the Shire of Walpeup.

Public Half-Holidays from the Hour of Twelve o'clock noon:—

*THURSDAY, THE 27TH DAY OF AUGUST, 1953, throughout the North Riding of the Shire of Arapiles.

* Annual Show.

Given under my Hand and the Seal of the State of Victoria aforesaid, at Melbourne, this fourteenth day of July, in the year of our Lord One thousand nine hundred and fifty-three, and in the second year of the reign of Her Majesty Queen Elizabeth II.

(L.S.)

CHARLES J. LOWE.

By His Excellency's Command,

J. H. SMITH,
for Chief Secretary.

GOD SAVE THE QUEEN!

APPOINTMENTS.

HIS Excellency the Administrator of the Government of the State of Victoria, by and with the advice of the Executive Council thereof, has, by Orders made on the 8th day of July, 1953, been pleased to make the under-mentioned appointments, viz:—

DEPARTMENT OF AGRICULTURE.

Inspectors of Stock.

GEOFFREY MORELAND, Assistant Poultry Expert.

pursuant to the provisions of section 5 of Part I. of the *Stock Diseases Act 1928*, to be an Inspector of Stock without additional salary, and for the period during which he shall continue to be employed in his present capacity.

ALBERT EDWARD COLEMAN (Constable of Police),

pursuant to the provisions of section 5 of Part I. of the *Stock Diseases Act 1928*, to be an Inspector of Stock at Koondrook, as from the 6th May, 1953, at the rate of £15 per annum, *vice* George Thomas Lawrence, resigned.

CHIEF SECRETARY'S DEPARTMENT.

Electoral Registrar (Acting).

JOHN HENRY PAGE,

to be Electoral Registrar (Acting) for the Bairnsdale, Bruthen, Lindenow, Lucknow, Omeo, Orbost, and Stratford Subdivisions of the Electoral District of Gippsland East; for the Maffra, Toongabbie, and Walhalla Subdivisions of the Electoral District of Gippsland North; for the Rose-dale, Sale, Traralgon, and Yarram Subdivisions of the Electoral District of Gippsland South; and for the Foster and Leongatha Subdivisions of the Electoral District of Wonthaggi, to take effect on and from the 29th June, 1953, during the absence, on leave, of Arthur Francis McDowell.

Members, Workers' Compensation Board.

ALLAN ELDRIDGE PARKES, the person nominated jointly in the prescribed manner by the insurers under the *Workers Compensation Act 1951*, and the members of the governing body of the association known as The Victorian Employers' Federation, and

JAMES WILLIAM WILKINSON, the person nominated in the prescribed manner by the members of the Melbourne Trades Hall Council,

pursuant to the provisions of the *Workers Compensation Act 1951*, to be members of the Workers' Compensation Board, for a period of five years from the 18th July, 1953.

Licensing Inspectors.

JOHN THOMAS PERKINS, Inspector of Police,

pursuant to the provisions of the Licensing Acts, to be a Licensing Inspector for each and every Licensing District in the State of Victoria, *vice* Allen Henry Oswald Robinson, transferred.

ARTHUR RUPERT STANTON, Superintendent of Police, pursuant to the provisions of the Licensing Acts, to be a Licensing Inspector for each and every Licensing District in the State of Victoria, *vice* William George Hogg, deceased.

Probation Officer.

VALERIE M. DOUGLAS,

pursuant to the provisions of section 536 of the *Crimes Act 1928*, to be a Probation Officer for the purposes of the said Act in Melbourne and suburbs.

LAW DEPARTMENT.

Magistrates.

JAMES IRELAND FRANCIS COUPER, Dumbalk, and ARTHUR LITTLEWOOD CROSS, 5 Northway, Yallourn, to Keep the Peace in the Eastern Bailiwick of the State of Victoria;

GEORGE LEONARD DOUGLAS WELLS, 315 Gray-street, Hamilton, and

THOMAS ARTHUR CHILTON, Allansford, to Keep the Peace in the Western Bailiwick of the State of Victoria;

GILBERT FINLAY BOYLE, 106 Barnard-street, Bendigo, to Keep the Peace in the Midland Bailiwick of the State of Victoria;

ERIC RAYMOND COLE, Curia-street, Mansfield, to Keep the Peace in the Northern Bailiwick of the State of Victoria; and

ALAN COURTNEY AGNEW, 9A Norwood-street, Burwood, KENNETH HEYWOOD WEBB, Clarinda-street, Somerville, STANLEY WILLIAM DAVIE, "Erehwon," Cowes,

HORRIE RICHARD SAMUEL SPENCER, Harkaway, JOHN GERRARD LYONS, Police Department, Melbourne,

and

EDWARD FRANCIS RYAN, Police Department, Melbourne,

to Keep the Peace in the Central Bailiwick of the State of Victoria.

Commissioners for Taking Declarations, &c.

WILLIAM PERCY CASE ROOKING, Secretary, St. Kilda Cricket Club, St. Kilda,

to be a Commissioner for taking Declarations and Affidavits under the provisions of Division 8 of Part IV. of the *Evidence Act 1928*, to resign upon ceasing to occupy his present position;

ARCHIBALD NORMAN WRIGHT, Willaura,

JAMES ALWYN GEORGE KERR, Willaura,

RAYMOND JOHN WILTSHIRE, 187 Lonsdale-street, Dandenong,

NOEL PETER O'BRIEN, 32 Ogilvie-street, Essendon,

MARY VERONICA SNELL, Snake Valley,

CHARLES THOMAS ADAMS, Snake Valley,

MARJORIE BLOCK, 3 Clapham-road, Oakleigh,

KEITH JOHN MEEK, Lake Bolac,

ERIC VAYNE CONWAY, 571 Church-street, Richmond,

and

STANLEY CHARLES ALEXANDER BALE, 45 Prospect-street, Box Hill,

to be Commissioners for taking Declarations and Affidavits under the provisions of Division 8 of Part IV. of the *Evidence Act 1928*, to resign upon removing from the neighbourhood of the addresses stated; and

HARRY HAROLD ROWE, an Officer of The Royal Agricultural Society of Victoria, 422 Collins-street, Melbourne,

to be a Commissioner for taking Declarations and Affidavits under the provisions of Division 8 of Part IV. of the *Evidence Act 1928*, to resign upon ceasing to occupy his present position.

Sworn Valuator.

CLARENCE PERCIVAL WOHLERS, 22 Cooraminta-street, East Brunswick,

to be a Sworn Valuator for Anglesey, Bourke, Dalhousie, Dundas, Moira, Rodney, and Talbot, pursuant to the provisions of section 14 of the *Transfer of Land Act 1928*.

Clerks of Children's Courts.

DESMOND BRUCE SCULLY

to be Clerk of the Children's Court at Nhill, Dimboola, Jeparit, Kaniva, and Rainbow, during the absence, on annual leave, of H. E. Daly, to take effect from the date of commencement of duty; and

JOHN JOSEPH GLEESON

to be Clerk of the Children's Court at Mansfield, Alexandra, Avenel, Jamieson, Woods Point, and Yea, during the absence, on annual leave, of J. Kearney, to take effect from the date of commencement of duty.

DEPARTMENT OF HEALTH.

Members, Hospitals and Charities Commission.

JOHN HENRY LINDELL, M.D., M.S.,

pursuant to the provisions of section 9 of the *Hospitals and Charities Act 1948*, to be a Member and Chairman of the Hospitals and Charities Commission, for a period of five years, at a salary of £3,122 a year, as fixed for the position by the Governor in Council;

ALEXANDER JAMES MCLELLAN,

pursuant to the provisions of section 9 of the *Hospitals and Charities Act 1948*, to be a Member of the Hospitals and Charities Commission, for a period of five years, at a salary of £1,650 a year, as fixed for the position by the Governor in Council; and

WILLIAM LESLIE ROWE,
pursuant to the provisions of section 9 of the *Hospitals and Charities Act 1948*, to be a Member and Deputy Chairman of the Hospitals and Charities Commission, for a period of one month, without salary.

DEPARTMENT OF CROWN LANDS AND SURVEY.

Trustee of Site.

ARCHIE MIDDLEMISS
to be a Trustee of the land permanently reserved on the 17th May, 1887, as a site for a Racecourse and other purposes of Public Recreation, *vice* Charles Dickie, deceased.

DEPARTMENT OF THE TREASURER.

Collector of Imposts (Acting).

CODE, REGINALD

to act temporarily as Collector of Imposts, Motor Registration Branch, during the absence of A. H. O'Dee, on leave.

A. MAHLSTEDT,

Clerk of the Executive Council.

At the Executive Council Chamber,
Melbourne, 8th July, 1953.

REVOCATION OF APPOINTMENT.

HIS Excellency the Administrator of the Government of the State of Victoria, by and with the advice of the Executive Council thereof, has, by Order made on the 8th day of July, 1953, revoked the appointment of the person named hereunder to the office mentioned, *viz.*:—

LAW DEPARTMENT.

VINCENT ALAN MURN, as a Commissioner for taking Declarations and Affidavits, pursuant to the provisions of the *Evidence Act 1928*.

A. MAHLSTEDT,

Clerk of the Executive Council.

At the Executive Council Chamber,
Melbourne, 8th July, 1953.

RESIGNATION.

HIS Excellency the Administrator of the Government of the State of Victoria, by and with the advice of the Executive Council thereof, has, by Order made on the 8th day of July, 1953, accepted the resignation of the person named hereunder, of the office mentioned, *viz.*:—

CHIEF SECRETARY'S DEPARTMENT.

ALLEN HENRY OSWALD ROBINSON, as a Licensing Inspector for each and every Licensing District in the State of Victoria, to date from and inclusive of the 25th June, 1953.

A. MAHLSTEDT,

Clerk of the Executive Council.

At the Executive Council Chamber,
Melbourne, 8th July, 1953.

Stock Diseases Act 1928 (No. 3779).

QUARANTINE DISTRICTS UNDER REGULATION 37.
QUARANTINE restrictions imposed on the following properties have been removed:—

Name; Address.

Bodsworth, S.; Bobinawarrah East.
Campbell, H. F.; Mardan.
Campbell, P. D.; Dumbalk.
Campbell, T.; Tallangatta Valley.
Hore, E. S.; "Inverness," Talgarno.
Milnes, F. B.; Mardan.
O'Keefe, F. M.; "Pratts," Boorhaman.
Ramsay, H.; Mardan.
Robinson, G. H.; Nerrena.

R. J. DE C. TALBOT,

Chief Inspector of Stock.

Stock Diseases Act 1928 (No. 3779).

QUARANTINE DISTRICTS.

PURSUANT to clause 37 of the Regulations under the *Stock Diseases Act 1928*, the property described hereunder has been declared a quarantine district on account of the presence thereon of stock known to have been or suspected of having been in contact with stock affected with contagious pleuro-pneumonia:—

Name; Address.

O'Keefe, F. M.; "Gutherles," Boorhaman.

R. J. DE C. TALBOT,

Chief Inspector of Stock.

MELBOURNE AND METROPOLITAN BOARD OF WORKS.

NOTICE TO THE OWNERS OF TENEMENTS IN THE UNDERMENTIONED STREETS AND THE PRIVATE STREETS, LANES, COURTS, AND ALLEYS OPENING THERETO.

THE main pipe in the said streets being laid down, the owners of all tenements situated as under, are hereby required, on or before 10th August, 1953, to cause a proper pipe and stop-cocks to be laid, so as to supply water within such tenements from the main pipe.

C. F. TRATHAN,

Secretary.

30th June, 1953.

STREET AND POSITION.

Hawthorn.

Cato-street, from Auburn-road to Tooronga-road.

Heidelberg.

Jacka-street, from 9 chains south-east of McLeod-parade to Ruthven-street.

Ruthven-street, from Jacka-street to McNamara-street.

Ruthven-street, from Jacka-street westwards 8½ chains.

Mulgrave.

High-street-road, from Springvale-road to Hammence-street.

Hammence-street, from High Street-road to Lindwall-street.

Harvie-street, from Springvale-road to Compton-street.

Langridge-street, from Springvale-road to Hammence-street.

Lindwall-street, from Hammence-street westwards 4½ chains.

Lindwall-street, from Hammence-street eastwards 8½ chains.

Nunawading.

Clare-street, from Whitehorse-road northwards 5 chains.

Richmond.

Allowah-terrace, from Bridge-road southwards 4 chains.

St. Kilda.

Right-of-way (1½ chain south of Argyle-street), from Queen-street westwards 1½ chain.

DEPARTMENT OF MINES.

SUBJECT to any necessary excisions, &c., it is proposed to grant the following leases:—

9158, Ballarat; Rupert Edmond Wood; 76a. 1r. 28p., Parish of Blackwood.

3277, Beechworth; Alec William Kohn; 40a. 1r. 9p., Parish of Beechworth.

7355, Mineral; Arthur Henry Stephens; 147a. 0r. 11p., Parish of Walwa.

APPLICATION FOR LEASE DECLARED ABANDONED.

9162, Ballarat; Lionel Joyce Stingers and Joseph Stingers; 40 acres at Creswick.

MINING LEASE GRANTED.

8282, Beechworth; Cocks Eldorado Gold Dredging N. L.; 19a. 2r. 10p., Parish of Byawatha.

CONSENT GRANTED TO TRANSFER A MINING LEASE.

7296, Mineral; from Henry Hearn (now deceased), Douglas George Scott, and Alfred Edward Hearn to S. N. Rodda Pty. Ltd.

MINING LEASE EXPIRED.

10949, Bendigo; William Wallace Wilson; 6a. 1r. 29p., Parish of Kimbolton.

A. M. FRASER,

Minister of Mines.

MINING LEASES DECLARED VOID.

9097, Castlemaine; Argus Hill Chewton Gold N. L.; 69a. 1r. Sp., Parish of Chewton.

11105, Bendigo; George Ernest Dickenson and Frederick Harold Tadgell; 166a. 0r. 5p., Parishes of Sandhurst and Mandurang.

REX R. NEAL,

Secretary for Mines.

Transport Regulation Acts.

TRANSPORT REGULATION BOARD.

NOTICES OF PUBLIC HEARINGS.

NOTICE is hereby given that the applications made by the persons named below for licences to operate the commercial goods vehicles on the route or routes, or in the manner set out opposite their names, will be heard at a time and place to be communicated to the parties concerned:—

Name and Address; Licence Conditions.

- ALBURY TYRE SERVICE PTY. LTD., 530 Kiewa-street, Albury; 1 commercial goods vehicle (14 cwt.) to operate in Victoria within a radius of 100 miles of the New South Wales-Victorian border at Albury for the carriage of tires for recapping, retreading and renewing.
- ALEXANDER, J. R., 149 Inglewood-road, Golden Square; 1 commercial goods vehicle (12 cwt.) to operate throughout the State of Victoria in the course of business as "electrical contractor"—tools and material incidental to own contracts.
- ARTHUR, W. H., 294 Maude-street, Shepparton; application to vary the terms of existing licence No. D.4180 by the inclusion of ability to carry non-alcoholic brewed beverages between Melbourne and Shepparton, on behalf of Taraxale Brewing Co. Pty. Ltd., and empty returns on return journey.
- BLAKELY, B., & Co., 30 Main-street, Ballarat; 1 commercial goods vehicle (160 cwt.) to operate—(a) between Melbourne and Ballarat, via the Western Highway for the carriage of non-alcoholic brewed beverages, on behalf of Taraxale Brewing Co. Pty. Ltd., returning with empty returns, (b) within a radius of 25 miles of Ballarat—general goods.
- COOKE, J. G., Channel-street, Cohuna; 1 commercial goods vehicle (160 cwt.) to operate—(a) between Melbourne and Cohuna for the carriage of non-alcoholic brewed beverages, on behalf of Taraxale Brewing Co. Pty. Ltd., returning with empty returns, (b) third schedule goods throughout the State of Victoria.
- DUNK, A. L., Cass-street, Rosebud; application to vary the terms of existing licence No. T.T.D.1575 by deleting present conditions, and adding in lieu—(a) from forest landings in the Connor's Plains area to Saxton's mill at Licola—logs, (b) from Saxton's mill at Licola to the railway siding at Heyfield—sawn timber.
- HANSFORD, C. T., Bay-street, Golden Square; 1 commercial goods vehicle (90 cwt.) to operate—(a) between Melbourne and Bendigo for the carriage of non-alcoholic brewed beverages, on behalf of Taraxale Brewing Co. Pty. Ltd., returning with empty returns, (b) within a radius of 25 miles of Bendigo—general goods.
- HAYNES, R. L., 45 Coppin-street, East Malvern; 1 commercial goods vehicle (56 cwt.) to operate in the course of business as confectionery wholesaler and distributor of own goods—(a) within a radius of 50 miles of Melbourne, (b) from the railway stations at Colac, Warrnambool, Warragul, Traralgon, Sale, Seymour, Shepparton, Ballarat, Stawell, and Horsham to retail traders' tributary to such railway stations.
- HOVEY, R. C., 97 Garden-street, East Geelong; 1 commercial goods vehicle (200 cwt.) to operate—(a) between Melbourne and Geelong for the carriage of non-alcoholic brewed beverages, on behalf of Taraxale Brewing Co. Pty. Ltd., returning with empty returns, (b) within a radius of 25 miles of Geelong—general goods.
- JUDD, F. H. (Judd's Riverina Transport), Central Chambers, Albury, New South Wales; 1 commercial goods vehicle (200 cwt.) to operate—(a) from Melbourne to Wodonga, via the Hume Highway, for the carriage of non-alcoholic brewed beverages, on behalf of Taraxale Brewing Co. Pty. Ltd., returning with empty returns, (b) within a radius of 20 miles of the Victorian-New South Wales border at Albury—general goods.
- KLEINMAN-ZAHIRA, D., 269 North-road, South Caulfield; 1 commercial goods vehicle (8 cwt.) to operate throughout the State of Victoria in the course of business as an itinerant retailer of ladies' wear only.
- LACK, F. J., Edis-street, Kyabram; 1 commercial goods vehicle (180 cwt.) to operate—(a) between Melbourne, Kyabram, and Tongala for the carriage of non-alcoholic brewed beverages, on behalf of Taraxale Brewing Co. Pty. Ltd., returning with empty returns, (b) within a radius of 20 miles of Kyabram—general goods.
- LANNING, J. T. & G., Fodder Store, McKillop P.O.; 1 commercial goods vehicle (100 cwt.) to operate within a radius of 20 miles of the McKillop Post Office and to and from Melbourne, in the course of business as "fodder merchant"—fodder, chaff, bran, and poultry foods.
- MARKS, L. W., Private Bag, Swan Hill; 1 commercial goods vehicle (100 cwt.) to operate—(a) between Melbourne, Bendigo, and Swan Hill for the carriage of non-alcoholic brewed beverages, on behalf of Taraxale Brewing Co. Pty. Ltd., returning with empty returns, (b) third schedule commodities throughout the State of Victoria.
- MCCARROLL, W. A., 75 Cooper-street, West Preston; 1 commercial goods vehicle (200 cwt.) to operate—(a) between Melbourne and Warracknaheal for the carriage of non-alcoholic brewed beverages, on behalf of Taraxale Brewing Co. Pty. Ltd., returning with empty returns, (b) third schedule commodities throughout the State of Victoria.
- NUT FOONS PTY. LTD., 271 Grant-street, South Melbourne; 1 commercial goods vehicle (60 cwt.) to operate—(a) within a radius of 50 miles of Melbourne—own peanut products and table margarine, (b) from the railway stations at Ballarat and Bendigo to retailers' tributary to such stations—own peanut products and table margarine.
- ROBERTSON, K. J., 9 Hotham-street, Seddon; 1 commercial goods vehicle (100 cwt.) to operate within a radius of 25 miles of Melbourne and to and from sand pits situate on the Frankston-Cranbourne road—sand, gravel, soil, and loam.
- RUSSELL, C. R., 4 Railway-avenue, Horsham; 1 commercial goods vehicle (99 cwt.) to operate—(a) between Melbourne and Horsham for the carriage of non-alcoholic brewed beverages, on behalf of Taraxale Brewing Co. Pty. Ltd., returning with empty returns, (b) third schedule commodities throughout the State of Victoria.
- SHAW, E. W., 18 Bent-street, North Brighton; 1 commercial goods vehicle (116 cwt.) to operate from Cardinia, via Melbourne, to Geelong for the carriage of moulding sand, on behalf of International Harvester Co. of Geelong.
- SINCLAIR, A. E., 92 Balaclava-road, Caulfield; 1 commercial goods vehicle (8 cwt.) to operate throughout the State of Victoria in the course of business as "hawker"—drapery and chinaware.
- SMITH, L. A., Armstrong-street, Tongala; 1 commercial goods vehicle (15 cwt.) to operate throughout the State of Victoria in the course of business as "plumber"—equipment, tools, and material incidental to trade.
- SPROULE, N. E., 53 Breese-street, West Brunswick; 1 commercial goods vehicle (6 cwt.) to operate—(a) within a radius of 25 miles of Melbourne—own foodstuffs, (b) throughout the State of Victoria in the course of business as "hawker"—clothing and fishermen's requisites.
- WRIGHT, A. L. & P. R., Silvan-road, McKillop; 1 commercial goods vehicle (100 cwt.) to operate—(a) within a radius of 25 miles of Melbourne—general goods, (b) within a radius of 50 miles of Mt. Evelyn P.O.—petroleum products from own depot.

NOTICE is hereby given that the applications made by the persons named below for renewal of licences to operate the commercial goods vehicles on the route or routes, or in the manner set out opposite their names, will be heard at a time and place to be communicated to the parties concerned:—

Name and Address; Present Franchise; Licence Number; Date of Expiry.

ENSIGN DRY CLEANERS LTD., 24 Leinsler-grove, Northcote; in the course of business as "industrial dry cleaners"—goods to be cleaned or having been cleaned—(a) within a radius of 50 miles from the G.P.O., Melbourne, (b) from and to the premises of the holders of this licence to and from clients at Ballarat, Maryborough, Castlemaine, Bendigo, and Kyneton servicing the aforementioned places on a weekly round trip; D.5674; 18th October, 1953.

WERNER, R., & Co. PTY. LTD., 54-86 Burnley-street, Richmond; throughout the State of Victoria for the purpose of installing and maintaining commercial refrigeration plants at butter factories, abattoirs, cool stores, food processing factories, and ice works—tools of trade and spare parts, also refrigerating and welding gases incidental to the aforesaid installation and maintenance work; D.5729; 18th October, 1953.

NOTICE is hereby given that the applications made by the persons named below for renewal of temporary licences, for a period of twelve months, to operate the commercial goods vehicles on the route or routes, or in the manner set out opposite their names, will be heard at a time and place to be communicated to the parties concerned:—

Name and Address; Present Franchise; Licence Number; Date of Expiry.

ALLAN, T. W., Avoca; (1) redgum logs from Avoca to Terang, (2) sawn timber and fencing posts from own mill at Lamplough to Ararat, Mortlake, Terang, and Camperdown; T.T.D.1453; 26th November, 1953.

BEECH TIMBER & TRADING CO., Nepean Highway, Mentone; (1) logs from any forest landing in the Ryton and Buln Buln areas to own mills at Gembrook and Pakenham, (2) sawn timber from own mills at Gembrook and Pakenham to own yards at Mentone, (3) sawn timber to any merchant or builder if delivered to a timber yard or direct on to a building site, which is located within a radius of 25 miles of the G.P.O., Melbourne; T.T.D.1451, T.T.D.1452; 26th November, 1953.

DUNSTAN, A., & SONS, 1 Tallangatta-road, Wodonga; (1) logs from the Forests Commission's lease at Mt. Wills to own mill at Eskdale, (2) sawn timber from own mill at Eskdale to own timber yards at Wodonga, also to railway yards at Wodonga and Albury; T.T.D.1339; 20th November, 1953.

HALL, S. G., Narbethong; palings and short rails from own mills at Narbethong to yards at East Malvern; T.T.D.1455; 26th November, 1953.

HASSETT, J. & R., Young-street, Drouin; (1) logs from any forest landing in the Jeeralang area to mills at Drouin, (2) sawn timber from mills at Drouin to building sites in the metropolitan area; T.T.D.1443; 19th November, 1953.

HOLLINGSWORTH, J. W., 31 Macarthur-street, Bairnsdale; hewn timber, under contract to S.E.C., from Bairnsdale to Yallourn and Morwell areas; T.T.D.1341; 20th November, 1953.

HUME & ISER PTY. LTD., 35 Charleston-street, Bendigo; sawn timber from mills at Kyneton and within 60 miles of Bendigo to own timber yards at Bendigo; T.T.D.1252; 14th November, 1953.

RIELLY, T. I. & A. H., Keilor-road, Keilor; (1) logs from any forest landing in the Lancefield and Woodend areas to own mill at Keilor, (2) sawn timber from mills at Lancefield to own timber yards at Keilor, (3) sawn timber from own mill at Keilor to consignees within a radius of 25 miles of the G.P.O., Melbourne; T.T.D.1457; 26th November, 1953.

SMITH, V. K., 54 Skene-street, Colac; (a) logs from any forest landing within a radius of 50 miles of Colac to mills at Gellibrand and Colac, (b) sawn timber from mills at Gellibrand and Colac to building sites within a radius of 50 miles of Colac in house lots only; T.T.D.1449; 26th November, 1953.

TERRETT, F. H., 225 Bridge-street, Benalla; (1) logs from any forest landing in the Bulla and Tumbulup areas to own mills at Benalla, (2) sawn timber from own mills at Benalla to consignees at Shepparton, Numurkah, and Echuca; T.T.D.1440; 19th November, 1953.

WALKER, J. W., Chum Creek-road, Healesville; (1) logs from any forest landing in the Niagaroon and Upper Yarra forestry districts and the North Big River area to the railway station at Healesville, and to any mill or dump which is located within a radius of 20 miles of such landing or of the railway station at Healesville, (2) logs from such other areas or to such other destinations as may be authorized, in writing, by the Board from time to time; T.T.D.1340; 20th November, 1953.

WALKER, WM. C., Buxton-road, Marysville; (1) logs from any forest landing in the Niagaroon and Upper Yarra forestry districts and the North Big River areas—(a) to the railway station at Warburton and/or Yarra Junction, and to any mill or dump which is located within a radius of 20 miles of such landing or of the railway stations at Warburton and/or Yarra Junction, (b) to any mill or yard situate within a radius of 25 miles of the G.P.O., Melbourne, (2) logs from such other areas or to such other destinations as may be authorized, in writing, by the Board from time to time; T.T.D.1448; 26th November, 1953.

WILLIAMS, K. F., 125 Tucker-road, Bentleigh; (1) mill and case logs from any forest landing in the Bullengarook area to mills at Hampton, (2) firewood from Bullengarook area to yards in the metropolitan area; T.T.D.1439; 19th November, 1953.

NOTICE is hereby given that the applications made by the persons named below for licences to operate commercial passenger vehicles on the route or routes, or in the manner set out opposite their names, will be heard at a time and place to be communicated to the parties:—

Name of Applicant; Nature of Application.

BRYANT, H. C., care of Bridge Inn Hotel, Mernda; 1 commercial passenger vehicle, with seating capacity for 31 persons, to operate as (a) school bus service Kinglake-Eltham High School under contract to Education Department, (b) school service two (2) trips daily Eltham-Eltham High School—fare 3d., (c) a special service omnibus (charter conditions) within a radius of 50 miles of Eltham Railway Station.

NOTE.—This school service replacing that service withdrawn by Lyons, Eltham, as from 15th June, 1953.

BRYANT, H. C., care of Bridge Inn Hotel, Mernda; 1 commercial passenger vehicle, with seating capacity for 31 persons, to operate as (a) school bus service Strathewen-Eltham High School under contract to Education Department, (b) school service two trips daily Eltham-Eltham High School—fare 3d., (c) a special service omnibus (charter conditions) within a radius of 50 miles of Eltham Railway Station.

NOTE.—This school service replacing that service withdrawn by Lyons, Eltham, as from 15th June, 1953.

BRYANT, H. C., care of Bridge Inn Hotel, Mernda; 1 commercial passenger vehicle, with seating capacity for 29 persons, to operate as (a) school bus service Doreen-Eltham High School under contract to Education Department, (b) school service two trips daily Eltham-Eltham High School—fare 3d., (c) a special service omnibus (charter conditions) within a radius of 50 miles of Eltham Railway Station.

NOTE.—This school service replacing that service withdrawn by Lyons, Eltham, as from 15th June, 1953.

DAVIES, E., Bus Service, Valley-street, East Oakleigh; application for variation of Route 39A (Oakleigh-Scoresby) to include the ability to extend two trips per day from Stud-road terminal to Upper Ferntree Gully Railway Station.

Leaving Oakleigh 6.15 a.m., returning from Fern-tree Gully 6.55 a.m.

Leave Oakleigh 4.55 p.m., returning from Fern-tree Gully 5.35 p.m.

NOTE.—Application made for six months' trial period only.

DAVIES, E., Bus Service, Valley-street, East Oakleigh; 1 commercial passenger vehicle, large seating capacity, to operate as a metropolitan stage omnibus service North-road-Hughesdale-Holmesglen; Commencing at corner of Poath-road and Donal-street, via Donal, Reid streets, North-road, Poath-road, Chadstone-road, Abbotsford-road, Quentin-road, Chapman-street, Rangeview-avenue to Chadstone-road.

Sections on Route.

1. Corner of Poath and North roads to Hughesdale Station.

2. Hughesdale Station to Rangeview-avenue and Chadstone-road.

3. Rangeview-avenue and Chadstone-road, via Chadstone-road, Abbotsford-road, Quentin-road, Chapman-road, Rangeview and Chadstone roads.

Fares to be Charged.

Section 1—4d. Section 2—4d. Section 3—2d. Through fare 10d.

Time-table to be Operated.

| Leave North-road. | Leave Abbotsford-road. |
|-------------------|------------------------|
| 8.00 a.m. | 8.20 a.m. |
| 8.40 a.m. | 9.00 a.m. |
| 9.20 a.m. | 9.40 a.m. |
| 10.10 a.m. | 10.30 a.m. |
| 11.00 a.m. | 11.20 a.m. |
| 3.30 p.m. | 3.50 p.m. |
| 4.25 p.m. | 4.45 p.m. |
| 5.20 p.m. | 5.45 p.m. |
| 6.15 p.m. | 6.35 p.m. |

Saturday—8 a.m. to 11.20 a.m. only.

Sunday—no service.

DUNCAN'S GREEN BUS SERVICE, 130 Mount-street, Heidelberg; 1 commercial passenger vehicle to operate as an additional vehicle on Route 19 (Heidelberg-Collingwood) under the same terms and conditions as existing M.O. licence Nos. 44, 45, 46, 47, 48, 49, 50, 51, 52.

DYSON, L. C., Plenty-road, Bundoora; 3 commercial passenger vehicles, with seating capacity for 25, 25, and 24 persons, respectively, to operate as metropolitan route omnibuses on the route between the Regent Railway Station and the corner of McMahon-road and Strathmerton-street, Reservoir, via Tyler-street, Plenty-road, Chaleyer-street, Creville-street, Summerhill-road, Boldrewood-parade, Strathmerton-street. (Sections, fares, and time-tables to be arranged.)

NOTE.—This service to be operated when roads are made and capable of carrying omnibus traffic. Vehicles to be interchangeable with those at present operated on Route 46A (Regent—Janefield—Gresswell).

GABRIEL, R. J., 28 Arnold-street, South Yarra; 1 commercial passenger vehicle, with seating capacity for five persons, to operate as a metropolitan taxi cab for the carriage of passengers otherwise than at separate and distinct fares for each passenger within a radius of 50 miles of the General Post Office, in the City of Melbourne, on journeys commencing within the metropolitan area. (Subject to the cancellation of metropolitan taxi licence No. M.T.886, at present in the name of the late A. E. B. Dartnell, care of Public Trustee, Melbourne.)

GANGE, A. J., 214 Brunswick-street, Fitzroy; application for renewal of metropolitan private hire car licence No. 62 (expiring 13th September, 1953) to operate from Astoria Private Hire Depots.

GANGE, A. J., 214 Brunswick-street, Fitzroy; application for renewal of metropolitan private hire car licence No. 65 (expiring 8th August, 1953) to operate from Astoria Private Hire Depots.

GRINHAM, R. E., 122 Lygon-street, Carlton; 1 commercial passenger vehicle, with seating capacity for five persons, to operate as a metropolitan private hire car for the carriage of passengers otherwise than at separate and distinct fares for each passenger throughout Victoria, with the proviso that the vehicle shall be ordered or be bespoke from place of business situate at 948 Mt. Alexander-road, Essendon. (Subject to the cancellation of licence No. M.H.766, at present in the name of J. B. Stanton.)

NULINE BUS SERVICE, 291 North-road, South Caulfield; application for variation of Route 115A to delete from present prescription of that portion of route between the corner of Marriage-road and Burwah-avenue and Connor-street and Marriage-road, via Marriage-road, Balfour-street, Dendy-street, Connor-street, and instead to include the ability to operate as follows:—(a) From the corner of Burwah-avenue and Marriage-road, via Burwah-avenue, Dendy-street, Balfour-street, thence via normal route, (b) for the carriage of school children between the corner of Nepean Highway and Marriage-road and the Wilson-street State School, via Marriage-road, Balfour-street, Dendy-street, Connor-street, thence via normal route.

Depart Nepean Highway and Marriage-road 8.30 a.m.

Depart Wilson-street State School 3.35 p.m.

PARLOR CARS PTY. LTD., 244 Nicholson-street, Fitzroy; application for variation of licence Nos. M.C.41, 42, 203, 204, 205, 206, 207, 219, 228, 244, 250, 252, 287, 288, 289, 290 to include the ability to conduct golfing tours by the direct route to Flinders, Woodend, Beacon Hills, Long Island, Barwon Heads, Sorrento, and to return via the same route in each case. The purpose of the tour being to play golf in congenial company with the benefit of organized competitions and inclusive catering.

SHERRY, T., 212 Francis-street, Yarraville; 1 commercial passenger vehicle, with seating capacity for 27 persons, to operate as a special service omnibus under the same terms and conditions as at present held by F. N. Mann. (Subject to the cancellation of licence No. M.C.25, at present held by F. N. Mann, Footscray.)

TENNI, T. R., 37 Moore-street, Moonee Ponds; 1 commercial passenger vehicle, with seating capacity for seven persons, to operate as a metropolitan private hire car for the carriage of passengers otherwise than at separate and distinct fares for each passenger throughout Victoria, with the proviso that the vehicle shall be ordered or be bespoke from place of business situate at Melbourne Taxis, Bridge-road, Richmond. (Subject to the cancellation of licence No. M.H.647, at present in the name of V. E. M. Blake.)

NOTICE is hereby given that the applications made by the persons named below for licences to operate commercial passenger vehicles on the route or routes, or in the manner set out opposite their names, will be heard at a time and place to be communicated to the parties:—

Name of Applicant; Nature of Application.

ANDERSON, H. J., High-street, Kangaroo Flat, Bendigo; 1 commercial passenger vehicle, with seating capacity for 24 persons, to operate as a substitute vehicle to vehicles holding licence Nos. U.O.5 and U.O.6 held by the applicant.

BENDERS BUSWAYS, 215 Aberdeen-street, Newtown, Geelong; application for variation of all U.O. licences to include the ability to operate the following tours:—(a) Geelong to Melbourne and detour of Melbourne and suburbs (to operate only after 6 p.m.)—fare 17s. 6d. adults, 10s. children, (b) Geelong via Eldon Weir, via Melbourne, Healesville, Eldon, and return, (c) Geelong to Bendigo, via Bacchus Marsh, Ballan, Hepburn Springs (lunch), Castlemaine (detour of Bendigo), and return via Kyneton, Woodend, Gisborne, and Bacchus Marsh.

DOYLE, P., 118 Vaughan-street, Shepparton; application for variation of licence No. T.S.345 to include the ability to operate for the carriage only of the Shepparton North State School children between the corner of Welshpool and Fryers-street and the Shepparton North State School, via Marungi-street, Knight-street, Verney-road, Rae-street, Clive-street, and Balaclava-road. Fare 9d. return, 3s. weekly.

GIBLETT, M. E., 26 Clifton-street, Charlton; 1 commercial passenger vehicle, with seating capacity for five persons, to operate as follows:—(a) At separate and distinct fares within a radius of 5 miles of Charlton Post Office, (b) under private hire conditions within a radius of 50 miles of Charlton Post Office, (c) for the carriage of passengers, mails, and parcels between Charlton and St. Arnaud, via Slaty Creek and Coonooc Bridge.

TIME-TABLE.

Monday, Wednesday, Friday.

Depart 12.15 p.m. Charlton Arrive 4.15 p.m.

Fares.

Charlton to St. Arnaud, 6s. single, 10s. return.
Charlton to Coonooc Bridge, 3s. single, 5s. return.
Charlton to Slaty Creek, 5s. single, 8s. return.

TAYLFORTH BROTHERS PTY. LTD., 7 Lockwood-road, Shepparton; 6 commercial passenger vehicles, with seating capacity for 33, 29, 29, 34, 29, and 29 persons, respectively, to operate as follows:—(a) Under the same terms and conditions as licence Nos. A.164, A.2322, A.2323, A.2324, A.2325, and C.O.303, (b) for the carriage of passengers, mails, newspapers, and urgent parcels between Shepparton and Katamatite, via Dookie.

TIME-TABLE.

Mondays, Wednesdays, Fridays.

| Read Down. | | Read Up. | |
|-------------------|-------------|-----------|--------|
| Depart 12.30 p.m. | Shepparton | 4.30 p.m. | Arrive |
| Depart 12.45 p.m. | Pine Lodge | 4.15 p.m. | Depart |
| Depart 1.00 p.m. | Cosgrove | 4.00 p.m. | Depart |
| Depart 1.15 p.m. | Dookie | 3.45 p.m. | Depart |
| Depart 1.25 p.m. | Yabba South | 3.35 p.m. | Depart |
| Depart 1.35 p.m. | Yabba North | 3.25 p.m. | Depart |
| Depart 1.45 p.m. | Youanmite | 3.15 p.m. | Depart |
| Arrive 2.00 p.m. | Katamatite | 3.00 p.m. | Depart |

Saturdays.

| | | | |
|-------------------|------------|------------|--------|
| Depart 9.30 a.m. | Shepparton | 11.15 a.m. | Arrive |
| Depart 9.45 a.m. | Pine Lodge | 11.00 a.m. | Depart |
| Depart 10.00 a.m. | Cosgrove | 10.45 a.m. | Depart |
| Arrive 10.15 a.m. | Dookie | 10.30 a.m. | Depart |

SCHEDULE OF FARES.

| | Shepparton | Pine Lodge | Cosgrove | Dookie | Yabba South | Yabba North | Youanmite |
|-------------|------------|------------|----------|--------|-------------|-------------|-----------|
| | s. | d. | s. | d. | s. | d. | s. |
| Katamatite | 9 | 0 | 7 | 0 | 5 | 6 | 4 |
| Youanmite | 8 | 0 | 6 | 0 | 4 | 6 | 3 |
| Yabba North | 6 | 4 | 6 | 3 | 0 | 2 | 0 |
| Yabba South | 6 | 0 | 4 | 0 | 2 | 6 | 1 |
| Dookie | 4 | 6 | 2 | 6 | 1 | 0 | |
| Cosgrove | 3 | 6 | 1 | 6 | | | |
| Pine Lodge | 2 | 0 | | | | | |
| Shepparton | | | | | | | |

All single fares.

HORWOOD, R. C., 108 Barkly-street, Ballarat; application for variation of licence No. U.O.202 to include the ability to operate as follows:—(a) On all public holidays other than Good Friday, Anzac Day, and Xmas Day (time-table as operated on Saturdays), (b) an 8 a.m. church trip on Sundays only between Mt. Clear and St. Alipius Church, Victoria-street, via Geelong-road, Elsworth, Joseph, York, Kline, Eureka, Rodiea, and Victoria streets, and return via reverse route after church service.

FARNSWORTH, J. J., Nepean Highway, Portsea; application for variation of all "A" licences to include the ability to operate as follows:—

(a) Between Sorrento and Back Beach, Sorrento, commencing at the corner of St. Paul's-road and The Esplanade and travelling to the Back Beach Kiosk.

TIME-TABLE.

From December 26th to first Saturday after Australia Day, inclusive.

Leave Esplanade—

9.36 a.m. and each 20 minutes to 12.36 p.m.
1.36 p.m. and each 20 minutes to 5.16 p.m.

Leave Back Beach Kiosk—

9.50 a.m. and each 20 minutes to 12.50 p.m.
1.50 p.m. and each 20 minutes to 5.30 p.m.

Xmas Day and Sundays.

Leave Esplanade—

12.16 p.m., 12.36 p.m., 1.36 p.m., and each 20 minutes to 5.16 p.m.

Leave Back Beach Kiosk—

12.10 p.m., 12.30 p.m., 12.50 p.m., 1.50 p.m., and each 20 minutes to 5.30 p.m.

From first Monday after Australia Day to first Sunday after Easter Sunday, inclusive.

Leave Esplanade—

10.36 a.m. and each half-hour to 12.36 p.m.,
1.36 p.m. and each half-hour to 5.06 p.m.

Leave Back Beach Kiosk—

10.30 a.m. and each half-hour to 12.30 p.m.,
1.30 p.m. and each half-hour to 5 p.m., 5.15 p.m.

Sundays.

Leave Esplanade—

12.06 p.m., 12.36 p.m., 1.36 p.m., and each half-hour to 5.06 p.m.

Leave Back Beach Kiosk—

12 noon, 12.30 p.m., 1.30 p.m., and each half-hour to 5 p.m., 5.15 p.m.

Esplanade to Back Beach, 9d.
Intermediate and minimum, 6d.

(b) To have added ability to take up and set down passengers at the Sorrento Pier as required, provided the service is operating to the above time-table.

KING, C. N., Murrayville; 1 commercial passenger vehicle, with seating capacity for five persons, to be purchased, to operate as follows:—(a) At separate and distinct fares within a radius of 10 miles of Murrayville Post Office, (b) under private hire conditions within a radius of 100 miles of Murrayville Post Office, (c) for the carriage of mails between Murrayville and Mulcra North, via Mulcra, under the terms of a contract entered into with the Postmaster-General's Department.

LITTLE, B. J. & L., 9 MacAlister-street, Sale; application for variation of licence No. C.O.96 to—(a) delete the condition relating to the carriage of employees of the Daylesford Woollen and Worsted Mills Pty. Ltd., (b) to include the ability to operate between the Sale Aerodrome and Morwell.

TIME-TABLE.

| | | |
|------------------|---------|-----------|
| Depart 5.30 p.m. | Sale | Wednesday |
| Depart 5.30 p.m. | Sale | Friday |
| Depart 6.00 a.m. | Morwell | Monday |
| Depart 6.00 a.m. | Morwell | Thursday |

MONSON, A. J., Mount-street, Albury; 1 commercial passenger vehicle, with seating capacity for ten persons, to operate as follows:—(a) For the carriage of school children only between Spring Creek and Tallangatta, via Bullhead-road, under contract to the Education Department, (b) as a country special service omnibus, subject to all regulations appertaining to such operations and subject that journeys undertaken commence within a radius of 10 miles of Tallangatta Post Office, (c) under special traffic conditions, subject to all the regulations appertaining to such operations and subject that journeys undertaken commence within a radius of 10 miles of Tallangatta Post Office.

MORRISON, C. E., "Thalassa," Heals-street, Dromana; 1 commercial passenger vehicle, with seating capacity for four persons, to operate as follows:—(a) At separate and distinct fares within the Shire of Flinders, (b) under private hire conditions within a radius of 50 miles of Dromana Post Office. (Subject to the cancellation of licence No. C.T.329, at present in the name of G. Cussons, Dromana.)

PARKER, W. H., Leman-crescent, Noble Park; 1 commercial passenger vehicle, with seating capacity for five persons, to operate as follows:—(a) At separate and distinct fares within a radius of 5 miles of Dandenong Railway Station, (b) under private hire conditions within a radius of 50 miles of Dandenong Railway Station. (Subject to the cancellation of licence No. A.405, at present in the name of F. P. Sherry, Dandenong.)

PURCELL, J. P., 8 Day-street, Dandenong; 1 commercial passenger vehicle, with seating capacity for five persons, to operate as follows:—(a) At separate and distinct fares within a radius of 5 miles of Dandenong Railway Station, (b) under private hire conditions within a radius of 50 miles of Dandenong Railway Station. (Subject to the cancellation of C.H. licence in course of transfer from F. P. Sherry, Dandenong.)

WILKINS, A. W., 1329 Howitt-street, Ballarat; 1 commercial passenger vehicle, to be purchased, to operate under the same terms and conditions as licence No. U.O.201, at present in the name of J. J. Robinson, Ballarat. (Subject to the cancellation of licence No. U.O.201, at present in the name of J. J. Robinson, Ballarat.)

WILKINS, A. W., 1329 Howitt-street, Ballarat; application for variation of licence Nos. U.O.222, U.O.223, U.O.224, and U.O.226 to include the ability to operate under the same terms and conditions as licence No. U.O.201 in course of transfer to the applicant from J. J. Robinson, Ballarat.

KINGSTON, F. C., 19 Wimmera-street, Stawell; application for renewal of licence No. A.2770 (expiring 11th July, 1953) authorizing operations as follows:—(a) As an additional vehicle to vehicles licensed Nos. A.364, A.365, A.466, A.467, A.468, and A.749, (b) under charter conditions within a radius of 50 miles of the post office at Stawell, (c) under modified charter conditions within a radius of 30 miles of the post office at Stawell.

LATROBE VALLEY BUS LINES, 66-68 Princes-street, Traralgon; application for renewal of licence No. A.2801 (expiring 23rd September, 1953) authorizing operations as follows:—To operate under the same terms and conditions as contained in the Additional Conditions Document C.O.513 and all collateral licences.

LEYSHAN, F. C. (trading as Heyfield Bus Service), Box 15, Heyfield; application for renewal of licence No. T.C.O.5164 (expiring 30th June, 1953) authorizing operations as follows:—As a stage omnibus on the following routes:—(a) Between St. Clair's Mill on the Maffra-Heyfield road and Boucher's Store in McFarlane-street, Heyfield, via Weir-road, Mary-street, Allman-street, and Mills-street, to the Heyfield Hospital, thence via Temple-street and McFarlane-street, (b) between St. Clair's Mill on the Maffra-Heyfield road and the Heyfield School in Temple-street, Heyfield, via Weir-road, Mary-street, Allman-street, and Mills-street, (c) between the Heyfield Post Office and Boucher's Store in McFarlane-street, Heyfield, via Temple-street to McFarlane-street, thence via Smeaton-road, Firebrace-road, Glenmaggie-road, and Temple-street (Mondays and Thursdays only of each week), (d) passengers may be taken up and set down at any place along the said route, (e) under charter conditions within a radius of 50 miles of the post office at Heyfield.

PORTSEA PASSENGER SERVICE LTD., Station-street, Frankston; application for renewal of licence No. A.2886 (expiring 24th October, 1953) authorizing operations to operate under the same terms and conditions as contained in Additional Conditions Document No. A.555.

WAILES, A. E., Beech-street, Whittlesea; application for renewal of licence No. A.2904 (expiring 25th October, 1953) authorizing operations as follows:—(a) At separate and distinct fares within a radius of 5 miles of the post office at Whittlesea, (b) under private hire conditions within a radius of 50 miles of the post office at Whittlesea.

TAYLFORTH BROTHERS PTY. LTD., 7 Lockwood-road, Shepparton; application in respect to all licensed large-seating capacity vehicles to operate—(a) under same terms and conditions of licences at present held by the applicant, (b) between Shepparton and Melbourne on Sundays only on the following time-table:—

Leave Shepparton 7.30 a.m. Sundays only.
 Leave Shepparton 1.15 p.m. Sundays only.
 Leave Shepparton 5.30 p.m. Sundays only.
 Leave Melbourne 4.15 p.m. Sundays only.
 Leave Melbourne 6.30 p.m. Sundays only.
 Leave Melbourne 9.30 p.m. Sundays only.

DOUGLAS TAXI SERVICE PTY. LTD., 98 Young-street, Frankston; application for renewal of licence No. A.2871 (expiring 10th October, 1953) authorizing operations as follows:—(a) At separate and distinct fares within a radius of 5 miles of the railway station at Frankston, (b) under private hire conditions within a radius of 50 miles of the railway station at Frankston.

A PPLICATIONS for licences to operate commercial passenger vehicles, with seating capacity for five persons, for the carriage of passengers throughout Victoria, otherwise than at separate and distinct fares for each passenger:—

MORRISON, C. E., "Thalassa," Heals-street, Dromana. (Subject to the cancellation of licence No. C.H.239, at present in the name of G. Cussons, Dromana.)

POLLOCK, M. McD. (trading as Mordialloc Taxi Service), 12 Carrier-avenue, Mordialloc. (Subject to the cancellation of licence No. C.H.62, at present in the name of E. L. Walker, Mordialloc.) (To operate from 12 Carrier-avenue, Mordialloc, and 495 Main-street, Mordialloc.)

PURCELL, J. P., 8 Day-street, Dandenong. (Subject to the cancellation of licence No. C.H.257, at present in the name of F. P. Sherry, Dandenong.)

WOOD, H. H., Raglan-street, Creswick.

A PPLICATION for renewal of private hire licence expiring in September, 1953:—

SERGEANT, S. E., Poowong; P.H.1638.

A PPLICATIONS for renewal of private hire licences expiring in October, 1953:—

DOUGLAS TAXI SERVICE PTY. LTD., 98 Young-street, Frankston; P.H.1609.

LINDSAY, K. A., Church-street, Whittlesea; P.H.1646.

OLSEN, O. J., Melbourne-road, Frankston; P.H.1616.

Notice of any objection should be forwarded to reach the Secretary to the Board not later than Wednesday, 29th July, 1953.

E. V. FIELD,
Secretary.

Exhibition Buildings, Rathdown-street, Carlton, N.3, 15th July, 1953.

The Fisheries Acts.

NOTICE OF INTENTION TO PROHIBIT ALL FISHING IN OR THE TAKING OF FISH FROM PORTION OF THE CAMPASPE RIVER FROM 1st SEPTEMBER TO 30th NOVEMBER (BOTH DAYS INCLUSIVE) IN EACH YEAR.

IT is hereby notified for general information that it is intended, after the expiration of one month from the date of publication of this notice in the *Government Gazette*, to move His Excellency the Governor in Council to make a Proclamation to provide as follows:—

- Revoking the Proclamation made the 29th day of June, 1943, and published in the *Government Gazette* of the 7th day of July, 1943, respecting fishing in certain streams from 1st September to 30th November in each year;
- varying the Proclamation made the 1st day of September, 1937, and published in the *Government Gazette* of the 8th day of September, 1937, respecting prohibition of fishing in certain streams, by deleting therefrom all reference to the Campaspe River;
- prohibiting all fishing in or the taking of fish from the Campaspe River below or downstream from the Murray Highway bridge over such

stream, during the period from the first day of September to the thirtieth day of November (both days inclusive) in each year.

J. H. SMITH,
for Chief Secretary.

A. DUNBAVIN BUTCHER,
Director of Fisheries and Game.
13th July, 1953.

Town and Country Planning Act 1944.

SHIRE OF WERRIBEE.

INTERIM DEVELOPMENT ORDER.

WHEREAS by virtue of the powers conferred by the *Town and Country Planning Act 1944*, and every other power enabling them in that behalf, the preparation of a planning scheme in accordance with the said Act has been commenced by the Council of the Shire of Werribee (hereinafter referred to as the Responsible Authority) which hereby makes the following Interim Development Order:—

1. The development of all land referred to in the Schedule and the erection, construction and carrying out of any buildings, roads or other works on any of the said land is hereby prohibited.

2. Any person may apply to the Responsible Authority for permission to develop, subdivide or otherwise use any land or erect or construct any buildings, roads or other works, during the operation of this Order.

3. Any application for permission to develop, subdivide or otherwise use any land or erect or construct any buildings, roads or other works may be granted by the Responsible Authority subject to such conditions as are specified in the permit, or may be refused.

4. Any owner of any land who, after the publication of a copy of this Order, contravenes any of the provisions contained herein, shall, when directed by notice in writing, remove, pull down, take up or alter any building, road or other works, and, if any owner fails to do so within the time specified by the notice, the Responsible Authority may carry out all or any of such works and recover all expenses incurred, after due notice has been given to the owner, lessee, and/or occupier in accordance with the provisions of section 12, sub-section (3) of the Act.

5. None of the provisions of this Order shall prohibit the continuance of the use of any land or buildings for the purpose for which it was used immediately before the coming into operation of this Order.

6. This Order shall remain in operation until the approval of the planning Scheme, in accordance with the *Town and Country Planning Act 1944*, or until this Interim Development Order is revoked by the Governor in Council.

7. Schedule of land affected.—The whole of the Altona Riding of the Shire of Werribee, being all that area contained within the following boundaries: Commencing on the shore of Port Phillip Bay at the mouth of the Kororoit Creek; thence westerly by that creek to a point in line with the west boundary of allotment D.1, section 3, Parish of Cut Paw Paw; thence northerly by that boundary, Laverton-street, a line, Blenheim-road, and Hansen-street to Blackshaw-road; thence east by Blackshaw-road to New-street; thence north by New-street to the north boundary of section 6; thence westerly by the north boundary of sections 6 and 5 a road along the north boundaries of sections 4, 3, 2, and 1, Brooklyn, to the Princes Highway; thence south-westerly by that highway to the western boundary of section XI., Parish of Truganina; thence southerly by a road known as Magazine-road along the western boundary of sections XI., VI., and IV., to Skeleton Water Holes Creek; thence south-easterly and north-easterly by that Creek to the shore of Port Phillip Bay; thence north-easterly by that shore to the point of commencement.

The common seal of the President, Councillors, and Ratepayers was ordered to be affixed this 9th day of April, 1953.

(SEAL) J. F. MOORE, President.
 W. E. CARRUTHERS, Councillor.
 N. G. MINNS, Shire Secretary.

Report by the Town and Country Planning Board on the 2nd day of July, 1953. Recommended for approval—FRED. C. COOK, Chairman.

Approved by the Governor in Council,
14th July, 1953.

A. MAHLSTEDT,
Clerk of the Executive Council.

CONTRACTS ACCEPTED.—(Series 1952-53.)**PUBLIC WORKS.****CORRECTION.**

Gazette reference No. 3042 in *Gazette* 524 of 1st July, 1953, should read £273 0s. 8d. and not £173 0s. 8d. as shown.

3205. Williamstown, Dredge *Matthew Flinders*, (1) sealing and cement washing forepeak, £208 0s. 2d.—Charles Francis Fitzgerald.

3206. Williamstown, Dredge *Matthew Flinders*, (1) repairs to hopper doors, £106 14s. 4d.—Melbourne Harbor Trust Commissioners.

3207. Williamstown, Dredge *Matthew Flinders*, (1) generally maintaining various pipe lines (steam, salt-water, &c.), £929 5s. 1d.—V. F. Harris Pty. Ltd.

3208. Dookie, Agricultural College, (6) supply of electric motors and switchgear, £805 17s. 9d.—Johnson and Phillips Ltd.

3209. Williamstown, Explosives Lighter *Tameit*, (1) cleaning down hull, &c., £331 17s. 6d.—Hobson Bay Dock and Engineering Co. Ltd.

3210. Melbourne Law Courts (new), (1) labour and materials used on roof on south side, £675; sewerage works and alterations (new penal offices), £605 7s.; extending downpipes, regrading gutters and flashing, &c., £326 1s. 1d.—£1,606 8s. 1d.—William J. Bugg.

3211. Altona, Explosives, Truganina, (1) supply of rails and fish plates, £299 8s. 7d.—Miller and Co. (Machinery) Pty. Ltd.

3212. Various, Jetties, Black Rock, Rye, Hastings, Flinders, (1) supply of timber, £127 15s. 4d.—Albert R. Weisselberg Timber Company.

3213. Melbourne, Law Courts (new), (1) ceilings to courts 1 and 2, and outside courts, £183 5s.—Picton Hopkins & Son Pty. Ltd.

3214. Williamstown, Explosives Lighter *Derrimutt*, (1) docking and painting, £164.—Hobson's Bay Dock and Engineering Co. Pty. Ltd.

3215. Royal Park, Mental Hospital, (1) provision of curtains for Female Receiving Ward, £103 12s. 6d.—A. E. Hoad and Co.

3216. Boisdale, Consolidated School, (1) supply of food storage cabinet, £204 6s.—Kelvinator Australia Ltd.

3217. Larundel, Mental Hospital, (1) supply of two refrigerators, £242 6s. 9d.—Eckersley and Sons Pty. Ltd.

3218. Warracknabeal, District Hospital, (1) alterations to tank stand for water supply, £150 15s. 6d.—Wimmera Engineering Co.

3219. Dooen, "Longerenong" Agricultural College, (1) supply of generating set, &c.—£3,855 10s.—Southern Cross Windmills and Engines Pty. Ltd.

3220. Port Melbourne, Public Works Depot, (1) supply of tractor, bulgrader, &c., £7,710.—Victorian Industrial Sales and Service Pty. Ltd.

3221. South Melbourne, Public Works Storeyard, (1) supply of concrete slabs, £550.—E.P.M. Concrete Pty. Ltd.

3222. Stawell, Pleasant Creek Special School, (5) supply of 114 yards of marble linoleum, £105 3s. 3d.—W. P. Murison.

3223. Beechworth, Mental Hospital, Nurses' Quarters, (5) supply of 545 square yards of "A" marble linoleum, £502 19s. 10.—W. P. Murison.

3224. Hawthorn, Swinburne Technical School, (4) supply of shelving, £250 10s. 6d.—Kennett Bros. and Rayner Pty. Ltd.; supply of blackout blinds, £575 15s.—G. A. Hurse.

3225. Melbourne, State Offices, (1) supply of brown coal, £144 9s. 5d.—State Electricity Commission of Victoria.

3226. Boisdale, Consolidated School, (1) supply of domestic refrigerator, £116.—Quirk's Refrigerators Pty. Ltd.

3227. Royal Park, Mental Hospital, (1) supply of linoleum, £121 11s.—Johnstons Pty. Ltd.

3228. Kew, Mental Hospital, (1) tapping of water mains, £221 15s. 6d.—Melbourne and Metropolitan Board of Works.

3229. Moe, multi-purpose school, (9) supply and fix 115 Venetian blinds, £1,125 10s. 2d.—C. H. Stirling; supply and lay "A" brown linoleum, £1,250 1s. 9d.—Johnstons Furniture Productions Pty. Ltd.

3230. Various, Schools, (5) supply of 300 kerosene heaters, £2,782 10s.—Forbco Industries Pty. Ltd.; supply of 300 wire guards, £615.—A. Jones and Co.

3231. Frankston, Foreshore, (1) supply of screenings, £217 16s. 3d.—G. H. Reid and Sons.

3232. Bendigo, Her Majesty's Gaol, (2) supply and installation of stainless steel kitchen equipment, £788.—L. J. Morgan Pty. Ltd.

3233. Brighton, State School No. 1542, (3) electrical installation, boiler house, £161 10s.—H. H. Rowell.

3234. Camberwell, State School No. 888, (4) Repairs to roof and plaster, £205 10s.—J. B. Eva and Co.

No. 540.—6477/53.—2

3235. Dooen, "Longerenong" Agricultural College, (1) renewal and overhaul of electrical installation in various residences, £261 4s. 9d.—E. D. Hopper.

3236. Eltham, State School No. 209, (1) drinking and washing facilities, £108 3s. 8d.—V. G. F. Burden.

3237. Kew, Mental Hospital, Children's Cottages, (4) provision of fly-wire doors and windows, £387.—Barron Bros.

3238. Kew, "Glendonald" School for Deaf Children, (2) electrical installation in prefabricated building, £303 10s.—K. L. Day.

3239. Mildura South, State School No. 4389, (2) provision of additional out-offices, £512 10s.—Lewis and Hudswell.

3240. Melbourne, St. Kilda-road, Royal Victorian Institute for the Blind, Nurses' Quarters, (1) electrical installation, £288 10s.—H. H. Rowell.

3241. Melbourne, St. Kilda-road, Royal Victorian Institute for the Blind, (8) gas hot-water service in new Nurses' Hostel, £199 16s.—J. M. Glassel and Co. Pty. Ltd.

3242. Melbourne, C.2, Department of Agriculture, Head Office, (3) structural work for installation of new lift, £3,987.—Thompson and Chalmers Pty. Ltd.

3243. Northcote, State School No. 1401, Helen-street, (4) provision of additional staircases, £658 18s. 6d.—R. P. Finn.

3244. Rokewood, Police Station, (6) external painting and repairs, £194.—J. McMahon.

3245. Richmond, Technical School, (13) electrical installation in plumbing and sheet-metal shops, £601 15s.—K. J. West.

3246. Shepparton, Technical School, (3) alterations and additions to sewerage connexions, £320 3s. 6d.—Shepparton Plumbing Services.

3247. South Melbourne, Technical School, (7) supply and installation of exhaust hoods to plumber's shop, £125.—H. W. Creek and Sons Pty. Ltd.

3248. Sunbury, Mental Hospital, (3) renewal of wooden floor at laundry, £230.—B. Motton.

3249. Wahgunyah, Nursery, (1) electrical installation and reticulation, £875.—J. Catterall.

3250. Werribee, State Research Farm, School of Dairy Technology, (1) internal painting, Manager's office and staff room, painting external woodwork to butter and cheese factory, £190.—S. A. Lawrence and Sons.

3251. Yallourn, Technical School, (1) renewal of sheet iron roof, &c., £287 5s.—A. F. Angus.

S. MERRIFIELD, Commissioner of Public Works. 9.7.53.

ORDERS IN COUNCIL.—(Series 1952-53.)**STATE ELECTRICITY COMMISSION.**

3252. Lagging of the main steam and feed pipework and other plant, associated with the installation of the Velox boilers and 38 MW turbo-generator at Richmond Power Station, £21,885.—Gibson Battle (Melb.) Pty. Ltd.

3253. The supply, manufacture, and delivery of galvanized steel structures for Eildon Weir Crossing, Kiewa-Melbourne transmission line, £12,999.—W. H. and S. Massey Pty. Ltd.

Approved by the Governor in Council, 29th June, 1953.—A. MAHLSTEDT, Clerk of the Executive Council.

CONTRACTS ACCEPTED.—(Series 1953-54.)**VICTORIAN RAILWAYS.**

1. Manufacture, supply, delivery, and installation of water tube boilers and mountings complete, Newport Workshops, at rates (Contract 58916).—Babcock and Wilcox of Australia Pty. Ltd. 2. Railways Stores Suspense Account, Act 3759, section 105—supply and delivery of general stores, at rates, as may be ordered during the period 1st July, 1953, to 30th June, 1955, Items 2,000 to 3,819 inclusive. Details as per Book No. 2 on display at the Comptroller of Stores, Room 109, Spencer-street, and Comptroller of Accounts, Room 177, Spencer-street. 3. Reconstruction of roadway, Armbrook, at rates (Contract 59899).—Hasler Constructions Pty. Ltd. 4. Transferring goods between broad and narrow gauge, Moe, at rates (Contract 59988).—E. A. Skinner. 5. Transferring goods between broad and narrow gauge, Colac, at rates (Contract 59991).—T. J. Murfitt.

By order of the Victorian Railways Commissioners,

N. QUAIL, Secretary. 9.7.53.

PROVISIONS.

Gazette No. 521, 25th June, 1953, Provisions, Schedule No. 17, Sub-Schedule No. 2, Groceries.—For Item No. 39, substitute 4s. 1½d. per lb.

Schedule No. 20, Sub-Schedule No. 3, Jams.—For J. Langlands and Sons Pty. Ltd. substitute A. E. and E. M. Woolman, Dooen.

W. H. RUTHERFORD, Secretary to the Tender Board. 13.7.53.

ORDERS IN COUNCIL.—(Series 1953-54.)

EDUCATION DEPARTMENT.

194. One only 6½-in. geared head lathe, Nuttall, for Caulfield Technical School, £1,097.—Electronic Industries Limited, Grant-street, South Melbourne.
195. One only fatigue testing machine, for Caulfield Technical School, £450.—Rusden, Birrell, and Company Pty. Ltd., 63 Burwood-road, Hawthorn.
196. Three only 5 KVA single-phase oil transformers, 6,600/240 volts, at £91 8s. each, for Caulfield Technical School, £274 4s.—English Electric Company Ltd., 189 William-street, Melbourne.
197. One only 15 KVA three-phase oil transformer, 6,600/415/240 volts, Delta Star, for Caulfield Technical School, £166 10s.—Wilson Electric Transformer Co. Pty. Ltd., 43 Crockford-street, Port Melbourne.
198. One only 30-in. bar folding machine, "John Heine," Model 57H, for Echuca Technical School, £106.—McPherson's Limited, Collins-street, Melbourne.
199. One only 9-in. Hercus lathe, Model C, for Melbourne Technical College, £187 7s. 2d.—McPherson's Limited, Collins-street, Melbourne.
200. One only duplicating machine, "Rex," for Swinburne Technical College, £187 13s. 7d.—Chartres Pty. Ltd., 375 Collins-street, Melbourne.
201. One only Hercules Diesel engine, £85; one only brake booster, £19; one only fuel pump, £35, for Warrnambool Technical School.—L. Maloney, Warrnambool.

202. Two only Remington typewriters, at £76 each, for Warrnambool Technical School, £152.—Chartres Pty. Ltd., 375 Collins-street, Melbourne.

Approved by the Governor in Council, the 8th July, 1953.
—A. MAHLSTEDT, Clerk of the Executive Council.

State Electricity Commission Acts.

STATE ELECTRICITY COMMISSION OF VICTORIA.

ELECTRICAL APPROVALS BOARD.

IN accordance with the requirements of the Electrical Approvals Regulations—Proceedings of Electrical Approvals Board, the State Electricity Commission of Victoria hereby gives notice that the following appointments have been made, pursuant to the provisions contained in section 7 of the *State Electricity Commission Act 1934* and the said Regulations, viz.:—

RONALD JAMES MARRIOTT, as representing the interests of manufacturers in Victoria of electrical goods;
ALFRED THOMAS WILLIAMS, as representing the interests of electrical undertakers—

to be members of the said Board, to hold office for three years as from the 1st day of July, 1953.

Dated the tenth day of July, 1953.

D. H. MUNRO,
Secretary.

STATE RIVERS AND WATER SUPPLY COMMISSION.

LICENCES TO DIVERT WATER AND CUT RACES PURSUANT TO THE WATER ACTS.

LICENCES as detailed hereunder for the term of years from the date specified in each case have been granted by the Governor in Council to the persons named in the following Schedule:—

| Licence No. | Term of Licence and Commencing Date. | Name and Address of Person to Whom Licence was Granted. | Source of Supply. | Area Authorized to be Irrigated Per Annum. | Volume of Water Authorized to be Diverted Per Annum. |
|-------------|--------------------------------------|--|---|--|--|
| | | | | (acres) | (ac. ft.) |
| 342 | Thirteen years from 1.7.46 | C. Parry and Son, Daltons Bridge, via Cohuna | Gunbower Creek .. | 45 | 90 |
| 670 | Fifteen years from 1.7.52 | E. J. and E. Humphrey, Piangil | River Murray .. | 40 | 80 |
| 671 | Fifteen years from 1.7.52 | G. S. McPhee, Iraak | River Murray .. | 28 | 84 |
| 672 | Fifteen years from 1.7.52 | J. Barko, Iraak | River Murray .. | 65 | 195 |
| 673 | Fifteen years from 1.7.52 | J. C. Fanning, Yarroweyah North .. | Torgannah Lagoon | 16 | 32 |
| 674 | Fifteen years from 1.7.52 | Geelong Church of England Grammar School, Corio | Timbertop Creek (trib. of Delatite River) | .. | (gallons) 5,000,000 |
| 675 | Five years from 1.7.52 | Overseas Telecommunications Commission (Australia), Melbourne | Little River (trib.) | .. | 1,500,000 |
| 676 | Fifteen years from 1.7.52 | W. A. Pollard, Carisbrook | Tullaroop Creek .. | 10 | (ac. ft.) 15 |
| 677 | Fifteen years from 1.7.52 | Minister of Agriculture, Victoria .. | Ovens River .. | 20 | 40 |
| 678 | Fifteen years from 1.7.52 | Mrs. M. V. Breeding, Mildura | River Murray .. | 20 | 60 |
| 679 | Fifteen years from 1.7.51 | N. B. S. Hutchinson, Mildura | River Murray .. | 42 | 84 |
| 680 | Fifteen years from 1.7.52 | C. W. Artley, Koondrook | Lower Gunbower Creek | 8 | 16 |
| 681 | Fifteen years from 1.7.52 | Alistair F. Williamson, Carisbrook .. | Tullaroop Creek .. | 25 | 37½ |
| 682 | Fifteen years from 1.7.52 | James Kissick, Wattle-avenue, Mildura .. | River Murray .. | 38 | 114 |
| 683 | Fifteen years from 1.7.52 | R. L. McKinnon, Colignan | River Murray .. | 9 | 18 |
| 684 | Fifteen years from 1.7.52 | Mrs. B. E. Brown, Carisbrook | Tullaroop Creek .. | 10 | 15 |
| 685 | Fifteen years from 1.7.52 | C. F. Bennett, Wemen | River Murray .. | 25 | 75 |
| 686 | Fifteen years from 1.7.53 | British Celanese (Overseas) Ltd., Celanese House, Hanover-square, London | Barwon River .. | .. | (gallons) 1,500 million |
| 687 | Fifteen years from 1.7.52 | R. J. Parker, Bannockburn | Moorarbool River | 10 | (ac. ft.) 20 |
| 688 | Fifteen years from 1.7.53 | H. K. Kiley, Piangil | River Murray .. | 250 | 500 |
| 689 | Twelve years from 1.7.53 | K. A. Greenham, Swan Hill | River Murray .. | 200 | 400 |

Transfers of Licences detailed have been approved by the Governor in Council, and effected as from the date set out in each case:—

| Licence No. | Name of Transferor. | Name of Transferee. | Source of Supply. | Date of Transfer. |
|-------------|---------------------------------|----------------------|-------------------|-------------------|
| 283 | J. V. and R. G. Vallance | R. G. Vallance | Pyramid Creek .. | 31.3.53 |
| 456 | Guiseppe and Grazia Gallo | G. Cordoma | River Murray .. | 3.3.53 |
| 390 | A. H. Borneman | George Peace | Box Creek .. | 15.6.53 |

Melbourne, 9th July, 1953.

L. DUGGAN, Secretary,
State Rivers and Water Supply Commission.

THE GEELONG HARBOR TRUST COMMISSIONERS.

REGULATIONS.

UNDER and by virtue of the powers conferred by the Geelong Harbor Trust Acts, the Geelong Harbor Trust Commissioners, subject to the consent of the Governor in Council, hereby make the following Regulations, namely:—

1. The Regulations relating to the alteration and issue of debentures and inscribed stock made by the Commissioners on the twenty-eighth day of August, 1952, and gazetted on the seventh day of October, 1952, are hereinafter referred to as "the Regulations."

2. Next after clause (b) of Regulation 2 of the Regulations the following clause is inserted:—

"(c) Notwithstanding anything contained in this Regulation the Commissioners may send debentures by registered post to the owner at the address disclosed in the application for such debentures and such posting shall constitute effective delivery of the debentures by the Commissioners to the owner."

In witness whereof the common seal of the Geelong Harbor Trust Commissioners was hereunto affixed this 4th day of June, 1953.

The common seal of the Geelong Harbor Trust Commissioners was hereunto affixed this 4th day of June, 1953, in the presence of—

(SEAL) HERBERT A. LUMB, Commissioner.
E. J. FAIRNIE, Commissioner.
R. R. PHILLIPS, Secretary.

Approved by the Governor in Council,
8th July, 1953.

A. MAHLSTEDT,
Clerk of the Executive Council.

Local Government Act 1946, Section 525.

SHIRE OF ROMSEY.

DECLARATION THAT LAND HEREIN DEDICATED TO THE PUBLIC SHALL BE IN LIEU OF AN EXISTING ROAD.

THE Council of the Shire of Romsey hereby directs that the land set out or described in the First Schedule hereto, which has been acquired by the Council shall be a public highway as from the date of this order.

The said Council hereby declares that such land hereby dedicated to the public shall be in lieu of the existing road set out or described in the Second Schedule hereto.

FIRST SCHEDULE.

All those pieces of land commencing: Firstly, on the north-west boundary of Crown allotment 1E, section K, Parish of Lancefield, County of Bourke, at a point bearing N. 51 deg. 12 min. E. distant 127 links and bearing N. 44 deg. E. distant 1,156 links from the north-west angle thereof; thence by lines bearing S. 55 deg. E. 808 links, S. 13 deg. 44 min. E. 244 links and S. 13 deg. 3 min. W. 254 links to the Deep Creek; thence north-easterly by the Deep Creek; thence by lines bearing N. 13 deg. 44 min. W. 390 links, N. 55 deg. W. 828 links; thence S. 44 deg. W. 101 links by the said north-west boundary of Crown allotment 1E to the commencing point. Secondly, on the southern boundary of Crown portion 23, Parish of Springfield, County of Bourke at a point distant 2,005 links from the south-east angle thereof; thence by lines bearing N. 72 deg. 55 min. W. 316 links, S. 88 deg. 36 min. W. 2,552 links, N. 76 deg. 3 min. W. 428 links, N. 43 deg. 14 min. W. 331 links, N. 1 deg. 58 min. E. 318 links, N. 13 deg. 44 min. W. 105 links to the Deep Creek; thence south-westerly by the Deep Creek; thence by lines bearing S. 13 deg. 44 min. E. 50 links, S. 1 deg. 58 min. W. 346 links, S. 43 deg. 14 min. E. 403 links, S. 76 deg. 3 min. E. 472 links, to the said southern boundary of the said Crown portion 23; and thence by that boundary N. 88 deg. 36 min. E. 2,566 links to the commencing point.

SECOND SCHEDULE.

All that piece of land being parts of Crown allotments 27 and 28, section B, Parish of Monegeetta, County of Bourke, commencing at a point on the northern boundary of Crown allotment 27 bearing E. 8 deg. 15 min. N. 3,100 links from the north-west angle thereof; thence S. 28 deg. E. about 1,513 links; thence E. 18 deg. 30 min. S. about 1,034 links to a Government road; thence by that road E. 8 deg. 15 min. N. 222 links; thence W. 18 deg. 30 min. N. about 1,192 links; thence N. 28 deg. W. about 1,437 links

to the said northern boundary of Crown allotment 27; thence by that boundary W. 8 deg. 15 min. S. 106 links to the commencing point.

The common seal of the President, Councillors, and Ratepayers of the Shire of Romsey was affixed hereto, this second day of April, 1952, in the presence of—

(SEAL) L. J. COOK, President.
G. A. KETTLEWELL, Councillor.
J. PATTERSON, Secretary.

Approved by the Governor in Council,
8th July, 1953.

A. MAHLSTEDT,
Clerk of the Executive Council.

LAW DEPARTMENT.—ATTORNEY-GENERAL.

SITTINGS OF THE SUPREME COURT, MELBOURNE.—
ADDITIONAL DAY APPOINTED.

HIS Excellency the Administrator of the Government of the State of Victoria, by and with the advice of the Executive Council thereof, doth by Order made on the 8th day of July, 1953, appoint Wednesday, the 15th day of July, 1953, a day for the Sittings of the Supreme Court in the Criminal Jurisdiction at Melbourne, in addition to the days heretofore appointed.

A. MAHLSTEDT,
Clerk of the Executive Council.

At the Executive Council Chamber,
Melbourne, 8th July, 1953.

LAW DEPARTMENT.—ATTORNEY-GENERAL.

COURTS OF PETTY SESSIONS, ROMSEY.—DAY AND
HOUR APPOINTED.

HIS Excellency the Administrator of the Government of the State of Victoria, by and with the advice of the Executive Council thereof, doth by Order made on the 8th day of July, 1953, pursuant to the provisions of section 61 of the *Justices Act 1928*, appoint every alternate Friday, at Ten o'clock a.m., for the holding of Courts of Petty Sessions at Romsey, in lieu of the days and hours heretofore appointed—to take effect as from and inclusive of the 7th August, 1953.

A. MAHLSTEDT,
Clerk of the Executive Council.

At the Executive Council Chamber,
Melbourne, 8th July, 1953.

4 GEORGE VI. No. 4755, SECTION 6.

I HEREBY give notice that on the 30th June, 1953, I filed an election to administer the following deceased person's estate, in accordance with section 6 of the *Public Trustee Act 1940*:—

*WERNER, ELIZABETH GESA, also known as Gesa Elizabeth Werner, late of 205 Church-street, Middle Brighton, married woman, died 3rd May, 1953.

* According to the provisions of the will.

I HEREBY give notice that on the 1st July, 1953, I filed elections to administer the following deceased persons' estates, in accordance with section 6 of the *Public Trustee Act 1940*:—

GAYLOR, CHARLES WALDMAR, formerly of Eric-street, Belgrave, but late of Melbourne Benevolent Home, Cheltenham, pensioner, died 13th May, 1953, intestate.

HAMILTON, ROBERT FAIRBAIRN, also known as Robert Jones, formerly of 92 Keele-street, Collingwood, and Y.M.C.A., Melbourne, but late of 374 St. Kilda-road, Melbourne, useful, died 19th February, 1953, intestate.

I HEREBY give notice that on the 2nd July, 1953, I filed elections to administer the following deceased persons' estates, in accordance with section 6 of the *Public Trustee Act 1940*:—

CHRISTIAN, CHARLOTTE EMMA, formerly of 21A Tonkin-lane, Richmond, but late of Melbourne Benevolent Home, Cheltenham, spinster, died 15th February, 1953, intestate.

*DALTON, ARTHUR, late of 5 Buckhurst-street, South Melbourne, machinist, died 1st June, 1953.

HUMPHREYS, JESSIE DUNSMORE, formerly of 24 Barrow-street, Coburg, but late of Kew, home duties, died 29th January, 1953, intestate.

*PAULL, MARY, formerly of Morrah-street, Parkville, and Mount Royal, Parkville, but late of Austin Hospital, Heidelberg, pensioner, died 23rd April, 1953.

SOUTHGATE, JANE, late of Bendigo Benevolent Home, Bendigo, pensioner, died 28th March, 1953, intestate.

* According to the provisions of the will.

I HEREBY give notice that on the 6th July, 1953, I filed an election to administer the following deceased person's estate, in accordance with section 6 of the *Public Trustee Act 1940*:—

UREN, WILLIAM, formerly of 230 Myers-street, Geelong, but late of Austin Hospital, Heidelberg, miner, died 1st January, 1953, intestate.

I HEREBY give notice that on the 7th July, 1953, I filed an election to administer the following deceased person's estate, in accordance with section 6 of the *Public Trustee Act 1940*:—

LAUGIER, HENRIETTA ABBY SHADFORTH, also known as Henrietta Abby Shadforth Laugier, late of Gippsland Benevolent Home, Bairnsdale, widow, died 16th June, 1952, intestate.

C. J. GARDNER,
Public Trustee.

412 Collins-street, Melbourne, C.1, 8th July, 1953.

NOTICE.

ADMINISTRATION of the estate of each of the under-mentioned deceased persons has been granted to the Public Trustee, and creditors, next of kin, and all others having claims against the estate of any of the persons so mentioned are required to send particulars of their claims to the Public Trustee, No. 412 Collins-street, Melbourne, on or before the 17th September, 1953, or they will be excluded from the distribution of the estate when the assets are being distributed:—

CHRISTIAN, CHARLOTTE EMMA, formerly of 21A Tonkin-lane, Richmond, but late of Melbourne Benevolent Home, Cheltenham, spinster, died 15th February, 1953, intestate.

CULLEN, DAVID WILLIAM, late of Darwin, Northern Territory, fitter, died on or about 7th June, 1950, intestate.

*DALTON, ARTHUR, late of 5 Buckhurst-street, South Melbourne, machinist, died 1st June, 1953.

GAYLOR, CHARLES WALDMAR, formerly of Eric-street, Belgrave, but late of Melbourne Benevolent Home, Cheltenham, pensioner, died 13th May, 1953, intestate.

†GOLDING, RICHARD, late of 43 Arthurton-road, Northcote, retired carrier, died 30th July, 1945.

†GRANT, JOHN, formerly of 70 Jolimont-street, Jolimont, but late of 133 Gladstone-avenue, Northcote, retired railway employee, died 9th April, 1953.

GREGORY, THORNTON ADOLPHUS SELWYN, late of Ararat, clerk, died 2nd October, 1952, intestate.

HAMILTON, ROBERT FAIRBAIRN, also known as Robert Jones, formerly of 92 Keele-street, Collingwood, and Y.M.C.A., Melbourne, but late of 374 St. Kilda-road, Melbourne, useful, died 19th February, 1953, intestate.

†HAYES, MARY JANE, late of 130 Elm-street, Northcote, widow, died 16th March, 1953.

HUMPHREYS, JESSIE DUNSMORE, formerly of 24 Barrow-street, Coburg, but late of Kew, home duties, died 29th January, 1953, intestate.

LAMB, JOSEPH STORY, late of 16 Brixton-street, Flemington, cabinetmaker, died 27th February, 1953, intestate.

LAUGIER, HENRIETTA ABBY SHADFORTH, also known as Henrietta Abby Shadforth Laugier, late of Gippsland Benevolent Home, Bairnsdale, widow, died 16th June, 1952, intestate.

*PAULL, MARY, formerly of Morrah-street, Parkville, and Mount Royal, Parkville, but late of Austin Hospital, Heidelberg, pensioner, died 23rd April, 1953.

PICKERING, THOMAS CHARLES, late of 5 Melville-street, North Fitzroy, retired carpenter, died 25th February, 1953, intestate.

†POWER, JOHN, late of 8 Caroline-street, South Yarra, pensioner, died 5th May, 1953.

SHARP, JAMES JOHN, also known as James Sharp, late of Hall-street, Cohuna, dragline operator, died 27th January, 1953, intestate.

SOUTHGATE, JANE, late of Bendigo Benevolent Home, Bendigo, pensioner, died 28th March, 1953, intestate.

UREN, WILLIAM, formerly of 230 Myers-street, Geelong, but late of Austin Hospital, Heidelberg, miner, died 1st January, 1953, intestate.

*WERNER, ELIZABETH GESA, also known as Gesa Elizabeth Werner, late of 205 Church-street, Middle Brighton, married woman, died 3rd May, 1953.

†WILLIAMS, ALFRED STUART, late of 38 Thames-street, Box Hill, accountant, died 22nd April, 1953.

†WILLIAMSON, JOHN ARNOLD, late of Richmond, New South Wales, farm manager, died 28th April, 1952.

* According to the provisions of the will.
† With the will annexed.

C. J. GARDNER,
Public Trustee.

Melbourne, 8th July, 1953.

Infectious Diseases Hospital Act 1928.

NOMINATIONS FOR TRIENNIAL ELECTION, UNDER PREFERENTIAL VOTING CONDITIONS, OF REPRESENTATIVES ON THE HOSPITAL BOARD.

IN pursuance of the provisions of the *Infectious Diseases Hospital Act 1928*, and of the Regulations made thereunder, I hereby give notice that I have specified Thursday, the 27th day of August, 1953, as the day on or before which the Council of the City of Melbourne may nominate a suitable person to be its representative member on the Queen's Memorial Infectious Diseases Hospital Board; and further, that I have specified Thursday, the 27th day of August, 1953, as the day on or before which—

- (1) the Council of each of the municipalities composing the "A" Group, viz.:—Collingwood, Doncaster and Templestowe, Eltham, Fitzroy, Richmond, Heidelberg, and Whittesea;
- (2) the Council of each of the municipalities composing the "B" Group, viz.:—Williamstown, Footscray, Sunshine, Essendon, Coburg, Brunswick, Preston, Northcote, Broadmeadows, Werribee, and Kellor;
- (3) the Council of each of the municipalities composing the "C" Group, viz.:—Malvern, Hawthorn, Kew, Camberwell, Box Hill, Healesville, Dandenong, Upper Yarra, Lillydale, Ringwood, Nunawading, and Fern Tree Gully;
- (4) the Council of each of the municipalities composing the "D" Group, viz.:—Port Melbourne, South Melbourne, St. Kilda, and Brighton; and
- (5) the Council of each of the municipalities composing the "E" Group, viz.:—Frahman, Caulfield, Moorabbin, Oakleigh, Frankston and Hastings, Mornington, Sandringham, Mordialloc, Chelsea, and Cranbourne—

respectively, may nominate a suitable person to be its representative member on the Queen's Memorial Infectious Diseases Hospital Board.

Dated at Melbourne this 8th day of July, 1953.

KEVIN BRENNAN,
Returning Officer.

Department of Health, 295 Queen-street, Melbourne, C.1.

BROADFORD WATERWORKS TRUST.

RATING BY-LAW FOR THE YEAR 1953.

THE Broadford Waterworks Trust, in pursuance and exercise of the powers conferred by the Water Acts, doth hereby make a rate for the supply of water for domestic purposes of Two shillings and three pence in the pound on the net annual value of lands and tenements liable to be rated within the Broadford Urban District provided that in no case shall the amount of rate payable per annum in respect of any tenement (other than land on which there is no building) be less than Eighty shillings, and in respect of any land on which there is no building less than Thirty shillings.

Such rates are made and shall be levied upon the occupiers or owners of the said lands and tenements for the year commencing the 1st day of January, 1953, and shall be payable on the 23rd day of July, 1953, at the office of the said Trust.

The maximum quantity of water to be supplied in any one year without further charge to any property rated by the Trust is hereby fixed at the quantity produced by a charge of Two shillings per 1,000 gallons on the first £10 of the rate and Six pence per 1,000 gallons on the amount of rate exceeding £10.

The charge for water supplied to any property rated by the Trust in excess of such maximum quantity is hereby fixed at Two shillings per 1,000 gallons on quantities used between the maximum quantity as computed in the preceding clause and 100,000 gallons, and Six pence per 1,000 gallons over 100,000 gallons.

The charge for water supplied by measure shall be payable, on demand, at the office of the Trust.

Passed this second day of July, 1953.

(SEAL) T. M. NEILL, Chairman.
M. D. WADE, Secretary.

Approved, 10th July, 1953.—C. P. STONEHAM, Minister of Water Supply.

BACCHUS MARSH SHIRE COUNCIL.—SHIRE OF BACCHUS MARSH WATER SUPPLY DISTRICT.

FIXING THE LIMIT OF A BANK OVERDRAFT.

HIS Excellency the Administrator of the Government of the State of Victoria, by and with the advice of the Executive Council thereof, doth by Order made on the 14th day of July, 1953, in pursuance of the provisions of section 273 of the *Water Act 1928* (No. 3801), fix the limit of the overdraft to be obtained by the Council of the Shire of Bacchus Marsh from the Commercial Bank of Australia Limited, Bacchus Marsh, at an amount not to exceed at any one time the sum of One thousand pounds (£1,000).

A. MAHLSTEDT,
Clerk of the Executive Council.

At the Executive Council Chamber,
Melbourne, 14th July, 1953.

BACCHUS MARSH SHIRE COUNCIL.—SHIRE OF BACCHUS MARSH WATER SUPPLY DISTRICT.

AUTHORITY TO OBTAIN A BANK OVERDRAFT.

HIS Excellency the Administrator of the Government of the State of Victoria, by and with the advice of the Executive Council thereof, doth by Order made on the 14th day of July, 1953, authorize the Council of the Shire of Bacchus Marsh to obtain, in pursuance of the provisions of section 271 of the *Water Act 1928* (No. 3801), an advance or advances during the year 1953 from the Commercial Bank of Australia Limited, Bacchus Marsh, by overdraft of the Council's current account thereat, such overdraft not to exceed at any one time the sum of Three thousand five hundred pounds (£3,500).

A. MAHLSTEDT,
Clerk of the Executive Council.

At the Executive Council Chamber,
Melbourne, 14th July, 1953.

EDUCATION DEPARTMENT.

SUMMONING OFFICER.

I HEREBY appoint the under-mentioned person, under section 31 of the *Education Act 1928* to summon parents within the State of Victoria:—

Senior Constable SAMUEL JAMES HOWARD, No. 7942

A. E. SHEPHERD,
Minister of Education.

Melbourne, 6th July, 1953.

EDUCATION DEPARTMENT.

SUMMONING OFFICER.

I HEREBY appoint the under-mentioned person, under section 31 of the *Education Act 1928* to summon parents within the State of Victoria:—

Senior Constable NORMAN MURRAY McDONALD, No. 8909.

A. E. SHEPHERD,
Minister of Education.

Melbourne, 6th July, 1953.

ENGINEERS OF WATER SUPPLY—EXAMINATION OF CANDIDATES FOR CERTIFICATES OF QUALIFICATION.

THE Board of Examiners of Engineers of Water Supply for the State of Victoria, appointed under the provisions of the Water Acts, hereby gives notice that an examination of candidates for Certificates of Qualification will be held on Wednesday, Thursday, and Friday, the 26th, 27th, and 28th August, 1953, at the University of Melbourne, Carlton, N.3.

All applications from intending candidates must be in the hands of the Secretary to the Board not later than Wednesday, 5th August, 1953.

By order,
K. E. FINDLAY,
Secretary, Board of Examiners.

State Rivers and Water Supply Commission, Melbourne,
13th July, 1953.

SUPERANNUATION ACTS.

At the Executive Council Chamber, Melbourne, the eighth day of July, 1953.

PRESENT:

His Excellency the Administrator of the Government of the State of Victoria.

Mr. Galvin | Mr. Shepherd.
Mr. Smith |

IN accordance with the provisions of section 2 (j) (ii) of the *Superannuation (Amendment) Act 1949* (No. 5395), His Excellency the Administrator of the Government of the State of Victoria, by and with the advice of the Executive Council thereof, doth by this Order declare that the provisions of the Superannuation Acts shall apply to—

FRANK PETER MOUNTJOY

in his capacity as Chairman of the Transport Regulation Board.

And the Honorable Leslie William Galvin, for and on behalf of Her Majesty's Treasurer for the State of Victoria, shall give the necessary directions herein accordingly.

A. MAHLSTEDT,
Clerk of the Executive Council.

LOCAL GOVERNMENT ACT 1946.

At the Executive Council Chamber, Melbourne, the eighth day of July, 1953.

PRESENT:

His Excellency the Administrator of the Government of the State of Victoria.

Mr. Galvin | Mr. Shepherd.
Mr. Smith |

ALTERATION OF HOUR FOR CLOSING POLL AT MUNICIPAL ELECTIONS, BOROUGH OF CAMPERDOWN.

IN pursuance of the provisions of section 134 of the *Local Government Act 1946*, His Excellency the Administrator of the Government of the State of Victoria, by and with the advice of the Executive Council thereof, and acting on a petition presented by the Council of the Borough of Camperdown, dated the 10th June, 1953, doth, by this Order, declare that the hour for closing the poll at municipal elections for the Borough of Camperdown shall be Eight o'clock in the afternoon.

And the Honorable Samuel Merrifield, Her Majesty's Commissioner of Public Works for the State of Victoria, shall give the necessary directions herein accordingly.

A. MAHLSTEDT,
Clerk of the Executive Council.

LOCAL GOVERNMENT ACT 1946.

At the Executive Council Chamber, Melbourne, the eighth day of July, 1953.

PRESENT:

His Excellency the Administrator of the Government of the State of Victoria.

Mr. Galvin | Mr. Shepherd.
Mr. Smith |

VOTING BY POST AT MUNICIPAL ELECTIONS.

DIVISION 15 OF PART V. OF THE CONSTITUTION ACT AMENDMENT ACT 1928 (No. 3660), MADE APPLICABLE TO ELECTIONS OF COUNCILLORS UNDER THE PROVISIONS OF SECTION 149 OF THE LOCAL GOVERNMENT ACT 1946 (No. 5203).

HIS Excellency the Administrator of the Government of the State of Victoria, by and with the advice of the Executive Council thereof, and pursuant to the petitions of the Councils of the municipalities of the Boroughs of Camperdown and Inglewood, doth by this Order, under provisions of section 149 of the *Local Government Act 1946* (No. 5203), direct that the provisions of Division 15 of Part V. of *The Constitution Act Amendment Act 1928* (No. 3660), applicable and severally hereinafter set out with alterations therein, such alterations being deemed necessary for the purpose of carrying into effect such provisions, shall apply to the election of councillors for the said municipalities.

VOTING BY POST.

Obtaining of Forms of Application for Postal Ballot-papers.

274. (1) Any person entitled to vote at an election about to be held in any municipality who satisfies the returning officer—

- (a) that he resides at least 5 miles from the nearest polling place at which he is entitled to vote; or
- (b) that he has reason to believe that on the polling day during the hours of polling he will not be within 5 miles of the nearest polling place at which he is entitled to vote; or
- (c) that on account of ill health or infirmity he will be prevented from voting personally at any such polling place,

may before the polling day make application in the form B of the 25th Schedule or to the like effect to the returning officer for such municipality for a postal ballot-paper or postal ballot-papers enabling him to vote through the post at such election instead of attending personally to tender his vote thereat.

(2) In the case of an application on the ground that he has reason to believe that on the polling day, during the hours of polling, he will not be within 5 miles of the nearest polling place at which he is entitled to vote, the applicant shall state in his application the reason for such belief.

Application to be Signed in Presence of Authorized Witness.

(3) With respect to applications for postal ballot-papers the following provisions shall have effect:—

(a) The following directions with respect to such applications shall be substantially observed:—

- (i) When so much of the form of application as precedes the places for the signatures has been filled in and otherwise completed, the applicant shall exhibit his form of application to an authorized witness;
- (ii) The applicant shall then, in the presence of the authorized witness, sign his name in his own handwriting on the form of application in the place provided for the signature of the applicant; and
- (iii) The authorized witness shall then sign his name in his own handwriting in the place provided for the signature of the authorized witness, and shall add the title under which he acts as an authorized witness, his residence, and the date;

(b) An authorized witness shall not witness the signature of any applicant on any application for a postal ballot-paper or postal ballot-papers, unless the authorized witness—

- (i) has satisfied himself as to the identity of the applicant;
- (ii) has seen the applicant sign the application in his own handwriting; and
- (iii) knows that the statements contained in the application are true, or has satisfied himself (whether by inquiry from the applicant or otherwise) that the said statements are true.

Authorized Witness Not to Induce, &c., Persons to Apply for Postal Ballot-papers.

(c) An authorized witness shall not persuade or induce or associate himself with any person in persuading or inducing any person to make application for a postal ballot-paper or postal ballot-papers.

Authorized Witness Not to Visit Person to Witness Signature to Application except on Account of Ill Health or Infirmity.

(d) An authorized witness shall not—

- (i) visit any person for the purpose of witnessing the signature of such person to his application for a postal ballot-paper or postal ballot-papers; or
- (ii) witness the signature of any person to any such application in any place other than the ordinary residence or place of business of the authorized witness;

Provided that if any person desires to make application for a postal ballot-paper or postal ballot-papers and is unable on account of ill health or infirmity to present himself before an authorized witness, any member of the Police Force or other authorized witness, when so requested by any such person, in writing, may visit such person for the purpose of witnessing his signature to such application.

Penalty.

(e) Every authorized witness guilty of any contravention of or failure to observe any of the provisions of this sub-section as applied shall be liable to a penalty of not more than One hundred pounds, or to imprisonment for a term of not more than three months.

Posting of List of Applicants for Postal Ballot-Papers.

(f) A list containing the names of all applicants for postal ballot-papers, and the respective addresses to which they have been requested to be sent, shall be posted for public inspection outside the office of the returning officer of the district for which they are issued.

On Application, Returning Officer to Supply Postal Ballot-Paper or Postal Ballot-papers.

276. (1) (a) On receiving from any applicant an application for a postal ballot-paper or postal ballot-papers, the returning officer, having ascertained that the name of the applicant is upon the voters' roll to be used at the election for the municipality specified in the application, and that the applicant is not prohibited from voting, and if satisfied that the application is properly signed by the applicant and is properly witnessed, and that the applicant is entitled according to the statements contained in his application to a postal ballot-paper or postal ballot-papers, shall deliver to the applicant or post to him at the postal address named in the application a postal ballot-paper (with a counterfoil attached), or if such applicant appears by the voters' roll to be entitled to give more votes than one, then so many ballot-papers as may be equal to the number of votes not exceeding three which such applicant so appears to be entitled to give in the form or to the effect of the 26th Schedule, together with an envelope addressed to such returning officer at the polling place at which he intends to preside. Such envelope shall be marked "Postal Ballot-paper."

(b) If the returning officer is not satisfied that the application is properly signed by the applicant, or that the application is properly witnessed, or that the applicant is entitled to vote by post, he shall forthwith post to the applicant a notice in the form of the 28th Schedule or to the like effect.

Folding of Ballot-paper.

(2) Each ballot-paper before being enclosed shall be folded to the counterfoil.

Effect of Immaterial Error.

277. No application for a postal ballot-paper or postal ballot-papers shall, if properly signed by the applicant and properly witnessed, be deemed insufficient or invalid by reason only that in such application there is an omission or incorrect or insufficient description or misdescription in respect of any of the particulars required by law to be contained therein, if the returning officer is satisfied that the applicant is entitled to a postal ballot-paper or postal ballot-papers.

Initialling of Ballot-papers.

278. (1) The returning officer shall—

- (a) initial each postal ballot-paper issued; and
- (b) keep and number the applications therefor in consecutive order, writing the corresponding number on the counterfoil of the ballot-paper.

(2) On the counterfoil the returning officer shall also write the number on the voters' roll of the person to whom the postal ballot-paper is issued.

(3) Every postal ballot-paper issued by a returning officer after four o'clock in the afternoon of the day of nomination shall have printed or written thereon, in alphabetical order of surnames, the surnames and christian or other names of the candidates for election and, in the case of two or more candidates having the said surname and christian or other names, the residence and occupation of each such candidate: Provided that if no two candidates have the same surname, a postal ballot-paper so issued and upon which the candidates' names are written may have the surnames only of the candidates written thereon.

Record of Issue of Voting by Postal Ballot-paper or Postal Ballot-papers.

279. (1) The returning officer shall on the voters' roll to be used at the election for the municipality to which such postal ballot-paper or postal ballot-papers relate note opposite the applicant's name wherever it appears the fact that such postal ballot-paper has or postal ballot-papers have been issued to such applicant, and the date of such issue.

Notification to Presiding Officers.

(2) In case there is not time to note the fact of the issue of any postal ballot-paper or postal ballot-papers on every such roll on which such applicant's name appears which is to be used at the election, the returning officer shall in such manner as he thinks fit immediately notify such issue to the deputy returning officer at every polling place for such municipality at which a roll is to be used on which such applicant's name appears.

Mode of Voting by Means of Postal Ballot-papers.

280. The following directions for regulating voting by means of postal ballot-papers shall be substantially observed:—

(1) The voter shall exhibit his postal ballot-paper unmarked to an authorized witness.

(2) The voter shall in the presence of the authorized witness but so that the witness cannot see the vote—

(a) write on the ballot-paper the surnames of all the candidates (if the candidates' names are not already printed or written thereon when the ballot-paper is issued to him); and

(b) indicate the order of his preference by placing the figures 1, 2, 3, 4 and so on opposite the candidates' names.

Provided that where there are only two candidates, the provisions of paragraphs (a) and (b) shall be deemed to be sufficiently complied with if the ballot-paper is inscribed or marked in any manner so as clearly to indicate for whom the voter votes.

(3) In the case of a ballot-paper upon which the candidates' names are not printed or written when issued to the voter the voter shall, if more candidates than one have the same surname, also insert in the ballot-paper the christian or other names of each such candidate, and if more candidates than one have the same surname and christian or other names the residence and occupation of each such candidate.

(4) If the voter's sight is so impaired that he is unable to vote without assistance, the authorized witness, at the request of the voter—

(a) shall mark his vote on the ballot-paper and shall (if the voter so desires) mark the same in the presence of another person; or

(b) shall permit some other person appointed by the voter to mark the ballot-paper for him.

(5) The voter shall then refold the ballot-paper and fasten the same.

(6) The voter shall then sign his name in his own handwriting on the counterfoil in the place provided for the signature of the voter.

(7) The authorized witness shall then sign his name in his own handwriting in the place provided for the signature of the witness, and shall add the title under which he acts as an authorized witness, his residence, and the date.

(8) The voter shall then place the ballot-paper with the counterfoil attached, or ballot-papers each with counterfoil attached, into the envelope addressed to the returning officer, fasten the envelope in the presence of the authorized witness, and post it.

Duty of Authorized Witness.

281. (1) The authorized witness shall—

(a) see that the foregoing directions are substantially complied with;

(b) refrain from looking at the vote given by the voter except where the voter cannot vote without assistance and the voter requests his assistance;

(c) not disclose any knowledge officially acquired by him touching the vote of the voter save in answer to some question which he is legally bound to answer or in compliance with the express provisions of the law relating to elections of councillors for municipalities.

Witnessing Signature to Postal Ballot-Paper or Counterfoil.

(2) An authorized witness shall not—

(a) visit any voter for the purpose of witnessing the signature of such voter to his postal ballot-paper or postal ballot-papers;

(b) witness the signature of any voter to his postal ballot-paper or postal ballot-papers at any place other than the ordinary residence or place of business of the authorized witness; or

(c) witness the signature of any voter to his postal ballot-paper or postal ballot-papers unless the authorized witness has satisfied himself as to the identity of the voter and has seen the voter sign the counterfoil or counterfoils in the voter's own handwriting.

Provided that if any voter has received a postal ballot-paper or postal ballot-papers, and is unable, on account of ill health or infirmity, to present himself before an authorized witness, any member of the Police Force or other authorized witness when so requested by any such voter, in writing, may visit such voter for the purpose of witnessing his signature to such postal ballot-paper or postal ballot-papers.

Penalty.

(3) Every authorized witness guilty of any contravention of any of the provisions of this section shall be liable to a penalty of not more than One hundred pounds, or to imprisonment, with or without hard labour, for a term of not more than three months.

Mistakes in Spelling Immaterial.

282. No postal ballot-paper shall be rejected because of any mistake in spelling the name of the candidate if the intention is clear.

Person who has Received Postal Ballot-paper or Postal Ballot-papers Not to Vote Personally Without Giving up Same.

283. (1) Except as provided in the next succeeding section, no person to whom a postal ballot-paper for any election has or postal ballot-papers have been sent shall be entitled to vote personally at any poll unless he previously gives up such postal ballot-paper or postal ballot-papers unmarked to the returning officer or deputy at the polling place at which he is entitled to vote.

(2) Such officer shall immediately cancel any such postal ballot-paper and retain it.

Provision when Person claims to vote, although Postal Ballot-paper already issued.

284. (1) If a person to whom a postal ballot-paper appears to have been sent states that he has not received such postal ballot-paper and claims to vote personally at any polling place within the municipality to which such postal ballot paper relates, the returning officer or deputy at such booth may take from such person a declaration in the form of the Twenty-ninth Schedule or to the like effect. Thereupon such person shall be entitled to vote personally at such poll and his vote shall be taken in the ordinary way.

(2) If such vote is received by the deputy returning officer he shall immediately advise the returning officer of the fact of such person having voted personally and shall forward the declaration to the returning officer with the ballot-papers, and if any postal ballot-paper purports to have been received from the same person such postal ballot-paper shall be rejected at the counting of the votes and the returning officer shall state thereon the reason of such rejection.

Additional Question to be put on Tender of Vote Personally.

285. (1) The returning officer or deputy shall before any person personally tendering his vote at any election

for any municipality receives a ballot-paper or ballot-papers (but not afterwards), put to such person the following question in addition to any others he may lawfully put:—

Have you received a postal ballot-paper or postal ballot-papers enabling you to vote at the election for a councillor or councillors (as the case may be) for the Subdivision of the to-day? (*In the case of an adjourned poll the day from which the poll was adjourned should also be named in the question.*)

Refusal, &c., to Answer.

(2) Every person having tendered his vote when such question is put as aforesaid who refuses or omits distinctly to answer the same, and every person who answers the question in the affirmative but does not deliver up his postal ballot-paper or postal ballot-papers, unmarked, shall be and be deemed prohibited from voting then and afterwards at such election, and shall be guilty of an offence and shall be liable to a penalty of not more than Twenty pounds or to imprisonment with or without hard labour for a term of not more than one month.

Penalty for False Answer.

(3) Every person who wilfully makes a false answer to such question put as aforesaid shall be guilty of an offence, and shall be liable to a penalty of not more than Fifty pounds or to imprisonment with or without hard labour for a term of not more than three months.

Inclusion of Votes through the Post at close of Poll.

286. When immediately upon the close of any poll the returning officer is proceeding to ascertain the number of votes for each candidate, the returning officer shall produce unopened all envelopes containing postal ballot-papers received by him through the post up to the close of the poll, and such envelopes shall be opened in the presence of the scrutineers present and poll clerk (if any) but of no other person, and shall be dealt with as follows, namely:—

- (a) The returning officer shall produce all applications for postal ballot-papers;
- (b) The returning officer, without unfolding each postal ballot-paper or allowing it to be inspected, shall compare the signature of the voter on the counterfoil with the signature of the applicant and allow the scrutineers to inspect the same, and the returning officer shall determine whether or not the signature on the postal ballot-paper is that of the applicant;
- (c) If the postal ballot-paper is allowed by the returning officer he shall tear off the counterfoil without seeing the names of the candidate or candidates voted for, and shall insert the folded postal ballot-paper in a ballot-box separate from that used during the polling, and when all such postal ballot-papers have been so inserted the counting of the votes recorded therein shall commence;
- (d) Any postal ballot-paper not witnessed as required by these provisions as applied shall be disallowed by the returning officer;
- (e) The returning officer shall attach all the counterfoils together;
- (f) The list of the number of votes received by each candidate shall show separately the votes tendered personally and the votes given by postal ballot-papers;
- (g) If the returning officer disallows a postal ballot-paper then such ballot-paper shall be included in a sealed parcel of ballot-papers which shall be set aside for separate custody and transmitted to the clerk of the municipality.

Applications and Counterfoils to be forwarded to the Clerk of the Municipality after Declaration of Poll and to be Open for Inspection.

288. Notwithstanding anything in the *Local Government Act 1946*—

(a) All applications for postal ballot-papers and all counterfoils of postal ballot-papers received by a returning officer—

- (i) shall not be made up or enclosed in the sealed parcels as required by sections 144 and 145 of the said Act, but shall be made up and enclosed in a special packet which shall be endorsed with a description of the contents and the name of the subdivision, the name of the municipality, and the date of the polling (which endorsement shall be signed by the returning officer), and forthwith after the declaration of the poll shall be forwarded by the returning officer to the clerk of the municipality;

Preservation of Applications and Counterfoils.

- (ii) shall be safely kept by the clerk of the municipality for twelve months; and

Applications and Counterfoils Open to Public Inspection.

- (iii) after receipt thereof by the clerk of the municipality shall be open to public inspection at all convenient times during office hours at the office of the municipality until the expiration of the said period of twelve months; and
- (iv) after the period of twelve months referred to the applications for postal ballot-papers and counterfoils of ballot-papers shall be destroyed as provided by section 145 of the *Local Government Act*.

Clerk of the Municipality to give Receipt for Packet.

- (b) the clerk of the municipality shall forthwith give or send to the returning officer a receipt under his hand for every such special packet received by him.

Production before Police Magistrate.

- (c) the clerk of the municipality shall produce any such applications or counterfoils when required to do so by any police magistrate for the purposes of any recount of votes by such police magistrate.

Applications and Counterfoils to be Evidence.

(d) any application for a postal ballot-paper and any counterfoil of a postal ballot-paper taken from any such special packet and having written thereon respectively under the hand of the clerk of the municipality a certificate of the several particulars required by this section to be endorsed upon such packet, and that the same was taken from such packet shall be evidence in any Court or before any justice—

- (i) that the same was so taken;
- (ii) that the same, if an application was received by the returning officer (at the election to which such endorsement and writing relate), and that a postal ballot-paper the counterfoil of which bears the application number corresponding with the application number written on the application, was issued by the returning officer to the applicant whose name appears on the application; and
- (iii) that the same, if a counterfoil, was the counterfoil of a postal ballot-paper used at the said election.

Certain Offences to be Bribery.

289. The following persons shall be deemed guilty of bribery:—

- (a) Every person who directly or indirectly makes overtures to any person for the acquiring by gift or purchase or who acquires by gift or purchase from any person any postal ballot-paper; and
- (b) every person who directly or indirectly makes overtures to any other person for the giving away or parting with the possession of or selling any postal ballot-paper or who gives away any such paper or who sells or (except as in this Division as applied provided) parts with the possession of any postal ballot-paper.

Making False Application a Misdemeanour.

290. If in any application for a postal ballot-paper any person makes any false statement or if any person applies for a postal ballot-paper to which some other person is entitled he shall be guilty of a misdemeanour and shall be liable to imprisonment with or without hard labour for a term of not more than two years.

False Declaration Perjury.

291. Every person who wilfully makes and subscribes any declaration for the purposes of this Division as applied, the same being untrue or false in any particular, shall be liable to the penalties of perjury.

Inducing Disclosure of Vote by Post, &c., an Offence.

292. Every person who—

- (a) directly or indirectly requires, induces, or attempts to induce any person to show by producing his postal ballot-paper for whom he intends to vote at any election; or

- (b) unless authorized by this Division as applied writes the name or names of any candidate or candidates or marks any vote in any postal ballot-paper not issued to such person; or
- (c) opens any envelope addressed to a returning officer not being duly authorized so to do by such returning officer—

shall be guilty of an offence, and shall be liable to imprisonment with or without hard labour for a term of not more than one year.

Inducing Persons to Vote for any Particular Candidate by Bribery or Intimidation.

293. (1) Every person who requires, induces, or attempts to induce any person in his employment to obtain a postal ballot-paper with the intention of influencing such person by bribery or intimidation to record his vote in favour of any particular candidate shall be guilty of an offence, and shall be liable to a penalty of not more than Fifty pounds, to be recovered in a summary way before a court of petty sessions by any person who sues for the same.

(2) Bribery or intimidation shall for the purposes of this section include any promise or threat either expressed, implied, or understood of any benefit or disadvantage to accrue directly or indirectly to such person from such first-mentioned person.

Authorized Witnesses.

294. The following persons being resident in Victoria shall be authorized witnesses in and for Victoria within the meaning of this Division as applied:—

- (a) All returning officers and electoral registrars appointed under any Act relating to elections for the Legislative Council or the Legislative Assembly; all postmasters or postmistresses or persons in charge of post offices; all police magistrates; all justices; all commissioners for taking declarations and affidavits; all head teachers of State schools; all members of the Police Force; all clerks of petty sessions; all railway stationmasters; all councillors of and the clerk or secretary of any city, town, borough, or shire; all barristers and solicitors; and all legally qualified medical practitioners.
- (b) All persons or classes of persons employed in the Public Service of Victoria who are appointed by the Governor in Council to be authorized witnesses within the meaning of this Division as applied.

No person who is a candidate for any election shall be an authorized witness at or in connexion with that election.

SCHEDULES.

TWENTY-FIFTH SCHEDULE.—FORM B.
(Section 274.)

Application for a Postal Ballot-paper or Postal Ballot-papers.

To the Returning Officer for the (a) Subdivision of (b) I, (c) hereby apply for a postal ballot-paper (or postal ballot-papers).

(1) I am a person entitled to vote at an election about to be held for the (d) Subdivision (or Municipality).

(a) Here insert the name of Subdivision, (b) here insert name of municipality; (c) here insert christian or other name or names, surname, residence, and occupation; (d) here insert name of Subdivision or Municipality.

(2) The ground on which I apply for the postal ballot-paper is—

* (a) That I reside at least 5 miles from the nearest polling place at which I am entitled to vote.

* (b) That I have reason to believe that on the polling day during the hours of polling I will not be within 5 miles of the nearest polling place at which I am entitled to vote.
My reasons for this belief are—

* (c) That on account of ill health or infirmity I will be prevented from voting personally on polling day.

*NOTE.—The applicant will strike out any two of the above grounds which do not apply to his particular case, as only one ground is necessary for the application.

(3) I request that the postal ballot-paper (or postal ballot-papers) may be forwarded to me at (e) or (as the case may be) be delivered to me personally.

(e) Here state address to which postal ballot-paper or postal ballot-papers are to be sent.

Signed by the applicant in his own handwriting in my presence—

Signature of applicant in own handwriting.

Signature of authorized witness in own handwriting.

Title under which witness acts as an authorized witness.

Residence of authorized witness.

Dated at this day of

19

CAUTION.—Any person making a false statement in an application is liable to imprisonment for a term of not more than two years.

Authorized Witnesses.

The following persons being resident in Victoria are authorized witnesses in and for Victoria:—

- (a) All returning officers and electoral registrars appointed under any Act relating to elections for the Legislative Council or the Legislative Assembly; all postmasters or postmistresses or persons in charge of post offices; all police magistrates; all justices; all commissioners for taking declarations and affidavits; all head teachers of State schools; all members of the Police Force; all clerks of petty sessions; all railway stationmasters; all councillors of and the clerk or secretary of any city, town, borough, or shire; all barristers and solicitors; and all legally qualified medical practitioners.
- (b) All persons or classes of persons employed in the Public Service of Victoria who are appointed by the Governor in Council to be authorized witnesses.

No person who is a candidate at any election shall be an authorized witness at that election.

Instructions to Applicants and Authorized Witnesses.

(a) When so much of the form of application as precedes the places for the signatures has been filled in and otherwise completed the applicant shall exhibit his form of application to an authorized witness.

(b) The applicant shall then in the presence of the authorized witness sign his name in his own handwriting on the form of application in the place provided for the signature of the applicant.

(c) The authorized witness shall then sign his name in his own handwriting in the place provided for the signature of the authorized witness, and shall add the title under which he acts as an authorized witness, his residence, and the date.

Offences and Penalties.

(a) An authorized witness shall not witness the signature of any applicant on any application for a postal ballot-paper or postal ballot-papers unless the authorized witness—

- (i) has satisfied himself as to the identity of the applicant;
- (ii) has seen the applicant sign the application in his own handwriting; and
- (iii) knows that the statements contained in the application are true or has satisfied himself (whether by inquiry from the applicant or otherwise) that the said statements are true.

(b) An authorized witness shall not persuade or induce or associate himself with any person in persuading or inducing any person to make application for a postal ballot-paper or postal ballot-papers.

(c) An authorized witness shall not—

- (i) visit any person for the purpose of witnessing the signature of such person to his application for a postal ballot-paper or postal ballot-papers; or
- (ii) witness the signature of any applicant to any such application in any place other than the ordinary residence or place of business of the authorized witness.

Provided that if any person desires to make application for a postal ballot-paper or postal ballot-papers, and is unable on account of ill health or infirmity to present himself before an authorized witness any member of the Police Force or other authorized witness when so requested by any such person in writing may visit such person for the purpose of witnessing his signature to such application.

Every authorized witness guilty of any of these offences is liable to a penalty of not more than One hundred pounds, or to imprisonment for a term of not more than three months.

TWENTY-SIXTH SCHEDULE.

(Section 276.)

Postal Ballot-paper.

Subdivision of

(Before marking this ballot-paper exhibit it unmarked to an authorized witness and read carefully the Instructions to Voter printed hereon.)

Candidates' Names.

(a) Counterfoil—

Subdivision of

(b) No. of Application— Voter's Roll No.

(a) To be printed so that it shall be on the outside when the ballot-paper is folded, and so that it may be read and torn off without the names of candidates voted for being seen.

(b) To be filled in by the returning officer before posting.

I declare that I have not already posted a ballot-paper in respect of, or voted personally at the election in respect of which this vote is given.

Signature of voter—

Witness—

[Authorized witness to sign here and insert the title under which he acts as an authorized witness, his residence, and the date.]

Instructions to Voter.

(a) The voter shall exhibit his postal ballot-paper unmarked to an authorized witness.

(b) The voter shall in the presence of the authorized witness but so that the witness cannot see the vote—

(i) write the surnames of the candidates on the ballot-paper under the heading Candidates' Names (if such names are not already printed or written under that heading); and

(ii) place the figure 1 opposite the name of the candidate for whom the voter votes as his first preference and the figures 2, 3, 4 (and so on as the case requires) to indicate the order of the voter's preference for all the remaining candidates.

(c) If the candidates' names are not printed or written under the heading Candidates' Names when the ballot-paper is issued to the voter the voter shall if more candidates than one have the same surname also insert in the ballot-paper the christian or other names of such candidates, and if more candidates than one have the same surname and christian or other names the residences and occupations of such candidates.

(d) If the voter's sight is so impaired that he is unable to vote without assistance, the authorized witness, at the request of the voter, shall mark his vote on the ballot-paper and shall (if the voter so desires) mark the same in the presence of another person, or shall (if the voter so desires) permit some other person appointed by the voter to mark the ballot-paper for him.

(e) The voter shall then re-fold the ballot-paper and fasten the same.

(f) The voter shall then sign his name in his own handwriting on the counterfoil in the place provided for the signature of the voter.

(g) The authorized witness shall then sign his name in his own handwriting in the place provided for the signature of the witness, and shall add the title under which he acts as an authorized witness, his residence, and the date.

(h) The voter shall then place the ballot paper, with the counterfoil attached, into the envelope addressed to the returning officer, fasten the envelope in the presence of the authorized witness, and post it.

(i) This ballot-paper cannot be counted in the election unless it is received by the returning officer before the closing of the poll.

Instructions to Authorized Witness.

The authorized witness shall—

(a) see that the foregoing directions are substantially complied with;

(b) refrain from looking at the vote given by the voter except where the voter cannot vote without assistance and the voter requests his assistance;

(c) not disclose any knowledge officially acquired by him touching the vote of the voter save in answer to some question which he is legally bound to answer or in compliance with the express provisions of the law relating to elections of councillors for municipalities.

An authorized witness shall not—

(a) visit any voter for the purpose of witnessing the signature of such voter to his postal ballot-paper;

(b) witness the signature of any voter to his postal ballot-paper at any place other than the ordinary residence or place of business of the authorized witness; or

(c) witness the signature of any voter to his postal ballot-paper unless the authorized witness has satisfied himself as to the identity of the voter and has seen the voter sign the counterfoil in his own handwriting;

Provided that if any voter has received a postal ballot-paper and is unable on account of ill health or infirmity to present himself before an authorized witness, any member of the Police Force or other authorized witness, when so requested by any such voter in writing, may visit such voter for the purpose of witnessing his signature to such postal ballot-paper.

Every authorized witness guilty of a contravention of any of these instructions to authorized witnesses is liable to a penalty of not more than One hundred pounds, or to imprisonment, with or without hard labour, for a term of not more than three months.

TWENTY-EIGHTH SCHEDULE.

(Section 276.)

As returning officer for the Subdivision of _____ I desire to inform you that after perusing your application for a postal ballot-paper I am not satisfied—

- *that your application is properly signed; or
- *that your application is properly witnessed; or
- *that you are entitled to vote through the post at the forthcoming election of a councillor (or councillors) for Subdivision of the _____ municipality of _____

Therefore, if you desire to vote at that election, you will have to attend personally at the polling booth and tender your vote.

Dated at this day of 19

*NOTE.—The returning officer will strike out any of these statements which is inapplicable to the particular case.

TWENTY-NINTH SCHEDULE.

(Section 284.)

Declaration of Person Claiming to Vote at Polling Booth.

I, _____, residing at _____ do hereby declare that my name is included in the voters' roll for the Subdivision of the _____ and that I have not received a postal ballot-paper entitling me to vote by post at the election of a councillor (or councillors) now being held in the said _____ and that I desire to vote personally at such election.

Signed and declared at _____ Polling booth this _____ day of _____ in the presence of—
Returning Officer or Deputy Returning Officer.

CAUTION.—Any person who wilfully makes and subscribes a declaration which is untrue or false in any particular is deemed to be guilty of wilful and corrupt perjury, and is punishable accordingly.

And the Honorable Samuel Merrifield, Her Majesty's Commissioner of Public Works for the State of Victoria, shall give the necessary directions herein accordingly.

A. MAHLSTEDT,
Clerk of the Executive Council.

MARKETING OF PRIMARY PRODUCTS ACT 1935 (No. 4337).

*At the Executive Council Chamber, Melbourne,
the eighth day of July, 1953.*

PRESENT:

His Excellency the Administrator of the Government of the
State of Victoria.

Mr. Galvin
Mr. Smith

Mr. Shepherd.

REGULATION.

IN pursuance of the powers conferred by the *Marketing of Primary Products Act 1935* (No. 4337), His Excellency the Administrator of the Government of the State of Victoria, by and with the advice of the Executive Council thereof, doth hereby make the following Regulation (that is to say):—

1. The Regulations under the above-mentioned Act made on the twenty-fourth day of December, 1935, and amended on the 5th May, 1936, and the 15th October, 1940, are hereby further amended as follows:—

- (a) In Regulation 36 (b) all words after the word "accordance" shall be deleted and there shall be substituted therefor the following words "with Sub-section (4) of Section 144 of the *Local Government Act* No. 5203."

And the Honorable Clive Phillip Stoneham, Her Majesty's Minister of Agriculture for the State of Victoria, shall give the necessary directions herein accordingly.

A. MAHLSTEDT,
Clerk of the Executive Council.

TEACHING SERVICE ACT 1946.

*At the Executive Council Chamber, Melbourne,
the eighth day of July, 1953.*

PRESENT:

His Excellency the Administrator of the Government of the
State of Victoria.

Mr. Galvin
Mr. Smith

Mr. Shepherd.

REGULATIONS.

IN pursuance of the powers conferred by the *Teaching Service Act 1946*, His Excellency the Administrator of the Government of the State of Victoria, by and with the advice of the Executive Council thereof, doth hereby amend the Teaching Service (Governor in Council) Regulations in the manner following, that is to say:—

REGULATION 4.

Leave of Absence: Sick Leave and Special Leave.

- To the heading above clause 17, add the expression "or Malaya".
- In sub-clause 17 (a), after the expression "war service in Korea", add the expression "or Malaya".

REGULATION 5.

In clause 6, after the expression "and thirty-nine", insert the expression "or in connexion with the warlike operations in Korea after the twenty-sixth day of June, One thousand nine hundred and fifty, or in Malaya after the twenty-eighth day of June, One thousand nine hundred and fifty".

And the Honorable Alfred Ernest Shepherd, Her Majesty's Minister of Education for the State of Victoria, shall give the necessary directions herein accordingly.

A. MAHLSTEDT,
Clerk of the Executive Council.

FRUIT AND VEGETABLES ACT 1928.

*At the Executive Council Chamber, Melbourne,
the eighth day of July, 1953.*

PRESENT:

His Excellency the Administrator of the Government of the
State of Victoria.

Mr. Galvin | Mr. Shepherd.
Mr. Smith |

AMENDMENT OF REGULATIONS.

IN pursuance of the powers conferred by the *Fruit and Vegetables Act 1928* (No. 3687), His Excellency the Administrator of the Government of the State of Victoria, by and with the advice of the Executive Council thereof, doth hereby make the following Regulation, that is to say:—

In Regulation 20 of the Regulations made on the 11th day of November, 1935, after paragraph (c) there shall be inserted the following proviso:—

Provided that during the period 15th July, 1953, to the 31st October, 1953, potatoes of a minimum weight of 2 oz. which comply with this definition in all respects other than size and weight, may be sold as No. 1 grade.

And the Honorable Clive Phillip Stoneham, Her Majesty's Minister of Agriculture for the State of Victoria, shall give the necessary directions herein accordingly.

A. MAHLSTEDT,
Clerk of the Executive Council.

HOSPITALS AND CHARITIES ACT 1948 (No. 5300),
SECTION SIXTEEN.

*At the Executive Council Chamber, Melbourne, the
eighth day of July, 1953.*

PRESENT:

His Excellency the Administrator of the Government of the
State of Victoria.

Mr. Galvin | Mr. Shepherd.
Mr. Smith |

SALARIES OF MEMBERS OF THE HOSPITALS AND
CHARITIES COMMISSION.

PURSUANT to the provisions of sub-section (1) of section sixteen of Act No. 5300, the Administrator of the Government of the State of Victoria, by and with the advice of the Executive Council thereof, hereby fixes the salaries of two of the members of the Hospitals and Charities Commission at the rates shown below against the respective offices of such members and hereby declares that the rates so fixed shall be subject to such cost of living adjustment as may be prescribed from time to time under the provisions of the Public Service Acts as applying to the salaries or wages of officers or employees within the meaning of those Acts.

| Office | Rate |
|---|--------|
| The member appointed by the Governor in Council as Chairman of the Hospitals and Charities Commission | £3,122 |
| The third member | 1,650 |

And the Honorable William Peter Barry, Her Majesty's Minister of Health for the State of Victoria, shall give the necessary directions herein accordingly.

A. MAHLSTEDT,
Clerk of the Executive Council.

HOSPITALS AND CHARITIES ACT 1948 (No. 5300),
SECTION 9 (3).

*At the Executive Council Chamber, Melbourne, the
eighth day of July, 1953.*

PRESENT:

His Excellency the Administrator of the Government of the
State of Victoria.

Mr. Galvin | Mr. Shepherd.
Mr. Smith |

WHEREAS by the *Hospitals and Charities Act 1948*, it is provided that there shall be a Commission to be called "The Hospitals and Charities Commission" to consist of three members appointed by the Governor in Council:

And whereas it is further provided that no member of the Commission shall during his continuance in office be engaged without the sanction of the Governor in Council in any employment other than in connexion with the duties of his office:

And whereas Dr. John Henry Lindell and William Leslie Rowe are members of the said Commission:

And whereas it is desired that Dr. John Henry Lindell and William Leslie Rowe should engage in employment other than in connexion with the duties of their offices as members of the said Commission:

Now therefore I, the Administrator of the Government of the State of Victoria, by and with the advice of the Executive Council of the said State, do hereby sanction the engagement of Dr. John Henry Lindell as Medical Superintendent of the Royal Melbourne Hospital, and of William Leslie Rowe, as Secretary of the Department of Health, while occupying positions as members of the said Commission.

And the Honorable William Peter Barry, Her Majesty's Minister of Health for the State of Victoria, shall give the necessary directions herein accordingly.

A. MAHLSTEDT,
Clerk of the Executive Council.

DEPARTMENT OF CROWN LANDS AND SURVEY.

At the Executive Council Chamber, Melbourne, the eighth day of July, 1953.

PRESENT:

His Excellency the Administrator of the Government of the State of Victoria.

Mr. Galvin
Mr. Smith

|

Mr. Shepherd.

UNUSED AND UNMADE ROADS CLOSED.

HIS Excellency the Administrator of the Government of the State of Victoria, by and with the advice of the Executive Council thereof, doth hereby direct that, in pursuance of the provisions of section 304 of the Land Act 1928, the unused and unmade roads referred to hereunder be closed, viz.:-

Parish of Wonthaggi North, County of Mornington, being the road between allotments 9, 10, and allotments 11, 12, section A.—(W.345⁽¹²⁾) (13/A.C.).

Parish of Heathcote, County of Dalhousie, being the road indicated by hachure on plan hereunder.—(H.75⁽¹³⁾) (H.019106).

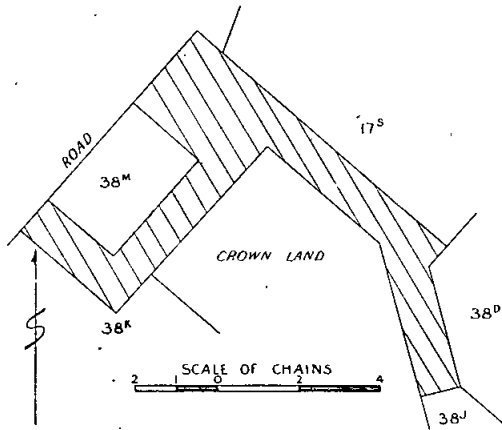

Parish of Dueran, County of Delatite, being the road indicated by hachure on plan hereunder.—(D.174⁽⁴⁾) (H.021456).

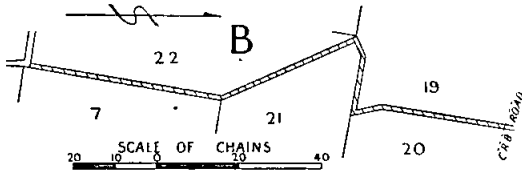

And the Honorable Robert Wilfred Holt, Her Majesty's Commissioner of Crown Lands and Survey for the State of Victoria, shall give the necessary directions herein accordingly.

A. MAHLSTEDT,
Clerk of the Executive Council.

DEPARTMENT OF CROWN LANDS AND SURVEY.

At the Executive Council Chamber, Melbourne, the eighth day of July, 1953.

PRESENT:

His Excellency the Administrator of the Government of the State of Victoria.

Mr. Galvin
Mr. Smith

|

Mr. Shepherd.

LANDS TEMPORARILY RESERVED AS SITES.

HIS Excellency the Administrator of the Government of the State of Victoria, by and with the advice of the Executive Council thereof, doth hereby, in pursuance of

the provisions of the Land Act 1928, reserve, temporarily, and also except from occupation for mining purposes under any miner's right, the lands hereinafter described:—

BRANJEE.—Site for a Rubbish and Night-soil Depot, 21 acres 2 roods 20 perches, more or less, Parish of Branjee, County of Delatite, as indicated by hachure on plan hereunder.—(B.589^(*)) (Rs.7063).

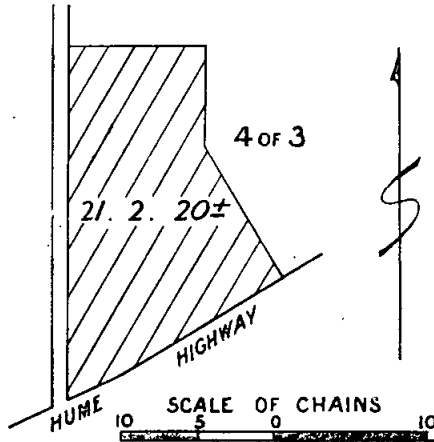

BRUNSWICK.—Site for Road and Public purposes, 2 roods 30 perches, more or less, City of Brunswick, Parish of Jika Jika, County of Bourke, as indicated by hachure on plan hereunder.—(J.16^(*)) (Rs.6086).

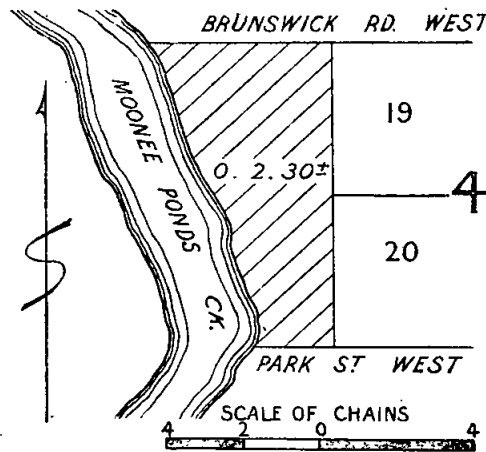

MANSFIELD.—Site for Public Recreation, 2 roods 30 perches, more or less, Township of Mansfield, Parish of Mansfield, County of Delatite, as indicated by hachure on plan hereunder.—(M.35^(s)) (Rs.1817).

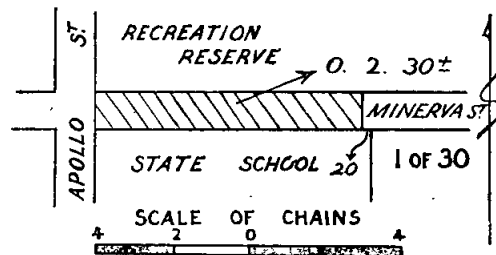

And the Honorable Robert Wilfred Holt, Her Majesty's Commissioner of Crown Lands and Survey for the State of Victoria, shall give the necessary directions herein accordingly.

A. MAHLSTEDT,
Clerk of the Executive Council.

DEPARTMENT OF CROWN LANDS AND SURVEY.

At the Executive Council Chamber, Melbourne, the eighth day of July, 1953.

PRESENT:

His Excellency the Administrator of the Government of the State of Victoria.

| | | |
|------------|--|---------------|
| Mr. Galvin | | Mr. Shepherd. |
| Mr. Smith | | |

REVOCATION OF ORDER IN COUNCIL TEMPORARILY RESERVING AND WITHHOLDING FROM SALE, LEASING, AND LICENSING CERTAIN LAND.

HIS Excellency the Administrator of the Government of the State of Victoria, by and with the advice of the Executive Council thereof, doth hereby, in pursuance of the provisions of the *Land Act 1928*, revoke the temporary reservation and the withholding from sale, leasing, and licensing of the land mentioned hereunder:—

KANYAPELLA.—Order in Council of the 30th January, 1884, of 5 acres of land in the Parish of Kanyapella, as a site for Public purposes (State School).—(C.95170.)

And the Honorable Robert Wilfred Holt, Her Majesty's Commissioner of Crown Lands and Survey for the State of Victoria, shall give the necessary directions herein accordingly.

A. MAHLSTEDT,
Clerk of the Executive Council.

COUNTRY ROADS BOARD.

At the Executive Council Chamber, Melbourne, the eighth day of July, 1953.

PRESENT:

His Excellency the Administrator of the Government of the State of Victoria.

| | | |
|------------|--|---------------|
| Mr. Galvin | | Mr. Shepherd. |
| Mr. Smith | | |

ORDER APPROVING OF A DEVIATION FROM A MAIN ROAD IN THE SHIRE OF CRANBOURNE.

WHEREAS the Country Roads Board constituted under the *Country Roads Act 1928* (No. 3662) has represented to His Excellency the Governor in Council that it appears to it desirable that the deviation hereinafter referred to from the existing Ballarto-road in the Shire of Cranbourne (declared to be a main road under the said Act which declaration was confirmed by the Order in Council published in the *Government Gazette* of the 18th June, 1947, on pages 2949-51) should be made by the said Board: And whereas the said Board in accordance with the requirements of section 19 of the said cited Act has caused to be prepared a map plan and estimate showing the points between which and on and through what land the said deviation is proposed to be made and the cost of acquiring the land and constructing the said deviation: And whereas on an inspection of the said map and plan and a consideration of the said estimate His Excellency the Governor in Council is satisfied that there are funds legally available for acquiring the land and constructing the said deviation: Now therefore be it known by this present Order that His Excellency the Administrator of the Government of the State of Victoria with the advice of the Executive Council thereof doth hereby approve of the said road being made, that is to say:—

All that piece of land in the Parish of Cranbourne, the boundaries of which are as follow:—Commencing at a point on the northern boundary of allotment 36A of the said parish distant 270 deg. 5½ min. 606 links from the north-eastern angle of the said allotment; thence by lines bearing respectively 109 deg. 42½ min. 474.7 links, 160 deg. 16½ min. 183.3 links, and 303 deg. 10½ min. 607.8 links to the point of commencement—which said piece of land is particularly delineated and shown coloured red on survey plan numbered 5733, lodged in the office of the Country Roads Board.

And the Honorable Samuel Merrifield, Her Majesty's Commissioner of Public Works for the State of Victoria, shall give the necessary directions herein accordingly.

A. MAHLSTEDT,
Clerk of the Executive Council.

COUNTRY ROADS BOARD.

At the Executive Council Chamber, Melbourne, the eighth day of July, 1953.

PRESENT:

His Excellency the Administrator of the Government of the State of Victoria.

| | | |
|------------|--|---------------|
| Mr. Galvin | | Mr. Shepherd. |
| Mr. Smith | | |

ORDER APPROVING OF A DEVIATION FROM A MAIN ROAD IN THE SHIRE OF MORNINGTON.

WHEREAS the Country Roads Board constituted under the *Country Roads Act 1928* (No. 3662) has represented to His Excellency the Governor in Council that it appears to it desirable that the deviation hereinafter referred to from the existing Moorooduc-road in the Shire of Mornington (declared to be a main road under the said Act which declaration was confirmed by the Order in Council published in the *Government Gazette* of the 16th July, 1947, on pages 3851-5) should be made by the said Board: And whereas the said Board in accordance with the requirements of section 19 of the said cited Act has caused to be prepared a map plan and estimate showing the points between which and on and through what land the said deviation is proposed to be made and the cost of acquiring the land and constructing the said deviation: And whereas on an inspection of the said map and plan and a consideration of the said estimate His Excellency the Governor in Council is satisfied that there are funds legally available for acquiring the land and constructing the said deviation: Now therefore be it known by this present Order that His Excellency the Administrator of the Government of the State of Victoria with the advice of the Executive Council thereof doth hereby approve of the said road being made, that is to say:—

All that piece of land in the Parish of Moorooduc, the boundaries of which are as follow:—Commencing at the south-western angle of allotment 3, section A, of the said parish; thence by lines bearing respectively 350 deg. 30 min. 960 links, 30 deg. 0 min. 944.6 links, and 190 deg. 5 min. 1,792.6 links to the point of commencement—which said piece of land is particularly delineated and shown coloured red on survey plan numbered 5729, lodged in the office of the Country Roads Board.

And the Honorable Samuel Merrifield, Her Majesty's Commissioner of Public Works for the State of Victoria, shall give the necessary directions herein accordingly.

A. MAHLSTEDT,
Clerk of the Executive Council.

Soil Conservation and Land Utilization Act 1947.
SOIL CONSERVATION AUTHORITY.

At the Executive Council Chamber, Melbourne, the eighth day of July, 1953.

PRESENT:

His Excellency the Administrator of the Government of the State of Victoria.

| | | |
|------------|--|---------------|
| Mr. Galvin | | Mr. Shepherd. |
| Mr. Smith | | |

CONSTITUTION OF A SOIL CONSERVATION DISTRICT.

IN pursuance of the powers conferred by section 15 of the *Soil Conservation and Land Utilization Act 1947*, His Excellency the Administrator of the Government of the State of Victoria, upon the recommendation of the Authority, by and with the advice of the Executive Council thereof, doth hereby constitute the following district as a Soil Conservation District:—

The Upper Murray Soil Conservation District (the District is defined on a map lodged at the head office of the Soil Conservation Authority, 378 Cotham-road, Kew).

And the Honorable Robert Wilfred Holt, Her Majesty's Minister for Conservation for the State of Victoria, shall give the necessary directions herein accordingly.

A. MAHLSTEDT,
Clerk of the Executive Council.

DEPARTMENT OF PUBLIC WORKS.

At the Executive Council Chamber, Melbourne, the eighth day of July, 1953.

PRESENT:

His Excellency the Administrator of the Government of the State of Victoria.

| | | |
|------------|--|---------------|
| Mr. Galvin | | Mr. Shepherd. |
| Mr. Smith | | |

VARIATION OF SPECIFICATIONS FOR PRIVATE STREET CONSTRUCTION SCHEMES, CITY OF BOX HILL.

IN pursuance of the provisions of the *Local Government (Private Street Construction) Act 1947*, His Excellency the Administrator of the Government of the State of Victoria, being satisfied that the works provided for in the schemes adopted by the Council of the City of Box Hill for the construction of—

| | |
|--|---|
| Linden-street, Duncan-street, Asquith-street, Haig-street, and | Parts of—Foch-street, Birdwood-street, Sycamore-street, Peace-street, Devon-street, |
|--|---|

being private streets within the municipal district of the said City, cannot be satisfactorily executed in accordance with the specifications, maps, plans, sections, and elevations in the schemes, doth by this Order, by and with the advice of the Executive Council of the said State, authorize the Council of the City of Box Hill to execute the works with the substitution in the said specifications of the following specification for the construction of asphalt paths for the specification for the construction of concrete paths:—

Specification for Construction of Asphalt Paths in Duncan, Asquith, Haig, and Linden streets, and parts of Birdwood, Foch, Peace, Devon, and Sycamore streets.

Preparation of Site.—Paths are to be boxed out for a depth of 3 inches and to a width of 4 ft. 6 in. from the building line and to the same longitudinal grade as the top of existing kerbing.

Paths.—The paths are to be constructed in two stages. Stage 1 shall consist of the placing and spreading of bituminous mixed screenings to a depth of 3 inches. These screenings are to be raked and levelled before rolling with a 30-cwt. power roller. All depressions appearing during rollings are to be made good by the addition of extra material. Stage 2 consists of the application of a top coat of stone-filled sheet asphalt to a depth of three-quarters of an inch. The top coat is to be spread hot, raked, and left even and true to grade before rolling with a 30-cwt. power roller.

Maintenance.—The paths are to be maintained for a period of two months after completion.

And the Honorable Samuel Merrifield, Her Majesty's Commissioner of Public Works for the State of Victoria, shall give the necessary directions herein accordingly.

A. MAHLSTEDT,
Clerk of the Executive Council.

MARKETING OF PRIMARY PRODUCTS ACT 1935 (No. 4337).

At the Executive Council Chamber, Melbourne, the eighth day of July, 1953.

PRESENT:

His Excellency the Administrator of the Government of the State of Victoria.

| | | |
|------------|--|---------------|
| Mr. Galvin | | Mr. Shepherd. |
| Mr. Smith | | |

APPOINTMENT OF A DAY FOR A POLL TO BE TAKEN OF THE PRODUCERS OF SEED BEANS FOR THE ELECTION OF REPRESENTATIVES OF PRODUCERS TO BE ELECTIVE MEMBERS OF THE SEED BEANS MARKETING BOARD.

IN pursuance of the provisions in that behalf contained in section 9 of the *Marketing of Primary Products Act 1935* (No. 4337), His Excellency the Administrator of the Government of the State of Victoria, in the Commonwealth of Australia, by and with the advice of the Executive

Council of the said State, doth by this Order hereby appoint Monday, the thirty-first day of August, 1953, as the day for a poll to be taken of the producers of seed beans for the election of four (4) representatives to be elective members of the Seed Beans Marketing Board, and doth further appoint one electoral area covering the whole of the State of Victoria for such election.

And the Honorable Clive Phillip Stoneham, Her Majesty's Minister of Agriculture for the State of Victoria, shall give the necessary directions herein accordingly.

A. MAHLSTEDT,
Clerk of the Executive Council.

COLAC SEWERAGE AUTHORITY.

At the Executive Council Chamber, Melbourne, the eighth day of July, 1953.

PRESENT:

His Excellency the Administrator of the Government of the State of Victoria.

| | | |
|------------|--|---------------|
| Mr. Galvin | | Mr. Shepherd. |
| Mr. Smith | | |

CONSENT TO BORROWING £10,000.

UNDER the powers conferred by the Sewerage Districts Acts and all other powers enabling him in that behalf, His Excellency the Administrator of the Government of the State of Victoria, by and with the advice of the Executive Council of the said State, doth hereby consent to the Colac Sewerage Authority borrowing by the issue of debentures, a sum of Ten thousand pounds (£10,000) to meet the cost of additions to sewage treatment works and pumping plant as set forth in the detailed statement bearing date the 3rd July, 1953.

And the Honorable Clive Phillip Stoneham, Her Majesty's Minister of Water Supply for the State of Victoria, shall give the necessary directions herein accordingly.

A. MAHLSTEDT,
Clerk of the Executive Council.

SHEPPARTON SEWERAGE AUTHORITY.

At the Executive Council Chamber, Melbourne, the eighth day of July, 1953.

PRESENT:

His Excellency the Administrator of the Government of the State of Victoria.

| | | |
|------------|--|---------------|
| Mr. Galvin | | Mr. Shepherd. |
| Mr. Smith | | |

CONSENT TO BORROWING £6,000.

UNDER the powers conferred by the Sewerage Districts Acts and all other powers enabling him in that behalf, His Excellency the Administrator of the Government of the State of Victoria, by and with the advice of the Executive Council of the said State, doth hereby consent to the Shepparton Sewerage Authority borrowing at interest, a sum of Six thousand pounds (£6,000), subject to the provisions of the Sewerage Districts Acts and for the carrying out of the works in accordance with the provisions of sections 91, 126, and 133 of the *Sewerage Districts Act 1928* (No. 3772), the said sum to be borrowed by the issue of debentures under the said Sewerage Districts Acts. All moneys received by the said Authority in repayment of costs and expenses of the said works, and any of them shall be set aside for the purpose of and applied in repayment of the said sum so borrowed.

And the Honorable Clive Phillip Stoneham, Her Majesty's Minister of Water Supply for the State of Victoria, shall give the necessary directions herein accordingly.

A. MAHLSTEDT,
Clerk of the Executive Council.

BENDIGO SEWERAGE AUTHORITY.

At the Executive Council Chamber, Melbourne, the eighth day of July, 1953.

PRESENT:

His Excellency the Administrator of the Government of the State of Victoria.

Mr. Galvin | Mr. Shepherd.
Mr. Smith

CONSENT TO BORROWING £55,000.

UNDER the powers conferred by the Sewerage Districts Acts and all other powers enabling him in that behalf, His Excellency the Administrator of the Government of the State of Victoria, by and with the advice of the Executive Council of the said State, doth hereby consent to the Bendigo Sewerage Authority borrowing, by the issue of debentures, a sum of Fifty-five thousand pounds (£55,000), in two separate amounts of £15,000 and £40,000 respectively, to meet the cost of sewer extensions as set forth in the detailed statement bearing date the 2nd July, 1953.

And the Honorable Clive Phillip Stoneham, Her Majesty's Minister of Water Supply for the State of Victoria, shall give the necessary directions herein accordingly.

A. MAHLSTEDT,
Clerk of the Executive Council.

BENEFIT ASSOCIATIONS ACTS.

At the Executive Council Chamber, Melbourne, the fourteenth day of July, 1953.

PRESENT:

His Excellency the Administrator of the Government of the State of Victoria.

Mr. Shepherd | Mr. Smith.

ASSOCIATION DECLARED TO BE EXEMPT FROM THE ACTS.

HIS Excellency the Administrator of the Government of the State of Victoria, in the Commonwealth of Australia, by and with the advice of the Executive Council of the said State, and in pursuance of the provisions of the Benefit Associations Acts, doth by this Order declare that the association known as the Army Health Benefits Society be exempt from the provisions of the said Acts.

And the Honorable Joseph Henry Smith, for and on behalf of Her Majesty's Chief Secretary for the State of Victoria, shall give the necessary directions herein accordingly.

A. MAHLSTEDT,
Clerk of the Executive Council.

ROAD TRAFFIC ACT 1935.

At the Executive Council Chamber, Melbourne, the fourteenth day of July, 1953.

PRESENT:

His Excellency the Administrator of the Government of the State of Victoria.

Mr. Shepherd | Mr. Smith.

AMENDMENT OF REGULATION.

WHEREAS by a Regulation made by the Governor in Council on the thirteenth day of October, 1941, and published in the *Government Gazette* of the fifteenth day of October, 1941, certain streets in the Cities of Brighton and Footscray were designated as "major streets" for the purposes of the Road Traffic Regulations 1939:

And whereas it is deemed desirable that the first-mentioned Regulation should be amended in the manner hereinafter specified:

Now therefore His Excellency the Administrator of the Government of the State of Victoria in the Commonwealth of Australia, by and with the advice of the Executive Council of the said State, and in pursuance of the powers conferred by the *Road Traffic Act 1935*, and all other powers him thereunto enabling, doth hereby amend the first-mentioned Regulation as follows:—

The expression "Hyde-street, from Bunbury-street to Stony Creek" is hereby revoked and the following substituted therefor—

"Hyde-street, from a line being the prolongation of the southern property line of Napier-street to Stony Creek."

And the Honorable Joseph Henry Smith, for and on behalf of Her Majesty's Chief Secretary for the State of Victoria, shall give the necessary directions herein accordingly.

A. MAHLSTEDT,
Clerk of the Executive Council.

FACTORIES AND SHOPS ACTS.

*At the Executive Council Chamber, Melbourne, the
fourteenth day of July, 1953.*

PRESENT:

His Excellency the Administrator of the Government of
the State of Victoria.

Mr. Shepherd | Mr. Smith.

VARIATION OF THE POWERS OF THE BRICK TRADE BOARD AND ADJUSTMENT OF THE POWERS OF THE BRICK TRADE BOARD AND OF THE CEMENT ARTICLES BOARD.

WHEREAS, in pursuance of the provisions of the Factories and Shops Acts for the time being in force, the Governor in Council did by Order appoint a Wages Board described as the Brick Trade Board and did by subsequent Order extend and vary the powers of the said Board: And whereas it is expedient to further vary the said powers in the manner hereinafter appearing:

Now, therefore, His Excellency the Administrator of the Government of the State of Victoria, by and with the advice of the Executive Council thereof, under the powers in that behalf conferred by the Factories and Shops Acts, doth hereby:—

(1) Vary the Orders above mentioned, so that in substitution for the powers thereby conferred the said Brick Trade Board shall be given the following powers, that is to say:—

To determine the lowest prices or rates which may be paid to any person or persons or classes of persons employed—

- (a) in the process, trade or business of brickmaking (including clay-digging);
(b) in the process, trade or business of sand and lime brickmaking.

(2) Adjust the powers of the Brick Trade Board and of the Cement Articles Board by depriving the said Brick Trade Board of the power to determine the lowest prices or rates which may be paid to any person or persons or classes of persons employed in the making of cement bricks and conferring such power exclusively on the said Cement Articles Board.

And the Honorable Archibald McDonald Fraser, Her Majesty's Minister of Labour for the State of Victoria, shall give the necessary directions herein accordingly.

A. MAHLSTEDT,
Clerk of the Executive Council.

APPROACHING LAND SALES.

SALES of Crown lands, in fee-simple, will be held at the under-mentioned places and dates, viz.:—

| | No. of Gazette. |
|---|--------------------|
| Ballarat.—Wednesday, 19th August, 1953 .. | 540 |
| Geelong.—Thursday, 23rd July, 1953 .. | 510 |
| Ouyen.—Wednesday, 12th August, 1953 .. | 527 |
| Warragul.—Thursday, 6th August, 1953 .. | 524 |
| Wodonga.—Tuesday, 28th July, 1953 .. | 510 |

SALE OF CROWN LANDS BY AUCTION.

The lands will be sold in fee-simple, and subject to the covenants, conditions, exceptions, and reservations directed by the Governor in Council by an Order in Council dated the 5th August, 1930, and published in the *Government Gazette* of the 8th August, 1930, varied as herein.

A deposit of at least twelve and a half per centum of the price at which each lot is sold must be paid by the purchaser at the time of sale, and all such payments shall be made in coin, bank notes or cheques approved by the officer conducting the sale, and the residue of such price will be payable in equal instalments, in accordance with the scale hereunder, on the last day of each successive period of six months from the time of sale, or, if the purchaser choose, at any earlier time or times; and such residue of the purchase money shall bear interest at the rate of five pounds per centum per annum, to be computed with respect to each instalment for the period which has elapsed between the time of sale and the time of the payment of such instalment. If the residue of the price be paid within thirty days after the time of the sale no interest will be payable thereon.

The Governor in Council may allow a transfer of the purchaser's interest to an approved person at any time

before the final payment of the purchase money is made. The fee for transfer shall be One pound and such transfer will be subject to payment of stamp duty.

SCALE OF PAYMENTS OF RESIDUE.

| |
|--|
| £20 and under, 6 instalments. |
| Over £20, and not exceeding £50, 8 instalments. |
| Over £50, and not exceeding £100, 10 instalments. |
| Over £100, and not exceeding £200, 12 instalments. |
| Over £200, and not exceeding £300, 14 instalments. |
| Over £300, and not exceeding £400, 16 instalments. |
| Over £400, and not exceeding £500, 18 instalments. |
| Over £500, 20 instalments. |

FEEs, ETC.

The amount payable for Assurance Fund (One halfpenny for each £1 of purchase price) and Crown grant fee must be paid with the balance of purchase money. The following is the scale of fees for Crown grants:—

- 50 acres and under, £1 10s.
Over 50 acres, £2.

Where the purchase money does not exceed £5, the grant fee is £1.

Valuations of improvements (if not purchased by the owner thereof), and charges for survey, must also be paid at the time of sale.

R. W. HOLT,

Commissioner of Crown Lands and Survey.

Office of Crown Lands and Survey,
Melbourne, 13th July, 1953.

BALLARAT.—Sale (No. 11024) of Crown lands, in fee-simple, by auction, will be held at the LAND OFFICE, CAMP-STREET, BALLARAT, on WEDNESDAY, the 19th AUGUST, 1953, at half-past TWO o'clock p.m. To be conducted by H. H. DODD, Land Officer. Auctioneer: EDGAR BARTROP, 54 Lydiard-street south, Ballarat.

CITY OF BALLAARAT, PARISH OF BALLAARAT, COUNTY OF GRENVILLE.

Fronting Windermere-street.

Upset price £160 the lot. Charge for survey £5 10s.

Lot 1. Area 1 rood (subject to survey), allotment 12A of section 103. One month allowed for removal of improvements.

CITY OF BALLAARAT (AT BALLAARAT EAST), PARISH OF BALLAARAT, COUNTY OF GRANT.

Fronting Kline-street.

Upset price £75 the lot. Charge for survey £6 2s. 6d.

Lot 2. Area 2 acres (subject to survey), allotment 14 of section 50.

BROOMFIELD, PARISH OF CRESWICK, COUNTY OF TALBOT.

In Centre of Township.

Upset price £10 the lot. Charge for survey £5 15s.

Lot 3. Area 2 roods (subject to survey), allotment 15B of section F2. Valuation of improvements £1,056 (J. Caldwell).

CRESWICK, PARISH OF CRESWICK, COUNTY OF TALBOT.

Corner of Old Boundary-road and Ayres-street.

Upset price £20 the lot. Charge for survey £5 5s.

Lot 4. Area 39 perches, allotment 20 of section 19. One month allowed for removal of improvements.

PARISH OF BALLAARAT, COUNTY OF RIPON.

In the East of the Parish; fronting C.R.B. road.

Upset price £10 the lot. Charge for survey £5 15s.

Lot 5. Area 1 acre (subject to survey), allotment 10C of section Y. One month allowed for removal of improvements.

PARISH OF BLACKWOOD, COUNTY OF BOURKE.

West of the Town of Blackwood.

Upset price £9 the lot. Charge for survey £6 10s.

Lot 6. Area 2 roods (subject to survey), allotment 15A of section A.

PARISH OF BUNINYONG, COUNTY OF GRANT.

In the West of the Parish.

Upset price £50 the lot. Charge for survey £8 2s. 6d.

Lot 7. Area 20 acres (subject to survey), allotment 8q³. Valuation of improvements £29 7s. 6d. (K. M. O'Keefe).

PARISH OF MOORARBOOL EAST, COUNTY OF BOURKE.

South-east of the Township of Blakeville.

Upset price £4 the lot. Charge for survey £5 10s.

Lot 8. Area 1r. 24p. (subject to survey), allotment 8 of section C. Valuation of improvements £255 (The Methodist Church in Victoria).

PARISH OF SMYTHESDALE, COUNTY OF GRENVILLE.

Frontage to Main-road South of the Township.

Upset price £7 the lot. Charge for survey £5 17s. 6d.

Lot 9. Area 1a. 0r. 7p., allotment 62c. One month allowed for removal of improvements.

PARISH OF ARGYLE, COUNTY OF GRENVILLE.

In the East of the Parish.

Upset price £30 the lot. Charge for survey £10 2s. 6d.

Lot 10. Area 15a. 3r. 2p., allotments 18g and 18h.

South of the Township of Linton.

Upset price £7 the lot. Charge for survey £5 15s.

Lot 11. Area 2r. 30 5/10p., allotment 34c. One month allowed for removal of improvements.

PROPOSED REVOCATION OF TEMPORARY RESERVATION OF LAND BY ORDER IN COUNCIL (AS TO PORTION).

IN pursuance of the provisions of the Land Act 1928, notice is hereby given that it is the intention of the Governor in Council to revoke portion of the temporary reservation of land by Order in Council hereunder referred to, viz.:—

The following Notice was published 1° on the 24th June, 1953, pursuant to Order of the 16th June, 1953.

OMEQ.—The temporary reservation, by Order in Council of the 4th November, 1889, of certain Crown land situate within a distance of 3 chains from the banks of the Livingstone Creek, for the supply of Gravel and Sand, revoked as to part by Order of the 16th January, 1940, is about to be revoked so far only as the portion in the Township of Omeo, containing 1 acre 0 roods 30 perches, more or less, indicated by hachure on plan hereunder, is concerned.—(O.19(s) (C.86890).

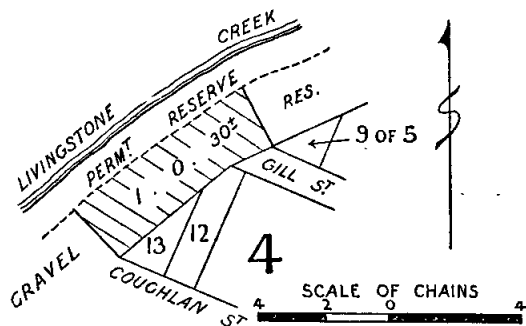

R. W. HOLT,
Commissioner of Crown Lands and Survey.

WEDDERBURNE.—The temporary reservation, by Order in Council of the 27th January, 1885, of 317 acres 2 roods 38 perches of land in the Parish of Wedderburne, as a site for a Watershed or Gathering Ground for Water Supply purposes, is about to be revoked.—(W.116(s) (Rs.1593).

WEDDERBURNE.—The temporary reservation as a site for Affording Access to Water and the withholding from sale, leasing, and licensing, by Order in Council of the 22nd September, 1880, of 2 acres 3 roods 35 perches of land in the Parish of Wedderburne, are about to be revoked.—(W.116(s) (C.80186).

WEDDERBURNE.—The temporary reservation as a site for Affording Access to Water and the withholding from sale, leasing, and licensing, by Order in Council of the 11th October, 1880, of 2 acres 0 roods 4 perches of land in the Parish of Wedderburne, are about to be revoked.—(W.116(s) (C.80186).

WEDDERBURNE.—The temporary reservation, by Order in Council of the 26th March, 1935, of 29 acres 2 roods 25 7/10 perches, more or less, of land in the Parish of Wedderburne, as a site for Channel for Water Supply purposes, is about to be revoked so far only as portions 4 and 5 thereof, containing respectively 3 acres 1 rood 9 2/10 perches and 22 acres 1 rood 27 8/10 perches, are concerned.—(W.116(s) (Rs.1593).

OMEQ.—The temporary reservation, by Order in Council of the 4th November, 1889, of certain Crown land situate within a distance of three chains from the banks of the Livingstone Creek for the supply of Gravel and Sand, revoked as to part by Order of the 16th January, 1940, is about to be revoked so far only as the portion in the Township of Omeo, containing 1 acre 0 roods 30 perches, more or less, indicated by hachure on plan hereunder, is concerned.—(O.19(s) (C.86890).

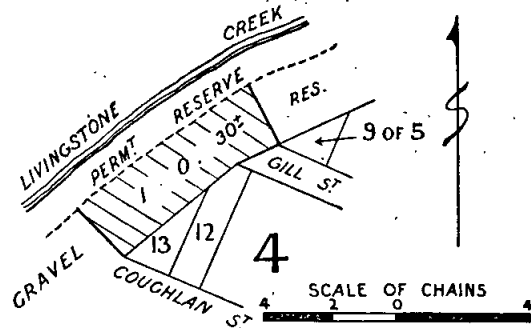

COLAC.—The temporary reservation, by Order in Council of the 14th November, 1859, of certain Crown land at Lake Colac, as a site for Public purposes, is about to be revoked so far only as the portion, indicated by hachure on plan hereunder, is concerned.—(C.279(s) (Rs.1374).

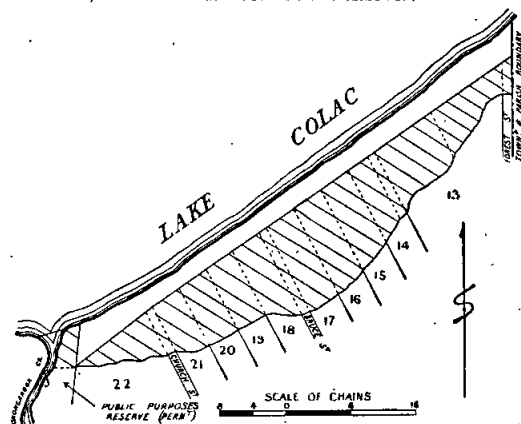

PROPOSED REVOCATIONS OF TEMPORARY RESERVATIONS OF LANDS BY ORDERS IN COUNCIL.

IN pursuance of the provisions of the Land Act 1928, notice is hereby given that it is the intention of the Governor in Council to revoke the temporary reservations of lands by Orders in Council hereunder referred to, viz.:—

The following Notices were published 1° on the 15th July, 1953, pursuant to Orders of the 8th July, 1953.

HOTSPUR.—The temporary reservation, by Order in Council of the 11th August, 1873, of 5 acres of land in the Township of Hotspur, as a site for State School purposes, is about to be revoked.—(H.103(s) (C.95323).

WOOLAMAI.—The temporary reservation, by Order in Council of the 2nd July, 1923, of 2 roods of land in the Township of Marrooing (now Woolamai), as a site for a Public Hall, is about to be revoked.—(M.574(1) (Rs.2773).

WEDDERBURNE.—The temporary reservation, by Order in Council of the 24th December, 1904, of 950 acres, more or less, of land in the Parish of Wedderburne, as a site for the Growth of Timber for the purpose of the manufacture or production of eucalyptus oil, is about to be revoked.—(W.116(s) (C.73488).

TOOLAMBA WEST.—The temporary reservation, by Order in Council of the 11th October, 1875 (see Government Gazette of 15th October, 1875, page 1968), of 9 acres 0 roods 4 perches of land (now shown as 9 acres 0 roods 8 perches), in the Parish of Toolamba West, as a site for Cemetery

purposes, is about to be revoked so far only as the portion containing 17 perches, more or less, indicated by hachure on plan hereunder, is concerned.—(T.201⁽¹⁰⁾) (C.94015).

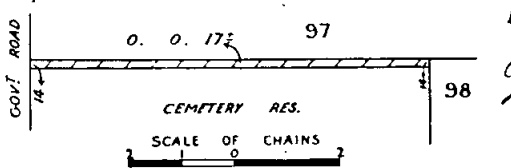

TOOLAMBA.—The temporary reservation, by Order in Council of the 14th March, 1908, of 36 perches of land in the Parish of Toolamba, as a site for Water Supply purposes, revoked as to part by Order of the 12th July, 1909, is about to be revoked so far only as the portion containing 1 perch, more or less, indicated by hachure on plan hereunder, is concerned.—(T.201⁽¹¹⁾) (C.40236).

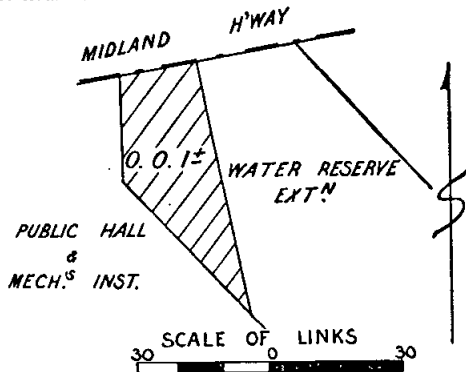

TOOLAMBA.—The temporary reservation, by Order in Council of the 7th September, 1909, of 2 roods 32 perches of land in the Parish of Toolamba, as a site for a Mechanics' Institute and Public Hall, is about to be revoked so far only as the portion containing 1 rood 28 perches, more or less, indicated by hachure on plan hereunder, is concerned.—(T.201⁽¹¹⁾) (C.80525).

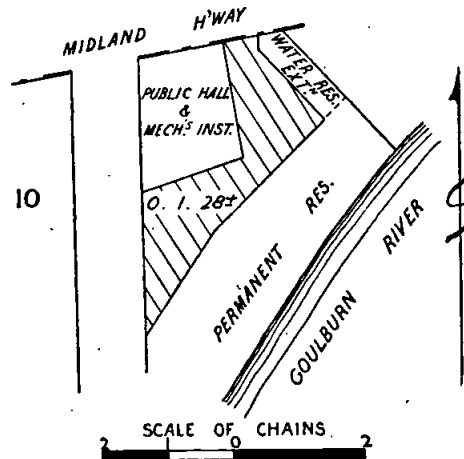

R. W. HOLT,
Commissioner of Crown Lands and Survey.

Land Act 1928.

LICENCES UNDER THE LAND ACTS 1915 AND 1928 DECLARED VOID.

NOTICE is hereby given that the Licences in the Schedule hereunder have been declared void for the reason specified in each case.

| District. | Corr. No. | Name of Licensee. | Section of Land Act under which Licensed. | Parish. | Allotment. | Section. | Area. | | | Annual Rental. | Reasons for Voiding. |
|-------------|-----------|---------------------------|---|-----------|------------|----------|-------|----|--------------------------------|----------------|--------------------------------|
| | | | | | | | A. | R. | P. | | |
| Ballarat .. | 954/129 | Walter Gordon Kelso .. | 129 | Ballaarat | 24A | 100 | 0 | 1 | 1 ⁴ / ₁₀ | 1 10 0 | Non-compliance with conditions |
| Bendigo .. | 0982/129 | Isabel Vera Clayton .. | 129 | Sandhurst | 269o | .. | 0 | 1 | 0 | 1 0 0 | Non-compliance with conditions |
| Bendigo .. | 0632/129 | Leslie Ronald Christopher | 129 | Sandhurst | 136A | C | 0 | 1 | 0 | 1 10 0 | Lessee's request |
| Bendigo .. | 0627/129 | George Marcus Brown .. | 129 | Sandhurst | 550K | K | 0 | 1 | 4 | 0 7 6 | Lessee's request |

Department of Crown Lands and Survey,
Melbourne, 15th July, 1953.

R. W. HOLT,
Commissioner of Crown Lands and Survey.

Land Act 1928.

LEASE SURRENDERED.

NOTICE is hereby given that the Governor in Council has accepted the surrender of the Lease mentioned in the Schedule hereunder for the reason specified.

| District. | Corr. No. | Name. | Section of Land Act under which Leased. | Parish. | Allotment. | Area. | Class. | Reason. |
|--------------|-----------|-----------------------------------|---|-----------------|------------------|-------------------------------------|--------|--------------------|
| Melbourne .. | O556/125 | Warburton Franki (Melbourne) Ltd. | 125 | Melbourne South | 12, section 101A | 0 0 38 ⁸ / ₁₀ | .. | New lease to issue |

R. W. HOLT,
Commissioner of Crown Lands and Survey.

Department of Crown Lands and Survey,
Melbourne, 7th July, 1953.

LAND AVAILABLE UNDER THE SOLDIER SETTLEMENT ACTS.

NOTIFICATION is hereby given in accordance with section 16 of the *Soldier Settlement Act 1946*, that the under-mentioned lots are available or are about to become available for settlement.

Any discharged soldier who has applied to the Commission on or before the 15th July, 1953, for classification in the required class or classes of primary production for which the lots are made available and whose application has been accepted but not necessarily finalized, or any discharged soldier who has been classified as suitable in such class or classes of primary production, may apply on the prescribed form for settlement on any lot or lots, indicating where he applies in respect of more than one lot, his order of preference therefor.

The prescribed application forms, plans, and further particulars may be obtained from the Enquiry Branch, Soldier Settlement Commission, State Public Offices, Melbourne. The closing date for the receipt of completed application for settlement on these holdings is the 10th August, 1953, such applications to be in the hands of the Secretary, Soldier Settlement Commission, on or before that date.

S. P. BROMFIELD,
Secretary.

Soldier Settlement Commission,
Melbourne, 10th July, 1953.

SCHEDULE OF ALLOTMENTS.

SUBDIVISION OF "SALT CREEK" ESTATE.

PARISH OF COBRA KILLUC.—COUNTY OF HAMPDEN.

Suitable for Grazing (Sheep) with some Dairying.

| Lot No. on Plan of Subdivision. | Approximate Area in Acres (Subject to Survey). |
|---------------------------------|--|
| 1 | 543 |
| 2 | 544 |
| 3 | 547 |
| 4 | 550 |
| 5 | 538 |
| 6 | 548 |
| 7 | 544 |
| 8 | 537 |
| 9 | 724 |
| 10 | 542 |
| 11 | 544 |
| 12 | 536 |
| 13 | 550 |

SUBDIVISION OF "TRAWALLA SOUTH" ESTATE.

PARISH OF KORNONG.—COUNTY OF HAMPDEN.

Suitable for Grazing (Sheep) with some Dairying.

| Lot No. on Plan of Subdivision. | Approximate Area in Acres (Subject to Survey). |
|---------------------------------|--|
| 1 | 633 |
| 2 | 621 |
| 3 | 628 |
| 4 | 658 |
| 5 | 740 |
| 6 | 643 |
| 7 | 803 |
| 8 | 631 |
| 9 | 731 |

PUBLIC HEARINGS BY PERSONS APPOINTED UNDER THE 34TH SECTION OF THE LAND ACT 1928.

NOTICE is hereby given that at the times and places mentioned in the Schedule hereunder, applications for leases and licences under the Land Acts, objections to such applications, objections to proposed proclamations, alterations, additions, diminutions, revocations, or unions of commons, and reasons against forfeiture of any leases or licences under the Land Acts deemed liable to forfeiture, will be publicly heard by the persons whose names are set opposite such places respectively in such Schedule, being persons appointed by me, the responsible Minister of the Crown administering the Land Acts, to hear the same and report thereon in writing to me.

R. W. HOLT,
Commissioner of Crown Lands and Survey, and
President of the Board of Land and Works.

Department of Crown Lands and Survey,
Melbourne, 15th July, 1953.

SCHEDULE.

- HORSHAM LAND OFFICE, Thursday, 30th July, 1953, at 10 a.m.—S. C. Lepp, Land Officer, Horsham.
- BENDIGO LAND OFFICE, Thursday, 30th July, 1953, at 10 a.m.—H. J. Henkel, Land Officer, Bendigo.
- BAIRNSDALE LAND OFFICE, Wednesday, 29th July, 1953, at 2 p.m.—R. A. Walker, Land Officer, Bairnsdale.
- MECHANICS' HALL, ORBOST, Friday, 31st July, 1953, at 10.30 a.m.—R. A. Walker, Land Officer, Bairnsdale.

TENDERS.

TENDERS will be received at this office until **TEN A.M.** on the days and for the purposes under mentioned.

Particulars may be learnt at this Office and also at places shown in parenthesis.

W.O. means Inspector of Works Office; P.S.—Police Station; T.S.—Technical School; H.E.S.—Higher Elementary School; S.S.—State School; H.S.—High School.

The Board of Land and Works will not necessarily accept the lowest or any tender.

NOTE.—No preliminary deposits are to be lodged with tenders, but a deposit, in accordance with the following Schedule, will be required from the successful tenderer:—

| | |
|--|--------------------------|
| | £ |
| For contract amounts not exceeding £200 | 2 |
| For contract amounts exceeding £200 and not exceeding £500 | 5 |
| For contract amounts exceeding £500 and not exceeding £1,000 | 10 |
| For contract amounts exceeding £1,000—1 per cent. of tender | 500 (maximum deposit) |

21st July, 1953.

Ararat.—Extension to hot-water service equipment, Nurses' Hostel. (W.O., Ararat, Ballarat.)

Armadale.—Installation of new lavatory basins and extensions to sewer drains, "Larnook" Domestic Arts School.

Bandigo.—Electric hot-water service in caretaker's residence, Public Works Department. (W.O., Bendigo.)

Bethanga.—Erection of a new shelter pavilion, 20 ft. x 10 ft., S.S. No. 1883. (W.O., Wangaratta; S.S., Bethanga.)

Birchip.—External and internal repairs and painting, Court House. (W.O., Warracknabeal; P.S., Hopetoun; Court House, Birchip.) (Amended specification.)

Brooklyn.—Electrical installation, S.S. No. 4710.

Brunswick.—External painting and repairs to school buildings, T.S. (T.S., Brunswick.)

Camberwell East.—Erection of external stairs, Girls' Secondary School.

Carlton.—Installation of new closet and basin in Principal's Quarters, Teachers' College.

Geelong.—Additions and remodelling (quantities available), Matthew Flinders Girls' School. (W.O., Geelong; Matthew Flinders Girls' School, Geelong.)

Geelong.—Erection and completion of a "Bristol" prefabricated School building, "Lunan" Teachers' College. (W.O., Geelong; "Lunan" Teachers' College, Geelong.)

Geelong.—Electrical installation in Craft and Woodwork Rooms, Teachers' College. (W.O., Geelong; Teachers' Training College, Geelong.)

Gorae West.—Electrical installation in teacher's residence, S.S. No. 4556. (W.O., Hamilton.)

Katandra West.—Restoration of building *ex* Gobarup East, S.S. No. 4401. (W.O., Benalla; S.S., Katandra West.)

Kew.—Electrical installation for Staff Mess Room, Children's Cottages, Mental Hospital.

Kotupna.—New concrete slab to boys' and girls' out-offices, new concrete floor to verandah at residence, S.S. No. 1999. (W.O., Shepparton; P.S., Numurkah; S.S., Kotupna.)

Maryborough East.—Removal and re-erection of classroom from Percydale, S.S. No. 2828. (W.O., Bendigo, Maryborough; S.S., Maryborough East.)

Melbourne.—Removal of existing wiring and supply of new electrical installation, Council of Adult Education.

Mentone.—Electrical installation and improvements at S.S. No. 2950.

Mordialloc.—Adaptation of Army hut to classroom, H.S. (H.S., Mordialloc.)

Oakleigh South.—Electrical installation in class-rooms, S.S. No. 4712.

Parkville.—Renovation and renewal of blackboards, University High School.

Quambatook.—New out-offices and septic tank at school only, Group School No. 2443. (W.O., Swan Hill; Group School, Quambatook.)

Rosebud.—Conversion of Army hut to two classrooms, office, and staffroom, S.S. No. 2627. (P.S., Frankston; S.S., Rosebud.) (Amended specification.)

Royal Park.—External repairs and painting of Female Acute Block, Female Convalescent Block, Kitchen, and Concert Hall Block, Mental Hospital.

Royal Park.—Supply and installation of hot-water service and gas heating, Nurses' Home, Mental Hospital.

Rutherglen.—Electrical installation in two new residences, Research Station. (W.O., Wangaratta; P.S., Rutherglen.)

Shepparton.—Repairs and external painting to residence situated at 104 Maude-street, H.S. (W.O., Shepparton; H.S., Shepparton.)

Shepparton North.—Erection of covered ways, S.S. No. 4657. (W.O., Shepparton.)

Various.—The erection of standard timber-framed classrooms, offices, stores, and services in No. 4 sectional contracts comprising 28, 26, 30, and 28 classrooms respectively on various sites (the tenderer may tender for all or any of the sectional contracts), Schools. (W.O., Ballarat, Bendigo, Geelong, Traralgon, Maryborough; P.S., Stawell.)

Various.—Supply and installation of 500 venetian blinds, schools.

Violet Town.—Reblocking of residence, P.S. (W.O., Benalla; P.S., Euroa, Violet Town.) (Amended specification.)

Werribee.—Erection of glass-house, Research Farm. (Research Farm, Werribee.)

Winters Flat.—Proposed new windows, &c., external painting, S.S. No. 652. (W.O., Bendigo, Kyneton; S.S., Winters Flat.)

Wilson's Reef.—Electrical installation in teacher's residence, S.S. No. 1437. (W.O., Bendigo.)

Wyuna West.—Electrical installation in teacher's residence, S.S. No. 3549. (W.O., Shepparton.)

Yarraville.—New water service, S.S. No. 1501.

28th July, 1953.

Ballan.—Repairs and renovations, S.S. No. 1435. (W.O., Ballarat; S.S., Ballan.)

Ballarat.—New bathroom and showers to Male Hostel, Mental Hospital. (W.O., Ballarat; Mental Hospital, Ballarat.)

Ballarat North.—Electrical installation, S.S. No. 4690. (W.O., Ballarat.) (Amended specification.)

Beveridge.—New flooring, repairs, and external painting, S.S. No. 1476. (S.S., Beveridge.)

Bundalaguah.—Raising, filling, and fencing to residence, S.S. No. 1107. (W.O., Bairnsdale; S.S., Bundalaguah.)

Coburg.—Supply and installation of structural steelwork, Wire-netting Factory, Pentridge Gaol.

Eltham North.—Erection of boys' and girls' out-office block and shelter pavilions, S.S. No. 4212.

Elwood.—Additional girls' out-office accommodation, S.S. No. 3942.

Elwood.—Supply of piles f.o.r. sending station, Jetty, Public Works Department.

Flemington.—Replacement of glass louvre blades to lantern light, Government Pavilion, Showgrounds.

Frankston East.—Electrical installation in class-rooms, S.S. No. 4682.

Girgarre East.—Repair and renewal of ant-damaged timbers, S.S. No. 1732. (W.O., Shepparton; S.S., Girgarre East.)

Hamilton.—Mechanical services in new workshops, central heating of hot water, H.S. (W.O., Hamilton, Warrnambool.)

Healesville.—Electrical installation in class-rooms, Higher Elementary School No. 849.

Highbett.—Erection and completion of "Bristol" prefabricated building, S.S. No. 4677. (S.S., Highbett.)

Kaniva.—Supply of water-treatment plant, Consolidated School.

Kellalac South.—Removal of Kerewichip S.S. No. 3212, and re-erection at Kellalac South site, S.S. No. 2358. (W.O., Warracknabeal; S.S., Kellalac South.)

Kew.—Supply and installation of ceiling fans in Artisans' Workshops, Mental Hospital.

Manangatang.—Supply and delivery of domestic type refrigerator in Cookery Room, Consolidated School.

Melton.—External repairs and painting, Police Station. (P.S., Melton.)

Melbourne.—Renewal of water service, T.S., Latrobe-street. (T.S., Melbourne.)

Melbourne.—Alteration to sanitary fittings in Cell Block, Law Courts.

Melbourne.—Electrical installation, Radio Laboratory, 61 Spring-street.

Narbethong.—Extension of school building, new skylights, and painting, S.S. No. 3459. (W.O., Alexandra; S.S., Narbethong.)

Nirranda East.—Extension and renovations to school, S.S. No. 2475. (W.O., Camperdown, Warrnambool; S.S., Nirranda East.)

Omco Valley.—Purchase and removal of school building and two out-offices (not including shelter shed), S.S. No. 3328. (W.O., Bairnsdale; P.S., Omco.)

Ovens Vale.—Purchase and removal of school building (not including shelter pavilion), S.S. No. 1407. (W.O., Benalla; P.S., Myrtleford.)

Prahran.—Supply, delivery, installation, and testing of new gas hot-water service and sink heater and complete removal of existing hot-water service, P.S.

Queenscliff.—Erection of boys' and girls' out-office blocks, shelter pavilions, and water service, Higher Elementary School. (W.O., Geelong; P.S., Queenscliff.)

Richmond.—Renovations to Caretaker's Cottage, S.S. No. 1567.

Royal Park.—Electrical installation in Medical Superintendent's residence, Children's Welfare Department.

Sandringham East.—Improved water supply installation, S.S. No. 4429. (S.S., Sandringham East.)

Seymour.—Rewiring of residence, H.S.

Tawonga.—Erection of a "Bristol" prefabricated school building, S.S. No. 2282. (W.O., Benalla; S.S., Tawonga.)

South Melbourne.—Improved lighting and additional power outlets in Sewing Room, MacRobertson's Girls' High School.

Toorak.—Rewiring electrical installation, new switchboards, additional light and power, Teachers' College.

Traralgon.—Additional out-offices and water facilities, S.S. No. 4652. (W.O., Traralgon.)

Traralgon.—Erection of two shelter sheds, 30 ft. x 15 ft., and a block of out-offices, combined with a woodshed, S.S. No. 4699. (W.O., Traralgon.)

Travancore.—Supply and delivery of a sound film projection equipment, Developmental Centre.

Trentham.—Alterations, repairs, and renovations, P.S. (W.O., Bendigo, Kyneton; P.S., Trentham.)

Warragul.—Erection of a brick boiler house, H.S. (W.O., Traralgon; H.S., Warragul.)

Werribee.—Erection of additional out-offices, S.S. No. 649. (S.S., Werribee.)

Werribee.—Electrical installation in Stud Cattle Building, Research Farm. (Research Farm, Werribee.)

Williamstown.—Overhaul and repairs to slate roof, S.S. No. 1183.

Wodonga.—Provision of a fuel store, 10 ft. x 8 ft., S.S. No. 37. (W.O., Wangaratta; S.S., Wodonga.)

Woodend.—New out-offices and septic tank, S.S. No. 647. (W.O., Kyneton.)

Yarraville.—New external staircase, S.S. No. 1501.

4th August, 1953.

Alamein.—Erection and completion of Bristol prefabricated buildings, S.S. No. 4649.

Apollo Bay.—Electrical installation, Consolidated School. (W.O., Geelong; Consolidated School, Apollo Bay.)

Ballarat.—Alterations, additions, and renovations, Male Teachers' Hostel. (W.O., Ballarat.)

Balmattum.—General repairs and external painting, S.S. No. 743. (W.O., Benalla.) (Amended specification.)

Benalla.—Completion of office accommodation and men's quarters, P.S. (W.O., Benalla.) (Amended specification.)

Blackwood North.—Repairs, painting, and new out-offices, S.S. No. 1636. (W.O., Bendigo, Kyneton; S.S., Blackwood North.)

Boinka.—Renewals, repairs, and painting, S.S. No. 3800. (W.O., Mildura; S.S., Boinka.)

Box Hill.—Provision of additional escape stairs, T.S.

Brunswick South.—New front fence, S.S. No. 2743. (S.S., Brunswick South.)

Burwood East.—External painting to school and residence, S.S. No. 454. (S.S., Burwood East.)

Dandenong.—Repairs to balcony and verandah, High School. (High School, Dandenong.)

Dugay's Bridge.—Restoration of building removed from Prentice Freehold, S.S. No. 1752. (W.O., Wangaratta; S.S., Dugay's Bridge.)

Garvoc.—Erection of fixed partition, S.S. No. 996. (W.O., Warrnambool, Camperdown; P.S., Cobden; S.S., Garvoc.)

Goroke.—Electrical installation, Consolidated School. (W.O., Horsham; P.S., Goroke.)

Hamilton.—New timber frame lobby for P.W.D. Inspector, P.W.D. (W.O., Hamilton.)

Hawthorn.—Repairs and painting, "Moorakyne" Hostel.

Heatherton.—Purchase and removal of number six pine trees, Sanatorium. (Sanatorium, Heatherton.)

Hopetoun.—Renovations to three buildings, S.S. No. 3167. (W.O., Warracknabeal; P.S., Hopetoun.)

Kensington.—Conversion of class-room to science room, S.S. No. 2374.

Kew.—Electrical installation for new boiler, Mental Hospital.

Melbourne.—External repairs and painting Sailors' Home.

Mildura.—Conversion of property No. 17 Argyle-street to Boys' Hostel, High School. (W.O., Mildura; High School, Mildura.)

Montague.—Alterations to kitchen, S.S. No. 2784.

Mudgegonga.—Removal of six pine trees, S.S. No. 2171. (W.O., Benalla; S.S., Mudgegonga.)

Myola East.—Provision of two out-offices, S.S. No. 2407. (W.O., Shepparton, Bendigo; S.S., Myola East.)

North Shore.—Conversion of Army hut to class-room, S.S. No. 4301. (W.O., Geelong; S.S., North Shore.)

Royal Park.—Installation of new "Twin Rapid" steam press in laundry, Mental Hospital.

Sale.—Renovations, &c., 8A and 8B Barkly-street, T.S. (W.O., Bairnsdale; T.S., Sale.)

South Melbourne.—Alterations and additions to workshops, T.S.

Timboon.—Conversion of class-room into sports pavilion, Consolidated School. (W.O., Camperdown, Warrnambool; P.S., Colac; Consolidated School, Timboon.)

Turrumberry North.—Repairs to residence, S.S. No. 1738. (W.O., Bendigo; P.S., Cohuna.)

Various.—Supply and installation of five gas-burner systems for school science rooms, Schools.

Wangaratta.—Electrical installation in prefabricated school, H.S., Yarrunga Annexe. (W.O., Wangaratta.)

Warragul.—Replacement, repairs, and painting, S.S. No. 2104. (W.O., Traralgon; S.S., Warragul.)

Wodonga.—Stripping and re-slating roof, Court House. (W.O., Wangaratta; P.S., Wodonga.)

Woraigworm.—Repairs and renovations to school and out-buildings, S.S. No. 2619. (W.O., Warracknabeal; P.S., Dimboola, Nhill; S.S., Woraigworm.)

11th August, 1953.

Footscray North.—Additional girls' out-office accommodation, S.S. No. 4160.

Melbourne.—Additional class-rooms, School for Deaf and Dumb Children, No. 3774, St. Kilda-road.

Tenders to be addressed to the Honorable the Commissioner of Public Works, and envelope containing tender marked "Tender for due

S. MERRIFIELD,

Commissioner of Public Works

Public Works Department,
Melbourne, 14th July, 1953.

PUBLIC SERVICE NOTICES.

PUBLIC SERVICE OF VICTORIA.—VACANCIES.

APPPLICATIONS will be received by the Public Service Board up to Wednesday, the 29th July, 1953, from persons employed in the Public Service of Victoria, who are eligible and qualified, for appointment to the under-mentioned positions:—

ADMINISTRATIVE DIVISION.

Clerk, Class "B1," Crown Law Offices, Department of Law.

Yearly Salary.—£958, minimum; £1,050, maximum.
Duties.—To act as Senior Clerk and Officer in Charge of the Correspondence Branch, Crown Law Offices, and to perform the duties of the Chief Clerk during his absence.

Qualifications.—To be a competent correspondent and possess a knowledge of the Public Service Acts and Regulations, of the Acts administered and Rules promulgated by the Law Department and of official precedent; to have had practical experience in the drafting of Orders in Council, Proclamations, Rules, &c., and of departmental procedure and of the procedure in relation to the passage of and Royal Assent to Bills. To possess experience in the control of staff, and to have the necessary practical knowledge of proceedings before Courts for the purpose of dealing with reports of inspection on the books and accounts of Clerks of Courts.

NOTE.—Officers of the Professional Division who were previously classified in the Administrative Division are eligible to apply.

Clerk, Class "C," Office of the Public Trustee, Department of Law.

Yearly Salary.—£520, minimum; £624, maximum.
Duties.—To act as Assistant Trust Officer (Deceased Estates).

Qualifications.—A general knowledge of the Public Trustee and other Acts, and the Regulations thereunder, and the law affecting the administration of the estates of deceased persons and of agencies and trust estates; experience in the management and conduct of estates under the supervision of the Trust Officer.

NOTE.—The successful applicant will be eligible to progress to Class "C1" on completion of twelve months' satisfactory service on the maximum of Class "C."

PROFESSIONAL DIVISION.

District Health Officer, Grade II, Class "A1," General Health Branch, Department of Health.

Yearly Salary.—£1,335, minimum; £1,485, maximum.
Duties.—To carry out such duties as are imposed by or conferred under the Health Acts, including inspection as to the public health and sanitary circumstances of the district; investigating and reporting on outbreaks of infectious diseases and any other matters affecting public health; and any other duties required by the Chief Health Officer or the Commission of Public Health. A District Health Officer may be required to reside at the headquarters of his district.

Qualifications.—To be a legally qualified medical practitioner registered in Victoria; to have had approved experience in public health duties.

NOTE.—The holder of a Degree in or Diploma of Public Health will receive a salary of £1,550, minimum; £1,650, maximum, a year.

Engineer, Class "B," Department of Public Works.

Yearly Salary.—£841, minimum; £919, maximum.
Duties.—To assist in the design of proposed civil engineering works and in the supervision of maintenance and construction work in office or field, as required.

Qualifications.—To be a graduate in Civil Engineering of a recognized University, or a holder of a certificate issued by the Municipal Engineers' Board of Victoria, or to hold at least equivalent suitable qualifications; to be versed in the methods of modern civil engineering design and practice, and to have had experience in civil engineering construction works in the field.

Psychologist (Male), Class "B," Royal Park Mental Hospital, Department of Health.

Yearly Salary.—£841, minimum; £919, maximum.
Duties.—Within the Mental Hygiene Branch, to make psychological examinations of patients and produce reports, and arrange vocational guidance and assist in the vocational rehabilitation of patients.

Qualifications.—To be a University graduate, with psychology as a major subject. To have had post-graduate experience in psychology in the field of mental hygiene.

Cartographic Assistant, Class "C," Department of Crown Lands and Survey.

Yearly Salary.—£520, minimum; £624, maximum.
Duties.—To prepare for reproduction final drawings of topographical and cadastral maps and plans from compiled information, and to assist in the training of junior staff as required.

Qualifications.—To be a first-class penman, thoroughly experienced in all types of mapping technique and conversant with the various methods of map and plan reproduction.

Field Geologist, Class "C," Department of Mines.

Yearly Salary.—£520, minimum; £624, maximum.
Duties.—To assist in conducting geological surface and underground surveys, and in preparing reports thereon.

Qualifications.—To hold a University degree or its equivalent with geology as a major subject.

NOTE.—After twelve months' service on the maximum salary of the class, appointee will be eligible for appointment as Field Geologist, Class "C1." The possessor of the degree of Master of Science or a higher qualification will be appointed at a commencing salary of £546 a year.

TECHNICAL AND GENERAL DIVISION.

Fireman, Larundel Mental Hospital, Department of Health. (Three vacancies.)

Yearly Salary.—£341, minimum; £367, maximum.
Duties.—To fire boilers and to assist engineer mechanic.

Qualifications.—Boiler Attendants' Certificate or higher qualification.

Shorthand Writer and Typist (Female), Grade III, Department of Premier.

Yearly Salary.—£351, minimum; £364, maximum.
Qualifications.—To have passed the Public Service Board's Shorthand Speed Test at the rate of 120 words per minute.

Lift Attendant, Department of Public Works.

Salary.—£313 a year.

Kitchenman, Beechworth Mental Hospital, Department of Health.

Salary.—£312 a year.
Duties.—To assist Cooks generally—preparation of vegetables and other foodstuffs. Attending to cleanliness of kitchen.

Qualifications.—Ability to carry out above-mentioned duties. Some knowledge of cooking is desirable.

NOTE.—In addition to the salary rates quoted, a cost of living adjustment (£378 a year for adult males and £284 a year for adult females), which varies in accordance with the rise or fall in the index number of the cost of living, is payable.

By order,

E. F. FITZGIBBON,
Secretary.

Office of the Public Service Board,
Melbourne, 14th July, 1953.

No. 545.

Public Service Act 1946, Section 39.

REGULATIONS.—PART III.—SALARIES, INCREMENTS, AND ALLOWANCES.

THE Public Service Board, in pursuance of the powers conferred by the *Public Service Act 1946*, hereby amends its Regulations as shown below:—

FIRST SCHEDULE.

PROFESSIONAL DIVISION.

Offices and Rates of Salaries.

| Office. | Yearly Rate of Salary. | |
|-------------------------------------|------------------------|----------|
| | Minimum. | Maximum. |
| | £ | £ |
| DEPARTMENT OF AGRICULTURE. | | |
| CLASS "C. 1" | | |
| Add— Field Agrostologist | 668 | 720 |

This Regulation shall have effect as on and from the 31st March, 1953.

D. D. PAINE, Chairman.

E. F. FITZGIBBON, Secretary.

Office of the Public Service Board,
Melbourne, 1st July, 1953.

PUBLIC SERVICE (PUBLIC SERVICE BOARD) REGULATION 39.—RECLASSIFICATIONS.

THE Public Service Board has raised the classification of the under-mentioned offices as shown, and the Permanent Heads of the Departments have recommended the officers named for appointment.

| Office and Present Classification. | Revised Classification. | Duties. | Qualifications. | Officer Recommended for Appointment. | | |
|--|--|---|---|--|--|-------------------------|
| | | | | Name. | Classification. | Date of Classification. |
| PROFESSIONAL DIVISION. | | | | | | |
| DEPARTMENT OF CROWN LANDS AND SURVEY. | | | | | | |
| Senior Draughtsman, Class "B" | Superintending Draughtsman, Class "B1" | | To be a competent survey draughtsman with a thorough knowledge and experience of the various processes of map production in colour, including colour separation of negatives and preparation of plates for line and half-tone, and of the printing down of same; to possess the ability to direct and control staff | Pescia, C. C. . . | Senior Draughtsman, Class "B" | 6.8.51 |
| DEPARTMENT OF PUBLIC WORKS. | | | | | | |
| Draughtsman, Class "D" | Class "C" . . | To prepare preliminary sketches, contract plans, details, and specifications for modern buildings | To be qualified in building construction and to be capable of undertaking the duties outlined | Moriarty, J. J. | Draughtsman, Class "D" | 23.10.51 |
| DEPARTMENT OF HEALTH. | | | | | | |
| <i>Maternal and Child Hygiene Branch.</i> | | | | | | |
| School Dental Officer (Female), Grade II., Class "B1" | Grade I., Class "A" (£1,110-£1,210) | To perform dental duties, as directed, at the School Dental Centre and visit country areas with mobile dental units | To be a legally qualified dentist registered in Victoria, and to possess approved university qualification, with appropriate dental experience | Campbell, J. M. | School Dental Officer (Female), Grade II., Class "B1" | 7.2.52 |
| School Medical Officer (Female), Grade II., Class "B1" (two offices) | Grade I., Class "A" (£1,110-£1,210), (two offices) | To carry out medical inspections of school children and other medical duties as directed by the Chief Medical Inspector | To be a legally qualified medical practitioner, registered in Victoria. Applicants must be prepared to undertake country duties and should furnish evidence of hospital and other experience | Altmann, S. C. A. Horton, A. M. V. P. | School Medical Officer (Female), Grade II., Class "B1" | 1.9.49 1.12.47 |
| DEPARTMENT OF AGRICULTURE. | | | | | | |
| Senior Inspector of Agriculture, Class "A" (£1,110-£1,210) | Classes "A" and "A1" (£1,120-£1,320) | Under the Agricultural Superintendent, to assist in the control and direction of the work of the Agricultural Division of the Department of Agriculture | Degree in Agricultural Science; proved capacity in agricultural administration | Miller, W. B. . . | Senior Inspector of Agriculture, Class "A" | 1.2.47 |

Appeals against such recommendations should be lodged with the Secretary to the Public Service Board not later than Saturday, the 26th July, 1953.

Office of the Public Service Board,
Melbourne, 14th July, 1953.

By order,
E. F. FITZGIBBON,
Secretary.

PUBLIC SERVICE (PUBLIC SERVICE BOARD) REGULATION 39.—VACANCY.

THE Permanent Head of the Department shown has recommended the officer named hereunder for appointment to the under-mentioned vacancy.

| Office and Classification. | Duties. | Qualifications. | Officer Recommended for Appointment. | | |
|--|---------|---|--------------------------------------|-------------------------------|-------------------------|
| | | | Name. | Classification. | Date of Classification. |
| PROFESSIONAL DIVISION. | | | | | |
| DEPARTMENT OF CROWN LANDS AND SURVEY. | | | | | |
| Assistant Superintending Draughtsman, Class "B1" | | To be a competent survey draughtsman with extensive experience in the preparation of all plans based on the relevant sections of the Land Act; to be thoroughly conversant with departmental procedure and requirements, and to possess the ability to train and direct staff | Lynch, G. . . | Senior Draughtsman, Class "B" | 5.11.51 |

Appeals against such recommendation should be lodged with the Secretary to the Public Service Board not later than Saturday, the 25th July, 1953.

Office of the Public Service Board,
Melbourne, 14th July, 1953.

By order,
E. F. FITZGIBBON,
Secretary.

Teaching Service Act 1946.

TEACHING SERVICE (TEACHERS TRIBUNAL) REGULATIONS.

AMENDMENT No. 52.

THE Teachers Tribunal, in pursuance of the powers conferred by the *Teaching Service Act 1946*, hereby amends Regulation 14 of the Teaching Service (Teachers Tribunal) Regulations in the manner following, that is to say:—

Regulation 14.

1. In clause 1, above the expression "A Head Teacher of the First Class to or in a school", insert the following proviso:—

"Provided that, subject to approval by the Tribunal, a Head Teacher of the Special Class may be appointed to or in a school which is outside the metropolitan area (as defined in clause 3 of Regulation 4 of the Teaching Service (Teachers Tribunal) Regulations) and has a net enrolment of at least 700 pupils."

2. In clause 2, in the staffing schedule, for net enrolments of 665-709 and 710-754 respectively—

(a) insert the figure "1" in each case in the column headed "Women Assistants II." and (b) for the figures "9" and "10" in the column headed "Additional Assistants", substitute the figures "8" and "9" respectively.

3. In paragraph (a) of the proviso to clause 2, for the expression "First Class shall", substitute the expression "First Class may, with the approval of the Tribunal,".

4. In paragraph (c) of the proviso to clause 2, for the figure "755" substitute the figure "600".

W. H. ELLWOOD, Chairman.

G. FENNELL, Secretary.

Office of the Teachers Tribunal,

Melbourne, 6th July, 1953.

Teaching Service Act 1946.

TEACHING SERVICE (TEACHERS TRIBUNAL) REGULATIONS.

AMENDMENT No. 53.

THE Teachers Tribunal, in pursuance of the powers conferred by the *Teaching Service Act 1946*, hereby amends Regulation 15 of the Teaching Service (Teachers Tribunal) Regulations in the manner following, that is to say:—

Regulation 15.

1. In clause 1 in the staffing schedule—

(a) For net enrolment of 390-419, (i) for the figure "2" in the column headed "Men Assistants III.", substitute the figure "3", and (ii) for the figure "5" in the column headed "Additional Assistants", substitute the figure "4".

(b) For net enrolments of 500-539, 540-584 and 585-629 respectively, (i) insert the figure "1" in each case in the column headed "Women Assistants II.", and (ii) for the figures "6", "7" and "7" in the column headed "Additional Assistants", substitute the figures "5", "6" and "6" respectively.

2. Delete paragraph (c) of the proviso in clause 1.

W. H. ELLWOOD, Chairman.

G. FENNELL, Secretary.

Office of the Teachers Tribunal,

Melbourne, 6th July, 1953.

PRIVATE ADVERTISEMENTS.

TAKE notice that by deed poll executed the 9th day of July, 1953, and registered this day in the office of the Registrar-General, I, Olive Patricia Quinn, of 48 Rouse-street, Port Melbourne, Victoria, waitress, have abandoned the name Quinn and assumed in its place the name Cotton, and am now known as Olive Patricia Cotton.
Dated the 9th day of July, 1953.

O. P. COTTON.

Witness—DAVID H. THOMAS, solicitor, Melbourne. 6022

NOTICE is hereby given that Daniel Scott Proprietary Limited, has applied for a lease under section 125 of the Land Acts for a term of 48 years from 8th November, 1953, of allotment 2b, section 63A, City of Port Melbourne, containing 3 acres 3 roods and 10 perches, as a site for manufacturing purposes. 5782

NOTICE OF INTENTION TO APPLY FOR A LICENCE TO DIVERT WATER AND CUT RACES FROM THE NARCOOYIA CREEK AT A POINT OPPOSITE ALLOTMENT 4, PARISH OF NENANDIE, ABOUT A MILE FROM ITS JUNCTION WITH THE MURRAY RIVER.

I HEREBY give notice that I intend to apply for a licence empowering me to divert water for a term of fifteen years to the extent of 300 acre-feet per annum at a maximum rate of 4 acre-feet per day of 24 hours, for irrigation of 150 acres, being parts of Crown allotments 4 and 4A, Parish of Nenandie, and to occupy certain Crown lands for works of storage and diversion, and to cut a race thereon.

Any objection to such application must be forwarded, in writing, to the State Rivers and Water Supply Commission, Melbourne, within 30 days of the date hereof.
Dated this 9th day of July, 1953.

WALTER JAMES POWER.

Private Bag, Piangil. 5990

NOTICE OF INTENTION TO APPLY FOR A LICENCE TO DIVERT WATER AND CUT RACES FROM THE MURRAY RIVER AT COLIGNAN.

I HEREBY give notice that I intend to apply for a licence empowering me to divert water for a term of fifteen years to the extent of 50 acre-feet per annum at a maximum rate of 2 acre-feet per day of 24 hours for irrigation of 25 acres, being part of allotment 22, section —, and Parish of Colignan, and to occupy certain Crown lands for works of storage and diversion, and to cut a race thereon.

Any objection to such application must be forwarded, in writing, to the State Rivers and Water Supply Commission, Melbourne, within 30 days of the date hereof.

ROBERT THOMAS DAWES.

Colignan, 10th July, 1953. 5989

CITY OF GEELONG.

BY-LAW No. 131.

A By-law of the City of Geelong, made under the provisions of the *Health Act* 1928 and every other power enabling it in that behalf for prescribing the fees and dues payable for services rendered at the abattoirs.

IN pursuance of the powers conferred by the *Health Act* 1928 and every other power enabling it in that behalf, it is hereby enacted by the Council of the City of Geelong as follows:—

1. In this By-law:—

“Council” means the Council of the City of Geelong.
“Abattoirs” means the City of Geelong public abattoirs.
“Bobby calf” means a calf not more than six weeks old.

2. The fees and dues hereinafter prescribed shall be those payable for the under-mentioned services rendered at the abattoirs, namely:—

For the use of the abattoirs for—

| | f | s. | d. |
|---|---|----|----|
| (1) Slaughtering any— | | | |
| (a) bull, cow, calf (other than a bobby calf), heifer, ox, or steer | 0 | 3 | 0 |
| (b) bobby calf, goat, kid, lamb, or sheep | 0 | 1 | 0 |
| (c) head of swine | 0 | 2 | 0 |
| (2) Examining any— | | | |
| (a) bull, cow, calf (other than a bobby calf), heifer, ox, or steer | 0 | 2 | 6 |
| (b) bobby calf, goat, kid, lamb, or sheep | 0 | 1 | 0 |
| (c) swine | 0 | 2 | 0 |

(3) Examining and branding any carcass of or meat derived from any—

| | | | |
|---|---|---|---|
| (a) bull, cow, calf (other than a bobby calf), heifer, ox, or steer | 0 | 4 | 0 |
| (b) bobby calf, goat, kid, lamb, or sheep | 0 | 1 | 6 |
| (c) swine | 0 | 2 | 0 |

(4) For any certificate as to an examination made by a meat inspector

0 4 0

(5) For chilling a carcass of any—

| | | | |
|---|---|---|---|
| (a) bull, cow, calf (other than a bobby calf), heifer, ox, or steer | 0 | 4 | 6 |
| (b) bobby calf, goat, kid, lamb, or sheep | 0 | 1 | 0 |
| (c) swine | 0 | 1 | 0 |

3. The fees prescribed in clause 2 of this By-law shall be paid by every person about to use the abattoirs before using the same.

4. Clauses numbered 8 and 19 of By-law No. 70 of the City of Geelong prescribing fees or dues to be paid by persons using the abattoirs for services rendered, as amended by By-laws Nos. 83 and 87, shall in so far as the same have not already been repealed be and the same are hereby repealed.

Resolution for passing this By-law agreed to by the Council this 28th day of April, 1953, and confirmed the 26th day of May, 1953.

The common seal of the Mayor, Councillors, and Citizens of the City of Geelong was affixed hereto, in the presence of—

(SEAL) MORRIS JACOBS, Mayor.
L. L. WALTER, Town Clerk.

Submitted to the Commission of Public Health on the 9th day of June, 1953.—G. V. STAFFORD, Secretary to the Commission.

Approved by the Governor in Council the 29th day of June, 1953.—A. MAHLSTEDT, Clerk of the Executive Council. 5988

CITY OF HORSHAM.

BY-LAW No. 38.

A By-law of the City of Horsham, made under the provisions of the Local Government Acts and Health Acts, and numbered 38, for the purpose of amending By-law No. 26 of the said City.

IN pursuance of the powers conferred by the Local Government Acts and the Health Acts and every other power it thereunto enabling, the Mayor, Councillors, and Citizens of the City of Horsham order as follows:—

That By-law No. 26 of the said City be amended:—

1. By repealing clause 7 and substituting therefor the following:—

“7. The municipality may charge and collect for its own use the following fees and dues in respect of the matters following, that is to say —

| | | |
|---|----|----|
| For the use of the establishment for slaughtering any— | s. | d. |
| (a) Bull, cow, calf (other than a bobby calf), heifer, ox, or steer | 3 | 0 |
| (b) Bobby calf, goat, kid, lamb, or sheep | 1 | 0 |
| (c) Head of swine | 2 | 0 |

For examining any—

| | | |
|---|---|---|
| (a) Bull, cow, calf (other than a bobby calf), heifer, ox, or steer | 2 | 6 |
| (b) Bobby calf, goat, kid, lamb, or sheep | 1 | 0 |
| (c) Head of swine | 2 | 0 |

For examining and branding any carcass of or meat derived from any—

| | | |
|---|---|---|
| (a) Bull, cow, calf (other than a bobby calf), heifer, ox, or steer | 4 | 0 |
| (b) Bobby calf, goat, kid, lamb, or sheep | 1 | 6 |
| (c) Swine | 2 | 0 |

For any certificate as to an examination made by a meat inspector

4 0

In this clause ‘bobby calf’ means a calf not more than six weeks old.”

2. By inserting after clause 9 the following:—

“9A. No person unless having lawful business to transact at the establishment shall enter thereon or remain therein and if any such person does not leave immediately upon being requested so to do by the

superintendent or other person in charge thereof for the time being he shall be guilty of an offence against this By-law."

"9a. Any person who shall be under the influence of liquor or who shall be guilty of profane swearing or of foul or abusive language or conduct or of obscenity or indecency or who shall obstruct in the execution of his duty any officer or employee of the Council who shall for the time being be on duty at the establishment or who shall refuse to comply with any lawful direction of any such officer or employee shall be guilty of an offence against this By-law."

3. By repealing the following words in clause 2:—

"On Saturdays from Five o'clock in the forenoon to Eleven o'clock in the forenoon."

The foregoing By-law was passed at a meeting of the Council of the City of Horsham held on the 15th day of April, 1953, and confirmed at a meeting held on the 12th day of May, 1953.

W. J. MORSON, Mayor.
I. M. ANDERSON, Councillor.
A. J. WATTS, Town Clerk.

Submitted to the Commission of Public Health on the 19th day of May, 1953.—G. V. STAFFORD, Secretary to the Commission.

Approved by the Governor in Council, 29th June, 1953.—A. MAHLSTEDT, Clerk of the Executive Council. 5969

CITY OF SANDRINGHAM.

LOAN No. 44.

NOTICE is hereby given that the Council of the City of Sandringham did at a meeting held on the 30th day of June, 1953, resolve as follows:—

"That the following Resolution of the Council passed on the 1st day of June, 1953, for the making of a Special Order be confirmed, namely:—

- (i) That the Council of the City of Sandringham borrow the sum of Twenty thousand pounds (£20,000) by the issue of debentures for such amount secured on the credit of the Mayor, Councillors, and Citizens of the said City, in accordance with the provisions of section 583 of the *Local Government Act, 1946*; and
- (ii) the rate of interest to be paid shall not exceed Four pounds seventeen shillings and six pence (£4 17s. 6d.) per centum per annum; and
- (iii) the loan is to be repaid by thirty (30) equal half-yearly instalments of principal and interest combined, on the 1st day of February and the 1st day of August in each year at the National Bank of Australasia Limited, Melbourne, or Council's bankers for the time being; and
- (iv) the purpose for which the loan is to be applied is for the construction of private streets and drains within the municipality, in accordance with the provisions of Division 10, Part XIX., and also section 612, Division 5, Part XXI., of the *Local Government Act 1946*."

5971

F. G. TRICKS, Town Clerk.

CITY OF SUNSHINE.

LOAN No. 27.

Notice of Intention to Borrow the Sum of Thirty Thousand Pounds (£30,000) for Permanent Works and Undertakings.

TAKE notice that the Council of the City of Sunshine proposes to borrow on the credit of the Mayor, Councillors, and Citizens of the said City the sum of Thirty thousand pounds (£30,000), such sum to be raised by the issue of debentures in accordance with the provisions of the *Local Government Acts*; the maximum rate of interest to be paid shall be Four pounds seventeen shillings and six pence (£4 17s. 6d.) per centum per annum; the period of the loan shall be 25 years; the loan shall be liquidated by 50 half-yearly instalments of approximately £1,044 11s. 5d., which shall cover principal and interest payable on the 1st day of April and the 1st day of October in each year during the currency of the loan at the National Bank of Australasia Ltd., Melbourne, or the Council's bankers for the time being in Melbourne. The permanent works and undertakings upon which such loan is to be expended are:—

Road Construction.—Churchill-avenue, £10,000; streets abutting reserves in Housing Commission area south of Ballarat-road east of Ashley-street, £4,000; and Housing Commission area north of Ballarat-road, £1,654; section

17—between Ashley and Duke streets, £8,000; streets, foot-paths, and drainage—Railway Housing Estates, South-road, Wright-street, £6,346—total, £30,000

The plans and specifications and estimate of cost of the works referred to above, and a statement showing the proposed expenditure of the money to be borrowed, are open for inspection at the Municipal Offices, Hampshire-road, Sunshine.

By order of the Council,

5973

E. HARGREAVES, Town Clerk.

SHIRE OF FRANKSTON AND HASTINGS.

LOAN No. 39.

Notice of Intention to Borrow the Sum of £5,000 for Permanent Works and Undertakings.

NOTICE is hereby given that the Council of the Shire of Frankston and Hastings proposes to borrow the sum of Five thousand pounds on the credit of the municipal revenues of the President, Councillors, and Rate-payers of the said Shire, such sum to be raised by the issue of debentures in accordance with the provisions of the *Local Government Acts*.

1. The maximum rate of interest that may be paid is 4½ per cent. per annum.

2. The purpose for which the loan is to be applied is—

Drainage works—

Housing Commission.

McAlister-street.

Jubilee-avenue.

3. The period of the loan shall be fifteen years.

4. The moneys borrowed shall be repayable by providing out of the Municipal Fund 30 half-yearly instalments of £236 18s. 1d. each, including principal and interest, on the 1st day of March and the 1st day of September during the currency of the loan. The first instalment shall be payable on the 1st day of March, 1954.

5. Such moneys shall be repayable at the Commonwealth Bank of Australia, Melbourne.

The plans and specifications and the estimate of the cost of the proposed works, and a statement showing the proposed expenditure of the moneys to be borrowed, are open for inspection at the Shire Office, Frankston.

Dated this 7th day of July, 1953.

5974

G. C. PENTLAND, Shire Secretary.

SHIRE OF MANSFIELD.

-BY-LAW No. 38.

A By-law of the Shire of Mansfield, made under Part XXX. of the *Local Government Act 1946*, and numbered 38, for the purpose of altering By-law No. 28 and repealing By-law No. 34, for regulating the Mansfield Corporation Sale Yards, for licensing yards and premises for the sale of cattle within the municipal district, for fixing the dues to be paid for such licences, and for appointing tolls and dues to be demanded from every person exposing or offering for sale or selling any cattle in the Mansfield Corporation Sale Yards, and from any person who shall at any time use for the sale of cattle any licensed yards or premises within the municipal district.

IN pursuance of the powers conferred by the *Local Government Act 1946* and by every other Act and power enabling it in that behalf, the President, Councillors, and Ratepayers of the Shire of Mansfield order as follows:—

That Regulation No. 1 of By-law No. 28 and the whole of By-law No. 34 be repealed, and the following scale of charges adopted for exposing for sale or selling in any market:—

Horses, Cattle, &c.

| | s. | d. |
|--|----|----|
| Every horse, ass, or mule | 1 | 3 |
| Every head of neat cattle | 1 | 3 |
| Every bull | 1 | 6 |
| Every calf (under twelve months old) | 0 | 6 |
| Every sheep or lamb | 0 | 1½ |
| Every goat | 0 | 3 |
| Every pig | 0 | 9 |
| For remaining within yard overnight— | | |
| Every horse, ass, mule, or pig | 1 | 0 |
| Every head of neat cattle | 0 | 6 |
| Every sheep, lamb, or goat | 0 | 1 |

The Resolution for passing this By-law was agreed to by the Council on the 25th March, 1953, and confirmed on the 22nd April, 1953.

(SEAL)

GEORGE CUMMINS, President.
P. B. SMITH, Councillor.
R. WOMERSLEY, Shire Secretary.

5970

SHIRE OF MILDURA.

BY-LAW No. 93.

A By-law of the Shire of Mildura, and numbered 93, being an amendment of By-law No. 83, altering and amending the rates and fees payable at the abattoirs under the Health Act 1928, and for the regulation and management of the abattoirs of the Shire of Mildura.

IN pursuance of the powers conferred by the Local Government Act 1946, and the Health Act 1928, and every other Act or power enabling them in that behalf the Council of the Shire of Mildura order as follows and make the following By-law:—

That By-law No. 83 be repealed and By-law No. 83 be further amended by deleting clauses (a), (b), (c), (d), and (e), and substituting in lieu thereof the following fees and dues:—

| | s. d. |
|--|-------|
| (a) For examining any— | |
| Bull, cow, calf (other than bobby calf), heifer, ox, or steer .. | 2 6 |
| Bobby calf, goat, kid, lamb, or sheep .. | 0 2 |
| Swine .. | 1 0 |
| (b) For the use of the abattoirs for slaughtering any— | |
| Bull, cow, calf (other than bobby calf), heifer, ox, or steer .. | 3 0 |
| Bobby calf, goat, kid, lamb, or sheep .. | 0 6 |
| Swine .. | 1 0 |
| (c) For examining and branding any carcass of or meat derived from any— | |
| Bull, cow, calf (other than bobby calf), heifer, ox, or steer .. | 4 0 |
| Bobby calf, goat, kid, lamb, or sheep .. | 0 6 |
| Swine .. | 1 0 |
| (d) For certificate as to examination made by a meat inspector .. | 4 0 |
| (e) For chilling a carcass of any— | |
| Bull, cow, calf (other than bobby calf), heifer, ox, or steer, for a period up to 100 hours .. | 4 6 |
| and for each subsequent period of up to 100 hours .. | 4 6 |
| Bobby calf, goat, kid, lamb, or sheep for a period up to 100 hours .. | 0 10 |
| and for each subsequent period of up to 100 hours .. | 0 10 |
| Swine for period up to 100 hours .. | 1 0 |
| and for each subsequent period up to 100 hours .. | 1 0 |

In this By-law a "bobby calf" means a calf not more than six weeks old.

Resolution adopting this By-law agreed to by the Council the second day of April, One thousand nine hundred and fifty-three, and confirmed the seventh day of May, One thousand nine hundred and fifty-three.

Signed and sealed in our presence—

(SEAL) H. CRAMP, President.
J. HENSILWOOD, Councillor.
A. D. HARVEY, Shire Secretary.

Submitted to the Commission of Public Health on the nineteenth day of May, One thousand nine hundred and fifty-three.—G. V. STAFFORD, Secretary of the Commission.

Approved by the Governor in Council, the 29th day of June, 1953.—A. MAHLSTEDT, Clerk of the Executive Council. 5987

SHIRE OF MORNINGTON.

BY-LAW No. 63.

A By-law of the Shire of Mornington, made under the Health Acts, and numbered 63, for the regulation and management of the meat area within the municipal district of the said Shire, and for—

- (a) prescribing the times for slaughtering animals at public or private abattoirs; and
- (b) amending By-law No. 50 of the said Shire.

IN exercise of the power conferred by the Health Acts and of every and any other power it thereunto enabling, the President, Councillors, and Ratepayers of the Shire of Mornington hereby order as follows:—

1. This By-law shall have full force and operation after its approval by the Governor in Council and immediately from the date of its publication in the Victoria Government Gazette.

2. By-law No. 50 of the said Shire is hereby amended by deleting clause (4) thereof and by substituting therefor the following new clause:—

"(4) The times for slaughtering animals in the meat area shall be as follows:—

- (a) From the 1st April to the 31st August in each year between the hours of Five o'clock a.m. and Three o'clock p.m. on Monday, Tuesday, Wednesday, Thursday, and Friday in each week; and
- (b) from the 1st January to the 31st March and from the 1st September to the 31st December in each year between the hours of Five o'clock a.m. and Four o'clock p.m. on Monday, Tuesday, Wednesday, Thursday, and Friday in each week; and
- (c) animals may be slaughtered in the meat area on a Saturday, Sunday, or a gazetted holiday only with the consent, in writing, of the meat inspector to whom at least 24 hours' notice of intention to slaughter on that day must be given."

Resolution for passing this By-law was adopted by the Council of the Shire of Mornington on the 17th day of April, 1953, and confirmed on the 15th day of May, 1953.

In witness whereof the common seal of the President, Councillors, and Ratepayers of the Shire of Mornington was hereto affixed, in the presence of—

W. WATT LEGGATT, Shire President.
(SEAL) C. B. WILSON, Councillor.
D. G. COLLINGS, Shire Secretary.

Submitted to the Commission of Public Health at its meeting on the 9th day of June, 1953.—G. V. STAFFORD, Secretary, Commission of Public Health.

Approved by the Governor in Council, the 29th day of June, 1953.—A. MAHLSTEDT, Clerk of the Executive Council. 5967

NOTICE OF DISSOLUTION OF PARTNERSHIP.

NOTICE is hereby given that the partnership heretofore subsisting between John Stuart Gould and Jack Gould, carrying on business as farmers at Wedderburn, under the name of "John S. and Jack Gould," has been dissolved by mutual consent as at the 30th day of June, 1953. All debts due to and owing by the said late firm will be received and paid by the said Jack Gould, who will continue to carry on farming operations on his own account at Wedderburn.

Dated this 6th day of July, 1953.

HYETT, WILLIS, & HYETT, 51 Bull-street, Bendigo, solicitors for both parties. 5976

NOTICE is hereby given that the partnership heretofore subsisting between John Peter Miner and Cyril Francis James D'Astole, carrying on business as cartage contractors at 260 Moorabool-street, Geelong, under the style or firm name of "Miner's Transport," has been dissolved as from the 22nd day of June, 1953, so far as concerns the said John Peter Miner.

Dated the 9th day of July, 1953.

5980 JOHN PETER MINER.
C. D'ASTOLE.

PARTNERSHIP ACT 1928.

THE partnership of Henry Baker and George Patrick Morgan, carrying on business as sawmillers at Whitfield, under the firm name of Baker and Morgan, was dissolved by mutual consent on the 30th day of June, 1953.

5979 HENRY BAKER.
G. P. MORGAN.

NOTICE OF DISSOLUTION OF PARTNERSHIP.

NOTICE is hereby given that the partnership heretofore subsisting between the undersigned Stephan Ribarics and Bela Hie, carrying on business under the name of S.R.B.H. Motor Repairs, at 3 Collingwood-road, Newport, has been dissolved by mutual consent, as from the 30th day of June, 1953. All debts due to and owing by the said firm will be received and paid by the said Stephan Ribarics, who will carry on business under the name of S. R. Motor Repairs, at the same address.

Dated at Melbourne the 6th day of July, 1953.

S. RIBARICS.
B. HIE.
R. E. Lewis and Son, solicitors, 379 Collins-street, Melbourne. 6013

NOTICE OF DISSOLUTION OF PARTNERSHIP.

NOTICE is hereby given that the partnership heretofore subsisting between the undersigned Michel Jaquinot, of 457 Toorak-road, Toorak, in the State of Victoria, and James Rainbow, formerly of 454 Canning-street, North Carlton, but now of Station-street, Chelsea, in the said State, carrying on the business of a hairdressing salon at 457 Toorak-road, Toorak, under the name of "Michel' Salon de Coiffure", has been dissolved by mutual consent as from the 30th day of June, 1953. All debts due to and owing by the said late firm will be received and paid by the said Michel Jaquinot, who will continue to carry on the business at the same place.

Dated at Melbourne the 13th day of July, 1953.

MICHEL JAQUINOT.
JAMES RAINBOW.

Witness to all the above signatures—MARY FRANCES
TIERNAN, solicitor, Melbourne. 6021

NOTICE is hereby given that the partnership heretofore carried on by William Henry Beecham and Basil Allwynne West, at 110 Gaffney-street, Coburg, under the name "Beecham and West", has been dissolved by mutual consent as on and from the 30th day of June, 1953.

Dated the 9th day of July, 1953.

W. BEECHAM.
BASIL ALLWYNNE WEST.

Oswald Burt and Co., solicitors, 394 Collins-street, Melbourne. 6032

NOTICE is hereby given that the partnership formerly carried on under the name of "Federal Platers", at 250 High-street, Prahran, by Ronald Malcolm Bailey, Reginald Sidney McCann, and Thomas Walter Bailey, has been dissolved, and that the business will hereafter be carried on by the said Ronald Malcolm Bailey, of 35 McKittrick-road, Moorabbin.

Dated the 8th day of July, 1953.

C. L. BARBOUR, 89 Queen-street, Melbourne, solicitor for the said Ronald Malcolm Bailey. 6030

DISSOLUTION NOTICE.

NOTICE is hereby given that the partnership heretofore subsisting between the undersigned Joan Ryan and Dorothea Ryan, carrying on a business as a private hospital known as "Ambermere," Knight-street, Shepparton, has been dissolved by mutual consent as from the 13th day of February, 1953. All debts due to and owing by the said late firm will be received and paid by the said Joan Ryan, who will continue to carry on the business at the same place and under the style of "Ambermere Hospital."

Dated this 8th day of July, 1953.

DOROTHEA RYAN.
JOAN RYAN.

Witness to signatures—H. KENNEDY, F.C.C.A., accountant, Shepparton. 5993

NOTICE OF DISSOLUTION OF PARTNERSHIP.

NOTICE is hereby given that the partnership heretofore subsisting between the undersigned Malachy Ryan and John Neil Byrne, carrying on business as barristers and solicitors, at 79 Bridge-street, Benalla, under the name of Mal. Ryan, Lewers, and Byrne, has been dissolved by mutual consent as from the 30th day of June, 1953. All debts due to and owing by the said late firm will be received and paid by John Neil Byrne, who will continue to carry on the business at the same place.

Dated at Benalla, the 1st day of July, 1953.

MAL. RYAN.
J. NEIL BYRNE.

Witness—TREVOR KIMBALL. 5994

NOTICE.

NOTICE is hereby given that the partnership heretofore subsisting between George Keeble and Richard Keeble, in the business of farmers, carried on by them at Bona Vista, has been dissolved by mutual consent as from the 30th day of June, 1953. All debts due to and owing by the late partnership will be received and paid by the said George Keeble.

Dated this 9th day of July, 1953.

G. KEEBLE.
R. KEEBLE.

Courtney and Dunn, solicitors, Warragul. 5991

PARTNERSHIP ACT.

NOTICE is hereby given that the partnership heretofore subsisting between the undersigned Louis Edward Trewin and George Charles Lambert, carrying on business as service station proprietors, at Moore-street, Rochester, under the name of L. and T. Rochester Motors, has been dissolved by mutual consent as from the 30th day of June, 1953, so far as concerns the said George Charles Lambert, who retires from the said firm. All debts due to and owing by the said firm will be received and paid by the said Louis Edward Trewin, who will continue to carry on the said business at the same place under the said name of L. and T. Rochester Motors. And notice is also hereby given that the said Louis Edward Trewin and George Charles Lambert will continue to hold and exercise together the franchise which they have hitherto held together from the Ford Motor Company of Australia, for so long as the agreement between the said company and themselves shall continue in force, and it is expressly declared that their so holding and exercising the said franchise shall not give rise to any relationship of partnership between them.

Dated the 1st day of July, 1953.

G. C. LAMBERT.
L. E. TREWIN.

H. W. Raleigh and Roberts, solicitors, Rochester. 5983

NOTICE is hereby given that the partnership heretofore subsisting between Charles John Christie, of 5A Evans-street, East Brunswick, plasterer, Kenneth Alexander Thomson, of 243 Devon-road, Pascoe Vale, plasterer, and Paul Elton Pringle, of 193 Victoria-street, East Brunswick, plasterer, carrying on business as fibro plaster manufacturers at 23 Irene-avenue, Coburg, under the style or firm name Paramount Fibro Plaster Co., has been dissolved by mutual consent as from the 30th day of June, 1953. All debts due to and claims in respect of debts owing by the said late firm will be received by the said Kenneth Alexander Thomson.

Dated the 2nd day of July, 1953.

C. J. CHRISTIE.
K. A. THOMSON.
P. E. PRINGLE.

6009

Companies Act 1938.

JOLLYWASH PTY. LTD. (IN LIQUIDATION).

TAKE notice that the affairs of the above company having been fully wound up, the liquidator, J. H. Opas, hereby calls a General Meeting of the members of the company, to be held at Room 314, 83 William-street, Melbourne, at Three o'clock in the afternoon of Friday, 21st day of August, 1953, for the purpose of laying before the meeting a final account of the winding up. 6037

VOGUE FURNITURE PTY. LTD. (IN LIQUIDATION).

TAKE notice that the affairs of the above company having been fully wound up, the liquidator, Geoffrey Lyon, hereby calls a General Meeting of the members of the above company, to be held at Room 314, 83 William-street, Melbourne, at Three o'clock in the afternoon of Friday, 21st day of August, 1953, for the purpose of laying before the meeting a final account of the winding up. 6036

Companies Act 1938.

THE CLIFFORD CASH ORDER PROPRIETARY LIMITED.

AT an Extraordinary General Meeting of the above-named company, duly convened and held at 18 Queen-street, Melbourne, on the 23rd day of June, 1953, the following Special Resolution was duly passed:—

"That the company be wound up voluntarily, and that John A. C. Andrew, chartered accountant (Aust.), be appointed liquidator of the company."

Dated this 23rd day of June, 1953.

6024 A. H. TEMPLE, Director.

COMMONWEALTH CATERING CO. (VICTORIA) PROPRIETARY LIMITED.

AT an Extraordinary General Meeting of the above-named company duly convened and held at the offices of Messrs. W. V. Armstrong and Co., 62 Pitt-street, Sydney, on Tuesday, the 7th day of July, 1953, the following Resolution was duly passed as a Special Resolution:—

"That the company be wound up voluntarily and that Mr. William Victor Armstrong, chartered accountant (Aust.), of 62 Pitt-street, Sydney, be and is hereby appointed liquidator for the purpose of such winding up."

Dated the 8th day of July, 1953.

6023 A. E. McCARTNEY, Chairman.

In the Supreme Court.—In the matter of Part I. of the *Companies Act 1938*, and in the matter of YARRA PARK INVESTMENTS PTY. LIMITED.

NOTICE is hereby given that a petition for the winding up of the above-named company by the Supreme Court was on the 9th day of July, 1953, presented to the said court by Harry Herbert Dudley Ingram, of 133 Barkly-street, North Fitzroy, in Victoria, accountant, a creditor of the said company. And that the said petition is directed to be heard before the said Supreme Court sitting at Law Courts, William-street, Melbourne, on the 31st day of July, 1953, and any creditor or contributory of the said company desirous to support or oppose the making of an order on the said petition may appear at the time of hearing by himself or his counsel for that purpose, and a copy of the petition will be furnished to any creditor or contributory of the said company requiring the same by the undersigned on payment of the regulated charge for the same. The petitioner's address is as set out above. The petitioner's solicitor is A. H. Pearcey, of W. E. Pearcey and Ivey, 443 Little Collins-street, Melbourne.

A. H. PEARCEY.

NOTE.—Any person who intends to appear on the hearing of the said petition must serve on or send by post to the above-named A. H. Pearcey notice, in writing, of his intention so to do. The notice must state the name and address of the person, or, if a firm, the name and address of the firm, and must be signed by the person or firm, or his or their solicitor (if any) and must be served or, if posted, must be sent by post in sufficient time to reach the above-named not later than Four o'clock in the afternoon of the 30th day of July, 1953.

6029

In the Supreme Court.—In the matter of Part I. of the *Companies Act 1938*, and in the matter of YARRA PARK INDUSTRIES PTY. LIMITED.

NOTICE is hereby given that a petition for the winding up of the above-named company by the Supreme Court was on the 9th day of July, 1953, presented to the said court by Harry Herbert Dudley Ingram, of 133 Barkly-street, North Fitzroy, in Victoria, accountant, a creditor of the said company. And that the said petition is directed to be heard before the said Supreme Court sitting at Law Courts, William-street, Melbourne, on the 31st day of July, 1953, and any creditor or contributory of the said company desirous to support or oppose the making of an order on the said petition may appear at the time of hearing by himself or his counsel for that purpose, and a copy of the petition will be furnished to any creditor or contributory of the said company requiring the same by the undersigned on payment of the regulated charge for the same. The petitioner's address is as set out above. The petitioner's solicitor is A. H. Pearcey, of W. E. Pearcey and Ivey, 443 Little Collins-street, Melbourne.

A. H. PEARCEY.

NOTE.—Any person who intends to appear on the hearing of the said petition must serve on or send by post to the above named A. H. Pearcey notice, in writing, of his intention so to do. The notice must state the name and address of the person, or, if a firm, the name and address of the firm, and must be signed by the person or firm, or his or their solicitor (if any) and must be served or, if posted, must be sent by post in sufficient time to reach the above-named not later than Four o'clock in the afternoon of the 30th of July, 1953.

6028

Companies Act 1938.—In the matter of TAMAR RIVER FERRIES PTY. LTD (in Voluntary Liquidation).—Notice to Creditors.

PERSONS having claims against the above-named company must prove their debts or claims before 31st August, 1953. Proofs must be forwarded to the liquidator, Leonard Thomas Stewart, 30 Highett-road, Hampton. Failure to prove will exclude the claimant from any distribution prior to proof.

6006

L. T. STEWART, Liquidator.

BUKIT KUBU RUBBER ESTATES LIMITED (IN VOLUNTARY LIQUIDATION).

NOTICE OF MEETING.

NOTICE is hereby given that a General Meeting of the shareholders of the above company will be held at the registered office of the company, 84 William-street, Melbourne, at 2.15 p.m., on Monday the 17th August, 1953.

Business.

1. To receive and adopt the statement of affairs and realization account for the year ended 30th June, 1953.

2. General.

6000

SHERRARD WARNOCK, Liquidator.

Companies Act, Section 226.

BRUNSWICK FURNITURE PTY. LTD.

NOTICE is hereby given that at an Extraordinary General Meeting of the above-named company duly convened and held at 129 Glenlyon-road, East Brunswick, on the 6th day of July, 1953, the following Special Resolution was duly passed, namely:—

"That the company be wound up voluntarily and that P. A. Tierney, of 39 Ramsay-avenue, Kew, and F. Haines, of Grange-road, Frankston, be and are hereby appointed liquidators for the purposes of such winding up."

Dated this 6th day of July, 1953.

P. A. TIERNEY, Liquidator.
F. HAINES, Liquidator.

5997

Companies Act 1938.—Special Resolution, Pursuant to Section 226.—MALLEE ROOTS PROPRIETARY LIMITED.

AT an Extraordinary General Meeting of the above-named company, duly convened and held at North Fitzroy, on Tuesday, 7th July, 1953, the following Resolution was duly passed as a Special Resolution:—

"That the company be wound up voluntarily."

And at such last-mentioned meeting, John Kenneth Hall, of 390 Little Collins-street, Melbourne, was appointed liquidator for the purposes of the winding up.

5996.

R. L. BISHOP, Chairman.

Companies Act 1938.—MALLEE ROOTS PROPRIETARY LIMITED (IN LIQUIDATION).

CREDITORS are notified that it is my intention to clear a First and Final Dividend of Twenty shillings in the pound in the above matter. Creditors who have not proved their debts by the 30th day of July, 1953, will be excluded from the dividend.

Dated this 9th day of July, 1953.

J. KENNETH HALL, Liquidator.

Hall and Rose,

Chartered Accountants (Aust.),
390 Little Collins-street,
Melbourne, C.1.

5995

L. PADGHAM BUILDERS AND CONTRACTORS PTY. LTD. (IN VOLUNTARY LIQUIDATION).

NOTICE is hereby given that the Final Meeting of the above company will be held at the office of Thos. F. Hiscock, chartered accountant (Aust.), 44 Queen-street, Melbourne, on Monday the 10th August, 1953, at Ten a.m., at which meeting an account will be laid before the company, showing the manner in which the winding up has been conducted and the property of the company disposed of.

Dated this 7th day of July, 1953.

5984

THOS. F. HISCOCK, Liquidator.

PURSUANT to the *Trustee Act 1928*, notice is hereby given that all persons having any claims against the estate of Kathleen Uprichard, late of 683 Burke-road, Upper Hawthorn, widow, deceased, and probate of whose will was granted to the The Trustees Executors and Agency Company Limited, of 401 Collins-street, Melbourne, and Clarence William Willoughby Webster, of 430 Little Collins-street, Melbourne aforesaid, solicitors, are hereby required to send particulars, in writing, of such claims to them, care of the said company, on or before the 30th day of September, 1953, and notice is hereby also given that after the last-mentioned date they will proceed to distribute the assets of the said deceased amongst the persons entitled thereto, having regard only to the claims of which they shall then have had notice.

Dated the 14th day of July, 1953.

PEARCE & WEBSTER, solicitors, 430 Little Collins-street, Melbourne. 6025

MICHAEL PIERCE RUSSELL (usually known as Michael Russell), late of No. 77 Murphy-street, Richmond, gentleman, DECEASED (who died on the 30th day of July, 1952).

CREDITORS, next of kin, and all other persons having claims against the estate of the above-mentioned deceased, are required by the executor of the will, Maurice Goldberg, of No. 305 Bridge-road, Richmond, barrister and solicitor, to send particulars to him, on or before the 30th day of September, 1953, after which date he will distribute the assets, having regard only to the claims of which he then has notice.

MAURICE GOLDBERG, solicitor, No. 305 Bridge-road, Richmond. 6016

Trustee Act 1928.

NOTICE TO CLAIMANTS.

PURSUANT to the Trustee Act 1928, creditors, next of kin, and all other persons having claims in respect of the estate of any deceased person named below are required to send particulars thereof to the legal personal representative or representatives at the address stated below, on or before the date stated, after which date the representative or representatives will distribute the assets, having regard only to the claims of which notice has been received:—

John Simmonds Matters, late of Koroit, retired printer, deceased, died 6th April, 1953.—Claims to the executors, William Heyward Matters, of Koroit, printer, and Lloyd George Matters, of 23 Jean-street, Cheltenham, civil servant, care of Conlan and Leishman, solicitors, 36 Bank-street, Port Fairy, by 19th September, 1953. 5992

Beatrice Ann Victoria Ralph, late of 39 O'Grady-street, Clifton Hill, spinster, died 11th April, 1953.—Claims to the executor, Reginald Rupert Gray, solicitor, of 195 High-street, Northcote, care of Gray and Gray, solicitors, 195 High-street, Northcote, by 20th September, 1953. 6014

Florence Elizabeth Mitchell (sometimes known as Florence Elizabeth Hale), late of 287 Union-road, Balwyn, in the State of Victoria, widow, deceased, died 23rd May, 1953.—Claims to the executor, National Trustees, Executors, and Agency Company of Australasia Limited, whose registered office is at 95 Queen-street, Melbourne, by 23rd September, 1953. J. W. Glover, LL.B., solicitor, 422 Collins-street, Melbourne. 6018

CREDITORS, next of kin, and all others having claims in respect of the estate of Eric Herrmann Booth, late of 20 Queen-street, Melbourne, and 13 Monaro-road, Malvern, in the State of Victoria, chemical engineer and company director, deceased (who died on the 30th day of January, 1953), are to send particulars of their claims to the executrix, Katherine Mary Clare Booth, care of the undersigned, by the 20th day of September, 1953, after which date she will distribute the assets of the estate, having regard only to claims of which she then has notice.

Dated this 7th day of July, 1953.

R. E. LEWIS & SON, 379 Collins-street, Melbourne, C.1, solicitors for the executrix. 6015

CREDITORS, next of kin, and others having claims in respect of the estate of Marie May Sinclair, late of Lockwood-grove, Belgrave Heights, widow, deceased (who died on the 23rd day of May, 1952, and probate of whose will was granted by the Supreme Court of Victoria, on the 24th day of April, 1953, to James Alexander Calderwood, the executor named in the said will), are to send particulars of their claims to the said executor, addressed to John D. Evans Rockman and Co., Frankston, by the 30th day of September, 1953, after which date he will distribute the assets, having regard only to the claims of which he then has notice.

Dated this 13th day of July, 1953.

JOHN D. EVANS ROCKMAN & CO., 62A Young-street, Frankston, solicitors for the said executor. 6027

CREDITORS, next of kin, and others having claims in respect of the estate of Charles Albert Paine, late of Heather Dell, York-road, Broadstone, Dorsetshire, in England, deceased (who died on the 11th day of February, 1953), are to send particulars of their claims to The Trustees, Executors, and Agency Company Limited, of 401 Collins-street, Melbourne, in Victoria, by the 16th day of September, 1953, after which date it will distribute the assets, having regard only to the claims of which it then has notice.

AITKEN, WALKER, & STRACHAN, 123 William-street, Melbourne. 6020

CREDITORS, next of kin, and others having claims in respect of the estate of Hugh Robert Sloan, formerly of The Grand Hotel, Mildura, in the State of Victoria, but late of The Commercial Travellers' Association, of 318 Flinders-street, Melbourne, in the said State, gentleman, deceased (who died on the 27th day of February, 1953), are to send particulars of their claims to The Equity Trustees, Executors, and Agency Company Limited, of 472 Bourke-street, Melbourne, by the 12th day of September, 1953, after which date it will distribute the assets, having regard only to the claims of which it then has notice.

DARVALL & HAMBLETON, solicitors, 352 Collins-street, Melbourne. 6033

CREDITORS, next of kin, and others having claims in respect of the estate of Herbert John Green, late of 339 Toorak-road, South Yarra, retired, deceased (who died on the 6th day of May, 1953, and probate of whose will was granted by the Supreme Court of Victoria, on the 3rd day of July, 1953, to The Fidelity Trustee Company Limited, of 50 Market-street, Melbourne, the executor named in the said will), are to send particulars of their claims to the said executor, at its address above mentioned, by the 17th day of September, 1953, after which date it will distribute the assets, having regard only to the claims of which it then has notice.

Dated this 8th day of July, 1953.

BLAKE & RIGGALL, 120 William-street, Melbourne, solicitors for the said executor. 6031

CREDITORS, next of kin, and others having claims in respect of the estate of Frances Homan Campbell-Walker, late of "Barbreck," Bartels-street, McCrae, home duties, deceased (who died on the 10th day of March, 1948, and probate of whose will was granted by the Supreme Court of Victoria, on the 22nd day of October, 1948, to William Somerville Campbell and Alister Muir Campbell, the executors named in the said will), are to send particulars of their claims to the said executors, addressed to the care of John D. Evans Rockman and Co., Mornington, by the 30th day of September, 1953, after which date they will distribute the assets, having regard only to the claims of which they then have notice.

Dated this 9th day of July, 1953.

JOHN D. EVANS ROCKMAN & CO., Mornington, solicitors for the said executor. 6026

CREDITORS, next of kin, and others having claims in respect of the estate of Frank Matt, late of 10 Mayfield-street, East St. Kilda, in the State of Victoria, retired tramway employee, deceased (who died on the 2nd day of March, 1953), are to send particulars of their claims to The Trustees, Executors, and Agency Company Limited, of 401 Collins-street, Melbourne, by the 25th day of September, 1953, after which date it will distribute the assets, having regard only to the claims of which it then has notice.

Dated the 15th day of July, 1953.

ELLISON, HEWISON, & WHITEHEAD, solicitors, 352 Collins-street, Melbourne. 6034

CREDITORS, next of kin, and others having claims in respect of the estate of George Laritz Leopold Chapman, late of 30 Hayes-street, Northcote, in the State of Victoria, retired house renovator, deceased (who died on the 14th day of May, 1953), are to send the particulars of their claims to his executor, The Trustees, Executors, and Agency Company Limited, of 401 Collins-street, Melbourne, by the 18th day of September, 1953, after which date it will distribute the assets, having regard only to the claims of which it then has notice.

HADEN SMITH & FITCHETT, solicitors, 405 Collins-street, Melbourne. 6035

VERA HELEN PATTERSON, late of 121 Finch-street, East Malvern, in the State of Victoria, spinster, DECEASED (who died on the 24th day of May, 1953).

CREDITORS, next of kin, and other persons having claims against the estate of the said deceased are required by Thomas Graham and John Stanley Elder, both of 406 Collins-street, Melbourne, in the said State, solicitors, the executors of the will of the said deceased, to send particulars of claims, in writing, to either of the said executors, at their address aforesaid, on or before the 17th day of September, 1953, after which date the said executors will distribute the assets, having regard only to the claims of which they shall then have had notice.

MADDEN, BUTLER, ELDER, & GRAHAM, 406 Collins-street, Melbourne. 6038

WILLIAM STOCKTON (also known as William Alfred Stockton), late of 13 Phillips-avenue, Murrumbena, gas company employee (who died on 15th March, 1953).

CREDITORS, next of kin, and all others having claims against the estate of the deceased are required by the administratrix of the said estate to send particulars to her, care of the undersigned, on or before 23rd September, 1953, after which date the assets will be distributed, having regard only to the claims of which notice shall have been received.

DUNCAN MACKINNON & CO., solicitors, 379 Collins-street, Melbourne. 6039

WILLIAM REGINALD GORDON WHITE, late of 4 Bruce-court, Elsternwick, in the State of Victoria, company director, DECEASED.

CREDITORS, next of kin, and others having claims against the estate of the above-named deceased are required by the executors, Aline Jersey White, David White, Clive Edwin Hunt, Edward James Whyte, and Robert Nelson Vroland, to send particulars thereof to them, at the under-mentioned address, on or before 17th September, 1953, after which date they will proceed to distribute the assets of the estate, having regard only to claims of which they then have notice.

RODDA, BALLARD, & VROLAND, 430 Little Collins-street, Melbourne, solicitors for the executors. 6040

CREDITORS, next of kin, and others having claims in respect of the estate of Emily Hatchell Walden, formerly of 1026 Malvern-road, Armadale, but late of Rutland Nursing Home, William-street, Brighton, spinster, deceased (who died on the 10th day of July, 1952, and probate of whose will was granted by the Supreme Court of Victoria on the 13th day of October, 1952, to Dorothy Jean Ross, of the Melbourne Church of England Girls' Grammar School, Anderson-street, South Yarra, head-mistress, the executrix named in the said will), are to send particulars of their claims to her, care of the under-signed, by the 23rd day of September, 1953, after which date she will distribute the assets, having regard only to the claims of which she then has notice.

Dated this 14th day of July, 1953.

SNOWDEN, NEAVE, & DEMAINE, solicitors, 433 Little Collins-street, Melbourne. 6041

PURSUANT to the *Trustee Act 1928*, all persons having claims against the property or estate of Gwendoline Rose Dorney, late of Fairy-street, Warrnambool, spinster, deceased (who died on the 9th day of January, 1953, and probate of whose will was granted by the Supreme Court of Victoria, on the 26th day of May, 1953, to John Dent, the executor named therein), are hereby required to send particulars of such claims to the said executor, care of the under-mentioned solicitor, on or before the 15th day of September, 1953, after the expiration of which time the said executor will proceed to distribute the assets of the said deceased amongst the persons entitled thereto, having regard only to the claims of which he shall have had notice.

Dated this 1st day of July, 1953.

D. MADDEN, solicitor, Warrnambool, solicitor for the executor. 6019

CREDITORS, next of kin, and all others having claims against the estate of Alex Hubert Outhwaite, late of 368 Collins-street, Melbourne, in Victoria, chartered accountant (Australia), deceased (who died on the 31st day of May, 1953), are to send particulars of their claims to the executor, William Auncell Keysey a'Beckett, of 368 Collins-street, Melbourne aforesaid, chartered accountant (Australia), care of the under-mentioned solicitors, by the 16th day of September, 1953, after which date he will distribute the assets of the estate, having regard only to claims of which he then has notice.

AITKEN, WALKER, & STRACHAN, of 123 William-street, Melbourne, solicitors for the estate. 6017

CREDITORS, next of kin, and others having claims in respect of the estate of Janet Owens, formerly of 88 Gipps-street, East Melbourne, but late of 89 Westbank-terrace, Richmond, in the State of Victoria, widow, deceased (who died on the 25th day of March, 1953), are to send the particulars of their claims to National Trustees, Executors, and Agency Company of Australasia Limited, whose registered office is situate at 95 Queen-street, Melbourne, by the 17th day of September, 1953, after which date it will distribute the assets, having regard only to the claims of which it then has notice.

C. T. ERLAND, solicitor, 191 Queen-street, Melbourne. 6007

CREDITORS, next of kin, and others having claims in respect of the estate of Harriet Emma Atwood, late of 15 Bourke-street, Melbourne, in the State of Victoria, confectioner, deceased, intestate (who died on the 13th day of September, 1952), are required to send particulars of such claims to her administrator, Henry Thomas Atwood, commercial traveller, care of the under-mentioned solicitors, on or before the 17th day of September, 1953, after which date the said administrator will distribute the assets, having regard only to the claims of which he shall then have had notice.

PURVES & PURVES, solicitors, 448 Collins-street, Melbourne. 6008

CREDITORS, next of kin, and all others having claims against the estate of Thomas Moylan, formerly of 377 Park-street, South Melbourne, in the State of Victoria, wireless mechanic, but late of 60 Margaret-street, Moonee Ponds, in the said State, library attendant, deceased, intestate (who died on the 29th day of March, 1953), are required to send particulars of their claims to the administrator, John Francis Moylan, of 50 Woodland-street, North Essendon, on or before the 30th day of September, 1953, after which date he will distribute the assets, having regard only to the claims of which he then has notice.

6010

NOTICE TO CLAIMANTS.

THE PERPETUAL EXECUTORS AND TRUSTEES ASSOCIATION OF AUSTRALIA LIMITED, whose registered office is situate at Nos. 100-104 Queen-street, Melbourne, in the State of Victoria, and Pauline Christina Davis, of Ensay, in the said State, widow, the executors of the will of James Davis, late of Ensay aforesaid, farmer and grazier, deceased (who died on the 14th day of December, 1952), require all creditors, next of kin, and others having claims against the property or estate of the said deceased to send to the said executors, in the care of the said association, on or before the 20th day of September, 1953, particulars, in writing, of such claims, after which date the said executors intend to convey or distribute such property or estate to or among the persons entitled thereto, having regard only to the claims of which they shall have had notice.

Dated the 3rd day of July, 1953.

WARREN & GRAHAM, solicitors, Bairnsdale. 5977

PURSUANT to the *Trustee Act 1928*, all persons having claims against the estate of James Swayn, late of Barwon-road, South Geelong, farmer, deceased (who died 28th April, 1953), are required to send particulars of such claims to the executor, Ernest Albert Swayn, addressed to the care of the under-mentioned solicitors, on or before 25th September, 1953, after the expiration of which time the executor will proceed to distribute the assets of the said deceased amongst the persons entitled thereto, having regard only to the claims of which he shall have had notice.

A. H. BOWMAN & SON, 43 Yarra-street, Geelong, solicitors for the executor. 5988

PURSUANT to the *Trustee Act 1928*, all persons having claims against the estate of Charles Samuel Taylor, late of "Ripplebrook," Barwon Downs, dairy farmer, deceased (who died on 18th March, 1953), are required to send particulars of such claims to the executors, Raymond Charles Hart and Eric Leslie Hart, addressed to the care of the under-mentioned solicitor, on or before 1st October, 1953, after the expiration of which time the executors will proceed to distribute the assets of the said deceased amongst the persons entitled thereto, having regard only to the claims of which they shall have had notice.

A. W. MALES, LL.B., 57A Yarra-street, Geelong, solicitor for the executors. 6002

CREDITORS, next of kin, and others having claims in respect of the estate of James Pearson, late of No. 340 Bell-street, Preston, gentleman (who died on the 22nd April, 1953), are to send the particulars of their claims to The Trustees, Executors, and Agency Company Limited, the registered office of which is situated at No. 401 Collins-street, Melbourne, by the 16th September, 1953, after which date it will distribute the assets, having regard only to the claims of which it then has notice.

WEIGALL & CROWTHER, 459 Chancery-lane, Melbourne, solicitors for the said company. 5999

WILLIAM JOSEPH ROGERS, late of 96 Vine-street, Bendigo, in the State of Victoria, storeman, DECEASED.

CREDITORS, next of kin, and all other persons having claims against the estate of the said deceased are required by Sandhurst and Northern District Trustees, Executors, and Agency Company Limited, of View-street, Bendigo, the executor of the will of the above-named deceased to send particulars thereof, in writing, to the said company, on or before the 10th day of September, 1953, after which date the said company will proceed to distribute the assets of the said deceased among the persons entitled thereto, having regard only to the claims of which it shall then have notice.

Dated the 8th day of July, 1953.

T. M. WILLIAMS, WATSON, & JAMES, of Bull-street, Bendigo, solicitors for the executor. 5975

NOTICE TO CREDITORS.

CREDITORS, next of kin, and others having claims in respect of the estate of Mary Kent, formerly of 4 Colvin-grove, Hawthorn, but late of 4 Scott-street, Essendon, widow, deceased (who died on the 3rd day of May, 1953), are required to send particulars of their claims to National Trustees, Executors, and Agency Company of Australasia Limited, of 95 Queen-street, Melbourne, by the 19th day of September, 1953, after which date it will distribute the assets, having regard only to the claims of which it then has notice.

DESMOND, FITZGERALD, CAREY, & MORAN,
solicitors, 396 Flinders-lane, Melbourne. 5998

CREDITORS and others having claims in respect of the estate of Katie Bradley, late of Elmhurst, widow, deceased (who died on the 13th March, 1953), are to send particulars, in writing, of their claims to The Fidelity Trustee Company Limited, of 101 Lydiard-street north, Ballarat, the executor of the will of the said deceased, on or before the 23rd September, 1953, after which date it will distribute the assets, having regard only to the claims of which it then has notice.

STEWART W. IRWIN, solicitor, Ararat. 5981

HENRY ELKANAH TAYLOR, late of 167 Albert-street, Sebastopol, pensioner, DECEASED (who died on the 22nd September, 1952).

CREDITORS, next of kin, and other persons having claims against the estate of the deceased are required by the executors, Henry Elkanah Duncan Ernest Taylor, of 20 Rochford-street, East Bentleigh, lift attendant, and George Kingsley Sutton, of 38 Lydiard-street south, Ballarat, solicitor, to send particulars to them, care of the undersigned, on or before the 18th September, 1953, after which date they will distribute the assets, having regard only to the claims of which they then have notice.

DOOLEY, SUTTON, & A. W. LONG, 38 Lydiard-street south, Ballarat, solicitors. 5982

CREDITORS, next of kin, and others having claims in respect of the estate of Albert Eldridge, late of 544 Station-street, North Carlton, retired railway employee, deceased (who died on the 21st day of May, 1953), are to send particulars of their claims to the National Trustees, Executors, and Agency Company of Australasia Limited, whose registered office is situate at 95 Queen-street, Melbourne, by the 17th September, 1953, after which date it will distribute the assets, having regard only to the claims of which it then has notice.

WARMING & HAYES, of 422 Collins-street, Melbourne, solicitors for the said company. 6001

In the Supreme Court of the State of Victoria.—*Fi. Fa.*

NOTICE is hereby given that, under and by virtue of certain process issued out of the Supreme Court of the State of Victoria and directed to the Sheriff, requiring him to levy certain moneys of the real and personal estate of Ernest Thomas James, of Lutlet-street, Creswick, contractor, the said Sheriff will, on Thursday, the 27th day of August, 1953, at the hour of Two o'clock in the afternoon, cause to be sold at Police Station, Creswick (unless the said process shall have been previously satisfied or the said Sheriff be otherwise stayed):—

All the right, title, estate, and interest (if any) of the said Ernest Thomas James, of Lutlet-street, Creswick, contractor, in and to all that piece of land being Crown allotment 1, section 11, Parish of Creswick, Borough of Creswick, County of Talbot, and being the whole of the land comprised in Crown grant, volume 4051, folio 810160, consisting of 1 acre 1 rood 27 perches, with frontage of 248 links to Lutlet-street, Creswick, on which is erected a six-roomed brick and weatherboard house.

And all that piece of land being Crown allotment 2, section 11, Parish of Creswick, Borough of Creswick, County of Talbot, and being the whole of the land comprised in Crown grant, volume 2511, folio 502191, consisting of 2 roods 21 9/10 perches, with frontage of 126 links to Lutlet-street, Creswick.

And all that piece of land being Crown allotment "C" of section 11, Parish of Creswick, Borough of Creswick, County of Talbot, and being the whole of the land comprised in Crown grant, volume 1460, folio 291994, consisting of 1 acre 2 roods 23 2/10 perches, with frontage of 400 links to Lutlet-street, Creswick.

No. 540.—6477/53.—4

And so much and such parts as lie above the depth of 100 feet below the surface of all that piece of land being allotment 3 of section 15 in the Parish of Creswick, Borough of Creswick, County of Talbot, and being the whole of the land comprised in Crown grant, volume 1610, folio 321982, consisting of 2 acres 0 roods 16 3/10 perches, with frontage of 421 links to Lutlet-street, Creswick.

And so much and such parts as lie above the depth of 50 feet below the surface of all that piece of land being part of Crown allotment 4 of section 11, Parish of Creswick, Borough of Creswick, County of Talbot, together with the rights of the owner under sub-section 2 of section 11 of the *Land Act* 1891, and being the whole of the land comprised in certificate of title, volume 3375, folio 674851, consisting of 3 roods, with a frontage of 137 links to Lutlet-street, Creswick.

N.B.—Terms: Cash. No cheques taken.

Dated at Ballarat, this 11th day of July, 1953.

6011 J. A. SLEETH, Sheriff's Bailiff.

MINING NOTICE.

NORTH DEBORAH MINING COMPANY NO LIABILITY.
NOTICE.

ALL shares in this company, included in Nos. 262001 to 588577, on which the 22nd Call of Three pence per share remains unpaid, are forfeited, and will be sold by public auction at the Stock Exchange, Bendigo, on Thursday, 23rd July, 1953, at Four o'clock p.m., unless previously redeemed as required by the *Companies Act* 1938.

J. J. STANISTREET, Manager.
5978 (McColl, Rankin, and Stanistreet).

IMPOUNDINGS.

BENDIGO.—Impounded in Bendigo Pound, on 8th July, 1953.

1 bay pony gelding, one hind foot white, star on forehead
If not claimed and expenses paid, to be sold on 29th July, 1953.

6003—9/4 V. E. BOWER,
Poundkeeper.

COLERAINE.—Impounded by E. Dohle, from Tahara.

Nos. 54, 55, 56, and 57. 4 woolly sheep, various earmarks, no visible brand

If not claimed and expenses paid, to be sold on 1st August, 1953.

6005—9/4 S. R. DOLMAN,
Poundkeeper.

KEILOR.—Impounded in Keilor Pound.

1 bay draught gelding, white feet, blaze, shod, collar scar on shoulder, no visible brand

If not claimed and expenses paid, to be sold on 30th July, 1953.

6004—9/4 D. PASCOE,
Poundkeeper.

LARA.—Impounded in Lara Pound, off private property.

1 ewe, two black stripes across back, red raddle along back

If not claimed and expenses paid, to be sold on 8th August, 1953.

5986—8/ STEPHEN GROVES,
Poundkeeper.

MIRBOO NORTH.—Impounded in Mirboo North Pound, on 8th July, 1953.

1 bay mare, blaze face, no visible brand

1 bay mare, no visible brand

1 chestnut mare, blaze face, no visible brand; colt foal at foot

If not claimed and expenses paid, to be sold on 11th August, 1953.

5985—13/4 J. G. BIRD,
Poundkeeper.

TATURA.—Impounded in Tatura Pound.

- 1 bay delivery gelding, aged, shod all round, no visible brand
- 1 bay delivery gelding, aged, no visible brand
- 1 bay delivery gelding, aged, white stripe down forehead, white on off front foot, two front shoes, no visible brand
- 1 black and white cow, one horn, no visible brand
- 1 red and white cow, slit out of near ear, no visible brand
- 1 Jersey cow, slit out of two ears, like (off rump
- 1 dark Jersey cow, nip out of top off ear, no visible brand
- 1 red and white cow, no visible brand

If not claimed and expenses paid, to be sold on 6th August, 1953.

E. SHEALES,
Poundkeeper.

5972—21/4

WARRNAMBOOL.—Impounded in Warrnambool Pound.

- 1 Jersey cow, notch off ear, no visible brand
- 1 Jersey heifer, no visible brand

If not claimed and expenses paid, to be sold on 29th July, 1953.

R. STONEHOUSE,
Poundkeeper.

6012—9/4

STATE ACTS, 1950.

COPIES of the following Acts of Parliament of Victoria may be obtained at the Government Printing Office, or from any bookseller, at the price set opposite to each:—

| No. | Price. |
|--|--------|
| | s. d. |
| 5451. Consolidated Revenue | 0 6 |
| 5452. Consolidated Revenue | 0 6 |
| 5453. Superannuation | 0 6 |
| 5454. Marine (Temporary Exemptions) | 0 6 |
| 5455. Consolidated Revenue | 0 6 |
| 5456. Melbourne Harbor Trust (Housing Advances) | 0 6 |
| 5457. University (Veterinary Research) | 0 6 |
| 5458. Pyalong Lands Exchange | 0 9 |
| 5459. Goods (Textile Products) | 0 9 |
| 5460. Police Regulation (Pensions) | 0 6 |
| 5461. Melbourne (Bowen-street) Land | 0 9 |
| 5462. Printers and Newspapers (Foreign Advertisements) | 0 6 |
| 5463. Police Offences (Race-meetings) | 0 6 |
| 5464. Non-Contributory State Pensions | 0 6 |
| 5465. Legislative Council Reform | 2 0 |
| 5466. State Electricity Commission (Contracts) | 0 6 |
| 5467. Police Regulation (Pensions) Amendment | 0 6 |
| 5468. Prices Regulation (Extension) | 0 6 |
| 5469. Factories and Shops (Amendment) | 0 6 |
| 5470. Nurses and Midwives | 1 3 |
| 5471. Weights and Measures | 1 6 |
| 5472. Supreme Court (Judges) | 0 6 |
| 5473. Drainage Areas | 1 3 |
| 5474. Consolidated Revenue | 0 6 |
| 5475. Forests (Accounts and Funds) | 0 6 |
| 5476. Coal Mining Industry (Long-Service Leave) | 0 9 |
| 5477. Acts Interpretation (Amendment) | 0 6 |
| 5478. Agricultural Colleges (Amendment) | 0 6 |
| 5479. Building Operations and Building Materials, &c. | 0 9 |
| 5480. Shrine of Remembrance Site | 0 6 |
| 5481. Public Works Loan and Application | 0 6 |
| 5482. Grain Elevators | 0 6 |
| 5483. Teaching Service (Amendment) | 0 9 |
| 5484. Imported Materials Loan and Application, &c. | 0 6 |
| 5485. Water Supply Loan and Application | 1 3 |
| 5486. Victorian Inland Meat Authority (Advances) | 0 6 |
| 5487. Melbourne and Metropolitan Board of Works (Contracts) | 0 6 |
| 5488. Melbourne and Metropolitan Board of Works (Borrowing Powers) | 0 6 |
| 5489. Cattle Compensation | 0 6 |
| 5490. Coal Mines Regulation (Accidents Relief) | 0 6 |
| 5491. Public Contracts (Amendment) | 0 6 |
| 5492. Water | 0 9 |
| 5493. Administration and Probate Duties | 0 6 |
| 5494. Country Roads Board | 0 6 |
| 5495. Land Tax | 0 6 |
| 5496. Motor Car (Drivers' Licences) | 0 6 |
| 5497. Tallangatta Township (Removal) | 0 9 |
| 5498. Medical | 0 6 |
| 5499. State Forests Loan and Application | 0 6 |
| 5500. Surplus Revenue (Unexpended Balances) | 0 6 |
| 5501. Treasury Bonds | 0 6 |
| 5502. Co-operative Housing Societies | 1 0 |
| 5503. Police Offences (Idle and Disorderly Persons) | 0 6 |

STATE ACTS, 1950—continued.

| No. | Price. |
|---|--------|
| | s. d. |
| 5504. Gelliondale Land (Mineral Lease) | 0 6 |
| 5505. Local Government (Imported Houses) | 0 6 |
| 5506. Police Offences (Animals) | 0 6 |
| 5507. Gas and Fuel Corporation | 2 6 |
| 5508. Jubilee and Centenary Sports | 0 6 |
| 5509. Railways Dismantling | 0 9 |
| 5510. Geelong (Kardinia Park) Land | 0 6 |
| 5511. Coal Mine Workers Pensions (Amendment) | 0 6 |
| 5512. Municipalities and Other Authorities Finances | 0 9 |
| 5513. Public Officers Salaries | 0 6 |
| 5514. State Electricity Commission | 0 6 |
| 5515. Public Works Loan and Application (No. 2) | 0 9 |
| 5516. Ministers of the Crown and Parliamentary Salaries | 0 6 |
| 5517. Fire Brigades (Long-Service Leave) | 0 9 |
| 5518. Fisheries (Inland Angling) | 0 6 |
| 5519. Mental Hygiene Authority | 1 6 |
| 5520. Railway Loan and Application | 1 3 |
| 5521. Education (Religious Instruction) | 0 6 |
| 5522. Workers' Compensation (Amendment) | 1 0 |
| 5523. Public Trustee | 0 6 |
| 5524. McPherson's Limited Pension Fund | 0 6 |
| 5525. Landlord and Tenant (Servicemen) | 0 6 |
| 5526. Local Government (Shire of Braybrook) | 0 6 |
| 5527. Appropriation of Revenue | 4 6 |

W. M. HOUSTON,
Government Printer.

STATE ACTS, 1951.

COPIES of the following Acts of Parliament of Victoria may be obtained at the Government Printing Office, or from any bookseller, at the price set opposite to each:—

| No. | Price. |
|--|--------|
| | s. d. |
| 5528. Consolidated Revenue | 0 6 |
| 5529. State Electricity Commission (Overdraft) | 0 6 |
| 5530. Local Government (Enrolment) | 0 6 |
| 5531. Crimes (Reformatory Prisons) | 0 6 |
| 5532. The Geelong Gas Company's | 0 6 |
| 5533. Railways (Amendment) | 0 6 |
| 5534. Poisons | 0 6 |
| 5535. Select Committee (Egg and Egg Pulp) Marketing | 0 6 |
| 5536. Coal Mining Industry (Long-Service Leave) Amendment | 0 6 |
| 5537. Education (Amendment) | 0 6 |
| 5538. Friendly Societies | 0 6 |
| 5539. State Development | 0 6 |
| 5540. Stamps (Cheques) | 0 6 |
| 5541. Public Service | 0 9 |
| 5542. Country Fire Authority (Financial) | 0 6 |
| 5543. Consolidated Revenue | 0 6 |
| 5544. Coal Mine Workers' Pensions (Contributions) | 0 6 |
| 5545. Vermin and Noxious Weeds (Financial) | 0 6 |
| 5546. Medical (Temporary Registration) | 0 6 |
| 5547. Consolidated Revenue | 0 6 |
| 5548. Railways (Furlough) | 0 6 |
| 5549. Police Regulation | 0 6 |
| 5550. Milk Board | 1 6 |
| 5551. Bendigo (Rosalind Park) Lands | 1 0 |
| 5552. Railways Dismantling | 0 9 |
| 5553. Transfer of Land (Forgeries) | 0 6 |
| 5554. Newport "A" Power Station | 0 6 |
| 5555. Local Government (Overdrafts) | 0 6 |
| 5556. Marketing of Primary Products (Tomatoes) | 0 6 |
| 5557. Winchelsea Coal Mine | 1 0 |
| 5558. Special Funds (Amendment) | 0 6 |
| 5559. Transport | 1 3 |
| 5560. Marine (Amendment) | 0 6 |
| 5561. Portland Harbor Trust (Amendment) | 0 6 |
| 5562. Transport Regulation Board | 0 6 |
| 5563. Imported Materials Loan and Application (Financial) | 0 6 |
| 5564. Co-operative Housing Societies (Amendment) | 0 6 |
| 5565. Egg and Egg Pulp Marketing Board | 0 6 |
| 5566. Stamps (Betting Tax) | 0 9 |
| 5567. Land Tax | 0 6 |
| 5568. Consolidated Revenue | 0 6 |
| 5569. Transport Regulation (Fees) | 0 6 |
| 5570. Factories and Shops (Registration Fees) | 0 6 |
| 5571. Soldier Settlement | 0 9 |
| 5572. Marine (Pilotage Rates) | 0 6 |
| 5573. Water (Amendment) | 0 9 |
| 5574. Latrobe Valley Drainage | 1 9 |
| 5575. Grace Joel Scholarship | 0 6 |
| 5576. Building Operations and Building Materials Control (Extension) | 0 6 |
| 5577. Benefit Associations | 1 6 |
| 5578. Public Account | 1 0 |

STATE ACTS, 1951—continued.

| No. | Price. |
|---|--------|
| | s. d. |
| 5579. University | 0 6 |
| 5580. Prices Regulation (Amendment) .. . | 0 6 |
| 5581. Stamps (Duties) | 0 6 |
| 5582. Gippsland Railway (Duplication and Re- grading) Extension | 0 6 |
| 5583. Motor Car (Registration Fees) .. . | 0 6 |
| 5584. Licensing (Fees) | 0 6 |
| 5585. Land (Development Leases) .. . | 0 9 |
| 5586. Parliamentary Salaries | 0 6 |
| 5587. Parliamentary Contributory Retirement Fund | 0 6 |
| 5588. State Forests Loan Application .. . | 0 6 |
| 5589. Water Supply Loan Application .. . | 1 0 |
| 5590. Administration and Probate (Estates) .. | 1 6 |
| 5591. Kerang and Koondrook Tramway .. . | 0 6 |
| 5592. Ballarat Gas Company's | 0 6 |
| 5593. Revocation and Excision of Crown Reserva- tions | 1 3 |
| 5594. Wrongs (Contributory Negligence) .. . | 0 6 |
| 5595. Local Government (Imported Houses) .. | 0 6 |
| 5596. Woorayl (Unimproved Rating Poll) .. . | 0 6 |
| 5597. Health (Radiological Examinations) .. | 0 6 |
| 5598. Melbourne Harbor Trust | 0 6 |
| 5599. Friendly Societies (Amendment) .. . | 0 6 |
| 5600. Railway Loan Application | 1 0 |
| 5601. Workers Compensation | 3 3 |
| 5602. Statute Law Revision | 0 9 |
| 5603. Revenue Deficit Funding | 0 6 |
| 5604. Solicitor-General | 0 6 |
| 5605. Wheat Industry Stabilization (Amendment) | 0 6 |
| 5606. Local Government (Warrnambool) .. . | 0 6 |
| 5607. Geelong Harbor Trust (Amendment) .. | 0 9 |
| 5608. Justices (Service of Process) | 0 6 |
| 5609. Melbourne and Metropolitan Board of Works (Borrowing Powers) | 0 6 |
| 5610. Firearms | 2 0 |
| 5611. Licensing (Mildura) | 0 6 |
| 5612. Marketing of Primary Products (Egg and Egg Pulp) | 0 9 |
| 5613. Lands (Charitable Trusts) | 0 6 |
| 5614. Melbourne Cricket Ground | 0 9 |
| 5615. Judges and Public Officers Salaries .. . | 0 6 |
| 5616. Motor Car | 3 0 |
| 5617. Firearms Offences | 0 6 |
| 5618. Public Works Loan Application .. . | 0 6 |
| 5619. Appropriation of Revenue | 4 3 |

W. M. HOUSTON,
Government Printer.

STATE ACTS, 1952.

COPIES of the following Acts of Parliament of Victoria may be obtained at the Government Printing Office, or from any bookseller, at the price set opposite to each:—

| No. | Price. |
|---|--------|
| | s. d. |
| 5620. Consolidated Revenue | 0 6 |
| 5621. Consolidated Revenue | 0 6 |
| 5622. Lands (Charitable Trusts) | 0 6 |
| 5623. Registration of Births Deaths and Marriages | 0 6 |
| 5624. Forests (Exchange of Lands) | 0 6 |
| 5625. Geelong Harbor Trust (Financial) .. . | 1 3 |
| 5626. Coal Mine Workers Pensions (Amendment) | 0 6 |
| 5627. County Court (Amendment) | 0 9 |
| 5628. Mines (Amendment) | 0 9 |
| 5629. Consolidated Revenue | 0 6 |
| 5630. Teaching Service (Amendment) .. . | 0 6 |
| 5631. Land (Development Leases) Amendment .. | 0 6 |
| 5632. Supreme Court (Judge's Cost of Living) .. | 0 6 |
| 5633. Weights and Measures (Amendment) .. | 0 6 |
| 5634. Veterinary Surgeons (Foreign Qualification) | 0 6 |
| 5635. State Electricity Commission (Appliances) .. | 0 6 |
| 5636. Prices Regulation (Butter and Cheese) .. | 0 6 |
| 5637. Water | 1 0 |
| 5638. Co-operative Housing Societies (Guarantees and Indemnities) | 0 6 |
| 5639. State Electricity Commission (Borrowing) .. | 0 6 |
| 5640. Country Roads (Amendment) | 0 6 |
| 5641. Motor Car (Amendment) | 0 6 |
| 5642. Land Tax | 0 6 |
| 5643. Hairdressers Registration (Amendment) .. | 0 6 |
| 5644. Totalizer (Amendment) | 0 6 |
| 5645. Melbourne and Metropolitan Tramways (Fire Brigades Payments) | 0 6 |
| 5646. Health (Meat Supervision) | 0 6 |
| 5647. Evidence | 0 6 |
| 5648. Imported Materials Loan and Application (Amendment) | 0 6 |
| 5649. Geelong Waterworks and Sewerage (Amend- ment) | 0 6 |

STATE ACTS, 1952—continued.

| No. | Price. |
|---|--------|
| | s. d. |
| 5650. Building Operations and Building Materials Control | 0 6 |
| 5651. Country Fire Authority | 0 9 |
| 5652. Parliamentary Contributory Retirement Fund | 0 6 |
| 5653. Miners' Phthisis (Treasury Allowances) Amendment | 0 6 |
| 5654. Girl Guides Association | 1 0 |
| 5655. Consolidated Revenue | 0 6 |
| 5656. Revenue Deficit Funding | 0 6 |
| 5657. Public Works Loan Application | 0 6 |
| 5658. Local Government (Imported Houses) .. | 0 6 |
| 5659. Railway Loan Application | 1 0 |
| 5660. State Forests Loan Application | 0 6 |
| 5661. Water Supply Loan Application | 1 0 |
| 5662. Hospital Benefits | 0 9 |
| 5663. Appropriation of Revenue | 4 3 |

W. M. HOUSTON,
Government Printer.

STATE ACTS, 1953.

COPIES of the following Acts of Parliament of Victoria may be obtained at the Government Printing Office, or from any bookseller, at the price set opposite to each:—

| No. | Price. |
|---|--------|
| | s. d. |
| 5664. Parliamentary Elections (State Servants) .. | 0 6 |
| 5665. Factories and Shops (Industrial Appeals Court) | 0 6 |
| 5666. Adoption of Children (Amendment) .. . | 0 6 |
| 5667. Select Committee (Potato Marketing) .. . | 0 6 |
| 5668. Melbourne and Metropolitan Board of Works (Borrowing Powers) | 0 6 |
| 5669. Water (Amendment) | 0 6 |
| 5670. Trustee (Amendment) | 0 6 |
| 5671. Public Account (Amendment) | 0 6 |
| 5672. Transport Regulation (Amendment) .. . | 0 6 |
| 5673. Superannuation Police and State Pensions .. | 0 6 |
| 5674. Coal Mine Workers' Pensions (Amendment) .. | 0 6 |
| 5675. Health (Plumbers and Gas-fitters) | 0 6 |
| 5676. Workers Compensation | 1 3 |
| 5677. Parking of Vehicles | 0 9 |
| 5678. Melbourne Harbor Trust (Tolls) | 0 6 |
| 5679. The Geelong Gas Company's | 0 6 |
| 5680. Barley Marketing (Amendment) | 0 6 |
| 5681. Benefit Associations | 0 9 |
| 5682. Consolidated Revenue | 0 6 |

W. M. HOUSTON,
Government Printer.

SUBSCRIPTIONS.—The subscription, including postage, is £2 5s. per annum, £1 2s. 6d. half-yearly, or 11s. 3d. per quarter, payable in advance.

Subscriptions are required to commence and terminate with a month.

A lesser period than three months cannot be subscribed for.

Subscribers do not receive the Acts of Parliament with the GAZETTE.

ADVERTISEMENTS are charged at the rate of 1s. 4d. per line single column, and 2s. 8d. per line double column.

The title (£5 Reward, Dissolution of Partnerships, &c.) forms one or more lines as a heading.

On an average, ten words make a line.

Every signature must likewise be counted as a line.

The final words of a paragraph, though only portion of a line, must be counted as one line.

SIGNATURES (in particular) and proper names must be written very plainly in the text; ONE SIDE ONLY of each slip of paper should be WRITTEN UPON.

ALL COMMUNICATIONS should be addressed to "The Government Printer, Melbourne."

ALL DOCUMENTS illegibly written will be returned unpublished, and, where brands occur unprovided for by the ordinary letters of the alphabet, a worded explanatory description must be furnished.

THE VICTORIA GOVERNMENT GAZETTE is published on WEDNESDAY EVENING in each week, and Notices for insertion will be received by the Government Printer at or before Two p.m. at ordinary rates, and late advertisements between Two p.m. and Five p.m. at double rates on the day preceding the day of publication.

Single copies of the VICTORIA GOVERNMENT GAZETTE are Nine pence, posted One shilling, each.

No GAZETTES prior to January, 1942, in stock.

***ALL PAYMENTS ARE REQUIRED IN ADVANCE.—Remittances should be made by postal note, money order, or draft in favour of the Government Printer. Advertisements unaccompanied by a remittance sufficient to cover the cost of insertion will be returned unpublished.

THE "VICTORIA GOVERNMENT GAZETTE."

ATTENTION is invited to the following procedure in relation to the publication of official matter in the Government Gazette:—

1. Matter submitted to the Executive Council.

Matter submitted to the Executive Council which requires gazettal will normally be published in the issue of the following week.

Where urgent gazettal is required, special arrangements should be made with the Gazette Officer.

Publication will be facilitated by the submission of carbon copies for the use of the Gazette Officer.

2. Other matter.

(a) All other matter duly certified by a responsible officer for publication should be lodged with the Gazette Officer not later than half-past Ten a.m. on Tuesday.

(b) Lengthy or involved notices should be forwarded several days before publication.

(c) Proofs, which will be supplied only when specifically requested, or at the direction of the Gazette Officer, should be returned promptly to avoid delay in publication.

(d) No additions or amendments to matter for publication will be accepted by telephone.

AGENTS FOR THE "VICTORIA GOVERNMENT GAZETTE."

The following have been appointed agents to receive Advertisements and Subscriptions for the Victoria Government Gazette:—

ARMSTRONG'S AGENCY, 143 Queen-street, Melbourne.

ARMSTRONG BROS., Kyneton.

MESSRS. ARNALL & JACKSON, 115 Barkly-street, West Brunswick.

MR. M. R. BADE, Tobacconist, Sturt-street, Ballarat.

MR. WM. DAVIS, Mildura.

A. J. DIGBY (B. S. and N. W. CASH), Main-street, Bairnsdale.

EDGAR'S NEWS AGENCY, Hargreaves-street, Bendigo.

MESSRS. HENRY FRANKS & CO., Booksellers and Stationers, Market-square, Geelong.

MESSRS. GORDON & GOTCH, News Agents, 511 Little Collins-street, Melbourne; and corner Barrack and Clarence streets, Sydney.

A. C. HAMPTON, 243 Mitchell-street, Bendigo.

MESSRS. HARSTON, PARTRIDGE, & CO., 455 Little Collins-street, Melbourne.

MR. C. F. LATIMER, News Agent, Casterton.

MESSRS. H. PAYNE & R. N. LOWE, 4 View Point, Bendigo.

MESSRS. R. H. & W. M. PETTY, News Agent, Wangaratta.

J. PURDIE & CO., 138 Moorabool-street, Geelong.

F. W. RASHLEIGH & SON, Nunn-street, Benalla.

MESSRS. A. S. RICHARDSON and T. C. GARDNER, trading as The Mercantile Exchange, 380 Collins-street, Melbourne.

ROBERTSON & MULLENS LTD., Elizabeth-street, Melbourne.

SALE AUTHORIZED NEWS AGENTS, Sale.

MESSRS. SMITH & DUNNON, Hamilton.

F. D. & J. R. TRAINOR, 246 Wyndham-street, Shepparton.

E. W. B. WELSH, Hogan-street, Tatura.

A copy of the Gazette filed at each place for public reference.

CONTENTS.

| | PAGE |
|--|------------|
| Acts of Parliament on sale at the Government Printing Office | 3470 |
| Appointments | 3430 |
| Contracts | 3437 |
| Country Roads Board | 3450 |
| Courts | 3439 |
| Estates of Deceased Persons | 3440 |
| Government Notices | 3431 |
| Impoundings | 3469 |
| Lands | 3453 |
| Melbourne and Metropolitan Board of Works— | |
| Notice | 3431 |
| Mining | 3431, 3469 |
| Orders in Council | 3441 |
| Private Advertisements | 3462 |
| Proclamations | 3421 |
| Public Half-Holidays | 3429 |
| Public Service Notices | 3459 |
| Resignations | 3431 |
| State Rivers and Water Supply Commission | 3438 |
| Tenders | 3456 |
| Transport Regulation Board—Public Hearings | 3432 |
| Waterworks Trusts | 3441 |