



VICTORIA GOVERNMENT GAZETTE.

Published by Authority.

[Registered at the General Post Office, Melbourne, for transmission by post as a newspaper.]

No. 749]

WEDNESDAY, AUGUST 19.

[1953

The Game Acts.

SANCTUARY FOR NATIVE GAME AT THE MELBOURNE AND METROPOLITAN BOARD OF WORKS SEWERAGE FARM, WERRIBEE, AND LITTLE RIVER.

PROCLAMATION

By His Excellency the Administrator of the Government of the State of Victoria and its Dependencies in the Commonwealth of Australia, &c., &c., &c.

I, THE Administrator of the Government of the State of Victoria in the Commonwealth of Australia, by and with the advice of the Executive Council of the said State, and in pursuance of the provisions of the Game Acts and all other powers me enabling in that behalf do by this my Proclamation revoke the Proclamation made the fourth day of February 1947, and published in the *Victoria Government Gazette* of the fifth day of February 1947 respecting the protection of native game at the Melbourne and Metropolitan Board of Works Sewerage Farm Werribee and in lieu thereof direct that the parts of Victoria within the boundaries hereinafter described shall be localities in which from the first day of January to the thirty-first day of December (both days inclusive) in each year, it shall be unlawful for any person to kill or destroy any native game included in the Third Schedule to the *Game Act 1928*:—

PARTS OF VICTORIA ABOVE REFERRED TO.

Twenty-four thousand nine hundred acres, more or less. County of Grant, Parishes of Mambourin, Cocoroc, and Murtcaim, commencing at the northern angle of Crown allotment 22A, Town of Werribee, Parish of Mambourin; thence south-westerly by the south-eastern boundary of Geelong-road to the western angle of Crown allotment 4, section 16, Parish of Cocoroc; thence easterly by the southern boundary of the last-mentioned Crown allotment to the eastern boundary of Crown allotment 2, section 12, Parish of Cocoroc; thence southerly by the eastern boundary, and westerly by the southern boundary of the last-mentioned Crown allotment for a distance of 3,802 links; thence southerly by a line bearing south 11 deg. 26½ min. east for a distance of 4,282 links to the northern boundary of a Government road; thence further southerly by a line in continuation of the previous line to the southern boundary of the last-mentioned Government road; thence westerly by the last-mentioned boundary to the south-eastern boundary of Geelong-road; thence south-westerly by the south-eastern boundary of Geelong-road across Little River to the western boundary of lot 22 on plan of subdivision No. 7173 lodged in the Office of Titles and being part of Crown section 21, Parish of Murtcaim; thence southerly by the western boundaries of lots 22 and 23 on plan of subdivision No. 7173 aforesaid to the northern boundary of a Government road; thence further southerly by a line in continuation of the previous line

to the northern boundary of lot 30 on the plan of subdivision No. 7173 aforesaid; thence westerly by the last-mentioned boundary to the north-western angle of the last-mentioned lot; thence southerly by the western boundaries of that lot and of lot 29 on the plan of subdivision No. 7173 aforesaid to the northern boundary of Crown section 7, Parish of Murtcaim; thence westerly by the last-mentioned boundary for a distance of 1,951 links; thence southerly by a line bearing south 0 deg. 6 min. west for a distance of 8,046 links; thence easterly by a line bearing north 89 deg. 56 min. east to a line parallel to and 40 chains distant from the high water mark on the foreshore of Port Phillip Bay; thence generally north-easterly by the last-mentioned line to the western boundary of Chirnsides-road; thence northerly by the western boundary of the said road to the southern boundary of Cozens-road; thence north-easterly by a direct line to the western end of the Weir on No. 1 Lagoon; thence easterly by the Weir footbridge and easterly and north-easterly by the southern and south-eastern banks of No. 1 Lagoon and a direct line in continuation of the said south-eastern bank to the left bank of Little River; thence generally south-easterly by the said left bank to the high water mark on the foreshore of Port Phillip Bay; thence generally north-easterly by the said high water mark to the right bank of Werribee River; thence generally northerly by the right bank of Werribee River and a line bearing north 5 deg. 54 min. west to the south-eastern boundary of Crown allotment 1, section A, Parish of Mambourin; thence easterly by the last-mentioned boundary, and northerly by the eastern boundary of the last-mentioned Crown allotment to the right bank of Werribee River; thence north-westerly by the right bank of Werribee River to the southern boundary of lot 22 on plan of subdivision No. 4509 lodged in the Office of Titles; thence south-westerly and north-westerly by the last-mentioned boundary to the western boundary of Crown portion 1, section 7, Parish of Mambourin; thence westerly by a line across a Government road to the western boundary thereof; thence northerly by the last-mentioned boundary to the eastern angle of Crown allotment 22A, Town of Werribee, Parish of Mambourin; thence north-westerly by the north-eastern boundary of the last-mentioned Crown allotment to the commencing point.

Given under my Hand and the Seal of the State of Victoria aforesaid, at Melbourne, this eighteenth day of August, in the year of our Lord One thousand nine hundred and fifty-three, and the second year of the reign of Her Majesty Queen Elizabeth II.

(L.S.)

CHARLES J. LOWE.

By His Excellency's Command,

L. W. GALVIN,

Chief Secretary.

GOD SAVE THE QUEEN!

Land Act 1928.

PROCLAMATION RESCINDED AND TOWNSHIP OF BALLAARAT EAST PROCLAIMED.

PROCLAMATION

By His Excellency the Administrator of the Government of the State of Victoria and its Dependencies in the Commonwealth of Australia, &c., &c., &c.

I, THE Administrator of the Government of the State of Victoria in the Commonwealth of Australia by and with the advice of the Executive Council of the said State and in pursuance of the provisions contained in section 25 of the Land Act 1928 as amended by section 2 of the Land Act 1933 do by this my Proclamation rescind the Proclamation dated 14th January 1861 defining a certain area of land as the Town of Ballarat East (see Government Gazette 1861 page 147) and in lieu thereof do hereby proclaim as a Township under the designation of Ballarat East the area of land in the Parish of Ballarat, Counties of Grant and Grenville within the boundaries indicated by conventional township sign on the plan hereunder.—(B.128(15) (C.93051).

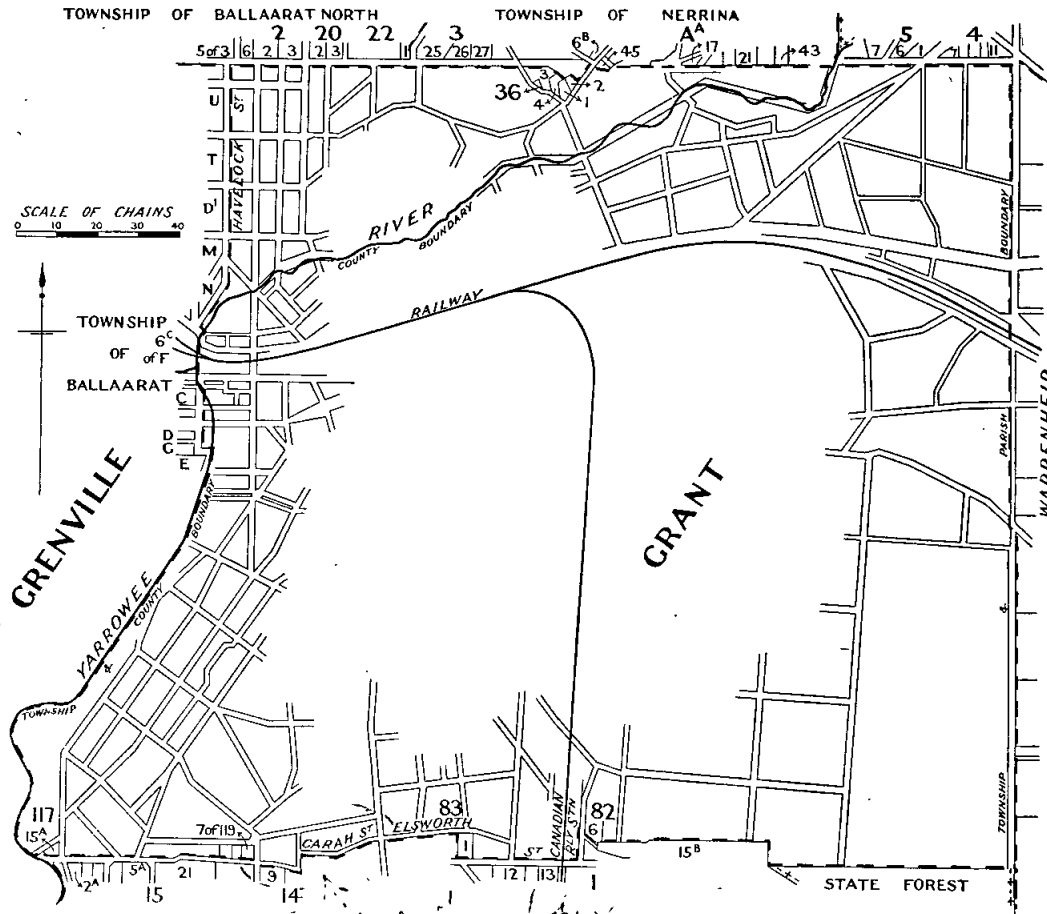

Given under my hand and the seal of the State of Victoria aforesaid, at Melbourne, this eleventh day of August, in the year of our Lord One thousand nine hundred and fifty-three, and in the second year of the reign of Her Majesty Queen Elizabeth II.

(L.S.)

By His Excellency's Command,

CHARLES J. LOWE,

R. W. HOLT,

Commissioner of Crown Lands and Survey.

GOD SAVE THE QUEEN!

Land Act 1928.

PROCLAMATION RESCINDED AND TOWNSHIP OF ECHUCA PROCLAIMED.

PROCLAMATION

By His Excellency the Administrator of the Government of the State of Victoria and its Dependencies in the Commonwealth of Australia, &c., &c., &c.

I, THE Administrator of the Government of the State of Victoria in the Commonwealth of Australia by and with the advice of the Executive Council of the said State and in pursuance of the provisions contained in section 25 of the Land Act 1928 do by this my Proclamation rescind the Proclamation dated 2nd October 1857 reserving and

appointing for a township a certain area of land at Echuca (see *Government Gazette* 1857 page 1839) and do hereby proclaim as a Township under the designation of Echuca the area of land in the Parish of Echuca North, County of Rodney and the Parish of Wharparilla, County of Gunbower within the boundaries indicated by conventional township sign on the plan hereunder.—(E.3(3) (E.96(6) (W.132(2) (C.93066).

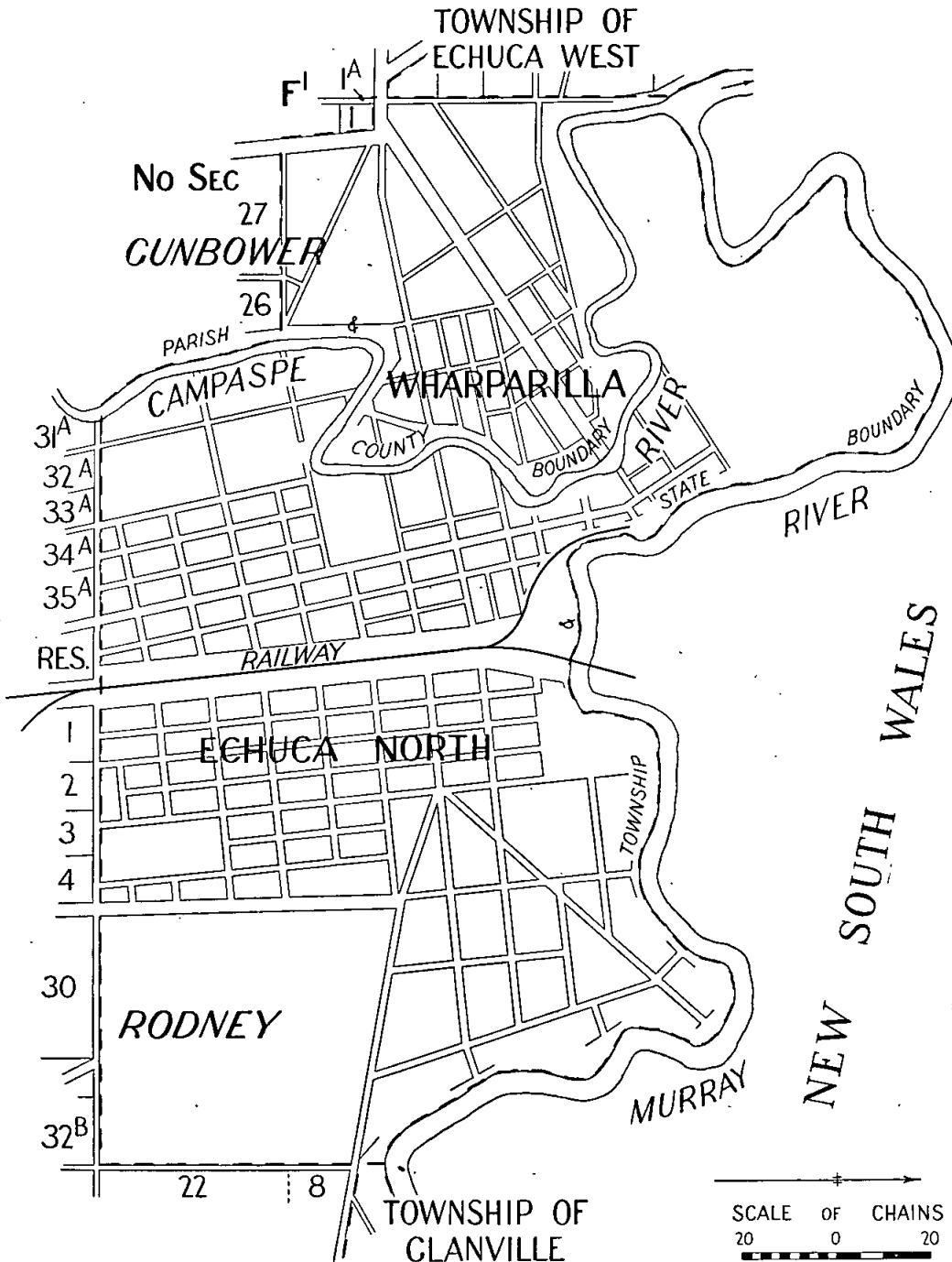

Given under my hand and the seal of the State of Victoria aforesaid, at Melbourne, this eleventh day of August, in the year of our Lord One thousand nine hundred and fifty-three, and in the second year of the reign of Her Majesty Queen Elizabeth II.

(L.S.)

By His Excellency's Command,

R. W. HOLT,
Commissioner of Crown Lands and Survey.

CHARLES J. LOWE.

GOD SAVE THE QUEEN!

Land Act 1928.

ORDERS REVOKED AND TOWNSHIP OF BALLAARAT PROCLAIMED.

PROCLAMATION

By His Excellency the Administrator of the Government of the State of Victoria and its Dependencies in the Commonwealth of Australia, &c., &c., &c.

I THE Administrator of the Government of the State of Victoria in the Commonwealth of Australia by and with the advice of the Executive Council of the said State and in pursuance of the provisions contained in section 25 of the Land Act 1928 as amended by section 2 of the Land Act 1933 do by this my Proclamation revoke the Order dated 29th July 1852 fixing a site for a Village at Ballaarat on the Yarrowee River, near Yulle's Head Station (see *Government Gazette* 1852 page 801), the Order dated 11th February, 1854, defining the boundary of the Township Reserve of Ballaarat, County of Grenville (see *Government Gazette* 1854 pages 512 and 532) and the Order dated 31st October 1856 defining an extension of the Township Reserve of Ballaarat as notified on 11th February 1854 (see *Government Gazette* 1856 page 1859) and in lieu thereof do hereby proclaim as a Township under the designation of Ballaarat, the area of land in the Parish of Ballaarat, County of Grenville within the boundaries indicated by conventional township sign on the plan hereunder.—(B.128⁽¹³⁾) (C.95336).

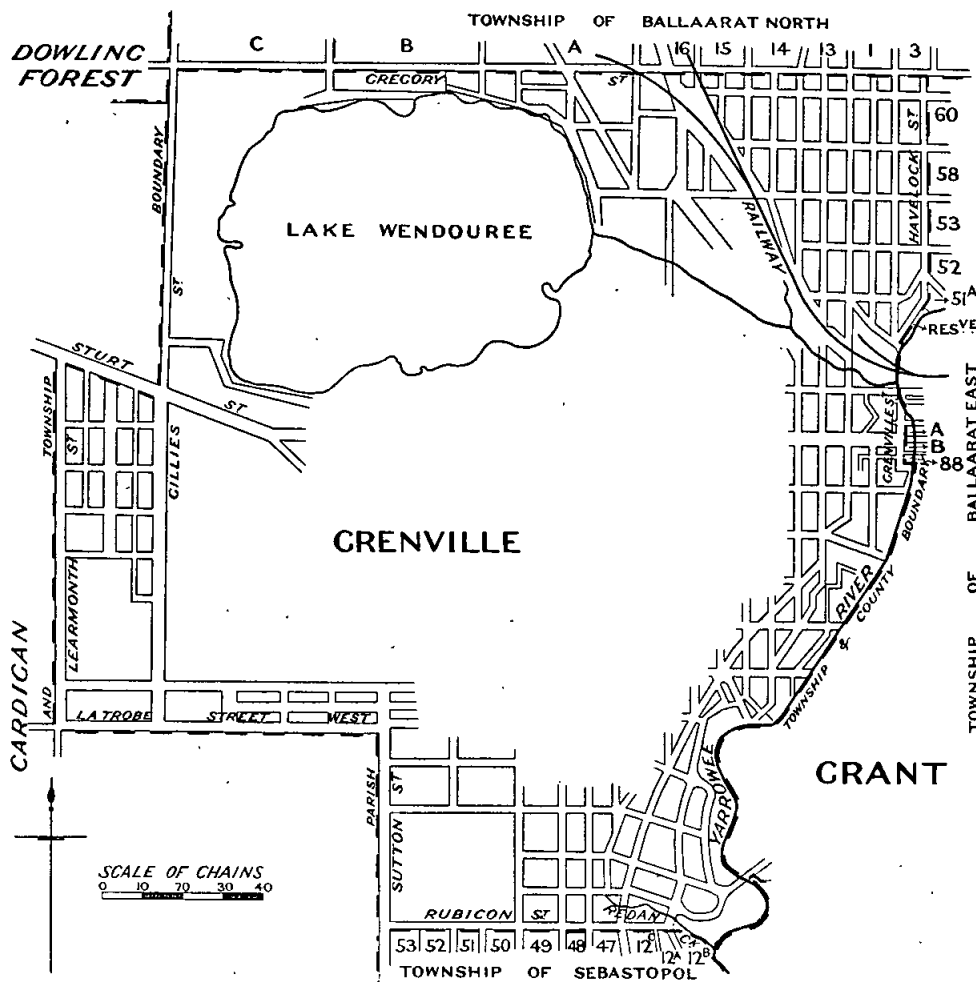

Given under my hand and the seal of the State of Victoria aforesaid, at Melbourne, this eleventh day of August, in the year of our Lord One thousand nine hundred and fifty-three, and in the second year of the reign of Her Majesty Queen Elizabeth II.

(L.S.)

By His Excellency's Command,

CHARLES J. LOWE.

R. W. HOLT,

Commissioner of Crown Lands and Survey.

GOD SAVE THE QUEEN!

Land Act 1928.

PROCLAMATIONS RESCINDED AS TO WHOLE AND AS TO PART (TOWNSHIP OF NERRENA) AND TOWNSHIP OF NERRINA PROCLAIMED.

PROCLAMATION

By His Excellency the Administrator of the Government of the State of Victoria and its Dependencies in the Commonwealth of Australia, &c., &c., &c.

I, THE Administrator of the Government of the State of Victoria in the Commonwealth of Australia by and with the advice of the Executive Council of the said State and in pursuance of the provisions contained in section 25 of the Land Act 1928 do by this my Proclamation rescind the Proclamation dated 14th July 1890 defining a certain area of land as a Township at Nerrena in the Parish of Ballaarat (see *Government Gazette* 1890 page 2877), the Proclamation dated 6th March 1893 defining certain areas of land as Townships insofar as it refers to the Township in extension of the Township at Nerrena (see *Government Gazette* 1893 page 1302) and the Proclamation dated 26th September 1893 defining a certain area of land as a Township in further extension of the Township at Nerrena and the extension thereof (see *Government Gazette* 1893 page 3962) and in lieu thereof do hereby proclaim as a Township under the designation of Nerrina the area of land in the Parish of Ballaarat, County of Grenville within the boundaries indicated by conventional township sign on the plan hereunder.—(B.126⁽¹⁾) (B.127^(c2)) (C.93921).

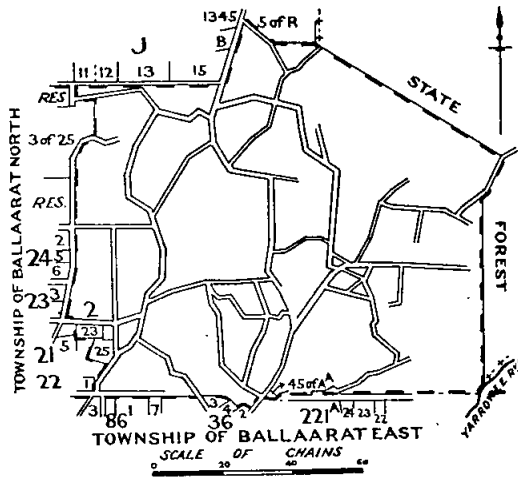

Given under my hand and the seal of the State of Victoria aforesaid, at Melbourne, this eleventh day of August, in the year of our Lord One thousand nine hundred and fifty-three, and in the second year of the reign of Her Majesty Queen Elizabeth II.

(L.S.) CHARLES J. LOWE.

By His Excellency's Command,
R. W. HOLT,
Commissioner of Crown Lands and Survey.

GOD SAVE THE QUEEN!

Land Act 1928.

PROCLAMATIONS RESCINDED AS TO WHOLE AND AS TO PART AND TOWNSHIP OF BALLAARAT NORTH PROCLAIMED.

PROCLAMATION

By His Excellency the Administrator of the Government of the State of Victoria and its Dependencies in the Commonwealth of Australia, &c., &c., &c.

I, THE Administrator of the Government of the State of Victoria in the Commonwealth of Australia by and with the advice of the Executive Council of the said State and in pursuance of the provisions contained in section 25

of the Land Act 1928 do by this my Proclamation rescind the Proclamation dated 12th January 1886 defining certain areas of land as Townships insofar as it refers to the Township at Ballaarat North in the Parish of Ballaarat (see *Government Gazette* 1886 page 64), the Proclamation dated 30th January 1893 defining an extension of the Township of Ballaarat North (see *Government Gazette* 1893 page 684) and the Proclamation dated 6th March 1893 defining certain areas of land as Townships insofar as it refers to the Township of Ballaarat North (see *Government Gazette* 1893 page 1302) as reduced by Proclamation dated 26th September 1893 (see *Government Gazette* 1893 page 3962) and in lieu thereof do hereby proclaim as a Township under the designation of Ballaarat North the area of land in the Parish of Ballaarat, County of Grenville within the boundaries indicated by conventional township sign on the plan hereunder.—(B.126⁽¹⁾) (B.128⁽²⁾) (C.95397).

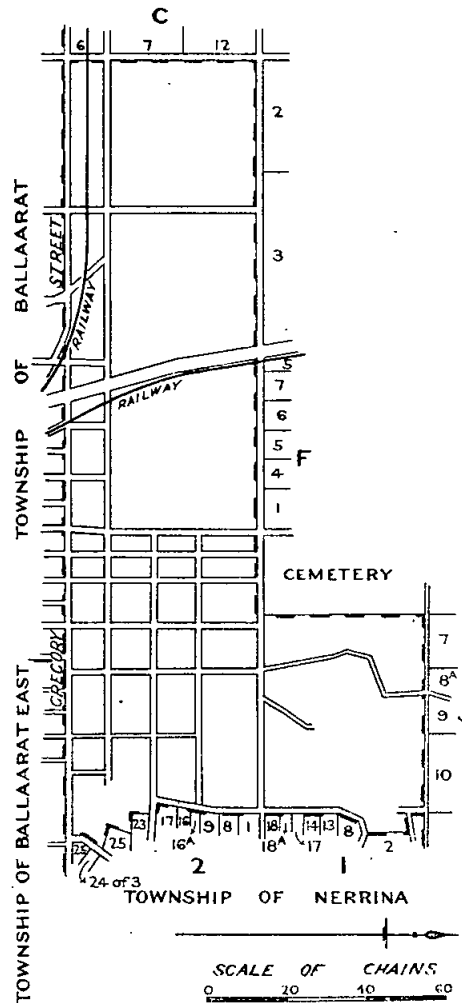

Given under my hand and the seal of the State of Victoria aforesaid, at Melbourne, this eleventh day of August, in the year of our Lord One thousand nine hundred and fifty-three, and in the second year of the reign of Her Majesty Queen Elizabeth II.

(L.S.) CHARLES J. LOWE.

By His Excellency's Command,
R. W. HOLT,
Commissioner of Crown Lands and Survey.

GOD SAVE THE QUEEN!

Apprenticeship Acts.

APPRENTICESHIP COMMISSION OF VICTORIA.—
APPRENTICESHIP TRADES PROCLAIMED.

PROCLAMATION

By His Excellency the Administrator of the Government of the State of Victoria and its Dependencies in the Commonwealth of Australia, &c., &c., &c.

WHEREAS section 13 of the *Apprenticeship Act* 1928 as amended by section 3 of the *Apprenticeship Act* 1936 provides, *inter alia*, that after the Minister has taken into consideration any recommendation made by the Apprenticeship Commission the Governor in Council for the purposes of the said Acts may from time to time by Proclamation proclaim any trades to be apprenticeship trades:

And whereas the Apprenticeship Commission, having notified in the manner prescribed by the said Acts its intention to recommend that the trades set out hereunder, as carried on in the Cities of Ballarat, Bendigo, Geelong, Geelong West, and Newtown and Chilwell, and the Boroughs of Eaglehawk and Sebastopol, be so proclaimed, and having received no representations by or on behalf of employers or employees in the said trades, has recommended to the Minister that the said trades be so proclaimed:

And whereas the Minister has taken the said recommendation into consideration:

Now therefore I, the Administrator of the Government of the State of Victoria in the Commonwealth of Australia, by and with the advice of the Executive Council of the said State, do by this my Proclamation proclaim the trades set out hereunder, as carried on in the Cities of Ballarat, Bendigo, Geelong, Geelong West, and Newtown and Chilwell, and the Boroughs of Eaglehawk and Sebastopol, to be apprenticeship trades, viz.:—

Screen Printing Art,
Screen Printing Designing,
Screen Printing Art and Screen Printing Designing.

Given under my Hand and the Seal of the State of Victoria aforesaid, at Melbourne, this eighteenth day of August, in the year of our Lord One thousand nine hundred and fifty-three, and in the second year of the reign of Her Majesty Queen Elizabeth II.

(L.S.) CHARLES J. LOWE.

By His Excellency's Command,

A. M. FRASER,
Minister of Labour.

GOD SAVE THE QUEEN!

Health Acts.

REVOCATION OF THE CONSTITUTION OF THE
LILLYDALE MEAT AREA.

PROCLAMATION

By His Excellency the Administrator of the Government of the State of Victoria and its Dependencies in the Commonwealth of Australia, &c., &c., &c.

BY virtue of the powers conferred by the Health Acts, I the Administrator of the Government of the State of Victoria, in the Commonwealth of Australia, on the recommendation of the Commission of Public Health, and by and with the advice of the Executive Council of the said State, do by this my Proclamation revoke the constitution of the Lillydale Meat Area as defined in the Proclamation dated the nineteenth day of August, One thousand nine hundred and thirty-five, and published in the *Victoria Government Gazette* of the twenty-first day of August, of the year aforesaid.

Given under my hand and the seal of the State of Victoria aforesaid, at Melbourne, this eleventh day of August, in the year of our Lord One thousand nine hundred and fifty-three, and in the second year of the reign of Her Majesty Queen Elizabeth II.

(L.S.) CHARLES J. LOWE.

By His Excellency's Command,

WM. BARRY,
Minister of Health.

GOD SAVE THE QUEEN!

Health Acts.

RECONSTITUTION OF A MEAT AREA.

PROCLAMATION

By His Excellency the Administrator of the Government of the State of Victoria and its Dependencies in the Commonwealth of Australia, &c., &c., &c.

BY virtue of the powers conferred by the Health Acts, I the Administrator of the Government of the State of Victoria, in the Commonwealth of Australia, on the recommendation of the Commission of Public Health, and by and with the advice of the Executive Council of the said State, do by this my Proclamation constitute as a meat area, to be known as the Lillydale Meat Area, that portion of the municipal district of the Shire of Lillydale here described, namely:—

All that part of the Parish of Ringwood within the boundaries of the Shire of Lillydale; all that part of the Parish of Warrandyte within the boundaries of the Shire of Lillydale; all that part of the Parish of Mooroolbark commencing at the north-west angle of allotment 11A at the junction of Lincoln-road and Dorset-road, Croydon, and bounded thence easterly and south-easterly along Lincoln-road and Cambridge-road to the junction of the latter road with the Lillydale-Montrose-road at the eastern angle of allotment 35B; thence southerly by a line to the southern angle of allotment 34E; thence south-easterly and southerly by Sheffield-road to the southern boundary of the parish boundary; thence westerly along that boundary to Dorset-road and thence northerly by Dorset-road to the commencing point.

Given under my hand and the seal of the State of Victoria aforesaid, at Melbourne, this eleventh day of August, in the year of our Lord One thousand nine hundred and fifty-three, and in the second year of the reign of Her Majesty Queen Elizabeth II.

(L.S.) CHARLES J. LOWE.

By His Excellency's Command,

WM. BARRY,
Minister of Health.

GOD SAVE THE QUEEN!

PUBLIC HOLIDAYS.

PROCLAMATION

By His Excellency the Administrator of the Government of the State of Victoria and its Dependencies in the Commonwealth of Australia, &c., &c., &c.

IN pursuance of the provisions contained in Part III. of the *Public Service Act* 1946, I, the Administrator of the Government of the State of Victoria, in the Commonwealth of Australia, by and with the advice of the Executive Council of the said State, do by this my Proclamation appoint the days and dates hereunder mentioned to be observed as Public Holidays or Public Half-Holidays (as the case may be) at the places respectively specified, viz.:—

Public Holidays:—

MONDAY, THE 28TH DAY OF DECEMBER, 1953, throughout the State of Victoria.

Public Half-Holidays from the Hour of Twelve o'clock noon:—

*WEDNESDAY, THE 7TH OCTOBER, 1953, throughout the Area West of the Loddon River, within the Shire of Gordon.

*TUESDAY, THE 6TH OCTOBER, 1953, throughout the North Riding of the Shire of Dunmunkle.

*Agricultural Shows.

Given under my Hand and the Seal of the State of Victoria aforesaid, at Melbourne, this eighteenth day of August, in the year of our Lord One thousand nine hundred and fifty-three, and in the second year of the reign of Her Majesty Queen Elizabeth II.

(L.S.) CHARLES J. LOWE.

By His Excellency's Command,

J. H. SMITH,
for Chief Secretary.

GOD SAVE THE QUEEN!

APPOINTMENTS.

HIS Excellency the Administrator of the Government of the State of Victoria, by and with the advice of the Executive Council thereof, has, by Orders made on the 11th day of August, 1953, been pleased to make the under-mentioned appointments, viz.:—

CHIEF SECRETARY'S DEPARTMENT.

Licensing Inspector.

CHARLES VICTOR ASHE, Superintendent of Police, pursuant to the provisions of the Licensing Acts, to be a Licensing Inspector for each and every Licensing District in the State of Victoria, *vice* Arthur Edmond Shields retired.

Registrar of Births and Deaths.

ARTHUR ALAN OTIS, pursuant to the provisions of section 4 of the *Registration of Births Deaths and Marriages Act 1928*, to be a Registrar of Births and Deaths for the Metropolitan Registration District, without fees, from the 3rd August, 1953, to the 5th September, 1953.

DEPARTMENT OF HEALTH.

Government Representative on Hospital Committee.

DONALD McLEAN LINDSAY

to be Government Representative on the Committee of Management of the Creswick District Hospital, pursuant to the provisions of section 48 of the *Hospitals and Charities Act 1948*, for a further term of three years as from the 22nd August, 1953.

Psychiatrist.

ARCHIE SAMUEL ELLIS, M.B., B.S., D.P.M., to be Psychiatrist, Mental Hygiene Branch, Department of Health, pursuant to the provisions of section 18 (2) of the *Mental Hygiene Authority Act 1950*, as from and inclusive of the 27th July, 1953.

Trustees of Cemeteries.

ALLAN McDONALD

to be a Trustee, Heathcote Public Cemetery, *vice* George Kilroy, resigned, and

STANLEY THOMAS MILSON

to be a Trustee, Heathcote Public Cemetery *vice* Ernest Hutson, resigned;

JAMES ARTHUR QUILFORD,

ROBERT GRIEVE, and

JOHN OATES,

to be Trustees, Wonthaggi Public Cemetery;

FREDERICK EDWARD REESE

to be a Trustee, Burrum Burrum Public Cemetery, *vice* H. Clifford, resigned;

ALAN FRANCIS GUNN,

FRANCIS RALPH BLACKSHAW, and

JAMES FREDERICK TILGNER,

to be Trustees, Thorpdale Public Cemetery;

ALASTER CAMERON,

HARRY PERRY,

LESLIE PLUMRIDGE,

HERBERT ANSTEY, and

ARTHUR OLNEY,

to be Trustees, Marlo Public Cemetery;

JOHN FLETT MAUGHAN

to be a Trustee, Boroondara General Cemetery, *vice* Rev. Canon George Sutton, resigned; and

NORMAN CLAPPERTON WOODWARD

to be a Trustee, Maddingley General Cemetery, *vice* H. L. Simon, deceased.

Public Vaccinator.

BARRY RUTHERFORD GROVE, M.B., B.S.,

to be Public Vaccinator, Shire of Donald.

LAW DEPARTMENT.

Magistrate.

WILLIAM ALAN RAINBOW, Housing Commission, Unit No. 11, 15th-street, Irymple,

to Keep the Peace in the Midland Bailiwick of the State of Victoria.

Commissioners for Taking Declarations, &c.

ALEXANDER CUNNINGHAM TULLOCH, an Officer of Hilton Hosiery Limited, 291 Albion-street, West Brunswick,

to be a Commissioner for taking Declarations and Affidavits under the provisions of Division 8 of Part IV. of the *Evidence Act 1928*, to resign upon ceasing to occupy his present position;

JAMES PATRICK MARDLING, 56 Mt. Dandenong-road, Ringwood East,

RICHARD EDWIN KIRBY, 8 Nicholson-street, Essendon, ARTHUR BARRINGTON WELLS, Marongo-avenue, Hamilton,

AUSTIN KERRINS, 18 Hunt-street, Ballarat, and

WILLIAM PATRICK JOHN TOWERS, 23 Turnbull-street, Clifton Hill,

to be Commissioners for taking Declarations and Affidavits under the provisions of Division 8 of Part IV. of the *Evidence Act 1928*, to resign upon removing from the neighbourhood of the addresses stated.

Deputy Prothonotary, &c.

CYRIL JOHN THOMPSON

to be Deputy Prothonotary and Clerk of the Children's Court at Geelong, during the absence on annual leave of A. G. Glasson, to take effect from the date of commencement of duty.

Sheriff's Substitute.

CYRIL JOHN THOMPSON

as Clerk of the Peace and Registrar of the County Court at Geelong and by virtue of section 92 of the *Juries Act 1928*, to do and perform with respect to the Courts at that place, in the place and stead of the Sheriff, all such acts and things as the Sheriff is, by the said Act, authorized or required to do or perform, during the absence on annual leave of A. G. Glasson, to take effect from the date of commencement of duty.

DEPARTMENT OF WATER SUPPLY.

Waterworks Trust Commissioners.

JAMES CAMPBELL GLESON

to be a Commissioner of the Moe Waterworks Trust for a period of four years from the date hereof, subject to the provisions of the Water Acts;

CHRISTOPHER CORNELIUS BROWN

to be a Commissioner of the Underbool Waterworks Trust, *vice* William James Willoughby, resigned, to hold such office from the date hereof until the 19th September, 1953, subject to the provisions of the Water Acts; and

VINCENT LOUIS SLEEMAN

to be a Commissioner of the Warracknabeal Waterworks Trust, *vice* Keith Ronald Roll, resigned, to hold such office from the date hereof until the 14th July, 1956, subject to the provisions of the Water Acts.

A. MAHLSTEDT,

Clerk of the Executive Council.

At the Executive Council Chamber,
Melbourne, 11th August, 1953.

APPOINTMENTS.

HIS Excellency the Administrator of the Government of the State of Victoria, by and with the advice of the Executive Council thereof, has, by Order made on the 18th day of August, 1953, been pleased to make the under-mentioned appointments, viz.:—

CHIEF SECRETARY'S DEPARTMENT.

Commissioners for Purposes of Electoral Districts Act.

FRANK ERNEST CAHILL, Esq., Chief Electoral Officer, REGINALD CLIVE NANCE, Esq., Commonwealth Electoral Officer for the State of Victoria, and

WILLIAM MALCOLM CRAWFORD, Esq., Secretary for Lands, pursuant to the provisions of section 3 of the *Electoral Districts Act 1953* (No. 5683), to be Commissioners for the purpose of the redivision of the State of Victoria into electoral districts, in accordance with the provisions of the said Act; and

FRANK ERNEST CAHILL, Esq., Chief Electoral Officer, to be Chairman of the aforesaid Commissioners.

A. MAHLSTEDT,

Clerk of the Executive Council.

At the Executive Council Chamber,
Melbourne, 18th August, 1953.

RESIGNATIONS.

HIS Excellency the Administrator of the Government of the State of Victoria, by and with the advice of the Executive Council thereof, has, by Orders made on the 11th day of August, 1953, accepted the resignations of the persons named hereunder of the offices mentioned, viz.:—

CHIEF SECRETARY'S DEPARTMENT.

WILLIAM JAMES SLOAN, as a Licensing Inspector for each and every Licensing District in the State of Victoria, to date from and inclusive of the 26th July, 1953.

LAW DEPARTMENT.

ALFRED CHARLES BAYLES, from the Commission of the Peace for the Midland Bailiwick of the State of Victoria; and

ARTHUR EDWARD SPRAKE, from the Commission of the Peace for the Western Bailiwick of the State of Victoria.

A. MAHLSTEDT,
Clerk of the Executive Council.

At the Executive Council Chamber,
Melbourne, 11th August, 1953.

NOTICE.

ADMINISTRATION of the estate of each of the under-mentioned deceased persons has been granted to the Public Trustee, and creditors, next of kin, and all others having claims against the estate of any of the persons so mentioned are required to send particulars of their claims to the Public Trustee, No. 412 Collins-street, Melbourne, on or before the 21st October, 1953, or they will be excluded from the distribution of the estate when the assets are being distributed:—

*BENNEL, THOMAS WILLIAM, late of 21 Churchill-grove, Glenferrie, retired, died 27th May, 1953.

BISSETT, RAYMOND HARVEY, late of Wyndham-street, Drysdale, launchman signalman, died 7th September, 1950, intestate.

BROCKLEY, FRANCES MARGARET, late of 24 Peronne-street, Pascoe Vale, widow, died 24th September, 1952, intestate.

CARPENTER, CHARLES, late of Flat 2, Strath Lodge, 22A The Esplanade, St. Kilda, turf commissioner, died 5th April, 1941, intestate.

*CARROLL, MARY ELLEN, formerly of 5 Durham-street, Kensington, but late of 16 El Nido-grove, Glenhuntly, married woman, died 17th April, 1953.

†COLLINS, WILLIAM DAVID, late of Flat 4, 21 Marine-parade, St. Kilda, retired, died 26th April, 1953.

*DALTON, ELIZA, late of Dookie Agricultural College, Dookie, widow, died 15th June, 1953.

*GOATES, EDWARD JOHN, late of 3 Beamish-street, Werribee, municipal employee, died 9th November, 1943.

GODWIN, MARY ISOBEL, also known as Mary Isabel Godwin, late of Collin-road, East Oakleigh, married woman, died on or about 2nd May, 1951, intestate.

GOUROVITCH, ANNIE, formerly of 61 Hughes-street, East Malvern, but late of 619 St. Kilda-road, Melbourne, pensioner, died 24th February, 1953, intestate.

GRIFFETT, JOHN, formerly of 38 Hilda-street, Shenton Park, Western Australia, but late of Repatriation General Hospital, Heidelberg, Victoria, orderly, died 23rd May, 1952, intestate.

†LEES, HERBERT SCOFIELD, also known as Herbert Schofield Lees, late of 41 Blackwood-street, North Melbourne, retired truck driver, died 26th June, 1953.

†MURPHY, RITA MURIEL, formerly of 5 Mackay-street, Prahran, but late of 32 Stanley-street, Warrnambool, widow, died 3rd June, 1950.

†NELSON, NORMAN RICHARD, formerly a member of the First Australian Imperial Forces, and 128 Heatherton-road, Springvale, but late of Corrigan-road, Noble Park, retired, died 21st May, 1953.

*PATTIE, GEORGE EDWIN, late of 77 Chirnside-street, West Footscray, engineer, died 20th April, 1953.

PIGGIN, EDWARD NORMAN, late of 22 Flower-street, Essendon, pensioner, died 13th July, 1948, intestate.

RANDALL, WILLIAM LESLIE, late of 2 Lunette-avenue, Preston, cabinet maker, died 25th June, 1953, intestate.

REID, ANDREW, late of 29 Adelaide-street, West Footscray, retired quarryman, died 23rd February, 1950, intestate.

ROBINS, WALTER OSCAR, formerly of 108 Union-road, Surrey Hills, but late of 14 Scott-street, Canterbury, and 96 Maling-road, Canterbury, boot repairer, died 11th July, 1953, intestate.

†ROBINSON, KATHERINE, also known as Katherine Osborne Robinson, formerly of Thornton, but late of Old Main-road, Diamond Creek, widow, died 17th June, 1953.

*SOLOMON, JOHN BARON, also known as John Solomon, late of 18 Harwood-street, Elwood, business agent, died 17th March, 1953.

WILLIAMS, MARGARET, late of Bendigo Benevolent Home, Bendigo, married woman, died 24th September, 1952, intestate.

* With the will annexed.

† According to the provisions of the will.

C. J. GARDNER,
Public Trustee.

Melbourne, 12th August, 1953.

4 GEORGE VI. No. 4755, SECTION 6.

I HEREBY give notice that on the 8th July, 1953, I filed an election to administer the following deceased person's estate in accordance with section 6 of the *Public Trustee Act 1940*:—

*COLLINS, WILLIAM DAVID, late of Flat 4, 21 Marine-parade, St. Kilda, retired, died 26th April, 1953.

* According to the provisions of the will.

I HEREBY give notice that on the 4th August, 1953, I filed elections to administer the following deceased persons' estates in accordance with section 6 of the *Public Trustee Act 1940*:—

*NELSON, NORMAN RICHARD, formerly a member of the First Australian Imperial Forces, and 128 Heatherton-road, Springvale, but late of Corrigan-road, Noble Park, retired, died 21st May, 1953.

WILLIAMS, MARGARET, late of Bendigo Benevolent Home, Bendigo, married woman, died 24th September, 1952, intestate.

* According to the provisions of the will.

I HEREBY give notice that on the 5th August, 1953, I filed an election to administer the following deceased person's estate in accordance with section 6 of the *Public Trustee Act 1940*:—

GODWIN, MARY ISOBEL, also known as Mary Isabel Godwin, late of Collin-road, East Oakleigh, married woman, died on or about 2nd May, 1951, intestate.

I HEREBY give notice that on the 6th August, 1953, I filed elections to administer the following deceased persons' estates in accordance with section 6 of the *Public Trustee Act 1940*:—

GOUROVITCH, ANNIE, formerly of 61 Hughes-street, East Malvern, but late of 619 St. Kilda-road, Melbourne, pensioner, died 24th February, 1953, intestate.

*MURPHY, RITA MURIEL, formerly of 5 Mackay-street, Prahran, but late of 32 Stanley-street, Warrnambool, widow, died 3rd June, 1950.

ROBINS, WALTER OSCAR, formerly of 108 Union-road, Surrey Hills, but late of 14 Scott-street, Canterbury, and 96 Maling-road, Canterbury, boot repairer, died 11th July, 1953, intestate.

* According to the provisions of the will.

I HEREBY give notice that on the 7th August, 1953, I filed elections to administer the following deceased persons' estates in accordance with section 6 of the *Public Trustee Act 1940*:—

CARPENTER, CHARLES, late of Flat 2, Strath Lodge, 22A The Esplanade, St. Kilda, turf commissioner, died 5th April, 1941, intestate.

*LEES, HERBERT SCOFIELD, also known as Herbert Schofield Lees, late of 41 Blackwood-street, North Melbourne, retired truck driver, died 26th June, 1953.

*ROBINSON, KATHERINE, also known as Katherine Osborne Robinson, formerly of Thornton, but late of Old Main-road, Diamond Creek, widow, died 17th June, 1953.

* According to the provisions of the will.

I HEREBY give notice that on the 10th August, 1953, I filed elections to administer the following deceased persons' estates in accordance with section 6 of the *Public Trustee Act 1940*:—

PIGGIN, EDWARD NORMAN, late of 22 Flower-street, Essendon, pensioner, died 13th July, 1948, intestate.

RANDALL, WILLIAM LESLIE, late of 2 Lunette-avenue, Preston, cabinet maker, died 25th June, 1953, intestate.

REID, ANDREW, late of 29 Adelaide-street, West Footscray, retired quarryman, died 23rd February, 1950, intestate.

C. J. GARDNER,
Public Trustee.

412 Collins-street, Melbourne, C.1, 12th August, 1953.

INDUSTRIAL AND PROVIDENT SOCIETIES ACT 1928.

NOTICE is hereby given that a society called "Euroa Co-operative Society Limited" is registered under the provisions of the above Act.

Given under my hand this 3rd day of July, 1953.

D. J. McARDLE,
Registrar of Friendly Societies.

CONTRACTS ACCEPTED.—(Series 1953-54.)

GENERAL STORES.

Gazette No. 534, 10th July, 1953, Schedule No. 29, Cordage, &c.—For the rates shown opposite the following items, substitute the rates as set out hereunder, as from 31st July, 1953:—Item No. 1, £14 3s. 6d. per cwt.; Item No. 2, £15 13s. 9d. per cwt.; Item No. 3, 8s. 2½d. per lb.; Item No. 4—No. 0, 10s. 3d. per dozen, No. 1, 13s. 6d. per dozen, No. 5, £1 5s. 3d. per dozen; Item No. 5, 8s. 2½d. per lb.; Item No. 6, 8s. 0½d. per lb.; Item No. 7, 14-lb. coils, 5s. 2½d. per lb., 1-lb. reels, 5s. 4d. per lb.; Item No. 12, 8s. 0½d. per lb.; Item No. 14, 1 in. and up, £28 6s. 9d. per cwt., ¾ in. and ⅝ in., £29 11s. 6d. per cwt., under ¾ in., £30 17s. 6d. per cwt.; Item No. 15, over 1½-in. circumference, £14 4s. 3d. per cwt., 1½-in. circumference and under, £15 1s. 9d. per cwt.; Item No. 16, 1 in. and up, £14 1s. 9d. per cwt., ¾ in. to ⅝ in., £14 18s. 6d. per cwt., under ¾ in., £15 per cwt.; Item No. 17, 1 in. and up, £14 1s. 9d. per cwt., ¾ in. to ⅝ in., £14 18s. 6d. per cwt., under ¾ in., £15 per cwt.; Item No. 18, 1 in. and up, £18 14s. per cwt., ¾ in. to ⅝ in., £19 2s. 9d. per cwt., under ¾ in., £19 12s. 3d. per cwt.; Item No. 19, 1 in. and up, £18 14s. per cwt., ¾ in. to ⅝ in., £19 12s. 9d. per cwt., under ¾ in., £19 12s. 3d. per cwt.; Item No. 20, £28 6s. 9d. per cwt.; Item No. 27, £13 6s. per cwt.; Item No. 28, 7s. per lb.; Item No. 29, 6s. 10d. per lb.; Item No. 30, 10s. 0½d. per lb.; Item No. 31, £27 17s. 3d. per cwt.; Item No. 32, 14-lb. coils, 3s. 0½d. per lb., 1-lb. reels, 3s. 1½d. per lb. Item Nos. 3, 5, 6, 7, 8, 9, 10, 12, and 32, additional charge for cut lengths, in sizes 1 in. and up, 1½d. per lb.; in sizes under 1 in., 2d. per lb. Item Nos. 14, 15, 16, 17, 18, 19, 20, and 21, additional charge for broken coils, in sizes 1 in. and under 5 in., 15s. per cwt.; in sizes under 1 in., 20s. per cwt.

Gazette No. 534, 10th July, 1953, Schedule No. 37, Electric Lamps, &c.—For Item Nos. 102 and 105 substitute 18s. and £1 6s. per dozen respectively, as from 1st August, 1953.

Gazette No. 534, 10th July, 1953, Schedule No. 46, India-rubber Goods.—For Item Nos. 29 and 30 substitute 9s. 9d. and 8s. 1d. per yard respectively, as from 1st July, 1953.

Gazette No. 534, 10th July, 1953, Schedule No. 46, India-rubber Goods.—For the rates shown opposite the following items, substitute the rates per pair as set out hereunder, as from 1st August, 1953:—Item No. 37, £3 13s. 4d., sizes 5 to 11, £3 19s. 4d., size 12, £4 1s. 4d., size 13; Item No. 38, £2 0s. 5d., sizes 5 to 11, £2 4s. 5d., size 12, £2 5s. 5d., size 13.

Gazette No. 534, 10th July, 1953, Schedule No. 62, Paints, &c.—For Item Nos. 82 and 83 substitute £4 9s. 9d., and £5 1s. 9d. per cwt. respectively, as from 1st August, 1953. For packages of less than 1 cwt. add 33s. 5d. per cwt. for 7 lb., 18s. 1d. per cwt. for 14 lb., 9s. 4d. per cwt. for 28 lb., 4s. 9d. per cwt. for 56 lb.

W. H. RUTHERFORD, Secretary to the Tender Board.
17.8.53.

PUBLIC WORKS.

479. Royal Park, Mental Hospital, (2) supply and laying rubber flooring, also floor sanding (several wards), £1,151 3s. 2d.—Dunlop Floorings Pty. Ltd.

480. South Melbourne, Police Station, (1) supply and installation of hot-water service, &c. ("Ideal" gas fire and boiler), £308.—Gas and Fuel Corporation of Victoria.

481. Melbourne, Russell-street Police Headquarters, (2) installation of fluorescent lighting and alterations to wiring, &c., to D.24, £149 18s. 6d.—R. G. Harris Pty. Ltd.

482. Melbourne, State Land Tax and Probate Duties Office, (1) steel shelving, £115 18s. 6d.—E. T. Brown Ltd.

483. Red Hill, Consolidated School, (1) repairs to H/W pump and bore pump, £117 3s. 4d.—Thos. J. Tait.

484. Geelong, Gordon Institute of Technology, (1) provide and lay malthoid flooring to workshops, £107.—H. Armitage.

485. Winchelsea, Comfort Station, (2) tiling roof of building, £119 3s. 9d.—Builders' Roofing and Trading Co.

486. Edenhope, Consolidated and Higher Elementary School, (4) general furniture and fittings (tables and cabinet), £100 12s.—Hunt and Keeley; benches, bookshelf, wardrobes, and tables, £147.—Kennett Bros. and Rayner Pty. Ltd.; lino, £232 10s. 7d.—W. P. Murison.

487. Landsborough, Police Station, (4) renovations and external painting, £173.—C. G. Barker and N. H. Weeks.

488. Fitzroy, Girls' Secondary School, (1) furniture, £175 11s.—Johnston's Pty. Ltd.

489. Dookie, Agricultural College, (3) supply and installation of kerosene hot-water service in the domestic quarters, £182 7s. 6d.—J. Wilson.

490. Brighton, State School No. 1542, (7) renewal of blackboards, £169.—J. Lynch.

491. Royal Park, Mental Hospital, (4) supply of 50 laminex top dining tables, £473 2s. 6d.; supply 200 cantilever chairs, £740.—Berwin Manufacturing Pty. Ltd.

492. Royal Park, Mental Hospital, (3) curtains for Receiving Home, £274 15s. 6d.—A. E. Hoad and Co.
493. Heatherton, Sanatorium, (9) curtains, £233 16s.—A. E. Hoad and Co.; linoleum, £601 14s. 10d.—W. P. Murison.

494. Various, Schools, (6) supply and fix 597 Venetian blinds for "Jennings" prefabricated timber classrooms, £4,353 2s. 6d.—Carlisle Blind and Canvas Co.

495. Greenvale, Sanatorium, (1) maintenance and testing service of passenger lift, 1st July, 1953, to 30th June, 1954, £153 2s.—Johns and Waygood Ltd.

496. Royal Park, Mental Hospital, (5) supply of 40 bedside lockers, £285.—Kennett Bros. and Rayner Pty. Ltd.

497. Tandarook South, State School No. 4127, (1) erection of fence at Teacher's residence, £251 15s. 10d.—J. White.

498. Horsham, Transport Regulation Board, (3) supply, installation, and testing of a gas hot-water service in a new timber residence, £131 17s. 3d.—J. M. Glassel and Co. Pty. Ltd.

499. Traralgon, High School, (2) provision of fence and partition at Australian Paper Manufacturer's No. 4 Hostel, £182 5s.—R. E. King.

500. Royal Park, Mental Hospital, Medical Superintendent's Residence, (1) supplying and fixing curtains, £218 18s.—A. E. Hoad and Co.

501. Melbourne, State Offices, (1) supply of brown coal, £208 17s. 7d.—State Electricity Commission of Victoria.

502. Yallourn, State School No. 4085, (1) supply of 242 cubic yards of gravel, £121.—H. J. Tulloch.

503. Welshpool, Harbor Works, (1) supply of timber, £302 11s. 7d.—Mount Alfred Timber Mills.

504. St. Kilda, Harbor Works, (1) supply of timber, £340 2s. 7d.—Mount Alfred Timber Mills.

505. Gippsland Lakes, Harbor Works, (1) supply of timber, £136 5s. 7d.—Mount Alfred Timber Mills.

506. St. Kilda, Harbor Works, (1) supply of timber, £175 10s. 7d.—Mount Alfred Timber Mills.

507. Kew, Mental Hospital, (1) supply of lubricating oil, £107 2s. 2d.—W. B. Dick and Co. (Aust.) Pty. Ltd.

508. Various, Jetties—Black Rock, Tooradin, Rye, and Mentone, (1) supply of timber, £178 0s. 6d.—Albert R. Weisselberg Timber Trading Co.

509. Gowerville, State School No. 4674, (1) supply of salamander, £131 0s. 6d.—Albion Quarrying Co. Pty. Ltd.

510. Donald, District Hospital, (1) supply of kitchen equipment, £691 10s.—Brice Scale and Slicer Co.

511. South Melbourne, Public Works Department Storeyard, (1) supply of rotary clothes hoists, £168.—Toyne's Rotary Clothes Hoist Pty. Ltd.

512. South Melbourne, Storeyard, (1) supply of concrete pipes, £127 19s. 5d.—Concrete Constructions Pty. Ltd.

513. Terang, High School, (1) supply of ice cream cabinet, £375.—M. F. Ahearn and Co. Pty. Ltd.

514. Anglesea, Tourist Resort, (1) supply of concrete slabs and posts, £197 13s. 3d.—Monier Pipe Co. Pty. Ltd.

515. St. Kilda, Harbor Works, (1) supply of timber, £134.—Mount Alfred Timber Mills.

516. Port Melbourne, Public Works Department Depot, (1) supply of wheel assemblies, £154 7s.—Queen's Bridge Motor and Engineering Co. Ltd.

517. Port Melbourne, Public Works Department Depot, (1) supply of screenings, £148 13s. 9d.—Willis Quarries.

518. Tallangatta Valley, State School No. 2337, (1) supply of building materials, £156 18s. 6d.—J. Davis, Tallangatta.

519. South Melbourne, Public Works Department Storeyard, (1) supply of pipes, £246 5s.—Mellody's Pottery Pty. Ltd.

520. East Kew, State School No. 3161, (1) supply of fire extinguishers, £165 12s. 6d.—Wormald Bros. Pty. Ltd.

521. Brighton, Harbor Works, (1) supply and delivery of stone, £253 4s.—J. Starbuck and Sons.

522. French Island, Site Works, (1) supply of 100 yards of screenings, £330.—R. T. Sims.

523. Morwell, State School No. 4680, (1) supply of screenings, £117 10s.—A.G.M. Quarries.

524. Sunbury, Mental Hospital, (1) supply of plastic water piping, £116 11s. 3d.—C.I.A. Associated Agencies.

525. Boisdale, Consolidated School, (1) supply of ice cream cabinet, complete, £381 5s.—M. F. Ahearn and Co. Pty. Ltd.

526. Royal Park, Mental Hospital, (1) supply of fire extinguishers, £171 8s. 6d.—Wormald Bros. Pty. Ltd.

527. Sunbury, Mental Hospital, (1) supply of steam valves and traps, £121 13s. 2d.—Bell Asbestos and Engineering (Aust.) Ltd.

528. Mont Park, Mental Hospital, (4) supply and delivery of 34 inner spring mattresses, £268 12s.—Classic Bedding Company.

529. Mont Park, Mental Hospital, (1) supply and delivery of twelve cane lounge chairs and four cane settees, £108.—W. Wilkes Pty. Ltd.

530. Mont Park, Mental Hospital, (4) supply and delivery of 34 bedroom chairs and 34 dressing stools, £321 6s.—Johnston's Furniture Productions Pty. Ltd.

531. Mont Park, Mental Hospital, (4) supply and delivery of furniture to Nurses' Hostel Extension—34 divans, 34 dressing tables, and 34 wardrobes, £1,418 13s.—Romney Woodcraft Pty. Ltd.; 34 chests of drawers and 34 bed end shelf units, £683 8s.—Kennett Bros. and Rayner Pty. Ltd.

S. MERRIFIELD, Commissioner of Public Works. 10.8.53.

532. Armadale, "Larnook" Domestic Arts College, (6) installation of drive lighting, £228 16s.—L. W. Buchanan.

533. Alamein, State School No. 4649, (1) erection and completion of prefabricated "Bristol" buildings, £5,948.—Overseas Corporation (Aust.) Ltd.

534. Alamein, State School No. 4649, (6) electrical installation in additional prefabricated units, £212.—K. L. Day.

535. Bendigo, High School, (1) provision of granolithic flooring, £137 18s.—W. H. Paxton.

536. Golden Point, State School No. 1493, 1106 Ligar-street, residence, (4) installation of sewerage, £119 17s. 6d.—W. S. Cudgeon and Son.

537. Ballarat, Webster-street, Teachers' Training College Hostel, (4) underpinning tie rods, &c., £187.—S. C. Ludbrook.

538. Collingwood, Technical School, (6) roof repairs, £158 2s. 6d.—A. Crewther and Son.

539. Carlton, Lygon-street, Physical Education Remedial Gymnasium, (1) repairs, &c., £149 5s.—R. P. Finn.

540. Digby, State School No. 2047, (1) remodelling of Teacher's residence, £1,661 13s. 3d.—L. W. Cooper.

541. Ellinbank, Research Station, (1) provision of stumps for prefabricated residence, £145 10s.—D. L. Reid.

542. Emu, State School No. 2011, (5) repairs and painting to school and residence, £417 2s.—R. House.

543. Eastwood, State School No. 4702, (4) electrical installation, £141.—L. W. Buchanan.

544. Essendon, Technical School, (4) internal and external painting, repairs, &c., to residence, £235.—J. Lynch.

545. Frankston, High School, (6) additional out-offices and new septic tank system, £1,971.—D. H. Armstrong.

546. Janefield, Mental Hospital, three staff residences, (1) provision of Nos. 3 garages, £385 10s.—D. A. Davies.

S. MERRIFIELD, Commissioner of Public Works. 11.8.53.

547. Kew, Mental Hospital, (4) electrical installation for kitchen, £1,543 9s. 7d.—K. L. Day.

548. Kew, Mental Hospital, (2) rebuilding tops of chimneys, £216.—J. L. Devenish.

549. Kew, Mental Hospital, (8) rewiring and additions to electrical installation in Wards D.1, F.1, and F.5, £905.—G. Wilkie Electrical Co.

550. Kew, Mental Hospital, (1) installation of 2 (two) wash basins, in Hairdressing Saloon, £130.—E. S. Ashton.

551. Lalor, State School No. 4709, (5) erection of boys' and girls' out-office blocks and shelter sheds, £1,785.—G. Wood and Son.

552. Mont Park, "Larundel" Mental Hospital, (1) supply and erection of garage for engineer mechanic, £128 10s.—D. A. Davies.

553. Moe, State School No. 2142, Residence, 36 Fowler-street, (5) erection of additional room and out-buildings, £438 15s.—D. L. Reid.

554. Moorabbin, State School No. 4687, Tucker-road, (11) supply, delivery, installation, and testing of warm air heating in eight-classroom prefabricated block, £1,693.—Crockford and Robertson Pty. Ltd.

555. Morwell, State School No. 4680, (4) electrical installation in six (6) classroom "Bristol" prefabricated units, £398 17s. 6d.—L. W. Buchanan.

556. Moorabbin, State School No. 4687, (11) electrical installation in eight-room prefabricated school building, £425.—K. L. Day.

557. Melbourne, 179 Queen-street, Public Offices, (4) central heating, £165 15s.—D. H. Armstrong.

558. Melbourne, Public Offices, 179 Queen-street, (8) electrical installation, Land Tax and Probate Office, £520.—G. Wilkie Electrical Co.

559. Melbourne, New Treasury Buildings, Public Works Department, (3) alterations to main switchboard, £326 5s.—Gellibrand Electric Co.

560. Rosebud, High School, (5) erection and completion of a "Bristol" prefabricated school building and out-offices, £10,680.—Overseas Corporation (Aust.) Ltd.

561. Sandringham East, State School No. 4429, (4) restoration of fire damaged rooms, £1,298.—E. Beadle.

562. Sunshine, Technical School, (3) erection of prefabricated school, £1,322.—Overseas Corporation Australia Limited.

563. Sunbury, Mental Hospital, (5) new sink and drainer in Female Hospital, Ward F.8, £219.—L. J. Morgan Pty. Ltd.

564. Shepparton, Technical School, (4) electrical installation, £2,107 2s. 6d.—P. T. Bonnett.

565. St. Albans, State School No. 2969, (2) additional out-office accommodation and two shelter sheds, £1,525.—G. Wood and Son.

566. Tottenham, State School No. 4707, (6) electrical installation in new school, £159.—L. W. Buchanan.

567. Tallandoon North, State School No. 3682, (1) erection of a shelter shed, type "A," £260 16s.—J. Davis.

568. Traralgon, Inspector of Mines residence, (8) erection of an office at 5 Lafayett-street, £244.—M. S. Simpson.

569. Various, Section D, (8) erection of standard school classrooms, £47,790.—McDonald Constructions.

570. Wodonga, Police Station, (2) supply and installation of hard fuel hot-water service, £163 10s.—Ross Pty. Ltd.

S. MERRIFIELD, Commissioner of Public Works. 12.8.53.

ORDERS IN COUNCIL.—(Series 1953-54.)

STATE ELECTRICITY COMMISSION.

571. The fabrication and erection of structural steelwork in the metropolitan area, for a period of twelve months, at Schedule rates, to Quotation No. 3958.—Donaldson Bros. Constructions.

572. The supply and delivery of bread for Yallourn messes, for a period of twelve months, at Schedule rates, to Specification No. 52-53/87.—B. R. Meadows and Sons.

573. The supply and delivery of milk for Yallourn messes, for a period of twelve months, at Schedule rates, to Specification No. 52-53/86.—South-Eastern Milk Products Ltd.

Approved by the Governor in Council, 4th August, 1953.—A. MAHLSTEDT, Clerk of the Executive Council.

Pounds Act 1928.

SHIRE OF WARANGA.

TABLE of Rates to be charged for the trespass of cattle and their sustenance while impounded, fixed by the Council of the Shire of Waranga.

Description of Cattle Trespassing.	Trespass Rates.		Sustenance Fees.
	Upon Land other than Tillage Land Enclosed by a Substantial Fence.	Upon Tillage Land Enclosed by a Substantial Fence.	Amount to be Charged Daily for Sustenance while Impounded.
	£ s. d.	£ s. d.	£ s. d.
For every sheep ..	0 0 1	0 0 6	0 1 0
For every goat ..	0 0 1	0 1 0	0 2 0
For every pig ..	0 0 6	0 5 0	0 2 0
For every head of other cattle ..	0 5 0	0 10 0	0 5 0

By order of the Council,

W. C. GEYLE,
Shire Secretary.

Approved by the Governor in Council, 11th August, 1953.

A. MAHLSTEDT,
Clerk of the Executive Council.

Audit Act 1928.

CERTIFICATION OF ACCOUNTS.

HIS Excellency the Administrator of the Government of the State of Victoria, by and with the advice of the Executive Council thereof, and in pursuance of the provisions of clause 31 of the General Regulations Respecting Public Accounts, doth by Order made on the 11th day of August, 1953, authorize:—

To the appointments of the various officers now authorized to certify accounts for expenditure under the division of the Honorable The Minister of Transport there be added the following:—

Refunds—Transport Regulation Fund—Officer in Charge, Motor Registration Branch.

A. MAHLSTEDT,
Clerk of the Executive Council.

At the Executive Council Chamber,
Melbourne, the 11th August, 1953.

Transport Regulation Acts.
TRANSPORT REGULATION BOARD.
NOTICES OF PUBLIC HEARINGS.

NOTICE is hereby given that the applications made by the persons named below for licences to operate the commercial goods vehicles on the route or routes, or in the manner set out opposite their names, will be heard at a time and place to be communicated to the parties concerned:—

Name and Address; Nature of Application.

- BUFTON, H. A., Breakwater, via Geelong; 1 commercial goods vehicle (100 cwt.) to operate—(a) within a radius of 25 miles of Geelong—general goods, (b) within a radius of 100 miles of Geelong—live stock.
- COLMAN, S. (trading as Colman Bros. Pty. Ltd.), 204 High-street, Maryborough; 1 commercial goods vehicle (15 cwt.) to operate between Castlemaine and Donald, via Maryborough, for the carriage of newspapers only.
- FORD, F. T., 19A Bridge-street, Benalla; 1 commercial goods vehicle (10 cwt.) to operate throughout the State of Victoria in the course of business as "builder"—building material incidental to own contracts.
- HASTINGS, E. S., Edenhope; 1 commercial goods vehicle (200 cwt.) to operate from and to Edenhope and Apsley to and from Hamilton, via Harrow, Coleraine, and Wannon, subject to no goods being picked up or set down within a radius of 5 miles of the railway stations at Coleraine and Wannon—general goods. (This is an application for licence No. D.3575, issued previously to J. Pedler, of Northcote.)
- HUDSON, R. A., 29 Victoria-street, Ballarat; 1 commercial goods vehicle (12 cwt.) to operate throughout the State of Victoria in the course of business as "electrical contractor"—tools, material, and equipment incidental to trade and own contracts.
- KLIPPEL, K. J., Corryong; 1 commercial goods vehicle (100 cwt.) to operate for the carriage of general goods—(a) within a radius of 25 miles of Corryong, (b) from and to the Victorian-New South Wales border *en route* Albury to and from places situate within the area defined in paragraph (a) above but excluding places situate on the Murray Valley Highway between Wodonga and Walwa. (This is an application for licence No. D.4285, previously held by A. F. Sheather, Corryong.)
- LEECH, A. H., Fryers-road, Campbells Creek; 1 commercial goods vehicle (120 cwt.) to operate throughout the State of Victoria in the course of business as "marine dealer"—marine stores.
- LEW, H., 27 Scott-street, Caulfield; 1 commercial goods vehicle (6 cwt.) to operate within a radius of 50 miles of Melbourne and to and from Warragul market in the course of business as "market stall holder"—own tobacco.
- MURK, A., 124 Balaclava-road, North Caulfield; 1 commercial goods vehicle (8 cwt.) to operate within a radius of 50 miles of Melbourne and to and from Warragul in the course of business as "hawker"—drapery.
- THE MYER EMPORIUM (BALLARAT) PTY. LTD., 301 Sturt-street, Ballarat; 2 commercial goods vehicles (6 cwt. each) sedans, to operate throughout the State of Victoria for incidental delivery of any items of general merchandise sold by the Myer Emporium, and to be used by the Ballarat manager and buyers, on isolated occasions only, to contact branch stores and Melbourne store, with ability to take up stock urgently required.
- MCDONALD, L. F., White-road, Wonthaggi; application to vary the terms of existing licence No. D.7789 by deleting present conditions and adding, in lieu, the ability to operate throughout the State of Victoria in the course of business as "house-moving contractor"—houses, sheds, and outbuildings (low loader).
- SHERLOCK & HAY PTY. LTD., 81 Young-street, Frankston; 1 commercial goods vehicle (242 cwt.) to operate within a radius of 50 miles of Frankston in the course of business as "timber merchants"—own timber and building supplies.
- SHIELS, E. A., 5 Provost-street, North Melbourne; 1 commercial goods vehicle (95 cwt.) to operate throughout the State of Victoria in the course of business as "marine dealer"—marine stores and bags.
- SLADE BROS., Mangan-street, Tongala; 1 commercial goods vehicle (140 cwt.) to operate—(a) within a radius of 25 miles of Tongala in the course of business as "timber and hardware merchants"—own goods, (b) from Benalla to own premises at Tongala—sawn timber.
- SLATER, S. N., 31 Meadow-street, East St. Kilda; 1 commercial goods vehicle (21 cwt.) to operate throughout the State of Victoria in the course of business as

"commercial traveller"—wooden lattice frames for demonstration purposes only with the right to make incidental urgent deliveries.

- STIRLING, D. H., Main-street, Croydon; 1 commercial goods vehicle (126 cwt.) to operate—(a) within a radius of 25 miles of Melbourne—general goods, (b) within a radius of 40 miles of Melbourne—roofing tiles on behalf of Wunderlich Ltd.
- STREET, S., 137 Timor-street, Warrnambool; 1 commercial goods vehicle (80 cwt.) to operate between Warrnambool and Melbourne for the carriage of second-hand bags for repair and repaired bags.
- THORSON, A. H., 13 Little Page-street, Albert Park; 1 commercial goods vehicle (8 cwt.) to operate throughout the State of Victoria for the carriage of second-hand bags.
- U.S. MOTORS (BELGRAVE) PTY. LTD., Main-road, Belgrave; 1 commercial goods vehicle (20 cwt.) to operate within a radius of 50 miles of Olinda for the purpose of repairing or towing disabled or wrecked vehicles to or from the applicant's premises at Olinda—tools, spare parts, and material incidental to trade.
- VICTORIAN INDUSTRIAL SALES & SERVICE PTY. LTD., Power-street, South Melbourne; 1 commercial goods vehicle (7 cwt.) to operate throughout the State of Victoria for the purpose of servicing and maintaining tractors and farm machinery—tools, spare parts, and material incidental to trade.
- WARD, L. C., Griffith, New South Wales; 1 commercial goods vehicle (200 cwt.) to operate—(a) from Richmond Brewery, Melbourne, to the Victorian-New South Wales border *en route* to Griffith (N.S.W.)—beer, (b) from the New South Wales-Victorian border *en route* from Griffith, to Richmond Brewery, Melbourne—empty returns.
- WILSON, L., Bell-street, Ballarat; 1 commercial goods vehicle (100 cwt.) to operate in the course of business as "manufacturers of sheet metal goods"—(a) within a radius of 50 miles of Ballarat—own goods, (b) from Ballarat to Melbourne and Geelong—all types of sheet metal manufactured goods, (c) from Melbourne to Ballarat—sheet metal, tubing, plumbers and electrical fittings, thermostats and gas cylinders for use in own factory.

NOTICE is hereby given that the applications made by the persons named below for renewal of licences to operate the commercial goods vehicles on the route or routes, or in the manner set out opposite their names, will be heard at a time and place to be communicated to the parties concerned:—

Name and Address; Present Franchise; Licence No.; Date of Expiry.

- ARGENT, L. C., Box 224, Warracknabeal; from and to Warracknabeal, to and from Jeparit, via Peppers Plains—general goods; D.5461; 27th July, 1953.
- AHLBERG, S. W. J. (trading as F. Daniels and Sons), Palmerston-street, Warragul; in the course of business as "manufacturers of aerated waters and cordials"—goods being the property of the holders of this licence—(a) within a radius of 35 miles from Warragul, (b) from and to Warragul to and from Melbourne; D.5672; 18th October, 1953.
- HOADLEY'S CHOCOLATES LTD., "Barrackville," Coventry-street, South Melbourne; cocoa and confectionery, the property of the holder of this licence, and carried in the course of business as "cocoa and confectionery distributors" on the under-mentioned routes:—(a) from the railway station at Warrnambool to retailers whose premises are situate at Warrnambool and places on the route from the aforesaid railway station to the Victorian-South Australian border *en route* to Mt. Gambier (S.A.), and from the Victorian-South Australian border *en route* from Naracoorte (S.A.) to Hamilton, (b) from the railway station at Hamilton to retailers whose premises are situate at Coleraine, Casterton, Penhurst, and places on the most direct route between the aforesaid towns, (c) from the railway station at Warrnambool to retailers whose premises are situate at Terang, Cobden, and places on the most direct route between the aforesaid towns, (d) from the railway station at Colac to retailers whose premises are situate at Colac, Cressy, Camperdown, Mortlake, and places situate on the most direct route between the aforesaid towns; D.5759; 14th November, 1953.
- LIFEGUARDS MILK PRODUCTS LTD., 530-536 Flinders-lane, Melbourne, C.I.; (a) to and from Alvie and places in the Alvie district from and to the licensee's factory at Bacchus Marsh—fresh milk and empty milk cans, (b) to and from the licensee's factory at Bacchus

Marsh from and to the City of Melbourne the under-mentioned goods only:—(i) Licensee's own manufactured products, (ii) malt, sugar, and other raw materials for manufacture of licensee's own products, (iii) empty cans, shooks, wire, nails, labels, and other packaging materials for packing of licensee's own manufactured products, (iv) empty milk cans for return, (v) machinery required for urgent repair or replacement purposes, (c) from and to places within a radius of 25 miles from Ballarat to and from licensee's factory at Bacchus Marsh—fresh milk and empty milk cans; D.5738, D.5741, D.5743, D.5744, D.5745, D.5746, D.5747, D.5748, D.5749; 1st November, 1953.

PENINSULA HAULAGE PTY. LTD., Bay-street, Frankston; (a) within a radius of 20 miles from Frankston—general goods, (b) within a radius of 100 miles from Frankston—bricks on behalf of Colortone Brick Ltd., of Frankston; D.5769; 14th November, 1953.

NOTICE is hereby given that the applications made by the persons named below for licences to operate commercial passenger vehicles on the route or routes, or in the manner set out opposite their names, will be heard at a time and place to be communicated to the parties:—

Name of Applicant; Nature of Application.

THOMSON, J. K., 61 Spring-street, Preston; application for variation of licence Nos. M.C.153 and M.C.154 to include the ability to operate under contract to T. Calderwood, Williamstown, for the carriage of employees only of the Braun Construction Co., between Newport Railway Station and the Vacuum Oil Company Refinery at Altona.

THOMSON, J. K., 61 Spring-street, Preston; application for variation of licence No. M.C.521 to include the ability to convey employees of Independence Mills, Preston, from Flinders-street, Melbourne (vicinity Gas and Fuel Corporation offices) to the Independence Mills near the intersection of Raglan and Princes streets, Preston. One trip *ex* City a.m. and one trip to City p.m., to be under contract to Independence Mills.

BURNHAM, W. A., 61 Herbert-street, Parkdale; application for variation of licence No. G.P.336 to delete the restricting clause relating to charter operations which states "that any journey undertaken shall commence within a radius of 3 miles of the Mordialloc Post Office" and instead to have the ability to commence journeys from any point within the metropolitan area.

CALLAGHAN, M., 155 Princes-street, Flemington; application for variation of licence No. M.C.408 to include the ability to operate under charter to T. L. Calderwood, 130 Melbourne-road, North Williamstown, for the transport of Braun Transworld Corporation employees from Newport to job site on Stanvac Refinery, near Altona. Two trips, 7.15 a.m. and 4.30 p.m.

BENNETT, O. L., 22 Victoria-terrace, Western Beach, Geelong; 1 commercial passenger vehicle, with seating capacity for five persons, to operate as an urban taxi cab for the carriage of passengers otherwise than at separate and distinct fares for each passenger within a radius of 50 miles of the general post office in the urban district of Geelong on journeys commencing within the urban area (subject to the cancellation of urban taxi licence No. U.T.456, at present in the name of R. M. Bourke).

HEIDELBERG MOTOR OMNIBUS Co. (1938) PTY. LTD., 537 Upper Heidelberg-road, Heidelberg; application for 1 commercial passenger vehicle, seating capacity 25 persons, to operate as an additional vehicle on Route No. 123A (Ivanhoe-West Heidelberg), under the same terms and conditions as M.O. licence Nos. M.O.420 and M.O.295.

GROGAN, J., 18 McKay-street, Sunshine; 1 commercial passenger vehicle, with seating capacity for five persons, to operate as a metropolitan private hire car for the carriage of passengers otherwise than at separate and distinct fares for each passenger throughout Victoria, with the proviso that the vehicle shall be ordered or be bespoke from place of business situate at Embassy Taxis (subject to the cancellation of licence No. M.H.514, at present in the name of Stanley Auto Service Pty. Ltd.).

JENNER TRANSPORT Co. PTY. LTD., 23 Shepparson-avenue, Carnegie; application for variation of route No. 77A (Murrumbidgee-East Malvern) to (a) delete that section of the route between corner of Dainy-road and Crosbie-street and the corner of Crosbie-street and North-road, (b) to include the ability to operate an extension of route from the corner of Brett-street and North-road, via North-road and East Boundary-road to the corner of East Boundary-road and Centre-road.

PATTERSON, T., 43 Burnell-street, West Brunswick; 1 commercial passenger vehicle, with seating capacity for five persons, to operate as a metropolitan private hire car for the carriage of passengers otherwise than at separate and distinct fares for each passenger throughout Victoria, with the proviso that the vehicle shall be ordered or be bespoke from place of business situate at approved Embassy Private Hire Service Depots (subject to the cancellation of licence No. M.H.471, at present in the name of Mrs. A. E. Bennett).

GLAUM, T. L., 42 Schulz-street, East Bentleigh; 1 commercial passenger vehicle, with seating capacity for five persons, to operate as a metropolitan private hire car for the carriage of passengers otherwise than at separate and distinct fares for each passenger throughout Victoria with the proviso that the vehicle shall be ordered or be bespoke from place of business situate at approved Embassy Private Hire Service Depots (subject to the cancellation of licence No. M.H.145, at present in the name of Mrs. E. R. Howard).

RICE, A. H., 77 Forrest-street, Bendigo; 1 commercial passenger vehicle, with seating capacity for five persons, to operate as an urban taxi within the urban district of Bendigo.

SUMNER, G., 76 Sternberg-street, Kennington, Bendigo; 1 commercial passenger vehicle, with seating capacity for five persons, to operate as an urban taxi within the urban district of Bendigo.

BECKMAN, K. E., 25 Brown-street, Long Gully, Bendigo; 1 commercial passenger vehicle, with seating capacity for five persons, to operate as an urban taxi within the urban district of Bendigo.

MURDOCH, R. A., 74 Pegleg-road, Eaglehawk, Bendigo; 1 commercial passenger vehicle, with seating capacity for five persons, to operate as an urban taxi within the urban district of Bendigo.

NOTICE is hereby given that the applications made by the persons named below for licences to operate commercial passenger vehicles on the route or routes, or in the manner set out opposite their names, will be heard at a time and place to be communicated to the parties:—

Name of Applicant; Nature of Application.

ROBERTS, J. H., Main-street, Tallangatta; 1 commercial passenger vehicle, with seating capacity for 33 persons, to operate as follows:—(a) For the carriage of school children only between Tallangatta and Wodonga, via Murray Valley Highway, under contract to the Education Department, (b) picture trip Saturday night only between Tallangatta and Albury, via Kiewa and Wodonga—

Time-table.

Depart 6.30 a.m.	Tallangatta	Arrive 1.30 a.m.
Arrive 7.00 p.m.	Kiewa	Arrive 12.30 a.m.
Arrive 7.45 p.m.	Albury	Depart 12 midnight

(c) To operate as a country special service omnibus, subject to all regulations appertaining to such operations and subject that journeys undertaken commence within a radius of 10 miles of Tallangatta Post Office, (d) to operate under special traffic conditions, subject to all the regulations appertaining to such operations and subject that journeys undertaken commence within a radius of 10 miles of Tallangatta Post Office.

MURRAY VALLEY COACHES LTD., cnr. Kiewa and Swift streets, Albury, N.S.W.; application for renewal of licence No. C.O.71 (expiring 5th December, 1953) authorizing operators to operate as and when required in substitution for, but not in addition to, any one of the licensed vehicles holding stage omnibus rights under full term licences, as at present held by the applicant.

WOOD, H. H., Creswick; application for renewal of licence C.T.41 (expiring 5th December, 1953) authorizing operations as follows:—(a) At separate and distinct fares within a radius of 5 miles from the post office at Creswick, (b) mails may be carried on the vehicle between the Creswick Post Office and the Creswick Railway Station, (c) under private hire conditions within a radius of 50 miles of the post office at Creswick.

SPIKER, A. H., Commercial-road, Tarnagulla; 1 commercial passenger vehicle, with seating capacity for eight persons, to operate for the carriage of passengers, mails, and parcels between Bendigo and Tarnagulla,

via Llanelly, Arnold, Newbridge, Woodstock, East Shelbourne, Lockwood South, Lockwood, Kangaroo Flat, and Golden Square—

Time-table.

Monday to Friday.		Monday to Friday.		Sat. only.
Read Down.		Read Up.	Read Up.	
Dep. 7.40 a.m.	Tarnagulla	Arr. 3.45 p.m.	3.30 p.m.	
Dep. 7.50 a.m.	Llanelly	Arr. 3.30 p.m.	3.15 p.m.	
Dep. 8.00 a.m.	Arnold	Arr. 3.20 p.m.	3.05 p.m.	
Dep. 8.15 a.m.	Newbridge	Arr. 3.05 p.m.	2.50 p.m.	
Dep. 8.50 a.m.	Woodstock	Arr. 2.40 p.m.	2.25 p.m.	
Dep. 9.05 a.m.	East Shelbourne	Arr. 2.15 p.m.	2.00 p.m.	
Dep. 9.20 a.m.	Lockwood South	Arr. 1.55 p.m.	1.40 p.m.	
Dep. 9.30 a.m.	Lockwood	Arr. 1.45 p.m.	1.30 p.m.	
Dep. 9.45 a.m.	Kangaroo Flat	Arr. 1.30 p.m.	1.15 p.m.	
Dep. 10.00 a.m.	Golden Square	Arr. 1.20 p.m.	1.05 p.m.	
Arr. 10.15 a.m.	Bendigo	Dep. 1.15 p.m.	1.00 p.m.	

Return Fares.

Tarnagulla to Bendigo—11s.
Llanelly to Bendigo—10s.
Arnold to Bendigo—10s.
Newbridge to Bendigo—9s.
Woodstock to Bendigo—7s.
Lockwood to Bendigo—3s.
South Lockwood to Bendigo—4s.

(Note.—This replaces service recently discontinued by D. J. Pollock, Tarnagulla.)

WILLIAMS, A. T., Howe-street, Daylesford; 1 commercial passenger vehicle, with seating capacity for five persons, to be purchased, to operate as follows:—(a) For the carriage only of school children and teachers between Daylesford Holy Cross Convent and Blampied Catholic School, via Eganstown and return, (b) under private hire conditions within a radius of 50 miles of Daylesford Post Office.

MILNER, C. E., Main-street, Warburton; application for renewal of licence No. C.O.321 (expiring 22nd November, 1953) authorizing operations as follows:—As a stage omnibus on the following routes:—(a) On any route within a radius of 6 miles from the Warburton Railway Station, (b) between the Warburton Railway Station and any of the following guest houses, viz: Mayerloyd, Chalet, Mountain Grand, Warburton House, St. Lawrence, and Lorraine Guest Houses, and Alpine Retreat Hotel, (c) between Cement Creek and Mount Donna Buang, as and when required during snow season only, (d) between Millgrove and Warburton Picture Theatre, Mondays, Wednesdays, and Saturdays only, (e) between Warburton and the Warburton Catholic Church (Sundays only of each week), (f) passengers may be carried at separate and distinct fares for each passenger on the routes defined in part (a) to (e) of routes above, (g) between Yarra Junction and Upper Yarra Dam, under contract to the Melbourne and Metropolitan Board of Works for the carriage only of employees of the said Board, (h) between Mayerloyd Guest House and Warburton State School, (i) specified day tours from Warburton—

1. Warburton to Mt. Donna Buang and return.
 2. Warburton to Cement Creek and return.
 3. Warburton to Acheron Way and return.
 4. Warburton to McVeigh's and return.
 5. Warburton to Powelltown and return.
 6. Warburton to O'Shannessy's Weir and return.
 7. Warburton to Marysville, via the Acheron Way, and return via the Black Spur and Healesville.
 8. Warburton to Ben Cairn, via Mt. Donna Buang and return via Don Valley.
 9. Warburton to Reefon Spur, Cumberland Valley, and Mansfield, and return via the Acheron Way.
 10. Warburton to Starlings Gap, via Powelltown, and return via Starvation Creek.
 11. Warburton to Alexandra, via the Acheron Way and Narbethong, and return.
 12. Warburton to Eildon Weir, via the Acheron Way, and return.
 13. Warburton to Warragul, via Nayook, Powelltown and Noojee, and return.
 14. Warburton to Mt. Dandenong, via Wandin and Silvan, and return via Emerald, Cockatoo, and Woori Yallock.
 15. Warburton to Healesville and Maroondah Lake, via the Don Valley-road, and return via Dalray-road.
 16. Warburton to Healesville Sanctuary, via the Don Valley-road, and return via Dalray-road.
- (j) Under private hire conditions within a radius of 50 miles of the railway station at Warburton, (k) the vehicle hereby licensed having a seating capacity

for five passengers may also be operated as a country special service omnibus subject to clauses 1 and 5 of Division 11, Part (III.) of Transport Consolidated Regulations, subject to the condition that all journeys undertaken commence within a radius of 10 miles from the post office at Warburton.

LANE, A. L. (trading as South-Western Roadways), 159 Raglan-parade, Warrnambool; application for renewal of licence Nos. A.2907 and A.2908 (expiring 6th September, 1953) authorizing operations as follows:—

1. Each vehicle so licensed may be operated as a stage omnibus between Camperdown and Ballarat, via either of the following routes:—(a) Via Derrinallum, Lismore, Skipton, Smythesdale, Ross Creek, (b) via Derrinallum, Lismore, Mt. Bute, Mannibadar, Pittong, Linton, Scarsdale, Smythesdale, and Ross Creek, (c) on any journey to Ballarat, via the route defined in part (a) of "routes" above, passengers may be set down anywhere along the route, but no passengers shall be taken up between and including a point 1 mile south of Skipton and a point 1 mile east of Smythesdale, and on journeys from Ballarat, via the route defined in part (a) of "routes" above, passengers may be taken up at any place along the route, but shall not be set down at any place west of a point 1 mile west of Scarsdale, (d) on any journey to Ballarat, via the route defined in part (b) of "routes" above, passengers may be set down at any place *en route*, but shall not be taken up at any place between and including Pittong and Smythesdale and between and including Sebastopol and Ballarat, and on any journey from Ballarat, via the route defined in part (b) of "routes" above, passengers may be taken up at any place situate between and including Ballarat and Sebastopol and at any place between and including Smythesdale and Pittong, (e) parcels may be carried, subject to the following conditions:—(1) The total weight of parcels carried on either vehicle at any one time shall not exceed 2 cwt., (2) The same restrictions as set out in clause 1 above as to the carriage of passengers shall also apply to the carriage of parcels, and in addition it shall be a condition that no parcels whatsoever shall be carried from Camperdown to Ballarat or from Ballarat to Camperdown, (f) the terminal point of the service in the City of Ballarat shall be in the premises of William Edward Rafferty, Lydiard-street, there carrying on business under the style of Central Garage and Exchange Service Station, and on every journey into or out of the City of Ballarat the vehicle shall arrive at and depart from the said premises.

2. Specified day tours from Camperdown. *Routes:* (1) Camperdown to the Grampians, via Ararat, and returning via the same route or alternatively via Victoria Valley, (2) Camperdown to Lorne, via Colac, returning via the same route, (3) Camperdown to Apollo Bay, via Colac, returning via the same route or alternatively via Lavers Hill, (4) Camperdown to Port Campbell and Peterborough, via Newfield, returning via the same route or alternatively via Timboon, (5) Camperdown to Warrnambool, via Terang, returning via Mortlake, (6) Camperdown to Daylesford and Hepburn Springs, via Ballarat, returning via the same route, (7) Camperdown to Portland via Warrnambool and Port Fairy, returning via the same route, (8) Camperdown to Port Fairy, via Warrnambool, returning via the same route, (9) Camperdown to Anglesea, via Colac and Lorne, returning via the same route, (10) Camperdown to Torquay, via Colac and Lorne, returning via the same route, (11) Camperdown to Mt. Leura and Camperdown, Lakes Entrance, and return.

3. Under charter conditions within a radius of 20 miles from the post office at Camperdown, and from Camperdown to Colac, Port Campbell, Peterborough, Princetown, Warrnambool, Lismore, Cressy, Heytesbury, Lorne, Apollo Bay, Timboon, Mortlake, Ballarat, Geelong, Port Fairy, and Portland.

LANE, A. L. (trading as South-Western Roadways), 159 Raglan-parade, Warrnambool; application for variation of licence No. A.2908 to delete all of the conditions referred to in renewal of licence above, and instead to include ability to operate as follows:—(a) For the carriage of school children between Mepunga East and Warrnambool, via Allansford, Wangoon, and Russells Creek, under contract to the Education Department, (b) as a country special service omnibus within a radius of 50 miles of Warrnambool, subject that parties are only engaged within a radius of 10 miles of Warrnambool, (c) interchangeability to all large-seating capacity vehicles owned and operated by the applicant, with the exception of vehicles operating under contract to the Education Department.

LANE, A. L. (trading as South-Western Roadways), 159 Raglan-parade, Warrnambool; application for variation of licence No. A.2907 to delete paragraphs 1 (b) and 1 (e) referred to in conditions of renewal above, and instead to include the ability to operate for the carriage of goods—(a) goods up to 2 cwt. may be carried, perishable goods up to 2 cwt. may be carried, newspapers may be carried, (b) perishable goods may be carried through, ordinary goods may be carried through.

LANE, A. L. (trading as South-Western Roadways), 159 Raglan-parade, Warrnambool; application for renewal of licence No. A.3054 (expiring 13th September, 1953) authorizing operations as follows:—(a) School service between Mortlake and Terang Higher Elementary School, under contract to the Education Department, (b) the holder of this licence is also the holder of licence Nos. A.2810, A.2811, and A.2812, which authorize the vehicles thereby licensed to be operated *inter alia* as stage omnibuses on certain routes and subject to certain conditions more particularly described in the additional conditions of licence documents appended to such licences, the vehicle hereby licensed may be operated on the said stage omnibus routes only and not elsewhere in substitution for but not in addition to any vehicle licensed by the other said "A" licences numbered as aforesaid, and when so operated shall adhere and be subject to all of the terms and conditions to which the said "A" licences are subject.

(Note.—Formerly issued in the joint name of A. L. Lane and F. E. Hitchcock, trading as Hitchcock and Lane.)

LANE, A. L. (trading as South-Western Roadways), 159 Raglan-parade, Warrnambool; application for variation of licence No. A.3054 to include ability to operate for the carriage of school children/teachers of the Terang High School to sports meetings, educational excursions, situated within a radius of 50 miles of Terang as and when required by the Terang High School.

LANE, A. L. (trading as South-Western Roadways), 159 Raglan-parade, Warrnambool; application for renewal of licence Nos. A.2810, A.2811, and A.2812 (expiring 12th September, 1953) authorizing operations as follows:—As stage omnibuses on the following routes:—

1. (a) Between the Terang Railway Station and the Mortlake Post Office, via Noorat, (b) between Mortlake and the racecourses at Colac, Camperdown, Terang, and Darlington respectively, (c) between the township and racecourses at Colac, Camperdown, Mortlake, and Terang respectively, journeys shall not be made on the routes defined in parts (b) and (c) of "routes" above other than on days when public race meetings are held at the said racecourses, (d) between Mortlake and Warrnambool, via Ballangeich and Purnim, on Saturday nights only, so as to depart from Mortlake at 6.30 p.m. and to depart from Warrnambool upon the return journey at 12.30 a.m. on Sunday, (e) passengers may be carried at separate and distinct fares for each passenger on the routes defined in parts (a), (b), and (c) of "routes" above, (f) on the route defined in part (d) of "routes" above, no passengers shall be taken up or set down between Purnim and Warrnambool.

2. Goods may be carried to or from any place on the route defined in part (a) of "routes" above, subject to the following conditions:—(a) Mails and parcels may be carried but so that the weight of any one parcel so carried shall not exceed 14 lb., and so that the total weight of parcels carried on any vehicle at any one time shall not exceed 56 lb., (b) perishable goods up to but not exceeding a total weight of 3 cwt. may also be carried, provided that such perishable goods are carried in a properly-constructed box at the rear of the vehicle or vehicles, (c) no goods shall be carried on the routes defined in parts (b) and (c) of "routes" above.

3. In addition to operating on the route defined in part (a) of "routes" above, the vehicles as incidental to any journey may for the purpose of taking up and setting down passengers deviate from such route, but such deviation shall not exceed the following limits, that is to say:—(a) Within the limits of the township of Mortlake and/or the township of Terang, (b) such deviation shall be made only before or after the commencement or termination of any journey specified in the schedule of time-tables as approved by the Transport Regulation Board from time to time, and shall not affect the maintenance of

the time-tables as aforesaid, (c) when a vehicle makes a deviation from the route as above mentioned an extra charge may be made to the passengers who are taken up or set down, and such charge shall be on the basis of 1s. per mile for half the extra distance involved.

4. The vehicle licensed by licence No. A.2812 may also be operated for the carriage of passengers at separate and distinct fares for each passenger within a radius of 5 miles from the post office at Mortlake.

5. The vehicle licensed by licence No. A.2812 may also be operated for the carriage of passengers otherwise than at separate and distinct fares for each passenger within a radius of 50 miles from the post office at Mortlake.

6. Specified day tours from Mortlake:—(A) From Mortlake to Warrnambool, via Ellerslie, returning via the same route or alternatively via Terang, (B) from Mortlake to Port Campbell, via Terang, Nirranda, Nullawarre, and Peterborough, returning via the same route or alternatively via Timboon, Cobden, and Terang, (C) from Mortlake to Port Fairy, via Hexham and Koroit, returning via the same route or alternatively via Warrnambool, (D) from Mortlake to Portland, via Hexham, Koroit, and Port Campbell, or alternatively via Heywood and Woolsthorpe, (E) from Mortlake to The Grampians, via Lake Bolac and Ararat, returning via the same route or alternatively via the Victorian Valley and Lake Bolac, (F) from Mortlake to Lorne, via Camperdown and Colac, returning via the same route or alternatively via Apollo Bay and Colac, (G) from Mortlake to Mt. Eccles, via Hawkesdale South, returning via the same route, (H) from Mortlake to Melba Gully, via Terang, Nirranda, Nullawarre, Peterborough, and Port Campbell, returning via the same route or alternatively via Colac, (I) from Mortlake to Tower Hill Crater, via Ellerslie and Warrnambool, returning via the same route.

7. The vehicle licensed by licence No. A.2810 may also be operated as a special service omnibus within a radius of 20 miles from the post office at Mortlake and from Mortlake to Port Campbell, Lismore, Warrnambool, Camperdown, Cobden, Derrinalum, Colac, and Hamilton.

LANE, A. L. (trading as South-Western Roadways), 159 Raglan-parade, Warrnambool; application for variation of licence No. A.2810 and collateral licences to delete from conditions of renewal referred to above in parts 1, 2, 3, 6, and 7, and instead to include ability to operate as follows:—*Stage Omnibus Routes*:—(1) Between Terang and Mortlake, via Noorat, (2) between Mortlake and the racecourses at Colac, Camperdown, Terang, Darlington, Koroit, Port Fairy, and Warrnambool, (3) between the township and the racecourses at Colac, Camperdown, Terang, Darlington, Koroit, Port Fairy, and Warrnambool, (4) between Mortlake and showgrounds/football grounds at the following places:—Port Fairy, Warrnambool, Terang, Camperdown, Cobden, Colac, Noorat, Koroit, (5) between Mortlake and Mt. Fyans. *Carriage of Passengers—Conditions*: Passengers may be carried at separate and distinct fares for each passenger on the routes defined in parts (a), (b), (c), (d), (e), and (f). *Carriage of Goods—Conditions*: (1) Goods may be carried to or from any place on the routes defined in parts (a), (f), (2) mails and newspapers may be carried, parcels may be carried so that the total weight shall not exceed 3 cwt., (3) perishable goods may be carried so that the total weight shall not exceed 3 cwt. *Touring operations*: Passengers may join the vehicle and finally leave the vehicle at Mortlake or at some place within a radius of 10 miles of Mortlake Post Office. *Special Service operations*: To operate within a radius of 50 miles of Mortlake. *Interchangeability* with other large-seating capacity vehicles operated by the applicant (excepting school services).

LANE, A. L. (trading as South-Western Roadways), 159 Raglan-parade, Warrnambool; application for variation of licence No. A.2811 to include the ability to operate for the carriage of school children between Mortlake-North Station-Mortlake, under contract to the Education Department.

PYKE, A. G., 26 Carlisle-street, St. Kilda; 1 commercial passenger vehicle, with seating capacity for five persons, to operate as follows:—(a) At separate and distinct fares within a radius of 5 miles of Avoca Post Office, (b) under private hire conditions within a radius of 50 miles of Avoca Post Office.

APPPLICATIONS for licences to operate commercial passenger vehicles, with seating capacity for five persons, for the carriage of passengers throughout Victoria, otherwise than at separate and distinct fares for each passenger:—

MULLER, E., Thornton.
FLETCHER, M. C., Marine-parade, Lorne.

Notice of any objection should be forwarded to reach the Secretary to the Board not later than Wednesday, 2nd September, 1953.

E. V. FIELD,
Secretary.

Exhibition Buildings, Rathdown-street, Carlton, N.3,
19th August, 1953.

Transport Regulation Acts.
TRANSPORT REGULATION BOARD.

NOTICE No. 3.

Geelong Urban District.

APPROVAL OF STAND FOR COUNTRY STAGE OMNIBUSES.

TAKE notice that, pursuant to the powers conferred on the Board by the provisions of the Transport Consolidated Regulations as to the appointment and approval of stands for licensed commercial passenger vehicles, the Board hereby approves, in accordance with the provisions of Regulation 5 of Part I. of the said Regulations, of the stand herein notified for the use of such vehicles, the licences in respect of which are classified as country stage omnibus licences.

WITHIN THE MUNICIPALITY OF THE CITY OF GEELONG.

Street; Location; Purpose.

Little Malop-street: north side, extending from a point 30 feet east of the building alignment at the east corner of Jacobs-street and Little Malop-street, and thence along the north side of Little Malop-street to a point 30 feet west of the western building alignment of McCann and Little Malop streets; terminal point of country stage omnibuses—stand for six vehicles.

By order of the Transport Regulation Board,

E. V. FIELD,
Secretary.

Transport Regulation Acts.
TRANSPORT REGULATION BOARD.

NOTICE No. 4.

Appointment of an Inspector.

TAKE notice that, pursuant to powers conferred on the Board by the provisions of the Regulation 4 of Part I. of the Transport Consolidated Regulations, the Board hereby notifies the appointment as an Inspector of—

JOSEPH WILLIAM LAWRENCE BULL

whilst such person is in uniform within the corporate limits of the City of Geelong and during the period of his appointment as By-laws and Traffic Officer of the said Council.

By order of the Transport Regulation Board,

E. V. FIELD,
Secretary.

Hospitals and Charities Act 1948 (No. 5300).

PETITION TO INCORPORATE EDENHOPE AND DISTRICT HOSPITAL.

IT is hereby notified, in accordance with the provisions of section 46 (2) and section 64 of Act No. 5300, that the Hospitals and Charities Commission of Victoria has received a petition signed by not less than twenty-five contributors to the Edenhope and District Hospital, an Institution capable of incorporation under the provisions of the said Act, praying that the said Hospital be incorporated.

If a counter petition signed by an equal or greater number of contributors is not lodged with the aforesaid Commission within one month after the publication of this notice, the Governor in Council may, by Order made pursuant to Act No. 5300 and published in the *Government Gazette*, declare the contributors for the time being to the said hospital to be a body corporate by the name set forth in such Order.

WM. BARRY,
Minister of Health.

Marketing of Primary Products Act 1935 (No. 4337).

THE EGG AND EGG PULP MARKETING BOARD.

BY Proclamation published in the *Government Gazette* No. 691, Wednesday, 12th August, 1953, the Governor in Council provided and declared that all eggs (with certain exceptions) coming into existence within a period of two years from the 16th day of August, 1953, shall become vested in and be delivered by producers to the Egg and Egg Pulp Marketing Board or its authorized agents.

The Egg and Egg Pulp Marketing Board, by this public notice, directs that eggs (excepting eggs which are exempt from delivery according to section 19 of the *Marketing of Primary Products Act 1935*, No. 4337), shall be delivered to the Board, or its authorized agents, at any one or more of the following grading and selling floors and/or receiving depots:—

BOARD OPERATED RECEIVING, GRADING, AND SELLING FLOORS.

Ballarat Grading Floor.—Peel-street north, Ballarat.
Box Hill Grading Floor.—Corner Whitehorse-road and Market-street, Box Hill.
Horsham Grading Floor.—79 Wilson-street, Horsham.
Oakleigh Grading Floor.—Broadway, Oakleigh.

BOARD OPERATED RECEIVING AND SELLING DEPOTS.

Hamilton Receiving Depot.—97 French-street, Hamilton.

AUTHORIZED AGENTS' RECEIVING, GRADING, AND SELLING FLOORS.

Ararat and District Co-operative Butter Factory Pty. Ltd.
—Vincent-street, Ararat.

Austral Grain and Ambler Pty. Ltd.—46 King-street, Melbourne.

Ballantyne, K. L. Pty. Ltd.—Grant-street, South Melbourne.

British United Dairies Pty. Ltd.—33-35 King-street, Melbourne.

Butt and Gardiner.—Beach-street, Frankston.

Chanter, R. J.—Kirkland-avenue, Euroa.

City Egg Distributors.—Lynch-street, Footscray.

Crystal Egg Company.—Garsed-street, Bendigo.

Eastern Co-operative Society Ltd.—Railway-crescent, Croydon.

Geelong and Cressy Trading Co. Ltd.—138 Malop-street, Geelong.

Goulding, J. F.—12 Lonsdale-street, Dandenong.

Hinks and Girvan.—High-street, Maryborough.

Hunter, W. B.—139 High-street, Shepparton.

Hunter, W. B.—22 Carrier-street, Benalla.

Hunter, W. B.—Lake-road, Kyabram.

Field, T. H.—6 Union-street, Sale.

Kenny, J. G.—Murchison.

Mildura Co-operative Producers' Egg Floor Society Ltd.—Langtree-avenue, Mildura.

Moore and Gove.—163 Scott-street, Warracknabeal.

Nettelbeck and Stalker.—Upper Region-street, Dimboola.

Neylon, T. J., and Sons.—150 Smith-street, Thornbury.

Ovens and Murray Trading Co.—30 Reid-street, Wangaratta.

Parker, S. K.—53 Hovell-street, Wodonga.

Pryddersch, T. A.—1 Seaby-street, Stawell.

Royle, Wm., and Son.—483 Flinders-lane, Melbourne.

Soding Bros. (Melb.) Pty. Ltd.—468 Flinders-lane, Melbourne.

Soding Bros. (Melb.) Pty. Ltd.—66 Moyston-street, Castlemaine.

Soding Bros. (Melb.) Pty. Ltd.—High-street, Charlton.

Sympag Pty. Ltd.—Camp-street, Kangaroo Flat (Bendigo).

Taylor, J. R., and Co. Pty. Ltd.—186 Bridport-street, Albert Park.

United Poultry Farmers' Co-operative Society Ltd.—124 Bell-street, East Preston.

Ziersch, L. L.—145 Kepler-street, Warrnambool.

LICENSED COLLECTORS.

Bilton, H.—Durmdas-street, St. Arnaud.

Lancaster, M. J.—Kaniva.

O'Connell, M. E. (Miss).—Wood-street, Donald.

Rodda, W. T.—316 Main-street, Bairnsdale.

Seletto, C. (Miss).—Biggs-lane, Warragul.

Borwick, P. B. and R. W.—Murray-street, Colac.

K. G. LEE,
Secretary.

MILDURA URBAN WATER TRUST.

RATING BY-LAW.

ON the 16th July, 1953, in accordance with the approved estimates, the Mildura Urban Water Trust doth hereby make a rate for the supply of water for domestic purposes of One shilling (1s.) in the pound (£1) of the municipal valuation of lands and tenements liable to be rated within its district.

Provided that in no case shall the amount of rate payable per annum in respect of any tenement (other than on land on which there is no building) be less than Seventy shillings (70s.), and in respect of any land on which there is no building be less than Thirty-five shillings (35s.)

On villa lots (for irrigation purposes only) a rate of One hundred and Ninety-two shillings per acre on planted land or land receiving water.

The above rates to be payable in one amount on the 30th September, 1953, and if not paid by the 30th November, 1953, to bear interest at the rate of Six per cent. (6%) per annum from 30th September, 1953, to the date of payment.

The common seal of the Mildura Urban Water Trust was hereto affixed by direction of the said Trust by—

E. J. ROBBINS, Secretary.

in the presence of—

(SEAL) J. S. SHELLIDAY, Commissioner.
C. G. EVANS, Commissioner.

Approved by the Governor in Council, 11th August, 1953.
A. MAHLSTEDT, Clerk of the Executive Council.

MILDURA URBAN WATER TRUST.

By-Law.

MILDURA URBAN WATER TRUST, pursuant to and in exercise and execution of the powers conferred on it by the Mildura Irrigation and Water Trusts Acts and the Water Acts, doth hereby make the By-law following:—

The maximum quantity of water to be supplied in any one year without further charge to any property rated by the Trust is hereby fixed at the quantity, which at a charge of One shilling and three pence per thousand gallons would produce an amount equal to the amount of the rate levied on such property for the said year.

The charge for water supplied by measure to any property rated by the Trust in excess of such maximum quantity, computed as in the last preceding clause, is hereby fixed at Eleven pence per thousand gallons, which shall be payable on demand.

The foregoing By-law, made and passed by the Mildura Urban Water Trust, and its common seal was hereto affixed by direction of the said Trust on 16th July, 1953, by—

E. J. ROBBINS, Secretary.

in the presence of—

(SEAL) J. S. SHELLIDAY, Commissioner.
C. G. EVANS, Commissioner.

Approved by the Governor in Council, 11th August, 1953.
A. MAHLSTEDT, Clerk of the Executive Council.

SHIRE OF BET BET.—DUNOLLY WATER SUPPLY.

RATING BY-LAW FOR THE YEAR 1952-53.

THE Council of the Shire of Bet Bet, in pursuance and exercise of the powers conferred by the Water Acts, doth hereby make a rate for the supply of water for domestic purposes of Three shillings and six pence in the pound on the annual municipal valuation of lands and tenements liable to be rated within the Dunolly Water Supply District.

Provided that in no case shall the amount of the rate payable per annum in respect of any tenements (other than land on which there is no building) be less than Eighty shillings (80s.), and in respect of any land on which there is no building less than Twenty shillings.

Such rates are made and shall be levied upon the occupiers or owners of the said lands and tenements for the year commencing 1st day of October, 1952, and ending 30th day of September, 1953, and shall be payable on the 25th day of August, 1953, at the office of the Council, Dunolly.

The maximum quantity of water to be supplied in any one year without further charge to any property rated by the Council is hereby fixed at the quantity which, at

a charge of One shilling and ten pence per 1,000 gallons, would produce an amount equal to the amount of rate levied on such property for the year.

The charge for water supplied by measure to any property rated by the Council in excess of such maximum quantity, computed as in the last preceding clause, is hereby fixed at One shilling and six pence per 1,000 gallons.

The charge for water supplied by measure to any property not rated by the Council is hereby fixed at One shilling and ten pence per 1,000 gallons, and the minimum quantity of water to be charged for in cases where water is so supplied is hereby fixed at 44,000 gallons.

The charge for water supplied by measure shall be payable, on demand, at the office of the Council, Dunolly.

Passed this 30th day of July, 1953, and the common seal of the Council affixed in the presence of—

(SEAL) W. K. CAMERON, President.
G. H. WHITEHEAD, Councillor.
J. B. OGLE, Secretary.

Approved, 10th August, 1953.—C. P. STONEHAM, Minister of Water Supply.

SHIRE OF BET BET.

TARNAGULLA WATER SUPPLY.

Rating By-law for the Year 1952-53.

THE Council of the Shire of Bet Bet, in pursuance and exercise of the powers conferred by the Water Acts, doth hereby make a rate for the supply of water for domestic purposes of Four shillings in the pound of the annual municipal valuation of lands and tenements liable to be rated within the Tarnagulla Water Supply District.

Provided that in no case shall the amount of rate payable per annum in respect of any tenement (other than land on which there is no building) be less than Ninety-five shillings (95s.), and in respect of any land on which there is no building less than Twenty shillings (20s.).

Such rates are made and shall be levied upon the occupiers or owners of the said lands and tenements for the year commencing the 1st day of October, 1952, and ending the 30th day of September, 1953, and shall be payable on the 25th day of August, 1953, at the office of the Council, Dunolly.

The maximum quantity of water to be supplied in any one year without further charge to any property rated by the Council is hereby fixed at the quantity which, at a charge of One shilling and ten pence per 1,000 gallons, would produce an amount equal to the amount of rate levied on such property for the year.

The charge for water supplied by measure to any property rated by the Council in excess of such maximum quantity, computed as in the last preceding clause, is hereby fixed at One shilling and six pence per 1,000 gallons.

The charge for water supplied by measure to any property not rated by the Council is hereby fixed at One shilling and ten pence per 1,000 gallons, and the minimum quantity of water to be charged for in cases where water is so supplied is hereby fixed at 52,000 gallons.

The charge for water supplied by measure shall be payable, on demand, at the office of the Council, Dunolly.

Passed this 30th day of July, 1953, and the common seal of the Council affixed in the presence of—

(SEAL) W. K. CAMERON, President.
G. H. WHITEHEAD, Councillor.
J. B. OGLE, Secretary.

Approved, 10th August, 1953.—C. P. STONEHAM, Minister of Water Supply.

EDUCATION DEPARTMENT.

SUMMONING OFFICER.

I HEREBY appoint the under-mentioned person, under section 31 of the *Education Act 1928*, to summon parents within the State of Victoria:—

Sergeant JOHN CHARLES WHITE, No. 8496.

A. E. SHEPHERD,

Minister of Education.

Melbourne, 10th August, 1953.

BUSINESS AGENTS ACT 1930.

IN accordance with the provisions of the above-mentioned Act, the following is published for general information:—

(a) List of Business Agent's Licences issued during the month of July, 1953, and prior months.

Name.	Principal Place of Business (Registered Office).	Name of Firm or Partnership.	Date from which Licence is Effective.
Andrews, J. F.	257 Toorak-road, South Yarra	J. S. Andrews	13.7.53
Ashworth, A. W.	171 McKinnon-road, McKinnon		21.7.53
Beggs, E. S.	Flat 1, 18 Essex-street, Glen Iris		22.7.53
Bloomfield, R. R.	214A Drummond-street south, Ballarat		1.7.53
Brook, H. C.	Wyunna-road, Kyabram		2.7.53
Brown, A. P. G.	Croydon Market, Croydon		8.7.53
Caldwell, W. A.	372 Barkly-street, Elwood		8.7.53
Campbell, H. E.	1 Beatty-avenue, Glenroy		29.5.53
Carr, J. M.	37 Malop-street, Geelong	Walter L. Carr and Co.	17.7.53
Carr, K. L.	37 Malop-street, Geelong	Walter L. Carr and Co.	17.7.53
Carr, P. M.	37 Malop-street, Geelong	Walter L. Carr and Co.	17.7.53
Considine, G. A.	Rutherglen-road, Newborough	Considine and Rose	29.7.53
Eccles, P. M.	195 Canterbury-road, Canterbury		27.7.53
Finning, J. C.	High-street, Cranbourne	Cranbourne Real Estate and Business Agency	1.7.53
Fisher, R. A. I.	10 Victoria-road, Camberwell		14.7.53
Fordham, O. L.	79 Warrigal-road, Oakleigh	Fordham Estate Agency	6.7.53
Healey, L. R.	27 Glenhuntly-road, Elsternwick	Adams and Barlow	16.7.53
Hosfal, E.	239 Collins-street, Melbourne	Mahony's Agency	14.7.53
Hume, K. S.	2A Atherton-road, Oakleigh		24.7.53
Hunt, B. H.	93 Malop-street, Geelong	Hunt, Pegg, and Hogarth	5.6.53
James, F. R.	62 Forrest-street, Sunshine	Sunshine West Real Estate Agency, F. R. James and Co.	21.7.53
Lacey, R. A.	348 Orrong-road, Caulfield North	F. G. Keys and Co.	28.7.53
McLean, H. G.	Canterbury-road, Heathmont	Heathmont Estate Agency	14.7.53
MacMillan, J. P.	311 Toorak-road, South Yarra	"Anacortes"	2.7.53
Rose, G. J.	Rutherglen-road, Newborough	Considine and Rose	29.7.53
Smith, G.	324 High-street, Windsor	The Vicki Estate Agency	18.6.53
Turner, J. E.	Flat 4, 379 Toorak-road, South Yarra		28.7.53
Wilson, V. S.	1 Fernhill-road, Sandringham, and 405 Collins-street, Melbourne		15.7.53
*Youngusband Ltd. (N. M. R. Lees, nominee)	94 King-street, Melbourne		2.7.53

* Transfer of Nominee.

(b) List of Business Agents Sub-Agent's Licences issued during the month of July, 1953, and prior months.

Name.	Registered Address.	Date from which Licence is Effective.	Name.	Registered Address.	Date from which Licence is Effective.
Belch, W. W.	7 New-street, Hampton	25.6.53	Lightfoot, L. G.	104 Wills-street, Bendigo	16.7.53
Davey, W. A.	c/o Elder Smith and Co. Ltd., Warracknabeal	22.7.53	Linauskas, E.	11 Airlie-avenue, East Prahran	30.7.53
Davies-Graham, A. G.	16 Violet-grove, East Kew	29.7.53	Luers, M.	Widdecombe-street, Casterton	29.7.53
Downie, W. C.	14 Fowler-street, Box Hill	23.7.53	McLean, H.	81 Abbotsford-street, North Melbourne	6.7.53
Edmands, W. H.	64 Gallipoli-parade, Pascoe Vale	30.6.53	Mann, P. O.	3 Estella-street, Glen Iris	2.7.53
Fitzgerald, C. P.	Main-road, Gembrook	22.7.53	Mason, K. T.	Carisbrook	30.7.53
Forbes, R.	3 Bendigo-crescent, Bendigo	16.7.53	Pearl, E. F.	Flat 4, 10 Scott-street, Elwood	7.7.53
Frankish, W. T. W.	169 Nepean Highway, Seaford	7.7.53	Phillips, P. I.	13 Whitmuir-road, Bentleigh	7.7.53
Garde, G. T.	51 Riversdale-road, Camberwell	16.7.53	Reid, L. I.	4 Esplanade-avenue, Brighton Beach	2.7.53
Griffin, N. J.	20 Seymour-road, Elsternwick	1.7.53	Sinclair, L. S.	29 Campbell-street, Coburg	16.7.53
Haywood-Williams, J. H.	137 Bradshaw-street, Essendon	14.7.53	Wadley, J. W.	42 Green-street, Wangaratta	20.7.53
Jeffreys, E. R.	1 Clarke-street, Casterton	29.7.53	Wilson, J. A.	15 McCracken-street, Essendon	15.7.53
Larsen, M. J.	23 Atkinson-street, Oakleigh	6.7.53	Wright, F. D. G.	Flat 2, 14 Arnold-street, South Yarra	21.7.53

The Treasury,
Melbourne, C.2, 10th August, 1953.

M. A. R. SYNNOT,
Registrar.

AUCTION SALES ACT 1928.

LIST of Persons to whom Auctioneers' Licences have been issued during the month of July, 1953.

Name.	Address.	Date of Issue.
Annetts, R. J.	74 David-street, Preston	3.7.53
Browster, G. W.	Leongatha	23.7.53
Coppel, N. G.	168 Cochrane-street, Elsternwick	20.7.53
Gibson, B. S.	297 Lonsdale-street, Dandenong	31.7.53
Kim, H. C.	30 Lily-street, Altona	27.7.53
*Palmer, B.	Bunyip	3.7.53
Wood, C. C.	Cohuna	23.7.53

* By transfer from J. W. Kavanagh.

The Treasury,
Melbourne, C.2, 10th August, 1953.

A. T. SMITHERS,
Director of Finance.

REAL ESTATE AGENTS ACTS.

IN accordance with the provisions of the above-mentioned Acts, the following is published for general information:—

(a) List of Real Estate Agent's Licences issued during the month of July, 1953, and prior months.

Name.	Principal Place of Business (Registered Office).	Name of Firm or Partnership.	Date from which Licence is Effective.
Andrews, J. F.	257 Toorak-road, South Yarra	J. S. Andrews	13.7.53
Ashworth, A. W.	171 McKinnon-road, McKinnon		21.7.53
Barlow, F. F. S.	Cr. Warrigal-road and Mills-street, Cheltenham		29.7.53
Beggs, E. S.	Flat 1, 18 Essex-street, Glen Iris		22.7.53
Bloomfield, R. R.	214A Drummond-street south, Ballarat		1.7.53
Brown, A. M.	Kent-avenue, Croydon	Max Brown	28.7.53
Brown, A. P. G.	Croydon Market, Croydon		8.7.53
Caldwell, W. A.	372 Barkly-street, Elwood		8.7.53
Campbell, H. E.	1 Beatty-avenue, Glenroy		29.5.53
Carr, J. M.	37 Malop-street, Geelong	Walter L. Carr and Co.	17.7.53
Carr, K. L.	37 Malop-street, Geelong	Walter L. Carr and Co.	17.7.53
Carr, P. M.	37 Malop-street, Geelong	Walter L. Carr and Co.	17.7.53
Carroll, F. M.	Cobram	W. A. McTaggart and Co.	29.7.53
Chapman, K.	19-21 Suffolk-road, Sunshine		14.7.53
Considine, G. A.	Rutherglen-road, Newborough	Considine and Rose	29.7.53
Ellis, A. C.	Main-street, Lilydale		10.7.53
Finning, J. C.	High-street, Cranbourne	Cranbourne Real Estate and Business Agency	1.7.53
Fisher, R. A. I.	10 Victoria-road, Camberwell		14.7.53
Fordham, O. L.	79 Warrigal-road, Oakleigh	Fordham Estate Agency	6.7.53
Healey, L. R.	27 Glenhuntly-road, Elsternwick	Adams and Barlow	16.7.53
Hehir, J.	Girgarre		23.7.53
Henderson, R. D.	Nepean Highway, Rosebud	Rosebud Real Estate Agency	7.7.53
Hosfal, E.	239 Collins-street, Melbourne	Mahony's Agency	14.7.53
Hosken, F. M.	315 Williamstown-road, Yarraville	Chas. Hosken	1.7.53
Hume, K. S.	2A Atherton-road, Oakleigh		24.7.53
James, F. R.	62 Forrest-street, Sunshine	F. R. James and Co., Sunshine West Real Estate	21.7.53
Jones, J. H.	9 Bath-street, Ballarat	Blomeley and Jones	31.7.53
Lacey, R. A.	348 Orrong-road, Caulfield North	F. G. Keys and Co.	28.7.53
Leeden, D. M.	57 Wilson-street, Middle Brighton	Brighton Estate Agency	25.6.53
McClellan, D. L. M.	422 Collins-street, Melbourne, and 34 Washing-ton-street, Toorak	Jas. McClellan	20.7.53
McDougall, W. K.	15 Charlotte-place, St. Kilda	Astor Estate Agency	14.7.53
McLean, H. G.	Canterbury-road, Heathmont	Heathmont Estate Agency	14.7.53
MacMillan, J. P.	311 Toorak-road, South Yarra	"Anacortes"	2.7.53
McNaughton, P. I.	16 Dudley-street, Brighton		16.7.53
Matthews, P. J.	113 Rose-street, West Coburg	Simon Dare	2.7.53
Miethe, B. C.	Willaura		3.7.53
Paynter, G. H. W.	Kyabram		23.7.53
Redcliffs Co-operative Packing Co. Ltd. (R. H. Tate, nominee)	Fitzroy-avenue, Redcliffs		9.7.53
Rose, G. J.	Rutherglen-road, Newborough	Considine and Rose	29.7.53
Rose, L. J.	Cobram		3.6.53
Ross, J. C.	470 High-street, Preston	James Ross and Co.	1.7.53
Turner, J. E.	Flat 4, 379 Toorak-road, South Yarra		28.7.53
Wagner, H. W.	5 Elphin-grove, Hawthorn		29.7.53
Wilson, V. S.	1 Fernhill-road, Sandringham, and 405 Collins-street, Melbourne		15.7.53
Wood, I. E.	Campbell-street, Swan Hill	H. A. Wood and Co.	2.7.53
*Younghusband Ltd. (N. M. R. Lees, nominee)	94 King-street, Melbourne		2.7.53

* Transfer of Nominee.

(b) List of Real Estate Sub-Agent's Licences issued during the month of July, 1953, and prior months.

Name.	Registered Address.	Date from which Licence is Effective.	Name.	Registered Address.	Date from which Licence is Effective.
Aarons, M. W.	49 John-street, Elwood	17.7.53	Finlayson, D. G.	25 Hilda-street, Balwyn	28.7.53
Barclay, V.	29 Docker-street, Wangaratta	6.7.53	Fitzgerald, C. P.	Main-road, Gembrook	22.7.53
Beach, D.	1 Yoorings-avenue, Norlane	17.7.53	Flintoff, E.	5 Loloma-court, Burwood	20.7.53
Beck, R. F.	7 Kilrush-street, Brighton	10.7.53	Frankish, W. T. W.	169 Nepean Highway, Seaford	7.7.53
Becker, C. J.	Veldt-street, Nathalia	27.7.53	French, M. E.	48 Foster-street, South Geelong	17.7.53
Belch, W. W.	7 New-street, Hampton	25.6.53	Frost, M. J.	Osborne-avenue, North Geelong	21.7.53
Best, D. L.	4 Paisley-street, Footscray	30.7.53	Garde, G. T.	51 Riversdale-road, Camberwell	16.7.53
Brain, P. M.	2 Ann-street, Wodonga	23.7.53	Gillespie, A. R.	126 Darling-road, East Malvern	8.7.53
Brown, R. E.	86 Cochrane-street, Gardenvale	30.6.53	Glassel, N. W.	16 Canberra-road, Toorak	30.7.53
Burlakow, J.	324 High-street, Windsor	18.6.53	Griffin, N. J.	20 Seymour-road, Elsternwick	1.7.53
Chaffey, B. J. H.	Kardella	23.7.53	Hardy, J. R.	Bryson's-road, South Warrandyte	28.7.53
Clifton, C. H. B.	Willaura	24.7.53	Hedge, L. H.	c/o Dalgety and Co. Ltd., Pen-hurst	5.5.53
Cope, A. B.	59 Godfrey-street, East Geelong	28.7.53	Hume, G. R.	Fussell-road, Kilsyth	8.7.53
Cramp, C. V.	16 Desmond-avenue, Highett	1.7.53	Jeffreys, E. R.	1 Clarke-street, Casterton	29.7.53
Culley, M. J.	16A Albany-road, Toorak	29.7.53	Johnston, H. G.	31 South-road, Brighton Beach	30.6.53
D'Arcy, T. J. G.	369 Dandenong-road, Armadale	30.6.53	Jupp, B. I. A.	81 Hotham-street, East St. Kilda	31.7.53
Davey, W. A.	c/o Elder Smith and Co. Ltd., Mortlake	22.7.53	Jupp, L. S.	81 Hotham-street, East St. Kilda	31.7.53
Davies-Graham, A. G.	16 Violet-grove, East Kew	29.7.53	Kinross, C. G.	161 Peel-street, Kew	8.7.53
Differding, P.	355 Barkly-street, Footscray	23.7.53	Larson, M. J. B.	23 Atkinson-street, Oakleigh	6.7.53
Downie, W. C.	14 Fowler-street, Box Hill	23.7.53	Leske, R. E.	9 Gibson-street, Box Hill South	9.7.53
Dunn, T. J.	10 Tennyson-street, Footscray	20.7.53	Lightfoot, L. G.	104 Wills-street, Bendigo	16.7.53
Edmands, W. H.	64 Gallipoli-parade, Pascoe Vale	30.6.53	Linauskas, E.	11 Airlie-avenue, East Prahran	30.7.53
			Lipman, J. R.	6 Helen-street, North Geelong	17.7.53

REAL ESTATE AGENTS ACTS—continued.

List of Real Estate Sub-Agent's Licences issued during the month of July, 1953, and prior months—continued.

Name.	Registered Address.	Date from which Licence is Effective.	Name.	Registered Address.	Date from which Licence is Effective.
Luers, M.	Widdecombe-street, Casterton	29.7.53	Phillips, P. I.	13 Whitmuir-road, Bentleigh	7.7.53
McCarty, W. T. L.	Campbell-street, Epping	29.7.53	Porter, M. McL.	115 Rosamond-road, Maidstone	6.7.53
Macdonald, R. A. D.	5 Elizabeth-street, Yarraville	2.7.53	Reid, L. I.	4 Esplanade-avenue, Brighton Beach	2.7.53
MacMillan, M.	311 Toorak-road, South Yarra	30.7.53	Robb, A. A.	c/o Victoria Hotel, Hamilton	24.7.53
Mann, P. O.	3 Estella-street, Glen Iris	2.7.53	Ruler, F. H.	Kyabram	20.7.53
Mason, K.	53 Nunn-street, Benalla	1.7.53	Ryan, R. W.	"Yaralla," Trafalgar	28.7.53
Mason, K. T.	Carisbrook	30.7.53	Salmon, H. J.	81 Melville-road, West Brunswick	1.1.53
Meade, W. T.	Port Campbell	1.7.53	Sidebottom, H. G.	Avenel	3.7.53
Menzies, A. J.	156 Doncaster-road, North Balwyn	30.7.53	Sinclair, L. S.	29 Campbell-street, Coburg	16.7.53
Montgomery, W. F.	Boston-road, Torquay	29.7.53	Spalding, K. M.	40 Benbow-street, Ararat	10.7.53
Morrow, H.	16 Melville-road, Pascoe Vale South	14.7.53	Stanway, G. C.	21 Park-street, South Yarra	25.6.53
Nolan, P. W.	c/o Gippsland and Northern Co-operative Co. Ltd., Wangaratta	6.7.53	Stinear, I. C.	40 Whitmuir-street, Bentleigh	10.7.53
Papworth, K. W.	78 O'Farrell-street, Yarraville	9.7.53	Sundborn, L. A.	3 Tunstall-avenue, Nunawading	9.7.53
Pearl, E. F.	10 Scott-street, Elwood	7.7.53	Tolley, L.	Williamson-street, Drouin	27.7.53
Phillips, G. C.	222a Beach-road, Black Rock	23.7.53	Vaughan, J. S.	74 Learmonth-street, Queenscliff	27.7.53
			Wadley, J. W.	42 Green-street, Wangaratta	20.7.53
			West, F. G.	May-road, Nottingham	20.7.53
			Wilson, J. A.	15 McCracken-street, Essendon	15.7.53
			Wright, F. D. G.	Flat 2, 14 Arnold-street, South Yarra	21.7.53

The Treasury,
Melbourne, C.2, 10th August, 1953.

M. A. R. SYNNOT,
Registrar.

MONEY LENDERS ACT 1938.

IN accordance with the provisions of the above-mentioned Act, the following is published for general information:—

Supplementary List of Persons to whom Money Lenders' Licences have been issued for the year ending 30th June, 1954.

Name.	Authorized Name.	Authorized Address.	Date of Issue.
Gaffney, G. T.	G. T. Gaffney carrying on business as G. T. Gaffney and R. K. McCleery	307 Sydney-road, Brunswick	15.7.53
Harris, J. W.	J. W. Harris	7 Railway-road, Blackburn	16.7.53
Latham, T. A.	T. A. Latham	704 Hawthorn-road, East Brighton	17.7.53
Lockwood, J. F.	J. F. Lockwood carrying on business as J. F. Lockwood and C. F. Mueller	231 High-street, Echuca	21.7.53
McCleery, R. K.	R. K. McCleery carrying on business as G. T. Gaffney and R. K. McCleery	307 Sydney-road, Brunswick	15.7.53
McKeown, W. J.	W. J. McKeown carrying on business as The W. J. McKeown Finance and Cash Order Co.	548 Sydney-road, Brunswick	17.7.53
Mueller, C. F.	C. F. Mueller carrying on business as J. F. Lockwood and C. F. Mueller	231 High-street, Echuca	21.7.53
Pemberton, M.	M. Pemberton	11 Millah-road, Balwyn	28.7.53

The Treasury,
Melbourne, C.2, 10th August, 1953.

M. A. R. SYNNOT,
Registrar.

NOTICE TO MARINERS.
[No. 19 of 1953.]

NOTICE TO MARINERS.
[No. 20 of 1953.]

AUSTRALIA.—VICTORIA.

AUSTRALIA.—VICTORIA.

GIPPSLAND LAKES.—ALTERATION IN LIGHT.

PORT PHILLIP—WEST CHANNEL—LIGHT-BEACON TO BE CONSTRUCTED.

Date.—On or about 3rd September, 1953.

Date.—On or about 20th August, 1953.

Position.—Western Pier Head Light, Lat. 37 deg. 53 min. S., Long. 147 deg. 58 min. E. (approximately).

Former Notice.—No. 12 of 1953 (1), (2); in force.

Details.—The fixed red light in the above position will be extinguished and replaced by a flashing red light every 5 seconds, thus:—Flash 0.5 sec. eclipse 4.5 sec.

Position.—No. 68 light-beacon (Woodriff)—50 feet north-east of former position and 037½ deg. distant 1.02 miles from No. 3R light-beacon (Tuckey). Lat. 38 deg. 14 min. 50 sec. S., Long. 144 deg. 43 min. 13 sec. E., (approximately).

Details.—By night, a fixed white light will be exhibited from the structure. Visibility—1 mile.

Abridged Description.—Fl. R. ev. 5 sec.

Caution.—During operations a red flag will be flown by the attendant vessel, and masters are warned that, in accordance with Port Rule 119, engines shall be slowed to less than half speed for at least half a cable before arriving abreast the works, and shall be kept so slowed until the works are passed. As breast anchors will be dropped to the westward, vessels should not under any circumstances have the leads open to the eastward when passing.

Publications Affected.—General Notice to Mariners Respecting Navigation in Victorian Waters, 1942, pages 256 and 325. Admiralty List of Lights, Vol. 10, 1952, No. 2548.

D. S. STEVENSON,

Port Officer.

D. S. STEVENSON,

Port Officer.

Ports and Harbors Branch,
Department of Public Works,
Melbourne, C.2, 13th August, 1953.

Ports and Harbors Branch,
Department of Public Works,
Melbourne, C.2, 17th August, 1953.

Stock Diseases Act 1928 (No. 3779).

QUARANTINE DISTRICTS UNDER REGULATION 37.

QUARANTINE restrictions imposed on the following properties have been removed:—

Name; Address.

Bennett, S.; Park-lane, Wangaratta.
Daldy, P. C.; Arcadia.
Ellwood, W. M.; Talgarno.
Hindle, J. and D.; Wangaratta.
King, P. C.; Benalla.
Paton, A. A. and A. J.; "Yabba," Tallangatta.
Paton, L. J.; "Timberlane," Tallangatta.
Walker, D.; "Moglonemby," Miepoll South.

R. J. DE C. TALBOT,
Chief Inspector of Stock.

Dairy Products Acts.

QUOTAS FOR BUTTER AND CHEESE.

BUTTER QUOTA.

ICLIVE PHILLIP STONEHAM, Minister of Agriculture in the State of Victoria, after consultation with the Victorian Dairy Products Board, and after ascertaining that the supply and distribution of butter at reasonable prices to consumers thereof in Victoria will be ensured, hereby determine a quota for butter as follows:—

The proportion shall be Seventy point nine one per cent.

The period for which this quota is to operate shall be the month of September, 1953.

CHEESE QUOTA.

ICLIVE PHILLIP STONEHAM, Minister of Agriculture in the State of Victoria, after consultation with the Victorian Dairy Products Board, and after ascertaining that the supply and distribution of cheese at reasonable prices to consumers thereof in Victoria will be ensured, hereby determine a quota for cheese as follows:—

The proportion shall be Sixty per cent.

The period for which this quota is to operate shall be the month of September, 1953.

C. P. STONEHAM
Minister of Agriculture.

13th August, 1953.

Benefit Associations Act 1953 (No. 5681).

CLAIMS AGAINST METROPOLITAN FUNERAL DIRECTORS PTY. LTD., formerly of 340 Collins-street, Melbourne (being an association ordered to be wound up by the Minister, under section twenty-six of the *Benefit Associations Act 1951*).

TAKE notice that any person (other than a contributor to the association or the personal representative of a contributor who has died) having any claim against the Metropolitan Funeral Directors Pty. Ltd. is required to lodge with the liquidator, at the office of the liquidator, particulars of his claim, in writing (verified by statutory declaration), before the 12th day of October, 1953, after which date the liquidator will proceed to the realization and distribution of the property of the association, having regard only to the claims of which he then has notice.

And further take notice that a provisional list of contributors of the association and personal representatives of contributors who have died may be inspected at the office of the liquidator, and any contributor or personal representative whose name does not appear on such list is required to lodge with the liquidator, at his office, particulars, in writing, in regard to his claim (together with any books, papers, and documents specified hereunder) to be a contributor or the personal representative thereof before the date specified aforesaid, after which date the liquidator will proceed to the realization and distribution of the property of the association, having regard only to the contributors and personal representatives provisionally listed and those of whose claims he then has notice.

Dated this 18th day of August, 1953.

E. T. SPACKMAN,
Liquidator.

The office of the liquidator is situate at c/o Government Statist's Office, 295 Queen-street, Melbourne (corner of Queen and Little Lonsdale streets, Room No. 7, Ground Floor).

The books, papers, and documents above referred to are—

In the case of a Contributor.—Certificate of registration or proof of date of commencing to contribute for funeral benefit, also the contribution card showing the latest date to which contributions have been paid.

In the case of a Personal Representative of a Deceased Contributor.—The above information as in the case of a contributor, together with proof that the claimant is the personal representative of the deceased contributor. Personal representative means the executor or administrator of the deceased contributor, but where some person other than such executor or administrator has paid or undertaken in writing to pay costs and expenses of the funeral, burial, or cremation of the deceased contributor of the above association and has not been reimbursed by the executor or administrator (if any) of the deceased contributor means that person. Undertaker's account must be produced.

Electric Light and Power Act 1928.

ORDER GRANTED BY THE GOVERNOR IN COUNCIL.

IT is hereby notified that an Order, pursuant to the provisions of the *Electric Light and Power Act 1928 (No. 3672)*, as hereunder mentioned, has been granted by His Excellency the Governor in Council, viz.:—

Order No. 281.—Order under section 10 of the above-mentioned Act granted to the Gunbower Co-operative Butter Factory and Trading Company Limited, in respect of the Township of Gunbower and environs.

A. MAHLSTEDT,
Clerk of the Executive Council.

At the Executive Council Chamber,
Melbourne 11th August, 1953.

LAW DEPARTMENT.—ATTORNEY-GENERAL.
COURT OF MINES.—ORDER REVOKED.

HIS Excellency the Administrator of the Government of the State of Victoria, by and with the advice of the Executive Council thereof, doth by Order made on the 11th day of August, 1953, revoke the Order in Council directing that the Court of Mines within and for the Mining District of Castlemaine to be held at Kyneton, as from and after the 31st December, 1953.

A. MAHLSTEDT,
Clerk of the Executive Council.

At the Executive Council Chamber,
Melbourne 11th August, 1953.

LAW DEPARTMENT.—ATTORNEY-GENERAL.
COURT OF GENERAL SESSIONS TO BE DISCONTINUED.

HIS Excellency the Administrator of the Government of the State of Victoria, by and with the advice of the Executive Council thereof, and in pursuance of the provisions of the *Justices Act 1928*, doth by Order made on the 11th August, 1953, direct that the Court of General Sessions of the Peace for the Midland Bailiwick at Kyneton cease to be held from and after the 31st December, 1953.

A. MAHLSTEDT,
Clerk of the Executive Council.

At the Executive Council Chamber,
Melbourne 11th August, 1953.

LAW DEPARTMENT.—ATTORNEY-GENERAL.
COURT OF GENERAL SESSIONS TO BE DISCONTINUED.

HIS Excellency the Administrator of the Government of the State of Victoria, by and with the advice of the Executive Council thereof, and in pursuance of the provisions of the *Justices Act 1928*, doth by Order made on the 11th August, 1953, direct that the Court of General Sessions of the Peace for the Central Bailiwick at Seymour cease to be held from and after the 31st December, 1953.

A. MAHLSTEDT,
Clerk of the Executive Council.

At the Executive Council Chamber,
Melbourne 11th August, 1953.

LAW DEPARTMENT.—ATTORNEY-GENERAL.
HOLDING OF COUNTY COURT AT CERTAIN PLACES DISCONTINUED.

HIS Excellency the Administrator of the Government of the State of Victoria, by and with the advice of the Executive Council thereof, and in pursuance of section 4 of the *County Court Act 1928*, doth by Order made on the 11th day of August, 1953, direct that the holding of the County Court at the places named hereunder be discontinued from and after the 31st December, 1953:—

Kyneton.
Seymour.

A. MAHLSTEDT,
Clerk of the Executive Council.

At the Executive Council Chamber,
Melbourne 11th August, 1953.

Apprenticeship Acts.

APPRENTICESHIP COMMISSION OF VICTORIA.

At the Executive Council Chamber, Melbourne, the eleventh day of August, 1953.

PRESENT:

His Excellency the Administrator of the Government of the State of Victoria.

Mr. Fraser | Mr. Shepherd.
Mr. Smith |

AMENDMENT OF AIRCRAFT MECHANIC TRADES APPRENTICESHIP REGULATIONS.

IN pursuance of the powers conferred by the Apprenticeship Acts, His Excellency the Administrator of the Government of the State of Victoria, by and with the advice of the Executive Council thereof, doth hereby, as from the beginning of the first pay period to commence in August, 1953, rescind Regulation 8 of the Aircraft Mechanic Trades Apprenticeship Regulations and substitute therefor the following:—

"8. The minimum rates of wages to be paid to apprentices in the said trades shall be as follows:—

Within 20 miles of G.P.O., Melbourne, within 10 miles of G.P.O., Geelong, at Warrnambool, and within Mildura and Gippsland Districts—

1st year—at the rate of 75s. 0d. per week.
2nd year—at the rate of 101s. 0d. per week.
3rd year—at the rate of 127s. 0d. per week.
4th year—at the rate of 195s. 0d. per week.
5th year—at the rate of 241s. 0d. per week.

At Yallourn—

1st year—at the rate of 77s. 6d. per week.
2nd year—at the rate of 104s. 0d. per week.
3rd year—at the rate of 130s. 6d. per week.
4th year—at the rate of 200s. 6d. per week.
5th year—at the rate of 247s. 6d. per week.

Other Parts of Victoria—

1st year—at the rate of 74s. 0d. per week.
2nd year—at the rate of 100s. 0d. per week.
3rd year—at the rate of 125s. 6d. per week.
4th year—at the rate of 192s. 6d. per week.
5th year—at the rate of 238s. 0d. per week."

AMENDMENT OF BOILERMAKING TRADES APPRENTICESHIP REGULATIONS.

IN pursuance of the powers conferred by the Apprenticeship Acts, His Excellency the Administrator of the Government of the State of Victoria, by and with the advice of the Executive Council thereof, doth hereby, as from the beginning of the first pay period to commence in August, 1953, rescind Regulation 8 of the Boilermaking Trades Apprenticeship Regulations and substitute therefor the following:—

"8. The minimum rates of wages to be paid to apprentices in the said trades shall be as follows:—

(1) With respect to the term of apprenticeship of five years—

1st year—at the rate of 75s. 0d. per week.
2nd year—at the rate of 101s. 0d. per week.
3rd year—at the rate of 127s. 0d. per week.
4th year—at the rate of 195s. 0d. per week.
5th year—at the rate of 241s. 0d. per week.

(2) With respect to the term of apprenticeship of four years—

1st year—at the rate of 80s. 0d. per week.
2nd year—at the rate of 127s. 0d. per week.
3rd year—at the rate of 195s. 0d. per week.
4th year—at the rate of 241s. 0d. per week."

AMENDMENT OF BOOTMAKING TRADES APPRENTICESHIP REGULATIONS.

IN pursuance of the powers conferred by the Apprenticeship Acts, His Excellency the Administrator of the Government of the State of Victoria, by and with the advice of the Executive Council thereof, doth hereby, as from the beginning of the first pay period to commence

in August, 1953, rescind Regulation 8 of the Bootmaking Trades Apprenticeship Regulations and substitute therefor the following:—

"8. The minimum rates of wages to be paid to apprentices in the said trades shall be as follows:—

(1) With respect to the term of apprenticeship of five years—

1st year—
1st six months—at the rate of 71s. 6d. per week.
2nd six months—at the rate of 89s. 0d. per week.

2nd year—
1st six months—at the rate of 107s. 0d. per week.
2nd six months—at the rate of 125s. 0d. per week.

3rd year—
1st six months—at the rate of 143s. 0d. per week.
2nd six months—at the rate of 166s. 6d. per week.

4th year—
1st six months—at the rate of 185s. 0d. per week.
2nd six months—at the rate of 203s. 0d. per week.

5th year—
1st six months—at the rate of 227s. 0d. per week.
2nd six months—at the rate of 244s. 0d. per week.

(2) With respect to the term of apprenticeship of four years—

1st year—
1st six months—at the rate of 89s. 0d. per week.
2nd six months—at the rate of 107s. 0d. per week.

2nd year—
1st six months—at the rate of 143s. 0d. per week.
2nd six months—at the rate of 166s. 6d. per week.

3rd year—
1st six months—at the rate of 185s. 0d. per week.
2nd six months—at the rate of 203s. 0d. per week.

4th year—
1st six months—at the rate of 227s. 0d. per week.
2nd six months—at the rate of 244s. 0d. per week.

(3) With respect to the term of apprenticeship of three years—

1st year—
1st six months—at the rate of 107s. 6d. per week.
2nd six months—at the rate of 143s. 0d. per week.

2nd year—
1st six months—at the rate of 185s. 0d. per week.
2nd six months—at the rate of 203s. 0d. per week.

3rd year—
1st six months—at the rate of 227s. 0d. per week.
2nd six months—at the rate of 244s. 0d. per week."

AMENDMENT OF BRICKLAYING TRADE APPRENTICESHIP REGULATIONS.

IN pursuance of the powers conferred by the Apprenticeship Acts, His Excellency the Administrator of the Government of the State of Victoria, by and with the advice of the Executive Council thereof, doth hereby, as from the beginning of the first pay period to commence in August, 1953, rescind Regulation 8 of the Bricklaying Trade Apprenticeship Regulations and substitute therefor the following:—

"8. The minimum rates of wages to be paid to apprentices in the said trade shall be as follows:—

1st year—at the rate of 70s. 8d. per week.
2nd year—at the rate of 94s. 10d. per week.
3rd year—at the rate of 132s. 6d. per week.
4th year—at the rate of 189s. 2d. per week.
5th year—at the rate of 243s. 10d. per week."

AMENDMENT OF BUTCHERING TRADES
APPRENTICESHIP REGULATIONS.

IN pursuance of the powers conferred by the Apprenticeship Acts, His Excellency the Administrator of the Government of the State of Victoria, by and with the advice of the Executive Council thereof, doth hereby, as from the beginning of the first pay period to commence in August, 1953, rescind Regulation 8 of the Butchering Trades Apprenticeship Regulations and substitute therefor the following:—

"8. The minimum rates of wages to be paid to apprentices in the said trades shall be as follows:—

- (1) With respect to the term of apprenticeship of five years—
 - 1st year—at the rate of 87s. 0d. per week.
 - 2nd year—at the rate of 116s. 0d. per week.
 - 3rd year—at the rate of 159s. 6d. per week.
 - 4th year—at the rate of 217s. 6d. per week.
 - 5th year—at the rate of 275s. 6d. per week.
- (2) With respect to the term of apprenticeship of four years—
 - 1st year—at the rate of 116s. 0d. per week.
 - 2nd year—at the rate of 145s. 0d. per week.
 - 3rd year—at the rate of 217s. 6d. per week.
 - 4th year—at the rate of 275s. 6d. per week."

AMENDMENT OF CARPENTRY AND JOINERY
TRADES APPRENTICESHIP REGULATIONS.

IN pursuance of the powers conferred by the Apprenticeship Acts, His Excellency the Administrator of the Government of the State of Victoria, by and with the advice of the Executive Council thereof, doth hereby, as from the beginning of the first pay period to commence in August, 1953, rescind Regulation 8 of the Carpentry and Joinery Trades Apprenticeship Regulations and substitute therefor the following:—

"8. The minimum rates of wages to be paid to apprentices in the said trades shall be as follows:—

- 1st year—at the rate of 70s. 8d. per week.
- 2nd year—at the rate of 94s. 10d. per week.
- 3rd year—at the rate of 132s. 6d. per week.
- 4th year—at the rate of 189s. 2d. per week.
- 5th year—at the rate of 243s. 10d. per week."

AMENDMENT OF COOKING TRADE
APPRENTICESHIP REGULATIONS.

IN pursuance of the powers conferred by the Apprenticeship Acts, His Excellency the Administrator of the Government of the State of Victoria, by and with the advice of the Executive Council thereof, doth hereby, as from the beginning of the first pay period to commence in August, 1953, rescind Regulation 8 of the Cooking Trade Apprenticeship Regulations and substitute therefor the following:—

"8. The minimum rates of wages to be paid to apprentices in the said trade shall be as follows:—

- (1) With respect to the term of apprenticeship of five years—

Male Apprentices.

 - 1st year—at the rate of 101s. 0d. per week.
 - 2nd year—at the rate of 117s. 6d. per week.
 - 3rd year—at the rate of 138s. 6d. per week.
 - 4th year—at the rate of 174s. 0d. per week.
 - 5th year—at the rate of 221s. 0d. per week.

Female Apprentices.

 - 1st year—at the rate of 75s. 6d. per week.
 - 2nd year—at the rate of 88s. 0d. per week.
 - 3rd year—at the rate of 105s. 6d. per week.
 - 4th year—at the rate of 123s. 0d. per week.
 - 5th year—at the rate of 149s. 6d. per week.
- (2) With respect to the term of apprenticeship of four years—

Male Apprentices.

 - 1st year—at the rate of 117s. 6d. per week.
 - 2nd year—at the rate of 138s. 6d. per week.
 - 3rd year—at the rate of 174s. 0d. per week.
 - 4th year—at the rate of 221s. 0d. per week.

Female Apprentices.

 - 1st year—at the rate of 88s. 0d. per week.
 - 2nd year—at the rate of 105s. 6d. per week.
 - 3rd year—at the rate of 123s. 0d. per week.
 - 4th year—at the rate of 149s. 6d. per week."

AMENDMENT OF DENTAL MECHANIC TRADE
APPRENTICESHIP REGULATIONS.

IN pursuance of the powers conferred by the Apprenticeship Acts, His Excellency the Administrator of the Government of the State of Victoria, by and with the advice of the Executive Council thereof, doth hereby, as from the beginning of the first pay period to commence in August, 1953, rescind Regulation 8 of the Dental Mechanic Trade Apprenticeship Regulations and substitute therefor the following:—

"8. The minimum rates of wages to be paid to apprentices in the said trade shall be as follows:—

- 1st year—at the rate of 61s. 6d. per week.
- 2nd year—at the rate of 85s. 6d. per week.
- 3rd year—at the rate of 110s. 0d. per week.
- 4th year—at the rate of 171s. 6d. per week.
- 5th year—at the rate of 214s. 6d. per week."

AMENDMENT OF ELECTRICAL TRADES
APPRENTICESHIP REGULATIONS.

IN pursuance of the powers conferred by the Apprenticeship Acts, His Excellency the Administrator of the Government of the State of Victoria, by and with the advice of the Executive Council thereof, doth hereby, as from the beginning of the first pay period to commence in August, 1953, rescind Regulation 8 of the Electrical Trades Apprenticeship Regulations and substitute therefor the following:—

"8. The minimum rates of wages to be paid to apprentices in the said trades shall be as follows:—

- (1) *Within 20 miles of G.P.O., Melbourne, within 10 miles G.P.O., Geelong, at Warrnambool, and within Mildura and Gippsland Districts—*
 - 1st year—at the rate of 75s. 0d. per week.
 - 2nd year—at the rate of 101s. 0d. per week.
 - 3rd year—at the rate of 127s. 0d. per week.
 - 4th year—at the rate of 195s. 0d. per week.
 - 5th year—at the rate of 241s. 0d. per week.
- (2) *At Yallourn—*
 - 1st year—at the rate of 77s. 6d. per week.
 - 2nd year—at the rate of 104s. 0d. per week.
 - 3rd year—at the rate of 130s. 6d. per week.
 - 4th year—at the rate of 200s. 6d. per week.
 - 5th year—at the rate of 247s. 6d. per week.
- (3) *Other Parts of Victoria—*
 - 1st year—at the rate of 74s. 0d. per week.
 - 2nd year—at the rate of 100s. 0d. per week.
 - 3rd year—at the rate of 125s. 6d. per week.
 - 4th year—at the rate of 192s. 6d. per week.
 - 5th year—at the rate of 238s. 0d. per week."

AMENDMENT OF ELECTROPLATING TRADE
APPRENTICESHIP REGULATIONS.

IN pursuance of the powers conferred by the Apprenticeship Acts, His Excellency the Administrator of the Government of the State of Victoria, by and with the advice of the Executive Council thereof, doth hereby, as from the beginning of the first pay period to commence in August, 1953, rescind Regulation 8 of the Electroplating Trade Apprenticeship Regulations and substitute therefor the following:—

"8. The minimum rates of wages to be paid to apprentices in the said trade shall be as follows:—

- (1) With respect to the term of apprenticeship of five years—
 - 1st year—at the rate of 75s. 0d. per week.
 - 2nd year—at the rate of 101s. 0d. per week.
 - 3rd year—at the rate of 127s. 0d. per week.
 - 4th year—at the rate of 195s. 0d. per week.
 - 5th year—at the rate of 241s. 0d. per week.
- (2) With respect to the term of apprenticeship of four years—
 - 1st year—at the rate of 80s. 0d. per week.
 - 2nd year—at the rate of 127s. 0d. per week.
 - 3rd year—at the rate of 195s. 0d. per week.
 - 4th year—at the rate of 241s. 0d. per week."

AMENDMENT OF ENGINEERING TRADES
APPRENTICESHIP REGULATIONS.

IN pursuance of the powers conferred by the Apprenticeship Acts, His Excellency the Administrator of the Government of the State of Victoria, by and with the advice of the Executive Council thereof, doth hereby, as from the beginning of the first pay period to commence in August, 1953, rescind Regulation 8 of the Engineering Trades Apprenticeship Regulations and substitute therefor the following:—

"8. (1) The minimum rates of wages to be paid to apprentices in the said trades shall be as follows:—

(a) *Within 20 miles of G.P.O., Melbourne, within 10 miles of G.P.O., Geelong, at Warrnambool, and within Mildura and Gippsland Districts—*

(i) With respect to the term of apprenticeship of five years—

- 1st year—at the rate of 75s. 0d. per week.
- 2nd year—at the rate of 101s. 0d. per week.
- 3rd year—at the rate of 127s. 0d. per week.
- 4th year—at the rate of 195s. 0d. per week.
- 5th year—at the rate of 241s. 0d. per week.

(ii) With respect to the term of apprenticeship of four years—

- 1st year—at the rate of 80s. 0d. per week.
- 2nd year—at the rate of 127s. 0d. per week.
- 3rd year—at the rate of 195s. 0d. per week.
- 4th year—at the rate of 241s. 0d. per week.

(b) *At Yallourn—*

(i) With respect to the term of apprenticeship of five years—

- 1st year—at the rate of 77s. 6d. per week.
- 2nd year—at the rate of 104s. 0d. per week.
- 3rd year—at the rate of 130s. 6d. per week.
- 4th year—at the rate of 200s. 6d. per week.
- 5th year—at the rate of 247s. 6d. per week.

(ii) With respect to the term of apprenticeship of four years—

- 1st year—at the rate of 82s. 0d. per week.
- 2nd year—at the rate of 130s. 6d. per week.
- 3rd year—at the rate of 200s. 6d. per week.
- 4th year—at the rate of 247s. 6d. per week.

(c) *Other Parts of Victoria—*

(i) With respect to the term of apprenticeship of five years—

- 1st year—at the rate of 74s. 0d. per week.
- 2nd year—at the rate of 100s. 0d. per week.
- 3rd year—at the rate of 125s. 6d. per week.
- 4th year—at the rate of 192s. 6d. per week.
- 5th year—at the rate of 238s. 0d. per week.

(ii) With respect to the term of apprenticeship of four years—

- 1st year—at the rate of 79s. 0d. per week.
- 2nd year—at the rate of 125s. 6d. per week.
- 3rd year—at the rate of 192s. 6d. per week.
- 4th year—at the rate of 238s. 0d. per week.

(2) With respect to the trade of Patternmaking only, a tool allowance of 4s. per week shall be paid to apprentices in each year of their apprenticeship course, in addition to the prescribed weekly wage."

AMENDMENT OF FURNITURE TRADES
APPRENTICESHIP REGULATIONS.

IN pursuance of the powers conferred by the Apprenticeship Acts, His Excellency the Administrator of the Government of the State of Victoria, by and with the advice of the Executive Council thereof, doth hereby, as from the beginning of the first pay period to commence in August, 1953, rescind Regulation 9 of the Furniture Trades Apprenticeship Regulations and substitute therefor the following:—

"9. The minimum rates of wages to be paid to apprentices in the said trades shall be as follows:—

(1) With respect to the term of apprenticeship of five years—

- 1st year—at the rate of 75s. 0d. per week.
- 2nd year—at the rate of 101s. 0d. per week.
- 3rd year—at the rate of 127s. 0d. per week.
- 4th year—at the rate of 195s. 0d. per week.
- 5th year—at the rate of 241s. 0d. per week.

(2) With respect to the term of apprenticeship of four years—

- 1st year—at the rate of 80s. 0d. per week.
- 2nd year—at the rate of 127s. 0d. per week.
- 3rd year—at the rate of 195s. 0d. per week.
- 4th year—at the rate of 241s. 0d. per week."

AMENDMENT OF HAIRDRESSING TRADES
APPRENTICESHIP REGULATIONS.

IN pursuance of the powers conferred by the Apprenticeship Acts, His Excellency the Administrator of the Government of the State of Victoria, by and with the advice of the Executive Council thereof, doth hereby, as from the beginning of the first pay period to commence in August, 1953, rescind Regulation 8 of the Hairdressing Trades Apprenticeship Regulations and substitute therefor the following:—

"8. The minimum rates of wages to be paid to apprentices in the said trades shall be as follows:—

Ladies' Hairdressing—

- 1st year—at the rate of 49s. 6d. per week.
- 2nd year—at the rate of 67s. 0d. per week.
- 3rd year—at the rate of 102s. 0d. per week.
- 4th year—at the rate of 153s. 0d. per week.

Men's Hairdressing—

- 1st year—at the rate of 58s. 6d. per week.
- 2nd year—at the rate of 89s. 6d. per week.
- 3rd year—at the rate of 129s. 0d. per week.
- 4th year—at the rate of 204s. 6d. per week.

Ladies' and Men's Hairdressing—

- 1st year—at the rate of 58s. 6d. per week.
- 2nd year—at the rate of 89s. 6d. per week.
- 3rd year—at the rate of 129s. 0d. per week.
- 4th year—at the rate of 204s. 6d. per week.
- 5th year—at the rate of 245s. 0d. per week."

AMENDMENT OF INSTRUMENT MAKING TRADE
APPRENTICESHIP REGULATIONS.

IN pursuance of the powers conferred by the Apprenticeship Acts, His Excellency the Administrator of the Government of the State of Victoria, by and with the advice of the Executive Council thereof, doth hereby, as from the beginning of the first pay period to commence in August, 1953, rescind Regulation 8 of the Instrument Making Trade Apprenticeship Regulations and substitute therefor the following:—

"8. The minimum rates of wages to be paid to apprentices in the said trade shall be as follows:—

(1) With respect to the term of apprenticeship of five years—

- 1st year—at the rate of 75s. 0d. per week.
- 2nd year—at the rate of 101s. 0d. per week.
- 3rd year—at the rate of 127s. 0d. per week.
- 4th year—at the rate of 195s. 0d. per week.
- 5th year—at the rate of 241s. 0d. per week.

(2) With respect to the term of apprenticeship of four years—

- 1st year—at the rate of 80s. 0d. per week.
- 2nd year—at the rate of 127s. 0d. per week.
- 3rd year—at the rate of 195s. 0d. per week.
- 4th year—at the rate of 241s. 0d. per week."

AMENDMENT OF MOTOR MECHANICS TRADES
APPRENTICESHIP REGULATIONS.

IN pursuance of the powers conferred by the Apprenticeship Acts, His Excellency the Administrator of the Government of the State of Victoria, by and with the advice of the Executive Council thereof, doth hereby, as from the beginning of the first pay period to commence in August, 1953, rescind Regulation 8 of the Motor Mechanics Trades Apprenticeship Regulations and substitute therefor the following:—

“8. The minimum rates of wages to be paid to apprentices in the said trades shall be as follows:—

Within 20 miles of G.P.O., Melbourne, within 10 miles of G.P.O., Geelong, at Warrnambool, and within Mildura and Gippsland Districts—

- (1) With respect to the term of apprenticeship of five years—
 - 1st year—at the rate of 75s. 0d. per week.
 - 2nd year—at the rate of 101s. 0d. per week.
 - 3rd year—at the rate of 127s. 0d. per week.
 - 4th year—at the rate of 195s. 0d. per week.
 - 5th year—at the rate of 241s. 0d. per week.
- (2) With respect to the term of apprenticeship of four years—
 - 1st year—at the rate of 80s. 0d. per week.
 - 2nd year—at the rate of 127s. 0d. per week.
 - 3rd year—at the rate of 195s. 0d. per week.
 - 4th year—at the rate of 241s. 0d. per week.

At Yallourn—

- (1) With respect to the term of apprenticeship of five years—
 - 1st year—at the rate of 77s. 6d. per week.
 - 2nd year—at the rate of 104s. 0d. per week.
 - 3rd year—at the rate of 130s. 6d. per week.
 - 4th year—at the rate of 200s. 6d. per week.
 - 5th year—at the rate of 247s. 6d. per week.
- (2) With respect to the term of apprenticeship of four years—
 - 1st year—at the rate of 82s. 0d. per week.
 - 2nd year—at the rate of 130s. 6d. per week.
 - 3rd year—at the rate of 200s. 6d. per week.
 - 4th year—at the rate of 247s. 6d. per week.

Other Parts of Victoria—

- (1) With respect to the term of apprenticeship of five years—
 - 1st year—at the rate of 74s. 0d. per week.
 - 2nd year—at the rate of 100s. 0d. per week.
 - 3rd year—at the rate of 125s. 6d. per week.
 - 4th year—at the rate of 192s. 6d. per week.
 - 5th year—at the rate of 238s. 0d. per week.
- (2) With respect to the term of apprenticeship of four years—
 - 1st year—at the rate of 79s. 0d. per week.
 - 2nd year—at the rate of 125s. 6d. per week.
 - 3rd year—at the rate of 192s. 6d. per week.
 - 4th year—at the rate of 238s. 0d. per week.

AMENDMENT OF MOULDING TRADES
APPRENTICESHIP REGULATIONS.

IN pursuance of the powers conferred by the Apprenticeship Acts, His Excellency the Administrator of the Government of the State of Victoria, by and with the advice of the Executive Council thereof, doth hereby, as from the beginning of the first pay period to commence in August, 1953, rescind Regulation 8 of the Moulding Trades Apprenticeship Regulations and substitute therefor the following:—

“8. The minimum rates of wages to be paid to apprentices in the said trades shall be as follows:—

- (1) With respect to the term of apprenticeship of five years—
 - 1st year—at the rate of 75s. 0d. per week.
 - 2nd year—at the rate of 101s. 0d. per week.
 - 3rd year—at the rate of 127s. 0d. per week.
 - 4th year—at the rate of 195s. 0d. per week.
 - 5th year—at the rate of 241s. 0d. per week.
- (2) With respect to the term of apprenticeship of four years—
 - 1st year—at the rate of 80s. 0d. per week.
 - 2nd year—at the rate of 127s. 0d. per week.
 - 3rd year—at the rate of 195s. 0d. per week.
 - 4th year—at the rate of 241s. 0d. per week.

AMENDMENT OF PAINTING TRADES
APPRENTICESHIP REGULATIONS.

IN pursuance of the powers conferred by the Apprenticeship Acts, His Excellency the Administrator of the Government of the State of Victoria, by and with the advice of the Executive Council thereof, doth hereby, as from the beginning of the first pay period to commence

in August, 1953, rescind Regulation 8 of the Painting Trades Apprenticeship Regulations and substitute therefor the following:—

“8. The minimum rates of wages to be paid to apprentices in the said trades shall be as follows:—

- 1st year—at the rate of 70s. 8d. per week.
- 2nd year—at the rate of 94s. 10d. per week.
- 3rd year—at the rate of 132s. 6d. per week.
- 4th year—at the rate of 189s. 2d. per week.
- 5th year—at the rate of 243s. 10d. per week.”

AMENDMENT OF PASTRYCOOKING TRADE
APPRENTICESHIP REGULATIONS.

IN pursuance of the powers conferred by the Apprenticeship Acts, His Excellency the Administrator of the Government of the State of Victoria, by and with the advice of the Executive Council thereof, doth hereby, as from the beginning of the first pay period to commence in August, 1953, rescind Regulation 8 of the Pastrycooking Trade Apprenticeship Regulations and substitute therefor the following:—

“8. The minimum rates of wages to be paid to apprentices in the said trade shall be as follows:—

- (1) With respect to the term of apprenticeship of five years—
 - 1st year—at the rate of 75s. 0d. per week.
 - 2nd year—at the rate of 101s. 0d. per week.
 - 3rd year—at the rate of 127s. 0d. per week.
 - 4th year—at the rate of 169s. 0d. per week.
 - 5th year—at the rate of 223s. 0d. per week.
- (2) With respect to the term of apprenticeship of four years—
 - 1st year—at the rate of 101s. 0d. per week.
 - 2nd year—at the rate of 127s. 0d. per week.
 - 3rd year—at the rate of 169s. 0d. per week.
 - 4th year—at the rate of 223s. 0d. per week.”

AMENDMENT OF PLASTERING TRADE
APPRENTICESHIP REGULATIONS.

IN pursuance of the powers conferred by the Apprenticeship Acts, His Excellency the Administrator of the Government of the State of Victoria, by and with the advice of the Executive Council thereof, doth hereby, as from the beginning of the first pay period to commence in August, 1953, rescind Regulation 8 of the Plastering Trade Apprenticeship Regulations and substitute therefor the following:—

“8. The minimum rates of wages to be paid to apprentices in the said trades shall be as follows:—

- 1st year—at the rate of 70s. 8d. per week.
- 2nd year—at the rate of 94s. 10d. per week.
- 3rd year—at the rate of 132s. 6d. per week.
- 4th year—at the rate of 189s. 2d. per week.
- 5th year—at the rate of 243s. 10d. per week.”

AMENDMENT OF PLUMBING AND GASFITTING
TRADES APPRENTICESHIP REGULATIONS.

IN pursuance of the powers conferred by the Apprenticeship Acts, His Excellency the Administrator of the Government of the State of Victoria, by and with the advice of the Executive Council thereof, doth hereby, as from the beginning of the first pay period to commence in August, 1953, rescind Regulation 8 of the Plumbing and Gasfitting Trades Apprenticeship Regulations and substitute therefor the following:—

“8. The minimum rates of wages to be paid to apprentices in the said trades shall be as follows:—

- 1st year—at the rate of 70s. 8d. per week.
- 2nd year—at the rate of 94s. 10d. per week.
- 3rd year—at the rate of 132s. 6d. per week.
- 4th year—at the rate of 189s. 2d. per week.
- 5th year—at the rate of 243s. 10d. per week.”

AMENDMENT OF PRINTING AND ALLIED TRADES
APPRENTICESHIP REGULATIONS.

IN pursuance of the powers conferred by the Apprenticeship Acts, His Excellency the Administrator of the Government of the State of Victoria, by and with the advice of the Executive Council thereof, doth hereby, as from the beginning of the first pay period to commence

in August, 1953, rescind Regulation 10 of the Printing and Allied Trades Apprenticeship Regulations and substitute therefor the following:—

"10. The minimum rates of wages to be paid to apprentices in the said trades shall be as follows:—

- (1) With respect to the term of apprenticeship of six years—
 - 1st year—at the rate of 66s. 0d. per week.
 - 2nd year—at the rate of 95s. 0d. per week.
 - 3rd year—at the rate of 110s. 0d. per week.
 - 4th year—at the rate of 132s. 0d. per week.
 - 5th year—at the rate of 161s. 0d. per week.
 - 6th year—at the rate of 219s. 6d. per week.
- (2) With respect to the term of apprenticeship of five years—
 - 1st year—at the rate of 95s. 0d. per week.
 - 2nd year—at the rate of 110s. 0d. per week.
 - 3rd year—at the rate of 132s. 0d. per week.
 - 4th year—at the rate of 161s. 0d. per week.
 - 5th year—at the rate of 219s. 6d. per week."

AMENDMENT OF PRINTING TRADES (COUNTRY) APPRENTICESHIP REGULATIONS.

IN pursuance of the powers conferred by the Apprenticeship Acts, His Excellency the Administrator of the Government of the State of Victoria, by and with the advice of the Executive Council thereof, doth hereby, as from the beginning of the first pay period to commence in August, 1953, rescind Regulation 8 of the Printing Trades (Country) Apprenticeship Regulations and substitute therefor the following:—

"8. The minimum rates of wages to be paid to apprentices in the said trades shall be as follows:—

- (1) With respect to the term of apprenticeship of six years—
 - 1st year—at the rate of 66s. 6d. per week.
 - 2nd year—at the rate of 96s. 0d. per week.
 - 3rd year—at the rate of 111s. 0d. per week.
 - 4th year—at the rate of 133s. 0d. per week.
 - 5th year—at the rate of 163s. 0d. per week.
 - 6th year—at the rate of 222s. 0d. per week.
- (2) With respect to the term of apprenticeship of five years—
 - 1st year—at the rate of 96s. 0d. per week.
 - 2nd year—at the rate of 111s. 0d. per week.
 - 3rd year—at the rate of 133s. 0d. per week.
 - 4th year—at the rate of 163s. 0d. per week.
 - 5th year—at the rate of 222s. 0d. per week."

AMENDMENT OF RADIO TRADESMAN TRADE APPRENTICESHIP REGULATIONS.

IN pursuance of the powers conferred by the Apprenticeship Acts, His Excellency the Administrator of the Government of the State of Victoria, by and with the advice of the Executive Council thereof, doth hereby, as from the beginning of the first pay period to commence in August, 1953, rescind Regulation 8 of the Radio Tradesman Trade Apprenticeship Regulations and substitute therefor the following:—

"8. The minimum rates of wages to be paid to apprentices in the said trade shall be as follows:—

- 1st year—at the rate of 75s. 0d. per week.
- 2nd year—at the rate of 101s. 0d. per week.
- 3rd year—at the rate of 127s. 0d. per week.
- 4th year—at the rate of 195s. 0d. per week.
- 5th year—at the rate of 241s. 0d. per week."

AMENDMENT OF SHEET METAL TRADE APPRENTICESHIP REGULATIONS.

IN pursuance of the powers conferred by the Apprenticeship Acts, His Excellency the Administrator of the Government of the State of Victoria, by and with the advice of the Executive Council thereof, doth hereby, as from the beginning of the first pay period to commence in August, 1953, rescind Regulation 8 of the Sheet Metal Trade Apprenticeship Regulations and substitute therefor the following:—

"8. The minimum rates of wages to be paid to apprentices in the said trade shall be as follows:—

- (1) With respect to the term of apprenticeship of five years—
 - 1st year—at the rate of 75s. 0d. per week.
 - 2nd year—at the rate of 101s. 0d. per week.
 - 3rd year—at the rate of 127s. 0d. per week.
 - 4th year—at the rate of 195s. 0d. per week.
 - 5th year—at the rate of 241s. 0d. per week.
- (2) With respect to the term of apprenticeship of four years—
 - 1st year—at the rate of 80s. 0d. per week.
 - 2nd year—at the rate of 127s. 0d. per week.
 - 3rd year—at the rate of 195s. 0d. per week.
 - 4th year—at the rate of 241s. 0d. per week."

AMENDMENT OF WATCHMAKING TRADES APPRENTICESHIP REGULATIONS.

IN pursuance of the powers conferred by the Apprenticeship Acts, His Excellency the Administrator of the Government of the State of Victoria, by and with the advice of the Executive Council thereof, doth hereby, as from the beginning of the first pay period to commence in August, 1953, rescind Regulation 8 of the Watchmaking Trades Apprenticeship Regulations and substitute therefor the following:—

"8. The minimum rates of wages to be paid to apprentices in the said trades shall be as follows:—

- 1st year—at the rate of 50s. 6d. per week.
- 2nd year—at the rate of 76s. 0d. per week.
- 3rd year—at the rate of 108s. 0d. per week.
- 4th year—at the rate of 143s. 6d. per week.
- 5th year—at the rate of 186s. 6d. per week.
- 6th year—at the rate of 234s. 6d. per week."

AMENDMENT OF BREAD TRADE APPRENTICESHIP REGULATIONS.

IN pursuance of the powers conferred by the Apprenticeship Acts, His Excellency the Administrator of the Government of the State of Victoria, by and with the advice of the Executive Council thereof, doth hereby, as from the beginning of the first pay period to commence in August, 1953, rescind Regulation 8 of the Bread Trade Apprenticeship Regulations and substitute therefor the following:—

"8. The minimum rates of wages to be paid to apprentices in the said trade shall be as follows:—

- (1) With respect to the term of apprenticeship of five years—
 - 1st year—
 - 1st six months—at the rate of 76s. 3d. per week.
 - 2nd six months—at the rate of 83s. 11d. per week.
 - 2nd year—
 - 1st six months—at the rate of 91s. 7d. per week.
 - 2nd six months—at the rate of 99s. 1d. per week.
 - 3rd year—
 - 1st six months—at the rate of 114s. 6d. per week.
 - 2nd six months—at the rate of 129s. 9d. per week.
 - 4th year—
 - 1st six months—at the rate of 152s. 7d. per week.
 - 2nd six months—at the rate of 175s. 6d. per week.
 - 5th year—
 - 1st six months—at the rate of 206s. 3d. per week.
 - 2nd six months—at the rate of 236s. 6d. per week.
- (2) With respect to the term of apprenticeship of four years—
 - 1st year—
 - 1st six months—at the rate of 91s. 7d. per week.
 - 2nd six months—at the rate of 99s. 1d. per week.
 - 2nd year—
 - 1st six months—at the rate of 114s. 6d. per week.
 - 2nd six months—at the rate of 129s. 9d. per week.
 - 3rd year—
 - 1st six months—at the rate of 152s. 7d. per week.
 - 2nd six months—at the rate of 175s. 6d. per week.
 - 4th year—
 - 1st six months—at the rate of 206s. 3d. per week.
 - 2nd six months—at the rate of 236s. 6d. per week."

And the Honorable Archibald McDonald Fraser, Her Majesty's Minister of Labour for the State of Victoria, shall give the necessary directions herein accordingly.

A. MAHLSTEDT,
Clerk of the Executive Council.

PUBLIC SERVICE ACT 1946.

*At the Executive Council Chamber, Melbourne, the
eleventh day of August, 1953.*

PRESENT:

His Excellency the Administrator of the Government of the State
of Victoria.

Mr. Fraser
Mr. Smith

Mr. Shepherd.

REGULATIONS.

IN pursuance of the powers conferred by the *Public Service Act 1946*, His Excellency the Administrator of the Government of the State of Victoria, by and with the advice of the Executive Council thereof, doth hereby amend the Public Service (Governor in Council) Regulations in the manner following, that is to say:—

PART IV.—LEAVE OF ABSENCE.

Long-Service Leave.

In Regulation 58, following the words "with the Melbourne Harbor Trust;" there shall be inserted the words:—

"with the Victoria Police Women's Auxiliary Force;"

And the Honorable Leslie William Galvin, Her Majesty's Acting Premier for the State of Victoria, shall give the necessary directions herein accordingly.

A. MAHLSTEDT,
Clerk of the Executive Council.

FORESTS COMMISSION OF VICTORIA.

*At the Executive Council Chamber, Melbourne, the
eleventh day of August, 1953.*

PRESENT:

His Excellency the Administrator of the Government of the State
of Victoria.

Mr. Fraser
Mr. Smith

Mr. Shepherd.

REGULATIONS AMENDED.

IN pursuance of the powers conferred by section 96 of the *Forests Act 1928*, His Excellency the Administrator of the Government of the State of Victoria, by and with the advice of the Executive Council thereof doth hereby amend the Regulations made under section 55 of the *Forests Act 1915*, and section 65 of the *Forests Act 1918*, on the 7th day of April, 1925, by inserting between clauses 40 and 41 thereof the following clause:—

"40A. Notwithstanding anything in clauses 38, 39, and 40 hereof, for the purposes of section 21 (1) (a) of the *Forests Act 1928*, the minimum rate of royalty in respect of logs obtained for sawmilling purposes shall be One shilling per 100 superficial feet calculated on the Quarter-girth System (Hoppus Log Volume)."

And the Honorable John William Galbally, Her Majesty's Minister of Forests for the State of Victoria, shall give the necessary directions herein accordingly.

A. MAHLSTEDT,
Clerk of the Executive Council.

MAINTENANCE ACT 1928.

At the Executive Council Chamber, Melbourne, the eleventh day of August, 1953.

PRESENT:

His Excellency the Administrator of the Government of the State of Victoria.

Mr. Fraser | Mr. Shepherd.
Mr. Smith

POWERS OF STIPENDIARY MAGISTRATE CONFERRED ON OFFICER OF CHILDREN'S WELFARE DEPARTMENT.

PURSUANT to the provisions of section 53 of the Maintenance Act 1928, His Excellency the Administrator of the Government of the State of Victoria, by and with the advice of the Executive Council thereof, doth by this Order confer the powers of stipendiary magistrate under Part III. of the said Act upon—

AUBREY JOSEPH ALBERT HODGENS, an officer of the Public Service in the Children's Welfare Department, in all cases where applications under the aforesaid Part are made by persons residing within 20 miles from the post office situate at the corner of Bourke-street and Elizabeth-street, in the City of Melbourne.

And the Honorable Joseph Henry Smith, for and on behalf of Her Majesty's Chief Secretary for the State of Victoria, shall give the necessary directions herein accordingly.

A. MAHLSTEDT,
Clerk of the Executive Council.

DEPARTMENT OF CROWN LANDS AND SURVEY.

At the Executive Council Chamber, Melbourne, the eleventh day of August, 1953.

PRESENT:

His Excellency the Administrator of the Government of the State of Victoria.

Mr. Fraser | Mr. Shepherd.
Mr. Smith

LAND TEMPORARILY RESERVED AS A SITE.

HIS Excellency the Administrator of the Government of the State of Victoria, by and with the advice of the Executive Council thereof, doth hereby, in pursuance of the provisions of the Land Act 1928, reserve, temporarily, and also except from occupation for mining purposes under any miner's right, the land hereinafter described:—

WITCHIPOOL (LAKE BULOKE).—Site for Public purposes, 613 acres, more or less, Parish of Witchipool, County of Borung, as indicated by hachure on plan hereunder.—(W.299(4) (Rs.2802).

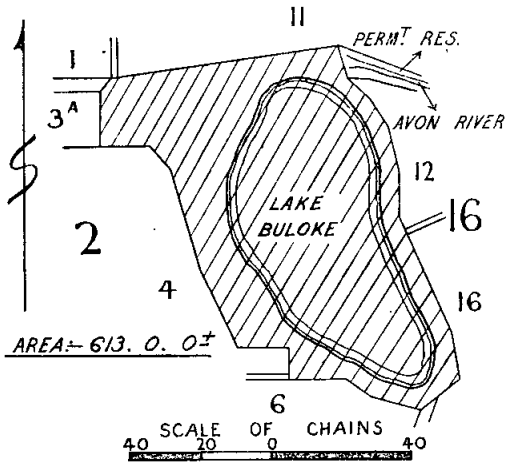

And the Honorable Robert Wilfred Holt, Her Majesty's Commissioner of Crown Lands and Survey for the State of Victoria, shall give the necessary directions herein accordingly.

A. MAHLSTEDT,
Clerk of the Executive Council.

DEPARTMENT OF CROWN LANDS AND SURVEY.

At the Executive Council Chamber, Melbourne, the eleventh day of August, 1953.

PRESENT:

His Excellency the Administrator of the Government of the State of Victoria.

Mr. Fraser | Mr. Shepherd.
Mr. Smith

UNUSED AND UNMADE ROADS CLOSED.

HIS Excellency the Administrator of the Government of the State of Victoria, by and with the advice of the Executive Council thereof, doth hereby direct that, in pursuance of the provisions of section 304 of the Land Act 1928, the unused and unmade roads referred to hereunder be closed, viz.:—

Parish of Drouin West, County of Buln Buln, being the road between allotments 67, 67A, and allotment 3 (south-western portion), section A, Township of Drouin.—(D.173(9) (D.173(P1) (Misc.2578).

Parish of Eumemmerring, County of Mornington, being the road between allotment 45 and allotment 46.—(E.78(4) (Misc.2577).

Parish of Condah, County of Normanby, being the road indicated by hachure on plan hereunder.—(C.362(3) (Z.31378).

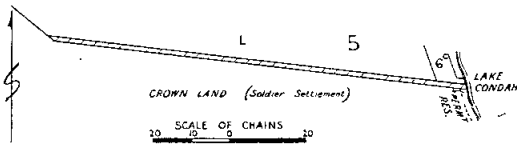

And the Honorable Robert Wilfred Holt, Her Majesty's Commissioner of Crown Lands and Survey for the State of Victoria, shall give the necessary directions herein accordingly.

A. MAHLSTEDT,
Clerk of the Executive Council.

Water Acts.

STATE RIVERS AND WATER SUPPLY COMMISSION.

At the Executive Council Chamber, Melbourne, the eleventh day of August, 1953.

PRESENT:

His Excellency the Administrator of the Government of the State of Victoria.

Mr. Fraser | Mr. Shepherd.
Mr. Smith

ACQUISITION OF LAND WITHIN THE TALLANGATTA URBAN AREA.

UNDER the powers conferred by section 3 of the Tallangatta Township (Removal) Act 1950 (No. 5497), and all other powers enabling him in that behalf, His Excellency the Administrator of the Government of the State of Victoria, by and with the advice of the Executive Council of the said State, on the recommendation of the State Rivers and Water Supply Commission, doth hereby approve of the acquisition by the State Rivers and Water Supply Commission of all that land set out and described in the Schedule hereto, which land is within the Tallangatta Urban Area.

SCHEDULE.

All that land comprising lot 1 on lodged plan of subdivision No. 4461, being part of Crown allotment 71A, Parish of Bullioh, in the County of Benambra, being the whole of the land described in certificate of title, volume 5638, folio 1127576.

And the Honorable Clive Phillip Stoneham, Her Majesty's Minister of Water Supply for the State of Victoria, shall give the necessary directions herein accordingly.

A. MAHLSTEDT,
Clerk of the Executive Council.

FACTORIES AND SHOPS ACTS.

At the Executive Council Chamber, Melbourne, the eighteenth day of August, 1953.

PRESENT:

His Excellency the Administrator of the Government of the State of Victoria.

Mr. Fraser | Mr. Smith.
Mr. Scully |

A FRUIT GROWERS BOARD TO BE APPOINTED.

UNDER the powers in that behalf conferred by the Factories and Shops Acts, His Excellency the Administrator of the Government of the State of Victoria, by and with the advice of the Executive Council thereof, doth hereby—

1. Declare that it is expedient to appoint a Wages Board to determine the lowest prices or rates which may be paid to any person or persons or classes of persons employed in the cultivation, picking, grading, packing, or forwarding of fresh fruits, including grapes, and the making, casking, bottling, packing, and forwarding at the winery of wine, for trade or sale (but not including any person employed at such work which may be or is the subject of a Determination of the Jam Trade Board, the Fruit Packing Board, the Storemen, Packers, and Sorters Board, or the Carters and Drivers Board).
2. Order that a Wages Board, consisting of six members and a chairman, three of such members being appointed as representatives of employers and three as representatives of employees, be constituted and appointed to determine the lowest prices or rates which may be paid to any person or persons or classes of persons employed in the cultivation, picking, grading, packing, and forwarding of fresh fruits, including grapes, and the making, casking, bottling, packing, and forwarding at the winery of wine, for trade or sale (but not including any person employed at such work which may be or is the subject of a Determination of the Jam Trade Board, the Fruit Packing Board, the Storemen, Packers, and Sorters Board, or the Carters and Drivers Board).

Also that such Wages Board may in any Regulation, Determination, Order, instrument or legal proceeding be described for all purposes as the Fruit Growers Board, and that the area or locality within which the Determination of the said Wages Board shall be operative shall be the whole of the State of Victoria.

And the Honorable Archibald McDonald Fraser, Her Majesty's Minister of Labour for the State of Victoria, shall give the necessary directions herein accordingly.

A. MAHLSTEDT,
Clerk of the Executive Council.

LANDLORD AND TENANT ACTS.

At the Executive Council Chamber, Melbourne, the eighteenth day of August, 1953.

PRESENT:

His Excellency the Administrator of the Government of the State of Victoria.

Mr. Fraser | Mr. Smith.
Mr. Scully |

ORDER EXCLUDING CERTAIN PREMISES FROM THE OPERATION OF THE PROVISIONS CONTAINED IN PARTS III. AND V. OF THE LANDLORD AND TENANT ACT 1948.

IN pursuance of the powers conferred upon him by the *Landlord and Tenant Act 1948*, His Excellency the Administrator of the Government of the State of Victoria, by and with the advice of the Executive Council thereof, doth hereby declare that the premises known as No. 181 Bannister-street, Bendigo, shall be excluded from the operation of the whole of the provisions contained in Parts III. and V. of the *Landlord and Tenant Act 1948*.

And the Honorable William Slater, Her Majesty's Attorney-General in and for the State of Victoria, shall give the necessary directions herein accordingly.

A. MAHLSTEDT,
Clerk of the Executive Council.

LANDLORD AND TENANT ACTS.

At the Executive Council Chamber, Melbourne, the eighteenth day of August, 1953.

PRESENT:

His Excellency the Administrator of the Government of the State of Victoria.

Mr. Fraser | Mr. Smith.
Mr. Scully |

ORDER EXTENDING APPLICATION OF THE LANDLORD AND TENANT ACT 1948 TO CERTAIN PREMISES.

WHEREAS by an Order published in the *Government Gazette* of the 13th August, 1952, at page 4356, the premises known as No. 32 Ethel-street, Traralgon, were excluded from the operation of Parts III. and V. of the *Landlord and Tenant Act 1948*: And whereas it is expedient that those Parts should again extend to such premises: Now therefore, in pursuance of the powers conferred upon him by the *Landlord and Tenant Act 1948*, His Excellency the Administrator of the Government of the State of Victoria, by and with the advice of the Executive Council thereof, doth hereby declare that the application of the whole of the *Landlord and Tenant Act 1948* shall extend to such premises.

And the Honorable William Slater, Her Majesty's Attorney-General in and for the State of Victoria, shall give the necessary directions herein accordingly.

A. MAHLSTEDT,
Clerk of the Executive Council.

APPROACHING LAND SALES.

SALES of Crown lands, in fee-simple, will be held at the under-mentioned places and dates, viz:—

	No. of Gazette.
Ballarat.—Wednesday, 19th August, 1953	540
Bendigo.—Thursday, 24th September, 1953	749
Colac.—Wednesday, 16th September, 1953	691
Melbourne.—Wednesday, 26th August, 1953	543

SALE OF CROWN LANDS BY AUCTION.

The lands will be sold in fee-simple, and subject to the covenants, conditions, exceptions, and reservations directed by the Governor in Council by an Order in Council dated the 5th August, 1930, and published in the *Government Gazette* of the 8th August, 1930, varied as herein.

A deposit of at least twelve and a half per centum of the price at which each lot is sold must be paid by the purchaser at the time of sale, and all such payments shall be made in coin, bank notes or cheques approved by the officer conducting the sale, and the residue of such price will be payable in equal instalments, in accordance with the scale hereunder, on the last day of each successive period of six months from the time of sale, or, if the purchaser choose, at any earlier time or times; and such residue of the purchase money shall bear interest at the rate of Five pounds per centum per annum, to be computed with respect to each instalment for the period which has elapsed between the time of sale and the time of the payment of such instalment. If the residue of the price be paid within thirty days after the time of the sale no interest will be payable thereon.

The Governor in Council may allow a transfer of the purchaser's interest to an approved person at any time before the final payment of the purchase money is made. The fee for transfer shall be One pound and such transfer will be subject to payment of stamp duty.

SCALE OF PAYMENTS OF RESIDUE.

£20 and under, 6 instalments.
Over £20, and not exceeding £50, 8 instalments.
Over £50, and not exceeding £100, 10 instalments.
Over £100, and not exceeding £200, 12 instalments.
Over £200, and not exceeding £300, 14 instalments.
Over £300, and not exceeding £400, 16 instalments.
Over £400, and not exceeding £500, 18 instalments.
Over £500, 20 instalments.

FEES, ETC.

The amount payable for Assurance Fund (One halfpenny for each £1 of purchase price) and Crown grant fee must be paid with the balance of purchase money. The following is the scale of fees for Crown grants:—

- 50 acres and under, £1 10s.
- Over 50 acres, £2.

Where the purchase money does not exceed £5, the grant fee is £1.

Charges for survey must be paid, in full, at the time of the sale.

Valuations of improvements to be paid, in full, within twenty-eight days of the sale.

R. W. HOLT,
Commissioner of Crown Lands and Survey,
Office of Crown Lands and Survey,
Melbourne, 17th August, 1953.

BENDIGO.—Sale (No. 11027) of Crown lands in fee-simple, by auction, will be held on the land in MOUNT KORONG-ROAD, BENDIGO, on THURSDAY, the 24th SEPTEMBER, 1953, at TEN a.m. To be conducted by H. J. HENKEL, Land Officer. Auctioneers: JAS. ANDREW & CO., 7 Queen-street, Bendigo.

CITY OF BENDIGO, PARISH OF SANDHURST, COUNTY OF BENDIGO.

Charge for survey £5 5s. per lot. All areas are subject to review.

Fronting Mount Korong-road.

Upset price £82 per lot.

- Lot 1. Area 22 perches, allotment 134A of section A. Valuation of improvements £274.
- Lot 2. Area 22 perches, allotment 134B of section A. Valuation of improvements £301 5s.
- Lot 3. Area 22 perches, allotment 134C of section A. Valuation of improvements £356.
- Lot 4. Area 27 perches, allotment 134D of section A. Valuation of improvements £479.

Upset price £167 10s. per lot.

- Lot 5. Area 27 perches, allotment 134E of section A. Valuation of improvements £435 10s.
- Lot 6. Area 27 perches, allotment 134F of section A. Valuation of improvements £435 10s.
- Lot 7. Area 27 perches, allotment 134H of section A. Valuation of improvements £435 10s.

Fronting Valentine-street.

Upset price £63 15s. per lot.

- Lot 8. Area 21½ perches, allotment 134K of section A. Valuation of improvements £242 5s. Subject to drainage easement.
- Lot 9. Area 21½ perches, allotment 134L of section A. Valuation of improvements £242 5s.
- Lot 10. Area 21½ perches, allotment 134M of section A. Valuation of improvements £242 5s.
- Lot 11. Area 21½ perches, allotment 134N of section A. Valuation of improvements £242 5s.
- Lot 12. Area 22 perches, allotment 134P of section A. Valuation of improvements £242 5s. Subject to drainage easement.

PROPOSED REVOCATION OF TEMPORARY RESERVATION AND THE WITHHOLDING FROM SALE, LEASING, AND LICENSING, OF CERTAIN LAND BY ORDER IN COUNCIL.

IN pursuance of the provisions of the *Land Act 1928*, notice is hereby given that it is the intention of the Governor in Council to revoke the temporary reservation and the withholding from sale, leasing, and licensing, of certain land by Order in Council hereinafter referred to:—

The following Notice was published 1° on the 19th August, 1953, pursuant to Order of the 11th August, 1953.

NORONG.—The temporary reservation as a site for Public purposes (State School) and the withholding from sale, leasing, and licensing, by Order in Council of the 21st February, 1881, of 5 acres of land in the Parish of Norong, are about to be revoked.—(N.74⁽³⁾) (Rs.4447).

R. W. HOLT,
Commissioner of Crown Lands and Survey.

PROPOSED REVOCATIONS OF PORTIONS OF TEMPORARY RESERVATIONS OF LANDS BY ORDERS IN COUNCIL.

IN pursuance of the provisions of the *Land Act 1928*, notice is hereby given that it is the intention of the Governor in Council to revoke portions of the temporary reservations of lands by Orders in Council hereunder referred to, viz:—

The following Notices were published 1° on the 29th July, 1953, pursuant to Orders of the 21st July, 1953.

OMEQ.—The temporary reservation by Order in Council of the 30th January, 1865, of 1 acre 3 roods 34 perches of land at Omeo as a site for a Pound, revoked as to part by Order of the 13th April, 1886, is about to be revoked so far as the balance thereof, containing 1 acre 0 roods 13 perches, more or less, is concerned.—(O.19⁽⁸⁾) (Rs.3799).

MARYBOROUGH.—The temporary reservation by Order in Council of the 26th March, 1895, of 3 roods 28 perches of land in the municipal district of Maryborough as a site for Drainage and Road purposes, revoked as to part by Order in Council of the 22nd April, 1952, is about to be revoked so far only as the portion containing 18 9/10 perches, indicated by hachure on plan hereunder, is concerned.—(M.66⁽¹⁰⁾) (Rs.2291).

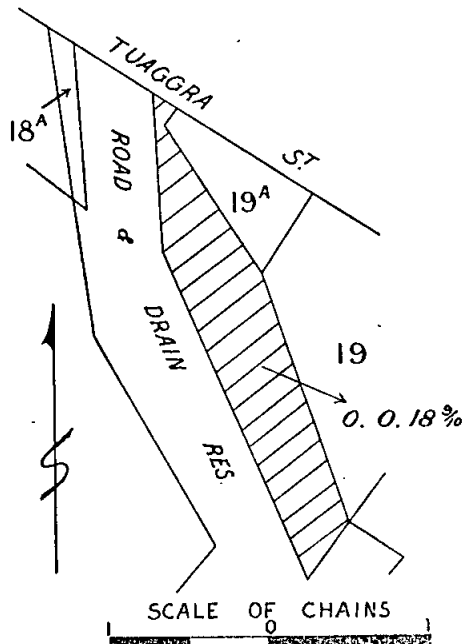

WARRANTYTE.—The temporary reservation by Order in Council of the 2nd February, 1928, of 2 acres 2 roods 27 perches of land in the Parish of Warrantyte as a site for Public Recreation, is about to be revoked so far only as the portion containing 20 perches, more or less, indicated by hachure on plan hereunder, is concerned.—(W.26⁽³⁾) (Rs.3614).

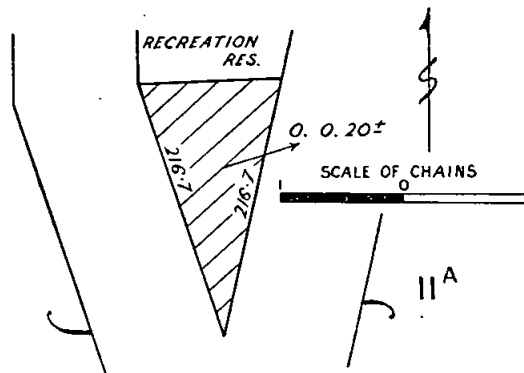

OMEQ.—The temporary reservation by Order in Council of the 11th May, 1886, of 9 acres 2 roods 12 perches of land in the Township of Omeo as a site for the use of the Omeo Agricultural and Pastoral Society, is about to be revoked so far only as the portion containing 1 acre 3 roods 30 perches, more or less, indicated by hachure on plan hereunder, is concerned.—(O.19⁽⁸⁾) (Rs.3799).

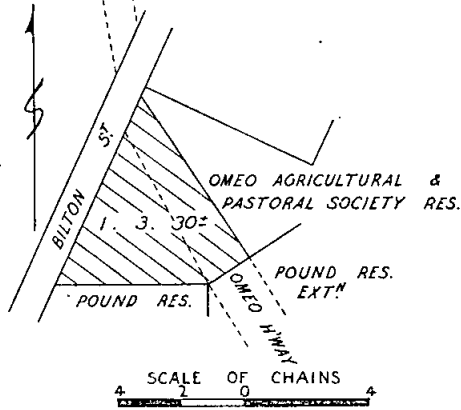

R. W. HOLT,
Commissioner of Crown Lands and Survey.

PROPOSED REVOCATIONS OF TEMPORARY RESERVATIONS OF LANDS BY ORDERS IN COUNCIL.

IN pursuance of the provisions of the *Land Act 1928*, notice is hereby given that it is the intention of the Governor in Council to revoke the temporary reservations of lands by Orders in Council hereunder referred to, viz.:—

The following Notices were published 1° on the 19th August, 1953, pursuant to Orders of the 11th August, 1953.

ECHUCA.—The temporary reservation without prejudice to the sale or other disposal of the land comprised therein for the purposes of a town by the Order in Council of the 26th October, 1863, of a certain area of land as the area of the Town of Echuca (see *Government Gazette* 1863, page 2719) is about to be revoked.—(E.3⁽³⁾) (E.96⁽⁵⁾) (C.93066).

DOOEN.—The temporary reservation by Order in Council of the 16th June, 1885, of 126 acres 0 roods 32 perches of land in the Parish of Dooen as a site for Police purposes, is about to be revoked.—(D.167⁽²⁾) (Rs.5740).

R. W. HOLT,
Commissioner of Crown Lands and Survey.

PROPOSED REVOCATION OF TEMPORARY RESERVATION AND THE WITHHOLDING FROM SALE, LEASING, AND LICENSING OF LAND BY ORDER IN COUNCIL.

IN pursuance of the provisions of the *Land Act 1928*, notice is hereby given that it is the intention of the Governor in Council to revoke the temporary reservation and the withholding from sale, leasing, and licensing of land by Order in Council hereunder referred to, viz.:—

The following Notice was published 1° on the 5th August, 1953, pursuant to Order of the 28th July, 1953.

GYMBOWEN.—The temporary reservation as a site for Public purposes (State School), and the withholding from sale, leasing, and licensing, by Order in Council of the 6th September, 1880, of 2 acres of land in the Parish of Gymbowen, are about to be revoked.—(G.230⁽²⁾) (C.93877).

R. W. HOLT,
Commissioner of Crown Lands and Survey.

PROPOSED REVOCATIONS OF TEMPORARY RESERVATIONS OF LANDS BY ORDERS IN COUNCIL—(AS TO PORTIONS).

IN pursuance of the provisions of the *Land Act 1928*, notice is hereby given that it is the intention of the Governor in Council to revoke portions of the temporary reservations of lands by Orders in Council hereunder referred to, viz.:—

The following Notices were published 1° on the 19th August, 1953, pursuant to Orders of the 11th August, 1953.

MARYBOROUGH.—The temporary reservation, by Order in Council of the 16th October, 1888, of 10 acres 0 roods 20 6/10 perches of land in the municipal district of Maryborough as a site for Drainage purposes, revoked as to part by various Orders, is about to be revoked, so far only as the portion containing 1 rood 8 perches, indicated by hachure on plan hereunder, is concerned.—(M.66⁽¹⁵⁾) (Rs.2292).

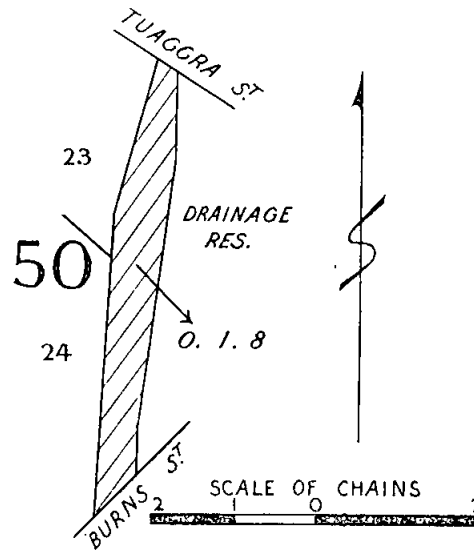

WOODEND.—The temporary reservation, by Order in Council of the 14th August, 1872, of 2 roods 1 6/10 perches of land in the Town of Woodend, being allotment 7 of section 2A, as a site for a Court House, is about to be revoked so far only as the portion containing 1 rood, more or less, indicated by hachure on plan hereunder, is concerned.—(W.199⁽⁴⁾) (Rs.7091).

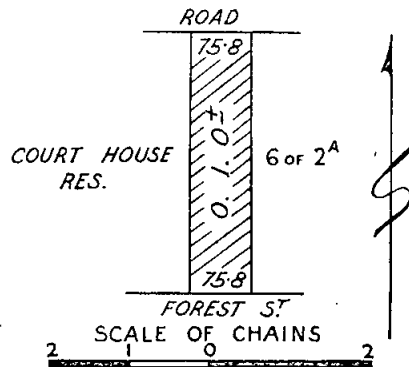

R. W. HOLT,
Commissioner of Crown Lands and Survey.

PROPOSED REVOCATIONS OF TEMPORARY RESERVATIONS AND THE WITHHOLDING FROM SALE, LEASING, AND LICENSING OF LANDS BY ORDERS IN COUNCIL.

IN pursuance of the provisions of the *Land Act* 1928, notice is hereby given that it is the intention of the Governor in Council to revoke the temporary reservations and the withholding from sale, leasing, and licensing of lands by Orders in Council hereunder referred to, viz.:-

The following Notices were published 1° on the 29th July, 1953, pursuant to Orders of the 21st July, 1953.

ELAINE.—The temporary reservation as a site for a Quarry, and the withholding from sale, leasing, and licensing, by Order in Council of the 13th August, 1883, of 4 acres 1 rood 12 perches of land at Elaine, are about to be revoked.—(E.103(2) (0510/121).

OMEQ.—The temporary reservation as a site for a Pound, and the withholding from sale, leasing, and licensing, by Order in Council of the 26th September, 1881, of 10 acres 1 rood 4 perches of land in the Parish of Cobungra (now in the Township of Omeo), revoked as to part by Order of the 13th April, 1886, are about to be revoked so far only as the portion containing 3 roods 20 perches, more or less, indicated by hachure on plan hereunder, is concerned.—(O.19(8) (Rs.3799).

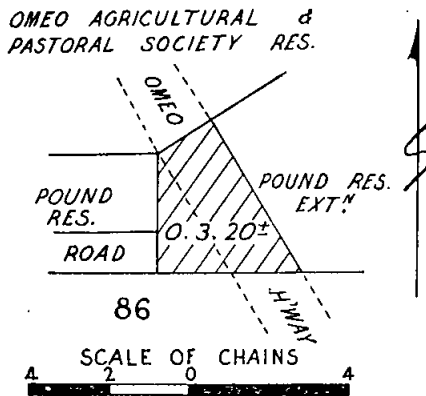

R. W. HOLT,
Commissioner of Crown Lands and Survey.

PROPOSED REVOCATIONS OF TEMPORARY RESERVATIONS OF LANDS BY ORDERS IN COUNCIL.

IN pursuance of the provisions of the *Land Act* 1928, notice is hereby given that it is the intention of the Governor in Council to revoke the temporary reservations of lands by Orders in Council hereunder referred to, viz.:-

The following Notices were published 1° on the 5th August, 1953, pursuant to Orders of the 28th July, 1953.

DINYARRAK.—The temporary reservation, by Order in Council of the 6th January, 1921, of 3 acres of land, in the Parish of Dinyarrak, as a site for a State School, is about to be revoked.—(D.176(2) (Rs.2255).

NUNTIN.—The temporary reservation, by Order in Council of the 28th June, 1871, of 8 acres of land, in the Parish of Nuntin, being part of allotments 1 and 2 of section 14B, as a site from whence gravel may be procured under the usual licenses, is about to be revoked.—(N.82(2) (Rs.2537).

OUYEN.—The temporary reservation, by Order in Council of the 25th July, 1950, of 3 acres 1 rood 18 perches of land, in the Township of Ouyen, as a site for Plantation purposes, is about to be revoked.—(O.22(B4) (Rs.6558).

WILLENABRINA.—The temporary reservation, by Order in Council of the 5th April, 1892, of 44 acres 3 roods 6 perches of land, in the Parish of Willenabrina, as a site for Water Supply purposes, is about to be revoked.—(W.352(4) (Rs.884).

WOORNDOO.—The temporary reservation, by Order in Council of the 17th November, 1869, of 5 acres of land at Woorndoo, as a site for a Cemetery, is about to be revoked.—(W.247(2) (Rs.2032).

R. W. HOLT,
Commissioner of Crown Lands and Survey.

PROPOSED REVOCATION OF TEMPORARY RESERVATION OF LAND BY ORDER IN COUNCIL.

IN pursuance of the provisions of the *Land Act* 1928, notice is hereby given that it is the intention of the Governor in Council to revoke the temporary reservation of land by Order in Council hereunder referred to, viz.:-

The following Notice was published 1° on the 12th August, 1953, pursuant to Order of the 4th August, 1953.

KEVINGTON.—The temporary reservation, by Order in Council of the 7th December, 1903, of 12 acres 2 roods 9 perches of land in the Parish of Kevington, being allotments 1, 2, and 3 of section 4, as a site for Public Recreation, is about to be revoked.—(K.116(2) (Rs.7146).

R. W. HOLT,
Commissioner of Crown Lands and Survey.

COMMON ABOUT TO BE DIMINISHED.

IN pursuance of the provisions contained in the *Land Act* 1928, notice is hereby given that it is the intention of the Governor in Council to diminish the common hereinafter mentioned, viz.:-

The following Notice was published 1° on the 29th July, 1953, pursuant to Order of the 21st July, 1953.

The Ballarat West Town Common, proclaimed as such by Proclamation bearing date the 28th January, 1861, is about to be diminished by the excision therefrom of the portion, containing 21 acres 1 rood, more or less, indicated by hachure on plan hereunder.—(C.91998.)

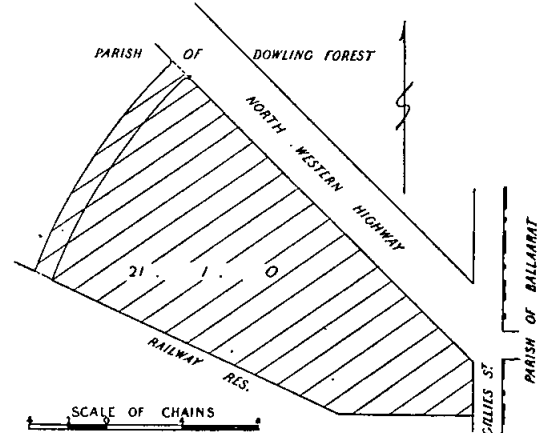

R. W. HOLT,
Commissioner of Crown Lands and Survey.

HOSPITALS AND CHARITIES COMMISSION.— VACANCY.

APPLICATIONS are invited for appointment to the position of—

ASSISTANT ACCOUNTANT.

Salary Range.—£754-£806 (plus cost of living adjustment, £384) a year.

Qualifications.—To be a qualified accountant; to be familiar with mechanized accounting and possess the ability to control staff. Experience in Treasury and Audit Office procedure or Hospital Accounting is desirable.

Applications accompanied by copies of testimonials close with the Secretary on 26th August, 1953.

H. N. ACKLON,
61 Spring-street, Melbourne. Secretary.

PUBLIC SERVICE NOTICES.

PUBLIC SERVICE (PUBLIC SERVICE BOARD) REGULATION 39.—VACANCIES.

THE Permanent Heads of the Departments shown have recommended the officers named hereunder for appointment to the under-mentioned vacancies.

Office and Classification.	Duties	Qualifications.	Officer Recommended for Appointment.		
			Name.	Classification.	Date of Classification.
ADMINISTRATIVE DIVISION.					
DEPARTMENT OF HEALTH.					
<i>Mental Hygiene Branch.</i>					
Clerk, Class "B," Sunbury Mental Hospital	To be responsible for the secretarial side of the administration, and to carry out the duties of Clerk of a Mental Hospital as prescribed by the Mental Hygiene Acts	To have experience in the management and organization of a Mental Hospital, including control of stores, clothing, provisions, and artisan activities, an intimate knowledge of the Mental Hygiene Acts, Mental Hygiene Authority Act and Regulations, and ability to control a large staff, including artisans	Baird, K. M. . .	Clerk, Class "C2"	10.12.51
NOTE.—Appointee will be eligible for progression to Class "B1" after the completion of three years' satisfactory service in Class "B".					
PROFESSIONAL DIVISION.					
DEPARTMENT OF MINES.					
Superintending Draughtsman, Class "B1"	To have charge of the computing, draughting, cartographic and lithographic work in connexion with the preparation of geological maps and plans	To have a thorough knowledge of all sections of the work prepared by the draughting staff, the administrative ability and personal qualities necessary for the control of varied technical staff	McInnes, D. W.	Senior Draughtsman, Class "B"	29.9.52
DEPARTMENT OF STATE FORESTS.					
Regional Engineer, Class "C"	To be responsible within the region for the planning of transportation systems, investigations, locations, surveys (some design) to required standards from basic information supplied by Forest Officers; to design associated engineering structures; to directly supervise engineering projects; to advise Forest Officers on engineering matters, and to supervise activities of Plant Inspector and/or Mechanics in region	To possess a University Degree or Diploma in Civil Engineering, and approved field experience, particularly in mountain forest areas	Day, H. B. . .	Forester, Grade II., Class "C"	1.12.51
TECHNICAL AND GENERAL DIVISION.					
DEPARTMENT OF EDUCATION.					
Senior Storeman	To assemble, pack, and despatch stores requisitioned by various Government offices; to assist generally and to relieve the Storekeeper during his absence	To be mentally alert, active, and vigorous, and capable of handling weights up to one cwt. Packing experience is desirable	Hutchinson, J. T.	Storeman . .	2.5.52

Appeals against such recommendations should be lodged with the Secretary to the Public Service Board not later than Saturday, the 29th August, 1953.

Office of the Public Service Board,
Melbourne, 18th August, 1953.

By order,
E. F. FITZGIBBON,
Secretary.

PUBLIC SERVICE (PUBLIC SERVICE BOARD) REGULATION 39.—VACANCY.

NOTICE is hereby given that the Permanent Head, Department of State Forests, has recommended to the Public Service Board that the under-mentioned vacancy, Professional Division, be filled by the employee named hereunder.

Office and Classification.	Duties.	Qualifications.	Person Recommended for Appointment.
Regional Engineer, Class "C"	To be responsible within the region for the planning of transportation systems, investigations, locations, surveys (some design) to required standards from basic information supplied by Forest Officers; to design associated engineering structures; to directly supervise engineering projects; to advise Forest Officers on engineering matters, and to supervise activities of Plant Inspector and/or Mechanics in region	To possess a University Degree or Diploma in Civil Engineering, and approved field experience, particularly in mountain forest areas	McKerrow, J. A.

Appeals against such recommendation should be lodged with the Secretary to the Public Service Board not later than Saturday, the 29th August, 1953.

Office of the Public Service Board,
Melbourne, 18th August, 1953.

By order,
E. F. FITZGIBBON,
Secretary.

PUBLIC SERVICE (PUBLIC SERVICE BOARD) REGULATION 39.—RECLASSIFICATION.

THE Public Service Board has raised the classification of the under-mentioned office as shown, and the Permanent Head of the Department has recommended the officer named for appointment.

Office and Present Classification.	Revised Classification.	Duties.	Qualifications.	Officer Recommended for Appointment.		
				Name.	Classification.	Date of Classification.
TECHNICAL AND GENERAL DIVISION.						
DEPARTMENT OF CROWN LANDS AND SURVEY.						
Photographer, Grade II.	Grade I.	Under the direction of the Senior Photographer, to supervise the work of a Photographic Section. To photograph maps, plans, documents and original subjects and prepare bromide prints and enlargements, to prepare rectified aerial photographs, enlargements and diapositives. To carry out other photographic work and train juniors as required	To be a competent photographer with a thorough knowledge of and experience in all branches of photography and be especially skilled in the rectification and reproduction of aerial photographs and the reproduction of aerial mosaics. To have the ability to control staff	Van Tol, T. J.	Photographer, Grade II.	12.9.51

Appeals against such recommendation should be lodged with the Secretary to the Public Service Board not later than Saturday, the 29th August, 1953.

Office of the Public Service Board,
Melbourne, 18th August, 1953.

By order,
E. F. FITZGIBBON,
Secretary.

PUBLIC SERVICE OF VICTORIA.—VACANCIES.

APPLICATIONS will be received by the Public Service Board up to Wednesday, the 2nd September, 1953, from persons employed in the Public Service of Victoria, who are eligible and qualified, for appointment to the under-mentioned positions:—

ADMINISTRATIVE DIVISION.

Clerk, Class "C2," Ararat Mental Hospital, Department of Health.

Yearly Salary.—£754, minimum; £806, maximum.

Duties.—To be responsible for the secretarial side of the administration, and to carry out the duties of Clerk of a Mental Hospital as prescribed by the Mental Hygiene Acts.

Qualifications.—To have experience in the management of a Mental Hospital, including control of stores, clothing, provisions, and artisan activities; an intimate knowledge of the Mental Hygiene Acts, Mental Hygiene Authority Act, and Regulations, and ability to control a large staff, including artisans.

NOTE.—Appointee will be eligible for progression to Class "B" after three years' satisfactory service in Class "C2."

Clerk, Class "C1," Head Office, Mental Hygiene Branch, Department of Health.

Yearly Salary.—£668, minimum; £720, maximum.

Duties.—To be in charge of the records of all contingency accounts, expenditure ledgers, the master order system, and all bulk buying of stores, clothing, bedding, and medicines.

Qualifications.—To have a knowledge of the Mental Hygiene Acts and Mental Hygiene Authority Act and Regulations and Public Service Acts and Regulations thereunder and Public Accounts Regulations; and of the requirements of Mental Hospitals and Clinics.

Clerk, Class "C," Public Solicitor's Office, Department of Law.

Yearly Salary.—£520, minimum; £624, maximum.

Duties.—To assist in criminal matters when required to do so and interview applicants for legal assistance.

Qualifications.—To be experienced in the handling of criminal defences and to have had experience in the practice and procedure under the *Poor Persons Legal Assistance Act 1928*.

PROFESSIONAL DIVISION.

Chief Engineer, Class "A1," Office of the Housing Commission, Department of Treasurer.

Yearly Salary.—£1,330, minimum; £1,430, maximum.

Duties.—To advise the Commission on engineering aspects in the selection of housing sites and layout of same. To exercise general control over all site engineering work, including site grading, drainage, and road construction, and to take charge of co-ordination of all services for housing estates. To act as a Member of the Directorate of the Concrete House Project.

Qualifications.—To possess a University Degree or Technical School Diploma in Civil Engineering, or to be the holder of a certificate issued by the Municipal Engineers' Board of Victoria, or equivalent qualifications. Considerable experience in site engineering as applied to large housing estates, and in co-ordination of services, is essential.

Divisional Working Plans Officer, Class "B1," Department of State Forests. (Three vacancies.)

Yearly Salary.—£958, minimum; £1,050, maximum.

Duties.—To prepare forest working, roading, fire protection, water conservation and utilization plans; to arrange, supervise, or undertake forest valuation, assessments, timber cruises and topographical mapping; to assist in the supervision and development of any prescribed field research project; to assist the Divisional Inspector with respect to silvicultural works and any other aspect of Divisional Administration he may require; to act as relieving officer.

Qualifications.—To be a graduate of the School of Forestry, Creswick, or to be the holder of the degree or diploma of a recognized School of Forestry; to have had approved experience in District Administration; to possess a thorough knowledge of the Forests Acts and Regulations and of Victorian forestry practice and procedure.

Assistant Engineer, Class "C," Soil Conservation Authority, Department of Premier.

Yearly Salary.—£520, minimum; £624, maximum.

Duties.—Under direction, to prepare designs and estimates of structures for erosion control, to investigate hydraulic problems associated with Soil Conservation, and to supervise construction of works.

Qualifications.—To possess a University Degree or a Diploma in Civil Engineering. Experience in construction, and knowledge of soil conservation, is desirable.

Draughtsman, Class "C," Department of Water Supply.

Yearly Salary.—£520, minimum; £624, maximum.

Duties.—To make computations and drawings of irrigation subdivisions, farm layouts, and channel works, including designs of details of structures, pipe lines and associated works. To make field measurements and investigations as required, and to assist with the training and supervision of junior draughtsmen.

Qualifications.—1. To have passed—

(a) the School Leaving examination, including English, Mathematics I: and Mathematics II.; or

(b) the School Intermediate examination and, in addition, School Leaving English, Mathematics I., and Mathematics II.; or

(c) an equivalent Technical School examination; and

2. To have had training or experience in the type of work outlined in the duties.

TECHNICAL AND GENERAL DIVISION.

Inspector of Works, Department of Public Works.

Yearly Salary.—£520, minimum; £624, maximum.

Qualifications.—To possess ability to make reports, prepare estimates of costs of works, and make sketch plans; to have a comprehensive knowledge of the building trades and suitable technical qualifications.

Warder, Penal and Gaols Branch, Department of Chief Secretary. (Twenty-six vacancies.)

Yearly Salary.—£339, minimum; £430, maximum.

Duties.—To control and to supervise male prisoners, and to perform other duties as required.

Qualifications.—As required by Regulation 31 of the Public Service (Public Service Board) Regulations.

Reservoir Keeper (Lake Lonsdale), Department of Water Supply.

Yearly Salary.—£370, minimum; £422, maximum.

Duties.—To control, operate, and maintain the works at Lake Lonsdale, Fyans Lake, and Fyans Creek; patrol a section of the Lonsdale-Glenorchy channel; carry out maintenance on Commission's works in connexion with channels and storages in the area; to regulate the inflow and outflow from these lakes; to supervise the work of other officers and casual labour employed, and to keep records in connexion with the work.

Qualifications.—Experience in the regulation of large volumes of water, a sound knowledge of concrete and earthwork construction; to be capable of handling men, horses, and mechanical equipment; to have experience in the maintenance and care of plantations, trees, and shrubs.

NOTE.—A house is available for the successful applicant, if married, for which a rental charge of approximately 6½ per cent. of total emolument (including cost of living adjustment), a year, will be made.

Library Attendant, Grade I., Public Library Branch, Department of Chief Secretary.

Yearly Salary.—£390, minimum; £403, maximum.

Duties.—To assist generally in the General Division work of the Library, and to perform the duties of Senior Library Attendant when required.

Qualifications.—To possess sound physique, good address, and suitability for attending to the public; to have served at least three years in the Reference or Lending Branch of the Public Library, or to have had such library experience as may be considered equivalent to such service.

Assistant (Female), Grade III., Children's Welfare Branch, Department of Chief Secretary.

Yearly Salary.—£312, minimum; £325, maximum.

Duties.—To assist the boarding-out officer in matters relating to the placement and supervision of State wards in foster homes and institutions; to maintain records in connexion therewith.

Qualifications.—To be competent to conduct discussions with institutional managements and private individuals; to have had experience in keeping records and other clerical work.

Cook (Female), Senior, Receiving Depot, Royal Park, Children's Welfare Branch, Department of Chief Secretary.

Salary.—£322 a year.

Duties.—To be responsible for the preparation of meals for staff and children at the Receiving Depot, Royal Park. To exercise supervision over the kitchen staff, and to have charge of the kitchen equipment and stores.

Qualifications.—To be competent and experienced in large scale cooking and to be capable of controlling a small staff.

Tailoress, Beechworth Mental Hospital, Department of Health.

Yearly Salary.—£301, minimum; £314, maximum.

Duties.—To make up and repair male clothing, including coats, vests, and trousers.

Qualifications.—To be a competent needlewoman and machinist, preferably with trade experience.

NOTE.—In addition to the salary rates quoted, a cost of living adjustment (£384 a year for adult males and £288 a year for adult females), which varies in accordance with the rise or fall in the index number of the cost of living, is payable.

By order,

E. F. FITZGIBBON,
Secretary.

Office of the Public Service Board,
Melbourne, 18th August, 1953.

PUBLIC SERVICE OF VICTORIA.—VACANCIES.

(TEMPORARY APPOINTMENT.)

APPLICATIONS will be received by the Public Service Board up to Wednesday, the 2nd September, 1953, from persons who are qualified for appointment to the under-mentioned positions:—

Inspector of Works, Grade II., Department of Public Works. (Four vacancies.)

Salary.—£455 a year.

Duties.—General inspection of public buildings and supervision of works carried out by the Public Works Department, and the preparation of reports in connexion therewith.

Qualifications.—To possess ability to make reports, prepare estimates of costs of works, and make sketch plans; to have a comprehensive knowledge of the building trades and suitable technical qualifications.

NOTE.—In addition to the salary rate quoted, a cost of living adjustment (£384 a year for adult males), which varies in accordance with the rise or fall in the index number of the cost of living, is payable.

By order,

E. F. FITZGIBBON,
Secretary.

Office of the Public Service Board,
Melbourne, 18th August, 1953.

No. 571.

Public Service Act 1946, Section 50.

REGULATIONS—PART III.—SALARIES, INCREMENTS, AND ALLOWANCES.

THE Public Service Board, in pursuance of the powers conferred by the *Public Service Act 1946*, hereby amends its Regulations as shown below:—

FIFTH SCHEDULE.

TEMPORARY EMPLOYEES.

DEPARTMENT OF HEALTH.

MENTAL HYGIENE.

Designations of Positions and Rates of Salaries.

Department and Designation of Position.	Yearly Rate of Salary.		Increments (Annual).
	Minimum.	Maximum.	
	£	£	
Add— Dental Attendant (Female) ..	260	273	..

This Regulation shall have effect from the 27th July, 1953.

D. D. PAINE, Chairman.

E. F. FITZGIBBON, Secretary.

Office of the Public Service Board,
Melbourne, 11th August, 1953.

No. 567.

Public Service Act 1946, Section 50.
REGULATIONS.—PART III.—SALARIES, INCREMENTS,
AND ALLOWANCES.

THE Public Service Board, in pursuance of the powers conferred by the *Public Service Act 1946*, hereby amends its Regulations as shown below :—

SECOND SCHEDULE.

TECHNICAL AND GENERAL DIVISION.
Offices and Rates of Salaries.

Department and Office.	Yearly Rate of Salary.		Increments (Annual).
	Minimum.	Maximum.	
	£	£	
GENERAL.			
<i>Delete—</i> Assistant Draughtswoman, Grade I.	299	325	..
Assistant Draughtswoman, Grade II.	338	364	..
<i>Add—</i> Assistant Draughtswoman, Grade I.	312	338	..
Assistant Draughtswoman, Grade II.	364	390	1 of £26

This Regulation shall have effect as on and from the 2nd August, 1953.

D. D. PAINE, Chairman.
E. F. FITZGIBBON, Secretary.

Office of the Public Service Board,
Melbourne, 3rd August, 1953.

No. 565.

Public Service Act 1946, Section 50.
REGULATIONS.—PART III.—SALARIES, INCREMENTS,
AND ALLOWANCES.

THE Public Service Board, in pursuance of the powers conferred by the *Public Service Act 1946*, hereby amends its Regulations as shown below :—

SECOND SCHEDULE.

TECHNICAL AND GENERAL DIVISION.
Offices and Rates of Salaries.

Department and Office.	Yearly Rate of Salary.	
	Minimum.	Maximum.
	£	£
DEPARTMENT OF EDUCATION.		
<i>Delete—</i> Storekeeper	390	403
<i>Add—</i> Storekeeper	403	416

D. D. PAINE, Chairman.
E. F. FITZGIBBON, Secretary.

Office of the Public Service Board,
Melbourne, 6th August, 1953.

No. 569.

Public Service Act 1946, Section 39.
REGULATIONS.—PART III.—SALARIES, INCREMENTS,
AND ALLOWANCES.

THE Public Service Board, in pursuance of the powers conferred by the *Public Service Act 1964*, hereby amends its Regulations as shown below :—

FIRST SCHEDULE.

PROFESSIONAL DIVISION.
Offices and Rates of Salaries.

Office.	Yearly Rate of Salary.	
	Minimum.	Maximum.
	£	£
DEPARTMENT OF AGRICULTURE.		
CLASS "C."		
<i>Add—</i> Assistant Live Stock Science Officer ..	520	624

D. D. PAINE, Chairman.
E. F. FITZGIBBON, Secretary.

Office of the Public Service Board,
Melbourne, 11th August, 1953.

No. 566.

Public Service Act 1946, Section 50.
REGULATIONS.—PART III.—SALARIES, INCREMENTS,
AND ALLOWANCES.

THE Public Service Board, in pursuance of the powers conferred by the *Public Service Act 1946*, hereby amends its Regulations as shown below :—

SIXTH SCHEDULE.

TEMPORARY EMPLOYEES.

Designations of Positions and Rates of Salaries.

Department and Designation of Position.	Yearly Rate of Salary.		Increments (Annual).
	Minimum.	Maximum.	
	£	£	
GENERAL.			
<i>Delete—</i> Assistant Draughtswoman, Grade I.	299	325	..
Assistant Draughtswoman, Grade II.	338	364	..
<i>Add—</i> Assistant Draughtswoman, Grade I.	312	338	..
Assistant Draughtswoman, Grade II.	364	390	1 of £26
DEPARTMENT OF PUBLIC WORKS.			
<i>Delete—</i> Draughtswoman, Grade I. ..	390	442	2 of £26
Draughtswoman, Grade II. ..	338	364	..

This Regulation shall have effect as on and from the 2nd August, 1953.

D. D. PAINE, Chairman.
E. F. FITZGIBBON, Secretary.

Office of the Public Service Board,
Melbourne, 3rd August, 1953.

No. 570.

Public Service Act 1946, Section 50.
REGULATIONS.—PART III.—SALARIES, INCREMENTS,
AND ALLOWANCES.

THE Public Service Board, in pursuance of the powers conferred by the *Public Service Act 1946*, hereby amends its Regulations as shown below :—

SIXTH SCHEDULE.

TEMPORARY EMPLOYEES.

Designations of Positions and Rates of Salaries.

Department and Designation of Position.	Yearly Rate of Salary.		Increments (Annual).
	Minimum.	Maximum.	
	£	£	
DEPARTMENT OF HEALTH.			
TUBERCULOSIS.			
<i>Add—</i> Matron, Stonnington ..	510	523	..

D. D. PAINE, Chairman.
E. F. FITZGIBBON, Secretary.

Office of the Public Service Board,
Melbourne, 10th August, 1953.

No. 568.

Public Service Act 1946, Section 39.

REGULATIONS.—PART III.—SALARIES, INCREMENTS, AND ALLOWANCES.

THE Public Service Board, in pursuance of the powers conferred by the *Public Service Act 1946*, hereby amends its Regulations as shown below:—

FIRST SCHEDULE.
PROFESSIONAL DIVISION.
Offices and Rates of Salaries.

Office.	Yearly Rate of Salary.	
	Minimum.	Maximum.
	£	£
DEPARTMENT OF AGRICULTURE.		
CLASS "A."		
Add— Senior Geneticist	1,110	1,210
CLASS "B1."		
Delete— Senior Cereal Geneticist	958	1,050

D. D. PAINE, Chairman.
E. F. FITZGIBBON, Secretary.

Office of the Public Service Board,
Melbourne, 3rd August, 1953.

No. 572.

Public Service Act 1946, Section 50.

REGULATIONS.—PART III.—SALARIES, INCREMENTS, AND ALLOWANCES.

THE Public Service Board, in pursuance of the powers conferred by the *Public Service Act 1946*, hereby amends its Regulations as shown below:—

SEVENTH SCHEDULE.
TECHNICAL AND GENERAL DIVISION.
DEPARTMENT OF HEALTH.
MENTAL HYGIENE.
Offices and Rates of Salaries.

Office.	Yearly Rate of Salary.		Increments (Annual).
	Minimum.	Maximum.	
	£	£	
GENERAL STAFF—FEMALES.			
Add— Dental Attendant	260	286	

This Regulation shall have effect from the 27th July, 1953.

D. D. PAINE, Chairman.
E. F. FITZGIBBON, Secretary.

Office of the Public Service Board,
Melbourne, 11th August, 1953.

Teaching Service Act 1946.

TEACHING SERVICE (TEACHERS TRIBUNAL) REGULATIONS.

AMENDMENT No. 61.

THE Teachers Tribunal, in pursuance of the powers conferred by the *Teaching Service Act 1946*, hereby amends Regulation 14 of the Teaching Service (Teachers Tribunal) Regulations in the manner following, that is to say:—

REGULATION 14.

In clause 10, for the expression "Six of these positions" substitute the expression "Twelve of these positions (six for men and six for women)".

W. H. ELLWOOD, Chairman.
G. FENNELL, Secretary.

Office of the Teachers Tribunal,
Melbourne, 12th August, 1953.

TENDERS.

TENDERS will be received at this office until TEN A.M. on the days and for the purposes under mentioned. Particulars may be learnt at this Office and also at places shown in parenthesis.

W.O. means Inspector of Works Office; P.S.—Police Station; T.S.—Technical School; H.E.S.—Higher Elementary School; S.S.—State School; H.S.—High School.

The Board of Land and Works will not necessarily accept the lowest or any tender.

NOTE.—No preliminary deposits are to be lodged with tenders, but a deposit, in accordance with the following Schedule, will be required from the successful tenderer:—

	£
For contract amounts not exceeding £200	2
For contract amounts exceeding £200 and not exceeding £500	5
For contract amounts exceeding £500 and not exceeding £1,000	10
For contract amounts exceeding £1,000—1 per cent. of tender	500
	(maximum deposit)

25th August, 1953.

Ballarat.—Erection of additional out-offices, School of Mines. (W.O., Ballarat; School of Mines, Ballarat.)

Balmoral.—Removal of Gritjurk school building to Balmoral and making good, Group School. (W.O., Hamilton; Maryborough; P.S., Ouyen.)

Balmoral.—Renovations to Brit Brit building, Group School. (W.O., Hamilton; Group School, Balmoral.)

Balmoral.—Erection of four-unit block of teachers' flats, Group School. (W.O., Hamilton, Horsham; Group School, Balmoral.) (Amended specification.)

Balwyn.—Erection of new timber-framed building, H.S.

Balwyn.—Electrical installation in section 1, H.S.

Balwyn.—Supply, delivery, installation, and testing of a warm air heating/ventilation system, H.S.

Beechworth.—Renovations to Superintendent's and Senior Warden's Quarters, Training Prison. (W.O., Wangaratta; P.S., Myrtleford; Training Prison, Beechworth.)

Benambra.—Supply and installation of hot-water service, P.S. (W.O., Bairnsdale.)

Birchip.—Repairs to detached classroom ex Wycheproof South, Higher Elementary School. (W.O., Warracknabeal, Bendigo; Higher Elementary School, Birchip.)

Blackburn North.—Supply and installation of central heating and hot-water service, S.S. No. 4715.

Brighton Beach.—External and internal painting and repairs, provision for cupboards, S.S. No. 2048. (S.S., Brighton Beach.)

Bundalaguah.—Raising, filling, and fencing to residence, S.S. No. 1107. (W.O., Bairnsdale; S.S., Bundalaguah.)

Buninyong.—Repairs and painting and provision of additional heating, S.S. No. 1270. (W.O., Ballarat; S.S., Buninyong.)

Burnley.—Additional light and power outlets, S.S. No. 2853.

Camberwell East.—Enclosing of verandahs and balconies at school, Girls' Secondary School.

Camberwell East.—Renewal of water service, Girls' School. (Girls' School, Camberwell East.)

Caniambo.—Repairs and painting and white-ant treatment to school and residence, S.S. No. 2230. (W.O., Benalla; S.S., Caniambo.)

Caulfield.—Renewal of wire mesh to balconies and stairways, T.S.

Chum Creek.—Internal and external renovations, S.S. No. 3279. (W.O., Alexandra; S.S., Chum Creek.)

Colac.—Additional sewerage facilities and septic tank, H.S. (W.O., Camperdown; H.S., Colac.)

Colac.—Staff room, sliding partition, wardrobes, repairs and painting, S.S. No. 117. (W.O., Camperdown; P.S., Colac; S.S. Colac.)

Collingwood.—Provision and fixing of sinks and cupboards to scullery, cookery, and laundry, Girls' Secondary School. (Girls' Secondary School, Collingwood.)

Cudgewa.—Repairs and external painting, S.S. No. 1956. (W.O., Wangaratta; S.S., Cudgewa.)

Dookie.—Supply and installation of refrigerating plant in the Butchery Demonstration Theatre, Cold Store, Agricultural college.

Essendon.—Replacements to spouting, H.S. (H.S., Essendon.)

Girgarre East.—Repair and renewal of ant damaged timbers, S.S. No. 1732. (W.O., Shepparton; S.S., Girgarre East.)

Glenroy.—Erection and completion of first section, timber-framed building, H.S.

Glenroy.—Electrical installation in section 1, H.S.

Glenroy.—Supply, delivery, installation, and testing of a warm air heating/ventilation system, H.S.

Glenrowan.—Erection of No. 1 shelter pavilion and No. 2 out-offices, S.S. No. 1742. (W.O., Benalla; S.S., Glenrowan.)

Hamilton.—Additions to electrical installation, H.S. (W.O., Hamilton.)

Hawthorn.—Minor alterations, "Moorakynne" Hostel.

Hopetoun.—Repairs and renewals to party and non-party fencing, S.S. No. 3167. (W.O., Warracknabeal; P.S., Hopetoun.)

Horsham.—New Shelter sheds, S.S. No. 298. (W.O., Horsham.)

Kew.—Sewerage drains for new buildings, "Glendonald" School for Deaf Children.

Kew.—Repositioning, motorization, and re-connecting of services to several machines in the Laundry, Mental Hospital.

Lang Lang.—Provision of a new tank stand, 2 No. new tanks, 2 No. lavatory basins and drinking troughs, S.S. No. 2899. (W.O., Korumburra; S.S., Lang Lang.)

Mack's Creek.—External and internal painting, S.S. No. 3357. (W.O., Traralgon; S.S., Mack's Creek.)

Malvern.—Improvement to lighting and new power outlets, Girls' Secondary School.

Malvern East.—Improvement in natural lighting, S.S. No. 4139. (S.S., Malvern East.)

Manangatang.—Electrical installation, District Hospital. (W.O., Swan Hill; P.S., Manangatang.)

Maryborough.—Removal and re-erection of shelter pavilions, repairs and painting, S.S. No. 404. (W.O., Maryborough; S.S., Maryborough.)

Melbourne.—Conversion of strongroom into a darkroom, 605 Flinders-street, Department of Fisheries and Game.

Merino.—Repairs and re-blocking, &c., S.S. No. 2115. (W.O., Hamilton; P.S., Casterton; S.S., Merino.)

Moreland.—External painting and repairs, also erection of new fuel shed and incineration area, S.S. No. 4635, Central. (Moreland Central S.S.)

Moreland.—Additional out-offices, S.S. No. 2837. (S.S., Moreland.)

Moyhu.—Erection of new shelter pavilion, tank stands, out-offices, &c., and general repairs and painting, S.S. No. 1335. (W.O., Benalla, Wangaratta; S.S., Moyhu.)

Nyah West.—Supply and delivery of four air circulators, S.S. No. 3922.

Preston.—Supply and installation of central heating and hot-water service, S.S. No. 4711.

Reservoir.—Repairs and renovations to residence, 10 Duffy-street, S.S. No. 3960.

Reservoir.—Erection and completion of section 1 of concrete veneer timber-framed school building, H.S.

Reservoir.—Electrical installation in section 1, H.S.

Reservoir.—Supply, delivery, installation and testing of a warm air heating/ventilation system, H.S.

Richmond.—Renovations to Caretaker's Cottage, S.S. No. 1567.

Rosebud.—Removal and replacement of floor to wash-house and external painting, &c., S.S. No. 2627. (S.S., Rosebud.)

South Melbourne.—Supply and installation of gas multi-point sink heater to Practice Flat, J. H. Boyd Domestic College.

Springvale.—Erection of first section of new buildings, H.S. (S.S., Springvale.)

Springvale.—Electrical installation in section 1, H.S.

Springvale.—Supply, delivery, installation, and testing of a warm air heating/ventilation system, H.S.

Sunbury.—Renewal of eaves, gutters, and downpipes to Wards M.1, 2, 3, and F.1, 2, 3, Mental Hospital. (Amended specification.)

Toorak.—External painting and repairs, Teachers' College. (11 Glenbervie-road, Toorak.)

Traralgon.—Erection of "Hawksley" 6-classroom prefabricated unit, S.S. No. 4699. (W.O., Traralgon; S.S., Traralgon.)

Traralgon.—Erection of "Hawksley" 6-classroom prefabricated unit, S.S. No. 4652. (W.O., Traralgon; S.S., Traralgon.)

Tungamah.—Repairs and painting, &c., school and residence, S.S. No. 2225. (W.O., Benalla; S.S., Tungamah.)

Ultima.—Septic tank installation, P.S. (W.O., Swan Hill; P.S., Ultima.)

Violet Town.—Re-blocking of residence, P.S. (W.O., Benalla; P.S., Euroa, Violet Town.) (Amended specification.)

Wodonga.—Repairs to flooring (white-ant damage), Higher Elementary School No. 37. (W.O., Wangaratta; Higher Elementary School, Wodonga.)

Yarrowonga.—Erection of first section of new buildings, H.S. (W.O., Benalla; H.S., Yarrowonga.)

Yarrowonga.—Electrical installation in section 1, H.S. (W.O., Wangaratta; P.S., Yarrowonga.)

Yarrowonga.—Supply, delivery, installation, and testing of a warm air heating/ventilation system, H.S. (S.S., Yarrowonga.)

Younanite.—Renovations and external painting to school and out-offices, S.S. No. 3641. (W.O., Benalla; S.S., Younanite.)

1st September, 1953.

Ararat.—Renovation of Farm Manager's residence, Mental Hospital. (W.O., Ballarat, Ararat.)

Ballarat.—Installation of sewerage, residence, 913 Have-lock-street, Transport Regulation Board. (W.O., Ballarat.)

Ballarat.—Alterations and additions to electrical installation, Teachers' College, 126 Webster-street.

Ballarat.—Installation of two sewerage pumps, and supply and installation of connecting piping, steelwork, &c., in sewerage pump house, Mental Hospital. (W.O., Ballarat.)

Balmattum.—General repairs and external painting, S.S. No. 743. (W.O., Benalla.) (Amended specification.)

Beechworth.—Electrical reticulation, Mental Hospital. (W.O., Wangaratta; Mental Hospital, Beechworth.) (Amended specification.)

Benalla.—Completion of office accommodation and men's quarters, P.S. (W.O., Benalla.) (Amended specification.)

Boinka.—Renewals, repairs, and painting, S.S. No. 3800. (W.O., Mildura; S.S., Boinka.)

Burrmine South.—Renewal of boys' out-office and general repairs, S.S. No. 2203. (W.O., Benalla; P.S., Yarrowonga; S.S., Burrmine South.)

Camperdown.—Erection of two shelter pavilions, 35 feet x 20 feet, H.S. (W.O., Camperdown; P.S., Colac.)

Castlemaine.—Renewal and repairs to fencing, S.S. No. 119. (W.O., Kyneton, Bendigo; P.S., Macedon, Daylesford; S.S., Castlemaine.) (Amended specification.)

Chiltern Valley.—Repairs and painting, S.S. No. 2804. (W.O., Wangaratta; S.S., Chiltern Valley.)

Dandenong.—Alterations and additional heating facilities, S.S. No. 1403. (S.S., Dandenong.)

Eltham North.—Electrical installation in "Jennings" prefabricated classrooms, S.S. No. 4212.

Heywood.—Renovations and additions, Consolidated School. (W.O., Hamilton, Warrnambool; P.S., Portland, Port Fairy; Consolidated School, Heywood.)

Kelvin View.—Repairs and painting, S.S. No. 3480. (W.O., Benalla.)

Kensington.—Conversion of classroom to science room, S.S. No. 2374.

Kew.—Remodelling Wards D.1 and F.1, Mental Hospital.

Labertouche.—Provision of No. 1 shelter pavilion, 15 feet x 10 feet, S.S. No. 2471. (W.O., Traralgon; S.S., Labertouche.)

Melbourne.—Constructing new dark room and alter Scientific Section, Police Headquarters, Russell-street.

Melbourne.—Purchase and removal of bricks, Dental Hospital, Elizabeth-street.

Melbourne.—Attention to prefabricated units and repairs to fence, Secondary Teachers' Training Centre, University Grounds.

Millgrove.—Repairs and external painting, S.S. No. 3655. (W.O., Alexandra; S.S., Millgrove.)

Mont Park.—Supply and installation of motors, Carpenter's Shop, Mental Hospital.

Narre Warren.—External and internal repairs and external painting, residence and school buildings, S.S. No. 2924. (W.O., Korumburra; S.S., Narre Warren.)

Red Bluff.—External painting of residence, S.S. No. 3526. (W.O., Wangaratta; P.S., Tallangatta.)

Royal Park.—Hot-water services in two prefabricated residences, Mental Hospital.

Rutherglen.—Sinking and equipping bore, and supply and installation of a pump and engine, Research Station. (Research Station, Rutherglen.)

Seymour.—New out-office accommodation and soakage pit, S.S. No. 547. (W.O., Alexandra; S.S., Seymour.)

Somerville.—Repairs and painting, S.S. No. 2656. (S.S., Somerville.)

Springvale.—Replacement of water service, S.S. No. 3507. (S.S., Springvale.)

Stawell.—Alterations to residence, Inspector's residence, Education Department. (W.O., Ararat; P.S., Stawell.) (Amended specification.)

Sunny Creek.—Repairs, &c., and internal and external painting, S.S. No. 2903. (W.O., Traralgon; S.S., Sunny Creek.)

Swan Hill.—Erection of new brick class-room, S.S. No. 1142. (P.S., Kerang; S.S., Swan Hill.)

Swanpool.—Repairs to white ant damage, S.S. No. 1310. (W.O., Benalla; S.S., Swanpool.)

Traralgon.—Electrical installation three No. 2 class-room "Hawksley" prefabricated units, S.S. No. 4652. (W.O., Traralgon; S.S., Traralgon.)

Traralgon.—Electrical installation in "Hawksley" prefabricated classrooms, S.S. No. 4699. (W.O., Traralgon.)

Walwa.—New shelter pavilions, S.S. No. 2806. (W.O., Wangaratta; S.S., Walwa.)

Warragul North.—New out-office block, drinking troughs, and water service, S.S. No. 4695. (W.O., Traralgon; P.S., Warragul.)

Woodend.—Extension of porch, cupboards under sink, &c., S.S. No. 647. (W.O., Kyneton, Bendigo; S.S., Woodend.)

Woragworm.—Repairs and renovations to school and out-buildings, S.S. No. 2619. (W.O., Warracknabeal; P.S., Dimboola, Nhill; S.S., Woragworm.)

Wycheproof.—Extension to porch to school, S.S. No. 1757. (W.O., Swan Hill; S.S., Wycheproof.)

Yarram.—External painting of Union-street residence, S.S. No. 693. (W.O., Traralgon; S.S., Yarram.)

Yarrawonga.—Repairs, &c., S.S. No. 1819. (W.O., Benalla; S.S., Yarrawonga.) (Amended specification.)

8th September, 1953.

Bringalbert.—Repairs and renovations, S.S. No. 2665. (W.O., Horsham; P.S., Edenhope, Goroke; S.S., Bringalbert.)

Broadmeadows.—Repairs and painting, S.S. No. 982. (S.S., Broadmeadows.)

Dimboola.—Alterations and renovations to shelter shed and residence, H.S. (W.O., Warracknabeal, Horsham; H.S., Dimboola.) (Amended specification.)

Dookie.—Erection of residence for House Supervisor, Agricultural College. (W.O., Shepparton; Agricultural College, Dookie.)

Dookie.—Repairs, renovations, painting to Vice-Principal's residence, Agricultural College. (W.O., Shepparton; Agricultural College, Dookie.) (Amended specification.)

Dunolly.—Erection of sleep-out, alterations, and painting to residence, S.S. No. 1582. (W.O., Maryborough.)

Fryerstown.—External renovations to residence, new washhouse, S.S. No. 252. (W.O., Bendigo, Kyneton; S.S., Fryerstown.)

Footscray.—Erection of timber-framed concrete veneer school, H.S.

Footscray.—Electrical installation in section 1, H.S.

Footscray.—Supply, delivery, installation, and testing of a warm air heating/ventilation system, H.S.

Harrisfield.—Purchase and removal of cottage and fowl pens, M.A. (P.S., Dandenong.)

Heatherton.—Purchase and removal of No. 6 pine trees, Sanatorium. (Sanatorium, Heatherton.)

Landsborough.—Provision of new kitchen, bathroom, flyscreens to residence, S.S. No. 1862. (W.O., Maryborough, Bendigo; S.S., Landsborough.)

Langi Kal Kal.—Conversion of shearing sheds into classrooms, Penal and Gaols Department. (W.O., Maryborough, Ararat.)

Langi Kal Kal.—New dormitory Block, Training Depot. (W.O., Maryborough, Ballarat.)

Melbourne.—Purchase and removal of two mechanical conveyors from Government Cool Stores. (W.O., Bendigo.)

Melbourne.—Purchase and removal of vertical cross tubular boiler from old boiler house at Government Cool Stores. (W.O., Bendigo.)

Melbourne.—Renewal of exhaust canopies and ducts in the kitchen, Police Headquarters, Russell-street.

Mentone.—Dampproofing and the provision of agricultural drains at the Sergeant's Quarters, P.S. (P.S., Mentone.)

Mount Macedon.—Repairs and external painting, S.S. No. 415. (W.O., Kyneton, Bendigo; S.S., Mount Macedon.)

Mudgegonga.—Removal of six pine trees, S.S. No. 2171. (W.O., Benalla; S.S., Mudgegonga.)

Nanneella Estate.—New shelter shed, out-offices, general repairs, and painting to school, residence, and out-buildings, S.S. No. 3708. (W.O., Shepparton; S.S., Nanneella Estate.) (Amended specification.)

Newlands.—Erection of No. 3 timber pavilions, S.S. No. 4646. (S.S., Newlands.)

South Yarra.—Alterations, additions, renovations, and painting, Bell Tower, Botanical Gardens.

Traralgon.—Erection of the H.S. (W.O., Traralgon.)

Traralgon.—Electrical installation, H.S. (W.O., Traralgon.)

Traralgon.—Supply and installation of mechanical services, H.S. (W.O., Traralgon.)

Wonthaggi.—Electrical installation, T.S. (W.O., Korumburra.)

Westbreen.—Repairs and external painting, S.S. No. 4158. (S.S., Westbreen.)

Wirrate.—Purchase and removal of school building and out-offices, S.S. No. 2858. (W.O., Shepparton; P.S., Nagambie.)

Wonthaggi.—Supply and installation of central heating, hot water, and sawdust extraction services, T.S. (W.O., Korumburra.)

Wonthaggi.—Additions and remodelling of T.S. (W.O., Korumburra; T.S., Wonthaggi.)

15th September, 1953.

Ballarat.—New staff toilet, wash basins, &c., S.S. No. 34, Humfrey-street. (W.O., Ballarat; S.S., Ballarat.)

Tenders to be addressed to the Honorable the Commissioner of Public Works, and envelope containing tender marked "Tender for

S. MERRIFIELD,

Commissioner of Public Works

Public Works Department.

Melbourne, 18th August, 1953.

TENDERS FOR GRAZING.

(Section 121, Land Act 1928.)

For the period 1st October, 1953, to 30th September, 1954, renewable annually for a further period where stated.

Tender forms and all particulars can be obtained on application to the Crown Lands Department, Melbourne, or any of the Lands Offices in the country.

Tenders endorsed "Tender for Grazing" should be placed in the Department of Crown Lands Tender-box, State Treasury Buildings, Melbourne, C.2, at or before Noon on Wednesday, the 23rd September, 1953.

TENDERS are invited and must be lodged at the Lands Department, Melbourne, at or before Noon on Wednesday, the 23rd September, 1953, for the right to depasture stock on the following unappropriated portions of lands, subject to the Regulations approved by the Governor in Council and also the subjoined conditions.

CONDITIONS.

1. The Period of occupation will be from 1st October, 1953, to 30th September, 1954, renewable annually for a further period where stated.

2. The rent for twelve months— for which the licence will be issued, and the licence fee of 7s. 6d., must accompany the tender; otherwise the offer of the next highest tenderer who complies with this condition may be accepted.

3. The licensee shall pay shire rates and all other charges for the period of occupation.

4. Separate tenders must be lodged for each block.

5. Tenders to be addressed to the Secretary for Lands (Department of Crown Lands Tender-box), Melbourne, C.2, and endorsed Tender for Grazing.

6. The highest or any tender not necessarily accepted.

7. Tenderers must give their full name, occupation, and ordinary postal address.

8. Where permission to fence has been granted, the outgoing tenant has the option to remove any existing fencing owned by him within one month, or he may arrange with the incoming tenant to pay for it in accordance with the provisions of section 124, Land Act 1928.

This does not apply to cases where the land was the subject of an expired Grazing Area Lease. In all such cases, the ingoing tenant will be held responsible for the care and maintenance of any improvements.

R. W. HOLT,

Commissioner of Crown Lands and Survey.

Department of Crown Lands and Survey,

Melbourne, 17th August, 1953.

Area 880 acres. Lot 1 (B.1685)—

Parish of Moyston West, being allotments 17, 17A, 22,

5, and 6 of section A. Formerly held by V. Nater.

Period of occupation, one year from 1st October, 1953, renewable annually for four years from 1st October, 1954. (Ararat 63/121.)

Area 827 acres. Lot 2 (B.1686)—

Parish of Moyston West, being allotments 18, 19, and 20 of section B. Period of occupation, one year

- from 1st October, 1953, renewable annually for four years from 1st October, 1954. (*Ararat* 74/121.)
- Area 747 acres. Lot 3 (B.1687)—
Parish of Moyston West, being allotments 17, 18A, and 18B of section B. Formerly held by T. W. Brady. Period of occupation, one year from 1st October, 1953, renewable annually for four years from 1st October, 1954. (*Ararat* 78/121.)
- Area 501 acres. Lot 4 (B.1688)—
Parish of Burrah Burrah, being allotment 12c. Formerly licensed to C. G. A. Cameron. Period of occupation, one year from 1st October, 1953, renewable annually for four years from 1st October, 1954. (*Ararat* 0172A/121.)
- Area 10,820 acres. Lot 5 (B.1689)—
Parishes of Woongulmerang East and Gelantipy East, being Grazing Block 19, County of Tambo. Formerly held by A. Hodge. Period of occupation, one year from 1st October, 1953, renewable annually for four years from 1st October, 1954. (*Bairnsdale* 124/121.)
- Area 14,000 acres. Lot 6 (B.1690)—
Parishes of Mallacoota and Betka, being Grazing Block 74, County of Croajingolong. Formerly held by P. G. Ventry. Period of occupation, one year from 1st October, 1953, renewable annually for four years from 1st October, 1954. (*Bairnsdale* 0619/121.)
- Area 3,580 acres. Lot 7 (B.1691)—
Parishes of Bonang and Cabanandra, being Grazing Block 5B, County of Croajingolong. Formerly held by R. Collings. Period of occupation, one year from 1st October, 1953, renewable annually for four years from 1st October, 1954. (*Bairnsdale* 123/121.)
- Area 23,500 acres. Lot 8 (B.1692)—
Parish of Deddick, being Grazing Block 14, County of Croajingolong. Formerly held by C. E. O'Hare. Period of occupation, one year from 1st October, 1953, renewable annually for four years from 1st October, 1954. (*Bairnsdale* 140/121.)
- Area 16,500 acres. Lot 9 (B.1693)—
Parishes of Wooyoot and Thurra, being Grazing Block 57B, County of Croajingolong. Formerly held by G. E. Cameron. Period of occupation, one year from 1st October, 1953, renewable annually for four years from 1st October, 1954. (*Bairnsdale* 159/121.)
- Area 1,897 acres. Lot 10 (B.1694)—
Parish of Canabore, County of Benambra, being allotments 14, 14A, 14B, 15, and 15A. Period of occupation, one year from 1st October, 1953, renewable annually for four years from 1st October, 1954. (*Beechworth* 181/121.)
- Area 2,625 acres. Lot 11 (B.1695)—
Parish of Canabore, County of Benambra, being allotments 37B, 40, 40A, and 41. Period of occupation, one year from 1st October, 1953, renewable annually for four years from 1st October, 1954. (*Beechworth* 158/121.)
- Area 6,622 acres. Lot 12 (B.1696)—
Parish of Walwa, being allotments 2 and 2A and Grazing Block 2, County of Benambra. Period of occupation, one year from 1st October, 1953, renewable annually for four years from 1st October, 1954. (*Beechworth* 0543/121.)
- Area 670 acres. Lot 13 (B.1697)—
Parish of Mullagong, County of Bogong, being allotments 22 and 23 of section 3. Formerly held by C. H. Smyth. Period of occupation, one year from 1st October, 1953, renewable annually for four years from 1st October, 1954. (*Beechworth* 0651/121.)
- Area 545 acres. Lot 14 (B.1698)—
Parish of Kaarimba, County of Moira, being allotments 27, 28, 29, 29A, 29B, 30, 30A, and 30B, section D. Period of occupation, one year from 1st October, 1953, renewable annually for four years from 1st October, 1954. (*Benalla* 0298/121.)
- Area 312 acres. Lot 15 (B.1699)—
Parish of Dingee, County of Bendigo, being the Tang Tang Water Reserve situated west of and adjoining allotments 128 and 129. Formerly licensed to N. J. Howe. Period of occupation, one year from 1st October, 1953, renewable annually for five years from 1st October, 1954. (*Echuca* 0851/121.)
- Area 59 acres. Lot 16 (B.1700)—
Parish of Anakie, being allotment 86 (Mt. Anakie Reserve). Formerly licensed to W. C. Osborne. Period of occupation, one year from 1st October, 1953, renewable annually for four years from 1st October, 1954. (*Geelong* 211/121.)
- Area 200 acres. Lot 17 (B.1701)—
Parish of Lake Wollard, being Lake Gherang Gherang, also known as Walsh's Swamp (excluding area reserved for Common). Formerly held by R. J. Stevenson. Period of occupation, one year from 1st October, 1953, renewable annually for four years from 1st October, 1954. (*Geelong* 116/121.)
- Area 356 acres. Lot 18 (B.1702)—
Parish of Wangerrip, being allotments 24, 24A, 25, and 26. Period of occupation, one year from 1st October, 1953, renewable annually for four years from 1st October, 1954. (*Geelong* 54/121.)
- Area 382 acres. Lot 19 (B.1703)—
Parish of Bessiebelle, County of Normanby, being allotments 81, 82, and 83. Formerly held by G. T. Roberts. Period of occupation, one year from 1st October, 1953, renewable annually for four years from 1st October, 1954. (*Hamilton* 01422/121.)
- Area 535 acres. Lot 20 (B.1704)—
Parish of Bessiebelle, County of Normanby, being allotments 51 and 86. Formerly held by G. T. Roberts. Period of occupation, one year from 1st October, 1953, renewable annually for four years from 1st October, 1954. (*Hamilton* 077/121.)
- Area 448 acres. Lot 21 (B.1705)—
Parish of Bessiebelle, County of Normanby, being allotment 78. Formerly held by G. T. Roberts. Period of occupation, one year from 1st October, 1953, renewable annually for four years from 1st October, 1954. (*Hamilton* 01120/121.)
- Area 315 acres. Lot 22 (B.1706)—
Parish of Tarranginnie, County of Lowan, being the Boyeo Swamp Reserve. Formerly held by A. McDonald. Period of occupation, one year from 1st October, 1953, renewable annually for four years from 1st October, 1954. (*Horsham* 01027/121.)
- Area 1,125 acres. Lot 23 (B.1707)—
Parish of Boorookpi, County of Lowan, being the Boorookpi Swamp Water Reserve. Formerly held by J. P. Walsh. The successful tenderer will be required to pay £55 12s., the valuation of improvements, fencing, with the exception of trough and piping for which one month will be allowed for removal. Period of occupation, one year from 1st October, 1953, renewable annually for four years from 1st October, 1954. (*Horsham* 01000/121.)
- Area 805 acres. Lot 24 (B.1708)—
Parish of Boga, County of Tatchera, being allotment 8B of section 4. Formerly held by Henry Russell Scriven, of Mystic Park, and situated west of Lake Tutchevop. Period of occupation, one year from 1st October, 1953, renewable annually for three years from 1st October, 1954. Outgoing licensee has the right to remove, within one month, any fencing owned by him. (*Kerang* 0815/121.)
- Area 500 acres. Lot 25 (B.1709)—
Parish of Waratah North, County of Buln Buln. Formerly held by F. W. Pilkington, and being the area south and south-east of allotment 22A and lying between Shallow Inlet and Waratah Bay. Excluding areas fronting Shallow Inlet, held under permissive occupancy by T. J. Henderson, and R. C. and H. Henderson. Period of occupation, one year from 1st October, 1953, renewable annually for two years from 1st October, 1954. (*Melbourne* 01274/121.)
- Area 30 acres. Lot 26 (B.1710)—
Parish of Woranga, County of Buln Buln, being the Stone Reserve situated between the Tarra River and allotment 13B. Formerly held by M. E. Read. Period of occupation, one year from 1st October, 1953, renewable annually for two years from 1st October, 1954. (*Melbourne* 01317/121.)
- Area 20,500 acres. Lot 27 (B.1711)—
Parish of Glenmore, being Grazing Block 14, County of Tambo. Formerly held by T. J. Rozynski. Period of occupation, one year from 1st October, 1953, renewable annually for four years from 1st October, 1954. (*Omeo* 71/121.)

- Area 5,080 acres. Lot 28 (B.1712)—
Parish of Mowamba, County of Benambra, being allotments 30, 31, 31A, 32, 33, 34, 35, 36, 42b, 43, 44, 55, 68, and 69. Period of occupation, one year from 1st October, 1953, renewable annually for four years from 1st October, 1954. (*Omeo* 80/121.)
- Area 3,178 acres. Lot 29 (B.1713)—
Parish of Licola North, County of Wonnangatta, being allotments 20, 21, 31b, 32a, 32b, 32c, and 32d. Formerly held by J. C. Higgins. Period of occupation, one year from 1st October, 1953, renewable annually for four years from 1st October, 1954. (*Sale* 0416/121.)
- Area 19,000 acres. Lot 30 (B.1714)—
Parish of Crookayan, being Grazing Block 54, County of Wonnangatta. Formerly held by J. A. McMichael and V. P. Cumming. Period of occupation, one year from 1st October, 1953, renewable annually for four years from 1st October, 1954. (*Sale* 0263/121.)
- Area 12,000 acres. Lot 31 (B.1715)—
Parish of Doledrook, being Grazing Block 55, County of Wonnangatta. Formerly held by P. Higgins. Period of occupation, one year from 1st October, 1953, renewable annually for four years from 1st October, 1954. (*Sale* 029/121.)
- Area 13,000 acres. Lot 32 (B.1716)—
Parish of Tamboritha, being Grazing Block 40b, County of Wonnangatta. Formerly held by J. C. Higgins. Period of occupation, one year from 1st October, 1953, renewable annually for four years from 1st October, 1954. (*Sale* 20/121.)
- Area 15,300 acres. Lot 33 (B.1717)—
County of Wonnangatta, being Grazing Block 46. Formerly held by K. M. Higgins. Period of occupation, one year from 1st October, 1953, renewable annually for four years from 1st October, 1954. (*Sale* 0497/121.)
- Area 4,300 acres. Lot 34 (B.1718)—
Parish of Coongulla, County of Tanjil, being allotments 11 and 12 of section A, allotments 15, 17, 31, and 38 of section C, and the Crown land north of allotments 15 and 16 of section C to the State Forest boundary. Period of occupation, one year from 1st October, 1953, renewable annually for four years from the 1st October, 1954. (*Sale* 169/121.)
- Area 4,500 acres. Lot 35 (B.1719)—
Parishes of Coongulla and Gillum, being Grazing Block 22A, County of Tanjil. Period of occupation, one year from 1st October, 1953, renewable annually for four years from 1st October, 1954. (*Sale* 99/121.)
- Area 225 acres. Lot 36 (B.1720)—
Parish of Bellaura, County of Borung, being allotment 50 and the frontage to the Little Wimmera River abutting thereon. Formerly held by J. D. Deans. Period of occupation, one year from 1st October, 1953, renewable annually for four years from 1st October, 1954. Valuation of sheep dip and yards £31, owned by J. D. Deans, to be paid by incoming tenant. Valuation of fencing £48 10s., owned by J. D. Deans, to be paid by incoming tenant, or alternatively J. D. Deans to be allowed one month to remove same. (*Stawell* 079/121.)
- Area 472 acres. Lot 37 (B.1721)—
Parish of Bellellen, County of Borung, being allotment 66. Formerly held by H. B. Newell. Period of occupation, one year from 1st October, 1953, renewable annually for four years from 1st October, 1954. The outgoing licensee has the right to remove fencing within one month or may make arrangements with the incoming tenant. (*Stawell* 089/121.)
- Area 651 acres. Lot 38 (B.1722)—
Parish of Bellellen, County of Borung, being allotment 69. Period of occupation, one year from 1st October, 1953, renewable annually for four years from 1st October, 1954. (*Stawell* 0122/121.)
- Area 16 acres. Lot 39 (B.1723)—
Township of Boolite, Parish of Dunmunkle, County of Borung, being the Crown lands in sections 1 and 2, and the Crown lands adjoining section 3. Formerly held by H. A. Newell. Period of occupation, one year from 1st October, 1953, renewable annually for four years from 1st October, 1954. (*Warracknabeal* 016/121.)

Area 2½ acres. Lot 40 (B.1724)—

Township of Omeo, fronting Bilton-street and formerly portion of the Pound Reserve. Fencing to be maintained. Period of occupation, one year from 1st October, 1953, renewable annually for four years from 1st October, 1954. (*Omeo* H023197.)

TENDERS FOR THE SERVICE, 1953-54.

PROVISIONS.

BUTTER AND CHEESE.

TENDERS will be received until Eleven o'clock a.m. on Friday, 11th September, 1953, from persons willing to furnish the under-mentioned supplies, in such quantities as may be ordered by the Victorian Government during the twelve months commencing on 1st October, 1953, as per Schedule No. 22—delivery to be made at the institutions at the under-mentioned places.

The places and supplies for which tenders will be received and the amount of the preliminary deposit required are as follows:—

Schedule No. 22.—Preliminary Deposit, £10.

Melbourne, Mont Park, Ararat, Ballarat, Beechworth, and Sunbury Districts—Butter and Cheese.
Greenvale Sanatorium and Pleasant Creek Special School, Stawell—Butter.

The prices tendered must not include sales tax.

Schedule as above, with full particulars, may be obtained from the Secretary to the Tender Board, and for the several districts, from the Medical Superintendent, Mental Hospital, at Ararat, Ballarat, Beechworth, Mont Park, and Sunbury, respectively; for Greenvale, from the Superintendent at the Sanatorium; for Stawell, from the Secretary, Special School, by whom also any information or explanation will be afforded to persons tendering.

Tenders must be accompanied by the preliminary deposit, as shown above, preferably by non-negotiable cheque payable to the order of the Secretary to the Tender Board. The amount and designation of the preliminary deposit enclosed must be clearly stated in the tender. *Savings Bank deposit book, fixed deposit receipts, Commonwealth Treasury bonds, or reference to securities on existing contracts will in no case be received or entertained as preliminary deposits.* Preliminary deposits will be returned within 30 days to unsuccessful tenderers on their application.

Security will be required either in Commonwealth Treasury Bonds, or approved bank guarantee, fixed deposit receipt, Savings Bank deposit book, or non-negotiable cheque in favour of the Secretary to the Tender Board, as the tenderer may elect.

The security must be completed and the contract signed within ten days of acceptance of the tender, failing which the contract may be again advertised, or another tender accepted.

The lowest or any tender will not necessarily be accepted.

In the event of tenderers withdrawing or attempting to withdraw their tenders before notification of acceptance of same, or failing to take up their accepted tenders within the prescribed period after notification of acceptance, the preliminary deposit will be forfeited and, in addition, they may be disqualified from tendering or holding any future contracts for Government supplies for a period of twelve months, such disqualification to date from the notification of acceptance of tender. It is also stipulated that, if a tenderer be a member of a firm and such firm be interested in the contract, the tender shall be in the name of the firm and not in that of the individual and that, for a breach of this condition, the preliminary deposit will be forfeited and the tender declared informal.

Tenders enclosed in a separate envelope, and having the words "Tender for at" (as the case may be) written thereon, must be deposited in the Tender Box at the Tender Board Offices, Gisborne-street, Melbourne, or, if sent by post, postage must be prepaid, and the tenders addressed to the Chairman of the Tender Board, Tender Board Offices, Gisborne-street, Melbourne, C.2, which office they must reach not later than by first post on the date of closing of tenders.

The conditions of contract are those published in the *Victoria Government Gazette*, No. 263, dated 22nd April, 1953, pages 1648 to 1650.

JOHN CAIN,
Treasurer.

The Treasury,
Melbourne, 17th August, 1953.

TENDERS FOR THE SERVICE 1953-54.

FIREWOOD (COUNTRY TOWNS).

TENDERS will be received until Eleven o'clock a.m. on Friday, 25th September, 1953, for the supply of Firewood, in such quantities as may be required by the Government of Victoria at the under-mentioned places, including supplies for High Schools under the Education Department, from the 1st October, 1953, to the 30th September, 1954. Supplies for the Railways Department and State Schools are not included.

Place.	Departments for which Supply is Required.	Estimated Annual Quantity of Firewood Required for Each Place.		
		In 2-ft. Lengths.	In 5-ft. Lengths.	In 6-ft. Lengths.
		Cords of 128 cubic feet when stacked.	Cords of 128 cubic feet when stacked.	Cords of 128 cubic feet when stacked.
Alexandra	Government Institutions, Offices, and High Schools	9
Bacchus Marsh	" " " "	7
Bairnsdale	" " " "	17
Benalla	" " " "	20
Bendigo	" " " "	25	35	..
Camperdown	" " " "	12
Casterton	" " " "	9
Castlemaine	" " " "	20
Colac	" " " "	17
Corryong	" " " "	7
Dandenong	" " " "	17
Daylesford	" " " "	7
Dimboola	" " " "	9
Echuca*	" " " "	20 tons
Foster	" " " "	6
Frankston	" " " "	9
Geelong	" " " "	27	..	200
Hamilton	" " " "	32
Horsham	" " " "	15
Kerang	" " " "	9
Kyneton	" " " "	7
Leongatha	" " " "	12
Lilydale	" " " "	7
Maryborough	" " " "	13
Mildura	" " " "	19
Moe	" " " "	7
Nhill	" " " "	7
Numurkah	" " " "	7
Orbost	" " " "	7
Ouyen	" " " "	7
Portland	" " " "	7
St. Arnaud	" " " "	10
Sale	" " " "	13	35	..
Seymour	" " " "	12
Shepparton	" " " "	17
Swan Hill	" " " "	12
Terang	" " " "	12
Traralgon	" " " "	10
Upwey	" " " "	7
Wangaratta	" " " "	7
Warracknabeal	" " " "	9
Warragul	" " " "	17
Warrnambool	" " " "	24
Wodonga	" " " "	12
Yallourn	" " " "	9
Yarram	" " " "	7

Printed forms of tender, showing estimates of requirements and conditions of contract, may be obtained from the Secretary to the Tender Board, Gisborne-street, Melbourne, C.2, or from the officer in charge of police at each of the above-mentioned places, by whom also any information or explanation will be afforded to persons tendering.

Prices, which must be expressed in words as well as in figures, and without alterations, erasures, or discrepancies, must be per cord of 128 cubic feet when stacked, including delivery and all charges.

Tenders, which must be upon the printed form, will be received for one or more of the above-mentioned places, and tenders for such places may be accepted separately; any of the lengths of wood stipulated may be tendered for and may be accepted separately.

Tenderers must specify the kind or kinds of firewood offered.

Telegrams or tenders not complying with the terms of advertisement will not be entertained.

No security will be required.

Tenderers failing to take up their accepted tenders, or failing to carry out their contracts satisfactorily, will be ineligible to again hold contracts for Government supplies.

Tenders must be enclosed in an envelope, marked "Tender for Firewood at....." as the case may be, and deposited in the Tender Box, Tender Board Offices, Gisborne-street, Melbourne, C.2; or, if sent by post, they must be addressed to the Chairman of the Tender Board, Tender Board Offices, Gisborne-street, Melbourne, C.2.

The lowest or any tender will not necessarily be accepted.

Acceptance of tenders will be notified in the *Government Gazette* and by letter to successful tenderers.

* Firewood sold by weight in this district.

CONDITIONS OF CONTRACT.

1. As the exact quantity of firewood which may be required cannot be stated, the estimate being approximate only, the Government will not be bound by the quantity stated, but will be at liberty to order more or less, according to circumstances, and the contractor will be bound to supply the same at contract rates.

2. All the firewood supplied under these contracts must be split out of large timber, must be perfectly sound, dry, and of the kind or kinds specified in the tender; neither burnt wood, heartwood, small branches, nor outside pieces of bark will be received. The billets must be not less than 4 inches nor more than 6 inches in diameter, and the long wood to be not less than 9 inches nor more than 18 inches in diameter. Delivery to be made on the written order of the authorized officer of the Department requiring the supply. The cord of firewood consists of 128 cubic feet when stacked. If the firewood be obtained from a State Forest Timber Reserve, or ordinary Crown lands, persons cutting or removing same must be provided with a licence or permit from the Forests Commission.

3. Orders will be issued half-yearly (except in cases where the storage is small, when they will be issued quarterly).

4. The contractor will be bound to place the firewood in stacks for measurement in such places as may be directed by the officer receiving the supply. The stacks are to be 2 feet wide (or 5 feet for long wood) by 5 feet high, with space between each stack for measuring; and the billets (or lengths) are all to lie the same way, viz., crossways of the stacks in the form of a cord, and are to be laid as closely and solidly as possible in the stack, and to the satisfaction of the officer receiving the supply. In the event of any inconvenience being caused, either through delay in delivery or of stacking the wood, or failure to stack the wood in the places directed, the Department concerned will purchase elsewhere or re-stack that delivered, at the risk of the contractor, from whose account any expense incurred thereby will be deducted, provided that the contractor shall be given 48 hours' notice before purchases are made or the wood re-stacked at his risk.

5. The officer receiving the supply shall have full power to reject any wood which he may consider not in accordance with the contract, notice of which will be given to the contractor in writing, stating the reason. The contractor may, however, claim a survey; but in that case he must, within 48 hours after objection is made, give notice thereof in writing to the officer rejecting the wood.

6. The board of survey will be composed of persons appointed by the Tender Board, and the decision of the board of survey is to be considered as final.

7. If the board of survey shall decide that the supply is not of proper quality, it must be immediately replaced by the contractor; failing which it will be procured elsewhere, and the extra expense incurred thereby, if any, will be deducted from the contractor's account.

8. Accounts for firewood shall be rendered to the Department receiving the supply immediately upon completion of the order, which must be attached to the account. Payment will be made through the Treasury, Melbourne.

9. In the event of any irregularity on the part of the contractor being repeated, it will be competent for the Government, in case such irregularity should be established to the satisfaction of the Tender Board, to cancel the contract forthwith.

10. Contractors are not at liberty to transfer their contracts under cover of power of attorney, coupled with an interest or otherwise, and no such transfer will be recognized by the Government.

11. Under no circumstances will a contractor be permitted to abandon his contract.

The Treasury,
Melbourne, 17th August, 1953.

JOHN CAIN,
Treasurer.

PRIVATE ADVERTISEMENTS.

I RICHARD CLAUD PARR, of 423 Bell-street, Preston, engineer, hereby give notice that I will not hereafter be responsible for any debts incurred in my name unless, pursuant to an authority hereafter given by me, in writing, and bearing my signature.

Dated the 14th day of August, 1953.

6405 RICHARD CLAUD PARR.

NOTICE is hereby given that Alf. A. Mitchell Pty. Ltd. has applied for a lease under section 125 of the Land Acts for a term of ten years from 24th September, 1953, of allotment 8, section B, City of South Melbourne, containing 1 rood 31 7/10 perches, as a site for Motor Body Building Works. 6121

NOTICE OF INTENTION TO APPLY FOR A LICENCE TO DIVERT WATER AND CUT RACES FROM THE RIVER MURRAY, AT KARADOC.

I HEREBY give notice that I intend to apply for a licence empowering me to divert water for a term of fifteen years to the extent of 96 acre-feet per annum at a maximum rate of 3 acre-feet per day of 24 hours for irrigation of 32 acres, being part of allotment Part A, Dewry Pre-emptive Right, Parish of Karadoc, and to occupy certain Crown lands for works of storage and diversion, and to cut a race thereon.

Any objection to such application must be forwarded, in writing, to the State Rivers and Water Supply Commission, Melbourne, within 30 days of the date hereof.

JOHN NEAL BROWN,
Box 203, Redcliffs, 13th August, 1953. 6366

NOTICE OF INTENTION TO APPLY FOR A LICENCE TO DIVERT WATER AND CUT RACES FROM THE RIVER MURRAY, AT COLIGNAN.

I HEREBY give notice that I intend to apply for a licence empowering me to divert water for a term of fifteen (15) years, to the extent of 500 acre-feet per annum at a maximum rate of 4 acre-feet per day of 24 hours for irrigation of 250 acres, being part of allotments 24 and 25, Parish of Colignan, and to occupy certain Crown lands for works of storage and diversion, and to cut a race thereon.

Any objection to such application must be forwarded, in writing, to the State Rivers and Water Supply Commission, Melbourne, within 30 days of the date hereof.

J. N. CROFTS,
P.O., Colignan, 10th August, 1953. 6354 6351

NOTICE OF INTENTION TO APPLY FOR A LICENCE TO DIVERT WATER AND CUT RACES FROM THE RIVER MURRAY, AT YARRAWONGA.

I HEREBY give notice that I intend to apply for a licence empowering me to divert water for a term of fifteen years, to the extent of 246 acre-feet per annum at a maximum rate of 12 acre-feet per day of 24 hours for irrigation of 123 acres, being Crown allotments 9A and 10A, Parish of Yarrowonga, and to occupy certain Crown lands for works of storage and diversion, and to cut a race thereon.

Any objection to such application must be forwarded, in writing, to the State Rivers and Water Supply Commission, Melbourne, within 30 days of the date hereof.

GRACE JANE BROWNING,
Yarrowonga, 17th August, 1953. 6359

CASTLEMAINE SEWERAGE AUTHORITY.

SIXTH SCHEDULE.

Area No. 36.

THE above-mentioned Sewerage Authority, having made provision for carrying off the sewage from each and every property which, or any part of which, is within the sewerage area hereinafter defined and described, doth hereby declare that on and after the 8th day of August, 1953, each and every property which, or any part of which, is within the said sewerage area shall be deemed to be a seweraged property within the meaning of the *Sewerage District Act 1928*.

The boundaries of the sewerage area hereinbefore referred to are—

- (a) *Norwood Hill*.—Housing Commission Estate, as subdivided, bounded by Ety, Freeman, Harris streets and Government-road, allotments 37 to 84 inclusive.
- (b) Allotments 1, 2, 3, 4, 5, and 20, section 100, bounded by Ety, Farnsworth, and Lawrence streets.
- (c) Allotments 1, 2, 3, 4, and 20, section 103, bounded by Lawrence, Farnsworth, and Landseer streets.
- (d) Allotments 1, 2, 3, part 4, section 104, bounded by Landseer, Farnsworth, and Gainsborough streets.

By order of the said Sewerage Authority,
GEO. W. McMEEKEY, Chairman.
G. R. GOUGH, Secretary.

CITY OF CHELSEA.

NOTICE OF CHANGE OF NAME OF STREET.

NOTICE is hereby given that, in pursuance of the powers conferred by the Local Government Acts, the Council of the City of Chelsea, at their meeting held on the 10th August, 1953, did resolve that the name of the street known as "York Way" be altered to "Afton Way."

Location.—North Ward, part of Crown allotment 13S, Parish of Lyndhurst, County of Mornington, between Laura-street and Albany-crescent.

6349 H. D. HACKWELL, Town Clerk.

CITY OF KEW.

LOAN No. 35.

Notice of Intention to Borrow the Sum of Twenty Thousand Pounds for Permanent Works and Undertakings.

NOTICE is hereby given that the Council of the City of Kew proposes to borrow the sum of Twenty thousand pounds on the credit of the municipal revenues of the Mayor, Councillors, and Citizens of the said City of Kew, such sum to be raised by the issue of debentures, in accordance with the provisions of the Local Government Acts.

1. The maximum rate of interest that may be paid is Four pounds seventeen shillings and six pence (£4 17s. 6d.) per cent. per annum.

2. The purposes for which the loan is to be applied are—

Place of Public Resort and Recreation	£
(Recreation Hall)	500
Municipal Depot (additions)	1,000
Construction of Roads	2,900
Reconstruction of Streets	14,200
Underground Stormwater Drains	1,400
	<hr/>
	£20,000

3. The period of the loan shall be twenty years.

4. The moneys borrowed shall be repayable by providing out of the municipal fund 40 half-yearly instalments of £788 7s. 3d. each, including principal and interest, on the 1st day of June and the 1st day of December during the currency of the loan. The first instalment shall be payable on the 1st day of June, 1954.

5. Such moneys shall be repayable at the National Bank of Australasia Ltd., Melbourne, or at the Council's bankers for the time being in Melbourne.

The plans and specifications and the estimate of the cost of the proposed works, and a statement showing the proposed expenditure of the moneys to be borrowed, are open for inspection at the Town Hall, Walpole-street, Kew.

Dated this 12th day of August, 1953.

6345 W. D. BIRRELL, Town Clerk.

CITY OF MELBOURNE.

BY-LAW No. 334.

A By-law of the City of Melbourne made under an Act of the Governor and Legislative Council of New South Wales 6 Victoria No. 18 intituled "An Act to amend an Act passed in the Sixth year of the reign of Her present Majesty intituled 'An Act to incorporate the inhabitants of the Town of Melbourne'" and numbered 334 to amend By-law numbered 322.

NOW therefore the Council of the City of Melbourne doth hereby in pursuance of the power conferred by the said Act 6 Victoria No. 18 and by every other Act or power enabling it in that behalf order as follows:—

1. This By-law shall from and after the date of the same coming into operation be read and construed as one with the said By-law numbered 322 intituled "A By-law to fix impose and levy tolls and dues at the Cattle Market of the City of Melbourne" and any By-laws amending the same.

2. Clause 2 (a) of the said By-law numbered 322 is hereby amended as follows:—

By repealing the words and figures "For every head of neat cattle (including bulls) 6d." and substituting therefore the words and figures "For every head of neat cattle (including bulls) 9d."

Resolution for passing this By-law agreed to by the Council of the City of Melbourne the 13th day of July, 1953, and confirmed the 10th day of August, 1953—

W. J. BRENS, Lord Mayor.
6346 H. S. WOOLTON, Town Clerk.

TOWN OF COLAC.

BY-LAW No. 17.

Abattoirs Dues and Fees.

A By-law of the Town of Colac, made under sections 284 and 292 of the Health Act 1928, and numbered 17 for the purpose of amending By-law No. 99 of the said town and fixing the rates of fees and dues payable to the Councils of the Town of Colac and the Shire of Colac under Part XIII. of the said Act.

IN pursuance of the powers conferred by the Health Act 1928 and the Local Government Act 1928, and the amendments thereof, and every other power enabling them in this behalf, the Mayor, Councillors, and Burgesses of the Town of Colac order as follows:—

1. This By-law shall come into operation on the day after the day of the publication hereof in the Victoria Government Gazette.

2. The whole of clause 3 of By-law No. 7 of the said Town of Colac is hereby repealed.

3. The fees and dues payable to the Councils of the Town of Colac and the Shire of Colac, under Part XII. of the Health Act 1928, shall be as follows:—

	per head.
(a) For use of the Colac Municipal Abattoirs for slaughtering any—	s. d.
Bull, cow, heifer, ox, or steer ..	3 0
Sheep, lamb, goat, or kid ..	1 0
Swine	2 0
Calf (under 100 lb. dead weight) ..	0 6
Calf (over 100 lb. dead weight) ..	2 0
(b) For examining any—	
Bull, cow, heifer, ox, or steer ..	1 6
Sheep, lamb, goat, or kid ..	0 3
Calf (under 100 lb. dead weight) ..	0 3
Calf (over 100 lb. dead weight) ..	0 6
Swine	1 0
(c) For examining and branding any carcass of or meat derived from any—	
Bull, cow, heifer, ox, or steer ..	4 0
Sheep, lamb, goat, or kid ..	0 9
Swine	2 0
Calf (under 100 lb. dead weight) ..	0 3
Calf (over 100 lb. dead weight) ..	1 0

Resolution for passing this By-law agreed to by the Council on the 27th day of May, 1953, and confirmed on the 24th day of June, 1953.

The common seal of the Mayor, Councillors, and Burgesses of the Town of Colac was hereto affixed by order of the Council in the presence of—

(SEAL) L. G. ATYEO, Mayor.
P. B. BORWICK, Councillor.
A. N. WALLS, Town Clerk.

Submitted to the Commission of Public Health on the 14th day of July, 1953.—G. V. STAFFORD, Secretary to the Commission.

Approved by the Governor in Council on the 4th day of August, 1953.—A. MAHLSTEDT, Clerk to the Executive Council. 6347

BOROUGH OF ECHUCA.

BY-LAW No. 44.

A By-law of the Borough of Echuca, made pursuant to section 197 of the Local Government Act No. 5203, and numbered 44, for the following purpose, that is to say:—

Regulating traffic within the Municipal District, and in particular prescribing those streets, roads, or highways within the Municipal District which shall be used by heavy vehicular traffic.

IN pursuance of the powers conferred by the Local Government Act and every other power thereunto enabling them in that behalf, the Mayor, Councillors, and Burgesses of the Borough of Echuca do hereby order as follows:—

1. This By-law shall come into operation and have effect immediately upon publication of the notice of the making hereof in the Victoria Government Gazette.

2. In this By-law "heavy traffic" means any vehicle or conveyance propelled or drawn by human, animal, mechanical, electrical, or other power the total weight of which, together with the equipment thereof and the load (if any), exceeds six tons.

3. No person shall drive or cause to be driven into or through any portion of the Municipal District any heavy traffic as herein defined, whether travelling within the

Municipal District or from one part of the country to another, except in or upon those roads, streets, and highways set forth and named in the Schedule hereto.

SCHEDULE.

- (a) Echuca-Cohuna main road, also commonly known as Warren-street and Terrick Terrick-road and part of High-street.
- (b) Echuca-Kyabram main road, also commonly known as Cornelia Creek-road.
- (c) Echuca-Nathalia main road, also commonly known as Pakenham-street and Goulburn-road.
- (d) Murray Valley Highway, also known, to part thereof, as Boundary-road.
- (e) Northern Highway, also known as High-street.
- (f) Sturt-street.

Resolution for the passing of this By-law was agreed to by the Council of the Borough of Echuca on the 13th day of July, 1953.

Confirmed the 10th day of August, 1953.

In witness whereof the common seal of the Mayor, Councillors, and Burgesses of the Borough of Echuca was hereto affixed by order of the Council in the presence of—

L. J. LORD, Mayor.

(SEAL) F. C. McCARTNEY, Councillor.

K. F. McCARTNEY, Town Clerk.

6361

BOROUGH OF ECHUCA.

BY-LAW No. 45.

A By-law of the Borough of Echuca, made under section 197 of the *Local Government Act 1946* (No. 5203), and numbered 45, for the following purpose, that is to say:—

Regulating the driving of cattle within the Municipal District and prescribing those streets, roads, or highways within the Municipal District in or along which cattle may be driven.

IN pursuance of the powers conferred by the *Local Government Act 1946* and any other power thereunto enabling them in that behalf, the Mayor, Councillors, and Burgesses of the Borough of Echuca do hereby order as follows:—

1. This By-law shall come into operation and have effect immediately upon publication of the notice of the making hereof in the *Victoria Government Gazette*.

2. No person shall drive or cause to be driven into or through any portion of the Municipal District any cattle intended for sale, slaughter, and shipment, or passing from one part of the country to another, save and except on roads or highways hereafter set forth and named, that is to say:—

- (a) When entering the Municipal District by the north-west from the junction of the Murray Valley Highway and the Echuca-Cohuna main road along Luth-street, Campaspe Esplanade, Crossenvale Bridge, and Boundary-road to West-road; thence south to the road on the northern boundary of Crown allotment 54, Parish of Echuca North; thence north-easterly to the railway crossing on the Murray Valley Highway to the municipal saleyards.
- (b) When entering the Municipal District from the south-west by the road passing between Crown allotment 18 on the one hand and Crown allotments 18A and 18B on the other hand, all in the Parish of Wharparilla, to Crossenvale Bridge; and thence by the route to the municipal saleyards described in paragraph (a) hereof.
- (c) When entering the Municipal District from the south-east along the road on the southern boundary of allotments 31 and 32F, Parish of Echuca North, to the Echuca-Kyabram road; thence north to the road on the southern boundary of suburban Crown allotments 5, 6, and 7, Parish of Echuca North; thence west to the Railway Reserve and by that reserve to the municipal saleyards.
- (d) When entering the Municipal District from the east along the Echuca-Nathalia road (also known as Goulburn-road) from the municipal boundary to Bowen-street; thence by Bowen-street south to Service-street; thence by Service-street west to Sturt-street; thence by Sturt-street south to the municipal saleyards.

- (e) When entering the Municipal District from New South Wales across the River Murray Bridge; thence via Sturt-street south to the municipal saleyards.

Resolution for the passing of this By-law was agreed to by the Council of the Borough of Echuca on the 13th day of July, 1953.

Confirmed the 10th day of August, 1953.

In witness whereof the common seal of the Mayor, Councillors, and Burgesses of the Borough of Echuca was hereto affixed by order of the Council in the presence of—

L. J. LORD, Mayor.

(SEAL) F. C. McCARTNEY, Councillor.

K. F. McCARTNEY, Town Clerk.

6362

BOROUGH OF RINGWOOD.

BY-LAW No. 30.

A By-law of the Borough of Ringwood made under the Local Government Acts and the Uniform Building Regulations Victoria, and numbered 30, for determining, applying, dispensing with or regulating such matters or things as are left to be determined, applied, dispensed with or regulated by the Council of any Municipality under the Uniform Building Regulations, Victoria.

IN pursuance of the powers conferred by the Local Government Acts and the Uniform Building Regulations Victoria, and of any and every other power it thereunto enabling the Mayor, Councillors, and Burgesses of the Borough of Ringwood order as follows:—

1. By-law No. 23 adopting Column No. 5 of the Uniform Building Regulations Victoria, is hereby repealed.

2. The minimum area, depth, and width of frontage specified in Column 3 of Table 803 of the Uniform Building Regulations Victoria, are hereby adopted as the minimum area, depth, and width of frontage of land on which a building shall be constructed throughout the whole of the municipal district.

Resolution for passing this By-law was agreed to by the Council on the 16th day of April, 1953, and confirmed on the 21st day of May, 1953.

The corporate seal of the Borough of Ringwood was hereunto affixed on the 21st day of May, 1953, in the presence of—

J. F. CORR, Mayor.

(SEAL) H. E. PARKER, Councillor.

ALFRED KELLY, Town Clerk.

Approved by the Governor in Council on the 28th July, 1953.—A. MAHLSTEDT, Clerk of the Executive Council. 6382

SHIRE OF BASS.

BY-LAW No. 30.

A By-law of the Shire of Bass, made under section 197 of the *Local Government Act 1946*, and numbered 30, authorizing the placing on roads, in situations approved by the Municipal Engineer (subject, in the case of State Highways, main roads, and tourist roads, to the further approval of the Country Roads Board) of stands or platforms for milk and cream cans, and prescribing the nature and size, and regulating the use of such stands and platforms.

IN pursuance of the powers conferred by the *Local Government Act 1946*, the President, Councillors, and Ratepayers of the Shire of Bass order as follows:—

1. In the interpretation of this By-law—

“Council” means Council of the Shire of Bass.

“Person” includes corporation.

“Road” means any street or road within the municipal district of the Shire of Bass.

Words importing the singular shall be deemed to include the plural.

2. Subject to the provisions hereinafter contained, the Council may, by its Engineer or other authorized officer, authorize any person to place upon any road a stand or platform for milk or cream cans.

3. Every such stand or platform shall conform in nature or size to the following requirements:—

Nature of Construction.

- (a) Any stand or platform placed on a road, in pursuance of this By-law, shall be soundly and neatly constructed and finished in a proper and workmanlike manner to the satisfaction of the Shire Engineer. The external surfaces of the end walls and outer faces of all posts of every such stand or platform shall be painted white, and such external surfaces shall be kept painted white.

- (b) Drains shall be constructed around or under the stands in such positions as shall be directed by the Shire Engineer. Such drains shall be maintained in a clean and serviceable condition to the satisfaction of the Shire Engineer, or any deputy appointed by him to give directions on this matter.

Size of Stands and Platforms.

- (a) The maximum width of any stand or platform measured in a direction at right angles to the direction of adjacent road formation, shall not exceed 5 feet, except in special circumstances, with the consent of Council.
- (b) The maximum length of any stand or platform, measured in a direction parallel to the direction of the adjacent road formation, shall not exceed 18 feet, except in special circumstances, with consent of Council.
- (c) The height of the floor of any unroofed platform shall not be less than 2 feet nor more than 3 ft. 6 in. above the level of adjacent ground.
- (d) No part of any roofed stand shall be at a height greater than 7 feet above the level of the adjacent ground.

4. Any person desiring to place such a stand or platform upon a road shall first make application to the Council, in the form contained in the Schedule hereto, for written permission (hereinafter called "permit") so to do, and shall obtain such permit.

5. No person shall place or erect or commence to place or erect or cause to be placed or erected or cause to be commenced the placing or erection of any such stand or platform on any road without having first made application to the Council in the form contained in the Schedule hereto for a permit so to do.

6. No person shall place or erect or commence to place or erect or cause to be placed or erected or cause to be commenced the placing or erection of any such stand or platform on any road without having first obtained a permit so to do.

7. On receipt of such application the Council shall refer same to its engineer, and if satisfied that the proposed stand or platform conforms to the specifications hereinbefore contained, the Council, by its authorized officer, shall issue a permit authorizing the placing of the same upon the road, in a situation approved by the engineer, provided, however, that if such road shall be a State highway, main road, tourist road, such authority shall be subject to the further approval of the Country Roads Board.

8. No person to whom a permit has been issued as aforesaid to place a stand or platform upon a road shall erect the same otherwise than in accordance with the terms of such permit and the provisions of this By-law.

9. No person shall use or cause to be used any stand or platform placed upon a road, in pursuance of a permit issued under this By-law for any purpose other than that of holding, loading, or unloading milk and/or cream cans.

10. Any person who erects or causes to be erected a stand or platform in pursuance of a permit issued under this By-law, or by whom or for whose benefit such stand or platform is currently used or maintained shall at all times maintain such stand or platform in a proper state of repair, both as to construction and painting, and the Council may at any time give written notice to such person requiring him to effect repairs as may be deemed necessary by the Council's engineer or other authorized officer.

11. The Council may at any time revoke a permit by giving written notice of revocation to the person to whom the permit for the erection of such stand or platform was issued or to the person by whom or for whose benefit such stand or platform is currently used or maintained.

12. Any person who, having erected a stand or platform in pursuance of a permit issued under the provisions of this By-law, or by whom or for whose benefit such stand or platform is currently used or maintained, fails to comply with the terms of any notice served on him under the foregoing provisions, shall be guilty of an offence.

13. No person shall place or erect or cause to be placed or erected, tram tracks or rails upon a road unless the fact is stated in his application and noted on permit.

In all cases where tram tracks or rails are placed on a road, such tram tracks or rails shall be placed at a natural surface level, but where, in any particular case, this is not practicable, application shall be made to Council to erect tram tracks or rails to be placed at other than natural ground surface. If such application is passed, wing fences shall be placed between the road boundary fences and the end of the tram track or rails. The wing fences shall be erected at a minimum angle of 45 degrees to the centre of the road and shall consist of posts spaced not more than

8 feet apart and two rails, the top of the upper rail shall not be less than 3 feet nor more than 3 ft. 6 in. above the natural surface of the ground. The posts and rails shall be painted white and such surfaces shall be kept painted white.

14. Any person who shall wilfully offend against or commit any breach of the By-law shall be liable for every offence to a penalty not exceeding Twenty pounds, and if such offence is a continuing one, to a further penalty not exceeding £1 per day for each day such offence is continued after a conviction or order by any court.

SCHEDULE.

Shire of Bass.

Application for Permit to Place on a Road a Platform or Stand for Cream Stand or Milk Cans.

To the Secretary,
Shire of Bass,
Dalyston.

I hereby apply for a permit to place on the road *an unroofed platform for (a) *a roofed stand

cream or milk cans adjacent to (b) allotment section Parish of *occupied by me. *owned by me.

The stand or platform will be erected in accordance with By-law No. of the Shire of Bass, and on the site approved by the Shire Engineer, and will be kept repaired and painted by me in a neat condition and good state of maintenance to the satisfaction of Council.

I undertake to remove the stand or platform and make good the site to the Council's satisfaction at any time upon being requested to do so.

.....Signature of Applicant.

.....Address.

Date / /

(a) State number of cans for which stand is to be designed.

(b) Description of land owned or occupied by applicant.

* Strike out words that are not applicable.

The Resolution for making and passing this By-law was agreed to by the Council at its meeting held on the 8th day of June, 1953, and confirmed on the 13th day of July, 1953.

The common seal of the President, Councillors, and Ratepayers of the Shire of Bass was hereunto affixed in the presence of—

(SEAL) THOMAS STEWART, President.
G. C. HADE, Councillor.
N. G. HAYNES, Secretary.

6360

SHIRE OF BROADFORD.

NOTICE is hereby given that Senior Constable William Edward Burns, No. 9504, has been appointed Prosecuting Officer for the Shire of Broadford, as from 6th August, 1953.

6350

M. D. WADE, Shire Secretary.

SHIRE OF DANDENONG.

RE-NAMING OF STREETS.

NOTICE is hereby given that the Council of the Shire of Dandenong has altered the following street names:—

Old Name.	New Name.
1. Heath-road	Fairbank-road.
2. Levingstone-road	Harold-road.
3. Foundation-street	Virginia-street.

6348

R. BOOTH, Shire Secretary.

SHIRE OF DUNMUNKLE.

LOAN No. 18.

Notice of Intention to Borrow the Sum of £10,000 for Permanent Works and Undertakings.

NOTICE is hereby given that the Council of the Shire of Dunmunkle proposes to borrow the sum of Ten thousand pounds, on the credit of the municipal revenues of the President, Councillors, and Ratepayers of the said shire, such sum to be raised by the issue of debentures, in accordance with the provisions of the Local Government Acts.

1. The maximum rate of interest that may be paid is 4½ per cent. per annum.

2. The purpose for which the loan is to be applied is the—

Conversion of Council Electric Supply Undertaking from Direct to Alternating Current.

3. The period of the loan shall be fifteen years.
4. The moneys borrowed shall be repayable by providing out of the municipal fund 30 half-yearly instalments of approximately £473 16s. 1d. each, including principal and interest, on the 1st day of May and the 1st day of November during the currency of the loan. The first instalment shall be payable on the 1st day of May, 1954.

5. Such moneys shall be repayable at The Commercial Bank of Australia Ltd., Melbourne, or at the Council's bankers for the time being in Melbourne.

The plans and specifications and the estimate of the cost of the proposed works, and a statement showing the proposed expenditure of the moneys to be borrowed, are open for inspection at the Shire Office, Rupanyup.

Dated this 4th day of August, 1953.

J. D. McNAMARA, A.A.S.A., L.C.A., A.C.I.S.,
6341 Shire Secretary.

SHIRE OF DUNMUNKLE.

LOAN No. 19.

Notice of Intention to Borrow the Sum of £10,000 for Permanent Works and Undertakings.

NOTICE is hereby given that the Council of the Shire of Dunmunkle proposes to borrow the sum of Ten thousand pounds, on the credit of the municipal revenues of the President, Councillors, and Ratepayers of the said shire, such sum to be raised by the issue of debentures, in accordance with the provisions of the Local Government Acts.

1. The maximum rate of interest that may be paid is 4½ per cent. per annum.

2. The purpose for which the loan is to be applied is the—

Conversion of Council Electric Supply Undertaking from Direct to Alternating Current.

3. The period of the loan shall be twenty years.

4. The moneys borrowed shall be repayable by providing out of the municipal fund 40 half-yearly instalments of approximately £394 3s. 7d. each, including principal and interest, on the 1st day of May and the 1st day of November during the currency of the loan. The first instalment shall be payable on the 1st day of May, 1954.

5. Such moneys shall be repayable at The Commercial Bank of Australia Ltd., Melbourne, or at the Council's bankers for the time being in Melbourne.

The plans and specifications and the estimate of the cost of the proposed works, and a statement showing the proposed expenditure of the moneys to be borrowed, are open for inspection at the Shire Office, Rupanyup.

Dated this 4th day of August, 1953.

J. D. McNAMARA, A.A.S.A., L.C.A., A.C.I.S.,
6342 Shire Secretary.

SHIRE OF DUNMUNKLE.

LOAN No. 20.

Notice of Intention to Borrow the Sum of £5,000 for Permanent Works and Undertakings.

NOTICE is hereby given that the Council of the Shire of Dunmunkle proposes to borrow the sum of Five thousand pounds, on the credit of the municipal revenues of the President, Councillors, and Ratepayers of the said shire, such sum to be raised by the issue of debentures, in accordance with the provisions of the Local Government Acts.

1. The maximum rate of interest that may be paid is 4½ per cent. per annum.

2. The purposes for which the loan is to be applied are—

(a) Conversion of Council Electric Supply Undertaking from Direct to Alternating Current.

(b) Purchase of road-making plant.

3. The period of the loan shall be ten years.

4. The moneys borrowed shall be repayable by providing out of the municipal fund twenty half-yearly instalments of approximately £318 16s. each, including principal and interest, on the 1st day of May and the 1st day of November during the currency of the loan. The first instalment shall be payable on the 1st day of May, 1954.

5. Such moneys shall be repayable at The Commercial Bank of Australia Ltd., Melbourne, or at the Council's bankers for the time being in Melbourne.

The plans and specifications and the estimate of the cost of the proposed works, and a statement showing the proposed expenditure of the moneys to be borrowed, are open for inspection at the Shire Office, Rupanyup.

Dated this 4th day of August, 1953.

J. D. McNAMARA, A.A.S.A., L.C.A., A.C.I.S.,
6343 Shire Secretary.

SHIRE OF KOWREE.

LOAN No. 7.

Notice of Intention to Borrow the Sum of £10,000 for Permanent Works and Undertakings.

NOTICE is hereby given that the Council of the Shire of Kowree proposes to borrow the sum of Ten thousand pounds on the credit of the municipal revenues of the President, Councillors, and Ratepayers of the said Shire, such sum to be raised by the issue of debentures, in accordance with the provisions of the Local Government Acts.

1. The maximum rate of interest that may be paid is 4½ per cent. per annum.

2. The purpose for which the loan is to be applied is—
Additions to Municipal Offices—£5,000.
Construction of Municipal Workshops—£1,000.
Construction of Footpaths and Drains—£4,000.

3. The period of the loan shall be twenty years.

4. The moneys borrowed shall be repayable by providing out of the municipal fund 40 half-yearly instalments of principal and interest on the 1st day of March and the 1st day of September during the currency of the loan. The first instalment shall be payable on the 1st day of March, 1954.

5. Such moneys shall be repayable at the National Bank of Australasia Limited, Melbourne, or at the Council's banker's for the time being in Melbourne.

The plans and specifications and the estimate of the cost of the proposed works, and a statement showing the proposed expenditure of the moneys to be borrowed, are open for inspection at the Shire Office, Edenhope.

W. M. OLIVER, Shire Secretary.

10th August, 1953.

6344

SHIRE OF RUTHERGLEN.

NOTICE is hereby given that Senior Constable Norman Murray McDonald was appointed Prosecuting Officer for the Shire of Rutherglen, on 7th August, 1953.

6365

C. A. RICKETTS, Shire Secretary.

SHIRE OF VIOLET TOWN.

LOAN No. 6.

Notice of Intention to Borrow the Sum of £5,000 for Permanent Works and Undertakings.

NOTICE is hereby given that the Council of the Shire of Violet Town proposes to borrow the sum of £5,000 on the credit of the municipal revenues of the President, Councillors, and Ratepayers of the said shire, such sum to be raised by the issue of debentures, in accordance with the provisions of the Local Government Act 1946.

The maximum rate of interest that may be paid is Four pounds seventeen shillings and six pence per cent. per annum.

The purpose for which the loan is to be applied is for the purchase of road-making machinery.

The period of the loan shall be ten years.

The moneys borrowed shall be repayable by providing out of the municipal fund twenty half-yearly instalments of approximately £318 16s. each, including principal and interest, on the 1st day of January and the 1st day of July during the currency of the loan. The first instalment shall be payable on the 1st day of January, 1954.

Such moneys shall be payable at the National Bank of Australasia, Melbourne, or at the Council's bankers for the time being in Melbourne.

The plans and specifications and the estimate of the cost of the proposed works, and a statement showing the proposed expenditure of the moneys to be borrowed, are open for inspection at the Shire Office, Violet Town.

Dated this 12th day of August, 1953.

6363

R. J. HAMMETT, Shire Secretary.

SHIRE OF WARRNAMBOOL.

POUNDKEEPERS.

NOTICE is hereby given that the under-mentioned persons have been appointed as Poundkeepers by the Council of the Shire of Warrnambool:—

Dorothy May Pimblett, at Winslow.

Ethel Annie Frost, at Nullawarre.

Denis Patrick O'Sullivan, at Purnim.

6387

A. F. PONTING, Shire Secretary.

SHIRE OF WARRNAMBOOL.

APPOINTMENT OF POUNDS.

NOTICE is hereby given that the Council of the Shire of Warrnambool, under the provisions of section 4 of the *Pounds Act 1928*, has appointed the places as described hereunder as Pounds:—

Part of allotment 3A, Parish of Purnim, County of Villiers, as the Purnim Pound.

Crown allotment 18, Parish of Nirranda, County of Villiers, as the Nullawarre Pound.

6388

A. F. PONTING, Shire Secretary.

NOTICE OF DISSOLUTION OF PARTNERSHIP.

NOTICE is hereby given that the partnership heretofore subsisting between the undersigned Frank Valentine Rossiter and Alwyn John Rossiter, carrying on business as printers and publishers, at Commercial-road, Yarram, under the name of "Rossiter Bros. and Co.," has been dissolved by mutual consent as from the 30th day of June, 1953.

Dated the 13th day of August, 1953.

F. V. ROSSITER.

ALWYN J. ROSSITER.

Witness to the above signatures—ERIC K. HART, solicitor, Yarram. 6380

The *Companies Act 1938*.—In the matter of FERGUSON SAWMILLS PTY. LTD., of 2 Ferguson-street, Abbotsford.

NOTICE is hereby given that an Extraordinary Meeting of the members of the above-named company will be held at the offices of Messrs. Kennedy, Small, and Middlemiss, 31 Queen-street, Melbourne, at 2.30 p.m. on Thursday, the 27th August, 1953, for the purpose of considering, and if thought fit, passing the following Resolution as a Special Resolution:—

"That it is desirable for the company to be wound up and that it be wound up voluntarily accordingly and that for such purpose Edward Ronald Small, of 31 Queen-street, Melbourne, chartered accountant (Aust.), be and is hereby appointed liquidator."

Dated this 18th day of August, 1953.

R. ELBOGEN, Director.

Kennedy, Small, and Middlemiss, chartered accountants (Aust.), 31 Queen-street, Melbourne. 6412

Companies Act 1938.—In the matter of HARCREST PTY. LTD. (in Voluntary Liquidation).

NOTICE is hereby given that a Final Meeting of members will be held on 18th September, at 2.30 p.m., at 341 Collins-street, Melbourne, to receive the liquidator's final accounts.

6406

ERIC A. CUST, Liquidator.

BLOCK INDUSTRIES PTY. LTD. (IN VOLUNTARY LIQUIDATION).

NOTICE is hereby given that a Final Distribution in Block Industries Pty. Ltd. (in Voluntary Liquidation), will be made on the 15th September, 1953. Creditors having any claim against the company should forward same, supported by proof of debt, to the office of the liquidator before that date, otherwise their claims will be excluded from such distribution.

R. A. H. CLEMENTS, F.C.A. (Aust.), Liquidator, 411 Collins-street, Melbourne, C.I. 6400

J. H. HOPMAN PTY. LTD. (IN VOLUNTARY LIQUIDATION).

NOTICE is hereby given that a Final Distribution in J. H. Hopman Pty. Ltd., (in Voluntary Liquidation), will be made on the 15th September, 1953. Creditors having any claim against the company should forward same, supported by proof of debt, to the office of the liquidator before that date, otherwise their claims will be excluded from such distribution.

R. A. H. CLEMENTS, F.C.A. (Aust.), Liquidator, 411 Collins-street, Melbourne, C.I. 6401

UNION GUT CO. PTY. LTD. (IN VOLUNTARY LIQUIDATION).

NOTICE is hereby given that a Final Distribution in Union Gut Co. Pty. Ltd. (in Voluntary Liquidation), will be made on the 15th September, 1953. Creditors having any claim against the company should forward same, supported by proof of debt, to the office of the liquidator before that date, otherwise their claims will be excluded from such distribution.

R. A. H. CLEMENTS, F.C.A. (Aust.), Liquidator, 411 Collins-street, Melbourne, C.I. 6402

The *Companies Act 1938*.

NOTICE OF FINAL MEETING.

IN THE MATTER OF FRANK ALEXANDER PROPRIETARY LIMITED.

NOTICE is hereby given that, pursuant to section 236 of the *Companies Act 1938*, a General Meeting of the members of the above-named company will be held at 473 Bourke-street, Melbourne, on Monday, the 21st day of September, 1953, at 4 o'clock in the afternoon, for the purpose of having an account laid before them, showing the manner in which the winding up has been conducted, and the property of the company disposed of, and of hearing any explanation that may be given by the liquidator.

Dated this 12th day of August, 1953.

6373

F. Y. RATTRAY, Liquidator.

In the matter of the *Companies Act 1938*, and in the matter of the AUSTRALIAN HOSPITAL BENEFITS PROPRIETARY LIMITED (in Voluntary Liquidation).

A GENERAL Meeting of the company will be held at 10 a.m., the 22nd day of September, 1953, at 204 Waverley-road, East Malvern, to receive an account of the winding up of the company.

6383

A. BRUCE, Liquidator.

NOTICE TO SHAREHOLDERS.

In the matter of the *Companies Act 1938*, and INDEPENDENT MANUFACTURING PTY. LIMITED INC. IN VICTORIA (in Liquidation).

NOTICE is hereby given in pursuance of section 236 of the *Companies Act 1938*, that a General Meeting of the members of the above-named company will be held on Wednesday, 30th September, 1953, at the office of the liquidator, 39 Martin-place, Sydney, at 11.30 o'clock in the forenoon, for the purpose of having an account laid before them showing the manner in which the winding up has been conducted and the property of the company disposed of, and of hearing any explanation that may be given by the liquidator.

Dated this 12th day of August, 1953.

6377

CONRAD F. HORLEY, Liquidator.

SUSAN MARY WAKEMAN, late of Swan Hill, in the State of Victoria, widow, DECEASED (who died on the 19th day of February, 1953).

CREDITORS, next of kin, and all other persons having claims against the estate of the deceased are required by the executors of the will, Clive Campbell Wakeman, of Swan Hill aforesaid, motor body builder, and Neil Wakeman, of Swan Hill aforesaid, draper, to send particulars to them, care of the undersigned, on or before the 11th day of November, 1953, after which date they will distribute the assets, having regard only to the claims of which they then have notice.

Dated the 11th day of August, 1953.

GARDEN & GREEN, solicitors, McCallum-street, Swan Hill. 6355

FRANK BISMORE ABEL, late of Nyah, in the State of Victoria, labourer, DECEASED, intestate (who died on the 16th day of April, 1953).

CREDITORS, next of kin, and all other persons having claims against the estate of the deceased are required by the administrator, David George Abel, of Bayles, in the said State, farmer, to send particulars to him, care of the undersigned, on or before the 12th day of November, 1953, after which date he will distribute the assets, having regard only to the claims of which he then has notice.

Dated the 12th day of August, 1953.

GARDEN & GREEN, solicitors, McCallum-street, Swan Hill. 6356

HERBERT GEORGE SQUIRES, late of 14 Beveridge-street, Swan Hill, in the State of Victoria, retired water bailiff, DECEASED (who died on the 8th day of June, 1953).

CREDITORS, next of kin, and all other persons having claims against the estate of the deceased are required by the executors of the will, Leslie Herbert Squires, farmer, and Dorothy Irene Mathers, married woman, both of Swan Hill aforesaid, to send particulars to them, care of the undersigned, on or before the 12th day of November, 1953, after which date they will distribute the assets, having regard only to the claims of which they then have notice.

Dated the 12th day of August, 1953.

GARDEN & GREEN, solicitors, McCallum-street, Swan Hill. 6357

Trustee Act 1928.

NOTICE TO CLAIMANTS.

PURSUANT to the *Trustee Act 1928*, creditors, next of kin, and all other persons having claims in respect of the estate of any deceased person named below are required to send particulars thereof to the legal personal representative or representatives at the address stated below, on or before the date stated, after which date the representative or representatives will distribute the assets, having regard only to the claims of which notice has been received:—

Alexander Murdoch Matheson McLennan, formerly of Fern Grove Farm, Murroon, but late of "Ardmhor", Barwon Downs, farmer and grazier, who died 29th April, 1953.—Claims to the applicants for probate, Edith Annie McLennan, formerly of "Ardmhor", Barwon Downs, but now of 165 Fyans-street, Chilwell, Geelong, widow, and Allan Elliott McDonald, of 189 Moorabool-street, Geelong, solicitor, care of Wighton and McDonald, solicitors, 189-191 Moorabool-street, Geelong, by 21st October, 1953.

6390

Jeannette Patching, late of Aberdeen-street, Geelong West, widow, died 18th May, 1953.—Claims to the executrix, Jeannette Lillian Greenfield, of 28 Aberdeen-street, Geelong West, widow, care of Wighton and McDonald, solicitors, 189-191 Moorabool-street, Geelong, by 21st October, 1953.

6391

JOHN MCLENNAN (also known as John Patrick McLennan), late of 6 Lorrean-avenue, East Brighton, gentleman, DECEASED (who died on 22nd January, 1953).

CREDITORS, next of kin, and all other persons having claims against the estate of the deceased are required by the executors of the will, Marguerite Flora McLennan, of 6 Lorrean-avenue, East Brighton, widow, Peter Anthony Barker, formerly of 116 Queen-street, Melbourne, but now of 114 Elizabeth-street, Melbourne, solicitor, and Edmund Timothy Mulcahy, formerly of 96 Orrong-road, Elsternwick, but now of 134 Cochrane-street, Gardenvale, accountant, to send particulars of such claims to them, care of the undersigned, on or before the 30th October, 1953, after which date the executors will distribute the assets, having regard only to the claims of which they then have notice.

Dated 10th August, 1953.

JOHN F. RIORDAN, solicitor, 26 Fryers-street, Shepparton.

6352

JOHN LESLIE THOMAS, late of Swan Hill, in the State of Victoria, farmer, DECEASED (who died on the 28th day of January, 1953).

CREDITORS, next of kin, and all other persons having claims against the estate of the deceased are required by the executors of the will, John Evans Thomas, farmer, and Mervyn Leslie Thomas, school teacher, both of Swan Hill aforesaid, to send particulars to them, care of the undersigned, on or before the 12th day of November, 1953, after which date they will distribute the assets, having regard only to the claims of which they then have notice.

Dated the 12th day of August, 1953.

GARDEN & GREEN, solicitors, McCallum-street, Swan Hill.

6358

CREDITORS, next of kin, and others having claims against the estate of Ernest William Butcher, late of Hamilton, retired railway employee, deceased (who died on the 12th day of December, 1952), are to send the particulars of such claims to The Fidelity Trustee Company Limited, of 101 Lydiard-street north, Ballarat, addressed to the said company, at its branch office, situate at 73 Thompson-street, Hamilton, by the 31st day of October, 1953, after which date the company will distribute the assets, having regard only to the claims of which it then has notice.

MELVILLE & WALKER, solicitors, 69-71 Thompson-street, Hamilton.

6353

CREDITORS, next of kin, and all others having claims against the estate of Caroline Firth, late of 59 Woodbine-grove, Chelsea, State of Victoria, married woman, deceased (died on the 10th day of May, 1953), are required to send particulars of their claims to the executor, Michael Niall, in care of Michael Niall and Co., solicitors, 360 Collins-street, Melbourne, on or before the 22nd day of October, 1953, after which date he will distribute the assets, having regard only to the claims of which he then has notice.

MICHAEL NIALL & CO., solicitors, 360 Collins-street, Melbourne.

6409

CREDITORS, next of kin, and all others having claims against the estate of Sidney Joseph Bishop, of 962 Station-street, Box Hill, in the State of Victoria, gentleman, deceased (who died on the 2nd day of January, 1953), are required to send particulars of their claims to the executrix, Lily May Bishop, in care of Michael Niall and Co., solicitors, 360 Collins-street, Melbourne, on or before the 22nd day of October, 1953, after which date she will distribute the assets, having regard only to the claims of which she then has notice.

MICHAEL NIALL & CO., solicitors, 360 Collins-street, Melbourne.

6410

PURSUANT to the provisions of the *Trustee Act 1928*, notice is hereby given that all persons claiming against the estate of James D'Ombra, late of Nangurna, Kalorama, in the State of Victoria, retired insurance manager, deceased (who died on the 24th day of April, 1953, and probate of whose will was on the 10th day of August, 1953, granted by the Supreme Court of Victoria to Clarence Tertius Robertson, of 60 McGregor-street, East Malvern, in the said State, insurance assessor, and The Trustees, Executors, and Agency Company Limited, of 401 Collins-street, Melbourne, aforesaid, the executors appointed thereby), are hereby required to send particulars, in writing, of such claims to the said executors, to care of The Trustees, Executors, and Agency Company Limited, at the address above, on or before the 21st day of October, 1953, after which date the said executors will proceed to convey or distribute the said estate to or among the persons entitled thereto, having regard only to the claims, whether formal or not, of which they shall then have had notice, and will not be liable for the assets so distributed to any person of whose claim they shall not then have had notice.

MALLESON, STEWART & CO., solicitors, 46 Queen-street, Melbourne.

6408

CREDITORS, next of kin, and others having claims in respect of the estate of Audrey Cohen, late of 19 Harcourt-street, Auburn, in the State of Victoria, manageress, deceased (who died on 25th day of December, 1952), are to send particulars of their claims to the executrix, care of the undersigned by the 18th day of October, 1953, after which date she will distribute the assets, having regard only to the claims of which she then has notice.

GORDON, RENNICK, & GAYNOR, 339 Collins-street, Melbourne, solicitors for the executrix.

6411

CREDITORS, next of kin, and others having claims in respect of the estate of Emma Rosina Beavis, late of 50 Royal-parade, Pascoe Vale, in the State of Victoria, spinster, deceased (who died on the 8th day of September, 1952), are to send particulars of their claims to the executor, care of the under-mentioned solicitors, on or before the 31st day of October, 1953, after which date he will distribute the assets, having regard only to the claims of which he then has notice.

E. P. JOHNSON & DAVIES, solicitors, 339 Collins-street, Melbourne.

6407

CREDITORS, next of kin, and others having claims in respect of the estate of Constance Ethel Grimley, formerly of 71 Wallace-street, West Preston, and 65 Jennings-street, Colac, but late of The Mental Hospital, Ballarat, widow, deceased (who died on the 31st March, 1953), are to send particulars of their claims to The Fidelity Trustee Company Limited, at 50 Market-street, Melbourne, by the 19th October, 1953, after which date it will distribute the assets, having regard only to the claims of which it then has notice.

6404

CREDITORS, next of kin, and others having claims in respect of the estate of Vera Caroline Sheeran, late of 15 Adrian-street, Burwood, widow (who died on the 12th day of December, 1952, and probate of whose will was on the 27th day of March, 1953, granted by the Supreme Court of Victoria to William Henry Sheeran, of Waugh-street, Charlton, manager, and Joseph Francis Sheeran, of 470 Lygon-street, Carlton, librarian, the executors appointed by such will), are required to send particulars of their claims to such executors, care of the undersigned solicitors, by the 31st day of October, 1953, after which date the said executors intend to distribute the assets, having regard only to the claims of which they then have notice.

Dated this 14th day of August, 1953.

BOOTHBY & BOOTHBY, 408 Collins-street, Melbourne, and Korumburra, solicitors for the executors.

6398

CREDITORS, next of kin, and others having claims against the estate of William Crosbie, late of Kinabulla, farmer, deceased (who died on the 23rd May, 1953), are requested to send particulars of their claims to the National Trustees, Executors, and Agency Company of Australasia Limited, of 95 Queen-street, Melbourne, on or before the 23rd day of October, 1953, after which date the said company will proceed to distribute the assets of the deceased, having regard only to the claims of which it shall then have had notice.

OAKLEY THOMPSON & CO., Birchip, proctors for the National Trustees, Executors, and Agency Company of Australasia Limited. 6371

CREDITORS, next of kin, and others having claims against the estate of Gwendoline Phyllis Markham, late of 15 Goodwin-street, Glen Iris, in the State of Victoria, married woman, deceased (who died on 12th October, 1952), are to send particulars of their claims to the executors, Cyril Markham and The Union Trustee Company of Australia Limited, at the registered office of the said company, 333 Collins-street, Melbourne, by the 21st day of October, 1953, after which date they will distribute the assets, having regard only to the claims of which they then have notice.

GODFREY & GODFREY, solicitors, 325 Collins-street, Melbourne. 6374

CREDITORS, next of kin, and others having claims against the estate of Anness Emma Swingler, late of Trafalgar, widow, deceased (who died on the 7th day of April, 1953), are to send particulars of their claims to Leslie John Stanley Swingler, of Trafalgar, farmer, care of undersigned solicitors, by the 23rd day of October, 1953, after which date the above-named will distribute the assets, having regard only to the claims of which he then has notice.

GRAY, FRIEND, MOONIE, & LONG, solicitors, Warragul. 6375

CREDITORS, next of kin, and others having claims in respect of the estate of Mary Monica Fitzgerald, formerly of Prince of Wales Hotel, Little Malop-street, Geelong, but late of 650 Malvern-road, Prahran, licensed victualler, deceased (who died on the 5th day of April, 1953), are to send particulars to the executors, William Henry Moule and Stephen George Alley, care of the under-mentioned solicitors, by the 30th day of October, 1953, after which date they will distribute the assets, having regard only to the claims of which they then have notice.

MOULE, HAMILTON, & DERHAM, solicitors, 394 Collins-street, Melbourne, C.I. 6372

CREDITORS, next of kin, and others having claims in respect of the estate of Doris Hughes, formerly of 8 Grandview-grove, East Prahran, and 1320 High-street, Malvern, but late of 7 Royal-crescent, Armadale, in the State of Victoria, widow, deceased (who died on the 7th day of May, 1953), are to send particulars of their claims to Alfred Ridgway, care of the undersigned, by the 4th day of November, 1953, after which date he will distribute the assets; having regard only to the claims of which he then has notice.

JAMES P. OGG & CRANAGE, of 165 Greville-street, Prahran. 6397

CREDITORS, next of kin, and others having claims in respect of the estate of Isabella Kirwan, late of 4 Harold-street, Albert Park, widow (who died on the 22nd day of November, 1952), are to send particulars of their claims to The Equity Trustees, Executors, and Agency Company Limited, of 472 Bourke-street, Melbourne, by the 31st day of October, 1953, after which date it will distribute the assets, having regard only to the claims of which it then has notice.

Dated this 14th day of August, 1953.

BOOTHBY & BOOTHBY, 408 Collins-street, Melbourne, and Korumburra, solicitors for the said company. 6399

CREDITORS, and others having claims against the estate of Robert Mackie Gunn, late of Toora, radio dealer, are required by his executor, John Robert Gunn, of Toora, retired builder, to send particulars of their claims to him, in care of the under-named solicitors, on or before 20th October, 1953, after which date the executor will distribute the assets of the said deceased to or among the persons entitled thereto, having regard only to the claims of which he then has notice.

SKINNER & HART, solicitors, Yarram. 6379

No. 749.—7759/53.—4

CREDITORS, next of kin, and others having claims in respect of the estate of Caroline Ann Wallace, formerly of 1 Bruce-court, Elsternwick, but late of 2 Wimbledon-avenue, Elwood, in the State of Victoria, deceased (who died on the 1st day of May, 1953), are to send particulars of their claims to The Perpetual Executors and Trustees Association of Australia Limited, at its registered office, Nos. 100-104 Queen-street, Melbourne, by the 29th day of October, 1953, after which date it will distribute the assets, having regard only to the claims of which it then has notice.

Dated the 19th August, 1953.

ELLISON, HEWISON, & WHITEHEAD, solicitors, 352 Collins-street, Melbourne. 6403

PURSUANT to the *Trustee Act 1928*, all persons having any claims against the estate of Percival John Morgan, late of 19 First-avenue, East Kew, gentleman, deceased (who died on the 11th July, 1953, and probate of whose will was granted by the Supreme Court of Victoria in its probate jurisdiction on the 11th August, 1953, to John William Pritchard, of 100 Queen-street, Melbourne, managing law clerk, the executor named therein), are hereby required to send particulars, in writing, of such claims to the said executor, at the office of the under-mentioned solicitor, on or before the 19th October, 1953, after the expiration of which time the said executor will proceed to distribute the assets of the said deceased among the persons entitled thereto, having regard only to the claims of which he shall then have had notice.

GEO. J. WISE, solicitor, 100 Queen-street, Melbourne. 6394

GEORGE ALFRED FEATHER DARLEY, DECEASED.

PURSUANT to the *Trustee Act 1928*, notice is hereby given that all persons having claims against the estate of George Alfred Feather Darley, late of Gipps-street, Port Fairy, in the State of Victoria, gentleman, deceased (who died on the 15th day of June, 1953), are hereby requested to send particulars, in writing, of such claims to Austin Charles Mulkearns, solicitor, of 108 Queen-street, Melbourne, the executor named in the deceased's will, on or before the 10th day of October, 1953, after which date the said executor will proceed to distribute the assets of the said deceased amongst the persons entitled thereto, having regard only to the claims of which he shall have had notice.

Dated this 13th day of August, 1953.

MORGAN, FYFFE, & MULKEARNS, Vaughan House, 108 Queen-street, Melbourne. 6393

PURSUANT to the *Trustee Act 1928*, all persons having claims against the estate or property of Daisy Tuffnell, late of Nangeela, near Casterton, in the State of Victoria, widow, deceased (who died on the 28th day of May, 1952, and probate of her will was granted by the Supreme Court of Victoria, on the 18th day of September, 1952, to Arthur William Bickley, of Wootong Vale, Coleraine, grazier, the executor named therein), are hereby required to send particulars of such claims to the said executor, care of Silvester and Silvester, solicitors, of Casterton, on or before the 5th day of November, 1953, after the expiration of which time the said executor will proceed to distribute the assets of the said deceased to the beneficiaries, having regard only to such claims of which he shall have had notice.

Dated the 14th day of August, 1953.

SILVESTER & SILVESTER, of Casterton, solicitors for the executor. 6386

ISABELLA TOMS, late of 15 Grandview-street, Moonee Ponds, widow, DECEASED.

CREDITORS, next of kin, and all other persons having claims against the estate of the above-named Isabella Toms, deceased, are required by the executors, Finlay McNab and Colin Edward McNab, both of 422 Collins-street, Melbourne, solicitors, to whom probate of the will of the said deceased was granted on the 12th day of June, 1953, to send particulars of their claims to the said executors, care of the undersigned solicitors, on or before the 1st day of November, 1953, after which date they will distribute the assets of the said deceased among the persons entitled thereto, having regard only to the claims of which they shall then have notice, and they will not be liable to any person of whose claims they have not then received notice.

McNAB & McNAB, solicitors, 422 Collins-street, Melbourne. 6392

ELIZABETH HEALY, late of Manifold-street, Camperdown, widow, DECEASED.

CREDITORS, next of kin, and others having claims against the estate of the above-named deceased (who died on the 30th day of March, 1953), are required to send particulars of their claims to the executor, Patrick Joseph Sinnott, of 144 Manifold-street, Camperdown, accountant, care of the undersigned solicitors, by the 31st day of October, 1953, after which date he will distribute the assets of the estate, having regard only to the claims of which he then has notice.

BUCKLAND & NEVETT, solicitors, Camperdown. 6384

CREDITORS, next of kin, and others having claims in respect of the estate of Stanley Clifford Steele, formerly of Prince of Wales Hotel, Fitzroy-street, St. Kilda, but late of Flat 1, "Plassey," Alexandra-avenue, Toorak, investor, deceased (who died on the 4th day of March, 1953), are required to send particulars of such claims to the executors, Stanley Jack Steele, Raymond Charles Steele, and Alan William Steele, addressed to them, care of Messrs. Ronald Stewart, Stock, and McIntosh, of 422 Collins-street, Melbourne, on or before the 23rd day of October, 1953, after which date the assets will be distributed, having regard only to the claims of which the said executors then have notice.

RONALD STEWART, STOCK, & MCINTOSH, solicitors, 422 Collins-street, Melbourne. 6378

ANDREW THOMAS HOLLAND, formerly of Leichardt, but late of Spring Gully-road, Bendigo, retired farmer, DECEASED.

CREDITORS, next of kin, and all other persons having claims against the estate of the deceased, are required by Minnie Holland, of Spring Gully-road, Bendigo, widow, and Kenneth William Holland, of Bridgewater, linesman, the executors of the will, to send particulars to them, care of the under-mentioned solicitors, on or before the 19th day of October, 1953, after which date they will distribute the assets, having regard only to the claims of which they shall then have notice.

Dated this 19th day of August, 1953.

T. M. WILLIAMS, WATSON, & JAMES, solicitors, 16 View-street, Bendigo. 6367

CREDITORS, next of kin, and others having claims in respect of the estate of Henry Beardsell, late of 1 Margaret-street, North Geelong, labourer, deceased (who died on the 2nd day of December, 1952, and probate of whose will was granted to Queenie Florence Heap, then of 1 Margaret-street, North Geelong, but now of 74 Richmond-street, North Geelong, married woman), are to send particulars of their claims to the said executrix, care of the undersigned solicitors, at their office hereunder mentioned, on or before the 21st day of October, 1953, after which date she will distribute the assets of the said deceased, having regard only to the claims of which she then shall have notice.

Dated the 18th day of August, 1953.

CRAWCOUR & HOLLYHOKE, solicitors, Geelong. 6368

CREDITORS, next of kin, and others having claims in respect of the estate of Albert Redfern England, formerly of 316 Aberdeen-street, Geelong West, but late of 177 Melbourne-road, North Geelong, in the State of Victoria, gentleman, deceased (who died on the 31st day of May, 1953), are to send particulars of their claims to The Fidelity Trustee Company Limited, of 101 Lydiard-street north, Ballarat, care of the branch office of the said company, Trustees' Chambers, Malop-street, Geelong, by the 21st day of October, 1953, after which date it will distribute the assets, having regard only to the claims of which it then has notice.

APTED & AINSWORTH, of 63 Yarra-street, Geelong, solicitors for the executor. 6369

CONSTANCE ISABEL HINDS, late of 329 Rainbow-street, Coogee, in the State of New South Wales, married woman, DECEASED, intestate.

CREDITORS, next of kin, and all other persons having claims against the estate of the deceased, are required to send particulars of their claims to the administrator, The Fidelity Trustee Company Limited, of 101 Lydiard-street north, Ballarat, in Victoria, care of its address above given, on or before the 22nd day of October, 1953, after which date it will distribute the assets, having regard only to the claims of which it shall then have notice.

R. J. GRIBBLE, HOLLWAY, & HEINZ, solicitors, 22 Lydiard-street south, Ballarat. 6370

In the Supreme Court of the State of Victoria.—*Fi. Fa.*

NOTICE is hereby given that, under and by virtue of certain process issued out of the Supreme Court of the State of Victoria and directed to the Sheriff requiring him to levy certain moneys of the real and personal estate of Albert John Puddy, of Barkly-terrace, East Bendigo, contractor, the said Sheriff will, on Wednesday, the 23rd day of September, 1953, at the hour of half past two o'clock in the afternoon, cause to be sold at the Police Station, White Hills (unless the said process shall have been previously satisfied or the said Sheriff be otherwise stayed):—

All the right, title, estate, and interest (if any) of the said Albert John Puddy in and to all that piece of land, being Crown allotment 5, section 34c, City of Bendigo, Parish of Sandhurst, County of Bendigo, being the whole of the land in certificate of title, volume 3239, folio 714, in Barkly-terrace, East Bendigo.

N.B.—Terms: Cash. No cheques taken.

Dated at White Hills, this 14th day of August, 1953.

6376 F. R. WARREN, Sheriff's Officer.

In the Supreme Court of the State of Victoria.—*Fi. Fa.*

NOTICE is hereby given that, under and by virtue of certain process issued out of the Supreme Court of the State of Victoria and directed to the Sheriff requiring him to levy certain moneys of the real and personal estate of Allan H. Hall, of 5 Elsey-road, Reservoir, transport operator, the said Sheriff will, on Monday, the 28th day of September, 1953, at the hour of Twelve o'clock noon, cause to be sold at the Post Office, Kinglake (unless the said process shall have been previously satisfied or the said Sheriff be otherwise stayed):—

All the right, title, estate, and interest (if any) of the said Allan H. Hall in and to all that piece of land being lots 26 and 27 and 28 and 78 and 79 on plan of subdivision 10,101, lodged in the Office of Titles and being part of Crown allotment 35, Parish of Kinglake, County of Anglesey, and being the land more particularly described in certificate of title, volume 7416, folio 162.

N.B.—Terms: Cash. No cheques taken.

Dated at Melbourne, this 17th day of August, 1953.

6395 FRANCIS H. TUCKER, Sheriff's Officer.

In the Supreme Court of the State of Victoria.—*Fi. Fa.*

NOTICE is hereby given that, under and by virtue of certain process issued out of the Supreme Court of the State of Victoria and directed to the Sheriff requiring him to levy certain moneys of the real and personal estate of George James Williams, of 134 Murray-street, Coburg, salesman, the said Sheriff will, on Monday, the 28th day of September, 1953, at the hour of Eleven o'clock in the forenoon, cause to be sold at the Police Station, 6 Ralph-street, Reservoir (unless the said process shall have been previously satisfied or the said Sheriff be otherwise stayed):—

All the right, title, estate, and interest (if any) of the said George James Williams in and to all that piece of land being lot 70 on plan of subdivision number 11,616, lodged in the Office of Titles and being part of Crown portion 12, Parish of Keelbundora, County of Bourke, and being the whole of the land more particularly described in certificate of title, volume 6950, folio 1389947.

N.B.—Terms: Cash. No cheques taken.

Dated at Melbourne, this 12th day of August, 1953.

6396 DAVID J. JOHNSTON, Sheriff's Officer.

IMPOUNDINGS.

BERWICK.—Impounded in Berwick Pound, by Ranger.

1 bay mare, aged, off front and two hind feet white, white-face, square tail, no visible brand

If not claimed and expenses paid, to be sold on 4th September, 1953.

6389—9/4 P. E. ALLISON, Poundkeeper.

BOX HILL.—Impounded in Box Hill Pound, by Ranger.

1 black pony mare, unshod, no visible brand
1 dark-brown pony gelding, white spots on back, unshod, no visible brand

If not claimed and expenses paid, to be sold on 20th August, 1953.

6339—10/8 H. J. BARRETT, Poundkeeper.

DANDENONG.—Impounded in Dandenong Pound, by Ranger E. Osborne.

1 red heifer, no visible brand

If not claimed and expenses paid, to be sold on 6th September, 1953.

6385—9/4

A. A. WALKER,
Poundkeeper.

HEALESVILLE.—Impounded in Healesville Pound.

1 aged brown gelding hack, faint white star on forehead, no visible brand

If not claimed and expenses paid, to be sold on 31st August, 1953.

6364—9/4

L. SAUNDERS,
Poundkeeper.

KEILOR.—Impounded in Keilor Pound.

1 draught chestnut mare, white feet, blaze, bumble knee off side, no visible brand

1 draught bay mare, off side hind foot white, blaze, no visible brand

1 light brown mare, hind feet white, no visible brand

1 black Jersey heifer, no visible brand

If not claimed and expenses paid, to be sold on 3rd September, 1953.

6381—14/8

D. PASCOE,
Poundkeeper.

OXLEY.—Impounded in Oxley Pound, by Herdsman, from Docker.

1 Jersey cow, notch under each ear, no visible brand; calf at foot

If not claimed and expenses paid, to be sold on 3rd September, 1953.

6340—10/8

G. WEIR,
Poundkeeper.

STATE ACTS, 1952.

COPIES of the following Acts of Parliament of Victoria may be obtained at the Government Printing Office, or from any bookseller, at the price set opposite to each:—

No.	Price. s. d.
5620. Consolidated Revenue	0 6
5621. Consolidated Revenue	0 6
5622. Lands (Charitable Trusts)	0 6
5623. Registration of Births Deaths and Marriages	0 6
5624. Forests (Exchange of Lands)	0 6
5625. Geelong Harbor Trust (Financial)	1 3
5626. Coal Mine Workers Pensions (Amendment)	0 6
5627. County Court (Amendment)	0 9
5628. Mines (Amendment)	0 9
5629. Consolidated Revenue	0 6
5630. Teaching Service (Amendment)	0 6
5631. Land (Development Leases) Amendment	0 6
5632. Supreme Court (Judge's Cost of Living)	0 6
5633. Weights and Measures (Amendment)	0 6
5634. Veterinary Surgeons (Foreign Qualification)	0 6
5635. State Electricity Commission (Appliances)	0 6
5636. Prices Regulation (Butter and Cheese)	0 6
5637. Water	1 0
5638. Co-operative Housing Societies (Guarantees and Indemnities)	0 6
5639. State Electricity Commission (Borrowing)	0 6
5640. Country Roads (Amendment)	0 6
5641. Motor Car (Amendment)	0 6
5642. Land Tax	0 6
5643. Hairdressers Registration (Amendment)	0 6
5644. Totalizator (Amendment)	0 6
5645. Melbourne and Metropolitan Tramways (Fire Brigades Payments)	0 6
5646. Health (Meat Supervision)	0 6
5647. Evidence	0 6
5648. Imported Materials Loan and Application (Amendment)	0 6
5649. Geelong Waterworks and Sewerage (Amendment)	0 6
5650. Building Operations and Building Materials Control	0 6
5651. Country Fire Authority	0 9
5652. Parliamentary Contributory Retirement Fund	0 6
5653. Miners' Phthisis (Treasury Allowances) Amendment	0 6
5654. Girl Guides Association	1 0
5655. Consolidated Revenue	0 6
5656. Revenue Deficit Funding	0 6
5657. Public Works Loan Application	0 6
5658. Local Government (Imported Houses)	0 6

STATE ACTS, 1952—continued.

No.	Price. s. d.
5659. Railway Loan Application	1 0
5660. State Forests Loan Application	0 6
5661. Water Supply Loan Application	1 0
5662. Hospital Benefits	0 9
5663. Appropriation of Revenue	4 3

W. M. HOUSTON.

Government Printer.

STATE ACTS, 1953.

COPIES of the following Acts of Parliament of Victoria may be obtained at the Government Printing Office, or from any bookseller, at the price set opposite to each:—

No.	Price. s. d.
5664. Parliamentary Elections (State Servants)	0 6
5665. Factories and Shops (Industrial Appeals Court)	0 6
5666. Adoption of Children (Amendment)	0 6
5667. Select Committee (Potato Marketing)	0 6
5668. Melbourne and Metropolitan Board of Works (Borrowing Powers)	0 6
5669. Water (Amendment)	0 6
5670. Trustee (Amendment)	0 6
5671. Public Account (Amendment)	0 6
5672. Transport Regulation (Amendment)	0 6
5673. Superannuation Police and State Pensions	0 6
5674. Coal Mine Workers' Pensions (Amendment)	0 6
5675. Health (Plumbers and Gas-fitters)	0 6
5676. Workers Compensation	1 3
5677. Parking of Vehicles	0 9
5678. Melbourne Harbor Trust (Tolls)	0 6
5679. The Geelong Gas Company's	0 6
5680. Barley Marketing (Amendment)	0 6
5681. Benefit Associations	0 9
5682. Consolidated Revenue	0 6

W. M. HOUSTON,

Government Printer.

AGENTS FOR THE "VICTORIA GOVERNMENT GAZETTE."

THE following have been appointed agents to receive Advertisements and Subscriptions for the *Victoria Government Gazette*:—

- ARMSTRONG'S AGENCY, 143 Queen-street, Melbourne.
- ARMSTRONG BROS., Kyneton.
- MESSRS. ARNALL & JACKSON, 115 Barkly-street, West Brunswick.
- MR. M. R. BADE, Tobacconist, Sturt-street, Ballarat.
- MR. WM. DAVIS, Mildura.
- A. J. DIGBY (B. S. and N. W. CASH), Main-street, Bairnsdale.
- EDGAR'S NEWS AGENCY, Hargreaves-street, Bendigo.
- MESSRS. HENRY FRANKS & CO., Booksellers and Stationers, Market-square, Geelong.
- MESSRS. GORDON & GOTCH, News Agents, 511 Little Collins-street, Melbourne; and corner Barrack and Clarence streets, Sydney.
- A. C. HAMPTON, 243 Mitchell-street, Bendigo.
- MESSRS. HARSTON, PARTRIDGE, & CO., 455 Little Collins-street, Melbourne.
- MR. C. F. LATIMER, News Agent, Casterton.
- McARTHUR'S AUTHORIZED NEWSAGENCY, 345 Wyndham-street, Shepparton.
- MESSRS. H. PAYNE & R. N. LOWE, 4 View Point, Bendigo.
- MESSRS. R. H. & W. M. PETTY, News Agent, Wangaratta.
- J. PURDIE & CO., 138 Moorabool-street, Geelong.
- F. W. RASHLEIGH & SON, Nunn-street, Benalla.
- MESSRS. A. S. RICHARDSON and T. C. GARDNER, trading as The Mercantile Exchange, 380 Collins-street, Melbourne.
- ROBERTSON & MULLENS LTD., Elizabeth-street, Melbourne.
- SALE AUTHORIZED NEWS AGENTS, Sale.
- MESSRS. SMITH & DUNNON, Hamilton.
- F. D. & J. R. TRAINOR, 246 Wyndham-street, Shepparton.
- E. W. B. WELSH, Hogan-street, Tatura.

A copy of the *Gazette* filed at each place for public reference.

THE "VICTORIA GOVERNMENT GAZETTE."

ATTENTION is invited to the following procedure in relation to the publication of official matter in the Government Gazette:—

1. Matter submitted to the Executive Council.

Matter submitted to the Executive Council which requires gazettal will normally be published in the issue of the following week.

Where urgent gazettal is required, special arrangements should be made with the Gazette Officer.

Publication will be facilitated by the submission of carbon copies for the use of the Gazette Officer.

2. Other matter.

(a) All other matter duly certified by a responsible officer for publication should be lodged with the Gazette Officer not later than half-past Ten a.m. on Tuesday.

(b) Lengthy or involved notices should be forwarded several days before publication.

(c) Proofs, which will be supplied only when specifically requested, or at the direction of the Gazette Officer, should be returned promptly to avoid delay in publication.

(d) No additions or amendments to matter for publication will be accepted by telephone.

SUBSCRIPTIONS.—The subscription, including postage, is £2 5s. per annum, £1 2s. 6d. half-yearly, or 11s. 3d. per quarter, payable in advance.

Subscriptions are required to commence and terminate with a month.

A lesser period than three months cannot be subscribed for.

Subscribers do not receive the Acts of Parliament with the GAZETTE.

ADVERTISEMENTS are charged at the rate of 1s. 4d. per line single column, and 2s. 8d. per line double column.

The title (E Reward, Dissolution of Partnerships, &c.) forms one or more lines as a heading.

On an average, ten words make a line.

Every signature must likewise be counted as a line.

The final words of a paragraph, though only portion of a line, must be counted as one line.

SIGNATURES (in particular) and proper names must be written very plainly in the text; ONE SIDE ONLY of each slip of paper should be WRITTEN UPON.

ALL COMMUNICATIONS should be addressed to "The Government Printer, Melbourne."

ALL DOCUMENTS illegibly written will be returned unpublished, and, where brands occur unprovided for by the ordinary letters of the alphabet, a worded explanatory description must be furnished.

THE VICTORIA GOVERNMENT GAZETTE is published on WEDNESDAY EVENING in each week, and Notices for insertion will be received by the Government Printer at or before Two p.m. at ordinary rates, and late advertisements between Two p.m. and Five p.m. at double rates on the day preceding the day of publication.

Single copies of the VICTORIA GOVERNMENT GAZETTE are Nine pence, posted One shilling, each.

No GAZETTES prior to January, 1942, in stock.

***ALL PAYMENTS ARE REQUIRED IN ADVANCE.—Remittances should be made by postal note, money order, or draft in favour of the Government Printer. Advertisements unaccompanied by a remittance sufficient to cover the cost of insertion will be returned unpublished.

CONTENTS.

	PAGE
Acts of Parliament on sale at the Government Printing Office	4323
Appointments	4279
Auction Sales Act	4289
Business Agents Act 1930	4289
Contracts	4281
Courts	4292
Estates of Deceased Persons	4280
Government Notices	4280
Impoundings	4322
Lands	4300
Money Lenders Act 1938—Supplementary List	4291
Notice to Mariners	4291
Orders in Council	4293
Private Advertisements	4314
Proclamations	4273
Public Holidays	4278
Public Service Notices	4304
Real Estate Agents Act	4290
Resignations	4279
Tenders	4308
Transport Regulation Board—Public Hearings	4283
Waterworks Trusts	4288



VICTORIA GOVERNMENT GAZETTE.

Published by Authority.

[Registered at the General Post Office, Melbourne, for transmission by post as a newspaper.]

No. 750]

WEDNESDAY, AUGUST 19.

[1953

• Prices Regulation Acts.

PRICES REGULATION ORDER No. 570.

NEW TYRES AND TUBES—SALES BY RETAIL.

IN pursuance of the powers conferred upon me by the Prices Regulation Acts, I, John Francis Waldron, Prices Commissioner, hereby make the following order:—

Citation.

1. This Order may be cited as Prices Regulation Order No. 570.

Revocation.

2. Prices Regulation Order No. 447 is hereby revoked insofar as it relates to the sale by retail of rubber tyres and tubes.

Application.

3. This Order shall apply to the sale by retail of new tyres and tubes manufactured in Australia.

Maximum Prices for New Tyres and Tubes Specified in the First Schedule.

4. I fix and declare the maximum price at which any person may sell by retail any new tyre or tube of the type and size specified in the First Schedule to this Order to be the price specified in the said First Schedule for that type and size of tyre or tube.

Provided that, in respect of the sale of any new tyre or tube, where any freight is incurred by the seller in transporting that tyre or tube from the point of purchase to his place of business, and is clearly recorded in the seller's books of accounts or records, the maximum price so specified for that tyre or tube may be increased by the amount of such freight.

Maximum Prices for New Tyres and Tubes Specified in the Second Schedule.

5. I fix and declare the maximum price at which any person may sell by retail any new tyre or tube of the type and size specified in the Second Schedule to this Order to be the sum of—

- (a) the price specified in the said Second Schedule for that type and size of tyre or tube; and
- (b) Commonwealth Sales Tax, if any.

Provided that, in respect of the sale of any new tyre or tube where any freight is incurred by the seller in transporting that tyre or tube from the point of purchase to his place of business and is clearly recorded in the seller's books of accounts or records, the maximum price so specified for that tyre or tube may be increased by the amount of such freight.

Price Differences to be Observed.

6. Notwithstanding anything contained in the foregoing provisions of this Order, where a seller of any new tyre or tube has customarily allowed any difference in price—

- (a) to any person or to persons included in any class of persons;
- (b) in respect of sales of certain quantities of new tyres or tubes; or
- (c) in respect of sales of new tyres or tubes under certain conditions of sale;

the maximum price fixed by or under this Order in respect of those new tyres or tubes shall, in the case of sales to any such person or persons or of such quantities or under such conditions, be reduced by the allowance of that difference.

Fixation of Maximum Prices by Notice.

7. Notwithstanding the foregoing provisions of this Order, I fix and declare the maximum prices at which new tyres or tubes, specified in a notice given in pursuance of this clause, may be sold by any person to whom such notice is given to be such prices as are fixed by the Prices Commissioner by notice in writing to that person.

THE FIRST SCHEDULE.

Description.	Size.	Two-ply Tyres.	Four-ply Tyres.	Six-ply Tyres.	Eight-ply Tyres.	Tubes.
		Each.	Each.	Each.	Each.	Each.
		£ s. d.	£ s. d.	£ s. d.	£ s. d.	£ s. d.
(1) Motor Car Tyres and Tubes (including Flap, if any)—						
(a) High Pressure, Beaded Edge, and Straight Sided Tyres	30 - 3½ B.E.	..	7 8 6	1 4 0
	30 - 3½ S.S.	..	6 13 0	1 4 0
	34 - 4½ S.S.	14 6 0	..	1 12 6
b) Balloon Tyres	730 x 130 B.E.	..	8 8 6	1 7 3
	3-50 x 19	..	5 4 0	1 1 6
	4-00 x 19	..	5 17 0	1 1 6
	4-40 x 19	..	6 10 0	1 5 9
	4-40 x 23 S.S.	..	7 9 0	1 8 6
	4-40 x 23 B.E.	..	8 1 0	1 8 6
	4-50 x 15	..	5 19 0	0 19 9
	4-50 x 17	..	6 6 0	1 2 9
	4-50 x 18	..	6 10 6	1 3 9
	4-50 x 21	..	7 5 0	8 11 6	..	1 6 0
	4-75 x 16	..	6 9 6	1 4 6
	5-00 x 14	..	6 16 0	8 4 0	..	1 5 9
	5-00 x 15	..	7 0 0	1 6 9
	5-00 x 16	..	7 2 0	8 10 0	..	1 7 3
	5-00 x 17	..	7 7 6	8 15 0	..	1 7 3
	5-00 x 18	..	7 11 6	8 19 6	..	1 7 3
	5-00 x 19	..	7 17 6	9 6 0	..	1 7 9
	5-00 x 20	..	8 4 6	9 13 0	..	1 7 9
	5-00 x 21	..	8 10 0	9 17 6	..	1 10 3
	5-00 x 22	..	8 17 0	10 4 6	..	1 10 3
	5-00 x 23	..	9 3 0	10 11 0	..	1 11 9
	5-00 x 24	..	9 9 0	10 17 6	..	1 11 9
	5-20 x 13	..	6 19 0	8 5 6	..	1 5 6
	5-20 x 15	6 12 0	7 7 6	1 6 9
	5-25 x 15	..	7 10 0	1 6 9
	5-25 x 16	..	7 14 0	9 4 0	..	1 7 3
	5-25 x 21	..	9 3 0	10 13 6	..	1 10 3
	5-50 x 15	..	7 18 0	9 13 0	..	1 9 0
	5-50 x 16	..	8 5 0	9 17 6	..	1 10 9
	5-50 x 17	..	8 11 0	10 4 6	..	1 11 3
	5-50 x 18	..	8 17 0	10 11 0	..	1 11 9
	5-50 x 19	..	9 4 0	10 17 6	..	1 11 9
	5-50 x 20	..	9 10 0	11 4 0	..	1 12 3
	5-60 x 15	..	8 5 0	9 14 0	..	1 9 0
	5-90 x 13	..	8 4 6	9 13 0	..	1 8 0
	5-90 x 14	..	8 9 0	9 17 6	..	1 7 6
	5-90 x 15	..	8 15 0	10 4 6	..	1 9 0
	6-00 x 15	..	8 18 6	10 8 0	..	1 11 9
	6-00 x 16	..	9 4 6	10 13 6	..	1 12 3
	6-00 x 16 S.P.	..	10 4 0	11 14 6	..	1 12 3
	6-00 x 17	11 2 0	..	1 11 3
	6-00 x 18	11 9 6	..	1 11 9
	6-00 x 19	11 17 0	..	1 11 9
	6-00 x 20	12 5 6	..	1 12 3
	6-00 x 21	12 13 0	..	1 12 3
	6-00 x 22	13 0 6	..	1 15 6
	6-00 x 24	13 16 0	..	1 16 6
	6-40 x 13	..	9 2 6	10 13 6	..	1 8 0
	6-40 x 15	..	9 10 6	11 7 6	..	1 11 9
	6-50 x 15	..	9 16 6	11 9 6	..	1 13 6
	6-50 x 16	..	10 4 6	11 17 0	..	1 15 6
	6-70 x 15	..	10 0 0	12 2 0	..	1 13 6
	6-70 x 16	..	10 5 6	12 11 0	..	1 15 6

THE FIRST SCHEDULE—continued.

Description.	Size.	Two-ply Tyres.	Four-ply Tyres.	Six-ply Tyres.	Eight-ply Tyres.	Tubes.
		Each.	Each.	Each.	Each.	Each.
		£ s. d.	£ s. d.	£ s. d.	£ s. d.	£ s. d.
(1) Motor Car Tyres and Tubes (including Flap, if any)— (b) Balloon Tyres— —continued.	7.00 x 15	12 18 0	..	1 15 9
	7.00 x 16	13 5 6	..	1 16 6
	7.00 x 17	13 14 0	..	1 17 3
	7.00 x 18	14 2 0	..	1 18 3
	7.00 x 19	14 9 0	..	1 18 3
	7.00 x 20	14 16 6	..	1 19 6
	7.00 x 21	15 4 6	..	1 19 6
	7.10 x 15	..	10 13 6	13 0 0	..	1 15 9
	7.50 x 16	14 1 6	..	1 19 9
	7.50 x 16 S.P.	15 10 0	..	1 19 9
7.60 x 15	..	11 1 0	13 7 6	..	1 15 9	
7.60 x 16	..	11 9 6	13 18 6	..	1 16 6	
(2) Light Truck and Utility Tyres and Tubes (including Flap, if any)	5.50 x 17	11 11 6	..	1 12 3
	6.00 x 16	12 0 6	..	1 14 3
	6.50 x 16	13 7 6	16 0 0	1 17 3
	7.00 x 15	14 9 6	..	1 18 3
	7.00 x 16	14 18 0	17 18 0	1 18 9
	7.50 x 16	15 17 0	19 0 0	2 2 3
	7.50 x 16 S.P.	17 1 0	20 8 6	2 2 3
	8.25 x 16	25 14 6	3 18 9

Description.	Size.	Ply Rating.	Commercial Tread Tyres.	Off-Road Tyres.	Dual Purpose Tyres.	Tubes.
			Each.	Each.	Each.	Each.
		o	£ s. d.	£ s. d.	£ s. d.	£ s. d.
(3) Truck and Bus Tyres and Tubes (including Flap, if any)	6.00 x 13	8	13 14 6	1 17 3
	6.00 x 20	8	17 4 0	2 3 3
	6.00 x 23	8	20 6 0	2 5 9
	6.50 x 20	6	17 17 0	2 12 0
	6.50 x 20	8	21 2 0	2 12 0
	7.00 x 13	8	19 3 6	2 8 6
	7.00 x 17	6	17 19 0	2 10 0
	7.00 x 17	8	21 2 0	2 10 0
	7.00 x 20	8	22 13 6	2 16 3
	7.00 x 20	10	26 11 0	28 11 6	..	2 16 3
	7.00 x 24	10	32 0 6	3 7 6
	7.50 x 15	12	..	30 6 0	..	2 13 0
	7.50 x 17	8	24 4 6	26 0 6	..	2 18 6
	7.50 x 18	8	25 0 0	26 18 0	..	3 5 0
	7.50 x 18	10	30 10 0	3 5 0
	7.50 x 20	8	26 11 0	28 11 6	..	3 12 9
	7.50 x 20	10	32 0 6	34 9 0	36 0 6	3 12 9
	7.50 x 20	12	37 10 0	3 12 9
	7.50 x 24	10	37 10 0	4 3 9
	8.25 x 10	8	28 10 0	3 8 9
	8.25 x 15	12	33 12 0	3 12 9
	8.25 x 15	14	40 12 0	3 12 9
	8.25 x 18	10	32 0 6	4 0 3
	8.25 x 20	10	35 3 6	37 16 6	39 10 6	4 3 9
	8.25 x 20	12	40 12 0	..	45 14 0	4 3 9
	8.25 x 20	14	45 18 6	4 3 9
	8.25 x 24	10	..	46 17 6	..	5 0 3
	9.00 x 13	6	21 17 6	3 1 6
	9.00 x 15	12	..	36 14 6	..	3 18 6
	9.00 x 16	10	34 7 0	36 19 0	..	4 16 9
	9.00 x 18	10	37 10 0	40 6 6	..	5 2 0
	9.00 x 20	10	40 12 0	43 13 6	45 14 0	5 6 6
	9.00 x 20	12	46 17 6	50 8 0	52 15 0	5 6 6
	9.00 x 20	14	53 0 0	5 6 6
	9.00 x 22	10	43 14 6	5 11 3
	9.00 x 24	10	..	51 10 6	..	5 16 6
	9.00 x 24	12	52 6 6	56 4 6	..	5 16 6
	10.00 x 15	14	57 16 0	5 7 6
	10.00 x 20	12	51 10 6	55 9 0	57 19 6	5 16 6
	10.00 x 20	14	59 5 0	65 5 0	66 13 0	5 16 6
10.00 x 20	16	67 0 0	5 16 6	
10.00 x 22	12	54 14 0	58 17 0	..	6 4 3	
10.00 x 24	12	57 16 0	6 12 3	
11.00 x 13	10	49 4 6	5 13 0	
11.00 x 13	12	53 3 6	5 13 0	
11.00 x 16	10	51 10 6	55 9 0	..	5 16 6	
11.00 x 18	12	59 6 6	63 16 0	..	6 3 6	
11.00 x 20	12	62 9 6	67 3 6	70 6 0	6 12 3	
11.00 x 20	14	75 4 0	80 17 6	84 12 6	6 12 3	
11.00 x 20	16	85 1 0	6 12 3	
11.00 x 24	12	70 6 0	7 6 6	

THE FIRST SCHEDULE—continued.

Description.	Size.	Ply Rating.	Commercial Tread Tyres.	Off-Road Tyres.	Dual Purpose Tyres.	Tubes.
			Each.	Each.	Each.	Each.
(3) Truck and Bus Tyres and Tubes (including Flap, if any)—continued.	11-00 x 24	14	£ 85 0 0	£ ..	£ ..	£ 7 6 6
	12-00 x 20	14	78 2 6	84 0 0	..	7 10 3
	12-00 x 20	16	..	100 15 6	..	7 10 3
	14-00 x 20	16	128 2 6	137 13 6	..	12 14 6
	14-00 x 20	18	146 16 6	157 17 6	..	12 14 6

Description.	Size.	Two-ply Tyres.	Four-ply Tyres.	Tubes.
		Each.	Each.	Each.
(4) Motor Cycle Tyres and Tubes	2-25 x 21	£ ..	£ 2 11 0	£ 0 11 0
	2-50 x 19	..	3 11 0	0 14 3
	2-75 x 19	..	3 18 0	0 16 3
	2-75 x 21	..	4 5 6	0 18 6
	3-00 x 19	3 12 6	4 13 0	1 0 6
	3-00 x 20	..	4 16 0	1 1 6
	3-00 x 21	..	5 0 0	1 2 0
	3-25 x 18	3 15 0	4 14 6	1 0 6
	3-25 x 19	3 19 6	4 19 0	1 0 6
	3-25 x 20	..	5 1 0	1 1 6
	3-50 x 19	..	5 4 0	1 1 6
	3-85 x 18 B.E.	..	7 4 0	1 0 6
	3-85 x 20 B.E.	..	7 15 6	1 2 9
	4-00 x 18	..	5 13 6	1 0 6
	4-00 x 19	..	5 17 0	1 1 6
	4-50 x 16	..	6 4 6	1 3 6
	4-50 x 18	..	6 10 6	1 3 9
4-75 x 16	..	6 9 6	1 4 6	

Description.	Tyres.	Tubes.	
	Each.	Each.	
(5) Bicycle Tyres and Tubes—	£ s. d.	£ s. d.	
	First Grade	0 18 1	0 8 3
	Second Grade	0 15 0	0 7 5
	Third Grade	0 12 9	0 6 7
	Speed	0 19 0	0 8 3
	Heavy Duty	1 14 0	0 9 6
	Extra Heavy Duty	2 0 11	0 9 6
	Light Weight	1 2 10	0 8 3
	Commercial—		
	Size 20 x 2	1 8 1	0 9 6
	Size 26 x 2	1 14 3	0 9 6

THE SECOND SCHEDULE.

Description.	Size.	Ply Rating.	Tyres.	Tubes.
			Each.	Each.
(1) Tractor and Implement Tyres and Tubes			£ s. d.	£ s. d.
	4-00 x 12	4	5 3 0	0 10 0
	4-00 x 19	4	5 9 6	1 1 0
	4-50 x 8	4	4 3 6	0 19 9
	5-00 x 15	4	6 15 6	1 4 9
	5-50 x 16	4	7 19 6	1 7 9
	5-50 x 16	6	9 0 0	1 7 9
	6-00 x 9	4	7 19 6	1 16 6
	6-00 x 9	6	9 0 0	1 16 6
	6-00 x 16	4	8 6 0	1 10 3
	6-00 x 16	6	9 14 0	1 10 3
	6-00 x 19	6	12 1 6	1 14 3
	6-50 x 40	4	28 5 6	4 15 6
	6-50 x 40	6	31 11 6	4 15 6
	7-00 x 7½	4	8 0 6	2 1 9
	7-00 x 7½	6	10 1 6	2 1 9

THE SECOND SCHEDULE—continued.

Description.	Size.	Ply Rating.	Tyres.	Tubes.
			Each.	Each.
			£ s. d.	£ s. d.
(1) Tractor and Implement Tyres and Tubes—continued.	7.50 x 16	6	13 12 6	1 17 0
	7.50 x 18	6	14 15 6	1 19 0
	7.50 x 20	6	15 17 0	2 10 6
	7.50 x 24	6	19 12 6	3 12 0
	9.00 x 24	4	32 7 0	4 18 3
	9.00 x 24	6	38 16 0	4 18 3
	9.00 x 36	6	47 7 0	6 0 3
	9.00 x 36	10	63 3 0	6 0 3
	10.00 x 36	6	60 8 0	6 16 0
	10.00 x 36	8	75 11 0	6 16 0
	10.50 x 20	6	38 16 0	4 18 3
	11.25 x 24	6	44 1 6	5 14 6
	11.25 x 24	10	61 19 0	5 14 6
	12.75 x 24	6	51 9 6	6 17 9
	12.75 x 24	8	64 5 6	6 17 9
	12.75 x 28	6	57 18 0	7 12 0
	12.75 x 28	8	71 15 0	7 12 0
	12.75 x 28	10	86 2 6	7 12 0
	12.75 x 32	6	65 8 6	8 11 3
	13.50 x 24	6	59 9 6	6 17 9
13.50 x 24	8	71 15 0	6 17 9	
13.50 x 28	6	67 19 6	7 12 0	
13.50 x 28	8	81 12 0	7 12 0	
13.50 x 32	6	76 6 0	8 11 3	
13.50 x 32	8	90 13 0	8 11 3	
(2) Tractor Tyres and Tubes, Wide Base	8 x 24	4	21 18 6	3 19 3
	9 x 24	4	24 18 6	4 3 3
	9 x 24	6	29 18 6	4 3 3
	9 x 36	6	43 16 6	5 8 3
	10.00 x 28	4	33 8 0	5 11 0
	10 x 28	6	40 1 0	5 11 0
	10 x 38	6	50 12 0	7 1 3
	11.00 x 28	4	37 16 6	6 5 3
	11 x 28	6	45 6 6	6 5 3
	11 x 38	6	54 7 0	7 15 3
	12 x 26	6	48 7 0	7 1 9
	12 x 38	6	61 3 6	8 15 9
	13 x 26	6	54 7 0	7 15 3
	14 x 28	6	64 4 0	9 16 6
	14 x 30	6	71 15 0	10 15 6
	15 x 28	6	72 10 6	11 6 6
15 x 30	6	80 16 6	12 10 0	
15 x 30	8	90 13 0	12 10 0	
(3) Grader and Earth Mover Tyres and Tubes	7.50 x 24	10	45 6 6	3 12 0
	9.00 x 24	10	46 9 6	5 6 3
	9.00 x 24	12	50 15 0	5 6 3
	9.00 x 36	10	63 3 0	6 0 3
	11.25 x 24	10	61 19 0	5 14 6
	12.75 x 24	8	64 5 6	6 17 9
	12.75 x 24	10	79 6 6	6 17 9
	12.75 x 24	12	94 8 6	6 17 9
	12.75 x 28	8	71 15 0	7 12 0
	12.75 x 28	10	86 2 6	7 12 0
	13.00 x 24	12	94 8 6	6 17 9
	13.50 x 24	8	71 15 0	6 17 9
	13.50 x 28	8	81 12 0	7 12 0
	13.50 x 32	8	90 13 0	8 11 3
	14.00 x 24	20	256 16 6	11 16 3
	16.00 x 20	16	237 4 0	17 13 3
	18.00 x 24	16	324 16 6	30 7 3
	18.00 x 24	20	364 2 0	30 7 3
18.00 x 24	24	400 14 0	30 7 3	
21.00 x 24	20	445 14 0	36 1 9	
(4) Pneumatic Industrial Tyres and Tubes	8 x 2	2	1 3 6	0 12 0
	10 x 2	2	1 9 0	0 12 3
	12 x 2	2	1 14 3	0 12 6
	10 x 3	2	2 12 9	0 15 0
	4.00 x 8	4	3 8 6	0 19 0
	4.00 x 8 H.D.	4	4 0 0	0 19 0
	4.50 x 8	4	4 3 3	0 19 9
	4.50 x 8	6	4 15 9	0 19 9
(5) Solid Detachable Industrial Tyres	6 x 2	..	1 1 9	..
	8 x 2	..	1 9 0	..
	10 x 2	..	1 15 6	..
	12 x 2	..	2 4 9	..
	8 x 3	..	2 14 0	..
10 x 3	..	2 17 9	..	

Dated this 13th day of August, 1953.

J. F. WALDRON,
Prices Commissioner.

By Authority: W. M. HOUSTON, Government Printer, Melbourne.





VICTORIA
GOVERNMENT GAZETTE.

Published by Authority.

[Registered at the General Post Office, Melbourne, for transmission by post as a newspaper.]

No. 751]

WEDNESDAY, AUGUST 19.

[1953

Factories and Shops Acts.

**DETERMINATION OF A WAGES BOARD ADJUSTED PURSUANT TO SECTION
21 OF THE FACTORIES AND SHOPS ACT 1934 (No. 4275).**

I, Raymond Henry Beers, Secretary for Labour, in pursuance of the powers conferred by the Factories and Shops Acts, hereby make and issue the following adjusted Determination of the Wages Board referred to hereunder showing adjusted rates and prices to operate from the beginning of the first pay period to commence in August, 1953.

Dated at Melbourne, this
18th day of August, 1953.

RAY H. BEERS,
Secretary for Labour.

GENERAL BOARD.

(Plaster Model Section.)

Clause 2 of the Determination for this Section published in *Government Gazette* No. 151 of the 9th February, 1951, shall be the-replaced by the following clause:—

2. WAGES PER WEEK OF 40 HOURS.

(a) Improvers.			(b) Other Employees.		
	Percentage of Basic Wage.	s. d.		s. d.	
Under 17 years of age	23	54 0	Persons engaged in making or preparing moulds ..	248	0
17 years of age	35	82 0	Persons engaged in coloring or decorating models—		
18 years of age	47	110 6	(a) by hand	262	0
19 years of age	63	148 0	(b) by spray, or otherwise than by hand ..	250	0
20 years of age	77	181 0	Persons engaged in assembling or fining models when taken from moulds	243	0
PROPORTION (IN ANY PLACE).			All others	238	0
One improver to every three adult employees.					

Clauses, other than clause 2, of the said Determination for this Section as amended on the 16th February, 1951, shall remain in force.

By Authority: W. M. HOUSTON, Government Printer, Melbourne.



VICTORIA
GOVERNMENT GAZETTE.

Published by Authority.

[Registered at the General Post Office, Melbourne, for transmission by post as a newspaper.]

No. 752]

WEDNESDAY, AUGUST 19.

[1953

Factories and Shops Acts.

**DETERMINATION OF A WAGES BOARD ADJUSTED PURSUANT TO SECTION
21 OF THE FACTORIES AND SHOPS ACT 1934 (No. 4275).**

I, Raymond Henry Beers, Secretary for Labour, in pursuance of the powers conferred by the Factories and Shops Acts, hereby make and issue the following adjusted Determination of the Wages Board referred to hereunder showing adjusted rates and prices to operate from the beginning of the first pay period to commence in August, 1953.

Dated at Melbourne, this
18th day of August, 1953.

RAY H. BEERS,
Secretary for Labour.

GENERAL BOARD.

(Renovating Carpets Section.)

Clause 2 of the Determination for this Section published in *Government Gazette* No. 150 of the 9th February, 1951, shall be replaced by the following clause:—

2. WAGES PER WEEK OF 40 HOURS.

(a) Improvers.			(b) Adults.		
	Percentage of Basic Wage.	s. d.		s. d.	
Under 17 years of age	23	54 0	Males—(i) of 3 months' or more experience ..	242	0
17 years of age	35	82 0	(ii) of less than 3 months' experience ..	238	0
18 " "	47	110 6	Females	176	0
19 " "	63	148 0			
20 " "	77	181 0			
<i>Proportion (in any place).</i>					
One improver to each adult employee.					

Clauses, other than clause 2, of the said Determination for this Section as amended on the 16th February, 1951, shall remain in force.

By Authority: W. M. HOUSTON, Government Printer, Melbourne.





VICTORIA GOVERNMENT GAZETTE.

Published by Authority.

[Registered at the General Post Office, Melbourne, for transmission by post as a newspaper.]

No. 753]

WEDNESDAY, AUGUST 19.

[1953

Factories and Shops Acts.

DETERMINATION OF A WAGES BOARD ADJUSTED PURSUANT TO SECTION 21 OF THE FACTORIES AND SHOPS ACT 1934 (No. 4275).

I, Raymond Henry Beers, Secretary for Labour, in pursuance of the powers conferred by the Factories and Shops Acts, hereby make and issue the following adjusted Determination of the Wages Board referred to hereunder showing adjusted rates and prices to operate from the beginning of the first pay period to commence in August, 1953.

Dated at Melbourne, this
18th day of August, 1953.

RAY H. BEERS,
Secretary for Labour.

SUGAR REFINERS BOARD.

Clauses 2 and 3 of the Determination published in *Government Gazette* No. 536 of the 14th July, 1953, shall be replaced by the following clauses:—

2.

APPRENTICES, IMPROVERS, OR JUVENILE WORKERS.

Wages per Week of 40 Hours.

Males.			Females.		
	Percentage of Basic Wage.	Weekly Wage.		Percentage of Female Basic Wage.	Weekly Wage.
		<i>s. d.</i>			<i>s. d.</i>
Under 16 years	34	80 0	Under 16 years	50	88 0
16 years	40	94 0	16 years	60	105 6
17 years	51	120 0	17 years	70	123 0
18 years	68	160 0	18 years	80	141 0
19 years	79	185 6	19 years	90	158 6
20 years	90	211 6	20 years	95	167 0

PROPORTION (IN ANY PLACE).
Apprentices or Improvers.
Males.

One apprentice and one improver to every three or fraction of three workers receiving not less than the rate payable from time to time to "All others".

Provided that any female 19 years of age or over, with six months' experience at the trade, shall be deemed to be an adult.

PROPORTION (IN ANY PLACE).
Apprentices or Improvers.
Females.

One apprentice and one improver to every three or fraction of three workers receiving not less than the rate payable from time to time to "Adult Females".

3.

OTHER EMPLOYEES.
Wages per Week of 40 Hours.

—	Adjustable Rate.	Additional Constant Loading.	Total Weekly Wage.
	<i>s. d.</i>	<i>s. d.</i>	<i>s. d.</i>
<i>Adult Males.</i>			
Raw Sugar Store—			
Unstoring raw sugar	254 0	11 0	265 0
Men cutting in	255 0	11 0	266 0
Whip hand unstoring raw sugar	250 0	11 0	261 0
Whip hand at elevator	250 0	11 0	261 0
Elevator attendant	255 0	11 0	266 0
Wash tank hands	248 0	11 0	259 0
Wash tank hands—assistants	247 0	11 0	258 0
Senior rigger	260 0	11 0	271 0
Other rigger	255 0	11 0	266 0
Melting House—			
Washing fugalmen	253 6	11 0	264 6
Melter attendant	248 0	11 0	259 0
Mixer	248 0	11 0	259 0
Carbonatation House—			
Men on liquor filter presses	249 0	11 0	260 0
Men on mud	249 0	11 0	260 0
Leading hand	261 0	11 0	272 0
Men on gas tank	256 6	11 0	267 6
Sweetland filter attendant	252 0	11 0	263 0
Men on crushing and stacking lime	248 0	11 0	259 0
Men on washing and checking filterpress sheets	249 0	11 0	260 0
Char End—			
Kiln repairers	248 0	11 0	259 0
Kiln firemen	256 0	11 0	267 0
Wet charmen	256 0	11 0	267 0
Char runners	256 0	11 0	267 0
Pan Floor—			
First sugar boilers	279 0	11 0	290 0
Second sugar boilers	270 0	11 0	281 0
Employee attending triple effert and assistant sugar boiler	251 0	11 0	262 0
Pan attendant	248 0	11 0	259 0
Refined sugar fugalmen	253 6	11 0	264 6
Refined sugar fugalmen—Leading hands	263 6	11 0	274 6
Jelly House—			
Leading hand	258 6	11 0	269 6
Jelly fugalmen	248 0	11 0	259 0
Refined Sugar Store—			
Receiving at truck yard (leading hands)	258 0	11 0	269 0
Icing mill attendant	248 0	11 0	259 0
Driers (leading hand)	258 0	11 0	269 0
Driers (others)	248 0	11 0	259 0
Automatic scale attendant	257 0	11 0	268 0
Automatic scale hands	248 0	11 0	259 0
Employee engaged loading trucks	248 0	11 0	259 0
Bag room checkers	248 0	11 0	259 0
Truckers and stackers	248 0	11 0	259 0
Leading hand packing floor	258 0	11 0	269 0
Hand packing sugar	248 0	11 0	259 0
Golden Syrup and Treacle—			
Men packing and weighing (bulk)	249 0	11 0	260 0
Golden syrup and treacle mixer	251 0	11 0	262 0
Liquor runners	266 6	11 0	277 6
Liquor runners—assistants	248 0	11 0	259 0
Distillery—			
Stillman	272 0	11 0	283 0
Mashman	254 0	11 0	265 0
C.O2 Bottle Attendant	257 0	11 0	268 0
Spirit and Methylating Rooms—			
Leading hand	269 6	11 0	280 6
Assistants	253 6	11 0	264 6
Cane-ite Store—			
Men storing and unstoring cane-ite and hardboard	249 0	11 0	260 0
Leading hand cleaning gang	258 0	11 0	269 0
Unstoring and/or loading bales for shipment	259 0	11 0	270 0
All others	245 0	11 0	256 0
Adult females (a) with less than 6 months' experience at the trade	176 3
(b) with 6 months' or more experience at the trade	178 3

Clauses, other than clauses 2 and 3, of the said Determination shall remain in force.



VICTORIA GOVERNMENT GAZETTE.

Published by Authority.

[Registered at the General Post Office, Melbourne, for transmission by post as a newspaper.]

No. 754]

WEDNESDAY, AUGUST 19.

[1953

Factories and Shops Acts.

DETERMINATION OF A WAGES BOARD ADJUSTED PURSUANT TO SECTION 21 OF THE FACTORIES AND SHOPS ACT 1934 (No. 4275).

I, Raymond Henry Beers, Secretary for Labour, in pursuance of the powers conferred by the Factories and Shops Acts, hereby make and issue the following adjusted Determination of the Wages Board referred to hereunder showing adjusted rates and prices to operate from the beginning of the first pay period to commence in August, 1953.

Dated at Melbourne, this
18th day of August, 1953.

RAY H. BEERS,
Secretary for Labour.

CIGAR TRADE BOARD.

Clauses 2, 3, and 4 of the Determination published in *Government Gazette* No. 792 of the 5th September, 1952, shall be replaced by the following clauses:—

2.

APPRENTICES AND IMPROVERS.

Wages per Week of 40 Hours.							Number (in any place).							
Making cigars or sorting and packing cigars:—							APPRENTICES.							
APPRENTICES.							One male apprentice to every three or fraction of three male workers receiving not less than the minimum wage. One female apprentice to every three or fraction of three female workers receiving not less than the minimum wage. (An amended indenture of apprenticeship prescribed was approved on 5.2.12.)							
Experience—														
1st year—														
1st six months	s. d.	..	*Percentage.								
2nd six months	42 7	..	16½								
2nd year							60 11	..	23½			
3rd year							91 1	..	34½			
4th year							115 3	..	44			
or in lieu of weekly wages the work may be paid at the following piece-work prices:—														
Making Cigars.														
2nd year		..		One-third of the piece-work prices		} See also clause 13, sub-clause (m)								
3rd year		..		Two-thirds of the piece-work prices.										
4th year		..		Three-quarters of the piece-work prices.										
Sorting and Packing Cigars.														
In Boxes of—														
500 cigars.		250 cigars.		100 cigars.		50 cigars.		25 cigars.		10 cigars.				
per 1,000.		per 1,000.		per 1,000.		per 1,000.		per 1,000.		per 1,000.				
s. d.		s. d.		s. d.		s. d.		s. d.		s. d.				
1 1·2		1 1·2		1 1·2		1 4·5		1 7·8		2 2·4				
2nd year		..		1 4·5		1 4·5		1 7·8		2 5·7				
3rd year		..		1 7·8		1 7·8		2 5·7		2 9				
4th year		..		1 11·1		2 2·4		3 0·3		3 3·6				
2 2·4		2 2·4		2 5·7		2 9		3 6·9		3 10·2				
} Plus 3 per centum. See also clause 13, sub-clause (m).														
IMPROVERS.									s. d.			*Percentage.		
18 years			91 1		..		34½		
19 years			127 1		..		48½		
20 years			157 10		..		60½		

* The percentages shown in these columns are the percentages of the minimum weekly wage from time to time payable to "All others (males)."

3. JUVENILE WORKERS, i.e., persons under 21 years of age (other than apprentices or improvers)—
(a) Males.

Employed In—	Wages per Week of 40 Hours.							
	1st Year's Experience.							
	1st Three Months.		2nd Three Months.		3rd Three Months.		4th Three Months.	
	Wages.	*Per-centage.	Wages.	*Per-centage.	Wages.	*Per-centage.	Wages.	*Per-centage.
	<i>s. d.</i>	%	<i>s. d.</i>	%	<i>s. d.</i>	%	<i>s. d.</i>	%
Making cigar boxes	42 7	16½	42 7	16½	48 6	18½	48 6	18½
Turning bunches	42 7	16½	42 7	16½	48 6	18½	48 6	18½
Stripping fillers	42 7	16½	42 7	16½	48 6	18½	54 4	20½

Employed In—	Wages per Week of 40 Hours.							
	2nd Year's Experience.							
	1st Six Months.		2nd Six Months.		3rd Year's Experience.		Fourth Year's Experience.	
	Wages.	*Per-centage.	Wages.	*Per-centage.	Wages.	*Per-centage.	Wages.	*Per-centage.
	<i>s. d.</i>	%	<i>s. d.</i>	%	<i>s. d.</i>	%	<i>s. d.</i>	%
Making cigar boxes	72 8	27½	78 7	30	108 1	41½	139 6	53½
Turning bunches	72 8	27½	78 7	30	108 1	41½	139 6	53½
Stripping fillers		Piecework prices		Piecework prices		Piecework prices		Piecework prices

Provided that, for the purposes of this Determination, experience in any of the above sections shall be deemed to be experience in any other section.

Age.

	14 Years.		15 Years.		16 Years.		17 Years.		18 Years.		19 Years.		20 Years.	
	Wage.	*Per-centage.	Wage.	*Per-centage.	Wage.	*Per-centage.	Wage.	*Per-centage.	Wage.	*Per-centage.	Wage.	*Per-centage.	Wage.	*Per-centage.
	<i>s. d.</i>	%	<i>s. d.</i>	%	<i>s. d.</i>	%	<i>s. d.</i>	%	<i>s. d.</i>	%	<i>s. d.</i>	%	<i>s. d.</i>	%
Any other class of work for which the rate of wages fixed does not exceed 262s. per week of 40 hours	53 9	20½	59 7	22½	72 8	27½	91 8	35	114 7	43½	149 4	57	189 4	72½

* The percentages shown in these columns are the percentages of the minimum wage from time to time payable to "All others (males)".
(b)

Females.

Employed In—	Wages per Week of 40 Hours.							
	1st Year's Experience.							
	1st Three Months.		2nd Three Months.		3rd Three Months.		4th Three Months.	
	Wages.	*Per-centage.	Wages.	*Per-centage.	Wages.	*Per-centage.	Wages.	*Per-centage.
	<i>s. d.</i>	%	<i>s. d.</i>	%	<i>s. d.</i>	%	<i>s. d.</i>	%
Trimming cigar boxes	45 9	26	53 3	30½	61 2	34½	68 8	39
Stripping and booking cigar bunch wrapper leaf	99 0	56½	99 0	56½	99 0	56½	99 0	56½
Ringed cigars	45 9	26	53 3	30½	61 2	34½	68 8	39
Stripping fillers	45 9	26	53 3	30½	61 2	34½	68 8	39
Packing cigars, viz. :—								
Havanette	45 9	26	53 3	30½	61 2	34½	68 8	39
Royal Bengals	45 9	26	53 3	30½	61 2	34½	68 8	39
Bonanzas	45 9	26	53 3	30½	61 2	34½	68 8	39
Gem of East Cigarillos	45 9	26	53 3	30½	61 2	34½	68 8	39
Swiss	45 9	26	53 3	30½	61 2	34½	68 8	39
Cartons or parcels	45 9	26	53 3	30½	61 2	34½	68 8	39
Machine work, viz. :—								
Making bunches	45 9	26	53 3	30½	61 2	34½	68 8	39
Covering cigars	45 9	26	53 3	30½	61 2	34½	68 8	39
Swiss	45 9	26	53 3	30½	61 2	34½	68 8	39
Lucky Hit	45 9	26	53 3	30½	61 2	34½	68 8	39
Havanettes	45 9	26	53 3	30½	61 2	34½	68 8	39
Senoritas	45 9	26	53 3	30½	61 2	34½	68 8	39

Provided that, for the purposes of this Determination, experience in any of the above sections shall be deemed to be experience in any other section.

Females—continued.

Employed in—	Wages per Week of 40 Hours.					
	2nd Year's Experience.				Third Year's Experience.	Fourth Year's Experience.
	1st Six Months.		2nd Six Months.			
	Wages.	*Per-centage.	Wages.	*Per-centage.		
<i>s. d.</i>	%	<i>s. d.</i>	%			
Trimming cigar boxes	76 1	43½	91 6	52	Piece-work prices	Piece-work prices
Stripping and booking cigar bunch wrapper leaf	129 4	73½	137 3	78	Minimum wage	Minimum wage
Ringling cigars	Piece-work prices		Piece-work prices		Piece-work prices	Piece-work prices
Stripping fillers	"		"		"	"
Packing cigars, viz. :—	"		"		"	"
Havanette	"		"		"	"
Royal Bengals	"		"		"	"
Bonanzas	"		"		"	"
Gem of East Cigarillos	"		"		"	"
Swiss	"		"		"	"
Cartons or parcels	"		"		"	"
Machine work, viz. :—	"		"		"	"
Making bunches	"		"		"	"
Covering cigars	"		"		"	"
Swiss	"		"		"	"
Lucky Hit	"		"		"	"
Havanettes	"		"		"	"
Senoritas	"		"		"	"
	} Making throughout		}		"	"

Provided that, for the purposes of this Determination, experience in any of the above sections shall be deemed to be experience in any other section.

Age.

	14 Years.		15 Years.		16 Years.		17 Years.		18 Years.		19 Years.		20 Years.	
	Wage.	*Per-centage.	Wage.	*Per-centage.	Wage.	*Per-centage.	Wage.	*Per-centage.	Wage.	*Per-centage.	Wage.	*Per-centage.	Wage.	*Per-centage.
	<i>s. d.</i>	%	<i>s. d.</i>	%	<i>s. d.</i>	%	<i>s. d.</i>	%	<i>s. d.</i>	%	<i>s. d.</i>	%	<i>s. d.</i>	%
Any other class of work for which the rate of wages fixed for adults does not exceed 176s. per week of 40 hours	57 8	32½	72 2	41	86 8	49½	96 10	55	110 11	63	127 2	72½	144 4	82

* The percentages shown in these columns are the percentages of the minimum weekly wage from time to time payable to "All Others (Females)".

4.

OTHER EMPLOYEES.

	Wages per Week of 40 Hours.	
	<i>£ s. d.</i>	
Strippers and bookers of cigar covering leaf (males)	13 6 5	
Strippers and bookers of cigar covering leaf (females)	9 14 0	
Strippers and bookers of cigar bunch wrapper leaf (females)	9 3 6	
Cigar box makers (males)	13 9 6	
Persons re-tying or boxing cigars, or engaged at any other work connected with sorting or packing cigars not specified herein (females)	8 19 6	
Stripping fillers (males)	13 2 0	
All others (males)	13 2 0	
" " (females) 75 per cent. of the Basic Wage	8 16 0	

Clauses, other than clauses 2, 3 and 4, of the said Determination shall remain in force, except that for sub-clause (m) of clause 13 the following shall be substituted:—

(m) The weekly earnings of pieceworkers who work on piecework the full working hours for which the time rates of wages prescribed by this Determination are payable shall be increased by the following amounts:—

Age.	Males.		Females.	
	Per Week.		Per Week.	
	<i>s. d.</i>		<i>s. d.</i>	
Adults	143 0	101 8		
14 years of age	29 6	33 1		
15 "	32 5	41 3		
16 "	39 7	49 9		
17 "	50 0	55 6		
18 "	62 5	63 5		
19 "	81 6	72 10		
20 "	103 5	82 8		

