



# VICTORIA

# GOVERNMENT GAZETTE

Published by Authority

[Registered at the General Post Office, Melbourne, for transmission by post as a newspaper.]

No. 249]

WEDNESDAY, OCTOBER 23

[1957

*Land Act 1928.*

AREA OF LAND COMPRISED IN CERTAIN CLASSES DIMINISHED OR INCREASED.

### PROCLAMATION

By His Excellency the Lieutenant-Governor of the State of Victoria and its Dependencies in the Commonwealth of Australia, &c., &c., &c.

WHEREAS by the *Land Act 1928* it is amongst other things enacted that the Governor in Council may, by Proclamation to be published in the *Government Gazette*, at any time diminish or increase the area of land comprised in any of the classes mentioned in Part I., Division 1, section 5, of the said *Land Act 1928*, but that the area of lands which may be sold by auction (Class 6), shall not be increased except as in certain cases in the said Act provided: Now therefore I, the Lieutenant-Governor of the State of Victoria, in the Commonwealth of Australia, by and with the advice of the Executive Council of the said State, and in accordance with the provisions of sections 94 and 117 of the *Land Act 1928* aforesaid, do hereby diminish or increase (as the case may be) the areas of Crown lands comprised in Classes 3 and 7 of the classes mentioned in section 5 of the *Land Act 1928* aforesaid, to the extent set forth in the subjoined Schedule (that is to say) :-

Schedule referred to.

CLASSES DIMINISHED OR INCREASED.

County.	Parish.	Allotment.	Section.	Area.	Diminished.	Increased.	Description.
					Class.	Class.	
				A. R. P.			
Benambra	Berringa	1B	K	52 0 17	7	3	South-west of Bethanga (01158/121)

Given under my Hand and the Seal of the State of Victoria, aforesaid, at Melbourne, this fifteenth day of October, in the year of our Lord One thousand nine hundred and fifty-seven, and in the sixth year of the reign of Her Majesty Queen Elizabeth II.

(L.S.)

E. F. HERRING.

By His Excellency's Command,

KEITH TURNBULL,  
Commissioner of Crown Lands and Survey.

GOD SAVE THE QUEEN!



Given under my Hand and the Seal of the State of Victoria aforesaid, at Melbourne, this fifteenth day of October in the year of our Lord One thousand nine hundred and fifty-seven, and in the sixth year of the reign of Her Majesty Queen Elizabeth II.

(L.S.) E. F. HERRING.

By His Excellency's Command,  
T. K. MALTBY;  
Commissioner of Public Works.

GOD SAVE THE QUEEN!

KATAMATITE WATERWORKS TRUST.  
DISTRICT PROCLAIMED AN URBAN DISTRICT.

PROCLAMATION

By His Excellency the Lieutenant-Governor of the State of Victoria and its Dependencies in the Commonwealth of Australia, &c., &c., &c.

UNDER the powers conferred by the Water Acts and all other powers enabling me in that behalf, I, the Lieutenant-Governor of the State of Victoria, in the Commonwealth of Australia, by and with the advice of the Executive Council of the said State, do hereby proclaim that on and from the date hereof the whole of the Waterworks District of the Katamatite Waterworks Trust shall be and become an Urban District for the purpose of and within the meaning of the said Acts.

Given under my Hand and the Seal of the State of Victoria aforesaid, at Melbourne, this twenty-second day of October, in the year of our Lord One thousand nine hundred and fifty-seven, and in the sixth year of the reign of Her Majesty Queen Elizabeth II.

(L.S.) E. F. HERRING.

By His Excellency's Command,  
W. J. MIBUS,  
Minister of Water Supply.

GOD SAVE THE QUEEN!

Banks and Currency Acts.

ALTERATION OF DAY APPOINTED FOR BANK HALF-HOLIDAY.

PROCLAMATION

By His Excellency the Lieutenant-Governor of the State of Victoria and its Dependencies in the Commonwealth of Australia, &c., &c., &c.

WHEREAS by a Proclamation issued on the 8th day of October, 1957, and published in the *Government Gazette* of the 9th day of October, 1957, Tuesday, the 29th day of October, 1957, from the hour of eleven o'clock in the forenoon, was appointed, pursuant to the powers conferred by the Banks and Currency Acts, for a bank half-holiday at Kilmore:

And whereas it is made to appear to the Governor in Council expedient that the said day should not be a bank half-holiday at Kilmore:

Now therefore I, the Lieutenant-Governor of the State of Victoria, in pursuance of the powers conferred by the Banks and Currency Acts, do by this my Proclamation declare that the said Tuesday, the 29th day of October, 1957, shall not be a bank half-holiday at Kilmore, and appoint in lieu thereof—

THURSDAY, THE 31ST DAY OF OCTOBER, 1957, from the hour of eleven o'clock in the forenoon, to be a bank half-holiday at Kilmore.

Given under my Hand and the Seal of the State of Victoria aforesaid, at Melbourne, this twenty-second day of October, in the year of our Lord One thousand nine hundred and fifty-seven, and in the sixth year of the reign of Her Majesty Queen Elizabeth II.

(L.S.) E. F. HERRING.

By His Excellency's Command,  
A. G. RYLAH,  
Chief Secretary.

GOD SAVE THE QUEEN!

Public Service Act 1946.

ALTERATION OF DAY APPOINTED FOR PUBLIC HALF-HOLIDAY.

PROCLAMATION

By His Excellency the Lieutenant-Governor of the State of Victoria and its Dependencies in the Commonwealth of Australia, &c., &c., &c.

WHEREAS by a Proclamation made on the 8th day of October, 1957, and published in the *Government Gazette* of the 9th day of October, 1957, Tuesday, the 29th day of October, 1957, has been appointed, pursuant to sub-section (2) of Section 67 of the *Public Service Act* 1946 to be kept as a public half-holiday throughout that part of Victoria being the Kilmore, Bylands and Glenburnie, Willowmavin and Moranding Ridings of the Shire of Kilmore:

And whereas it is made to appear to me expedient that Tuesday, the 29th day of October, 1957, should not be a public half-holiday throughout the said part of Victoria:

Now therefore I, the Lieutenant-Governor of the State of Victoria in the Commonwealth of Australia, by and with the advice of the Executive Council of the said State, and in pursuance of the provisions of sub-section (4) of Section 67 of the *Public Service Act* 1946, do by this my Proclamation declare that Tuesday, the 29th day of October, 1957, shall not be a public half-holiday throughout that part of Victoria being the Kilmore, Bylands and Glenburnie, Willowmavin and Moranding Ridings of the Shire of Kilmore, and appoint THURSDAY, THE 31ST DAY OF OCTOBER, 1957, to be a public half-holiday throughout the said Kilmore, Bylands and Glenburnie, Willowmavin and Moranding Ridings of the Shire of Kilmore.

Given under my Hand and the Seal of the State of Victoria aforesaid, at Melbourne, this twenty-second day of October, in the year of our Lord One thousand nine hundred and fifty-seven, and in the sixth year of the reign of Her Majesty Queen Elizabeth II.

(L.S.) E. F. HERRING.

By His Excellency's Command,  
A. G. RYLAH,  
Chief Secretary.

GOD SAVE THE QUEEN!

TEESDALE TOWN COMMON ABOLISHED.

PROCLAMATION

By His Excellency the Lieutenant-Governor of the State of Victoria and its Dependencies in the Commonwealth of Australia, &c., &c., &c.

WHEREAS by Division 10 of Part I. of the *Land Act* 1928 it is amongst other things enacted that the Governor in Council may from time to time increase, and, after one month's notice in the *Government Gazette*, diminish, alter, or abolish any common, and may from time to time re-proclaim the whole or any part of any such common for any of the purposes and subject to the provisions of the said Part of the said Act, and that nothing therein contained shall prevent the exercise of the powers conferred by the said Part of the said Act with respect to the leasing or licensing of any land comprised in any common: And whereas notice has been published in the *Government Gazette* for four (4) consecutive weeks of the intention to abolish the Teesdale Town Common: Now therefore I, the Lieutenant-Governor of the State of Victoria, in the Commonwealth of Australia, by and with the advice of the Executive Council of the said State, do hereby abolish

THE TEESDALE TOWN COMMON.

Given under my Hand and the Seal of the State of Victoria aforesaid, at Melbourne, this fifteenth day of October, in the year of our Lord One thousand nine hundred and fifty-seven, and in the sixth year of the reign of Her Majesty Queen Elizabeth II.

(L.S.) E. F. HERRING.

By His Excellency's Command,  
KEITH TURNBULL,  
Commissioner of Crown Lands and Survey.

GOD SAVE THE QUEEN!

## PUBLIC HOLIDAYS.

## PROCLAMATION

By His Excellency the Lieutenant-Governor of the State of Victoria and its Dependencies in the Commonwealth of Australia, &c., &c., &c.

IN pursuance of the provisions contained in Part III. of the *Public Service Act 1946*, I, the Lieutenant-Governor of the State of Victoria, in the Commonwealth of Australia, by and with the advice of the Executive Council of the said State, do by this my Proclamation appoint the days and dates hereunder mentioned to be observed as Public Holidays or Public Half-Holidays (as the case may be) at the places respectively specified, viz.:—

*Public Holiday:—*

SATURDAY, THE 2ND NOVEMBER, 1957, throughout the Central Riding of the Shire of Kerang.

*Public Half-Holidays from the Hour of Twelve o'clock noon:—*

TUESDAY, THE 5TH NOVEMBER, 1957, throughout the Ouyen and Walpeup Ridings of the Shire of Walpeup.

WEDNESDAY, THE 27TH NOVEMBER, 1957, throughout the Shire of Ballarat.

WEDNESDAY, THE 6TH NOVEMBER, 1957, throughout the Kyneton Riding of the Shire of Kyneton.

\*THURSDAY, THE 14TH NOVEMBER, 1957, throughout the City of Hamilton.

\* Agricultural Show.

Given under my Hand and the Seal of the State of Victoria aforesaid, at Melbourne, this twenty-second day of October, in the year of our Lord One thousand nine hundred and fifty-seven, and in the sixth year of the reign of Her Majesty Queen Elizabeth II.

(L.S.)

E. F. HERRING.

By His Excellency's Command,

MURRAY PORTER,  
for Chief Secretary.

GOD SAVE THE QUEEN!

## MELBOURNE CUP HOLIDAY.

NOTICE is hereby given that on—

TUESDAY, THE 5TH NOVEMBER, 1957, the Public Offices in the municipalities hereunder will be closed, that day having been proclaimed by the Governor in Council, under the powers conferred by the *Public Service Act 1946*, to be observed as a holiday in the Public Offices:—

Box Hill, Brighton, Broadmeadows, Brunswick, Camberwell, Caulfield, Chelsea, Coburg, Collingwood, Essendon, Fitzroy, Footscray, Hawthorn, Heidelberg, Kew, Malvern, Melbourne, Moorabbin, Mordialloc, Northcote, Nunawading, Oakleigh, Port Melbourne, Prahran, Preston, Richmond, St. Kilda, Sandringham, South Melbourne, Sunshine, and Williamstown; the Borough of Ringwood; the Shires of Altona, Bacchus Marsh, Berwick, Bulla, Cranbourne, Dandenong, Doncaster and Templestowe, Eltham, Fern Tree Gully, Frankston and Hastings, Gisborne, Keilor, Lillydale, Melton, Mornington, Mulgrave, Romsey, Springvale and Noble Park, Werribee, and Whittlesea.

This notice relates only to the closing of the State Public Offices. All inquiries regarding holidays in other offices and in shops and industry should be directed to the Department of Labour, Old Treasury Building, Spring-street, Melbourne, C.I. (Telephone MF-0321, Extension 266 or 6382.)

A. G. RYLAH,  
Chief Secretary.

Chief Secretary's Office,  
Melbourne, C.I. 11th October, 1957.

## ANNUAL LICENCE.

A LICENCE to carry on in Victoria, from 15th October, 1957, to 31st December, 1957, Fire, Marine, and Fidelity Guarantee Insurance business was issued to the under-mentioned company on 15th October, 1957:—

THE EASTERN UNITED ASSURANCE CORPORATION LIMITED.

D. G. RICHARDS,  
Comptroller of Stamps.

## MELBOURNE AND METROPOLITAN BOARD OF WORKS.

NOTICE is hereby given that after the publication of this advertisement in four consecutive ordinary numbers of the *Government Gazette* and four numbers of one of the daily newspapers published in the metropolis the Melbourne and Metropolitan Board of Works will proceed to compulsorily take (unless the same is in the meantime acquired by the Board from the owner or owners or other persons interested by mutual agreement) the land mentioned and described below.

The nature of the works in respect of which the land is proposed to be taken is the widening of those portions of High-street south, Denmark-street, High-street, and Cotham-road, Kew, which were by Order in Council dated the 7th day of May, 1957, declared a metropolitan main highway under section 7 of the *Melbourne and Metropolitan Board of Works Act 1956*.

The quantity of land which the Board requires for the purpose of such works is set forth below.

## PARTICULARS OF LAND.

Firstly.—All that piece of land being part of Crown portion 74, Parish of Boroondara, County of Bourke, commencing at a point in the eastern boundary of High-street south distant 47 ft. 2½ in. 208 deg. 21½ min. south of the intersection of the last-mentioned boundary and the western boundary of Denmark-street; thence easterly by a line bearing 104 deg. 45½ min. 23 ft. 3 in. to the last-mentioned boundary; thence southerly along the last-mentioned boundary bearing 179 deg. 55½ min. for a distance of 11 ft. 6 in.; thence generally northerly, westerly, and southerly 39 ft. 6½ in. along the arc of a circle with a radius of 14 ft. 11½ in. and its centre to the south to the eastern boundary of High-street south; thence northerly by the last-mentioned boundary bearing 28 deg. 21½ min. for a distance of 11 ft. 9 in. to the commencing point.

Secondly.—All that piece of land being part of Crown portion 80, Parish of Boroondara, County of Bourke, commencing at the intersection of the eastern boundary of Denmark-street and the southern boundary of High-street; thence easterly by the last-mentioned boundary bearing 57 deg. 25 min. 107 ft. 1 in., southerly 157 deg. 58 min. 15 ft. 3 in. easterly 57 deg. 25 min. 30 ft. 10 in.; thence westerly by lines bearing 230 deg. 41 min. 68 ft. 3 in., 237 deg. 25 min. 70 ft. 11 in., and 20 ft. 1½ in. along the arc of a circle with a radius of 20 feet and its centre to the south to the eastern boundary of Denmark-street; thence northerly by the last-mentioned boundary bearing 359 deg. 48 min. 38 ft. 2½ in. to the commencing point.

Thirdly.—All that piece of land being part of Crown portion 80, Parish of Boroondara, County of Bourke, commencing at the intersection of the southern boundary of High-street and the western boundary of a right-of-way distant 32 ft. 9½ in. 237 deg. 25 min. from the southern boundary of Cotham-road; thence southerly along the western boundary of the right-of-way aforesaid bearing 175 deg. 2 min. for a distance of 16 ft. 11 in.; thence westerly by a line bearing 237 deg. 25 min. for a distance of 46 ft. 7½ in. to High-street; thence northerly along High-street bearing 353 deg. 52 min. for a distance of 16 ft. 9 in.; thence easterly along the southern boundary of High-street bearing 57 deg. 25 min. for a distance of 47 ft. 0 in. to the commencing point.

Fourthly.—All that piece of land being part of Crown portion 80, Parish of Boroondara, County of Bourke, commencing at the intersection of the southern boundary of High-street and the eastern boundary of a right-of-way distant 20 ft. 8 in. 237 deg. 25 min. from the southern boundary of Cotham-road; thence easterly by a line bearing 70 deg. 44½ min. for a distance of 31 ft. 4½ in. to the southern boundary of Cotham-road; thence easterly by the last-mentioned boundary bearing 90 deg. 11 min. for a distance of 43 ft. 0 in.; thence westerly 55 ft. 8½ in. along the arc of a circle with a radius of 97 ft. 4½ in. and its centre to the south; thence westerly by a line bearing 57 deg. 25 min. for a distance of 21 ft. 9 in. to the eastern boundary of the right-of-way; thence northerly along the last-mentioned boundary bearing 354 deg. 50 min. for a distance of 16 ft. 10½ in. to the commencing point.

Dated this 8th day of October, 1957.

C. TRATHAN,  
Secretary.

Offices of the Melbourne and Metropolitan Board of Works, 110 Spencer-street, Melbourne.

(Published in lieu of Notices appearing on pages 3157 and 3221 of *Government Gazettes*, dated 25th September, and 2nd October, 1957, respectively.)

## Transport Regulation Acts.

## TRANSPORT REGULATION BOARD.

## NOTICES OF PUBLIC HEARINGS.

NOTICE is hereby given that the applications made by the persons named below for licences to operate commercial goods vehicles, on the route or routes or in the manner set out opposite their names, will be heard at a time and place to be communicated to the persons concerned:—

*Name and Address; Nature of Application.*

- BALLARAT ORPHANAGE**, 200 Victoria-street, Ballarat; 1 commercial goods vehicle (8 cwt.) to operate in course of business as "orphanage and dairy farm"—(a) within a radius of 50 miles of Ballarat—own goods, (b) throughout the State of Victoria—live-stock for exhibition purposes at shows, also camping gear and equipment for attendants.
- ROBERTS, K. C.**, Toole-street, Hopetoun; 1 commercial goods vehicle (200 cwt.) to operate—(a) within a radius of 20 miles of Hopetoun—general goods, (b) from Ampol Petroleum Co.'s depot at Horsham to places within a radius of 50 miles of Hopetoun—petroleum products in prescribed types of containers and empty returns on behalf of the said company.
- BARKMEYER, E. G.**, 107 View-street, Bendigo; 1 commercial goods vehicle (6 cwt.) to operate within an area bounded on the west by a north/south line drawn through Horsham and on the east by a north/south line drawn through Shepparton and on the south by an east/west line drawn through Ballarat in the course of business as "signwriter"—tools of trade and materials incidental to own contracts.
- BEER, E. C.**, P.O. Box 66, Lakes Entrance; 1 commercial goods vehicle (70 cwt.) to operate within the Bairnsdale Division of the C.R.B.—road-contracting plant and materials.
- BENTLEY, W. A.**, St. Aidan's-road, Bendigo; 1 commercial goods vehicle (7 cwt.) to operate within a radius of 50 miles of Bendigo and to and from St. Arnaud, Ballarat, and Cohuna in the course of business as "washing machine specialists"—tools of trade and spare parts incidental to the servicing and maintenance of washing machines, also advertising material incidental to own business.
- BOX, W. G.**, Forrest, via Colac; 1 commercial goods vehicle (205 cwt.) to operate for the carriage of—(a) logs from forest landings at Mount Sabine and Gerangamete to Hancock Bros. sawmill at Barramunga and Gerangamete, (b) sawn timber from Hancock Bros. sawmill at Barramunga and Gerangamete to consignees at Geelong.
- BROWN, M. S.**, MOTORS PTY. LTD., 10 Queen-street, Bendigo; 1 commercial goods vehicle (12 cwt.) to operate throughout the State of Victoria for the demonstration, repair, and servicing of tractors and farm implements—tools of trade, spare parts, and materials incidental to such work.
- BYRN, JAMES R.** (trading as Wangaratta Bottle Co.), 24 Norton-street, Wangaratta; 1 commercial goods vehicle (105 cwt.) to operate within a radius of 100 miles of the premises of the Wangaratta Bottle Co. at Wangaratta in the course of business as "marine dealer"—marine stores and old metals.
- FOORD, N. W. J.**, 107-9 Lydiard-street, Ballarat; 1 commercial goods vehicle (20 cwt.) to operate within a radius of 50 miles of the post office at Bendigo solely on behalf of the Phoenix Biscuit Co. and McAlpin's Flour Pty. Ltd.—goods being the property of the said companies.
- FRIGRITE LTD.**, Graham-street, Port Melbourne; 1 commercial goods vehicle (9 cwt.) to operate throughout the State of Victoria in the course of business as "refrigeration engineers" for the purpose of servicing, maintaining, and installing refrigeration units—refrigerators, tools of trade, spare parts, and materials incidental to such installation and servicing.
- GENERAL MOTORS-HOLDENS LTD.**, Princes Highway, Dandenong; 4 commercial goods vehicles (140 cwt. each) to operate within a radius of 30 miles of own premises at Dandenong in the course of business as "motor vehicle manufacturers" own motor parts and chassis members.
- HALE, A. G.**, Doreen; 1 commercial goods vehicle (257 cwt.) to operate from forest landings in the Flowerdale and Strath Creek areas to sawmills in the metropolitan area as directed by an officer of the Forests Commission.
- HOADLEY'S CHOCOLATES LTD.**, Coventry-street, South Melbourne; 1 commercial goods vehicle (52 cwt.) to operate for the carriage of confectionery from own depot at Bendigo, such confectionery having been railed to Bendigo—(a) to retailers *en route* to Shepparton, via Heathcote, (b) to retailers *en route* to Deniliquin, via Echuca, (c) to retailers *en route* to Castlemaine, via Maryborough and Dunolly, (d) to retailers within a radius of 25 miles of the post office at Bendigo.
- INTERNATIONAL HARVESTER CO. OF AUSTRALIA PTY. LTD.**, North Shore, Geelong; 2 commercial goods vehicles (200 and 50 cwt.) to operate throughout the State of Victoria in the course of business as "tractor and implement manufacturers and distributors"—(a) implements and accessories for demonstration purposes only, with the ability to make an urgent incidental delivery, (b) tools of trade, spare parts, and materials incidental to the repair and servicing of experimental tractors, implements, and farm machinery.
- KELLY, J. M. & J. C.**, Post Office, Cann River; 1 commercial goods vehicle (94 cwt.) to operate within the Bairnsdale Division of the C.R.B.—own crushing plant and road-contracting plant and materials.
- K.M. PLASTER PRODUCTS PTY. LTD.**, Bald Hill-road, Pakenham East; 1 commercial goods vehicle (106 cwt.) to operate within a radius of 25 miles of own premises at Pakenham East in the course of business as "fibro-plaster manufacturers"—own fibro-plaster sheets, mouldings, hemp, sisal, and fixing materials.
- LEITH, R. W.**, Leila-road, Warburton; application to vary the terms of existing licence No. T.T.D.1523 by the addition of the ability to operate from Platt's and McKechnie's sawmills at Millgrove to timber yards in the metropolitan area—sawn timber.
- MALADY, P. L.**, Raymond-street, Sale; 1 commercial goods vehicle (87 cwt.) to operate within a radius of 50 miles of Stratford—road-contracting plant and materials.
- MORRISH, W. R.**, Ouyen; application to vary the terms of existing licences Nos. D.A.1633, D.A.1633/1, and D.A.1633/2 by the deletion of paragraph (c) and adding in lieu the ability to operate throughout the Shires of Mildura, Walpeup, Swan Hill, Karkarook, and Wycheproof—road-contracting plant and materials.
- NESTLE'S FOOD SPECIALITIES (AUST.) LTD.**, Dennington; 1 commercial goods vehicle (10 cwt.) to operate within a radius of 50 miles of Dennington for the purpose of servicing and maintaining milking machines.
- ORR BROS. TIMBER & HARDWARE PTY. LTD.**, 14-16 Piper-street, Kyneton; 1 commercial goods vehicle (91 cwt.) to operate within a radius of 20 miles of the Kyneton Post Office and to and from the City of Melbourne in the course of business as "timber and hardware merchants"—own goods.
- SIMMONS, E.**, 78 Carpenter-street, Bendigo; 1 commercial goods vehicle (100 cwt.) to operate throughout the State of Victoria in the course of business as "monumental mason and hard floor finisher"—(a) tools of trade, equipment, and materials for use in the erection of memorials at cemeteries, (b) terrazzo slabs and associated materials used in connexion with the construction of hard floors, partitions, and steps.
- SKEEN, C. A., & A. L. McPHAIL**, Dawson-street, Sale; 1 commercial goods vehicle (96 cwt.) to operate—(a) within a radius of 20 miles of Sale—general goods, (b) within a radius of 50 miles of Sale—petroleum products in prescribed types of containers and empty returns, (c) from and to places within a radius of 50 miles of Sale to and from places in paragraph (a) second-hand household furniture.
- SLATTERY, J. H.**, Caramut; application to vary the terms of existing licence No. D.A.24232 by the addition of the ability to operate—(a) from places within a radius of 20 miles from the post office at Caramut to the Terang Railway Station—wool, (b) from places within a radius of 5 miles of the post office at Westmere to places within a radius of 20 miles of the post office at Caramut—fodder, (c) from places within a radius of 5 miles of the post office at Willaura to places within a radius of 20 miles of the post office at Caramut—fodder, (d) from the railway stations at Terang, Westmere, and Willaura to places within a radius of 20 miles of Caramut—general goods.
- STEPHENSON, A. L.**, 10 Premier-avenue, Mitcham; 1 commercial goods vehicle (17 cwt.) to operate throughout the State of Victoria as a manufacturer's representative for the purpose of advertising and sales promotion of own agency lines, with the ability to leave an urgent incidental order.
- THOMPSON, M. (Mrs.)**, 10 Munro-street, Ballarat; 1 commercial goods vehicle (67 cwt.) to operate west of a line drawn between Echuca and Melbourne in the course of business as "marine dealer"—marine stores and old metals.

- VASSIE, A. F., Private Bag 74, Colac; 1 commercial goods vehicle (50 cwt.) to operate—(a) within a radius of 20 miles of Colac in the course of business as "primary producer"—own goods, (b) throughout the State of Victoria in the course of business as "second-hand dealer"—all types of second-hand goods.
- VINALL, H. D. A., PTY. LTD., 19 Jane-street, Morwell; 1 commercial goods vehicle (201 cwt.) to operate—(a) within a radius of 20 miles of Morwell—general goods, (b) from Yallourn North Extension to Yarram, via Carrajung—brown coal, (c) from Yallourn North Extension to Toora, via Morwell, Boolarra, and Gunyah Junction—brown coal.
- WESTENDORF, F. V. & V. H. (trading as Westendorf and Son), Edgar-street, South Portland; 1 commercial goods vehicle (148 cwt.) to operate within the Shires of Wycheproof, Gordon, and Korong—road-contracting plant and materials.
- WHITEHEAD, J. W., 16 Hodgson-street, Mitcham; 1 commercial goods vehicle (100 cwt.) to operate within a radius of 70 miles of the premises of Wunderlich Pty. Ltd. at Vermont—tiles, battens, and tile-fixing materials.
- MURRAY VALLEY BY-PRODUCTS LTD., Osboldstone-road, Wangaratta; 1 commercial goods vehicle (approximately 260 cwt.), to be purchased, to operate from Wangaratta to Melbourne—liquid tallow, returning with petrol in bulk tanker.

NOTICE is hereby given that the applications made by the persons named below for renewal of licences to operate commercial goods vehicles, on the route or routes or in the manner set out opposite their names, will be heard at a time and place to be communicated to the persons concerned:—

*Name and Address; Present Franchise; Licence No.; Date of Expiry.*

- BEAUREPAIRE TYRE SERVICE PTY. LTD., 83-95 Franklin-street, Melbourne; 1 commercial goods vehicle to operate within an area bounded by Geelong, Meredith, Cressy, Camperdown, Port Campbell, Apollo Bay, and Lorne—tires and tubes for sale and delivery, used tires for repair and retreading, batteries, oil and car accessories in the course of licensee's business as "tire retreaders and distributors"; D.8148; 25th January, 1958.
- THE MYER EMPORIUM LTD., 314-336 Bourke-street, Melbourne; 1 commercial goods vehicle (7 cwt.) to operate throughout the State of Victoria in the course of business as "furnishers"—tools of trade, blinds, fittings, linoleum, carpets, and underfelt for use in own contracts; D.8145; 25th January, 1958.

NOTICE is hereby given that the applications made by the persons named below for renewal of licences with variation to operate the commercial goods vehicles on the route or routes, or in the manner set out opposite their names, will be heard at a time and place to be communicated to the parties concerned:—

*Name and Address; Present Franchise; Amended Conditions; Licence No.; Date of Expiry.*

- RICKEY, A. H., 8 Symons-street, Ballarat; 1 commercial goods vehicle (120 cwt.) to operate throughout the State of Victoria—road-contracting plant and materials; 1 commercial goods vehicle (120 cwt.) to operate—(a) throughout the State of Victoria in the course of business as "road and bridge construction and earth-moving contractor"—tools of trade and equipment incidental to own contracts, (b) within a radius of 20 miles of the site of any contract—any materials incidental to such contracts; D.8092; 19th October, 1957.
- SINGER SEWING MACHINE CO., 189 Liebig-street, Warrnambool; 1 commercial goods vehicle (10 cwt.) to operate for the carriage of new sewing machines, sewing machines for repair or having been repaired, spare parts and sewing machine accessories within an area bounded as follows:—(a) within the State of Victoria on the east by a line drawn through the Township of Darlington and to and from the City of Ballarat, (b) on the north by an east/west line drawn through the Township of Lake Bolac, (c) on the west by the Victorian/South Australian border; 1 commercial goods vehicle (10 cwt.) to operate within a radius of 50 miles of Warrnambool and to and from Ballarat—new and second-hand sewing machines and accessories; D.8124; 21st December, 1957.

NOTICE is hereby given that the applications made by the persons named below for licences to operate commercial passenger vehicles on the route or routes, or in the manner set out opposite their names, will be heard at a time and place to be communicated to the parties:—

*Name and Address; Nature of Application.*

- HIPWORTH, J. A., 27 Victoria-street, Kerang; 1 commercial passenger vehicle, with seating capacity for five persons, to operate under the same terms and conditions as existing Kerang taxi-cabs (subject to the cancellation of licence No. C.H.159, in the name of the applicant).
- BRAYBROOK, R., 30 Otway-street, Ballarat; application for variation of licence No. UO.202, to include the ability to extend the Mt. Pleasant service from the corner of Humfray and Barkly streets to Redan and Sebastopol streets, via Prest, Leith, Alfred, Hartford, Grant, and Victoria streets to Edward-street, Sebastopol, returning via Edward or Rowland streets, Vickers-street and Grant-street along the same route to corner Humfray and Barkly streets; thence via Barkly, Morton, Tress, Cobden, Maggie, Grant, and Albert streets to city.
- Restrictions.*—On journeys to and from City passengers may be taken up anywhere along route, but shall not be set down at any place along Leith-street between Yarrowee and Ripon streets.
- ROSS, W. J., Macedon-street, Sunbury; 1 commercial passenger vehicle, with seating capacity for five persons, to operate as follows:—(a) At separate and distinct fares within a radius of 5 miles of the Sunbury Post Office. (b) under private hire conditions throughout Victoria from Macedon-street, Sunbury (subject to the cancellation of licence No. C.H.205, in the name of the applicant).
- MARK, A. E., Lydiard-street, Ballarat; 1 commercial passenger vehicle, with seating capacity for 35 persons, to operate as an additional stage omnibus under the same terms and conditions as all "C.O." licences at present held by the applicant.
- CARTER, A. T. & K. A., Edgar-street, Heywood; 1 commercial passenger vehicle, with seating capacity for five persons, to operate for the carriage of passengers otherwise than at separate and distinct fares for each passenger throughout Victoria from Edgar-street, Heywood.
- PALMER, G. E. W. (trading as Federal Coach Lines), Mountain View-road, Boronia West; variation of "C.O." licences to include the ability to operate from Salmon-road via Scoresby-road, Boronia-road, Woodvale-road, Stonehaven-road, Narcissus-avenue, Springfield-road, Cypress-avenue, Dorset-road, Boronia Railway Station (with deviation to Boronia State Schools via Dorset-road, Oak-avenue, Range View-road, Chandler-road); thence via Dorset-road, Mount Dandenong-road, Main-street, to Croydon Railway Station.
- FARRUGIA, A., 148 North-road, Yallourn North; application for renewal of licence No. C.T.100, expiring 27th February, 1958, authorizing operations as a country taxicab from Yallourn North.
- APPLICATIONS for renewal of metropolitan special service omnibus licences as listed below to be renewed in the same terms and conditions as at present prescribed:—
- Name and Address; Licence No.; Registration No.; Expiry Date.*
- ALL-WEATHER SCENIC COACHES PTY. LTD., 105 Acland-street, St. Kilda; M.C.2, EU-477, 3rd February, 1958; M.C.3, KP-842, 21st February, 1958; M.C.4, KW-697, 21st February, 1958; M.C.5, GGD-096, 20th February, 1958.
- BRIEN, J. H., & Co. PTY. LTD., 130 Moreland-street, Footscray; M.C.150, GKL-595, 21st February, 1958; M.C.151, GKA-684, 21st February, 1958.
- PARLOR CARS PTY. LTD., 244 Nicholson-street, Fitzroy; M.C.32, OV-265, 21st February, 1958; M.C.157, GPC-406, 21st February, 1958; M.C.354, PZ-380, 21st February, 1958; M.C.355, WX-192, 21st February, 1958.
- REID, D. F., 252 St. George's-road, Northcote; M.C.272, PR-305, 21st February, 1958; M.C.419, KY-812, 21st February, 1958; M.C.420, SB-999, 20th February, 1958; M.C.421, ZF-870, 20th February, 1958.
- RICHARDS, S. L., 344 Barkly-street, Footscray; M.C.423, OD-871, 20th February, 1958; M.C.424, MN-436, 20th February, 1958; M.C.425, ZR-394, 21st February, 1958.

PARLOR CARS PTY. LTD., 244 Nicholson-street, Fitzroy; application for renewal of licence No. T.P.7, Registration No. GSU-586, Dodge, with seating capacity for twelve persons, expiring 28th November, 1957, to operate as a touring omnibus only in substitution for but not in addition to any "M.C." licensed vehicle which holds touring omnibus rights.

AMPOL (ALBA) PETROLEUM PTY. LTD., 792 Elizabeth-street, Melbourne, C.I.; application for authority to operate vehicle, Registration No. VF-174, with seating capacity for eleven passengers, for the carriage of employees of the applicant company (free of charge) to and from—(a) from terminal, Douglas-parade, Newport, to City (Flinders-street), via New Footscray or Dynon roads, and return, (b) to be also used to pick up and return Custom Officers and Company personnel, for late shifts, from various pick up points on devious routes.

*Time-table to be Observed:*

(a) Depart Flinders-street .. .. .	8.25 a.m.
Arrive Newport .. .. .	8.45 a.m.
Depart Newport .. .. .	4.35 p.m.
Arrive Flinders-street .. .. .	5.00 p.m.

(b) Could be used at any hour during night for pick up purposes on devious routes.

ASPINALL, R., 167 Porter-road, West Heidelberg; application for renewal of licence No. M.O.514, expiring 16th February, 1958, authorizing operations on Route 129A (Multiple) (Canterbury-Richmond) as prescribed.

CURRER, C. (trading as Black Rock Bus Service), 379 Beach-road, Mentone; application for renewal of licence No. C.O.68, expiring 5th December, 1957, authorizing operations on Route 215A (Cheltenham-Beaumaris), 217A (Black Rock-Mentone) as prescribed.

VICTORIA DOCK BUS CO. PTY. LTD., 3 Dynon-road, South Kensington; application for variation of Route 7 (Spencer-street-Victoria Dock) to delete the present prescribed service between 12.00 noon and 2.00 p.m. Saturdays.

SUHR, L. T., 559 Centre-road, Bentleigh; application for variation of Route 120A (Bentleigh-South Bentleigh) to operate an extension from the corner of East Boundary-road and Mawby-road, via East Boundary-road, Belle View-road, Brad-street, Chesterville-road, Highview-road, Brady-road, Normdale-road to the corner of Normdale and Bignell roads.

ROGERS, W. A. & J. M. WEST, c/o Deer Park Motors, Ballarat-road, Deer Park; application for variation of Route 130A (Deer Park-Sunshine) to include the ability to operate for the carriage of school children from Ardeer and Deer Park to the St. Albans High School. Commencing from Forest and Yallourn streets, Ardeer, via Forest, Fitzgerald, Tilburn, Station roads to Esplanade West, Esplanade East, to the St. Albans High School.

*Fares to be Charged:*

From Ardeer to High School .. .. .	9d. Single
From Deer Park to High School .. .. .	6d. Single
From St. Albans to High School .. .. .	3d. Single

BEACH TRANSPORT SERVICES LTD., 273 Beach-road, Mentone; application for renewal of licence No. C.O.1062, expiring 16th February, 1958, authorizing operations on Route 200A (Mordialloc-Chelsea) as prescribed.

Notice of any objection should be forwarded to reach the Secretary to the Board not later than Wednesday, 6th November, 1957.

E. V. FIELD,  
Secretary.

Exhibition Buildings, Rathdown-street, Carlton, N.3.  
Wednesday, 23rd October, 1957.

DEPARTMENT OF MINES.

**SUBJECT** to any necessary excisions, &c., it is proposed to grant the following leases:—

9164, Castlemaine; Wattle Gully Gold Mines N.L.; 224a. 3r. 33p., Parish of Chewton.

7427, Mineral; Albert Gordon Russell; 115a. 1r. 8p., Parishes of Numbruk and Moondarra.

7577, Mineral; James Lacey and James Kingwall; 1a. 0r. 24p., Parish of Castlemaine.

TAILINGS LICENCE EXPIRED.

2716 Tailings Licence; A. T. Coffield, Parish of Buninyong.  
W. J. MIBUS,  
Minister of Mines.

MINING LEASES DECLARED VOID.

7095 Maryborough; George McLeod Holt; 17 acres, Parish of Tarnagulla.

9132 Ballarat; James Govan, Wilson Govan and Alexander Govan; 9a. 2r. 32p., Parish of Ballarat.

8242 Beechworth; William Harris; 52a. 2r. 39p., Parish of Hotham.

TAILINGS LICENCE DECLARED VOID.

2727 Tailings Licence; The President, Councillors and Ratepayers of the Shire of Waranga; at Rushworth.

J. B. TILLEY,  
Secretary for Mines.

STATE RIVERS AND WATER SUPPLY  
COMMISSION.—EILDON SEWERAGE DISTRICT.

BY-LAW No. 2.

**THE** State Rivers and Water Supply Commission, as the authority administering the District, in pursuance and exercise of the powers conferred by the Sewerage Districts Acts, doth hereby make the following By-law:—

The following Sewerage Rate is hereby made under provisions of the Sewerage Districts Acts, and shall be levied upon the net annual value of all rateable sewered properties within the Eildon Sewerage District:—

1. Of any land or tenement situate within the Eildon Sewerage District, a sewerage rate of Three shillings in the pound of the net annual value of all rateable "sewered property" within the said District.

2. Such rate is made and shall be levied for the year beginning with the 1st day of July, 1957, and ending with the 30th day of June, 1958, and shall be payable on the 25th day of October, 1957, at the offices of the Commission, situate at Eildon or Melbourne.

3. Interest will be chargeable on all rates remaining unpaid for a period of *four months* from the date such rates become payable.

4. If any rateable property which is unsewered at the time of the making of the aforesaid rate becomes during the year a "sewered property," there shall be levied upon such property a proportionate part of the sewerage rate for the portion of the year after it has become a sewered property, and such property shall be deemed to have been lawfully rated accordingly.

5. For making and levying such rate the valuation for the time being of such lands and tenements for the municipal rate of the municipality in the municipal district of which such lands and tenements are situate shall be deemed and taken to be the valuation of such lands and tenements respectively; but if any such lands and tenements are not included in a valuation in force for the municipality in whose district they are situate, or if there is no such valuation, the net annual value thereof may for all purposes of such rate be determined in the manner provided in the Sewerage Districts Acts.

6. Such person or persons as the State Rivers and Water Supply Commission may from time to time appoint for that purpose shall be and is or are hereby authorized to demand, receive, collect, and recover the said rate and charges.

The Resolution for passing the foregoing By-law was agreed to by the State Rivers and Water Supply Commission on the 23rd day of September, 1957, and was confirmed by the said Commission on the 7th day of October, 1957.

The common seal of the State Rivers and Water Supply Commission was affixed hereto on the 10th day of October, 1957.

L. R. EAST, Chairman.  
(SEAL) H. W. MCCAY, Commissioner.  
J. A. AIRD, Commissioner.

Approved by the Governor in Council, 15th October, 1957.—A. MAHLSTEDT, Clerk of the Executive Council.

## SWAN HILL WATERWORKS TRUST.

## By-Law No. 5.

THE Swan Hill Waterworks Trust, in pursuance and exercise of the powers and authorities conferred by the Water Acts doth hereby make the By-law following for its Waterworks District:—

## PART I.—INTERPRETATION.

*Definitions.*

1. In this By-law unless inconsistent with the context or subject matter—

"The Act" means the Water Acts.

"Fittings" includes all appliances and things whatsoever, other than pipes, used in connexion with the conveying supplying storing or regulation of the flow of water in or derived from a main pipe.

"Main Pipe" means any pipe belonging to or under the control of the Trust and used for the conveying or supplying of water.

"Person" includes a Corporation or Company.

"Private Service" means and includes all pipes and fittings used in connexion with the supply of water from a main pipe to a tenement and/or in connexion with the use or consumption of such water in or on such tenement.

"Proper Officer" means any employee of the Trust authorized to execute any function on behalf of the Trust.

"Service Pipe" means any pipe (not being a main pipe) used for the conveying or supplying of water derived from a main pipe.

"Trust" means the Swan Hill Waterworks Trust.

"Works" means works of or in connexion with the laying constructing altering disconnecting removing repairing renewing or maintaining of a private service or any part thereof.

All words used in this By-law which are also used in the Act shall have the meanings assigned to them by the Act.

## PART II.—LICENSING OF PLUMBERS.

*Unlicensed Persons not to Interfere with Private Services.*

2. Before any person shall affix any service pipe to any main pipe of the Trust or alter repair or in any manner interfere with any pipe of the Trust or any service pipe tap or meter or other fitting connected with the main pipes of the Trust, he shall obtain from the Trust a licence in that behalf to execute such works, and no unlicensed person shall affix alter repair or in any manner interfere with any such main pipe service pipe tap meter or other fitting as aforesaid.

*Period of Licences; Cancellation of Licences; Fees Payable.*

3. Each licence shall be for the period ending 31st December next ensuing after the issue thereof, but may be renewed by the Trust at its discretion from time to time in each case to the following 31st December. The Trust shall have power at any time to suspend or cancel a licence in the event of the holder thereof performing his work in an unsatisfactory manner or committing any breach of the Act or of this By-law, and in such matters the Trust shall be sole judge. For each original licence the licensee shall pay to the Trust a fee of One pound, and for each renewal Five shillings.

*Proof of Fitness to be Given.*

4. Before any licence shall be granted by the Trust, the person applying for such licence shall satisfy the Trust by any tests required by the Trust or by virtue of his registration by the Plumbers and Gasfitters Board of Victoria that he is a competent plumber and that he is thoroughly conversant with the provisions of the By-laws of the Trust relating to water supply and with the Act so far as it applies to town supplies. The Trust may, if it so sees fit, refuse to grant such licence.

## PART III.—CONSTRUCTION AND ARRANGEMENT OF WORKS.

*Notice of Works to be Given.*

5. No person shall execute any works (except such works as are authorized by sections 191 and 194 of the Water Act 1928)—

(a) without having given to the Trust not less than two days prior to the commencement of the execution of such works—

(i) notice in writing of his intention so to do specifying the tenement in or in respect of which it is proposed to

execute such works and the time or times (being between the hours of 8 a.m. and 5 p.m. on any week day except a public holiday or a Saturday) during which it is proposed to execute such works.

(ii) a complete specification in writing of the works proposed to be done setting out the mode form strength material construction dimensions and arrangement of all pipes fittings and structures intended to be used in the execution of such works.

(iii) in the case of every private service containing any service pipe of diameter larger than 2 inches a properly prepared plan drawn to a scale specified thereon of the premises in or in respect of which it is proposed to execute the said works showing thereon all buildings erections and structures on the said premises and the proposed arrangement of all pipes and other works which it is proposed to lay or construct therein or thereon.

Every notice specification and plan shall be signed by the licensed plumber actually engaged to carry out the works referred to in the notice, or by a licensed plumber employing another licensed plumber to carry out the work under his supervision.

(b) contrary to or not in conformity with this By-law or such notice specification and plan mentioned in sub-paragraphs (i) (ii) and (iii) of paragraph (a) of this clause.

*Plumbers to Report.*

6. Each licensed plumber shall report to the Proper Officer of the Trust the completion of any new work extensions or repairs in connexion with any service within twenty-four hours of effecting same.

*Carrying Out of Plumbing Work.*

7. Every licensed plumber shall in carrying out any work of water supply—

(a) Execute the work in accordance with the provisions of the Act and of the By-laws of the Trust and any special directions or orders given or issued thereunder by the Trust by the Proper Officer of the Trust; and

(b) execute the work in a thorough and expeditious manner to the satisfaction of an inspecting officer of the Trust; and

(c) use materials of the description quality kind and standard prescribed by this By-law; and

(d) employ only competent operatives and assistants; and

(e) obtain permission, where necessary, for the execution of the work on, over or through any private property, or any street road park reserve or other public place or property; and

(f) pay all fees payable to the council of a municipality for the opening of any public road or street or otherwise in connexion with the works; and

(g) restore upon completion of the work any part of any public road or street to the satisfaction of the municipal council or other authority having control thereof; and

(h) except where authorized in writing by the owner or his agent to omit restoration, restore any other property interfered with by the work to the satisfaction of the Proper Officer of the Trust; and

(i) take all proper and necessary precautions so that no accident, damage or unnecessary inconvenience may be directly or indirectly occasioned by the execution of the work; and

(j) exercise at all times immediate supervision over the work.

8. (a) No service pipe (other than those installed for fire service purposes and sealed in accordance with the provisions of clause 34 of this By-law) which supplies water otherwise than by measure to any tenement shall have a bore exceeding  $\frac{1}{2}$  inch.

(b) No person shall connect or affix to the Trust's mains any service pipe (other than those installed for fire service purposes and sealed in accordance with the



provisions of clause 34 of this By-law) which has a diameter exceeding the appropriate diameter listed in the schedule hereunder written corresponding either to the Net Annual Valuation of the property to be served or to

the anticipated annual consumption of water at the said property as demonstrated to the satisfaction of the Proper Officer of the Trust and certified to under his hand, whichever is the larger—

Net Annual Valuation of Property.	Annual Consumption of Water.	Maximum Diameter of Service Pipe Allowed (in Inches).
Not over £150 .. .. .	Not over 200,000 gallons .. .. .	$\frac{1}{2}$
Over £150 but not over £300 .. .. .	Over 200,000 gallons, but not over 500,000 gallons .. .. .	1
Over £300 but not over £500 .. .. .	Over 500,000 gallons, but not over 800,000 gallons .. .. .	$1\frac{1}{2}$
Over £500 but not over £1,000 .. .. .	Over 800,000 gallons, but not over 1,500,000 gallons .. .. .	$1\frac{3}{4}$
Over £1,000 but not over £2,000 .. .. .	Over 1,500,000 gallons, but not over 3,000,000 gallons .. .. .	2

*Depth of Service Pipes.*

9. No person shall lay construct repair or alter any private service unless every service pipe forming part thereof for such portion of its length as lies in or on private property is securely clipped to a structure or is laid and constructed in such manner that the same is at all points at a depth of not less than 12 inches below the surface of the ground. Every such service pipe for such portion of its length as lies in or on any road street lane or right-of-way or where it may be exposed to vehicular traffic shall be laid and constructed in such manner that the same is at all points at a depth of not less than 18 inches below the surface of the ground or at such greater depth as the council of the municipality having control of the said road street lane or right-of-way may require.

*Access to Service Pipes.*

10. No person shall—

- (a) lay construct or alter any private service or any part thereof,
- (b) erect or construct any building erection or structure

in such place position or manner that any part of such private service is not easily accessible for the purposes of inspection repair and renewal unless such part is comprised of copper piping and copper fittings.

*Arrangement of Stop-Tap, etc.*

11. Every meter, stop-tap and stop-tap ferrule shall be opposite the tenement supplied and in one line at right angles to the main pipe to which such stop-tap ferrule is fixed, unless such an arrangement is impracticable in which case such services shall be provided with two high pressure screw down stop-taps, one of which shall be fixed opposite the stop-tap ferrule on the main pipe and the other in accordance with the provisions of clause 18 of this By-law.

*Cross Connexions.*

12. No person shall permit or suffer any fluid solid or gas, which in the opinion of the Proper Officer of the Trust is capable of polluting water supplied by the Trust, to have means of access to any pipe in communication directly or indirectly with any main pipe of the Trust.

Where any service pipe is connected to any cistern tank or receptacle used for the storage of water or fluid, there shall be an effective air gap at the outlet of such service pipe and the said outlet shall be not less than one-half inch above the highest possible water level in the said cistern tank or receptacle.

*Connexions to Steam Boilers.*

13. Water supply connexions to steam boilers shall be made as follows:—

- (a) By direct connexion from a service pipe, in which case a screw down high pressure stop-tap with its spindle vertically upwards shall be fixed on a vertically acting reflux valve shall be fixed between the stop-tap and the boiler and a half-inch testing ferrule or bib-tap shall be fixed between the reflux valve and the stop-tap; or
- (b) By direct connexion from a service pipe together with an injected supply from a storage tank or condensate sump, in which case, in addition to the provisions of paragraph (a) hereof, the injected water to a boiler shall be taken through a separate opening in the wall of the boiler. In no circumstances shall a connexion be permitted between any service pipe and the piping from a storage tank or condensate sump.

Water connexions may be made through the tops or sides of steam boilers.

*Specifications for Piping and Materials.*

14. No person shall use any pipe or fittings in or in connexion with a private service unless the same shall comply in all respects with the following specifications:—

- (a) The service pipes from main pipe to the meter shall be of copper tube and the whole of the balance of the pipes and fittings shall be of the best quality galvanized wrought-iron, copper, brass, cast iron, welded mild steel or asbestos cement, shall be sound and free from all defects and shall comply with the relevant specifications of the Standards Association of Australia where such specifications have been issued.
- (b) All pipes and pieces shall be true in sectional form, straight longitudinally, clear in bore and (in case of wrought-iron piping) properly galvanized throughout and shall be of equal strength and thickness throughout the entire body of the same.
- (c) Only pipes and fittings which have been tested in accordance with the requirements of the specifications of the Standards Association of Australia will be permitted to be used for services whether inside or outside the tenement.
- (d) All ends of galvanized wrought-iron and brass pipes bends and fittings shall be properly and truly threaded and capable of being screwed into thimbles, toes or fittings.
- (e) All stop-taps and bib-taps shall be screw down high pressure taps made of hard brass or gun-metal.

**PART V.—CONNEXIONS TO MAINS.**

*One Service Pipe to Each Tenement.*

15. No person shall affix or connect or cause or permit to be affixed or connected to any main pipe more than one service pipe or private service for the supply of water for domestic purposes to any one tenement.

*Connexion to Main Pipe.*

16. No person shall affix or connect any service pipe to any main pipe save by means of a stop-tap ferrule to which a right-angle bend of copper alloy is properly and securely attached.

*Size of Tappings Permitted.*

17. (a) The maximum diameters of tappings that will be permitted for main pipes of the respective diameters set out hereunder, and for cases where the tapping is made with or without a tapping saddle, are as follows:—

**MAXIMUM DIAMETER OF TAPPING IN INCHES.**

Diameter of Main Pipe in Inches.	Without Tapping Saddle (Cast-Iron Main Pipes Only).	With Tapping Saddle.
3	$\frac{1}{2}$	$1\frac{1}{2}$
4	$\frac{3}{4}$	$1\frac{3}{4}$
5	1	$1\frac{1}{2}$
6	1	$2\frac{1}{4}$
7	1	$2\frac{1}{2}$
8	$1\frac{1}{2}$	$2\frac{3}{4}$
9	$1\frac{3}{4}$	$2\frac{3}{4}$
Over 9	2	$2\frac{3}{4}$

*Tapping Fees.*

(b) No person shall affix or connect or cause to be affixed or connected any service pipe to any main pipe without having first paid to the Trust a tapping fee of Sixty shillings (60s.) for  $\frac{1}{2}$ -inch tapping and Twenty-five shillings (25s.) additional fee for each additional  $\frac{1}{4}$ -inch diameter, of pipe up to 2 inches.

*Position of Stop-taps.*

18. A high-pressure screw down stop-tap properly secured shall be fixed on each water service in one of the following positions:—

- (a) between the main pipe and the building line within six feet of the building line, and in this case the stop-tap shall be covered by a box which shall comply with the requirements of the municipality in which the service is laid.
- (b) where a meter is fixed, between the meter and the inlet bend thereto.
- (c) where a meter is not fixed, on the service pipe above the ground in an accessible position not more than six feet inside the building line.
- (d) the plumber shall carry out all necessary excavations for the tapping to be made.

**PART VI.—REPAIR.***Repair of Service Pipes.*

19. Any person using any private service shall at all times keep same in proper repair.

*Trust Can Repair Service Pipe in Certain Circumstances.*

20. If any person refuses neglects or delays to have any private service or any part thereof used by him properly repaired after having been required in writing by the Proper Officer of the Trust so to do the Trust by its Proper Officers servants or agents may enter into or upon any premises supplied by such private service or any part thereof and may where necessary repair or renew such private service or any part thereof so as to prevent the waste of water and may charge such person with the cost and expense of such repair or renewal and such cost and expense shall be a debt due by such person to the Trust.

**PART VII.—METERS.***Meters Supplied and Maintained.*

21. (a) Except as permitted in clause 34 of this By-law no person shall use any private service save for the supply of water solely for domestic purposes exclusive of the watering of any garden unless the whole of the water supplied to such private service passes through a meter.

(b) Such meters will be provided and maintained by the Trust and every person before installing a private service shall ascertain from the Trust the size of meter to be installed and shall make provision in the arrangement and construction of the private service for connexion of such meter in accordance with the following requirements:—

- (i) The meter shall be located within the property and not more than six feet from the building line.
- (ii) The meter shall be in an easily accessible position protected from accidental damage.
- (iii) The meter shall be properly and securely affixed to such private service or service pipe by means of connexions or quarter bends of brass, copper or copper alloy.
- (iv) The meter shall be fixed truly level on a solid foundation of brick stone or concrete the top of which foundation is level with or above the surface of the ground.
- (v) All washers used for connexion couplings for meters shall be made of leather.

(c) Pending connexion of the said meter the person authorized to install the service pipe shall connect a distance piece in the service pipe in place of the meter.

*Restriction of Access to Meter.*

22. No person shall construct place stack or store or permit or suffer to be constructed placed stacked or stored any building erection material or thing over or upon any meter connected or affixed to any private service or shall do or permit or suffer to be done any act matter or thing whereby inspection of such meter shall be prevented obstructed or in any way rendered difficult or interfered with.

*Replacement and Testing of Meter.*

23. (a) The Trust may at any time replace or remove for testing any meter attached to any private service.

*Fees Returned in Certain Circumstances.*

(b) Any consumer may at any time request the Trust in writing to test any meter attached to his private service and through which water supplied to him passes and shall at the time of the delivery of such request pay to the Trust the sum of One pound (£1). The Trust shall thereupon remove and test the meter or cause the same to be tested in such manner as it thinks fit. If such meter is found to be registering correctly the Trust may retain such sum of One pound (£1) in satisfaction of the fee for

testing meter hereinbefore prescribed but if such meter is found to be registering incorrectly such sum of One pound (£1) shall be returned to such consumer.

*Consumer Leaving Tenement to Notify Trust.*

24. Every person who shall cease to occupy the premises on which such meter is fixed shall give to the Trust in writing at least six days notice of his intention to do so.

**PART VIII.—MISUSE AND WASTE.***Supply Restricted to One Tenement Only.*

25. No person shall use or permit or suffer the use of any private service for the supply of water to more than one tenement.

*Cisterns, Tanks and Troughs.*

26. No person shall use or permit or suffer the use of any private service or any part thereof for the supply of water to any cistern tank or water trough unless such cistern tank or water trough is watertight and is provided with an equilibrium ball-valve or other mechanism efficiently regulating the flow of water thereinto in such manner that such water shall not overflow such cistern or tank. No person shall affix any overflow pipe to any cistern or tank in such manner or position that is not open to inspection. In this clause water trough means a water trough used for the supply of water to animals.

*Water Closets and Urinals.*

27. No person shall construct lay or use any service pipe which communicates directly or indirectly with or supplies water to any urinal or water closet or any part thereof save through a cistern or tank.

*Baths.*

28. No person shall use or permit or suffer the use of any private service for the purpose of supplying water to any bath capable of containing more than 100 gallons of water.

*No Overflow Pipe on Baths.*

29. No person shall affix an overflow pipe to any bath.

*Wasting of Water.*

30. No person supplied with water by the Trust shall waste the same or permit or suffer the same to run to waste.

*Sale of Water.*

31. No person shall take or carry away or permit or suffer any other person to take or carry away any such water from any premises supplied with water by the Trust and no person shall sell any water supplied by the Trust.

*Fire Brigades.*

32. No person other than a servant or agent of the council of the municipality of the Borough of Swan Hill or the Swan Hill Fire Brigade in the execution of his duty as such servant or agent shall without the written permission of the Trust open close or otherwise interfere with any hydrant attached to any main pipe.

*Taps in Parks and Reserves.*

33. No person other than a servant or agent of the municipality Corporation or body having the care and management of a public park public garden or reserve for public purposes shall without the previous consent of the Trust open close or otherwise interfere with any tap valve or other like regulator (except a drinking fountain or other tap provided for public use) in on or connected with any service pipe used for the supply of water to such park garden or reserve.

**PART IX.—PRIVATE FIRE SERVICES.***Private Fire Services.*

34. (a) Private fire services comprising pipes and fittings not exceeding six inches in diameter and without meters may be permitted at the expense of the owner of the premises subject to the payment of a fee of Fifteen shillings (15s.) per annum. Every such fire service shall be sealed. Except in case of fire no person shall without the authority of the Trust wilfully break the seal affixed to any private fire service and in the event of any such seal having been broken accidentally or otherwise the occupier of the tenement shall within twenty-four hours thereafter give notice in writing of the fact at the office of the Trust, and except in the case of a fire he shall pay a resealing fee of Fifteen shillings (15s.). No water shall be taken from any sealed portion of a private service except for the extinction of fire.

(b) Except as expressly provided in sub-clause (a) of this clause all portions of private services installed for fire service purposes shall comply with all provisions of this By-law.

(c) Every private fire service pipe shall be laid and fixed in a conspicuous position and shall be painted with a distinguishing coating of bright red paint which shall be maintained at all times.

(d) Any application for a fire service shall be made by the owner of the premises and in writing to the Trust.

(e) In the event of the owner or occupier committing any offence under the Act or any breach of this By-law or permitting or suffering any such offence or breach to be committed the Trust may by notice in writing to the owner withdraw permission for the private fire service and such service shall thereupon be disconnected.

**PART X.—INSPECTIONS.**

*Inspections.*

35. Any person authorized by the Trust in that behalf either generally or for any class of cases or in any particular case may at all reasonable times:—

(a) enter into or upon any premises for the purpose of inspecting and may inspect any private service or any part thereof or any works in course of execution therein or thereon, and/or

(b) enter into or upon any premises for the purpose of superintending the execution of any works in course of execution therein or thereon and may give to the owner or occupier of such premises or any person engaged in executing such works any directions or instructions necessary for the purpose of ensuring that all

relevant provisions of this By-law shall be duly complied with and observed during and in connexion with the execution of such works.  
(c) For any such purpose as aforesaid may dig or excavate in or upon any such premises.

*Hindering of Inspections.*

36. No person shall obstruct hinder impede resist oppose or refuse admission to any premises by the Proper Officer or any person duly authorized in that behalf by the Trust, or shall fail or neglect to carry out and observe all lawful directions and instructions given by him.

**PART XI.—PENALTIES.**

*Penalties.*

37. Any person who commits any breach of any of the provisions of this By-law shall be liable to a penalty of not more than Five Pounds (£5) and in the case of a continuing offence to a further penalty not exceeding Five Pounds (£5) for every day after notice of the offence from the Trust.

38. By-law No. 1 of the Trust made the 29th day of December, 1938, is hereby expressly revoked.

Passed this 13th day of June, 1957.

G. F. LAY, Chairman.  
(SEAL) H. W. HARRISON, Commissioner.  
K. C. GARING, Secretary.

Approved by the Governor in Council,  
15th October, 1957.

A. MAHLSTEDT,  
Clerk of the Executive Council.

**STATE RIVERS AND WATER SUPPLY COMMISSION.**

LICENCES as detailed hereunder to divert water and cut races pursuant to the provisions of the Water Acts have been transferred by the Governor in Council, as on and from the 15th October, 1957.

Licence No.	Source of Supply.	Name of Transferor.	Name and Address of Transferee.
576	River Murray .. .. .	C. F. and L. Kelly .. .. .	Frank Grivec and Grabis Grivec, of Merbein
189	Taylor's Creek .. .. .	F. W. Dehne .. .. .	Norma Annie North, of Gunbower
662	Torgannah Lagoon .. .. .	R. H. and G. E. Hancock .. .. .	Harold Edward Watson, Nellie Marie Watson and Colin Edward Watson, of Yarroweay North

Office of the State Rivers and Water Supply Commission,  
Melbourne, 15th October, 1957.

E. BROWN, Secretary,  
State Rivers and Water Supply Commission.

*Pounds Act 1928.*

**SHIRE OF BACCHUS MARSH.**

TABLE of rates to be charged for the trespass of cattle and their sustenance while impounded in the Bacchus Marsh Pound, fixed by the Council of the Shire of Bacchus Marsh.

Description of Cattle Trespassing.	Trespass Rates.		Sustenance Fees.
	Upon Land other than Tillage Land Enclosed by a Substantial Fence.	Upon Tillage Land Enclosed by a Substantial Fence.	Amount to be Charged Daily for Sustenance while Impounded.
	£ s. d.	£ s. d.	£ s. d.
For every sheep ..	0 0 3	0 2 0	0 1 0
For every goat ..	0 10 0	2 0 0	0 10 0
For every pig ..	0 10 0	2 0 0	0 10 0
For every head of other cattle ..	0 10 0	2 0 0	0 10 0

By order of the Council,  
A. W. BOND,  
Shire Secretary.

Approved by the Governor in Council,  
15th October, 1957.  
A. MAHLSTEDT,  
Clerk of the Executive Council.

*Pounds Act 1928.*

**BOROUGH OF SWAN HILL.**

TABLE of Rates to be charged for the trespass of cattle and their sustenance while impounded in the Swan Hill Pound, fixed by the Council of the Borough of Swan Hill.

Description of Cattle Trespassing.	Trespass Rates.		Sustenance Fees.
	Upon Land other than Tillage Land Enclosed by a Substantial Fence.	Upon Tillage Land Enclosed by a Substantial Fence.	Amount to be Charged Daily for Sustenance while Impounded.
	£ s. d.	£ s. d.	£ s. d.
For every sheep ..	0 0 3	0 1 0	0 1 0
For every goat ..	0 10 0	1 0 0	0 5 0
For every pig ..	0 10 0	2 0 0	0 10 0
For every head of other cattle ..	0 10 0	1 0 0	0 10 0

By order of the Council,  
K. C. GARING,  
Town Clerk.

Approved by the Governor in Council,  
15th October, 1957.  
A. MAHLSTEDT,  
Clerk of the Executive Council.

**CONTRACTS ACCEPTED.—(Series 1957-58.)**  
**PROVISIONS.**

*Gazette* No. 204, 12th July, 1957, Schedule No. 11, Sub-schedule No. 1.—For D. H. Moar, substitute M. C. Bennett, as from 29th September, 1957.

**GENERAL STORES.**

*Gazette* No. 206, 18th July, 1957, Schedule No. 39, Furniture, &c.—For Item No. 32 substitute £6 17s. 6d. each as from 18th October, 1957.

W. H. RUTHERFORD, Secretary to the Tender Board.  
21.10.57.

**PUBLIC WORKS.**

1306. Merton, State School No. 1532, (7) repairs and painting to school and residence, £850.—L. G. Aldous.  
1307. Moe, State School No. 2142, (3) erection of shelter pavilion, £450.—Morwell Decorating Co.

1308. Mont Park, Larundel Mental Hospital, (5) modifications to existing heating and hot-water services, Convalescent Ward, £1,443.—W. S. Atherton and Co.

1309. Mont Park, Mental Hospital, (3) provision of fibrous plaster walls and ceilings to two (2) T.B. units, £2,678.—Picton, Hopkins, and Son Pty. Ltd.

1310. Mornington, High School, (9) erection of second section of concrete veneer timber-framed building, £30,451 18s. 10d.—Leighton Pty. Ltd.

1311. Mortlake, State School No. 397, (1) erection of additional out-office accommodation, £340.—A. R. Greed.

1312. Myrtleford, Tobacco Research Station, (1) electrical installation to two residences, £359 6s.—K. W. Alexander.

1313. Myrtleford, Tobacco Research Station, (4) new toilet block, £674.—Leita Bros.

1314. Newcomb, State School No. 4776, (11) erection of six class-room primary school in L.T.C., £18,950.—John Peeman Pty. Ltd.

1315. Newcomb, State School No. 4776, (7) supply, delivery, installation, and testing of a warm air heating/ventilation system, £1,790.—Gray and Wood.

1316. Noble Park, Technical School, (5) installation of sawdust extraction system, £685.—Sandilux Pty. Ltd.

1317. Parkville, University High School, (8) replacement of chalkboards, £411.—W. W. Nankervis.

1318. Pearcedale, State School No. 2961, (4) installation of septic closets, £795.—D. B. Tincknell.

1319. Poowong, Consolidated School, (1) installation of septic tank, sewer drains, water supply, &c., £3,450.—D. B. Tincknell.

1320. Port Melbourne, Court House, (4) renovations, extensions, &c., £1,583 10s.—H. S. Bolger, jnr.

1321. Prahran, School for Deaf Children, No. 3774, St. Kilda-road, (4) fitting up of woodwork and metal work-rooms, £730.—F. T. Pulling and Sons Pty. Ltd.

1322. Prospect Estate, State School No. 4324, (4) repairs and painting, £487.—Morwell Decorating Co.

1323. Rosebud, State School No. 2627, (1) erection of additional out-offices, £1,020.—Geo. H. Curtis and Sons.

1324. Royal Park, "Turana," Children's Welfare Department, (4) re-wiring electrical installation, Senior Boys' Remand Section, £585 12s.—M. T. Carroll.

1325. Royal Park, Mental Hospital, (10) electrical installation for L.T.C. library building, £761 13s. 6d.—Hexter and Battison.

1326. St. Arnaud, State School No. 1646, (4) laying of sewer drains, &c., £698 15s.—W. D. Phillips.

1327. St. Kilda, State School No. 1479, (4) new external fire escape stairs and new internal landing, £589.—N. W. Jordan.

1328. Sale, State School No. 545, (4) additional out-offices, £528 18s.—R. Logan.

1329. Shepparton, Technical School, (4) electrical installation old Primary School, £297.—D. G. Porter.

1330. Shepparton, State School No. 4657, Gowrie-street, (4) extensions to heating system, £397.—Frederick W. Nielsen Pty. Ltd.

1331. South Melbourne, Police Depot, St. Kilda-road, (8) additional toilets for policewomen, £455.—Bull and Murphy.

1332. Springvale, State School No. 3507, (5) re-wiring and additions electrical installation, £959 4s.—T. L. Mackey.

1333. Strathmore, High School, (7) electrical installation in stages 1 and 2, £5,900.—H. T. Wheeler and Co. Pty. Ltd.

1334. Strathmore, High School, (10) supply, delivery, installation, and testing of the mechanical services for stages 1 and 2, £11,389.—Mideco Pty. Ltd.

1335. Sunbury, Mental Hospital, (2) electrical reticulation, recreation hall, kiosk, and staff messrooms, £964.—H. H. Green and Co. Pty. Ltd.

1336. Sunbury, State School No. 1002, (3) internal painting of residence and external painting of school, £348.—W. J. Joy.

1337. Taradale, State School No. 614, (4) erection of 20-ft. x 10-ft. shelter pavilion, £320 17s.—C. A. Gale.

1338. Toorak, "Marathon" Spastic Centre, 795 Malvern-road, (6) erection of two (2) L.T.C. classrooms, busport, and sundries, £4,973.—T. W. Morris and Son Pty. Ltd.

1339. Tottenham, State School No. 4707, (5) additional out-offices and stainless steel sink, £890.—J. L. Devenish.

1340. Upper Sandy Creek, State School No. 3145, (6) repairs and painting to school and out-buildings, £316.—D. Maher.

1341. Wangaratta, Mines Department, (2) repairs and painting to residence, Medowra-avenue, £333 5s.—J. Law and Son.

1342. Warrnambool, State School No. 1743, (3) internal and external repairs and painting to residence, 38 Princess-street, £645.—Moss and Herviou.

1343. Watsonia, Technical School, (13) electrical installation in stage 1, £3,900.—A. T. Lawrence.

1344. Werribee, Research Farm, (9) repairs and painting to house No. 5, £279.—D. Maher.

1345. Alphington, State School No. 3599, (6) new staff-room, cloakroom, and lavatory, £475 10s.—A. E. Allen.

1346. Armadale, "Trelowarren," Orrong-road, (9) erection of new out-buildings and repairs to fire damage, £339.—S. O. Cochran.

1347. Ararat, Mental Hospital, (4) two timber-framed concrete veneer standard ward units and services, £91,956.—T. W. Morris and Son Pty. Ltd.

1348. Bairnsdale, Technical School, (3) installation of two exhaust systems, £517 1s.—Frederick W. Nielsen Pty. Ltd.

1349. Beechworth, Mental Hospital, (8) supply and delivery of two package boiler units to new boiler-house, £12,756.—Crockford and Robertson Pty. Ltd.

1350. Benalla, High School, (1) raising of Hawksley building to permit drainage, £1,450.—F. R. Bail.

1351. Beeac, Police Station, (2) repairs and painting and rebuilding kitchen chimney, £540 10s.—C. Paatsch Pty. Ltd.

1352. Beulah, State School No. 3109 and residence, (2) renewal of non-party boundary fencing, £293 15s.—H. J. Schmidt.

1353. Binginwarri, State School No. 2863, (3) erection of an Ellinbank type teacher's residence, £3,936.—W. G. Campbell.

1354. Bon Beach, High School and State School No. 4798, (10) mechanical services for stages 1 and 2 of high school and primary school, £11,687.—D. H. Armstrong.

1355. Bon Beach, High School and State School No. 4798, (10) erection of an eight (8) classroom primary school and first and second sections of high school in L.T.C., £85,949.—A. V. Jennings Construction Co. Pty. Ltd.

1356. Boweya, State School No. 2488, (1) completion of repairs and painting, £295.—W. L. Gair.

T. K. MALTBY, Commissioner of Public Works.  
14.10.57.

**ORDERS IN COUNCIL.—(Series 1957-58.)**

**EDUCATION DEPARTMENT.**

1357. One only Burroughs calculator, style C1051 (S14051), for Gordon Institute of Technology, £198 18s.—Burroughs Ltd.

Approved by the Governor in Council, 15th October, 1957.—A. MAHLSTEDT, Clerk of the Executive Council.

**STATE ELECTRICITY COMMISSION.**

1358. The supply of 200 sets of 22 kV line type lighting arresters, to Specification No. 57-58/14, £10,800.—ASEA Electric (Aus.) Pty. Ltd.

1359. Repairs and alterations to structural steelwork, Morwell Project, for a period of twelve months, at Schedule rates.—Gas and Fuel Corporation of Victoria.

1360. The supply and delivery of 10,000 cubic yards of bluestone screenings and crushed rock for construction works in Yallourn area, to Specification No. 54-55/151, £17,750.—Manuells Bluestone Quarries.

1361. The supply of 70 miles of aluminium conductor for distribution and transmission lines, to Specification No. 57-58/27, £27,623 5s.—Olympic Cables Pty. Ltd.

1362. The supply of supervisory and indication apparatus for remote control of power stations at Rubicon from Ellidon Control Centre, to Specification No. 55-56/181, £10,288.—Siemens Schuckert (A'asia.) Pty. Ltd.

Approved by the Governor in Council, 8th October, 1957.—N. G. WISHART, Acting Clerk of the Executive Council.

## 4 GEORGE VI. No. 4755, SECTION 6.

I HEREBY give notice that on the 1st August, 1957, the Public Trustee filed an election to administer the following deceased person's estate, in accordance with section 6 of the *Public Trustee Act 1940*:—

\*DODD, WILLIAM, late of 8 Kent-street, Pascoe Vale, war pensioner, died 6th July, 1957.

\*According to the provisions of the will.

I HEREBY give notice that on the 4th October, 1957, the Public Trustee filed elections to administer the following deceased persons' estates, in accordance with section 6 of the *Public Trustee Act 1940*:—

\*BURKE, ELLEN TERESA, formerly of 27 Orwell-street, Potts Point, Sydney, but late of Convalescent Hospital, Kooyong-road, Caulfield, spinster, died 24th May, 1957.

\*CONNOLLY, WILLIAM JOHN, formerly of 203 Westgarth-street, Northcote, but late of 3 Warwick-avenue, Springvale, retired bootmaker, died 6th August, 1957.

\*According to the provisions of the will.

I HEREBY give notice that on the 8th October, 1957, the Public Trustee filed elections to administer the following deceased persons' estates, in accordance with section 6 of the *Public Trustee Act 1940*:—

\*HARRISON, ADALINE, also known as Adeline Harrison, and as Ada Harrison, formerly of 91 Wilson-street, South Yarra, and 11 Bent-street, Northcote, but late of Kew, spinster, died 28th July, 1957.

\*TRUMP, LILY, also known as Lilly Trump, late of 33 Mackenzie-street, Melbourne, hospital attendant, died 24th February, 1957.

\*WALSH, CHARLES, formerly of 1st A.I.F., but late of Melbourne Home and Hospital for the Aged, Cheltenham, pensioner, died 7th March, 1957.

\*According to the provisions of the will.

I HEREBY give notice that on the 10th October, 1957, the Public Trustee filed elections to administer the following deceased persons' estates, in accordance with section 6 of the *Public Trustee Act 1940*:—

\*ALLAN, JAMES ERNEST, formerly of 39 Victoria-street, Box Hill, but late of 9 Bruce-street, Box Hill, minister of religion, died 22nd August, 1957.

BREWSTER, GEORGE MONTCALM, also known as Monte Brewster, formerly of 231 Fitzroy-street, St. Kilda, but late of 56 Barkly-street, St. Kilda, hairdresser, died 12th August, 1957, intestate.

BROWN, EDWARD, late of Francis-street, Echuca, pensioner, died 26th June, 1957, intestate.

GANI, ABDYLL, also known as Abdul Gani, late of 260 Russell-street, Melbourne, no occupation, died 26th May, 1957, intestate.

JAMES, LILLIAN OPHELIA, also known as Lily Ophelia James, late of 14 Wellington-street, Newmarket, pensioner, died 12th July, 1957, intestate.

\*According to the provisions of the will.

I HEREBY give notice that on the 11th October, 1957, the Public Trustee filed elections to administer the following deceased persons' estates, in accordance with section 6 of the *Public Trustee Act 1940*:—

AGG, EMILY ROSE, formerly of 101 Simpson-street, East Melbourne, but late of Cheltenham, pensioner, died 11th August, 1956, intestate.

MARTIN, ALEXANDER, late of 7 Park-street, South Melbourne, gardener, died 3rd May, 1957, intestate.

MCCABE, ELSIE FLORENCE, late of Wangaratta, pensioner, died 12th July, 1957, intestate.

MCLEAN, JOHN ROGERS, late of Kyabram, labourer, died 7th July, 1940, intestate.

URQUHART, RICHARD LAYTON, late of 27 Frederick-street, Yarraville, storeman, died 14th August, 1957, intestate.

I HEREBY give notice that on the 14th October, 1957, the Public Trustee filed elections to administer the following deceased persons' estates, in accordance with section 6 of the *Public Trustee Act 1940*:—

\*LAND, ANNIE JEMIMA, late of 22 Bond-street, Ivanhoe, spinster, died 2nd September, 1957.

\*MOREY, FERNICE LOUISE, also known as Fernice Louisa Morey, late of 59 Highbury-grove, East Prahran, married woman, died 12th September, 1957.

\*According to the provisions of the will.

H. C. CHIPMAN,  
Public Trustee.

412 Collins-street, Melbourne, C.1, 16th October, 1957.

## NOTICE.

ADMINISTRATION of the estate of each of the under-mentioned deceased persons has been granted to the Public Trustee, and creditors, next of kin, and all others having claims against the estate of any of the persons so mentioned are required to send particulars of their claims to the Public Trustee No. 412 Collins-street, Melbourne, on or before the 26th December, 1957, or they will be excluded from the distribution of the estate when the assets are being distributed:—

AGG, EMILY ROSE, formerly of 101 Simpson-street, East Melbourne, but late of Cheltenham, pensioner, died 11th August, 1956, intestate.

\*ALLAN, JAMES ERNEST, formerly of 39 Victoria-street, Box Hill, but late of 9 Bruce-street, Box Hill, minister of religion, died 22nd August, 1957.

†BEAUMONT, MARY HANNAH, late of 35 Evelyn-street, Frankston, married woman, died 3rd April, 1957.

BEGLEY, ELLEN, late of 255 Flemington-road, North Melbourne, spinster, died 9th March, 1926, intestate.

†BENISON, ANNIE EMMA, late of 40 Stephenson-street, Grange, Brisbane, widow, died 18th September, 1956.

BOULTON, JOHN THORLEY, late of 94 Kellett-street, Northcote, carpenter, died 23rd July, 1957, intestate.

BREWSTER, GEORGE MONTCALM, also known as Monte Brewster, formerly of 231 Fitzroy-street, St. Kilda, but late of 56 Barkly-street, St. Kilda, hairdresser, died 12th August, 1957, intestate.

BROOKS, ROBERT EDMOND, late of 90 Madeline-street, East Preston, splint maker, died 1st October, 1956, intestate.

BROWN, EDWARD, late of Francis-street, Echuca, pensioner, died 26th June, 1957, intestate.

\*BURKE, ELLEN TERESA, formerly of 27 Orwell-street, Potts Point, Sydney, but late of Convalescent Hospital, Kooyong-road, Caulfield, spinster, died 24th May, 1957.

\*CONNOLLY, WILLIAM JOHN, formerly of 203 Westgarth-street, Northcote, but late of 3 Warwick-avenue, Springvale, retired bootmaker, died 6th August, 1957.

†COULTER, WILLIAM JOSEPH, late of Glenrowan, labourer, died 20th January, 1954.

\*DODD, WILLIAM, late of 8 Kent-street, Pascoe Vale, war pensioner, died 6th July, 1957.

GANI, ABDYLL, also known as Abdul Gani, late of 260 Russell-street, Melbourne, no occupation, died 26th May, 1957, intestate.

†GUNDRY, DERRICK LAURANCE, also known as Derrick Lawrence Gundry, late of 499 Whitehorse-road, Surrey Hills, doctor, died 3rd May, 1957.

\*HARRISON, ADALINE, also known as Adeline Harrison, and as Ada Harrison, formerly of 91 Wilson-street, South Yarra, and 11 Bent-street, Northcote, but late of Kew, spinster, died 28th July, 1957.

JAMES, LILLIAN OPHELIA, also known as Lily Ophelia James, late of 14 Wellington-street, Newmarket, pensioner, died 12th July, 1957, intestate.

†JOHNSTON, JOHN CHARLTON OWEN FITZGIBBON, also known as John Charlton Johnston, formerly of 24 Canning-road, Kalamunda, Western Australia, but late of 30 Woolwich-street, West Leederville, Western Australia, retired bank manager, died 17th October, 1956.

\*LAND, ANNIE JEMIMA, late of 22 Bond-street, Ivanhoe, spinster, died 2nd September, 1957.

†MAHER, JAMES FREDERICK, late of 339 Punt-road, Richmond, secretary, died 24th July, 1957.

†MARSLAND, SARAH JANE, formerly of 850 High-street, Preston, but late of 874 High-street, Reservoir, married woman, died 4th September, 1956.

MARTIN, ALEXANDER, late of 7 Park-street, South Melbourne, gardener, died 3rd May, 1957, intestate.

\*MOREY, FERNICE LOUISE, also known as Fernice Louisa Morey, late of 59 Highbury-grove, East Prahran, married woman, died 12th September, 1957.

MCCABE, ELSIE FLORENCE, late of Wangaratta, pensioner, died 12th July, 1957, intestate.

†MCELGUNN, JOHN PATRICK, formerly of 13 Bowen-street, Kew, but late of 93 O'Heas-road, Coburg, shipping clerk, died 20th July, 1957.

MCLEAN, JOHN ROGERS, late of Kyabram, labourer, died 7th July, 1940, intestate.

†MACKLEY, CHARLES GEORGE GORDON, late of 17 Nicholson-street, Coburg East, retired butcher, died 4th August, 1957.

O'KEEFE, MABEL VIOLET, late of 11 Ocean-street, Ormond, widow, died 28th June, 1956, intestate.

QUINN, HORACE AUBURN, also known as Horace Arthur Quinn, late of 214 Leicester-street, Carlton, retired pastry-cook, died 28th July, 1957, intestate.

†REID, SARA ELIZABETH, also known as Celia Elizabeth Reid, formerly of 26 Eumeralla-road, South Caulfield, but late of Hopetoun Private Hospital, 2 Hopetoun-street, Elsternwick, spinster, died 11th April, 1957.

\*TRUMP, LILY, also known as Lilly Trump, late of 33 Mackenzie-street, Melbourne, hospital attendant, died 24th February, 1957.

URQUHART, RICHARD LAYTON, late of 27 Frederick-street, Yarraville, storeman, died 14th August, 1957, intestate.

\*WALSH, CHARLES, formerly of 1st A.I.F., but late of Melbourne Home and Hospital for the Aged, Cheltenham, pensioner, died 7th March, 1957.

†WOOTEN, CLAUDE FRANCIS, formerly of 67 Hawden-street, Heidelberg, but late of Repatriation General Hospital, Heidelberg, hospital dresser, died 3rd July, 1956.

\*According to the provisions of the will.  
†With the will annexed.

H. C. CHIPMAN,  
Public Trustee.  
Melbourne, 16th October, 1957.

AUCTION SALES ACT 1928.

ALEXANDRA.—Notice is hereby given that the Annual Meeting of Justices for the Licensing of Auctioneers will be held at the Court House, Alexandra, on Tuesday, the 26th day of November, 1957, at Ten o'clock in the forenoon. Dated at Alexandra, this 14th day of October, 1957. —R. FREEMAN, Clerk of Petty Sessions.

MANSFIELD.—Notice is hereby give that the Annual Meeting of Justices for the Licensing of Auctioneers will be held at the Court House, Mansfield, on Tuesday, the 26th day of November, 1957, at Ten o'clock in the forenoon. Dated at Mansfield, this 14th day of October, 1957.—R. FREEMAN, Clerk of Petty Sessions.

MOE.—Notice is hereby given that the Annual Meeting of the Justices for the Licensing of Auctioneers will be held at the Court House at Moe, on Tuesday, the 26th day of November, 1957, at the hour of Ten thirty o'clock in the forenoon.—J. M. DUFFY, Clerk of Petty Sessions.

Children's Court Act 1956.

CHILDREN'S COURT, BALLARAT.—DAY AND HOUR APPOINTED.

HIS Excellency the Lieutenant-Governor of the State of Victoria, by and with the advice of the Executive Council thereof, doth by Order made on the 8th day of October, 1957, pursuant to the provisions of the *Children's Court Act 1956*, appoint every Wednesday at 2 p.m. as the day and hour for the holding of the Children's Court at Ballarat, in lieu of the day and hour heretofore appointed—to take effect as from and including the 8th January, 1958.

N. G. WISHART,  
Acting Clerk of the Executive Council.  
At the Executive Council Chamber,  
Melbourne, 8th October, 1957.

LAW DEPARTMENT.—ATTORNEY-GENERAL.  
CURATOR OF CONVICT'S PROPERTY.

HIS Excellency the Lieutenant-Governor of the State of Victoria, by and with the advice of the Executive Council thereof, doth by Order made on the 15th day of October, 1957, pursuant to the provisions of section 576 of the *Crimes Act 1928*, commit the custody and management of the property of the convict Ronald J. Ross to David Cleaver Moroney, of 225 Collins-street, Melbourne, as a Curator hereby appointed in that behalf.

A. MAHLSTEDT,  
Clerk of the Executive Council.  
At the Executive Council Chamber,  
Melbourne, 15th October, 1957.

COUNTY COURT.

CHANGE OF DATE OF SITTINGS.

NOTICE is hereby given that the Sittings of the County Court and Court of Insolvency appointed to be holden at Warragul, on Tuesday, the 10th day of December, 1957, have been altered, and the Sittings of the said Courts will be holden at Warragul, on Tuesday, the 17th day of December, 1957.

By order of the Judge,  
C. BRUMBY,  
Registrar.  
Melbourne, 17th October, 1957.

COUNTY COURTS.

NOTICE is hereby given that County Courts will be held during the year 1958 at the under-mentioned places on the days hereunder mentioned:—

ARARAT .. .. .	Tuesday, 1st April. Tuesday, 16th September.
BAIRNSDALE .. .. .	Tuesday, 13th May. Tuesday, 28th October.
BALLARAT .. .. .	Tuesday, 4th February. Tuesday, 15th April. Tuesday, 10th June. Tuesday, 5th August. Tuesday, 7th October.
BENDIGO .. .. .	Tuesday, 4th March. Tuesday, 24th June. Tuesday, 2nd September. Thursday, 6th November.
COLAC .. .. .	Tuesday, 25th March. Tuesday, 15th July. Tuesday, 21st October.
GEELONG .. .. .	Tuesday, 4th March. Tuesday, 3rd June. Tuesday, 9th September. Thursday, 6th November.
HAMILTON .. .. .	Tuesday, 6th May. Tuesday, 12th August. Tuesday, 21st October.
HORSHAM .. .. .	Tuesday, 15th April. Tuesday, 5th August. Tuesday, 2nd December.
KERANG .. .. .	Tuesday, 25th March. Tuesday, 26th August. Tuesday, 25th November.
KORUMBURRA .. .. .	Tuesday, 22nd April. Tuesday, 19th August. Tuesday, 2nd December.
MARYBOROUGH .. .. .	Tuesday, 1st April. Tuesday, 23rd September.
MELBOURNE .. .. .	Monday, 3rd February. Monday, 3rd March. Tuesday, 1st April. Thursday, 1st May. Monday, 2nd June. Tuesday, 1st July. Friday, 1st August. Monday, 1st September. Wednesday, 1st October. Monday, 3rd November. Monday, 1st December.
MILDURA .. .. .	Tuesday, 25th March. Tuesday, 15th July. Tuesday, 18th November.
MORWELL .. .. .	Tuesday, 3rd June. Tuesday, 25th November.
SALE .. .. .	Tuesday, 18th February. Tuesday, 6th May. Tuesday, 22nd July. Tuesday, 11th November.
SHEPPARTON .. .. .	Tuesday, 25th February. Tuesday, 13th May. Tuesday, 19th August. Tuesday, 9th December.
WANGARATTA .. .. .	Tuesday, 4th March. Tuesday, 20th May. Tuesday, 2nd September. Tuesday, 9th December.
WARRAGUL .. .. .	Tuesday, 18th March. Tuesday, 27th May. Tuesday, 26th August. Tuesday, 7th October.
WARRNAMBOOL .. .. .	Tuesday, 18th March. Tuesday, 22nd July. Tuesday, 28th October.

Except at Melbourne, Courts of Insolvency and Courts of Mines will be held on the days above mentioned, at such of the above-named places, as have been appointed for holding such Courts.

By order of the Judges,  
C. BRUMBY, Registrar,  
County Court, Melbourne.

This Notice is in lieu of the Notice published in the *Government Gazette* dated the 11th day of September, 1957, at page 3019.

NOTICE TO MARINERS.  
[No. 16 of 1957.]

AUSTRALIA.—VICTORIA.

WESTERNPORT.—INFORMATION ABOUT LIGHTS.

(1) *Alteration in Light.*

*Date.*—On or about 25th October, 1957.

*Position.*—Settlement Point, Corinella Jetty Light. Lat. 38 deg. 24 min. 30 sec. S., Long. 145 deg. 25 min. 30 sec. E. (approx.).

*Alterations.*—The flashing White light every 15 seconds will be altered to flashing Green every 3 seconds, flash 1 second. Other details will remain unchanged.

(2) *Light Established.*

*Date and Position.*—As in (1) above.

*Position of Light.*—303 deg. distant 2,470 feet from position in (1) above.

*Details.*—A flashing White light every 5 seconds, flash 1 second, will be established on a post surmounting a three-pile structure at an elevation of 20 feet above high water. Visibility 5 miles.

*Chart Affected.*—B.A. 1707.

*Publications.*—*General Notice to Mariners Respecting Navigation in Victorian Waters*, 1942, pages 190 and 320. *Australia Pilot*, Vol. II., 1956, page 110. *List of Lights*, Vol. 10, 1955, No. 2456.

V. G. SWANSON,  
Port Officer.

Ports and Harbors Branch,  
Department of Public Works,  
Melbourne, C.2, 16th October, 1957.

NOTICE TO MARINERS.  
[No. 17 of 1957.]

AUSTRALIA.—VICTORIA.

PORT PHILLIP—SOUTH CHANNEL DREDGED CUT—DREDGER  
LIMIT BUOYS PERMANENTLY REMOVED.

*Former Notice.*—No. 21 of 1955 hereby cancelled.

*Position.*—South Channel Pile Light. Lat. 38 deg. 19 min. 54 sec. S., Long. 144 deg. 51 min. 09 sec. E. (approx.).

*Details.*—200-gallon steel cask buoys with Green and Yellow vertical stripes and Yellow flag surmount bearing—

- (a) 297 deg. 45 min. distant 4.98 cables,
- (b) 308 deg. 45 min. distant 2.43 cables,
- (c) 032 deg. 30 min. distant 0.90 cables,
- (d) 089 deg. 15 min. distant 2.78 cables,

from the above position.

*Remarks.*—The dredger limit buoys have been permanently removed but dredging operations will continue in the Dredged Cut, and the usual precautions should be maintained in this section of the channel and when passing dredgers.

*Charts Affected.*—B.A. Nos. 1171, 2747.

*Publications.*—*General Notice to Mariners Respecting Navigation in Victorian Waters*, 1942, pages 104, 107, and 110. *Australia Pilot*, Vol. 11, 1956, page 73.

V. G. SWANSON,  
Port Officer.

Ports and Harbors Branch,  
Department of Public Works,  
Melbourne, C.2, 17th October, 1957.

*Children's Welfare Act 1954.*

DECLARATION OF INSTITUTION AS AN APPROVED  
CHILDREN'S HOME.

IN accordance with the provisions of clause 49 of Part VI. of the Children's Welfare Regulations 1955, notice is hereby given that on the seventeenth day of October, 1957, I, Arthur Gordon Rylah, Chief Secretary of the State of Victoria, acting in pursuance of the powers conferred by section fourteen of the *Children's Welfare Act 1954*, declared—

"Marillac House," 3 Mavis-avenue, East Brighton, to be an approved Children's Home for the purposes of the said Act.

A. G. RYLAH,  
Chief Secretary.

Chief Secretary's Office,  
Melbourne, 17th October, 1957.

Country Roads Acts.

COUNTRY ROADS BOARD.

NOTICE OF FIXING NEW ALIGNMENTS OF PRINCES HIGHWAY  
IN THE SHIRE OF TAMBO.

NOTICE is hereby given that the Country Roads Board, under the powers conferred upon it by the *Country Roads Act 1948* (No. 5290), has fixed new alignments for the north and south sides of Princes Highway in the Shire of Tambo as described hereunder, that is to say:—

(a) Commencing at the south-western angle of allotment 14, section B, Township of Nowa Nowa, Parish of Ninnie; thence by a line bearing 53 deg. 24½ min. 615.1 links to a point on the eastern boundary of the said allotment distant 8 deg. 30 min. 87.3 links from the south-eastern angle thereof.

(b) Commencing at a point on the eastern boundary of allotment 56, Township of Nowa Nowa, Parish of Ninnie, distant 140 deg. 0 min. 74.7 links from the north-eastern angle of the said allotment; thence by lines bearing respectively 276 deg. 43 min. 29.1 links, 233 deg. 24½ min. 380.7 links and 235 deg. 41 min. 312 links to a point on the northern boundary of allotment 57 of the said township distant 230 deg. 0 min. 310.5 links from the north-eastern angle thereof—

which said new alignments are shown on survey plan No. 6621, lodged in the office of the Country Roads Board.

Copies of the said survey plan are lodged in the offices of the Country Roads Board, the municipality of the Shire of Tambo, the Registrar of Titles, and the Registrar-General, respectively, and may be inspected by any person without a fee at any time at which such offices are open for business.

Dated the 17th day of October, 1957.

R. E. V. DONALDSON,  
Secretary.

Country Roads Board, Exhibition Buildings, Rathdown-  
street, Carlton, N.3.

APPOINTMENTS.

HIS Excellency the Lieutenant-Governor of the State of Victoria, by and with the advice of the Executive Council thereof, has, by Orders made on the 15th day of October, 1957, been pleased to make the under-mentioned appointments, viz.:—

CHIEF SECRETARY'S DEPARTMENT.

*Licensing Inspector.*

EDWARD CHARLES EWEN, Inspector of Police, pursuant to the provisions of the Licensing Acts, to be a Licensing Inspector for the Licensing District of Victoria, *vice* George Alexander Newton, resigned.

*Deputy Supervisor of Licensed Premises.*

THOMAS VINCENT CASEY, pursuant to the provisions of the Licensing Acts, to be Deputy Supervisor of Licensed Premises, *vice* William Edward McAllister, resigned.

*Electoral Registrar (Acting).*

KEVIN JAMES OGLE to be Electoral Registrar (Acting) for the Mitcham, Ringwood, and Wantirna Subdivisions of the Electoral District of Ringwood; and for the Croydon and Ferntree Gully Subdivisions of the Electoral District of Scoresby, to take effect on and from 3rd October, 1957, during the absence on leave of Oliver Hugh Robinson.

*Member of the Street Traders Licences Board.*

JAMES PATRICK DEVINE, an officer of the Children's Welfare Department, pursuant to the provisions of section 5 of the *Street Trading Act 1928*, to be a Member of the Street Traders Licences Board, for a period of two years from the 19th October, 1957.

*Governor of Training Prison.*

WILLIAM HERBERT BENNETT, pursuant to the provisions of the *Gaols Act 1928*, to be Governor (Acting) of the Beechworth Training Prison, from the 14th October, 1957, to the 20th October, 1957, both dates inclusive, during the absence on leave of William Callaghan.

*Officer in Charge of Fairlea Female Prison.*

KATHLEEN FERRIN, pursuant to the provisions of the *Gaols Act 1928*, to be Officer in Charge of Fairlea Female Prison.

*Officer in Charge (Acting) of Fairlea Female Prison.*

ELSIE MABEL IRVINE,  
pursuant to the provisions of the *Gaols Act 1928*, to be Officer in Charge (Acting) of Fairlea Female Prison, from the 12th October, 1957, to the 9th November, 1957, both dates inclusive, during the absence on leave of Kathleen Ferrin.

*Officer in Charge (Acting) of Gaol.*

SYDNEY JOHN JENNINGS,  
pursuant to the provisions of the *Gaols Act 1928*, to be Officer in Charge (Acting) of the Ballarat Gaol, from the 14th October, 1957, to the 27th October, 1957, both dates inclusive, during the absence on leave of Lionel Charles Wenn.

*Acting Registrars of Births and Deaths.*

GEORGE ANDERSON  
to be Acting Registrar of Births and Deaths at Ballarat, to date from 4th July, 1957, during absence on leave of Kathleen Lyons Walker;

MAXWELL MULLER  
to be Acting Registrar of Births and Deaths at Cohuna, to date from 26th July, 1957, pending a permanent appointment;

GILBERT LESLIE CAMERON  
to be Acting Registrar of Births and Deaths at Cohuna, to date from 16th August, 1957, pending a permanent appointment;

MILTON GREIG DAWBORN  
to be Acting Registrar of Births and Deaths at Healesville, to date from 17th September, 1957, during absence on leave of Lionel Thomas Saunders;

REGINALD JOHN MCALLISTER  
to be Acting Registrar of Births and Deaths at Korum-burra, to date from 14th August, 1957, during absence on leave of Donald William Hammond;

JOHN LAURENCE THOMPSON  
to be Acting Registrar of Births and Deaths at Kyneton, to date from 18th September, 1957, during absence on leave of Robert Neil Hollis;

JOHN MILTON DUGAN  
to be Acting Registrar of Births and Deaths at Mildura, to date from 16th September, 1957, during absence on leave of Joseph Kearney;

MICHAEL STANISLAUS BRADY  
to be Acting Registrar of Births and Deaths at Murchison, to date from 3rd July, 1957, pending a permanent appointment;

ERNEST FREDERICK LUBECK  
to be Acting Registrar of Births and Deaths at Seymour, to date from 29th July, 1957, during absence on leave of Margaret Lubeck;

ROBERT HENRY PAINE  
to be Acting Registrar of Births and Deaths at Warburton, to date from 6th September, 1957, pending a permanent appointment;

BARBARA WHITE  
to be Acting Registrar of Births and Deaths at Wedderburn, to date from 9th August, 1957, during absence on leave of Robert William Barclay; and

REGINALD JOHN MCALLISTER  
to be Acting Registrar of Births and Deaths at Wonthaggi, to date from 16th September, 1957, during the absence on leave of Kevin Gilbert Mason.

## DEPARTMENT OF CROWN LANDS AND SURVEY.

*Trustee of Site.*

JOSEPH DONAL CONNELLAN  
to be a Trustee of the land permanently reserved on the 19th August, 1862, as a site for a Mechanics' Institute and Experimental Gardens at Kyneton, in the place of John Harrison, deceased.

## LAW DEPARTMENT.

*Magistrates.*

RONALD JONES, Flat 1, 16 Studley-avenue, Kew.  
GEORGE PADGHAM, 35 Bundoran-parade, Box Hill North,  
FRANK ST. MORITZ PULS, 17 Bardolph-street, Burwood.  
LILLIAN ELSIE HALLETT, 77 Lorne-street, Fawkner,  
COLIN HENRI STIRLING, 21 Yuille-street, Brighton,  
JOHN DUNCAN CAMERON, 26 Winsome-street, Mentone.  
ALLAN MCLEAN, 477 Main-street, Mordialloc, and  
ALEXANDER EWAN MCDUGALL, Hamilton-street, Broad-ford,  
to Keep the Peace in the Central Bailiwick of the State of Victoria;

HENRY WILLIAM SNELL, 36 Ellis-street, Bendigo,  
to Keep the Peace in the Midland Bailiwick of the State of Victoria; and

CHRISTOPHER SIDNEY HOWE, Post Office, Swifts Creek,  
to Keep the Peace in the Eastern Bailiwick of the State of Victoria.

*Commissioners for Taking Declarations, &c.*

MICHAEL GEORGE SHEEHY, 26 Higinbotham-street, Coburg,

SYDNEY CLIVE ALEXANDER, 88 Parkmore-road, East Bentleigh,

JAMES RONALD MARKS, 15 Millard-street, Wangaratta,  
GEORGE FRANCIS IND, 91 Sussex-street, Coburg West,  
and

HARRISON CHARLES CHADWICK, 17 Balmoral-avenue, Pascoe Vale South, to be Commissioners for taking Declarations and Affidavits, pursuant to the provisions of the *Evidence Act 1928*, to resign upon removing from the neighbourhood of the addresses stated; and

THOMAS PATRICK LYNCH, officer of the Australian Mutual Provident Society, Ballarat, and  
ANTHONY JOHN COWD, officer of the Australian Mutual Provident Society, 425 Collins-street, Melbourne, to be Commissioners for taking Declarations and Affidavits, pursuant to the provisions of the *Evidence Act 1928*, to resign upon ceasing to occupy their present positions.

*Probation Officers of Children's Court.*

ERIC JOSEPH LOORIAM, Beechworth,  
to be Probation Officer for the Children's Court at Beechworth, pursuant to the provisions of the *Children's Court Act 1956*; and

JOAN JEWELL JENNINGS, 13 Greenwood-grove Traralgon,  
to be Probation Officer for the Children's Court at Traralgon, pursuant to the provisions of the *Children's Court Act 1956*.

## DEPARTMENT OF PUBLIC WORKS.

*Inspector of Municipal Accounts.*

DONALD MAXWELL PURDIE, a person holding a Certificate of Competency from the Municipal Auditors Board, to be an Inspector of Municipal Accounts, as from the 14th day of October, 1957, pursuant to section 489 of the Local Government Act.

## DEPARTMENT OF THE TREASURER.

*Receiver of Revenue (Acting).*

WILLIAM GEORGE BAGLIN  
to act temporarily as Receiver of Revenue, Taxation Office, 436 Lonsdale-street, Melbourne, *vice* P. W. Bennett.

A. MAHLSTEDT,  
Clerk of the Executive Council.

At the Executive Council Chamber,  
Melbourne, 15th October, 1957.

## RESIGNATIONS.

HIS Excellency the Lieutenant-Governor of the State of Victoria, by and with the advice of the Executive Council thereof, has, by Orders made on the 15th day of October, 1957, accepted the resignations of the persons named hereunder of the offices mentioned, *viz.*:—

## CHIEF SECRETARY'S DEPARTMENT.

THOMAS VINCENT CASEY, as Assistant Supervisor of Licensed Premises.

## LAW DEPARTMENT.

DAVID FITZGERALD, from the Commission of the Peace for the Central Bailiwick of the State of Victoria.

JABEZ HOPKINS MERRYMAN, as a Commissioner for taking Declarations and Affidavits, pursuant to the provisions of the *Evidence Act 1928*.

HARRY ROGERS, as a Commissioner for taking Declarations and Affidavits, pursuant to the provisions of the *Evidence Act 1928*.

CYRIL THOMAS FUREY, as a Commissioner for taking Declarations and Affidavits, pursuant to the provisions of the *Evidence Act 1928*.

A. MAHLSTEDT,  
Clerk of the Executive Council.

At the Executive Council Chamber,  
Melbourne, 15th October, 1957.



DEPARTMENT OF PUBLIC WORKS.

At the Executive Council Chamber, Melbourne, the  
fifteenth day of October, 1957.

PRESENT:

His Excellency the Lieutenant-Governor of Victoria.  
Mr. Reid | Mr. McArthur.

BREADTH OF CARRIAGEWAY AND FOOTWAY OF  
ROY-STREET ALTERED AS TO PART.—CITY OF  
SOUTH MELBOURNE.

IN pursuance of the provisions of section 519 of the *Local Government Act 1946*, His Excellency the Lieutenant-Governor of the State of Victoria, by and with the advice of the Executive Council thereof, and in compliance with a request of the Council of the City of South Melbourne, hereby alters the breadth of that part of the footway and the adjoining carriageway on the northern side of Roy-street, in the manner indicated on the plan hereunder:—

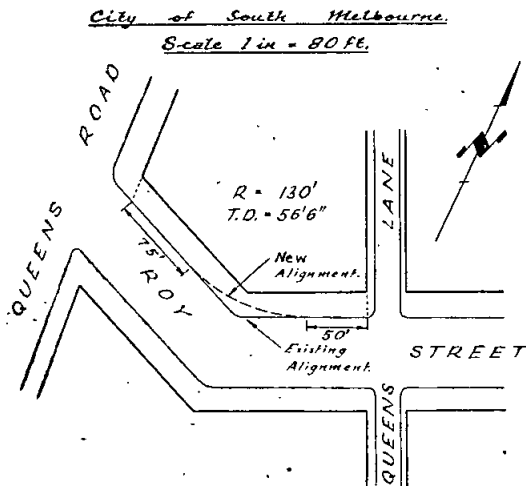

And the Honorable Sir Thomas Karran Maltby, Her Majesty's Commissioner of Public Works for the State of Victoria, shall give the necessary directions herein accordingly.

A. MAHLSTEDT,  
Clerk of the Executive Council.

DEPARTMENT OF CROWN LANDS AND SURVEY.

At the Executive Council Chamber, Melbourne, the  
fifteenth day of October, 1957.

PRESENT:

His Excellency the Lieutenant-Governor of Victoria.  
Mr. Reid | Mr. McArthur.

LANDS TEMPORARILY RESERVED AS SITES.

HIS Excellency the Lieutenant-Governor of the State of Victoria, by and with the advice of the Executive Council thereof, doth hereby, in pursuance of the provisions of the *Land Act 1928*, reserve, temporarily, and also except from occupation for mining purposes under any miner's right, the lands hereinafter described:—

BRUTHEN.—Site for the purposes of the Forests Acts, 2 roods 32 perches, more or less, Township of Bruthen, Parish of Tambo, County of Dargo, as indicated by hachure on plan hereunder.—(B.790<sup>(3)</sup>) (Rs.7666).

No. 249.—9907/57.—2

Subject to Survey

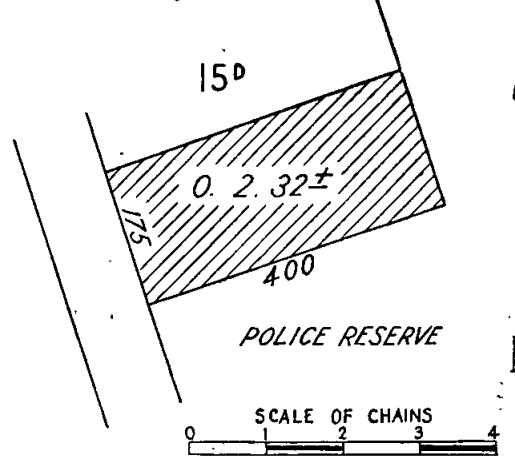

BULLARTO.—Site for a Public Hall, 2 roods 4 perches, Parish of Bullarto, County of Talbot, as indicated by hachure on plan hereunder.—(B.645<sup>(3)</sup>) (Rs.7661).

TOWNSHIP OF BULLARTO  
BULLARTO STATION  
GROUND

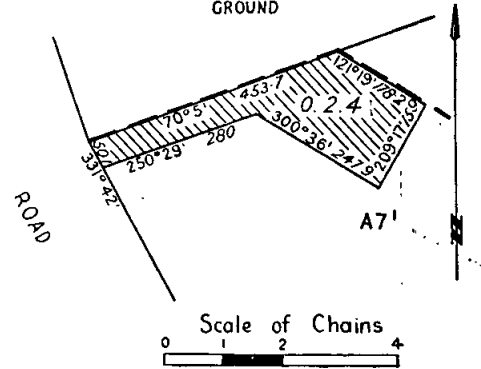

CLUB TERRACE.—Site for the purposes of the Forests Acts, 1 rood 15 perches, Township of Club Terrace, County of Croajingolong, as indicated by hachure on plan hereunder.—(C.457<sup>(3)</sup>) (Rs.7624).

Scale of Chains

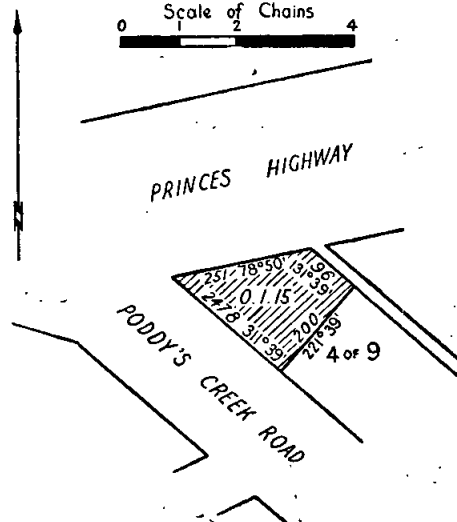

CUT-PAW-PAW (MARIBYRNONG).—Site for Police purposes, 23 perches, Parish of Cut-paw-paw, County of Bourke, as indicated by hachure on plan hereunder.—(C.345(10) (Rs.7667).

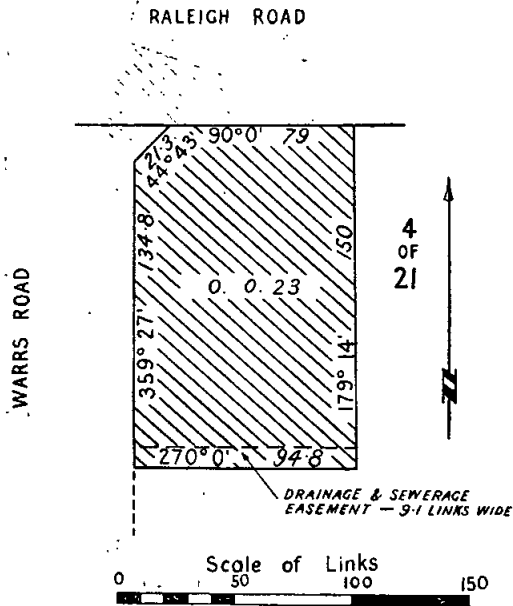

PORTLAND.—Site for a Rubbish Depot, 2 acres 2 roods, more or less, Parish of Portland, County of Normanby, as indicated by hachure on plan hereunder.—(P.69(8) (Rs.7669).

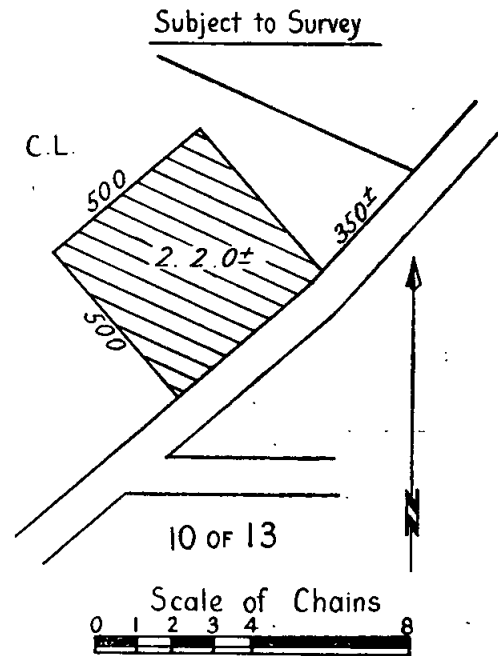

DIMBOOLA.—Site for State School purposes, 2 acres 32 perches, more or less, Parish of Dimboola, County of Borung, as indicated by hachure on plan hereunder.—(D.150(5) (Rs.7672).

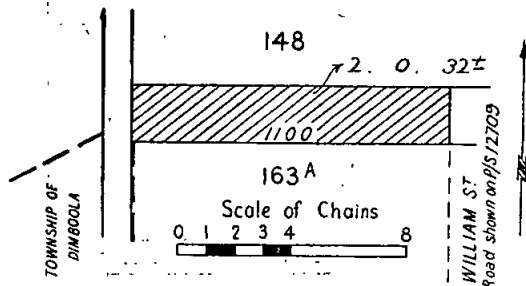

STAWELL.—Site for State School purposes, 1 acre 0 roods 8 perches, Township of Stawell, Parish of Stawell, County of Borung, as indicated by hachure on plan hereunder.—(S.329(11) (Rs.7595).

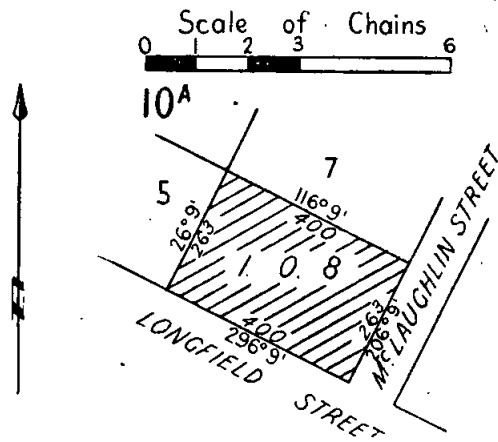

FRANKSTON.—Site for the Preservation of Native Flora, 25 acres, Parish of Frankston, County of Mornington, as indicated by hachure on plan hereunder.—(F.87(4) (Rs.1526).

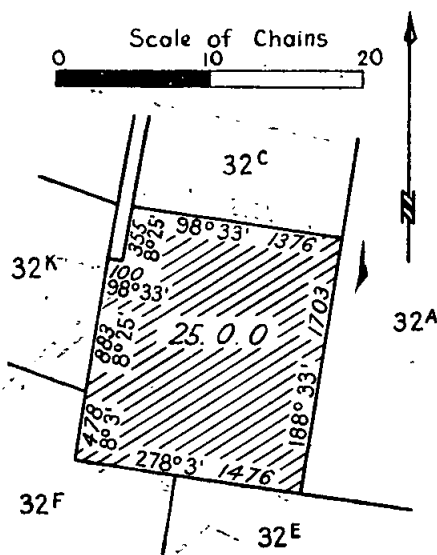

TOONGABBIE NORTH (COWWARR).—Site for a Public Hall, 1 rood 27 perches, Parish of Toongabbie North, County of Tanjil, as indicated by hachure on plan hereunder.—(T.164(2) (Rs.7662).

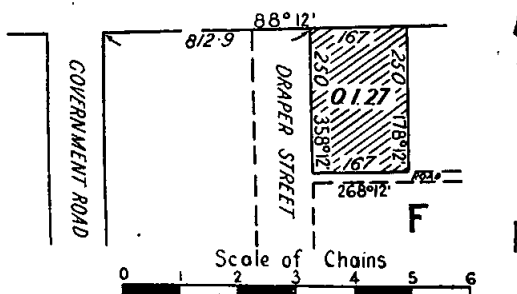

BALLAARAT EAST.—Site for State School purposes, in addition to and adjoining the sites temporarily reserved therefore by Orders in Council of the 28th February, 1871, and the 21st February, 1881, 15 perches, more or less, Township of Ballaarat East, Parish of Ballaarat, County of Grant, as indicated by hachure on plan hereunder.—(B.128(18)) (Rs.7321).

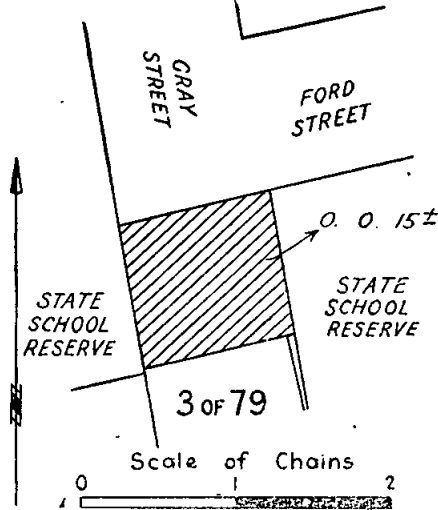

Parish of Yandoit, County of Talbot, being the road between allotments 4B, 6B, 13, 14, section 3A, and allotments 5E, section 2A, 6A, section 3A.—(Y.6(?) (W.71011)).

Parish of Youanmite, County of Moira, being the road between allotments 12, 11A, 13, 13A, section D, and allotments 11, 10, 10A, section D.—(Y.107(?) (H.023894)).

Township of Carisbrook, Parish of Carisbrook, County of Talbot, being the road indicated by hachure on plan hereunder.—(C.132(?) ; (?) (W.67216)).

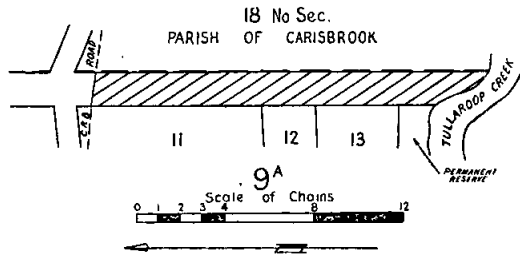

City of Geelong, Parish of Corio, County of Grant, being the roads indicated by hachure on plan hereunder.—(G.25(w1) (C.64092)).

MERINO.—Site for a Public Park, in addition to and adjoining the site temporarily reserved therefor by Order in Council of the 21st May, 1889, 2 roods 30 perches, more or less, Township of Merino, Parish of Merino, County of Normanby, as indicated by hachure on plan hereunder.—(M.248(4)) (Rs.1325).

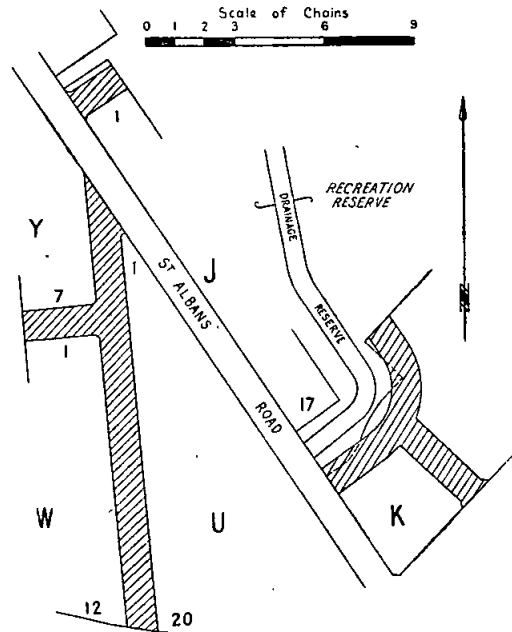
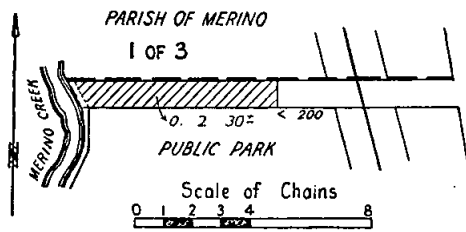

And the Honorable Keith Hector Turnbull, Her Majesty's Commissioner of Crown Lands and Survey for the State of Victoria, shall give the necessary directions herein accordingly.

A. MAHLSTEDT,  
Clerk of the Executive Council.

DEPARTMENT OF CROWN LANDS AND SURVEY.

At the Executive Council Chamber, Melbourne, the  
fifteenth day of October, 1957.

PRESENT:

His Excellency the Lieutenant-Governor of Victoria.  
Mr. Reid | Mr. McArthur.

UNUSED ROADS CLOSED.

HIS Excellency the Lieutenant-Governor of the State of Victoria, by and with the advice of the Executive Council thereof, doth hereby direct that, in pursuance of the provisions of section 304 of the Land Act 1928, the unused roads referred to hereunder be closed, viz.:

Township of Bear's Lagoon, Parish of Janiember East, County of Gunbower, being the road between allotments 6, 7, section 5, and allotments 1, 2, 3, 4, 5, section 5.—(M.494(1)) (W.67564).

Township of Werribee, Parish of Deutgam, County of Bourke, being the roads indicated by hachure on plan hereunder.—(W.230(4)) (C.93084).

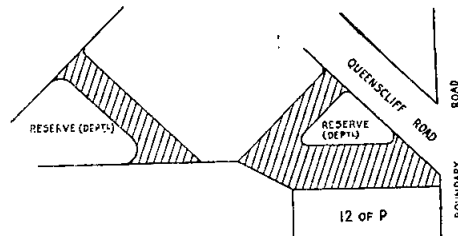

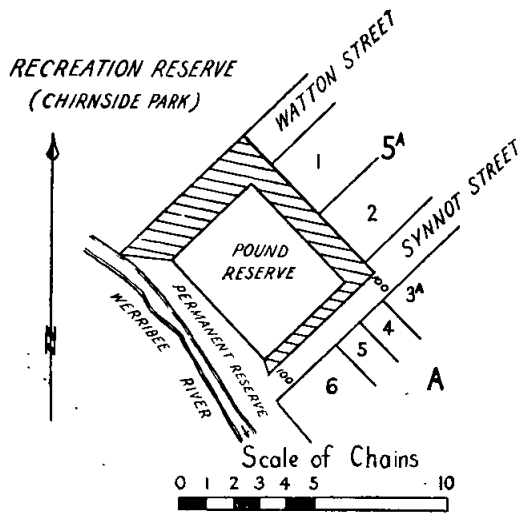

And the Honorable Keith Hector Turnbull, Her Majesty's Commissioner of Crown Lands and Survey for the State of Victoria, shall give the necessary directions herein accordingly.

A. MAHLSTEDT,  
Clerk of the Executive Council.

DEPARTMENT OF CROWN LANDS AND SURVEY.

At the Executive Council Chamber, Melbourne, the fifteenth day of October, 1957.

PRESENT:

His Excellency the Lieutenant-Governor of Victoria.  
Mr. Reid | Mr. McArthur.

REVOCATIONS OF TEMPORARY RESERVATIONS OF LANDS.

HIS Excellency the Lieutenant-Governor of the State of Victoria, by and with the advice of the Executive Council thereof, doth hereby, in pursuance of the provisions of the *Land Act* 1928, revoke the temporary reservations of lands by Orders in Council hereinafter referred to, viz.:—

OME0.—Orders in Council of 12th December, 1874, and 14th March, 1882, of 1 rood 23 perches of land in the Township of Omeo as a site for Shire Hall and Public Library.—(Rs.4245.)

OME0.—Orders in Council of 17th August, 1891, and 20th March, 1907, of 32 perches of land in the Township of Omeo as sites for Shire Hall and Public Library.—(Rs.4245.)

And the Honorable Keith Hector Turnbull, Her Majesty's Commissioner of Crown Lands and Survey for the State of Victoria, shall give the necessary directions herein accordingly.

A. MAHLSTEDT,  
Clerk of the Executive Council.

POISONS ACTS.

At the Executive Council Chamber, Melbourne, the fifteenth day of October, 1957.

PRESENT:

His Excellency the Lieutenant-Governor of Victoria.  
Mr. Reid | Mr. McArthur.

AMENDMENT OF THE DANGEROUS DRUGS REGULATIONS.

UNDER the powers in that behalf conferred by the *Poisons Act* 1928 as amended by any Act, His Excellency the Lieutenant-Governor of the State of Victoria, by and with the advice of the Executive Council of the said State, and on the recommendation of the Pharmacy Board of Victoria, doth make the Regulations following, that is to say:—

1. These Regulations may be cited as the Dangerous Drugs Regulations 1957 (No. 2) and shall be read and construed as one with the Dangerous Drugs Regulations 1930 and all Regulations amending the same.

2. At the end of paragraph (vii) of Regulation 34 of the Dangerous Drugs Regulations 1930, as amended by any Regulations, there shall be added the following item:—

“10. Rauwolfia and its active principles and all preparations admixtures and solutions of Rauwolfia or its active principles.”.

And the Honorable Ewen Paul Cameron, Her Majesty's Minister of Health for the State of Victoria, shall give the necessary directions herein accordingly.

A. MAHLSTEDT,  
Clerk of the Executive Council.

## COUNTRY ROADS BOARD.

At the Executive Council Chamber, Melbourne, the  
fifteenth day of October, 1957.

## PRESENT:

His Excellency the Lieutenant-Governor of Victoria.  
Mr. Reid | Mr. McArthur.

DECLARATION OF A DEVIATION FROM THE  
MURRAY VALLEY HIGHWAY IN THE SHIRE OF  
TOWONG.

WHEREAS by sections 74 and 58 of the *Country Roads Act 1928* (No. 3662) it is amongst other things enacted that when the Country Roads Board under the provisions of the Country Roads Act has by Resolution declared a deviation to be a State highway the said Board may also declare that such deviation shall be in lieu of any existing highway or part thereof named in such Resolution and that on publication in the *Government Gazette* of the Order confirming such Resolution the existing highway or part thereof shall cease to be a State highway or be discontinued as provided in the Resolution: And whereas the said Board has by Resolution declared the deviation on the land described in the First Schedule to such Resolution to be a State highway and has also declared that such deviation shall be in lieu of the part of the existing highway being the land described in the Second Schedule to the said Resolution and that such part of the said existing road as is described in the Third Schedule shall be discontinued: Now therefore His Excellency the Lieutenant-Governor of the State of Victoria by and with the advice of the Executive Council thereof doth hereby confirm the said Resolution.

Resolution for Declaration of a Deviation under the  
Country Roads Act.

Whereas the land the site of the highway the course of which is below set out was taken by the Board under the provisions of the *Country Roads Act 1928* for the purpose of constructing such highway deviation which highway deviation has now been laid out and formed on the same: And whereas the said Board (being the Country Roads Board incorporated under the said Act) thinks that the highway aforesaid is fit to be used as a public highway such Board at a meeting now holden acting under the authority conferred upon it by sections 74 and 58 of the said Act doth by this present Resolution hereby declare the said highway deviation the course of which is described in the First Schedule hereto with the commencing and terminating points thereof respectively specified to be part of a State highway within the meaning and for the purposes of the *Country Roads Act 1928*: And the said Board doth also declare that such deviation shall be in lieu of the existing highway or part thereof described in the Second Schedule hereto and that such part of the said existing road shall be discontinued.

FIRST SCHEDULE.  
Shire of Towong.

7. *Murray Valley Highway*.—All those pieces of land in the Parish of Beethang, the boundaries of which are as follow:—

- (a) Commencing at the north-eastern angle of allotment 5A, section 7, of the said parish; thence by lines bearing respectively 43 deg. 20 min. 73.5 links, 80 deg. 19 min. 936 links, 247 deg. 40 min. 561.5 links, 264 deg. 55 min. 499.9 links, and 43 deg. 23 min. 64.5 links to the point of commencement.
- (b) Commencing at the north-western angle of allotment 5, section 7, of the said parish; thence by lines bearing respectively 105 deg. 45 min. 40.9 links, 267 deg. 53 min. 238 links, 62 deg. 30 min. 106.6 links, and 105 deg. 45 min. 108 links to the point of commencement—

which said pieces of land are particularly delineated and shown coloured red on survey plans numbered 6411 and 6529, lodged in the office of the Country Roads Board.

SECOND SCHEDULE.  
Shire of Towong.

7. *Murray Valley Highway*.—All that piece of land in the Parish of Beethang, the boundaries of which are as follow:—Commencing at the north-western angle of allotment 5A, section 7, of the said parish; thence by lines bearing respectively 295 deg. 6 min. 224 links, 83 deg. 43 min. 249.9 links, 84 deg. 55 min. 185.8 links, 223 deg. 23 min. 235.5 links, 295 deg. 6 min. 76 links to the point of commencement—which said piece of land is

particularly delineated and shown coloured blue on survey plan numbered 6411, lodged in the office of the Country Roads Board.

The common seal of the Country Roads Board was hereto affixed at Carlton, this seventh day of October, One thousand nine hundred and fifty-seven, in the presence of—

(SEAL) D. V. DARWIN, Chairman.  
W. H. NEVILLE, Member.  
R. E. V. DONALDSON, Secretary.

And the Honorable Sir Thomas Karran Maltby, Her Majesty's Commissioner of Public Works for the State of Victoria shall give the necessary directions herein accordingly.

A. MAHLSTEDT,  
Clerk of the Executive Council.

## COUNTRY ROADS BOARD.

At the Executive Council Chamber, Melbourne, the  
fifteenth day of October, 1957.

## PRESENT:

His Excellency the Lieutenant-Governor of Victoria.  
Mr. Reid | Mr. McArthur.

DECLARATION OF THE WIDENING OF THE  
PYRENEES HIGHWAY IN THE SHIRE OF ARARAT.

WHEREAS by section 21 of the *Country Roads Act 1928* (No. 3662) as amended by the *Country Roads Act 1956* (No. 5978) it is amongst other things enacted that when the Country Roads Board under the provisions of the Country Roads Act has taken the land necessary for constructing the highway or deviation or widening it shall as soon as it thinks such highway or deviation or widening is fit to be used as a public highway by Resolution declare the highway or deviation or widening to be a State highway or part thereof and that upon publication in the *Government Gazette* of the Order of the Governor in Council confirming such Resolution such highway or deviation or widening shall thereupon be a State highway or a part thereof within the meaning of the said Act: And whereas the said Board has by Resolution declared the highway on the land described in the Schedule to such Resolution to be part of a State highway: Now therefore His Excellency the Lieutenant-Governor of the State of Victoria by and with the advice of the Executive Council thereof doth hereby confirm the said Resolution.

Resolution for Declaration of the Widening of a State  
Highway under the Country Roads Act.

Whereas the land the site of the highway the course of which is below set out was taken by the Board under the provisions of the Country Roads Act for the purpose of widening the State highway aforesaid which widening has now been laid out and formed on the same: And whereas the said Board (being the Country Roads Board incorporated under the said Acts) thinks that the widening aforesaid is fit to be used as part of a public highway such Board at a meeting now holden doth by this Resolution hereby declare the same as described in the Schedule hereto with the commencing and terminating points thereof respectively specified to be part of the State Highway within the meaning and for the purposes of the Country Roads Acts.

SCHEDULE.  
Shire of Ararat.

24. *Pyrenees Highway*.—All that piece of land in the Parish of Crowlands, the boundaries of which are as follow:—

Commencing at a point on the southern boundary of allotment 9A, section A, of the said parish distant 95 deg. 51 min. 2,051.9 links from the south-western angle of the said allotment; thence by lines bearing respectively 80 deg. 18½ min. 675.5 links, 241 deg. 47 min. 323.2 links, and 275 deg. 51 min. 383.1 links to the point of commencement.

Also, all that piece of land in the Parish of Mount Cole, the boundaries of which are as follow:—

Commencing at the northern angle of allotment 16, section 1, of the said parish; thence by lines bearing respectively 105 deg. 10 min. 457 links, 267 deg. 14½ min. 795.1 links, and 65 deg. 55 min. 386.7 links to the point of commencement—

which said pieces of land are particularly delineated and shown coloured red on survey plans numbered 6599 and 6600, lodged in the office of the Country Roads Board.

The common seal of the Country Roads Board was hereto affixed at Carlton, this seventh day of October, One thousand nine hundred and fifty-seven, in the presence of—

(SEAL) D. V. DARWIN, Chairman.  
W. H. NEVILLE, Member.  
R. E. V. DONALDSON, Secretary.

And the Honorable Sir Thomas Karran Maltby, Her Majesty's Commissioner of Public Works for the State of Victoria shall give the necessary directions herein accordingly.

A. MAHLSTEDT,  
Clerk of the Executive Council.

HOUSING ACTS.

At the Executive Council Chamber, Melbourne, the twenty-second day of October, 1957.

PRESENT:

His Excellency the Lieutenant-Governor of Victoria.  
Mr. Chandler | Mr. Bloomfield  
Mr. Turnbull | Mr. McArthur.  
Mr. Fraser

DECLARATION OF A RECLAMATION AREA AT CARLTON.

WHEREAS within an area in the City of Melbourne described in the Schedule hereto there are houses which—

- (a) are unfit for human habitation; and
- (b) are in the opinion of the Housing Commission insanitary or unhealthy by reason of—
  - (i) the excessive number of buildings within the area;
  - (ii) the bad arrangement of buildings within the area; and
  - (iii) the bad arrangement or narrowness of streets within the area:

And whereas the Housing Commission considers that housing conditions within this area cannot satisfactorily be dealt with unless the said area is dealt with under Part III. of the *Slim Reclamation and Housing Act 1938* (No. 4568) as a reclamation area and has recommended that the said area should be constituted a Reclamation Area:

And whereas the Housing Commission having duly complied with the provisions of sub-section (3) of section 19 of the said Act has submitted to the Governor in Council its recommendation that the said area should be constituted a Reclamation Area:

Now therefore I, the Lieutenant-Governor of the State of Victoria, in the Commonwealth of Australia, by and with the advice of the Executive Council of the said State, do hereby declare the said area to be a Reclamation Area.

SCHEDULE.

First.—All those pieces of land situate within the municipality of the City of Melbourne being parts of Crown allotments 11 and 12, section 36, at Carlton, in the Parish of Jika Jika, County of Bourke, and being the lands described in certificates of title entered in the register book of the Office of Titles, volume 3255, folium 804, volume 3307, folium 365, volume 3713, folium 483, volume 3721, folium 085, volume 3817, folium 266, volume 5704, folium 694, and volume 6385, folium 997.

Secondly.—All those pieces of land situate within the municipality of the City of Melbourne being parts of Crown allotments 11 and 12, section 36, at Carlton, in the Parish of Jika Jika, County of Bourke, and being the lands described in deeds of conveyance memorialized in the Office of the Registrar-General, and therein numbered 726 of book 618 and 828 of book 516.

And the Honorable Horace Rostill Petty, Her Majesty's Minister of Housing for the State of Victoria, shall give the necessary directions herein accordingly.

A. MAHLSTEDT,  
Clerk of the Executive Council.

HOUSING ACTS.

At the Executive Council Chamber, Melbourne, the twenty-second day of October, 1957.

PRESENT:

His Excellency the Lieutenant-Governor of Victoria.  
Mr. Chandler | Mr. Bloomfield  
Mr. Turnbull | Mr. McArthur.  
Mr. Fraser

CLOSING OF ROADS AND EXTINGUISHMENT OF EASEMENTS AND RESTRICTIVE COVENANTS.—CITY OF SUNSHINE.

WHEREAS by virtue and in exercise of the powers contained in the Housing Acts the Housing Commission has recommended to the Governor in Council that the roads, easements, and restrictive covenants described in the Schedule hereto be closed and extinguished:

Now therefore His Excellency the Lieutenant-Governor of the State of Victoria, in the Commonwealth of Australia, by and with the advice of the Executive Council thereof, doth in pursuance of the powers conferred by the said Acts and upon such recommendation, consent, and by this Order hereby close and extinguish such roads, easements, and restrictive covenants.

SCHEDULE.

First.—Any easements and any restrictive covenants affecting so much of the land described in certificate of title, volume 8132, folio 093, as lies to the north of the westerly prolongation of the southern boundary of the land described in certificate of title, volume 5679, folio 700.

Secondly.—All roads within, and any easements and any restrictive covenants affecting the land delineated and shown hachured on the plan hereunder.

PART OF CROWN PORTION 17  
PARISH OF CUT PAW PAW

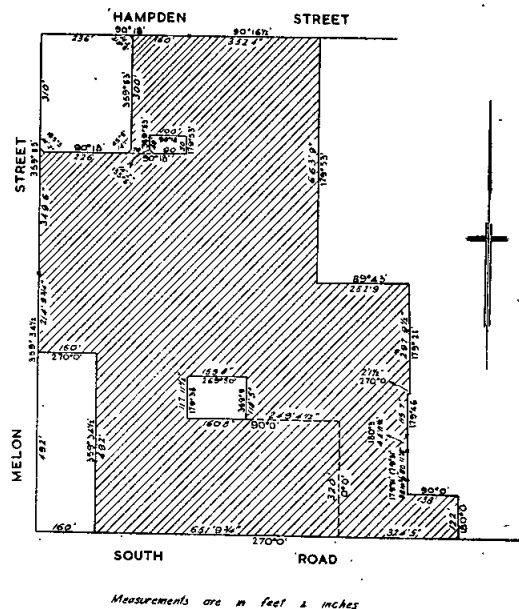

And the Honorable Horace Rostill Petty, Her Majesty's Minister of Housing for the State of Victoria, shall give the necessary directions herein accordingly.

A. MAHLSTEDT,  
Clerk of the Executive Council.

## WEIGHTS AND MEASURES ACTS.

*At the Executive Council Chamber, Melbourne, the  
twenty-second day of October, 1957.*

## PRESENT:

His Excellency the Lieutenant-Governor of Victoria.

Mr. Chandler	Mr. Bloomfield
Mr. Turnbull	Mr. McArthur.
Mr. Fraser	

## REGULATIONS.

IN pursuance of the powers conferred by the Weights and Measures Acts, His Excellency the Lieutenant-Governor of the State of Victoria, in the Commonwealth of Australia, by and with the advice of the Executive Council of the said State, doth make the Regulations following (that is to say):—

The Weights and Measures Regulations 1952, as amended, are hereby further amended as follows:—

1. The definition of "Acts" in Regulation 3 is hereby revoked and the following expression is substituted therefor:—

" 'Acts' means the Weights and Measures Acts for the time being in force."

2. The following proviso shall be added at the end of Regulation 19:—

"Provided that paragraph (d) of this Regulation shall be subject to temporary permits (for stated periods not extending beyond the thirty-first day of December, 1959) which the Superintendent may issue if he thinks fit, in cases where he has received applications (together with the prescribed fees) for the examination and testing of the patterns of instruments but where such examination and testing have not been completed."

3. In paragraph (i) of Regulation 82—

(a) the expression "subject to the provisions of the second proviso to paragraph (c) of Regulation 118," shall be inserted before the expression "have any indicator"; and

(b) the following expression shall be added at the end of such paragraph:—

"Provided also that this sub-paragraph shall not be deemed to prohibit the verification of any weighing instrument in which the index finger is in the same plane as the graduations and is not more than one thirty-second of one inch from any graduation."

4. The proviso to paragraph (a) of Regulation 99 is hereby revoked and the following expression is substituted therefor:—

"Provided that the maximum weight corresponding to the interval between successive graduations on spring balances—

(i) in use before the date of these Regulations; or

(ii) with circular dials of metal or other approved material on which 'For use by itinerant vendors only' or 'Hawker's scale only' is legibly stamped,

may be twice that prescribed in the table set out in this paragraph."

5. In Regulation 118—

(a) the following expression is hereby inserted after paragraph (c):—

"Provided also that neither this paragraph nor paragraph (i) of Regulation 82 shall be deemed to prohibit the verification of any self-indicating platform weighing machine or self-indicating weighbridge—

(i) having a dial on which—

(1) one end of each graduation meets a line defining the circumference of a circle;

(2) alternate graduations are on opposite sides of such line; and

- (3) there are not more than eight graduations to the inch on either side of such line; or
- (ii) which has an index finger moving over two concentric sets of graduations, the width of such index finger being not greater than that of any graduation over which it may pass or one thirty-second of one inch, whichever is the less; and”;

(b) the following expression is hereby inserted after such Regulation:—

“(e) the end of the index finger not wider than—

- (i) one-sixteenth of one inch in the case of a weighbridge or one thirty-second of one inch in the case of a platform weighing machine; or
- (ii) the width of any graduation over which such index finger may move,

whichever is the less.”

6. In paragraph (b) of Regulation 119—

(a) the table is hereby revoked and the following expression is substituted therefor:—

Capacity of Instrument.	Maximum Weight.
Less than 50 lb.	1 oz.
Not less than 50 lb., but less than 100 lb.	2 oz.
Not less than 100 lb., but less than 200 lb.	4 oz.
Not less than 200 lb., but less than 500 lb.	8 oz.
Not less than 500 lb., but less than 1,000 lb.	1 lb.
Not less than 1,000 lb., but less than 2,000 lb.	2 lb.
Not less than 2,000 lb., but less than 5,000 lb.	5 lb.
Not less than 5,000 lb., but less than 10,000 lb.	10 lb.
Not less than 10,000 lb., but less than 20,000 lb.	14 lb.
Not less than 20,000 lb., but less than 40,000 lb.	20 lb.
Not less than 40,000 lb., but less than 80,000 lb.	28 lb.
Not less than 80,000 lb., but less than 150,000 lb.	56 lb.
150,000 lb. and over	1 cwt.

(b) the following expression is hereby added at the end of the proviso to such paragraph:—

“Provided also that the Superintendent, if he thinks fit, may determine that, on any such ticket-printing instrument, the capacity of the instrument shall be deemed for the purposes of this paragraph to be increased by the weight corresponding to the interval between successive quantities which can be recorded on such instrument.”

7. The following expression is hereby added at the end of Regulation 142:—

“Provided that in the case of any liquid-measuring instrument dealt with by the central administration pursuant to subparagraph (xviii) of paragraph (a) of Regulation 187 hereof the Minister if he thinks fit may determine whether such instrument shall be classed as ‘wholesale’ or ‘retail.’”

8. The following expression is hereby inserted after paragraph (b) of Regulation 159:—

“Provided that this paragraph, in so far as it relates to the height of the inlet of a hose, shall not apply to any instrument of approved pattern, not intended for delivering liquid fuel into fuel tanks of motor vehicles.”

9. The following Regulation is hereby inserted after Regulation 184:—

“184A. Every person applying for verification, on his premises, of any measure of capacity or of any liquid-measuring instrument shall —

- (i) provide such water or other liquid as may be required; and



(ii) make such other arrangements as may be necessary—  
for the proper and expeditious verification of such measure or  
instrument.”

10. In Regulation 193—

(a) in paragraph (a) for the expression—

“No person shall use the method of end-and-end  
weighing in determining for use for trade by means  
of any weighbridge the weight of any vehicle”  
there shall be substituted the following expression:—

“No person shall use the method of end-and-end  
weighing in determining, by means of any weigh-  
bridge verified pursuant to the Acts, the weight of  
any vehicle”; and

(b) the following expression is added at the end of the  
Regulation:—

“(e) The Superintendent if he thinks fit and subject  
to such conditions as he may determine may  
approve of the use of a weighbridge for  
weighing moving rail trucks (whether  
loaded or unloaded), but, in any case where  
the weight of any such truck has been  
ascertained by weighing such truck when  
stationary, the weight so ascertained shall  
for the purposes of these Regulations be  
the weight of such vehicle.”

11. In Regulation 200—

(a) in paragraph (b) the expression “(i) candles” is hereby  
revoked;

(b) in paragraph (iv) of the proviso, the words “packed on  
a retailer's premises and” are hereby revoked;

(c) in paragraph (vi) of the proviso for sub-paragraphs (2),  
(3) and (4) the expression “(2) confectionery;” is  
substituted; and

(d) the following expression is inserted at the end of para-  
graph (vi) of the proviso:—

“(12) spices and condiments in packages of less  
than four ounces net weight.”

12. The following expression is hereby inserted after Regulation  
201:—

“201A. Fish, meat and poultry when sold by gross weight in  
packages weighing not more than two parts per centum of the  
net weight of such goods shall be exempted from the require-  
ments of sub-sections (1), (2) and (3) of section 75 of the  
*Weights and Measures Act 1939* if—

(i) such packages are plainly stamped or endorsed in  
legible hand-writing with a statement of the gross  
weight;

(ii) an invoice or delivery note showing the gross weight  
instead of the net weight is handed to the purchaser;  
or

(iii) such packages are weighed in the presence of the pur-  
chaser immediately before delivery is made.”

13. In Regulation 203—

(a) in paragraph (c), after the word “thereon” the following  
expression is hereby inserted:—

“or if the package is made wholly or partly of trans-  
parent material so that the number of articles therein  
(not exceeding six) can be readily seen”;

(b) for paragraph (g) the following expression is hereby  
substituted:—

“(g) confectionery or nuts in packages of less than  
four ounces net weight or, where such con-  
fectionery or nuts are packed on a retailer's  
premises and the packages containing such  
confectionery or nuts are held in receptacles  
bearing a prominent statement of the net  
weight and price of the confectionery or  
nuts contained in each package, not more  
than eight ounces net weight or Two  
shillings in price;”

(c) the following expression is hereby inserted after paragraph (j):—

“(ja) fish, meat and poultry if sold by gross weight pursuant to Regulation 201A hereof;”

(d) the following expression is hereby inserted after paragraph (r):—

“(ra) sweetbreads, brains, hearts and kidneys;”  
and

(e) the following expression is hereby added at the end of such Regulation:—

“Provided that, for the purposes of paragraph (f) of this Regulation, a statement of the name and address of the manufacturer or packer shall not be deemed to be advertising matter if the height of the letters of such statement is in accordance with the following table:—

Gross Weight of Package.	Maximum Height of Letters.
Not more than 1 lb. . . . .	$\frac{1}{8}$ inch
More than 1 lb. but not more than 2 lb. . . . .	$\frac{1}{4}$ inch
More than 2 lb. . . . .	$\frac{3}{8}$ inch”

14. In Regulation 204—

(a) the following expression is hereby inserted after the second proviso to sub-paragraph (v) of paragraph (a):—

“Provided also that the requirement that such marking be of a colour in distinct contrast to the background shall not apply in any case where such marking is clear and easily legible and has been formed on a bottle during the process of manufacture, by the use of a suitable mould.”; and

(b) the following expression is hereby added at the end of the Regulation:—

“(d) In any case where goods comprising pieces or articles each weighing not less than 1 ounce are packed in a package (other than on a retailer's premises) a statement, in legible handwriting, of the net weight of the contents of such package shall be deemed to comply with the requirements of sub-paragraph (v) of paragraph (a) of this Regulation if such statement is written on the package or on a label securely attached thereto.”

15. Regulation 207 is hereby revoked and the following expression is substituted therefor:—

“207. Paragraph (a) of Regulation 202 hereof shall not apply to aerated waters and fruit drinks until the first day of January, 1970.”

16. Paragraph (d) of Regulation 208 is hereby revoked and the following expression is substituted therefor:—

“(d) A weight of nine and one-half ounces is hereby prescribed as the appropriate weight, for a diabetic loaf or slimming loaf, for the purposes of sub-paragraph (j) of paragraph (iv) of the proviso to sub-section (4) of section 81 of the *Weights and Measures Act 1939*.”

17. The following expression is hereby added at the end of Regulation 211:—

“(c) Sales of coke made pursuant to paragraph (b) of this Regulation shall not be subject to sub-section (5) of section 83 of the *Weights and Measures Act 1939*.”

18. The following expression is hereby inserted at the end of Regulation 214:—

“(c) Coke being carried on any vehicle for delivery to a purchaser or being carried on any vehicle for the purpose of sale or intended sale may be in unlabelled sacks if sold or intended to be sold by approximate weight pursuant to paragraph (b) of Regulation 211 hereof.”

19. In Regulation 229, the following expression is hereby inserted between the words “retail” and “shall”:—

“(other than crushed ice packed in packages on the premises of the manufacturer).”

20. The following expression is hereby added at the end of Regulation 244:—

“(b) No person shall alter any weight ticket issued in respect of the weighing of any vehicle (whether loaded or unloaded) on any public weighbridge.”

21. The following expression is hereby added to Regulation 251:—

“(b) No person shall for fee or reward repair or adjust any weighing or measuring instrument unless he holds a current Certificate of Registration of Weighing and Measuring Instruments, issued in respect of the type of instrument so repaired or adjusted.

Provided that this paragraph shall not be deemed to prohibit—

(i) the repair or adjustment of a weighing or measuring instrument by the owner of such instrument or a person in the regular employ of such owner; or

(ii) the adjustment of a weighing or measuring instrument by an inspector authorized pursuant to the proviso to section 36 of the Acts or paragraph (c) of Regulation 265 hereof.”

22. In Regulation 260, the following expression is hereby inserted after the expression “Education Department of Victoria”:—

“and (except where such certificate of qualification is issued before the first day of March, 1958) of having had approved practical experience extending over at least fifty hours;”.

23. In those portions of Table 3 of Part XXIV. relating to—

(a) CRANE WEIGHING MACHINES (CAPACITY UNDER TWO TONS), WALL BEAMS, DEAD-WEIGHT MACHINES, PLATFORM WEIGHING MACHINES AND OVERHEAD WEIGHING MACHINES; and

(b) CRANE WEIGHING MACHINES (CAPACITY OF TWO TONS AND OVER) AND WEIGHBRIDGES,

the asterisks (wherever occurring) and the expressions denoted by asterisks are hereby revoked.

And the Honorable Murray Victor Porter, for and on behalf of Her Majesty's Chief Secretary for the State of Victoria, shall give the necessary directions herein accordingly.

A. MAHLSTEDT,  
Clerk of the Executive Council.

**BOROUGH ECHUCA WATER TRUST.**

*At the Executive Council Chamber, Melbourne, the twenty-second day of October, 1957.*

**PRESENT:**

His Excellency the Lieutenant-Governor of Victoria.  
Mr. Chandler                      Mr. Bloomfield  
Mr. Turnbull                      Mr. McArthur.  
Mr. Fraser

**SEYMOUR WATERWORKS TRUST.**

*At the Executive Council Chamber, Melbourne, the twenty-second day of October, 1957.*

**PRESENT:**

His Excellency the Lieutenant-Governor of Victoria.  
Mr. Chandler                      Mr. Bloomfield  
Mr. Turnbull                      Mr. McArthur.  
Mr. Fraser

**ADDITIONAL LOAN OF £7,643.**

**U**NDER the powers conferred by the Water Acts and all other powers enabling him in that behalf, His Excellency the Lieutenant-Governor of the State of Victoria, by and with the advice of the Executive Council of the said State, doth hereby grant an additional loan of Seven thousand six hundred and forty-three pounds (£7,643) to the Borough Echuca Water Trust for the construction of pumping plant, pipe mains, and the purchase and installation of meters, as set forth in the detailed statement bearing date the 17th October, 1957, and verified under the seal of the State Rivers and Water Supply Commission.

The loan hereby granted shall be subject to the provisions of the Water Acts.

And the Honorable Wilfred John Mibus, Her Majesty's Minister of Water Supply for the State of Victoria, shall give the necessary directions herein accordingly.

A. MAHLSTEDT,  
Clerk of the Executive Council.

**ADDITIONAL LOAN OF £7,002.**

**U**NDER the powers conferred by the Water Acts and all other powers enabling him in that behalf, His Excellency the Lieutenant-Governor of the State of Victoria, by and with the advice of the Executive Council of the said State, doth hereby grant an additional loan of Seven thousand and two pounds (£7,002) to the Seymour Waterworks Trust for the construction of pipe mains and the purchase and installation of meters, as set forth in the detailed statement bearing date the 17th October, 1957, and verified under the seal of the State Rivers and Water Supply Commission.

The loan hereby granted shall be subject to the provisions of the Water Acts.

And the Honorable Wilfred John Mibus, Her Majesty's Minister of Water Supply for the State of Victoria, shall give the necessary directions herein accordingly.

A. MAHLSTEDT,  
Clerk of the Executive Council.

## SHIRE OF STAWELL WATERWORKS TRUST.

*At the Executive Council Chamber, Melbourne, the twenty-second day of October, 1957.*

## PRESENT:

His Excellency the Lieutenant-Governor of Victoria.

Mr. Chandler	Mr. Bloomfield
Mr. Turnbull	Mr. McArthur.
Mr. Fraser	

## ADDITIONAL LOAN OF £16,000.

UNDER the powers conferred by the Water Acts and all other powers enabling him in that behalf, His Excellency the Lieutenant-Governor of the State of Victoria, by and with the advice of the Executive Council of the said State, doth hereby grant an additional loan of Sixteen thousand pounds (£16,000) to the Shire of Stawell Waterworks Trust for the construction of town water supply schemes for the Townships of Glenorchy, Great Western, and Hall's Gap, as set forth in the detailed statement bearing date the 17th October, 1957, and verified under the seal of the State Rivers and Water Supply Commission.

The loan hereby granted shall be subject to the provisions of the Water Acts.

And the Honorable Wilfred John Mibus, Her Majesty's Minister of Water Supply for the State of Victoria, shall give the necessary directions herein accordingly.

A. MAHLSTEDT,  
Clerk of the Executive Council.

## ROMSEY WATERWORKS TRUST.

*At the Executive Council Chamber, Melbourne, the twenty-second day of October, 1957.*

## PRESENT:

His Excellency the Lieutenant-Governor of Victoria.

Mr. Chandler	Mr. Bloomfield
Mr. Turnbull	Mr. McArthur.
Mr. Fraser	

## ADDITIONAL LOAN OF £1,742.

UNDER the powers conferred by the Water Acts and all other powers enabling him in that behalf, His Excellency the Lieutenant-Governor of the State of Victoria, by and with the advice of the Executive Council of the said State, doth hereby grant an additional loan of One thousand seven hundred and forty-two pounds (£1,742) to the Romsey Waterworks Trust for the construction of pipe mains and the purchase and installation of meters, as set forth in the detailed statement bearing date the 17th October, 1957, and verified under the seal of the State Rivers and Water Supply Commission.

The loan hereby granted shall be subject to the provisions of the Water Acts.

And the Honorable Wilfred John Mibus, Her Majesty's Minister of Water Supply for the State of Victoria, shall give the necessary directions herein accordingly.

A. MAHLSTEDT,  
Clerk of the Executive Council.

## LANG LANG WATERWORKS TRUST.

*At the Executive Council Chamber, Melbourne, the twenty-second day of October, 1957.*

## PRESENT:

His Excellency the Lieutenant-Governor of Victoria.

Mr. Chandler	Mr. Bloomfield
Mr. Turnbull	Mr. McArthur.
Mr. Fraser	

## CONSENT TO BORROWING £3,100.

UNDER the powers conferred by the Water Acts and all other powers enabling him in that behalf, His Excellency the Lieutenant-Governor of the State of Victoria, by and with the advice of the Executive Council

of the said State, doth hereby consent to the Lang Lang Waterworks Trust borrowing at interest the sum of Three thousand one hundred pounds (£3,100), bearing interest at the rate of £5 10s. per centum per annum, for the construction of a new town water supply scheme at Lang Lang, as set forth in the detailed statement bearing date the 17th October, 1957.

And the Honorable Wilfred John Mibus, Her Majesty's Minister of Water Supply for the State of Victoria, shall give the necessary directions herein accordingly.

A. MAHLSTEDT,  
Clerk of the Executive Council.

## WODONGA WATERWORKS TRUST.

*At the Executive Council Chamber, Melbourne, the twenty-second day of October, 1957.*

## PRESENT:

His Excellency the Lieutenant-Governor of Victoria.

Mr. Chandler	Mr. Bloomfield
Mr. Turnbull	Mr. McArthur.
Mr. Fraser	

## CONSENT TO BORROWING £10,000.

UNDER the powers conferred by the Water Acts and all other powers enabling him in that behalf, His Excellency the Lieutenant-Governor of the State of Victoria, by and with the advice of the Executive Council of the said State, doth hereby consent to the Wodonga Waterworks Trust borrowing at interest the sum of Ten thousand pounds (£10,000), bearing interest at the rate of £5 10s. per centum per annum, for the construction of a service basin and pipe mains, as set forth in the detailed statement bearing date the 17th October, 1957.

And the Honorable Wilfred John Mibus, Her Majesty's Minister of Water Supply for the State of Victoria, shall give the necessary directions herein accordingly.

A. MAHLSTEDT,  
Clerk of the Executive Council.

## MOE WATERWORKS TRUST.

*At the Executive Council Chamber, Melbourne, the twenty-second day of October, 1957.*

## PRESENT:

His Excellency the Lieutenant-Governor of Victoria.

Mr. Chandler	Mr. Bloomfield
Mr. Turnbull	Mr. McArthur.
Mr. Fraser	

## ADDITIONAL LOAN OF £38,713.

UNDER the powers conferred by the Water Acts and all other powers enabling him in that behalf, His Excellency the Lieutenant-Governor of the State of Victoria, by and with the advice of the Executive Council of the said State, doth hereby grant an additional loan of Thirty-eight thousand seven hundred and thirteen pounds (£38,713) to the Moe Waterworks Trust for the construction of pipe mains and the purchase and installation of meters, as set forth in the detailed statement bearing date the 17th October, 1957, and verified under the seal of the State Rivers and Water Supply Commission.

The loan hereby granted shall be subject to the provisions of the Water Acts.

And the Honorable Wilfred John Mibus, Her Majesty's Minister of Water Supply for the State of Victoria, shall give the necessary directions herein accordingly.

A. MAHLSTEDT,  
Clerk of the Executive Council.

## BENDIGO SEWERAGE AUTHORITY.

*At the Executive Council Chamber, Melbourne, the twenty-second day of October, 1957.*

## PRESENT:

His Excellency the Lieutenant-Governor of Victoria.

Mr. Chandler	Mr. Bloomfield
Mr. Turnbull	Mr. McArthur.
Mr. Fraser	

## CONSENT TO BORROWING £25,000.

UNDER the powers conferred by the Sewerage Districts Acts and all other powers enabling him in that behalf, His Excellency the Lieutenant-Governor of the State of Victoria, by and with the advice of the Executive Council of the said State, doth hereby consent to the Bendigo Sewerage Authority borrowing, by the issue of debentures, the sum of Twenty-five thousand pounds (£25,000) to meet the cost of sewerage extensions, as set forth in the detailed statement bearing date the 17th October, 1957.

And the Honorable Wilfred John Mibus, Her Majesty's Minister of Water Supply for the State of Victoria, shall give the necessary directions herein accordingly.

A. MAHLSTEDT,  
Clerk of the Executive Council.

## MARYBOROUGH SEWERAGE AUTHORITY.

*At the Executive Council Chamber, Melbourne, the twenty-second day of October, 1957.*

## PRESENT:

His Excellency the Lieutenant-Governor of Victoria.

Mr. Chandler	Mr. Bloomfield
Mr. Turnbull	Mr. McArthur.
Mr. Fraser	

## ADDITIONAL LOAN OF £62,000.

UNDER the powers conferred by the Sewerage Districts Acts and all other powers enabling him in that behalf, His Excellency the Lieutenant-Governor of the State of Victoria, by and with the advice of the Executive Council of the said State, doth hereby grant an additional loan of Sixty-two thousand pounds (£62,000) to the Maryborough Sewerage Authority for sewerage construction works at Maryborough, as set forth in the detailed statement bearing date the 18th October, 1957.

The loan hereby granted shall be subject to the provisions of the Sewerage Districts Acts.

And the Honorable Wilfred John Mibus, Her Majesty's Minister of Water Supply for the State of Victoria, shall give the necessary directions herein accordingly.

A. MAHLSTEDT,  
Clerk of the Executive Council.

## MORWELL SEWERAGE AUTHORITY.

*At the Executive Council Chamber, Melbourne, the twenty-second day of October, 1957.*

## PRESENT:

His Excellency the Lieutenant-Governor of Victoria.

Mr. Chandler	Mr. Bloomfield
Mr. Turnbull	Mr. McArthur.
Mr. Fraser	

## CONSENT TO BORROWING £14,000.

UNDER the powers conferred by the Sewerage Districts Acts and all other powers enabling him in that behalf, His Excellency the Lieutenant-Governor of the State of Victoria, by and with the advice of the Executive Council of the said State, doth hereby consent to the Morwell Sewerage Authority borrowing, by the issue of debentures, the sum of Fourteen thousand pounds

(£14,000) to meet the cost of sewerage works at Morwell, as set forth in the detailed statement bearing date the 17th October, 1957.

And the Honorable Wilfred John Mibus, Her Majesty's Minister of Water Supply for the State of Victoria, shall give the necessary directions herein accordingly.

A. MAHLSTEDT,  
Clerk of the Executive Council.

## OVENS RIVER IMPROVEMENT TRUST.

*At the Executive Council Chamber, Melbourne, the twenty-second day of October, 1957.*

## PRESENT:

His Excellency the Lieutenant-Governor of Victoria.

Mr. Chandler	Mr. Bloomfield
Mr. Turnbull	Mr. McArthur.
Mr. Fraser	

## LOAN OF £2,500.

IN pursuance of the powers conferred by section 43 of the *River Improvement Act 1948* and all other powers him thereunto enabling, His Excellency the Lieutenant-Governor of the State of Victoria, by and with the advice of the Executive Council of the said State, doth by this Order—

(1) Make advance by way of loan to the Ovens River Improvement Trust of a sum of Two thousand five hundred pounds (£2,500); and

(2) Apply the following terms and conditions:—

(a) That the said sum shall be used for the purpose of meeting the cost of surveys, preparation of plans and specifications of river improvement works, and of carrying out river improvement works along the Buffalo River within the boundaries of the Ovens River Improvement District.

(b) That the Ovens River Improvement Trust shall, in respect of such advance by way of loan, be subject to the powers, rights, duties and obligations conferred and imposed by—

(i) the provisions of sections 269, 270, 272 to 277, 279 and 280 of Part VII. of the *Water Act 1928*, as amended by any other Act, so adapted that the word "Authority" shall mean the Ovens River Improvement Trust; and

(ii) the provisions of section 281 of the said Part VII. of the *Water Act 1928*, so adapted as if for the expressions "any waterworks trust or local governing body" and "such waterworks trust or local governing body" there were substituted the expression "the Ovens River Improvement Trust".

And the Honorable Wilfred John Mibus, Her Majesty's Minister of Water Supply for the State of Victoria, shall give the necessary directions herein accordingly.

A. MAHLSTEDT,  
Clerk of the Executive Council.

## APPROACHING LAND SALES.

SALES of Crown lands, in fee-simple, will be held at the under-mentioned places and dates, viz.:—

	No. of Gazette
Inglewood.—Thursday, 14th November, 1957 ..	248
Murrayville.—Thursday, 21st November, 1957 ..	249
Ouyen.—Friday, 22nd November, 1957 ..	249
St. Arnaud.—Thursday, 14th November, 1957 ..	248
Underbool.—Thursday, 21st November, 1957 ..	249
Yarram.—Tuesday, 26th November, 1957 ..	249

**SALES OF CROWN LANDS BY AUCTION.**

The lands will be sold in fee-simple, and subject to the covenants, conditions, exceptions, and reservations directed by the Governor in Council by an Order in Council dated the 5th August, 1930, and published in the *Government Gazette* of the 8th August, 1930, varied as herein.

A deposit of at least twelve and a half per centum of the price at which each lot is sold must be paid by the purchaser at the time of sale, and all such payments shall be made in coin, bank notes or cheques approved by the officer conducting the sale, and the residue of such price will be payable in equal instalments, in accordance with the scale hereunder, on the last day of each successive period of six months from the time of sale, or, if the purchaser choose, at any earlier time or times; and such residue of the purchase money shall bear interest at the rate of Five pounds per centum per annum, to be computed with respect to each instalment for the period which has elapsed between the time of sale and the time of the payment of such instalment. If the residue of the price be paid within thirty days after the time of the sale no interest will be payable thereon.

The Governor in Council may allow a transfer of the purchaser's interest to an approved person at any time before the final payment of the purchase money is made. The fee for transfer shall be One pound and such transfer will be subject to payment of stamp duty.

**SCALE OF PAYMENTS OF RESIDUE.**

- £20 and under, 6 instalments.
- Over £20, and not exceeding £50, 8 instalments.
- Over £50, and not exceeding £100, 10 instalments.
- Over £100, and not exceeding £200, 12 instalments.
- Over £200, and not exceeding £300, 14 instalments.
- Over £300, and not exceeding £400, 16 instalments.
- Over £400, and not exceeding £500, 18 instalments.
- Over £500, 20 instalments.

**FEEs, ETC.**

The amount payable for Assurance Fund (One halfpenny for each £1 of purchase price) and Crown grant fee must be paid with the balance of purchase money. The following is the scale of fees for Crown grants:—

- 50 acres and under, £1 10s.
- Over 50 acres, £2.
- Where the purchase money does not exceed £5, the grant fee is £1.

Valuations of improvements (if not purchased by the owner thereof), and charges for survey, must also be paid at the time of sale.

**KEITH TURNBULL,**  
Commissioner of Crown Lands and Survey.

Office of Crown Lands and Survey,  
Melbourne, 16th October, 1957.

**MURRAYVILLE.**—Sale (No. 11310) of Crown lands, in fee-simple, by auction, will be held at the LAND INSPECTOR'S OFFICE, MURRAYVILLE, on THURSDAY, the 21st NOVEMBER, 1957, at half-past ELEVEN o'clock a.m. To be conducted by H. H. DODD, Land Officer.

MURRAYVILLE, PARISH OF DANYO, COUNTY OF WEEAH.  
*Fronting Poole-street.*

Upset price £20 per lot. Charge for survey £5 5s. per lot.  
Lot 1. Area 1 rood, allotment 22 of section 7.  
Lot 2. Area 1 rood, allotment 23 of section 7.

*In the West of the Township.*

Upset price £25 the lot. Charge for survey £5 10s.  
Lot 3. Area 1r. 8p., allotment 1 of section 8. Valuation of improvements to be announced at the sale.  
Upset price £20 per lot. Charge for survey £5 10s. per lot.  
Lot 4. Area 1r. 4p., allotment 22 of section 8.  
Lot 5. Area 1r. 4p., allotment 23 of section 8.

*Fronting Sharrock-street.*

Upset price £20 per lot. Charge for survey £5 5s. per lot.  
Lot 6. Area 3r. 35 5/10p., allotment 11 of section 17.  
Lot 7. Area 3r. 35 5/10p., allotment 12 of section 17.

**OUYEN.**—Sale (No. 11311) of Crown lands, in fee-simple, by auction, will be held at the LAND INSPECTOR'S OFFICE, OUYEN, on FRIDAY, the 22nd NOVEMBER, 1957, at ELEVEN o'clock a.m. To be conducted by H. H. DODD, Land Officer.

PARISH OF OUYEN, COUNTY OF KARKAROOO.  
*To the North of the Township of Ouyen.*

Upset price £25 per lot. Charge for survey £5 5s. per lot.  
Lot 1. Area 34 1/10 perches, allotment 6 of section B.  
Lot 2. Area 34 1/10 perches, allotment 7 of section B.  
Lot 3. Area 34 1/10 perches, allotment 8 of section B.

PARISH OF NULKWYNE, COUNTY OF KARKAROOO.  
*In the East of the Parish.*

Upset price £1 per acre. Charge for survey £10 5s.  
Lot 4. Area 30 acres, subject to survey and any necessary easements disclosed thereby, allotment 13a. One month allowed for removal of improvements.

**YARRAM.**—Sale (No. 11312) of Crown lands, in fee-simple, by auction, will be held at the LAND INSPECTOR'S OFFICE, YARRAM, on TUESDAY, the 26th NOVEMBER, 1957, at half-past TWO o'clock p.m. To be conducted by C. E. RICE, Land Officer, Melbourne.

TARRAVILLE, PARISH OF TARRA TARRA, COUNTY OF BULN BULN.  
*Fronting Townsend-street, approximately 7 chains South-east of Tarraville Bridge.*

Upset price £40 the lot. Charge for survey £8 17s. 6d.  
Lot 1. Area 3a. 1r., subject to survey and any necessary easements disclosed thereby, allotment 4 of section 9.

**UNDERBOOL.**—Sale (No. 11313) of Crown lands, in fee-simple, by auction, will be held at the LAND INSPECTOR'S OFFICE, UNDERBOOL, on THURSDAY, the 21st NOVEMBER, 1957, at THREE o'clock p.m. To be conducted by H. H. DODD, Land Officer.

UNDERBOOL, PARISH OF UNDERBOOL, COUNTY OF WEEAH.  
*Fronting Monash-avenue.*

Upset price £16 per lot. Charge for survey £5 10s. per lot.  
Lot 1. Area 1r. 20p., allotment 15 of section 8. Valuation of improvements to be announced at the sale.  
Lot 2. Area 1r. 20p., allotment 16 of section 8. Valuation of improvements to be announced at the sale.

**PROPOSED REVOCATION OF TEMPORARY RESERVATION OF LAND BY ORDER IN COUNCIL.**

IN pursuance of the provisions of the *Land Act 1928*, notice is hereby given that it is the intention of the Governor in Council to revoke the temporary reservation of land by Order in Council hereunder referred to, viz.:—

*The following Notice was published 1<sup>o</sup> on the 9th October, 1957, pursuant to Order of the 1st October, 1957.*

**MERBEIN.**—The temporary reservation, by Order in Council of the 26th January, 1916, of 44 acres 1 rood 36 perches of land in the Township of Merbein as a site for a Public Park and other purposes of Public Recreation, revoked as to part by various Orders, so far only as the portion containing 2 roods 20 perches, more or less, indicated by hachure on plan hereunder, is concerned.—(M.572A<sup>(3)</sup>) (Rs.860).

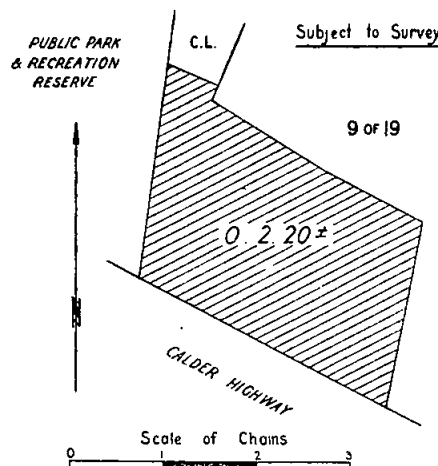

**KEITH TURNBULL,**  
Commissioner of Crown Lands and Survey.

**PROPOSED REVOCATIONS OF TEMPORARY RESERVATIONS OF LANDS BY ORDERS IN COUNCIL.**

IN pursuance of the provisions of the *Land Act 1928*, notice is hereby given that it is the intention of the Governor in Council to revoke the temporary reservations of lands by Orders in Council hereunder referred to, viz.:

The following Notices were published 1° on the 2nd October, 1957, pursuant to Orders of the 24th September, 1957.

**CARAMUT.**—The temporary reservation, by Order in Council of the 30th October, 1873, of 2 roods of land in the Township of Caramut, being allotment 1 of section 6, as a site for Mechanics' Institute purposes.—(C.190(1) (Rs.5115).

**WINYAYUNG.**—The temporary reservation, by Order in Council of the 14th February, 1870 (see *Government Gazette* of the 18th February, 1870, page 332), of 95 acres 2 roods 14 perches of land in the Parish of Winayung as a site for Camping and Watering purposes, so far only as the portion containing 48 acres, more or less, indicated by hachure on plan hereunder, is concerned.—(W.250A(1) (02047/121).

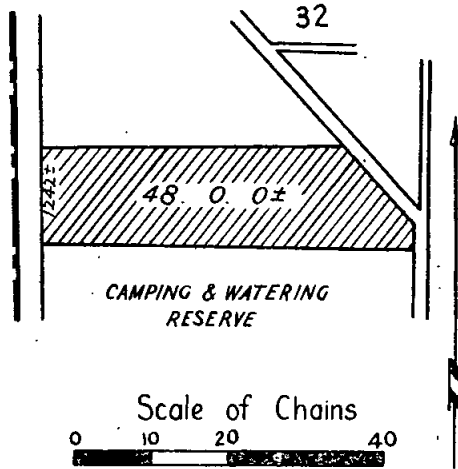

KEITH TURNBULL,  
Commissioner of Crown Lands and Survey.

**PROPOSED REVOCATIONS OF TEMPORARY RESERVATIONS OF LANDS BY ORDERS IN COUNCIL.**

IN pursuance of the provisions of the *Land Act 1928*, notice is hereby given that it is the intention of the Governor in Council to revoke the temporary reservations of lands by Orders in Council hereunder referred to, viz.:

The following Notices were published 1° on the 23rd October, 1957, pursuant to Orders of the 15th October, 1957.

**BARINGHUP.**—The temporary reservation, by Order in Council of the 23rd November, 1868, of 1 rood of land in the Township of Baringhup as a site for a Mechanics' Institute.—(B.6(2) (Rs.1899).

**BENDIGO.**—The temporary reservation, by Order in Council of the 2nd October, 1951, of 2 roods of land in the City of Bendigo as a site for a Free Kindergarten.—(S.372(32) (Rs.6708).

**EUREKA.**—The temporary reservation, by Order in Council of the 8th January, 1918, of 5 acres of land in the Parish of Eureka as a site for a State School.—(E.109(3) (Rs.1720).

**PEECHELBA.**—The temporary reservation, by Order in Council of the 14th April, 1930, of 3 roods 8 perches of land in the Parish of Peechelba as a site for a State School.—(P.137G(1) (Rs.3983).

**MALDON.**—The temporary reservation, by Order in Council of the 11th November, 1868 (see *Government Gazette* of the 24th November, 1868, page 2245), of 3 acres 0 roods 14 perches of land in the Township of Maldon as a site for Public Gardens, so far only as the portion containing 22 perches, more or less, indicated by hachure on plan hereunder, is concerned.—(M.449(10) (Rs.3677).

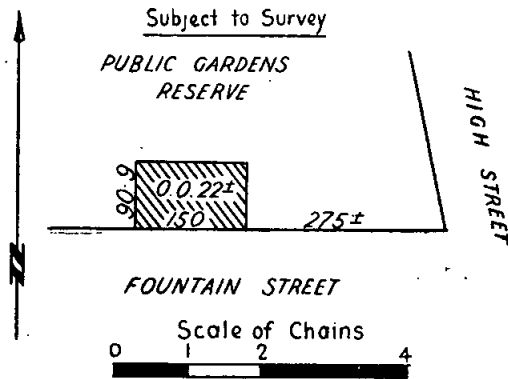

**SMYTHESDALE.**—The temporary reservation, by Order in Council of the 20th November, 1865, of 430 acres 1 rood 31 perches of land in the Parish of Smythesdale as a site for Drainage Area for Water Supply to Smythesdale, revoked as to part by various Orders, so far only as the portion containing 1 rood 14 perches, indicated by hachure on plan hereunder, is concerned.—(S.297(7) (Rs.5077).

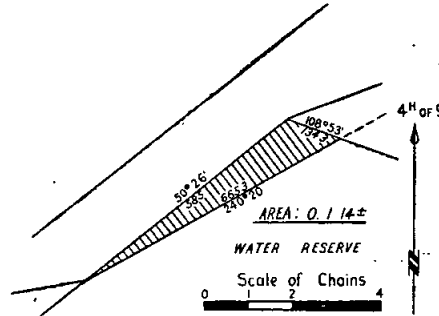

KEITH TURNBULL,  
Commissioner of Crown Lands and Survey.

**PUBLIC HEARINGS BY PERSONS APPOINTED UNDER THE 34TH SECTION OF THE LAND ACT 1928.**

NOTICE is hereby given that at the times and places mentioned in the Schedule hereunder, applications for leases and licences under the Land Acts, objections to such applications, objections to proposed proclamations, alterations, additions, diminutions, revocations, or unions of commons, and reasons against forfeiture of any leases or licences under the Land Acts deemed liable to forfeiture, will be publicly heard by the persons whose names are set opposite such places respectively in such Schedule, being persons appointed by me, the responsible Minister of the Crown administering the Land Acts, to hear the same and report thereon in writing to me.

KEITH TURNBULL,  
Commissioner of Crown Lands and Survey, and  
President of the Board of Land and Works.  
Department of Crown Lands and Survey.  
Melbourne, 23rd October, 1957.

**SCHEDULE.**

LAND OFFICE, BENDIGO, Thursday, 28th November, 1957, at 10 a.m.—H. J. Henkel, Land Officer, Bendigo.  
LAND INSPECTOR'S OFFICE, YARRAM, Tuesday, 26th November, 1957, at 3 p.m.—C. E. Rice, Land Officer, Melbourne.

**RETIREMENT AND APPOINTMENT OF MANAGERS OF COMMONS.**

IT is hereby notified for the information of all persons entitled to depasture stock on commons that successors to the individual managers thereof, who will retire on the 31st December, 1957, should be elected before the close of the year by the persons interested at public meetings duly convened for the purpose by the President of the Shire. The names, in full, of the gentlemen who may be elected for either one (1), two (2), or three (3) years, should be forwarded to the Department of Crown Lands and Survey.

KEITH TURNBULL,  
Commissioner of Crown Lands and Survey.

**TENDERS—PUBLIC WORKS DEPARTMENT**

**TENDERS** will be received at this office until **TEN a.m.** on the days and for the purposes under mentioned.

Particulars may be learnt at this Office and also at places shown in parenthesis.

W.O. means Inspector of Works Office; P.S.—Police Station; T.S.—Technical School; H.E.S.—Higher Elementary School; S.S.—State School; H.S.—High School.

The Board of Land and Works will not necessarily accept the lowest or any tender.

**NOTE.**—No preliminary deposits are to be lodged with tenders, but a deposit, in accordance with the following Schedule, will be required from the successful tenderer:—

For contract amounts exceeding £200 and not exceeding £500	5	£
For contract amounts exceeding £500 and not exceeding £1,000	10	
For contract amounts exceeding £1,000—1 per cent. of tender	500	(maximum deposit)

All tenders should be on a "firm tender" basis.

29th October, 1957.

Ararat.—New toilet block, "J" Ward, Mental Hospital. (W.O., Ararat; P.S., Stawell; Mental Hospital, Ararat.)

Ararat West.—Additional out-offices, S.S. No. 4720. (W.O., Ararat; P.S., Stawell; S.S., Ararat West.)

Beechworth.—Supply and installation of auxiliaries and pipework in new boiler house and steam pipe reticulation, Mental Hospital. (W.O., Wangaratta.)

Benalla.—Internal and external repairs and painting, residence, 44 Bridge-street, S.S. No. 31. (W.O., Benalla; S.S., Benalla.)

Blackburn South.—Additional out-office accommodation, drinking and washing facilities, S.S. No. 4035. (S.S., Blackburn South.)

Bonnie Doon.—New out-office block and septic tank installation, S.S. No. 2098. (W.O., Alexandra; S.S., Bonnie Doon.)

Byaduk North.—External and internal painting and new out-offices with septic closets, S.S. No. 1418. (W.O., Hamilton; S.S., Byaduk North.)

Camberwell.—Rewiring of and additions to electrical installation in Court House, Police Station and Sergeant's Residence.

Camberwell.—Revision and installation of electrical installation, Girls Secondary School, Mangarra-road.

Fifteen Mile Creek.—Restoration of school building removed from Boorhaman North, S.S. No. 2868. (W.O., Benalla; Wangaratta; S.S., Fifteen Mile Creek.)

Fitzroy North.—Renewal of non-party boundary fencing in pipe and chain mesh, S.S. No. 1490. (S.S., Fitzroy North.)

Footscray.—Construction of neutralizing chamber, first floor Science Room, Girls Secondary School. (Girls Secondary School, Footscray.)

Franklinford.—Purchase and removal of residence, fittings, tanks, out-office, &c., S.S. No. 257. (W.O., Kyneton.)

Geelong.—Electrical installation in new dormitories and recreation room, "Hawthorne" Teachers' Training College Hostel. (W.O., Geelong.)

Glenluce.—Purchase and removal of all buildings on site, S.S. No. 771. (W.O., Kyneton.)

Kiewa.—Repairs and painting, residence, Main-road, S.S. No. 1472. (W.O., Wangaratta; S.S., Kiewa; P.S., Tallangatta.)

Maribyrnong.—Supply, delivery, installation and testing of the mechanical services for stage 1 and 2 of building programme, High School.

Melbourne.—Supply and installation of collective control system equipment and power door operators on two (2) lifts, Police Headquarters, Russell-street.

Melbourne.—Rewiring of and electrical additions to stables, riding school and drill hall, Police Depot, St. Kilda-road.

Mont Park.—Conversion of existing L.T.C. building to cafeteria as annexe to kiosk, Mental Hospital. (W.O., Mont Park.)

Morwell.—External painting of church building, alteration to fireplace, S.S. No. 2136. (W.O., Traralgon; S.S., Morwell.)

Neerim South.—Erection of a new shelter pavilion, 20 feet x 16 feet, S.S. No. 2432. (W.O., Traralgon; S.S., Neerim South.)

Ormond.—Internal and external renovations, Police Station.

Port Melbourne.—Supply and delivery to Salmon-street Depot of one only concrete mixer,  $\frac{1}{2}$  cubic yard dry mix capacity, with power-operated loader, all steel wheels, electric motor drive, Plant Depot, Public Works Department. (Specifications of machine offered to be submitted with tender.)

Port Melbourne.—Supply and delivery to Salmon-street Depot of four (4)  $\frac{3}{4}$  cubic feet dry capacity concrete mixers, mounted on trailer chassis with pneumatic tires, driven by totally enclosed petrol engine, Plant Depot, Public Works Department. (Specifications to be submitted with tender.)

Port Melbourne.—Supply and delivery to Salmon-street Depot of one (1) pneumatic-tired tractor with petrol/kerosene engine, fitted with 15 cubic feet capacity front-end loader, all weather cab, and 30 cwt. crane attachment, Plant Depot, Public Works Department. (Specifications to be submitted with tender.)

Preston East.—Additional out-offices, drinking and washing facilities, S.S. No. 4316. (S.S., Preston East.)

Preston South.—Additional units to boys' and girls' out-offices, additional drinking facilities, S.S. No. 824. (S.S., Preston South.)

Royal Park.—Alterations, internal repairs and painting of reception and Toddlers Block, "Turana," Children's Welfare Department.

Sandringham.—Erection of No. 2 (two) new shelter pavilions, 32 feet x 16 feet, Technical School. (T.S., Sandringham.)

Shepparton.—Internal and external repairs and painting, Technical School. (W.O., Shepparton; T.S., Shepparton.)

Silvan.—New floor and windows to school, additional out-office accommodation, S.S. No. 1801. (S.S., Silvan.)

South Melbourne.—Electrical installation (rewiring), Police Station and Court House.

Thoonia.—Internal and external repairs and painting, new out-offices, S.S. No. 2056. (W.O., Benalla; Wangaratta; S.S., Thoonia.)

Warragul.—Erection of timber residence, Inspector of Works, Public Works Department. (W.O., Traralgon; P.S., Warragul.)

Warrnambool South.—Connecting of town sewerage and alterations, residence, 10 Elliot-street, S.S. No. 1902. (W.O., Warrnambool; S.S., Warrnambool South.)

West Melbourne.—External repairs and painting, S.S. No. 1689.

Williamstown.—Supply and installation of gas heaters and hot-water service, Police Station.

Wurruk.—Painting of school and residence, S.S. No. 2513. (W.O., Traralgon; S.S., Wurruk.)

Yarram.—Purchase and removal of converted Army hut building, S.S. No. 693. (W.O., Traralgon; S.S., Yarram.)

5th November, 1957.

Amstel.—Warm air heating/ventilation system in S.S. No. 4801.

Ararat.—Renovations to Medical Officer's Residence, Mental Hospital. (W.O., Ararat; Mental Hospital, Ararat.)

Benambra.—Repairs and painting to residence, repairs to school fence, S.S. No. 1764. (W.O., Bairnsdale; S.S., Benambra.)

Camberwell.—Supply, delivery, installation of extension to heating of additional classrooms and conversion of boilers to oil firing, Girls' Secondary School.

Camperdown.—General renovations, repairs, and painting, Police Station. (W.O., Camperdown; P.S., Camperdown.)

Coburg.—Supply, delivery, installation, and testing of oil-firing equipment in boiler house, Pentridge Gaol.

Collingwood.—Installation of triple chalkboards, &c., Girls' Secondary School. (Girls' Secondary School, Collingwood.)

Cudgee.—Septic tank installation and construction of new out-offices, school and residence, S.S. No. 105. (W.O., Warrnambool; S.S., Cudgee.)

Dudley.—Repairs and painting, S.S. No. 3674. (W.O., Korumburra; S.S., Dudley.)

Ellerslie.—Installation of septic tank, &c., S.S. No. 1461. (W.O., Warrnambool; S.S., Ellerslie.)

Geelong.—Internal painting of Chemistry Laboratory Foyer and Office, Gordon Institute of Technology. (W.O., Geelong.) (Amended specification.)

Horsham.—Street boundary fencing, High School. (W.O., Horsham; H.S., Horsham.)

Kenmare.—Erection of a 20 ft. x 10 ft. shelter pavilion, S.S. No. 3221. (W.O., Warracknabeal; S.S., Kenmare.)

Kingston.—Septic closets installation, S.S. No. 759. (W.O., Ballarat; S.S., Kingston.)

Korong Vale.—Repairs, renewals, and painting, S.S. No. 1800. (W.O., Bendigo; S.S., Korong Vale.)

Melbourne.—Repairs to bluestone entrance steps to building No. 1, Royal Melbourne Technical College. (Royal Melbourne Technical College, Melbourne.)



Mirboo North.—Renewal of boundary fencing, S.S. No. 2383. (W.O., Korumburra; S.S., Mirboo North.)  
 Moreland.—Repairs, replacements, painting, &c., S.S. No. 2837. (S.S., Moreland.)  
 Mont Park.—Internal and external painting, Senior Medical Officers Quarters, Janefield Mental Hospital. (W.O., Mont Park.)  
 Mont Park.—Electrical installation for remodelling and additions to Sub Acute Ward, Plenty Mental Hospital.  
 Mordialloc-Chelsea.—Wiring of two L.T.C. out-buildings for electric light and power, High School.  
 Murtoa.—Underpinning foundations of Court House. (W.O., Horsham; Warracknabeal; P.S., Murtoa.)  
 Port Melbourne.—Supply and delivery of six No. four-berth sleeper caravans suitable for use on departmental outdoor projects, Salmon-street, Public Works Department Depot. (Plans and specifications to be submitted with tenders.)  
 Prahran.—Supply and/or installation of stainless steel benches and other kitchen equipment, Secondary Teachers' College Hostel, 174 Punt-road.  
 Preston.—Electrical installation in prefab. outbuildings, Girls' Secondary School.  
 Pura Pura.—Erection of out-office block and septic tank installation, S.S. No. 4157. (W.O., Warrnambool; S.S., Pura Pura.)  
 San Remo.—Erection of teacher's new residence, garage, fencing, &c., S.S. No. 1369. (W.O., Korumburra; S.S., San Remo.)  
 San Remo.—Electrical installation in new "Ellinbank" type residence, S.S. No. 1369. (S.S., San Remo.)  
 San Remo.—Supply of piles to San Remo Jetty, Ports and Harbors. Public Works Department.  
 Stony Point.—Supply and delivery of 300 tons of squared bluestone blocks, Pier, Public Works Department.  
 Sunbury.—Purchase and removal of boilers (2), Mental Hospital.  
 Toorak.—Repairs and painting, S.S. No. 3016, Canterbury-road. (S.S., Toorak.)  
 Trafalgar.—Internal renovations and painting to school residence, S.S. No. 2185. (W.O., Traralgon; S.S., Trafalgar.)  
 Ultima.—Installation of septic tank, &c., S.S. No. 3426. (W.O., Swan Hill; S.S., Ultima.)  
 Wangaratta.—Boundary fencing (non-party), High School. (W.O., Wangaratta; H.S., Wangaratta.)  
 Westbreen.—Erection of one (1) 32 ft. x 16 ft. shelter pavilion, S.S. No. 4153. (S.S., Westbreen.)  
 Woorinen.—Installation of septic tank and provision of toilets, S.S. No. 3945. (W.O., Swan Hill; S.S., Woorinen.)  
 Woorndoo.—Erection of new out-office block at school and residence and installation of septic closets, S.S. No. 1001. (W.O., Warrnambool; S.S., Woorndoo.)  
 Yarram.—Erection of timber residence, Police Station. (W.O., Traralgon; P.S., Yarram.)  
 Yarram.—Erection of two (2) 32 ft. x 16 ft. shelter pavilions, High School. (W.O., Traralgon; H.S., Yarram.)

12th November, 1957.

Ararat West.—Supply and erect pipe rail and chain mesh, and sawn post and wire fencing, including gates, S.S. No. 4720. (W.O., Ararat; S.S., Ararat West.)  
 Baxter.—Erection of an "Ellinbank" type residence, S.S. No. 3023. (S.S., Baxter.)  
 Burwood.—Erection of brick veneer Police Station, brick garage and cells.  
 Burwood.—Electrical installation, Police Station.  
 Camberwell.—Re-rendering and waterproofing of parapet walls, High School. (H.S., Camberwell.)  
 Daylesford.—General repairs, renovations, provision of new out-office block, &c., Court House. (W.O., Kyneton; P.S., Daylesford.)  
 Doncaster.—Additional shelter accommodation, S.S. No. 197. (S.S., Doncaster.)  
 Geelong.—Supply delivery installation and testing of two gas hot water services and gas heating in Recreation Hall, Teachers' Training College, "Hawthorne" Hostel. (W.O., Geelong.)  
 Glenferrie.—Erection of sound proofed partition to plumbing shop, Swinburne Technical College. (Swinburne Technical College, Glenferrie.)  
 Glenloch East.—Repairs and painting, S.S. No. 4432. (W.O., Swan Hill; S.S., Glenloch East.)  
 Glenroy North.—Fencing, S.S. No. 4782. (S.S., Glenroy North.)  
 Herne Hill.—Internal and external painting, S.S. No. 4681. (W.O., Geelong; S.S., Herne Hill.)  
 Heywood.—Removal of Condah S.S. No. 1019 Residence to Heywood Consolidated School Site. (W.O., Warrnambool; Consolidated School, Heywood.)  
 Highett.—Third section of concrete veneer timber-framed school building, High School. (H.S., Highett.)  
 Highett.—Electrical installation in stage 3, High School. (H.S., Highett.)

No. 249.—9907/57.—3

Highett.—Mechanical services for stage 3 of building programme, High School. (H.S., Highett.)  
 Kew.—Installation of hot water heating and reorganization of H.W.S. system in main building, Mental Hospital. (Mental Hospital, Kew.)  
 Lavers Hill.—Internal and external renovations, Consolidated School. (W.O., Camperdown; Consolidated School, Lavers Hill.)  
 Leopold.—Erection of out-office block and installation of septic tanks, S.S. No. 1146. (W.O., Geelong; S.S., Leopold.)  
 Manangatang.—Renovations and painting, Lands Department Residence. (W.O., Swan Hill; Lands Department Office, Manangatang.)  
 Moe.—Erection of two brick cells, storeroom and exercise yard at Police Station. (W.O., Traralgon; P.S., Moe.)  
 Montague.—Repairs, painting and erection of garage, Police Station.  
 Morwell.—Additional out-offices, S.S. No. 4655. (W.O., Traralgon; S.S., Morwell.)  
 Point Lonsdale.—External painting and renewal of roof, Lighthouse Keeper's Quarters, Public Works Department. (W.O., Geelong; P.S., Queenscliff.)  
 Pakenham.—Extension of cafeteria, Consolidated School. (Consolidated School, Pakenham.)  
 Ringwood North.—Erection of cloakroom and staffroom, S.S. No. 4120. (S.S., Ringwood North.)  
 Stawell.—Repairs and painting to all buildings, High School. (W.O., Ararat; H.S., Stawell.)  
 Sunbury.—Supply, delivery, installation and testing of the steam main extension, Mental Hospital.  
 Sunshine East.—Supply and erection of 5-ft. paling fencing (party) to southern school boundary, S.S. No. 4645. (S.S., Sunshine East.)  
 Tullamarine.—Erection of new shelter pavilion 20 feet by 10 feet, S.S. No. 2613. (S.S., Tullamarine.)  
 Warracknabeal.—Purchase and removal of old Police Station Residence. (W.O., Warracknabeal.)  
 Warrnambool.—Remodelling of science room, provision of chalkboards, High School. (W.O., Warrnambool; H.S., Warrnambool.)  
 Warrnambool East.—Erection of six class-room L.T.C. primary school building, S.S. No. 4773. (W.O., Warrnambool.)  
 Warrnambool East.—Supply, delivery, installation and testing of a warm air heating ventilation system in S.S. No. 4773. (W.O., Warrnambool.)  
 Yarram.—Rewiring of and additions to electrical installation, Court House. (W.O., Korumburra; Traralgon; P.S., Yarram.)

19th November, 1957.

Kew.—Alterations, new garage, new fence, Police Station.  
 Malvern.—Internal repairs and painting to Sergeant's Residence, Police Station.

All tenders should be on a "firm tender" basis.

Tenders to be addressed to the Honorable the Commissioner of Public Works, and envelope containing tender marked "Tender for \_\_\_\_\_ due \_\_\_\_\_."

T. K. MALTBY,  
 Commissioner of Public Works.

Public Works Department,  
 Melbourne, 22nd October, 1957.

TENDERS FOR THE SERVICE, 1957-58.

GENERAL STORES.

TENDERS will be received until Eleven o'clock a.m. on Friday, 29th November, 1957, from persons willing to supply the under-named articles in such quantities as may be ordered by the Victorian Government during the twelve months commencing 1st January, 1958:—

Schedule No.

52. Tools (General).

75. Tyres and Tubes, Pneumatic, for Motor-cars, Trucks, Buses, Motor-cycles and Side-cars, and Bicycles.

The prices tendered must not include sales tax.

Security:—Five per cent. of total amount of tender accepted, but in no case will security of less than £3 be received.

Schedules as above, with full particulars, may be obtained from the Secretary to the Tender Board, by whom also the samples will be shown and any information afforded to persons tendering.

In all cases the total cost of each item must be extended in the columns provided.

Security will be required either in Commonwealth Treasury bonds, or approved bank guarantee, fixed deposit receipt, Savings Bank deposit book, or non-negotiable cheque in favour of the Secretary to the Tender Board, as the tenderer may elect.

The security must be completed and the contract signed within five days of acceptance of the tender, failing which the contract may be again advertised, or another tender accepted.

The lowest or any tender will not necessarily be accepted.

In the event of tenderers withdrawing or attempting to withdraw their tenders before notification of acceptance of same, or failing to take up their accepted tenders within the prescribed period after notification of acceptance, they may be disqualified from tendering or holding any future contracts for Government supplies for a period of twelve months, such disqualification to date from the notification of acceptance of tender. It is also stipulated that, if a tenderer be a member of a firm and such firm be interested in the contract, the tender shall be in the name of the firm and not in that of the individual and that, for a breach of this condition the tender will be declared informal.

Tenders enclosed in a separate envelope, and having the words "Tender for" (as the case may be) written thereon, must be deposited in the tender-box at the Tender Board Offices, Macarthur-street, Melbourne, or, if sent by post, postage must be prepaid and the tenders addressed to the Chairman of the Tender Board, Tender Board Offices, Macarthur-street, Melbourne, C.2, which office they must reach not later than by first post on the date of closing of tenders.

The conditions of contract are those published in the *Victoria Government Gazette*, No. 146, dated 3rd April, 1957, pages 1173 and 1174.

The Treasury,  
Melbourne, 21st October, 1957.

H. E. BOLTE,  
Treasurer.

TENDERS FOR THE SERVICE, 1957-58.  
PROVISIONS—MEAT.

TENDERS will be received until Eleven o'clock a.m. on Friday, 22nd November, 1957, from persons willing to furnish the under-mentioned supplies, in such quantities as may be ordered by the Victorian Government—delivery to be made at the under-mentioned places—during the three months commencing on 1st January, 1958.

The prices tendered must not include sales tax.

In all cases the total cost of each item must be extended in the columns provided.

The places for which tenders will be received and the amount of the security required for the due fulfilment of each contract, are as follows:—

	Security.
	£
Schedule No. 1.—Melbourne District—	
Meat—Kew Mental Hospital .. .. .	35
„ Pentridge Penal Establishment, Coburg, and "Fairlea" Female Prison, Fairfield .. .. .	35
„ Children's Welfare Depot, Royal Park; and Travancore Developmental Centre, Flemington .. .. .	8
„ "Winlaton" Juvenile School, Nuna- wading .. .. .	5
„ Receiving House and Mental Hospital, Royal Park .. .. .	10
Schedule No. 2.—Mont Park, Bundoora, Larundel, Janeffeld, Gresswell, and Pleasant View, Wood-street, Preston—	
Meat—Mont Park .. .. .	50
„ Preston .. .. .	5
Schedule No. 3.—S.S. Rip and Dredges—	
Meat .. .. .	5
Schedule No. 4.—Teachers' Colleges and Hostels at Grattan-street, 93 Drummond-street, Carlton; 470 and 481 St. Kilda-road, Melbourne; 152 Toorak-road west, South Yarra; Tate House, 373 Dandenong-road, Armadale; "Redcourt," No. 6, and "Larnook," 13 Orrong-road, Arma- dale; 11 Patterson-street, Hawthorn; 221 Burwood-road, Burwood; John Cannon House, 32 Belmont-avenue, Kew; and 17 Moule-avenue, Brighton; Henry Watson House, 260 Domain- road, South Yarra; and Police Hospital, St. Kilda-road, Melbourne—	
Meat .. .. .	15

Schedule No. 5.—Heatherton Sanatorium, Chel- tenham—	£
Meat .. .. .	5
Schedule No. 6.—Ararat District—	
Meat .. .. .	30
Schedule No. 7.—Ballarat District—	
Meat—Gaol, Mental Hospital .. .. .	35
„ Teachers' Hostels .. .. .	5
Schedule No. 8.—Beechworth District—	
Meat .. .. .	30
Schedule No. 9.—Bendigo District—	
Meat—Gaol, Mental Hospital .. .. .	5
„ Teachers' Hostels .. .. .	5
„ Training Centre, Mental Hygiene .. .. .	5
Schedule No. 10.—Castlemaine District—	
Meat .. .. .	3
Schedule No. 11.—School of Forestry, Creswick—	
Meat .. .. .	5
Schedule No. 13.—McLeod Settlement, French Island—	
Meat .. .. .	5
Schedule No. 14.—Geelong District—	
Meat—Gaol .. .. .	5
„ Teachers' Hostels .. .. .	5
Schedule No. 15.—Coorimungie Prison Camp, Heytesbury Forest—	
Meat .. .. .	4
Schedule No. 17.—Langi Kal Kal Training Centre—	
Meat .. .. .	5
Schedule No. 20.—Sale Gaol—	
Meat .. .. .	3
Schedule No. 21.—Pleasant Creek Special School, Stawell—	
Meat .. .. .	3
Schedule No. 22.—Sunbury District—	
Meat .. .. .	40
Schedule No. 23.—Warrnambool District—	
Meat .. .. .	5

Printed forms of tender and the conditions of contract may, in all cases, be obtained from the Secretary to the Tender Board, Macarthur-street, Melbourne, by whom also any information or explanation will be afforded to persons tendering.

Security will be required either in Commonwealth Treasury Bonds, or approved bank guarantee, fixed deposit receipt, Savings Bank deposit book, or non-negotiable cheque in favour of the Secretary to the Tender Board, as the tenderer may elect.

The security must be completed and the contract signed within five days of acceptance of the tender, failing which the service may be again advertised, or another tender accepted.

The lowest or any tender will not necessarily be accepted.

In the event of tenderers withdrawing or attempting to withdraw their tenders before notification of acceptance of same, or failing to take up their accepted tenders within the prescribed period after notification of acceptance they may be disqualified from tendering or holding any future contracts for Government supplies for a period of twelve months, such disqualification to date from the notification of acceptance of tender. It is also stipulated that, if a tenderer be a member of a firm and such firm be interested in the contract, the tender shall be in the name of the firm and not in that of the individual and that, for a breach of this condition, the tender will be declared informal.

Tenders, enclosed in a separate envelope, and having the words "Tender for" (as the case may be) written thereon, must be deposited in the Tender Box at the Tender Board Offices, Macarthur-street, Melbourne, or, if sent by post, postage must be prepaid, and the tenders addressed to the Chairman of the Tender Board, Tender Board Offices, Macarthur-street, Melbourne, C.2, which office they must reach not later than by first post on the date of closing of tenders.

CONDITIONS OF CONTRACT.

The conditions of contract are those published in the *Victoria Government Gazette*, No. 158, dated 1st May, 1957, pages 1462 to 1464.

H. E. BOLTE,  
Treasurer.

The Treasury,  
Melbourne, 21st October, 1957.

## PUBLIC SERVICE NOTICES

## PUBLIC SERVICE (PUBLIC SERVICE BOARD) REGULATION 39.—RECLASSIFICATIONS.

THE Public Service Board has raised the classification of the under-mentioned offices as shown, and the Permanent Heads of the Departments have recommended the officers named for appointment.

Office and Present Classification.	Revised Classification.	Duties.	Qualifications.	Officer Recommended for Appointment.		
				Name.	Classification.	Date of Classification.

## ADMINISTRATIVE DIVISION.

## DEPARTMENT OF HEALTH.

*Mental Hygiene Branch.*

Class "C2"	Class "B"	To act as Purchasing and Stores Officer	To have had experience in the purchasing and control of stores, clothing, provisions, drugs, &c.; to have ability to conduct interviews and correspondence on matters pertaining to the requirements of Mental Hospitals and Clinics; an intimate knowledge of the Public Service Acts and Regulations, and Regulations respecting Public Accounts	Rae, W. J. A.	Class "C2"	9.1.56
------------	-----------	---	--	---------------	------------	--------

## PROFESSIONAL DIVISION.

## DEPARTMENT OF PREMIER.

*Soil Conservation Authority.*

Assistant Conservation Officer (Technical and General Division)	Conservation Officer, Classes "C" and "C2"	To advise landholders on soil conservation measures; to carry out surveys for contour layout; to assist in the carrying out of soil conservation works	To have a thorough knowledge of the characteristics and use of land; experience in the practice of agriculture, and a knowledge of the principles and application of soil conservation methods; to be qualified in accordance with the provisions of Public Service (Public Service Board) Regulation 43 (1)	Garside, L. D.	Assistant Conservation Officer (Technical and General Division)	21.7.54
---	--	--	--	----------------	---	---------

## DEPARTMENT OF PUBLIC WORKS.

*Mechanical and Electrical Engineering Branch.*

Assistant Engineer, Class "C2"	Engineer, Class "B"	To prepare reports, plans, and specifications for the installation of equipment used in the preparation, cooking, and storage of food, and supervise the installation of such equipment; to be responsible, under direction, for the maintenance of such equipment, including refrigeration	To have had a sound technical training in mechanical engineering, and wide experience in the general planning and construction of kitchen equipment and associated maintenance of such equipment	Gunst, R. L.	Assistant Engineer, Class "C2"	9.1.50
Assistant Chief Mechanical and Electrical Engineer, Class "A" (£1,650-£1,750)	Class "A1" (£1,800-£1,900)	Under direction, to control the Design Section of the Mechanical and Electrical Engineering Branch engaged on the preparation of plans, specifications, and estimates for mechanical and electrical plant and installations for all types of Government buildings and hospitals; to assist the Chief Mechanical and Electrical Engineer in the general administration of the Mechanical and Electrical Engineering Branch	To possess a University Degree or a Technical School Diploma in Engineering; to have had extensive experience in the design, operation, and testing of modern mechanical and electrical equipment in large buildings and hospitals; to be capable of controlling and directing staff	Serpell, G. G.	Assistant Chief Mechanical and Electrical Engineer, Class "A" (£1,650-£1,750)	10.12.51

*Architectural Branch.*

Senior Designing Architect, Class "A" (£1,550-£1,650)	Superintending Architect (Design), Class "A1" (£1,800-£1,900)	To prepare, under the direction of the Chief Architect, projects for all types of Government buildings, to control a specialized section of the design staff, and to superintend the activities of the Senior Designing Architects	To be a fully qualified architect, possessing a University degree or a diploma of architecture, or to be a member of the Royal Victorian Institute of Architects, and to possess a wide experience in the planning and designing of modern buildings	Prentice, R. R.	Senior Designing Architect, Class "A" (£1,550-£1,650)	5.12.49
---	---	--	--	-----------------	---	---------

PUBLIC SERVICE (PUBLIC SERVICE BOARD) REGULATION 39.—RECLASSIFICATIONS—continued.

Office and Present Classification.	Revised Classification.	Duties.	Qualifications.	Officer Recommended for Appointment.		
				Name.	Classification.	Date of Classification.
PROFESSIONAL DIVISION—continued.						
DEPARTMENT OF AGRICULTURE.						
Agricultural Research Officer, Class "C2"	Agricultural Research Officer (Tobacco), Class "B"	Subject to the the Superintendent, to be responsible for the overall planning and supervision of tobacco investigations carried out by officers of the Agricultural Division and for the analysis and interpretation on investigational projects, conduct surveys and prepare submissions concerning new work, and carry out such other duties as may be required	A degree in Agricultural Science of Melbourne University; comprehensive experience in the conduct of tobacco investigational projects and the analysis and interpretation of results obtained from such projects	French, F. L.	Agricultural Research Officer, Class "C2"	12.4.56
Entomologist Class "C2" (two offices)	Class "B" (two offices)	Under the Chief Biologist, to conduct research work on problems of economic Entomology, particularly on Fruit Insect Pest problems; to carry out advisory work involving identification of insect pest specimens field surveys on the incidence of insect pest outbreaks, field demonstrations on their control, the preparation of sound technical reports and to deliver lectures on this subject	To possess the degree of Bachelor of Agricultural Science or Science with a sound experience in the conduct of research and advisory work in the field of economic entomology; capacity to prepare technical reports, to deliver lectures on this subject and a general knowledge of Agricultural and Horticultural practice	Morris, D. S.	Entomologist Class "C2"	23.2.56
		Under the Chief Biologist, to conduct research work on problems of economic entomology, including virus insect vectors; to carry out advisory work involving identification of insect pest specimens, field surveys on the incidence of insect pest outbreaks, field demonstrations on their control, the preparation of sound technical reports and to deliver lectures on this subject	To possess the degree of Bachelor of Agricultural Science or Science with a sound experience in the conduct of research and advisory work in the field of economic entomology; capacity to prepare technical reports, to deliver lectures on this subject and a general knowledge of Agricultural and Horticultural practice	O'Loughlin, G. T.	Entomologist, Class "C2"	6.1.56
Farm Survey Research Officer, Class "C2"	Class "B"	To conduct business surveys of farm costs in relation to the agricultural industries of the State; to conduct investigations into the economics of different systems of farm management and agricultural practice; to carry out such other investigations of an economic nature in relation to agricultural commodities as are required	Degree of Bachelor of Agricultural Science or its equivalent; sound general knowledge of Victorian agriculture with specialized training and experience in the carrying out of farm cost surveys and farm management studies	Meadley, D. R.	Farm Research Officer, Class "C2"	13.9.54
Field Agrostologist, Class "C2"	District Irrigation Officer Class "B"	Subject to the Superintendent of Agriculture, to conduct district investigations and carry out advisory work, in connexion with the establishment, maintenance and utilization of irrigated pastures, lucerne and fodder crops and problems of salt-affected lands; to generally promote the improvement of irrigation practices and pasture development	A degree in Agricultural Science, Melbourne University or its equivalent; experience in the conduct of field trials in respect to irrigated Agriculture and reclamation of salt-affected lands; proved ability to undertake irrigation advisory work, including lectures, broadcasts, the writing of articles and farm inspections	Garland, K. R.	Field Agrostologist, Class "C2"	21.2.57
Field Agrostologist, Class "C2"	Irrigation Research Officer Class "B"	Subject to the Superintendent of Agriculture, to conduct investigations into the hydraulic and hydrological problems of pasture irrigation and into related aspects of soil physics; to prepare reports and deliver lectures, in regard to such investigations	A Degree in Agricultural Science, Melbourne University, or its equivalent; experience in the conduct of investigations into hydraulic and hydrological problems of pasture irrigation; proved ability in the preparation of reports and delivery of lectures	Bartels, L. F.	Field Agrostologist, Class "C2"	31.3.56

PUBLIC SERVICE (PUBLIC SERVICE BOARD) REGULATION 39.—RECLASSIFICATIONS—*continued.*

Office and Present Classification.	Revised Classification.	Duties.	Qualifications.	Officer Recommended for Appointment.		
				Name.	Classification.	Date of Classification.
<b>PROFESSIONAL DIVISION—<i>continued.</i></b>						
<b>DEPARTMENT OF AGRICULTURE—<i>continued.</i></b>						
Geneticist (Vegetables) Class "C2"	Class "B"	Subject to the Superintendent of Agriculture, to undertake the development of breeding projects relating to the improvement of yield, quality and disease resistance in vegetable and horticultural crops	Degree in Agricultural Science of an Australian University; knowledge of modern breeding techniques; experience in the planning and execution of breeding programmes relating to vegetable and horticultural crops; ability to control staff	Pryke, P. I.	Geneticist (Vegetables) Class "C2"	28.6.56
Horticultural Research Officer, Class "C2"	Class "B"	As directed, to make investigations into horticultural problems and to conduct demonstrational and advisory work on horticultural crops	A degree in Agricultural Science of the Melbourne University or its equivalent, capacity for horticultural research and a practical knowledge of Victorian horticulture	Keatley, J. C. E.	Horticultural Research Officer, Class "C2"	21.2.57
Plant Pathologist, Class "C2" (two offices)	Class "B" (two offices)	Under the Chief Biologist, to conduct research and investigational work into the cause and control of Victorian plant disease problems, particularly fruit diseases; to survey plant disease outbreaks and to deliver lectures; to conduct field experiments and any other work in Plant Pathology as required	To possess the degree of Bachelor of Agricultural Science or a degree in Science with a sound post-graduate training in Plant Pathology, experience in the conduct of research and advisory work in plant disease problems and their control; capacity to lecture and to conduct laboratory and field experiments and to prepare suitable scientific reports	Jenkins, P. T.	Plant Pathologist, Class "C2"	7.2.57
		Under the Chief Biologist, to conduct research and investigational work into the cause and control of Victorian plant disease problems, particularly those caused by nematodes; to survey plant disease outbreaks and to deliver lectures; to conduct field experiments and any other work in Plant Pathology as required	To possess the degree of Bachelor of Agricultural Science, or a degree in Science, with a sound post-graduate training in Plant Pathology; experience in the conduct of research and advisory work in plant disease problems and their control; capacity to lecture and to conduct laboratory and field experiments and to prepare suitable scientific reports	Meagher, J. W.	Plant Pathologist, Class "C2"	11.4.57
<b>DEPARTMENT OF WATER SUPPLY.</b>						
District Engineer, Grade II., Class "B1"	Grade I., Class "A" (£1,550—£1,650)	To supervise staff and control all rural and urban water supplies, works, and expenditure within the Murtoa Centre; to direct surveys and to prepare plans, specifications, estimates, and reports, in regard to new works within the District, to supervise construction and maintenance of works, and to control water distribution within the Centre	To possess a degree or technical school diploma in civil engineering or other engineering qualifications; to be competent to carry out surveys and supervise water distribution; to be well versed in modern engineering practice and the design, construction and maintenance of channels and structures and water supply works; to be conversant with the control of water and with land values and have a thorough knowledge of the provisions of the Water Acts	Paul, A. C. . .	District Engineer, Grade II., Class "B1"	22.3.55
Hydrographer, Class "C"	Class "C1"	To establish and maintain river gauging stations, to make topographical surveys of streams, and to collect other hydrographic data; to maintain gauging equipment and automatic installations; to control gauge readers, and to make stream flow and survey computations	To have had extensive experience in hydrographic survey work, and experience in the use of survey instruments and in the compilation of plans and working drawings	Keep, A. G.	Hydrographer, Class "C"	8.6.53

PUBLIC SERVICE (PUBLIC SERVICE BOARD) REGULATION 39.—RECLASSIFICATIONS—continued.

Office and Present Classification.	Revised Classification.	Duties.	Qualifications.	Officer Recommended for Appointment.		
				Name.	Classification.	Date of Classification.
<b>TECHNICAL AND GENERAL DIVISION.</b>						
DEPARTMENT OF CHIEF SECRETARY.						
<i>State Motor Car Insurance Office.</i>						
Engineering Assessor	Engineering Assessor, Senior (£764-£790)	To act as Senior Assessor; to train and supervise Assessors; to arrange purchasing and repair facilities	To possess an "A" Grade Motor Mechanic's Certificate; to be experienced as an Assessor; to have proven ability to control staff and deal with clients	Lewis, N. A.	Engineering Assessor	1.7.54
DEPARTMENT OF LAW.						
<i>Courts Branch.</i>						
Assistant (Male), Grade II.	Grade I. (£481-£494)	To have charge of the Files and Records room at the City Court, Melbourne	To have a sound knowledge of the various types of Court Process relating to matters in the Civil Criminal and Quasi-Criminal Jurisdiction at the City Court, Melbourne	Ryan, J. T.	Assistant (Male), Grade II.	15.8.54

Appeals against such recommendations should be lodged with the Secretary to the Public Service Board not later than Saturday, the 2nd November, 1957.

Office of the Public Service Board,  
Melbourne, 22nd October, 1957.

By order,  
J. F. HALL,  
Acting Secretary.

PUBLIC SERVICE (PUBLIC SERVICE BOARD) REGULATION 39.—VACANCIES.

THE Permanent Heads of the Departments shown have recommended the officers named hereunder for appointment to the under-mentioned vacancies.

Office and Classification.	Duties.	Qualifications.	Officer Recommended for Appointment.		
			Name.	Classification.	Date of Classification.
<b>ADMINISTRATIVE DIVISION.</b>					
DEPARTMENT OF WATER SUPPLY.					
Officer in Charge, Stores Branch, Class "A" (£1,550-£1,650)	Under the Manager, Stores Branch, to be responsible for the purchase and issue of stores and materials for water supply works controlled by the Commission throughout the State	To be familiar with all types of stores and materials and mechanical plant and equipment used on the Commission's works, and to be capable of directing the work of a large staff. A thorough knowledge of the Commission's organization and stores system is essential	Forrester, L. R.	Class "B1"	27.8.51
<b>PROFESSIONAL DIVISION.</b>					
DEPARTMENT OF PUBLIC WORKS.					
Senior Architect, Class "B1"	To prepare, under the direction of the Chief Architect, preliminary and contract plans, details, specifications, reports, and estimates, and to generally supervise and guide a section of the draughting staff	To be a qualified architect experienced in the planning of modern buildings for State purposes, and to be capable of guiding a section of the draughting staff in problems arising in planning and design	Scharp, E. B. . .	Assistant District Architect, Class "B"	31.10.48
DEPARTMENT OF STATE FORESTS.					
Senior Draughtsman, Class "B"	To act as deputy to the Chief Draughtsman in the supervision of Drawing Office staff duties; to be responsible for the proper implementation of plan requirements of the Commission's Head Office, Divisional and Forest District Offices, including the maintenance of forest works progress and plantation records plans; to prepare material for half-tone and multi-colour reproduction, and to ensure the proper processing and treatment of negatives, plates, and colour media	To have a sound knowledge of the principles of planning operations in the management of forests, and the compilation and maintenance of basic works records plans; to be a competent lithographer; to have had experience in modern photo-lithographic processes; and to be competent in the practical treatment of material for multi-colour reproduction from metal by direct and offset processes; to possess ability to give instruction in penmanship, line, and half-tone drawing	Hilcke, R. F. . .	Senior Draughtsman, Class "C2"	12.5.52

Appeals against such recommendations should be lodged with the Secretary to the Public Service Board not later than Saturday, the 2nd November, 1957.

Office of the Public Service Board,  
Melbourne, 22nd October, 1957.

By order,  
J. F. HALL,  
Acting Secretary.

## PUBLIC SERVICE OF VICTORIA.—VACANCIES.

## DEPARTMENT OF HEALTH.

## MENTAL HYGIENE BRANCH.

## TECHNICAL AND GENERAL DIVISION.

APPLICATIONS will be received by the Public Service Board up to Wednesday, the 13th November, 1957, from persons employed in the Public Service of Victoria, who are eligible and qualified for appointment to the under-mentioned positions:—

**Deputy Charge Nurse (Male), Beechworth Mental Hospital.**

*Yearly Salary.*—£468, minimum; £494, maximum.

*Duties.*—To be second in charge of a ward and to relieve the Charge Nurse.

*Qualifications.*—To possess the Mental Hygiene Nursing Certificate and to have had experience in a Mental Hospital; to be a registered Mental Nurse.

**Charge Nurse (Female), All Institutions.**

*Yearly Salary.*—£443, minimum; £469, maximum.

*Duties.*—To take charge or sub-charge of a ward in a Mental Hospital.

*Qualifications.*—To possess the Mental Hygiene Nursing Certificate and to have had experience as a Deputy Charge Nurse (Female) in a Mental Hospital; to be a registered Mental Nurse.

*NOTE.*—The salary rates quoted above do not include the additional amounts which are payable under Regulation 77A of the Board's Regulations.

By order,

J. F. HALL,  
Acting Secretary.

Office of the Public Service Board,  
Melbourne, 22nd October, 1957.

## PUBLIC SERVICE OF VICTORIA.—VACANCIES.

(TEMPORARY APPOINTMENTS.)

APPLICATIONS will be received by the Public Service Board up to Wednesday, the 6th November, 1957, from persons who are qualified for appointment to the under-mentioned positions:—

**Claims Investigator, State Insurance Offices, Department of Chief Secretary.** (Three vacancies.)

*Yearly Salary.*—£715, minimum; £741, maximum.

*Duties.*—To investigate and report on Motor Car and Workers' Compensation claims.

*Qualifications.*—To have a practical knowledge of Motor Car and Workers' Compensation Insurance and experience in investigating and reporting on claims in respect of these types of business. A person with a good knowledge of the Motor Car and Workers' Compensation Acts and the law of negligence is preferred.

**Biograph Operator (Projectionist), Visual Education Centre, Department of Education.**

*Yearly Salary.*—£674.

*Duties.*—To assist in the maintenance of the film library and to operate and maintain a mobile unit which will travel to country districts in alternate weeks.

*Qualifications.*—To be an experienced projectionist, to have had experience in the servicing, care and maintenance of 16-mm. sound projectors and films. A knowledge of the titles and classification of educational films. Experience in the use of educational documentary films used in schools will be considered an advantage.

*NOTE.*—Evidence of the above requirements should be submitted. The person appointed will be required to provide his own car of at least 10 H.P. for the use of which an allowance will be paid.

**Radio Technician, Department of State Forests.**

*Yearly Salary.*—£450, minimum; £489, maximum.

*Duties.*—To install and service fixed and mobile radio equipment and instruct field officers in its use; under the supervision of the Radio Engineer to construct medium and highpower radio transmitters and high sensitivity radio receivers and to carry out incidental design associated with such construction.

*Qualifications.*—To be a qualified radio tradesman and preference will be given to holders of 1st Class Commercial Operator's Certificate of Proficiency or its equivalent and to be the holder of a current car driver's licence.

*NOTE.*—The salary rates quoted above do not include the additional amount which is payable under Regulation 77A of the Board's Regulations.

By order,

J. F. HALL,  
Acting Secretary.

Office of the Public Service Board,  
Melbourne, 22nd October, 1957.

## PUBLIC SERVICE OF VICTORIA.—VACANCIES.

APPLICATIONS will be received by the Public Service Board up to Wednesday, the 6th November, 1957, from persons employed in the Public Service of Victoria, who are eligible and qualified, for appointment to the under-mentioned positions:—

## ADMINISTRATIVE DIVISION.

**Assistant Secretary, Mental Hygiene Authority and Mental Hygiene Branch, Class "A," Department of Health.**

*Yearly Salary.*—£1,550, minimum; £1,750, maximum.

*Duties.*—To assist the Secretary in the general administration of the Branch, particularly in relation to the operation of the Mental Hygiene Acts and relevant legislation and to relieve the Secretary as required.

*Qualifications.*—A thorough knowledge of the Mental Hygiene Acts and of the administration of mental hospitals and of ancillary mental hygiene services.

**Class "C2," Commonwealth Scholarships Branch, Department of Education.**

*Yearly Salary.*—£940, minimum; £1,030, maximum.

*Duties.*—To conduct interviews with scholarship holders and to advise them of their rights and obligations under the scheme and of the appropriate guidance authority to which, in certain circumstances, they should apply for guidance; to keep a detailed record of interviews and to assist in the preparation of statistics; to assist with publicity for the Commonwealth Scholarship Scheme.

*Qualifications.*—Experience in conducting interviews and the preparation of statistics; a knowledge of University and Senior Technical School courses and procedures is desirable. Applicants should have completed or partly completed a University degree or diploma course.

**Class "C2," Department of Public Works.**

*Yearly Salary.*—£940, minimum; £1,030, maximum.

*Duties.*—Under the Officer-in-Charge, Works Administration Branch, to be responsible for the contract books; the checking and passing of all payments in respect of contracts, and the finalization of all files relating thereto.

*Qualifications.*—A knowledge of the relevant Acts and regulations; experience in departmental practice and procedure and in dealing with accounts; ability to control staff and experience in dealing with contractors.

**Class "C2," Department of Labour and Industry.**

*Yearly Salary.*—£940, minimum; £1,030, maximum.

*Duties.*—To act as Secretary to Wages Boards, and to keep minutes and records of Wages Board proceedings; to draft Determinations and assist in the supervision of the clerical work of the Wages Board Branch.

**Qualifications.**—To possess a thorough knowledge of the Labour and Industry Acts and Regulations so far as they affect the functions of Wages Boards. Ability to draft Determinations is required and a knowledge of departmental procedure.

**Class "C," Department of Education.**

**Yearly Salary.**—£598, minimum; £728, maximum.

**Duties.**—To act as deputy to the head of the Inspection Branch; to arrange for the medical examinations for members of the Teaching Service and for applicants for appointment thereto; to deal with reports submitted by the School Medical Officers.

**Qualifications.**—A good knowledge of the Superannuation Board's requirements relating to medical examinations and of the required medical standards for members of the Teaching Service; ability to conduct correspondence and interviews.

**Class "C," Department of Water Supply.**

**Yearly Salary.**—£598, minimum; £728, maximum.

**Duties.**—To analyse requisitions for stores and materials and to prepare orders for supplies required.

**Qualifications.**—To have a thorough knowledge of stores organization; and a knowledge of types of stores required for works and of firms from whom supplies can be obtained.

**PROFESSIONAL DIVISION.**

**Superintendent of Aborigines Welfare (Male), Classes "B1"—"A," Department of Chief Secretary.**

**Yearly Salary.**—£1,300, minimum; £1,550, maximum. (Commencing salary according to qualifications and experience.)

**Duties.**—To be the principal Field Officer of the Aborigines Welfare Board responsible for carrying into effect decisions and directions of the Board concerning the welfare of aborigines and their assimilation into the general community; to investigate matters bearing on the welfare of aborigines; supervise the arrangement or supply of services or assistance approved by the Board for aborigines; advise and assist aborigines in the observance of their responsibilities and in obtaining and remaining in employment and protect them from imposition or injustice; to enlist the practical interest of local organizations and individuals in the welfare and assimilation of aborigines, and act generally as the representative of the Board in its welfare work.

**Qualifications.**—A University Diploma of Social Studies or its equivalent, preferably with a background of anthropology. The temperament and experience in aboriginal welfare work to inspire confidence in the aborigines and members of the public. Initiative, organizing and administrative ability and a thorough understanding of factors affecting the assimilation of aborigines.

**NOTE.**—The successful applicant will be required to travel throughout Victoria and possess an approved motor vehicle and will be paid a mileage allowance therefor at the prescribed rate.

**Agronomist (Vegetables), Classes "B"—"B1," Department of Agriculture.**

**Yearly Salary.**—£1,100, minimum; £1,400, maximum.

**Duties.**—Under the Superintendent of Horticulture to supervise the research, advisory and seed certification work of the Department on vegetable crops and to be in charge of officers in the Horticulture Division engaged primarily on vegetable and vegetable seed work.

**Qualifications.**—A Degree in Agricultural Science of the Melbourne University or its equivalent; an extensive knowledge of vegetable and vegetable seed production in Victoria and a proved capacity for research and advisory work in these fields.

**Professional Assistant, Class "B," Office of the Public Solicitor, Department of Law.**

**Yearly Salary.**—£1,100, minimum; £1,200, maximum.

**Duties.**—To interview applicants for legal assistance; to prepare and conduct their applications in Court for leave to proceed *in forma pauperis* and to

conduct proceedings in the civil, divorce and criminal jurisdictions of the Supreme Court, County Courts, Courts of General Sessions and the Workers Compensation Board.

**Qualifications.**—To be a barrister and solicitor of the Supreme Court of Victoria; to have had adequate experience in the various jurisdictions of the Courts and in the procedure relating to the granting of legal aid.

**Assistant Engineer, Classes "C"—"C2," Department of Public Works. (Two vacancies.)**

**Yearly Salary.**—£785, minimum; £1,030, maximum—Graduates. £683, minimum; £1,030, maximum—Diplomates. (Commencing salary will be determined within this initial career range according to experience but advancement is not limited to the maximum quoted.)

**POSITION No. 1.**

**Architectural (Sewerage Section) Branch.**

**Duties.**—To prepare plans and specifications for water supply, storm-water and sewerage installations to public buildings and institutions.

**Qualifications.**—To possess a University Degree or Diploma in Civil Engineering or other recognized qualifications, preferably with some experience in design and construction of water supply, storm-water and sewerage installations.

**POSITION No. 2.**

**Architectural (Structural Section) Branch.**

**Duties.**—To prepare designs and details of structural work connected with departmental buildings.

**Qualifications.**—To possess an approved Degree or Diploma in Civil Engineering or to be an Associate Member of the Institution of Engineers, Australia; preferably with three years' experience in the design and detailing of structures in steel, reinforced concrete and timber.

**Guide Lecturer and Curator of Australian Art, Class "C1," National Gallery Branch, Department of Chief Secretary.**

**Yearly Salary.**—£785, minimum; £875, maximum.

**Duties.**—To conduct groups of school children and of adults on visits to the Gallery and to deliver lectures on all phases of art represented in the Gallery's collections; to be curator of the collections of Australian paintings and sculpture, and to study and interpret these collections for the benefit of the public.

**Qualifications.**—To possess a degree in the Fine Arts or its equivalent; to have wide experience in the visual arts, including a knowledge of the applied arts; to be experienced in lecturing, particularly to younger people.

**Professional Assistant, Class "C1," Crown Solicitor's Office, Department of Law.**

**Yearly Salary.**—£785, minimum; £875, maximum.

**Duties.**—To advise on files submitted by Government Departments and Instrumentalities in relation to proposed prosecutions and where necessary to draft and cause to be issued informations and other necessary summonses and documents in relation thereto; to conduct prosecutions in Courts of Petty Sessions throughout Victoria and to assist generally in the work of the Petty Sessions Prosecution Branch.

**Qualifications.**—To be a Barrister and Solicitor of the Supreme Court of Victoria who has had experience in conducting prosecutions in the Court of Petty Sessions.

**TECHNICAL AND GENERAL DIVISION.**

**Aborigines Welfare Officer (Male), Department of Chief Secretary.**

**Yearly Salary.**—£600, minimum; £678, maximum.

**Duties.**—To assist the Superintendent of Aborigines Welfare as required and investigate and report upon matters concerning the welfare and assimilation of aborigines as directed by the Aborigines Welfare Board.



**Qualifications.**—Good physique and education, and experience in social services work, preferably amongst aborigines; temperamental ability to inspire confidence in the aborigines and promote good social relations between them and the general community.

**NOTE.**—The successful applicant will be required to travel throughout Victoria and possess an approved motor vehicle and will be paid a mileage allowance therefor at the prescribed rate.

**Works Inspector, Murray Valley District (Nathalia), Department of Water Supply.**

**Yearly Salary.**—£565, minimum; £617, maximum.

**Duties.**—To supervise water distribution within his section of the district, and, under direction of the District Engineer or his deputy, to supervise the construction, maintenance and repair of works of water supply and drainage in the western portion of the Murray Valley Irrigation District; to supervise gangs and workmen engaged on these works; to be responsible for material and equipment in his charge and to keep records of work done and render reports thereon as required.

**Qualifications.**—To be capable of setting out work from plans; to have had extensive experience in the construction, maintenance and repair of supply channels and drainage systems in Irrigation Districts, and in the distribution and disposal of water therein; to have the capacity for handling men and supervising gangs engaged on the construction, maintenance and repair of district works; to be capable of keeping records required in association with such works.

**Assistant Conservation Officer, Soil Conservation Authority, Department of Premier. (Three vacancies.)**

**Yearly Salary.**—Junior—At 18 years of age, £293; at 19 years of age, £332; at 20 years of age, £384. Adult—£475, minimum; £657, maximum.

**Duties.**—Under direction, to advise landholders on land use and soil conservation practices and measures; to carry out surveys for soil conservation projects and works and to assist in the carrying out of such works.

**Qualifications.**—To have a knowledge of the characteristics and use of land and of the principles of soil conservation; to have experience in the practice of agriculture and in the application of soil conservation methods; to hold either the Diploma of Agriculture of a recognized agricultural college or the Certificate of Longerenong Agricultural College granted prior to 1946.

**Cash Register Operator, Motor Registration Branch, Office of the Chief Commissioner of Police, Department of Chief Secretary.**

**Yearly Salary.**—£570, minimum; £598, maximum.

**Duties.**—To operate a cash register.

**Qualifications.**—Ability to operate a multiple cash register and to handle and account for public moneys.

**Assistant (Male), Chemical Laboratory, Morgue, Coroner's Office, Department of Law.**

**Yearly Salary.**—Junior—At 18 years of age, £269; at 19 years of age, £321; at 20 years of age, £373. Adult—£438, minimum; £464, maximum.

**Duties.**—To carry out routine chemical tests and to assist generally in the laboratory.

**Qualifications.**—To have School Leaving Certificate or its equivalent and some training in chemistry and preferably to be pursuing a course of study in chemistry with a view to obtaining qualification.

**Watchman, Department of Public Works.**

**Yearly Salary.**—£325, minimum; £338, maximum.

**Duties.**—To carry out night-watching duties at the State Public Offices, 61 Spring-street, and other State Government Offices within the Treasury Reserve, Melbourne, C.2.

**Qualifications.**—To be active and in good health and to have a knowledge of the workings of the watchman's clock and fire alarm system.

**Labourer, Office of the Chief Commissioner of Police, Department of Chief Secretary.**

**Yearly Salary.**—£286, minimum; £299, maximum.

**NOTE.**—The salary rates quoted above do not include the additional amount which is payable under Regulation 77A of the Board's Regulations.

By order,

J. F. HALL,  
Acting Secretary.

Office of the Public Service Board,  
Melbourne, 22nd October, 1957.

No. 735.

Public Service Act 1946, Section 50.

**REGULATIONS.—PART III.—SALARIES, INCREMENTS, AND ALLOWANCES.**

THE Public Service Board, in pursuance of the powers conferred by the Public Service Act 1946, hereby amends its Regulations as shown below:—

**SECOND SCHEDULE.**

**TECHNICAL AND GENERAL DIVISION.**

*Offices and Rates of Salaries.*

Department and Office.	Yearly Rate of Salary.		Increments (Annual).
	Minimum.	Maximum.	
DEPARTMENT OF WATER SUPPLY.	£	£	
<i>Delete</i> —Inspector (Materials and Testing), Senior .. .. .	578	630	2 of £26
<i>Add</i> —Inspector (Materials and Testing), Senior .. .. .	617	669	2 of £26

*This Regulation shall have effect as on and from the 14th October, 1957.*

A. GARRAN, Chairman.  
J. F. HALL, Acting Secretary.

Office of the Public Service Board,  
Melbourne, 21st October, 1957.

No. 732.

Public Service Act 1946, Section 39.

**REGULATIONS.—PART III.—SALARIES, INCREMENTS, AND ALLOWANCES.**

THE Public Service Board, in pursuance of the powers conferred by the Public Service Act 1946, hereby amends its Regulations as shown below:—

**FIRST SCHEDULE.**

**PROFESSIONAL DIVISION.**

*Offices and Rates of Salaries.*

Office.	Yearly Rate of Salary.	
	Minimum.	Maximum.
DEPARTMENT OF PREMIER.	£	£
CLASS "B".		
<i>Add</i> —Publications and Information Officer, Soil Conservation Authority .. . . .	1,100	1,200
CLASS "C2".		
<i>Delete</i> —Publications and Information Officer, Soil Conservation Authority .. . . .	940	1,030

A. GARRAN, Chairman.  
V. P. SCULLY, Secretary.

Office of the Public Service Board,  
Melbourne, 14th October, 1957.

No. 731.

*Public Service Act 1946, Section 50.*

REGULATIONS.—PART III.—SALARIES, INCREMENTS, AND ALLOWANCES.

THE Public Service Board, in pursuance of the powers conferred by the *Public Service Act 1946*, hereby amends its Regulations as shown below :—

SIXTH SCHEDULE.  
TEMPORARY EMPLOYEES.

*Designations of Positions and Rates of Salaries.*

Department and Designation of Position.	Yearly Rate of Salary.		Increments (Annual).
	Minimum.	Maximum.	
DEPARTMENT OF HEALTH. GENERAL HEALTH.	£	£	
Delete— Analyst, Assistant .. .. .	494	572	3 of £26

A. GARRAN, Chairman.  
V. P. SCULLY, Secretary.

Office of the Public Service Board,  
Melbourne, 14th October, 1957.

No. 730.

*Public Service Act 1946, Section 50.*

REGULATIONS.—PART III.—SALARIES, INCREMENTS, AND ALLOWANCES.

THE Public Service Board, in pursuance of the powers conferred by the *Public Service Act 1946*, hereby amends its Regulations as shown below :—

SECOND SCHEDULE.

TECHNICAL AND GENERAL DIVISION.

*Offices and Rates of Salaries.*

Department and Office.	Yearly Rate of Salary.		Increments (Annual).
	Minimum.	Maximum.	
DEPARTMENT OF HEALTH. GENERAL HEALTH.	£	£	
Add— Assistant (Analytical) .. .	494	572	3 of £26

A. GARRAN, Chairman.  
V. P. SCULLY, Secretary.

Office of the Public Service Board,  
Melbourne, 14th October, 1957.

No. 734.

*Public Service Act 1946, Section 50.*

REGULATIONS.—PART III.—SALARIES, INCREMENTS, AND ALLOWANCES.

THE Public Service Board, in pursuance of the powers conferred by the *Public Service Act 1946*, hereby amends its Regulations as shown below :—

SIXTH SCHEDULE.  
TEMPORARY EMPLOYEES.

*Designations of Positions and Rates of Salaries.*

Department and Designation of Position.	Yearly Rate of Salary.		Increments (Annual).
	Minimum.	Maximum.	
DEPARTMENT OF CROWN LANDS AND SURVEY.	£	£	
Delete— Purchasing Officer .. .	514	540	1 of £26

A. GARRAN, Chairman.  
V. P. SCULLY, Secretary.

Office of the Public Service Board,  
Melbourne, 15th October, 1957.

No. 733.

*Public Service Act 1946, Section 50.*

REGULATIONS.—PART III.—SALARIES, INCREMENTS, AND ALLOWANCES.

THE Public Service Board, in pursuance of the powers conferred by the *Public Service Act 1946*, hereby amends its Regulations as shown below :—

SECOND SCHEDULE.

TECHNICAL AND GENERAL DIVISION.

*Offices and Rates of Salaries.*

Department and Office.	Yearly Rate of Salary.		Increments (Annual).
	Minimum.	Maximum.	
DEPARTMENT OF CROWN LANDS AND SURVEY.	£	£	
Add— Purchasing Officer .. .	514	566	2 of £26

A. GARRAN, Chairman.  
V. P. SCULLY, Secretary.

Office of the Public Service Board,  
Melbourne, 15th October, 1957.

PRIVATE ADVERTISEMENTS

CITY OF BRIGHTON.

BY-LAW No. 150.

NOTICE is hereby given that the above By-law for the purposes of—

- (a) repealing By-laws Nos. 96, 101, 108, and 114;
- (b) regulating the management and use of Municipal Baths situate at Middle Brighton;
- (c) fixing of fees to be charged for certain conveniences thereon and supply of various requisites and refreshments;
- (d) fixing of hours during which the Baths shall be open;

has been made and adopted by the Council and confirmed by the Governor in Council.

Copies of the said By-law are open for inspection free of charge during office hours at the office of the Council, Town Hall, Brighton.

Copies of such By-law are available for the sum of 1s. each.

H. C. FERGUSON, Town Clerk.

Town Hall, Brighton, 15th October, 1957. 2698

CITY OF BRIGHTON.

BY-LAW No. 151.

NOTICE is hereby given that the above By-law for the purposes of—

- (a) repealing By-laws Nos. 102, 109, and 115;
- (b) regulating the management and use of Municipal Baths situate at Brighton Beach;
- (c) fixing of fees to be charged for certain conveniences thereon and supply of various requisites and refreshments;
- (d) fixing of hours during which the Baths shall be open;

has been made and adopted by the Council and confirmed by the Governor in Council.

Copies of the said By-law are open for inspection free of charge during office hours at the office of the Council, Town Hall, Brighton.

Copies of such By-law are available for the sum of 1s. each.

H. C. FERGUSON, Town Clerk.

Town Hall, Brighton, 15th October, 1957. 2699

## CITY OF HAWTHORN.

## LOAN No. 34.

*Notice of Intention to Borrow the Sum of £30,000 for Permanent Works and Undertakings.*

NOTICE is hereby given that the Council of the City of Hawthorn proposes to borrow the sum of Thirty thousand pounds on the credit of the municipal revenues of the Mayor, Councillors, and Citizens of the said City, such sum to be raised by the issue of debentures in accordance with the provisions of the Local Government Acts.

1. The maximum rate of interest that may be paid is 5½ per centum per annum.
2. The purpose for which the loan is to be applied for is—

Construction of roads .. .. .	£26,000
Purchase and erection of traffic lights ..	£4,000

3. The period of the loan shall be fifteen years.
4. The moneys borrowed shall be repayable by providing out of the Municipal Fund 30 half-yearly instalments of approximately £1,481 10s. 8d. each, including principal and interest, on the 10th day of April and the 10th day of October during the currency of the loan. The first instalment shall be payable on the 10th day of April, 1958.
5. Such moneys shall be repayable at the principal office of the English, Scottish, and Australian Bank Ltd., Melbourne, or at the Council's bankers for the time being in the City of Melbourne.

The plans and specifications and the estimate of the cost of the proposed works, and a statement showing the proposed expenditure of the moneys to be borrowed, are open for inspection at the Municipal Offices, Town Hall, Hawthorn, during office hours.

Dated this 23rd day of October, 1957.

2730 J. T. GUNDRY, Town Clerk.

## Local Government Acts.

## CITY OF KEW.

NOTICE is hereby given that the Council of the Municipality of the City of Kew deems it expedient to widen Daniell-place within the City of Kew (from Barker's-road to Sackville-street), from 33 feet to 39 feet. For that purpose it has accordingly fixed a new alignment for the west side of Daniell-place (from Barker's-road to Sackville-street), in accordance with survey plan approved by the Council and for that purpose will acquire from the various owners thereof (either by agreement or compulsorily) the lands on the said side of Daniell-place between the old alignment and the new alignment.

A plan showing the position of the new alignment by reference to permanent marks and the old alignment and the position of walls fences buildings and other permanent structures and features has been prepared by E. L. Sim, Licensed Surveyor, which will be kept at the offices of the Council and be open to inspection by any person without fee at any time at which the said offices are open for business.

Copies of such plan certified by the said Surveyor may also be inspected without fee at the Office of the Registrar of Titles or the Office of the Registrar-General, 283 Queen-street, Melbourne, at any time at which such offices are open for business.

Dated this 22nd day of October, 1957.

2690 W. D. BIRRELL, Town Clerk.

## CITY OF MELBOURNE.

## TEMPORARY OVERDRAFT ACCOMMODATION.

NOTICE is hereby given that, in accordance with the provisions of section 14 of the *Melbourne and Geelong Debentures and Inscribed Stock Act 1932*, it is the intention of the Council, during the municipal year ending 30th September, 1958, to obtain from the Council's bankers, the National Bank of Australasia Limited, advances by overdraft of current account upon the credit of the municipality, for the purpose of carrying into effect the provisions of the several Acts of Parliament relating to the City of Melbourne and to provide funds for permanent works and undertakings.

The amount of overdraft accommodation required during the current municipal year is estimated not to exceed £600,000.

F. H. ROGAN, Town Clerk.

Town Hall, Melbourne, 15th October, 1957. 2686

## CITY OF MELBOURNE.

NOTICE is hereby given that the City Council at its Meeting held on the 7th instant decided that the unnamed lane off the west side of Exhibition-street, between Latrobe and Victoria streets, Melbourne, be named and known as Grant-lane.

2685 F. H. ROGAN, Town Clerk.

## CITY OF SHEPPARTON.

## LOAN No. 24.

*Notice of Intention to Borrow the Sum of Fifteen Thousand Pounds for Permanent Works and Undertakings.*

NOTICE is hereby given that the Council of the City of Shepparton proposes to borrow the sum of Fifteen thousand pounds (£15,000) on the credit of the municipal revenues of the Mayor, Councillors, and Citizens of the said City, such sum to be raised by the issue of debentures, in accordance with the provisions of the Local Government Acts.

1. The maximum rate of interest that may be paid is 5½ per centum per annum.
2. The purposes for which the loan is to be applied are—

(a) Street construction .. .. .	£5,000
(b) Provision of places of public resort and recreation .. .. .	6,000
(c) Provision of a municipal free library ..	4,000
	£15,000

3. The period of the loan shall be ten years.
4. The moneys borrowed shall be repayable by providing out of the municipal fund twenty half-yearly instalments of approximately £985 1s. 6d. each, including principal and interest, on the 1st day of April and on the 1st day of October during the currency of the loan. The first instalment shall be payable on the 1st day of April, 1958.
5. Such moneys shall be repayable at the Commonwealth Trading Bank of Australia, in Melbourne, or at the Council's bankers for the time being in Melbourne.

6. The plans, specifications, and the estimate of the cost of the proposed works, and a statement showing the proposed expenditure of the moneys to be borrowed, are open for inspection at the Town Hall, Shepparton.

Dated this 14th day of October, 1957.

2693 R. WEST, Town Clerk.

## CITY OF SHEPPARTON.

## LOAN No. 25.

*Notice of Intention to Borrow the Sum of Six Thousand Pounds for Permanent Works and Undertakings.*

NOTICE is hereby given that the Council of the City of Shepparton proposes to borrow the sum of Six thousand pounds (£6,000) on the credit of the municipal revenues of the Mayor, Councillors, and Citizens of the said City, such sum to be raised by the issue of debentures, in accordance with the provisions of the Local Government Acts.

1. The maximum rate of interest that may be paid is 5½ per centum per annum.
2. The purpose for which the loan is to be applied is—  
Street construction .. .. . £6,000
3. The period of the loan shall be fifteen years.

4. The moneys borrowed shall be repayable by providing out of the municipal fund 30 half-yearly instalments of £296 6s. 2d. each, including principal and interest, on the 1st day of April and the 1st day of October during the currency of the loan. The first instalment shall be payable on the 1st day of April, 1958.

5. Such moneys shall be payable at the Commonwealth Trading Bank of Australia, in Melbourne, or at the Council's bankers for the time being in Melbourne.

6. The plans, specifications, and the estimate of the cost of the proposed works, and a statement showing the proposed expenditure of the moneys to be borrowed, are open for inspection at the Town Hall, Shepparton.

Dated this 14th day of October, 1957.

2694 R. WEST, Town Clerk.

## BOROUGH OF BENALLA.

NOTICE is hereby given that it is the intention of the Council to proceed with undertakings under section 594 of the Local Government Act, as authorized by Order in Council dated 20th February, 1951.

The proposed works consist of the acquisition of land, opening of new street, and resubdivision and resale of surplus lands in section P, Town and Parish of Benalla, County of Delatite.

Plans and specifications of the proposed undertakings are deposited for inspection at the Borough Office, 28 Bridge-street, Benalla.

All persons affected by the proposed undertakings are required to set forth, in writing addressed to the Council or the Town Clerk, within 40 clear days from the 23rd day of October, 1957, all objections which they may have to the undertakings.

2702

D. C. LATCH, Town Clerk.

## SHIRE OF BALLARAT.

NOTICE is hereby given that Mr. L. W. Paterson, Clunes-road, Wendouree, has been appointed Assistant Road Ranger to this municipality, in lieu of Mr. H. A. Bolt, 604 Drummond-street, Ballarat, resigned.

2688

S. R. BEACH, Shire Secretary.

## SHIRE OF BIRCHIP.

## LOAN NO. 19.

*Amended Notice of Intention to Borrow the Sum of £9,000 for Permanent Works and Undertakings.*

NOTICE is hereby given that an amendment to the rate of interest as published in the *Gazette*, No. 247, 9th October, 1957, stating that the rate of interest that may be paid is 5 per cent. per annum, is as follows:—

1. The maximum rate of interest that may be paid is 5½ per cent. per annum.

Dated the 14th October, 1957.

2684

JOSEPH B. NEAL, Shire Secretary.

## SHIRE OF FERN TREE GULLY.

WHEREAS the Council of the Shire of Fern Tree Gully deems it expedient to execute the work or undertaking of providing the land described in the Schedule hereto as a place of public resort or recreation: And whereas for the purpose thereof the exercise of the compulsory power of taking the said land will in the Council's opinion be necessary and desirable: And whereas the Council has caused to be prepared maps and plans setting out and describing such work or undertaking and the exact site and admeasurements thereof and the names of the owners or reputed owners, lessees or reputed lessees, and the occupiers thereof as far as such names can be ascertained by the Council: And whereas such maps and plans are deposited at the office of the said Council at Fern Tree Gully, and are and shall be open for inspection by all persons interested, at all reasonable hours, for the space of 40 clear days after publication of this notice in the *Government Gazette*: Now notice is hereby given to all persons affected by the proposed work and undertaking, and they are hereby called upon to set forth in writing addressed to the said Council or the Shire Secretary of the Shire of Fern Tree Gully, within 40 clear days from the publication of this notice in the *Government Gazette*, all objections which they may have to the said work or undertaking.

## THE SCHEDULE HEREINBEFORE REFERRED TO.

All that land being part of Crown allotment 16, section B, Parish of Narree Worrان, County of Mornington, and more particularly described as part of that land described in certificate of title, volume 5959, folio 1191653, commencing at a point bearing 105 deg. 22 min. a distance of 109 ft. 10½ in. from the most northerly point of the land described in the said certificate of title; thence a distance of 181 ft. 5½ in. along the same line; thence a distance of 186 ft. 9½ in. along a line bearing 201 deg. 11 min.; thence a distance of 117 ft. 2½ in. along a line bearing 285 deg. 22 min.; thence a distance of 103 ft. 9½ in. along a line bearing 15 deg. 20 min.; thence a distance of 93 ft. 8½ in. along a line bearing 346 deg. 30 min. to the point of commencement.

2687

N. M. SIMMONS, Shire Secretary.

## SHIRE OF HAMPDEN.

## LOAN NO. 3.

*Notice of Intention to Borrow the Sum of £4,000 for Permanent Works and Undertakings.*

NOTICE is hereby given that the Council of the Shire of Hampden proposes to borrow the sum of Four thousand pounds, on the credit of the municipal revenues of the President, Councillors and Ratepayers of the said Shire, such sum to be raised by the issue of debentures, in accordance with the provisions of the Local Government Acts.

1. The maximum rate of interest that may be paid is 5½ per cent. per annum.

2. The purpose for which the loan is to be applied is the purchase of a dwelling house for use of its officers.

3. The period of the loan shall be ten years.

4. The moneys borrowed shall be repayable by providing out of the municipal fund twenty half-yearly instalments of approximately £262 13s. 6d. each, including principal and interest, on the 1st day of September and the 1st day of March during the currency of the loan. The first instalment shall be payable on the 1st day of September, 1958.

5. Such moneys shall be repayable at The National Bank of Australasia Limited, Melbourne, or at the Council's bankers for the time being in Melbourne.

The plans and specifications and the estimates of the cost of the proposed works, and a statement showing the proposed expenditure of the moneys to be borrowed, are open for inspection at the Shire Office, Camperdown.

Dated this 22nd day of October, 1957.

2701

THOS. F. LITTLE, Shire Secretary.

## SHIRE OF MARONG.

NOTICE OF INTENTION TO SPEND UNEXPENDED BALANCE OF LOAN FUNDS.

TAKE notice that the Council of the Shire of Marong proposes to expend the balance of funds raised under Loan No. 7 in accordance with the provisions of the *Local Government Act* 1946 as follows:—

(a) The amount of the original loan was £7,500 raised on 1st January, 1957.

(b) The several purposes for which the unexpended money was to have been applied are—

Purchase of front-end loader ..	£2,300
Amount expended ..	1,990

(c) The unexpended balance of £310 is now to be applied in part payment of a new front-end loader in conjunction with Loan No. 8.

(d) The estimate of the cost together with a statement of expenditure of the balance of loan moneys to be appropriated has been prepared and is open for inspection during office hours at the Shire Office, Marong.

Dated this 14th day of October, 1957.

2689

ROSS M. GRAHAM, Shire Secretary.

## SHIRE OF UPPER MURRAY.

## LOAN NO. 13.

*Notice of Intention to Borrow the Sum of £15,000 for Permanent Works and Undertakings.*

NOTICE is hereby given that the Council of the Shire of Upper Murray proposes to borrow the sum of Fifteen thousand pounds on the credit of the municipal revenues of the President, Councillors and Ratepayers of the said Shire, such sum to be raised by the issue of debentures, in accordance with the provisions of the Local Government Acts.

1. The maximum rate of interest that may be paid is 5½ per cent. per annum.

2. The purposes for which the loan is to be applied are—

(i) Erection of Infant Welfare Centre at Corryong ..	£3,800
(ii) Purchase of road-making plant ..	11,200
	£15,000

3. The period of the loan shall be ten years.

4. The moneys borrowed shall be repayable by providing out of the municipal fund twenty half-yearly instalments of approximately £985 1s. 6d. each, including principal and interest, on the 1st day of January and the 1st day of July during the currency of the loan. The first instalment shall be payable on the 1st day of July, 1958.

5. Such moneys shall be repayable at the Australia and New Zealand Bank Limited, Melbourne, or at the Council's bankers for the time being in Melbourne.

The plans and specifications and the estimate of the cost of the proposed works, and a statement showing the proposed expenditure of the moneys to be borrowed, are open for inspection at the Shire Office, Corryong.

Dated: 17th October, 1957.

2703 D. A. WILLIAMS, Shire Secretary.

#### SHIRE OF SEYMOUR.

##### DECLARATION OF A PUBLIC STREET.

THE Council of the Shire of Seymour, on application of the Housing Commission of Victoria, does hereby declare Howard-place, Perrin-street, Heywood-crescent and Morison-crescent, Seymour, to be dedicated to the public as public highways.

The common seal of the said Shire of Seymour was hereunto affixed in pursuance of an Order of the Council made the 14th day of October, 1957, in the presence of—

2719 (SEAL) M. E. COUGHLIN, President.  
ARTHUR SMITH, Councillor.  
H. E. CLAREY, Secretary.

#### SHIRE OF SEYMOUR.

NOTICE is hereby given that Sergeant G. A. North, No. 9309, has been appointed Prosecuting Officer and Inspector of Nuisances, for the Seymour Riding of the Shire of Seymour.

2718 H. E. CLAREY, Shire Secretary.

#### BENDIGO SEWERAGE AUTHORITY.

THE above-named Sewerage Authority having made provision for carrying off sewage from each and every property which, or any part of which, is within the Sewerage Areas hereinafter described, doth hereby declare that on and after the 1st day of December, 1957, each and every property which, or any part of which, is within the said Sewerage Areas shall be deemed to be a sewered property within the meaning of the Sewerage Districts Acts.

The boundaries of the said Sewerage Areas hereinbefore referred to are as follows, viz.:—

##### Sewerage Area No. 141.

Commencing at the intersection of the south-eastern boundary of Sewerage Area No. 60 with the north-eastern boundary of Sewerage Area No. 110; thence south-easterly along the boundary of Sewerage Area No. 110 to the north-western side of Murphy-street; thence by a line obliquely across Murphy-street to the westernmost corner of Crown allotment 6, no section, Parish of Sandhurst; thence easterly along the south boundary of the said Crown allotment 6 to the western side of a Government road; thence northerly along the said Government road to the south-eastern corner of Crown allotment 9, no section; thence easterly across the aforesaid Government road and along the southern boundary of Crown allotment 10, no section, to the north-western side of a Government road sometimes called Beischer-street; thence north-easterly along the said road and by a line across Strickland-road to the boundary of Sewerage Area No. 140; thence generally westerly along the boundaries of Sewerage Areas Nos. 140 and 60 to the point of commencement.

##### Sewerage Area No. 142.

Commencing on the north-west side of O'Dwyer-street at the easternmost corner of Crown allotment 54, section 1, at Bendigo, Parish of Sandhurst; thence generally westerly along the northern boundaries of Crown allotments 54 and 55, section 1, to the eastern side of St. Killian-street; thence generally southerly along the eastern sides of St. Killian and Finn streets to the north-western side of O'Dwyer-street; thence generally north-easterly along the north-western side of O'Dwyer-street to the point of commencement.

##### Sewerage Area No. 143.

Commencing at the south-western corner of Sewerage Area No. 82; thence generally southerly along the eastern side of Finn-street to the most western corner of Crown allotment 26b, section E, at Bendigo, Parish of Sandhurst; thence south-easterly along the south-western boundary of the said Crown allotment 26b to its southernmost corner; thence north-easterly along the south-eastern boundary of Crown allotments 26b, 26e, 26f, and 26g and the prolongation thereof to the southern boundary of Sewerage Area No. 82; thence westerly along the southern boundary of Sewerage Area No. 82 to the point of commencement.

#### Sewerage Area No. 144.

Commencing at the intersection of the centre-line of Burrowes-street with the boundary of Sewerage Area No. 49; thence south-westerly, northerly, and easterly along the centre-lines of Burrowes, Wilmot, and Elwood streets to the boundary of Sewerage Area No. 49; thence generally southerly along the said sewerage area boundary to the point of commencement.

By order of the Bendigo Sewerage Authority,

H. W. SNELL, Chairman.

H. A. MOORS, Secretary.

Dated the 14th day of October, 1957.

2696

#### KYABRAM SEWERAGE AUTHORITY.

##### GENERAL NOTICE.

THE above-named Sewerage Authority having made sewers for carrying off the sewage from each and every property which, or any part of which, abuts on the streets or parts of streets in which such sewers are laid and which are included within the Sewerage Area hereinafter described, doth hereby declare that on and after the 15th day of November, 1957, each and every property which, or any part of which, abuts on the said streets or parts of streets shall be deemed to be a sewered property within the meaning of the *Sewerage Districts Act 1928*.

The boundaries of the Sewerage Area hereinbefore referred to are—

- That area bounded by Allan-street on the north, Union-street on the west, Fischer-street to Lancaster-street on the south, the eastern boundary of the high school and Hawkins-street on the east.
- Saunders-street and Fenaughty-street from the S.R. channel east to Goddard-street.
- That area commencing from the Memorial Gardens in Allan-street north to part lot 15, L/P 3803, in Mellis-street, east to Albion-street, then south to Allan-street; thence to point of commencement.
- That area commencing at the corner of Allan and Albion streets north to Edis-street, east to the eastern boundary of lot 46, L/P 11064, south to Mackie-street, south-east along Oswald-street, south to Allan-street; thence west to point of commencement.

By order of the said Sewerage Authority,

ROY D. WATT, Chairman.

A. G. HUDSON, Secretary.

Dated this 11th day of October, 1957.

2697

#### LANG LANG WATERWORKS TRUST.

##### LANG LANG WATER SUPPLY.

NOTICE to owners of tenements in the under-mentioned streets, and the private streets, lanes, courts, and alleys opening thereto:—

- Westernport-road, to a point two hundred and forty feet (240') south of the western boundary of McDonalds-road.
- Whitstable-street, from Westernport-road to the northern side of Nellie-street.
- Cambridge-street, from Westernport-road to the southern boundary of Nellie-street.
- Station-street, from Westernport-road to lot No. 222, lodged plan 3250, north of Nellie-street.
- James-street, from Westernport-road to a point three hundred and seventy feet (370') south of Westernport-road.
- Salisbury-street, from Westernport-road to lot No. 110, lodged plan 2096.
- Roseberry-street, from Westernport-road to the southern boundary of lot No. 66, lodged plan 2096.
- Rupert-street, from Westernport-road to the southern boundary of lot No. 67, lodged plan 2096.
- Oldbury-street, from Westernport-road to McDonalds-road.
- McDonalds-road, on the east side from Carnarvon-street to Westernport-road and from Oldbury-street one hundred and five feet (105') south to Fisher's subdivision. On the west side from a point one hundred and twenty feet (120') north of Clarkes-road to a point five hundred and seventy feet (570') south of Clarkes-road.
- Carnarvon-street, from McDonalds-road to Roseberry-street.

The main pipe in the said streets being laid down, the owners of all tenements situated as above are hereby required, on or before the 1st day of December, 1957, to cause proper pipes and stopcocks to be laid, so as to supply water within such tenements from the main pipe.

2736

H. T. ROBOTHAM, Secretary.

## Water Acts.

## PROPOSED BALMORAL WATERWORKS TRUST.

NOTICE is hereby given that the Wannan Shire Council has made application to the Honorable the Minister of Water Supply for the constitution of a Waterworks Trust, and for the proclamation of a Waterworks District at Balmoral, and the construction, maintenance, and continuance of Water Supply Works within that district under the provisions of the Water Acts.

A general plan and description of the proposed works have been submitted with the application, and copies of same may be seen at Wannan Shire Office at Coleraine during office hours.

Dated at Coleraine the 15th day of October, 1957.

2662

V. J. WHARTON, Shire Secretary.

## NOTICE OF INTENTION TO APPLY FOR A LICENCE TO DIVERT WATER AND CUT RACE FROM THE GUNBOWER CREEK, AT COHUNA.

I HEREBY give notice that I intend to apply for a licence empowering me to divert water for a term of fifteen years to the extent of 20 acre-feet per annum at a maximum rate of 5 acre-feet per day of 24 hours for the irrigation of 10 acres, being part of allotments 8, 9, section B, Parish of Cohuna, and to occupy certain Crown lands for works of diversion, and to cut a race thereon.

Any objection to such application must be forwarded, in writing, to the State Rivers and Water Supply Commission, Melbourne, within 30 days of the date hereof.

HENERY FRANCIS VALLENCE.

Cohuna.

2728

I, NORMA ISABELL ALICE LESTER, of 16 First-avenue, Sunshine, Victoria, the mother and legal guardian of the infant Lesley May McDonald hereby give public notice that by deed poll dated the 14th day of October, 1957, duly executed and attested, and deposited with the Registrar-General of the said State on the 14th day of October, 1957, under No. 29744, I formally and absolutely renounce the surname of McDonald and declare that she will assume, adopt, and intend henceforth upon all occasions whatsoever to use and subscribe the surname of Lester instead of the said surname McDonald so as to be at all times thereafter called, known, and described by the said surname of Lester.

Dated the 18th day of October, 1957.

JOHN W. FAIRLIE &amp; GOLDENBERG, solicitors for the said Lesley May Lester.

2731

I, GEORGE WOJCIECHOWSKI-WILTON, of 43 St. John-street, Windsor, in the State of Victoria, law clerk, heretofore called and known by the name of Jerzy Joseph Wojciechowski, hereby give public notice that by a deed poll dated 14th October, 1957, duly executed and attested, and deposited with the Registrar-General of the said State on the 14th October, 1957, I formally and absolutely renounced and abandoned the said surname of Wojciechowski and declared that I had assumed and adopted and intended thenceforth upon all occasions whatsoever to use and subscribe the surname of Wojciechowski-Wilton instead of the said surname of Wojciechowski, and so as to be at all times thereafter called, known, and described by the said surname of Wojciechowski-Wilton.

Dated the 18th day of October, 1957.

JOHN W. FAIRLIE &amp; GOLDENBERG, solicitors for the said George Wojciechowski-Wilton.

2732

NOTICE is hereby given that The Shell Company of Australia Limited has applied for a lease under Section 125 of the Land Acts, for a term of ten years from 22nd December, 1957, of allotment 2A, section 63B, City of Port Melbourne, Parish of Melbourne South, containing 1 acre and 3 perches, as a site for a store and factory.

2748

## NOTICE OF DISSOLUTION OF PARTNERSHIP.

NOTICE is hereby given that the partnership between the undersigned Kenneth Dudley Tibbits, of 4 Cumberland-avenue, North Balwyn, and John Matthew Leonard, of 7 Tonkin-avenue, Balwyn, carrying on business at 731 Whitehorse-road, Mont Albert, under the name of Greythorne Caravans, has been dissolved by mutual consent and the business will in future be carried on under the same name, and at the same address by the said Kenneth Dudley Tibbits, as sole proprietor.

Dated the 14th day of October, 1957.

KENNETH D. TIBBITS.

J. M. LEONARD.

John H. Kinnear and Company, solicitors, 51 Riversdale-road, Camberwell.

2725

NOTICE is hereby given that the partnership heretofore subsisting between us the undersigned Ronald Ernest Price, Beryl Lyma Price, James Edward Crowther, Francis Joseph Stammers and Vera Frances Carr, carrying on business as manufacturing confectioners and general merchants at 117 Glenferrie-road, Malvern, under the names of Australian and Overseas Confectionery Distributors and Glenvern Novelty Sweet Company, has been dissolved by mutual consent, as from the 17th day of October, 1957, so far as concern the said Francis Joseph Stammers and Vera Frances Carr, who retire from the said partnership. All debts due to and owing by the said late partnership will be received and paid respectively by the said Ronald Ernest Price, Beryl Lyma Price and James Edward Crowther, who will continue to carry on the said business in partnership, at the same place, under the same business names.

Dated the 17th day of October, 1957.

R. E. PRICE.

B. PRICE.

JAMES E. CROWTHER.

F. J. STAMMERS.

FRANCES CARR.

2749

NOTICE is hereby given that the partnership heretofore subsisting between Alan Ray Beattie and Frank Millington, carrying on the business known as Eastern States Bird Co., at 123 St. Hellier-street, West Heidelberg, has been dissolved by mutual consent, as from the 14th September, 1957. All debts due to and owing by the said firm will be received and paid by Alan Ray Beattie, who will continue to carry on the business at the same place.

2757

A. R. BEATTIE.

F. MILLINGTON.

NOTICE is hereby given that the partnership heretofore existing between George Alphonse de Pury and Guillaume de Pury, carrying on business as farmers and graziers at "Yeringberg," Coldstream, under the name of "George de Pury and Son," has been dissolved by mutual consent of the executors of George Alphonse de Pury and Guillaume de Pury as from the 30th day of June, 1957. All debts due to and owing by the said late partnership will be received and paid by the undersigned executors of the will of the late George Alphonse de Pury, whose address is care of Aitken, Walker, and Strachan, solicitors, 123 William-street, Melbourne.

Dated this 14th day of October, 1957.

FLORENCE DE PURY,

J. FORD STRACHAN,

G. DE PURY,

executors of the will of George Alphonse de Pury, deceased.

G. DE PURY.

Aitken, Walker, and Strachan, solicitors.

2740

## NOTICE OF DISSOLUTION OF PARTNERSHIP.

NOTICE is hereby given that the partnership heretofore subsisting between the undersigned, William Thomas Abbott, of 233 Dandenong-road, Oakleigh, and Donald Alexander Baxter, of 32 James-street, Glenhuntly, carrying on business as manufacturers of toys and baby carriages at 22 Murdock-street, Clayton, under the name of Abbott and Baxter, has been dissolved by mutual consent as from the 14th day of October, 1957. All debts due to and owing by the said late firm will be received and paid by the said Donald Alexander Baxter, who will continue to carry on the business at the same place.

Dated at Oakleigh the 21st day of October, 1957.

W. T. ABBOTT.

D. A. BAXTER.

2741

**NOTICE** is hereby given that the partnership heretofore subsisting between the undersigned Stella Rachel Anderson, widow, Gwendoline Leah Hiscock, married woman, and Oswald William Hiscock, grazier, all of Ghin Ghin, Yea, in the State of Victoria, carrying on business as farmers and graziers at Ghin Ghin, Yea aforesaid, under the name of "Anderson, Hiscock and Hiscock," has been dissolved by mutual consent as from the 30th day of June, 1957. All debts due to and owing by the said late firm will be received and paid by the said Stella Rachel Anderson and the said Gwendoline Leah Hiscock, who will continue to carry on the business at the same place.

Dated the 30th day of June, 1957.

O. W. HISCOCK.  
S. R. ANDERSON.  
G. L. HISCOCK.

S. H. Austin Embling and Jackson, of Yea, solicitors for the said Stella Rachel Anderson, and the said Gwendoline Leah Hiscock.

Pearce and Webster, of 430 Little Collins-street, Melbourne, solicitors, for the said Oswald William Hiscock.  
2716

**ROBRON PRODUCTS PROPRIETARY LIMITED.**

**NOTICE CONVENING FINAL MEETING, PURSUANT TO SECTION 236.**

**NOTICE** is hereby given, in pursuance of section 236 of the *Companies Act 1938*, that a General Meeting of the members of the above-named company will be held at the registered office of the company, 54 Malop-street, Geelong, on Thursday, the 21st November, 1957, at Three o'clock p.m., for the purpose of having an account laid before them, showing the manner in which the winding up has been conducted and the property of the company disposed of and of hearing any explanation that may be given by the liquidator.

Dated the 14th day of October, 1957.

2695 G. W. THOM, Liquidator.

*Companies Act 1938.*

**P. BAMFORD PROPRIETARY LIMITED  
(IN VOLUNTARY LIQUIDATION).**

**A**T an Extraordinary General Meeting of the members of P. Bamford Proprietary Limited, duly convened and held at 333 Collins-street, Melbourne, on the 22nd day of October, 1957, the following Special Resolution was duly passed:—

"That the company be wound up voluntarily and that A. E. Bainbridge of R. A. Irish and Michelmores, 430 Little Collins-street, Melbourne, be and is hereby appointed liquidator for the purpose of such winding up."

Dated this 22nd day of October, 1957.

2734 C. O. BAMFORD, Director.

*Companies Act 1938.*

**P. BAMFORD PROPRIETARY LIMITED  
(IN VOLUNTARY LIQUIDATION).**

**NOTICE** is hereby given that the creditors of the above-named company, which is being voluntarily wound up, are required on or before the 6th day of December, 1957, being the day for that purpose fixed by me, the undersigned, the liquidator of the company, to come in and prove their debts or claims, or in default thereof they will be excluded from the benefit of any distribution made before such debts are proved.

Dated this 22nd day of October, 1957.

A. E. BAINBRIDGE, Liquidator.

R. A. Irish and Michelmores, 430 Little Collins-street, Melbourne.  
2735

*Companies Act 1938.*

**MENTONE GRAMMAR SCHOOL.**

**NOTICE OF INTENTION TO APPLY TO ATTORNEY-GENERAL FOR LICENCE, PURSUANT TO SECTION 18 (1).**

**I** JOHN FINDLAY ANDERSON, of 472 Bourke-street, Melbourne, solicitor, on behalf of Mentone Grammar School, an association about to be formed for the purposes of promoting education, hereby give notice of intention to apply to the Attorney-General for a licence directing that the association be registered as a company with limited liability without the addition of the word "Limited" to its name.

Dated this 17th day of October, 1957.

2763 J. F. ANDERSON.

In the Supreme Court of Victoria.—In the matter of Part I. of the *Companies Act 1938*, and in the matter of KIA ORA INVESTMENTS PROPRIETARY LIMITED.

**NOTICE** is hereby given that the Order of the Supreme Court of Victoria, dated the 4th day of October, 1957, confirming the reduction of the capital of the above-named company from £300,000 to £150,860, and the minute approved by the Court showing with respect to the share capital of the company as altered the several particulars required by the above Act were registered by the Registrar-General on the 15th day of October, 1957.

The said Minute is in the words and figures following:—

"The capital of the company henceforth is £150,860 divided into 61,376 shares of £1 each and 238,624 shares of 7s. 6d. each. At the date of the registration of this Minute all of the said 238,624 shares of 7s. 6d. each have been issued and are deemed to be fully paid up. None of the said 61,376 shares of £1 each have been issued."

Dated the 16th day of October, 1957.

MOULE, HAMILTON, & DERHAM, solicitors for the company.  
2744

In the matter of Part I. of the *Companies Act 1938*, and in the matter of ASSOCIATED PLASTER AND GYPSUM COMPANY PROPRIETARY LIMITED.

**NOTICE** is hereby given that a petition for the winding up of the above-named company by the Supreme Court was, on the 18th day of October, 1957, presented to the said Court by Peter Robert Peers, of Murrayville, in the State of Victoria, engineer: And that the said petition is directed to be heard before the Court sitting at Melbourne on the 15th day of November, 1957; and any creditor or contributory of the said company desirous to support or oppose the making of an order on the said petition may appear at the time of hearing by himself or his counsel for that purpose; and a copy of the petition will be furnished to any creditor or contributory of the said company requiring the same by the undersigned on payment of the regulated charge for the same.

The petitioner's address is Murrayville, in the State of Victoria.

The petitioner's solicitors are John W. McComas and Co., of 450 Collins-street, Melbourne.

(Signed) JOHN MCCOMAS & CO.

**NOTE.**—Any person who intends to appear on the hearing of the said petition must serve on or send by post to the above-named John W. McComas and Co., notice, in writing, of his intention so to do. The notice must state the name and address of the person, or, if a firm, the name and address of the firm, and must be signed by the person or firm, or his or their solicitor (if any), and must be served, or, if posted, must be sent by post in sufficient time to reach the above-named not later than Four o'clock in the afternoon of the 14th of November, 1957 (the day previous to the day appointed for the hearing of the petition).  
2751

In the matter of P. W. HEYMAN PROPRIETARY LIMITED.

**BY** Order of the Court dated the 17th day of October, 1957, Roberts Charles David Warne-Smith, the liquidator of the above-named company was granted his release and the company was dissolved.

Dated the 18th day of October, 1957.

HEDDERWICK, FOOKES, & ALSTON, 103 William-street, Melbourne, C.1, solicitors for the liquidator. 2755

**MOONYA ESTATES PROPRIETARY LIMITED.**

**SPECIAL RESOLUTION TO WIND UP, PURSUANT TO SECTION 226.**

**A**T an Extraordinary General Meeting of the above-named company duly convened and held at the registered office, No. 401 Collins-street, Melbourne, on Friday, the 18th day of October, 1957, the following Resolution was duly passed as a Special Resolution:—

"That the company be wound up voluntarily."

And at such last-mentioned meeting Alfred John Carlyle Livingston and Victor Moritz Ransome, of 401 Collins-street, Melbourne, were appointed liquidators for the purposes of the winding up.

Dated the 18th day of October, 1957.

2752 ARTHUR GODFREY, Chairman.

Form No. 54.

**KARR PTY. LIMITED.**

NOTICE OF MEETING OF CREDITORS WHEN MEETING TO CONSIDER WINDING UP RESOLUTION CALLED, PURSUANT TO SECTION 238.

NOTICE is hereby given that a Meeting of the creditors of the above-named company will be held at 3rd Floor, 44 Queen-street, Melbourne, on Friday, 1st November, 1957, at 11 o'clock in the forenoon, for the purpose of considering the position of the company's affairs, the company having convened an Extraordinary General Meeting of its members to be held at 3rd Floor, 44 Queen-street, Melbourne, on Friday, 1st of November, 1957, at 10.30 o'clock in the forenoon, for the purpose of considering and, if deemed expedient, passing, as an Extraordinary Resolution the Resolution following, that is to say:—

"That it has been proved to the satisfaction of this meeting that the company cannot by reason of its liabilities continue its business, and that it is advisable to wind up the same, and accordingly that the company be wound up voluntarily."

A Resolution will be submitted to the meeting for the nomination of a person acceptable to the creditors to be the liquidator of the company for the purposes of the winding up.

If the above-mentioned Resolutions be duly passed, then the following Resolution will be submitted as an Extraordinary Resolution:—

"That the liquidator be hereby authorized to divide all or such part of the surplus assets of the company as he shall think fit among the members of the company, in specie."

Dated the 22nd day of October, 1957.

By order of the Board,

2759

A. L. ROYCE, Secretary.

**GRINLINGTON & COMPANY PROPRIETARY LIMITED.**

PURSUANT TO SECTION 226 (1) OF THE COMPANIES ACT.

AT a General Meeting of the members of the said company, duly convened and held at 19 Queen-street, Melbourne, on Thursday, the 17th day of October, 1957, at 3.30 p.m., the following Resolution was duly passed as a Special Resolution:—

"That the company be wound up voluntarily."

Dated the 17th day of October, 1957.

2750

H. V. SAMPSON, Liquidator.  
A. M. COLQUHOUN, Liquidator.

**TILBURY MANUFACTURING CO. PROPRIETARY LIMITED (IN LIQUIDATION).**

NOTICE CONVENING FINAL MEETING, PURSUANT TO SECTION 236.

NOTICE is hereby given, in pursuance of section 236 of the Companies Act 1938, that a General Meeting of the members of the above-named company will be held at the office of the liquidator, John Willoughby Kenny, 422 Collins-street, Melbourne, on Tuesday, the 26th day of November, 1957, at half-past Ten o'clock in the morning, for the purpose of having an account laid before them showing the manner in which the winding up has been conducted and the property of the company disposed of, and of hearing any explanation that may be given by the liquidator.

2715

JOHN W. KENNY, Liquidator.

MARGARET McCLAREN, late of 6 Stuart-street, Moonee Ponds, in the State of Victoria, widow, DECEASED.

CREDITORS, next of kin, and others having claims in respect of the estate of the deceased (who died on the 23rd day of May, 1957), are required by the deceased's personal representative, Charles James Robertson McLaren, of 40 McLean-street, West Brunswick, in the said State, metal machinist, to send particulars to him, care of the under-mentioned solicitors, by the 15th day of January, 1958, after which date the personal representative may convey or distribute the assets, having regard only to the claims of which he has notice.

Dated the 17th day of October, 1957.

HEFFEY & BUTLER, 422 Collins-street, Melbourne, solicitors for the said Charles James Robertson McLaren.

2712

*Trustee Act 1928.***NOTICE TO CLAIMANTS.**

PURSUANT to the *Trustee Act 1928*, creditors, next of kin, and all other persons having claims in respect of the deceased person named below are required to send particulars of such claims to the legal personal representatives at the address stated, on or before the date stated, after which date the representatives will distribute the assets, having regard only to the claims of which notice has been received:—

James Thomas Stephen, late of Grant-street, Port Fairy, labourer, deceased, died 8th September, 1957.—Claims to the executrix, Annie Elizabeth Jean Stephen, of Grant-street, Port Fairy, widow, care of Conlan and Leishman, solicitors, 38 Bank-street, Port Fairy, by 3rd January, 1958. 2733

PURSUANT to the *Trustee Act 1928*, all persons having claims against the property or estate of Leslie George Benjamin, late of 30 Filbert-street, South Caulfield, retired, deceased (who died on the 16th day of May, 1957, and probate of whose will was granted by the Supreme Court of Victoria on the 20th day of September, 1957, to James William Fitzwalter Thomson, of 422-8 Collins-street, Melbourne, solicitor, the executor named therein), are hereby required to send particulars of such claims to the said executor, addressed to the care of Read and Read, solicitors, of 422-8 Collins-street, Melbourne, on or before the 31st day of December, 1957, after the expiration of which time the said executor will proceed to distribute the assets of the said deceased amongst the persons entitled thereto, having regard only to the claims of which he shall have had notice.

Dated this 18th day of October, 1957.

READ & READ, 422-8 Collins-street, Melbourne. 2713

PURSUANT to the *Trustee Act 1928*, all persons having claims against the property or estate of Horace Ebenezer Brewer, late of 39 Brett-street, Murrumbidgee, retired market gardener, deceased (who died on the 4th day of July, 1957, and probate of whose will was granted by the Supreme Court of Victoria on the 4th day of October, 1957, to Frederick Carter Read, of 422-8 Collins-street, Melbourne, solicitor, the executor named therein), are hereby required to send particulars of such claims to the said executor, on or before the 31st day of December, 1957, after the expiration of which time the said executor will proceed to distribute the assets of the said deceased amongst the persons entitled thereto, having regard only to the claims of which he shall have had notice.

Dated this 18th day of October, 1957.

READ & READ, 422-8 Collins-street, Melbourne, solicitors for the executor. 2714

ALL persons having claims against the estate of Lillier Ida Miller, late of Mullet Point, Warkworth, provincial district of Auckland, New Zealand, married woman, deceased (who died on the 3rd day of October, 1956, and probate of whose will was on the 3rd day of December, 1956, granted by the Supreme Court of New Zealand to The Guardian Trust and Executors Company of New Zealand Limited, and William Edward Aroha Miller, and application to the Supreme Court of Victoria (Probate Jurisdiction) by The Perpetual Executors and Trustees Association of Australia Limited, to seal, such probate having been granted on the 2nd day of October, 1956), are hereby required to send particulars of such claims to The Perpetual Executors and Trustees Association of Australia Limited, at its registered office at 100-104 Queen-street, Melbourne, on or before the 31st December, 1957, after which date the last-mentioned company will proceed to transfer, convey or distribute the said estate to or among the persons entitled thereto, having regard only to the claims of which it shall then have had notice, and will not be liable for the assets so transferred, conveyed or distributed to any persons of whose claim it shall not then have had notice.

LYNCH & MACDONALD, 360 Collins-street, Melbourne, solicitors for the executors. 2753

CREDITORS, next of kin, and others having claims in respect of the estate of Valeria Emma Gertrude Johnson, late of 13 Ferncroft-avenue, East Malvern, married woman, deceased (who died on 27th day of November, 1956), are to send particulars of their claims to the Equity Trustees, Executors and Agency Company, of 472 Bourke-street, Melbourne, by the 28th day of December, 1957, after which date it will distribute the assets, having regard only to the claims of which it then has notice. 2756



**CREDITORS**, next of kin, and others having claims in respect of the estate of William Allan John Blackwell, late of 65 Page-street, Albert Park, in the State of Victoria, packer, deceased (who died on the 10th day of January, 1955), are to send particulars of their claims to Corrie Mildred Blackwell, of 65 Page-street, Albert Park, by the 24th day of December, 1957, after which date she will distribute the assets, having regard only to the claims of which she then has notice.

HODGSON & FINLAYSON, 360 Collins-street, Melbourne, solicitors. 2758

**CREDITORS**, next of kin, and others having claims in respect of the estate of Winnifred Randall Gurdon, late of Kalorama, spinster, deceased (who died on the 21st June, 1957), are to send particulars of their claims to the executor, The Perpetual Executors and Trustees Association of Australia Limited, at its registered office, Nos. 100-104 Queen-street, Melbourne, by the 31st day of December, 1957, after which date it will distribute the assets, having regard only to the claims of which it then has notice.

GODFREY & GODFREY, solicitors, 325 Collins-street, Melbourne. 2762

**CREDITORS**, next of kin, and all others having claims in respect of the estate of Albert Edward Newman, late of "Nalinga," Anzac-avenue, Ferny Creek, retired dairy farmer, deceased (who died on the 26th day of August, 1957), are to send particulars of their claims to The Trustees, Executors and Agency Company Limited, of 401 Collins-street, Melbourne, by the 28th day of December, 1957, after which date it will distribute the assets, having regard only to the claims of which it then has notice.

RUSSELL, KENNEDY & COOK, solicitors, 401 Collins-street, Melbourne. 2760

**CREDITORS**, next of kin, and all others having claims in respect of the estate of Joseph Benjamin Mills, formerly of 93 Robert-street, Northcote, but late of 16 Oak-street, Hawthorn, chairman, Australian Apple and Pear Board, deceased (who died on the 29th day of July, 1957), are to send particulars of their claims to The Trustees, Executors and Agency Company Limited, of 401 Collins-street, Melbourne, by the 28th day of December, 1957, after which date it will distribute the assets, having regard only to the claims of which it then has notice.

RUSSELL, KENNEDY & COOK, solicitors, 401 Collins-street, Melbourne. 2761

**CREDITORS** and all others having claims against the estate of the under-mentioned person are required to send particulars thereof to the undersigned, on or before the 23rd day of December, 1957, otherwise they may be excluded when the assets are being distributed.

Name: JOHN JAMES KELLY,  
formerly of Karramomus, in the State of Victoria, but late of Arcadia, in the said State.

Occupation: Commission agent and grazier.

Date of Death: 7th November, 1957.

MORRISSY & DEANE, solicitors, Shepparton. 2727

**CREDITORS**, next of kin, and others having claims in respect of the estate of Alfred Ernest McCluskey, late of 348 Springvale-road, Springvale, retired railway employee, deceased (who died on the 20th day of August, 1957), are required to send particulars of their claim to the executor, Percy Charles Mostyn Loughhead, care of the undersigned, by the 31st day of December, 1957, after which date the said executor will distribute the assets, having regard only to the claim of which he then has notice.

TOLHURST, DRUCE & EMMERSON, 352 Collins-street, Melbourne, solicitors. 2747

HENRY TANNER, late of 51 Stenhouse-avenue, Brooklyn, engineer, DECEASED, intestate.

**CREDITORS**, next of kin, and all other persons having claims against the estate of the above-named deceased are required by the administrator, Henry Alfred Alexander Tanner, of 51 Stenhouse-avenue, Brooklyn, engineer, to send particulars of such claims to him, care of the undersigned, on or before the 23rd day of December, 1957, after which date he will distribute the assets, having regard only to the claims of which he has then had notice.

JONES & KENNEDY, solicitors, 213 Nicholson-street, Footscray. 2754

No. 249.—9907/57.—4

#### NOTICE TO CLAIMANTS.

**THE PERPETUAL EXECUTORS AND TRUSTEES ASSOCIATION OF AUSTRALIA LIMITED**, whose registered office is situate at Nos. 100-104 Queen-street, Melbourne, in the State of Victoria, and Thomas William Osboldstone, of 74 Acland-street, St. Kilda, in the said State, newsagent, the executors of the will of Sydney Alexander Bell, late of 98 Beaconsfield-parade, Albert Park, in the State of Victoria, investor (who died on the 30th April, 1957), require all creditors, next of kin and others having claims against the property or estate of the said deceased to send to the said executors, in the care of the said Association, on or before the 24th day of December, 1957, particulars, in writing, of such claims, after which date the said executors intend to convey or distribute such property or estate to or among the persons entitled thereto, having regard only to the claims of which they shall have had notice.

Dated the 16th day of October, 1957.

C. A. CURTAIN & SONS, of 90 Queen-street, Melbourne, solicitors for the executors. 2746

**CREDITORS**, next of kin, and all other persons having claims in respect of the estate of Rosalind Queenella Janson, late of "The Manor House" Lilydale, in Victoria, widow, deceased, are requested to send particulars of their claims to the executors, Lillian Zola Janson, of "The Manor House" Lilydale, spinster, and Robert Russell Aitken, of 123 William-street, Melbourne, solicitor, care of the under-mentioned solicitors, by the 24th day of December, 1957, after which date the executors will distribute the assets, having regard only to claims of which they then have notice.

AITKEN, WALKER & STRACHAN, of 123 William-street, Melbourne, solicitors. 2737

**CREDITORS**, next of kin, and others having claims in respect of the estate of William Percy Sheldon, more commonly known as William Sheldon, formerly of 42 Ruskin-street, Elwood, in the State of Victoria, but late of 8 Bath-street, St. Kilda, in the said State, gentleman, deceased (who died on the 26th day of July, 1957), are to send particulars of their claims to the Fidelity Trustee Company Limited (formerly The Ballarat Trustees, Executors and Agency Company Limited), whose registered office is situate at 101 Lydiard-street North, Ballarat, in the said State, by the 27th day of December, 1957, after which date it will distribute the assets, having regard only to the claims of which it then has notice.

RIVERS, W. DICKINSON & SON, 60 Market-street, Melbourne, solicitors for the executor. 2738

MICHAEL JOSEPH MARTIN, late of Evans-street, Sunbury, in the State of Victoria, gentleman, DECEASED.

**CREDITORS**, next of kin, and others having claims against the estate of deceased (who died on the 16th day of December, 1956), are required to send particulars thereof to Albert George Fry, of 41 Blackburn-road, Blackburn, care of the undersigned solicitor, by the 31st day of December, 1957, after which date he will distribute the assets of the deceased, having regard only to the claims of which he then has notice.

E. K. O'DONNELL, solicitor, 173 Greville-street, Prahran. 2739

WINIFRED NORTHCOTT, late of 48 Middlesex-road, Surrey Hills, in the State of Victoria, widow, DECEASED.

**CREDITORS**, next of kin, and others having claims in respect of the estate of the deceased (who died on the 20th day of November, 1956), are required by the personal representative, Henry John Leake Northcott, of Merino, in the said State, grazier, to send particulars to him, in care of the undersigned solicitors, by the 28th day of December, 1957, after which date the personal representative may convey or distribute the assets, having regard only to the claims of which he then has notice.

Dated the 14th day of October, 1957.

FITZGERALD & NASH, solicitors, Whyte-street, Coleraine. 2729

**CREDITORS**, next of kin, and others having claims against the estate of George James Williams, formerly of Clarendon, but late of 255 Albert-street, Sebastopol, in the State of Victoria, retired farmer, deceased (who died on the 23rd day of July, 1957), are to send particulars of their claims to The Fidelity Trustee Co. Ltd., of 101 Lydiard-street north, Ballarat, by the 20th day of December, 1957, after which date the company will distribute the assets, having regard only to the claims of which it then has notice.

2720

WILLIAM JAMES TREADWELL, late of 60 Acland-street, St. Kilda, in the State of Victoria, gentleman, DECEASED (who died on the 13th day of April, 1957).

**CREDITORS**, next of kin, and all other persons having claims against the estate of the said deceased are required by the executors, The Fidelity Trustee Company Limited, of 101 Lydiard-street north, Ballarat, and Francis Henry Treadwell, of Rugby-street, Belmont, Geelong, maintenance fitter, to send detailed particulars of their claims in respect of the said property to the said executors, at the address of the said company, on or before the 18th day of December, 1957, after which date they will proceed to distribute the said estate, having regard only to the claims of which they then have notice.

Dated this 7th day of October, 1957.

R. H. RAMSAY & GAUNT, 41 Lydiard-street south, Ballarat, solicitors for the said executors. 2721

JANET LYDIA JEANNE MARY WILKINSON, late of 4 Lonsdale-street, Ballarat, home duties, DECEASED (who died on the 18th July, 1956).

**CREDITORS**, next of kin, and all persons having claims against the estate of the deceased are required to send particulars to the executor, Albert Ernest Morffew, of Smythes Creek, clerk, care of the address below given, on or before the 19th day of December, 1957, after which date he will distribute the assets, having regard only to the claims of which he shall then have notice.

HEINZ & GORDON, solicitors, 22 Lydiard-street south, Ballarat. 2722

ROBERT LAMB, late of York-street, Sale, grazier (who died 24th June, 1957).

**CREDITORS**, next of kin, and all other persons having claims against the estate of the deceased are required by the executors of the will, Robert Norman Lamb, of Barkly-street, Sale, grazier, and Barbara Muriel Aveline Traill, of Fulham, married woman, to send particulars to them, care of the undersigned, on or before 24th December, 1957, after which date they will distribute the assets, having regard only to the claims of which they then have notice.

R. M. ROLLAND, solicitor, 57c Raymond-street, Sale. 2723

#### NOTICE TO CREDITORS.

**CREDITORS**, next of kin, and others having claims in respect of the estate of Alfred Edward Watson, formerly of Flat 2, 25 Beach-avenue, Elwood, but late of 6 Osborne-street, Gardenvale, retired bank manager, deceased (who died on the 6th day of May, 1957), are requested to send particulars of their claims to the executors, Edward John Watson and Kenneth John Clements, in care of Kenneth J. Clements, of 29 Glenhantly-road, Elsternwick, solicitor, by the 1st day of January, 1958, after which date the executors will distribute the assets, having regard only to the claims of which they have notice.

KENNETH J. CLEMENTS, 29 Glenhantly-road, Elsternwick, solicitor for the executors. 2724

**CREDITORS**, next of kin, and others having claims against the estate of Rose Mary Poole, late of Koon-drook, in the State of Victoria, widow, deceased (who died on the 24th day of October, 1956), are requested to send particulars of their claims to Farmers and Citizens Trustees Company Bendigo Limited, the administrator with the will annexed of the estate of the said deceased, of Charing Cross, Bendigo, in the said State, on or before the 31st day of December, 1957, after which date it will distribute the assets, having regard only to the claims of which it then has notice.

FRANCIS LYNCH, solicitor, 54 Wellington-street, Kerang. 2726

FREDERICK SHACKLETON, late of Thorpdale, grazier, DECEASED.

**CREDITORS**, next of kin, and others having claims in respect of the estate of the deceased (who died on the 8th day of October, 1956) are required by the executors, Evangeline Shackleton, Harold Garfield Shackleton, and Thelma Mann, all of Thorpdale, to send particulars to them, care of the undersigned solicitors, by the 31st day of December, 1957, after which date they may convey or distribute the assets, having regard only to the claims of which they then have notice.

GRAY, FRIEND, & LONG, solicitors, Warragul. 2691

JULIAN BROOK, late of Auckland, in the Dominion of New Zealand, retired schoolmaster, DECEASED.

**CREDITORS**, next of kin, and others having claims in respect of the estate of the abovenamed deceased (who died on the 10th day of February, 1957), are required by The Trustees, Executors and Agency Company Limited, of 401 Collins-street, Melbourne, in the State of Victoria, the executor in Victoria of the will of the abovenamed deceased, to send particulars to it by the 14th January, 1958, after which date the executor may convey or distribute the assets, having regard only to the claims of which it then has notice.

Dated the 18th day of October, 1957.

W. B. & O. McCUTCHEON, solicitors, 31 Queen-street, Melbourne. 2717

HENRY ASHBY BUNSTUN, formerly of Cloverlea, but late of 14 Steedman-street, Mordialloc, retired farmer, DECEASED.

**CREDITORS**, next of kin, and others having claims in respect of the estate of the deceased (who died on the 24th day of May, 1957) are required by the executrix, Elsie Bertha Bunstun, of 14 Steedman-street, Mordialloc, to send particulars to her, care of the undersigned solicitors, by the 31st day of December, 1957, after which date the executrix may convey or distribute the assets, having regard only to the claims of which she then has notice.

GRAY, FRIEND, & LONG, solicitors, Warragul. 2692

JOHN MASKELL, late of Princes Highway, Officer, retired railway employee, DECEASED.

**CREDITORS**, next of kin, and others having claims in respect of the estate of the deceased (who died on 30th July, 1956) are required by the executrix of his will, Elizabeth Maskell, of Princes Highway, Officer, widow, to send particulars to her, care of the under-named solicitor, on or before 31st December, 1957, after which date the executrix may convey or distribute the assets of the deceased, having regard only to the claims of which she then has notice.

JOHN GINNANE, solicitor, 153a Barkly-street, Footscray. 2704

**CREDITORS**, next of kin, and others having claims in respect of the estate of William Rust Boardman, formerly of 9 Rangeview-grove, North Balwyn, but late of 692 High-street, Golden Square, Bendigo, in the State of Victoria, retired grazier, deceased (who died on the 16th day of October, 1956, and probate of whose will was granted by the Supreme Court of Victoria, in its probate jurisdiction, to The Equity Trustees, Executors, and Agency Company Limited, of 472 Bourke-street, Melbourne, the executor appointed by the said will), are hereby required to send particulars of such claims, in writing, to the said company, on or before the 30th day of December, 1957, after which date the said executor will proceed to distribute the assets of the said deceased which shall have come to its hands among the persons entitled thereto, having regard only to the claims of which it shall then have had notice.

DUGDALE, SIMMONS, & STEVENS, "Peacock House," 486 Bourke-street, Melbourne, solicitors. 2705

**CREDITORS**, next of kin, and others having claims against the estate of John Shearn, late of Jindivick, farmer, deceased (who died on the 17th August, 1957), are requested to send particulars of their claims to Margaret Ellen Shearn and James William Shearn, the executors appointed by deceased's will, in care of the undersigned, by the 30th December, 1957, after which date they will distribute the assets, having regard only to the claims of which they shall then have had notice.

M. DAVINE, solicitor, Warragul. 2700

**CREDITORS**, next of kin, and others having claims in respect of the estate of Frances Jane Smith, late of "Dunesk," 11 Eglinton-street, Moonee Ponds, spinster (who died on the 14th June, 1957), are to send the particulars of their claims to the Equity Trustees, Executors, and Agency Company Limited, of 472 Bourke-street, Melbourne, by the 10th day of January, 1958, after which date it will distribute the assets, having regard only to the claims of which it then has notice.

HENDERSON & BALL, solicitors, 430 Little Collins-street, Melbourne. 2708

WILLIAM JAMES CLEARY, late of 94 Brunswick-road, East Brunswick, in the State of Victoria, DECEASED.

**CREDITORS**, next of kin, and others having claims in respect of the estate of the deceased (who died on the 16th day of March, 1957) are required by the deceased's personal representative, John Thomas Cleary, of 26 Clarke-street, East Brunswick, in the said State, boiler-maker, to send particulars to him, care of the under-mentioned solicitors, by the 31st day of December, 1957, after which date the personal representative may convey or distribute the assets, having regard only to the claims of which he then has notice.

Dated the 23rd day of October, 1957.

HEFFEY & BUTLER, 422 Collins-street, Melbourne, solicitors for the said John Thomas Cleary. 2707

ELLEN MARY JEFFERSON, late of 27 Teague-avenue, Mentone, in the State of Victoria, widow, DECEASED.

**CREDITORS**, next of kin, and others having claims in respect of the estate of the deceased (who died on the 8th day of July, 1957) are required by The Equity Trustees, Executors, and Agency Company Limited, of 472 Bourke-street, Melbourne, to send particulars to the said The Equity Trustees, Executors, and Agency Company Limited, at its aforesaid address, by the 31st day of January, 1958, after which date it may convey or distribute the assets, having regard only to the claims of which it then has notice.

Dated this 22nd day of October, 1957.

LOUGHREY & LOUGHREY, 108 Queen-street, Melbourne, solicitors for the company. 2709

JANE OTTELIE GRABASCH, late of 49 Wills-street, Bendigo, in the State of Victoria, widow, DECEASED, intestate.

**CREDITORS**, next of kin, and all other persons having claims against the estate of the said deceased are required by Farmers and Citizens Trustees Company, Bendigo Limited, of Charing Cross, Bendigo aforesaid, the administrator of the estate of the said deceased, to send particulars thereof to it on or before the 18th day of December, 1957, after which date it will proceed to distribute the assets of the said deceased, having regard only to the claims of which it shall then have notice.

Dated the 15th day of October, 1957.

WATSON, JAMES & ROGERS, of Bull-street, Bendigo, solicitors for the administrator. 2683

**PURSUANT** to the *Trustee Act 1928*, all persons having claims against the property or estate of Beatrice Victoria Marriage, late of 32 Hopkins-street, McKinnon, in the State of Victoria, married woman, deceased (who died on the 7th day of December, 1956, and probate of whose will was granted by the Supreme Court of Victoria on the 30th day of September, 1957, to John Maurice Marriage, the executor named therein), are hereby required to send particulars of such claims to the said executor addressed to the care of Sackville, Wilks and Co., 100 Collins-street, Melbourne, on or before the 18th day of December, 1957, after the expiration of which time the said executor will proceed to distribute the assets of the said deceased amongst the persons entitled thereto, having regard only to the claims of which he shall have had notice.

SACKVILLE, WILKS & CO., 100 Collins-street, Melbourne, solicitors for the executor. 2706

MARY LOUISA STEWART, late of 8 Foster-avenue, Glenhuntly, spinster, DECEASED, who died on the 11th day of July, 1957.

**CREDITORS**, next of kin, and others having claims against the estate of the deceased are required by The Union Trustee Company of Australia Limited, the registered office of which is at 333 Collins-street, Melbourne, which has applied for a grant of probate of the will of the said deceased, to send particulars to it before the 30th day of December, 1957, after which it will distribute the assets, having regard only to the claims of which it then has notice.

D. M. GILLIES & BOLTON, of 422 Collins-street, Melbourne. 2711

ANNE SCOTT BARNESLEY, late of 9 Herbert-street, Footscray, spinster, DECEASED.

**CREDITORS**, next of kin, and all other persons having claims against the estate of the said deceased are required by the executrix, Anne Scott, of 2 Argyle-street, West Footscray, married woman, to send particulars to her, care of the undernamed solicitor, on or before 31st December, 1957, after which date she will distribute the assets, having regard only to the claim of which she then has notice.

JOHN GINNANE, solicitor, 153A Barkly-street, Footscray. 2710

## MINING NOTICES

SOUTH ALLIGATOR URANIUM NO LIABILITY.

**NOTICE** is hereby given that a Call (the third) of six pence per share, on all issued contributing shares in the capital of the company, making such shares paid to 3s. 6d. each has been made due and payable, in the case of shares on the Melbourne Register, to the registered office of the company, 11th Floor, 100 Collins-street, Melbourne, Victoria, and, in the case of shares on the Adelaide Register, to the Adelaide office of the company, 7th Floor, 68 Grenfell-street, Adelaide, South Australia, on Wednesday, the 13th day of November, 1957.

By order of the Board,

M. B. GEMMELL, Legal Manager.

11th Floor, 100 Collins-street, Melbourne, C.1, Victoria, 16th October, 1957. 2745

## IMPOUNDINGS

**KERANG**.—Impounded in Kerang Pound.

1 Hereford cow, all white face and belly, two VV notches bottom of left ear, no visible brand

If not claimed and expenses paid, to be sold on 8th November, 1957.

F. NANCARROW,  
Poundkeeper.

2743—10/6

**MULGRAVE**.—Impounded in Mulgrave Pound.

1 skewbald pony mare, no visible brand

If not claimed and expenses paid, to be sold on 8th November, 1957.

P. C. CONLEN,  
Poundkeeper.

2742—9/

## THE "VICTORIA GOVERNMENT GAZETTE."

**ATTENTION** is invited to the following procedure in relation to the publication of official matter in the *Government Gazette*.—

1. *Matter submitted to the Executive Council.*

Matter submitted to the Executive Council which requires gazettal will normally be published in the issue of the following week.

Where urgent gazettal is required, special arrangements should be made with the *Gazette* Officer.

Publication will be facilitated by the submission of carbon copies for the use of the *Gazette* Officer.

2. *Other matter.*

(a) All other matter duly certified by a responsible officer for publication should be lodged with the *Gazette* Officer not later than half-past Ten a.m. on Tuesday.

(b) Lengthy or involved notices should be forwarded several days before publication.

(c) Proofs, which will be supplied only when specifically requested, or at the direction of the *Gazette* Officer, should be returned promptly to avoid delay in publication.

(d) No additions or amendments to matter for publication will be accepted by telephone.

THE VICTORIA GOVERNMENT GAZETTE is published on WEDNESDAY EVENING in each week, and Notices for insertion will be received by the Government Printer at or before Two p.m. at ordinary rates, and late advertisements between Two p.m. and Five p.m. at double rates on the day preceding the day of publication.

Single copies of the VICTORIA GOVERNMENT GAZETTE are One shilling, posted One shilling and three pence.

No GAZETTES prior to January, 1950, in stock.

\*\*\*ALL PAYMENTS ARE REQUIRED IN ADVANCE.—Remittances should be made by postal note, money order, or draft in favour of the Government Printer. Advertisements unaccompanied by a remittance sufficient to cover the cost of insertion will be returned unpublished.

SUBSCRIPTIONS.—The subscription, including postage, is £2 15s. per annum, £1 7s. 6d. half-yearly, or 13s. 9d. per quarter, payable in advance.

Subscriptions are required to commence and terminate with a month.

A lesser period than three months cannot be subscribed for.

Subscribers do not receive the Acts of Parliament with the GAZETTE.

ADVERTISEMENTS are charged at the rate of 1s. 6d. per line single column, and 3s. per line double column.

The title (£5 Reward, Dissolution of Partnerships, &c.) forms one or more lines as a heading.

On an average, ten words make a line.

Every signature must likewise be counted as a line.

The final words of a paragraph, though only portion of a line, must be counted as one line.

SIGNATURES (in particular) and proper names must be written very plainly in the text; ONE SIDE ONLY of each slip of paper should be WRITTEN UPON.

ALL COMMUNICATIONS should be addressed to "The Government Printer, Melbourne."

ALL DOCUMENTS illegibly written will be returned unpublished, and, where brands occur unprovided for by the ordinary letters of the alphabet, a worded explanatory description must be furnished.

AGENTS FOR THE "VICTORIA GOVERNMENT GAZETTE."

THE following have been appointed agents to receive Advertisements and Subscriptions for the Victoria Government Gazette:—

ARMSTRONG'S AGENCY, 143 Queen-street, Melbourne.

ARMSTRONG BROS., Kyneton.

MESSRS. ARNALL & JACKSON, 115 Barkly-street, West Brunswick.

BERRY, ANDERSON, & CO., 207 Sturt-street, Ballarat.

MR. WM. DAVIS, Mildura.

A. J. DIGBY (B. S. and N. W. Cash), Main-street, Bairnsdale.

EDGAR'S NEWS AGENCY, Hargreaves-street, Bendigo.

MESSRS. HENRY FRANKS & CO., Booksellers and Stationers, Market-square, Geelong.

MESSRS. GORDON & GOTCH, News Agents, 511 Little Collins-street, Melbourne; and corner Barrack and Clarence streets, Sydney.

A. C. HAMPTON, 243 Mitchell-street, Bendigo.

MESSRS. HARSTON, PARTRIDGE, & CO., 455 Little Collins-street, Melbourne.

MR. C. F. LATIMER, News Agent, Casterton.

McARTHUR'S AUTHORIZED NEWSAGENCY, 345 Wyndham-street, Shepparton.

MESSRS. R. H. & W. M. PETTY, News Agent, Wangaratta.

MESSRS. POWELL & DIXON, 89 Firebrace-street, Horsham.

J. PURDIE & CO., 138 Moorabool-street, Geelong.

F. W. RASHLEIGH & SON, Nunn-street, Benalla.

ROBERTSON & MULLENS LTD., Elizabeth-street, Melbourne.

SALE AUTHORIZED NEWS AGENTS, Sale.

SKINNER'S AUTHORIZED NEWSAGENCY, 49-51 Franklin-street, Traralgon.

MESSRS. SMITH & DUNNON, Hamilton.

THE MERCANTILE EXCHANGE, 380 Collins-street, Melbourne.

F. D. & J. R. TRAINOR, 246 Wyndham-street, Shepparton.

C. F. & H. J. VERNON, 162 Bridge-road, Richmond.

VIEW POINT AUTHORIZED NEWSAGENCY, 4 View Point, Bendigo.

E. W. B. WELSH, Hogan-street, Tatura.

A copy of the Gazette filed at each place for public reference.

CONTENTS

	PAGE
Appointments .. .. .	3371
Auction Sales Act .. .. .	3370
Contracts .. .. .	3368
Country Roads Board .. .. .	3371, 3377
Courts .. .. .	3370
Estates of Deceased Persons .. .. .	3369
Government Notices .. .. .	3360
Impoundings .. .. .	3407
Lands .. .. .	3385
Melbourne and Metropolitan Board of Works— Notices .. .. .	3360
Melbourne Cup Holiday .. .. .	3360
Mining .. .. .	3363, 3407
Notice to Mariners .. .. .	3371
Orders in Council .. .. .	3373
Private Advertisements .. .. .	3398
Proclamations .. .. .	3357
Public Holidays .. .. .	3360
Public Service Notices .. .. .	3391
Resignations .. .. .	3372
State Rivers and Water Supply Commission .. .. .	3363
Tenders .. .. .	3338
Transport Regulation Board—Public Hearings .. .. .	3361
Waterworks Trust .. .. .	3364