



VICTORIA
GOVERNMENT GAZETTE

Published by Authority

[Registered at the General Post Office, Melbourne, for transmission by post as a newspaper.]

No. 25]

WEDNESDAY, MARCH 30

[1960

Land Act 1958.

AREA OF LAND COMPRISED IN CERTAIN CLASSES DIMINISHED OR INCREASED.

PROCLAMATION

By His Excellency the Governor of the State of Victoria and its Dependencies in the Commonwealth of Australia,
&c., &c., &c.

WHEREAS by the *Land Act 1958* it is amongst other things enacted that the Governor in Council may, by Proclamation to be published in the *Government Gazette*, at any time diminish or increase the area of land comprised in any of the classes mentioned in Part I., Division 1, Section 5, of the said *Land Act 1958*, but that the area of lands which may be sold by auction (Class 6), shall not be increased except as in certain cases in the said Act provided: Now therefore I, the Governor of the State of Victoria, in the Commonwealth of Australia, by and with the advice of the Executive Council of the said State, and in accordance with the provisions of sections 94 and 117 of the *Land Act 1958* aforesaid, do hereby diminish or increase (as the case may be) the areas of Crown lands comprised in Classes 6 and 7 of the classes mentioned in section 5 of the *Land Act 1958* aforesaid, to the extent set forth in the subjoined Schedule (that is to say):—

Schedule referred to.

CLASSES DIMINISHED OR INCREASED.

County.	Parish.	Allotment.	Section.	Area.	Diminished.	Increased.	Description.
					Class.	Class.	
				A. R. P.			
Gladstone ..	Wedderburne ..	10H	5	3 0 0	7	6	North of the Township of Wedderburne South-east of Bendigo, fronting gravel road off Retreat-road
Bendigo ..	Sandhurst ..	120A	H	0 0 11	7	..	

Given under my Hand and the Seal of the State of Victoria, aforesaid, at Melbourne, this twenty-second day of March, in the year of our Lord One thousand nine hundred and sixty, and in the ninth year of the reign of Her Majesty Queen Elizabeth II.

(L.S.)

By His Excellency's Command,

DALLAS BROOKS.

KEITH TURNBULL,

Commissioner of Crown Lands and Survey.

GOD SAVE THE QUEEN!

Land Act 1958.

UNALIENATED CROWN LAND AVAILABLE FOR SETTLEMENT UNDER IMPROVEMENT PURCHASE LEASES.

PROCLAMATION

By His Excellency the Governor of the State of Victoria and its Dependencies in the Commonwealth of Australia,
&c., &c., &c.

IN pursuance of the provisions of section 153 of the *Land Act 1958*, I, the Governor of the State of Victoria, in the Commonwealth of Australia, by and with the advice of the Executive Council of the said State, do by this Proclamation declare the unalienated Crown lands mentioned in the subjoined Schedule, to be available for settlement under improvement purchase leases.

SCHEDULE.

County.	Parish.	Allotment.	Section.	Area.			Land Valuation.
				A.	R.	P.	
Normanby	Balrook	28A and 28B	..	170	0	0±	£1 5s. per acre
Karkaroc	Yaapeet	2A	..	350	0	0±	£4 per acre

Given under my Hand and the Seal of the State of Victoria aforesaid, at Melbourne, this twenty-second day of March, in the year of our Lord One thousand nine hundred and sixty, and in the ninth year of the reign of Her Majesty Queen Elizabeth II.

(L.S.)

By His Excellency's Command,

DALLAS BROOKS.

KEITH TURNBULL,
Commissioner of Crown Lands and Survey.

GOD SAVE THE QUEEN!

Milk and Dairy Supervision Act 1958 (No. 6317).
SHIRE OF TULLAROOP DEFINED AN URBAN DISTRICT.

PROCLAMATION

By His Excellency the Governor of the State of Victoria and its Dependencies in the Commonwealth of Australia,
&c., &c., &c.

IN pursuance of the provisions contained in Part III. of the *Milk and Dairy Supervision Act 1958* (No. 6317), I, the Governor of the State of Victoria, by and with the advice of the Executive Council of the said State, do hereby define the Municipal District of the Shire of Tullaroop an urban district as from and inclusive of the First day of April, One thousand nine hundred and sixty.

Given under my Hand and the Seal of the State of Victoria aforesaid, at Melbourne, this twenty-ninth day of March, in the year of our Lord One thousand nine hundred and sixty, and in the ninth year of the reign of Her Majesty Queen Elizabeth II.

(L.S.)

DALLAS BROOKS.

By His Excellency's Command,

G. L. CHANDLER,
Minister of Agriculture.

GOD SAVE THE QUEEN!

Forests Act 1958 (No. 6254).

VARIATION OF PROCLAMATION RELATING TO THE PROHIBITED PERIOD.

PROCLAMATION

By His Excellency the Governor of the State of Victoria and its Dependencies in the Commonwealth of Australia,
&c., &c., &c.

WHEREAS by section 3 of the *Forests Act 1958* it is enacted that the Governor in Council may from time to time by Proclamation published in the *Government Gazette* declare any period to be a prohibited period in respect of the fire protected area (other than a State forest or national park) and, without affecting the generality of the foregoing, may from time to time by

Proclamation so published declare different prohibited periods in respect of different parts of the fire protected area (other than a State forest or national park).

And whereas by the said section it is further enacted that any Proclamation so published may subsequently be revoked, amended or varied by the Governor in Council by Proclamation so published:

And whereas by Proclamation issued on the 1st December, 1959, and published in the *Government Gazette* on the 2nd December, 1959, a prohibited period expiring on the 15th April, 1960, was proclaimed in respect of portion of the fire protected area (other than State forests or national parks); including the areas specified in the Schedule hereto:

Now therefore I, the Governor of the State of Victoria, in the Commonwealth of Australia, by and with the advice of the Executive Council of the said State, and in pursuance of the powers conferred by the *Forests Act*, do by this my Proclamation vary the aforesaid Proclamation by proclaiming that the prohibited period in respect of the parts of the fire protected area (other than a State forest or national park) situated in such Municipalities as are specified in the Schedule hereto shall end at midnight between the Thirtieth day and the Thirty-first day of March, 1960.

SCHEDULE.

The Shires of Altona, Bellarine, Hampden, Leigh, Mortlake, South Barwon, Warrnambool, Werribee.
The Borough of Queenscliffe.
The Town of Camperdown.
The Cities of Ballarat, Geelong, Geelong West, Newtown and Chilwell.

Given under my Hand and the Seal of the State of Victoria aforesaid, at Melbourne, this twenty-ninth day of March, in the year of our Lord One thousand nine hundred and sixty, and in the ninth year of the reign of Her Majesty Queen Elizabeth II.

(L.S.)

DALLAS BROOKS.

By His Excellency's Command,

A. J. FRASER,
Minister of Forests.

GOD SAVE THE QUEEN!

Soldier Settlement Act 1958 (No. 6373).
ROADS CLOSED.

PROCLAMATION

By His Excellency the Governor of the State of Victoria and its Dependencies in the Commonwealth of Australia, &c., &c., &c.

WHEREAS section 40 (1) of the *Soldier Settlement Act 1958* (No. 6373) prescribes that where any road (whether used or unused and whether formed or unformed) forms part of or intersects any estate and the Soldier Settlement Commission, after consultation with the council or councils of the municipality or municipalities concerned, certifies that the said road is unsuited to the proper subdivision of the estate:

And whereas the Soldier Settlement Commission, after consultation with the councils of the municipalities concerned, has so certified:

Now therefore, I, the Governor of the State of Victoria, in the Commonwealth of Australia, by and with the advice of the Executive Council of the said State, and in pursuance of section 40 of the *Soldier Settlement Act 1958* (No. 6373), do by this my Proclamation direct that the roads, as described hereunder, be closed, that is to say:—

Parish of Balmoral, County of Dundas, being the road indicated by hachure on plan hereunder.—(B.44⁽²⁾) (D.33070).

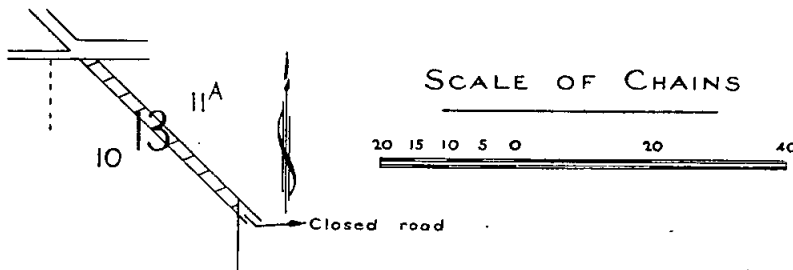

Parish of Bulgana, County of Borung, being the roads indicated by hachure on plans hereunder.—(B.659⁽²⁾) (D.34133).

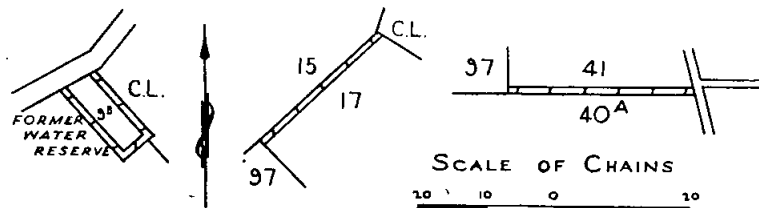

Parish of Bulgana, County of Borung, being the roads indicated by hachure on plan hereunder.—(B.659⁽²⁾) (D.34133).

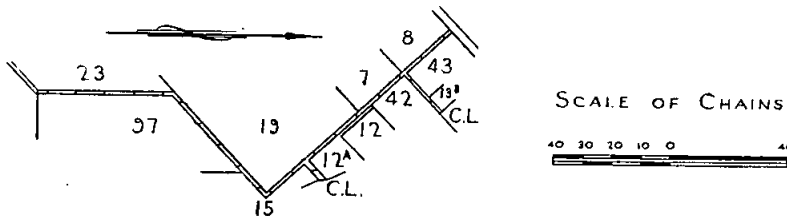

Parish of Gorong, County of Grant, being the roads indicated by hachure on plans hereunder.—(G.105⁽²⁾) (D.29570).

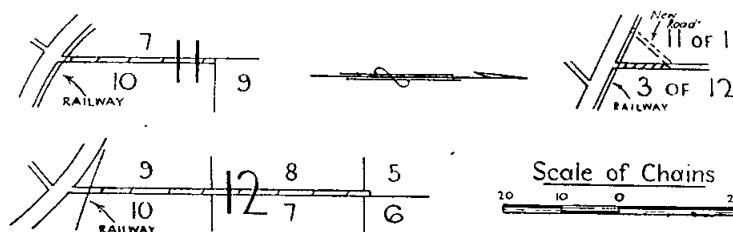

Parishes of Gorong and Yaloak, County of Grant, being the roads indicated by hachure on plan hereunder.—(G.105⁽³⁾) (Y.112⁽²⁾) (D.29570).

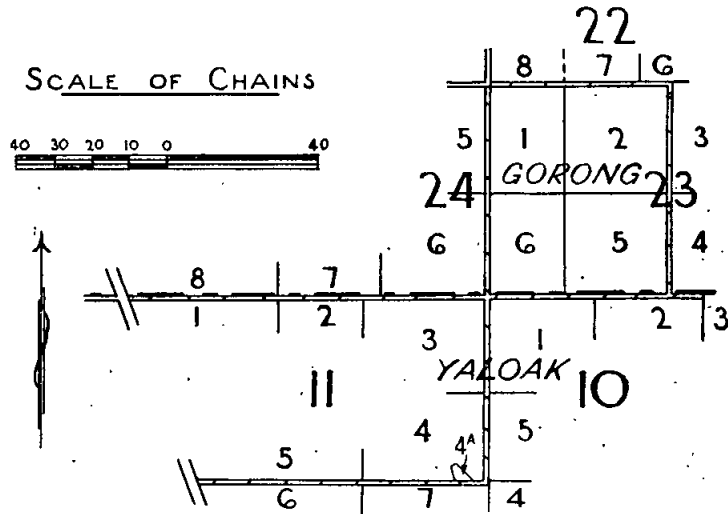

Parish of Gorong, County of Grant, being the road indicated by hachure on plan hereunder.—(G.105^(*)) (D.29570).

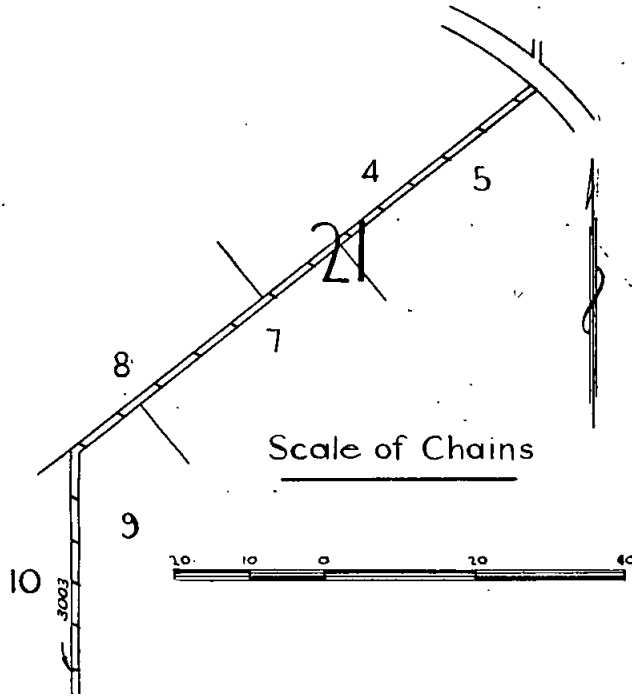

Parish of Gorong, County of Grant, being the roads indicated by hachure on plan hereunder.—(G.105⁽²⁾) (D.29570).

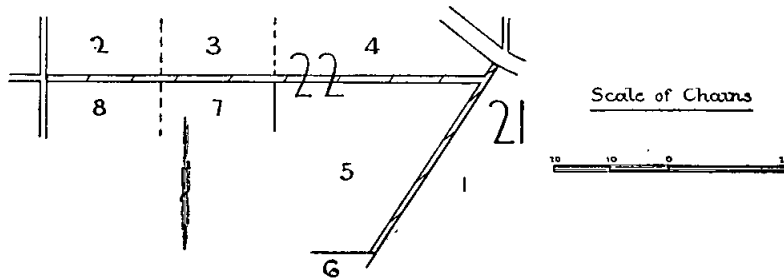

Parish of Gorong, County of Grant, being the road between allotment 4, section 11, and allotment 5, section II.—(G.105⁽³⁾) (D.29570).

Parish of Gorong, County of Grant, being the road between allotment 2, section 21 and allotment 3, section 21.—(G.105⁽³⁾) (D.29570).

Parish of Minjah, County of Villiers, being the road indicated by hachure on plan hereunder.—(M.124⁽⁴⁾) (K.103⁽²⁾) (D.29453).

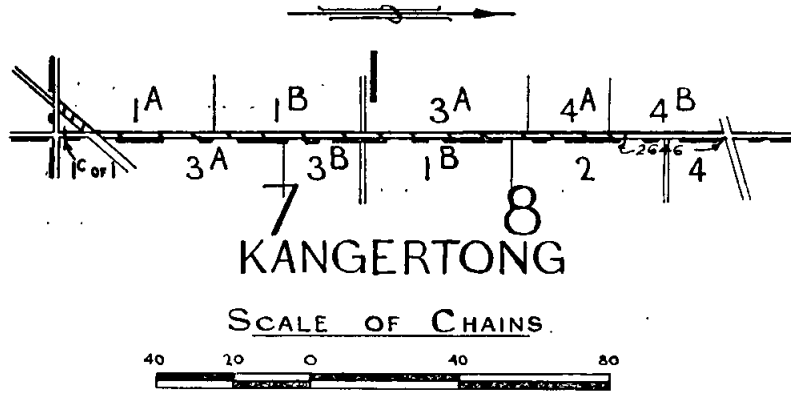

Parish of Kangertong, County of Villiers, being the road between allotment 3B, section 7 and allotments 1A, 1B, section 8.—(K.103⁽²⁾) (D.29453).

Parish of Kangertong, County of Villiers, being the road between allotment 2, section 8, and allotments 3, 4, section 8.—(K.103⁽²⁾) (D.29453).

Parish of Minjah, County of Villiers, being the road between allotment 2, section 21, Parish of Kangertong and allotment 1, section 10, Parish of Minjah.—(K.103⁽²⁾) (M.124⁽⁴⁾) (D.29453).

Parish of Minjah, County of Villiers, being the road between allotments 1B, 2B, section 1, and allotments 3A, 3B, section 1.—(M.124⁽⁴⁾) (D.29453).

Parish of Minjah, County of Villiers, being the road between allotments 3A, 3B, section 2, and allotments 4A, 4B, section 2.—(M.124⁽⁴⁾) (D.29453).

Parish of Ligar, County of Hampden, being the road between subdivision B of allotment 104, subdivisions A and B of allotment 111 and subdivision A of allotment 105, subdivisions A and B of allotment 110.—(L.77⁽⁸⁾) (D.33712).

Parish of Ligar, County of Hampden, being the road between subdivisions A and B of allotment 83 and subdivisions A and B of allotment 117.—(L.77⁽⁸⁾) (D.33712).

Parish of Ligar, County of Hampden, being the road between subdivisions A and B of allotment 114, subdivision B of allotment 113, subdivisions A and B of allotment 112 and subdivisions A and B of allotments 119, 120, 121, 122.—(L.77⁽⁸⁾) (D.33712).

Parish of Ligar, County of Hampden, being the road between allotment 14, subdivisions A and B of allotments 11, 10, 7 and allotment 101, subdivisions A and B of allotments 102, 103, 104.—(L.77⁽⁸⁾) (D.33712).

Parish of Ligar, County of Hampden, being the roads indicated by hachure on plan hereunder.—(L.77⁽⁸⁾) (D.33712).

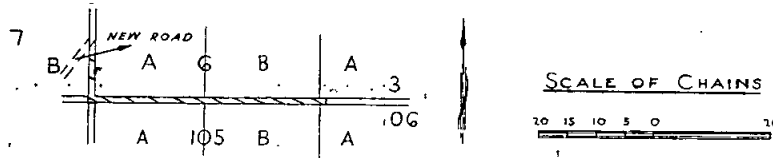

Parish of Caramut, County of Villiers, being the road between allotments 3, 2, 1, section 2, allotment 12, and allotment 3, section 1.—(C.193⁽²⁾) (D.29450).

Parish of Caramut, County of Villiers, being the roads indicated by hachure on plan hereunder.—(C.193⁽²⁾) (D.29450).



Parish of Caramut, County of Villiers, being the roads indicated by hachure on plans hereunder.—(C.193⁽²⁾) (D.29450).

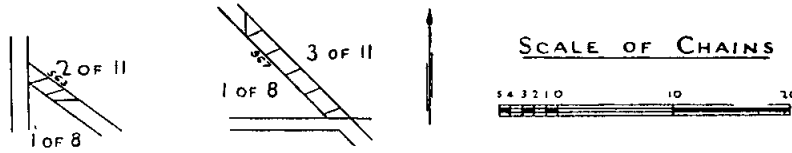

Parish of Eurambeen, County of Ripon, being the road between allotment P², Parish of Woodnaggerek and allotment 51c, Parish of Eurambeen.—(E.94⁽⁴⁾) (W.251⁽³⁾) (D.35122).

Parish of Eurambeen, County of Ripon, being the road between allotments 55A, 55B and allotment E.—(E.94⁽⁴⁾) (D.35122).

Parish of Eurambeen, County of Ripon, being the road indicated by hachure on plan hereunder.—(E.94⁽⁴⁾) (D.35122).

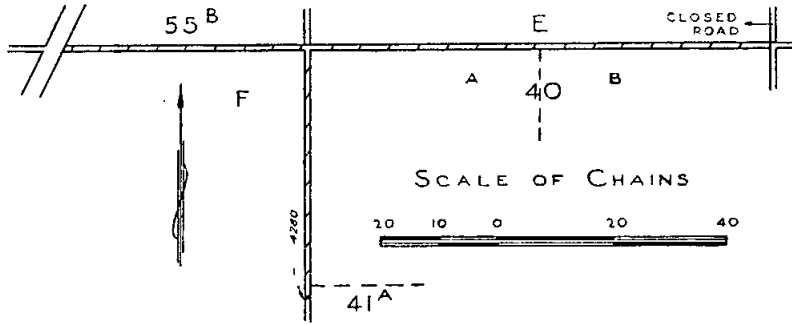

Parish of Ligar, County of Hampden, being the roads indicated by hachure on plan hereunder.—(L.77⁽³⁾) (D.33712).

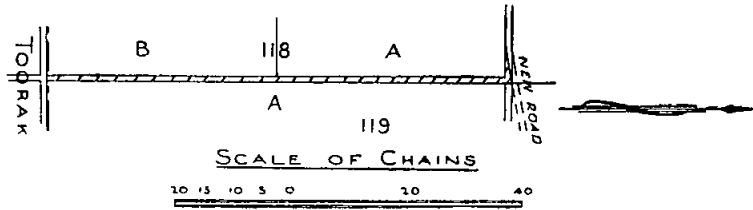

Parish of Murdeduke, County of Grenville, being the road indicated by hachure on plan hereunder.—(M.276⁽²⁾) (D.33071).



Parish of Napier, County of Normanby, being the road indicated by hachure on plan hereunder.—(N.34⁽²⁾) (D.32942).

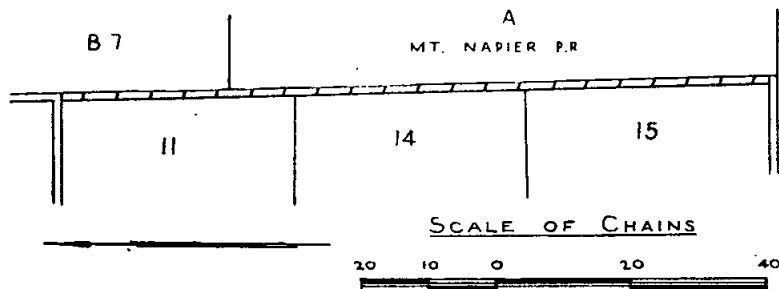

Parish of Napier, County of Normanby, being the road indicated by hachure on plan hereunder.—(N.34⁽²⁾) (D.32942).

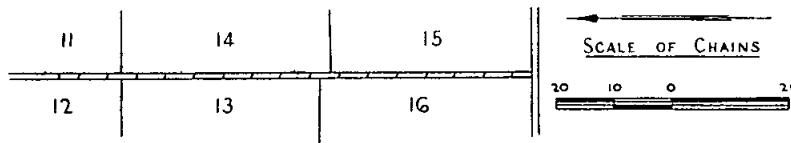

Parish of Napier, County of Normanby, being the road indicated by hachure on plan hereunder.—(N.34⁽²⁾) (D.32942).

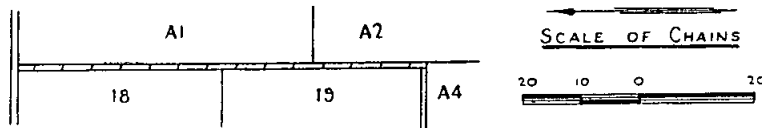

Parish of Napier, County of Normanby, being the road indicated by hachure on plan hereunder.—(N.34⁽²⁾) (D.32942).

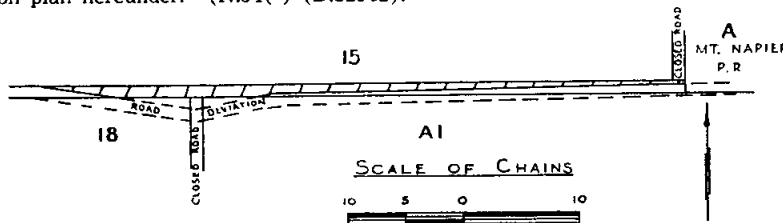

Given under my Hand and the Seal of the State of Victoria aforesaid, at Melbourne, the twenty-ninth day of March, in the year of our Lord, One thousand nine hundred and sixty, and in the ninth year of the reign of Her Majesty Queen Elizabeth II.

(L.S.)

DALLAS BROOKS.

By His Excellency's Command,

KEITH TURNBULL,
Commissioner of Crown Lands and Survey.

GOD SAVE THE QUEEN!

JUSTICES ACT 1958.

PROCLAMATION

By His Excellency the Governor of the State of Victoria and its Dependencies in the Commonwealth of Australia, &c., &c., &c.

WHEREAS by an Act of Parliament of the State of Victoria intituled the *Justices Act 1958* it is provided in sub-section (2) of section 24 thereof that the Governor in Council may by Proclamation published in the *Government Gazette* specify municipal districts for the purpose of section 24 of the said Act: And whereas it is considered desirable that the municipal district named in the Schedule hereto be so specified: Now therefore I, the Governor of the said State of Victoria, by and with the advice of the Executive Council thereof, do by this my Proclamation hereby specify for the purpose of the said section 24 of the said Act the municipal district whose name appears in the said Schedule—to take effect as on and from the 26th April, 1960.

SCHEDULE.

The City of Horsham.

Given under my Hand and the Seal of the State of Victoria aforesaid, at Melbourne, this twenty-ninth day of March, One thousand nine hundred and sixty, and in the ninth year of the reign of Her Majesty Queen Elizabeth II.

(L.S.)

DALLAS BROOKS.

By His Excellency's Command,

A. G. RYLAH,
Attorney-General.

GOD SAVE THE QUEEN!

EASTER HOLIDAYS.

It is hereby notified that on—

FRIDAY, THE 15TH,
SATURDAY, THE 16TH,
MONDAY, THE 18TH, and
TUESDAY, THE 19TH APRIL, 1960,

the Public Offices will be closed, such days being appointed by the *Public Service Act 1958* to be observed as holidays in the Public Offices throughout Victoria.

This notice relates only to the closing of the State Public Offices. All inquiries regarding the holidays in other offices and in shops and industry should be directed to the Department of Labour and Industry, Old Treasury Building, Spring-street, Melbourne, C.I. (Telephone MF 0321, Extension 266 or 6382.)

A. G. RYLAH,
Chief Secretary.

Chief Secretary's Office,
Melbourne, C.I., 24th March, 1960.

ANZAC DAY HOLIDAY.

It is hereby notified that on—

MONDAY, THE 25TH APRIL, 1960,

the Public Offices will be closed, such day having been appointed by the *Public Service Act 1958*, to be observed as a holiday in the Public Offices throughout the State of Victoria.

This notice relates only to the closing of the State Public Offices. All inquiries regarding the holiday in other offices and in shops and industry should be directed to the Department of Labour and Industry, Old Treasury Building, Spring-street, Melbourne, C.I. (Telephone MF 0321, Extension 266 or 6382.)

A. G. RYLAH,
Chief Secretary.

Chief Secretary's Office,
Melbourne, C.I., 29th March, 1960.

PUBLIC TRUSTEE ACT 1958, No. 6350, SECTION 17.

I HEREBY give notice that on the 17th March, 1960, the Public Trustee filed elections to administer the following deceased persons' estates, in accordance with section 17 of the *Public Trustee Act 1958*:—

*CLEARY, EILEEN MARY, late of 3 Albion-street, St. Kilda, spinster, died 11th May, 1959.

*CONOLLY, FLORENCE, formerly of 68 Queensberry-street, Carlton, but late of Sunbury, pensioner, died 5th December, 1959.

*FREDRICKSEN, CHRISTIAN JULIUS, late of 1 Borrie-street, Reservoir, pensioner, died 15th February, 1960.

*HORLEY, CAROLINE ELIZABETH, formerly of Fortescue-avenue, Seaford, but late of Caulfield Convalescent Hospital, 294 Kooyong-road, Caulfield, widow, died 18th November, 1959.

*KILNER, LYDIA JULIA, late of 39 Denbigh-street, Frankston, married woman, died 26th June, 1941.

*O'DONOGHUE, FLORENCE MARY, late of 82 Best-street, North Fitzroy, married woman, died 16th December, 1959.

*VEALE, CECIL ROBERT JAMES, formerly of 220 Inkerman-street, East St. Kilda, but late of 12 Briggs-crescent, Noble Park, retired bookbinder, died 28th November, 1959.

* According to the provisions of the will.

A. D. DUNCAN,
Public Trustee.

601 Little Collins-street, Melbourne, C.1, 23rd March, 1960.

NOTICE.

ADMINISTRATION of the estate of each of the under-mentioned deceased persons has been granted to the Public Trustee, and creditors, next of kin and all others having claims against the estate of any of the persons so mentioned are required to send particulars of their claims to the Public Trustee, 7th Floor, 601 Little Collins-street, Melbourne, on or before the 2nd June, 1960, or they will be excluded from the distribution of the estate when the assets are being distributed:—

†ALLAN, ROBERT JOHN, formerly of Flat 3, 475 St. Kilda-road, Elwood, and 222 Glenhuntingly-road, Elwood, but late of 10 Cotter-street, Richmond, fruiterer, died 12th December, 1959.

AYLWIN, ELLA CONSTANCE, late of 11 Barnsbury-road, Hawksburn, spinster, died 23rd June, 1959, intestate.

*CLEARY, EILEEN MARY, late of 3 Albion-street, St. Kilda, spinster, died 11th May, 1959.

†COLLARD, ALICE ETHEL, late of 13 Clyde-street, Thornbury, widow, died 22nd September, 1959.

*CONOLLY, FLORENCE, formerly of 68 Queensberry-street, Carlton, but late of Sunbury, pensioner, died 5th December, 1959.

†COURT, MARY THERESA, late of 8 Clayfield-road, Bretforten, Worcestershire, England, widow, died 23rd April, 1959.

†CRUMP, JOHN WALTER GEORGE, also known as John Walter Crump, late of 101 Gamon-street, Yarraville, retired engineer, died 28th December, 1959.

*FREDRICKSEN, CHRISTIAN JULIUS, late of 1 Borrie-street, Reservoir, pensioner, died 15th February, 1960.

†GRAHAM, CAROLINE ADA JANE, late of 167 Gladstone-street, South Melbourne, widow, died 24th October, 1959.

*HORLEY, CAROLINE ELIZABETH, formerly of Fortescue-avenue, Seaford, but late of Caulfield Convalescent Hospital, 294 Kooyong-road, Caulfield, widow, died 18th November, 1959.

*KILNER, LYDIA JULIA, late of 39 Denbigh-street, Frankston, married woman, died 26th June, 1941.

*MARKIEWICZ, JULIAN, late of 4 Essex-street, Pascoe Vale, builder, died 15th August, 1959, intestate.

*MOON, JOHN, late of 49 Woolley-street, Essendon, retired railway employee, died 13th December, 1959.

MOYLE, HERBERT, late of Wallan Hotel, Wallan, barman, died 15th June, 1959, intestate.

*O'DONOGHUE, FLORENCE MARY, late of 82 Best-street, North Fitzroy, married woman, died 16th December, 1959.

PHILLIPS, HECTOR, late of 60 Gisborne-road, Bacchus Marsh, farm labourer, died 18th September, 1959, intestate.

†SHARPLEY, ALBERT JAMES, late of 30 Lambeth-place, St. Kilda, tramway conductor, died 23rd October, 1959.

*VEALE, CECIL ROBERT JAMES, formerly of 220 Inkerman-street, East St. Kilda, but late of 12 Briggs-crescent, Noble Park, retired bookbinder, died 28th November, 1959.

† With the will annexed.

* According to the provisions of the will.

A. D. DUNCAN,
Public Trustee.

Melbourne, 23rd March, 1960.

PUBLICATION OF THE "VICTORIA GOVERNMENT GAZETTE".

BECAUSE of the Easter Holidays, the *Victoria Government Gazette* will be published on—

FRIDAY, THE 22ND APRIL, 1960,

instead of Wednesday, the 20th April, 1960.

All official matter for publication therein should be lodged with the *Gazette* Officer, Chief Secretary's Department (Telephone Extension 6282), not later than 10.30 a.m. on Thursday, the 21st April, 1960.

A. C. BROOKS,
Government Printer.

DEPARTMENT OF MINES.

SUBJECT to any necessary excisions, &c., it is proposed to grant the following mining lease:—
7753, Mineral; James Selkirk Pty. Ltd.; 77a. 1r. 33p., Parish of Lynchfield.

APPLICATION FOR LEASE DECLARED ABANDONED.
7766, Mineral; Frederick Maxwell Beveridge and Neville O'Connell; 11a. 2r. 30p., Parish of Maryborough.

APPLICATIONS FOR MINERAL SEARCH LICENCES DECLARED ABANDONED.

201, Mineral Search Licence; Sydney John Treasure and Alan James Treasure; 3,360 acres, Parish of Budgee Budgee.

203, Mineral Search Licence; Sydney John Treasure and Alan James Treasure; 3,900 acres, Parishes of Budgee Budgee and Cobbannah.

206, Mineral Search Licence; Sydney John Treasure and Alan James Treasure; 2,912 acres, Parishes of Budgee Budgee, Cobbannah and Tyirra.

207, Mineral Search Licence; Sydney John Treasure and Alan James Treasure; 5,040 acres, Parishes of Budgee Budgee, Cobbannah and Tyirra.

208, Mineral Search Licence; Daniel Rupert Websdale; 3,540 acres, Parishes of Tyirra and Cobbannah.

TAILINGS LICENCES GRANTED.

2918, Tailings Licence; Leslie James Shelton; Parishes of Burke and Lauriston.

2999, Tailings Licence; Walter Barwon Wilkinson; Parish of Durdidwarrah.

3005, Tailings Licence; Mayor, Councillors and Citizens of the City of Ballarat; Parish of Yarrooee (in lieu of Tailings Licence No. 2763, expired).

3007, Tailings Licence; J. Price; Parishes of Bet Bet and Maryborough (in lieu of Tailings Licence No. 2908, expired).

3008, Tailings Licence; President, Councillors and Rate-payers of the Shire of Creswick; Parish of Creswick (in lieu of Tailings Licence No. 2731, expired).

MINERAL SEARCH LICENCE GRANTED.

230, Mineral Search Licence; Frederick Daniel Lloyd, Graham John King and Joseph Royston Harbridge; 50 acres, Parish of Bullengarook.

W. J. MIBUS,
Minister of Mines.

National Parks Act 1958.

APPOINTMENT TO COMMITTEE OF MANAGEMENT.

NOTICE is hereby given that the National Parks Authority has appointed John Keith Dempster as a Member of The Lakes National Park Committee of Management for the period ending 31st December, 1961.

L. H. SMITH,
Director.

Office of the National Parks Authority,
Melbourne, 21st March, 1960.

National Parks Act 1958.

APPOINTMENT TO COMMITTEE OF MANAGEMENT.

NOTICE is hereby given that the National Parks Authority has appointed Ian John O'Donnell as a Member of the Fraser National Park Committee of Management for the period ending 31st December, 1961.

L. H. SMITH,
Director.

Office of the National Parks Authority,
Melbourne, 21st March, 1960.

Transport Regulation Acts.

TRANSPORT REGULATION BOARD.

NOTICES OF PUBLIC HEARINGS.

NOTICE is hereby given that the applications made by the persons named below for licences to operate commercial passenger vehicles on the route or routes, or in the manner set out opposite their names, will be heard at a time and place to be communicated to the parties:—

Name and Address; Nature of Application.

- READ, J. E., Birmingham-road, Mt. Evelyn; 1 commercial passenger vehicle, to be purchased, with seating capacity for 5 persons, to operate as a country taxi-cab at Mt. Evelyn.
- GIERSCH, N. J. & C. D. (trading as Clunes Road Lines), Albert-street, Creswick; 1 commercial passenger vehicle, with seating capacity for 33 persons, to operate as follows:—(a) As an additional stage omnibus on the Black Hill-Ballarat urban stage omnibus service, (b) as a special service omnibus, subject to the condition that all journeys undertaken commence within the Ballarat urban district.
- WATSON, CAMERON & Co., Whyte-street, Coleraine; 1 commercial passenger vehicle, with seating capacity for 27 persons, to operate as follows:—(a) For the carriage of school children only between Tarrington and Hamilton, under contract to the Education Department, (b) as a special service omnibus and under special traffic conditions, subject to the condition that all journeys undertaken commence within a radius of ten (10) miles of Hamilton Post Office.
- U.S. MOTORS (BELGRAVE) PTY. LTD., Main-road, Belgrave; 1 commercial passenger vehicle, with seating capacity for 35 persons, to operate as an additional stage omnibus under the same terms and conditions as all "C.O." licences at present held by the applicant.
- CROCKFORD, C. A., Lockington; 1 commercial passenger vehicle, with seating capacity for 33 persons, to operate as follows:—(a) For the carriage of school children only between Bamawn North and Lockington, under contract to the Education Department, (b) as a special service omnibus and under special traffic conditions, subject to the condition that all journeys undertaken commence within a radius of ten (10) miles of Lockington Post Office.
- CANT, K. R., 3 Quarry-road, Mitcham; 1 commercial passenger vehicle, to be purchased, with seating capacity for 5 persons, to operate under the same terms and conditions as existing taxi-cabs licensed at Mitcham.
- TRANS OTWAY LTD., corner of Ryrie and Fenwick streets, Geelong; 1 commercial passenger vehicle, with seating capacity for 35 persons, to operate as an additional stage omnibus under the same terms and conditions as all "C.O." licences at present held by the applicant.
- DINEEN, W. G., 40 Kitchener-street, Trafalgar; 1 commercial passenger vehicle, with seating capacity for 27 persons, to operate for the carriage of school children only on a round route commencing and terminating at Neerim South, via Jindivick and Rokeby.
- MORRIS, J., Main-road, Hurstbridge; 1 commercial passenger vehicle, to be purchased, with seating capacity for 5 persons, to operate under private hire conditions throughout Victoria from Main-road, Hurstbridge.
- UPPER BEACONSFIELD COACH SERVICE, Upper Beaconsfield; application for variation of all "C.O." licences to include the ability to operate a shopping trip from Upper Beaconsfield to Dandenong on Fridays:—

TIME-TABLE.

Depart Upper Beaconsfield	11.00 a.m.
Depart Dandenong	3.00 p.m.

- TURNBULL, A. A., James-street, Yarram; 1 commercial passenger vehicle, with seating capacity for 10 persons, to operate as follows:—(a) For the carriage of school children only from Boodyarn to the Won Wron State School, thence to Yarram State School, St. Mary's Convent and Yarram High School, thence to Woranga, Greenmount, and return to Yarram State School, (b) as a special service omnibus, subject to the condition that all journeys undertaken commence within a radius of ten (10) miles of the Yarram Post Office.
- VENTURA MOTORS PTY. LTD., 17 Centre-road, South Oakleigh; application for two additional commercial passenger vehicles, with seating capacity for 35 and 38 persons, to operate as country stage omnibuses on Route 208A (Box Hill-Mordialloc) under the same terms and conditions as vehicles already licensed in the name of the applicant.

PIONEER TOURIST COACHES PTY. LTD., 465 Swanston-street, Melbourne; 2 commercial passenger vehicles, with large seating capacity, to extend existing licensed services in New South Wales on to Corryong, Victoria, over routes and at fares and time-tables to be determined.

APPLICATIONS for metropolitan private hire car licences by the persons listed hereunder in respect of commercial passenger vehicles, with seating capacity for 5 persons, to operate under composite conditions from an approved depot in zone set out opposite their names:—

Name and Address; Zone.

- CRAVEN, A. E., 21 Letchworth-avenue, East Brighton; "B".
- WILLIAMS, E. R., 94 Stanhope-street, Footscray; "K".
- JENKINS, A. C., 5 Young-street, Springvale; "C", "B".
- MURPHY, L. S., 27 Clonaig-street, East Brighton; "B".
- HOPPER, J. J., 108 Albert-street, Windsor; "B".

APPLICATIONS for metropolitan taxi-cab licences by the persons listed hereunder in respect of commercial passenger vehicles, with seating capacity for 5 persons:—

Name and Address.

- SZAPORA, S., 27 Brook-crescent, Box Hill South.
- LACEY, H., 284 Nell-street, Watsonia.
- WEBB, D. J., 28 Bath-street, St. Kilda.

TRAYNOR, M. L., Lot 350, Faye-street, Heidelberg; 1 commercial passenger vehicle, with seating capacity for 5 persons, to operate as a metropolitan taxi-cab, subject to the cancellation of metropolitan private hire car licence No. M.H.1523, operated from Gem Taxis, 477 Upper Heidelberg-road, Heidelberg, in the name of the applicant.

APPLICATIONS for renewal of licences by persons listed hereunder to operate under the same terms and conditions from the date of expiry:—

Name and Address; Licence Number; Classification; Expiry Date.

- PEACHEY, E. J., 33 Telford-street, Yarrowonga; C.O.38; country omnibus; 25th August, 1960.
- RONEY, J. M., 27 Balcombe-road, Mentone; C.T.346; country taxi, Mentone; 13th March, 1960.
- HOBBS, G. K., K. L. & M. D. (trading as Horsham Taxi Service), 43 O'Callaghan-parade, Horsham; C.T.555; country taxi, Horsham; 21st March, 1960.
- MAY, C. J., 34 Henty-street, Casterton; C.T.386; country taxi, Casterton; 14th July, 1960.
- GRAY, W. H., Conness-street, Chiltern; C.H.323; country hire, Chiltern; 30th July, 1960.
- NEYLAND, N., Melton-road, Sydenham; C.H.10; country hire, Sydenham; 17th August, 1960.
- ROWSE, A. D., Loch; C.H.6; country hire, Loch; 6th July, 1960.
- ALL WEATHER SCENIC COACHES PTY. LTD., 105 Acland-street, St. Kilda; M.C.254, M.C.255, M.C.300; metropolitan charter; 3rd July, 1960.
- FOWLER, W., senr., 30-32 Coppin-street, Richmond; M.C.20; metropolitan charter; 16th August, 1960.
- BARNES, J. D., corner of Perth-avenue and Westgate-street, Sunshine; M.C.22; metropolitan charter; 16th August, 1960.

CHEETHAM SALT PTY. LTD., 71 Little Malop-street, Geelong; application for renewal of licence No. T.P.38 (expiring 26th July, 1960), authorizing operations under the same terms and conditions.

COAD, C. E., Albert-street, Port Albert; application for renewal of licence No. T.P.123 (expiring 20th July, 1960), authorizing operations under the same terms and conditions.

NOTICE is hereby given that the applications made by the persons named below for licences to operate the commercial goods vehicles on the route or routes, or in the manner set out opposite their names, will be heard at a time and place to be communicated to the persons concerned:—

Name and Address; Nature of Application.

- CHEW, L. G., 97 Rowan-street, Bendigo; 1 commercial goods vehicle (137 cwt.) to operate within a radius of 50 miles of the Chief Post Office at Bendigo in the course of business as a "building contractor"—tools of trade, builders' plant and equipment, and small quantities of materials, incidental to the completion of contracts entered into by the applicant.

- CLARKE, D. J., 34 Clifton-avenue, Stawell; 1 commercial goods vehicle (91 cwt.) to operate—(a) within a radius of 95 miles of the post office at Cohuna and/or within a radius of 100 miles of the post office at Merbein (Bendigo Division of the C.R.B.)—road-contracting plant and materials, (b) within a radius of 20 miles of the post office at Stawell—general goods.
- DAVIES, E. L., 57 Godfrey-street, East Geelong; application to vary the conditions of existing licences Nos. D.A.37497 and D.A.37497/1 by adding "throughout the State of Victoria for the purpose of installing and maintaining projection television receivers—tools of trade and spare parts".
- DUMESNY, S. A., Nirranda South; 1 commercial goods vehicle (110 cwt.) to operate—(a) within a radius of 20 miles of the post office at Nirranda South—general goods, (b) within a radius of 50 miles of the post office at Nirranda South—livestock.
- ALBRECHT, C. E. (trading as Frankston De Luxe Taxi Trucks), 11 Davey-street, Frankston; 1 commercial goods vehicle (10 cwt.) to operate—(a) within a radius of 20 miles of Frankston Post Office—general goods, (b) within a radius of 50 miles of Frankston Post Office—second-hand household furniture.
- HALLIDAY'S G.B. SERVICE, 215 Waverley-road, East Malvern; 1 commercial goods vehicle (8 cwt.) to operate throughout the State of Victoria in the course of business as "automotive bumper bar and radiator grille repairers and reconditioners" for the purpose of collecting second-hand and damaged bumper bars and grilles.
- HOGAN, K., care of Box 148, Bairnsdale; 1 commercial goods vehicle (98 cwt.) to operate—(a) within a radius of 20 miles of Bairnsdale—general goods, (b) throughout the Shires of Bairnsdale, Avon, Tambo, Orbost and Omeo—road-contracting plant and materials.
- JACKSON, W. J., Box 64, P.O., Wodonga; 1 commercial goods vehicle (37 cwt.) to operate within a radius of 75 miles of Wodonga in the course of business as "bulldozer contractor"—own bulldozer, own fuel and oil for use in bulldozer.
- JONES, D. W., PTY. LTD., 126 Cecil-street, Williamstown; 1 commercial goods vehicle (112 cwt.) to operate—(a) within a radius of 25 miles of the G.P.O., Melbourne—general goods, (b) within a radius of 50 miles of the G.P.O., Melbourne—petroleum products in prescribed types of containers and empty containers.
- JONES, H. H., 105 Skipton-street, Ballarat; 1 commercial goods vehicle (88 cwt.) to operate throughout the State of Victoria in the course of business as "marine collector"—marine stores as designated in the *Marine Stores and Old Metals Act 1958* (No. 6303), excluding operations to wharves, docks and shipsides for export purposes.
- KENDALL, A. W., Brodrigg River; 1 commercial goods vehicle (approximately 100 cwt.) to operate—(a) within a radius of 20 miles of Brodrigg River—general goods, (b) from and to Bairnsdale to and from Brodrigg River—petroleum products in prescribed types of containers and empty containers, on behalf of Ampol Petroleum Ltd., (c) from and to places situated within a radius of 20 miles of Brodrigg River to and from places situated within a radius of 50 miles of Brodrigg River—livestock.
- KENNEDY, W. S., 13 Driffeld-road, Morwell; 1 commercial goods vehicle (approximately 220 cwt.) to operate from forest landings in the Licola area to sawmills at Heyfield—logs.
- KERANG PLASTER SHEET CO. PTY. LTD., care of "Broadcasting House", View Point, Bendigo; 2 commercial goods vehicles (60 and 10 cwt.) to operate—(a) within a radius of 50 miles of the Kerang Post Office in the course of business as "plaster sheet manufacturers"—own goods, (b) from and to the Township of Kerang to and from the City of Bendigo in the course of business as "plaster sheet manufacturers"—own plaster sheets, hemp and tools of trade incidental to own contracts.
- KING, A., care of Hamilton Motel, Glenelg Highway, Hamilton; 1 commercial goods vehicle (15 cwt.) to operate within a radius of 50 miles from own premises at Hamilton in the course of business as "wholesale tobacconists"—own cigarettes.
- KING, E. A., 17 Wimmera-street, Stawell; application to vary the conditions of existing licence No. D.A.33409 by deleting "W. Phelan and Sons Pty. Ltd., of Maryborough", and adding in lieu "Stawell Timber Industries, of Lake-road, Stawell West".
- LEWIS, J. W., 153 Melbourne-avenue, Glenroy; 1 commercial goods vehicle (13 cwt.) to operate—(a) within a radius of 50 miles of own premises at Glenroy in the course of business as "plumber"—own goods, (b) throughout the State of Victoria, on behalf of Jim Styles Prefabricated House Manufacturer, for the purpose of supervising and installing plumbing installation—tools of trade, plumbers' equipment, and small quantities of material incidental to installation.
- LYNCH, E. P. & H. (trading as H. Lynch), Woods Point, Warburton; application to vary the conditions of existing licence No. T.D.1647 by adding "logs from forest landings in the Mount Erica area to Saxtons and Edwards' mills at Moe".
- MEIER, V., & SON, Lorquon; 1 commercial goods vehicle (120 cwt.) to operate—(a) within a radius of 20 miles of Lorquon—general goods, (b) from oil company depot at Dimboola to own depot at Lorquon and to places within paragraph (a) above—petroleum products in prescribed types of containers and empty containers.
- MILBURN, C. T., 32 Loller-street, Brighton; 1 commercial goods vehicle (8 cwt.) to operate throughout the State of Victoria in the course of business as "farm building manufacturer" for the purpose of supervising own contracts—tools of trade, builders' equipment, and small quantities of materials incidental to the completion of own contracts.
- MILLAR, J. R., Miller-street, Bendigo; 1 commercial goods vehicle (12 cwt.) to operate throughout the State of Victoria in the course of business as "hawker"—own clothing and drapery. *Special Condition*.—No goods are to be carried for re-sale or to be supplied to retail stores.
- MOORE ROAD MACHINERY (VICTORIA) PTY. LTD., Williamstown-road, Port Melbourne; 1 commercial goods vehicle (11 cwt.) to operate throughout the State of Victoria in the course of business as "engineers" for the purposes of repairing and servicing farm and industrial machinery—tools of trade, spare parts, and materials incidental to such work.
- MORONEY, E. P., 37 Edward-crescent, Trafalgar; 1 commercial goods vehicle (10 cwt.) to operate throughout the State of Victoria in the course of business as "logging contractor" for the purpose of repairing own logging equipment—tools of trade and spare parts incidental thereto.
- MCKINNON, R. A., Cann River; 1 commercial goods vehicle (237 cwt.) to operate—(a) from bush landings within a radius of 50 miles of Cann River to sawmills at Cann River—logs, (b) from sawmills at Cann River to railway station and consignees at Orbost—sawn timber.
- OLDHAM, L. S., Elgin-street, Myrtleford; 1 commercial goods vehicle (104 cwt.) to operate within the Shire of Bright for the carriage of household and street garbage for dumping.
- OSBORN, D. J., 162 Williamson-street, Bendigo; application to vary the conditions of existing licence No. D.A.1765 by deleting from paragraph (a) "Shell Co. of Australia Ltd. and Neptune Oil Co. Pty. Ltd.", and from paragraph (c) "within a radius of 100 miles from the Chief Post Office in the City of Bendigo", and adding in lieu paragraph (a) "all petrol companies", and paragraph (c) "within a radius of 150 miles from the Chief Post Office in the City of Bendigo".
- PEACOCK, R. T., & SONS, 341 Elgar-road, Box Hill; application to vary the conditions of existing licence No. D.A.1789/1 by adding to the paragraph (b) "the town of Balliang".
- PHILLIPS, W. D., 12 Dundas-street, St. Arnaud; 3 commercial goods vehicles (232, 201 and 256 cwt.) to operate—(a) within a radius of 20 miles from the post office at St. Arnaud—general goods, (b) within a radius of 70 miles from the post office at St. Arnaud—bricks.
- REYNOLDS & Co. PTY. LTD., 92 Toorak-road, South Yarra; application to vary the conditions of existing licence No. D.A.1910/3 by deleting section (ii) of paragraph (a).
- REYNOLDS & Co. PTY. LTD., 92 Toorak-road, South Yarra; 1 commercial goods vehicle (75 cwt.) to operate for the carriage of—(a) own confectionery goods in the course of business as "confectionery wholesalers and distributors"—(i) within a radius of 50 miles from the G.P.O., Melbourne, (ii) between the respective railway stations at and retailers in the Townships of Warragul, Sale, Traralgon, Bairnsdale, Yarram, Leongatha and Wonthaggi. *Special Conditions*.—(1) Goods to be consigned by rail to the country towns named in paragraph (a), part (ii) above, (2) freight records of goods consigned by rail to be submitted to the Board at three-monthly periods, (b) from the Townships indicated in paragraph (a), part (ii) above, to own premises situated within the City of Melbourne—unsold stocks of confectionery after completion of trading.

- PARTENIO, L. & E. (trading as L.P. Transport Co. Pty. Ltd.), corner of Percy and Talbot streets, Brunswick; 8 commercial goods vehicles (140, 145, 122, 109, 213, 214, 221 and 166 cwt.) to operate within a radius of 50 miles of the G.P.O., Melbourne, for the carriage of sand and screenings.
- RIDSDALE, G., 501 Leith-street, Ballarat; 1 commercial goods vehicle (8 cwt.) to operate—(a) west of a north/south line drawn through Melbourne in the course of business as a "sales agent for religious goods"—statues, prayer books, rosary beads, &c., (b) within a radius of 50 miles of the Chief Post Office at Ballarat—electrical goods, slow combustion stoves, heaters and sewing machines for repair and sale.
- ROCHE BROS. PTY. LTD., 22 Dynon-road, South Kensington; 2 commercial goods vehicles (each 7 cwt.) to operate—(a) throughout the State of Victoria in the course of business as "earth-moving contractors"—tools of trade, plant and equipment incidental to own contracts (b) within a radius of 20 miles from the site of any construction or maintenance work performed pursuant to paragraph (a) above, or from the railway station nearest thereto—any other materials required for such work.
- ROWLAND, E., Dumbalk; application to vary the conditions of existing licence No. D.A.28558/2 by adding "for the carriage of briquettes from the S.E.C. at Morwell to the Dumbalk Co-operative Butter and Cheese Co. Ltd. at Dumbalk".
- SAIYA, G., 61 Sydney-street, Sunshine; 1 commercial goods vehicle (115 cwt.) to operate—(a) within a radius of 25 miles of Melbourne—general goods, (b) within a radius of 50 miles of Albion Quarrying Co. Pty. Ltd., Sunshine—road-making plant and hot asphalt, premix and materials, on behalf of the said company.
- SELKIRK FREIGHT LINES PTY. LTD., Howitt-street, Ballarat; 2 commercial goods vehicles (each 17 cwt.) to operate—(a) within a radius of 50 miles of James Selkirk Pty. Ltd., brick manufacturers, Ballarat—goods solely on behalf of the said company (b) throughout the State of Victoria for the purpose of sales promotion and advertising, on behalf of James Selkirk Pty. Ltd.—samples and advertising material with the ability to leave a sample when required.
- E.I.L. SERVICE PTY. LTD., 161-173 Sturt-street, South Melbourne; 1 commercial goods vehicle (8 cwt.) to operate throughout the State of Victoria in the course of business as "electrical engineers" for the purpose of servicing, maintaining, and installing electrical appliances—tools of trade, spare parts, electrical appliances for installation, and materials incidental thereto.
- SMITH, A. H., LTD., Phillipson-street, Wangaratta; 1 commercial goods vehicle (70 cwt.) to operate in the course of business as "aerated waters manufacturers and cigarette distributors" within a radius of 50 miles of Wangaratta and to and from the Townships of Tallangatta, Harrierville, Rushworth, Murchison, Corryong, Numurkah, Tatura, Kyabram and Mt. Beauty—cigarettes and own aerated waters and empty returns.
- SMITH, J. B., 52 Anderson-street, East Geelong; 1 commercial goods vehicle (30 cwt.) to operate within a radius of 50 miles from the Chief Post Office in the City of Geelong with a specially constructed and insulated van, solely on behalf of South-West Frozen Foods and David Hyland and Sons Pty. Ltd.—ice, frozen and processed food products, empty containers, plant, and incidental equipment.
- STOCK, R. G., 115 Waiora-road, Rosanna; 1 commercial goods vehicle (87 cwt.) to operate—(a) within a radius of 25 miles of Melbourne—general goods, (b) within a radius of 70 miles of Glen Iris Brick Co., Bulleen—bricks.
- THE UNITED DISTILLERS PTY. LTD., Byrne-street, South Melbourne; 2 commercial goods vehicles (94 and 139 cwt.) to operate—(a) within a radius of 25 miles of own premises at South Melbourne in the course of business as "distillers"—own goods, (b) between own factory at Port Melbourne and own decentralized factory at Corio—raw materials and semi-processed spirit in bulk tanks.
- WEIR, A. J. S., 144 Nelson-street, Nhill; 1 commercial goods vehicle (257 cwt.) to operate—(a) within a radius of 20 miles from the post office at Nhill—general goods, (b) from the Horsham Caltex Oil Co. Depot to Nhill—petroleum products in prescribed containers and empty containers.
- WEST, W. K., 24 Peg Leg-road, Eaglehawk; 1 commercial goods vehicle (109 cwt.) to operate—(a) within a radius of 20 miles of the post office at Cohuna—general goods, (b) within a radius of 95 miles of the post office at Cohuna and/or within a radius of 100 miles of the post office at Merbein (Bendigo Division of the C.R.B.)—road-making plant and materials.

NOTICE is hereby given that the applications made by the persons named below for renewal of licences to operate the commercial goods vehicles on the route or routes, or in the manner set out hereunder opposite their names, will be heard at a time and place to be communicated to the persons concerned:—

Name and Address; Present Franchise; Licence No.; Date of Expiry.

- BEAUREPAIRE TYRE SERVICE PTY. LTD., 83-95 Franklin-street, Melbourne; 1 commercial goods vehicle (42 cwt.) to operate within an area bounded by the following townships:—Daylesford, Newstead, Maryborough, Bealiba, St. Arnaud, Moyston, Westmere, Skipton, Lismore, Cressy and Ballan in the course of business as "tire retreaders and distributors"—tires and tubes for sale and delivery, used tires for repair or retread or having been repaired or retreaded, batteries, oil, and car accessories; goods to be forwarded by rail to Ballarat and distributed in the aforesaid area; D.A.629/17; 27th June, 1960.
- BEEHAG, N. A., Minor-street, Echuca; 1 commercial goods vehicle (120 cwt.) to operate—(a) within a radius of 20 miles from the post office at Echuca—rice hulls for disposal by burning, (b) from and to the Township of Echuca to and from the City of Bendigo and the City of Melbourne—rice hulls; D.A.635; 2nd June, 1960.
- BENDIGO PRESERVING CO. LTD., Garsed-street, Bendigo; 1 commercial goods vehicle (97 cwt.) to operate within a radius of 50 miles from the Chief Post Office in the City of Bendigo and to and from the Townships of Tatura, Murchison, Kyabram and Shepparton in the course of business as "manufacturers of jams, canned fruit and condiments"—own manufactured products; D.A.7270/11; 18th June, 1960.
- CHEETHAM SALT LTD., 71 Little Malop-street, Geelong; 1 commercial goods vehicle (155 cwt.) to operate—(a) from the works of Cheetham Salt Ltd. situate in the City of Geelong and at the Township of Laverton to wharf and rail at Geelong and Laverton respectively—licensee's manufactured salt products, (b) between the works at Geelong and the works at Laverton referred to in paragraph (a) above—applicant's machinery, plant and manufactured goods, (c) between the works at Laverton referred to in paragraph (a) above and the City of Melbourne—applicant's manufactured goods, supplies, machinery and plant; D.A.832/1; 24th June, 1960.
- CHEETHAM SALT PTY. LTD., 71 Little Malop-street, Geelong; 1 commercial goods vehicle (200 cwt.) to operate from and to applicant's salt manufacturing works at Lara, Laverton and Moolap to and from the Cities of Geelong and Melbourne—applicant's own heavy equipment for repair and installation; D.A.832/2; 2nd June, 1960.
- C.I.G. (VICTORIA) PTY. LTD., 90 Bell-street, Preston; 4 commercial goods vehicles (each 7 cwt.) to operate throughout the State of Victoria in the course of business as "manufacturers of industrial gases and equipment" for the purpose of demonstrating own welding appliances and methods of welding—own welding gear and equipment; D.A.838/4, D.A.838/5, D.A.838/6, D.A.838/7; 18th June, 1960.
- DINSDALE, F. J. (Estate of the late), Station-street, Fern Tree Gully; 1 commercial goods vehicle (98 cwt.) to operate within a radius of 70 miles from the premises of the City Brick Works Co. Pty. Ltd. at Toorong-road, East Hawthorn—bricks on behalf of the said company; D.A.984/2; 18th June, 1960.
- EATON, H. E. & E. C., Newmerella, via Orbost; 1 commercial goods vehicle (206 cwt.) to operate—(a) within a radius of 20 miles from the post office at Newmerella—general goods, (b) throughout the Shires of Avon, Bairnsdale, Omeo, Tambo, and Orbost—road-making plant and materials; D.A.35231/1; 23rd April, 1960.
- HOGAN, K. F., Emerald; 1 commercial goods vehicle (102 cwt.) to operate—(a) within a radius of 20 miles from the post office at Emerald—general goods, (b) within a radius of 50 miles from the post office at Emerald—petroleum products in prescribed types of containers and empty containers on behalf of Atlantic Union Oil Co. Ltd.; D.A.7915; 18th June, 1960.
- LOWNDES, JOHN W., 15 Alexandra-avenue, East Geelong; 1 commercial goods vehicle (80 cwt.) to operate throughout the State of Victoria for the purpose of undertaking water boring contracts and installing and servicing windmills—tools of trade, spare parts, boring equipment and casing incidental to own contracts; D.A.1526; 2nd June, 1960.
- MITCHELL, D. K., 5 Clinton-street, West Heidelberg; 1 commercial goods vehicle (101 cwt.) to operate within a radius of 70 miles from the Glen Iris Brick Co. Pty. Ltd. at Thornbury—bricks on behalf of the aforesaid company; D.A.26545; 18th June, 1960.

REYNOLDS & CO. PTY. LTD., 92 Toorak-road, South Yarra; 1 commercial goods vehicle (75 cwt.) to operate—(a) own confectionery goods in the course of business as "confectionery wholesalers and distributors"—(i) within a radius of 50 miles from the G.P.O., Melbourne, (ii) between the respective railway stations at and retailers in the Townships of Wangaratta, Bright, Benalla, Wodonga and Euroa. *Special Condition.*—(1) Goods to be consigned by rail to the country towns named in paragraph (a), part (ii), above, (2) freight records of goods consigned by rail to be submitted to the Board at two-monthly periods, (b) from the townships indicated in paragraph (a), part (ii), above to applicant's own premises situated within the City of Melbourne—unsold stock of confectionery after completion of trading; D.A.1910; 18th December, 1959.

SOUTHERN PENINSULA TRANSPORT SERVICE PTY. LTD., Nepean Highway, Rosebud; 3 commercial goods vehicles (208, 256 and 192 cwt.) to operate—(a) from and to the City of Melbourne to and from places on or within three (3) miles distance from that portion of the Nepean Highway situated between the Township of Portsea and the bridge over Dunn's Creek—general goods, (b) between the railway station at Mornington and places situated on or not more than three (3) miles from that portion of the Nepean Highway between the Township of Portsea and the bridge over Dunn's Creek—general goods; D.A.2075/1, D.A.2075/2, D.A.2075/3; 23rd June, 1960.

STANSFIELD & SMITH PTY. LTD., 307-315 City-road, South Melbourne; 1 commercial goods vehicle (54 cwt.) to operate—(a) throughout the State of Victoria in the course of business as "glass merchants, painting and glazing contractors"—tools of trade, glass for installation, paints and materials for use on own contracts, (b) between the City of Melbourne and applicant's own store depot in the City of Ballarat—out-size uncrated plate glass for use on own contracts only; D.A.2097/3; 30th June, 1960.

THOMAS, H. E., Main Ridge; 1 commercial goods vehicle (245 cwt.) to operate from or to the City of Melbourne and within a distance of eight (8) miles beyond the limits thereof to or from places situated within a radius of nine (9) miles from the post office at Flinders, subject to the conditions that all journeys made pursuant to the conditions of this licence shall be via the Nepean Highway to Frankston, thence via the Frankston-Flinders road, passing through Somerville and Hastings—general goods; D.A.2147; 2nd June, 1960.

WILSON'S (BENALLA) TRANSPORT PTY. LTD., 202-208 East Bridge-street, Benalla; 2 commercial goods vehicles (242 and 256 cwt.) to operate—(a) within a radius of 20 miles from the post office at Benalla—general goods, (b) from and to places within a radius of 20 miles from the post office at Benalla to and from places within a radius of 40 miles from the post office at Benalla—building materials, subject to the condition that such goods shall not be carried to or from any place situate on the Hume Highway beyond Wangaratta or Euroa, (c) within a radius of 60 miles from the post office at Benalla—bricks and gravel, (d) from mills at Mt. Buller, Toombullup and Benalla only to consignees within a radius of 60 miles from the post office at Benalla, subject to the condition that no trip can be undertaken of distance in excess of 60 miles on any declared highway—sawn timber; D.A.2307/1, D.A.2307/3; 4th March, 1960.

WILSON'S (BENALLA) TRANSPORT PTY. LTD., 202-208 East Bridge-street, Benalla; 1 commercial goods vehicle (242 cwt.) to operate—(a) within a radius of 20 miles from the post office at Benalla—general goods, (b) from and to places situate within a radius of 20 miles from the post office at Benalla to and from places within a radius of 40 miles of the post office at Benalla—building materials, subject to the condition that such goods shall not be carried to and from any place situate on the Hume Highway beyond Wangaratta and Euroa, (c) within a radius of 60 miles from the post office at Benalla—bricks and gravel, (d) from mills at Mt. Buller, Toombullup and Benalla to consignees within a radius of 60 miles from the post office at Benalla—sawn timber, subject to the condition that no trip can be undertaken of distance in excess of 60 miles on any declared highway, (e) from Benalla to mills at Mt. Buller and Toombullup—mill machinery and incidental supplies, (f) within a radius of 60 miles from the post office at Benalla—joinery and plaster sheets; D.A.2307; 4th March, 1960.

WILSON'S (BENALLA) TRANSPORT PTY. LTD., 202-208 East Bridge-street, Benalla; 1 commercial goods vehicle (239 cwt.) to operate—(a) within a radius of 20 miles from the post office at Benalla—general goods,

(b) from and to places within a radius of 20 miles from the post office at Benalla to and from places within a radius of 40 miles from the post office at Benalla—building materials, subject to the condition that such goods shall not be carried to or from any place situate on the Hume Highway beyond Wangaratta or Euroa, (c) within a radius of 60 miles from the post office at Benalla—gravel and bricks, (d) sawn timber from mills at Mt. Buller, Toombullup and Benalla to consignees within a radius of 60 miles from the post office at Benalla, subject to the condition that no trip can be undertaken of distance in excess of 60 miles on any declared highway, (e) from Benalla to mills at Mt. Buller and Toombullup—mill machinery and incidental supplies; D.A.2307/2; 4th March, 1960.

WILSON, M. A. E., Sherwood-street, Birchip; 1 commercial goods vehicle (90 cwt.) to operate—(a) within a radius of 20 miles from the post office at Birchip—general goods, (b) within a radius of 50 miles from the post office at Birchip—road-making plant and materials; D.A.2310/2; 8th June, 1960.

Notice of any objection should be forwarded to reach the Secretary of the Board not later than Wednesday, 13th April, 1960.

E. V. FIELD,
Secretary.

Exhibition Buildings, Rathdown-street, Carlton, N.3,
28th March, 1960.

LAW DEPARTMENT.

SITTINGS OF THE SUPREME COURT, HORSHAM.

HIS Excellency the Governor of the State of Victoria, by and with the advice of the Executive Council thereof, doth by Order made on the 29th day of March, 1960, appoint Tuesday, the 21st day of June, 1960, for the Sittings of the Supreme Court in its Criminal and Civil Jurisdictions at Horsham, in addition to the days heretofore appointed.

A. MAHLSTEDT,
Clerk of the Executive Council.

At the Executive Council Chamber,
Melbourne, 29th March, 1960.

STAMPS ACT.

IN pursuance of the powers contained in the Stamps Act, I hereby certify that, until further notice, Mineral Ventures No Liability is a company engaged solely or principally in the search or mining for petroleum.

Dated the 30th day of March, 1960.

D. G. RICHARDS,
Comptroller of Stamps.

ANNUAL LICENCE.

A LICENCE to carry on assurance and insurance business in Victoria from 28th March, 1960, to 31st December, 1960, has been issued to the under-mentioned insurer:—

C.G.A. FIRE & ACCIDENT INSURANCE COMPANY LIMITED.

D. G. RICHARDS,
Comptroller of Stamps.

APPOINTMENT OF COMMITTEE OF MANAGEMENT OF MELVILLE CAVES RESERVE, PARISH OF KANGDERAAR.

WHEREAS by section 50 of the *Forests Act* 1958, No. 6254, it is provided that the Minister of Forests, on the recommendation of the Forests Commission, may appoint any number of persons not less than three to be a Committee of Management of any land forming part of any reserved forest, such land being a place of natural beauty or interest or a health resort, and may remove any of such persons: Now therefore I, Alexander John Fraser, Her Majesty's Minister of Forests in the State of Victoria, on the recommendation of the Forests Commission, do hereby appoint—

HAROLD HEINRICH BEER

in lieu of P. R. Sims as a Member of the Committee of Management, for the period till the 11th day of May, 1962, of the land forming part of the reserved forest in the Parish of Kangderaar, known as "Melville Caves Reserve", and more particularly shown on plan No. A-49/1080—1/1/50, in the file of correspondence No. 58/1436 of the Forests Commission.

Dated at Melbourne the 22nd day of March, 1960.

A. J. FRASER,
Minister of Forests.

AUCTION SALES ACT 1958.

LIST of Persons to whom Auctioneers' Licences have been issued during the months of January and February, 1960.

Name.	Address.	Date of Issue.
Ernest Lawson Adams	891 Burke-road, Camberwell	5.1.60
Gerrard Alderton	701 Toorak-road, Kooyong	7.1.60
Samuel Ames	1B Francesco-street, East Bentleigh	5.1.60
Peter Maxwell Ardley	20 Barrani-street, East Bentleigh	11.1.60
Alfred Roy Attenborough	19 Pioneer-street, Warragul	29.1.60
Norman Bain	53 Blackburn-road, Blackburn	7.1.60
William Herbert Barrow	64 Whitehorse-road, Deepdene	7.1.60
Frederick Bruce Bedwell	12 Gordon-street, Moorabbin	21.1.60
Frederick Albert Beer	Princes Highway, Noble Park	11.1.60
Walter Douglas Beer	67 Fifth-avenue, Chelsea Heights	5.1.60
Rupert John Brasher	Kyabram	11.1.60
Richard Murray Burchell	293 High-street, Prahran	11.1.60
Clarence Silvester Cavanagh	26 Smith-street, Collingwood	8.1.60
Harold Winthrop Clapp	108 Queen-street, Melbourne	5.1.60
Norman Gillon Coppel	165 Bay-street, Brighton	7.1.60
Percy William James Cousins	51 Ward-street, Ashburton	3.2.60
Ian James Crowder	Olivers Hill, Frankston	15.1.60
John Patrick Cummins	Wycheproof	25.1.60
Alan James Curran	44 Dunlop-avenue, Ascot Vale	7.1.60
William Ernest Danks	40 Barry-street, Brunswick	14.1.60
Ralph Alvisi Dawson	114A Hopkins-street, Footscray	11.1.60
Geoffrey David Dodds	1 Lansdowne-road, East St. Kilda	24.2.60
Arthur William Dougherty	35 Fitzroy-street, Sale	19.2.60
Serge Leslie Dowling	106 a'Beckett-street, Melbourne	7.1.60
Walter Drane	29 Summerhill-avenue, East Malvern	5.1.60
Edward Graham Farquharson	239 Collins-street, Melbourne	5.1.60
Vincent Anthony Flannery	37 Henshall-road, Strathmore	11.1.60
William George Ford	207 Walnut-avenue, Mildura	24.2.60
Eric Randal Gamon	130 Grey-street, St. Kilda	6.1.60
Francis Edward Gibson	50 Clovelly-avenue, Glenroy	7.1.60
Noel Grave	663 St. Kilda-road, Melbourne	5.1.60
Basil Edward Hayden	1 Russell-street, Ballarat	18.2.60
Geoffrey Osmond Heeps	47 Toorak-road, South Yarra	11.1.60
Peter Irving Hollings	30 Wallace-street, Maidstone	14.1.60
John Burnaby Hunt	413 Church-street, Richmond	11.1.60
Barry James Iles	16 Darling-avenue, Burwood	11.1.60
Henry Bissett Johnson	100 Collins-street, Melbourne	5.1.60
Harold Edward Kane	19 Holmes-road, Moonee Ponds	6.1.60
Leo Patrick Kearney	Murchison	22.2.60
Athol James Kennedy	1082 Burke-road, North Balwyn	12.2.60
Robert Mann Lambert	259 Collins-street, Melbourne	11.1.60
Edward Kenneth Leeden	67 Bay-street, North Brighton	7.1.60
William Thomas Garvey Long	13 Cullen-street, Kerang	9.2.60
Hector McDonald	68 The Corso, Parkdale	5.1.60
Jeffrey Ian McDonald	Flat 1, 13 Denham-place, Toorak	23.2.60
Robert Keith McLennan	44 King-street, Dandenong	5.1.60
William Francis McNally	Main-street, Upwey	5.1.60
Bruce Ebsworth Maling	34 Eilsa-street, North Balwyn	8.1.60
Sylvester Malone	50 Queen-street, Melbourne	5.1.60
Eugene Claude Mann	35 Station-street, East Burwood	11.1.60
Graeme Blakiston Martin	Goroke	15.1.60
Kenneth Harris Mcallin	4 Paisley-street, Footscray	5.1.60
Mervyn Noel Murphy	Kyneton	25.2.60
Donald Geoffrey Nicholls	372 Latrobe-street, Melbourne	7.1.60
Gordon Collole Norris	9 Langhorne-street, Dandenong	8.1.60
Kevin Joseph O'Loughlin	Warracknabeal	8.1.60
Myles Hunter Patterson	47 Victoria-street, Warragul	19.2.60
Thomas Joseph Pattison	25 French-street, Hamilton	28.1.60
Clive Alexander Philp	28 Maxwell-street, Kyneton	11.2.60
Arthur Edwin Plant	15 Banfield-street, Ararat	11.2.60
Peter John Rackham	25 Leonie-avenue, East Bentleigh	7.1.60
Frederick Henry Redding	225 Collins-street, Melbourne	6.1.60
James Stewart Richardson	Ouyen	16.2.60
Roy Satchwell	142 Burke-road, East Malvern	7.1.60
Robert Sauvarin	Raleigh-road, Maribyrnong	8.1.60
John Joseph Scarff	379 Collins-street, Melbourne	11.1.60
Peter John Schofield	951 Nepean Highway, Moorabbin	7.1.60
Thomas Gemmell Locan Scott	360 Chapel-street, Prahran	6.1.60
William Walter Shepherd	20 Erskine-avenue, Cheltenham	13.1.60
Charles Stuart Somers	277 Toorak-road, South Yarra	5.1.60
Ramon Lance Spagnol	230 Mansfield-road, Thornbury	17.2.60
William Howard St. Clair	133 William-street, Melbourne	6.1.60
John Henry Stephens	112 Somerville-road, Yarraville	4.1.60
William John Stutt	85 Queen-street, Melbourne	5.1.60
Kenneth John Thomas Sullivan	248 Waterloo-road, Oak Park	7.1.60
Benjamin Tipper	318 Hampton-street, Hampton	6.1.60
George Trezise	660 Plenty-road, Preston	6.1.60
Hugh Lewellin Trotter	Olinda-crescent, Olinda	5.1.60
Stanley Herbert Vague	Kyneton	25.1.60
William Leo Walsh	Main-street, Croydon	6.1.60
Norman Sidney Westland	Bendigo-road, Kerang	10.2.60
Robert John White	38A Glenhuntly-road, Elsternwick	7.1.60

STATE RIVERS AND WATER SUPPLY COMMISSION.

LICENCES TO DIVERT WATER AND CUT RACES PURSUANT TO THE PROVISIONS OF THE WATER ACT, 1958.

SCHEDULE of eight Licences to Divert Water, attached hereunder, recommended by the State Rivers and Water Supply Commission to be granted by the Governor in Council.

Licence No.	Term of Licence and Commencing Date.	Name and Address of Person to Whom Licence is to be Granted.	Source of Supply.	Area Authorized to be Irrigated Per Annum.	Volume of Water Authorized to be Diverted Per Annum.
				acres.	ac. ft.
1419	Fifteen years from 1.7.59	Ralph Lay, Heyfield	Thomson River . .	30	60
1420	Fifteen years from 1.7.59	Norman George Drew, Heyfield . .	Thomson River . .	30	60
1421	Fifteen years from 1.7.59	Alexander Nahk, Heyfield	Thomson River . .	10	20
1422	Fourteen and a half years from 1.1.60	Sydney Smith, and M. A. Smith, Yar-rowayah North	Torgannah Lagoon	14	28
1423	Fourteen and a half years from 1.1.60	Robert C. Hives, Kingaton	Bullarook Creek . .	20	20
1424	Fourteen and a half years from 1.1.60	Nicholas J. Rousch, Newlyn North . .	Hepburn's Lagoon	20	20
1425	Fourteen and a half years from 1.1.60	Powley Alexander Smith, Laanecoorie . .	Loddon River . .	20	40
1426	Eleven and a half years from 1.1.60	Allen Brownbill, Laanecoorie	Loddon River . .	5	10

Office of the State Rivers and Water Supply Commission,
Melbourne, 29th March, 1960.

E. BROWN, Secretary,
State Rivers and Water Supply Commission.

STATE RIVERS AND WATER SUPPLY COMMISSION.

BY-LAW No. 5323—REVOKING BY-LAWS Nos. 5 AND 50.

THE State Rivers and Water Supply Commission, in pursuance and exercise of the powers conferred by the Water Acts, doth hereby make the By-law following:—

1. By-law No. 5 made by the Commission on the seventeenth day of December, One thousand nine hundred and six, and amending By-law No. 50 made on the ninth day of March, One thousand nine hundred and eight, for the appointment of a time and place for the meetings of the Commission and the management and conduct of business thereat are hereby revoked.

The foregoing By-law No. 5323 was made by the State Rivers and Water Supply Commission on the fifteenth day of March, 1960, and the common seal of the said Commission was hereunto affixed the 18th day of March, 1960, in the presence of—

(SEAL) L. R. EAST, Chairman.
H. W. McCAY, Commissioner.
A. L. TISDALL, Commissioner.

Approved by the Governor in Council, 22nd March, 1960.—A. MAHLSTEDT, Clerk of the Executive Council.

Water Acts.

STATE RIVERS AND WATER SUPPLY COMMISSION.

CHELSEA—FRANKSTON URBAN DISTRICT.

NOTICE to owners of tenements in the under-mentioned streets in the Chelsea-Frankston Urban District and the private streets, lanes, courts and alleys opening thereto:—

CHELSEA.

Glenola-road, from end of existing main (opposite lot 5 about 3½ chains south-westerly from Scotch-parade) to end of existing main (opposite lot 15) a distance of about 2½ chains south-westerly.

FRANKSTON.

Blackbutt-court.
Charlton-place.
Elm-court.
Fenton-crescent, from Violet-street to Liddesdale-avenue.
Frankston-Dandenong road (east side), from Hannah-street to a point opposite lot 50 about 14 chains north-easterly from Pine-street.
Hannah-street.
Laurel-court.
Pine-street, from Frankston-Dandenong road to a point opposite lot 93 about 1 chain north-easterly from Tallow Wood-street.
Plantation-street, from Pine-street to a point opposite lot 60 about 11 chains north-easterly.

Tallow Wood-street, from Pine-street to Blackbutt-court.

The main pipe in the said streets being laid down, the owners of all tenements situated as above are hereby required on or before the 2nd day of May next, to cause proper pipes and stop cocks to be laid, so as to supply water within such tenements from the main pipe.

E. BROWN, Secretary,
State Rivers and Water Supply Commission.

Melbourne, 25th March, 1960.

NOTICE TO MARINERS.

[No. 3 of 1960.] P

AUSTRALIA.—VICTORIA.

PORT PHILLIP—SOUTH CHANNEL.

Light Beacon to be Constructed.

Date.—On or about 28th March, 1960.

Position.—South Channel Fort (White Triangulation Beacon, Δ E.). Lat. 38 deg. 18 min. 32 sec. S. Long. 144 deg. 48 min. 06 sec. E. (Approx.).

Details.—On or about the above date pile-driving operations for the construction of a new light-beacon will commence in the following position:—273 deg. 20 min. distant 1.33 miles from the South Channel Fort White Triangulation Beacon.

Remarks.—The light-beacon will be constructed on the northern side of the South Channel approximately 575 feet ENE from No. 5 Light-Buoy.

Further notice will issue on establishment of the light.

Caution.—Mariners are requested to keep well to the southward and to proceed at minimum speed consistent with safe navigation when passing vessels engaged on the above construction.

Small craft are warned of the existence of submerged cables and anchors to the north, east and west of the site which should be given a clearance of at least 300 feet.

Charts Affected.—B.A. Nos. 1171, 2747.

Publications.—Sailing Directions, Victoria, 1959, pages 230, 234, and 694. Australia Pilot, Vol. 11, 1956, page 72.

C. O'MALLEY,
Port Officer.

Ports and Harbors Branch,
Department of Public Works,
Melbourne, C.2, 16th March, 1960.

Local Government Act 1946, Part 48, Section 876.

LICENCES TO OCCUPY UNUSED ROADS.

NOTICE is hereby given that Licences to occupy Unused Roads have been issued to the following approved applicants, and that the Licence Fee specified in each case has been received by the Accountant, Department of Crown Lands and Survey, Melbourne, C.2.

Number of Licence.	Name and Address of Licensee.	Municipality.	Parish.	Abutting— Allotments and Sections.	Area.	Fee for Licence.			Date of Issue of Licence.	Date of Expiry of Licence.
						A.	R.	F.		
41951	Gilesenan, D. C., Caveat, via Seymour	Yea ..	Dropmore	South of 24, section B	2 2 0	1	0	0	1.1.60	31.12.62
41952	Cowles, M. T., 3 Como-avenue, South Yarra	Seymour ..	Northwood	Between 20A, 19 and 16B, 15A; between 32 and 16A, 16B; between 11B and 15B, 21	21 0 0	3	8	0	1.1.60	31.12.62
41953	Hardy, H. H., Box 6, Tal-langatta	Yaakand- andah	Tangambal- anga	North of 27D, section 12	4 2 0	1	0	0	1.1.60	31.12.62
41954	Clarke, E. and M., Seymour	Seymour ..	Seymour ..	Between 29, 28 and 30 and Sunday Creek P.R.	9 0 0	1	9	0	1.1.60	31.12.62
41955	MacGregor, W. Box 117, Benalla	Benalla ..	Tatong ..	West of P.R. ..	7 2 0	3	15	0	1.1.60	31.12.62
41956	Ley, T. M., Tallangatta ..	Towong ..	Bullioh ..	South and North West of 60; west of 60B, south and west of 16, section A, south of eastern part of 23, section A; east and south of 71D, east and south of 15, section A	32 0 0 32 0 0	7	0	0	1.1.60 1.1.60	31.12.62 31.12.62
41957	Nichol, W. P., Koorilla, via Bethanga	Towong ..	Tatonga ..	South of 4A, section 12; abut. 2, section 17	1 1 0	1	0	0	1.1.60	31.12.62
41958	Ley, B. J., Jarvis Creek, Tal-langatta	Towong ..	Tatonga ..	South of 7 and 8, section 14; north of eastern half of 5, section 20; through 12, section 20, northern portion east of 9, section 20	21 0 0	5	0	0	1.1.60	31.12.62
41959	Devanny, B. W., Gooram	Euroa ..	Gooram Gooram Gong	Western 18 chains south of 17, section A ..	1 3 4	1	15	0	1.1.60	31.12.62
41960	McDonald, J. G., Orbost ..	Orbost ..	Orbost ..	North of 3c, section 1B	1 0 0	1	0	0	1.1.60	31.12.62

Department of Crown Lands and Survey,
Melbourne, 24th March, 1960.

KEITH TURNBULL,
Commissioner of Crown Lands and Survey.

Local Government Act.
SHIRE OF WINCHELSEA.
ORDER CONFIRMED.

THE Minister of the Crown administering the *Local Government Act 1958*, on the 21st day of March, 1960, confirmed the Order hereinafter referred to, in pursuance of section 514 of the said Act, namely:—

An Order of the Council of the Shire of Winchelsea, made on the 10th February, 1960, for the purpose of providing a place for public resort and recreation, and for compulsorily acquiring for such purpose all that piece of land being part of Crown allotment 68, Parish of Barwon, and being the whole of the land described in certificate of title, volume 2993, folio 567.

M. V. PORTER,
Minister for Local Government.

SUMMONING OFFICER.

UNDER section 5 of the *Education Act 1958*, I hereby appoint—

RUSSELL RICHARD LENAGHAN
to summon parents within the State of Victoria.
J. S. BLOOMFIELD,
Minister of Education.

MUNICIPAL AUDITORS BOARD.

NOTICE is hereby given that an examination of persons over the age of 25 years desirous of obtaining a certificate to exercise the office of Municipal Auditor or Inspector of Municipal Accounts will be held on Wednesday, 18th May, 1960.

Applications for permission to sit for the examination will be received not later than 26th April, 1960.

J. F. O'DONNELL, Secretary,
Municipal Auditors Board.

Local Government Department, 61 Spring-street,
Melbourne, C.1.

Motor Car Act 1958.—Section 41.

EFFECTIVE DATE OF WITHDRAWAL BY
AUTHORIZED INSURER.

WHEREAS, by notice in writing dated the sixteenth day of March, 1960, the following authorized insurer under Part V. of the said Act, namely:—

THE BRITISH MEDICAL INSURANCE COMPANY OF VICTORIA LIMITED
has withdrawn from insurance business in terms of the aforesaid Part:

Now therefore I, Arthur Gordon Rylah, in pursuance of the provisions of section 41 of the said Act, do hereby specify the first day of June, 1960, as the date upon which such notice of withdrawal shall have effect.

A. G. RYLAH,
Chief Secretary.

Chief Secretary's Office,
Melbourne, 23rd March, 1960.

Motor Car Act 1958.—Section 41.

EFFECTIVE DATE OF WITHDRAWAL BY
AUTHORIZED INSURER.

WHEREAS, by notice in writing dated the sixteenth day of March, 1960, the following authorized insurer under Part V. of the said Act, namely:—

THE AUTOMOBILE FIRE & GENERAL INSURANCE CO. OF AUSTRALIA LTD.
has withdrawn from insurance business in terms of the aforesaid Part:

Now therefore I, Arthur Gordon Rylah, in pursuance of the provisions of section 41 of the said Act, do hereby specify the first day of June, 1960, as the date upon which such notice of withdrawal shall have effect.

A. G. RYLAH,
Chief Secretary.

Chief Secretary's Office,
Melbourne, 23rd March, 1960.

SHIRE OF KYNETON.

By-Law No. 48.

A By-law numbered 48 for the fixing of fees and dues to be charged for services rendered at the Kyneton Municipal Abattoirs.

IN exercise of the powers conferred by the Health Acts and by every other Act or power enabling it in that behalf, the Council of the Shire of Kyneton (and hereinafter called "the Council") makes the following By-law:—

1. The whole of Clause 6 of By-law No. 40 is hereby repealed.
2. The following fees and dues shall be payable to the Council for the above-mentioned services in connexion with the abattoirs.

Kind.	Use of Abattoirs.	Examining.	Examining and Branding.	Slaughtering and Dressing.	Chilling any Carcass for 72 hours.	Total.
	s. d.	s. d.	s. d.	£ s. d.	s. d.	£ s. d.
Cattle—						
101 lb. to 250 lb.	3 0	1 6	2 0	0 11 0	2 6	1 0 0
251 lb. and over	3 0	2 0	3 0	1 9 6	4 6	2 2 0
Bulls	3 0	2 0	3 0	1 14 6	4 6	2 7 0
Calves—						
100 lb. and under	1 0	0 9	1 0	0 4 3	1 0	0 8 0
Sheep	0 9	0 6	0 6	0 3 4	0 6	0 5 7
Rams	1 0	0 6	0 7	0 5 0	0 6	0 7 7
Pigs—						
100 lb. and under	1 3	1 3	0 6	0 8 6	1 0	0 12 6
101 lb. to 200 lb.	2 0	2 0	2 0	0 10 6	1 0	0 17 6
201 lb. and over	2 0	2 0	2 0	1 0 0	1 0	1 7 0

For any Certificate as to examination by a Meat Inspector, 4s. 0d.

Provided that if the carcass is retained in the chilling chamber for longer than the period (not being less than 72 hours exclusive of Saturdays, Sundays and Public Holidays) specified in the By-law, an additional fee not exceeding the original fee may be prescribed for each such additional period.

3. This By-law shall apply to and have operation throughout the whole of the Shire of Kyneton and shall come into effect immediately after its publication in the *Government Gazette*.

The resolution for passing this By-law was agreed to by the Council on the 9th day of December, 1959, and confirmed on the 13th day of January, 1960.

The Common Seal of the Shire of Kyneton was hereunto affixed in pursuance of an Order of the Council made the 13th day of January, 1960, in the presence of—

(SEAL)

J. F. LEVICK, President.
J. G. ROTHE, Councillor.
S. G. PORTER, Secretary.

Submitted to the Commission of Public Health on the 1st day of March, 1960.—F. P. Madden, Acting Secretary to the Commission.

Approved by the Governor in Council, 22nd March, 1960, A. MAHLSTEDT, Clerk of The Executive Council.

POLICE OFFENCES ACT 1958.

IN pursuance of the powers conferred upon the Chief Secretary by sub-section (3) of section 184 of the *Police Offences Act 1958*, I, Arthur Gordon Rylah, Her Majesty's Chief Secretary for the State of Victoria, do by this notice grant exemption from compliance with sub-sections (1) and (2) of section 184 of the said Act with respect to the publication *Blake's Beach* distributed by Colorgravure Publications, 26-30 Flinders-street, Melbourne.

A. G. RYLAH,
Chief Secretary.

Chief Secretary's Office,
Melbourne, 22nd March, 1960.

Children's Welfare Act 1958.—Section 14.

DECLARATION OF AN INSTITUTION AS AN APPROVED CHILDREN'S HOME.

IN accordance with the provisions of clause 49 of the *Children's Welfare Regulations 1955*, notice is hereby given that on the twenty-fifth day of March, 1960, I, Arthur Gordon Rylah, Chief Secretary of the State of Victoria, declared the under-mentioned institution as an approved Children's Home for the purposes of the *Children's Welfare Act 1958*:—

Convent of the Good Shepherd, Oakleigh ("Villa Mareta" Section), Castlebar-road, Oakleigh.

A. G. RYLAH,
Chief Secretary.

Chief Secretary's Office,
Melbourne, 25th March, 1960.

Hospitals and Charities Act 1958 (No. 6274).—Section 64.

PETITION TO INCORPORATE HELPING HAND ASSOCIATION FOR MENTALLY RETARDED CHILDREN—BRIGHTON AND DISTRICTS BRANCH.

IT is hereby notified, in accordance with the provisions of section 64 of Act No. 6274 that the Hospitals and Charities Commission has received a Petition signed by not less than twenty-five contributors to Helping Hand Association for Mentally Retarded Children—Brighton and Districts Branch, praying that the organization be incorporated under the provisions of the said Act. This organization established in Brighton will have for its objects the dispensing of charitable relief to infirm or incurable persons and the establishment and maintenance of a training centre for mentally retarded persons, including children, and is capable of being incorporated.

If a counter petition signed by an equal or greater number of contributors is not lodged with the aforesaid Commission at No. 1 Nicholson-street, Melbourne, within one calendar month of publication of this Notice, the Governor in Council may, by Order made pursuant to Act No. 6274, declare the contributors for the time being to Helping Hand Association for Mentally Retarded Children—Brighton and Districts Branch, to be a body corporate by the name set forth in such Order.

E. P. CAMERON,
Minister of Health.

Department of Health,
Melbourne.

(The foregoing Notice is published in lieu of the Notice of a Petition to incorporate Brighton and District Branch of the Helping Hand Association for Mentally Retarded Children which appeared on page 925 of *Government Gazette* No. 19 of the 16th March, 1960.)

MELBOURNE AND METROPOLITAN BOARD OF WORKS.

NOTICE TO THE OWNERS OF TENEMENTS IN THE UNDER-MENTIONED STREETS, AND THE PRIVATE STREETS, LANES, COURTS AND ALLEYS OPENING THERETO.

THE main pipe in the said streets being laid down, the owners of all tenements situated as under are hereby required on or before 2nd May, 1960, to cause a proper pipe and stop cocks to be laid so as to supply water within such tenements from the main pipe.

V. C. TREYVAUD,
Secretary.

22nd March, 1960.

STREET AND POSITION.

Box Hill.

Brook-crescent, from Station-street to Eley-road.
Greenbank-avenue, from Brook-crescent to Eley-road.
Station-street, from Bronte-avenue southwards 9 chains.
McIntyre-street, from Burwood-road to Judith-street.

Broadmeadows.

Dickinson-street, from South-street to Middle-street.
Francis-street, from South-street to Donald-street.
Donald-street, from Francis-street to Dickinson-street.
Nita-street, from Dickinson-street westwards 4½ chains.
Everitt-street, from South-street to Barbara-street.
Princess-street, from South-street southwards 9½ chains.
Virginia-street, from Princess-street eastwards 4½ chains.
Rose-street, from Princess-street eastwards 4 chains.
Cumberland-street, from Bounary-road to South street.
Donnelly-court, from Cumberland-street eastwards 5 chains.

Camberwell.

Frimley-road, from Mont Albert-road to Empress-road.
Vears-road, from Madeline-street southwards 2½ chains.

Heidelberg.

Nell-street, from 4½ chains west of McDowell-street westwards 2½ chains.
Esther-street, from McDowell-street to Henry-street.
Vermont-parade, from Adeline-street to McDowell-street.

Keilor.

Leslie-street, from Biggs-street to Eisner-street.
William-street, from Leslie-street eastwards 25 chains.
William-street, from Leslie-street westwards 1½ chain.
Biggs-street, from 2½ chains east of Leslie-street to Ivanhoe-avenue.
Wood-street, from Leslie-street eastwards 13½ chains.
Eisner-street, from Leslie-street eastwards 13½ chains.
Vincent-street, from Station-avenue, to Biggs-street.
Main-road east, from Lester-avenue to Errington-road.
McArthur-avenue, from Main-road east to Biggs-street.
Station-avenue, from 3 chains east of Vincent-avenue eastwards 8½ chains.
Lester-avenue, from Station-avenue southwards 9½ chains.
Leonard-avenue, from Main-road east to Station-avenue.
Ivanhoe-avenue, from Main-road east northwards 11 chains.
Errington-road, from Main-road east north-eastwards 12½ chains.
Scott-avenue, from Errington-road to Bernbanks-avenue.
Manfred-avenue, from Scott-avenue north-eastwards 14 chains.
Bernbanks-avenue, from Scott-avenue to Cowper-avenue.
Cowper-avenue, from Bernbanks-avenue southwards 8 chains.

Kew.

Henty-court, from Tara-avenue eastwards 2½ chains.

Mulgrave.

Wellington-road, from 2 chains east of Irwin-street eastwards 6 chains.

Nunawading.

Crowe-street, from Burwood-road to Mudgee-street.
Moona-street, from Crowe-street eastwards 9 chains.
Inga-street, from Crowe-street eastwards 9 chains.
Mudgee-street, from Crowe-street eastwards 9 chains.

Prahran.

Tashinny-road, from Ellerslie-place eastwards 4½ chains.

Ringwood.

Reserve-road, from 4½ chains north-east and south-east of The Centreway south-eastwards 6½ chains.
Wattle-avenue, from 6 chains south-east of The Centreway south-eastwards 2½ chains.
John-street, from 4½ chains south of Unsworth-road to Cross-street.

No. 25.—2674/60.—2

Through-road, from 7½ chains south of Unsworth-road to Cross-street.

Pauls-court, from Unsworth-road northwards 7½ chains.
Glencairn-avenue, from 9½ chains south-east of Mullum Mullum-road south-eastwards 8½ chains.
Leonard-street, from 13½ chains north-west of Maroondah Highway north-westwards 1½ chain.
Wood-street, from 1 chain south of Wonadawn-avenue to Green-street.
Green-street, from Wood-street westwards 5½ chains.
Velma-grove, from Mirabel-avenue southwards 2½ chains.

Sunshine.

Main-road east, from Lester-avenue to Errington-road.

Cemeteries Act 1958 (No. 6217).

SCALE OF FEES OF THE DANDENONG PUBLIC CEMETERY.

IN pursuance of the powers conferred by Cemeteries Acts, the Council of the City of Dandenong, as Trustees of the Dandenong Public Cemetery, hereby makes the following scale of fees, which shall come into operation on publication in the *Government Gazette*, and from and after such publication any scale of fees heretofore made by the said Council shall be and is hereby rescinded to the extent to which it conflicts with this scale:—

	£	s.	d.
Purchase of grave—land 8 ft. x 4 ft.	5	5	0
Number Plate	1	2	6
Sinking of grave (to 7 feet)	7	10	0
Sinking of grave—Child under 12 years (to 7 feet)	5	0	0
Re-opening of grave to 5 feet	5	10	0
Public grave (adult)	5	0	0
Public grave (child under 7 years)	3	0	0
Interment of ashes	1	10	0
Exhumation fee	6	6	0
Certificate of right of burial	0	5	0
Monumental work—2½ per cent. on cost of work— Minimum fee	0	10	6

Attention to grave—Arrangement may be made with Trustees. (Information from Town Clerk.)

Extras—Oversize grave (over 2 ft. 3 in.)	0	15	0
Late fees	0	10	6
Saturdays, Sundays, Holidays	4	10	0
Insufficient notice	1	0	0
Burials before 3 p.m. Mondays other than Holidays	3	10	0
Burials after 3.45 p.m.	1	1	0

The common seal of the Mayor, Councillors, and Citizens of the City of Dandenong was hereto affixed this 25th day of January, 1960—

M. JARVIS, Chairman.
(SEAL) VICTOR R. THARLE, Councillor.
W. SCHOON, Councillor.
R. BOOTH, Town Clerk.

Approved by the Governor in Council,
22nd March, 1960.

A. MAHLSTEDT,
Clerk of the Executive Council.

Town and Country Planning Act 1958.

CITY OF MALVERN.

INTERIM DEVELOPMENT ORDER.

BY virtue of the powers conferred by the *Town and Country Planning Act 1958* and of every other power enabling it in that behalf, the Council of the City of Malvern (hereinafter referred to as the Responsible Authority) having commenced the preparation of a Planning Scheme in accordance with the said Act hereby makes the following Interim Development Order for the purpose of regulating, restricting, restraining or prohibiting the use or development of any land or the erection, construction or carrying out of any buildings or works on any land within the area described or shown on the map as the Schedule hereto.

1. After the coming into operation of this Interim Development Order no person shall use or develop any land or erect, construct or carry out any buildings or works on any land within the area included in the Schedule, except in accordance with the provisions of a permit issued by the Responsible Authority.

2. Any application for a permit to use or develop any land or to erect, construct or carry out any buildings or works shall be accompanied by a sketch plan or copy of certificate of title of the land and a description of the proposed use or development, and type or construction of any buildings or works proposed to be erected, constructed or carried out and such other particulars relating to the application as the Responsible Authority may require.

3. This Interim Development shall not prevent the continuance of the use of any land or buildings for the purposes for which such land or buildings were lawfully used immediately before the coming into operation of this Order.

4. Schedule—the whole of the municipal district of the City of Malvern.

(SEAL) J. JOHNSON, Mayor.
S. E. STEVENS, Councillor.
D. W. LUCAS, Town Clerk.

Report by the Town and Country Planning Board on the 25th day of February, 1960. Recommended for approval.—FRED. C. COOK, Chairman.

Approved by the Governor in Council on the 22nd day of March, 1960.—A. MAHLSTEDT, Clerk of the Executive Council.

ROSEDALE WATERWORKS TRUST.

AUTHORITY TO OBTAIN BANK OVERDRAFT.

HIS Excellency the Governor of the State of Victoria, by and with the advice of the Executive Council thereof, doth by Order made on the 29th day of March, 1960, authorize the Rosedale Waterworks Trust to obtain, in pursuance of the provisions of section 286 of the *Water Act 1958* (No. 6413), an advance or advances during the year 1960 from the Australia and New Zealand Bank Limited, Rosedale, by overdraft of the Trust's current account thereat, such overdraft not to exceed at any one time the sum of Two hundred pounds (£200).

A. MAHLSTEDT,
Clerk of the Executive Council.

At the Executive Council Chamber,
Melbourne, 29th March, 1960.

YEA WATERWORKS TRUST.

RATING BY-LAW, 1960.

THE Yea Waterworks Trust, in pursuance and exercise of the powers conferred by the Water Acts, hereby makes the following rates and charges for the supply of water within the Yea Urban District. On lands and tenements liable to be rated, a rate of Ten pence in the pound on the amount of the net annual municipal valuation not exceeding Six hundred pounds, provided that in no case shall the amount of such rate payable in respect of any tenement (other than land on which there is no building) be less than Four pounds, and in respect of any land on which there is no building less than Twenty shillings.

On such lands and tenements the annual municipal valuation of which exceeds Six hundred pounds, a rate of Twenty-five pounds.

Such rates are made and shall be levied upon occupiers or owners of the said lands and tenements for the year commencing on the 1st day of January, 1960, and shall be payable on the 29th day of April, 1960, at the office of the said Trust, Shire Hall, Yea.

The charge for water supplied by measure to any property not rated by the Trust is hereby fixed at One shilling and two pence for 1,000 gallons, and the minimum quantity of water to be charged for in cases where water is so supplied is fixed at 20,000 gallons.

The charge for water supplied by measure shall be payable, on demand, at the office of the said Trust, Shire Hall, Yea.

Passed on the 29th day of February, 1960.

(SEAL) E. M. SMITH, Chairman.
F. F. BERKERY, Secretary.

Approved, 22nd March, 1960.—W. J. MIBUS, Minister of Water Supply.

KERANG WATERWORKS TRUST.

AUTHORITY TO OBTAIN BANK OVERDRAFT.

HIS Excellency the Governor of the State of Victoria, by and with the advice of the Executive Council thereof, doth by Order made on the 29th day of March, 1960, authorize the Kerang Waterworks Trust to obtain, in pursuance of the provisions of section 286 of the *Water Act 1958* (No. 6413), an advance or advances during the year 1960 from the English Scottish and Australian Bank Limited, Kerang, by overdraft of the Trust's current account thereat, such overdraft not to exceed at any one time the sum of Five thousand pounds (£5,000).

A. MAHLSTEDT,
Clerk of the Executive Council.

At the Executive Council Chamber,
Melbourne, 29th March, 1960.

SPRINGHURST WATERWORKS TRUST.

AUTHORITY TO OBTAIN BANK OVERDRAFT.

HIS Excellency the Governor of the State of Victoria, by and with the advice of the Executive Council thereof, doth by Order made on the 29th day of March, 1960, authorize the Springhurst Waterworks Trust to obtain, in pursuance of the provisions of section 286 of the *Water Act 1958* (No. 6413), an advance or advances during the year 1960 from the National Bank of Australasia Limited, Wangaratta, by overdraft of the Trust's current account thereat, such overdraft not to exceed at any one time the sum of Two hundred pounds (£200).

A. MAHLSTEDT,
Clerk of the Executive Council.

At the Executive Council Chamber,
Melbourne, 29th March, 1960.

MARYSVILLE WATERWORKS TRUST.

FIXING THE LIMIT OF A BANK OVERDRAFT.

HIS Excellency the Governor of the State of Victoria, by and with the advice of the Executive Council thereof, doth by Order made on the 29th day of March, 1960, in pursuance of the provisions of section 288 of the *Water Act 1958* (No. 6413), fix the limit of the overdraft to be obtained by the Marysville Waterworks Trust from the Australia and New Zealand Bank Limited, Alexandra, at an amount not to exceed at any one time the sum of Three thousand pounds (£3,000).

A. MAHLSTEDT,
Clerk of the Executive Council.

At the Executive Council Chamber,
Melbourne, 29th March, 1960.

TYERS AND GLENGARRY WATERWORKS TRUST.

FIXING THE LIMIT OF A BANK OVERDRAFT.

HIS Excellency the Governor of the State of Victoria, by and with the advice of the Executive Council thereof, doth by Order made on the 29th day of March, 1960, in pursuance of the provisions of section 288 of the *Water Act 1958* (No. 6413), fix the limit of the overdraft to be obtained by the Tyers and Glengarry Waterworks Trust from the Commonwealth Trading Bank of Australia, Traralgon, at an amount not to exceed at any one time the sum of Ten thousand pounds (£10,000).

A. MAHLSTEDT,
Clerk of the Executive Council.

At the Executive Council Chamber,
Melbourne, 29th March, 1960.

COLERAINE AND CASTERTON WATERWORKS TRUST.

RATING BY-LAW FOR THE YEAR 1960.

THE Coleraine and Casterton Waterworks Trust, in pursuance and exercise of the powers conferred by the Water Acts, doth hereby make a rate for the supply of water for domestic purposes of Two shillings and five pence in the pound on the annual municipal valuation of lands and tenements liable to be rated within the Casterton Urban District, provided that in no case shall the amount of rate payable per annum in respect of any tenement (other than land on which there is no building) be less than Two pounds ten shillings, and in respect of any land on which there is no building less than Twelve shillings and six pence.

Such rates are made and shall be levied upon the occupiers or owners of the said lands and tenements for the year commencing the 1st day of January, 1960, and shall be payable on the 1st day of April, 1960, at the office of the said Trust.

The maximum quantity of water to be supplied in any one year without further charge to any property rated by the Trust is hereby fixed at the quantity produced by the charge of Two shillings and five pence per 1,000 gallons to the value of the rate.

The charge for water supplied to any property by the Trust in excess of such maximum quantity is hereby fixed at Two shillings and five pence per 1,000 gallons.

The charge for water supplied by measure shall be payable, on demand, at the office of the Trust.

This By-law shall apply to the Urban District of Casterton, as such District is proclaimed and defined in an Order in Council bearing the date of 22nd June, 1927.

Passed this 24th day of February, 1960.

(SEAL) FENTON R. DENNEY, Chairman.
R. S. PAYNE, Secretary.

Approved, 22nd March, 1960.—W. J. MIBUS, Minister of Water Supply.

BEALIBA WATERWORKS TRUST.

RATING BY-LAW FOR THE YEAR 1960.

THE Commissioners of the Bealiba Waterworks Trust, in pursuance and exercise of the powers conferred by the Water Acts, doth hereby make a rate for the supply of water for domestic purposes of Two shillings in the pound on the annual municipal valuation of the lands and tenements liable to be rated within the Bealiba Urban District.

Provided that in no case shall the amount of rate payable per annum in respect of any tenement (other than land on which there is no building) be less than Fifty-five shillings, and in respect of any land on which there is no building less than Fifteen shillings.

Such rates are made and shall be levied upon the occupiers or owners of the said lands and tenements for the year commencing the 1st January, 1960, and shall be payable on the 22nd day of April, 1960, at the office of the Trust, Dunolly.

The maximum quantity of water to be supplied in any one year without further charge to any property rated by the Trust is hereby fixed at the quantity which, at a charge of Two shillings per 1,000 gallons, would produce an amount equal to the amount of rate levied on such property for the said year.

The charge for water supplied by measure to any property rated by the Trust in excess of such maximum quantity, computed as in the last preceding clause, is hereby fixed at One shilling and six pence per 1,000 gallons.

The charge for water supplied by measure to any property not rated by the Trust is hereby fixed at Two shillings per 1,000 gallons, and the minimum quantity of water to be charged for in cases where water is so supplied is hereby fixed at 30,000 gallons.

The charge for water supplied by measure shall be payable, on demand, at the office of the Trust, Dunolly.

Passed this 7th day of March, 1960.

G. H. WHITEHEAD, Chairman.
(SEAL) A. H. HENDERSON, Commissioner:
N. McCARTNEY, Secretary.

Approved, 22nd March, 1960.—W. J. MIBUS, Minister of Water Supply.

COLERAINE AND CASTERTON WATERWORKS TRUST.

RATING BY-LAW FOR THE YEAR 1960.

THE Coleraine and Casterton Waterworks Trust, in pursuance and exercise of the powers conferred by the Water Acts, doth hereby make a rate for the supply of water for domestic purposes of Two shillings and five pence in the pound on the annual municipal valuation of lands and tenements liable to be rated within the Coleraine Urban District, provided that in no case shall the amount of rate payable per annum in respect of any tenement (other than land on which there is no building) be less than Two pounds ten shillings, and in respect of any land on which there is no building less than Twelve shillings and six pence.

Such rates are made and shall be levied upon the occupiers or owners of the said lands and tenements for the year commencing the 1st day of January, 1960, and shall be payable on the 1st day of April, 1960, at the office of the said Trust.

The maximum quantity of water to be supplied in any one year without further charge to any property rated by the Trust is hereby fixed at the quantity produced by the charge of Two shillings and five pence per 1,000 gallons to the value of the rate.

The charge for water supplied to any property by the Trust in excess of such maximum quantity is hereby fixed at Two shillings and five pence per 1,000 gallons.

The charge for water supplied by measure shall be payable, on demand, at the office of the Trust.

This By-law shall apply to the Urban District of Coleraine as such is proclaimed and defined in an Order in Council bearing the date of 22nd June, 1927.

Passed this 24th day of February, 1960.

(SEAL) FENTON R. DENNEY, Chairman.
R. S. PAYNE, Secretary.

Approved, 22nd March, 1960.—W. J. MIBUS, Minister of Water Supply.

WODONGA SEWERAGE AUTHORITY.

FIXING THE LIMIT OF A BANK OVERDRAFT.

HIS Excellency the Governor of the State of Victoria, by and with the advice of the Executive Council thereof, doth by Order made on the 29th day of March, 1960, in pursuance of the provisions of section 79 of the *Sewerage Districts Act 1958* (No. 6368), fix the limit of the overdraft to be obtained by the Wodonga Sewerage Authority from the Commercial Banking Company of Sydney Limited, Wodonga, at an amount not to exceed at any one time the sum of Ten thousand pounds (£10,000).

A. MAHLSTEDT,
Clerk of the Executive Council.

At the Executive Council Chamber,
Melbourne, 29th March, 1960.

CONTRACTS ACCEPTED.—(Series 1959-60.)

CEREALS.

Requirements under Sub-Schedule No. 7 of Schedule No. 1 for the month of April, 1960, are to be purchased from the under-mentioned firms at the rate per cwt. respectively indicated, viz., Robert Harper & Co. Ltd., Oatmeal, plain, 45s.; Rice, dressed, 82s.; Rice, unpolished, 82s.; Tapioca, seed, 8d. per lb., less 3 per cent. 14 days or 24 per cent. 30 days, H. S. K. Ward Pty. Ltd.; Barley, pearl, 46s.; Oatmeal, flaked, 53s.; Peas, split, yellow, 100s.

W. F. GOODES, Acting Secretary to the Tender Board.
28.3.60.

ORDERS IN COUNCIL.—(Series 1959-60.)

PUBLIC WORKS.

3677. Government Printing Office, North Melbourne, supply and installation of piling, £2,625.—West's Shell Piling (A'asia.) Pty. Ltd. (M.183465.)

3678. Healesville Potato Research Station, construction of soil conservation works and culvert, £650 0s. 10d.—Healesville Shire Council. (N.E.152402.)

3679. High School, Reservoir, cost of construction of underground drainage, £600.—Preston City Council. (N.E.96253 "E.")

3680. State School No. 4138, Box Hill South, supply and installation of gas heating to replace kerosene heaters, £312.—The Colonial Gas Association Ltd. (N.E.201013.)

Approved by the Governor in Council, 22nd March, 1960.—A. MAHLSTEDT, Clerk of the Executive Council.

STATE ELECTRICITY COMMISSION.

3681. The supply of 144 only 66 kV condenser bushings for main transformers, to specification No. 59-60/56, £14,940.—English Electric Co. of Aust. Pty. Ltd.

3682. The construction of earthworks and six spillways, Rocky Valley Aqueduct, Kiewa Hydro-Electric Scheme, to Specifications, Nos. 59-60/83 and 59-60/84, £10,450.—Leighton Pty. Ltd.

3683. The supply of meat and smallgoods for Yallourn messes for a period of twelve months, to Specification No. 59-60/182, at Schedule Rates.—Rice Bros.

Approved by the Governor in Council, 16th March, 1960.—A. MAHLSTEDT, Clerk of the Executive Council.

APPOINTMENTS.

HIS Excellency the Governor of the State of Victoria, by and with the advice of the Executive Council thereof, has, by Orders made on the 22nd day of March, 1960, been pleased to make the under-mentioned appointments, viz.:—

CHIEF SECRETARY'S DEPARTMENT.

Acting Chief Commissioner of Police.

RUPERT HENRY ARNOLD, Inspecting Superintendent of Police,

pursuant to the provisions of the *Police Regulation Act 1958*, to act in place of the Chief Commissioner of Police, from the 2nd April, 1960, to the 9th April, 1960, both dates inclusive, during the absence of Selwyn Havelock Watson Craig Porter.

Member of the Youth Organizations Assistance Committee.

REGINALD ALLFREE SMITHERS, Q.C.,

pursuant to the provisions of the *Youth Organizations Assistance Act 1958*, to be a member of the Youth Organizations Assistance Committee, for the period ending the 12th March, 1963.

Registrar of Births and Deaths.

ALEXANDER ROBERT WILSON,

pursuant to the provisions of section 4 of the *Registration of Births and Deaths and Marriages Act 1958*, to be Registrar of Births and Deaths at Corryong, to date from commencement of duty, with fees, vice John Henry Brown, resigned.

DEPARTMENT OF HEALTH.

Trustees of Cemeteries.

ARTHUR JAMES JACKMAN

to be a Trustee, Cavendish Public Cemetery, vice T. R. Warters (deceased);

ARTHUR BODLEY

to be a Trustee, Fern Tree Gully Public Cemetery, vice R. E. Read (resigned); and

NORMAN ALFRED SANDFORD

to be a Trustee, Yarrowonga Public Cemetery, vice R. Nevin (deceased).

Public Vaccinator.

BRUCE COX, M.B., B.S.,

to be Public Vaccinator for the Shire of Berwick.

LAW DEPARTMENT.

Queen's Counsel.

BASIL LATHROP MURRAY, Esquire,

to be one of Her Majesty's Counsel, under the Regulations of the 11th October, 1955 to have precedence next after Philip Henry Napoleon Opas, esquire.

Justices of the Peace.

VERNON ARTHUR WATKINS, care of Town Hall, St. Kilda, to Keep the Peace in the Central Bailiwick of the State of Victoria;

ORMOND LANCELOT DUCKETT, care of State Savings Bank, Willaura,

to Keep the Peace in the Western Bailiwick of the State of Victoria; and

ALLEN RAYMOND GOODEAR, 47A Crisp-street, Hampton, and

NORMAN JOHN TANNER, "Yarragunyah", Dellas-avenue, Templestowe,

to Keep the Peace in the Central Bailiwick of the State of Victoria.

Commissioners for Taking Declarations, &c.

ROBERT THOMAS FERGUSON MCGOVAN, State School 2738, Chetwynd, and

HECTOR AUBREY CRAIG, 25 Duke-street, Kew,

to be Commissioners for taking Declarations and Affidavits, pursuant to the provisions of the *Evidence Act 1958*, to resign upon removing from the neighbourhood of the addresses stated; and

HENRY AUSTIN MCKAY, Officer of the Department of Labour and Industry (Victoria), Spring-street, Melbourne,

to be a Commissioner for taking Declarations and Affidavits, pursuant to the provisions of the *Evidence Act 1958*, to refrain from charging fees and to resign upon ceasing to be an officer of the Department of Labour and Industry.

Clerk of Children's Courts.

GREGORY JAMES FINDLAY,

to be Clerk of the Children's Court at Creswick, Clunes, Daylesford and Trentham during the absence of M. W. Gerkens on annual leave, to take effect from the date of commencement of duty.

Deputy Clerk of the Peace, Registrar of the County Court, &c.

REGINALD JOHN MCALLISTER,

to be Deputy Clerk of the Peace, Registrar of the County Court, Clerk of Petty Sessions and Clerk of the Children's Court at Colac, and Clerk of Petty Sessions and Clerk of the Children's Court at Apollo Bay, Beech Forest, Birregurra, Lorne and Winchelsea, during the absence on annual leave of A. R. Penfold, to take effect from the date of commencement of duty.

Probation Officer of Children's Courts.

DAVID PURCELL, 62 King-street, Essendon,

to be a Probation Officer for the Children's Court at Moonee Ponds, pursuant to the provisions of the *Children's Court Act 1958*; and

ROBERT SUTTON, Salvation Army Headquarters, 215 Spring-street, Melbourne,

to be a Probation Officer for the Children's Court at Melbourne, pursuant to the provisions of the *Children's Court Act 1958*.

Bailiff of the County Court.

OFFICER IN CHARGE OF THE POLICE STATION at Kennington

to be a Bailiff of the County Court at Bendigo, pursuant to the provisions of section 23, *County Court Act 1958*, to take effect from the date of commencement of duty.

Sworn Valuator.

WILLIAM BRUCE McNABB, care of Jess and McNabb, 51 Queen-street, Melbourne,

to be a Sworn Valuator for the County of Bourke, pursuant to the provisions of the *Transfer of Land Act 1958*.

Clerk of Petty Sessions.

BRYAN JOHN COSGRIFF

to be Clerk of Petty Sessions at Ringwood and Clerk of Petty Sessions and Clerk of the Children's Court at Healesville during the absence of P. C. Clothier on annual leave, to take effect from the date of commencement of duty.

A. MAHLSTEDT,

Clerk of the Executive Council.

At the Executive Council Chamber,

Melbourne, 22nd March, 1960.

APPOINTMENTS.

HIS Excellency the Governor of the State of Victoria, by and with the advice of the Executive Council thereof, has, by Orders made on the 29th day of March, 1960, been pleased to make the under-mentioned appointments, viz.:—

LAW DEPARTMENT.

Chairmen of General Sessions.

GRATTAN BERNARD GUNSON, Esq., LL.M.,

A Barrister at Law of Victoria who has practised for a longer period than five years,

to be a Chairman of General Sessions under the provisions of the *Justices Act 1958*, to take effect from the date of commencement of duty until the 31st March, 1961, inclusive; and

BASIL GEORGE ROBERT BULLER MURPHY, Esq., LL.B.,

A Barrister at Law of Victoria who has practised for a longer period than five years,

to be a Chairman of General Sessions under the provisions of the *Justices Act 1958*, to take effect from the date of commencement of duty until the 31st March, 1961, inclusive.

A. MAHLSTEDT,

Clerk of the Executive Council.

At the Executive Council Chamber,

Melbourne, 29th March, 1960.

RESIGNATIONS.

HIS Excellency the Governor of the State of Victoria, by and with the advice of the Executive Council thereof, has, by Orders made on the 29th day of March, 1960, accepted the resignations of the persons named hereunder of the offices mentioned, viz.:-

CHIEF SECRETARY'S DEPARTMENT.

JOHN HENRY BROWN, as Registrar of Births and Deaths at Corryong.

LAW DEPARTMENT.

HENRY WILLIAM BIRD, from the Commission of the Peace for the Midland Balliwick of the State of Victoria.

MARGARET NOEL ROBERTSON, from the Commission of the Peace for the Central Balliwick of the State of Victoria.

ALBERT JOHN GEORGE BOYD, from the Commission of the Peace for the Central Balliwick of the State of Victoria.

A. MAHLSTEDT,

Clerk of the Executive Council.

At the Executive Council Chamber, Melbourne, 29th March, 1960.

LOCAL GOVERNMENT DEPARTMENT.

At the Executive Council Chamber, Melbourne, the twenty-second day of March, 1960.

PRESENT:

His Excellency the Governor of Victoria.

Mr. Cameron
Mr. Fraser

Mr. Mibus.

ALTERATION, FIXATION AND DECLARATION OF BREADTHS OF CARRIAGE-WAYS AND FOOTWAYS, CITY OF SOUTH MELBOURNE.

(PREVIOUS GAZETTALS 1876/213, 1906/963, 1858/1701, 1908/4092, 1930/1617.)

IN pursuance of the provisions of section 520 of the Local Government Act 1958, His Excellency the Governor of the State of Victoria, by and with the advice of the Executive Council thereof, and in compliance with a request of the Council of the City of South Melbourne, hereby alters the breadths of the carriage-ways and footways of those portions of Yarra Bank-road, Riverside-avenue and Queen's Bridge-street, as shown on the plan hereunder and fixes and declares such breadths in the manner indicated on the said plan.

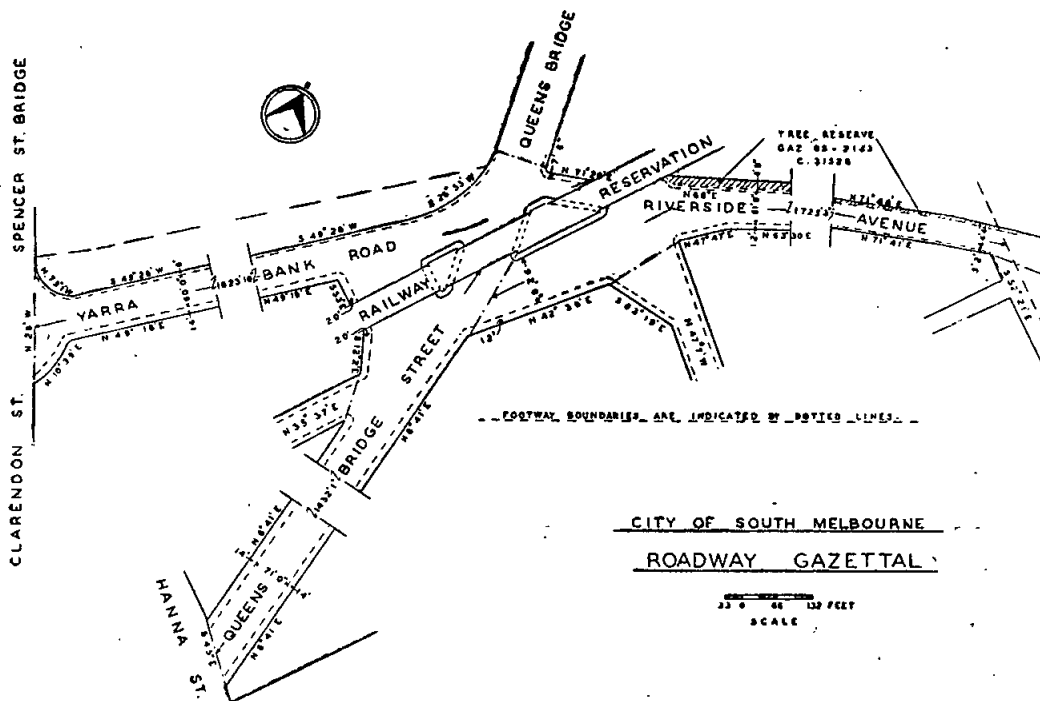

And the Honorable Murray Victor Porter, Her Majesty's Minister for Local Government for the State of Victoria, shall give the necessary directions herein accordingly.

A. MAHLSTEDT,
Clerk of the Executive Council.

COUNTRY ROADS BOARD.

At the Executive Council Chamber, Melbourne, the
twenty-second day of March, 1960.

PRESENT:

His Excellency the Governor of Victoria.
Mr. Cameron | Mr. Mibus.
Mr. Fraser

ORDER APPROVING OF WIDENING AN EXISTING
MAIN ROAD IN THE SHIRE OF GRENVILLE.

WHEREAS the Country Roads Board constituted under the *Country Roads Act 1958* (No. 6229) has represented to His Excellency the Governor in Council that it appears to it desirable that the existing Lismore-road in the Shire of Grenville (declared to be a main road under the said Act which declaration was confirmed by the Order in Council published in the *Government Gazette* of the 16th June, 1915, on page 2111) should be widened by the said Board: And whereas the said Board in accordance with the requirements of section 19 of the said cited Act has caused to be prepared a map plan and estimate showing the points between which and on and through what land the said widening is proposed to be made and the cost of acquiring the land: And whereas on an inspection of the said map and plan and a consideration of the said estimate His Excellency the Governor in Council is satisfied that there are funds legally available for acquiring the land: Now therefore be it known by this present Order that His Excellency the Governor of the State of Victoria with the advice of the Executive Council thereof doth hereby approve of the said road being widened, that is to say:—

All those pieces of land in the Parish of Mindai, the boundaries of which are as follow:—

- (a) Commencing at the north-eastern angle of allotment 47, section C, of the said parish; thence by lines bearing respectively 219 deg. 29 min. 180 links, 17 deg. 44 min. 144.6 links and 89 deg. 2 min. 70.4 links to the point of commencement.
- (b) Commencing at the north-western angle of allotment 49, section C, of the said parish; thence by lines bearing respectively 89 deg. 2 min. 30 links, 234 deg. 36½ min. 87.5 links and 39 deg. 29 min. 65 links to the point of commencement—

which said pieces of land are particularly delineated and shown coloured red on survey plan numbered 6968, lodged in the office of the Country Roads Board.

And the Honorable Sir Thomas Karran Maltby, Her Majesty's Commissioner of Public Works for the State of Victoria, shall give the necessary directions herein accordingly.

A. MAHLSTEDT,
Clerk of the Executive Council.

COUNTRY ROADS BOARD.

At the Executive Council Chamber, Melbourne, the
twenty-second day of March, 1960.

PRESENT:

His Excellency the Governor of Victoria.
Mr. Cameron | Mr. Mibus.
Mr. Fraser

ORDER APPROVING OF A NEW MAIN ROAD IN THE
SHIRE OF ORBOST.

WHEREAS the Country Roads Board constituted under the *Country Roads Act 1958* (No. 6229) has represented to His Excellency the Governor in Council that it appears to it desirable that the new Marlo road in the Shire of Orbost should be made by the said Board: And whereas the said Board in accordance with the requirements of section 19 of the said cited Act has caused to be prepared a map plan and estimate showing the points between which and on and through what land the said new road proposed to be made and the cost of acquiring the land: And whereas on an inspection of the said map and plan and a consideration of the said estimate His Excellency the Governor in Council is satisfied that there are funds legally available for acquiring the land: Now therefore be it known by this present Order that His Excellency the Governor of the State of Victoria with the

advice of the Executive Council thereof doth hereby approve of the said road being made, that is to say:—

All that piece of land in the Parish of Orbost East, the boundaries of which are as follow:—Commencing at the south-eastern angle of allotment 9b, section C, of the said parish; thence by lines bearing respectively 319 deg. 48 min. 360.7 links, 47 deg. 4 min. 305.9 links, 30 deg. 13 min. 306.8 links, 11 deg. 0 min. 4,008 links, 326 deg. 9 min. 42.5 links, 101 deg. 18 min. 30 links, 101 deg. 0 min. 180 links, 236 deg. 0 min. 42.4 links, 191 deg. 0 min. 4,891.6 links and 319 deg. 48 min. 192.5 links to the point of commencement—which said piece of land is particularly delineated and shown coloured red and yellow on survey plan numbered 7443, lodged in the office of the Country Roads Board.

And the Honorable Sir Thomas Karran Maltby, Her Majesty's Commissioner of Public Works for the State of Victoria, shall give the necessary directions herein accordingly.

A. MAHLSTEDT,
Clerk of the Executive Council.

COUNTRY ROADS BOARD.

At the Executive Council Chamber, Melbourne, the
twenty-second day of March, 1960.

PRESENT:

His Excellency the Governor of Victoria.
Mr. Cameron | Mr. Mibus.
Mr. Fraser

ORDER APPROVING OF WIDENING AN EXISTING
MAIN ROAD IN THE SHIRE OF MINHAMITE.

WHEREAS the Country Roads Board constituted under the *Country Roads Act 1958* (No. 6229) has represented to His Excellency the Governor in Council that it appears to it desirable that the existing Woolsthorpe-Heywood road in the Shire of Minhamite (declared to be a main road under the said Act which declaration was confirmed by the Order in Council published in the *Government Gazette* of the 27th August, 1941, on page 2974) should be widened by the said Board: And whereas the said Board in accordance with the requirements of section 19 of the said cited Act has caused to be prepared a map plan and estimate showing the points between which and on and through what land the said widening is proposed to be made and the cost of acquiring the land: And whereas on an inspection of the said map and plan and a consideration of the said estimate His Excellency the Governor in Council is satisfied that there are funds legally available for acquiring the land: Now therefore be it known by this present Order that His Excellency the Governor of the State of Victoria with the advice of the Executive Council thereof doth hereby approve of the said road being widened, that is to say:—

All that piece of land in the Parish of Kapong, the boundaries of which are as follow:—Commencing at the north-eastern angle of allotment 5, section 3, of the said parish; thence by lines bearing respectively 153 deg. 5 min. 200 links, 311 deg. 4 min. 370.9 links and 109 deg. 4 min. 200 links to the point of commencement—which said piece of land is particularly delineated and shown coloured red on survey plan numbered 7456, lodged in the office of the Country Roads Board.

And the Honorable Sir Thomas Karran Maltby, Her Majesty's Commissioner of Public Works for the State of Victoria, shall give the necessary directions herein accordingly.

A. MAHLSTEDT,
Clerk of the Executive Council.

COUNTRY ROADS BOARD.

At the Executive Council Chamber, Melbourne, the
twenty-second day of March, 1960.

PRESENT:

His Excellency the Governor of Victoria.
Mr. Cameron | Mr. Mibus.
Mr. Fraser

ORDER APPROVING OF WIDENING AN EXISTING
MAIN ROAD IN THE SHIRE OF MINHAMITE.

WHEREAS the Country Roads Board constituted under the *Country Roads Act 1958* (No. 6229) has represented to His Excellency the Governor in Council that it appears to it desirable that the existing Woolsthorpe-Heywood road in the Shire of Minhamite (declared to be

a main road under the said Act which declaration was confirmed by the Order in Council published in the *Government Gazette* of the 27th August, 1941, on page 2974) should be widened by the said Board: And whereas the said Board in accordance with the requirements of section 19 of the said cited Act has caused to be prepared a map plan and estimate showing the points between which and on and through what land the said widening is proposed to be made and the cost of acquiring the land: And whereas on an inspection of the said map and plan and a consideration of the said estimate His Excellency the Governor in Council is satisfied that there are funds legally available for acquiring the land: Now therefore be it known by this present Order that His Excellency the Governor of the State of Victoria with the advice of the Executive Council thereof doth hereby approve of the said road being widened, that is to say:—

All that piece of land in the Parish of Kapong, the boundaries of which are as follow:—Commencing at the north-eastern angle of allotment 1A, section 3, of the said parish; thence by lines bearing respectively 127 deg. 19 min. 317.4 links, 290 deg. 29 min. 635.7 links and 95 deg. 0 min. 344.4 links to the point of commencement—which said piece of land is particularly delineated and shown coloured red on survey plan numbered 7455, lodged in the office of the Country Roads Board.

And the Honorable Sir Thomas Karran Maltby, Her Majesty's Commissioner of Public Works for the State of Victoria, shall give the necessary directions herein accordingly.

A. MAHLSTEDT,
Clerk of the Executive Council.

COUNTRY ROADS BOARD.

At the Executive Council Chamber, Melbourne, the twenty-second day of March, 1960.

PRESENT:

His Excellency the Governor of Victoria.	
Mr. Cameron	Mr. Mibus.
Mr. Fraser	

ORDER APPROVING OF A DEVIATION FROM A MAIN ROAD IN THE SHIRE OF ALBERTON.

WHEREAS the Country Roads Board constituted under the *Country Roads Act* 1958 (No. 6229) has represented to His Excellency the Governor in Council that it appears to it desirable that the deviation hereinafter referred to from the existing Manns Beach road in the Shire of Alberton (declared to be a main road under the said Act which declaration was confirmed by the Order in Council published in the *Government Gazette* of the 5th March, 1941, on page 1027) should be made by the said Board: And whereas the said Board in accordance with the requirements of section 19 of the said cited Act has caused to be prepared a map plan and estimate showing the points between which and on and through what land the said deviation is proposed to be made and the cost of acquiring the land: And whereas on an inspection of the said map and plan and a consideration of the said estimate His Excellency the Governor in Council is satisfied that there are funds legally available for acquiring the land: Now therefore be it known by this present Order that His Excellency the Governor of the State of Victoria with the advice of the Executive Council thereof doth hereby approve of the said road being made, that is to say:—

All that piece of land in the Parish of Tarra Tarra, the boundaries of which are as follow:—Commencing at the south-eastern angle of allotment 2, section 2, Township of Tarraville, in the said parish; thence by lines bearing respectively 270 deg. 0 min. 166.9 links, 57 deg. 27 min. 125.7 links, 33 deg. 53 min. 109.3 links and 180 deg. 0 min. 158.3 links to the point of commencement—which said piece of land is particularly delineated and shown coloured red on survey plan numbered 7431, lodged in the office of the Country Roads Board.

And the Honorable Sir Thomas Karran Maltby, Her Majesty's Commissioner of Public Works for the State of Victoria, shall give the necessary directions herein accordingly.

A. MAHLSTEDT,
Clerk of the Executive Council.

COUNTRY ROADS BOARD.

At the Executive Council Chamber, Melbourne, the twenty-second day of March, 1960.

PRESENT:

His Excellency the Governor of Victoria.	
Mr. Cameron	Mr. Mibus.
Mr. Fraser	

ORDER APPROVING OF WIDENING AN EXISTING STATE HIGHWAY IN THE SHIRE OF MORWELL.

WHEREAS the Country Roads Board constituted under the *Country Roads Act* 1958 (No. 6229) has represented to His Excellency the Governor in Council that it appears to it desirable that the existing Princes Highway in the Shire of Morwell (declared to be a State highway under the said Act which declaration was confirmed by the Order in Council published in the *Government Gazette* of the 8th July, 1925, on pages 2371-3) should be widened by the said Board: And whereas the said Board in accordance with the requirements of section 19 of the said cited Act has caused to be prepared a map plan and estimate showing the points between which and on and through what land the said widening is proposed to be made and the cost of acquiring the land: And whereas on an inspection of the said map and plan and a consideration of the said estimate His Excellency the Governor in Council is satisfied that there are funds legally available for acquiring the land: Now therefore be it known by this present Order that His Excellency the Governor of the State of Victoria with the advice of the Executive Council thereof doth hereby approve of the said highway being widened, that is to say:—

All that piece of land in the Parish of Maryvale, the boundaries of which are as follow:—Commencing at a point on the north-eastern boundary of allotment 65 of the said parish, distant 296 deg. 48 min. 654.1 links from the eastern angle of the said allotment; thence, by lines bearing respectively 230 deg. 34 min. 179.6 links, 359 deg. 51 min. 290 links, 64 deg. 13 min. 259.2 links, 74 deg. 21 min. 410 links and 230 deg. 34 min. 631.9 links to the point of commencement—which said piece of land is particularly delineated and shown coloured red on survey plan numbered 7457, lodged in the office of the Country Roads Board.

And the Honorable Sir Thomas Karran Maltby, Her Majesty's Commissioner of Public Works for the State of Victoria, shall give the necessary directions herein accordingly.

A. MAHLSTEDT,
Clerk of the Executive Council.

COUNTRY ROADS BOARD.

At the Executive Council Chamber, Melbourne, the twenty-second day of March, 1960.

PRESENT:

His Excellency the Governor of Victoria.	
Mr. Cameron	Mr. Mibus.
Mr. Fraser	

ORDER APPROVING OF A DEVIATION FROM A MAIN ROAD IN THE SHIRE OF ORBOST.

WHEREAS the Country Roads Board constituted under the *Country Roads Act* 1958 (No. 6229) has represented to His Excellency the Governor in Council that it appears to it desirable that the deviation hereinafter referred to from the existing Marlo road in the Shire of Orbost (declared to be a main road under said Act which declaration was confirmed by the Order in Council published in the *Government Gazette* of the 29th January, 1919, on page 224) should be made by the said Board: And whereas the said Board in accordance with the requirements of section 19 of the said cited Act has caused to be prepared a map plan and estimate showing the points between which and on and through what land the said deviation is proposed to be made and the cost of acquiring the land: And whereas on an inspection of the said map and plan and a consideration of the said estimate His Excellency the Governor in Council is satisfied that there are funds legally available for acquiring the land: Now therefore be it known by this

present Order that His Excellency the Governor of the State of Victoria with the advice of the Executive Council thereof doth hereby approve of the said road being made, that is to say:—

All that piece of land in the Parish of Orbost East, the boundaries of which are as follow:—Commencing at a point on the northern boundary of allotment 15, section C, of the said parish distant 89 deg. 29 min. 21.3 links from the north-western angle of the said allotment; thence by lines bearing respectively 2 deg. 41 min. 51.2 links, 24 deg. 48 min. 477.4 links, 16 deg. 24 min. 103 links, 189 deg. 35½ min. 450.9 links, 182 deg. 41 min. 383.8 links, 171 deg. 15 min. 366.4 links, 160 deg. 9 min. 513.1 links, 157 deg. 39 min. 3,669.4 links, 156 deg. 35½ min. 811.3 links, 157 deg. 39 min. 366.2 links, 158 deg. 38 min. 873.4 links, 158 deg. 43½ min. 752.9 links, 180 deg. 20 min. 440.5 links, 189 deg. 40 min. 317.5 links, 195 deg. 23 min. 1,080 links, 191 deg. 0 min. 1,368.5 links, 122 deg. 23½ min. 32.8 links, 333 deg. 47 min. 45 links, 191 deg. 0 min. 150 links, 281 deg. 0 min. 150 links, 11 deg. 0 min. 150 links, 281 deg. 18 min. 30 links, 56 deg. 9 min. 42.3 links, 11 deg. 0 min. 2,756.9 links, 0 deg. 20 min. 395.5 links, 348 deg. 14 min. 391.8 links, 339 deg. 20 min. 303 links, 336 deg. 40 min. 873.4 links, 337 deg. 39 min. 366.2 links, 338 deg. 42½ min. 811.3 links, 337 deg. 39 min. 3,672.7 links, 340 deg. 9 min. 530.9 links, 351 deg. 15 min. 396 links and 2 deg. 41 min. 252.8 links to the point of commencement—which said piece of land is particularly delineated and shown coloured red and yellow on survey plans numbered 744 and 743, lodged in the office of the Country Roads Board.

And the Honorable Sir Thomas Karran Maltby, Her Majesty's Commissioner of Public Works for the State of Victoria, shall give the necessary directions herein accordingly.

A. MAHLSTEDT,
Clerk of the Executive Council.

DEPARTMENT OF CROWN LANDS AND SURVEY.

At the Executive Council Chamber, Melbourne, the twenty-second day of March, 1960.

PRESENT:

His Excellency the Governor of Victoria.
Mr. Cameron | Mr. Mibus.
Mr. Fraser

UNUSED ROADS CLOSED.

HIS Excellency the Governor of the State of Victoria, by and with the advice of the Executive Council thereof, doth hereby direct that, in pursuance of the provisions of section 349 of the Land Act 1960, the unused roads referred to hereunder be closed, viz.:—

Parish of Drik Drik, County of Normanby, being the road indicated by hachure on plan hereunder.—(D.152(*) (Z.28602).

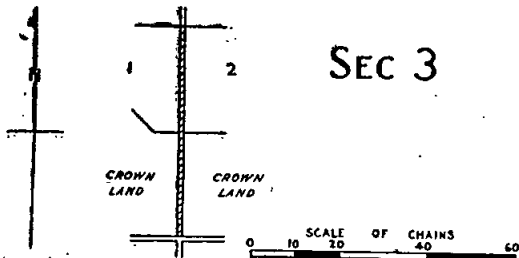

And the Honorable Keith Hector Turnbull, Her Majesty's Commissioner of Crown Lands and Survey for the State of Victoria, shall give the necessary directions herein accordingly.

A. MAHLSTEDT,
Clerk of the Executive Council.

DEPARTMENT OF CROWN LANDS AND SURVEY.

At the Executive Council Chamber, Melbourne, the twenty-second day of March, 1960.

PRESENT:

His Excellency the Governor of Victoria.
Mr. Cameron | Mr. Mibus.
Mr. Fraser

LAND TEMPORARILY RESERVED AS A SITE.

HIS Excellency the Governor of the State of Victoria, by and with the advice of the Executive Council thereof, doth hereby, in pursuance of the provisions of the Land Act 1958, reserve, temporarily, and also except from occupation for mining purposes under any miner's right, the land hereinafter described:—

BOOLE POOLE.—Site for a Public Park, 993 acres, more or less, Parish of Boole Poole, County of Tanjil, as indicated by hachure on plan hereunder.—(B.743(*) (Rs.3633).

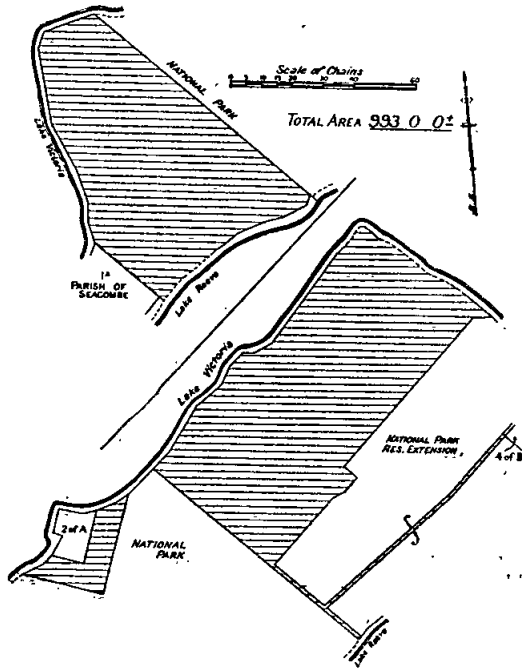

And the Honorable Keith Hector Turnbull, Her Majesty's Commissioner of Crown Lands and Survey for the State of Victoria, shall give the necessary directions herein accordingly.

A. MAHLSTEDT,
Clerk of the Executive Council.

MILK BOARD ACT 1958.

At the Executive Council Chamber, Melbourne, the Twenty-second day of March, 1960.

PRESENT:

His Excellency the Governor of Victoria.
Mr. Cameron | Mr. Mibus.
Mr. Fraser

IN pursuance of the powers conferred by the Milk Board Act and all other powers enabling him in that behalf, His Excellency the Governor of Victoria, by and with the advice of the Executive Council thereof, doth hereby approve of the following Determination of milk prices by the Milk Board, such Determination to take effect from the 1st day of April, 1960.

DETERMINATION.

1. The price which shall be paid by the Board to dairy farmers for milk for sale or distribution in the Maryborough Milk District shall be:—

3s. 4 4/2d. per gallon.

Provided that the Board shall be entitled to deduct from the said price such sum per gallon as may be determined by the Board from time to time in respect of the transport of such milk.

2. The minimum prices payable per gallon to dairymen (in the case of sales other than sales by retail) for milk of the kinds and quantities as described hereunder for sale or distribution in the Maryborough Milk District shall be:—

	Milk (Unflavoured).	Milk (Flavoured).
	s. d.	s. d.
(i) By dairymen (other than the owners of house-trade dairies)		
(a) for bottled milk—		
Third-pints		6 9
Half-pints	4 6½	5 9
Pints	4 3	
(b) for bulk milk	3 11	
(ii) By Hospitals, Charitable or similar institutions as authorized in writing by the Board:—		
for bottled milk (delivered)—		
Half-pints	5 5½	
Pints	5 2	
(iii) By owners of milk shops, owners of house-trade dairies, and any other persons—		
for bottled milk (delivered)—		
Third-pints		7 9
Half-pints	5 8½	6 9
Pints	5 5	
(iv) By purchasers of bulk milk (other than dairymen as in (i))—		
In daily quantities of 2 to 25 gallons	4 11	
In daily quantities of 26 to 50 gallons	4 9	
In daily quantities of 51 to 100 gallons	4 7	
In daily quantities of more than 100 gallons	4 5	

3. The maximum prices at which milk of the kinds and quantities as described hereunder may be sold by retail in the Maryborough Milk District shall be:—

	Milk (Unflavoured).	Milk (Flavoured).
	s. d.	s. d.
(a) for Bottled Milk—		
In Third-pint bottles		0 6
In Half-pint bottles	0 5½	0 7½
In Pint bottles (for quantities of less than one quart) (for quantities of one quart or more)	1 7	
(b) for Bulk Milk—		
In quantities of:—		
Half-pint	0 5	
One-pint	0 9	
One quart, or more	1 6	

Provided that for purchases of bottled milk on an account basis deliveries of less than one quart on any one day may be charged for at the pint rate, and provided further that for each half-pint bottle supplied the maximum rate of 5½d. per bottle may be charged.

- O. R. BROWNE, Chairman of Milk Board.
R. K. HARVEY, Member of Milk Board.
C. J. B. McPHERSON, Member of Milk Board.
R. D. HALL, Secretary of Milk Board.

And the Honorable Gilbert Lawrence Chandler, Her Majesty's Minister of Agriculture for the State of Victoria, shall give the necessary directions herein accordingly.

A. MAHLSTEDT.
Clerk of the Executive Council.

HEALTH ACT 1958 (No. 6270).

At the Executive Council Chamber, Melbourne, the twenty-second day of March, 1960.

PRESENT:

His Excellency the Governor of Victoria.
Mr. Cameron | Mr. Mibus.
Mr. Fraser

DIVISION 1 OF PART V. OF THE HEALTH ACT 1958 (No. 6270), RELATING TO PIGGERIES, EXTENDED TO THE WHOLE OF THE MUNICIPAL DISTRICT OF THE SHIRE OF MELTON.

UNDER the powers conferred by the *Health Act* 1958 (No. 6270), His Excellency the Governor of the State of Victoria, by and with the advice of the Executive Council thereof, on the request of the Council of the Shire of Melton, and on the recommendation of the Commission of Public Health, doth hereby order that the provisions of Division 1 of Part V. of the said Act, so far as those provisions are applicable to piggeries, shall be extended to the whole of the municipal district of the Shire of Melton.

And the Honorable Ewen Paul Cameron, Her Majesty's Minister of Health for the State of Victoria, shall give the necessary directions herein accordingly.

A. MAHLSTEDT.
Clerk of the Executive Council.

MARKETING OF PRIMARY PRODUCTS ACT 1958.

At the Executive Council Chamber, Melbourne, the twenty-second day of March, 1960.

PRESENT:

His Excellency the Governor of Victoria.
Mr. Cameron | Mr. Mibus.
Mr. Fraser

APPOINTMENT OF A DAY FOR A POLL TO BE TAKEN OF THE PRODUCERS OF EGGS AND EGG PULP FOR THE ELECTION OF A REPRESENTATIVE OF PRODUCERS TO BE AN ELECTIVE MEMBER OF THE EGG AND EGG PULP MARKETING BOARD.

IN pursuance of the provisions in that behalf contained in the *Marketing of Primary Products Act* 1958, His Excellency the Governor of the State of Victoria, by and with the advice of the Executive Council thereof, doth by this Order hereby appoint Tuesday, the 31st day of May, 1960, as the day for a poll to be taken of the producers of eggs and egg pulp for the election of one (1) representative to be an elective member of the Egg and Egg Pulp Marketing Board, and doth further appoint an electoral area, defined as follows, for such election, that is to say:—

ELECTORAL AREA No. 2.

The Bacchus Marsh Subdivision of the State Electoral District of Ballarat South; the Lancefield, Gisborne, Sunbury, Broadmeadows, Whittlesea, Glenroy and Fawkner Subdivisions of the State Electoral District of Broadmeadows; the South Barwon Subdivision of the State Electoral District of Polwarth; the Rokewood Subdivision of the State Electoral District of Hampden; the Metropolitan State Electoral Districts; and the State Electoral Districts of Mentone, Box Hill, Mulgrave, Ringwood, Scoresby, Dandenong, Mornington, Evelyn, Gippsland West, Gippsland South, Gippsland East, Morwell, Grant, Geelong and Geelong West.

And the Honorable Gilbert Lawrence Chandler, Her Majesty's Minister of Agriculture for the State of Victoria, shall give the necessary directions herein accordingly.

A. MAHLSTEDT.
Clerk of the Executive Council.

COUNTRY FIRE AUTHORITY ACT 1958.

*At the Executive Council Chamber, Melbourne, the
twenty-ninth day of March, 1960.*

PRESENT:

His Excellency the Governor of Victoria.
Sir Arthur Warner | Mr. Porter.

AMENDMENT OF REGULATIONS.

HIS Excellency the Governor of the State of Victoria, in the Commonwealth of Australia, by and with the advice of the Executive Council of the said State, in pursuance of the powers conferred by the *Country Fire Authority Act 1958* and all other powers him thereunto enabling, doth hereby further amend the "Country Fire Authority Superannuation and Endowment Assurance Regulations 1953" as follows, that is to say:—

1. In clause 2—
 - (a) After the definition of "Life Assurance Company", there shall be inserted the following definitions:—
 - "Member" includes a subscriber and a State contributor as hereinafter defined.
 - "State contributor" means a male person—
 - (i) who is performing duties of a permanent nature in the service of the Authority;
 - (ii) who has become with the assent of the Authority a contributor to the Superannuation Fund which section 5 (1) of the *Superannuation Act 1958* declares has been established (hereinafter called "the State Scheme");
 - (iii) who immediately prior to becoming a contributor to the State Scheme was a subscriber as hereinafter defined.
 - (b) For the definition of "subscriber", there shall be submitted the following definition:—
 - "Subscriber" means a male person—
 - (i) who is performing duties of a permanent nature in the service of the Authority;
 - (ii) who is declared by resolution of the Authority to be a subscriber to the Fund; and
 - (iii) who has not become with the assent of the Authority a State contributor.
2. In sub-clause (1) of clause 5 after the word "Authority" there shall be inserted the words "or he becomes a State contributor whichever event shall first occur.
3. In clause 7 for the word "subscriber" (wherever occurring) there shall be substituted the word "member".
4. In clause 12 for the word "subscribers", there shall be substituted the word "members".
5. In clause 13—
 - (a) for the word "subscriber", there shall be substituted the word "member"; and
 - (b) for the word "subscribers", there shall be substituted the word "members".
6. In clause 14 for the word "subscriber", there shall be substituted the word "member".
7. In clause 16—
 - (a) for the word "subscriber" (wherever occurring) there shall be substituted the word "member";
 - (b) for the word "subscribers" (wherever occurring) there shall be substituted the word "members"; and
 - (c) after the words "assigned to him absolutely" (wherever occurring) there shall be inserted the words "if such policy has not previously been so assigned".
8. After clause 16, there shall be inserted the following clause:—

"16A. A policy on the life of a member shall upon such member becoming a State contributor be forthwith assigned to him absolutely."
9. In clauses 17, 18, 19, 20, 22, and 23 for the word "subscriber" (wherever occurring) there shall be substituted the word "member".

10. After sub-clause (2) of clause 18, there shall be inserted the following sub-clause:—

“(3) Notwithstanding anything hereinbefore contained the provisions of sub-clause (1) of this clause shall not apply to a policy which has been assigned to a member pursuant to clause 16A of these Regulations.”

11. In clause 22 for the word “subscribers”, there shall be substituted the word “members”.

And the Honorable Arthur Gordon Rylah, Her Majesty's Chief Secretary for the State of Victoria, shall give the necessary directions herein accordingly.

A. MAHLSTEDT,
Clerk of the Executive Council.

POLICE REGULATION ACT 1958.

*At the Executive Council Chamber, Melbourne, the
twenty-ninth day of March, 1960.*

PRESENT:

His Excellency the Governor of Victoria.
Sir Arthur Warner | Mr. Porter.

AMENDMENT OF REGULATIONS.

HIS Excellency the Governor of the State of Victoria, in the Commonwealth of Australia, by and with the advice of the Executive Council of the said State, and in pursuance of the provisions of the *Police Regulation Act 1958*, doth hereby further amend the Police Regulations 1957 as follows, that is to say:—

1. In Regulation 405 under the sub-heading—

“Officers (not including Station Officers)” for the expression—

“3 Air Force—blue shirts, and six detached collars of the same material and colour as shirts” there shall be substituted the expression—“3 shirts of blue end-on-end material of approved colour and pattern. If collars are not attached two collars of the same material for each such shirt.”

2. In Regulation 405 under the heading—

“Station Officers, Sub-Officers and Constables (Foot Police)” for the expression—

“3 Air Force—blue shirts with two breast pockets with flaps and shoulder straps, and six detached collars of the same material and colour as shirts” there shall be substituted the expression—“3 shirts of blue end-on-end material of approved colour and pattern with two breast pockets with flaps and shoulder straps. If collars are not attached two collars of the same material for each such shirt.”

3. In Regulation 405 under the heading—

“Sub-Officers and Constables (Mounted Police)” for the expression—

“3 Air Force—blue shirts and six detached collars, as prescribed for foot police” there shall be substituted the expression—“3 shirts of blue end-on-end material of approved colour and pattern, as prescribed for foot police.”

4. In Regulation 405 under the heading—

“Sub-Officers and Constables (Mobile Traffic Police, members of the Force performing motor cycle or motor car duty, motor testing Police and such other members as are authorized by Chief Commissioner)” for the expression—

“3 Air Force—blue shirts and six detached collars as prescribed for foot police” there shall be substituted the expression—“3 shirts of blue end-on-end material of approved colour and pattern, as prescribed for foot police”.

And the Honorable Lindsay Hamilton Simpson Thompson, for and on behalf of Her Majesty's Chief Secretary for the State of Victoria, shall give the necessary directions herein accordingly.

A. MAHLSTEDT,
Clerk of the Executive Council.

HOUSING ACT.

At the Executive Council Chamber, Melbourne, the twenty-ninth day of March, 1960.

PRESENT:

His Excellency the Governor of Victoria.
Sir Arthur Warner | Mr. Porter.

EXTINGUISHMENT OF EASEMENTS,
CLARKE-STREET, NORTHCOTE.

WHEREAS by virtue and in exercise of the powers contained in the *Housing Act 1958* (No. 6275) the Housing Commission has recommended to the Governor in Council that certain easements described in the Schedule hereto be extinguished.

Now therefore His Excellency the Governor of the State of Victoria, in the Commonwealth of Australia, by and with the advice of the Executive Council thereof, doth, in pursuance of the powers conferred by the said Act and upon such recommendation, consent and by this Order hereby extinguish those easements.

SCHEDULE.

First.—Any easements subsisting over, upon or affecting the land shown coloured blue on the map in the margin of certificate of title, volume 3374, folio 602.

Secondly.—Any easements subsisting over, upon, or affecting the land comprised in certificate of title, volume 6486, folio 109.

And the Honorable Horace Rostill Petty, Her Majesty's Minister of Housing for the State of Victoria, shall give the necessary directions herein accordingly.

A. MAHLSTEDT,
Clerk of the Executive Council.

HOUSING ACT.

At the Executive Council Chamber, Melbourne, the twenty-ninth day of March, 1960.

PRESENT:

His Excellency the Governor of Victoria.
Sir Arthur Warner | Mr. Porter.

DECLARATION OF A RECLAMATION AREA AT
NORTHCOTE.

WHEREAS within an area in the City of Northcote described in the Schedule hereto there are houses which—

- (a) are unfit for human habitation and
- (b) are in the opinion of the Housing Commission insanitary or unhealthy by reason of—
 - (i) the excessive number of buildings within the area;
 - (ii) the bad arrangement of buildings within the area; and
 - (iii) the bad arrangement or narrowness of streets within the area.

And whereas the Housing Commission considers that housing conditions within the area cannot satisfactorily be dealt with unless the said area is dealt with under Part III. of the *Slum Reclamation and Housing Act 1958* (No. 6275) as a Reclamation Area and has recommended that the said area should be constituted a Reclamation Area.

And whereas the Housing Commission having duly complied with the provisions of sub-section (3) of section 67 of the said Act has submitted to the Governor in Council its recommendation that the said area should be constituted a Reclamation Area.

Now therefore I, the Governor of the State of Victoria, in the Commonwealth of Australia, by and with the advice of the Executive Council of the said State, do hereby declare the said area to be a Reclamation Area.

SCHEDULE.

All that piece of land situated within the municipality of the City of Northcote being Crown allotments 1, 2, 3, 4 and 5, all of section 10, City of Northcote, Parish of

Jika Jika, County of Bourke, *excepting* thereout so much of Crown allotment 1, section 10, aforesaid as is comprised in certificate of title, volume 6858, folio 483, and further *excepting* so much of Crown allotments 1 and 2, section 10, aforesaid, as is comprised in certificate of title, volume 4652, folio 300.

And the Honorable Horace Rostill Petty, Her Majesty's Minister of Housing for the State of Victoria, shall give the necessary directions herein accordingly.

A. MAHLSTEDT,
Clerk of the Executive Council.

GEELONG WATERWORKS AND SEWERAGE TRUST.

At the Executive Council Chamber, Melbourne, the twenty-ninth day of March, 1960.

PRESENT:

His Excellency the Governor of Victoria.
Sir Arthur Warner | Mr. Porter.

CONSENT TO BORROWING £50,000.

UNDER the powers conferred by the Geelong Waterworks and Sewerage Acts and all other powers enabling him in that behalf, His Excellency the Governor of the State of Victoria, by and with the advice of the Executive Council of the said State, doth hereby consent to the Geelong Waterworks and Sewerage Trust borrowing, at interest, subject to the Geelong Waterworks and Sewerage Acts, the sum of Fifty thousand pounds (£50,000) to meet the cost of water supply works.

And the Honorable Wilfred John Mibus, Her Majesty's Minister of Water Supply for the State of Victoria, shall give the necessary directions herein accordingly.

A. MAHLSTEDT,
Clerk of the Executive Council.

CAMPERDOWN SEWERAGE AUTHORITY.

At the Executive Council Chamber, Melbourne, the twenty-ninth day of March, 1960.

PRESENT:

His Excellency the Governor of Victoria.
Sir Arthur Warner | Mr. Porter.

CONSENT TO BORROWING £82,000.

UNDER the powers conferred by the *Sewerage Districts Act 1958* and all other powers enabling him in that behalf, His Excellency the Governor of the State of Victoria, by and with the advice of the Executive Council of the said State, doth hereby consent to the Camperdown Sewerage Authority borrowing, by the issue of a debenture, the sum of Eighty-two thousand pounds (£82,000) to meet the cost of sewerage works at Camperdown, as set forth in the detailed statement bearing date the 25th March, 1960.

And the Honorable Wilfred John Mibus, Her Majesty's Minister of Water Supply for the State of Victoria, shall give the necessary directions herein accordingly.

A. MAHLSTEDT,
Clerk of the Executive Council.

SWAN HILL SEWERAGE AUTHORITY.

At the Executive Council Chamber, Melbourne, the twenty-ninth day of March, 1960.

PRESENT:

His Excellency the Governor of Victoria.
Sir Arthur Warner | Mr. Porter.

CONSENT TO BORROWING £6,000.

UNDER the powers conferred by the *Sewerage Districts Act 1958* and all other powers enabling him in that behalf, His Excellency the Governor of the State of Victoria, by and with the advice of the Executive Council of the said State, doth hereby consent to the Swan Hill

Sewerage Authority borrowing, by the issue of debentures, the sum of Six thousand pounds (£6,000) to meet the cost of sewerage extensions, as set forth in the detailed statement bearing date the 25th March, 1960.

And the Honorable Wilfred John Mibus, Her Majesty's Minister of Water Supply for the State of Victoria, shall give the necessary directions herein accordingly.

A. MAHLSTEDT,
Clerk of the Executive Council.

WODONGA SEWERAGE AUTHORITY.

At the Executive Council Chamber, Melbourne, the twenty-ninth day of March, 1960.

PRESENT:

His Excellency the Governor of Victoria.
Sir Arthur Warner | Mr. Porter.

CONSENT TO BORROWING £65,000.

UNDER the powers conferred by the *Sewerage Districts Act 1958* and all other powers enabling him in that behalf, His Excellency the Governor of the State of Victoria, by and with the advice of the Executive Council of the said State, doth hereby consent to the Wodonga Sewerage Authority borrowing, by the issue of debentures, the sum of Sixty-five thousand pounds (£65,000) in two amounts of Fifty thousand pounds (£50,000) and Fifteen thousand pounds (£15,000) respectively to meet the cost of sewerage works, as set forth in the detailed statement bearing date the 25th March, 1960.

And the Honorable Wilfred John Mibus, Her Majesty's Minister of Water Supply for the State of Victoria, shall give the necessary directions herein accordingly.

A. MAHLSTEDT,
Clerk of the Executive Council.

WODONGA SEWERAGE AUTHORITY.

At the Executive Council Chamber, Melbourne, the twenty-ninth day of March, 1960.

PRESENT:

His Excellency the Governor of Victoria.
Sir Arthur Warner | Mr. Porter.

CONSENT TO BORROWING £25,000.

UNDER the powers conferred by the *Sewerage Districts Act 1958* and all other powers enabling him in that behalf, His Excellency the Governor of the State of Victoria, by and with the advice of the Executive Council of the said State, doth hereby consent to the Wodonga Sewerage Authority borrowing, by the assignment of rates and charges, the sum of Twenty-five thousand pounds (£25,000) towards the cost of sewerage works, as set forth in the detailed statement bearing date the 25th March, 1960.

And the Honorable Wilfred John Mibus, Her Majesty's Minister of Water Supply for the State of Victoria, shall give the necessary directions herein accordingly.

A. MAHLSTEDT,
Clerk of the Executive Council.

WODONGA SEWERAGE AUTHORITY.

At the Executive Council Chamber, Melbourne, the twenty-ninth day of March, 1960.

PRESENT:

His Excellency the Governor of Victoria.
Sir Arthur Warner | Mr. Porter.

REPEAL OF ORDER.

UNDER the powers conferred by the *Sewerage Districts Act 1958* and all other powers enabling him in that behalf, His Excellency the Governor of the State of Victoria, by and with the advice of the Executive Council of the said State, doth hereby repeal the Order made by the Governor in Council on the 21st March, 1939, and

published in the *Victoria Government Gazette* dated 29th March, 1939, fixing the limit of the overdraft to be obtained by the Wodonga Sewerage Authority from the Commercial Banking Company of Sydney Limited, Wodonga, at an amount not to exceed at any one time the sum of Two thousand pounds (£2,000).

And as on and from the date hereof the said Order of the Governor in Council shall be deemed to be repealed accordingly.

And the Honorable Wilfred John Mibus, Her Majesty's Minister of Water Supply for the State of Victoria, shall give the necessary directions herein accordingly.

A. MAHLSTEDT,
Clerk of the Executive Council.

SPRINGVALE AND NOBLE PARK SEWERAGE AUTHORITY.

At the Executive Council Chamber, Melbourne, the twenty-ninth day of March, 1960.

PRESENT:

His Excellency the Governor of Victoria.
Sir Arthur Warner | Mr. Porter.

POWER TO BORROW £10,000.

UNDER the powers conferred by the *Sewerage Districts Act 1958* and all other powers enabling him in that behalf, His Excellency the Governor of the State of Victoria, by and with the advice of the Executive Council of the said State, doth hereby consent to the Springvale and Noble Park Sewerage Authority borrowing, at interest, an additional sum of Ten thousand pounds (£10,000) for the carrying out of works, in accordance with the provisions of sections 95, 130 and 137 of the *Sewerage Districts Act 1958*, the said sum to be borrowed by way of overdraft from the Commercial Bank of Australia Limited. All moneys received by the said Authority in repayment of costs and expenses of the said works, or any of them, shall be set aside for the purpose of and applied in repayment of the said sum so borrowed.

And the Honorable Wilfred John Mibus, Her Majesty's Minister of Water Supply for the State of Victoria, shall give the necessary directions herein accordingly.

A. MAHLSTEDT,
Clerk of the Executive Council.

LATROBE VALLEY WATER AND SEWERAGE BOARD.

At the Executive Council Chamber, Melbourne, the twenty-ninth day of March, 1960.

PRESENT:

His Excellency the Governor of Victoria.
Sir Arthur Warner | Mr. Porter.

ADDITIONAL LOAN OF £200,000.

UNDER the powers conferred by the *Latrobe Valley Act 1958* and all other powers enabling him in that behalf, His Excellency the Governor of the State of Victoria, by and with the advice of the Executive Council of the said State, doth hereby grant an additional loan of Two hundred thousand pounds (£200,000) to the Latrobe Valley Water and Sewerage Board for the purpose of constructing sewers, pipe-lines, channels, storages, and purchase of land and construction or purchase of works or buildings and development of land disposal scheme, as set forth in the detailed statement bearing date the 24th March, 1960.

The loan hereby granted shall be subject to the provisions of the *Latrobe Valley Act 1958*.

And the Honorable Wilfred John Mibus, Her Majesty's Minister of Water Supply for the State of Victoria, shall give the necessary directions herein accordingly.

A. MAHLSTEDT,
Clerk of the Executive Council.

MAFFRA SEWERAGE AUTHORITY.

At the Executive Council Chamber, Melbourne, the twenty-ninth day of March, 1960.

PRESENT:

His Excellency the Governor of Victoria.
Sir Arthur Warner | Mr. Porter.

EXTENT OF SEWERAGE DISTRICT INCREASED.

UNDER the powers conferred by the *Sewerage Districts Act 1958* and all other powers enabling him in that behalf, His Excellency the Governor of the State of Victoria, by and with the advice of the Executive Council of the said State doth hereby declare, order, and direct as follows:—

That the extent of the Sewerage District of the Maffra Sewerage Authority be increased by adding to the same the lands comprised within the boundaries described in the Schedule hereto, and as on and from the date hereof the extent of such District shall be deemed to be increased accordingly.

SCHEDULE.

Commencing at a point on the southern boundary of Crown allotment 76B, Township of Maffra, Parish of Maffra, County of Tanjil, 500 links westerly of its south-eastern angle, being a point on the northern boundary of the existing Maffra Sewerage District; thence by a line through the said Crown allotment 76B bearing due north a distance of 500 links; thence easterly by a line through the said Crown allotment 76B and across a road to the north-western angle of lot 1 shown on lodged plan of subdivision No. 25103; thence easterly along the northern boundaries of the said lot 1 and of lots 21, 20, 19, 18, 17, 16, 15 and 14 to the north-eastern angle of the said lot 14; thence easterly by a line across a right-of-way to the north-western angle of lot 1 shown on lodged plan of subdivision No. 9431; thence easterly along the northern boundaries of the said lot 1 and of lots 2, 3, 4, 5, 6 and 7 to the north-eastern angle of the said lot 7; thence easterly by a line across a road to the north-western angle of lot 8; thence easterly along the northern boundaries of the said lot 8 and of lots 9, 10, 11, 12 and 13 to the north-eastern angle of the said lot 13; thence southerly along the eastern boundary of the said lot 13 to its south-eastern angle, being a point on the northern boundary of the existing Maffra Sewerage District; thence westerly along the northern boundary of the existing Maffra Sewerage District to the point of commencement—all of which boundaries are shown on a plan approved by the Governor in Council and deposited in the office of the State Rivers and Water Supply Commission, Melbourne.—(Corres. Rs.59/2006/12.)

And the Honorable Wilfred John Mibus, Her Majesty's Minister of Water Supply for the State of Victoria, shall give the necessary directions herein accordingly.

A. MAHLSTEDT,
Clerk of the Executive Council.

TRAFALGAR WATERWORKS TRUST.

At the Executive Council Chamber, Melbourne, the twenty-ninth day of March, 1960.

PRESENT:

His Excellency the Governor of Victoria.
Sir Arthur Warner | Mr. Porter.

ADDITIONAL LOAN OF £2,008.

UNDER the powers conferred by the Water Acts and all other powers enabling him in that behalf, His Excellency the Governor of the State of Victoria, by and with the advice of the Executive Council of the said State, doth hereby grant an additional loan of Two thousand and eight pounds (£2,008) to the Trafalgar Waterworks Trust for the construction of pipe mains, as set forth in the detailed statement bearing date the 24th March, 1960, and verified under the seal of the State Rivers and Water Supply Commission.

The loan hereby granted shall be subject to the provisions of the Water Acts.

And the Honorable Wilfred John Mibus, Her Majesty's Minister of Water Supply for the State of Victoria, shall give the necessary directions herein accordingly.

A. MAHLSTEDT,
Clerk of the Executive Council.

APPROACHING LAND SALES.

SALES of Crown lands, in fee-simple, will be held at the under-mentioned places and dates, viz.:—

	No. of Gazette.
Bendigo.—Thursday, 21st April, 1960	19
Castlemaine.—Monday, 11th April, 1960	18
Daylesford.—Monday, 11th April, 1960	18

PROPOSED REVOCATIONS OF TEMPORARY RESERVATIONS AND THE WITHHOLDING FROM SALE, LEASING, AND LICENSING, OF LANDS BY ORDERS IN COUNCIL.

IN pursuance of the provisions of the *Land Act 1958*, notice is hereby given that it is the intention of the Governor in Council to revoke the temporary reservations and the withholding from sale, leasing, and licensing, of lands by Orders in Council hereunder referred to, viz.:—

The following Notices were published 1^o on the 9th March, 1960, pursuant to Orders of the 1st March, 1960.

CALVIL.—The temporary reservation as a site for Public purposes (State School) and the withholding from sale, leasing and licensing by Order in Council of the 8th October, 1877, of 2 acres of land in the Parish of Calvil.—(C.354(*) (C.96973).

MOORABBIN (CHELTENHAM).—The temporary reservation as a site for Public Buildings and the withholding from sale, leasing and licensing by Order in Council of the 17th November, 1884, of 1 acre 0 roods 23 perches of land in the Parish of Moorabbin so far only as the portion containing 1 rood 5 perches, indicated by hachure on plan hereunder, is concerned.—(M.164(*) (Rs.7395).

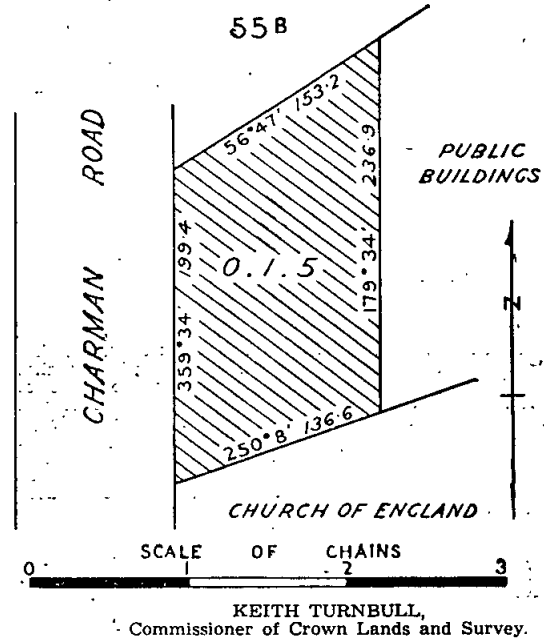

PROPOSED REVOCATIONS OF TEMPORARY RESERVATIONS OF LANDS BY ORDERS IN COUNCIL.

IN pursuance of the provisions of the *Land Act 1928*, notice is hereby given that it is the intention of the Governor in Council to revoke the temporary reservations of lands by Orders in Council hereunder referred to, viz.:—

The following Notices were published 1^o on the 16th March, 1960, pursuant to Orders of the 8th March, 1960.

YARROWEYAH NORTH.—The temporary reservation, by Order in Council of the 16th March, 1897 (see *Government Gazette* of the 19th March, 1897, page 1150), of 1 acre 2 roods 27 5/10 perches of land in the Township of Koonoomoo (now Township of Yarroweyah North), as a site for a State School.—(Y.111(*) (C.96157).

YARROWEYAH NORTH.—The temporary reservation, by Order in Council of the 12th March, 1889, of 59 acres 3 roods 14 perches of land (now shown as 59 acres 2 roods 21 perches by re-survey) in the Township of Koonoomoo (now Township of Yarroweyah North), as a site for a Racecourse and other purposes of Public Recreation.—(Y.111(*) (Rs.2262).

KEITH TURNBULL,
Commissioner of Crown Lands and Survey.

PROPOSED REVOCATIONS OF TEMPORARY RESERVATIONS OF LANDS BY ORDERS IN COUNCIL.

IN pursuance of the provisions of the *Land Act 1958*, notice is hereby given that it is the intention of the Governor in Council to revoke the temporary reservations of lands by Orders in Council hereunder referred to, viz.:—

The following Notices were published 1° on the 23rd March, 1960, pursuant to Orders of the 16th March, 1960.

ELLESMERE.—The temporary reservation, by Orders in Council of the 6th August, 1888, and the 21st May, 1912, of 1 acre of land and 2 roods 16 8/10 perches of land, respectively, in the Parish of Ellesmere, as sites for State School.—(E.97(*) (W.68983).

SANDHURST (EAGLEHAWK).—The temporary reservation, by Order in Council of the 23rd August, 1949, of 1 acre 0 roods 30 perches of land at Eaglehawk, Parish of Sandhurst, as a site for a Rubbish Depot.—(S.371(2°) (Rs.6355).

BENALLA.—The temporary reservation, by Order in Council of the 27th April, 1868, of 1 acre 3 roods 19 perches of land in the Township of Benalla, as a site for Police purposes.—(B.390(*) (Rs.3271).

PANITYA.—The temporary reservation, by Order in Council of the 24th January, 1911, of 2 roods of land in the Township of Panitya, as a site for a Public Hall.—(P.173(*) (Rs.2875).

ELLESMERE.—The temporary reservation, by Order in Council of the 13th January, 1873, of 21 acres 0 roods 32 perches of land in the Parish of Ellesmere, as a site for Watering purposes, revoked as to part by various Orders, so far as the balance thereof, containing 12 acres 3 roods 4 2/10 perches, is concerned.—(E.97(*) (W.68983).

KEITH TURNBULL,
Commissioner of Crown Lands and Survey.

PROPOSED REVOCATIONS OF TEMPORARY RESERVATIONS OF LANDS BY ORDERS IN COUNCIL (AS TO PORTION).

IN pursuance of the provisions of the *Land Act 1958*, notice is hereby given that it is the intention of the Governor in Council to revoke portion of the temporary reservations of lands by the Orders in Council hereunder referred to, viz.:—

The following Notices were published 1° on the 9th March, 1960, pursuant to Orders of the 1st March, 1960.

MORNINGTON.—The temporary reservation, by Order in Council of the 29th December, 1932, of 3 roods 17 3/10 perches of land in the Township of Mornington as a site for Public Buildings, so far only as the portion containing 10 perches, more or less, indicated by hachure on plan hereunder, is concerned.—(M.162(2°) (Rs.4285).

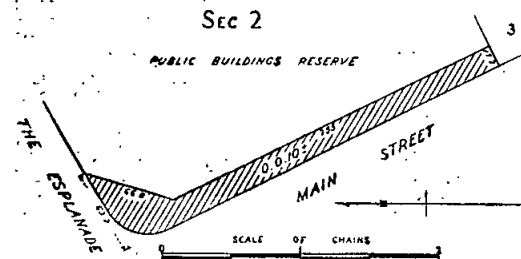

PORT CAMPBELL.—The temporary reservation, by Order in Council of the 24th August, 1909, of 36 acres of land in the Township of Port Campbell as a site for Public purposes, revoked as to part by Order of the 11th July, 1932, so far only as the portion containing 1 rood 14 perches, more or less, indicated by hachure on plan hereunder, is concerned.—(P.147(2°) (Rs.2308).

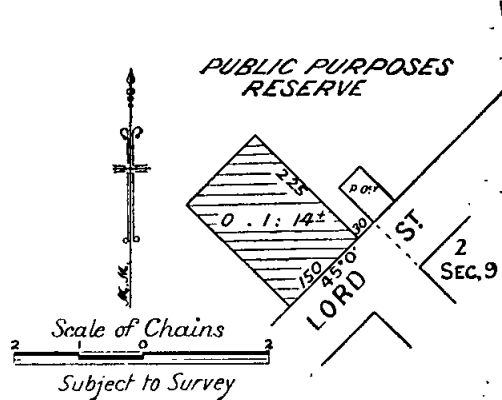

WARRNAMBOOL.—The temporary reservation, by Order in Council of the 19th December, 1938, of 1 rood 18 4/10 perches of land in the Township of Warrnambool as a site for Shire Hall and Offices, so far only as the portion containing 15 perches, indicated by hachure on plan hereunder, is concerned.—(W.99(7°) (Rs.4861).

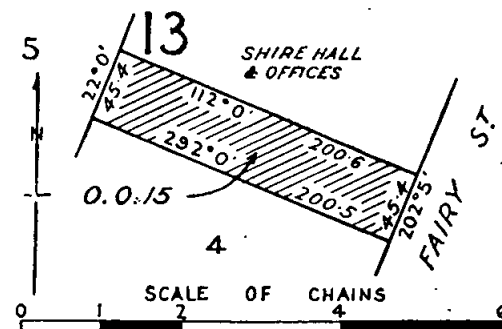

KEITH TURNBULL,
Commissioner of Crown Lands and Survey.

REGULATIONS FOR THE CARE, PROTECTION AND MANAGEMENT OF THE RESERVE FOR PUBLIC GARDEN AND RECREATION IN THE PARISH OF CUT-PAW-PAW, AT WILLIAMSTOWN, KNOWN AS THE "DENNIS RESERVE".

WHEREAS by section 218 of the *Land Act 1958* power is given to the Board of Land and Works to make Regulations in respect of the care, protection and management of any Crown land which has been reserved under the Land Acts for any public purpose whatsoever and which has not been conveyed to or vested in trustees, and for the further purposes as enacted: Now therefore the Board of Land and Works in pursuance of the power conferred aforesaid, doth hereby make the following Regulations in respect of the land in the City of Williamstown temporarily reserved for public garden and recreation by Orders in Council of 29th June, 1885, and 20th October, 1959, and known as the "Dennis Reserve", hereinafter referred to as the "Reserve", in lieu of all previous Regulations which are hereby rescinded. The Reserve has been placed under the control of a Committee of Management hereinafter referred to as the "Committee".

REGULATIONS.

1. The Reserve shall be divided as follows:—
 - 1st.—The Williamstown Men's Bowling Green, including the Club Pavilion.
 - 2nd.—The Williamstown Ladies' Bowling Green, including the Club Pavilion.
 - 3rd.—The Tennis Courts.
 - 4th.—The Williamstown Elderly Citizens' Club Rooms.

2. The Committee may from time to time grant to any club the use of any such Division set apart as aforesaid upon such terms and conditions as may be considered reasonable and consistent with these Regulations and the reservation.

3. No person shall engage in cricket, football or any other game in the Reserve without the permission of the Committee unless such person is a member of any club duly authorized to play therein.

4. No person not being a player or official shall cross or trespass on any playing area during any sports, match, games, fêtes or other amusements or during practice at sports or games when such crossing or trespassing would be injurious to or an undue interference with the progress of the aforesaid matches, games, fêtes, or other amusements or the practice of the aforesaid sports or games.

5. Persons renting or hiring any stand, building, erection or enclosure on the occasions of any sports or fêtes or holiday amusements may be required to deposit an amount not exceeding Twenty pounds by way of guarantee that due care shall be taken of such stand, building, erection, or enclosure, and such Committee in its absolute discretion may take good any damage or injury sustained by such stand, building, erection, or enclosure, or anything contained therein, during such occupancy or hiring, and deduct the cost of making good such loss or damage from the sum of money deposited by way of guarantee, and all persons so renting or hiring shall abide by these Regulations or by any order given by the Committee.

6. No person shall enter or remain in the Reserve while in a state of intoxication or who may offend against decency as regards dress, language, or conduct.

7. No person shall destroy, damage, pick, pluck, tear, remove or interfere in any way with any of the trees, shrubs, grass, flowers, seeds, or other vegetation in the Reserve or walk on the beds or borders therein.

8. No person shall climb or jump over the gates or fences in or bounding the Reserve, stick bills thereon, or cut names on or in any way damage, disfigure, destroy, or remove any of the buildings, walls, gates, fences, seats, groyne, drains or any improvements in the Reserve.

9. No person shall ride or lead on to or on any part of the Reserve or bring on to or put in the Reserve or tether or cause to be tethered on any part of the Reserve any cattle, horses, sheep, goats, pigs, or other animals except as otherwise permitted by these Regulations.

10. No person shall cause or suffer any dog belonging to him or in his charge to enter or remain in the Reserve unless such dog be and continue to be effectively controlled by means of a chain or cord or leash and be effectively restrained from causing annoyance to any person and the owner of any dog which is found in the Reserve and which is not under the effective control of some person by means of a chain or cord or leash shall be guilty of an offence against these Regulations.

11. No person shall park a motor car or other vehicle within the Reserve except at such places as are set apart by the Committee for this purpose.

12. No person shall camp in the Reserve.

13. No person shall erect therein any building or any tent, booth or other structure, or offer for sale any article in the Reserve without the permission, in writing, of the Committee first obtained.

14. No person shall conduct or take part in any public meeting or entertainment of any sort in the Reserve without the permission, in writing of the Committee first obtained.

15. No person shall preach or declaim, harangue, or deliver any address of any kind to members of the public in any part of the Reserve without the permission, in writing, of the Committee first obtained.

16. No person shall play any musical instrument, sing, recite, conduct, or take part in any band performance or entertainment of any sort in the Reserve without the permission, in writing, of the Committee first obtained.

17. No person shall bet publicly in any part of the Reserve.

18. No person shall light a fire on any part of the Reserve.

19. No person shall commit a nuisance on any part of the Reserve or in any shed, or other buildings upon the Reserve.

20. No person shall throw any stone or other missile within the Reserve.

21. No person shall deposit or cause to be deposited waste paper, bottles, tins, food, refuse, fruit, fruit skins, or any other litter or refuse on any part of the Reserve except in receptacles provided for that purpose.

22. No person shall use any of the closets, urinals, or dressing sheds in the Reserve or any portion of the closets, urinals, or dressing sheds for any other purpose than that for which they are constructed.

23. No person shall break glass of any kind in the Reserve, or leave therein anything which would injure members of the public.

24. No person shall discharge any firearm or air-gun or set off any fireworks in any part of the Reserve.

25. No person shall use or cause any building erected within the Reserve to be used for residential purposes.

26. No person shall bring any liquor on to the Reserve or consume it thereon save and except that this clause will not have application in respect of licensed premises forming part of Division One of these Regulations.

27. No person shall remove or cause to be removed any sand, stone, soil, or other material from any part of the Reserve.

28. No person clothed in bathing costume shall come on to or be on or remain on any part of the Reserve, unless effectively and decently clad in a suitable bathing costume.

29. No person shall defecate or urinate in any part of the Reserve except in the closets and urinals provided therein for these purposes.

30. No person shall post or place any advertisement, bill, poster, or any other like sign in any part of the Reserve.

31. No person shall drive, ride push or pull, any motor car, cycle, or other vehicle (whether propelled by mechanical or other means) on to, over, across, or along any part of the Reserve, except on the areas set apart or marked out for vehicular traffic, save and except as may be necessary to mow or roll grass.

32. No person shall engage or take part in any vehicular or foot racing upon any part of the Reserve.

33. No person shall obstruct or interfere with the passage of members of the public using the Reserve, or wilfully obstruct in the execution of his duty or insult any employee of the Committee or any member or employee of such Committee.

34. No person shall behave in an unseemly, improper, riotous, or noisy manner to the annoyance of the public or blaspheme, use profane or obscene language or behave in an indecent manner in or on any part of the Reserve.

35. Any person committing any breach of these Regulations who refuses to state his name and place of abode to any member of the Committee or to an employee of such Committee or who in the opinion of such member or employee states a false name or place of abode shall be guilty of an offence under these Regulations.—(Rs. 2445.)

The common seal of the Board of Land and Works was hereto affixed this twenty-fourth day of March, 1960, in the presence of—

(SEAL)

KEITH TURNBULL, President.

G. L. WOOD, Member.

Every person who contravenes or fails to comply with these Regulations shall, in accordance with the provisions of Section 218 of the Land Act 1958, for each offence be liable to a penalty of not more than Five pounds, and every person who contravenes or fails to comply with any such Regulations, and who, after he has been warned by any bailiff of Crown lands or by any member of the Police Force, does not desist therefrom, may be forthwith apprehended by such Bailiff or member of the Police Force and taken before some justice to be dealt with according to law and shall be liable to a penalty of not more than Ten pounds.

APPLICATION OF REGULATIONS MADE FOR THE CARE, PROTECTION AND MANAGEMENT OF THE HEPBURN SPRINGS RESERVE TO THE ADJOINING ARGYLE MINERAL SPRINGS RESERVE.

THE Regulations made by the Board of Land and Works on the 3rd February, 1960, for the care, protection and management of the Hepburn Springs Reserve, in the Township of Hepburn, Parish of Wombat, being the land temporarily reserved by Order in Council dated the 4th August, 1959, as a site for Mineral Springs and Public Park, and known as the "Hepburn Springs Reserve", are hereby applied to the remaining portion of the land in the Township of Hepburn and the Parish of Wombat temporarily reserved by Order in Council dated the 16th March, 1914, as a site for the preservation

of such land and the Springs thereon for the Recreation, Convenience and Amusement of the People, and known as the "Argyle Mineral Springs Reserve".—(Rs.1611.)

The common seal of the Board of Land and Works was hereunto affixed this twenty-fourth day of March, One thousand nine hundred and sixty, in the presence of—

(SEAL) KEITH TURNBULL, President.
G. L. WOOD, Member.

PUBLIC HEARINGS BY PERSONS APPOINTED UNDER THE 34TH SECTION OF THE LAND ACT 1958.

NOTICE is hereby given that at the times and places mentioned in the Schedule hereunder, applications for leases and licences under the Land Acts, objections to such applications, objections to proposed proclamations, alterations, additions, diminutions, revocations, or unions of commons, and reasons against forfeiture of any leases or licences under the Land Acts deemed liable to forfeiture, will be publicly heard by the persons whose names are set opposite such places respectively in such Schedule, being persons appointed by me, the responsible Minister of the Crown administering the Land Acts, to hear the same and report thereon in writing to me.

KEITH TURNBULL,
Commissioner of Crown Lands and Survey, and
President of the Board of Land and Works.

Department of Crown Lands and Survey,
Melbourne, 28th March, 1960.

SCHEDULE.

LAND INSPECTOR'S OFFICE, KERANG, Wednesday,
13th April, 1960, at 10.30 a.m.—W. C. Harry.
LAND INSPECTOR'S OFFICE, SWAN HILL, Wednesday,
13th April, 1960, at 1.30 p.m.—W. C. Harry.
LAND OFFICE, BAIRNSDALE, Wednesday, 20th April,
1960, at 9.30 a.m.—R. A. Walker.
MECHANICS' HALL, ORBOST, Thursday, 21st April,
1960, at 10.30 a.m.—R. A. Walker.

**COMMITTEES OF MANAGEMENT OF RESERVES.
APPOINTMENTS.**

WHEREAS by section 221 of the *Land Act 1958* it is provided that it shall be lawful for the Governor in Council or the Board of Land and Works to appoint and remove any number of persons, not less than three, or any municipal council, or the governing body of any corporation, to be a Committee of Management of any specified Crown land reserved either temporarily or permanently for any of the purposes set out in section 14 of the *Land Act 1958*, and not conveyed to or vested in trustees: Now therefore the Board of Land and Works doth hereby appoint the under-mentioned persons to be members of the Committee of Management of the Reserves named:—

"COMBIENBAR PUBLIC RECREATION AND PUBLIC HALL RESERVE."

Stephen Keith Farmer, John Bertie Clay and William Michael Shiels as members of the Committee of Management for a period of three (3) years of the land in the Parish of Combiensbar temporarily reserved by Orders in Council dated the 20th July, 1925, and 22nd December, 1953, as a site for Public Recreation and Public Hall.—(Corres. Rs.3150.)

"SHELFORD HALL RESERVE."

John Richard Heard, Thomas Edward Meek, Philip Charles Shea, Allan James Turpie, John Leo. Burt, William Geoffrey Leask and Douglas Andrew Simpson as a Committee of Management for a period of three (3) years of the land temporarily reserved by Orders in Council dated 1st August, 1864, and 23rd October, 1945, as a site for a Mechanics' Institute in the Township of Shelford, and known as the "Shelford Hall Reserve".—(Corres. Rs.2561.)

"ALLANSFORD RECREATION RESERVE."

William Henry Byron, Vivian Grant McKean, John Lewis Morgan, Albert Lindsay Pulham and Thomas Arthur Chilton as a Committee of Management for a period of three (3) years of the land temporarily reserved by Order in Council dated 24th September, 1912, as a site for Public Recreation in the Parish of Tallangatta, and known as the "Allansford Recreation Reserve".—(Corres. Rs.4293.)

No. 25.—2674/60.—3

"WATCHEM RACECOURSE AND RECREATION RESERVE."

William Norman Slocombe, Hector William Dickie, Albert Thomas Blair, Samuel William Fielding, Gustave Frederick Zimmer, John Fallon McErvale, Thomas Patrick Connellan, James Augustine Colbert and William Joseph Willey as a Committee of Management for a period of three (3) years of the land temporarily reserved by Order in Council dated the 18th August, 1959, as a site for Racecourse and Public Recreation in the Township of Watchem, in addition to and adjoining the site temporarily reserved therefore by Order in Council of 8th December, 1931, and together known as the "Watchem Racecourse and Recreation Reserve".—(Corres. Rs.4160.)

"DOOKIE RACECOURSE AND RECREATION RESERVE."

Fredrick George Petherd, Stanley Ernest O'Brien, Leo Daniel McGrath, Calvin Stanley Kellow and Allan Ford, as a Committee of Management for a period of three (3) years of the remaining portion of the land temporarily reserved by Order in Council of the 6th October, 1873, as a site for Racing and General Recreation purposes in the Parish of Pine Lodge, and known as the "Dookie Racecourse and Recreation Reserve".—(Corres. Rs.741.)

"HAZELWOOD SOUTH PUBLIC HALL RESERVE."

Cyril Hare, John Wesley Medew, Robert Tolmie Porter, Howard Rae Walker, Eric Ormond Rowley, Albert William Northway and Thomas Desmond Lawless as a Committee of Management for a period of three (3) years from 24th March, 1960, of the land in the Parish of Hazelwood temporarily reserved by Order in Council dated the 4th November, 1953, as a site for a Public Hall.—(Corres. Rs.5910.)

"NEWBOROUGH RECREATION RESERVE."

The Council of the Borough of Moe as a Committee of Management of the lands in the Parish of Narracan temporarily reserved by Order in Council of 15th December, 1959, as a site for Public Recreation, and known as the "Newborough Recreation Reserve".—(Corres. Rs.7895.)

"GREENVALE RECREATION RESERVE."

The Council of the Shire of Bulla as a Committee of Management of the lands in the Parish of Yuroke temporarily reserved by Order in Council of 5th February, 1906, as a site for Public Recreation, and known as the "Greenvale Recreation Reserve".—(Corres. Rs.1054.)

"COBDEN RECREATION RESERVE."

James Michael McCabe, as a member of the Committee of Management for a period ending 1st September, 1962, of the land temporarily reserved by Order in Council dated 8th November, 1886, as a site for Public Recreation in the Township of Cobden, and known as the "Cobden Recreation Reserve".—(Corres. Rs.683.)

"BRANXHOLME PUBLIC HALL RESERVE."

Grace Edith Silvester, Colin Arthur Macgurgan, Marion Agnes MacLean, Ernest Franklin Silvester, William Leslie Hogan, John Alexander Sharp, Lewis David Edwards, Thelma Dorothy MacLean, and Abedi Alfred Bourke as a Committee of Management for a period of three (3) years of the land in the Township and Parish of Branxholme temporarily reserved by Order in Council of 22nd December, 1959, as a site for a Public Hall, and known as the "Branxholme Public Hall Reserve".—(Corres. Rs.7886.)

"GOULD PUBLIC HALL RESERVE."

Douglas John Lewis, Harry Anzac Almond, Albert Ronald Bastin, Jack Alexander Oliver, J. G. Brown, Thomas Arthur Brown and David F. Mitchell as a Committee of Management for a period of three (3) years from 22nd March, 1960, of the remaining portion of the land temporarily reserved by Order in Council dated the 12th May, 1924, as a site for a Public Hall in the Township of Gould, Parish of Tanjil East, and known as the "Gould Public Hall Reserve".—(Corres. Rs.1627.)

"BUCHAN RECREATION RESERVE."

Lochiel Alexander Cameron, George Ernest Conway Johnson, Daisy Bell, Peter Douglas Mitton, B. Mitton, Samuel Walter Lane, and William John Crowe as a Committee of Management for a period of three (3) years of the land temporarily reserved by Order in Council dated the 16th October 1934, as a site for Public Recreation in the Township of Buchan, Parish of Buchan, and known as the "Buchan Recreation Reserve".—(Corres. Rs.4407.)

"BANNOCKBURN MECHANICS' INSTITUTE RESERVE."

David Edmund Clark in the room of William David Patterson (resigned), and Alan Ernest Johnson as members of the Committee of Management for the period ending the 21st November, 1961, of the land temporarily reserved by Order in Council dated the 12th March, 1907, as a site for a Mechanics' Institute and Free Library at Bannockburn and known as the "Bannockburn Mechanics Institute Reserve".—(Corres. Rs.2121.)

"CASTERTON SHOWGROUNDS RESERVE."

Charles Kenneth Carmichael, Desmond P. Mullane, George Charles Black, William Russell Taylor, Herbert David Mitchell, Robert James Nicol, John Thomas

O'Brien, and Ernest James Ley as a Committee of Management for a period of three (3) years of the land temporarily reserved by Order in Council dated the 9th August, 1886, as a site for Show-yards in the Town of Casterton, and known as the "Casterton Showgrounds reserve".—(Corres. Rs.1738.)

In witness whereof the common seal of the Board of Land and Works was hereunto affixed this 24th day of March, One thousand nine hundred and sixty, in the presence of—

(SEAL) KEITH TURNBULL, President.
G. L. WOOD, Member.

Land Act 1958.

LEASE SURRENDERED.

NOTICE is hereby given that the Governor in Council has accepted the surrender of the Lease mentioned in the Schedule hereunder for the reason specified in each case.

District.	Corr. No.	Name.	Section of Land Act under which Leased.	Parish.	Allotment.	Section.	Area.	Class.	Reason.
Melbourne	1976/44	Herbert William Asmussen	44	Neerim East	47A	..	A. R. P. 320 0 0	..	New lease to issue

Department of Crown Lands and Survey,
Melbourne, 21st March, 1960.

KEITH TURNBULL,
Commissioner of Crown Lands and Survey.

Land Act 1958.

LICENCES UNDER THE LAND ACTS 1915 AND 1928 DECLARED VOID.

NOTICE is hereby given that the Licences in the Schedule hereunder have been Declared Void for the reason specified in each case.

District.	Corr. No.	Name of Licensee.	Section of Land Act under which Licensed.	Parish.	Allotment.	Section.	Area.	Annual Rental.	Reason for Voiding.
Melbourne	02590/129	Mayne Nickless Limited	129	Doutta Galla	8	1B	A. R. P. 2 3 7	..	Licence cancelled as from 31st January, 1960. Site vacated by licensee
Kerang ..	01739/129	Louis Trevor Swifte	129	Township of Kerang	6	39	0 0 38	..	Licence Surrendered
Melbourne	02551/129	Francis L. and Mary A. Harris	129	Township of Maribyrnong	3A and 3B	21	0 0 7	..	Licence Expired

Department of Crown Lands and Survey,
Melbourne, 25th March, 1960.

KEITH TURNBULL,
Commissioner of Crown Lands and Survey.

TENDERS—PUBLIC WORKS DEPARTMENT

TENDERS will be received at this Department until TEN a.m. on the Tuesdays, and for the purposes, under mentioned.

Particulars may be learnt at the Department and also at places shown in parenthesis.

W.O. means Inspector of Works Office; P.S.—Police Station; T.S.—Technical School; H.E.S.—Higher Elementary School; S.S.—State School; H.S.—High School; C.S.—Consolidated School.

Tenders should be submitted on the Department's printed Tender Form. All tenders must be on a "Firm Tender" basis. The Board of Land and Works will not necessarily accept the lowest or any tender.

Tenders to be addressed to the Commissioner of Public Works, and envelope containing tender to be marked "Tender for _____, closing Tuesday, _____".

NOTE.—No preliminary deposit is to be lodged with any tender, but a deposit in accordance with the prescribed Schedule may be required from each successful tenderer.

5th April, 1960.

Ararat.—Supply and delivery of electric stoves, &c., Cottage Homes, Children's Welfare Department.

Bacchus Marsh.—Replacement of science sinks, &c., High School. (W.O., Ballarat; H.S., Bacchus Marsh.)

Ballarat.—Provision of new toilet block, &c., at Farm Mental Hospital. (W.O., Ballarat; Mental Hospital, Ballarat.)

Ballarat.—Erection of concrete fire escape to Senior Nurses' Home, Mental Hospital. (W.O., Ballarat; Mental Hospital, Ballarat.)

Carapook.—Additional out-office and drinking facilities, S.S. No. 1969. (W.O., Hamilton; S.S., Carapook.)

Castle Donnington.—Installation of septic closets and repairs, S.S. No. 3762. (W.O., Swan Hill; S.S., Castle Donnington.)

Caulfield.—Supply of equipment for first section, Technical School.

Colac.—Supply and installation of a gas-heating system, Court House. (W.O., Camperdown; P.S., Colac.)

Corryong.—Erection of additional out-offices, Consolidated School. (W.O., Wangaratta; C.S., Corryong.)

Flemington.—Supply of refrigerator, Girls' Secondary School.

Footscray.—Installation of P.V.C. troughs, &c., Technical School. (T.S., Footscray.)

Frankston.—Fibrous plaster and acoustic tiles, Technical School. (Amended specification.)

Frankston.—Repairs and painting of residence, High School. (H.S., Frankston.)

French Island.—Supply and loading on rail of fencing wire, Penal Settlement.

Geelong.—Erection of 32 ft. x 16 ft. shelter pavilion, Gordon Institute of Technology. (W.O., Geelong; Gordon Institute of Technology, Geelong.)

Glenmore.—Resiting of out-offices and installation of septic closets, S.S. No. 3688. (W.O., Ballarat; S.S., Glenmore.)

Greensborough.—Provision of two additional toilets, S.S. No. 2062. (S.S., Greensborough.)

Heatherton.—Supply of additional kitchen equipment, Sanatorium.

Keon Park.—Erection of four (4) additional class-rooms, S.S. No. 4739. (S.S., Keon Park.)

Kew.—Supply and fix cement roofing tiles to Male Wards B.1 and B.3, Mental Hospital.

Kew.—Tubular steel tables and chairs for children's cottages, Mental Hospital.

Kew.—Metal cots for children's cottages, Mental Hospital.

Kew.—Alteration and conversion of hot water system from 180° F. to 105° F. in wards 21 and 25, children's cottages, Mental Hospital.

Konongwootung North.—Erection of out-office block, septic tank installation, &c., S.S. No. 4362. (W.O., Hamilton; S.S., Konongwootung North.)

Leongatha.—Repairs and painting and provision of new display boards, S.S. No. 2981. (W.O., Korumburra; S.S., Leongatha.)

Lindenow.—Repairs and painting, residence, S.S. No. 1120. (W.O., Bairnsdale.)

Lyndhurst.—Installation of septic closets, school and residence, S.S. No. 732. (S.S., Lyndhurst.)

Melbourne.—Renovations to furniture, Parliament House.

Melbourne.—Supply and installation of two 1½-h.p. 13,500 B.T.U.'s, 3,000-watts air-conditioning units, Mental Hygiene Authority, 300 Queen-street. (Specifications to be submitted with tender.)

Melbourne.—Fibrous plaster and acoustic tile, Explosives and Gas Examining Branch, 427 Spencer-street.

Mont Park.—Low temperature hot-water service in Wards F.2, 3, and 4, Janefield Mental Hospital.

Mordialloc.—Domestic Arts and Manual Arts Wings, High School. (H.S., Mordialloc.)

Netherby.—Metal tank stands, tanks, lavatory trough, extension water service, &c., S.S. No. 2651. (W.O., Horsham; P.S., Nhill; S.S., Netherby.) (Amended specification.)

Niddrie.—Erection of second and third sections of standard Technical School. (T.S., Niddrie.)

Quambatook.—Repairs to ceiling, floor, chimney, chalk-board renewals, &c., Group S.S. No. 2443. (W.O., Swan Hill; Group S.S., Quambatook.)

Rutherglen.—Internal repairs and painting to Research Officer's residence, Research Station, Agriculture Department. (W.O., Wangaratta.)

Sunbury.—Erection of new mortuary, Mental Hospital. (Mental Hospital, Sunbury.)

Sunbury.—Supply and installation of mechanical services in four-berth Mortuary, Mental Hospital. (Mental Hospital, Sunbury.)

Sunshine North.—Laying of sewer drains, installation sanitary fittings in staff toilets, flushometer supply, &c., S.S. No. 4745. (S.S., Sunshine North.)

Traralgon.—Repairs and painting, High School. (W.O., Traralgon; H.S., Traralgon.)

Valencia.—Renovations to residence, S.S. No. 1622. (W.O., Bairnsdale; S.S., Valencia.)

Warrnambool.—Supply and delivery of broken stone, Mental Hospital. (W.O., Warrnambool.)

Warrnambool.—Supply and delivery of soil, approximately 4,000 cubic yards, Mental Hospital. (W.O., Warrnambool.)

West Melbourne.—Supply and delivery of sawn hardwood, Cool Stores. (W.O., Bairnsdale.)

12th April, 1960.

Ararat.—Additional toilets in brickwork, resiting of troughs, High School. (W.O., Ararat; P.S., Stawell; H.S., Ararat.)

Beaufort.—Installation of septic tank system, S.S. No. 60. (W.O., Ballarat; S.S., Beaufort.)

Belgrave South.—Provision of additional out-offices and repairs, S.S. No. 3551. (S.S., Belgrave South.)

Bendigo.—Erection of first section Junior Technical School. (W.O., Bendigo, Ballarat.)

Bendigo.—Mechanical services, stage one, Technical School. (W.O., Bendigo.)

Bendigo.—Supply and fix blackout curtains, "Pleasant Vale", Teachers' College. (W.O., Bendigo.)

Berwick.—New out-offices and septic tank installation at school and residence, S.S. No. 40. (S.S., Berwick.)

Coburg.—Supply of one (1) only two-drum sanding machine, 36 inches, Pentridge Gaol. (Specifications to be supplied with tender.)

Coburg.—Painting and repairs, S.S. No. 484. (S.S., Coburg.)

Cohuna.—Renovations to canteen and provision of skylights to class-rooms, &c., Consolidated School. (W.O., Bendigo; C.S., Cohuna.)

Coromby.—Construction of out-offices, woodshed, installation of septic closets, S.S. No. 2082. (W.O., Warracknabeal, Horsham; S.S., Coromby.)

Doutta Galla.—Connexion to sewerage main, &c., S.S. No. 4708. (S.S., Doutta Galla.)

Eastmeadows.—Warm air heating/ventilation system, S.S. No. 4865.

Echuca East.—Erection of four (4) additional class-rooms, S.S. No. 2667. (W.O., Shepparton; S.S., Echuca East.)

Fawkner East.—Heating/ventilation system, S.S. No. 4846.

Geelong.—Alterations and additional Boiler House, Teachers' Hostel, "Ariston". (W.O., Geelong.)

Gonn Crossing.—Septic closet installations, &c., S.S. No. 4566. (W.O., Swan Hill; S.S., Gonn Crossing.)

Huntingdale.—Electrical installation in stages one and two, High School.

Kaniva.—Additional porch and rearrangement of access to Infants' Room, Consolidated School. (W.O., Horsham; P.S., Nhill, and C.S., Kaniva.)

Keon Park.—Electrical installation, four (4) additional class-rooms, S.S. No. 4739.

Keon Park.—Extension of heating/ventilation system to four class-rooms, S.S. No. 4739. (S.S., Keon Park.)

Leongatha.—New toilet block and connexion of school to town sewerage system, High School. (W.O., Korumburra; H.S., Leongatha.)

Manifold Heights.—Installation of skylights, S.S. No. 4224. (W.O., Geelong; S.S., Manifold Heights.)

Melton.—Repairs and painting, school and residence, S.S. No. 430. (S.S., Melton.)

Minjah.—Erection of out-offices, septic tank installation, &c., S.S. No. 4829. (W.O., Warrnambool; S.S., Minjah.)

Mysia.—Renewal of roof, S.S. No. 1899. (W.O., Bendigo; S.S., Mysia.)

Noble Park.—Erection of No. 2 shelter pavilions, 32 ft. x 16 ft., Technical School. (T.S., Noble Park.)

Orbost North.—Construction of sub-surface filter, laying of drains, &c., S.S. No. 4767. (W.O., Bairnsdale; S.S., Orbost North.)

Pakenham.—Replacement of window sashes, Consolidated School. (C.S., Pakenham.)

Parktone.—Erection of six (6) class-room Primary School, L.T.C., S.S. No. 4843.

Parktone.—Electrical installation in six (6) L.T.C. class-rooms, &c., new Primary School, S.S. No. 4843.

Parktone.—Warm-air heating/ventilation system, S.S. No. 4843.

Prahran.—Demolition of old brick residence, &c., Girls' Technical School.

Redan.—General repairs and renovations with provision of skylights to class-rooms, S.S. No. 1289. (W.O., Ballarat; S.S., Redan.)

South Melbourne.—Electrical installation in heat treatment section, Technical School. (T.S., South Melbourne.)

Stawell.—Erection of brick veneer residence, Police Station. (W.O., Ararat; P.S., Stawell.)

Stawell.—Additions and renovations to Sergeant's Residence, Police Station. (W.O., Ararat; P.S., Stawell.)

Sunbury.—Curtain material, Mental Hospital.

Sunbury.—New toilet block at Artisans' Block, Mental Hospital. (Mental Hospital, Sunbury.)

Sunbury.—Conversion of old Tailoress's Room to Hair-dressing Salon, Mental Hospital. (Mental Hospital, Sunbury.)

Syndal.—Electrical installation in stages two and three, Technical School. (T.S., Syndal.)

Syndal.—Mechanical services, stages two and three, Technical School. (T.S., Syndal.)

Taradale.—Internal and external renovations, S.S. No. 614. (W.O., Kyneton; S.S., Taradale.)

Traralgon.—Replace urinal, connect existing fixtures to drain, extend water supply, S.S. No. 3584. (W.O., Traralgon; S.S., Traralgon.)

West Melbourne.—Manufacture, supply, and delivery of precast, prestressed concrete grillage beams, Government Cool Stores.

Wonthaggi North.—Internal and external renovations and painting, S.S. No. 3716. (W.O., Korumburra; S.S., Wonthaggi North.)

Yallourn.—Repairs to roof, Technical School. (W.O., Traralgon; T.S., Yallourn.)

Yannathan South.—Residence, internal and external renovations; school, repairs to floor, S.S. No. 3225. (W.O., Korumburra; S.S., Yannathan South.)

19th April, 1960.

Ararat.—Electrical installation in Engineers' Workshop, Mental Hospital. (W.O., Ararat.)

Ballarat East.—Purchase and removal of two old Army huts on Hopetoun-street site, High School. (W.O., Ballarat; H.S., Ballarat East.)

Bendigo.—Alterations and additions to the hot-water and ventilation services, Gaol. (W.O., Bendigo.)

Box Hill.—Repairs to floor and doors to aluminium building, High School. (H.S., Box Hill.)

Bright.—Effluent pump in septic tank, Higher Elementary School, No. 776. (W.O., Wangaratta.)

Buffalo.—External renovations and enclosing veranda to residence, S.S. No. 3240. (W.O., Korumburra; S.S., Buffalo.)

Cohuna.—Erection of additional offices, State Rivers and Water Supply Commission. (W.O., Bendigo; P.S., Cohuna.)

Echuca East.—Extension to the heating/ventilation system to four (4) additional class-rooms, S.S. No. 2667. (W.O., Shepparton, Bendigo; S.S., Echuca East.)

Essendon.—Renovations to biology room, High School. (H.S., Essendon.)

Geelong.—Provision of a 2-ton chain hoist, trolley and associated steelwork, Gordon Institute of Technology. (Amended specification.) (W.O., Geelong; Gordon Institute of Technology, Geelong.)

Geelong East.—Mechanical services, stages two and three, Technical School. (W.O., Geelong; T.S., Geelong East.)

Greythorn.—Additional out-offices, S.S. No. 4694.

Hampton.—New water supply, S.S. No. 3754. (S.S., Hampton.) (Amended specification.)

Longerenong.—Renovations to bathroom and kitchen, main building, Agricultural College. (W.O., Horsham, Warracknabeal; Agricultural College, Longerenong.)

Melbourne.—Heating of six (6) new waiting rooms, Law Courts.

Melbourne.—Alterations and renovations to room D.1—Building No. 4, Royal Melbourne Technical College.

Melbourne.—Repairs and alterations to Building No. 15, Royal Melbourne Technical College.

Morwell North.—Internal and external renovations, S.S. No. 2621. (W.O., Traralgon; S.S., Morwell North.)

Mossiface.—Renovations to school buildings, S.S. No. 3176. (W.O., Bairnsdale; S.S., Mossiface.)

Natimuk.—Purchase and removal of old residence, S.S. No. 1548. (W.O., Horsham; S.S., Natimuk.)

Oakleigh.—Replace double doors, chalkboards, provide skylights to Infants' Hall and weather shelter to Head Teacher's office door, S.S. No. 1601. (S.S., Oakleigh.)

Oakleigh.—Additional toilets, S.S. Nursery, No. 4214. (S.S., Nursery, Oakleigh.)

Port Melbourne.—Renewal of water service to school and residence, S.S. No. 2932.

Ruby.—New out-office block for boys and girls, with septic closets, new septic closet to Teacher's residence, S.S. No. 3208. (W.O., Korumburra; S.S., Ruby.)

Sunbury.—Electrical installation for the Hairdressing Salon, Mental Hospital.

Sunbury.—Conversion of old boiler-house to Pharmacy, Mental Hospital. (Mental Hospital, Sunbury.)

Swan Reach.—Repairs and painting to the school and residence, S.S. No. 1631. (W.O., Bairnsdale; S.S., Swan Reach.)

Whitfield.—New closets, installation of septic tank, &c., school and residence, S.S. No. 2441. (W.O., Benalla; S.S., Whitfield.)

Wonthaggi.—Erection of garage, Clerk of Courts residence. (W.O., Korumburra; P.S., Wonthaggi.)

26th April, 1960.

West Melbourne.—Internal renovations, S.S. No. 1689.

T. K. MALTBY,
Commissioner of Public Works.

Public Works Department,
Melbourne, 29th March, 1960.

TENDERS FOR THE SERVICE, 1960/61.

GENERAL STORES.

TENDERS will be received until Eleven o'clock a.m. on Friday, 6th May, 1960 from persons willing to supply the under-mentioned articles in such quantities as may be ordered by the Victorian Government during the twelve months commencing 1st July, 1960:—

Schedule No.

6. Hosiery.
13. Acids, Sulphuric, &c.
17. Belting—Leather and Rubber.
18. Bolts, Nuts, Washers, &c.
19. Bricks, Cement, Lime, &c.
20. Brushware—Painters'.
23. Carbon Papers and Typewriter Ribbons, &c.
25. Chemicals, &c.
26. Clothing—Uniform.
27. Cocks and Fittings, &c.
28. Coppers, Furnaces, and Stoves.
29. Cordage, Lines, Rope, &c.
32. Disinfectants.
36. Earthenware and Glassware.
37. Electric Lamps, Accessories, Cables, Conduit.
39. Furniture, Blinds, and Carpets.
41. Garments—Dust Coats, &c.
43. Haberdashery.
44. Hats—Men's.
45. India-rubber Goods.
47. Inks—Writing, &c.
48. Iron (Galvanized).
49. Steel (Mild).
53. Leather.
54. Metals.
57. Nails, Rivets, Screws, &c.
58. Nails (Wire).
62. Paint and Painters' Sundries.

The prices tendered must not include sales tax.

Security.—Five per cent. of total amount of tender accepted, but in no case will security of less than £3 be received.

Schedules as above, with full particulars, may be obtained from the Secretary to the Tender Board, Macarthur-street, Melbourne, C.2, by whom also the samples will be shown and any information afforded to persons tendering.

In all cases the total cost of each item must be extended in the columns provided.

Security will be required either in Commonwealth Treasury bonds, or approved bank guarantee, fixed deposit receipt, Savings Bank deposit book, or non-negotiable cheque in favour of the Secretary to the Tender Board, as the tenderer may elect.

The security must be completed and the contract signed within five days of acceptance of the tender, failing which the service may be again advertised, or another tender accepted.

The lowest or any tender will not necessarily be accepted.

In the event of tenderers withdrawing or attempting to withdraw their tenders before notification of acceptance of same, or failing to take up their accepted tenders within the prescribed period after notification of acceptance, they may be disqualified from tendering or holding any future contracts for Government supplies for a period of twelve months, such disqualification to date from the notification of acceptance of tender. It is also stipulated that, if a tenderer be a member of a firm and such firm be interested in the contract, the tender shall be in the name of the firm and not in that of the individual and that, for a breach of this condition, the tender will be declared informal.

Tenders enclosed in a separate envelope, and having the words "Tender for ———" (as the case may be) written thereon, must be deposited in the Tender-box at the Tender Board Offices, Macarthur-street, Melbourne, C.2, or, if sent by post, postage must be prepaid and the tenders addressed to the Chairman of the Tender Board, Tender Board Offices, Macarthur-street, Melbourne, C.2, which office they must reach not later than by first post on the date of closing of tenders.

CONDITIONS OF CONTRACT.

1. Except where definite quantities are specified the Government will not be bound to order from the contractor all the articles enumerated in the schedule, but only those articles, and such quantities of those articles, as it may be found necessary to order. Should the Government, however, require a larger supply of any article than the

estimated quantity stated in the schedule, the contractor will nevertheless be bound to supply the same at contract rates. The Government reserves the right to purchase otherwise than from the contractor articles of any of the several kinds enumerated in the schedule, the purchase of which is, in the opinion of the Tender Board, necessary in order to meet special circumstances or special requirements.

2. Under this contract goods may be ordered by any Department of the Commonwealth, but it shall be optional on the part of the contractor to supply.

3. The supplies are to be the same as sample where so stated, and of the particular manufacture indicated in the schedule. In the case of different makers' goods, the contractor will be required to supply the kind ordered. *The supplies are to be the best quality of their several kinds or manufacture.* In the event of the tender having been accepted for goods manufactured within the Commonwealth or within any other part of the British Empire (as the case may be), all such goods supplied shall, if required by the Government, bear evidence that they are of the particular manufacture tendered for and, in addition, the contractor may at any time during the currency of the contract be called on to furnish a statutory declaration as to the country of origin of the goods supplied.

4. Except where otherwise stated in the schedule, the value of all packages, cases, casks, &c., whether bulk be broken or not, must be included in the prices stated in the contractor's tender; all such packages, &c., shall be considered the property of the Government, and no charges or expenses whatsoever beyond the price tendered and set out in the schedule will be allowed to the contractor for any articles or packages, cases, casks, &c. The net weight or quantity only will be paid for. The contractor must provide, without extra charge, whatever labour may be required in the packing of stores.

5. All orders for supplies will emanate from the Departments requiring the goods, which shall be delivered as may be directed by the officer ordering the supply. At the time of delivering the supplies, the contractor shall produce the order for same to the officer authorized to accept delivery, and such officer shall acknowledge thereon the receipt of the stores accepted and return the order to the contractor, who will attach it to his claim for payment.

6. Supplies ordered for delivery in the Melbourne District are to be delivered free of all charges (whether cartage, freight, &c.), and, for the purpose of this contract, the Melbourne District will include a radius of 12 miles from the Elizabeth-street Post Office. For supplies outside that radius the goods must be delivered free on rails at Flinders-street or Spencer-street Railway Stations as required.

7. Arrangements as to time of delivery and inspection of goods will be made by the officer ordering the supply.

8. Orders must receive prompt execution; in the event of the goods not being delivered within forty-eight hours after the contractor shall have received the order or within such other time as the order may specify for delivery, it will be competent for the officer named in clause 7, or the head of the Department to whom the goods are to be supplied, on giving the contractor twenty-four hours' notice, to purchase the supplies, or any like supplies that are suitable for the service, at the contractor's risk, and the extra expense incurred over and above the contract price (if any) will be deducted from the contractor's account or from the security money.

9. Delivery will not be deemed to have been made until the goods have been approved of. In the event of the rejection or return of any supplies, the contractor shall bear the whole cost of replacing the supplies rejected or returned, otherwise purchases will be effected at the contractor's risk and the extra expense deducted as provided in clause 8.

10. The contractor will be required to furnish his account in the prescribed form as soon as possible after the delivery of the goods, the account to be accompanied by the receipted delivery orders on which it is based. Where practicable, the use of more than one account form for each Department or sub-Department must be avoided. The rates and the quantities quoted in the orders cannot be increased.

11. The acceptance of the supplies shall be subject to the approval of the officer authorized to take delivery of the stores, or such other officer as shall be named in the schedule. The contractor may, however, claim a survey on any goods objected to; but in that case, he must, within twenty-four hours after objection is made, give notice thereof, in writing, to the officer rejecting the goods. If, after the delivery of the supplies has been taken, any deficiency or defect is discovered therein, such deficient or defective stores may be returned to the contractor,

12. The members of Boards of survey will be appointed by the Treasurer of the State for the time being, and the decision of the Board is to be considered as final. If the Board shall decide that the article is not of proper quality it must be immediately replaced by the contractor, failing which it, or any like supply that is suitable for the service, will be procured elsewhere, and the survey fees and extra expense (if any) will be charged as provided in clause 8.

13. A refusal to execute orders, irregularity in the quantity or quality of the supplies, delay in delivering or replacing them when required, or non-compliance with the terms of clauses 15 and 16 of these Conditions respecting the forwarding of consignment notes, &c., will subject the contractor, upon report from the Tender Board, to such mulct not exceeding Fifty pounds as the Treasurer may direct, and the amount may be deducted as provided in clause 8. It will also be in the power of the said Treasurer upon such refusal, irregularity, or delay to terminate the contract forthwith and declare forfeit the whole or any portion of the security money; and, in addition, the contractor will be disqualified from tendering or holding any future contract or contracts for a period of twelve months from the date of such disqualification.

14. All goods forwarded under this contract shall, where railway facilities are available, be forwarded by rail, and all consignments shall bear the number of the consignment notes under which they are forwarded, and also the name of the contractor by whom consigned, on a legibly-written business label.

15. When the contractor is required to make delivery of goods at a railway station for transmission by rail for any Department excepting Departments of the Commonwealth, he shall obtain a receipt for the goods in duplicate on the Stores and Transport consignment note, at the same time handing in a triplicate and quadruplicate of the form as an authority for the Railways to act as agent for, and charge the freight to, *the Stores and Transport Office or such other Department as shall be named therein.* He shall as soon as possible, and not later than twenty-four hours thereafter, deliver the original at the Tender Board Offices, the duplicate to be forwarded to the consignee in accordance with clause 16, and the quintuplicate to be retained by himself. (In the case of Commonwealth Departments, however, the Commonwealth consignment note only, which accompanies the order, must be used.) Should the goods thus forwarded be rejected, the contractor must bear the cost of replacing such goods, for which service the departmental consignment note must not be used. Any infringement of this condition will subject the contractor to such mulct as is provided in clause 13.

16. *Immediately after the consignment of the goods, the officer to whom they are forwarded shall be notified by the contractor, on the duplicate consignment note provided for the purpose, that the goods have been sent. On receipt of this document, the officer to whom it has been forwarded shall acknowledge thereon the receipt of the goods without delay to the Stores and Transport Office. In the event of loss through failure on the part of the contractor to comply with this condition he will be held responsible, and the amount of the loss incurred thereby will be deducted as provided in clause 8.*

17. Should the order on the contractor specially provide that goods of a fragile character, or such as are liable to suffer loss by leakage, shall be consigned at the risk of the Railways Commissioners under special freight conditions, the contractor shall in such instance provide, in writing on the consignment note, an intimation to that effect failing which, in the event of loss, he shall bear the whole cost of replacing the goods, the amount thereof to be deducted from the contractor's account or from the security money.

18. The contractor is not at liberty to transfer his contract under cover of power of attorney, coupled with an interest or otherwise, and no such transfer will be recognized by the Government. Should it be found during the currency of the contract that the contractor has not conformed to the condition of advertisement—which stipulates that if a tenderer be a member of a firm and such firm be interested in the contract, the tender shall be in the name of the firm, and not in that of the individual—then the Treasurer may, on the recommendation of the Tender Board, determine the contract and forfeit the security money.

19. The contract entered into under these conditions is not to be considered as being broken, infringed, or vitiated by the importation of stores for the Government service, or by any contracts or purchases made by the Agent-General for Victoria, or by any contracts or agreements made for any works or supplies by the Department of Public Works through the Board of Land and Works, or by the State Rivers and Water Supply, Forests, and Electricity Commissioners, or the Country Roads Board, or for the Railways Department, or for supplies for Technical, High, or Higher Elementary Schools, or for

connexions and fittings for Drills and Batteries, or by any article being made at and supplied for the use of any Government establishment, or by the consumption of the surplus stock of any Government establishment.

20. Notwithstanding anything to the contrary contained in section 152 of the *Customs Act* 1901-36, it is hereby expressly provided that upon any alteration of the duty collected affecting the goods included in this contract, the contract price shall not be altered, and the contract may be terminated at the option of either party by two months' notice, in writing, from the first day of the calendar month next ensuing and within the period for which the contract is made. The contract for the unaffected items shall remain in full force and effect. Any notice to be served under this condition shall be deemed to have been duly served if sent to the contractor in a registered letter to his last-known place of business or abode.

The foregoing provision shall not apply where the contract is for definite quantities of imported goods to be delivered at stated times, as stipulated in the schedule, and any alteration in the duty of Customs or Telegraphic Transfer rate of exchange affecting the goods included in such contract shall be to the accounts of the Government; adjustments to be based on the F.O.B. and C.I.F. prices of the goods, respectively, and the Telegraphic Transfer rate ruling at the time of delivery of the goods.

21. Under no circumstances, other than those mentioned in clause 20, will the contractor be permitted to abandon his contract. In the event of the contractor failing to carry on the contract, the contract security money will in that case be absolutely forfeited and, in addition, the contractor will be held liable for any loss which the Government may sustain in consequence of such failure.

H. E. BOLTE,
Treasurer.

The Treasury,
Melbourne, 28th March, 1960.

PUBLIC SERVICE NOTICES

PUBLIC SERVICE OF VICTORIA—VACANCIES.

APPLICATIONS will be received by the Public Service Board up to Wednesday, 13th April, 1960, from persons employed in the Public Service of Victoria, who are eligible and qualified, for appointment to the under-mentioned positions:—

ADMINISTRATIVE DIVISION.

Class "B", Premier's Office, Department of Premier.

Yearly Salary.—£1,390, minimum; £1,500, maximum.

Duties.—To act as Secretary to the Parliamentary Public Works Committee.

Qualifications.—Experience in secretarial work and in carrying out public investigations and drafting official reports; a knowledge of the Public Works Committee Acts and of the functions of Public Departments; ability to draft regulations and analyse evidence.

Class "B", Division of State Development, Department of Premier.

Yearly Salary.—£1,390, minimum; £1,500, maximum.

Duties.—To act as Senior Research Officer; under the direction of the Officer in charge of the Division, to be responsible for the planning, supervision and co-ordination of the work of the Research Staff; to supervise the collation and preparation of statistical information for the compilation of regional resources surveys and for allied purposes; to carry out specialized research duties in connection with industrial development.

Qualifications.—A degree in Commerce or Economics and experience in the collation and interpretation of statistics and in the conduct of resources surveys are desirable.

Class "B", Department of Public Works.

Yearly Salary.—£1,390, minimum; £1,500, maximum.

Duties.—To be Staff and Industrial Officer of the Department.

Qualifications.—A good knowledge of the Public Service Acts and Regulations, to be familiar with the law and practice relating to Federal Awards and State Determinations; and to be conversant with engineering and architectural constructional works and marine work carried out by the Department.

Assistant Public Service Inspector (Organization and Methods), Class "C2", Office of the Public Service Board, Department of the Premier.

Yearly Salary.—£1,170, minimum; £1,280, maximum.

Duties.—In accordance with Section 44 (2) of the *Public Service Act* 1958, to undertake, under direction, investigations in relation to the promotion of efficiency in the working of, and the oversight of the methods of conducting business in departments.

Qualifications.—Ability to conduct investigations into, and report on, procedures and work methods in the Public Service. A Diploma in Public Administration or other appropriate qualification or qualification as an accountant will be an advantage.

Class "C2", Department of Local Government.

Yearly Salary.—£1,170, minimum; £1,280, maximum.

Duties.—To be secretary to the Building Regulations Committee and perform other duties as required.

Qualifications.—A knowledge of Parts VIII and XLIX, and of the 33rd Schedule of the Local Government Acts and the Uniform Building Regulations; ability to draft regulations and perform secretarial duties.

Class "C1", State Accident Insurance Office, Department of Chief Secretary.

Yearly Salary.—£960, minimum; £1,060, maximum.

Duties.—To prepare statistical accounting and other data for the State Accident and Motor Car Insurance Offices and to relieve the Officer in Charge of the Punched Card Section as required.

Qualifications.—A specialized knowledge of the Powers Punched Card accounting system preferably with experience of office procedure of the Motor Car and Accident Offices and in the preparation of insurance statistics; to be a qualified Accountant, or to have made substantial progress towards such qualification.

Class "C1" (Numurkah), Department of Water Supply.

Yearly Salary.—£960, minimum; £1,060, maximum.

Duties.—To assist the Works Accountant in all matters associated with Accounting procedure and practice and to relieve the Works Accountant in his absence.

Qualifications.—To have completed Stage 1 of the examination for admission to the Australian Society of Accountants or its equivalent. A good knowledge of the Public Accounts and Stores Regulations 1958. Ability to assume responsibilities and control staff.

NOTE.—A residence is available for the successful applicant, if married, for which rental of 10 per cent. of standard salary, plus £16 a year, will be charged. Particulars available from the Department of Water Supply.

Class "C", Audit Office, Department of Premier.

Yearly Salary.—£710, minimum; £860, maximum.

Duties.—To assist in the audit and examination of accounts.

Qualifications.—A knowledge of the Audit Act and the Regulations thereunder, and to have entered on a course in accountancy.

Class "C", Motor Registration Branch, Office of the Chief Commissioner of Police, Department of Chief Secretary.

Yearly Salary.—£710, minimum; £860, maximum.

Duties.—To have charge of the Drivers' Counter.

Qualifications.—Ability to control staff and to deal with the public. A knowledge of the provisions of the Motor Car Acts and Regulations relating to drivers' licences is desirable.

Class "C", State Accident Insurance Office, Department of Chief Secretary.

Yearly Salary.—£710, minimum; £860, maximum.

Duties.—To be responsible for the collection of outstanding debts, to control and record dishonored cheques, references to Crown Solicitor of files of debtors, and preparation of affidavits and proofs of debt.

Qualifications.—Knowledge of office systems of premium calculations and records, ability to conduct credit collection correspondence and to deal with the public.

Class "C", State Motor Car Insurance Office, Department of Chief Secretary.

Yearly Salary.—£710, minimum; £860, maximum.

Duties.—To supervise the work of the Third Party Section of the Policy Department; to certify as to the existence and coverage of policies prior to the admission of claims.

Qualifications.—A good knowledge of Comprehensive and Statutory Motor Vehicle Insurance and of the Motor Car Act; practical experience in the insurance of motor vehicles is desirable.

PROFESSIONAL DIVISION.

Agricultural Research Officer, Classes "C-C2", Department of Agriculture.

Yearly Salary.—£960, minimum; £1,280, maximum. (Commencing salary according to experience.)

Duties.—To assist in the production of technical articles, bulletins, pamphlets and radio scripts and other activities as directed.

Qualifications.—A degree in Agricultural Science.

Assistant Lecturer in Animal Husbandry, Classes "C-C2", Dookie Agricultural College, Department of Agriculture.

Yearly Salary.—£960, minimum; £1,280, maximum. (Commencing salary according to experience.)

Duties.—To assist the Lecturer in Animal Husbandry and to lecture and demonstrate in various aspects of Animal Husbandry and related sciences, to share house duties and to perform other duties as required.

Qualifications.—A University degree in Agricultural Science or its equivalent and some experience in practical Animal Husbandry, particularly Sheep Husbandry.

NOTE.—Opportunities for further training will be given to the successful applicant. A residence is available for the successful applicant, if married, for which rental of 10 per cent. of standard salary, plus £16 a year, will be charged. Particulars available from the Department of Agriculture.

Assistant Plant Pathologist, Classes "C-C2", Department of Agriculture.

Yearly Salary.—£960, minimum; £1,280, maximum—Agricultural Scientist Graduate. £860, minimum; £1,280, maximum—Science Graduate. (Commencing salary according to experience.)

Duties.—To assist in the programme of research work in plant nutrition being conducted at the Plant Research Laboratory, Burnley.

Qualifications.—A degree of Bachelor of Agricultural Science or Science with Botany as a major subject and the necessary interest, capacity and research ability for this work.

Assistant Live Stock Research Officer, Classes "C-C2", Department of Agriculture.

Yearly Salary.—£960, minimum; £1,280, maximum. (Commencing salary according to experience.)

Duties.—Under direction, to undertake research projects in the Animal Husbandry Research Branch, Live Stock Division.

Qualifications.—A degree in Agricultural Science of an Australian University, or equivalent qualification; experience with livestock desirable.

TECHNICAL AND GENERAL DIVISION.

Orchard Supervisor, Grade II, Department of Agriculture. (Four vacancies.)

Yearly Salary.—£718, minimum; £846, maximum.

Duties.—To inspect pursuant to the *Vegetation and Vine Diseases and Fruit and Vegetables Act 1958* orchards, nurseries, markets, &c., and to advise growers on all phases of orchard work.

Qualifications.—To have passed the Orchard Supervisors examination; to have a good practical knowledge of fruit growing and to have had experience in orchard supervision work.

Laboratory Assistant (Female), Grade I, Department of Agriculture. (Two vacancies.)

Yearly Salary.—Junior—Under 16 years of age, £130; at 16 years of age, £169; at 17 years of age, £182; at 18 years of age, £208; at 19 years of age, £247; at 20 years of age, £286. Adult—£364, minimum; £428, maximum.

Duties.—To assist in laboratory work relating to research projects at the Animal Husbandry Research Centre, Werribee.

Qualifications.—Leaving Certificate, or equivalent; laboratory experience desirable.

Blacksmith's Striker, Ports and Harbours Branch, Department of Public Works.

Yearly Salary.—£350, minimum; £414, maximum.

Duties.—To assist with forging and welding operations in the blacksmith's shop at the Williamstown Dredging Depot.

Qualifications.—To have had experience in a blacksmith's shop as a striker and to understand the principles and operations of oxy-acetylene and electric welding as applied to marine and general repairs.

NOTE.—The salary rates quoted above do not include the additional amounts which are payable under Regulation 77A of the Board's Regulations.

By order,
V. P. SCULLY,
Secretary.

Office of the Public Service Board,
Melbourne, 29th March, 1960.

PUBLIC SERVICE OF VICTORIA.—VACANCIES.

DEPARTMENT OF HEALTH.

MENTAL HYGIENE BRANCH.

TECHNICAL AND GENERAL DIVISION.

APPLICATIONS will be received by the Public Service Board up to Wednesday, 20th April, 1960, from persons employed in the Public Service of Victoria, who are eligible and qualified, for appointment to the under-mentioned positions:—

Charge Nurse (Male), Beechworth Mental Hospital.

Yearly Salary.—£606, minimum; £654, maximum.

Duties.—To take charge or sub-charge of a ward in a Mental Hospital.

Qualifications.—To possess the Mental Hygiene Nursing Certificate and to have had experience as a Deputy Charge Nurse in a Mental Hospital; to possess a current Practising Certificate as issued by the Victorian Nursing Council.

Deputy Charge Nurse (Male), Sandhurst Boys' Centre, Bendigo.

Yearly Salary.—£542, minimum; £574, maximum.

Duties.—To be second in charge of a ward and to relieve the charge nurse.

Qualifications.—To possess the Mental Hygiene Nursing Certificate with a current practising certificate as issued by the Victorian Nursing Council and to have had experience in a Mental Hospital.

Electrical Mechanic, Mont Park Mental Hospital.

Yearly Salary.—£510, minimum; £558, maximum.

Duties.—Under the direction of the Engineer to maintain wiring and electrical equipment, to undertake minor electrical installations, and to assist the Engineer generally.

Qualifications.—To hold "A" grade wiring licence.

Fireman, Larundel Mental Hospital. (Two vacancies.)

Yearly Salary.—£430, minimum; £462, maximum.

Duties.—To fire boilers and to assist Engineer Mechanic.

Qualifications.—Boiler Attendant's Certificate or higher qualifications.

NOTE.—The salary rates quoted above do not include the additional amounts which are payable under Regulation 77A of the Board's Regulations.

By order,
V. P. SCULLY,
Secretary.

Office of the Public Service Board,
Melbourne, 29th March, 1960.

PUBLIC SERVICE OF VICTORIA.—VACANCIES.

(TEMPORARY APPOINTMENTS.)

APPLICATIONS will be received by the Public Service Board up to Wednesday, the 13th April, 1960, from persons, who are qualified, for appointment to the under-mentioned positions:—

Inspector of Works, Department of Public Works.

Yearly Salary.—£846, minimum; £942, maximum.

ARCHITECTURAL BRANCH.

(Six vacancies.)

Duties.—General inspections of public buildings and supervision of works carried out by the Department of Public Works and the preparation of reports in connexion therewith.

Qualifications.—To possess ability to make reports, prepare estimates and costs of works, make sketch plans and prepare specifications for minor works; to have a comprehensive knowledge of the building trades and suitable technical qualifications. The possession of a current motor car driver's licence is essential.

NOTE.—The successful applicants must be prepared to be stationed in any one of the Inspectorial centres throughout the State of Victoria, as may be necessary from time to time.

MECHANICAL AND ELECTRICAL ENGINEERING BRANCH.

(Two vacancies.)

POSITION No. 1.

Duties.—To supervise and inspect mechanical plant and installations carried out under contract in all types of public buildings; to prepare reports and estimates, with sketch plans where required, in connexion with repairs and maintenance of such equipment.

Qualifications.—To possess a good practical trade experience in mechanical engineering and pipe fittings, particularly in relation to heating, hot-water supply, mechanical ventilation, refrigeration, steam plant and welding; to have had suitable training in subjects relative to above. The possession of a current motor car driver's licence is essential.

POSITION No. 2.

Duties.—To carry out inspections of electric light and power installations, telephones, fire alarms, and clock systems and associated maintenance work in all types of public buildings; to prepare reports and estimates of such works, also specifications for minor works.

Qualifications.—To possess an "A" Grade electric wireman's licence issued by the State Electricity Commission of Victoria and to have a good general training and experience in electric light and power installations, including telephones, fire alarms, and clock systems. The possession of a current motor car driver's licence is essential.

The salary rates quoted above do not include the additional amount which is payable under Regulation 77A of the Board's Regulations.

By order,

V. P. SCULLY,
Secretary.

Office of the Public Service Board,
Melbourne, 29th March, 1960.

PUBLIC SERVICE OF VICTORIA.—QUALIFYING TEST—TYPISTS (FEMALE).

THE under-mentioned candidates passed in the order of merit indicated, the typing test at 42 words a minute held on 5th March, 1960:—

Order of Merit.

Order of Merit.	Candidate.
1	Olsen, Maureen (Mrs.).
2	Whyte, Joan Margaret.
3	Kovacic, Sara (Mrs.).
4	Dowlan, Carol Mabel.
5	Williams, Helen Gwendoline.
6	Collins, Lorraine Rose (Mrs.).
7	O'Brien, Doreen Ursula.
8	Lubeck, Beryl.
9	Noonan, Gwendoline Irene.
10	Parker, Valda May.
11	Carr, Ivy Myrtle (Mrs.).
12	Barrett, Sandra Margaret.
13	Hewlings, Dorothy Maude.
14	Huber, Eve (Mrs.).
15	Taylor, Mary Monica.
16	Pye, Dorothy.
17	Jensen, Betty Lynette.
18	Gunn, Irene Lorraine.
19	Paterson, Dorothy May (Mrs.).
20	Budd, Dilys Maureen (Mrs.).
21	Clark, Mabel Mary.
22	Mackay, Winifred Florence (Mrs.).
23	Wake, Meryl Amelia (Mrs.).
24	Armstrong, Thelma Hutton.
25	Langley, Anne Louise.
26	Dunstone, Gwentyth Freda.
27	McLaren, Judith Ann.
28	Binns, Betty Margaret.
29	Polglaze, Betty Lillian (Mrs.).
30	Stevenson, Lynette Violet Jean.
31	Finney, Lois Dorothea.
32	Hill, Joan (Mrs.).
33	Clegg, Margaret Simpson.

By order,

V. P. SCULLY,
Secretary.

Office of the Public Service Board,
Melbourne, 28th March, 1960.

PUBLIC SERVICE ACT 1958, SECTION 55.

JAMES MAURICE MCGUINNESS, Class "E", Administrative Division, Office of Titles, Department of Law, having been charged under the provisions of section 55 of the *Public Service Act 1958*, with a breach of the Public Service (Governor in Council) Regulations in that, between the 7th day of January, 1960, and the 26th day of February, 1960, he was absent from duty without leave, and such charge having been referred by direction of the Honorable the Attorney-General to the Public Service Board, the Board, after inquiry, finds such charge proved, and under the provisions of the section of the Act above cited, hereby dismisses the said JAMES MAURICE MCGUINNESS from the Public Service.

A. GARRAN, Chairman.
V. P. SCULLY, Secretary.

Office of the Public Service Board,
Melbourne, 23rd March, 1960.

No. 1012.

Public Service Act 1958, Section 50.

REGULATIONS—PART III.—SALARIES, INCREMENTS, AND ALLOWANCES.

THE Public Service Board, in pursuance of the powers conferred by the *Public Service Act 1958*, hereby amends its Regulations as shown below:—

FIFTH SCHEDULE.

TEMPORARY EMPLOYEES.

DEPARTMENT OF HEALTH.

MENTAL HYGIENE.

Designation of Positions and Rates of Salaries.

Designation of Position.	Yearly Rate of Salary.		Increments (Annual).
	Minimum.	Maximum.	
	£	£	
Delete— Seamstress	364	..
Add— Seamstress— Junior—			
At 17 years of age	156	..
At 18 years of age	182	..
At 19 years of age	221	..
At 20 years of age	260	..
Adult	364	..

This Regulation shall have effect as on and from the 21st February, 1960.

A. GARRAN, Chairman.
V. P. SCULLY, Secretary.

Office of the Public Service Board,
Melbourne, 15th March, 1960.

No. 1011.

Public Service Act 1958, Section 39.

REGULATIONS.—PART III.—SALARIES, INCREMENTS, AND ALLOWANCES.

THE Public Service Board, in pursuance of the powers conferred by the *Public Service Act 1958*, hereby amends its Regulations as shown below.

FIRST SCHEDULE.

PROFESSIONAL DIVISION.

Amount of Salary Assigned to Offices in Class "A1".

Office.	Yearly Rate of Salary.
	£
DEPARTMENT OF PREMIER.	
Delete— Director of National Parks, National Parks Authority	2,300
Director of Tourist Development	2,300
Add— Director of National Parks, National Parks Authority	2,425
Director of Tourist Development	2,425

A. GARRAN, Chairman.
V. P. SCULLY, Secretary.

Office of the Public Service Board,
Melbourne, 21st March, 1960.

PUBLIC SERVICE (PUBLIC SERVICE BOARD) REGULATION 39.—RECLASSIFICATIONS.

THE Public Service Board has raised the classification of the under-mentioned offices as shown, and the Permanent Heads of the Departments have recommended the officers named for appointment.

Office and Present Classification.	Revised Classification.	Duties.	Qualifications.	Officer Recommended for Appointment.		
				Name.	Classification.	Date of Classification.

ADMINISTRATIVE DIVISION.

DEPARTMENT OF CHIEF SECRETARY.

Office of the Chief Commissioner of Police.

Class "E"	Class "C"	To be Secretary to the Committee of Management of the Police College; to order supplies and deal with correspondence, accounts and records relating to the domestic management of the College	Experience in the conduct of correspondence and in the preparation of agenda and financial statements. A knowledge of the organization of the Police Department is desirable	Batt, W. K. C.	Class "E"	24.10.56
-----------	-----------	-----------------------------------------------------------------------------------------------------------------------------------------------------------------------------------------------	------------------------------------------------------------------------------------------------------------------------------------------------------------------------------	----------------	-----------	----------

PROFESSIONAL DIVISION.

DEPARTMENT OF HEALTH.

General Health Branch.

Chemist, Class "C2"	Class "B"	To undertake advanced analyses of foods, &c.; to investigate methods of analysis; to give expert evidence in court and to carry out other chemical work as directed	To be a qualified chemist and an approved analyst under the Health Act with considerable experience in the analysis of foods, waters, effluents, &c.	McBrien, E. J.	Chemist, Class "C2"	4.12.55
---------------------	-----------	---------------------------------------------------------------------------------------------------------------------------------------------------------------------	------------------------------------------------------------------------------------------------------------------------------------------------------	----------------	---------------------	---------

DEPARTMENT OF AGRICULTURE.

Burnley Horticultural College.

Agricultural Science Instructor, Class "B"	Vice-Principal, Burnley Horticultural College, Class "B1"	To assist the Principal generally in the administration of the College and to take charge during the absence of the Principal; to teach one or more subjects of the College curriculum and to examine students therein; to perform other duties as directed	To possess a University degree in Agricultural Science, Science or Arts; sound experience in teaching on the staff of a Horticultural or Agricultural College	Littlejohn, E. B.	Agricultural Science Instructor, Class "B"	6.5.56
--------------------------------------------	-----------------------------------------------------------	-------------------------------------------------------------------------------------------------------------------------------------------------------------------------------------------------------------------------------------------------------------	---------------------------------------------------------------------------------------------------------------------------------------------------------------	-------------------	--------------------------------------------	--------

TECHNICAL AND GENERAL DIVISION.

DEPARTMENT OF AGRICULTURE.

Assistant (Male), Grade II, Grades 18-21 inclusive (two offices)	Grade I., Grades 23-25 inclusive (two offices)	Under the Vegetation and Vine Diseases Act to charge inspection fees, &c., on interstate fruit and vegetable imports, and to keep ledger accounts and records relating to such imports and charges	A good knowledge of the Vegetation and Vine Diseases Act and the regulations thereunder, in so far as they relate to the payment of charges; experience in the keeping of ledger accounts and records, and the preparation of returns	Caruana, E. T.	Assistant (Male), Grade II.	29.1.53
		Under the Vegetation and Vine Diseases Act to collect from markets, railways, airways, shipping offices, &c., data on interstate imports of fruit, vegetables, &c.	A good knowledge of the Vegetation and Vine Diseases Act and the regulations thereunder in so far as they relate to the payment of charges; experience in the collection and recording of statistics	Ringrose, A. J.	Assistant (Male), Grade II.	5.11.45

DEPARTMENT OF WATER SUPPLY.

Survey Assistant, Grade II, Grades 22-26 inclusive (five offices)	Grade I., Grades 32-34 inclusive (five offices)	Under the supervision of a licensed surveyor or engineer to carry out engineering and other surveys	At least four years' experience as a Survey Assistant, or equivalent qualification; to be capable of taking charge of a survey party not subject to daily supervision	Craig, N. T.	Survey Assistants, Grade II.	1.7.57 1.7.57 28.11.57 22.1.59
				Mitchell, R. C.		
				Lewkowitzsch, G.		
				Ralph, E. G.		
				Turnbull, G. B.		

Appeals against such recommendations should be lodged with the Secretary to the Public Service Board not later than Saturday, the 9th April, 1960.

By order,

Office of the Public Service Board,
Melbourne, 29th March, 1960.

V. P. SCULLY,
Secretary.

PUBLIC SERVICE (PUBLIC SERVICE BOARD) REGULATION 39.—VACANCY.

THE Permanent Head of the Department shown has recommended the officer named hereunder for appointment to the under-mentioned vacancy.

Office and Classification.	Duties.	Qualifications.	Officer Recommended for Appointment.		
			Name.	Classification.	Date of Classification.
PROFESSIONAL DIVISION.					
DEPARTMENT OF LAW.					
<i>Office of Titles, Survey Branch.</i>					
Section Leader Draughtsman, Class "B"	To control the work of his section and the training of his staff; to carry out the final examination of Certificates of Title, Plans of subdivision and other surveys as required	A sound knowledge of the practical application of survey with extensive experience in Transfer dealings and other office procedure under the Transfer of Land and cognate Acts	Leach, J. D. . .	Senior Draughtsman Class "C2"	5.11.56

Appeals against such recommendation should be lodged with the Secretary to the Public Service Board not later than Saturday, the 9th April, 1960.

Office of the Public Service Board,
Melbourne, 29th March, 1960.

By Order,
V. P. SCULLY,
Secretary.

PRIVATE ADVERTISEMENTS

CITY OF COBURG.

PRIVATE STREETS LOAN No. 13.

NOTICE is hereby given that at a meeting of the Council of the City of Coburg held on Monday, 15th February, 1960, the Council did pass a Special Order for the borrowing of Thirty thousand pounds (£30,000), on the credit of the Mayor, Councillors and Citizens of the City of Coburg, such sum to be raised by the grant of a mortgage, in accordance with the provisions of the *Local Government Act 1958*.

- The rate of interest to be paid is Five pounds ten shillings (£5 10s.) per centum per annum.
- The moneys borrowed shall be repayable by 30 equal half-yearly instalments of One thousand four hundred and eighty-one pounds ten shillings and eight pence (£1,481 10s. 8d.), including principal and interest, by providing out of the receipts of moneys payable under schemes of private street construction and advances from the Municipal Fund should such receipts be insufficient, the required amounts on the 1st day of May and the 1st day of November during the currency of the loan. The first instalment shall be payable on the 1st day of November, 1960.
- The period of the loan shall be fifteen years.
- Such moneys shall be repayable at the Commonwealth Savings Bank of Australia, Melbourne.
- The purpose for which the loan is to be applied is the defraying of the cost of the execution of schemes of private street construction.

And notice is hereby further given that, the Council at its meeting held on Monday, 21st March, 1960, did confirm such Special Order.

9216

G. A. BRIDGES, Town Clerk.

CITY OF COLLINGWOOD.

LOAN No. 15.

Notice of Intention to Borrow the Sum of £20,000 for Permanent Works and Undertakings.

NOTICE is hereby given that the Council of the City of Collingwood proposes to borrow the sum of Twenty thousand pounds on the credit of the municipal revenues of the Mayor, Councillors and Citizens of the said City, such sum to be raised by the grant of a mortgage, in accordance with the provisions of the *Local Government Act 1958*, and notice is hereby further given:—

- The maximum rate of interest that may be paid is 5½ per cent. per annum.
- The purposes for which the loan is to be applied are:—

Street construction	£17,300
Parking meters	1,500
Construction of drains	750
Traffic signals	450
			£20,000

- The period of the loan shall be fifteen years.
- The money borrowed shall be repayable by providing out of the Municipal Fund 30 half-yearly instalments of £987 13s. 10d. each, including principal and interest, on the 15th day of June and the 15th day of December during the currency of the loan. The first instalment shall be payable on the 15th day of December, 1960.
- Such moneys shall be repayable at the Commonwealth Trading Bank, Melbourne, or at the Council's bankers for the time being in Melbourne.

The plans and specifications and the estimate of costs of the proposed works, and a statement showing the proposed expenditure of the moneys to be borrowed, are open for inspection at the office of the City Engineer, Town Hall, Collingwood, during office hours.

G. J. BROWN, Town Clerk.

Town Hall, Collingwood.

9224

Local Government Act 1958.

CITY OF DANDENONG.

NOTICE OF INTENTION TO TAKE LAND COMPULSORILY.

NOTICE is hereby given that it is the intention of the Council of the City of Dandenong, in exercising the powers conferred on it by the *Local Government Act 1958*, to take compulsorily the following land:—

All that piece of land being part of lot 13 shown on plan of subdivision No. 4924 lodged in the Office of Titles, part Crown allotment 5, section 3, Town and Parish of Dandenong, County of Bourke, and being more particularly described as all that piece of land commencing at the south-eastern corner of the said lot 13; thence by a line bearing 281 deg. 2 min. for a distance of 20 feet; thence by a line bearing 43 deg. 44 min. 30 sec. for a distance of 21 ft. 7½ in.; thence by a line bearing 166 deg. 27 min. to the point of commencement.

The said land is required for and being taken for the purpose of executing the following work or undertaking by the said Council:—The provision of land for widening the roadway at the north-western corner of Foster-street and Thomas-street by the said Council within its municipal district.

The Council has caused to be prepared a specification, map and plan showing the nature and extent of such work or undertaking and more particularly describing the said land and the exact site and admeasurements thereof and stating that the name of the owner of the said land is Lily May Schoon.

The said specification, map and plan have been approved by the Council and are now deposited for inspection by all persons interested at the offices of the City of Dandenong, situate at the Town Hall, Lonsdale-street, Dandenong, and may be inspected there during office hours.

All persons affected by the proposed work and undertaking are hereby required to set forth, in writing, addressed to the said Council or to the Municipal Clerk thereof, within 40 clear days from the publication of this notice in the *Government Gazette*, all objections which they may have to such work or undertaking.

Dated the 29th day of March, 1960.

By order of the Council,

9230 R. BOOTH, Town Clerk and Municipal Clerk.

CITY OF HAMILTON.

LOAN No. 32.

Notice of Intention to Borrow the Sum of £20,000 for Permanent Works and Undertakings.

NOTICE is hereby given that the Council of the City of Hamilton, proposes to borrow the sum of Twenty thousand pounds on the credit of the municipal revenues of the Mayor, Councillors and Citizens of the said City, such sum to be raised by the grant of a mortgage, in accordance with the provisions of the *Local Government Act 1958*.

1. The maximum rate of interest that may be paid is Five pounds ten shillings per centum per annum.

2. The purpose for which the loan is to be applied is—
Part cost of erection of composite Art Gallery/Library Building.

3. The period of the loan shall be 25 years.

4. The moneys borrowed shall be repayable by providing out of the Municipal Fund 50 half-yearly instalments of £740 16s. 4d. each, including principal and interest, on the 1st day of August and the 1st day of February during the currency of the loan. The first instalment shall be payable on the 1st day of February, 1961.

5. Such moneys shall be repayable at The Commercial Bank of Australia Ltd., 337 Collins-street, Melbourne, or at such other place or places in Melbourne as the lender may from time to time require.

The plans and specifications and the estimate of the cost of the proposed works and a statement showing the proposed expenditure of the moneys to be borrowed, are open for inspection at the Town Hall, Hamilton.

Dated the 16th day of March, 1960.

9220 H. F. DONALD, Town Clerk.

CITY OF MOORABBIN.

ORDER CHANGING NAME OF STREET.

NOTICE is hereby given that at a meeting of the Council of the City of Moorabbin held on the 21st March, 1960, the said Council, in pursuance of the powers conferred by the *Local Government Act 1958*, did make an Order changing the name of the following street:—

Old Name.—Isabella-street (north-south arm only).

New Name.—Wendy-street.

Location.—Between Isabella-street (off Chapel-road, Moorabbin) and Rodney-street.

By order,

9225 V. A. SMITH, Town Clerk.

Town & Country Planning Acts.

CITY OF MOORABBIN.

NOTICE THAT A PLANNING SCHEME TO AMEND THE CITY OF MOORABBIN PLANNING SCHEME, SECTION 1, HAS BEEN PREPARED AND IS AVAILABLE FOR INSPECTION.

The City of Moorabbin Planning Scheme, Section 1.—Amendment No. 6, 1960.

NOTICE is hereby given that the Council of the City of Moorabbin, in pursuance of its powers under the Town and Country Planning Acts, has prepared a Planning Scheme for that portion of the City of Moorabbin as defined on the maps comprising the First Schedule to the City of Moorabbin Planning Scheme, Section 1, for the purpose of zoning and regulating buildings and other works.

All maps, plans, descriptions and other data fully setting out and explaining the Planning Scheme have been deposited at the Municipal Offices, Nepean Highway,

Moorabbin, and at the office of the Town and Country Planning Board, Melbourne, and will be open for inspection without payment of any fee, by all persons affected, between the hours of 9 a.m. and 5 p.m. on all days of the week except Saturdays, Sundays and public holidays until and including the 30th day of June, 1960.

Any persons affected by the Planning Scheme are required to set forth, in writing, all objections they may have, addressed to the Town Clerk, Moorabbin City Council, P.O. Box No. 21, Moorabbin, S.20, on or before the 30th day of June, 1960.

Dated this 28th day of March, 1960.

9281

V. A. SMITH, Town Clerk.

Town & Country Planning Acts.

CITY OF MOORABBIN.

NOTICE THAT A PLANNING SCHEME TO AMEND THE CITY OF MOORABBIN PLANNING SCHEME 1952 HAS BEEN PREPARED AND IS AVAILABLE FOR INSPECTION.

The City of Moorabbin Planning Scheme 1952.—Amendment No. 10, 1960.

NOTICE is hereby given that the Council of the City of Moorabbin, in pursuance of its powers under the Town and Country Planning Acts, has prepared a Planning Scheme for that portion of the City of Moorabbin as defined by the grey border on the map comprising the First Schedule to the City of Moorabbin Planning Scheme 1952 for the purpose of zoning and regulating buildings and other works.

All maps, plans, descriptions and other data fully setting out and explaining the Planning Scheme have been deposited at the Municipal Offices, Nepean Highway, Moorabbin, and at the office of the Town and Country Planning Board, Melbourne, and will be open for inspection without payment of any fee, by all persons affected, between the hours of 9 a.m. and 5 p.m. on all days of the week except Saturdays, Sundays and public holidays until and including the 30th day of June, 1960.

Any persons affected by the Planning Scheme are required to set forth, in writing, all objections they may have, addressed to the Town Clerk, Moorabbin City Council, P.O. Box No. 21, Moorabbin, S.20, on or before the 30th day of June, 1960.

Dated this 28th day of March, 1960.

9282

V. A. SMITH, Town Clerk.

CITY OF NUNAWADING.

BY-LAW No. 43.

A By-law of the City of Nunawading made under the Local Government Acts and numbered 43, for amending By-law No. 41, of the City of Nunawading.

IN pursuance of the powers conferred by the Local Government Acts and of any and every other power thereunto enabling the Mayor, Councillors and Citizens of the City of Nunawading orders as follows:—

Clause 4 of the said By-law number 41, shall be amended by substituting for the expression "Clause 1 or Clause 2" the expression "Clause 2 or Clause 3".

Resolution for the passing of this By-law was agreed to by the Council of the City of Nunawading on the 22nd February, 1960, and confirmed on the 21st March, 1960.

The corporate seal of the Mayor, Councillors and Citizens of the City of Nunawading was hereunto affixed, in the presence of—

C. S. ROSS, Mayor.

(SEAL) F. A. NETTLE, Councillor.

9211

A. ROY CHARLESWORTH, Town Clerk.

SHIRE OF ELTHAM.

LOAN No. 35.

Notice of Intention to Borrow the Sum of £30,500 for Permanent Works and Undertakings.

NOTICE is hereby given that the Council of the Shire of Eltham proposes to borrow the sum of £30,500 on the credit of the municipal revenues of the President, Councillors and Ratepayers of the said Shire, such sum to be raised by the grant of a mortgage, in accordance with the provisions of the Local Government Acts.

1. The maximum rate of interest that may be paid is £5 10s. per cent. per annum.
2. The purpose for which the loan is to be applied is the construction of underground drains.
3. The period of the loan shall be twenty years.
4. The moneys borrowed shall be repayable by providing out of the municipal fund forty half-yearly instalments of approximately £1,266 14s. each, including principal and interest, on the first day of December and the first day of June in each year. The first instalment shall be payable on the first day of December, 1960.

5. Such moneys shall be repayable at the Commercial Bank of Australasia Limited, Melbourne, or at the Council's bankers for the time being in Melbourne.

The plans and specifications and the estimate of the cost of the proposed works, and a statement showing the proposed expenditure of the moneys to be borrowed, are open for inspection at the Shire Offices, Eltham.

M. B. WATSON, Shire Secretary.

30th March, 1960.

9284

Local Government Act 1958.

SHIRE OF LEIGH.

NOTICE OF INTENTION TO TAKE LAND COMPULSORILY.

NOTICE is given that it is the intention of the Council of the Shire of Leigh, in exercise of the powers conferred on it by the *Local Government Act 1958*, to take compulsorily the following land:—

"The piece of land containing one rood 28 perches, or thereabouts, being Crown allotment 4 of section 9, Township of Rokewood, Parish of Corindhap, County of Grenville, volume 278, folio 55591."

The said land is required for and being taken for the following work or undertaking by the said Council:—

"The Council proposes to extend the Rokewood Depot, use the land for parking vehicles and erection of a machinery shed."

The Council has caused to be prepared specifications, maps and plans showing the nature and extent of such work or undertaking, and more particularly describing the said land and the exact site and admeasurements thereof, and stating the names of the owners or reputed owners, lessees or reputed lessees, or occupiers as far as can be ascertained by the said Council.

The said specifications, maps and plans are now deposited for inspection by all persons interested at the office of the Shire of Leigh, situate at the Shire Office, Rokewood, and may be inspected there during office hours.

All persons affected by the proposed work or undertaking are hereby required to set forth, in writing, addressed to the said Council or to the Municipal Clerk, within 40 clear days from the publication of this notice in the *Government Gazette*, all objections which they may have to such work or undertaking.

Dated this 23rd day of March, 1960.

By order of the Council,

9229

JAMES H. MITCHELL, Shire Secretary.

SHIRE OF LEIGH.

NOTICE is hereby given that First Constable Bruce Roy Taylor, Rokewood, has been appointed Prosecuting Officer for the Shire of Leigh.

9228

JAMES H. MITCHELL, Shire Secretary.

SHIRE OF MILDURA.

LOAN No. 35.

Notice of Intention to Borrow the Sum of £15,000 for Permanent Works and Undertakings.

NOTICE is hereby given that the Council of the Shire of Mildura proposes to borrow the sum of Fifteen thousand pounds on the credit of the municipal revenues of the President, Councillors and Ratepayers of the said

Shire, such sum to be raised by the granting of a mortgage, in accordance with the provisions of the Local Government Acts.

1. The maximum rate of interest that may be paid is 5½ per centum per annum.
2. The purpose for which the loan is to be applied is purchase of road-making plant.
3. The period of the loan shall be ten years.
4. The moneys borrowed shall be repayable by providing out of the Municipal Fund twenty half-yearly instalments of approximately £985 1s. 6d. each, including principal and interest, on the 1st day of December and the 1st day of June during the currency of the loan. The first instalment shall be payable on the 1st day of December, 1960.

5. Such moneys shall be repayable at the National Bank of Australasia Limited, Melbourne, or at the Council's bankers for the time being in Melbourne.

The plans and specifications and the estimate of the cost of the proposed works, and a statement showing the proposed expenditure of the moneys to be borrowed, are open for inspection at the Shire Offices, Deakin-avenue, Mildura, during usual office hours.

Dated 23rd March, 1960.

9227

A. D. HARVEY, Shire Secretary.

Town and Country Planning Acts.—Eighth Schedule.

OCEAN-ROAD PLANNING SCHEME 1955.

AMENDMENT No. 3, 1959 (SHIRE OF OTWAY).

NOTICE is hereby given that the Shire of Otway, in pursuance of its powers under the Town and Country Planning Acts, has prepared a Planning Scheme for part of Crown allotment 8s, section 2a, Parish of Krambruk, on which a sawmill is at present located for the purpose of including the said land in the Rural Forest Zone.

All maps, plans, descriptions and other data fully setting out and explaining the Planning Scheme have been deposited at the office of the Shire of Otway, Beech Forest, and at the office of the Town and Country Planning Board, Melbourne, and will be open for inspection, without payment of any fee, by all persons affected between the hours of 9 a.m. and 5 p.m. on all days of the week except Saturdays, Sundays and public holidays, until and including the 30th day of April, 1960.

Any persons affected by the Planning Scheme are required to set forth, in writing, all objections they may have, addressed to the Shire Secretary, Shire of Otway, Beech Forest, on or before the 30th day of April, 1960.

9286

T. J. FRY, Shire Secretary.

SHIRE OF RODNEY.

NOTICE is hereby given that, Robert Henry Gome, of Mooroopna, has been appointed poundkeeper of the Mooroopna Pound vice G. E. Nelson, resigned.

9217

R. PERRY, Shire Secretary.

SHIRE OF SWAN HILL.

LOAN No. 23.

Notice of Intention to Borrow the Sum of £6,000 for Permanent Works and Undertakings.

NOTICE is hereby given that the Council of the Shire of Swan Hill proposes to borrow the sum of Six thousand pounds on the credit of the municipal revenues of the President, Councillors and Ratepayers of the said Shire, such sum to be raised by the grant of a mortgage, in accordance with the provisions of the *Local Government Act 1958*.

1. The maximum rate of interest that may be paid is 5½ per cent. per annum.
2. The purposes for which the loan is to be applied are:—

(1) Erection of Comfort Station, Nyah West	£2,000
(2) Channelling and drainage works in townships	4,000
	£6,000
3. The period of the loan shall be ten years.

4. The moneys borrowed shall be repayable by providing out of the Municipal Fund twenty half-yearly instalments of £394 0s. 7d. each, including principal and interest, on the 1st day of January and the 1st day of July during the currency of the loan. The first instalment shall be payable on the 1st day of January, 1961.

5. Such moneys shall be repayable at the A.N.Z. Savings Bank, Melbourne.

The plans and specifications and the estimate of the proposed works and a statement showing the proposed expenditure of the moneys to be borrowed, are open for inspection at the Shire Offices, Swan Hill.

Date: 24th March, 1960.

9239 F. B. WOMERSLEY, Shire Secretary.

SHIRE OF SWAN HILL.

LOAN No. 24.

Notice of Intention to Borrow the Sum of £6,000 for Permanent Works and Undertakings.

NOTICE is hereby given that the Council of the Shire of Swan Hill proposes to borrow the sum of Six thousand pounds on the credit of the municipal revenues of the President, Councillors and Ratepayers of the said Shire, such sum to be raised by the grant of a mortgage, in accordance with the provisions of the *Local Government Act 1958*.

1. The maximum rate of interest that may be paid is £5 7s. 6d. per centum per annum.

2. The purposes for which the loan is to be applied are:—

(1) Purchase of F.E. loader and two light tractors £6,000

3. The period of the loan shall be five years.

4. The moneys borrowed shall be repayable by providing out of the Municipal Fund ten half-yearly instalments of £692 4s. 3d. each, including principal and interest, on the 1st day of January and the 1st day of July during the currency of the loan. The first instalment shall be payable on the 1st day of January, 1961.

5. Such moneys shall be repayable at the Commonwealth Trading Bank of Australia, Melbourne.

The plans and specifications and the estimate of the proposed works and a statement showing the proposed expenditure of the moneys to be borrowed, are open for inspection at the Shire Offices, Swan Hill.

Date: 24th March, 1960.

9240 F. B. WOMERSLEY, Shire Secretary.

Town and Country Planning Act 1958.

SHIRE OF WARRAGUL PLANNING SCHEME 1954.— AMENDMENT No. 1, 1960.

NOTICE is hereby given that the Shire of Warragul, in pursuance of its powers under the *Town and Country Planning Act 1958*, has prepared a Planning Scheme for the Shire of Warragul Planning Scheme 1954 for the purpose of re-zoning three small areas.

All maps, plans, descriptions and other data fully setting out and explaining the Planning Scheme have been deposited at the Shire Office, Warragul, and at the office of the Town and Country Planning Board, Melbourne, and will be open for inspection without payment of any fee by all persons affected between the hours of 9 a.m. and 5 p.m. on all days of the week except Saturdays, Sundays and public holidays, until and including the 1st day of May, 1960.

Any persons affected by the Planning Scheme are required to set forth, in writing, all objections they may have, addressed to the Shire Secretary, Shire Hall, Warragul, on or before the 1st day of May, 1960.

9241 D. McADIE, Shire Secretary.

SHIRE OF WERRIBEE.

LOAN No. W.S.2.

Notice of Intention to Borrow £5,000 for Permanent Works and Undertakings.

NOTICE is hereby given that the Council of the Shire of Werribee proposes to borrow the sum of Five thousand pounds on the credit of the municipal revenues of the President, Councillors and Ratepayers of the said Shire, such sum to be raised by the issue of debentures, in accordance with the provisions of the *Local Government Acts*.

1. The maximum rate of interest that may be payable is 5½ per cent. per annum.

2. The purpose for which the loan is to be applied is water reticulation, Werribee South.

3. The period of the loan shall be ten years.

4. The moneys borrowed shall be repayable by providing out of the Municipal Fund ten yearly instalments of approximately £651 5s. each, including principal and interest, on the 1st day of March during the currency of the loan. The first instalment shall be payable on the 1st day of March, 1961.

5. Such moneys shall be payable at the National Bank of Australasia Limited, Melbourne, or at the Council's bankers for the time being in Melbourne.

The plans and estimate of the cost of the proposed works, and a statement showing the proposed expenditure of moneys to be borrowed, are open for inspection at the Shire Office, Werribee.

Dated 24th March, 1960.

9226 N. G. MINNS, Secretary.

NOTICE is hereby given that Electronic Industries Limited, has applied for a lease under section 134 of the *Land Act 1958*, for a term of 42 years from 1st June, 1960, of allotment 12, section D, City of South Melbourne, Parish of Melbourne South, containing 0 acres 1 rood and 32 perches as a site for offices, stores, manufacturing purposes, and car radio installation and servicing. 9298

NOTICE is hereby given that Mayne Nickless Limited has applied for a lease under section 134 of the *Land Act 1958*, for a term of 48 years from 1st May, 1960, of allotments 14, 16 and 17, section A, Parish of Doutta Galla, containing 6 acres 3 roods and 33 perches, as a site for a transport terminal. 8962

VICTORIAN TRANSPORTS DEPOTS LTD.

NOTICE is hereby given that Victorian Transport Depots Limited has applied for a lease under section 134 of the *Land Act 1958*, for a term of 45 years from 1st May, 1960, of allotment 14, section 1B, Parish of Doutta Galla, containing 6 acres 0 roods 3 perches, as a site for a transport depot and service station. 8949

NOTICE is hereby given that The Colonial Sugar Refining Co. Ltd. has applied for a lease under section 134, *Land Act 1958*, for a term of 21 years as a site for a pump house and pipe-line situate adjacent to the Service Basin on the Reserve for Water Supply purposes at Bacchus Marsh. 9103

THE MOUNT BEAUTY WATER TRUST COMMISSIONERS.

NOTICE is hereby given to owners of tenements in the streets set out in the Schedule hereto and the private streets, lanes, courts and alleys, opening thereto that the main pipes in the said streets being laid down, the owners of all tenements situated as above are required to cause proper pipes and stop cocks to be laid so as to supply water within such tenements from the main pipe and the laying of all such pipes and stop cocks shall be completed on or before the 1st day of May, 1960.

Lakeside-avenue, from Hollands-street to Fairway-avenue.
Beauty-avenue, from Kiewa-crescent to Lakeside-avenue.
Kiewa-crescent, north-easterly from Park-street to Lakeside-avenue.

Arthur-street, from Maddison-street to Kiewa-crescent.
Hall-street, from Tawonga-crescent to Lakeside-avenue.
Mountain-avenue, from Tawonga-crescent to Roper-street.
Hollands-street, from Upper Kiewa Valley-road to Park-street.

Park-street, from Kiewa-crescent to Bogong-avenue.
Bogong-avenue, from Park-street to Tawonga-crescent.
Tawonga-crescent, from Upper Kiewa Valley-road to Mountain-avenue.

Kiewa-crescent, from Lakeside-avenue easterly to Park-street.

Maddison-street, from Kiewa-crescent to Bogong-avenue.
Upper Kiewa Valley-road from Tailrace Canal to Tawonga-crescent.

Mount-street, from Lakeside-avenue to Mountain-avenue.
Roper-street, from Lakeside-avenue to Fairway-avenue.
Fairway-avenue, from Roper-street to Freeburgh-avenue.
Simmonds-street, from Nelse-street to Werमतong-avenue.
Freeburgh-avenue, from Nelse-street to Fairway-avenue.
McKay-street from Nelse-street to Valley-avenue.
Nelse-street, from Lakeside-avenue to McKay-street.
Valley-avenue, from east end of McKay-street to Freeburgh-avenue.

Werमतong-avenue, from Roper-street to Valley-avenue.
Wallace-street, from Roper-street to Valley-avenue.

N. ALEXANDER, Secretary.

Mount Beauty Water Trust Commissioners, 18th March, 1960. 9210

NOTICE OF DISSOLUTION OF PARTNERSHIP.

NOTICE is hereby given that the partnership heretofore subsisting between Brian Richard Goldsmith, of 52 Grange-road, Toorak, cafe proprietor, and Sybil Hylander, of 19 Kensington-road, South Yarra, married woman, carrying on business as cafe proprietors, at 303 Toorak-road, South Yarra, under the style or firm of "Goldy's", has been dissolved as from the 31st day of December, 1959, so far as concerns the said Brian Richard Goldsmith, who retires from the said firm. The said Sybil Hylander and Dennis Hylander, of 19 Kensington-road, South Yarra, will carry on the business as from the said date and will be responsible for the payment of all debts in connexion therewith.

Dated the 21st day of January, 1960.

Witness—JAMES B. DUGGAN.
BRIAN GOLDSMITH.
S. HYLANDER.
Witness—W. R. STERN.
D. HYLANDER.
Witness—W. R. STERN, solicitor, Melbourne.
Mahony, O'Brien and Duggan, solicitors, 20 Queen-street, Melbourne. 9269

NOTICE OF DISSOLUTION.

NOTICE is hereby given that the partnership heretofore subsisting between Marjorie Sexton and William George La Mude, carrying on business as Mareville Millinery, at 258 Flinders-lane, Melbourne, has been dissolved as from the first day of January, 1960, so far as concerns the said Marjorie Sexton, who retires from the said firm, the said William George La Mude will henceforth carry on the said business on his own account.

Dated the 9th day of March, 1960.

9305 MARJORIE SEXTON.
WILLIAM GEORGE LA MUDE.

NOTICE is hereby given that the partnership heretofore subsisting between Kevin Archibald Bain and Mary Clare Bain, carrying on business as a drapery and gifts shop at 4 Mowbray-street, Albert Park, under the style or firm name of "Mary C. Bain," has been dissolved as from the 15th day of March, 1960.

Dated the 23rd day of March, 1960.

K. A. BAIN.
MARY C. BAIN.
RODDA, BALLARD & VROLAND, solicitors, 430 Little Collins-street, Melbourne. 9272

MEETING OF CREDITORS.

NOTICE is hereby given of a meeting of creditors of the company to be held at the offices of the Institute of Chartered Accountants, 23 McKillop-street, Melbourne, on Tuesday, the 5th day of April, 1960, at Ten-thirty a.m. in the morning.

Business.

As the company is to meet on the 4th day of April, 1960, at Ten a.m., to consider a Special Resolution that it be wound up voluntarily, business of this meeting will be:—

1. To appoint a liquidator.
2. To nominate and appoint a Committee of Inspection if necessary.
3. To fix the remuneration of liquidator if no Committee of Inspection is appointed.

By Order of the Board,
9277 B. E. HARDINGE, Director.

The Companies Act 1958.—In the matter of ERMCO INDUSTRIES PROPRIETARY LIMITED.—Notice *re* Meeting of Creditors, Pursuant to Section 201 (2).

NOTICE is hereby given that a meeting of creditors of the above-named company will be held at the offices of Kennedy, Smail and Middlemiss, 31 Queen-street, Melbourne, on Monday, the 4th day of April, 1960, at Three o'clock p.m., the company having convened a meeting of its members for the same day for the purpose of considering a Resolution that the company be wound up voluntarily.

Dated this 21st day of March, 1960.

E. J. HYLARD, Director.
KENNEDY, SMAIL & MIDDLEMISS, 31 Queen-street, Melbourne. 9267

The Companies Act 1958.—In the matter of MULTI PARK PROPRIETARY LIMITED.—Notice *re* Meeting of Creditors, Pursuant to Section 201 (2).

NOTICE is hereby given that a meeting of creditors of the above-named company will be held at the offices of Kennedy, Smail and Middlemiss, 31 Queen-street, Melbourne, on Monday, the 11th day of April, 1960, at Eleven a.m., the company having convened a meeting of its members for the same day for the purpose of considering a Resolution that the company be wound up voluntarily.

Dated this 21st day of March, 1960.

M. F. CLARK.
C. F. BEAUMONT.
E. R. SMAIL, trustee in the bankrupt estate of M. F. Clark and C. F. Beaumont.
KENNEDY, SMAIL & MIDDLEMISS, 31 Queen-street, Melbourne. 9264

In the matter of CENTRAL STEEL OF AUSTRALIA PROPRIETARY LIMITED.

WINDING up order made the 24th day of March, 1960. Name and address of official liquidator: Ronald Hewson, of Box Hill.

GILLOTT, MOIR & AHERN, 95 Queen-street, Melbourne, solicitors for Standard Steel Proprietary Limited, the petitioner. 9263

No. of Company 25296.

GLEN SHIAN PROPRIETARY LIMITED.

NOTICE CONVENING FINAL MEETING, PURSUANT TO SECTION 210.

NOTICE is hereby given in pursuance of section 210 of the Companies Act 1958, that a General Meeting of the members of the above-named company will be held at 419 Lonsdale-street, Melbourne, on Thursday, the 5th day of May, 1960, at Two-thirty o'clock in the afternoon, for the purpose of having an account laid before them showing the manner in which the winding up has been conducted and the property of the company disposed of, and of hearing any explanation that may be given by the liquidators.

9262 RICHARD ALLEN, Liquidator.
KINGSLEY A. ALLEN, Liquidator.

In the Supreme Court.—In the matter of the Companies Act 1958, and in the matter of MCLEOD'S SOAP COMPANY PROPRIETARY LIMITED.

NOTICE is hereby given that the Order of the Supreme Court of Victoria dated the 1st day of March, 1960, confirming the reduction of the capital of the above-named company from £100,000 to £91,600 and the minute approved by the Court showing with respect to the share capital of the company as altered the several particulars required by the above Act were registered by the Registrar of Companies on the 18th day of March, 1960.

The said minute is in the words and figures following:—

"The capital of the company henceforth is £91,600 divided into 500 8 per cent. First Cumulative Preference Shares of £10 each, 625 8 per cent. Second Cumulative Preference Shares of £10 each, 2,035 Ordinary Shares of £10 each, and 6,000 Unissued Shares of £10 each.

At the date of the registration of this minute all of the said 500 8 per cent. First Cumulative Preference Shares of £10 each, 625 8 per cent. Second Cumulative Preference Shares of £10 each, 2,035 Ordinary Shares of £10 each have been issued and are deemed to be fully paid."

Dated the 21st day of March, 1960.

MOULE, HAMILTON & DERHAM, solicitors for the company. 9304

JAKO STEEL FARM BUILDINGS COMPANY PROPRIETARY LIMITED.

NOTICE is hereby given, under section 195 (3) of the Companies Act 1958, that at a General Meeting of members of the above-named company, duly convened and held at 801 Latrobe-street, Ballarat, on the 18th day of March, 1960, the following Special Resolution was duly passed:—

"That the company be wound up voluntarily, and that John Bernard Carroll be appointed liquidator."

Dated this 19th day of March, 1960.

9234 J. B. CARROLL, Liquidator.

Companies Act 1958.

BROMPTON PROPRIETARY LIMITED (IN VOLUNTARY LIQUIDATION).

NOTICE is hereby given, pursuant to section 195 of the *Companies Act 1958*, that at a General Meeting of the company held at 11 Moorakynne-avenue, Malvern, on 21st March, 1960, the following Special Resolution was duly passed:—

“That the company be wound up voluntarily and that Noel Wilfred Buckley, of 360 Collins-street, Melbourne, be appointed liquidator for the purposes of the winding up.”

Dated this 23rd day of March, 1960.

N. W. BUCKLEY, Liquidator.

Address of Liquidator: 360 Collins-street, Melbourne. 9258

IN THE MATTER OF WALDECK BUILDERS PROPRIETARY LIMITED.

NOTICE is hereby given that at an Extraordinary General Meeting of the above-named company, duly convened and held at 366 Bourke-street, Melbourne, at Two o'clock in the afternoon, on the 15th day of March, 1960, the following Special Resolution was duly passed:—

“That it has been proved to the satisfaction of this Meeting that the company cannot, by reason of its liabilities, continue in business, and that it is advisable to wind up, and accordingly that the company be wound up voluntarily and that Allan John Irwin, of 366 Bourke-street, Melbourne, be appointed liquidator for the purpose of the winding up.”

Dated this 16th day of March, 1960.

9295 A. J. IRWIN, Liquidator.

GEORGE A. PICKERING PTY. LTD. (IN VOLUNTARY LIQUIDATION).

NOTICE is hereby given, pursuant to section 210 (2) of the *Companies Act 1958*, that a General Meeting of the above-named company will be held at the office of G. F. Yates, chartered accountant, “Clyde House”, 182 Collins-street, Melbourne, on Monday, the 2nd day of May, 1960, at Eleven o'clock in the forenoon, for the purpose of having an account laid before them showing the manner in which the winding up has been conducted and the property of the company disposed of, and of hearing any explanation that may be given by the liquidator.

Dated this 28th day of March, 1960.

9276 G. F. YATES, Liquidator.

WELLINGTON ALLUVIALS LIMITED (IN LIQUIDATION).

NOTICE is hereby given that, pursuant to section 235 of the *Companies Act 1958*, a General Meeting of shareholders of Wellington Alluvials Limited (in voluntary liquidation), will be held at 500 Bourke-street, Melbourne, on Thursday, 5th May, 1960, at 2.15 p.m., for the purpose of laying before it the liquidators' account showing how the winding up has been conducted and the property of the company disposed of and giving any explanation thereof.

Dated this 29th day of March, 1960.

9260 R. G. NEWTON } Joint Liquidators.
J. K. LITTLE }

No. of Company 25099.

Form No. 2.

TINTAGEL PTY. LTD.

PURSUANT TO SECTIONS 16 (2) AND 121 (1).

AT an Extraordinary General Meeting of the members of Tintagel Pty. Ltd., duly convened and held at 229 Exhibition-street, Melbourne, on the 25th day of March, 1960, the following Special Resolution was duly passed:—

“That the company be wound up voluntarily and that Alan Douglas, of 229 Exhibition-street, Melbourne, be appointed liquidator for the purpose of such winding up.”

Dated this 25th day of March, 1960.

9244 A. DOUGLAS, Secretary.

HUDDART PARKER LIMITED.

(No. 4969/8303.)

REGISTER of Unclaimed Money held by Huddart Parker Limited, 486 Collins-street, Melbourne, in Victoria, at 31st December, 1953.

Date of Last Claim.	Name of Owner on Books.	Total Amount Due to Owner.	
		£ s. d.	
1951—January	J. Shaw, Watchman	1 9 10	
	J. Sinclair, Yardman	2 17 8	
	J. Harris, Yardman	1 5 3	
	W. Rutledge, Yardman	1 5 3	
	February	J. Miles, A. B., <i>Goulburn</i> ..	1 5 6
		A. Barlow, Tally Clerk	2 9 3
		Condie, Coal Worker, 6954 ..	0 6 0
		R. Hill, Coal Worker, 7341 ..	0 2 4
		H. Caune, Coal Worker, 2269 ..	0 3 8
	April ..	E. Sullivan, Coal Worker, 4458 ..	0 6 0
		R. Cochrane, R. Murchison ..	8 18 11
		June ..	T. Holdcraft, Painter and Docker ..
P. Balfe, Painter and Docker ..			0 7 5
July ..		G. Baker, Painter and Docker ..	0 7 5
		J. Cutmore, Painter and Docker ..	0 7 5
		P. Hood, Painter and Docker ..	0 7 5
		S. Middleton, Painter and Docker ..	0 7 5
		L. Leigh, Painter and Docker ..	0 7 5
		F. Hogan, Painter and Docker ..	0 7 5
		H. Hays, Painter and Docker ..	0 7 5
		J. Vaughan, Painter and Docker ..	0 7 5
	L. Foote, Painter and Docker ..	0 7 5	
	April ..	Basford, <i>Elmore</i>	0 13 6
		W. Henry	0 4 0
	December	R. Flinkenberg	0 4 0
H. Arthur		0 4 0	
J. Cooper		0 2 0	
E. Cairns, Coal Worker		0 7 9	
J. Goudie, Coal Worker		0 7 8	
J. Williams, Coal Worker		0 7 8	
1952—March ..		J. Stivey, Coal Worker	0 3 0
		K. Watterson, Coal Worker ..	0 3 0
		J. Vonow, Coal Worker	0 3 0
		G. Graham, Coal Worker	0 9 10
		J. Thomas, Coal Worker	0 7 5
		June ..	F. Harris, Seaman
	W. Quinn, Seaman		0 15 0
	1953—April ..	B. Flaherty, Painter and Docker ..	1 10 6
		June ..	P. Foley, Painter and Docker ..
	J. Kennedy, Painter and Docker ..		0 5 5
	R. Russell, Painter and Docker ..		0 5 5
	J. Jackson, Painter and Docker ..		0 5 5
D. Thompson, Painter and Docker ..	0 3 4		
M. Gallagher, Painter and Docker ..	0 3 4		
			30 7 1

Melbourne, 11th January, 1960.

9119

Companies Act 1958—Tenth Schedule.

Z. R. HOLDINGS LIMITED.

REGISTER of Unclaimed Money held by the Z. R. Holdings Limited.

Name of Owner on Books.	Total Amount Due to Owner.	Description of Unclaimed Money.	Date of Last Claim.
	£ s. d.		
Ashmore, William Henry ..	24 0 0	Dividend	..
Fitzhenry, Eileen	44 0 0
Isaacson, (estate) late Isador ..	16 16 0
McCartney, Christina Haye ..	22 8 0
O'Donnell, (estate) late Margaret Ellen ..	1 12 0
McLaughlin, Minna Geraldine ..	10 3 0
Taranto, Allan	17 10 0
Weeks, James Robert	60 0 0
	196 9 0		

Dated this 15th day of March, 1960.

9156

A. DARLING, Secretary.

ARGUS AND AUSTRALASIAN LIMITED.

REGISTER of Unclaimed Moneys held by the Argus and Australasian Limited.

Name and Address of Owner on Books.	Total Amount Due to Owner.	Description of Unclaimed Money.	Date of Last Claim.
	£ s. d.		
Estate of late Alexander Wilfred Allan, 28 Normanby-street, Middle Brighton	14 0 0	Dividends for 1956 and 1957 on 100 preference shares ..	1.10.55
Estate of late William Adrian Bronnan, 11 Banool-avenue, Kew	7 0 0	Dividends for 1957 on 100 preference shares ..	1.10.56
Estate of late Albert Lachlan Briant, 74 Gladstone-street, Leura, New South Wales	14 0 0	Dividends for 1954-57 on 50 preferred ordinary shares ..	1.10.53
Nancy R. Court, 16 Capulet-street, Moonee Ponds	0 7 0	Dividend for 1957 on 5 preferred ordinary shares ..	1.10.56
Ethel French, last known address, 187 Nott-street, Port Melbourne	4 18 0	Dividends for 1951-57 on 10 preference shares
James Keith Hassel, 25 Glenbervie-road, North Essendon	0 14 0	Dividends for 1957 on 10 preferred ordinary shares ..	1.10.56
John Percy James, 872 Nicholson-street, North Fitzroy	3 10 0	Dividends for 1951, 1953, 1955-57 on 10 preference shares ..	1.10.54
Estate of late Kathleen Lynch, 9 Upton-road, Windsor	7 0 0	Dividend for 1957 on 100 preferred ordinary shares ..	1.10.56
Douglas Alexander Rodsted, 9 Florence-street, Mentone	2 9 0	Dividend for 1957 on 10 preference and 25 preferred ordinary shares ..	1.10.56
Robert J. Stuart, 41 Vautier-street, Elwood	4 18 0	Dividends for 1951-7 on 10 preference shares ..	21.9.50
Estate of late George Nelson Thomson and Ethel Avis Neeld, 29 Ellis-road, East Malvern	1 8 0	Dividends for 1956 and 1957 on 10 preferred ordinary shares ..	1.10.55
Leslie Wentman, 8 Norfolk-avenue, Surrey Hills	0 7 0	Dividend for 1957 on 5 preference shares ..	1.10.56
Herbert Wilson, Williamina Wilson and Dorothy Annie Wilson, Robinson's-road Langwarrin	63 0 0	Dividends for 1955-57 on 300 preference shares ..	1.10.54
Estate of late Emanuel Abrahams and Alfred Abrahams, 18 Ontario-street, Caulfield	1 8 0	Dividends for 1952 on 20 preference shares ..	1.10.51
Estate of late William Barr, 496 Brunswick-street, North Fitzroy	7 0 0	Dividend for 1955 on 100 preferred ordinary shares ..	1.10.54
Estate of late George William Cane, c/o Merton G. Walker, 143 Bamra-road, Caulfield	3 10 0	Dividend for 1953 on 50 preference shares ..	1.10.52
Alfred Neil Chick, 40 Normanby-street, Middle Brighton	0 7 0	Dividend for 1956 on 5 preferred ordinary shares ..	1.10.55
Estate of late William Thomas Crofts, 466B Williamstown-road, Port Melbourne	1 8 0	Dividend for 1956 on 20 preferred ordinary shares ..	1.10.55
Stanley Colledge, Angelsea	1 8 0	Dividend for 1955 on 20 preference shares ..	1.10.54
Frank T. Davison, 26 Beaver-street, Essendon	1 1 0	Dividend for 1954 on 15 preference shares ..	1.10.53
Ethel Mabel Evans, 59 Horace-street, Malvern	4 4 0	Dividend for 1955 on 60 preference shares ..	1.10.54
Esther Paterson Gill, 258 Beaconsfield-parade, Middle Park	3 10 0	Dividend for 1956 on 50 preference shares ..	1.10.55
Estate of late Stanley Ormond Gillespie, 17 Glyndon-avenue, Brighton	7 0 0	Dividend for 1955 on 100 preferred ordinary shares ..	1.10.54
Estate of late Marion M. Henderson, c/o Arthur Phillips and Just, 472 Bourke-street, Melbourne	28 0 0	Dividend for 1956 on 400 preference shares ..	1.10.55
Estate of late William Inglis, 68 Moreland-road, North Brunswick	5 12 0	Dividends for 1952-55 on 20 preference shares ..	1.10.51
Charles Denton Kemp, 365 Wattle-tree-road, East Malvern	3 10 0	Dividend for 1955 on 50 preferred ordinary shares ..	1.10.54
Mrs. H. B. Meek, 3 Ada-avenue, Wahroonga, New South Wales	1 8 0	Dividend for 1955 on 20 preference shares ..	1.10.54
Ruby M. Moorman, 27 Stafford-street, Northcote	0 14 0	Dividend for 1955 on 10 preferred ordinary shares ..	1.10.54
Estate of late Mary Constance Marshall, P.O., Box 233, Bowen, Queensland	1 15 0	Dividend for 1952 on 25 preferred ordinary shares ..	1.10.51
Estate of late Herbert Oleson, 118 Emmaline-street, Croxton	0 14 0	Dividend for 1956 on 10 preference shares ..	1.10.55
Jocelyn Swift Perkins, 8A Carswell-close, Hawthorn	0 15 0	Dividend for 1952 on 25 preference shares ..	1.10.51
Estate of late Clarence Avondale Patchell, c/o 389 Lonsdale-street, Melbourne	1 8 0	Dividend for 1955 on 20 preference shares ..	1.10.54
Phyllis Arnell Rayner, 5 Tennyson-street, Forrest, Australian Capital Territory	7 0 0	Dividends for 1951 and 1952 on 50 preference shares ..	21.9.50
Stanley R. Ronald, 403 St. George's-road, North Fitzroy	0 14 0	Dividend for 1956 on 10 preference shares ..	1.10.55
Estate of late Catherine M. Stewart, c/o Blake and Riggall, 120 William-street, Melbourne	49 0 0	Dividends for 1955 and 1956 on 350 preferred ordinary shares ..	1.10.54
Estate of late Irving Stockdale, 17 Valley View-road, Glen Iris	0 16 10	Dividends for 1956 on 12 preference shares ..	1.10.55
Han Cheng Lim, 5 Balmoral-road, Singapore	14 0 0	Dividend for 1954 on 200 preferred ordinary shares ..	1.10.53
Estate of late William Adrian Brennan, 11 Banool-avenue, Kew	105 8 4	Acquisition of 100 preference shares
Henry Seward Crawford, 67 Turner-street, Abbotsford	52 14 2	Acquisition of 50 preference shares
Ethel French, last known address, 187 Nott-street, Port Melbourne	10 10 10	Acquisition of 10 preference shares
John Percy James, 872 Nicholson-street, North Fitzroy	10 10 10	Acquisition of 10 preference shares
William Bolton Paxton, 89 Queen-street, Melbourne	42 3 4	Acquisition of 40 preference shares
Estate of late Leonard Hector Saunders	210 16 8	Acquisition of 200 preference shares
Robert J. Stuart, 41 Vautier-street, Elwood, c/o Douglas and Collins, Solicitors, 15 Paterson-street, Launceston	10 10 10	Acquisition of 10 preference shares

WESTERN DISTRICT CO-OPERATIVE CO. LTD.

REGISTER of Unclaimed Moneys held by Western District Co-Operative Co. Ltd., 14-20 King-street, Melbourne, C.I.

Name and Address of Owner on Books.	Total Amount Due to Owner.	Description of Unclaimed Money.	Date of Last Claim.
	£ s. d.	Dividend for years—	
Albury Co-operative Butter Factory Co. Ltd.	9 5 0	1953	No claim
Axford, Henry V., Terang	0 10 0	1951	"
Barr, Ann Maria, Ormond-road, Geelong	0 5 0	1953	"
Barry, Estate of Patrick, c/o Mrs. Turner, Bowdley-street, Ormond	1 0 0	1945	"
Bell Bros. (James and Angus), Cororooke	0 10 0	1953	"
Bellohambers, Walter, 630 High-street, Golden Square, Bendigo	0 10 0	1953	"
Boyd, Alexander Edward, Stoneyford	0 10 0	1949	"
Brown, George Fynney, P.O. Yambuk	0 5 0	1953	"
Burnie, Estate of Reginald M., c/o Hazel M. Burnie, Howman's Loose Bag, via Allansford	1 0 0	1952	"
Cameron, Ewen Oliver Crossley, 71 French-street, Hamilton	0 10 0	1950	"
Carter, Edwin John, 138 Koroit-street, Warrnambool	0 5 0	1953	"
Chandley, William, Eurack	0 5 0	1953	"
Conway, William, Crossley	1 0 0	1946, 1950	"
Cox, Mrs. Janet Alice, "The Lodge", Moonce Valley, Moonce Ponds	0 10 0	1946	"
Crowe, Albert Ernest, Western Reserve, Warrnambool	1 0 0	1952, 1953	"
Daffy, Estate of R. C., c/o Executrix Mrs. K. C. Daffy, "Athlone", Beacoe	0 10 0	1950	"
Darcy, Estate of Patrick, c/o Executive Chas. Darcy, Wool Wool	1 0 0	1950	"
Delaney, Peter, Polding-street, Port Fairy	0 5 0	1953	"
Donaghy, John, Modewarre Post Office	0 5 0	1953	"
Eldridge, Thomas Henry, Jr., Warrion	0 5 0	1953	"
Eldridge, Estate of Thomas, Sr., Alvie	0 5 0	1953	"
Elliott, Estate of Herbert George, Pyramid Hill	2 10 0	1949	"
Ferrari, Olinto Charles George (deceased), c/o P. H. Piffey, 422 Collins-street, Melbourne	1 5 0	1953	"
French, John, 4 Wilson-street, Colac	0 5 0	1953	"
Gent, Gordon McD. and Dorothy E., Malop-street, Geelong	0 10 0	1953	"
Gleeson, Thomas, 50 John-street, East Brunswick	1 0 0	1953	"
Good, Estate of Leslie E., "Kia Ora", Warrnambool	2 0 0	1943, 1945	"
Glennan, Cornelius, Dalvin-road, Noorat	0 10 0	1946	"
Hallyburton, Estate of George, Pomborneit	0 10 0	1953	"
Harney, Robert P., Garvoc	2 5 0	1950	"
Hill, Estate of Joseph, Post Office, Nullawarre	6 10 0	1941-53	"
Horne, William (deceased), c/o J. G. R. Horne, "Iuka", Yulong, via Colac	1 5 0	1953	"
Hett, Henry E. and William R., Alvie	1 0 0	1953	"
Inghis, George, Cororooke	0 5 0	1953	"
James, Henry William, Coleraine	0 5 0	1953	"
Johnstone, Easton Leslie, Mailer's Flat	0 10 0	1945	"
Kerr, R., Camperdown	7 10 0	1941, 1945-47, 1949-50	"
Lane, Estate of John, c/o Fitzgerald and Nash, Coleraine	1 0 0	1946-47	"
Lester, Estate of William, c/o Ruth Lester, Ararat	0 5 0	1953	"
Luke, James, 14 King-street, Warrnambool	0 10 0	1953	"
Macdonald, Estate of Lachlan, c/o J. S. Tait and Co., Warrnambool	2 0 0	1944, 1950	"
Macleod, Estate of John, c/o M. Macleod, Glenormiston North	1 5 0	1944	"
Mackay, Andrew, Warrion	0 5 0	1953	"
McCabe, Estate of C., c/o Gavin Duffy, Camperdown	1 5 0	1949	"
McCarthy, Estate of Robert Thomas, c/o Mrs. Mary McCarthy, Coragulac, via Colac	0 10 0	1953	"
McComb, William James, Nalangil	0 10 0	1953	"
McCosker, Thomas, Dennington	16 0 0	1938-53	"
McCullough, William J., 27 Rose-street, Bentleigh	1 0 0	1952-53	"
McDonald, Mrs. Mary, 141 Clarke-street, Northcote	0 5 0	1953	"
McEntee Bros. (Augustine L. and Bryan K.), "Coathness", Cudgee	1 0 0	1953	"
McIntosh, Peter, c/o Mrs. Ray Cole, Church-street, Colac	1 0 0	1945, 1950	"
McKenzie, Alex., "Hillside", Donnybrook	0 5 0	1953	"
McKenzie Estate of Roderick, c/o Mrs. W. Hunt, 11 Edward-street, Shepparton	0 5 0	1953	"
McKenzie, William, c/o Mrs. J. McKenzie, 1 Frank-street, Newtown, Geelong	0 10 0	1948	"
McLennan, E. L., Unknown Address	1 10 0	1941	"
McLennan, Estate of Murdoch, c/o St. John Clark, Mitchell and Barwon, Colac	1 5 0	1951	"
McLeod, Estate of Malcom, c/o Mrs. Edie McLeod, Forpdale	3 0 0	1948, 1952, 1953	"
McMahon, Estate of Thomas J., c/o J. J. McMahon, Robinson-street, Camperdown	1 10 0	1945, 1946, 1950	"
McNicol, Estate of Arch., c/o Silvester and Silvester, Casterton	8 0 0	1942, 1944-48, 1950-51	"
McNicol, Neil, "Danna", Tahara	3 0 0	1946, 1952-53	"
McRae, Duncan William, Larpent	0 10 0	1953	"
Meredith, Mrs. Roberta Jane, 16 Fitzroy-street, Geelong East	0 15 0	1953	"
Mirtschin, Mrs. Martha, Penshurst	0 10 0	1951	"
Moodie, Stephen Lewis, Hync-street, Lilydale	0 5 0	1953	"
Moore, Geo. S., Axfords Private Bag, Terang	0 5 0	1953	"
Morris, Estate of Jeremiah H., c/o Mrs. W. Hunt, 11 Edwards-street, Shepparton	0 5 0	1953	"
Morrissey, Estate of Thos. Jos., Box 12, Beacoe	1 0 0	1950, 1953	"
Muir, Robert Archibald, Cudgee	0 5 0	1953	"
Noonan, T., Penshurst	1 10 0	1951-53	"
O'Keefe Bros. (Michael and Daniel), Glenormiston South	1 5 0	1946	"
O'Shea, William (deceased), c/o J. J. Kervin, Pirron Yallock	0 5 0	1953	"
Parish, John Foster, Russells Creek, via Warrnambool	0 5 0	1953	"
Ponting, William Leslie, Cororooke	1 0 0	1945, 1948	"
Richards, William Henry, Cororooke	0 5 0	1953	"
Ridgeway, Ernest Lyle, 20 McLaughlin-street, Colac	0 10 0	1952	"
Rogers, Chas. John, 84 Koroit-street, Warrnambool	2 10 0	1952	"
Ross, Robert, 308 Timor-street, Warrnambool	0 10 0	1953	"
Rowe, John Henry Stuart, 30 Salisbury-avenue, Blackburn	0 10 0	1949	"
Russell, Estate of Thomas, Cororooke	0 10 0	1948	"

UNCLAIMED MONEYS HELD BY WESTERN DISTRICT CO-OPERATIVE CO. LTD.—continued.

Name and Address of Owner on Books.	Total Amount Due to Owner.	Description of Unclaimed Money.	Date of Last Claim.
	£ s. d.	Dividend for years—	
Ryan, Mrs. Catherine, Cororooke	0 5 0	1953	No claim
Ryan, Patrick Denis, Grasmere	1 5 0	1953	"
Sadler, Estate of Joseph, c/o David E. Trickett, Terang	2 0 0	1950-53	"
Seale, George, Cororooke	0 5 0	1953	"
Simpkin, Mrs. Elizabeth L., Beac	0 5 0	1953	"
Simpson, Alexander Bell, Allansford	1 5 0	1950	"
Smith, Mrs. Bernard Cyril, 21 Lansdowne-street, East Melbourne	0 5 0	1953	"
Smith, Mrs. Mary, Mepunga	1 5 0	1949	"
Stephens, Henry, Warrion	0 5 0	1953	"
Stonehouse, Estate of Alex., c/o A. L. Stonehouse, Jr., Private Bag, Terang	0 10 0	1946	"
Stonehouse, Estate of Henry J., Garvoc	1 0 0	1945	"
Trust, George, 45 Vale-street, St. Kilda	0 5 0	1953	"
Turner, Joseph Ernest, 13 Roxley-street, Geelong West	1 0 0	1953	"
Underwood, William, 18 Pollock-street, Colac	0 10 0	1949	"
Urguhard, Estate of Mrs. Mary, "Narwarick", Camperdown	1 0 0	1948	"
Walker, John, Roadside Delivery, Timboon	0 10 0	1953	"
Wallace and Inglis, Alvie	1 10 0	1949-50	"
Waller, Estate of William, Penshurst	0 10 0	1949	"
Warburton, Francis W., Private Bag, Kerang	0 5 0	1953	"
Westlake, William, Ottway-street, Portland	5 0 0	1946, 1953	"
Williams, James, Garvoc	0 5 0	1953	"
Wilson, Estate of Richard O., c/o R. O. and A. F. Wilson, Private Bag 66, Colac	0 10 0	1953	"
Wylie, Estate of John, c/o Mr. Philip R. Fraser, 59 Yarra-street, Geelong	0 10 0	1945	"
	126 15 0		

Melbourne, 21st March, 1960.

L. H. EDWARDS,

9148

Secretary.

Tenth Schedule.

GORMANDALE CO-OPERATIVE CREAMERY AND BUTTER FACTORY CO. LTD.

REGISTER of Unclaimed Moneys held by the Gormandale Co-operative Creamery and Butter Factory Co. Ltd.

Name of Owner on Books.	Total Amount Due to Owner.	Description of Unclaimed Money.	Date of Last Claim.
	£ s. d.		
No Record	0 3 8	No Record	No Record
No Record	0 8 6	No Record	No Record
Exors. T. Stuckey, c/o J. T. Stuckey, Flynn	0 11 0	Dividend on 11 shares	November, 1939
No Record	0 2 5	Payment for cream	August, 1941
Exors. A. Leech, c/o J. P. McDonnell, 405-407 Collins-street, Melbourne	0 10 0	Dividend on 10 shares	November, 1941
Albert Whateley, Flynn	0 10 0	Dividends on 5 shares	November, 1941
No Record	0 2 4	Payment for cream	May, 1942
No Record	0 10 10	Payment for cream	June, 1942
No Record	3 8 7	Payment for cream	June, 1942
No Record	0 2 1	Payment for cream	June, 1943
No Record	0 0 10	Payment for cream	June, 1943
No Record	1 13 7	Payment for cream	May, 1944
Exors. Elizabeth Canfield, Traralgon	0 10 0	Dividend on 10 shares	November, 1946
Mrs. E. Scott, Traralgon	0 2 4	Payment for cream	July, 1947
Exors. G. Harrap, York-street, Sale	0 5 0	Dividend on 5 shares	November, 1947
Clara Hayes, Box 33, Hopetoun	0 5 0	Dividend on 5 shares	November, 1948
C. E. Bourke, Willung South	0 5 0	Dividend on 5 shares	November, 1949
Exors. Lew Martin, Grey-street, Traralgon	1 0 0	Dividends on 5 shares	November, 1951
E. Barton, Carrajung	2 8 4	Payment for cream	September, 1951
J. W. Munn, Jerralang Junction	9 1 3	Payment for cream	September, 1953
A. B. Bell, Traralgon	0 7 6	Dividend on 5 shares	November, 1953
A. Knox, Yinnar	0 7 6	Dividend on 5 shares	November, 1953
J. T. O'Connor, Yannathan	1 2 6	Dividend on 15 shares	November, 1953
Jas. Caldwell, 105 Stewart-street, Brunswick	6 0 0	Dividends on 15 shares	November, 1953
C. G. Harrap, Nyanda-street, Burwood	0 15 0	Dividends on 5 shares	November, 1953
E. Peel, Kincaid-street, Wagga, New South Wales	1 15 0	Dividends on 5 shares	November, 1953
Exors. W. Rutherford, Leongatha	1 0 0	Dividends on 5 shares	November, 1953
S. Shallue, 24 Gordon-street, Traralgon	0 7 6	Dividends on 5 shares	November, 1953
G. Summerfield, Gainsborough, via Darnum	2 0 0	Dividends on 5 shares	November, 1953
Exors. T. Fleming, Willung	0 15 0	Dividend on 10 shares	November, 1953
W. J. Hiam, Officer	1 10 0	Dividends on 20 shares	November, 1953
F. Shiels, 238 Bay-street, North Brighton	3 10 0	Dividends on 5 shares	November, 1953
H. Green, Carrajung	14 13 7	Payment for cream	February, 1954

BINTANG LIMITED.

REGISTER of Unclaimed Money held by Bintang Limited.

Name.	Last Known Address.	Amount.
		£ s. d.
Phillips, John Keith	"Airla", Park-street, St. Kilda	4 0 0
Broadbent, Ethel	28 Jolimont Terrace, Jolimont	2 0 0
Nicholas, Elsie Mabel (deceased)	c/o Miss D. Nicholas, 24 Crimea-street, North Caulfield	7 10 0
Nicholas, Frank George Turner (deceased)	c/o Miss D. Nicholas, 24 Crimea-street, North Caulfield	2 0 0
Dynon, Joseph John	"Donnachaidh", Dalgety-road, Beaumaris	15 0 0
Bult, Aubrey John Clifton (deceased)	390 Collins-street, Melbourne	1 0 0
White, Jessie McHardie (deceased)	c/o R. G. Macfarlan, 123 William-street, Melbourne	1 5 0
Hunt, Stella de Vere (deceased)	c/o H. M. Ridley, 163 William-street, Melbourne	0 10 0
Curtis, James	"Seven Oaks", Pennant Hills-road, Carlingford, New South Wales	3 0 0
Wilson, George John Montaigne	6 Cowles-road, Mosman, New South Wales	1 0 0
Scott, Stanley Edgar, and Simpson, Harry Noel	68 Minnamurra-road, North-bridge, New South Wales	1 10 0
Cronin, James William (deceased)	c/o F. D. J. Morgan, 53 Pararamatta-road, Cronulla, New South Wales	6 5 0
Scott, Stanley Edgar	c/o S. K. Johnson, 10 O'Connell-street, Sydney, New South Wales	0 10 0
Millikin, Imilda May (deceased)	c/o T. B. Bresnahan, Tamworth, New South Wales	2 10 0
Curran, Patricia	10 O'Connell-street, Sydney, New South Wales	42 0 0
		90 0 0

Dated the 18th day of March, 1960.

9189

G. B. DICKER,
Secretary.

Companies Act 1958—Tenth Schedule.

ZIRCON RUTILE PTY. LTD.

REGISTER of Unclaimed Money held by the Zircon Rutile Pty. Ltd.

Name of Owner on Books.	Total Amount Due to Owner.	Description of Unclaimed Money.	Date of Last Claim.
£ s. d.			
Ashmore, William Henry	42 13 9	Dividend	..
Evans, Reginald	0 5 0	"	..
Fitzhenry, Eileen	77 11 1	"	..
Isaacson, (estate) late Isidor	29 13 5	"	..
Muir, M. G.	1 5 0	"	..
McCartney, Christina Haye	39 11 3	"	..
Punton, John	5 0 0	"	..
Robb, Cyril	0 1 0	"	..
Thomson, Duncan	0 2 6	"	..
Weeks, James Robert	105 13 2	"	..
Love, (estate) late E. D.	4 6 0	"	..
O'Donnell, (estate) late Margaret Ellen	2 1 0	"	..
Gillespie, Helen	1 17 6	"	..
Schiavoni, J. J.	3 2 6	"	..
Elliott, (estate) late Horace	1 12 0	"	..
Johnston, Godfrey Wentworth H.	0 10 0	"	..
315 5 2			

Dated this 15th day of March, 1960.

9155

A. DARLING,
Secretary.

The Companies Act 1958—10th Schedule.

AUTO PURCHASE PROPRIETARY LIMITED.

REGISTER of Unclaimed Moneys held by Auto Purchase Proprietary Limited, as at 1st March, 1960.

Name and Address of Owner in Books.	Total Amount Due to Owner.	Description of Unclaimed Money.	Date of Last Claim.
£ s. d.			
Vincent Vernon Hart deceased, 360 Collins-street, Melbourne	84 4 0	Dividend on 400 Shares	No claim

G. E. BARKER, Secretary.

Dated at Melbourne, this 21st day of March, 1960. 9195

The Companies Act 1958—10th Schedule.

VILLAGE THEATRE LIMITED.

REGISTER of Unclaimed Moneys held by the Village Theatre Limited, as at 1st March, 1960.

Name and Address of Owner in Books.	Total Amount Due to Owner.	Description of Unclaimed Money.	Date of Last Claim.
£ s. d.			
Karl Millbrook, 161 Toorak-road, South Yarra	1 7 8	Dividend on 1 Share	No claim

G. E. BARKER, Secretary.

Dated at Melbourne, this 21st day of March, 1960. 9194

HUDDART PARKER LIMITED.

(No. 4969/8303.)

REGISTER of Unclaimed Money held by Huddart Parker Limited, 466 Collins-street, Melbourne, in Victoria, for the years 1954-1959.

Date of Last Claim.	Name of Owner on Books.	Total Amount Due to Owner.
		£ s. d.
1955—August	J. Morris, Painter and Docker	0 3 10
	D. Blacken, Painter and Docker	0 3 10
	P. Devine, Painter and Docker	0 3 10
	W. Allen, Painter and Docker	0 3 10
	D. Markwell, Painter and Docker	0 3 10
	T. Molloy, Painter and Docker	0 13 5
	R. Ashworth, Painter and Docker	0 2 6
	H. James, Painter and Docker	0 2 6
	P. Turner, Painter and Docker	0 2 6
	K. Fisher, Painter and Docker	0 3 8
October	J. Dart, Painter and Docker	0 5 2
	R. Steele, Painter and Docker	0 19 6
	D. Markwell, Painter and Docker	0 5 2
	W. Allen, Painter and Docker	0 16 2
	J. Morris, Painter and Docker	0 6 1
	S. Cameron, Painter and Docker	0 1 3
	P. Devine, Painter and Docker	0 6 1
	D. Blackler, Painter and Docker	0 15 10
	T. Bell, Painter and Docker	0 2 6
	R. Penrose, Painter and Docker	0 8 6
1956—May	J. Casson, Butcher, <i>Woomera</i>	1 0 0
	H. Bertram, Butcher, <i>Westralia</i>	2 18 0
1957—July	T. Jones, Cook, <i>Batman</i>	6 15 5
	B. Farrell, Painter and Docker	0 2 0
1958—March	J. Northcote, Painter and Docker	0 2 0
	E. King, Painter and Docker	0 15 9
	E. Jeanat, Painter and Docker	0 15 9
May	A. Micallef, <i>Westralia</i>	0 7 0
	D. Kearmahar, Painter and Docker	0 6 0
1959—November	K. Beavis, Passage Money	5 0 0
	May and Baker, Passage Money	1 0 0
	J. Palmer, Wharfage	2 15 0
December	Passage Money	0 1 0
		28 7 11

Melbourne, 11th January, 1960.

9118

Companies Act 1958.—Pursuant to Section 153 (3)
WANGARATTA WOOLLEN MILLS LIMITED.

REGISTER of Unclaimed Moneys held by Wangaratta Woollen Mills Limited, as at 1st March, 1960.

Name of Owner on Books.	Total Amount due to Owner.	Description of Unclaimed Money.	Date of last Claim.
	£ s. d.		
Bell, J. R.	0 12 0	Dividends payable in respect of year ended 31.5.53	..
Bradley, P. J. (estate of)	5 17 7	" " "	..
Buscall, E. J. (estate of)	0 12 0	" " "	..
Dodd, W.	0 12 0	" " "	..
Hennessy, P. (estate of)	0 12 0	" " "	..
Hill, W. J.	0 12 0	" " "	..
Klemm, T. A.	1 19 7	" " "	..
Lawrence, J. F. (estate of)	0 12 0	" " "	..
Lennard, E. E.	1 10 0	" " "	..
Lindner, J. W. (estate of)	6 0 0	" " "	..
Martin, T. (estate of)	0 12 0	" " "	..
McPherson, C. J.	0 12 0	" " "	..
Nolan, T. C. (estate of)	6 0 0	" " "	..
Naughtin, M. M. (estate of)	2 2 0	" " "	..
Ohlin, W.	0 12 0	" " "	..
O'Malley, M. (estate of)	0 13 2	" " "	..
Slater, G.	1 16 0	" " "	..
Way, G. S. (estate of)	0 12 0	" " "	..
Wright, C. S.	12 0 0	" " "	..
	43 18 4		

9237

Companies Act 1958, Section 153.—Tenth Schedule.
McEWAN'S LIMITED.

REGISTER of Unclaimed Money held by McEwan's Limited.

Name and Address of Owner on Books.	Total Amount Due to Owner.	Description of Unclaimed Money.	Date of Last Claim.
	£ s. d.		
Estate C. E. Moore (deceased), 82 The Grove, East Coburg	5 0 0	Dividends on 50 shares for years 1952 and 1953	No Claim

9170

C. L. SAMPSON,
Secretary.

The Companies Act 1958.
**THE CASTLEMAINE BREWERY COMPANY
 MELBOURNE LIMITED.**

REGISTER of Unclaimed Moneys held by the Castlemaine Brewery Company Limited on 1st March, 1960.

Name of Owner on Books.	Total Amount Due to Owner.	Description of Unclaimed Money.
	£ s. d.	
Blake, Thomas (deceased), (address unknown)	8 14 0	Dividends 1951-52
Donovan Honoria M., (address unknown)	1 10 0	" "
Edwards, James Herbert, (address unknown)	17 14 0	" "

9193

CREDITORS, next of kin, and others having claims in respect of the estate of Alice Simms Horkings, late of 281 Beach-road, Black Rock, in the State of Victoria, widow, deceased (who died on the 16th day of October, 1959), are to send the particulars of their claims to the Equity Trustees, Executors and Agency Company Limited, of 472 Bourke-street, Melbourne, by the 1st day of June, 1960, after which date it will distribute the assets, having regard only to the claims of which it then has notice.

DOOLAN, KEMP & TOWNSEND, solicitors, 340 Collins-street, Melbourne. 9221

CREDITORS, and others having claims against the estate of Lee Go, formerly of 67 Hampton-street, Hampton, but late of 1 Crisp-street, Hampton, retired laundryman, deceased, are required to send particulars, in writing, of their claims to the executors, care of the undersigned, on or before the 31st May, 1960, after which date they will distribute the assets, having regard only to the claims of which they then have notice.

BRUCE R. TIVEY, solicitor, Ararat. 9213

KENNETH CLEMENT GARING, late of 16 Long-street, Swan Hill, in the State of Victoria, Town Clerk, DECEASED (who died on the 17th November, 1959).

CREDITORS, next of kin, and all other persons having claims against the estate of the deceased are required by the executrix of the will, Marie Garing, to send particulars to her, care of the undersigned, on or before the 22nd day of June, 1960, after which date she will distribute the assets, having regard only to the claims of which she then has notice.

GARDEN & GREEN, solicitors, McCallum-street, Swan Hill. 9223

THOMAS SHIPTON SAMPSON, late of Lang Lang, farmer, DECEASED.

CREDITORS, next of kin, and others having claims against the estate of the deceased (who died on the 29th of September, 1959), are required by the executor, The Trustees, Executors and Agency Company Limited, of 401 Collins-street, Melbourne, to send particulars to it by the 31st day of May, 1960, after which date the executor may convey and distribute the assets, having regard only to the claims of which it then has notice.

GRAY, FRIEND & LONG, solicitors, Warragul. 9242

CREDITORS, next of kin, and others having claims against the estate of Alan Hood Jamieson, late of Sutton-road, Warragul, farmer, deceased (who died on the 19th October, 1959), are to send particulars of their claims to The Union Trustee Company of Australia Limited, of 333 Collins-street, Melbourne, the executor appointed by deceased's Will, on or before the 6th June, 1960, after which date the company will distribute the assets, having regard only to the claims of which it shall then have had notice.

M. DAVINE, solicitor, Warragul. 9279

EMILY ESTELLA WILSON, late of Autumn-street, Geelong West, widow, DECEASED.

CREDITORS, next of kin, and others having claims in respect of the estate of the deceased (who died on the 7th day of July, 1959), are required by the personal representatives, Richard Joseph Branch, contractor, and Stanley Neville Branch, draughtsman, both of Lara, to send particulars to them, care of the under-mentioned solicitors, by the 1st day of June, 1960, after which date the personal representatives may convey or distribute the assets, having regard only to the claims of which they then have notice.

WHYTE, JUST & MOORE, solicitors, 27 Malop-street, Geelong. 9254

CREDITORS, next of kin, and others having claims in respect of the estate of Winifred Jackson, of The Grand Hotel, Hunter-street, Sydney, in the State of New South Wales, married woman, deceased (who died on the 17th day of March, 1959), are to send particulars of their claims to The Trustees, Executors and Agency Company Limited, of 401 Collins-street, Melbourne, by the 28th day of May, 1960, after which date it will distribute the assets, having regard only to the claims of which it then has notice.

J. COLIN STEDMAN & CAMERON, solicitors, 339 Collins-street, Melbourne. 9275

PURSUANT to the Trustee Act, creditors, claimants and all persons having claims against the estate of Eric William Osmond, late of 32 Lynch-street, Footscray, in the State of Victoria, toolmaker, deceased, are required to send in writing notice of their claims to Cecil William Osmond, of 32 Lynch-street, Footscray aforesaid, retired bank official, to whom letters of administration of the estate of the said deceased were granted by the Supreme Court of Victoria, on or before the 1st day of June, 1960, after which date the administrator will distribute the assets to the persons beneficially entitled thereto, having regard only to the claims of which the administrator shall then have had notice.

KIDDLE, BRIGGS & WILLOX, 400 Collins-street, Melbourne, solicitors for the administrator. 9268

CREDITORS, next of kin, and others having claims in respect of the estate of Arthur Kingston James, late of 21 Rose-street, Box Hill, council employee, deceased (who died on the 19th day of October, 1959), are to send the particulars of their claims to The Fidelity Trustee Company Limited, at its Melbourne office, No. 50 Market-street, Melbourne, by the 31st day of May, 1960, after which date it will distribute the assets, having regard only to the claims of which it then has notice.

RIGBY & FIELDING, solicitors, 90 William-street, Melbourne. 9274

CREDITORS, next of kin, and others having claims in respect of the estate of Elizabeth Clarisse McVey, late of Dunedin, in New Zealand, spinster, deceased (who died on the 15th day of August, 1959), are to send particulars of their claims to The Trustees, Executors and Agency Company Limited, of 401 Collins-street, Melbourne, in Victoria, by the 31st day of May, 1960, after which date it will distribute the assets, having regard only to the claims of which it then has notice.

RIGBY & FIELDING, solicitors, 90 William-street, Melbourne. 9273

CREDITORS, next of kin, and others having claims in respect of the estate of May Dale, late of Vincent-street, Daylesford, widow, deceased (who died on the first day of May, 1959), are required to send particulars of their claims to the administrator, The Equity Trustees, Executors and Agency Company Limited, of 472 Bourke-street, Melbourne, by the 10th day of June, 1960, after which date the administrator may convey or distribute the assets, having regard only to the claims of which it then has notice.

TREVOR MORRIS & SON, solicitors, 108 Queen-street, Melbourne. 9271

CREDITORS, next of kin, and others having claims in respect of the estate of Harold Frederick Swanson, late of 66 Blair-street, Coburg, retired builder, deceased (who died on 15th day of December, 1959), are required by the executor of his will, John Lawrence Molomby, of 99 Queen-street, Melbourne, to send particulars to the said executor, care of the under-mentioned solicitors, by the 31st day of May, 1960, after which date the executor may convey or distribute the assets, having regard only to the claims of which he then has notice.

MOLOMBY & MOLOMBY, 99 Queen-street, Melbourne, solicitors. 9270

CREDITORS, next of kin, and others having claims in respect of the estate of Phebe White, late of 44 Denbigh-road, Armadale, in the State of Victoria, spinster, deceased (who died on the 17th day of December, 1959), are to send particulars to The Trustees, Executors and Agency Company Limited, of 401 Collins-street, Melbourne, by the 8th day of June, 1960, after which date the said company will distribute the estate of the deceased, having regard only to the claims of which it then has notice.

GILLOTT, MOIR & AHERN, solicitors, 95 Queen-street, Melbourne. 9266

CREDITORS, next of kin, and others having claims in respect of the estate of Lady Mary Marjorie Alexa Gavan Duffy, late of "Clivedon Mansions", Wellington-parade, East Melbourne, in the State of Victoria, married woman, deceased (who died on the 18th day of October, 1959), are to send particulars of their claims to National Trustees, Executors and Agency Company of Australasia Limited, 95 Queen-street, Melbourne, by the 1st day of June, 1960, after which date the said company will distribute the estate of the said deceased, having regard only to the claims of which it then has notice.

GILLOTT, MOIR & AHERN, solicitors, 95 Queen-street, Melbourne. 9265

CREDITORS, next of kin, and all others having claims against the estate of Ellice Marlow Slane, late of Auckland, in the Provincial District of Auckland, in the Dominion of New Zealand, gentleman, deceased (who died on 1st February, 1959), are to send particulars of their claims by the 1st day of June, 1960, to The Trustees, Executors and Agency Company Limited, of 401 Collins-street, Melbourne, on whose application as attorney under power of The Guardian Trust and Executors Company of New Zealand Limited, the executor to whom probate of the will of the said deceased was granted by the Supreme Court of New Zealand Northern Judicial District, Auckland Registry, the said probate was resealed by the Supreme Court of Victoria, and after the said 1st day of June, 1960, the said The Trustees, Executors and Agency Company Limited will distribute the assets, having regard only to the claims of which it then has notice.

HADEN SMITH & FITCHETT, solicitors, 405 Collins-street, Melbourne. 9297

CREDITORS, next of kin, and all others having claims in respect of the estate of Elizabeth Grace Perry, late of Arnold-street, Orbost, widow, deceased (who died on 1st May, 1958, and Probate of whose will was duly granted to Lila Elizabeth Neilson, of 1 Fordham-avenue, Camberwell, married woman, and William Henry Baughurst, of Orbost, grocer, the executors named therein), are required to send particulars of their claims to the said executors, care of the under-mentioned solicitors, on or before the 1st day of June, 1960, after which date the said executors will proceed to distribute the estate of the said deceased to the persons entitled thereto, having regard only to the claims of which they shall then have had notice.

W. A. PRENDERGAST & ROBINSON, 17 Queen-street, Melbourne, solicitors. 9303

AGNES MARY NEYLON, late of 317 St. Kilda-road, Brighton, in the State of Victoria, widow, DECEASED.

CREDITORS, next of kin, and others having claims in respect of the estate of the above-named deceased (who died on the 10th day of December, 1959), are required by the executor, the National Trustees, Executors and Agency Company of Australasia Limited, of 95 Queen-street, Melbourne, to send particulars to the above-named company, by the 30th day of May, 1960, after which date the executor may convey or distribute the assets, having regard only to the claims of which the said company then has notice.

Dated the 30th day of March, 1960.

OSWALD BURT & CO., of 178 William-street, Melbourne, solicitors for the above-named executor. 9259

MARY EMMA HAYMAN, formerly of 11 Masefield-street, Sandringham, but late of 209 Bluff-road, Sandringham, widow, DECEASED.

CREDITORS, next of kin, and others having claims in respect of the estate of the deceased (who died on the 14th day of October, 1959, and probate of whose will and codicil was granted to The Equity Trustees, Executors and Agency Company Limited, of 472 Bourke-street, Melbourne), are required by the said personal representative of the said deceased to send particulars to it at 472 Bourke-street, Melbourne, by the 31st day of May, 1960, after which date the said personal representative may convey or distribute the assets, having regard only to the claims of which it then has notice.

ALLAN C. BELCHER, solicitor, 422 Collins-street, Melbourne. 9301

JESSIE MARY SYME, late of 7 Florence-avenue, Kew, in the State of Victoria, married woman, DECEASED.

CREDITORS, next of kin, and others having claims in respect of the estate of the deceased (who died on the 24th day of October, 1959), are required by the personal representatives, Ronald York Syme, of 98 Pleasant-road, East Hawthorn, sharebroker, Kenneth Burdett York Syme, of 13 Toorak-avenue, Toorak, shipping manager, and The Union Trustee Company of Australasia Limited, of 333 Collins-street, Melbourne, to send particulars to them, in the care of the said company, by the 3rd day of June, 1960, after which date they may convey or distribute the assets, having regard only to the claims of which they then have notice.

HEDDERWICK, FOOKES & ALSTON, 103 William-street, Melbourne. 9296

VERA McLENNAN, late of 15 Kendall-street, Elwood, in the State of Victoria, widow, DECEASED.

CREDITORS, next of kin, and others having claims in respect of the estate of the deceased (who died on the 13th day of September, 1959), are required by the executrix and trustee, Violet McPhee, of No. 1 Poplar-street, Caulfield, care of R. Wadhams and Doig, solicitors, of 383 Flinders-lane, Melbourne, to send particulars to her by the 10th day of June, 1960, after which the said trustee may convey or distribute the assets, having regard only to the claims of which she then has notice.

R. WADHAM & DOIG, of 383 Flinders-lane, Melbourne, solicitors. 9300

CREDITORS, next of kin, and others having claims in respect of the estate of William Thomas Manger, late of 4 Clarendon-street, Coburg, railway employee, deceased (who died on the 4th day of August, 1958), are required to send particulars of their claims to the executor, Robert Mifflin Manger, care of his solicitors, Louis P. Le Grand and Randles, 660 Sydney-road, Brunswick, by the 1st day of June, 1960, after which date the said executor will distribute the assets, having regard only to the claims of which he then has notice.

LOUIS P. LE GRAND & RANGLES, solicitors, 660 Sydney-road, Brunswick. 9294

DAVID ROBERTSON JOHNSTON, late of 54 Calvert-street, Colac, retired grocer, DECEASED.

CREDITORS, next of kin, and others having claims in respect of the estate of the deceased (who died on the 26th day of June, 1959), are required by the executors, Colin Crichton Begg and George Charles Norwood, both of Colac, solicitors, to send particulars to them, by the 1st day of June, 1960, after which date the executors may convey or distribute the assets, having regard only to the claims of which they then have notice.

Dated the 11th day of March, 1960.

SEWELL & SEWELL, Colac, solicitors for the executors. 9287

SYDNEY WILLIAM BARTLETT, late of 393 Buckley-street, Essendon, retired builder, DECEASED.

CREDITORS, next of kin, and others having claims in respect of the estate of the deceased (who died on the 8th day of January, 1960), are required by the trustee, The Fidelity Trustee Company Limited, of 101 Lydiard-street north, Ballarat, to send particulars of their claims to it, by the 9th day of June, 1960, after which date the said company may convey or distribute the assets, having regard only to the claims of which it shall then have had notice.

DUGDALE, SIMMONS & STEVENS, Peacock House, 486 Bourke-street, Melbourne, solicitors. 9302

In the Supreme Court of the State of Victoria.

SALE BY THE SHERIFF.

ON Friday, the 13th day of May, 1960, at Eleven a.m., at the Police Station, Grimshaw-street, Greensborough (unless process be stayed or satisfied):—

All the estate and interest (if any) of Edwin John Brewer, of Crest-street, Greensborough, plumber, as proprietor of an estate in fee simple in firstly: All that piece of land being lot 166 on plan of subdivision No. 11093, lodged in the Office of Titles and being part of Crown portion 13, Parish of Nillumbik, County of Evelyn, and being the whole of the land in certificate of title, volume 8040, folio 412. Secondly, all that piece of land being lots 167 and 168 on plan of subdivision No. 11093, lodged in the Office of Titles, and being part of Crown portion 13, Parish of Nillumbik, County of Evelyn, and being the whole of the land in certificate of title, volume 7770, folio 064, lot 166, has a frontage of 80 feet to Crest-street and a depth of 192 ft. 10 in. At the rear of the lot are some fowl pens which are erected on lot 166 and protrude into lot 168. Lot 167 has a frontage of 182 ft. 10 in. to Forest-street and 70 feet to Crest-street. Erected thereon is a triple fronted single-storey white painted weatherboard house with corrugated iron roof and is situated on the corner of Crest and Forest streets, Greensborough. Lot 168 has a frontage of 254 ft. 4 in. to Hope-street, and erected on the rear of the lot are some fowl pens which protrude into lot 166.

Registered mortgage No. A.225829 for approximately £2,000 affects the said estate and interest only in regard to lots 167 and 168.

Terms: Cash only.

DAVID J. JOHNSTON, Sheriff's Officer.

28th March, 1960.

9291

In the Supreme Court of the State of Victoria.

SALE BY THE SHERIFF.

ON Friday, the 6th day of May, 1960, at Eleven a.m., at the Police Station, Reservoir (unless process be stayed or satisfied):—

All the estate and interest (if any) of Bignell Estates Proprietary Limited, a company whose registered office is 6-8 Claremont-street, South Yarra, as proprietor of an estate in fee simple in the land described in certificate of title, volume 8209, folio 366, upon which is erected a three-bedroom cream brick veneer house, with red tile roof and steel frame windows, and has a frontage of 40 feet to Chaley-street, East Preston. There is a low brick fence in front and the property is known as lot 261, Chaley-street, East Preston. Lot 261 is on the south side of Chaley-street, commencing 315 ft. 5½ in. west from Crevelli-street.

Registered mortgage No. A.714362 for approximately £2,500 affects the said estate and interest.

Terms: Cash only.

DAVID J. JOHNSTON, Sheriff's Officer.

28th March, 1960. 9288

In the Supreme Court of the State of Victoria.

SALE BY THE SHERIFF.

ON Monday, the 9th day of May, 1960 at Eleven a.m., at the Police Station, Lincoln-road, Essendon (unless process be stayed or satisfied):—

All the estate and interest (if any) of Robert Bryce Williams, of lot 1 Clydesdale-road, North Essendon, sheet metal worker, as proprietor of an estate in fee simple in the land described in certificate of title, volume 8182, folio 919, upon which is erected a weatherboard house known as No. 20 Clydesdale-road, North Essendon.

Registered mortgage No. A.425964 for approximately £2,600, and registered caveat No. A.619903, affect the said estate and interest.

Terms: Cash only.

DAVID J. JOHNSTON, Sheriff's Officer.

28th March, 1960. 9289

In the Supreme Court of the State of Victoria.

SALE BY THE SHERIFF.

ON Wednesday, the 11th day of May, 1960, at Eleven a.m., at the Police Station, Kingsville (unless process be stayed or satisfied):—

All the estate and interest (if any) of John Albert Tribe, of lot 232 Stenhouse-avenue, Brooklyn, bread carter, as proprietor of an estate in fee simple in the land described in certificate of title, volume 7969, folio 122, upon which is erected a weatherboard house known as lot 232 Stenhouse-avenue, Brooklyn.

Registered mortgage No. A.429902 for approximately £2,450 affects the said estate and interest.

Terms: Cash only.

DAVID J. JOHNSTON, Sheriff's Officer.

28th March, 1960. 9290

In the Supreme Court of the State of Victoria.

SALE BY THE SHERIFF.

ON Friday, the 13th day of May, 1960, at Two p.m., at the Police Station, at Piangil (unless process be stayed or satisfied):—

All the estate and interest (if any) of Harry Kevin Kiley (known as Kevin Kiley), of Piangil, Victoria, dealer, as proprietor of an estate in fee simple in all these pieces of land delineated and coloured purple on the map in the margin containing 87½ acres 3 rods and 4 perches or thereabouts, being Crown allotments 116, 116A, 117, 124 and 125, Parish of Piangil, County of Tatchera, being the land particularly described in certificate of title, volume 7746, folio 112, upon which is erected a five-roomed brick dwelling with a brick garage, together with cowsheds, store sheds, machinery sheds and pigstys. The said land is located in the Piangil district, and can be reached by travelling 28 miles north from Swan Hill along the Murray Valley Highway. At the 28-mile post there is a turn-off to the right of about 1 mile to Tooleybuc (New South Wales). Proceed along this turn-off to a farm house which is approximately 100 yards from the bridge over the River Murray. Immediately to the left past this farm house is a dirt road which leads directly to the property. Proceed along this dirt road, which runs parallel to the River Murray, for approximately a ½ mile. At this point there is a gate (being the only gate along the

road) which is the entrance to the property. The land is bounded on the east side by the River Murray, and on the western side by the Murray Valley Highway, and consists of approximately 872 acres.

Registered mortgage No. A.23437 for an undisclosed amount, affects the said estate and interest.

Terms: Cash only.

K. BROWN, Sheriff's Officer.
9255

25th March, 1960.

MINING NOTICES

NEW ENGLAND ANTIMONY MINES N.L.

NOTICE is hereby given that all issued contributing shares in the capital of the company on which a Call (the Seventh) of 1s. 6d. per share due on Wednesday, 9th March, 1960, has not been paid are forfeited and will be sold at 12.15 p.m. on Wednesday, 6th April, 1960, in the Vestibule of The Stock Exchange of Melbourne, without postponement.

By order of the Board,

A. T. MOLLOY, Secretary.

11th Floor, 100 Collins-street, Melbourne, C.I. 9261

IMPOUNDINGS

HAMILTON.—Impounded in Hamilton Pound, from Salpan-road, Tarrenlea, by Dundas Ranger.

1 Corriedale ram, front notch near ear, punch hole off ear, no visible brand

Impounded from Digby-road, by Shire Ranger.

1 Hereford steer, slit near ear, no visible brand

If not claimed and expenses paid, to be sold on 2nd April, 1960.

9285—15/ F. FYFE, Poundkeeper.

HEIDELBERG.—Impounded in Macleod Pound.

1 bay gelding, white star, no visible brand

1 grey gelding, no visible brand

If not claimed and expenses paid, to be sold on 14th April, 1960.

9256—10/6 F. PHILLIPS, Poundkeeper.

SWAN HILL.—Impounded in Swan Hill Pound.

1 Southdown ram, 6-tooth, Inglewood ear tag

If not claimed and expenses paid, to be sold on 13th April, 1960.

9278—9/ C. RONCON, Poundkeeper.

WHITTLESEA.—Impounded in Whittlesea Pound, by Ranger.

1 black crossbred heifer, no visible brand

2 red and white crossbred heifers, no visible brand

If not claimed and expenses paid, to be sold on 19th April, 1960.

9307—12/ B. F. ELLER, Poundkeeper.

CONTENTS

	PAGE
Appointments	1082
Auction Sales Act	1075
Anzac Day Holiday	1069
Cemetery—Scale of Fees	1079
Contracts	1081
Country Roads Board	1084
Easter Holidays	1069
Estates of Deceased Persons	1070
Government Notices	1069
Impoundings	1118
Lands	1092
Licences to Occupy Unused Roads	1077
Melbourne and Metropolitan Board of Works— Notices	1079
Mining	1070, 1118
Notice to Mariners	1076
Orders in Council	1083
Private Advertisements	1104
Proclamations	1063
Publication of the <i>Victoria Government Gazette</i>	1070
Public Service Notices	1100
Resignations	1083
State Rivers and Water Supply Commission	1076
Tenders	1096
Transport Regulation Board—Public Hearings	1071
Waterworks Trusts	1080



VICTORIA GOVERNMENT GAZETTE

Published by Authority

[Registered at the General Post Office, Melbourne, for transmission by post as a newspaper.]

No. 26]

WEDNESDAY, MARCH 30

[1960

Country Fire Authority Act 1958.

VARIATION OF SUMMER PERIOD IN RESPECT OF SPECIFIED PARTS OF THE COUNTRY AREA OF VICTORIA.

WHEREAS by section 4 of the *Country Fire Authority Act 1958* it is enacted that the Chief Secretary of Victoria, after consultation with the Minister of Forests, may from time to time by declaration published in the *Government Gazette* declare any period to be the summer period in respect of the country area of Victoria, or any specified part or parts thereof and, without affecting the generality of the foregoing, may declare different periods to be the summer period in respect of different parts of the said country area:

And whereas by the said section it is further enacted that any declaration so published may be revoked, amended, or varied by a subsequent declaration so published:

And whereas by declarations published in the *Government Gazette* of the 16th December, 1959, and the 23rd December, 1959, different summer periods expiring on the fifteenth day of April, 1960, were declared in respect of different parts of the country area of Victoria, including the parts of the said country area specified in the Schedule hereto:

And whereas by Proclamations issued on the 1st December, 1959, and the 8th December, 1959, and published in the *Government Gazette* of the 2nd December, 1959, and the 9th December, 1959, respectively, different summer periods expiring on the fifteenth day of April, 1960, were proclaimed in respect of different parts of the country area of Victoria, including the parts of the said country area specified in the Schedule hereto:

And whereas it is deemed expedient that the aforesaid declarations and Proclamations should be varied in the manner hereinafter described:

And whereas the Chief Secretary and the Minister of Forests have consulted accordingly:

Now therefore I, Arthur Gordon Rylah, Chief Secretary of Victoria, do by this my declaration vary the aforesaid declarations and Proclamations by declaring that the summer period in respect of the parts of the country area of Victoria specified in the Schedule hereto shall end at midnight on the thirtieth day of March, 1960.

SCHEDULE.

- The Third Fire Control Region comprising the municipal districts of the Cities of Geelong, Geelong West and Newtown and Chilwell, and those portions of the Shires of Bellarine, Corio and South Barwon not included in the Seventh Fire Control Region;
- the Sixth Fire Control Region comprising the municipal districts of the City of Colac, the Town of Camperdown and the Shires of Colac, Hampden, Heytesbury and Otway;
- the Seventh Fire Control Region comprising the municipal districts of the Borough of Queenscliffe, the Shires of Bannockburn, Barrabool, Leigh, Winchelsea and those portions of the Shires of Bellarine, Corio and South Barwon not included in the Third Fire Control Region;
- the Eighth Fire Control Region comprising the municipal districts of the Cities of Chelsea and Dandenong, the Borough of Wonthaggi, the Shires of Bass, Berwick, Cranbourne, Flinders, Frankston and Hastings, Mornington, Phillip Island and Springvale and Noble Park, and those portions of the Shire of Muirgrave not included in the Metropolitan Fire District and French Island;
- the Ninth Fire Control Region comprising the municipal districts of the Borough of Moe, the Shires of Buln Buln, Korumburra, Mirboo, Narracan, South Gippsland, Warragul and Woorayl and the Yallourn Works Area, as defined pursuant to the *State Electricity Commission Act 1958*;
- the Twelfth Fire Control Region comprising the municipal districts of the Shires of Alexandra and Yea;
- the Thirteenth Fire Control Region comprising the municipal districts of the Shires of Fern Tree Gully, Healesville and Upper Yarra, and those portions of the City of Heidelberg and the Shires of Doncaster and Templestowe, Eltham and Lillydale not included in the Metropolitan Fire District;
- the Fourteenth Fire Control Region comprising the municipal districts of the Shires of Bacchus Marsh, Broadford, Bulla, Gisborne, Kilmore, Melton, Newham and Woodend and Romsey, and those portions of the Cities of Broadmeadows and Sunshine and the Shires of Altona, Kellor, Werribee and Whittlesea not included in the Metropolitan Fire District;
- and those portions of the Twenty-second Fire Control Region comprised by the municipal districts of the Shires of Goulburn, Pyalong and Seymour.

A. G. RYLAH,
Chief Secretary.

Chief Secretary's Office,
Melbourne, 29th March, 1960.

7

3

2

1911

7

7

7