



VICTORIA GOVERNMENT GAZETTE

Published by Authority

[Registered at the General Post Office, Melbourne, for transmission by post as a newspaper.]

No. 92]

WEDNESDAY, OCTOBER 5

[1960

Land Act 1958.

UNALIENATED CROWN LAND AVAILABLE FOR SETTLEMENT UNDER IMPROVEMENT PURCHASE LEASES.

PROCLAMATION

By His Excellency the Governor of the State of Victoria and its Dependencies in the Commonwealth of Australia,
&c., &c., &c.

IN pursuance of the provisions of Section 153 of the *Land Act 1958*, I, the Governor of the State of Victoria, in the Commonwealth of Australia, by and with the advice of the Executive Council of the said State, do by this Proclamation declare the unalienated Crown lands mentioned in the subjoined schedule, to be available for settlement under improvement purchase leases.

SCHEDULE.

| County. | Parish. | Allotment. | Section. | Area. | | | Land Valuation. |
|---------------|-------------------|------------|----------|-------|----|----|-----------------|
| | | | | A. | R. | P. | |
| Lowan | Jilpanger | 11C | .. | 390 | 0 | 0± | £2 per acre |

Given under my Hand and the Seal of the State of Victoria aforesaid, at Melbourne this twenty-seventh day of September, in the year of our Lord One thousand nine hundred and sixty, and in the ninth year of the reign of Her Majesty Queen Elizabeth II.

(L.S.)

DALLAS BROOKS.

By His Excellency's Command,

KEITH TURNBULL,
Commissioner of Crown Lands and Survey.

GOD SAVE THE QUEEN!

PUBLIC HIGHWAYS.—CITY OF CAMBERWELL.

PROCLAMATION

By His Excellency the Governor of the State of Victoria and its Dependencies in the Commonwealth of Australia, &c., &c., &c.

WHEREAS by the *Local Government Act 1958*, section 519, it is amongst other things enacted that it shall be lawful for the Governor in Council at any time, and from time to time, upon the request of the council of any municipality, by notice in the *Government Gazette*, to declare any land reserved, used or by purchase or exchange acquired for a street, road, highway, thoroughfare, bridge, square, court, alley or right-of-way to be a public highway, and that such land shall thereupon and thenceforth from the date of such Proclamation become and be absolutely dedicated to the public as a public highway within the meaning of any law then or thereafter in force:

And whereas the Council of the City of Camberwell has requested that the lands hereinafter mentioned, which have been used for roads within the said City, be so declared to be public highways:

Now, therefore, I, the Governor of the State of Victoria in the Commonwealth of Australia, by and with the advice of the Executive Council of the said State, do by this Proclamation, declare that all those pieces of land used for roads known as Walnut-street, part Stroma-avenue and Turnley-street, and being part of Elgar's Crown Special Survey, Parish of Boroondara, County of Bourke, and being shown by hachure on the plans hereunder, shall be public highways within the meaning of the said Act.

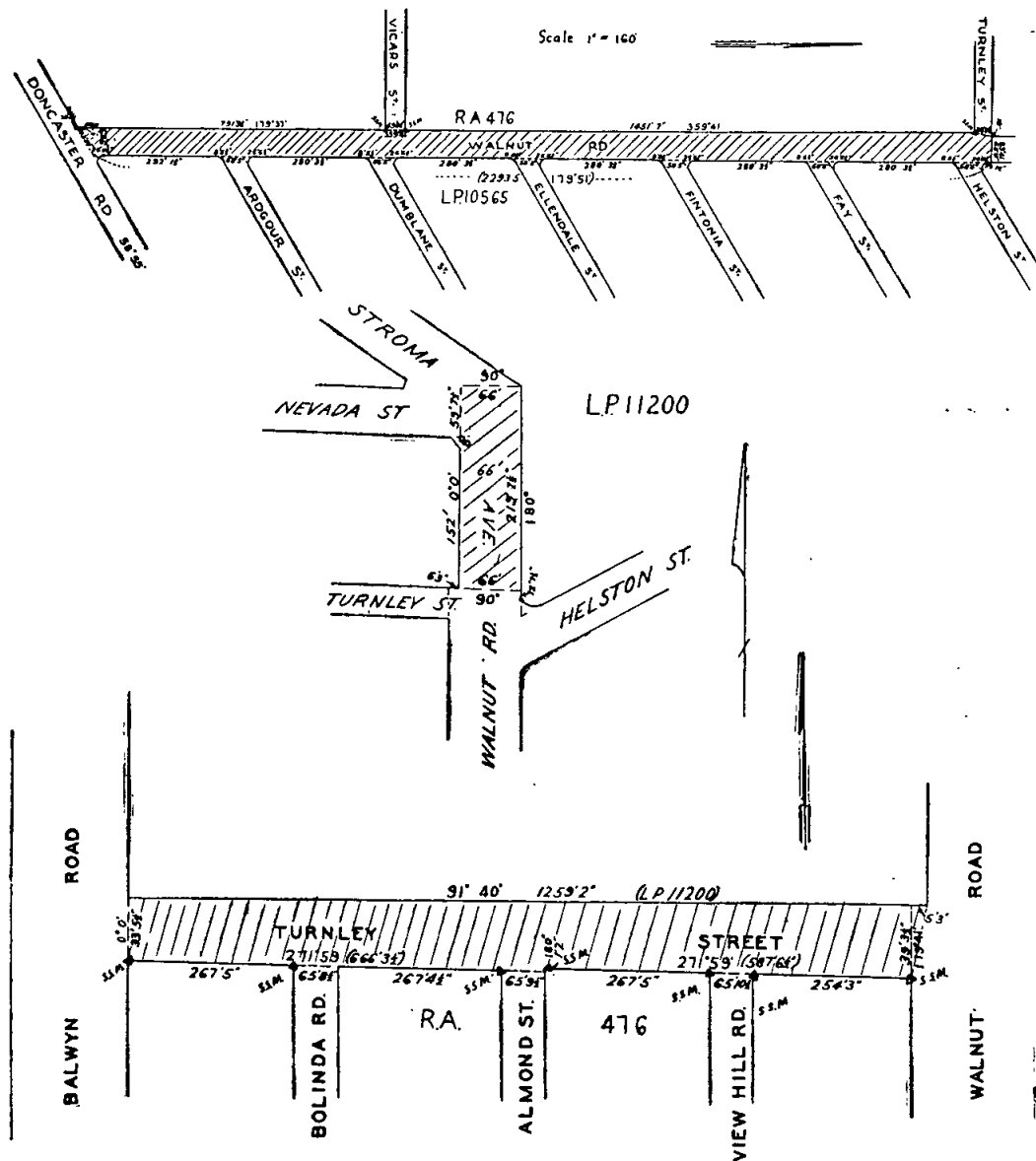

Given under my hand and the Seal of the State of Victoria aforesaid, at Melbourne, this twenty-seventh day of September, in the year of our Lord One thousand nine hundred and sixty, and in the ninth year of the reign of Her Majesty Queen Elizabeth II.

(L.S.)

DALLAS BROOKS.

By His Excellency's Command,

MURRAY PORTER,
Minister for Local Government.

PUBLIC HIGHWAY.—CITY OF NUNAWADING.

PROCLAMATION

By His Excellency the Governor of the State of Victoria and its Dependencies in the Commonwealth of Australia, &c., &c., &c.

WHEREAS by the *Local Government Act 1958*, section 519, it is amongst other things enacted that it shall be lawful for the Governor in Council at any time, and from time to time, upon the request of the council of any municipality, by notice published in the *Government Gazette*, to declare any land reserved, used or by purchase or exchange acquired for a street, road, highway, thoroughfare, bridge, square, court, alley or right-of-way to be a public highway, and that such land shall thereupon and thenceforth from the date of such Proclamation become and be absolutely dedicated to the public as a public highway within the meaning of any law then or thereafter in force:

And whereas the Council of the City of Nunawading has requested that the land hereinafter mentioned, which has been used for a street within the said City, be so declared to be a public highway:

Now, therefore, I, the Governor of the State of Victoria in the Commonwealth of Australia, by and with the advice of the Executive Council of the said State, hereby proclaim that all that piece of land used for a street known as Zander-avenue, Nunawading, being set out as a street on lodged plan No. 19728, being part of Crown portion 66, Parish of Nunawading, and being shown by hachure on the plan hereunder, shall be a public highway within the meaning of the said Act.

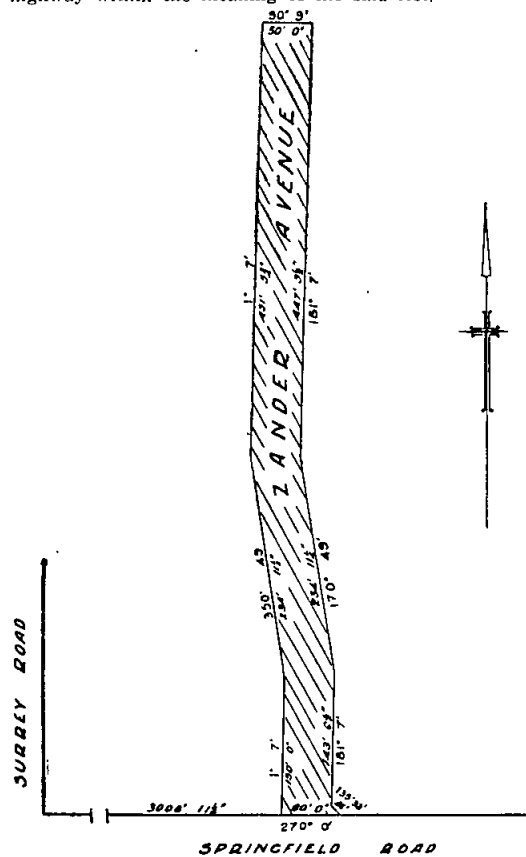

Given under my Hand and the Seal of the State of Victoria aforesaid, at Melbourne, this twenty-seventh day of September, in the year of our Lord One thousand nine hundred and sixty, and in the ninth year of the reign of Her Majesty Queen Elizabeth II.

(L.S.) DALLAS BROOKS.

By His Excellency's Command,
MURRAY PORTER,
Minister for Local Government.
GOD SAVE THE QUEEN!

BANK HOLIDAYS.

PROCLAMATION

By His Excellency the Governor of the State of Victoria and its Dependencies in the Commonwealth of Australia, &c., &c., &c.

IN pursuance of the provisions of the *Banks Holidays Act 1958*, I, the Governor of the State of Victoria, in the Commonwealth of Australia, do by this my Proclamation appoint the days and dates named hereunder special days to be observed as Bank Holidays or Bank-Holidays (as the case may be) at the places respectively mentioned, that is to say:—

Bank Holidays:—

- WEDNESDAY, THE 19TH OCTOBER, 1960, at Dookie.
- SATURDAY, THE 29TH OCTOBER, 1960, at Sale.
- SATURDAY, THE 29TH OCTOBER, 1960, at Murtoa.

Given under my Hand and the Seal of the State of Victoria aforesaid, at Melbourne, this fourth day of October, in the year of our Lord One thousand nine hundred and sixty, and in the ninth year of the reign of Her Majesty Queen Elizabeth II.

(L.S.) DALLAS BROOKS.

By His Excellency's Command,
L. H. S. THOMPSON,
Acting Chief Secretary.
GOD SAVE THE QUEEN!

MELBOURNE CUP DAY.—PUBLIC HOLIDAY.

PROCLAMATION

By His Excellency the Governor of the State of Victoria and its Dependencies in the Commonwealth of Australia, &c., &c., &c.

IN pursuance of the provisions contained in Part III. of the *Public Service Act 1958*, I, the Governor of the State of Victoria, in the Commonwealth of Australia, by and with the advice of the Executive Council of the said State, do by this my Proclamation appoint the day and date hereunder mentioned to be observed as a Public Holiday at the places respectively specified, viz:—

Public Holiday:—

- TUESDAY, THE 1ST NOVEMBER, 1960,
Throughout the Cities of Box Hill, Brighton, Broadmeadows, Brunswick, Camberwell, Caulfield, Chelsea, Coburg, Collingwood, Dandenong, Essendon, Fitzroy, Footscray, Hawthorn, Heidelberg, Kew, Malvern, Melbourne, Moorabbin, Mordialloc, Northcote, Nunawading, Oakleigh, Port Melbourne, Prahran, Preston, Richmond, Ringwood, St. Kilda, Sandringham, South Melbourne, Sunshine and Williamstown; the Shires of Altona, Bacchus Marsh, Berwick, Bulla, Cranbourne, Doncaster and Templestowe, Eltham, Fern Tree Gully, Frankston and Hastings, Gisborne, Keilor, Lillydale, Melton, Mornington, Mulgrave, Romsey, Springvale and Noble Park, Werribee and Whittlesea.

Given under my Hand and the Seal of the State of Victoria aforesaid, at Melbourne, this fourth day of October, in the year of our Lord One thousand nine hundred and sixty, and in the ninth year of the reign of Her Majesty Queen Elizabeth II.

(L.S.) DALLAS BROOKS.

By His Excellency's Command,
L. H. S. THOMPSON,
Acting Chief Secretary.
GOD SAVE THE QUEEN!

HOLIDAY.—MELBOURNE CUP DAY.

NOTICE is hereby given that on—

TUESDAY, THE 1ST NOVEMBER, 1960,

the Public Offices in the municipalities mentioned hereunder will be closed, that day being appointed by the *Public Service Act 1958* to be observed as a holiday in the Public Offices:—

- The Cities of Box Hill, Brighton, Broadmeadows, Brunswick, Camberwell, Caulfield, Chelsea, Coburg, Collingwood, Dandenong, Essendon, Fitzroy, Footscray, Hawthorn, Heidelberg, Kew, Malvern, Melbourne, Moorabbin, Mordialloc, Northcote, Nunawading, Oakleigh, Port

Melbourne, Prahran, Preston, Richmond, St. Kilda, Sandringham, South Melbourne, Sunshine and Williamstown; the Borough of Ringwood; the Shires of Altona, Bacchus Marsh, Berwick, Bulla, Cranbourne, Doncaster and Templestowe, Eltham, Fern Tree Gully, Frankston and Hastings, Gisborne, Keilor, Lillydale, Melton, Mornington, Mulgrave, Romsey, Springvale and Noble Park, Werribee and Whittlesea.

This notice relates only to the closing of the State Public Offices. All inquiries regarding holidays in other offices and in shops and industry should be directed to the Department of Labour and Industry, Old Treasury Building, Spring-street, Melbourne. (Telephone 63 0321, Extension 6158 or 6382.)

L. H. S. THOMPSON,
Acting Chief Secretary.

Chief Secretary's Office,
Melbourne, 4th October, 1960.

NOTICE.

ADMINISTRATION of the estate of each of the under-mentioned deceased persons has been granted to the Public Trustee, and creditors, next of kin, and all others having claims against the estate of any of the persons so mentioned are required to send particulars of their claims to the Public Trustee, 7th Floor, 601 Little Collins-street, Melbourne, on or before the 8th December, 1960, or they will be excluded from the distribution of the estate when the assets are being distributed:—

*CARTER, HARRIET, late of 20 Empress-road, Surrey Hills, gentlewoman, died 12th May, 1959.

*DAYMOND, ALICIA JANE, late of 71 Robeson-street, West Preston, widow, died 29th June, 1960.

*DONOHUE, JAMES BERTIE, late of 6 Munro-avenue, Carnegie, retired railway employee, died 9th June, 1960.

DOWNES, JAMES, late of Bendigo Benevolent Home, Bendigo, labourer, died 26th August, 1959, intestate.

†EVANS, HENRY ALFRED, formerly of Richmond-road, Richmond, South Australia, but late of 47A Brighton-road, Elwood, retired bookmaker, died 8th March, 1960.

*FFRENCH, ANNIE, formerly of Regents-court, South Yarra, but late of 5 Chaddesley-avenue, East St. Kilda, pensioner, died 22nd September, 1959.

KING, JOHN HENRY, late of 60 Devon-avenue, West Coburg, died 22nd June, 1960, intestate.

MORISON, JOHN, formerly of 176 Toorak-road, South Yarra, but late of 25 Wanalta-road, Glenhuntly, labourer, died 30th April, 1960, intestate.

MCALPINE, KEITH CHARLES, late of Longwarry, council employee, died 7th July, 1960, intestate.

ROFE, CHARLOTTE MONICA, also known as Lottie Rofe, late of 353 Brunswick-road, West Brunswick, widow, died 20th June, 1960, intestate.

*SCOTT, THOMAS, late of 56 Whitby-street, West Brunswick, manager, died 5th November, 1959.

SHANLEY, KEVIN FRANCIS, late of 12 Bangerang-avenue, North Sunshine, painter, died 21st May, 1960, intestate.

SHARMAN, ERIC WILLIAM, formerly of 33 Henry-street, Windsor, but late of Kinglake West, labourer, died 13th July, 1960, intestate.

*STEVENS, THOMAS, late of Wangarabell (in the will spelt Wangrabelle), grazier, died 20th August, 1942.

*WYLIE, EDITH BOROONDARA, late of 29 Seaford-road, Seaford, widow, died 14th August, 1959.

* With the will annexed.

† According to the provisions of the will.

A. D. DUNCAN,
Public Trustee.

Melbourne, 28th September, 1960.

PUBLIC TRUSTEE ACT 1958 (No. 6350).—SECTION 17.

I HEREBY give notice that on the 16th September, 1960, the Public Trustee filed an election to administer the following deceased person's estate, in accordance with section 17 of the *Public Trustee Act 1958*:—

MCALPINE, KEITH CHARLES, late of Longwarry, council employee, died 7th July, 1960, intestate.

I HEREBY give notice that on the 19th September, 1960, the Public Trustee filed elections to administer the following deceased persons' estates, in accordance with section 17 of the *Public Trustee Act 1958*:—

DOWNES, JAMES, late of Bendigo Benevolent Home, Bendigo, labourer, died 26th August, 1959, intestate.

*EVANS, HENRY ALFRED, formerly of Richmond-road, Richmond, South Australia, but late of 47A Brighton-road, Elwood, retired bookmaker, died 8th March, 1960.

* According to the provisions of the will.

A. D. DUNCAN,
Public Trustee.

601 Little Collins-street, Melbourne, C.1, 28th September, 1960.

Local Government Act 1958.

PETITION FOR ALTERATION OF THE NAME OF THE SHIRE OF FRANKSTON AND HASTINGS.

IN pursuance of the provisions of section 43 of the Local Government Act 1958, the substance and prayer of a petition presented to His Excellency the Governor in Council, in accordance with section 38 of the said Act, are published, viz.:—

The President, Councillors and Ratepayers of the Shire of Frankston and Hastings pray that His Excellency the Governor in Council will, in exercise of the powers provided by section 16 of the *Local Government Act 1958*, alter the name of the said municipality to the Shire of Frankston.

M. V. PORTER,
Minister for Local Government.

Local Government Department,
Melbourne.

RULES OF THE SUPREME COURT.

IN pursuance of the powers conferred by the *Supreme Court Act 1958* and all other powers hereunto enabling the following amendments of Chapter I. of the Rules of the Supreme Court are made:—

In Rule 1B of Order LIV.—

- (a) after the expression "Order LIV. Rules 5, 6, 7, 8 and 9," there shall be inserted the expression "Order LIV. (C) Rule 5,"; and
(b) at the end of the Rule there shall be inserted the following expression:—

"or under sub-section (3) of section eighty-four of the *Property Law Act 1958*."

Dated this twenty-first day of September, 1960, at Judges' Chambers, Supreme Court, Melbourne.

E. F. HERRING, C.J.
CHARLES J. LOWE, J.
C. GAVAN DUFFY, J.
NORMAN O'BRYAN, J.
ARTHUR DEAN, J.
R. R. SHOLL, J.
T. W. SMITH, J.
R. V. MONAHAN, J.
A. D. G. ADAM, J.
D. M. LITTLE, J.

CONTRACTS ACCEPTED.—(Series 1960-61.)

| Contract No. | Particulars. | Amount. | Name of Contractor. | Charge against Vote or Fund. |
|--------------|---|--------------------|---|-----------------------------------|
| 1065 | PROVISIONS— Supply of Butter and Cheese in such quantities as may be ordered from 1st October, 1960, to 30th September, 1961 | Rates as per annex | Ararat Butter and Freezing Co. Ltd. | Contingencies, 1960-61 1961-62 |
| 1066 | " " " " " " | " | Austral Grain and Ambler Pty. Ltd. | |
| 1067 | " " " " " " | " | P. Cleland and Sons Pty. Ltd. | |
| 1068 | " " " " " " | " | Myrtleford Co-op. Butter Factory Co. Ltd. | |
| 1069 | " " " " " " | " | Stawell Butter Factory and Ice Co. | |
| 1070 | " " " " " " | " | Wallace Dairy Co. Ltd. | |

Approved—H. E. BOLTE, Treasurer, 20.9.60.

ANNEX TO CONTRACT NOS. 1960/1065 TO 1960/1070.

Schedule No. 24.

PROVISIONS—BUTTER AND CHEESE.

CONTRACT FROM 1ST OCTOBER, 1960, TO 30TH SEPTEMBER, 1961.

1960/1065.—Ararat Butter and Freezing Co. Ltd. Security, £60.
 1960/1066.—Austral Grain and Ambler Pty. Ltd. Security, £100.
 1960/1067.—P. Cleland and Sons Pty. Ltd. Security, £400.
 1960/1068.—Myrtleford Co-op. Butter Factory Co. Ltd. Security, £60.
 1960/1069.—Stawell Butter Factory and Ice Co. Security, £25.
 1960/1070.—Wallace Dairy Co. Ltd. Security, £60.

Butter.—To be choicest grade Creamery Butter, to score not less than 93 points Government Grade, Commerce Regulations Standard.

Cheese.—To be first-class quality, semi or fully matured, as ordered, and not less than three months old. If the quantity admits it shall be boxed for transport.

| Item No. | Particulars. | Rate. | Name of Contractor. |
|----------|--|------------------------------|---|
| 1 | Melbourne District— Butter | Per cwt.—Ruling market rate* | P. Cleland and Sons Pty. Ltd. |
| 2 | Cheese | Per cwt.—Metropolitan rate* | |
| 3 | Mont Park District— Butter | Per cwt.—Ruling market rate* | |
| 4 | Cheese | Per cwt.—Metropolitan rate* | |
| 5 | Ararat District— Butter | Per cwt.—Ruling market rate | Ararat Butter and Freezing Co. Ltd. |
| 6 | Cheese | Per cwt.—Country rate§ | Austral Grain and Ambler Pty. Ltd. |
| 7 | Ballarat District— Butter | Per cwt.—Ruling Market rate | Wallace Dairy Co. Ltd. |
| 8 | Cheese | Per cwt.—£15 3 4 | |
| 9 | Beechworth District— Butter | Per cwt.—Ruling market rate | Myrtleford Co-op. Butter Factory Co. Ltd. |
| 10 | Cheese | Per cwt.—Country rate¶ | |
| 11 | Stawell—Pleasant Creek Special School— Butter | Per cwt.—Ruling market rate | Stawell Butter Factory & Ice Co. |
| 12 | Cheese | Per cwt.—Country rate§ | |
| 13 | Sunbury District— Butter | Per cwt.—Ruling market rate | Austral Grain and Ambler Pty. Ltd. |
| 14 | Cheese | Per cwt.—Country rate † | |

Butter.—Ruling market rate, bulk £25 1s. 8d., Pats, £25 16s. 8d. per cwt.

Cheese.—

Metropolitan rate per lb.—

| | | |
|-----------------------|------------------------|-----------------------|
| 40-lb. size— | 20-lb. size— | 10-lb. size— |
| Semi-matured, 3s. 1d. | Semi-matured, 3s. 1½d. | Semi-matured, 3s. 2d. |
| Matured, 3s. 3½d. | Matured, 3s. 4d. | Matured, 3s. 4½d. |

§ Country rate per lb. (Ararat and Stawell)—

| | | |
|-----------------------|------------------------|-----------------------|
| 40-lb. size— | 20-lb. size— | 10-lb. size— |
| Semi-matured, 3s. 0d. | Semi-matured, 3s. 0½d. | Semi-matured, 3s. 1d. |
| Matured, 3s. 2d. | Matured, 3s. 2½d. | Matured, 3s. 3d. |

¶ Country rate per lb. (Beechworth)—

| | | |
|------------------------|-------------------------|------------------------|
| 40-lb. size— | 20-lb. size— | 10-lb. size— |
| Semi-matured, 2s. 11d. | Semi-matured, 2s. 11½d. | Semi-matured, 3s. 0½d. |
| Matured, 3s. 1d. | Matured, 3s. 1½d. | Matured, 3s. 2½d. |

† Country rate per lb. (Sunbury)—

| | | |
|------------------------|-------------------------|-----------------------|
| 40-lb. size— | 20-lb. size— | 10-lb. size— |
| Semi-matured, 2s. 11d. | Semi-matured, 2s. 11½d. | Semi-matured, 3s. 0d. |
| Matured, 3s. 1d. | Matured, 3s. 1½d. | Matured, 3s. 2d. |

* Items Nos. 1 to 4—Cartage charges: Butter, 2s. per box; Cheese, 40-lb. 2s. per cheese; 20-lb. single cheese 2s., two or more, 1s. 6d. per cheese; 10-lb. single cheese 1s. 6d., two or more, 1s. per cheese.

CONTRACTS ACCEPTED.—(Series 1960-61.)

PROVISIONS.—MEAT.

| No. of Contract. | Particulars of Each Tender Accepted. | Amount. | Name of Contractor. | Charge Against Vote or Fund. | |
|--|--|--------------------|--|------------------------------|--|
| PROVISIONS— | | | | | |
| Supply of Meat, in such quantities as may be ordered, from 1st October, 1960, to 31st December, 1960. | | | | | |
| Schedule No. 1.—Melbourne District— | | | | | |
| 1125 | Kew Mental Hospital | Rates as per annex | F. Watkins Pty. Ltd. .. | Contingencies, 1960-61 | |
| 1126 | Pentridge Penal Establishment and "Fairlea" Female Prison, Fairfield | " " | Jackson's Meat Co. Pty. Ltd. | | |
| 1127 | Children's Welfare Depot, Royal Park, and Travancore Developmental Centre, Flemington | " " | J. H. Cooke Pty. Ltd. .. | | |
| 1128 | "Winlaton" Juvenile School, 186 Springvale-road, Nunawading | " " | J. H. Cooke Pty. Ltd. .. | | |
| 1129 | Royal Park Mental Hospital and Receiving House .. | " " | J. H. Cooke Pty. Ltd. .. | | |
| Schedule No. 2.—Mont Park, Bundoora, Larundel, Janesfield, Gresswell, and Pleasant View, Wood-street, Preston— | | | | | |
| 1130 | Mont Park District | " " | W. Angliss and Co. (Aust.) Pty. Ltd. | | |
| 1131 | Preston | " " | W. Angliss and Co. (Aust.) Pty. Ltd. | | |
| 1132 | Schedule No. 3.—SS. Rip and Dredges | " " | Jackson's Meat Co. Pty. Ltd. | | |
| 1133 | Schedule No. 4.—Teachers' College and Hostels at Grattan-street, 93 Drummond-street, Carlton; 470 and 481 St. Kilda-road, Melbourne; 19 Queens-road, Melbourne; 152 Toorak-road west, South Yarra; Frank Tate House, 373 Dandenong-road, Armadale; "Redcourt" 6 and "Lar-nook," 13 Orrong-road Armadale; 11 Patterson-street, Hawthorn; 174 Punt-road, Prahran; 221 Burwood-road, Burwood; John Cannon House, 32 Belmont-avenue, Kew; 17 Moule-avenue, Brighton; Police Hospital, St. Kilda-road, Melbourne; and Mental Hygiene Clinic, 321 Glenferrie-road, Malvern | " " | J. H. Cooke Pty. Ltd. .. W. Angliss and Co. (Aust.) Pty. Ltd. | | |
| 1134 | Schedule No. 5.—Heatherton Sanatorium, Cheltenham .. | " " | H. A. Morris | | |
| 1135 | Schedule No. 6.—Ararat District | " " | H. A. Morris | | |
| 1136 | Schedule No. 7.—Ballarat District— Gaol and Mental Hospital | " " | H. A. Morris | | |
| 1137 | Teachers' Hostels | " " | H. A. Morris | | |
| 1138 | Schedule No. 8.—Beechworth District | " " | E. Spencer | | |
| Schedule No. 9.—Bendigo District— | | | | | |
| 1139 | Gaol | " " | Alan H. Gittins | | |
| 1140 | Sandhurst Boys' Centre | " " | Alan H. Gittins | | |
| 1141 | Teachers' Hostels | " " | M. P. & L. K. Marchioni | | |
| 1142 | Schedule No. 10.—Castlemaine District | " " | McQueen Bros. | | |
| 1143 | Schedule No. 11.—School of Forestry, Creswick | " " | H. J. Symons Pty. Ltd. | | |
| 1144 | Schedule No. 13.—McLeod Settlement, French Island .. | " " | George Hayman | | |
| Schedule No. 14.—Geelong District— | | | | | |
| 1145 | Gaol | " " | A. R. Bubb | | |
| 1146 | Teachers' College Hostels | " " | A. C. Knight | | |
| 1147 | Schedule No. 15.—Coorimungle Prison Camp, Heytesbury Forest | " " | Heytesbury Butchery | | |
| 1148 | Schedule No. 17.—Langi Kal Kal Training Centre | " " | F. P. Haintz and Son | | |
| 1149 | Schedule No. 20.—Sale Gaol | " " | Sale North Meat Supply | | |
| 1150 | Schedule No. 21.—Pleasant Creek Special School, Stawell .. | " " | H. A. Morris | | |
| 1151 | Schedule No. 22.—Sunbury District | " " | F. Watkins Pty. Ltd. | | |
| 1152 | Schedule No. 23.—Warrnambool District | " " | Thomas Borthwick & Sons (A/Asia) Ltd. | | |

Approved H. E. BOLTE, Treasurer.—20.9.60.

SCHEDULE NO. 1.—MELBOURNE DISTRICT.

ANNEX TO CONTRACT No. 1960/1125.

F. Watkins Pty. Ltd., 184 Bourke-street, Melbourne.

Sub-schedule No. 9.

MEAT FOR MENTAL HOSPITAL, KEW.

Security, £35.

| | £ | s. | d. |
|---|---------|----|----|
| Fresh Beef— | | | |
| 1. Rolled Roast boneless (Brisket excluded) per cntl. | 13 | 6 | 8 |
| 2. Buttocks | do. | 12 | 18 |
| 3. Shin and Gravy Beef (boneless) | do. | 12 | 10 |
| 4. Corned Beef—Rolled or Round, as ordered, without bone or cartilage | do. | 12 | 10 |
| 5. Fresh Mutton—(Whole Sheep) (Kidney fat to be removed) | | | |
| 6. Veal—boned | per lb. | 0 | 2 |
| 7. Sausage Meat | do. | 0 | 1 |
| 8. Sausages—Mixed | do. | 0 | 1 |
| 9. Livers—Sheep | do. | 0 | 2 |
| 10. " Ox | do. | 0 | 1 |
| 11. Kidneys, Ox | do. | 0 | 2 |
| 12. " Sheep | do. | 0 | 2 |
| 13. Tripe, Fresh | do. | 0 | 1 |
| 14. Tongues—Ox | do. | 0 | 1 |

SCHEDULE No. 1.—MELBOURNE DISTRICT—continued.

| | £ | s. | d. |
|----------------------------------|----------|----|----|
| 15. Sausage—Belgium | per lb. | 0 | 2 |
| 16. Beef Loaf | do. | 0 | 2 |
| 17. Ham Loaf | do. | 0 | 3 |
| 18. Veal Loaf | do. | 0 | 3 |
| 19. Saveloys | per doz. | 0 | 3 |
| 20. Brains, Sheep | per set | 0 | 0 |
| 21. Fowls, First quality | per lb. | 0 | 5 |
| 22. Bacon Sides | do. | 0 | 5 |
| 23. Rabbit Fillets | do. | 0 | 4 |

ANNEX TO CONTRACT No. 1960/1126.

Jackson's Meat Co. Pty. Ltd. P.O. Box 163, Footscray.

Sub-schedule No. 10.

MEAT FOR PENTRIDGE PENAL ESTABLISHMENT, COBURG; AND

"FAIRLEA" FEMALE PRISON, FAIRFIELD.

Security, £35.

| | £ | s. | d. |
|---|-----------|----|----|
| Fresh Beef— | | | |
| 1. Fore-quarters | per cntl. | 9 | 7 |
| 2. Minced | do. | 13 | 15 |
| 3. Corned Beef—Rolled or Round, as ordered, without bone or cartilage | do. | 13 | 15 |
| 4. Fresh Mutton (whole sheep) | do. | 5 | 8 |
| 5. Sausages—Mixed—thin | per lb. | 0 | 1 |

SCHEDULE No. 1.—MELBOURNE DISTRICT—continued.

| | per lb. | £ | s. | d. |
|--------------------------------|---------|---|----|----|
| 6. Fresh Suet—Kidney | per lb. | 0 | 0 | 9 |
| 7. Saveloys | do. | 0 | 1 | 8 |
| 8. Sausage—Beef German | do. | 0 | 2 | 2 |
| 9. Sausage Mince | do. | 0 | 1 | 1 |
| 10. Dripping, Beef | do. | 0 | 1 | 4 |
| 11. Frankfurts | do. | 0 | 2 | 2 |
| 12. Livers—Sheep | do. | 0 | 1 | 10 |

ANNEX TO CONTRACT No. 1960/1127.

J. H. Cooke Pty. Ltd., 378 Queen's-parade, Clifton Hill.

Sub-schedule No. 11.

MEAT FOR CHILDREN'S WELFARE DEPOT, ROYAL PARK, AND TRAVANCORE DEVELOPMENTAL CENTRE, FLEMINGTON.

| | per lb. | £ | s. | d. |
|---|---------|---|----|----|
| 1. Fresh Beef—Rolled Roast Sirloin—Boneless | per lb. | 0 | 3 | 0 |
| 2. Beef—Corned—Silverside | do. | 0 | 3 | 6 |
| Fresh Mutton— | | | | |
| 3. Legs | do. | 0 | 1 | 9 |
| 4. Legs (Two tooth) | do. | 0 | 1 | 10 |
| 5. Chops—Mid Loin (Two tooth) | do. | 0 | 1 | 6 |
| 6. Rib Chops as Cutlets (Two tooth) | do. | 0 | 1 | 6 |
| Steak— | | | | |
| 7. Rump | do. | 0 | 4 | 6 |
| 8. Blade | do. | 0 | 3 | 3 |
| 9. Minced | do. | 0 | 2 | 6 |
| 10. Skirt | do. | 0 | 3 | 0 |
| 11. Veal—Fillet, boneless | do. | 0 | 3 | 9 |
| 12. Pickled Pork | do. | 0 | 2 | 0 |
| 13. Sausages—Mixed | do. | 0 | 1 | 10 |
| 14. Sausage—Strasburg, Pork | do. | 0 | 3 | 5 |
| 15. Tripe—Fresh | do. | 0 | 0 | 10 |
| 16. Frys—Lamb | do. | 0 | 2 | 0 |
| 17. Brains—Sheep | per set | 0 | 0 | 6 |
| 18. Shanks—Sheep | each | 0 | 0 | 6 |
| 19. Ox Tongue | per lb. | 0 | 1 | 0 |
| 20. Frankfurts | do. | 0 | 2 | 8 |
| 21. Rabbits—Fresh | do. | 0 | 3 | 5 |

ANNEX TO CONTRACT No. 1960/1128.

J. H. Cooke Pty. Ltd. 378 Queen's-parade, Clifton Hill.

Sub-schedule No. 12.

FOR "WINLATON" JUVENILE SCHOOL, 186 SPRINGVALE-ROAD, NUNAWADING.

| | per lb. | £ | s. | d. |
|---|---------|---|----|----|
| Fresh Beef— | | | | |
| 1. Rolled Roast Sirloin, Boneless | per lb. | 0 | 2 | 6 |
| 2. Corned—Silverside | do. | 0 | 3 | 6 |
| 3. Mutton Fresh—Fore-quarters | do. | 0 | 1 | 0 |
| 4. " " Legs | do. | 0 | 1 | 9 |
| 5. " " Legs (Two tooth) | do. | 0 | 1 | 10 |
| 6. " " Chops—Mid Loin (Two tooth) | do. | 0 | 1 | 9 |
| 7. Steak—Rump | | | | |
| 8. " Stewing | do. | 0 | 3 | 3 |
| 9. " Minced | do. | 0 | 2 | 6 |
| 10. Sausages—Mixed | do. | 0 | 2 | 0 |
| 11. Sausage Meat | do. | 0 | 1 | 0 |
| 12. Frys—Lamb | do. | 0 | 2 | 6 |
| 13. Veal—Fillet—Boneless | do. | 0 | 3 | 10 |
| 14. Pork—Pickled | do. | 0 | 2 | 0 |
| 15. Kidneys—Ox | do. | 0 | 2 | 6 |
| 16. Tongues—Ox | do. | 0 | 1 | 6 |
| 17. Tripe—Fresh | do. | 0 | 0 | 10 |
| 18. Brains—Sheep | per set | 0 | 0 | 6 |
| 19. Shanks—Sheep | each | 0 | 0 | 6 |
| 20. Sausage—Strasburg—Pork | per lb. | 0 | 3 | 3 |
| 21. Frankfurts | do. | 0 | 2 | 4 |
| 22. Rabbits—Fresh | do. | 0 | 3 | 5 |

ANNEX TO CONTRACT No. 1960/1129.

J. H. Cooke Pty. Ltd., 378 Queen's-parade, Clifton Hill

Sub-schedule No. 13.

MEAT FOR RECEIVING HOUSE AND MENTAL HOSPITAL, ROYAL PARK.

| | per lb. | £ | s. | d. |
|---|---------|---|----|----|
| Fresh Beef— | | | | |
| 1. Rolled Roast, boneless (Brisket excluded) | per lb. | 0 | 2 | 9 |
| 2. Thick Flank | do. | 0 | 3 | 2 |
| 3. Topside | do. | 0 | 3 | 3 |
| 4. Fresh Mutton (Legs) | do. | 0 | 1 | 9 |
| 5. Corned Beef—Rolled or Round, as ordered, without bone or cartilage | do. | 0 | 3 | 1 |
| 6. Chops—Middle Loin | do. | 0 | 1 | 4 |
| 7. " Fore-quarter | do. | 0 | 1 | 0 |
| 8. Sausages—Mixed | do. | 0 | 1 | 10 |
| 9. Sausage—Mince | do. | 0 | 1 | 0 |
| 10. Veal, fillets | do. | 0 | 2 | 9 |
| 11. Livers—Calves | do. | 0 | 1 | 0 |
| 12. Tripe—Fresh | do. | 0 | 0 | 7 |
| 13. Rabbits—Fresh | do. | 0 | 3 | 3 |
| 14. Fowls—First quality | do. | 0 | 5 | 5 |

SCHEDULE No. 2.—MONT PARK AND SANATORIUM GRESSWELL, ETC.

ANNEX TO CONTRACT No. 1960/1130.

W. Angliss and Co. (Aust.) Pty. Ltd., 42 Bourke-street, Melbourne

Sub-schedule No. 4.

MEAT.

(For Mont Park Mental Hospital, &c.)

| | per | £ | s. | d. |
|---|-----------|----|----|----|
| Fresh Beef— | | | | |
| 1. Buttocks | per cntl. | 12 | 10 | 0 |
| 2. Roast | do. | 6 | 13 | 4 |
| 3. Rolled Roast—Boneless (Brisket excluded) | do. | 12 | 18 | 4 |
| Beef, Corned— | | | | |
| 4. Rolled or Round, as ordered, without bone or cartilage | do. | 11 | 5 | 0 |
| 5. Corned—Silverside | do. | 17 | 10 | 0 |
| Mutton, Fresh— | | | | |
| 6. Carcass or Sides (Kidney fat to be removed) | do. | 4 | 2 | 3½ |
| 7. Legs | per lb. | 0 | 1 | 5 |
| 8. Fore-quarter | do. | 0 | 0 | 8 |
| Chops— | | | | |
| 9. Fore-quarter | do. | 0 | 1 | 2 |
| 10. Loin | do. | 0 | 1 | 5 |
| Steak— | | | | |
| 11. Thick Flank | do. | 0 | 3 | 3 |
| 12. Rump | do. | 0 | 4 | 3 |
| 13. Minced | do. | 0 | 2 | 3 |
| 14. Topside | do. | 0 | 3 | 6 |
| 15. Sausage—Meat | do. | 0 | 1 | 5 |
| 16. Sausages—Mixed | do. | 0 | 2 | 1 |
| 17. Shanks—Sheep | each | 0 | 0 | 6 |
| 18. Tripe—Fresh | per lb. | 0 | 0 | 8½ |
| 19. Brains—Sheep | per set | 0 | 0 | 7 |
| 20. Kidneys—Ox | per lb. | 0 | 3 | 0 |
| 21. Livers—Sheep | do. | 0 | 2 | 3 |
| 22. Livers—Calves | do. | 0 | 1 | 3 |
| 23. Sausage—Strasburg, Pork | do. | 0 | 3 | 4 |
| 24. Rabbits—Fresh (Gresswell only) | do. | 0 | 3 | 0 |
| 25. Saveloys | per doz. | 0 | 4 | 0 |
| 26. Tongues—Ox | per lb. | 0 | 1 | 6 |
| 27. Tongues—Sheep | each | 0 | 0 | 6 |
| 28. Ham Loaf | per lb. | 0 | 3 | 3 |
| 29. Fillet Veal | do. | 0 | 2 | 6 |
| 30. Veal and Pork Loaf | do. | 0 | 4 | 5 |
| 31. Pressed Shoulder Ham | do. | 0 | 7 | 6 |
| 32. Fowls—First quality | do. | 0 | 5 | 6 |
| 33. Lamb Chops (Gresswell only) | do. | 0 | 4 | 0 |
| 34. Frankfurts (Gresswell only) | per doz. | 0 | 5 | 0 |

ANNEX TO CONTRACT No. 1960/1131.

W. Angliss and Co. (Aust.) Pty. Ltd., 42 Bourke-street, Melbourne.

Sub-schedule No. 5.

MEAT.

(For Pleasant View Receiving House, Wood-street, Preston.)

| | per lb. | £ | s. | d. |
|---|----------|---|----|----|
| Security, £5. | | | | |
| Fresh Beef—Roast—Boneless (Brisket excluded) | | | | |
| 1. Fresh Beef—Roast—Boneless (Brisket excluded) | per lb. | 0 | 4 | 3 |
| 2. Corned Beef—Silverside | do. | 0 | 3 | 6 |
| 3. Fresh Lamb—Legs | do. | 0 | 3 | 0 |
| Steak— | | | | |
| 4. Buttock | do. | 0 | 3 | 0 |
| 5. Fillet | do. | 0 | 6 | 6 |
| Chops— | | | | |
| 6. Loin—Lamb | do. | 0 | 4 | 0 |
| 7. Fore-quarter—Lamb | do. | 0 | 1 | 6 |
| 8. Livers—Lamb | do. | 0 | 2 | 3 |
| 9. Sausages—Pork | do. | 0 | 2 | 1 |
| 10. Dripping—Beef | do. | 0 | 1 | 3 |
| 11. Tongues—Ox | do. | 0 | 1 | 10 |
| 12. Brains—Sheep | per set | 0 | 0 | 7 |
| 13. Frankfurts | per doz. | 0 | 5 | 0 |
| 14. Pork—Fresh—Legs | per lb. | 0 | 3 | 9 |
| 15. Sausage—Strasburg—Pork | do. | 0 | 3 | 4 |
| 16. Rabbits—Fresh | do. | 0 | 3 | 0 |
| 17. Capons | do. | 0 | 6 | 6 |
| 18. Tripe | do. | 0 | 0 | 10 |
| 19. Ham, tinned, 2lb. tin | do. | 0 | 10 | 0 |
| 20. Bacon, boned | do. | 0 | 5 | 4 |

SCHEDULE No. 3.—S.S. "Rip" AND DREDGES.
ANNEX TO CONTRACT No. 1960/1132.
Jacksens Meat Co. Pty. Ltd., P.O. Box 163, Footscray.

Sub-schedule No. 3.

MEAT.

(Delivery at River Yarra Wharfs.)

| | Security, £5. | £ | s. | d. |
|---------------------|----------------|---|----|----|
| 1. Fresh Beef—Roast | per lb. | 0 | 1 | 3 |
| Beef—Corned— | | | | |
| 2. Silverside | do. | 0 | 4 | 3 |
| 3. Rolled | do. | 0 | 1 | 3 |
| Fresh Mutton— | | | | |
| 4. Fore-quarter | do. | 0 | 0 | 6 |
| 5. Legs | do. | 0 | 1 | 11 |
| Chops— | | | | |
| 6. Forequarter | do. | 0 | 0 | 10 |
| 7. Loin | do. | 0 | 1 | 8 |
| Steak— | | | | |
| 8. Rump | do. | 0 | 6 | 9 |
| 9. Stewing | do. | 0 | 3 | 0 |
| 10. Topside | do. | 0 | 4 | 0 |
| 11. Sausages—Mixed | do. | 0 | 1 | 10 |
| 12. Tripe—Fresh | do. | 0 | 0 | 10 |
| 13. Livers—Sheep | do. | 0 | 1 | 6 |
| 14. Suet—Kidney | do. | 0 | 0 | 8 |
| 15. Rabbits—Fresh | do. | 0 | 3 | 6 |
| 16. Ice | per cwt. | 0 | 4 | 6 |

SCHEDULE No. 4.—TEACHERS' COLLEGES, HOSTELS,
POLICE HOSPITAL, ETC.

(Delivery at Institutions.)

TEACHERS' COLLEGES AND HOSTELS AT GRATTAN-STREET, 93 DRUMMOND-STREET, CARLTON; 470 AND 481 ST. KILDA-ROAD, MELBOURNE; 19 QUEENS-ROAD, MELBOURNE; 152 TOOBAK-ROAD WEST, SOUTH YARRA; TATE HOUSE, 373 DANDENONG-ROAD, ARMADALE; "REDCOURT" NO. 6, AND "LABNOOK," 13 ORBRONG-ROAD, ARMADALE; 11 PATTERSON-STREET, HAWTHORN; 174 PUNT-ROAD, FRAHRAN, 221 BURWOOD-ROAD, BURWOOD; JOHN CANNON HOUSE, 32 BELMONT-AVENUE, KEW; 17 MOULE-AVENUE, BRIGHTON; POLICE HOSPITAL, ST. KILDA-ROAD, MELBOURNE; AND MENTAL HYGIENE CLINIC, 321 GLENFERRIE-ROAD, MALVERN.

ANNEX TO CONTRACT No. 1960/1133.

J. H. Cooke Pty. Ltd., 378 Queen's-parade, Clifton Hill.

Sub-schedule No. 2.

MEAT.

Security, £15.

| | Security, £15. | £ | s. | d. |
|--------------------------------|----------------|----|--------|----|
| Fresh Beef— | | | | |
| 1. Rolled Prime Ribs, boneless | per lb. | 0 | 2 | 9 |
| 2. Topside | do. | 0 | 3 | 6 |
| 3. Sirloin, boneless | do. | 0 | 3 | 0 |
| Fresh Mutton— | | | | |
| 4. Legs | do. | 0 | 1 | 6 |
| 5. Legs, pickled | do. | 0 | 1 | 6 |
| 6. Sides, Two-tooth | do. | 0 | 1 | 3 |
| 7. Legs, Two-tooth | do. | 0 | 1 | 10 |
| 8. Cutlets | do. | 0 | 1 | 7 |
| 9. Chops, Middle Loin | do. | 0 | 1 | 6 |
| 10. Chops, Forequarter | do. | 0 | 1 | 3 |
| 11. Chops, Chump | do. | 0 | 1 | 6 |
| 12. Beef—Corned, Silverside | do. | 0 | 3 | 6 |
| Veal— | | | | |
| 13. Shoulder, boned | do. | 0 | 2 | 0 |
| 14. Fillet, boneless | do. | 0 | 3 | 10 |
| Steak— | | | | |
| 15. Blade | do. | 0 | 3 | 3 |
| 16. Minced Blade | do. | 0 | 2 | 6 |
| 17. Stewing | do. | 0 | 3 | 0 |
| 18. Rump | do. | 0 | 4 | 3 |
| 19. Minced Steak | do. | 0 | 2 | 6 |
| 20. Sausages—Mixed | do. | 0 | 1 | 10 |
| Sausage— | | | | |
| 21. Meat | do. | 0 | 1 | 3 |
| 22. Beef, German | do. | 0 | 2 | 5 |
| 23. Strasburg | do. | 0 | 3 | 3 |
| 24. Livers—Sheep | do. | 0 | 2 | 3 |
| Kidneys— | | | | |
| 25. Sheep | do. | 0 | 1 | 6 |
| 26. Ox | do. | 0 | 2 | 6 |
| 27. Tongues—Ox | do. | 0 | 1 | 3 |
| 28. Ox Tails | do. | 0 | 1 | 6 |
| 29. Brains—Sheep | per set | 0 | 0 | 4 |
| 30. Tripe—Fresh | per lb. | 0 | 0 | 9 |
| 31. Frankfurts | do. | 0 | 2 | 4 |
| 32. Bones—Soup | do. | no | charge | |
| 33. Suet—Kidney | do. | 0 | 0 | 6 |
| 34. Rabbits—Fresh | do. | 0 | 3 | 3 |
| 35. Fowls—First quality | do. | 0 | 5 | 6 |
| 36. Pork—Legs | do. | 0 | 4 | 3 |

SCHEDULE No. 5.—HEATHERTON SANATORIUM.
ANNEX TO CONTRACT No. 1960/1134.

W. Angliss and Co. (Aust.) Pty. Ltd., 42 Bourke-street, Melbourne. C.I.

Sub-schedule No. 3.

MEAT.

Security, £5.

| | Security, £5. | £ | s. | d. |
|-----------------------------|---------------|---|----|----|
| 1. Beef, Fresh Roast—Rump | per lb. | 0 | 4 | 0 |
| 2. " " Corned—Silverside | do. | 0 | 3 | 6 |
| 3. Lamb, Fresh—Legs | do. | 0 | 2 | 9 |
| 4. " " " Shoulder—Rolled | do. | 0 | 1 | 6 |
| 5. " " " Chops Mid. Loin | do. | 0 | 4 | 0 |
| 6. " " " Chops, Chump | do. | 0 | 3 | 3 |
| 7. " " " Chops, Forequarter | do. | 0 | 1 | 9 |
| 8. " " " Cutlets | do. | 0 | 4 | 3 |
| 9. Pork, Fresh—Legs | do. | 0 | 4 | 0 |
| 10. " " " Chops | do. | 0 | 4 | 6 |
| 11. " " " Minced | do. | 0 | 4 | 3 |
| 12. Veal—Shoulder—Boned | do. | 0 | 1 | 4 |
| 13. " " " Cutlets | do. | 0 | 3 | 11 |
| 14. Steak—Rump | do. | 0 | 4 | 6 |
| 15. " " " Blade | do. | 0 | 3 | 0 |
| 16. " " " Topside | do. | 0 | 3 | 0 |
| 17. " " " Minced | do. | 0 | 2 | 3 |
| 18. " " " Porterhouse | do. | 0 | 4 | 11 |
| 19. " " " Fillet | do. | 0 | 7 | 0 |
| 20. Tripe—Fresh | do. | 0 | 0 | 10 |
| 21. Brains—Sheep | per set | 0 | 0 | 7 |
| 22. Lambs Fry | per lb. | 0 | 2 | 3 |
| 23. Tongues—Sheep | do. | 0 | 2 | 0 |
| 24. Kidneys—Ox | do. | 0 | 3 | 0 |
| 25. Tails—Ox | do. | 0 | 2 | 0 |
| 26. Sausages—Pork | do. | 0 | 2 | 0 |
| 27. Frankfurts—Vienna | do. | 0 | 3 | 4 |
| 28. Beef German—Sausage | do. | 0 | 2 | 6 |
| 29. Ham—Loaf | do. | 0 | 3 | 3 |
| 30. " " " Pressed Shoulder | do. | 0 | 7 | 6 |
| 31. Rabbits, Fresh | do. | 0 | 3 | 0 |
| 32. Capons | do. | 0 | 6 | 6 |

SCHEDULE No. 6.—ARARAT DISTRICT.

ANNEX TO CONTRACT No. 1960/1135.

H. A. Morris, 107 Victoria-street, Ballarat.

Sub-schedule No. 4.

MEAT.

Security, £30.

| | Security, £30. | £ | s. | d. |
|---|----------------|----|----|----|
| Fresh Beef— | | | | |
| 1. Rolled Roast (Boneless, brisket excluded) | per ont. | 10 | 0 | 0 |
| 2. Buttocks | do. | 11 | 13 | 4 |
| 3. Fresh Mutton—Kidney fat to be removed | do. | 5 | 0 | 0 |
| 4. " " " Middle Loin Chops | do. | 5 | 0 | 0 |
| 5. Corned Beef—Rolled or Round, as ordered, without bone or cartilage | do. | 10 | 0 | 0 |
| 6. Kidney—Ox | per lb. | 0 | 1 | 3 |
| 7. Veal—Filletted | do. | 0 | 1 | 11 |
| 8. Sausages—Mixed | do. | 0 | 1 | 8½ |
| 9. Livers—Sheep | do. | 0 | 0 | 6 |
| 10. Tripe—Fresh | do. | 0 | 0 | 6 |
| 11. Steak—Topside | do. | 0 | 3 | 3 |
| 12. Beef Luncheon Loaf | do. | 0 | 2 | 0 |
| 13. Sausage Meat | do. | 0 | 1 | 0 |

SCHEDULE No. 7.—BALLARAT DISTRICT.

ANNEX TO CONTRACT No. 1960/1136.

H. A. Morris, 107 Victoria-street, Ballarat.

Sub-schedule No. 4.

MEAT.

(For Gaol and Mental Hospital.)

Security, £35.

| | Security, £35. | £ | s. | d. |
|---|----------------|----|----|----|
| Fresh Beef— | | | | |
| 1. Buttocks | per ont. | 12 | 18 | 4 |
| 2. Roast—Rolled (Brisket excluded) | do. | 10 | 16 | 8 |
| 3. Beef, Corned, Rolled or Round, as ordered, without bone or cartilage | do. | 10 | 8 | 4 |
| Mutton—Fresh— | | | | |
| 4. Kidney fat removed (Mental Hospital) | do. | 5 | 8 | 4 |
| 5. Mincemeat | per lb. | 0 | 1 | 0 |
| 6. Sausages | do. | 0 | 1 | 8 |
| 7. Sausage, Beef, German | do. | 0 | 2 | 0 |
| 8. Tripe | do. | 0 | 0 | 6 |
| 9. Ham Loaf | do. | 0 | 2 | 0 |
| 10. Savelys | do. | 0 | 1 | 9 |

SCHEDULE No. 7.—BALLARAT DISTRICT—continued.

ANNEX TO CONTRACT No. 1960/1137.

H. A. Morris, 107 Victoria-street, Ballarat.

Sub-schedule No. 5.

MEAT.

For delivery to Teachers' College Hostels as under:—

Beaufort House, Beaufort-avenue, Ballarat
1415 Sturt-street, Ballarat
130 Victoria-street, Ballarat
126 Webster-street, Ballarat

| | Security, £5. | £ | s. | d. |
|-----------------------------------|---------------|---|----|----|
| 1. Fresh Beef—Sirloin | per lb. | 0 | 2 | 9 |
| 2. Beef—Corned—Silverside | do. | 0 | 3 | 3 |
| Fresh Mutton— | | | | |
| 3. Legs | do. | 0 | 1 | 9 |
| 4. Forquarter Chops | do. | 0 | 0 | 11 |
| 5. Legs Pickled | do. | 0 | 1 | 9 |
| Two Tooth— | | | | |
| 6. Chump Chops | do. | 0 | 1 | 10 |
| 7. Mid Loin Chops | do. | 0 | 1 | 7 |
| Veal— | | | | |
| 8. Shoulder, Boned | do. | 0 | 2 | 6 |
| 9. Fillet, Boneless | do. | 0 | 3 | 3 |
| Steak— | | | | |
| 10. Blade | do. | 0 | 2 | 6 |
| 11. Minced | do. | 0 | 2 | 3 |
| 12. Sausages—Mixed | do. | 0 | 1 | 9 |
| 13. Sausage Meat | do. | 0 | 1 | 1 |
| 14. Livers—Calves | do. | 0 | 0 | 6 |
| 15. Kidneys—Ox | do. | 0 | 2 | 0 |
| 16. Frankfurts | do. | 0 | 1 | 9 |
| 17. Ham Loaf | do. | 0 | 2 | 10 |
| 18. Dripping—Beef | do. | 0 | 0 | 10 |
| 19. Shanks—sheep | each | 0 | 0 | 6 |

SCHEDULE No. 8.—BEECHWORTH DISTRICT.

ANNEX TO CONTRACT No. 1960/1138.

E. Spencer, Camp-street, Beechworth.

Sub-schedule No. 4.

MEAT.

| | Security, £30. | £ | s. | d. |
|---|----------------|----|----|----|
| 1. Fresh Beef (Gaol) | per cntl. | 13 | 6 | 8 |
| 2. Fresh Beef—Rolled Roast, boneless, brisket excluded | do. | 14 | 3 | 4 |
| 3. Corned Beef, Rolled or Round as ordered, without bone or cartilage | do. | 14 | 3 | 4 |
| 4. Shins of Beef (bone in) | do. | 6 | 5 | 0 |
| 5. Mutton—Fresh (kidney fat to be removed for Mental Hospitals) | do. | 5 | 16 | 8 |
| 6. Beef Steak, minced | do. | 14 | 3 | 4 |
| 7. Sausage Meat | per lb. | 0 | 1 | 5 |
| 8. Sausages—Mixed | do. | 0 | 1 | 11 |
| 9. Sausage—German | do. | 0 | 2 | 9 |
| 10. Tripe—Fresh | do. | 0 | 1 | 4 |
| 11. Veal—Boned | do. | 0 | 2 | 9 |
| 12. Livers—Sheep | do. | 0 | 1 | 10 |
| 13. Mutton Chops | do. | 0 | 1 | 4 |
| 14. Saveloys | do. | 0 | 2 | 0 |
| 15. Kidneys—Ox | do. | 0 | 2 | 0 |
| 16. Dripping—Beef | do. | 0 | 1 | 0 |

SCHEDULE No. 9.—BENDIGO DISTRICT.

ANNEX TO CONTRACT No. 1960/1139.

Alan H. Gittins, 350 Hargreaves-street, Bendigo.

Sub-schedule No. 5.

MEAT.

For Gaol.

| | Security, £5. | £ | s. | d. |
|--|---------------|---|----|----|
| 1. Fresh Beef | per lb. | 0 | 2 | 3 |
| 2. Corned Beef—Rolled, without bone or cartilage | do. | 0 | 1 | 11 |
| 3. Fresh Mutton | do. | 0 | 1 | 0 |
| 4. Sausages—Mixed | do. | 0 | 1 | 9 |
| 5. Minced meat | do. | 0 | 1 | 3 |

ANNEX TO CONTRACT No. 1960/1140.

Alan H. Gittins, 350 Hargreaves-street, Bendigo.

Sub-schedule No. 6.

MEAT.

For Sandhurst Boys' Centre, Bendigo.

| | Security, £5. | £ | s. | d. |
|--|---------------|---|----|----|
| 1. Fresh Beef—Rolled Roast, boneless, brisket excluded | per lb. | 0 | 3 | 3 |
| 2. Fresh Beef—Buttocks | do. | 0 | 2 | 9 |

SCHEDULE No. 9.—BENDIGO DISTRICT—continued.

| | £ | s. | d. | |
|---|----------|----|----|----|
| 3. Corned Beef—Rolled or round, as ordered, without bone or cartilage | per lb. | 0 | 2 | 6 |
| 4. Corned Silverside | do. | 0 | 3 | 5 |
| 5. Fresh Mutton—Legs | do. | 0 | 1 | 10 |
| 6. " " Chops, Mid-Loin | do. | 0 | 1 | 10 |
| 7. " " Chops, Forequarter | do. | 0 | 1 | 6 |
| 8. Steak—Rump | do. | 0 | 5 | 0 |
| 9. Veal—Fillet, boneless | do. | 0 | 3 | 0 |
| 10. Sausage Meat | do. | 0 | 1 | 3 |
| 11. Livers—Sheep | do. | 0 | 0 | 11 |
| 12. Kidney—Ox | do. | 0 | 1 | 3 |
| 13. Sausages—Mixed | do. | 0 | 1 | 9 |
| 14. Sausage—Beef German | do. | 0 | 2 | 6 |
| 15. Saveloys | per doz. | 0 | 3 | 9 |
| 16. Bacon, Rashers, Shoulder | per lb. | 0 | 6 | 3 |
| 17. Dripping—Beef | do. | 0 | 0 | 9 |

ANNEX TO CONTRACT No. 1960/1141.

M. P. & L. K. Marchioni, Cnr. Killians Walk and Queen-street Bendigo.

Sub-schedule No. 7.

MEAT.

For Teachers' College Hostels as under—

Osborne-street, Pleasant Vale, Bendigo.

"Lancewood," McLaren-street, Bendigo.

"Comersdale," Pantom-street, Golden Square, Bendigo.

Security, £5.

| | £ | s. | d. | |
|---|---------|----|----|----|
| Fresh Beef— | | | | |
| 1. Topside | per lb. | 0 | 3 | 6 |
| 2. Corned Beef—Rolled or Round, as ordered, without bone or cartilage | do. | 0 | 2 | 6 |
| 3. Corned Silverside | do. | 0 | 3 | 6 |
| 4. Fresh Mutton—Carcass | do. | 0 | 1 | 2 |
| Steak— | | | | |
| 5. Blade (Minced) | do. | 0 | 2 | 10 |
| 6. Chuck | do. | 0 | 2 | 8 |
| 7. Rump | do. | 0 | 5 | 6 |
| 8. Sausages—Mixed | do. | 0 | 1 | 10 |
| 9. Sausage Meat | do. | 0 | 1 | 8 |
| 10. Livers—Sheep | do. | 0 | 0 | 9 |
| 11. Veal, Fillet—boneless | do. | 0 | 4 | 6 |
| 12. Brains—Sheep | per set | 0 | 0 | 6 |
| 13. Kidneys—Ox | per lb. | 0 | 1 | 6 |
| 14. Ox Tails | do. | 0 | 1 | 6 |

SCHEDULE No. 10.—CASTLEMAINE GAOL.

ANNEX TO CONTRACT No. 1960/1142.

McQueen Brothers, Hargreaves-street, Castlemaine.

Sub-schedule No. 2.

MEAT.

Security, £5.

| | £ | s. | d. | |
|---|----------|----|----|----|
| 1. Fresh Beef | per lb. | 0 | 1 | 11 |
| 2. Fresh Mutton | do. | 0 | 1 | 3 |
| 3. Corned Beef—Rolled or Round, as ordered, without bone or cartilage | do. | 0 | 2 | 1 |
| 4. Minced Meat—Beef | do. | 0 | 2 | 1 |
| 5. Sausage Meat | do. | 0 | 1 | 0 |
| 6. Sausages—Mixed | do. | 0 | 1 | 6 |
| 7. Saveloys | per doz. | 0 | 4 | 6 |

SCHEDULE No. 11.—SCHOOL OF FORESTRY, CRESWICK

ANNEX TO CONTRACT No. 1960/1143.

H. J. Symons, Pty. Ltd., 1015 Macarthur-street, Ballarat.

Sub-schedule No. 4.

MEAT.

Security, £3.

| | £ | s. | d. | |
|------------------------------------|---------|----|----|---|
| 1. Fresh Beef—Forequarters | per lb. | 0 | 2 | 4 |
| 2. Mutton | do. | 0 | 1 | 2 |
| 3. Sausages—Mixed | do. | 0 | 1 | 3 |
| 4. Steak—Minced | do. | 0 | 2 | 0 |
| 5. Livers—Sheep | do. | 0 | 0 | 6 |

SCHEDULE No. 13.—McLEOD SETTLEMENT,

FRENCH ISLAND.

ANNEX TO CONTRACT No. 1960/1144.

George Hayman, Lang Lang.

Sub-schedule No. 3.

MEAT.

Security, £5.

| | £ | s. | d. | |
|---------------------------|---------|----|----|---|
| 1. Fresh Beef | per lb. | 0 | 2 | 9 |
| 2. Mutton | do. | 0 | 1 | 3 |
| 3. Sausages—Mixed | do. | 0 | 2 | 3 |

SCHEDULE NO. 14.—GEELONG DISTRICT.

ANNEX TO CONTRACT No. 1960/1145.

A. R. Bubb, 147 Moorabool-street, Geelong.

Sub-schedule No. 3.

MEAT.

For Gaol.

Security, £5.

| | £ | s. | d. |
|---|---|----|----|
| 1. Fresh Beef per lb. | 0 | 2 | 0 |
| 2. Corned Beef—Rolled or Round, without bone or cartilage do. | 0 | 2 | 3 |
| 3. Fresh Mutton—Forequarters do. | 0 | 1 | 0 |
| 4. " " —Legs do. | 0 | 1 | 6 |
| 5. Beef—Minced do. | 0 | 2 | 2 |
| 6. Sausages—Mixed do. | 0 | 1 | 8 |
| 7. Sausage Meat do. | 0 | 1 | 0 |

ANNEX TO CONTRACT No. 1960/1146.

A. C. Knight, 11 Melbourne-road, Drumcondra, Geelong.

Sub-schedule No. 4.

MEAT.

For delivery to Teachers' College Hostels as under—

- "Lauriston," 23 Aberdeen-street, Geelong.
- "Forty-Five," The Esplanade, Western Beach, Geelong.
- "Hawthorn," Aberdeen-street, Geelong
- "Ariston," Pakington-street, Geelong.
- "Warrain," 56 Western Beach, Geelong.

Security, £5.

| | £ | s. | d. |
|---|---|----|----|
| Fresh Beef— | | | |
| 1. Sirloin, boneless per lb. | 0 | 3 | 9 |
| 2. Topside Roast do. | 0 | 3 | 8 |
| 3. Corned Beef—Rolled or Round, as ordered, without bone or cartilage do. | 0 | 3 | 9 |
| Mutton— | | | |
| 4. Legs, Two-tooth do. | 0 | 1 | 6 |
| 5. Forequarters, boned, rolled, and pickled do. | 0 | 1 | 1 |
| 6. Chops, Forequarter do. | 0 | 1 | 2 |
| 7. Chops, Loin do. | 0 | 1 | 10 |
| Steak— | | | |
| 8. Chuck do. | 0 | 3 | 3 |
| 9. Bladebone do. | 0 | 3 | 6 |
| 10. Minced do. | 0 | 2 | 6 |
| 11. Fillet—Veal do. | 0 | 2 | 3 |
| 12. Tongues—Ox do. | 0 | 1 | 4 |
| 13. Kidneys—Ox do. | 0 | 1 | 9 |
| Sausages— | | | |
| 14. Mixed, thin do. | 0 | 1 | 6 |
| 15. Pork, thick do. | 0 | 1 | 6 |
| 16. Sausage—Pork, German do. | 0 | 3 | 9 |
| 17. Sausage Mince do. | 0 | 1 | 0 |
| 18. Bacon—Shoulder do. | 0 | 4 | 6 |

SCHEDULE No. 15.—COORIE MUNGLE PRISON CAMP, HEYTESBURY FOREST.

ANNEX TO CONTRACT No. 1960/1147.

Heytesbury Butchery, Timboon.

Sub-schedule No. 3.

MEAT.

Security, £4.

| | £ | s. | d. |
|---|---|----|----|
| 1. Fresh Beef per lb. | 0 | 4 | 4 |
| 2. Corned Beef—Rolled or Round, as ordered, without bone or cartilage do. | 0 | 3 | 6 |
| 3. Sausages—Mixed do. | 0 | 2 | 6 |
| 4. Sausage Mince do. | 0 | 1 | 10 |
| 5. Dripping—Beef do. | 0 | 1 | 0 |

SCHEDULE No. 17.—LANGI KAL KAL TRAINING CENTRE

ANNEX TO CONTRACT No. 1960/1148.

F. P. Haintz and Son, Havelock-street, Beaufort.

Sub-schedule No. 2.

MEAT.

Security, £5.

| | £ | s. | d. |
|--|---|----|----|
| 1. Fresh Beef—Boneless per lb. | 0 | 4 | 0 |
| 2. Sausages—Mixed do. | 0 | 1 | 9 |
| 3. Mince Meat do. | 0 | 1 | 6 |

SCHEDULE No. 20.—SALE GAOL.

ANNEX TO CONTRACT No. 1960/1149.

Sale North Meat Supply, 65A Raglan-street, Sale.

Sub-schedule No. 2.

MEAT.

Security, £3.

| | £ | s. | d. |
|---|---|----|----|
| 1. Fresh Beef—Stewing per lb. | 0 | 4 | 0 |
| 2. Fresh Mutton, Chops—Forequarter do. | 0 | 2 | 0 |
| 3. " " Legs do. | 0 | 2 | 6 |
| 4. Corned Beef—Rolled or Round, as ordered, without bone or cartilage do. | 0 | 3 | 6 |
| 5. Sausages—Mixed do. | 0 | 2 | 6 |

SCHEDULE No. 21.—PLEASANT CREEK SPECIAL SCHOOL, STAWELL.

ANNEX TO CONTRACT No. 1960/1150.

H. A. Morris, 107 Victoria-street, Ballarat.

Sub-schedule No. 3.

MEAT.

| | £ | s. | d. |
|---|---|----|----|
| Steak— | | | |
| 1. Topside (Grilling) per lb. | 0 | 3 | 3 |
| 2. Stewing (Minced when required) do. | 0 | 2 | 6 |
| 3. Beef, Corned Silverside do. | 0 | 3 | 3 |
| 4. Fresh Mutton—Leg do. | 0 | 1 | 9 |
| 5. Chops—Middle Loin do. | 0 | 1 | 2 |
| 6. Kidneys—Ox do. | 0 | 1 | 9 |
| 7. Sausages—Pork do. | 0 | 1 | 11 |
| 8. Livers—Sheep do. | 0 | 1 | 0 |
| 9. Sausage—Pork—German do. | 0 | 2 | 6 |
| 10. Frankfurts—First quality do. | 0 | 1 | 10 |

SCHEDULE No. 22.—SUNBURY DISTRICT.

ANNEX TO CONTRACT No. 1960/1151.

F. Watkins Pty. Ltd., 184 Bourke-street, Melbourne.

Sub-schedule No. 5.

MEAT.

Security, £40.

| | £ | s. | d. |
|---|----|----|----|
| Fresh Beef— | | | |
| 1. Rolled Roast, boneless, (brisket excluded) per cntl. | 13 | 6 | 8 |
| 2. Buttocks do. | 13 | 6 | 8 |
| Fresh Mutton— | | | |
| 3. Kidney fat to be removed do. | 4 | 15 | 10 |
| 4. Corned Beef—Rolled or Round, as ordered, without bone or cartilage do. | 13 | 6 | 8 |
| 5. Sausages—Mixed per lb. | 0 | 1 | 10 |
| 6. Sausage Meat do. | 0 | 1 | 5 |
| 7. Sausage—Beef—German do. | 0 | 2 | 4 |
| 8. Veal—Boneless do. | 0 | 2 | 8 |
| 9. Tripe—Fresh do. | 0 | 1 | 0 |
| 10. Livers—Sheep do. | 0 | 2 | 0 |
| 11. Ox Kidney do. | 0 | 3 | 0 |
| 12. Ox Tongue do. | 0 | 1 | 4 |
| 13. Saveloys per doz. | 0 | 3 | 6 |
| 14. Sheep Tongues per lb. | 0 | 1 | 8 |

SCHEDULE No. 23.—WARRNAMBOOL DISTRICT.

ANNEX TO CONTRACT No. 1960/1152.

Thomas Borthwick and Sons (Asia) Ltd., P.O. Box 150, Portland.

Sub-schedule No. 4.

MEAT.

Security, £5.

| | £ | s. | d. |
|---|---|----|----|
| 1. Fresh Beef—Rolled Roast (brisket excluded) per lb. | 0 | 3 | 6 |
| 2. Corned Beef—Rolled or Round, as ordered do. | 0 | 3 | 0 |
| Fresh Mutton— | | | |
| 3. Forequarters do. | 0 | 1 | 2 |
| 4. Legs do. | 0 | 1 | 11 |
| 5. Chops—Middle Loin do. | 0 | 1 | 6 |
| Steak— | | | |
| 6. Topside do. | 0 | 4 | 3 |
| 7. Stewing do. | 0 | 3 | 8 |
| 8. Sausage—Beef German do. | 0 | 2 | 7 |
| 9. Livers—Sheep do. | 0 | 1 | 6 |
| 10. Sausage Meat do. | 0 | 1 | 8 |

CONTRACTS ACCEPTED.—(Series 1960-61.)
REQUISITES FOR EDUCATION DEPARTMENT.

SCHEDULE No. 1.

REQUISITES (JUNIOR SCHOOL), EDUCATION DEPARTMENT.

Contract from 1st September, 1960, to 31st August, 1961.

| | |
|--|-----------------|
| 1960/990.— <i>Art and Craft Supply Co. Pty. Ltd.</i> | Security, £100. |
| 1960/991.— <i>A. E. Flanders and Co.</i> | Security, £25. |
| 1960/992.— <i>L. and I. Glenn Pty. Ltd.</i> | Security, £25. |
| 1960/993.— <i>R. E. Mustow</i> | Security, £100. |
| 1960/994.— <i>Rexall Products</i> | Security, £100. |
| 1960/995.— <i>Sands and McDougall Pty. Ltd.</i> | Security, £100. |
| 1960/996.— <i>Chas. E. Tims and Son</i> | Security, £100. |
| 1960/997.— <i>Tomasetti and Son Pty. Ltd.</i> | Security, £100. |

Where the name of the supplier opposite any item is shown in italics, with the sign (A), no contract has been executed nor security lodged, requirements of such items are to be purchased from the supplier named, under Tender Board Agreement.

| Item No. | Description of Articles. | Rate. | Name of Contractor. |
|----------|---|---------|--------------------------------------|
| | | £ s. d. | |
| 1 | Powder, colours in, 1-lb. cardboard boxes per doz. boxes | | |
| | Red | 1 6 0* | } Rexall Products |
| | Blue | 1 6 0* | |
| | Yellow | 1 6 0* | |
| | Sea Green | 1 6 0* | |
| | Purple | 1 6 0* | |
| | Turquoise | 1 6 0* | |
| | Orange | 1 6 0* | |
| | Leaf-green | 1 6 0* | |
| | Black | 1 2 0* | |
| | White | 0 18 0* | |
| 2 | Brushes (hair), No. 8— | | |
| | (a) $\frac{1}{2}$ " round per doz. | 0 19 3 | } Art and Craft Supply Co. Pty. Ltd. |
| | (b) $\frac{1}{2}$ " flat " | 0 19 3 | |
| 3 | Newsprint, white, 15" x 11", in packets of 100 sheets .. per doz. packets | .. | Obtain from Government Printer. |
| 4 | Chalkboards (Timson Plate), green, size 16" x 12" .. per doz. | 2 4 0† | Chas. E. Tims and Son |
| 5 | Chalk, white, in boxes of 1 gross "Brittania" .. per box | 0 2 8 | Art and Craft Supply Co. Pty. Ltd. |
| 6 | Chalk, coloured, in boxes of 1 gross "Bellico"— | | |
| | (a) Yellow | 0 6 8 | } R. E. Mustow |
| | (b) Mixed—ratio per box as follows:— | | |
| | 24 sticks—Bright yellow | } 0 7 4 | |
| | 18 " Terracotta brown | | |
| | 24 " Orange | | |
| | 12 " Bright red | | |
| | 12 " Blue | | |
| | 12 " Dark green | | |
| | 18 " Leaf-green | | |
| | 12 " Purple | | |
| | 12 " Black | | |
| 7 | Surface Paper, Squares, mixed colours in packets of 360 squares— per doz. packets | | 1 12 6 |
| | (a) 5" squares (pkt. of 360) | 5 19 0 | |
| | (b) 10" squares (pkt. of 360) | | |
| | Each packet of 360 squares to contain colours collated in the following ration:— | | |
| | 60 squares each—Red, blue, yellow, sea-green | | |
| | 20 " " Purple, turquoise, orange, leaf-green | | |
| | 10 " " White, black, grey, brown | | |
| 8 | Plain White Card, 4-sheet paste board— | | |
| | (a) 8" squares in pkts. of 50 | 2 8 0 | } Tomasetti and Son Pty. Ltd. |
| | (b) sheets 20" x 12 $\frac{1}{2}$ " in pkts. of 50 sheets | 7 18 0 | |
| 9 | Scissors, Metal Kindergarten, No. 100—3 $\frac{1}{2}$ " .. per gross | 2 19 0 | A. E. Flanders and Co. |
| 10 | Beads, Plastic, $\frac{1}{4}$ " coloured in boxes of 100 beads. Each box to contain 20 beads of the following colours:—Red, green, blue, yellow, white per doz. boxes | 1 18 0 | Art and Craft Supply Co. Pty. Ltd. |
| 11 | Laces, Plastic, for threading 20 beads $\frac{1}{4}$ ". To be in equal numbers per gross of colours, red, green, blue, yellow, white | 0 9 0* | Rexall Products |
| 12 | Tablets, Plastic, reversible, blue, yellow, 1" squares by $\frac{1}{8}$ " deep: per doz. in packets of 100 packets | 3 13 2 | Art and Craft Supply Co. Pty. Ltd. |
| 13 | Sticks, Plastic, Coloured, in packets of 100. Each packet to contain 20 sticks of the following colour:—Red, green, blue, yellow, white:— | | |
| | (a) Size 2" | 0 18 6 | } L. and I. Glenn, Pty. Ltd. |
| | (b) Size 4" | 1 7 6 | |
| | (c) Size 6" | 1 16 0 | |

* Less 3 $\frac{1}{2}$ per cent.—14 days. † Less 20 per cent.

CONTRACTS ACCEPTED.—(Series 1960-61)—continued.

REQUISITES FOR EDUCATION DEPARTMENT.

SCHEDULE No. 2.

EXERCISE BOOKS AND REQUISITES, EDUCATION DEPARTMENT.

Contract from 1st September, 1960, to 31st August, 1961.

| | | |
|--|---------|-----------------|
| 1960/998.—W. J. Carr Pty. Ltd. | | Security, £50. |
| 1960/999.—Corrugated Fibre Container Pty. Ltd. | | Security, £20. |
| 1960/1000.—Alex. Cowan (Aust.) Pty. Ltd. | | Security, £100. |
| 1960/1001.—Modern Printing Co. Pty. Ltd. | | Security, £20. |
| 1960/1002.—R. E. Mustow | | Security, £60. |
| 1960/1003.—Perth Stationers | | Security, £15. |
| 1960/1004.—Redmond Inglis and Co. Pty. Ltd. | | Security, £25. |
| 1960/1005.—Sands and McDougall Pty. Ltd. | | Security, £60. |

All supplies under this Schedule will be ordered by the Stores Officer, Education Department, and must be delivered as directed by him.

| Item No. | Description of Articles. | Rate. | Name of Contractor. |
|----------|--|---------------------|--------------------------------------|
| 1 | Compasses, 4" legs "Tokin" per doz. | £ s. d. 0 7 0 | Perth Stationers |
| 2 | " " wooden, 12" legs rubber tip " | | Purchase (Clause 109) |
| 3 | Erasers, blackboard, Felt " | 1 9 0 | R. E. Mustow |
| 4 | Pastels, 12 in a box "Reeves" per doz. | 0 10 3 | Perth Stationers |
| 5 | Rulers, box, flat, 12", marked in inches, eights, and metric per gross measures | 1 13 0 | Sands and McDougall Pty. Ltd. |
| 6 | Rulers, Blackboard, graduated each | 0 5 9 | |
| 7 | Squares, set, 45°, 6" side, calibrated per doz. | 0 6 9 | |
| 8 | " " 60°, 8" side, calibrated " | 0 6 9 | |
| 9 | " " Blackboard { 45° each | 0 4 6 | |
| | " " { 60° " | 0 4 6 | |
| 10 | " T. 18", oiled per doz. | 2 6 6 | |
| 11 | " T. 24", oiled " | | |
| 12 | " T. 42", oiled " | | |
| 13 | Ink wells (porcelain), covered, to fit 1½" hole per gross | 2 7 0 | |
| 14 | Slate cloth, on rollers, 52" x 36" each | | Purchase (Clause 109) |
| 15 | Protractors, Blackboard " | 0 5 10 | R. E. Mustow |
| 16 | Resurfacers, Blackboard per tin | | Purchase (Clause 109) |
| 17 | Forks, Tuning, "C", C.512, 125 c.m. length. each | | Sands and McDougall Pty. Ltd. |
| 18 | Books, Exercise, 4 sheet, foolscap quarto, 8" x 6½", plain sheet. Quality of the paper to be Cream wove, 18 lb. large post 16½" x 21" 500 sheets to the ream, hard engine sized. Cover to be of white chip-board, green marbled, .014-.015, printed "Exercise Book, Grades I. and II.", and may bear a trade symbol | per gross 3 0 10 | |
| 19 | Books, Exercise, 6 sheet, size 9" x 7", with faint ruling 18 m.m. from line to line. Quality of paper to be cream wove, 18 lb. large post 16½" x 21", 500 sheets to ream, hard engine sized. Cover to be of white chip-board, .014-.015 printed in green to an approved typographical design "Exercise Book, Grade III." with 18 m.m. rulings, and may bear a trade symbol | 4 3 7 | Modern Printing Co. Pty. Ltd. |
| 20 | Books, Exercise, 6 sheet, size 9" x 7", with faint ruling 14m.m. from line to line. Quality of paper to be cream wove 18 lb. large post 16½" x 21", 500 sheets to ream, hard engine sized. Cover to be of white chip-board, .014-.015 printed in green to an approved typographical design "Exercise Book, Grade IV." with 14 m.m. rulings and may bear a trade symbol | 4 3 6 | W. J. Carr Pty. Ltd. |
| 21 | Books, Exercise, 12 sheet. 1 section stapled, size 9" x 7", with faint ruling, 9m.m. from line to line. Quality of paper to be cream wove, 18 lb. large post 16½" x 21", 500 sheets to ream, hard engine sized. Cover to be of white chip-board .014-.015 printed in bronze blue to an approved typographical design "Exercise Book", and may bear a trade symbol | 7 2 0 | Alex Cowan (Aust.) Pty. Ltd. |
| 22 | Books, Exercise, 24 sheet, size 9" x 7", section sewn, quarto bound, ruling, quality of paper and cover to be as prescribed for Item 21, cover to be printed "Exercise Book", and may bear a trade symbol | 16 17 3 | Redmond Inglis and Co. Pty. Ltd. |
| 23 | Books, Exercise, Mapping, 8 sheet, 9" x 7", Burnie cream wove paper, plain—cover to be of marble chip-board, printed "Exercise Book—Mapping", and may bear a trade symbol | 5 5 3 | Alex. Cowan (Aust.) Pty. Ltd. |
| 24 | Books, Exercise, Science, 8 sheet, 9" x 7", quality of paper and cover to be as prescribed for Item 21, cover to be red, printed "Science Book." The leaves to be lithographed, faint ruled on one side, and in tenths on the reverse side, the tenths to appear on the right hand side when the book is opened, the inch ruling to be slightly thicker to show the inch lines distinctly. Each page to contain 48 1" squares, 8 down, 6 across, and may bear a trade symbol | 7 5 0 | |
| 25 | Books, Drawing, line, 8 leaves, 10½" x 7½", stapled along longer side, white cartridge paper, Imperial, 56 lb., 480 sheets, smooth, wood free, opaque. Cover to be blue pressings, Quad. Cap., 72 lb., 480 sheets, printed "Drawing Book", and may bear a trade symbol | 3 17 0 | W. J. Carr Pty. Ltd. |
| 26 | Containers, cardboard, corrugated fibre, 16" x 12" x 12" each | | Purchase (Clause 109) |
| 27 | Containers, cardboard, corrugated fibre, 12" x 12" x 12" " | | |
| 28 | Containers, cardboard, corrugated fibre, 12" x 9" x 12" " | | Corrugated Fibre Container Pty. Ltd. |
| 29 | Containers, cardboard, corrugated fibre, 15" x 9½" x 12" " | 0 1 8½ | |
| 30 | Containers, cardboard, corrugated fibre, 15" x 9½" x 4" " | | |
| 31 | Containers, cardboard, corrugated fibre, 20" x 15" x 12" " | 0 3 0½ | Corrugated Fibre Container Pty. Ltd. |
| 32 | Containers, cardboard, corrugated fibre, 24" x 15" x 12" " | 0 3 5 | |
| 33 | Containers, cardboard, corrugated fibre, 42" x 8" x 8" " | 0 3 2 | |

CONTRACTS ACCEPTED.—(Series 1960-61)—continued.
REQUISITES FOR EDUCATION DEPARTMENT.

- Schedule No. 3 Chemicals for Science Classes for District High Schools and Higher Elementary Schools, &c.
- Schedule No. 4 Requisites for Science Classes for District High Schools and Higher Elementary Schools, &c.
- Schedule No. 5 Utensils and Requisites for Girls' Schools, Cookery and Needlework Centres.

Requirements under the above-mentioned Schedules for the period from 1st September, 1960, to 31st August, 1961, are to be obtained in accordance with the provisions of Regulation 109, Part V., Public Accounts and Stores Regulations, 1958.

15th September, 1960.

W. H. RUTHERFORD,
Secretary to the Tender Board.

GENERAL STORES.

SCHEDULE No. 69.

STATIONERY, GENERAL.

Contract from 1st September, 1960, to 31st August, 1961.

- 1960/1006.—Able Staples Pty. Ltd. Security, £25.
- 1960/1007.—Angus and Co. Pty. Ltd. Security, £25.
- 1960/1008.—B. J. Ball Ltd. Security, £10.
- 1960/1009.—Behr-Manning (Aust.) Pty. Ltd. Security, £20.
- 1960/1010.—Biro Swan and Gollin Pty. Ltd. Security, £25.
- 1960/1011.—Briscoes Ltd. Security, £40.
- 1960/1012.—Alex. Cowan (Aust.) Pty. Ltd. Security, £5.
- 1960/1013.—W. and G. Dean Pty. Ltd. Security, £10.
- 1960/1014.—Dunlop Pty. Ltd. Security, £7.
- 1960/1015.—Dunlop Rubber Australia Ltd. Security, £15.
- 1960/1016.—Edwards Dunlop and Co. Ltd. Security, £100.
- 1960/1017.—F. J. House Pty. Ltd. Security, £15.
- 1960/1018.—John Jackson and Co. Pty. Ltd. Security, £18.
- 1960/1019.—R. E. Mustow Security, £50.
- 1960/1020.—Olivetti Australia Pty. Ltd. Security, £100.
- 1960/1021.—Perth Stationers Security, £10.
- 1960/1022.—Sands and McDougall Pty. Ltd. Security, £100.
- 1960/1023.—Sellotape (Aust.) Pty. Ltd. Security, £20.
- 1960/1024.—Spicers (Australia) Ltd. Security, £26.
- 1960/1025.—John Withers and Son Pty. Ltd. Security, £45.

All supplies under this Schedule will be ordered by the Stores Officer, Education Department, and must be delivered as directed by him.

| Item No. | Description of Articles. | Rate. | Name of Contractor. | |
|----------|--|------------------------|--|-------------------------------|
| 1 | Balances, Letter, with weights, $\frac{1}{2}$ oz. to 8 oz. each | £ s. d. 1 5 9 | Sands and McDougall Pty. Ltd. Purchase (Clause 109) | |
| 2 | Bands, elastic, assorted, 2" to 3 $\frac{1}{2}$ ", assorted widths, 6 $\frac{1}{2}$ " to 6 $\frac{3}{4}$ ", in boxes of 1 gross | | | |
| 3 | " elastic, 0 $\frac{1}{2}$ ", 2" x $\frac{1}{2}$ " x $\frac{1}{16}$ ", in boxes of 1 gross | 0 2 2 $\frac{1}{2}$ * | Dunlop Rubber Australia Ltd. | |
| 4 | " elastic, 00 $\frac{1}{2}$ ", 2 $\frac{1}{2}$ " x $\frac{1}{2}$ " x $\frac{1}{16}$ ", in boxes of 1 gross | 0 2 4* | | |
| 5 | " elastic, 000 $\frac{1}{2}$ ", 3" x $\frac{1}{2}$ " x $\frac{1}{16}$ ", in boxes of 1 gross | 0 2 7 $\frac{1}{2}$ * | | |
| 6 | " elastic, 0000 $\frac{1}{2}$ ", 3 $\frac{1}{2}$ " x $\frac{1}{2}$ " x $\frac{1}{16}$ ", in boxes of 1 gross | 0 2 10 $\frac{1}{2}$ * | | |
| 7 | " elastic, flat, 4 $\frac{1}{2}$ " x $\frac{1}{2}$ " x $\frac{1}{16}$ ", in boxes of 1 gross | 0 14 0* | | |
| 8 | " elastic, flat, 6" x $\frac{1}{2}$ " x $\frac{1}{16}$ ", in boxes of 1 gross | 0 15 8* | | |
| 9 | " elastic, thread, grey, 1 $\frac{1}{2}$ " x $\frac{1}{16}$ " x $\frac{1}{16}$ ", in boxes of 1 gross, per doz. boxes | 0 7 7* | | |
| 10 | " elastic, thread, grey, 1 $\frac{1}{2}$ " x $\frac{1}{16}$ " x $\frac{1}{16}$ ", in boxes of 1 gross, No. 10 | 0 8 2* | | |
| 11 | " elastic, thread, grey, 2" x $\frac{1}{16}$ " x $\frac{1}{16}$ ", in boxes of 1 gross, No. 12 | 0 8 10* | | |
| 12 | " elastic, thread, grey, 3" x $\frac{1}{16}$ " x $\frac{1}{16}$ ", in boxes of 1 gross, No. 14 | 0 10 8* | | |
| 13 | " elastic, thread, grey, 3" x $\frac{1}{16}$ " x $\frac{1}{16}$ ", in boxes of 1 gross, No. 18 | 0 10 8* | | |
| 13 | Baskets, document, wire, demy each | | Purchase (Clause 109) | |
| 14 | " document, wire, foolscap | 0 1 9 $\frac{1}{2}$ | Sands and McDougall Pty. Ltd. Briscoes Ltd. | |
| 15 | " waste paper, top 11 $\frac{1}{2}$ " in diameter, bottom 7 $\frac{1}{2}$ " diameter height 10 $\frac{1}{2}$ ", metal, bucket type | 0 7 3 $\frac{1}{2}$ | | |
| 16 | Books—Bibles, Church of England, Ruby | | Purchase (Clause 109) | |
| 17 | Binders, metal fasteners, with washers, No. 641, in boxes of 1 gross | 0 3 8* | Edwards Dunlop and Co. Ltd. | |
| 18 | " metal fasteners, with washers, No. 642, in boxes of 1 gross | 0 3 8* | | |
| 19 | " metal fasteners, with washers, No. 643, in boxes of 1 gross, "Koala" | 0 3 11* | | |
| 20 | " metal fasteners, with washers, No. 644, in boxes of 1 gross, "Koala" | 0 4 6* | | |
| 21 | " metal fasteners, with washers, No. 645, in boxes of 1 gross | 0 5 0* | | |
| 22 | " metal fasteners, with washers, No. 646, in boxes of 1 gross | 0 5 9* | | |
| 23 | " screw, brass, 1" per doz. | 0 3 6 | | Sands and McDougall Pty. Ltd. |
| 24 | " screw, brass, 1 $\frac{1}{2}$ " | 0 3 10 | | |
| 25 | " screw, brass, 2" | 0 4 2 | | |
| 26 | " screw, brass, 2 $\frac{1}{2}$ " | 0 4 4 | | |
| 27 | Bodkins, with eye, riveted through handle, 4 $\frac{1}{2}$ " blade each | 0 3 3 | R. E. Mustow | |
| 28 | " with eye, 4 $\frac{1}{2}$ " blade | 0 3 0* | | |
| 29 | Bowls, glass, Bankers, 3 $\frac{1}{2}$ " diameter at top | 0 0 6 $\frac{1}{2}$ | Edwards Dunlop and Co. Ltd. | |
| 30 | Boxes, cloth covered, for ledger cards, 4" x 6" | 0 3 7 | | |
| 31 | " cloth covered, for ledger cards, 6" x 8" | 0 5 3 | Sands and McDougall Pty. Ltd. | |
| 32 | " cash, 8", with trays | 0 15 7 | | |
| 33 | " cash, 12", with trays | 1 0 6 | Perth Stationers | |
| 34 | " cash, 14", with trays | 1 11 6 | | |
| | Brushes, Artists— | | B. J. Ball Ltd. | |
| 35 | Sable (red), crow, finest, in quills, Winsor and Newton's .. per doz. | 1 7 0 | | |
| 36 | Sable (red), duck, finest, in quills, Winsor and Newton's .. | 2 0 0 | W. and G. Dean Pty. Ltd. | |
| 37 | Sable (red), goose, finest, in quills, Winsor and Newton's .. | 3 12 0 | | |
| 38 | Sable (red), large swan, finest, in quills, Winsor and Newton's each | 2 13 6 | | |
| 39 | Sable (red), small swan, finest, in quills, Winsor and Newton's .. | 1 12 6 | | |

* Less 2 $\frac{1}{2}$ per cent.—30 days.

CONTRACTS ACCEPTED.—(Series 1960-61)—continued.

| Item No. | Description of Articles. | Rate. | Name of Contractor. |
|----------------------------|--|-------------------------------|--------------------------------------|
| SCHEDULE No. 69—continued. | | | |
| 40 | Brushes, damping, felt and rubber, 3¼" each | | Purchase (Clause 109) |
| 41 | " litho., sable, Winsor and Newton's, Series 16, No. 0 per doz. | 1 3 0 | |
| 42 | " litho., sable, Winsor and Newton's, Series 16, No. 1 | 1 7 0 | W. and G. Dean Pty. Ltd. |
| 43 | " litho., sable, Winsor and Newton's, Series 16, No. 2 | 1 10 0 | |
| 44 | " litho., sable, Winsor and Newton's, Series 16, No. 3 | 1 16 0 | |
| 45 | " litho., sable, Series 16, No. 4 | 2 10 0 | |
| 46 | " litho., sable, Series 16, No. 5 | 3 6 6 | |
| 47 | " litho., sable, Winsor and Newton's, Series 16, No. 6 | 4 10 0 | |
| 48 | " litho., sable, Series 16, No. 7 | 5 14 0 | |
| 49 | " paste and gum, ¼", flat | 1 8 0 | Thos. Mitchell and Co. Pty. Ltd. (A) |
| 50 | " paste and gum, ½", flat | 1 12 0 | |
| 51 | " typewriter, tooth brush type, 6" overall | 0 18 0 | |
| 52 | " typewriter, wire handle, bottle type | 0 16 0 | Sands and McDougall Pty. Ltd. |
| 53 | Cards, playing, "Tiger" per doz. | 1 7 6 | |
| 54 | Cases, attache, solid leather, with one X tin plate enamelled frame clamped into body of case, two Australian locks; lined with leather cloth, round leather covered metal handle, best make and finish, metal protected corners riveted on lid per inch | 0 3 4½ | J. Jackson and Co. Pty. Ltd. |
| 55 | Stationery head for previous item, to be of best leather cloth throughout, well sown, best make and finish, pockets fastened with leather flap each | 0 15 3 | |
| 56 | Satchels, black leather, zip folio, zip 3 sides full, reinforced metal back | 2 3 0 | W. Pocknall (A) |
| 57 | Clag— In 10-oz. bottles, with brushes, "Clag" per doz. bottles | 0 15 0 | Angus and Co. Pty. Ltd. |
| 58 | In 20-oz. bottles, without brushes, "Ivy" | 0 18 6 | |
| 59 | Office paste Powder—3-oz. packets per gross | | Purchase (Clause 109) |
| 60 | Clips, bulldog, 2¼", No. 1910 per doz. | 0 5 5 | Perth Stationers |
| 61 | " bulldog, small, No. 1895 | 0 1 10½ | |
| 62 | " glider or equal thereto, large, in boxes of 100 per doz. boxes | 0 4 5 | John Withers and Son Pty. Ltd. |
| 63 | " glider or equal thereto, small, in boxes of 100 | 0 4 1 | |
| 64 | " letter, side, foolscap size each | 0 4 2 | |
| 65 | " letter, end, foolscap size | 0 4 2 | |
| 66 | Colours, water, moist, whole cakes in pans, Winsor and Newton's— Series No. 1—Burnt Sienna, Burnt Umber, Chinese White, Chrome Yellow, Emerald Green, Indian Red, Mauve, Neutral Tint, Payn's Grey, Prussian Blue, Raw Sienna, Raw Umber, Vandyke Brown, Venetian Red, Yellow Ochre per doz. pans | | Purchase (Clause 109) |
| 67 | Series No. 2—Gamboge; Hooker's Green, No. 1; Hooker's Green, No. 2; Indigo; Purple Lake; Scarlet Lake; Sepia | | |
| 68 | Series No. 3—Cobalt Blue, French Blue, French Ultramarine, Crimson Lake | | |
| 69 | Series No. 4—Aurora Yellow, Carmine, Violet Carmine, Vermillion | | |
| 70 | Colours, liquid, Chinese White, Winsor and Newton's, in bottles per doz. bottles | 1 2 0 | Max Wurcker Pty. Ltd. (A) |
| 71 | Covers, typewriter, foolscap size, oilcloth each | 0 6 3 | John Withers and Son Pty. Ltd. |
| 72 | " typewriter, brief size, oilcloth | 0 7 3 | |
| 73 | " typewriter, policy size, oilcloth | | Purchase (Clause 109) |
| 74 | Correctors, blue and red print, in 1-oz. bottles per doz. | 1 0 0 | Max Wurcker Pty. Ltd. (A) |
| 75 | Crayons, solid marking, coloured per gross | 1 7 6 | Sands and McDougall Pty. Ltd. |
| 76 | Cushions, chair, rubber each | 0 9 6 | Dunlopillo Pty. Ltd. |
| 77 | Damper, label, 4", roller, bakelite | 0 7 0 | Sands and McDougall Pty. Ltd. |
| 78 | Diaries, Australian, various, pocket series | Vic. published price less 40% | |
| 79 | " Australian, various, cloth series | | Purchase (Clause 109) |
| 80 | " Australian, various, rough series | | |
| 81 | Directories, municipal, ¼-bound or library, latest edition | Published Price | Sands and McDougall Pty. Ltd. |
| 82 | " Victorian, latest edition | | John Withers and Son Pty. Ltd. |
| 83 | Erasers, circular, typewriter per doz. | 0 2 11 | |
| 84 | " combined, 2¼", ink and pencil | 0 1 9 | R. E. Mustow |
| 85 | " draughtsmen | | Purchase (Clause 109) |
| 86 | " pliable, pencil per lb. | 0 7 3 | John Withers and Son Pty. Ltd. |
| 87 | Eyelets, short—500 in box per box | | |
| 88 | " medium | | |
| 89 | " long | | |
| 90 | Fasteners paper, ¼", R.O., 1 gross in box per doz. boxes | | Purchase (Clause 109) |
| 91 | " paper, ¼", S.1 and R.1, 1 gross in box | | |
| 92 | " paper, ¼", R.2, 1 gross in box | | |
| 93 | " paper, ¼", S.3 and R.3, 1 gross in box | | |
| 94 | " paper, ¼", S.4, 1 gross in box | | |
| 95 | " paper, ¼", S.5, 1 gross in box | | |
| 96 | " paper, ¼", R.6, 1 gross in box | | |
| 97 | " paper, ¼", S.7 and R.7, 1 gross in box | | |
| 98 | " paper, ¼", S.8 and R.8, 1 gross in box | | |
| 99 | " paper, ¼", R.10, 1 gross in box | | |
| 100 | " paper, "Ty-tite", 1 gross in box per box | 2 4 0 | Ty-tite Products (A) |
| 101 | Files box, indexed, foolscap with clip, 15" x 11¼" x 3" each | 0 9 6 | Alex. Cowan (Aust.) Pty. Ltd. |
| 102 | " box, foolscap, not indexed, 14¼" x 9¼" x 2" | 0 5 2 | R. E. Mustow |
| 103 | " concertina, manila, foolscap | 0 10 0 | Perth Stationers |

CONTRACTS ACCEPTED.—(Series 1960-61)—continued.

| Item No. | Description of Articles. | Rate. | Name of Contractor. |
|----------------------------------|--|---------|--------------------------------|
| SCHEDULE No. 69—continued. | | | |
| | | £ s. d. | |
| 104 | Files, concertina, manila, quarto each | | Purchase (Clause 109) |
| 105 | .. foolscap, with index " " | | |
| 106 | .. springback, foolscap " " | 0 5 5 | |
| 107 | .. springback, music size " " | | John Withers and Son Pty. Ltd. |
| 108 | .. springback, octavo " " | | |
| 109 | .. springback, large quarto, 11¼" x 9" " " | | |
| 110 | .. springback, small quarto " " | | Purchase (Clause 109) |
| 111 | Glue, "Seccotine" per doz. tubes | | |
| 112 | Grips, { Finger and Thumb—½" per doz. " | 0 1 1* | Dunlop Rubber Australia Ltd. |
| | .. " .. ¾" " " | 0 1 2½* | |
| 113 | .. finger, thimble style, large " " | 0 1 10* | |
| 114 | .. finger, thimble style, medium " " | 0 1 7* | |
| 115 | .. finger, thimble style, small " " | 0 1 7* | |
| 116 | Gum, art, blocks, 2¼" x 1½" x 1¼", "Radiant" " | 0 10 0 | Perth Stationers |
| 117 | .. dry, arabic per lb. | | Purchase (Clause 109) |
| 118 | .. liquid, 4-oz. bottles with cap and brush per doz. | 0 13 4 | Angus and Co. Pty. Ltd. |
| 119 | Ink, fountain pen blue, black, and assorted colours, 4-oz. bottles, per doz. bottles | 0 9 0 | Biro Swan and Gollin Pty. Ltd. |
| 120 | .. marking "Melanyl" per bot. | 0 0 8½ | Perth Stationers |
| 121 | .. metal stamp, black, in 1-oz. bottles, fast drying " | | Purchase (Clause 109) |
| 122 | .. metal stamp, coloured, in 1-oz. bottles, fast drying " | | |
| 123 | .. obliterating, De La Rue's, I.R., stamp " | | |
| 124 | .. obliterating, De La Rue's, metal stamp " | | R. E. Mustow |
| 125 | .. waterproof, drawing, ¼-oz. bottles, black and assorted colours | 0 1 0¼ | |
| 126 | Inkstands, glass, with tray, two holes and caps each | 0 7 6 | Sands and McDougall Pty. Ltd. |
| 127 | .. glass, square, 3¼", glass top with pen tray " | 0 2 6 | |
| 128 | Knives, desk erasers each | 0 5 5 | |
| 129 | Labels, gummed, 2¼" x 1½", with border, pads of 100 per pad | 0 0 11 | John Withers and Son Pty. Ltd. |
| 130 | .. gummed, 1" x ¾" with border, box of 100 per box | | Purchase (Clause 109) |
| 131 | Machines, eyelet, hand punches each | 1 3 6 | Sands and McDougall Pty. Ltd. |
| 132 | .. numbering, "Velos" 950, 6 figure " | 2 17 9 | Able Staples Pty. Ltd. |
| 133 | .. stapling, "Rexel" No. 169 " | 1 4 6 | |
| 134 | Cans, oil, for typewriters, 1-oz. screw top, long neck " | | Purchase (Clause 109) |
| 135 | Openers, letter, steel " | 0 2 0 | Sands and McDougall Pty. Ltd. |
| 136 | Pads, self-inking, I.R. stamp, 2½" x 4½", red, blue, purple, black, green No. 1 per doz. | 1 5 10 | Alex Cowan (Aust.) Pty. Ltd. |
| 137 | .. self-inking, I. R., stamp 3½" x 6", green, black, blue, red, purple, No. 2 " | 1 14 0 | |
| 138 | Paper, rolls, for adding machines, 3¾" x 3½", in 80-yd. rolls per roll | 0 1 8† | Edwards Dunlop and Co. Ltd. |
| 139 | .. rolls for adding machines, 2¼" x 3½", in 80-yd. rolls " | 0 1 6† | |
| 140 | .. rolls, for cash register, size "Y" " | | |
| 141 | Pencil, lengthener per doz. | | Purchase (Clause 109) |
| 142 | Pencils, coloured, hexagonal, blue " | 0 2 8† | Edwards Dunlop and Co. Ltd. |
| 143 | .. coloured, blue, round " | 0 2 10† | |
| 144 | .. coloured, hexagonal, green " | 0 2 8† | |
| 145 | .. coloured, green, round " | 0 2 10† | |
| 146 | .. coloured, hexagonal, red " | 0 2 8† | |
| 147 | .. coloured, red, round " | 0 2 10† | |
| 148 | .. coloured, round, combined red and blue " | 0 4 6 | |
| 149 | .. coloured, violet, round " | 0 2 10† | R. E. Mustow |
| 150 | .. crayon, coloured, in boxes of 12 colours " | 1 8 0 | Edwards Dunlop and Co. Ltd. |
| 151 | .. drawing " | 0 5 8† | R. E. Mustow |
| 152 | .. office, H. B., "Cadet" " | 0 1 5½ | Edwards Dunlop and Co. Ltd. |
| 153 | .. indelible, "Ascot" " | 0 1 3 | Sands and McDougall Pty. Ltd. |
| 154 | .. refills, for propellers, black per doz. boxes | 0 3 8 | R. E. Mustow |
| 155 | .. refills, for propellers, coloured " | | Purchase (Clause 109) |
| 156 | .. waterproof per doz. | | |
| 157 | Pens, Ball Point, Bic Crystal, "Throwaway" " | 0 5 6 | Biro Swan and Gollin Pty. Ltd. |
| 158 | .. refills " | | Purchase (Clause 109) |
| 159 | .. drawing, large, "Harling's", B.E. 2 " | | |
| 160 | .. drawing, small, "Harling's", B.E. 12 " | | |
| 161 | .. stylo, "Conway Stewart", No. 115 each | 0 12 4† | Edwards Dunlop and Co. Ltd. |
| Pen Nibs, in boxes of one gross— | | | |
| 162 | Anchor, Nos. 1, 2, 3 per box | | Purchase (Clause 109) |
| 163 | Australian, No. 9 " | | |
| 164 | Journal " | | |
| 165 | Ball-pointed, grey, graded " | | |
| 166 | "First class", No. 9 "Eastford" " | | |
| 167 | Gillots, No. 170 " | | |
| 168 | .. No. 290 " | | |
| 169 | .. No. 292 " | | |
| 170 | .. No. 293 " | | |
| 171 | .. No. 303 " | | |
| 172 | .. Nos. 404m, 404f " | | |
| 173 | .. mapping " | | |
| 174 | "J", black " | | |
| 175 | "J", black " | | |
| 176 | "J", elongated, black, "Bedford" " | | |
| 177 | "J", black, "Bedford" " | | |
| 178 | Magazine, Brandauer and Co. " | | |

* Rates less 2½% for payment by end of month following month of delivery.

† Less 2½%—30 days.

CONTRACTS ACCEPTED.—(Series 1960-61)—continued.

| Item No. | Description of Articles. | Rate. | Name of Contractor. |
|--|--|--------------------------|--------------------------------|
| SCHEDULE No. 69—continued. | | | |
| Pen Nibs, in boxes of one gross—continued— | | | |
| 179 | Mail Eastford "Scribe" per box | .. | Purchase (Clause 109) |
| 180 | Manifolding, No. 0505 | .. | |
| 181 | Probate, Esterbrook | .. | |
| 182 | Relief, "Renown" | .. | |
| 183 | Review, Brandauer and Co. | .. | |
| 184 | Scribbler, No. 147. "Ariel" | .. | |
| 185 | Times, "Hinkswell" | .. | |
| 186 | Waverley "Light Brigade" | .. | |
| 187 | Lawson | .. | |
| 188 | Leicester | .. | |
| 189 | Dawson, No. 9 "Eastford" | .. | |
| 190 | Mitchell | .. | |
| 191 | Kopinib | .. | |
| 192 | Latem | .. | |
| 193 | Pedigree | .. | |
| 194 | Penholders Wooden, rubber grip, assorted colours per gross | 2 7 6 | |
| 195 | Pins, drawing, $\frac{1}{4}$ " diameter 144 in box per box | 0 2 0 | |
| 196 | Pounce per lb. | .. | |
| 197 | Protractors 6" celluloid each | .. | |
| 198 | " circular celluloid, 5", full circle, $\frac{1}{16}$ " thick, $\frac{1}{4}$ " top bevel, two-way reading | .. | |
| 199 | Punches, for files, two holes, c to c, small | 0 4 10† | Edwards Dunlop and Co. Ltd. |
| 200 | Refills, for table calendars, "Pioneer" | 0 2 3† | Spicers (Australia) Ltd. |
| 201 | " " " "Invicta" | Published price less 40% | Sands and McDougall Pty. Ltd. |
| 202 | Stands for table calendars, "Pioneer" per doz. | 2 0 0† | Spicers (Australia) Ltd. |
| 203 | " " " "Invicta" | .. | Purchase (Clause 109) |
| 204 | Rulers, ebony, round, 15" | .. | B. J. Ball Ltd. |
| 205 | Rulers, flat, 15", brass edge, "Rulex" | 0 11 10 | |
| 206 | " flexible, metal, 15" | .. | |
| 207 | Scissors, office, 6" | 2 5 9 | S. H. Isaacs (A) |
| 208 | " surgical, 6" | .. | Purchase (Clause 109) |
| 209 | Scales, draughtsmen's, boxwood, engine-divided— $\frac{1}{8}$ " and $\frac{1}{4}$ "; $\frac{1}{2}$ " and $\frac{3}{4}$ "; $\frac{1}{2}$ " and $\frac{3}{4}$ "; $\frac{1}{2}$ " and 1"; Armstrong | .. | |
| 210 | " survey, boxwood, engine-divided, 10/20, 20/40, 30/60, 40/80, 40/160, 50/100—double sided | .. | Purchase (Clause 109) |
| 211 | Seals, gummed, notarial, No. 3 (packet of 100) per pkt. | 0 0 8 | |
| 212 | Sharpeners, pencil, rotary, adjustable, "Velos Empire" each | 1 6 6 | R. E. Mustow |
| 213 | Silencers, mats, for typewriter, 12" x 12" | 0 9 9 | |
| 214 | Sponges, to fit bowls | .. | John Withers and Son Pty. Ltd. |
| 215 | Squares, set, 45°, celluloid, 6" .040 | .. | |
| 216 | " set, 45°, celluloid, 8" .040 | .. | |
| 217 | " set, 45°, celluloid, 10" .040 | .. | |
| 218 | " set, 60°, celluloid, 8" .040 | .. | |
| 219 | " set, 60°, celluloid, 10" .050 | .. | |
| 220 | " set, 60°, celluloid, 12" .060 | .. | |
| 221 | Stamps, dating, medium, No. 2 | 0 2 6† | Edwards Dunlop and Co. Ltd. |
| 222 | " " small, No. 1 $\frac{1}{2}$ | 0 1 8 $\frac{1}{2}$ | |
| 223 | Rests for stamps, metal, to take ten stamps | 0 9 11 | Sands and McDougall Pty. Ltd. |
| Staples for stapling machines— | | | |
| 224 | Velos (1,000) in box per box | 0 1 0 | Able Staples Pty. Ltd. |
| 225 | Hotchkiss No. 1 or Velos (5,000 in box) | 0 4 3† | F. J. House Pty. Ltd. |
| 226 | Hotchkiss No. 1A or Velos (5,000 in box) | 0 4 3† | |
| 227 | Bostitch or Velos (5,000 in box) | 0 4 3† | |
| 228 | Comet Mark V. (5,000 in box) | 0 4 3† | |
| 229 | Velos Crown C. No. 350 (5,000 in box) | 0 4 3† | |
| 230 | Koala, No. 60 (3,000 in box) | 0 3 0 | Able Staples Pty. Ltd. |
| 231 | " No. 80 (5,000 in box) | 0 4 3† | F. J. House Pty. Ltd. |
| 232 | Straps, cotton, 2 ft., 1-in. wide, with buckle per doz. | 0 6 1 | Sands and McDougall Pty. Ltd. |
| 233 | " cotton, 3 ft., 1-in. wide, with buckle | 0 7 9 | |
| 234 | " cotton, 4 ft., 1-in. wide, with buckle | 0 9 11 | |
| 235 | Tape, Cellulose, $\frac{1}{2}$ in. x 72 yards per roll | 0 4 3 | John Withers and Son Pty. Ltd. |
| 236 | " " $\frac{3}{4}$ in. x 72 yards | 0 5 11 | |
| 237 | " " 1 in. x 72 yards | 0 7 7 | |
| 238 | " " $\frac{1}{2}$ in. x 36 yards | 0 2 6 | |
| 239 | " " $\frac{3}{4}$ in. x 36 yards | 0 3 1 | |
| 240 | " " 1 in. x 36 yards | 0 4 3 | Scellotape (Aust.) Pty. Ltd. |
| 241 | " " $\frac{1}{2}$ in. x 225 in. (and dispenser) each | .. | John Withers and Son Pty. Ltd. |
| 242 | " " $\frac{3}{4}$ in. x 300 in. (and dispenser) per roll | .. | Scellotape (Aust.) Pty. Ltd. |
| 243 | " Paper, brown, gummed, 1 in. No. 60 | 0 3 2† | Purchase (Clause 109) |
| 244 | " " " " 2 in. No. 80 | 0 6 4† | Edwards Dunlop and Co. Ltd. |
| 245 | " adhesive, opaque, linen, $\frac{1}{2}$ in. | .. | |
| 246 | " " " " $\frac{3}{4}$ in. | .. | Purchase (Clause 109) |
| 247 | Trays, pen, glass, 9 $\frac{1}{2}$ in. x 3 in. each | 0 3 0 | Sands and McDougall Pty. Ltd. |
| 248 | Type Cleaner | 0 1 8 $\frac{1}{2}$ | John Withers and Son Pty. Ltd. |
| 249 | Dispenser, tape, cellulose, to take 1296" | 0 12 8 | Behr-Manning (Aust.) Pty. Ltd. |
| 250 | " " " " 2592" | 0 19 0 | Purchase (Clause 109) |
| 251 | Typewriters, foolscap size | 32 10 0 | |
| 252 | " brief size | 33 10 0 | |
| 253 | " policy size | 39 10 0 | Olivetti Australia Pty. Ltd. |
| 254 | Wax, sealing, red, packed in 1-lb. boxes per lb. | .. | Purchase (Clause 109) |
| 255 | Weights, paper, glass, 4 in. x 2 $\frac{1}{2}$ in. x 1 in. each | 0 2 0† | |

† Less 2 $\frac{1}{2}$ per cent.—30 days.

CONTRACTS ACCEPTED.—(Series 1960-61.)

SCHEDULE No. 68.

GENERAL STORES—STAMPS, RUBBER.

Contract from 1st September, 1960, to 31st August, 1961.

1960/1026.—M. G. King's Rubber Stamp Co. .. Security, £13.

Delivery to be made at the Education Department's stationery Store, within 7 days of receipt of order.

| Item No. | Description of Articles. | Rate. | Name of Contractor. |
|----------|--|--------------|-------------------------------|
| | | <i>s. d.</i> | |
| | Stamps, rubber, wooden handle and mount, any length up to 5", type up to $\frac{3}{4}$ " high— | | |
| 1 | One line each | 4 0 | M. G. King's Rubber Stamp Co. |
| 2 | Two lines " | 4 9 | |
| 3 | Three lines " | 5 6 | |
| 4 | Four lines " | 6 9 | |
| 5 | Over four lines line extra | 1 6 | |
| | Stamps, rubber, wooden handle and mount, circular, oval, or square, any wording not exceeding— | | |
| 6 | 2" x 1 $\frac{1}{2}$ " each | 7 6 | Purchase (Clause 109) |
| 7 | 3" x 2" " | 9 6 | |
| 8 | 4" x 3" " | .. | |

Approved—H. E. BOLTE, Treasurer. 15.9.60.

CONTRACTS ACCEPTED.—(Series 1960-61.)

FIREWOOD.

Period—From 1st October, 1960, to 30th September, 1961.

| Item No. | Security. | Particulars. | Kinds of Firewood. | Rate per Cord of 128 cubic feet. | Name of Contractor. | Charge against Vote or Fund. |
|----------|-----------|---|--|----------------------------------|---|-------------------------------------|
| | £ | FIREWOOD— | | £ s. d. | | |
| | | Supply of Firewood, in such quantities as may be ordered, from 1st October, 1960, to 30th September, 1961, at the under-mentioned places. | | | | |
| 1 | 20 | Ararat— For the various Government Offices including Mental Hospital, in 2-ft. billets | Red Gum and Box .. | 9 3 0 | <i>A. Storti, Banfield-street, Ararat (A)</i> | Contingencies, 1960-61 and 1961-62. |
| 1 | 3 | Ballarat— For the various Government Offices, in 2-ft. billets | Gum; Peppermint, and Messmate | 6 0 0 | <i>H. O'Callaghan, 1119 Howitt-street, Ballarat</i> | |
| 2 | 25 | For the Mental Hospital only, in 2-ft. billets. | Gum, Peppermint, and Messmate | 4 15 6 | | |
| 3 | 25 | For the Mental Hospital, in 5-ft. lengths | Stringybark, Gum and Peppermint | 3 18 0 | <i>W. P. Truddenham and Sons Ross Creek (A)</i> | |
| 4 | 5 | For the Gaol only; in 5-ft. lengths | | 4 2 0 | | |
| 1 | 3 | Beechworth— For the Mental Hospital and Government Offices, in 2-ft. billets. | Stringybark, Red Gum, Red Box, Messmate, and Apple Box | 6 0 0 | <i>F. C. Jensen, Beechworth (A)</i> | |
| 2 | 25 | For the Mental Hospital in 5-ft. lengths | | 3 12 6 | | |
| 1 | .. | Stawell— For the Pleasant Creek Special School in 1-ft. billets | Box | 7 10 0 | <i>D. H. Repper, Ilwarrara, via Stawell (A)</i> | |
| 2 | 5 | For Government Offices and Pleasant Creek Special School in 2-ft. billets | | 7 5 0 | | |
| 3 | 10 | For the Pleasant Creek Special School, in 5-ft. lengths | | 3 15 0 | | |
| 1 | .. | Sunbury— For Mental Hospital, in 2-ft. billets | Mixed Wood | .. | Order from Forests Commission | |
| 1 | .. | Werribee— For Research Farm— 1-ft. billets | Mixed Wood | .. | Order from Forests Commission | |
| 2 | .. | 2-ft. billets | | | | |

Where the name of the supplier is shown in italics, with the sign (A), no contract has been executed, and supplies are to be purchased from the persons named, under Tender Board Agreement.

W. H. RUTHERFORD,
Secretary to the Tender Board.

CONTRACTS ACCEPTED.—(Series 1960-61.)
FIREWOOD.—COUNTRY TOWNS, ETC.
 Period—From 1st October, 1960, to 30th September, 1961.

| Contract No. | Place. | Kinds of Firewood. | Rate per Cord of 128 Cubic Feet. | | | | Name of Contractor. | Charge against Vote or Fund. |
|--------------|----------------|---------------------------------|----------------------------------|-------------------|-------------------|-------------------|---|------------------------------|
| | | | In 1-ft. Billets. | In 2-ft. Billets. | In 5-ft. Lengths. | In 6-ft. Lengths. | | |
| | | | s. d. | s. d. | s. d. | s. d. | | |
| 1153 | Bacchus Marsh | Peppermint, Gum and Stringybark | 125 0 | .. | .. | .. | C. G. Bourke, 264 Dundas-street, Thornbury | |
| 1154 | Bairnsdale .. | | .. | .. | .. | .. | Purchase by agreement | |
| 1155 | Benalla .. | | .. | .. | .. | .. | | |
| 1156 | Bendigo .. | Grey and Red Box .. | 224 0 | 213 4 | 115 0 | .. | | |
| 1157 | Camperdown .. | Messmate .. | .. | 175 0 | .. | .. | L. L. Grayland, Cobden | |
| 1158 | Casterton .. | | .. | .. | .. | .. | Purchase by agreement .. | |
| 1159 | Castlemaine .. | Peppermint and Box .. | .. | .. | 85 0 | .. | R. L. Maltby, Taradale .. | |
| 1160 | " .. | Grey Box .. | .. | 209 6 | .. | .. | J. H. Jones, Princes-street, Campbells Creek | |
| 1161 | Colac .. | Peppermint and Messmate .. | .. | 110 0 | .. | .. | L. A. Morrow, Barongarook, P.O., via Colac | |
| 1162 | Corryong .. | | .. | .. | .. | .. | Purchase by agreement .. | |
| 1163 | Dandenong .. | Gum and Box .. | .. | 200 0 | .. | .. | Woodlands Fuel Supply, 28 Joffe-road, Pascoe Vale | |
| 1164 | Daylesford .. | Peppermint, Gum and Stringybark | 125 0 | .. | .. | .. | C. G. Bourke, 264 Dundas-street, Thornbury | |
| 1165 | Dimboola .. | White Gum and Box .. | 170 0 | 155 0 | .. | .. | R. N. Warner, 11 Denham-street, Dimboola | |
| 1166 | Echuca .. | Red Gum .. | .. | 144 0 | .. | .. | N. A. Backway, 20 Eyre-street, Echuca | |
| 1167 | Frankston .. | | .. | .. | .. | .. | Purchase by agreement .. | |
| 1168 | Geelong .. | Dry Gum .. | .. | .. | .. | 110 0 | W. W. Shell, Meredith .. | |
| 1169 | Horsham .. | White Gum and Box .. | 170 0 | 160 0 | .. | .. | R. N. Warner, 11 Denham-street, Dimboola | |
| 1170 | Kyneton .. | Peppermint and Gum .. | 137 6 | .. | .. | .. | C. G. Bourke, 264 Dundas-street, Thornbury | |
| 1171 | Lilydale .. | Peppermint and Stringybark | .. | 175 0 | .. | .. | R. A. Symonds, "Spring Grove Farm", Hoddles Creek | |
| 1172 | Maryborough .. | Grey Box .. | .. | 205 0 | .. | .. | R. S. Pora, High-street, Avoca .. | |
| 1173 | Mildura .. | Box .. | .. | 180 0 | .. | .. | A. E. Cleary and Sons, 154 Magnolia-avenue, Mildura | |
| 1174 | Nhill .. | Box and Bulloak .. | 190 0 | 190 0 | .. | .. | Jan Bos, 112 Nelson-street, Nhill | |
| 1175 | Nmurkah .. | | .. | .. | .. | .. | Purchase by agreement | |
| 1176 | Portland .. | | .. | .. | .. | .. | | |
| 1177 | Red Cliffs .. | Box .. | .. | 180 0 | .. | .. | A. E. Cleary and Sons, 154 Magnolia-avenue, Mildura | |
| 1178 | St. Arnaud .. | | .. | .. | .. | .. | Purchase by agreement .. | |
| 1179 | Sale .. | Red Gum .. | .. | 160 0 | 150 0 | .. | K. F. Pyfe, 9 Turnbull-street, Sale | |
| 1180 | Seymour .. | Grey and Red Box .. | .. | 210 0 | .. | .. | C. A. Brown, 33 Wimble-street, Seymour | |
| 1181 | Shepparton .. | | .. | .. | .. | .. | Purchase by agreement | |
| 1182 | Swan Hill .. | | .. | .. | .. | .. | | |
| 1183 | Terang .. | | .. | .. | .. | .. | | |
| 1184 | Traralgon .. | | .. | .. | .. | .. | | |
| 1185 | Upwey .. | | .. | .. | .. | .. | R. S. Dunstan, White-street, Wangaratta | |
| 1186 | Wangaratta .. | Red Gum .. | .. | 120 0 | .. | .. | | |
| 1187 | Warracknabeal | Box and White Gum .. | 195 0 | 180 0 | .. | .. | R. N. Warner, 11 Denham-street, Dimboola | |
| 1188 | Warragul .. | | .. | .. | .. | .. | Purchase by agreement .. | |
| 1189 | Warrnambool .. | Messmate .. | .. | 130 0 | .. | .. | J. O. D. French, 28 Mickle-street, Warrnambool | |
| 1190 | Wodonga .. | Red Box and Mixed .. | .. | 120 0 | .. | .. | Wodonga Woodyard, Box 57, Post Office, Wodonga | |
| 1191 | Yallourn .. | Messmate and Stringybark | .. | 140 0 | .. | .. | E. V. Broberg, 17 Broadway West, Yallourn | |
| 1192 | Yarram .. | | .. | .. | .. | .. | Purchase by agreement | |

Contingencies, 1960-61 and 1961-62.

Approved—H. E. Bolte, Treasurer. 20.9.1960.

CONTRACTS ACCEPTED.—(Series 1960-61.)
PUBLIC WORKS.

- 1028. Ashwood, State School No. 4698, (4) provision of internal toilets, £411.—R. T. Smith.
- 1029. Auburn South, State School No. 4183, (2) new chain wire fence, £303 10s.—Otter Tubular and Steel Fabrication Co.
- 1030. Camperdown, Inspector of Works, (2) repairs and painting to residence, £563.—Pyers Bros.
- 1031. Carlton, Melbourne Teachers' College, (4) new store shed, £327 10s.—F. T. Pulling and Sons Pty. Ltd.
- 1032. Carlton, State School No. 2365, (5) renewal of roof, £1,630.—Allied Roofing and Painting Industries Pty. Ltd.
- 1033. Coburg, Teachers' College, (2) general furniture—cupboards, shelving and racks, £576 3s.—Cherry and Sons Pty. Ltd.

- 1034. Croydon, State School No. 2900, (8) electrical installation, re-wiring and improved lighting, £583 16s.—N. R. K. Biddiscombe.
- 1035. Dandenong, High School, (5) replacement of chalkboards, £300.—F. Freeman.
- 1036. Essendon, State School No. 483, (3) renewal of chalkboards, £366 10s.—F. T. Pulling and Sons Pty. Ltd.
- 1037. Foster, Consolidated School, (4) external repairs and painting to residence, £374 10s.—R. G. Hughes.
- 1038. Frankston, Technical School, (3) electrical installation in new class-room block, £3,344.—Jordans' Pty. Ltd.
- 1039. Geelong, Ariston Hostel, Teacher's College, (3) alterations and additions to boiler house, £1,189 17s.—E. R. Slaven.
- 1040. Geelong, Gordon Institute of Technology, (3) electrical installation in additional L.T.C. class-rooms, £790.—A. G. Walker.

1041. Gembrook, State School No. 2506, (3) internal and external repairs and painting to residence, £440.—N. Walker.
1042. Glenferrie, Swinburne Technical College, (6) electrical installation, extension for plumbing workshop, £430.—W. P. J. Maher.
1043. Glenormiston, Agricultural College, (2) erection of onion storage shed, £712.—Pyers Bros.
1044. Glenroy, Court House, (7) electrical installation, £632 14s. 3d.—Jennings Electrics.
1045. Glen Waverley, State School No. 2219, (3) septic tank installation, £3,952.—H. S. Bolger.
1046. Gowerville, State School No. 4674, (2) plenum heating system in class-rooms, £2,100.—Gray and Wood.
1047. Horsham, State School No. 298, (5) erection of pipe rail and wire mesh fencing to infants school, £295.—A. R. Wheatley.
1048. Kew, State School No. 1075, (4) new water service, infants school, £391 17s. 3d.—B. J. Coffey.
1049. Kew, State School No. 1075, (7) alterations to class-room and provision of staff toilet (1st floor), £1,115 16s.—B. R. Watts and Co.
1050. Melbourne, Government Tourist Bureau, (1) installation of new air filter in existing air conditioning system, £364.—Bruce Sheet Metal Service.
1051. Melbourne, Royal Melbourne Technical College, Swanston-street, (4) electrical installation, £2,524.—Laurel Electric Pty. Ltd.
1052. Melbourne, National Parks Authority, 276 Collins-street, (2) mechanical services, £393.—Ford-Swinton Industries Pty. Ltd.
1053. Moomba Park, State School No. 4876, (3) electrical installation, £1,200.—A. R. Kilevics.
1054. Morwell, State School No. 4692, (5) electrical installation in four additional L.T.C. class-rooms, £520.—A. R. Kilevics.
1055. Morwell, Titles Office, (4) external painting, provision of woodshed, &c., £270.—John Corser Pty. Ltd.
1056. Ormond, Special School No. 4846, (5) renewal of electrical installation, £584.—L. J. Handel.
1057. Ormond East, State School No. 4366, (7) internal and external repairs and painting to school and out-buildings, £2,925.—Donovan and Brown.
1058. Princes Hill, State School No. 2955, (5) improved lighting in infants building, £320 16s. 6d.—Jennings Electrics.
1059. Quarry Hill, State School No. 1165, (3) removal of galleries in three (3) class-rooms, &c., £479 10s.—N. C. Thirwell.
1060. Rainbow, Lands and Survey Department, (1) residence, supply of a timber-framed ready-built home—Phelan type P-8-3, £4,643 9s. 3d.—W. Phelan and Sons Pty. Ltd.
1061. Werribee, State Research Farm, (2) supply, delivery of oil fired incinerator and oil tank to Animal Husbandry Centre, £2,385.—R. G. Williams and Co. Pty. Ltd.
1062. Wickliffe, State School No. 948, (2) erection of new out-office, woodshed block, installation of septic closets, £892 17s.—D. R. Mason.
1063. Wonthaggi, Court House, (4) internal and external renovations, &c., £1,325.—Wonthaggi Construction Co.
1064. Yallourn, Junior Technical School, (5) re-siting shelter pavilions, £390.—E. W. Gravett.
- T. K. MALTBY, Commissioner of Public Works. 26.9.60.
1071. Sale, Technical School, (3) internal and external repairs and painting to residence, £385.—P. Sheehy and P. Casey.
1072. Sunbury, Mental Hospital, (3) electrical installation in pharmacy, £575.—K. J. Dupuy.
1073. Tatyoon, State School No. 1812, (2) internal and external repairs and painting, £1,281.—E. J. Lewis.
1074. Werribee, State Research Farm, (3) supply, &c., of spray irrigation system, Stage 1, £2,796 8s. 9d.—Food Machinery (Australia) Limited.
1075. Wilkur, State School No. 3503, (2) erection of shelter pavilion 16 ft. x 10 ft., £361 10s.—F. L. Cook.
1076. Werribee, State Research Farm, (2) supply, delivery of oil fired incinerator and oil tank to Animal Husbandry Centre, £2,385.—R. G. Williams and Co. Pty. Ltd.
1077. Wickliffe, State School No. 948, (2) erection of new out-office, woodshed block, installation of septic closets, £892 17s.—D. R. Mason.
1078. Wonthaggi, Court House, (4) internal and external renovations, &c., £1,325.—Wonthaggi Construction Co.
1079. Yallourn, Junior Technical School, (5) re-siting shelter pavilions, £390.—E. W. Gravett.
1080. Ararat, Mental Hospital, (2) repairs to boiler room, £350.—A. Green.
1081. Ardeer, State School No. 4848, (4) erection of No. 4 class-room Primary School, £25,878.—A. V. Jennings Construction Co. Pty. Ltd.
1082. Bacchus Marsh, High School, (4) replacement of science sinks, &c., £375.—W. S. Gudgeon and Sons.
1083. Ballan, State School No. 1435, (3) repairs, re-blocking and internal renovations, £545 7s. 6d.—A. K. Wood.
1084. Ballarat, Mental Hospital, (2) central heating in female wards, F.14, F.15, F.16 and F.3, £4,754.—G. Stone and Sons.
1085. Bayswater, Special School No. 4152, (3) water service for head teacher's residence and school, £405.—G. T. Nicholds.
1086. Beechworth, Mental Hospital, (5) roadway, lighting for new ward area, £1,766 3s.—Worboys and Currie.
1087. Bonnie Doon, State School No. 2098, (5) erection of new 16 ft. x 10 ft. shelter pavilion, external painting, to school and residence toilet, £359.—J. F. Wicking.
1088. Broadmeadows, High School, (7) electrical installation in Stages 1 and 2, £5,350 10s.—A. E. Stone.
1089. Bullarook, State School No. 39, (2) re-blocking and internal renovations to residence, £959 10s. 2d.—Seddon Contract Services.
1090. Colac West, State School No. 4064, (3) electrical installation, £640 4s.—W. S. C. Lee.
1091. Coleraine, Court House, (3) internal and external renovations, £930 10s. 6d.—F. J. White.
1092. Collingwood, Girls' Secondary School, (4) covered way, £625.—F. T. Pulling and Sons Pty. Ltd.
1093. Dandenong, State School No. 1403, (4) electrical installation, £638 5s. 6d.—R. McKernan and Son.
1094. Dartmoor, State School No. 1035, (4) erection of out-office block and installation of septic tank, £1,220.—J. F. Wicking.
1095. Doutta Galla, State School No. 4708, (5) connexion to sewerage main, &c., £2,360.—J. L. Devenish.
1096. Doveton West, State School No. 4820, (3) electrical installation in additional six L.T.C. class-rooms, &c., £693 10s.—K. R. Phelan.
1097. Drik Drik, State School No. 971, (3) new out-office block and septic tank installation, £805.—J. F. Wicking.
1098. Erica, State School No. 2437, (3) additional out-offices with septic closets, £390.—W. G. Campbell.
1099. Fern Tree Gully, Technical School, (1) erection of post and wire fencing, £498.—W. and R. W. Lee.
1100. Foster, High School, (7) repairs and painting, £1,300.—R. S. Green.
1101. Gunbower, Police Station, (3) erection of timber-framed residence and office, garage, fuel store and brick cell unit, £7,297.—E. J. Synnott.
1102. Hawthorn, Swinburne Technical School, (5) plenum heating and hot water service in new class-room block, £10,249.—Belsair Pty. Ltd.
1103. Healesville, Court House, (3) internal and external renovations, £625.—F. W. Harris.
1104. Lake Burrumbeet, State School No. 368, (1) erection of a 16 ft. x 10 ft. shelter pavilion, £285 8s. 3d.—J. A. Newman.
1105. Little River, State School No. 1961, (3) installation of septic tanks, £420.—J. F. Wicking.
1106. Mannibadar, State School No. 4446, (2) repairs to porch, resite tanks and stands, provision of drinking troughs, £250.—J. F. Wicking.
1107. Maribyrnong, High School, (3) mechanical services, extended third section, £4,049.—Frederick W. Nielsen Pty. Ltd.
1108. Mitiama, State School No. 2657, (4) general repairs and renovations, £677 10s.—J. A. Stone.
1109. Moomba Park, State School No. 4876, (3) oil fired plenum heating, £3,750.—Gray and Wood.
1110. Moorabbin Heights, State School No. 4837, (4) erection of chain mesh and post and wire fencing, £348.—W. and R. W. Lee.
1111. Morwell, State School No. 2136, (2) internal and external repairs and painting, £948.—E. Vogt.
1112. Mulgrave, State School No. 2172, (3) installation of septic tank, &c., and construction of boys' new out-offices, £882.—J. F. Wicking.
- T. K. MALTBY, Commissioner of Public Works. 3.10.60.

ORDERS IN COUNCIL.—(Series 1960-61.)

EDUCATION DEPARTMENT.

1027. One only Dyeline printing machine, for Preston Technical School, £181 6s. 8d.—Microfax Pty. Ltd.
- Approved by the Governor in Council, 27th September, 1960.—N. G. WISHART, Acting Clerk of the Executive Council.

STATE ELECTRICITY COMMISSION.

1113. The supply of sixteen electric motor-driven belt conveyors for metropolitan fuel supply depots, to Specification No. 60-61/41, £6,900.—B. Anquetil.

1114. The supply of spare blading and diaphragms for 12.5 MW and 25 MW turbines, required for maintenance purposes, Yallourn "A" and "B" Power Stations, to Quotation No. 3318, £35,553.—Australian Electrical Industries Pty. Ltd.

1115. The supply of two 1,200 amp. and four 400 amp. 3.3 kV circuit breaker units for Boiler House "A" Annex, Morwell Power Station, to Quotation No. 3852, £9,524 5s.—English Electric Co. of (Aust.) Pty. Ltd.

1116. The supply of three sets of 220 kV power line carrier high tension coupling apparatus for Geelong and Keilor Terminal Stations, to Quotation No. 3791, £11,260 7s.—Gibson Battle (Melb.) Pty. Ltd.

1117. The supply of 4,500 220 kV switch gear insulators, to Specification No. 60-61/58, £31,658 3s. 8d.—R. M. Hall Pty. Ltd.

1118. The supply of 2,000 220 kV switch gear insulators, to Specification No. 60-61/58, £12,233 6s.—R. E. Jeffries Pty. Ltd.

1119. The supply of 2,000 single phase A.C. kilowatt-hour meters, for metering of consumers' premises, to Specification No. 59-60/100, £18,500.—Siemens Halske Siemens Schuckert (A'asia) Pty. Ltd.

1120. The purchase of land at corner of Flinders-lane and Downie-street, Melbourne, being lots 1, 2, 3 and 4 on plan of subdivision No. 12408, lodged in the Office of Titles and being part of Crown allotments 3 and 4, section 1, City of Melbourne, Parish of Melbourne North, and being the whole of the land comprised in certificate of title volume 8096, folio 126, and part of Crown allotments 3 and 4 of the said section, City and Parish, and being the whole of the land comprised in certificate of title, volume 7150, folio 869, for use as car park, £35,250.—F. H. Stephens (Vic.) Pty. Ltd.

1121. The supply of twelve 22 kV 1,000 MVA outdoor circuit-breaker units and spares for metropolitan and country terminal stations, to Specification No. 59-60/309, £31,378.—Westinghouse Rosebery Pty. Ltd.

1122. The supply of eight fire-fighting tanks, each complete with petrol-driven pumping equipment, for fire fighting in Yallourn area, to Specification No. 60-61/31, £10,674 15s.—Wormald Bros. (Vic.) Pty. Ltd.

1123. The supply of copper to aluminium "T" clamps for transmission and distribution lines for a period of two years, to Specification No. 60-61/11, at Schedule rates.—A. R. Hales and Sons Pty. Ltd.

1124. The supply of copper to aluminium "T" clamps for transmission and distribution lines for a period of two years, to Specification No. 60-61/11, at Schedule rates.—Stanger and Co. Ltd.

Approved by the Governor in Council, 20th September, 1960.—A. MAHLSTEDT, Clerk of the Executive Council.

AUCTION SALES ACT 1958.

ALEXANDRA.—Notice is hereby given that the Annual Meeting of Justices for the licensing of auctioneers will be held at the Court House, Alexandra, on Tuesday, the 22nd November, 1960, at the hour of Ten o'clock in the forenoon. Dated at Alexandra, the 29th day of September, 1960.—M. M. SAUNDER, Clerk of Petty Sessions.

CHARLTON.—Notice is hereby given that the Annual Meeting of Justices for the licensing of auctioneers will be held at the Court House, Charlton, on Tuesday, the 22nd day of November, 1960, at the hour of Ten o'clock in the forenoon. Dated this 29th day of September, 1960.—D. L. CROFT, Clerk of Petty Sessions.

GEELONG.—Notice is hereby given that the Annual Meeting of Justices for the licensing of auctioneers will be held at the Court House, Geelong, on Tuesday, the 22nd of November, 1960, at the hour of Ten o'clock in the forenoon.—J. MILLS, Clerk of Petty Sessions.

HAMILTON.—Notice is hereby given that the Annual Meeting of Justices for the licensing of auctioneers will be held at the Court House, Hamilton, on Tuesday, the 22nd day of November, 1960, at the hour of Ten o'clock in the forenoon.—D. W. HAMMOND, Clerk of Petty Sessions.

KYNETON.—Notice is hereby given that the Annual Meeting of Justices for the licensing of auctioneers will be held at the Court House, Kyneton, on Tuesday, the 22nd November, 1960, at the hour of Ten o'clock in the forenoon.—G. W. THOMPSON, Clerk of Petty Sessions.

MANSFIELD.—Notice is hereby given that the Annual Meeting of Justices for the licensing of auctioneers will be held at the Court House, Mansfield, on Tuesday, the 22nd November, 1960, at the hour of Ten o'clock in the forenoon. Dated at Mansfield, the 29th day of September, 1960.—M. M. SAUNDER, Clerk of Petty Sessions.

MARYBOROUGH.—The Annual Meeting of the Justices for the licensing of auctioneers will be held at the Court House, at Maryborough, on Tuesday, the 22nd November, 1960, at Ten o'clock in the forenoon.—J. CAVEN, Clerk of Petty Sessions.

NHILL.—Notice is hereby given that the Annual Meeting of Justices for the licensing of auctioneers will be held at the Court House, Nhill, on Tuesday, the 22nd November, 1960, at Ten o'clock in the forenoon.—P. J. MENKHORST, Clerk of Petty Sessions.

NUMURKAH.—Notice is hereby given that the Annual Meeting of Justices for the licensing of auctioneers will be held at the Court House, Numurkah, on Tuesday, the 22nd day of November, 1960, at the hour of Ten o'clock in the forenoon.—J. L. COLLINS, Clerk of Petty Sessions.

SEA LAKE.—Notice is hereby given that the Annual Meeting of Justices for the licensing of auctioneers will be held at the Court House, Sea Lake, on Tuesday, the 22nd day of November, 1960, at the hour of half-past Ten o'clock in the forenoon. Dated this 29th day of September, 1960.—D. L. CROFT, Clerk of Petty Sessions.

SWAN HILL.—Notice is hereby given that the Annual Meeting of Justices for the licensing of auctioneers will be held at the Court House, Swan Hill, on Tuesday, the 22nd day of November, 1960, at the hour of Ten o'clock in the forenoon. Dated this 29th day of September, 1960.—R. N. HOLLIS, Clerk of Petty Sessions.

WARRNAMBOOL.—Notice is hereby given that the Annual Meeting of Justices for the licensing of auctioneers will be held at the Court House, Warrnambool, on Tuesday, the 22nd day of November, 1960, at the hour of Ten o'clock in the forenoon. Dated at Warrnambool, this 26th day of September, 1960.—J. F. O'HARA, Clerk of Petty Sessions.

WANGARATTA.—Notice is hereby given that the Annual Meeting of Justices for the licensing of auctioneers will be held at the Court House, Wangaratta, on Tuesday, the 22nd day of November, 1960, at the hour of Ten o'clock in the forenoon.—M. A. TUOHY, Clerk of Courts.

WARRACKNABEAL.—Notice is hereby given that the Annual Meeting of Justices for the licensing of auctioneers will be held at the Court House, Warracknabeal, on Tuesday, the twenty-second day of November, 1960, at the hour of Ten o'clock in the forenoon. Dated, this twenty-eighth day of September, 1960.—E. N. DRAYTON, Clerk of Petty Sessions.

WARRAGUL.—Notice is hereby given that the Annual Meeting of Justices for the Licensing of Auctioneers will be held at the Court House, Warragul, on Tuesday, the 22nd day of November, 1960, at the hour of Ten o'clock in the forenoon. Dated this 3rd day of October, 1960.—G. MILLER, Clerk of Petty Sessions.

WEDDERBURN.—Notice is hereby given that the Annual Meeting of Justices for the licensing of auctioneers will be held at the Court House, Wedderburn, on Tuesday, the 22nd day of November, 1960, at the hour of Ten o'clock in the forenoon. Dated this 29th day of September, 1960.—D. L. CROFT, Clerk of Petty Sessions.

WYCHEPROOF.—Notice is hereby given that the Annual Meeting of Justices for the licensing of auctioneers will be held at the Court House, Wycheproof, on Tuesday, the 22nd day of November, 1960, at the hour of Ten o'clock in the forenoon. Dated this 29th day of September, 1960.—D. L. CROFT, Clerk of Petty Sessions.

YARRAWONGA.—Notice is hereby given that the Annual Meeting of Justices for the licensing of auctioneers will be held at the Court House, Yarrowonga, on Tuesday, the 22nd day of November, 1960, at Ten o'clock in the forenoon.—M. A. TUOHY, Clerk of Courts.

STATE RIVERS AND WATER SUPPLY COMMISSION.

LICENCES TO DIVERT WATER AND CUT RACES, PURSUANT TO THE PROVISIONS OF THE WATER ACTS.

LICENCES as detailed hereunder for the term of years from the date specified in each case have been granted by the Governor in Council to the persons named in the following Schedule:—

SCHEDULE.

| Licence No. | Term of Licence and Commencing Date. | Name and Address of Person to Whom Licence is to be Granted. | Source of Supply. | Area Authorized to be Irrigated Per Annum. | Volume of Water Authorized to be Diverted Per Annum. |
|-------------|--------------------------------------|---|------------------------------|--|--|
| | | | | acres. | ac. ft. |
| 286 | Five years from 1.7.60 .. | The Executors of the Estate of Florence Irene Cross, Lake Charm | Lake Charm .. | 25 | 50 |
| 298 | Fifteen years from 1.7.60.. | Humphrey Courtenay Kempe, Lindsay Point | River Murray (Lindsay Creek) | 200 | 600 |
| 1528 | Fifteen years from 1.7.60.. | Ronald Hunter Mansfield, Nathalia .. | Goulburn River .. | 70 | 140 |
| 1529 | Fourteen years from 1.7.60 | Donald Buxton Phillips, Denison .. | Thomson River .. | 30 | 60 |
| 1530 | Fifteen years from 1.7.60.. | David George Richards, Carisbrook .. | Tullaroop Creek .. | 10 | 20 |

Office of the State Rivers and Water Supply Commission,
Melbourne, 4th October, 1960.

E. BROWN, Secretary,
State Rivers and Water Supply Commission.

Water Acts.

STATE RIVERS AND WATER SUPPLY COMMISSION.

DROMANA—PORTSEA URBAN DISTRICT.

NOTICE to owners of tenements in the under-mentioned street in the Dromana—Portsea Urban District, and the private streets, lanes, courts and alleys opening thereto:—

Elwers-road, from Mount View-road to Keogh-street.

The main pipe in the said street being laid down, the owners of all tenements situated as above are hereby required, on or before the 7th day of November next, to cause proper pipes and stop cocks to be laid, so as to supply water within such tenements from the main pipe.

This notice is in substitution for the one appearing in the *Victoria Government Gazette*, No. 84, dated 7th September, 1960, in so far as Elwers-road is concerned.

E. BROWN, Secretary,
State Rivers and Water Supply Commission.
Melbourne, 30th September, 1960.

Water Acts.

STATE RIVERS AND WATER SUPPLY COMMISSION.

CHELSEA—FRANKSTON URBAN DISTRICT.

NOTICE to owners of tenements in the under-mentioned streets in the Chelsea—Frankston Urban District, and the private streets, lanes, courts and alleys opening thereto:—

Carrum.

Brixton-street, from Station-street to a point opposite lot 9, about 4½ chains north-easterly from Monaco-avenue.

Monaco-avenue, from end of existing main (opposite lot 22) to Brixton-street.

Seaford.

Chicquita-avenue.

Belvedere-road, from Glendale-avenue to Wicklow-street.

Forest-drive, from Frankston—Dandenong road to Mahogany-avenue.

Glendale-avenue.

Frankston—Dandenong road (east side), from end of existing main (opposite lot 50) to a point opposite lot 248 about ½ chain north-easterly from Mahogany-avenue.

Frankston—Dandenong road (west side), from end of existing main (opposite lot 31) to a point opposite lot 62 about ½ chain south-westerly from William-street.

Ironbark-court.

Jarraha-court.

Karri-court.

Mahogany-avenue.

Pine-street, from end of existing main (opposite lot 98) to Forest-drive.

Plantation-street, from Laurel-court to Forest-drive.

Seacrest-avenue.

Stringybark-crescent.

Tallow Wood-street, from Blackbutt-court to a point opposite lot 138 about ½ chain westerly from Messmate-street.

The main pipe in the said streets being laid down, the owners of all tenements situated as above are hereby required, on or before the 7th day of November next, to cause proper pipes and stop cocks to be laid, so as to supply water within such tenements from the main pipe.

E. BROWN, Secretary,
State Rivers and Water Supply Commission.
Melbourne, 30th September, 1960.

STATE FORESTS DEPARTMENT.

APPOINTMENT OF COMMITTEE OF MANAGEMENT OF "CUMBERLAND SCENIC RESERVE".

WHEREAS by section 50 of the *Forests Act 1958* (No. 6254) it is provided that the Minister of Forests may, on the recommendation of the Forests Commission, appoint any number of persons, not less than three, to be a Committee of Management of any land forming part of any reserved forest, such land being a place of natural beauty or interest or a health resort, and may remove any such persons: Now therefore, I, Alexander John Fraser, Her Majesty's Minister of Forests for the State of Victoria, on the recommendation of the Forests Commission, do hereby appoint:—

F. J. BARTON, Shop Proprietor, Marysville, Councillor of Shire of Healesville,

J. HAYCRAFT, Guesthouse Proprietor, Marysville,

B. J. HIGGS, Shop Proprietor, Marysville, and

F. J. MAY, Forest Officer, Marysville,

as members of the Committee of Management until the 30th day of September, 1963, of the land forming part of the Reserved Forest in the Parish of Manango, County of Evelyn, described in the accompanying Schedule and known as the "Cumberland Scenic Reserve", such land being a place of natural beauty and interest.

SCHEDULE ABOVE REFERRED TO.

Parish of Manango, County of Evelyn, comprising 650 acres, more or less, shown by pink colour on the plan marked 59/2654 over 20.9.60 on file of correspondence No. 59/2654 in the Forests Department.

Dated at Melbourne, the 23rd day of September, 1960.

A. J. FRASER,
Minister of Forests.

Children's Welfare Act 1958.—Section 14.

DECLARATION OF AN INSTITUTION AS AN APPROVED CHILDREN'S HOME.

IN accordance with the provisions of clause 49 of the Children's Welfare Regulations 1955, notice is hereby given that on the twenty-sixth day of September, 1960, I, Lindsay Hamilton Simpson Thompson, Acting Chief Secretary of the State of Victoria, declared the under-mentioned institution as an approved Children's Home for the purposes of the *Children's Welfare Act 1958*:—

"St. Joseph's Nursery", 20 Gellibrand-street, Kew.

L. H. S. THOMPSON,
Acting Chief Secretary.

Chief Secretary's Office,
Melbourne, 26th September, 1960.

Transport Regulation Acts:
TRANSPORT REGULATION BOARD.

NOTICES OF PUBLIC HEARINGS.

NOTICE is hereby given that the applications made by the persons named below for licences to operate the commercial goods vehicles on the route or routes, or in the manner set out opposite their names, will be heard at a time and place to be communicated to the persons concerned:—

Name and Address; Nature of Application.

- ALBION QUARRYING CO. PTY. LTD.**, corner of Arden and Laurens streets, North Melbourne; 1 commercial goods vehicle (90 cwt.) to operate throughout the State of Victoria as a road-spraying tanker unit—tar and bitumen incidental to own road-spraying contracts.
- AUSTWICK, N. A. & W. C.**, 32 Margaret-street, Clayton; 1 commercial goods vehicle (231 cwt.) to operate—(a) within a radius of 20 miles of Clayton—general goods, (b) within a radius of 70 miles of Jayworth Besser Ltd., Dandenong—bricks.
- BRICK INDUSTRIES LTD.**, Middleborough-road, Burwood; 1 commercial goods vehicle (127 cwt.) to operate within a radius of 70 miles of own premises at Burwood in the course of business as “brick manufacturers”—own bricks.
- CANAVAN, P. J. & E.**, Myamyn; 1 commercial goods vehicle (102 cwt.) to operate—(a) within a radius of 20 miles from the post office at Myamyn—general goods, (b) within a radius of 50 miles from the post office at Myamyn—petroleum products in prescribed types of containers and empty containers for return, (c) to and from places as defined in paragraph (a) above from and to places within a radius of 50 miles of the post office at Myamyn—livestock.
- DALZIEL, J. C.**, 421 Lyons-street, Ballarat North; application to vary the conditions of existing licence No. D.A.940/1 by adding within a radius of 25 miles from the Chief Post Office in the City of Ballarat—general goods.
- DEVRIES, W. R.**, Lakes Entrance; 1 commercial goods vehicle (100 cwt.) to operate—(a) from forest landings in the Orbost and Nowa Nowa areas to sawmills at Orbost and Nowa Nowa—logs, (b) from sawmills at Orbost and Nowa Nowa to the railway station at Orbost—sawn timber.
- EAST, G. J.**, 78 Wallace-street, Bairnsdale; 1 commercial goods vehicle (188 cwt.) to operate—(a) within a radius of 20 miles of the post office at Bairnsdale—general goods, (b) within a radius of 50 miles of Bairnsdale and within an area east of a north/south line drawn through Rosedale—road-contracting plant and materials.
- ELDER, SMITH & Co. LTD.**, 499 Bourke-street, Melbourne; 4 commercial goods vehicles (12, 9, 9, and 11 cwt. each) to operate throughout the State of Victoria in the course of business as “farm machinery distributors” for the purpose of servicing, supervising installation, and demonstrating farm machinery—tools of trade, spare parts, farm machinery for demonstration, and for specialized installation.
- EVANS, C. R.**, Club-terrace, Bairnsdale; 1 commercial goods vehicle (335 cwt.) to operate—(a) from forest landings in the Lind Park area to sawmills at Club-terrace—logs, (b) from timber yards at Club-terrace to the railway station at Orbost—sawn timber.
- FISHER, J. M., & SONS**, Apollo Bay; 1 commercial goods vehicle, to be purchased, to operate—(a) between Apollo Bay and Melbourne—general goods, (b) between Geelong and Apollo Bay—general goods.
- GOLDSMITH, I. L.**, Donna Buang-road, Warburton; 1 commercial goods vehicle (96 cwt.) to operate—(a) within a radius of 20 miles of Warburton—general goods, (b) within a radius of 70 miles of the post office at Healesville (Dandenong Division of Country Roads Board)—road-contracting plant and materials.
- HUTCHINSON, L. J.**, 16 Nimmo-street, Essendon; 1 commercial goods vehicle (63 cwt.) to operate throughout the State of Victoria in the course of business as “spray painter and roof repairer” in a specially constructed vehicle, for the purpose of spraying and repairing roofs—tools of trade, small quantities of material incidental to own contracts.
- HUXTABLE, K. J.**, 202 Station-street, Koo-Wee-Rup; 2 commercial goods vehicles (229 and 106 cwt. each) to operate—(a) within a radius of 20 miles of Koo-Wee-Rup—general goods, (b) within a radius of 50 miles of Koo-Wee-Rup—fresh vegetables and fruit and empty return containers, (c) from depots in Melbourne to Koo-Wee-Rup and return—petroleum products and empty return containers.
- HYLAND, DAVID, & SONS PTY. LTD.**, 456 Flinders-lane, Melbourne; application to vary the conditions of existing temporary licence No. T.D.2650 by adding frozen lemons and orange juice in tins and frozen foods.
- IRELAND, C.**, Natimuk; 1 commercial goods vehicle (110 cwt.) to operate within a radius of 95 miles of the post office at Cohuna and/or within a radius of 100 miles of the post office at Merbein (Bendigo Division of the Country Roads Board)—road-contracting plant and materials.
- JENKINS, C.**, 107 Dight-street, Collingwood; 1 commercial goods vehicle (30 cwt.) to operate throughout the State of Victoria as a “scrap metal dealer” for the purpose of collecting scrap metals.
- KERR, V. M.**, Barkley-street, Rutherglen; 1 commercial goods vehicle (150 cwt.) to operate—(a) within a radius of 20 miles of the post office at Rutherglen—general goods, (b) to and from places as defined in paragraph (a) above, from and to places within a radius of 50 miles of the post office at Rutherglen—livestock.
- KING, H. C., & Co.**, Yinnar; application to vary the conditions of existing licence No. D.A.28096/2 by adding as paragraph (c) from Warragul to Erica—petroleum products and return with empty return containers.
- KRAFT FOODS LIMITED**, Salmon-street, Port Melbourne; 1 commercial goods vehicle (14 cwt.) to operate—(a) within a radius of 50 miles of the post office situated at the corner of Bourke and Elizabeth streets in the City of Melbourne in the course of business as “cheese manufacturers”—own goods, (b) throughout the State of Victoria in the course of business as “cheese manufacturers” for the purpose of installing advertising displays—tools of trade, own advertising materials, and display samples.
- MALONE, P. R.**, Grasmere Junction; 1 commercial goods vehicle (231 cwt.) to operate—(a) within a radius of 20 miles of the post office at Grasmere—general goods, (b) within a radius of 50 miles of the aforesaid post office—fresh milk, empty milk cans, and fresh meat.
- MCINERNEY, T.**, 1306 Gregory-street, Ballarat; 1 commercial goods vehicle (59 cwt.) to operate throughout the State of Victoria in the course of business as “marine collector”—marine stores as designated in the *Marine Stores and Old Metals Act 1958* (No. 6303), but excluding the carriage of any such goods to wharves, docks, or ships for shipment or export purposes.
- MCINTOSH, A.**, 83 Mercer-street, Geelong; 1 commercial goods vehicle (16 cwt.) to operate throughout the State of Victoria for the purpose of towing and repairing disabled or wrecked vehicles—tools of trade and materials incidental thereto.
- MCMEEKIN, R. A.**, Church-street, Kangaroo Flat; 1 commercial goods vehicle (8 cwt.) to operate within a radius of 100 miles of the Chief Post Office at Bendigo, excluding Melbourne, in the course of business as “refrigeration engineers” for the purpose of servicing and repairing refrigeration equipment—tools of trade, spare parts, refrigerators for repair or having been repaired, and equipment incidental thereto.
- PARKINSON, M. & D. R.** (trading as Parkinson Motors), Ford-street, Beechworth; 1 commercial goods vehicle (9 cwt.) to operate between Beechworth and Wangaratta for the carriage of mails, under contract to the P.M.G. Department, parcels and newspapers.
- PULLING, F. T., & SONS PTY. LTD.**, 8 Lord-street, Richmond; 1 commercial goods vehicle (15 cwt.) to operate throughout the State of Victoria in the course of business as “builders and contractors” in a supervisory capacity, with the ability to carry tools of trade and incidental items of components for replacement or completion of work in hand, all other materials having been transported by rail.
- READ, J. E. & P. M.**, Coombs-road, Taggerty; 1 commercial goods vehicle (283 cwt.) to operate from forest landings at Mt. Bulla to sawmills at Mansfield—logs.
- REPLACEMENT PARTS PTY. LTD.**, 618 Elizabeth-street, Melbourne; 1 commercial goods vehicle (14 cwt.) to operate within a radius of 50 miles of own branch premises at Shepparton and to Pyalong in the course of business as “automotive parts distributors and reconditioners”—own goods and automotive parts and engines for reconditioning or having been reconditioned.
- THE ROSELLA PRESERVING & MANUFACTURING CO. PTY. LTD.**, 64 Balmain-street, Richmond, E.1; 1 commercial goods vehicle (16 cwt.) to operate—(a) within a radius of 50 miles from own premises at Richmond in the course of business as “food preservers”—own goods,

(b) throughout the State of Victoria for the purpose of advertising own products and sales promotion—own manufactured products and advertising materials incidental thereto.

SANTOS, W., care of J. Santos, Haradoc-avenue, Irymple; 1 commercial goods vehicle (100 cwt.) to operate throughout the Shires of Wycheproof, Karkaroc, Walpeup, and Mildura—road-contracting plant and materials.

SEALWALL PACKS PTY. LTD., 41A Perth-street, Prahran; 1 commercial goods vehicle (7 cwt.) to operate throughout the State of Victoria in the course of business as "water proofing consultants" for the purpose of demonstrating water proofing materials—tools of trade, water proofing equipment for demonstration purposes only, and small quantities of materials incidental thereto.

TRANS OTWAY LIMITED, corner of Rylie and Fenwick streets, Geelong; 2 commercial goods vehicles (79 and 246 cwt. each) to operate—(a) from and to the metropolitan area of the City of Melbourne (as defined in the *Transport Regulation Act 1958*) or from and to the Geelong District (as defined in the First Schedule for the *Commercial Goods Vehicles Act 1958*) to and from places situated on or accessible only from the Great Ocean-road between a point 1 mile west of the Township of Lorne and the Township of Apollo Bay—general goods, (b) from and to the Township of Apollo Bay to and from the Township of Colac—general goods, (c) within a radius of 20 miles from the post office at Apollo Bay—general goods, (d) within a radius of 25 miles from the Chief Post Office in the City of Geelong—general goods.

TRARALGON EARTHMOVING CO., care of A. O. Jones, Quentin-road, East Malvern; application to vary the conditions of existing licence No. D.A.39898 by deleting Traralgon from paragraphs (a) and (c), and adding in lieu to, paragraphs (a), and (c)—Healesville.

WEAVER, R. E., 5 Bosanquet-avenue, Herne Hill; 1 commercial goods vehicle (248 cwt.) to operate—(a) within a radius of 25 miles of the Chief Post Office at Geelong—general goods, (b) within a radius of 75 miles of the Chief Post Office in the City of Geelong (Geelong Division of the Country Roads Board)—road-contracting plant and materials.

WEBB, FRED, PTY. LTD., 197 Graham-street, Wonthaggi; 1 commercial goods vehicle (8 cwt.) to operate throughout the State of Victoria in the course of business as "quarrymasters" for the purpose of servicing and maintaining own bulldozers, quarrying equipment, and vehicles—tools of trade, spare parts, and materials incidental to such servicing and maintenance work.

WILCOX, A. L., Hume Highway, Euroa; 1 commercial goods vehicle (15 cwt.) to operate throughout the State of Victoria for the purposes of repairing or towing disabled or wrecked vehicles—tools of trade, spare parts, and materials incidental thereto.

WISE, D. K. & I. T., 355 Kiewa-street, Albury; 1 commercial goods vehicle (132 cwt.) to operate—(a) within a radius of 20 miles of Wodonga—general goods, (b) within a radius of 60 miles of Wodonga—lock joint and pressure reinforced concrete pipes, solely on behalf of Rocla Pipes Ltd., of Bandiana.

NOTICE is hereby given that the applications made by the persons named below for renewal of licences to operate the commercial goods vehicles on the route or routes or in the manner set out opposite their names, will be heard at a time and place to be communicated to the persons concerned:—

Name and Address, Present Franchise, Licence No., Date of Expiry.

BAMBER, H. W., & R. N. FINEMAN (trading as Bamber and Fineman), 7 Bent-street, North Brighton; 1 commercial goods vehicle (83 cwt.) to operate throughout the State of Victoria—tools of trade, gear and equipment, and materials incidental to licensees' own contracts, in the course of their business as "house lifters, reblockers, and removers"; D.A.2390; 21st December, 1960.

BEER, A. L., Post Office, Strathmerton; 1 commercial goods vehicle (112 cwt.) to operate—(a) within a radius of 20 miles from the post office at Strathmerton—general goods, (b) within a radius of 50 miles from the post office at Strathmerton—road-contracting plant and materials; D.A.27931; 17th December, 1960.

BRITISH UNITED DAIRIES PTY. LTD., 141 Osborne-street, South Yarra; 1 commercial goods vehicle (8 cwt.) to operate throughout the State of Victoria in the course of licensee's business as "manufacturers of milk

products" for the purpose of sales promotion and advertising own lines only—samples of licensee's own manufactured products with the ability to make an urgent incidental delivery; D.A.27168/1; 17th December, 1960.

BROWN, E. L. (trading as Brown and Mitchell), Box 2, Post Office, Harrow; 1 commercial goods vehicle (78 cwt.) to operate for the carriage of general goods within an area bounded as follows:—(a) On the west by the South Australian border, (b) on the north by the road running from Horsham, via Natimuk and Geroke, to the border of South Australia, en route to Frances (South Australia); (c) on the east by the road running from Horsham, via Noradjuha, Jalumba, Kanagulk and Balmoral to Hamilton, (d) on the south by the road running from Hamilton, via Coleraine and Casterton, to the border of South Australia, en route to Penola, South Australia. Special condition: It is also a condition of this licence that no such goods can be carried for consignment at railhead at Hamilton and Horsham for places outside the area as defined above, and no such goods which have been consigned to the railheads at Hamilton and Horsham can be carried from the railway yards to the aforementioned area; D.A.5038/1; 17th December, 1960.

BRUNT, S. G., Cranbourne; 1 commercial goods vehicle (146 cwt.) to operate within a radius of 20 miles from the post office at Cranbourne and to and from the City of Melbourne, in the course of licensee's business as "grain, produce and hardware merchant"—own goods; D.A.28821; 17th December, 1960.

CANN, F. M., 18 Collie-street, North Melbourne; 1 commercial goods vehicle (95 cwt.) to operate within a radius of 70 miles from the premises of the New Brunswick Brick and Pottery Co. Pty. Ltd. at East Brunswick—earthenware pipes and fittings on behalf of the said company; D.A.23876/1; 17th December, 1960.

HINE, L. J., Box 12, Rowsley; 1 commercial goods vehicle (80 cwt.) to operate—(a) within a radius of 20 miles from the post office at Rowsley—general goods, (b) from clay pits in the Rowsley district to consignees in the City of Melbourne and the metropolitan area and to the City of Geelong—refractory clay, (c) between the City of Melbourne and the Township of Rowsley—petroleum products in prescribed types of containers and empty containers as agent for the Atlantic Union Oil Co. Pty. Ltd.; D.A.1303/2; 13th December, 1960.

HOLLAND, J. S., 39 High-street, Mont Albert; 1 commercial goods vehicle (7 cwt.) to operate within a radius of 50 miles from the post office situate at the corner of Bourke and Elizabeth streets, in the City of Melbourne, and to and from the markets at Warragul and Trafalgar, in the course of business as "stallholder"—own softgoods; D.A.1316; 21st December, 1960.

JONES, W. L. (trading as W. T. Jones and Son), 11 Piper-street, Kyneton; 1 commercial goods vehicle (100 cwt.) to operate within a radius of 150 miles from the post office situated at Kyneton, in the course of business as "monumental masons"—monumental stones, tools of trade and incidental materials for use on licensee's own contracts; D.A.1404; 1st December, 1960.

LEECH, A. G., PTY. LTD., 56 Kars-street, Maryborough; 1 commercial goods vehicle (83 cwt.) to operate within a radius of 95 miles of the post office at Cohuna and/or within a radius of 100 miles of the post office at Merbein (Bendigo Division of the Country Roads Board) and within a radius of 80 miles of the post office at Dimboola (Horsham Division of the Country Roads Board) and within a radius of 55 miles of the post office at Beaufort (Ballarat Division of the Country Roads Board)—road-contracting plant and materials; D.A.1482/2; 17th December, 1960.

NALDER, J. C. & P. M. (trading as Nalder's Garage), 2-4 Patrick-street, Stawell; 1 commercial goods vehicle (63 cwt.) to operate throughout the State of Victoria as a tow truck for the purpose of towing disabled or wrecked vehicles—tools, spare parts and materials incidental to trade; D.A.27941; 17th December, 1960.

WELLER, K. A., Myrtle-street, Myrtleford; 1 commercial goods vehicle (20 cwt.) to operate within a radius of 50 miles from the post office at Myrtleford for the carriage of agricultural machinery and towing disabled or wrecked vehicles to or from the holder's premises at Myrtleford—tools of trade and incidental materials; D.A.2265; 1st December, 1960.

NOTICE is hereby given that the applications made by the persons named below for licences to operate commercial passenger vehicles, on the route or routes or in the manner set out opposite their names, will be heard at a time and place to be communicated to the parties:—

Name and Address; Nature of Application.

WARRAGUL BUS LINES PTY. LTD., Queen-street, Warragul; 1 commercial passenger vehicle, with seating capacity for 31 persons, to operate as an additional stage omnibus under the same terms and conditions as all "C.O." licences at present held by the applicant.

MORTLAKE ROADWAYS PTY. LTD., 205 Raglan-parade, Warrnambool; 1 commercial passenger vehicle, with seating capacity for 33 persons, to operate for the carriage of school children only between Darlington East and Mortlake under contract to the Education Department.

CADAN, J. F., 80 Albion-street, Kyabram; 1 commercial passenger vehicle, to be purchased, with seating capacity for five persons, to operate under the same terms and conditions as existing taxi-cabs licensed at Kyabram.

WARNECKE, W. T., Highett-street, Mansfield; application for renewal of licence No. C.T.266 (expiring 20th April, 1959) authorizing operations as a country taxi-cab from Mansfield.

HOY'S PASSENGER SERVICE, Wangaratta; 1 commercial passenger vehicle, with seating capacity for 32 persons, to operate as an additional vehicle under the same terms and conditions as all "C.O." licences at present held by the applicant.

BELL-STREET BUS CO. PTY. LTD., 324 Bell-street, Pascoe Vale; application for variation of Route 112A (Coburg-Merlynston) to extend service from the existing terminus at the corner of Cumberland-road and Kent-road, via Kent-road, Cornwall-street, Pascoe-street and West-street, to the corner of West-street and Glenroy-road. (Sections, fares and time-tables to be determined.)

NOTE.—The applicant requests that the above extension be granted as a permanent right or alternatively as a temporary measure until road facilities are adequate for the operation by Northern Bus Lines of the proposed bus service from Glenroy to Merlynston, via Glenroy-road, West-street, South-street, Sussex-street and Boundary-road.

SHAVE, O. C., 1964 Malvern-road, East Malvern; application for 1 additional commercial passenger vehicle, with seating capacity for 29 passengers, to operate as a metropolitan stage omnibus on Route 47A (Carnegie-Holmesglen-Syndal) under the same terms and conditions as licences already operating in the applicant's name.

JONES, T. I., 12 Castlebar-road, Oakleigh; application for 1 additional commercial passenger vehicle, with seating capacity for 35 passengers, to operate as a metropolitan stage omnibus on Route 77A (Murrumbena) under the same terms and conditions as licences already held in the applicant's name.

ELSTON, G. F., 22 Ludstone-street, Hampton; application for 1 additional commercial passenger vehicle, with seating capacity for 41 passengers, to operate as country stage omnibus on Route 215A (Cheltenham-Beaumaris) under the same terms and conditions as licences already operating in the name of the applicant.

BELL-STREET BUS CO. PTY. LTD., 324 Bell-street, Preston; a required number of commercial passenger vehicles, with large seating capacity, to be purchased, to operate as metropolitan route omnibuses on the following route:—Pascoe Vale South—Essendon: Commencing at the corner of Melville-road and Bell-street, Pascoe Vale South, via Bell-street and Bell-street extension towards Essendon on a route to be determined when bridgeworks over the Moonee Ponds Creek are completed. (Sections, fares and time-tables to be determined.)

APPLICATIONS for metropolitan private hire car licences by the persons listed hereunder in respect of commercial passenger vehicles, with seating capacity for five persons, to operate under composite conditions from an approved depot in zone set out opposite their names:—

Name and Address; Zone.

MICALLEF, P., 67 Winifred-street, Oak Park; "N".
BUCKINGHAM, R. H., 1 Shirley-street, Fawkner; "H".
D'ENYAR, C. J., 17 Service-road, Blackburn; "D", "E".

McNEILL, G. D., 3 Edith-street, Pascoe Vale; "J".

LOCKE, V., 73 Grosvenor-street, St. Kilda; "D", "E", "O".

COSTER, B., 15 Ramsden-street, Clifton Hill; 1 commercial passenger vehicle, with seating capacity for five persons, to operate as a metropolitan taxi-cab.

SHEEN, W. R., 19 Thornton-street, Kew; 1 commercial passenger vehicle, with seating capacity for five persons, to operate as a metropolitan taxi-cab, subject to the cancellation of metropolitan private hire car licence No. M.H.1687 operated from Regal Private Hire Service, 50 Riversdale-road, Camberwell, in the name of the applicant.

Notice of any objection should be forwarded to reach the Secretary to the Board not later than Wednesday, 19th October, 1960.

E. V. FIELD,

Secretary.

Exhibition Buildings, Rathdown-street, Carlton, N.3,
Wednesday, 5th October, 1960.

DEPARTMENT OF MINES.

APPLICATION FOR LEASE DECLARED ABANDONED.

7552, Mineral; Henry Allan Green; 106a. 2r. 34p., Parish of Lynchfield.

MINING LEASES GRANTED.

8344, Beechworth; Roger Geoffrey Blake; 31a. 1r. 1p., Parish of Burrungabugge.

11355, Bendigo; Arthur William James Mitchell and Albert John Mitchell; 6a. 1r. 30p., Parish of Redcastle.

7782, Mineral; John William Condon; 140a. 0r. 12p., Parish of Gerangamete.

7790, Mineral; Francis Ronald Cole and Mary Valerie Cole; 30a. 0r. 8p., Parish of Moorbanool.

7851, Mineral; William Gerrard Roache; 5a. 0r. 7p., Parish of Lorne (in lieu of lease No. 7438, Mineral, expired).

TAILINGS LICENCES GRANTED.

3056, Tailings Licence; Bendigo Pottery Pty. Ltd.; at Bendigo (in lieu of tailings licence No. 2973, expired).

3060, Tailings Licence; H. L. Rigbye; at Eaglehawk.

3061, Tailings Licence; Antonio Sist; Parish of Langi Kal Kal (in lieu of tailings licence No. 2976, expired).

3062, Tailings Licence; Lindsay Gordon Lakey; Parish of Maldon (in lieu of tailings licence No. 2946, expired).

CONSENTS GRANTED TO TRANSFER MINING LEASE.

7222, Mineral; from Richard Walter Donaldson and Arthur Ernest Cooper to John Clarence Crisp; and from John Clarence Crisp to The Wedderburn Brick and Pipe Works Proprietary Limited.

EXTENSION OF TERM OF PETROLEUM PROSPECTING LICENCES.

196, Petroleum Prospecting Licence; Oilco Limited; 191 square miles, Parishes of Maffra, Stratford, Woundallah, Denison, Winnindoo, Tinamba, Toongabbie North, Glenmaggie, Coongulla, Wa-de-lock and Bundalaguah.

197, Petroleum Prospecting Licence; Oilco Limited; 195 square miles, Parishes of Coongulla, Wa-de-lock, Briagolong, Bow-Worrung, Narrang, Glenaladale, Koorool, Marlooh, Nindoo and Stratford.

201, Petroleum Prospecting Licence; Oilco Limited; 96 square miles, Parishes of Tong Bong, Loy Yang, Callignee, Bulga, Carrajung, Boodyarn, Wonwron and Mullungdung.

W. J. MIBUS,
Minister of Mines.

MINING LEASE DECLARED VOID.

8154, Beechworth; Clarence George Henry Poole and Peter Clarke Poole; 15a. 2r. 36p., Parish of Kevington.

J. B. TILLEY,
Secretary for Mines.

MELBOURNE AND METROPOLITAN BOARD OF WORKS.

GENERAL NOTICE.

THE Melbourne and Metropolitan Board of Works, having made sewers for carrying off the sewage from each and every property which, or any part of which, abuts on the streets or parts of streets in which such sewers are laid, and which are included within the sewerage areas hereinafter described, do hereby declare that on and after the 5th November, 1960, each and every property which, or any part of which, abuts on the said streets or parts of streets, shall be deemed to be a seweraged property within the meaning of the Melbourne and Metropolitan Board of Works Act 1958.

The Sewerage Areas hereinbefore referred to are:—

Sewerage Area No. 1652.

Shire of Keilor.—Commencing at the intersection of Grieve-street and Teague-street, thence westerly along Teague-street, southerly along Albert-street, easterly along Vaynor-street, southerly along the western boundaries of lots 457 Vaynor-street and 504 Ida-street, easterly along Ida-street, southerly and easterly along the western and southern boundaries of lot 531 Ida-street, southerly along Pearl-street, easterly along portion of the southern boundary of lot 26 Pearl-street, southerly along the western boundaries of lots 3 and 9 Hampton-road, and 22 and 9 Emerald-street, further southerly by a line in continuation to Ruby-street, westerly along Ruby-street, southerly along the western boundary of lot 1 Ruby-street, easterly along the southern boundaries of the said lot 1 and lot 2 Ruby-street, northerly along the eastern boundary of the said lot 2, easterly along Ruby-street, northerly along the eastern boundary of lot 4 Ruby-street, easterly along portion of the southern boundary of lot 8 Emerald-street, northerly along the eastern boundaries of the said lot 8, lot 23 Emerald-street, and lots 8 and 2 Hampton-road, easterly along portion of the southern boundary of lot 5 Diamond-street, northerly along Diamond-street, westerly along Rose Hill-road, northerly along the eastern boundary of lot 4 Rose Hill-road, easterly along portion of the southern boundary of lot 6 Diamond-street, northerly along Diamond-street, easterly along the southern boundary of lot 5 Diamond-street, southerly by a subdivision line a distance of 35 feet, easterly by a subdivision line to a point in Hoffmans-road 238 feet south of the southern side of Ida-street, northerly along Hoffmans-road, westerly along the northern boundaries of lot 6 Hoffmans-road and lots 352 and 353 Teague-street, northerly by a line parallel to Hoffmans-road to Muriel-street, westerly along Muriel-street, southerly along Grieve-street to the commencing point.

Sewerage Area No. 1653.

City of Essendon and Shire of Keilor.—Commencing at the junction of Market-street and Graves-street on the boundary of Sewerage Area No. 999, thence northerly, generally westerly, and northerly following the said boundary to the junction of Bradshaw-street and Keilor-road, westerly along Keilor-road, northerly along Birdwood-street, westerly along Dudley-street, southerly along Treadwell-road, westerly along the northern boundaries of properties Nos. 326 and 328 Keilor-road, southerly along the western boundary of the said No. 328, further southerly along the western boundaries of lots 4 Keilor-road, 1 Carrington-road, 1 to 3 Hoffmans-road, and 264 and 265 Grandview-road, westerly and southerly along Hoffmans-road, easterly along the southern boundary of lot 580 Hoffmans-road and a line in continuation to the boundary of Sewerage Area No. 1629, northerly following the said boundary to Market-street, easterly along Market-street to the commencing point.

Sewerage Area No. 1654.

City of Footscray.—Commencing at the intersection of Ballarat-road and Nicholson-street, thence northerly along Nicholson-street to a point about 285 feet north of the northern side of Ballarat-road, westerly by a line to a point 135 feet west of the western side of Nicholson-street, northerly by a line parallel to Nicholson-street to Farnsworth-avenue, westerly along Farnsworth-avenue, north-westerly along Smith-crescent, north-easterly along the south-eastern boundary of lot 52A Smith-crescent, north-westerly along the north-eastern boundaries of the said lot 52A, lot 53A, and lots 54 to 59 Smith-crescent, northerly by a line to the north-eastern angle of lot 67 Smith-crescent, westerly along the northern boundaries of the said lot 67, lot 37 Smith-crescent and lot 36 Rippon-street to the boundary of Sewerage Area No. 1019, southerly, westerly and southerly following the said boundary and the boundary of Sewerage Area No. 1136 to the junction of Fern-terrace and Ballarat-road, easterly along Ballarat-road to the commencing point.

Sewerage Area No. 1655.

City of Williamstown.—Commencing at the junction of Mason-street and Maddox-street, thence southerly along Maddox-street, westerly along the Geelong railway line to a point in line with Sydney-street, northerly by a line to and along Sydney-street, westerly and northerly along the southern and western boundaries of lot 45 Sydney-street, north-easterly along portion of the northern boundary of the said lot 45, north-westerly along the south-western boundary of lot 47 Rosshire-road, northerly along the western boundary of lot 118 Rosshire-road, south-westerly by a line parallel to Rosshire-road to Basil-street, northerly along Basil-street, westerly along the southern boundary of lot 3 Basil-street, northerly along the western boundaries of the said lot 3 and lot 2 Woods-street, westerly along Woods-street, northerly along Clyde-street, westerly along the southern boundaries of lots 114 Clyde-street and 132 Blenheim-road, northerly along Blenheim-road, easterly along Mason-street to the commencing point.

Sewerage Area No. 1656.

City of Broadmeadows.—Commencing at the junction of Argyle-street and McBryde-street, thence northerly along McBryde-street, westerly along Lorne-street, northerly along Wyuna-street to the boundary of Sewerage Area No. 1213, westerly, southerly, easterly, and southerly following the said boundary and the boundary of Sewerage Area No. 1579 to a point in Argyle-street about 212 feet west of the western side of Wembley-road, easterly along Argyle-street to the commencing point.

Sewerage Area No. 1657.

City of Nunawading.—Commencing at the junction of Aberdeen-road and School-street on the boundary of Sewerage Area No. 1469, thence easterly, southerly, and easterly following the said boundary to the north-eastern angle of lot 16 Highfield-avenue, southerly along the eastern boundary of the said lot 16, westerly along Highfield-avenue, southerly along Aberdeen-road, westerly along Perth-street, northerly along Middleborough-road, easterly along Craig-street, southerly along Aberdeen-road to the commencing point.

Sewerage Area No. 1658.

City of Coburg.—Commencing at the junction of Murray-road and Newlands-road, thence northerly along Newlands-road, easterly and northerly along Golf-road, north-easterly along the south-eastern boundaries of lot 104 Golf-road and lots 100 to 95 Nola-street, northerly along the eastern boundaries of the said lot 95 and lots 94 to 92 Nola-street, westerly along the northern boundary of the said lot 92, northerly along Nola-street, westerly along the northern boundaries of lots 58 Nola-street and 36 and 490 Golf-road, northerly along the eastern boundaries of properties on the eastern side of Newlands-road to the south-eastern angle of lot 20 Newlands-road, north-easterly along the south-eastern boundary of lot 22 Golf-road, north-westerly along Golf-road, northerly along Newlands-road, westerly along McMahoons-road, northerly along the eastern boundary of lot 7 McMahoons-road, westerly along the northern boundaries of the said lot 7, lots 8 to 10, and lots 17 to 15 McMahoons-road, northerly along View-street, westerly along the northern boundary of lot 23 View-street, northerly along portion of the eastern boundary of lot 27 Speedie-street, westerly along the northern boundaries of the said lot 27, lot 28 Speedie-street, and lots 35 and 36 McDonnell-street, further westerly by a line in continuation to Merri Creek, generally southerly along Merri Creek to a point in line with Lake-grove, southerly by a line to and along Lake-grove to Murray-road, easterly along Murray-road to the commencing point.

Further particulars regarding the streets or parts of streets in which sewers have been laid may be ascertained on inquiry at the Board's office.

By order of the Board,

V. C. TREYVAUD,

Secretary.

110 Spencer-street, Melbourne, C.1, 4th October, 1960.

Country Fire Authority Act.

PERMISSION TO HOLD FIRE BRIGADE DEMONSTRATION.

IN pursuance of the provisions of section 103 (1) and (2) of the *Country Fire Authority Act 1958*, the Country Fire Authority has granted permission for the holding of a fire brigade demonstration as under:—

URBAN FIRE BRIGADES.

At Dandenong, on Saturday, 3rd December, 1960.

G. G. SINCLAIR, Secretary.

Town and Country Planning Act 1958 (As Amended).

TOWN AND COUNTRY PLANNING BOARD.

INTERIM DEVELOPMENT ORDER.

Notice of Approval.

IN pursuance of the powers conferred by the *Town and Country Planning Act 1958*, as amended, the Governor of the State of Victoria, by and with advice of the Executive Council thereof, on the fourth day of October, 1960, approved for a further twelve months an Interim Development Order by the Town and Country Planning Board in respect of the municipal district of the Shire of Fern Tree Gully.

Except in accordance with the provisions of a permit issued by the Town and Country Planning Board, the Order generally prohibits, in the major portion of the Shire, the subdivision of land into allotments having an area of less than five acres and the use or development of land other than land which was shown as a separate allotment on a plan of subdivision sealed by the Council prior to December 31, 1958.

The felling, destroying or uprooting of any trees of an indigenous species on and near any road or street or within a specified distance of any creek, stream or defined natural watercourse, or within certain other specified areas, is also prohibited except in accordance with the provisions of a permit issued by the Town and Country Planning Board.

The provisions of the Interim Development Order do not prevent the continuance of the use of any land or buildings for the purposes for which such land or buildings were lawfully used immediately before the coming into operation of the Order.

A copy of the Interim Development Order and a map showing the area affected may be inspected free of charge at the office of the Council of the Shire of Fern Tree Gully at Fern Tree Gully, and at the office of the Town and Country Planning Board, 61 Spring-street, Melbourne.

NOEL L. LYNEHAM,
Secretary.

Town and Country Planning Act 1958 (As Amended).

TRARALGON PLANNING SCHEME, 1957.

NOTICE OF APPROVAL.

IN pursuance of the powers conferred by the *Town and Country Planning Act 1958*, as amended, the Governor of the State of Victoria, by and with advice of the Executive Council thereof, on the 20th September, 1960, approved with modifications a Planning Scheme entitled the Traralgon Planning Scheme 1957, in respect of part of the municipal district of the Shire of Traralgon.

A copy of the Planning Scheme as approved may be inspected during office hours at the office of the Town and Country Planning Board, 61 Spring-street, Melbourne; at the Office of the Shire of Traralgon, Traralgon; and when available, at the Office of Titles, Melbourne, and at the Central Plan Office of the Department of Crown Lands and Survey, Melbourne.

NOEL L. LYNEHAM,
Secretary, Town and Country Planning Board.

Electric Light and Power Act 1958.

ORDERS GRANTED BY THE GOVERNOR IN COUNCIL.

IT is hereby notified that Orders, pursuant to the provisions of the *Electric Light and Power Act 1958* (No. 6241), as hereunder mentioned, have been granted by His Excellency the Governor in Council, viz.:—

- Order No. 318.—Order under section 13 of the above-mentioned Act granted to the Preston City Council.
Order No. 319.—Order under section 13 of the above-mentioned Act granted to the Footscray City Council.
Order No. 320.—Order under section 13 of the above-mentioned Act granted to the Coburg City Council.
Order No. 321.—Order under section 13 of the above-mentioned Act granted to the Melbourne City Council.
Order No. 322.—Order under section 13 of the above-mentioned Act granted to the Brunswick City Council.

G. O. REID,
Minister of Electrical Undertakings.

State Electricity Commission of Victoria,
4th October, 1960.

VEGETATION AND VINE DISEASES ACT 1958.

I, THE undersigned Gilbert Lawrence Chandler, being the responsible Minister of the Crown for the time being administering the *Vegetation and Vine Diseases Act 1958*, in accordance with the provisions of section 9 of the said Act, do hereby appoint the under-mentioned persons to exercise with respect to any land whatsoever in that part of Victoria which lies within the limits of the Central Bailiwick of the Supreme Court of Victoria as defined in the Third Schedule to the *Supreme Court Act 1958*, the following powers, that is to say, to enter upon any such land whatsoever at any time with or without assistants to search for diseased trees, plants or vegetables and to remain thereon so long as may be reasonable for such purpose:—

MCPHAIL, JOHN ALEXANDER.
BARBER, BERNARD.
COWEY, DAVID.
BELL, GEORGE EDWARD.
MCKIMMIE, CLIVE FREDERIC.
STEDMAN, STUART MACKENZIE.
STICHLING, CLAUDE BERESFORD.
TATE, GREGORY HERBERT.

Given under my hand, at Melbourne, the 26th day of September, 1960.

G. L. CHANDLER,
Minister of Agriculture.

VEGETATION AND VINE DISEASES ACT 1958.

I, THE undersigned Gilbert Lawrence Chandler, being the responsible Minister of the Crown for the time being administering the *Vegetation and Vine Diseases Act 1958*, in accordance with the provisions of section 9 of the said Act, do hereby appoint the under-mentioned persons to exercise with respect to any land whatsoever in that part of Victoria which lies within the limits of the Eastern, Western, Midland, Northern and Southern Bailiwicks of the Supreme Court of Victoria as defined in the Third Schedule to the *Supreme Court Act 1958*, the following powers, that is to say, to enter upon any such land whatsoever at any time with or without assistants to search for diseased trees, plants or vegetables and to remain thereon so long as may be reasonable for such purpose:—

MCPHAIL, JOHN ALEXANDER.
BARBER, BERNARD.
COWEY, DAVID.
BELL, GEORGE EDWARD.
MCKIMMIE, CLIVE FREDERIC.
STEDMAN, STUART MACKENZIE.
STICHLING, CLAUDE BERESFORD.
TATE, GREGORY HERBERT.

Given under my hand, at Melbourne, the 26th day of September, 1960.

G. L. CHANDLER,
Minister of Agriculture.

NOTICE TO MARINERS.

[No. 13 of 1960.]

AUSTRALIA.—VICTORIA.

THE following Notice to Mariners, which has been received from the Harbor Master, Geelong, is published for general information.

C. O'MALLEY,
Port Officer.

Ports and Harbors Branch,
Department of Public Works,
Melbourne, C.2, 27th September, 1960.

GEELONG HARBOR TRUST COMMISSIONERS.

PORT OF GEELONG.

Point Richards Channel—(1) *Light Beacon Demolished.*
(2) *Light Buoy Established—Temporary.*

Position.—No. 6 Light Beacon Point Richards Channel. Lat. 38 deg. 05 min. 42 sec. S. Long. 144 deg. 36 min. 10 sec. E. (approximately).

Details (1).—No. 6 Light Beacon Point Richards Channel, in the above position, has been demolished.

Details (2).—A light buoy has been established in the above position, in place of the demolished No. 6 Light Beacon.

Character.—Flashing green every 4 seconds.

Elevation.—13 feet (from lattice work mast).

Colour.—Black.

Remarks.—Light buoy will remain in above position pending construction of new light beacon.

MARYSVILLE WATERWORKS TRUST.

RATING BY-LAW FOR THE YEAR 1960.

THE Marysville Waterworks Trust, in pursuance and exercise of powers conferred by the Water Acts, doth hereby make a rate for the supply of water for domestic purposes of One shilling and eight pence in the pound of the annual municipal valuation of the land and tenements liable to be rated within the Marysville Urban District, provided that in no case shall the amount payable per annum in respect of any tenements (other than land on which there is no building) be less than One pound, and in respect of land on which there is no building less than Ten shillings.

Such rates are made and levied upon the occupiers and/or owners of the said land and tenements for the year commencing on the first day of January, 1960, and shall be payable on the fifteenth day of October, 1960, at the office of the said Trust.

Passed at the meeting of the Trust held on Friday, 27th May, 1960.

(SEAL) J. A. GRIEVE, Chairman.
W. MASSEY, Secretary.

Approved, 28th September, 1960.—W. J. MIBUS, Minister of Water Supply.

MERRIGUM WATERWORKS TRUST.

EXTENSION OF TIME FOR COMPLETION OF LIST OF VOTERS.

HIS Excellency the Governor of the State of Victoria, by and with the advice of the Executive Council thereof, doth by Order made on the 4th October, 1960, in pursuance of the provisions of section 130 of the Water Act 1958, extend the time for the completion of the list of voters for the election of Commissioners of the Merrigum Waterworks Trust from the 12th September, 1960, until the 21st September, 1960.

N. C. WISHART,
Acting Clerk of the Executive Council.
At the Executive Council Chamber,
Melbourne, 4th October, 1960.

DEPARTMENT OF LABOUR AND INDUSTRY.

DETERMINATION OF THE FIRE FIGHTERS BOARD.

ATTENTION is drawn to the fact that notices of appeal to the Industrial Appeals Court have been lodged against certain parts of the Determination of the Fire Fighters Board, made on the 14th September, 1960.

Section 45 (1) (b) of Act 6283 provides that when an appeal is made in accordance with that Act, the Determination or part thereof appealed against shall not come into operation until the appeal has been dealt with by the Court.

H. N. JONES,
Secretary.

APPOINTMENTS.

HIS Excellency the Governor of the State of Victoria, by and with the advice of the Executive Council thereof, has, by Orders made on the 27th day of September, 1960, been pleased to make the under-mentioned appointments, viz.—

DEPARTMENT OF AGRICULTURE.

GUY NEWTON MOORE, 108 Queen-street, Melbourne, pursuant to the provisions of the *Western Metropolitan Market Act 1938*, to make an audit and report on the accounts of the Western Metropolitan Market Trust for the year ending 30th September, 1960.

CHIEF SECRETARY'S DEPARTMENT.

Electoral Registrar (Acting).

JAMES THOMAS MCALLEN

to be Electoral Registrar (Acting) for the Burnley, Hawthorn, and Richmond South Subdivisions of the Electoral District of Hawthorn; and for the Abbotsford, Collingwood, and Richmond Subdivisions of the Electoral District of Richmond, to take effect on and from the 16th September, 1960, during the absence, on leave of Sydney Allan Wilkes.

DEPARTMENT OF CROWN LANDS AND SURVEY.

Trustee of Site.

The Honorable Sir ARTHUR GEORGE WARNER, M.L.C., representing the Board of Land and Works, to be a Trustee of the site for Racing, Recreation, and Public Park purposes at Caulfield, in the place of William McIlroy, deceased.

Bailiff of Crown Lands.

ANDREW WILLIAM REYNOLDS

to be a Bailiff of Crown lands, without salary.

DEPARTMENT OF HEALTH.

Medical Officer, Mental Hygiene Branch.

IVOR GOWRAN FITZ-PATRICK, M.B., B.Ch., D.P.M., to be a Medical Officer (Male), Grade I, Mental Hygiene Branch, Department of Health, pursuant to the provisions of section 20 (2) of the *Mental Hygiene Act 1958*, as from and including the 18th August, 1960.

Government Representatives on Hospital Committees.

NORMAN GEORGE HARRIS

to be Government Representative on the Committee of Management of South Gippsland Hospital, pursuant to the provisions of section 48 of the *Hospitals and Charities Act 1958*, for a further term of three years as from and inclusive of the 22nd October, 1960; and

JOSEPH WILLIAM WILSON

to be Government Representative on the Committee of Management of Wonthaggi and District Hospital, pursuant to the provisions of section 48 of the *Hospitals and Charities Act 1958*, for a further term of three years as from and inclusive of the 2nd October, 1960.

LAW DEPARTMENT.

Justices of the Peace.

MICHAEL BELMONT DALE, 11 Fulham-avenue, South Yarra,

EDGAR FREDERICK BLANCHARD, Princes Highway, Springvale North, and

JOHN TREVOR RUST, Arthur's Seat-road, Dromana, to Keep the Peace in the Central Bailiwick of the State of Victoria;

PERCY WILLIAM BOUCHER, Swift's Creek, to Keep the Peace in the Eastern Bailiwick of the State of Victoria; and

ALEXANDER WOODFORD THOMAS, Manangatang, and HENRY NAPIER LLOYD, Kooloonong, to Keep the Peace in the Midland Bailiwick of the State of Victoria.

Commissioners for Taking Declarations, &c.

CHARLES HENRY RIXON, Deputy Government Printer, Melbourne,

to be a Commissioner for taking Declarations and Affidavits, pursuant to the provisions of the *Evidence Act 1958*, to refrain from charging fees and to resign upon ceasing to be an officer of the Department of Treasurer;

EVERETT THOMSON BENT, care of Bastian Phillips and Associates, 65 Queens-road, Melbourne,

DANIEL EDWARD CONNELL, Secretary, Society of St. Vincent de Paul, 585 Little Collins-street, Melbourne, and

BRENDAN ALOYSIUS GRIFFIN, Y.C.W. Co-operative Society Ltd., 157 a Beckett-street, Melbourne,

to be Commissioners for taking Declarations and Affidavits, pursuant to the provisions of the *Evidence Act 1958*, to resign upon ceasing to occupy their present positions; and

SPYRIDON NICHOLAS PLATIS, 69 Hope-street, South Yarra,

DONALD WALKER, 66 Armstrong-street, Colac, and ALPHONSE BUTOWSKI, 113A Chomley-street, East Prahran,

to be Commissioners for taking Declarations and Affidavits, pursuant to the provisions of the *Evidence Act 1958*, to resign upon removing from the neighbourhood of the addresses stated.

Probation Officer for Children's Court.

PATRICK JOSEPH JEFFREY, St. Mary's, Presbytery, Castlemaine,

to be a Probation Officer for the Children's Court at Castlemaine, pursuant to the provisions of the *Children's Court Act 1958*.

Sworn Valuator.

FRANCIS JOSEPH RENEHAN, care of Housing Commission, 179 Queen-street, Melbourne,

to be a Sworn Valuator for the State of Victoria, pursuant to the provisions of the *Transfer of Land Act 1958*.

MINISTRY OF TRANSPORT.
Co-ordinator of Transport.

ALAN GEORGE BROWN,
pursuant to the provisions of section 4 (1) (a) of the *Ministry of Transport Act 1958*, to be Co-ordinator of Transport for a term of three (3) years, as from and including the 10th October, 1960.

DEPARTMENT OF THE TREASURER.
Collectors of Imposts.

WILLIAM LETHBRIDGE CLIFFORD HALL
to act temporarily as Collector of Imposts, Chief Secretary's Office, during the absence of D. H. McDermott, on leave; and

EDWARD NORMAND MANSFIELD
to act temporarily as Collector of Imposts, Children's Welfare Department, during the absence of N. R. Semmens, on leave.

Receiver of Revenue.

GREGORY FRANCIS MEEHAN
to act temporarily as Receiver of Revenue, Swan Hill, during the absence of R. N. Hollis, on leave.

N. G. WISHART,
Acting Clerk of the Executive Council.

At the Executive Council Chamber,
Melbourne, 27th September, 1960.

RESIGNATIONS.

HIS Excellency the Governor of the State of Victoria, by and with the advice of the Executive Council thereof, has, by Orders made on the 27th day of September, 1960, accepted the resignations of the persons named hereunder of the offices mentioned, viz.:—

LAW DEPARTMENT.

JOHN THOMAS JASPER MORGAN, from the Commission of the Peace for the Northern Bailiwick of the State of Victoria.

LAWRENCE FREDERICK VERDUN SYMES, as a Commissioner for taking Declarations and Affidavits, pursuant to the provisions of the *Evidence Act 1958*.

N. G. WISHART,
Acting Clerk of the Executive Council.

At the Executive Council Chamber,
Melbourne, 27th September, 1960.

DEPARTMENT OF CROWN LANDS AND SURVEY.

At the Executive Council Chamber, Melbourne, the
twenty-seventh day of September, 1960.

PRESENT:

His Excellency the Governor of Victoria.
Mr. Cameron | Mr. Mibus.

REVOCATION OF PORTION OF THE TEMPORARY RESERVATION, AND THE WITHHOLDING FROM SALE, LEASING AND LICENSING BY ORDER IN COUNCIL OF CERTAIN LAND.

HIS Excellency the Governor of the State of Victoria, by and with the advice of the Executive Council thereof, doth hereby, in pursuance of the provisions of the *Land Act 1958*, revoke portion of the temporary reservation, and the withholding from sale, leasing and licensing of portion of the land mentioned hereunder:—

LORNE.—Order in Council of 31st May, 1880, of 6 acres 1 rood 12 perches of land in the Township of Lorne as a site for Cricket and other purposes of Public Recreation, so far only as regards the portion thereof comprised within the boundaries published in the *Government Gazette* of 31st August, 1960, and containing 4 perches, more or less.—(Rs.90.)

And the Honorable Keith Hector Turnbull, Her Majesty's Commissioner of Crown Lands and Survey for the State of Victoria, shall give the necessary directions herein accordingly.

N. G. WISHART,
Acting Clerk of the Executive Council.

DEPARTMENT OF CROWN LANDS AND SURVEY.

At the Executive Council Chamber, Melbourne, the
twenty-seventh day of September, 1960.

PRESENT:

His Excellency the Governor of Victoria.
Mr. Cameron | Mr. Mibus.

LAND TEMPORARILY RESERVED AS A SITE.

HIS Excellency the Governor of the State of Victoria, by and with the advice of the Executive Council thereof, doth hereby, in pursuance of the provisions of the *Land Act 1958*, reserve, temporarily, and also except from occupation for mining purposes under any miner's right, the land hereinafter described:—

ANGAHOOK.—Site for Public purposes, 50 acres, more or less, Parish of Angahook, County of Polwarth, as indicated, by hachure on, plan hereunder.—(A.163(4) (Rs.7974).

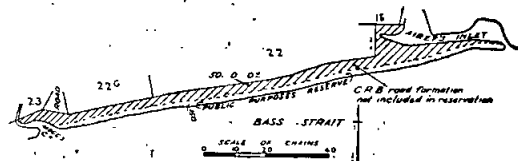

And the Honorable Keith Hector Turnbull, Her Majesty's Commissioner of Crown Lands and Survey for the State of Victoria, shall give the necessary directions herein accordingly.

N. G. WISHART,
Acting Clerk of the Executive Council.

DEPARTMENT OF CROWN LANDS AND SURVEY.

At the Executive Council Chamber, Melbourne, the
twenty-seventh day of September, 1960.

PRESENT:

His Excellency the Governor of Victoria.
Mr. Cameron | Mr. Mibus.

LAND PERMANENTLY RESERVED AS A SITE.

HIS Excellency the Governor of the State of Victoria, by and with the advice of the Executive Council thereof, doth hereby, in pursuance of the provisions of the *Land Act 1958*, permanently reserve as a site for Public Recreation, 27 perches, more or less, of land in the Parish of Nepean as indicated by description and hachure on plan published in the *Government Gazette* of 31st August, 1960.—(Rs.1037.)

And the Honorable Keith Hector Turnbull, Her Majesty's Commissioner of Crown Lands and Survey for the State of Victoria, shall give the necessary directions herein accordingly.

N. G. WISHART,
Acting Clerk of the Executive Council.

DEPARTMENT OF CROWN LANDS AND SURVEY.

At the Executive Council Chamber, Melbourne, the
twenty-seventh day of September, 1960.

PRESENT:

His Excellency the Governor of Victoria.
Mr. Cameron | Mr. Mibus.

UNUSED ROADS CLOSED.

HIS Excellency the Governor of the State of Victoria, by and with the advice of the Executive Council thereof, doth hereby direct that, in pursuance of the provisions of section 349 of the *Land Act 1958*, the unused roads referred to hereunder be closed, viz.:—

Township of Raywood, Parish of Neilborough, County of Bendigo, being the road forming the south boundary of allotments 4, 5, 6, and 7, section 11.—(R.57(2) (W.69575).

Parish of St. Helens, County of Villiers, being the road indicated by hachure on plan hereunder.—(S.357(2) (Z.30778).

DEPARTMENT OF CROWN LANDS AND SURVEY.

At the Executive Council Chamber, Melbourne, the twentieth day of September, 1960.

PRESENT:

His Excellency the Governor of Victoria.
 Sir Arthur Warner | Mr. Chandler.
 Mr. Mibus

UNUSED ROAD CLOSED.

HIS Excellency the Governor of the State of Victoria, by and with the advice of the Executive Council thereof, doth hereby direct that, in pursuance of the provisions of section 349 of the Land Act 1958, the unused road referred to hereunder be closed, viz.:

Parish of Argyle, County of Grenville, being the road indicated by hachure on plan hereunder.—(A.152(5) (Rs.5120).

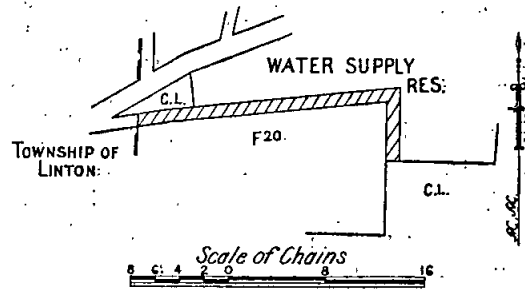
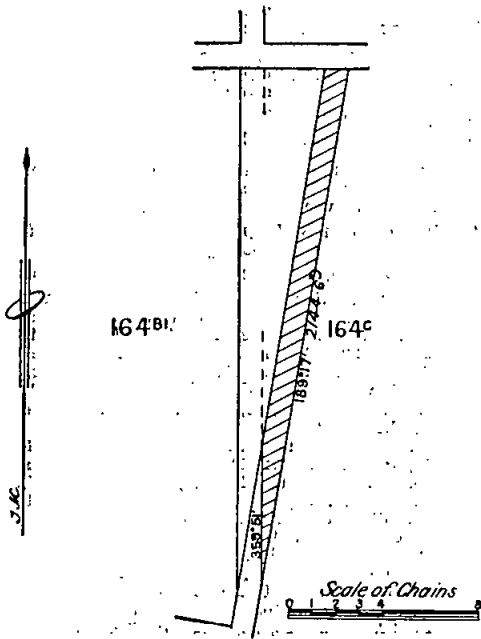

And the Honorable Keith Hector Turnbull, Her Majesty's Commissioner of Crown Lands and Survey for the State of Victoria, shall give the necessary directions herein accordingly.

N. G. WISHART,
 Acting Clerk of the Executive Council.

And the Honorable Keith Hector Turnbull, Her Majesty's Commissioner of Crown Lands and Survey for the State of Victoria, shall give the necessary directions herein accordingly.

A. MAHLSTEDT,
 Clerk of the Executive Council.

SEEDS ACT 1958 (No. 6364).

At the Executive Council Chamber, Melbourne, the twenty-seventh day of September, 1960.

PRESENT:

His Excellency the Governor of Victoria.
 Mr. Cameron | Mr. Mibus.

REGULATIONS.

UNDER the powers conferred by the Seeds Act 1958 (No. 6364) to make regulations for or with respect to the carrying out of Victorian seed certification schemes including the conditions under which certificates in accordance with such schemes may be granted, His Excellency the Governor of the State of Victoria, by and with the advice of the Executive Council of the said State, doth hereby make the following Regulations, that is to say:—

The Regulations made on the 14th December, 1936, and amended on 13th December, 1937, 9th December, 1947, 14th June, 1955, and 28th August, 1956, are hereby further amended as follows:—

- (a) At the end of Regulation 10 there shall be inserted the following words:—
 “(VIII.) Palestine Strawberry Clover 5 pounds.”
- (b) At the end of the Second Schedule there shall be inserted the following words:—
 “(VIII.) Palestine Strawberry Clover.
 Three pence for every ten lb. or part thereof.”
- (c) At the end of the Third Schedule there shall be inserted the following words:—
 “(VIII.) Palestine Strawberry Clover.
 One penny halfpenny for every ten lb. or part thereof.”
- (d) At the end of the Fourth Schedule there shall be inserted the following words:—
 “(VIII.) One penny halfpenny for every ten lb. or part thereof.”

And the Honorable Gilbert Lawrence Chandler, Her Majesty's Minister of Agriculture for the State of Victoria, shall give the necessary directions herein accordingly.

N. G. WISHART,
 Acting Clerk of the Executive Council.

GRAIN ELEVATORS ACT 1958 (No. 4270).

At the Executive Council Chamber, Melbourne, the
twenty-seventh day of September, 1960.

PRESENT:

His Excellency the Governor of Victoria.
Mr. Cameron | Mr. Mibus.

DEFINITION OF AREAS—ORDERS AMENDED.

IN accordance with the provisions of section 10 of the Grain Elevators Act 1958, His Excellency the Governor of the State of Victoria, by and with the advice of the Executive Council thereof, doth hereby approve the following amendments to the Schedules to the Orders in Council of the 20th November, 1939, 4th December, 1939, 18th November, 1940, 26th November, 1941, 14th December, 1942, 6th December, 1943, 1st December, 1953, and 22nd December, 1958, as amended, defining the areas with respect to which elevators have been constructed to provide facilities for handling wheat grown or being in such areas, such amendments to come into operation from and inclusive of the 15th October, 1960, that is to say:—

AMENDMENTS TO THE SCHEDULE TO THE ORDER MADE ON THE 26TH NOVEMBER, 1941, AS AMENDED ON THE 30TH NOVEMBER, 1942, 20TH DECEMBER, 1943, 30TH AUGUST, 1949, 22ND DECEMBER, 1953, 24TH JULY, 1956, 22ND DECEMBER, 1958, AND 27TH JANUARY, 1960.

In the Defined Area in Respect of the Elevator Situated at Barraport.

Add the following allotment (or portion) numbers:—
County of Tatchera, Parish of Marmal, allotments 18, 34.

AMENDMENTS TO THE SCHEDULE TO THE ORDER MADE ON THE 6TH DECEMBER, 1943, AS AMENDED ON THE 22ND DECEMBER, 1953, 3RD DECEMBER, 1957, AND 27TH JANUARY, 1960.

In the Defined Area in Respect of the Elevator Situated at Berrwillock.

Add the following allotment (or portion) numbers:—
County of Tatchera, Parish of Kaniera, allotments 38, 39.
County of Tatchera, Parish of Jil Jil, allotments 55A, 58A.

AMENDMENTS TO THE SCHEDULE TO THE ORDER MADE ON THE 14TH DECEMBER, 1942, AS AMENDED ON THE 20TH DECEMBER, 1943, AND 22ND DECEMBER, 1953.

In the Defined Area in Respect of the Elevator Situated at Cobram.

Add the following allotment (or portion) numbers:—
County of Moira, Parish of Strathmerton, section B, allotments 4, 5, 5A, 6, 6A, 7, 7A, 7B, 7C, 7D, 8, 9, 10, 11, 12, 19, 20, 20A, 21, 22, 23, 24, 25, 26, 26A, 27, 28, 29, 30, 31, 32, 39, 40, 47A, 48A, 56, 57, 58, 59, 60, 63B, 63C, 65, 66.
Section B, allotments 4, 5, 6, 7.
County of Moira, Parish of Yarroweyah, section A, allotments 1, 1A, 3, 19, 19A, 19B.
Section B, allotments 1, 1A, 2, 3, 3A, 4, 5, 6, 7, 8, 9, 10, 11, 11A, 12, 13, 14, 15, 16.
Section C, allotments 3, 4, 5, 6, 7, 8, 8A, 8B, 9, 10, 10A, 11, 11A, 11B, 12, 13, 14.

AMENDMENTS TO THE SCHEDULE TO THE ORDER MADE ON THE 6TH DECEMBER, 1943, AS AMENDED ON THE 22ND DECEMBER, 1953, AND 24TH JULY, 1956.

In the Defined Area in Respect of the Elevator Situated at Culgoa.

Delete the following allotment (or portion) numbers:—
County of Tatchera, Parish of Kaniera, allotments 38, 39.

AMENDMENTS TO THE SCHEDULE TO THE ORDER MADE ON THE 14TH DECEMBER, 1942, AS AMENDED ON THE 30TH AUGUST, 1949, 22ND DECEMBER, 1953, 22ND DECEMBER, 1958, AND 27TH JANUARY, 1960.

In the Defined Area in Respect of the Elevator Situated at Gredgwin.

Delete the following allotment (or portion) numbers:—
County of Tatchera, Parish of Marmal, allotments 18, 34.

AMENDMENTS TO THE SCHEDULE TO THE ORDER MADE ON THE 20TH NOVEMBER, 1939, AS AMENDED ON THE 26TH NOVEMBER, 1940, AND 22ND DECEMBER, 1953.

In the Defined Area in Respect of the Elevator Situated at Horsham.

Delete the following allotment (or portion) numbers:—
County of Borung, Parish of Vectis East, allotment 8.

AMENDMENTS TO THE SCHEDULE TO THE ORDER MADE ON THE 14TH DECEMBER, 1942, AS AMENDED ON THE 22ND DECEMBER, 1953, AND 24TH JULY, 1956.

In the Defined Area in Respect of the Elevator Situated at Katunga.

Add the following allotment (or portion) numbers:—

County of Moira, Parish of Strathmerton, section A, allotments 1, 2, 3, 4, 5, 6, 7, 7A, 7B, 8, 9, 9A, 10, 10A, 10B, 11, 11A, 12, 13, 14, 15, 16, 17, 18, 19, 20, 21, 22, 23, 23A, 24, 24A, 25, 26, 26A, 27, 28, 29, 30, 31, 31A, 32, 33, 34, 35, 36, 37, 37A, 37B, 38, 38A, 38B, 38C, 39, 39A, 39B, 39C, 40, 41, 41A, 42, 43, 43A, 44, 45, 46, 46A, 47, 48, 48A, 48B, Portion A, Ulupna P.P.
Section B, allotments 1, 2, 2A, 2B, 2C, 3, 13, 14, 15, 16, 17, 17A, 17B, 18, 18A, 33, 34, 35, 36, 37, 38, 43, 43A, 44A, 44B, 44C, 44D, 45, 46, 46A, 47, 47A, 48, 49, 49A, 49B, 52, 53, 53A, 53B, 54, 55, 61, 61B, 61C, 61D, 61E, 62, 62A, 63, 65B.

Section B, allotments 1, 3.

County of Moira, Parish of Ulupna, section A, allotments 1, 1A, 1B, 1B1, 1C, 1D, 2, 3, 4, 5, 6, 6A, 6B, 6C, 8, 8A, 9, 10, 10B, 11, 11A, 11B, 12, 12A, 13, 14, 14A, 15, 16, 16A, 16B, 16C, 17, 18, 18A, 19, 20, 21, 22, 23, 24, 25, 26, 37A, 37B, 37C, 37D, 38C.

Section B, allotments 1, 2, 8, 10, 16, 17, 18, 19, 20, 20A, 21, 22, 24, 25, 26, 27, 28, 29, 30, 31, 32.

Section C, allotments 6, 7, 8, 9, 10, 11, 12, 13, 13A.

AMENDMENTS TO THE SCHEDULE TO THE ORDER MADE ON THE 22ND DECEMBER, 1958.

In the Defined Area in Respect of the Elevator Situated at Ninda.

Add the following allotment (or portion) numbers:—
County of Karkaroc, Parish of Bourka, allotment 42.

AMENDMENTS TO THE SCHEDULE TO THE ORDER MADE ON THE 4TH DECEMBER, 1939, AS AMENDED ON THE 26TH NOVEMBER, 1940, 26TH NOVEMBER, 1941, 30TH AUGUST, 1949, 22ND DECEMBER, 1953, 24TH JULY, 1956, AND 22ND DECEMBER, 1958.

In the Defined Area in Respect of the Elevator Situated at Nullan.

Add the following allotment (or portion) numbers:—
County of Borung, Parish of Kewell East, allotment 29.

AMENDMENTS TO THE SCHEDULE TO THE ORDER MADE ON THE 1ST DECEMBER, 1953.

In the Defined Area in Respect of the Elevator Situated at Remlaw.

Add the following allotment (or portion) numbers:—
County of Borung, Parish of Vectis East, allotment 8.

AMENDMENTS TO THE SCHEDULE TO THE ORDER MADE ON THE 6TH DECEMBER, 1943, AS AMENDED ON THE 22ND DECEMBER, 1953, 24TH JULY, 1956, 3RD DECEMBER, 1957, AND 22ND DECEMBER, 1958.

In the Defined Area in Respect of the Elevator Situated at Sea Lake.

Delete the following allotment (or portion) numbers:—
County of Karkaroc, Parish of Bourka, allotment 42.

AMENDMENTS TO THE SCHEDULE TO THE ORDER MADE ON THE 18TH NOVEMBER, 1940, AS AMENDED ON THE 26TH NOVEMBER, 1941.

In the Defined Area in Respect of the Elevator Situated at Sheep Hills.

Delete the following allotment (or portion) numbers:—
County of Borung, Parish of Kewell East, allotment 29.

AMENDMENTS TO THE SCHEDULE TO THE ORDER MADE ON THE 1ST DECEMBER, 1953.

In the Defined Area in Respect of the Elevator Situated at Strathmerton.

Delete all allotment (or portion) numbers shown in Schedule dated 1st December, 1953.

AMENDMENTS TO THE SCHEDULE TO THE ORDER MADE ON THE 14TH DECEMBER, 1942, AS AMENDED ON THE 20TH DECEMBER, 1943, 22ND DECEMBER, 1953, AND 24TH JULY, 1956.

In the Defined Area in Respect of the Elevator Situated at Waaia.

Add the following allotment (or portion) numbers:—

County of Moira, Parish of Ulupna, section A, allotments 7, 7A, 27, 27A, 27B, 27C, 27D, 28, 29, 30, 32, 32A, 34, 35, 35A, 35B, 35C, 36, 36A, 36B, 36C, 37, 38A, 38B, Portion 1 (Bearli).

Section B, allotments 3, 4, 5, 6, 7, 9, 11, 12, 13, 14, 15.

Section C, allotments 1, 2, 3, 4, 5.

County of Moira, Parish of Yalca, section F, allotments 11A, 11B, 14, 16, 16A, 16B, 16C, 16D, 17, 17A, 17B, 18, 21A, 21B, 22, 23, 24, 25, 26, 27.

AMENDMENTS TO THE SCHEDULE TO THE ORDER MADE ON THE 14TH DECEMBER, 1942, AS AMENDED ON THE 20TH DECEMBER, 1943, 26TH NOVEMBER, 1946, 3RD DECEMBER, 1957, AND 27TH JANUARY, 1960.

In the Defined Area in Respect of the Elevator Situated at Warne.

Delete the following allotment (or portion) numbers:—

County of Tatchera, Parish of Jil Jil, allotment 56.

AMENDMENTS TO THE SCHEDULE TO THE ORDER MADE ON THE 20TH NOVEMBER, 1939, AS AMENDED ON THE 26TH NOVEMBER, 1940, AND 24TH JULY, 1956.

In the Defined Area in Respect of the Elevator Situated at Warracknabeal.

Add the following allotment (or portion) numbers:—

County of Borung, Parish of Wilkur, allotments 15, 15B.

AMENDMENTS TO THE SCHEDULE TO THE ORDER MADE ON THE 20TH NOVEMBER, 1939, AS AMENDED ON THE 26TH NOVEMBER, 1941, 30TH NOVEMBER, 1942, 20TH DECEMBER, 1943, 30TH AUGUST, 1949, 22ND DECEMBER, 1953, 24TH JULY, 1956, AND 3RD DECEMBER, 1957.

In the Defined Area in Respect of the Elevator Situated at Watchem.

Delete the following allotment (or portion) numbers:—

County of Borung, Parish of Wilkur, allotments 15, 15B.

And the Honorable Gilbert Lawrence Chandler, Her Majesty's Minister of Agriculture for the State of Victoria, shall give the necessary directions herein accordingly.

N. G. WISHART,

Acting Clerk of the Executive Council.

Water Acts.

STATE RIVERS AND WATER SUPPLY COMMISSION.

At the Executive Council Chamber, Melbourne, the twenty-seventh day of September, 1960.

PRESENT:

His Excellency the Governor of Victoria.

Mr. Cameron | Mr. Mibus.

BERWICK URBAN DISTRICT.—DISTRICT EXTENDED.

UNDER the powers conferred by the Water Acts and all other powers enabling him in that behalf, His Excellency the Governor of the State of Victoria, with the advice of the Executive Council of the said State, on the recommendation of the State Rivers and Water Supply Commission, doth hereby declare, order, and direct as follows:—

That the Berwick Urban District be extended by adding to the same the lands set out and described in the Schedule hereto, and as on and from the date of this Order such district shall be deemed to be extended.

SCHEDULE.

Commencing at the most northern angle of lot 21 on lodged plan of subdivision No. 50578, being part of allotment 15, Parish of Berwick, County of Mornington;

thence south-easterly by the north-eastern boundary of the land contained in that lodged plan to its intersection with the western boundary of the Berwick Urban District prior to this Order; thence southerly by that boundary to the northern boundary of the Princes Highway; thence westerly by the last-mentioned boundary to the south-eastern angle of lot 1 on lodged plan of subdivision No. 50594; thence northerly by the eastern boundary of that lot to the north-eastern angle thereof; thence easterly by the northern boundaries of lots 24-31 inclusive, and northerly, easterly and south-easterly by the western boundaries of lots 32 and 33 and the northern and north-eastern boundaries of the last-mentioned lot to the north-western boundary of York-road; thence north-easterly by a line in continuation of that boundary to the north-eastern boundary of Rheanva-street; thence south-easterly by that boundary to the most western angle of lot 21 on lodged plan of subdivision No. 50578 aforesaid; thence north-easterly by the north-western boundary of that lot to the point of commencement.

The lands described in the foregoing Schedule are shown on a plan approved by the Governor in Council, and deposited in the office of the State Rivers and Water Supply Commission, Melbourne.—(Corr. No. 59/8170.)

And the Honorable Wilfred John Mibus, Her Majesty's Minister of Water Supply for the State of Victoria, shall give the necessary directions herein accordingly.

N. G. WISHART,

Acting Clerk of the Executive Council.

LOCAL GOVERNMENT ACT.

At the Executive Council Chamber, Melbourne, the twenty-seventh day of September, 1960.

PRESENT:

His Excellency the Governor of Victoria.

Mr. Cameron | Mr. Mibus.

WHEREAS it is provided in section 240A of the *Local Government Act 1958*, as amended by Act No. 6601, that where the council of a municipality has acquired any land for any particular purpose and it appears to the council that the land or some part thereof is not required for the purpose for which the land was acquired, the council may, subject to compliance with the provisions contained in the said section and with the consent of the Governor in Council, use the land or the part of the land in question for some other purpose for which the municipality is authorized to hold land:

And whereas it appears to the Council of the City of Dandenong that the land described hereunder, which was originally acquired for market purposes, is no longer required for such purposes but is required for the purpose of a council depot, and the Council has complied with the requirements of the said section 240A by publishing in a newspaper generally circulating in the district notice of intention to make such request and stating that, at the next ordinary meeting of the Council, after the expiration of 40 days after the publication of the notice, it will consider any objections to the proposal:

And whereas no objections were received by the Council and the Council has submitted the proposal to the Minister:

Now, therefore, His Excellency the Governor of the State of Victoria, by and with the advice of the Executive Council thereof, hereby consents to the land described hereunder being used for the purpose of a council depot:—

All that piece of land being part of Crown allotment 3, section 49, Parish of Dandenong, commencing at a point on the western alignment of Greaves-street shown on lodged plan No. 8157, and being the south-east angle of the said Crown allotment 3; thence by lines bearing respectively 270 degrees distant 331 ft. 7½ in., 360 degrees distant 564 ft. 8½ in., 89 deg. 46 min. distant 315 ft. 4½ in., 134 deg. 53 min. distant 21 ft. 1 in. and 180 degrees distant 552 ft. 1 in. to the point of commencement.

And the Honorable Murray Victor Porter, Her Majesty's Minister for Local Government for the State of Victoria, shall give the necessary directions herein accordingly.

N. G. WISHART,

Acting Clerk of the Executive Council.

WATER ACTS.

At the Executive Council Chamber, Melbourne, the fourth day of October, 1960.

PRESENT:

| | |
|--|-----------|
| His Excellency the Governor of Victoria. | |
| Mr. Chandler | Mr. Reid. |
| Mr. Thompson | |

WYCHITELLA WATERWORKS DISTRICT.—PORTION EXCISED.

UNDER the powers conferred by the Water Acts and all other powers enabling him in that behalf, His Excellency the Governor of the State of Victoria, with the advice of the Executive Council of the said State, on the recommendation of the State Rivers and Water Supply Commission, doth hereby declare, order, and direct as follows:—

That there shall be excised from the Wychitella Waterworks District that portion of the same set out and described in the Schedule hereto, which portion as from the date of this Order shall be deemed to be excised accordingly.

SCHEDULE.

Commencing at the south-eastern angle of allotment 10A, Parish of Yeungroon, County of Gladstone; thence westerly by the southern boundary of said allotment 10A and by a line in continuation thereof to the left bank of the Avoca River; thence northerly by that river bank to a point in line with the southern boundary of allotment A Spring Bank east P.R.; thence easterly by a line and the last-mentioned boundary to the western boundary of a 3-chain road; thence southerly by the said road boundary to the point of commencement.

The lands set out and described in the foregoing Schedule are shown on a plan approved by the Governor in Council, and deposited in the Office of the State Rivers and Water Supply Commission, Melbourne.—(Corres. No. 60/4039.)

And the Honorable Wilfred John Mibus, Her Majesty's Minister of Water Supply for the State of Victoria, shall give the necessary directions herein accordingly.

N. G. WISHART,
Acting Clerk of the Executive Council.

WATER ACTS.

At the Executive Council Chamber, Melbourne, the fourth day of October, 1960.

PRESENT:

| | |
|--|-----------|
| His Excellency the Governor of Victoria. | |
| Mr. Chandler | Mr. Reid. |
| Mr. Thompson | |

NAR-NAR-GOON AND TYNONG URBAN DISTRICT.—DISTRICT EXTENDED.

UNDER the powers conferred by the Water Acts and all other powers enabling him in that behalf, His Excellency the Governor of the State of Victoria, with the advice of the Executive Council of the said State, on the recommendation of the State Rivers and Water Supply Commission, doth hereby declare, order, and direct as follows:—

That the Nar-Nar-Goon and Tynong Urban District be extended by adding to the same the lands set out and described in the Schedule hereto and as on and from the date of this Order such district shall be deemed to be extended.

SCHEDULE.

1. Commencing at the south-western angle of lot 10 on lodged plan of subdivision No. 6711, being part of allotment 6, Parish of Bunyip, County of Mornington; thence generally easterly by the southern boundaries of lots 10 and 9 and a line connecting them to a point 325 links easterly from the south-western angle of the said lot 9; thence northerly by a line parallel to the eastern boundary of View-street to the southern boundary thereof; thence westerly by the last-mentioned boundary to the eastern boundary of View-street aforesaid; thence

northerly by a line and the eastern boundary of lot 8 a distance of 250 links from the northern boundary of View-street; thence by a line bearing N. 80 deg. 40 min. W. to the western boundary of the said lot 8; thence southerly by the western boundaries of lots 8 and 10 to the point of commencement.

2. Commencing at the north-western angle of lot 27 on lodged plan of subdivision No. 6106, being part of Crown allotment 6, Parish of Bunyip, County of Mornington; thence easterly by the northern boundaries of lots 27-39 inclusive, and a line connecting them, to the north-eastern angle of lot 39; thence southerly by the eastern boundary of that lot, and by a line in continuation thereof to the southern boundary of the Tynong-Garfield road; thence westerly by that boundary to its intersection with a line drawn from the north-western angle of lot 15 on lodged plan of subdivision No. 9150 to the south-western angle of lot 27 aforesaid; thence generally northerly by that line and the western boundary of the said lot 27, to the point of commencement.

The lands described in the foregoing Schedule are shown on a plan approved by the Governor in Council, and deposited in the Office of the State Rivers and Water Supply Commission, Melbourne.—(Corres. No. 59/7063.)

And the Honorable Wilfred John Mibus, Her Majesty's Minister of Water Supply for the State of Victoria, shall give the necessary directions herein accordingly.

N. G. WISHART,
Acting Clerk of the Executive Council.

WATER ACTS.

At the Executive Council Chamber, Melbourne, the fourth day of October, 1960.

PRESENT:

| | |
|--|-----------|
| His Excellency the Governor of Victoria. | |
| Mr. Chandler | Mr. Reid. |
| Mr. Thompson | |

OUYEN WATERWORKS DISTRICT.—DISTRICT EXTENDED.

UNDER the powers conferred by the Water Acts and all other powers enabling him in that behalf, His Excellency the Governor of the State of Victoria, with the advice of the Executive Council of the said State, on the recommendation of the State Rivers and Water Supply Commission, doth hereby declare, order, and direct as follows:—

That the Ouyen Waterworks District be extended by adding to the same the land set out and described in the Schedule hereto and as on and from the date of this Order such District shall be deemed to be so extended.

SCHEDULE.

All that land comprising allotment 39, Parish of Gnarr, County of Weeah.

The lands set out and described in the foregoing Schedule are shown on a plan approved by the Governor in Council, and deposited in the Office of the State Rivers and Water Supply Commission, Melbourne.—(Corres. No. 60/4257.)

And the Honorable Wilfred John Mibus, Her Majesty's Minister of Water Supply for the State of Victoria, shall give the necessary directions herein accordingly.

N. G. WISHART,
Acting Clerk of the Executive Council.

KANIVA SEWERAGE AUTHORITY.

At the Executive Council Chamber, Melbourne, the fourth day of October, 1960.

PRESENT:

| | |
|--|-----------|
| His Excellency the Governor of Victoria. | |
| Mr. Chandler | Mr. Reid. |
| Mr. Thompson | |

CONSENT TO BORROWING £60,000.

UNDER the powers conferred by the *Sewerage Districts Act 1958* and all other powers enabling him in that behalf, His Excellency the Governor of the State of

Victoria, by and with the advice of the Executive Council of the said State, doth hereby consent to the Kaniva Sewerage Authority borrowing the sum of Sixty thousand pounds (£60,000) in two amounts of Thirty thousand pounds (£30,000) each, by the issue of a debenture, to meet the cost of sewerage works at Kaniva, as set forth in the detailed statement bearing date the 30th September, 1960.

And the Honorable Wilfred John Mibus, Her Majesty's Minister of Water Supply for the State of Victoria, shall give the necessary directions herein accordingly.

N. G. WISHART,
Acting Clerk of the Executive Council.

WODONGA WATERWORKS TRUST.

At the Executive Council Chamber, Melbourne, the fourth day of October, 1960.

PRESENT:

His Excellency the Governor of Victoria.
Mr. Chandler | Mr. Reid.
Mr. Thompson |

AMENDMENT OF ORDER.

UNDER the powers conferred by the Water Acts and all other powers enabling him in that behalf, His Excellency the Governor of the State of Victoria, by and with the advice of the Executive Council of the said State, doth hereby amend as follows the Order in Council made the 12th January, 1960, and published in the *Victoria Government Gazette*, dated 13th January, 1960, authorizing the overdraft to be obtained by the Wodonga Waterworks Trust:—

For the expression "at an amount not to exceed at any one time the sum of One thousand five hundred pounds (£1,500)" there shall be substituted the expression "at an amount not to exceed at any one time the sum of Three thousand pounds (£3,000)".

And the Honorable Wilfred John Mibus, Her Majesty's Minister of Water Supply for the State of Victoria, shall give the necessary directions herein accordingly.

N. G. WISHART,
Acting Clerk of the Executive Council.

WHOROULY CREEK IMPROVEMENT TRUST.

At the Executive Council Chamber, Melbourne, the fourth day of October, 1960.

PRESENT:

His Excellency the Governor of Victoria.
Mr. Chandler | Mr. Reid.
Mr. Thompson |

LOAN OF £7,000.

IN pursuance of the powers conferred by section 43 of the *River Improvement Act 1958* and all other powers enabling him in that behalf, His Excellency the Governor of the State of Victoria, by and with the advice of the Executive Council of the said State, doth by this Order—

1. Make advance by way of loan to the Whorouly Creek Improvement Trust of a sum of Seven thousand pounds (£7,000); and

2. Apply the following terms and conditions:—

(a) That the said sum shall be used for the carrying out of approved river improvement works within the boundaries of the Whorouly Creek Improvement District,

(b) That the Whorouly Creek Improvement Trust shall, in respect of such advance by way of loan, be subject to the powers, rights, duties and obligations conferred and imposed by—

(i) the provisions of sections 284, 285 and 287 to 294 of Part VII. of the *Water Act 1958*, so adapted that the word "Authority" therein shall mean "the Mitchell River Improvement Trust", and

(ii) the provisions of section 295 of the said Part VII. of the *Water Act 1958*, so adapted as if for the expressions "any waterworks trust or local governing body" and "such waterworks trust or local governing body" there were substituted the expression "the Mitchell River Improvement Trust".

And the Honorable Wilfred John Mibus, Her Majesty's Minister of Water Supply for the State of Victoria, shall give the necessary directions herein accordingly.

N. G. WISHART,
Acting Clerk of the Executive Council.

SOIL CONSERVATION AND LAND UTILIZATION ACT 1958.

At the Executive Council Chamber, Melbourne, the fourth day of October, 1960.

PRESENT:

His Excellency the Governor of Victoria.
Mr. Chandler | Mr. Reid.
Mr. Thompson |

SOIL CONSERVATION DISTRICTS.

IN pursuance of the powers conferred by section 15 of the Soil Conservation and Land Utilization Act, His Excellency the Governor of the State of Victoria, by and with the advice of the Executive Council thereof, upon the recommendation of the Soil Conservation Authority, doth hereby constitute the following districts as Soil Conservation Districts.

1. *Western Gippsland Soil Conservation District* comprising the Borough of Wonthaggi, the Shires of Bass, Buln Buln, Korumburra, Mirboo, Narracan, Warragul and Woorayl.

2. *Southern Gippsland Soil Conservation District* comprising the Shires of Alberton, Morwell, Rosedale, Traralgon, South Gippsland and the Yallourn Works Area.

3. *Avon Soil Conservation District* comprising the City of Sale, the Shires of Avon, Bairnsdale and Maffra.

4. *Tambo Soil Conservation District* comprising the Shires of Orbost, Tambo and Omeo, with the exception of that part of the Shire of Omeo included in the Bogong High Plains Soil Conservation District.

And the Honorable Henry Edward Bolte, Her Majesty's Minister for Conservation in the State of Victoria, shall give the necessary directions herein accordingly.

N. G. WISHART,
Acting Clerk of the Executive Council.

STAMPS ACT 1958, No. 6375.

At the Executive Council Chamber, Melbourne, the fourth day of October, 1960.

PRESENT:

His Excellency the Governor of Victoria.
Mr. Chandler | Mr. Reid.
Mr. Thompson |

REVOCATION OF DECLARATION OF APPROVED VENDORS.

HIS Excellency the Governor of the State of Victoria, by and with the advice of the Executive Council thereof, doth by this Order made pursuant to section 131c of the *Stamps Act 1958* (No. 6375), revoke the declaration made on the 24th day of February, 1959, and published in the *Government Gazette* of the 25th day of February, 1959, declaring certain persons to be "approved vendors" for the purposes of subdivision (14) of Division three of Part II. of the *Stamps Act 1958* in so far as the said declaration refers to the under-mentioned person—

81. JENSEN INVESTMENTS PTY. LTD.

And the Honorable Henry Edward Bolte, Her Majesty's Treasurer for the State of Victoria, shall give the necessary directions herein accordingly.

N. G. WISHART,
Acting Clerk of the Executive Council.

STAMPS ACT 1958, No. 6375.

At the Executive Council Chamber, Melbourne, the fourth day of October, 1960.

PRESENT:

His Excellency the Governor of Victoria.
Mr. Chandler | Mr. Reid.
Mr. Thompson |

DECLARATION OF APPROVED VENDORS.

HIS Excellency the Governor of the State of Victoria, by and with the advice of the Executive Council thereof, doth by this Order made pursuant to section 131c (1) of the *Stamps Act* 1958, declare the under-mentioned person carrying on business as a vendor of goods under instalment purchase agreements to be an "approved vendor" for the purposes of subdivision (14) of Division three of Part II. of the *Stamps Act* 1958:—

171. BLACKWOOD INVESTMENTS PTY. LTD.

And the Honorable Henry Edward Bolte, Her Majesty's Treasurer for the State of Victoria, shall give the necessary directions herein accordingly.

N. G. WISHART,
Acting Clerk of the Executive Council.

LANDLORD AND TENANT ACT 1958.

At the Executive Council Chamber, Melbourne, the fourth day of October, 1960.

PRESENT:

His Excellency the Governor of the State of Victoria.
Mr. Chandler | Mr. Reid.
Mr. Thompson |

ORDER EXTENDING APPLICATION OF PART V. OF THE LANDLORD AND TENANT ACT 1958 TO CERTAIN PREMISES.

IN pursuance of the powers conferred by section 44 of the *Landlord and Tenant Act* 1958, His Excellency the Governor of the State of Victoria, by and with the advice of the Executive Council thereof, doth hereby declare that the application of Part V. of the *Landlord and Tenant Act* 1958 shall extend to the following premises, viz.: The premises known as Number 39 Edinburgh-street, Flemington.

And the Honorable Lindsay Hamilton Simpson Thompson, for and on behalf of Her Majesty's Attorney-General in and for the State of Victoria, shall give the necessary directions herein accordingly.

N. G. WISHART,
Acting Clerk of the Executive Council.

APPROACHING LAND SALES.

SALES of Crown lands, in fee-simple, will be held at the under-mentioned places and dates, viz.:—

| | No. of Gazette. |
|---|-----------------|
| Ballarat.—Tuesday, 11th October, 1960 .. | 84 |
| Boort.—Monday, 24th October, 1960 .. | 85 |
| Geelong.—Thursday, 11th November, 1960 .. | 92 |
| Inglewood.—Wednesday, 26th October, 1960 .. | 85 |
| Kerang.—Monday, 24th October, 1960 .. | 85 |
| Manangatang.—Tuesday, 25th October, 1960 .. | 85 |
| Pyramid Hill.—Monday, 24th October, 1960 .. | 85 |
| Redcliffs.—Friday, 7th October, 1960 .. | 83 |
| Robinvale.—Tuesday, 25th October, 1960 .. | 85 |
| Swan Hill.—Monday, 24th October, 1960 .. | 85 |
| Yarram.—Wednesday, 5th October, 1960 .. | 83 |

SALE OF CLOSER SETTLEMENT LANDS BY AUCTION.

| | |
|---|----|
| Kerang.—Monday, 24th October, 1960 .. | 85 |
| Redcliffs.—Friday, 7th October, 1960 .. | 83 |

SALES OF CROWN LANDS BY AUCTION.

The land will be offered for sale in fee-simple, and subject to the provisions of the Land Act and Regulations thereunder.

The upset price is the sum at which bidding will start, and no bid below that sum can be accepted. The highest bidder at or above that sum shall be the purchaser, subject to signature of contract and any necessary payment.

TERMS:

A deposit of at least 12½% of the purchase price must be paid at the sale, either in cash or by cheque.

The residue is payable in half-yearly instalments, in accordance with the following scale, or may be paid off at any earlier time.

| |
|--|
| £20 and under, 6 instalments. |
| Over £20, and not exceeding £50, 8 instalments. |
| Over £50, and not exceeding £100, 10 instalments. |
| Over £100, and not exceeding £200, 12 instalments. |
| Over £200, and not exceeding £300, 14 instalments. |
| Over £300, and not exceeding £400, 16 instalments. |
| Over £400, and not exceeding £500, 18 instalments. |
| Over £500, 20 instalments. |

Interest at the rate of 5% per annum is payable with all payments of residue, and is computed for each instalment from the date of sale to the date of such payment. Additional interest is charged if any instalment is not paid on or before the due date.

If paid off within 30 days of sale, no interest is payable.

FEES, ETC.:

Also payable at the sale, in addition to the deposit, are the survey fee and the valuation of improvements (if purchaser be not the owner thereof).

Payable with balance of purchase money—

| | |
|---------------------------------------|---------|
| Crown Grant fee—50 acres and under .. | £1 10s. |
| Over 50 acres .. | £2 |
| Purchase money £5 or under .. | £1 |

Assurance Fund contribution—One halfpenny for each £1 of purchase price. (This is a fund established to guarantee the validity of freehold titles.)

Transfer of interest prior to completion of payment may be allowed on payment of £1 fee and subject to stamp duty.

If unable to attend personally, a prospective purchaser may arrange for another person to bid as his agent.

KEITH TURNBULL,

Commissioner of Crown Lands and Survey.

Office of Crown Lands and Survey,
Melbourne, 5th October, 1960.

GEELONG.—Sale (No. 11517) of Crown lands in fee-simple, by auction, will be held at the ROOMS OF WM. M. REID PTY. LTD., 144 RYRIE-STREET, GEELONG, on THURSDAY, the 11th NOVEMBER, 1960, at a quarter-past ELEVEN o'clock a.m. To be conducted by W. M. WALSH, Land Officer. Auctioneers: WM. M. REID PTY. LTD., 144 Ryrie-street, Geelong.

Lot 1.

CITY OF GEELONG, PARISH OF CORIO, COUNTY OF GRANT.
Having a Frontage of About 50 Feet to the South Side of Denndin-street, About 180 Feet West of Boundary-road.

Upset price £600 the lot. Survey fee £5 5s.

Area 29 perches, subject to survey and any necessary easements disclosed thereby, allotment 24 of section 86. One month allowed for removal of improvements.—(M.3098.)

Lot 2.

TOWNSHIP OF BREAMLEA, PARISH OF CONEWARRE, COUNTY OF GRANT.

Having a Frontage of 136 Links to North Side of Blyth-street, About 5 Chains West of Whittington-street.

Upset price £35 the lot. Survey fee £6.

Area 27 perches, allotment 28 of section B.—(G.64012.)

Lot 3.

TOWNSHIP OF SHELFORD, PARISH OF DOROQ, COUNTY OF GRENVILLE.

Extending from Tolson-street to Thomson-street About 4 Chains South of Mercer-street.

Upset price £25 the lot. Survey fee £6.

Area 1 r. 35 p., subject to survey and any necessary easements disclosed thereby, allotment 1A of section 11.—(G.64021.)

Land Act 1958.

PERMITS CANCELLED.

NOTICE is hereby given that the permits mentioned in the Schedule hereunder have been cancelled.

| District. | Corr. No. | Name of Permit Holder. | Parish. | Allotment. | Section. | Area. |
|-----------|-----------|------------------------|--------------|------------|----------|------------|
| Geelong | 503/44·81 | Donald George Smith .. | Wangerrip .. | 50 and 51 | .. | 200 acres. |

Department of Crown Lands and Survey,
Melbourne, 3rd October, 1960.

KEITH TURNBULL,
Commissioner of Crown Lands and Survey.

Land Act 1958.

LICENCES UNDER THE LAND ACTS 1915 AND 1928 DECLARED VOID.

NOTICE is hereby given that the Licences in the Schedule hereunder have been Declared Void for the reason specified in each case.

| District. | Corr. No. | Name of Licensee. | Section of Land Act under which Licensed. | Parish. | Allotment. | Section. | Area. | Annual Rental. | Reasons for Voiding. |
|-----------|---------------|---|---|--------------|------------|----------|--------------------|----------------|--|
| Melbourne | 02572/ 129 | Melbourne and Metropolitan Tramways Board | 129 | Doutta Galla | 11 | 1B | A. R. P. 15 0 7 | £3,000 | Licence cancelled as from 9.2.60 (Crown Grant issued). |
| Bendigo | 01056/ 129 | Charles Edward McGregor | 129 | Nerring .. | 332 | A | 0 3 24 | £1 0 0 | Surrendered. |

Department of Crown Lands and Survey,
Melbourne, 3rd October, 1960.

KEITH TURNBULL,
Commissioner of Crown Lands and Survey.

Land Act 1958.

LEASES SURRENDERED.

NOTICE is hereby given that the Governor in Council has accepted the surrender of the Leases mentioned in the schedule hereunder for the reason specified in each case.

| District. | Corr. No. | Name. | Section of Land Act under which Leased. | Parish. | Allotment. | Section. | Area. | Class. | Reason. |
|-----------|----------------|---------------------------------------|---|-------------|------------|----------|--------------------|--------|---------------------------------------|
| Melbourne | 1992/ 44·81 | James Thomas Davy | 50 | Neerim East | 47a | .. | A. R. P. 95 0 6 | .. | New lease to issue. |
| Melbourne | 0630/125 | Chemhouse Products (A/asia) Pty. Ltd. | 125 | Cut-paw-paw | G | 3 | 5 0 0 | .. | Surrendered as from 11th August, 1960 |

Department of Crown Lands and Survey,
Melbourne, 26th September, 1960.

KEITH TURNBULL,
Commissioner of Crown Lands and Survey.

Soldier Settlement Acts.

LEASE SURRENDERED.

NOTICE is hereby given that the Soldier Settlement Commission, pursuant to the powers conferred upon it by the Soldier Settlement Acts, has accepted the surrender of the lease mentioned in the Schedule hereunder for the reason specified.

SCHEDULE.

| Corr. No. | Name. | Section of Act No. 5179 under which Leased. | Parish. | Allotment. | Area. | Reason. |
|-----------|---------------|---|------------|-----------------|---------------------|--------------------|
| 2165/27 | L. K. Camm .. | 27 | Denison .. | 34 Section D | A. R. P. 103 1 5 | New lease to issue |

Soldier Settlement Commission,
28th September, 1960.

I. K. MORTON,
Secretary.

LAND AVAILABLE UNDER THE SOLDIER SETTLEMENT ACT.

(FOR ELIGIBLE EX-SERVICEMEN ONLY.)

NOTIFICATION is hereby given in accordance with Section 50 of the *Soldier Settlement Act 1958* that the undermentioned holding is available for settlement.

Any discharged serviceman who has applied to the Commission on or before the 5th October, 1960, for classification in the required class of primary production for which the holding is made available and whose application has been accepted but not necessarily finalized, or any discharged serviceman who has been classified as suitable in such class of primary production, may apply on the prescribed form for settlement on the holding.

The prescribed application forms, plans and further particulars may be obtained from the Enquiry Branch, Soldier Settlement Commission, State Public Offices, Melbourne. The closing date for the receipt of completed applications for settlement on this holding is the 24th October, 1960. Such applications to be in the hands of the Secretary, Soldier Settlement Commission, on or before that date.

I. K. MORTON,
Secretary.

Soldier Settlement Commission,
Melbourne, 3rd October, 1960.

SCHEDULE OF ALLOTMENTS.

PORTION OF MOUNT NAPIER ESTATE.
PARISH OF NAPIER, COUNTY OF NORMANBY.
Suitable for grazing (Sheep) and mixed farming.

| Allotment No. on Plan of Subdivision. | Area. |
|---------------------------------------|---------|
| | |
| 2 | 583 2 0 |

PROPOSED REVOCATION OF TEMPORARY RESERVATION AND THE WITHHOLDING FROM SALE, LEASING, AND LICENSING, OF LAND BY ORDER IN COUNCIL.

IN pursuance of the provisions of the *Land Act 1958*, notice is hereby given that it is the intention of the Governor in Council to revoke the temporary reservation and the withholding from sale, leasing, and licensing, of land by Order in Council hereunder referred to, viz.:—

The following Notice was published 1° on the 28th September, 1960, pursuant to Order of the 20th September, 1960.

NURCOUNG.—The temporary reservation as a site for Conservation of Water, and the withholding from sale, leasing and licensing, by Order in Council of the 13th November, 1883, of 88 acres 1 rood 8 perches of land in the Parish of Nurcoung, so far only as regards the portion containing 5 acres 0 roods 20 perches, more or less, indicated by hachure on plan hereunder, is concerned.—(N.147(*) (Rs.7333).

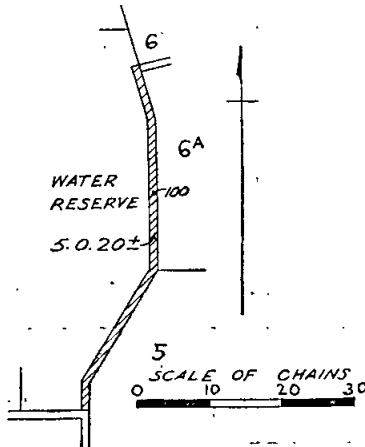

KEITH TURNBULL,
Commissioner of Crown Lands and Survey.

PROPOSED REVOCATION OF TEMPORARY RESERVATION, AND THE WITHHOLDING FROM SALE, LEASING, AND LICENSING OF LAND BY ORDER IN COUNCIL.

IN pursuance of the provisions of the *Land Act 1958*, notice is hereby given that it is the intention of the Governor in Council to revoke the temporary reservation, and the withholding from sale, leasing, and licensing of land by Order in Council hereunder referred to, viz.:—

The following Notice was published 1° on the 21st September, 1960, pursuant to Order of the 13th September, 1960.

KARYRIE.—The temporary reservation as a site for Public purposes (State School) and the withholding from sale, leasing and licensing, by Order in Council of the 20th December, 1880, of 5 acres of land in the Parish of Karyrie, are about to be revoked.—(K.138(2) (C.97970).

KEITH TURNBULL,
Commissioner of Crown Lands and Survey.

PROPOSED REVOCATIONS OF THE BALANCE OR PORTIONS OF TEMPORARY RESERVATIONS OF LANDS BY ORDERS IN COUNCIL.

IN pursuance of the provisions of the *Land Act 1958*, notice is hereby given that it is the intention of the Governor in Council to revoke the balance or portions of the temporary reservations of lands by Orders in Council hereunder referred to viz.:—

The following Notices were published 1° on the 21st September, 1960, pursuant to Orders of the 13th September, 1960.

WONTHAGGI.—The temporary reservation, by Order in Council of the 19th June, 1956, of 1 acre 2 roods, more or less of land in the Township of Wonthaggi as a site for Plantation purposes.—(W.345(10) (Rs.1811).

WONTHAGGI.—The temporary reservation, by Order in Council of the 23rd July, 1918, of 2 acres 2 roods 37½ perches of land in the Township of Wonthaggi as a site for Plantation purposes, revoked as to part by Order of the 10th July, 1956, so far as the balance thereof containing 3 roods 37½ perches, is concerned.—(W.345(10) (Rs.1811).

LALLAT.—The temporary reservation, by Order in Council of the 9th September, 1929, of 6 acres of land in the Parish of Lallat as a site for Supply of Gravel, so far only as the portion containing 1 acre 20 perches, more or less, indicated by hachure on plan hereunder, is concerned.—(L.151(*) (Rs.3902).

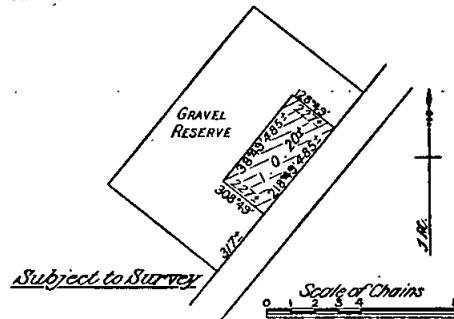

MIRBOO NORTH.—The temporary reservation, by Order in Council of the 14th October, 1958, of 2 acres 20 perches of land in the Township of Mirboo North as a site for the purposes of the Forests Act so far only as the portion containing 1 rood 11 perches, indicated by hachure on plan hereunder, is concerned.—(M.517(12) (Rs.7601).

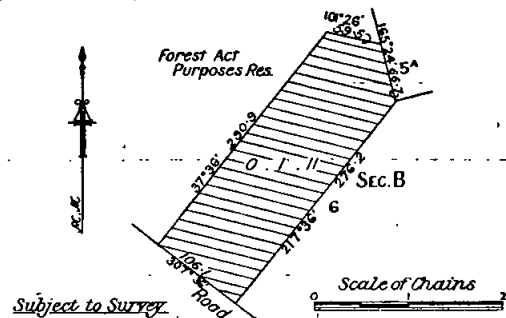

OUYEN.—The temporary reservation, by Order in Council of the 20th March, 1917, of 83 acres 3 roods 32 perches of land in the Parish of Ouyen as a site for Railway purposes, revoked as to part by various Orders, so far only as regards the portion containing 3 acres 3 roods, more or less, indicated by hachure on plan hereunder, is concerned.—(O.22(*) (Rs.1437).

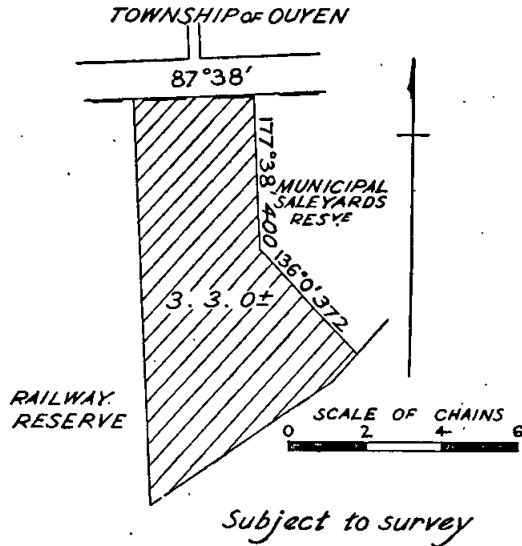

PENSHURST.—The temporary reservation, by Order in Council of the 10th November, 1863, of 1 acre 2 roods of land in the Township of Peshurst as a site for Police purposes, revoked as to part by Order of the 17th June, 1952, so far only as the portion containing 9 perches, indicated by hachure on plan hereunder, is concerned.—(P.29(*) (C.92424).

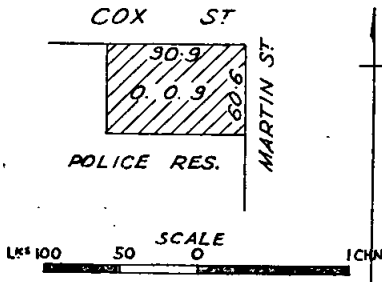

SANDHURST.—The temporary reservation, by Order in Council of the 12th May, 1927, of 77 acres 1 rood 34 perches of land at Bendigo, in the Parish of Sandhurst, as a site for Public Recreation, revoked as to part by various Orders, so far only as the portion containing 6 perches, more or less, indicated by hachure on plan hereunder, is concerned.—(S.372(*) (Rs.3458).

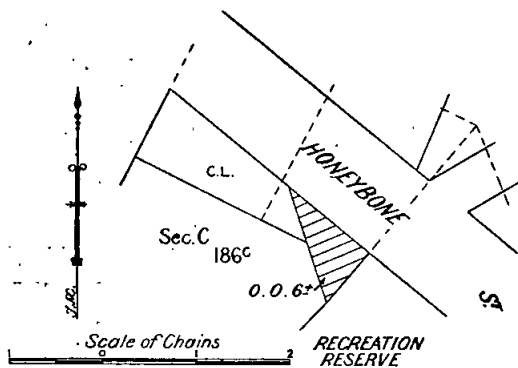

KEITH TURNBULL,
Commissioner of Crown Lands and Survey.

PROPOSED REVOCATIONS OF TEMPORARY RESERVATIONS OF LANDS BY ORDERS IN COUNCIL.

IN pursuance of the provisions of the Land Act 1958, notice is hereby given that it is the intention of the Governor in Council to revoke the temporary reservations of lands by Orders in Council hereunder referred to, viz.:

The following Notices were published 1° on the 21st September, 1960, pursuant to Orders of the 6th September, 1960.

SEBASTOPOL.—The temporary reservation, by Order in Council of the 23rd July, 1934, of 3 acres 2 roods 6 perches of land in the Township of Sebastopol as a site for a Rubbish Depot.—(S.353(*) (Rs.4395).

JIKA JIKA (PRESTON).—The temporary reservation, by Order in Council of the 6th May, 1940, of 1 acre 1 rood 26 8/10 perches of land in the Parish of Jika Jika as a site for Educational and Recreation purposes.—(J.16(*) (Rs.5039).

KEITH TURNBULL,
Commissioner of Crown Lands and Survey.

PROPOSED REVOCATION OF TEMPORARY RESERVATION, AND THE WITHHOLDING FROM SALE, LEASING, AND LICENSING OF LAND BY ORDER IN COUNCIL.

IN pursuance of the provisions of the Land Act 1958, notice is hereby given that it is the intention of the Governor in Council to revoke the temporary reservation, and the withholding from sale, leasing, and licensing, of land by Order in Council hereunder referred to, viz.:

The following Notice was published 1° on the 14th September 1960, pursuant to Order of the 6th September, 1960.

YANIPY.—The temporary reservation as a site for Camping and for affording access to Water and the withholding from sale, leasing and licensing, by Order in Council of the 9th August, 1881, of 120 acres of land in the Parish of Yanipy, revoked as to part by various Orders, so far as the balance thereof, containing 111 acres 1 rood is concerned.—(Y.90(A²) (Rs.5293).

KEITH TURNBULL,
Commissioner of Crown Lands and Survey.

PROPOSED REVOCATIONS OF TEMPORARY RESERVATIONS OF LANDS BY ORDERS IN COUNCIL.

IN pursuance of the provisions of the Land Act 1958, notice is hereby given that it is the intention of the Governor in Council to revoke the temporary reservations of lands by Orders in Council hereunder referred to, viz.:

The following Notices were published 1° on the 14th September, 1960, pursuant to Orders of the 6th September, 1960.

BALLAN.—The temporary reservation, by Order in Council of the 12th December, 1950, of 37 acres of land in the Township of Ballan, as a site for Public Park and Public Recreation, so far only as the portion containing 35 perches, more or less, indicated by hachure on plan hereunder, is concerned.—(B.23(*) (Rs.6597).

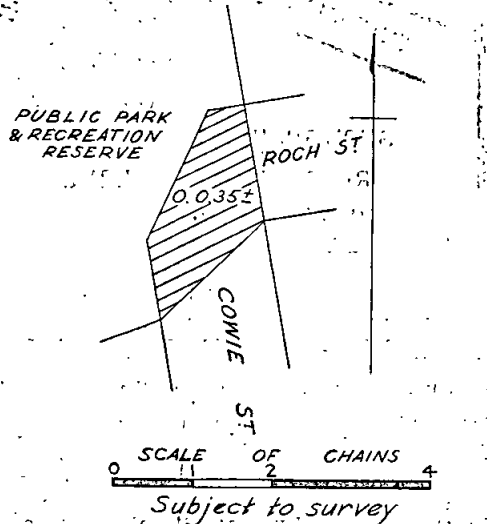

CARRAH.—The temporary reservation, by Order in Council of the 19th December, 1932, of 10 acres of land in the Parish of Carrah, as a site for the Supply of Gravel, so far only as the portion containing 3 acres, more or less, indicated by hachure on plan hereunder, is concerned.—(C.152(2) (Rs.4278).

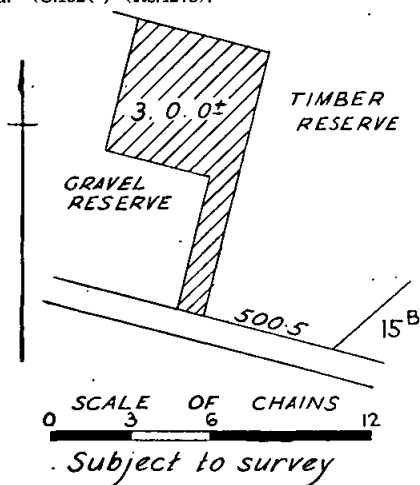

KEITH TURNBULL,
Commissioner of Crown Lands and Survey.

PROPOSED REVOCATION OF PORTION OF TEMPORARY RESERVATION OF LAND BY ORDER IN COUNCIL.

IN pursuance of the provisions of the *Land Act 1958*, notice is hereby given that it is the intention of the Governor in Council to revoke the temporary reservation of land by Order in Council hereunder referred to, viz.:—

The following Notice was published 1° on the 5th October, 1960, pursuant to Order of the 27th September, 1960.

SWAN HILL.—The temporary reservation, by Orders in Council of the 29th November, 1897, and the 18th January, 1949, of 8 acres 2 roods of land in the Township of Swan Hill, as a site for Show Yards and Public Recreation, and the temporary reservation by Order of the 27th June, 1950, of 2 roods 17 6/10 perches of land as an extension thereto, so far only as the respective portions containing 26 perches and 3 perches, indicated by hachure on plan hereunder, are concerned.—(S.464(2) (Rs.2474).

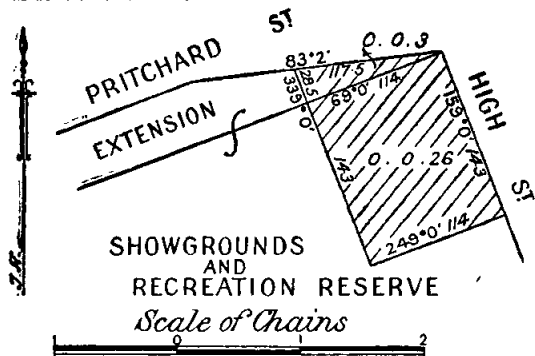

KEITH TURNBULL,
Commissioner of Crown Lands and Survey.

PROPOSED REVOCATION OF TEMPORARY RESERVATION OF LAND BY ORDER IN COUNCIL.

IN pursuance of the provisions of the *Land Act 1958*, notice is hereby given that it is the intention of the Governor in Council to revoke the temporary reservation of land by Order in Council hereunder referred to, viz.:—

The following Notice was published 1° on the 5th October, 1960, pursuant to Order of the 20th September, 1960.

ARGYLE.—The temporary reservation, by Order in Council of the 4th November, 1940, of 20 acres of land

in the Parish of Argyle as a site for Water Supply purposes.—(A.152(2) (Rs.5120).

KEITH TURNBULL,
Commissioner of Crown Lands and Survey.

(Published in lieu of notice appearing on page 3175 of *Government Gazette* dated 28th September, 1960.)

AMENDMENT OF REGULATIONS FOR THE CARE, PROTECTION AND MANAGEMENT OF "ROSALIND PARK", BENDIGO.

THE Board of Land and Works, in pursuance of the powers conferred on it by section 218 of the *Land Act 1958*, doth hereby make the following further amendments to the Regulations made on 20th February, 1952, and amended on 4th January, 1956, for the care, protection and management of the land in the City of Bendigo reserved by Order in Council of 5th February, 1952, as a site for Public Recreation and Drainage purposes, and known as "Rosalind Park":—

PART I.—GENERAL.

By inserting the words "lawns" between the words "trees" and "shrubs" in Regulation 2 (g).

By deleting Regulation 14 and substituting therefor the following:—

14. No person shall take or drive any carriage, cart or other vehicle into the Reserve without the permission of the Committee.

PART II.—THE QUEEN ELIZABETH OVAL.

By deleting Regulation 7 and substituting therefor the following:—

7. Every person, club or society renting or hiring the ground for any purpose whatsoever and who make any charge to the public for admission to the ground shall pay to the Committee such fee for the use of the ground as the Committee may from time to time determine, but the maximum charge shall not exceed the sum equivalent to 15 per cent. of the amount received from the public for admission to the ground and grandstands with a minimum payment of £5.

PART III.—MUNICIPAL SWIMMING POOL.

By deleting Regulation 13 and substituting therefor the following:—

13. The maximum charges for admission to the pool premises shall be as follows:—

| | £ | s. | d. |
|----------------------------------|---|----|----|
| Persons— | | | |
| Under sixteen years of age .. | 0 | 1 | 0 |
| Sixteen years of age or over .. | 0 | 2 | 0 |
| Hire of locker .. | 0 | 1 | 0 |
| Hire of towel .. | 0 | 1 | 0 |
| Hire of gown .. | 0 | 1 | 0 |
| Season tickets— | | | |
| Under sixteen years of age .. | 2 | 0 | 0 |
| Sixteen years of age and over .. | 4 | 0 | 0 |

The common seal of the Board of Land and Works was hereunto affixed this 27th day of September, 1960, in the presence of—

(SEAL) KEITH TURNBULL, President.
G. L. WOOD, Member.

(Rs.1375.)

REGULATIONS FOR THE CARE, PROTECTION, AND MANAGEMENT OF THE "FORSTER-ROAD RECREATION RESERVE, NOTTING HILL".

WHEREAS by section 218 of the *Land Act 1958* power is given to the Board of Land and Works to make Regulations in respect of the care, protection, and management of any Crown land which has been reserved under the Land Acts for any public purpose whatsoever and which has not been conveyed to or vested in trustees, and for the further purposes as enacted: Now therefore the Board of Land and Works, in pursuance of the power conferred aforesaid, doth hereby make the following Regulations in respect of the land in the Parish of Mulgrave temporarily reserved as a site for Public Recreation purposes by Order in Council of 4th May, 1927, and known as "Forster-road Recreation Reserve, Notting Hill" (hereinafter referred to as the "Reserve").

The Reserve has been placed under the control of the Council of the Shire of Mulgrave as a Committee of Management (hereinafter referred to as the "Committee").

1. The Reserve, with the exception of any portion thereof which may be let by the Committee to any club, association, person or society to conduct its activities in accordance with clause 11 of these Regulations, shall be open to the public at all times, free of charge, except on such days not exceeding 52 in any one year, as it or any portion thereof may be set aside by the Committee for fêtes, entertainments or amusements on any of which occasions admission shall be subject to such conditions as the Committee may determine.

2. No person shall—

- (a) enter or remain in the Reserve who may offend against decency as regards dress, language or conduct, or who may behave in a disorderly or offensive manner or create or take part in any disturbance;
- (b) enter or remain in the Reserve whilst in a state of intoxication;
- (c) bring any intoxicating liquor on the Reserve without the consent of the Committee first being obtained;
- (d) exercise or train any horse or pony on the Reserve, or any part thereof, without the consent of the Committee first being obtained.

3. No person shall interfere with, damage, or destroy the vegetation or any buildings in the Reserve, nor throw stones or other missiles, nor light fires, except in fireplaces specially provided by the Committee, nor deposit litter or refuse of any kind therein.

4. No person shall bring into the Reserve any cattle, horses, sheep, goats, pigs, or other animals, nor permit the same to enter, without the permission of the Committee being first obtained, otherwise the same may be impounded by the Committee.

5. No person shall erect any tent, booth, or other structure, nor offer any article for sale or hire in the Reserve without the permission of the Committee being first obtained.

6. No person shall use, or cause to be used any structure, tent, caravan or any vehicle of any description in the Reserve for camping or living therein.

7. No person shall enter the Reserve with any vehicle or on horseback without the permission of the Committee being first obtained, nor ride or drive amongst or to the danger or annoyance of persons assembled on any part of the Reserve.

8. No person shall bet publicly in any part of the Reserve without the permission, in writing, of the Committee being first obtained.

9. No person shall play, practise or engage in any sport except in that portion of the Reserve set apart for the purpose, and then only on such terms and conditions as the Committee may determine.

10. The Committee shall have the power to hold entertainments, shows or performances on the Reserve and to make a charge for admission thereto, as herein provided.

11. The Committee shall have the power to let any portion of the Reserve to any club, association, person or society for the purpose of holding any shows, sports or entertainments or to any club, association or society to conduct its activities subject to the payment of such fees and on such conditions as may seem to be reasonable and consistent with these Regulations, and to authorize any club, association, society or person to make a charge for admission as the Committee may determine.

12. No person except the Committee or its officers or employees on duty shall enter any part of the Reserve on an occasion when a charge is made for admission thereto, without first paying the fees chargeable for admission.

13. Persons renting or hiring any stand, building, erection or enclosure on the occasion of any sport, fêtes, or amusements may be required to deposit any sum which the Committee may determine by way of guarantee that due care may be taken of such stand, building, erection or enclosure, and such Committee, in its absolute discretion, may make good any damage or injury or loss from the sum of money so deposited by way of guarantee, and all persons so renting or hiring shall abide by these Regulations and by any order given by the Committee.—(Rs.3448.)

The common seal of the Board of Land and Works was hereto affixed this 27th day of September, 1960, in the presence of—

(SEAL) KEITH TURNBULL, President.
G. L. WOOD, Member.

Every person who contravenes or fails to comply with these Regulations shall, in accordance with the provisions of section 218 of the *Land Act 1958*, for each offence be liable to a penalty of not more than Five pounds, and every person who contravenes or fails to comply with any such Regulations, and who, after he has been warned by any bailiff of Crown lands or by any member of the Police Force, does not desist therefrom, may be forthwith apprehended by such bailiff or member of the Police Force and taken before some justice to be dealt with according to law and shall be liable to a penalty of not more than Ten pounds.

COMMITTEES OF MANAGEMENT OF RESERVES.

APPOINTMENTS.

WHEREAS by section 221 of the *Land Act 1958* it is provided that it shall be lawful for the Governor in Council or the Board of Land and Works to appoint and remove any number of persons, not less than three, or any municipal council, or the governing body of any corporation, to be a Committee of Management of any specified Crown land reserved either temporarily or permanently for any of the purposes set out in section 14 of the *Land Act 1958*, and not conveyed to or vested in trustees: Now therefore the Board of Land and Works doth hereby appoint the under-mentioned persons to be members of the Committee of Management of the Reserves named:—

"AVENEL RACECOURSE AND RECREATION RESERVE."

John Bernard Holloway, in the place of John David Burt, deceased, as a member of the Committee of Management for the period ending the 10th August, 1963, of the land temporarily reserved by Orders in Council dated 18th July, 1864, and 4th June, 1935, for Racing and other purposes of Public Recreation in the Township of Avenel, and known as the "Avenel Racecourse and Recreation Reserve"—(Corres. Rs.639.)

"WESTERN RESERVE", CASTLEMAINE.

John S. Tabuteau as a representative of the Council of the Castlemaine Technical School, in the place of Thomas Clarence Stoneman, deceased, as a member of the Committee of Management of the land reserved by Order in Council of the 5th May, 1936, as a site for Public Recreation and Educational purposes in the Township and Parish of Castlemaine, and of the land reserved by Order in Council of 5th April, 1921, as a site for a District High School in the Parish of Castlemaine, and known as the "Western Reserve"—(Corres. Rs.3445.)

"GLADYSDALE PUBLIC HALL RESERVE."

Ernest Lloyd, Donald F. G. Parkinson, Donald J. Lloyd, William B. Parkinson, Lawrence Wetherall Frankish, Bernard James O'Connell, Laura J. McMaster, Annie May Lloyd, Arthur George E. Lloyd, Phyllis Alma Frankish and Eileen May O'Connell as a Committee of Management for a period of three (3) years of the lands temporarily reserved by Orders in Council dated 14th September, 1915, and 11th November, 1919, as sites for Public Hall in the Parish of Beenak, at Gladysdale, and known as the "Gladysdale Public Hall Reserve"—(Corres. Rs.913.)

"SHEPPARTON PUBLIC GARDENS RESERVE."

The Council of the City of Shepparton as a Committee of Management of the land in the Township and Parish of Shepparton temporarily reserved by Order in Council dated 16th August, 1960, as a site for Public Gardens, and known as the "Shepparton Public Gardens Reserve"—(Corres. Rs.746.)

"KORUMBURRA RECREATION RESERVE."

William Henry Peters and Henry Charles Goad as members of the Committee of Management for so long only as they continue to be Councillors and the elect of the Council of the Shire of Korumburra of the land temporarily reserved by Order in Council dated the 19th August, 1895, as a site for Public Recreation in the Township of Korumburra, and known as the "Korumburra Recreation Reserve", in the places of Decima Mary Mayne and Henry Herbert Dowell, who have ceased to be Councillors.—(Corres. Rs.757.)

"KINGLAKE WEST PUBLIC HALL RESERVE."

Stanley William Owen, Henry Neville Stuart, Edward John Liersch, Donald Leslie Watson, Edwin William Blake, Harold Edwin John Collier, John Michael Kelly,

and Christopher Spencer as a Committee of Management for a period of three (3) years of the land temporarily reserved by Order in Council dated 16th December, 1907, as a site for a Mechanics' Institute in the Parish of Kinglake, and known as "Kinglake West Public Hall Reserve".—(Corres. Rs.4697.)

"WOORINEN SOUTH RECREATION RESERVE."

George Appleyard Smith, Bruce Roy Mitchell, William Walter Warburton, Edmund Albert Ward, Percival Allan Currie, Colin George Harvey, Barry John Warburton, Glen Campbell Cameron, Keith John Woodburn and James Alfred Warburton as a Committee of Management for a period of three (3) years of the remaining portion of land in the Parish of Woorinen temporarily reserved by Order in Council dated the 8th February, 1937, as a site for Public Recreation, and known as the "Woorinen South Recreation Reserve".—(Corres. Rs.4657.)

"OCEAN PARK RESERVE", SORRENTO.

John Francis Watts, Frank Leslie Coker, George Alfred Knowles, Albert Edward Schlipalius, Henry Tayton and William Stanley Welland Croad for a period of three (3) years from the 1st October, 1960, and Alfred John Heath Dark (as Chairman, and for so long as he shall be a Councillor and the elect of the Council of the Shire of Flinders), as a Committee of Management of the under-mentioned Reserves, comprising:—The land permanently reserved by Order in Council dated 17th April, 1924, as a site for the purpose of protecting sold and occupied lands from the eruption of sand, and for Public Park and Public Recreation, being the land known as "Ocean Park" in the Parishes of Nepean and Fingal, at Sorrento; and also of the lands permanently reserved by Orders in Council dated the 18th July, 1924, and 13th May, 1932, for Public Park and Recreation purposes in the Parish of Nepean (including "London Bridge" Site), excepting, however, the areas coloured red on plans marked 3 over 1.12.53 attached to Lands Department correspondence Rs.7224 and N over 10.11.55 attached to Lands Department correspondence Rs.7400.—(Corres. Rs.2110.)

"LEONARD'S HILL MECHANICS' INSTITUTE AND FREE LIBRARY RESERVE."

John Meredith Linwood, Albert Henry Liversidge, Roy Liversidge, John Frost, Keith Richardson, Florence Liversidge, Jean Richardson, Valerie Lockman and Brian Scott as a Committee of Management for a period of three (3) years of the land permanently reserved by Order in Council dated the 14th June, 1904, as a site for a Mechanics' Institute and Free Library in the Parish of Wombat (at Leonard's Hill), and known as the "Leonard's Hill Mechanics' Institute and Free Library Reserve".—(Corres. Rs.2268.)

"KEW GUIDE DOG CENTRE RESERVE."

Sir Norman Angus Martin, Basil Osborne and Samuel Clarkson (for so long only as each is the nominee of the Guide Dogs for the Blind Association of Victoria) as a Committee of Management of the land temporarily reserved by Order in Council dated the 16th August, 1960, as a site for a Guide Dog Centre, and known as the "Kew Guide Dog Centre Reserve".—(Corres. Rs.7934.)

"SAILOR'S FALLS RECREATION RESERVE."

John Muir, Michael Dwyer, John Plant, Michael Hogan, Jack Shanahan, Charles Linwood and George Howard as a Committee of Management for a period of three (3) years of the land in the Parish of Wombat temporarily reserved as a site for Public Recreation by Order in Council of the 23rd November, 1891, and known as the "Sailor's Falls Recreation Reserve".—(Corres. Rs.457.)

"BEACONSFIELD PUBLIC HALL RESERVE."

James Norman Parkes, Florence Rita Barby, Horace Albert Samuel Barby, Harry Britton Elms, Theresa Mary Curtis, Desmond Kelvin Hill, Mervyn Robert Howard, Dorothy Mary Barnes, Charles Henry Barnes, Kathleen Helen Curtis and Thomas William Slessar as a Committee of Management for a period of three (3) years of the land temporarily reserved by Order in Council dated 8th November, 1943, as a site for a Public Hall in the Parish of Pakenham, and known as the "Beaconsfield Public Hall Reserve".—(Corres. Rs.5406.)

"PENSURST PUBLIC PARK AND RECREATION RESERVE."

The Council of the Shire of Mount Rouse as a Committee of Management of the land in the Township of Penshurst, Parish of Boram Boram, temporarily reserved by Order in Council dated the 13th September, 1960, as a site for a Public Park and Public Recreation, and known as the "Penshurst Public Park and Recreation Reserve".—(Corres. Rs.376.)

"KATANDRA RECREATION RESERVE."

Denis Francis Lane, John Ernest Jones, Robert Desmond Della Vedova, Eric Charles Thorne, Alfred Clarence Thorne, Elwin Thomas Wallden and Richard Charles Lelievre as a Committee of Management for a period of three (3) years of the land in the Township and Parish of Katandra temporarily reserved by Order in Council dated the 12th July, 1960, as a site for Public Recreation, and known as the "Katandra Recreation Reserve", the aforementioned land being that indicated by red colour on plan marked K/8.6.60 attached to Lands Department correspondence Rs.7943.—(Corres. Rs.7943.)

"KILCUNDA FORESHORE RESERVE."

John Wylie (junior), Alan Richard Hamilton, Peter William Dwyer, John William Carew, John Wylie (senior), William James Price and William Gerald Brighton as a Committee of Management for a period of three (3) years of the land temporarily reserved by Order in Council dated the 20th January, 1914, as a site for purposes of Public Recreation in the Township of Kilocunda, and known as the "Kilocunda Foreshore Reserve".—(Corres. Rs.119.)

"MURCHISON RECREATION RESERVE."

James George Kenny, Ernest Keith McNally, William Henry Trevasakis, Joseph Ray Tweddle, Lloyd George Tweddle, Geoffrey Herbert Tainton, Kevin Matthew Feehan, James Alistair Bryden Rogers and John Kenneth Finlay as a Committee of Management for a period of three (3) years of the land temporarily reserved by Order in Council dated the 26th April, 1950, and the remaining portion of the land temporarily reserved by Order in Council dated 27th April, 1868, for Recreation purposes at Murchison, and known as the "Murchison Recreation Reserve".—(Corres. Rs.1864.)

"SORRENTO FORESHORE RESERVE."

Cyril Charles Tregilles, Leopold George Johnson, Alfred Stuart, Neville Charles Morgan, Robert William Hutchins, Richard Frederick Gale, William Felix Mullen and Benjamin Charles Wilson for a period of three (3) years from the 1st October, 1960, and Sydney Alfred Baker (as Chairman), for so long as he shall continue to be a Councillor and the elect of the Council of the Shire of Flinders, as a Committee of Management of such portion of the land reserved as a site for Public purposes on the foreshore of Port Phillip Bay in the Parish of Nepean, at Sorrento, and known as the "Sorrento Foreshore Reserve", as indicated by red colour on plan marked S over 12.2.23 with Lands Department correspondence Rs.1010, excepting, however, the area occupied by the Country Roads Board and municipal roads.—(Corres. Rs.1010.)

"RHYLL MECHANICS' INSTITUTE RESERVE."

The Council of the Shire of Phillip Island as a Committee of Management of the land in the Parish of Phillip Island temporarily reserved by Order in Council dated 2nd June, 1891, as a site for a Mechanics' Institute, and known as the "Rhyll Mechanics' Institute Reserve".—(Corres. Rs.2163.)

"CLAYTON (SPRINGS-ROAD) RECREATION RESERVE."

Frank Slater and Eric Sabine Perryman (for so long only as they continue to be Councillors and the elect of the Council of the City of Oakleigh), in the places of Harold Francis Ryan and Henry Rieveley Kay, who have ceased to be Councillors, as members of the Committee of Management of the land temporarily reserved by Order in Council dated 30th January, 1923, as a site for Recreation purposes in the Parish of Mordialloc, at Clarinda, and known as the "Clayton (Springs-road) Recreation Reserve".—(Corres. Rs.2690.)

"APPIN PUBLIC HALL AND PUBLIC RECREATION RESERVE."

William Alfred Wood, Albert David Higgie, William John Delamare, John Colin Higgie, Francis Douglas Boyd, Neil Sutherland, Francis Thomas O'Eyrne, John Thomas Hewitt and Ellis James Ritchie as a Committee of

Management for a period of three (3) years of the land in the Parish of Meering temporarily reserved by Order in Council dated the 3rd August, 1954, as a site for a Public Hall and for Public Recreation, and known as the "Appin Public Hall and Public Recreation Reserve".—(Corres. Rs.7281.)

"PORT CAMPBELL PUBLIC HALL AND FREE LIBRARY RESERVE."

Cecil William John Burgin, Jeannie May Hose, John Wallace Donald McKenzie, George Joseph Cairns, Claude Henry Charles Sharp, Donald Joseph Fitzpatrick and Roy Anzac Hose as a Committee of Management for a period of three (3) years of the land temporarily reserved by Order in Council dated 29th June, 1887, as a site for a Free Library in the Parish of Paaratte, at Port Campbell, and known as the "Port Campbell Public Hall and Free Library Reserve".—(Corres. Rs.3505.)

"KYABRAM RAILWAY RECREATION RESERVE."

Maurice Charles March, Percy Walton, Maxwell Cameron Sutherland, Percival Perkins and William McMaster-Smith as a Committee of Management for a period of three (3) years of the remaining portion of the land temporarily reserved by Order in Council dated 16th October, 1893, as a site for Public Recreation in the Village of Kyabram, and known as the "Kyabram Railway Recreation Reserve".—(Corres. Rs.742.)

In witness whereof the common seal of the Board of Land and Works was hereunto affixed this twenty-seventh day of September, One thousand nine hundred and sixty, in the presence of—

(SEAL) KEITH TURNBULL, President.
G. L. WOOD, Member.

PUBLIC SERVICE NOTICES

PUBLIC SERVICE (PUBLIC SERVICE BOARD) REGULATION 39.—RECLASSIFICATIONS.

HE Public Service Board has raised the classification of the under-mentioned offices as shown, and the Permanent Heads of the Departments have recommended the officers named for appointment.

| Office and Present Classification. | Revised Classification. | Duties. | Qualifications. | Officer Recommended for Appointment. | | |
|---|---|---|---|--------------------------------------|------------------------------------|-------------------------|
| | | | | Name. | Classification. | Date of Classification. |
| PROFESSIONAL DIVISION. | | | | | | |
| DEPARTMENT OF CHIEF SECRETARY. | | | | | | |
| <i>National Museums Branch.</i> | | | | | | |
| Curator of Anthropology, Class "C" | Class "C1" | To be Curator of the Ethnological and Anthropological Collections in the National Museum of Victoria, to undertake scientific research on the collections and in the field; to advise the public and scientific organizations on matters relating to Ethnology and Anthropology, and perform other duties as required | Experience in Ethnology and Anthropology particularly relating to museum work; ability to act as Curator of the Museum collections, and experience in research methods | Massola, A. . . | Curator of Anthropology, Class "C" | 8.6.58 |
| DEPARTMENT OF WATER SUPPLY. | | | | | | |
| Executive Assistant, Class "B1" | Executive Assistant, (Plant), Class "A" | To organize and co-ordinate the distribution, use and maintenance of mechanical plant within the Wimmera-Mallee Division; to investigate and make recommendations for improvements of plant and for development of special plant requirements; to study and report on the utilization of plant for remodelling, reconstruction, and maintenance of channels | Extensive experience of the use of plant including ditchers of all types used in connection with remodelling, reconstruction, maintenance, and new construction of earthen channels; experience in field maintenance of large and small tractors, ability in the administration of districts and handling of men, and preferably a good knowledge of the Wimmera-Mallee Water Distribution and Channel System | Bentley, W. H. E. | Executive Assistant, Class "B1" | 3.1.51 |
| TECHNICAL AND GENERAL DIVISION. | | | | | | |
| DEPARTMENT OF HEALTH. | | | | | | |
| MENTAL HYGIENE BRANCH. | | | | | | |
| <i>Sandhurst Boys' Centre.</i> | | | | | | |
| Engineer Mechanic, Grade III., Grades 21-24 inclusive | Trade Instructor, Grade II., Grades 24-26 inclusive | To be responsible for the management and maintenance of steam boilers, hot and cold water services, cooking appliances, electrical and sewerage installations, to take charge of classes in metal work and to instruct patients in all aspects of the work | Sound mechanical knowledge and a Boiler Attendant's Certificate or higher qualifications with ability to instruct patients in the trade processes | Farrar, W. B. | Engineer Mechanic, Grade III. | 4.9.59 |

Appeals against such recommendations should be lodged with the Secretary to the Public Service Board not later than Saturday, the 15th October, 1960.

Office of the Public Service Board,
Melbourne, 4th October, 1960.

By order,
V. P. SCULLY,
Secretary.

PUBLIC SERVICE OF VICTORIA.—VACANCIES.

A PPLICATIONS will be received by the Public Service Board up to Wednesday, the 19th October, 1960, from persons employed in the Public Service of Victoria, who are eligible and qualified, for appointment to the under-mentioned positions:—

ADMINISTRATIVE DIVISION.

Class "C1", Department of Local Government.

Yearly Salary.—£960, minimum; £1,060, maximum.

Duties.—To draft correspondence and prepare Orders in Council and Minister's Certificates; to organize the hearing of appeals under the Town and Country Planning Acts, answer enquiries and advise in relation thereto and assist generally.

Qualifications.—A competent correspondent preferably with a knowledge of secretarial work; organizing ability and experience in dealing with the public.

Class "C", Office of the Government Statist, Department of Chief Secretary.

Yearly Salary.—£710, minimum; £860, maximum.

Duties.—To assist in the examination of Friendly Society returns and the compilation of Friendly Society Statistics.

Qualifications.—A good knowledge of the *Friendly Societies Act 1958* and Regulations and Friendly Society practices. To have commenced a course of study in accountancy.

Class "C", Department of Crown Lands and Survey.

Yearly Salary.—£710, minimum; £860, maximum.

Duties.—Under direction to purchase stores and equipment for Survey Branches; to maintain liaison with different firms regarding purchases, keep all registers and cards, check and recommend payment of accounts, and deal with general correspondence.

Qualifications.—A good knowledge of the Public Accounts and Stores Regulations. A knowledge of the Survey Co-ordination Act and Regulations and familiarity with the workings of the Central Plan Office, the Photographic Laboratory and Aerial Survey and Draughting Branches are desirable.

Class "C", Milk Board, Department of Agriculture.

Yearly Salary.—£710, minimum; £860, maximum.

Duties.—Under the Officer in Charge, Accounts Section, to supervise and control staff engaged in the administration of the Commonwealth/State Free Milk Scheme; to check claims for payment and prepare reports on the operation of the Scheme.

Qualifications.—A knowledge of the procedure connected with the payment of accounts and the maintenance of statistical records; ability to control and direct staff.

PROFESSIONAL DIVISION.

Senior Inspecting Clerk of Courts, Class "A", Courts Branch, Department of Law.

Yearly Salary.—£1,920, minimum; £2,060, maximum.

Qualifications.—To have passed the Stipendiary Magistrates' qualifying examination and to have had at least ten years' experience as a Clerk of Courts; a thorough knowledge of the duties of the office and of the Office of Receiver and Paymaster.

Assistant District Engineer (Mechanical), Classes "C2"—"B", Department of Public Works.

Yearly Salary.—£1,170, minimum; £1,500, maximum. (Commencing salary according to experience.)

Duties.—To assist a District Engineer (Mechanical) in the supervision of contracts for mechanical plant and installations for Government buildings, and associated maintenance works; to prepare reports on maintenance works and carry out tests on completed mechanical installations as directed.

Qualifications.—A degree or diploma in Mechanical Engineering or equivalent; a good practical experience in the design, installation, maintenance and testing of modern mechanical equipment in buildings.

Assistant Agricultural Extension Officer, Classes "C"—"C2", Department of Agriculture.

Yearly Salary.—£960, minimum; £1,280, maximum. (Commencing salary according to experience.)

Duties.—After a period of training to undertake district agricultural extension work.

Qualifications.—University degree in Agricultural Science.

Assistant Entomologist, Classes "C"—"C2", Department of Agriculture.

Yearly Salary.—£960, minimum; £1,280, maximum—Agricultural Science Graduate; £860, minimum; £1,280, maximum—Science Graduate. (Commencing salary according to experience.)

Duties.—To assist in research work on problems of Economic Entomology, particularly on Citrus and Vine insect pest problems.

Qualifications.—A degree in Agricultural Science or Science with training in economic entomology.

NOTE.—The successful applicant, after a period of training at the Plant Research Laboratory, Burnley, will be located in the Mildura area.

Assistant Engineer, Classes "C"—"C2", Shepparton Centre, Department of Water Supply.

Yearly Salary.—£960, minimum; £1,280, maximum—Graduate; £810, minimum; £1,280, maximum—Diplomate. (Commencing salary according to experience.)

Duties.—To prepare designs and estimates for hydraulic and other structures, dams and channels, and, where necessary, supervise construction work of this nature.

Qualifications.—A University Degree or Diploma in Civil Engineering or other recognized engineering qualification, preferably with some experience in design and construction of water supply work.

TECHNICAL AND GENERAL DIVISION.

Construction Inspector, Office of the Housing Commission, Department of Treasurer.

Yearly Salary.—£798, minimum; £894, maximum.

Duties.—To inspect and report on the quality and standard of works in metropolitan and country areas prior to the Commission's acceptance from contractors; subsequent inspections and reports as required.

Qualifications.—Wide practical experience in construction of residential buildings, and ability to perform the duties of the position. Technical school or trade qualifications in building construction are desirable. A current car driver's licence.

Field Officer, Department of Agriculture. (Two vacancies.)

Yearly Salary.—Junior—At 17 years of age, £221; at 18 years of age, £299; at 19 years of age, £338; at 20 years of age, £390. Adult—£654, minimum; £798, maximum.

(Commencing salary will be determined within this initial range according to experience, but advancement is not limited to the maximum quoted.)

Duties.—To assist in horticultural experiments and other work as directed.

Qualifications.—The Diploma of an approved Agricultural College (Australian) or its equivalent.

Alternate Qualifications.—The Certificate of Competency of Burnley School of Horticulture. Successful applicants with alternate qualifications will be required to pass an efficiency examination before being eligible for promotion to Senior Field Officer.

NOTE.—Field Officers are eligible for appointment to the position of Field Officer, Senior, salary range £846—£942, and on passing a qualifying examination, for appointment to the Professional Division as Experimental Officer, salary range £810—£1,280.

Farm Mechanic, Department of Agriculture.

Yearly Salary.—£510, minimum; £558, maximum.

Duties.—To maintain the equipment of the Scoresby Horticultural Research Station and the associated experimental cool stores; to keep records of equipment, assist in the construction of special equipment and in the orchard when required.

Qualifications.—A good knowledge of the maintenance of refrigeration equipment; skill and experience in the care and maintenance of vehicles and orchard machinery; ability to carry out maintenance and minor repairs of orchard equipment.

Motor Truck Driver, Leading Hand, Tuberculosis Branch, Department of Health.

Yearly Salary.—£478, minimum; £494, maximum.

Duties.—To drive X-ray vans and other motor vehicles as required; to allocate duties as directed to Motor Drivers in the Division of X-ray Surveys of the Tuberculosis Branch; to be responsible for the regular inspection and maintenance of motor vehicles of the Branch.

Qualifications.—A licensed driver with experience in driving motor trucks of up to 5 tons capacity; to be capable of handling heavy X-ray equipment; to have a good knowledge of the mechanics of motor vehicles and of roads throughout Victoria.

Handcraft Instructor (Female), Social Welfare Branch, Department of Chief Secretary.

Yearly Salary.—£444, minimum; £476, maximum.

Duties.—To be in charge of Craft Work at Fairlea Female Prison.

Qualifications.—To be a general craft worker, able to teach and demonstrate; to be competent to keep records of purchases of raw materials, manufactured articles and sales.

NOTE.—Quarters and rations are available for which a charge of £166 per annum is made.

NOTE.—The salary rates quoted above do not include the additional amount which is payable under Regulation 77A of the Board's Regulations.

By order,

V. P. SCULLY,

Secretary.

Office of the Public Service Board,
Melbourne, 4th October, 1960.

PUBLIC SERVICE OF VICTORIA.—VACANCIES.

DEPARTMENT OF HEALTH.

MENTAL HYGIENE BRANCH.

TECHNICAL AND GENERAL DIVISION.

A PPLICATIONS will be received by the Public Service Board up to Wednesday, the 26th October, 1960, from persons employed in the Public Service of Victoria, who are eligible and qualified for appointment to the under-mentioned positions:—

Charge Nurse (Male), Ararat Mental Hospital.

Yearly Salary.—£606, minimum; £654, maximum.

Duties.—To take charge or sub-charge of a ward in a Mental Hospital.

Qualifications.—A current practising certificate for Mental Nursing and experience as a Deputy Charge Nurse in a Mental Hospital.

Electrical Mechanic, Larundel Mental Hospital.

Yearly Salary.—£510, minimum; £558, maximum.

Duties.—Under the Engineer to be responsible for the maintenance of wiring and electrical equipment; to undertake minor electrical installations and assist the Engineer generally.

Qualifications.—A "B" Grade wiring licence.

Painter, Grade I, Beechworth Mental Hospital.

Yearly Salary.—£510, minimum; £558, maximum.

Duties.—To carry out general painting, paper hanging and glazing, and the training of patients to help in painting work.

Qualifications.—To be a competent and qualified painter (conversant with mixing and using of paints), paperhanger, and glazier, and experienced in the control of mental patients.

Farm Assistant, Janefield Colony.

Yearly Salary.—£366, minimum; £430, maximum.

Duties.—To assist in all farm work.

Qualifications.—Ability to carry out all ordinary farm work and possession of a motor driver's licence.

NOTE.—The salary rates quoted above do not include the additional amount which is payable under Regulation 77A of the Board's Regulations.

By order,

V. P. SCULLY,

Secretary.

Office of the Public Service Board,
Melbourne, 4th October, 1960.

Public Service Act 1958.

**PUBLIC SERVICE (PUBLIC SERVICE BOARD)
REGULATION 46.**

EXAMINATION—CLERK OF COURTS.

NOTICE is hereby given that the candidates named hereunder qualified for promotion to Class "C", Professional Division, as Clerks of Courts at the examination held on the 11th and 12th August, 1960.

Name.

Bonell, Eric.
Bramley, Ross Alan.
Clothier, Bryan Joseph.
Connolly, Michael.
Coutts, Robin Noel.
Curtis, Kenneth Brian.
Dennis, Denis Brian.
Ellis, Anthony Russell.
Hyams, Brian John.
Ison, Alfred Russell.
Johnston, Walter Raymond.
Martin, William Desmond.
Matfin, Alan John.
McFarlane, Roger Leonard.
Oehms, Laurence Ross.
O'Donoghue, David James.
Spencer, Alan Francis.
Tobin, John Charles.
Warne, Rodney Taylor.
Wilkinson, John Henry.
Williamson, Gavan George.

The following candidates passed in the subjects shown:—

Introduction to Law and Practice.

Bonell, Eric.
Dennis, Denis Brian.
Dunlop, Anthony Ronald John.
Ellis, Anthony Russell.
Gemmell, James Sloan.
Gidley, John Arthur.
Ison, Alfred Russell.
Mansbridge, Brian Thomas.
McMahon, Kevin George.
O'Farrell, Lawrence.
Ryan, Michael Augustus.
Street, Patrick Denis.
Walker, Russell Evan Goold.
Williamson, Gavan George.
Wilson, Robert Ractliffe.

Statute Law No. 1.

Bedohazy, Thomas.
Bramley, Ross Alan.
Coutts, Robin Noel.
Curtis, Kenneth Brian.
Dennis, Denis Brian.
Ellis, Anthony Russell.
Hyams, Brian John.
Ison, Alfred Russell.
Johnston, Walter Raymond.
Matfin, Alan John.
McDonald, Joseph Septimus.
McFarlane, Roger Leonard.
Oehms, Laurence Ross.
O'Farrell, Lawrence.
Smith, Lionel Cedric Winton.
Stocks, Bernard James.
Tobin, John Charles.

Statute Law No. 2.

Bonell, Eric.
Bramley, Ross Alan.
Clothier, Bryan Joseph.
Connolly, Michael.
Coutts, Robin Noel.
Denahy, John Gerald.
Dennis, Denis Brian.
Ellis, Anthony Russell.
Gidley, John Arthur.
Johnston, Walter Raymond.

EXAMINATION—CLERK OF COURTS—*continued.*

Martin, William Desmond.
 Matfin, Alan John.
 McFarlane, Roger Leonard.
 O'Donoghue, David James.
 Oehms, Laurence Ross.
 Smith, Bernard Peter Gerard.
 Spencer, Alan Francis.
 Warne, Rodney Taylor.
 Wilkinson, John Henry.
 Williamson, Gavan George.
 Wilson, Robert Ractliffe.

By order,
 V. P. SCULLY,
 Secretary.

Office of the Public Service Board,
 Melbourne, 4th October, 1960.

No. 1059.

Public Service Act 1958, Section 39.

REGULATIONS.—PART III.—SALARIES, INCREMENTS AND ALLOWANCES.

THE Public Service Board, in pursuance of the powers conferred by the *Public Service Act 1958*, hereby amends its Regulations as shown below:—

FIRST SCHEDULE.

PROFESSIONAL DIVISION.

Amount of Salary Assigned to Offices in Class "A1".

| Office. | Yearly Rate of Salary. |
|--|------------------------|
| £ | |
| DEPARTMENT OF MINES. | |
| <i>Delete—</i> Chief Government Geologist | 3,075 |
| <i>Add—</i> Director of Geological Survey | 3,525 |

A. GARRAN, Chairman.
 V. P. SCULLY, Secretary.

Office of the Public Service Board,
 Melbourne, 26th September, 1960.

No. 1060.

Public Service Act 1958.

REGULATIONS.—PART III.—SALARIES, INCREMENTS AND ALLOWANCES.

THE Public Service Board, in pursuance of the powers conferred by the *Public Service Act 1958*, hereby amends its Regulations as shown below:—

FOURTH SCHEDULE.

ADMINISTRATIVE DIVISION.

Amount of Salary Assigned to Offices in Class "A1".

| Office. | Yearly Rate of Salary. |
|---|------------------------|
| £ | |
| DEPARTMENT OF WATER SUPPLY. | |
| <i>Add—</i> Officer in Charge, Stores Branch | 2,300 |

A. GARRAN, Chairman.
 V. P. SCULLY, Secretary.

Office of the Public Service Board,
 Melbourne, 26th September, 1960.

No. 1061.

PUBLIC SERVICE ACT 1958.

THE Public Service Board, in pursuance of the powers conferred by the *Public Service Act 1958*, hereby amends the Public Service (Public Service Board) Regulations as follows:—

PART I.—APPOINTMENTS TO THE ADMINISTRATIVE, PROFESSIONAL, AND TECHNICAL AND GENERAL DIVISIONS.

TECHNICAL AND GENERAL DIVISION.

Department of Health—Mental Hygiene Branch.

Regulation 34 is revoked and the following Regulation is substituted therefor:—

"34. (1) Candidates for appointment to the office of Student Nurse (Male or Female) must be not less than eighteen and not more than 40 years of age: Provided that any candidate under the age of 56 years who has a current practising certificate in respect of mental nursing or mental deficiency nursing issued by the Victorian Nursing Council shall be eligible for appointment.

(2) A candidate for appointment to the office of Student Male Nurse must possess a merit certificate or equivalent qualification.

(3) All appointments of Student Nurses (Male or Female) to the staff shall be on probation and shall be subject to the passing of the examinations prescribed by Regulation 52 of these Regulations. Any such appointment shall not be confirmed unless the appointee passes the Final Examination within five years after appointment."

PART II.—PROMOTIONS AND TRANSFERS.

TECHNICAL AND GENERAL DIVISION.

Department of Health—Mental Hygiene Branch.

Regulation 52 is revoked and the following Regulation is substituted therefor:—

"52. (1) In order to qualify for promotion to positions on the nursing staff of Mental Hospitals, Student Nurses (Male or Female) will be required to pass three examinations and register with the Victorian Nursing Council. It shall be compulsory for Student Nurses to attend lectures and tutorials as required by the Victorian Nursing Council and to complete a full three years' training before registration with that Council. Sick leave and leave granted under Regulation 44 of the Public Service (Governor in Council) Regulations will not be counted for the purpose of this sub-regulation as part of any period of training. During the course of this training, trainees will undertake the following examinations:—

(a) First Professional examination for trainees in mental nursing and mental deficiency nursing set by the Victorian Nursing Council.

This examination cannot be undertaken until at least nine months after the Student Nurse has been enrolled for training with the Victorian Nursing Council.

An officer who fails to pass the examination at two successive attempts must cease training.

(b) Second year examination set by the Mental Hygiene Authority—
 Subjects:

- (i) For trainees in mental nursing:
 - Medical and surgical nursing.
 - Physical diseases and disorders.
 - Introduction to psychiatry and psychiatric nursing.
 - Ward management—
 - administrative and legal responsibilities.
 - Materia Medica.

- (ii) For trainees in mental deficiency nursing:
 - Medical and surgical nursing.
 - Physical diseases and disorders.
 - Introduction to neurology of mental deficiency and to mental deficiency nursing.
 - Ward management—
 - administrative and legal responsibilities.
 - Materia Medica.

This examination cannot be undertaken until at least one year after passing the First Professional examination referred to in paragraph (a).

- (c) Final examination for trainee mental nurses or trainee Mental Deficiency Nurses set by the Victorian Nursing Council.

This examination cannot be undertaken until at least one year after the passing of the Second Year Examination referred to in paragraph (b).

(2) Any Student Nurse who has passed the Final Examination and is in possession of a current Practising Certificate in respect of mental nursing or mental deficiency nursing issued by the Victorian Nursing Council shall, on the recommendation of the Permanent Head, be promoted to the office of Staff Nurse (Male) or Staff Nurse (Female) (as the case may be):

Provided that any person appointed to such an office otherwise than by promotion from an office in the Mental Hygiene Branch shall be appointed on probation for a period not less than twelve months.

(3) No person shall be eligible for appointment to or shall continue to hold the office of Staff Nurse (Male or Female) or Deputy Charge Nurse (Male or Female) or Charge Nurse (Male or Female) or higher nursing position unless such person is in possession of a current practising certificate in respect of mental nursing or mental deficiency nursing (as the case may be) issued by the Victorian Nursing Council.

(4) An officer or employee on the nursing staff of the Mental Hygiene Branch who possesses a current practising certificate for general nursing issued by the Victorian Nursing Council, may, on the recommendation of the Permanent Head, be paid an allowance at the rate of £30 a year in addition to the salary appropriate to his or her office or designation."

PART III.—SALARIES, INCREMENTS, AND ALLOWANCES.

Regulation 68 is revoked and the following Regulation is substituted therefor:—

"68. Notwithstanding anything in Regulation 60, officers occupying the office of Student Nurse or Ward Assistant in the Mental Hygiene Branch, Department of Health, shall be granted annual increments of £16 a year each, provided that, in the case of a Student Nurse the granting of such increments shall be conditional on passing the First Professional and Second Year Examinations respectively as prescribed in Regulation 52."

A. GARRAN, Chairman.
V. P. SCULLY, Secretary.

Office of the Public Service Board,
Melbourne, 27th September, 1960.

TOWN AND COUNTRY PLANNING BOARD.

SECRETARY.

A PERSON with wide experience of public administration and office routine is required by the Town and Country Planning Board for the office of Secretary.

A knowledge of the scope and operation of planning and other allied legislation, and ability to correlate material and prepare reports of the Board's activities is necessary.

The actual salary ranges from £2,411—£2,551 per annum, and other conditions are similar to those of the Public Service.

Applications endorsed "Secretary", setting out age, qualifications, experience and war service (if any) should be addressed to the Chairman, Town and Country Planning Board, 61 Spring-street, Melbourne, on or before 17th October, 1960.

TENDERS—PUBLIC WORKS DEPARTMENT

TENDERS will be received at this Department until TEN a.m. on the Tuesdays, and for the purposes, under mentioned.

Particulars may be learnt at the Department and also at places shown in parenthesis.

W.O. means Inspector of Works Office; P.S.—Police Station; T.S.—Technical School; H.E.S.—Higher Elementary School; S.S.—State School; H.S.—High School; C.S.—Consolidated School.

Tenders should be submitted on the Department's printed Tender Form. All tenders must be on a "Firm Tender" basis. The Board of Land and Works will not necessarily accept the lowest or any tender.

Tenders to be addressed to the Commissioner of Public Works, and envelope containing tender to be marked "Tender for _____, closing Tuesday, _____".

NOTE.—No preliminary deposit is to be lodged with any tender, but a deposit in accordance with the prescribed Schedule, may be required from each successful tenderer.

11th October, 1960.

Allansford.—Repairs and painting, Police Station. (W.O., Warrnambool; P.S., Allansford.)

Bairnsdale.—Repairs, external and internal painting, new shelter-shed, Technical School. (W.O., Bairnsdale; T.S., Bairnsdale.)

Bairnsdale.—Internal and external renovations and minor repairs, S.S. 754. (W.O., Bairnsdale; S.S., Bairnsdale.)

Balmoral.—Internal and external repairs and painting, Court House. (W.O., Hamilton; P.S., Balmoral.)

Beaufort.—Supply and installation of an effluent pump for septic tank, High School. (W.O., Ballarat.)

Bell Park.—Extensions to main sewer, High School. (W.O., Geelong.) (Amended specification.)

Bendigo.—Erection of shelter-sheds and store, Girls' Secondary School. (W.O., Bendigo; Girls' Secondary School, Bendigo.)

Bright.—Sale and removal of old school building, S.S. 776. (W.O., Benalla; S.S., Bright.)

Broadford.—Roof and general repairs, S.S. 1125. (W.O., Alexandra; S.S., Broadford.)

Camberwell South.—External renovations to school, S.S. 4170.

Coatesville.—Septic tank installation, &c., S.S. 4712. (S.S., Coatesville.)

Collingwood.—Alterations and additions to electrical installation in part of Footwear School, 1st Floor, Technical School. (T.S., Collingwood.)

Dandenong.—Repairs and painting, S.S. 1403. (S.S., Dandenong.) (Amended specification.)

Dookie.—Fencing, Police Station. (W.O., Shepparton; P.S., Dookie.)

Echuca.—Court House: Repairs and external painting. Residence: Installation of fly-screens, fly-door, and woodshed. (W.O., Shepparton; P.S., Echuca.)

Echuca East.—Non-party fencing, S.S. 2667. (W.O., Shepparton; S.S., Echuca East.)

Kensington.—Provision of new laundry at residence, 71 McCracken-street, S.S. 2374.

Laang.—Erection of out-office block and installation of septic closets, S.S. 1411. (W.O., Warrnambool; S.S., Laang.)

Manifold Heights.—Repairs and renovations residence, 3 Miles-street, Newtown, S.S. 4224. (W.O., Geelong; S.S., Manifold Heights.)

Melbourne.—Electrical installation on mezzanine floor, Public Library, Swanston-street.

Melbourne.—Supply and fix steel shelving, Education Department.

Melbourne.—Central heating, State Offices, 295 Queen-street.

Mont Park.—Electrical installation in Occupational Therapy Centre, Plenty Mental Hospital. (W.O., Mont Park, Mental Hospital.)

Nathalia.—Erection of new class-room wing, High School. (W.O., Shepparton; H.S., Nathalia.)

Neerim South.—Electrical installation in new class-room and store, H.E.S. 2432. (W.O., Warragul; H.E.S., Neerim South.)

Noble Park.—Benches, timber construction, Technical School.

Niddrie.—Electrical installation—for new school, S.S. 4849.

Prahran.—Renewal of electrical installation, Technical School. (T.S., Prahran.)

St. Kilda.—Internal and external repairs and renovations to main school, Infants' School and caretaker's residence, S.S. 1479.

Sale.—Underpinning and renovations to residence, 25 McAlister-street, Technical School. (W.O., Bairnsdale; T.S., Sale.)

Shepparton.—Erection of domestic arts block, High School. (W.O., Shepparton.)

Shepparton.—Electrical installation, new modified Domestic Arts Wing and additional class-rooms, High School. (W.O., Shepparton.)

Smythesdale.—External renovations and repairs to residence, S.S. 978. (W.O., Ballarat; S.S., Smythesdale.)

Sunbury.—Central heating and low temperature hot-water service for Ward F.10, Mental Hospital. (Mental Hospital, Sunbury.)

Toolamba West.—Construction of new out-office block and septic tank, S.S. 1674. (W.O., Shepparton; S.S., Toolamba West.)

Tyrendarra.—Erection of woodshed-out-office unit combined, S.S. 1630. (W.O., Warrnambool; S.S., Tyrendarra.)

18th October, 1960.

Ballarat.—Hot water systems and plenum heating to Ward F.3, Mental Hospital. (W.O., Ballarat; Mental Hospital, Ballarat.)

Braybrook.—Erection of shelter pavilions, High School. Carlton.—Supply and installation of aluminium windows, doors and curtain walling, &c., Secondary Teachers' College.

Coburg.—Mechanical services to the new Boiler House and existing laundry, Pentridge Gaol.

Eastmeadows.—Erection of shelter pavilions, S.S. 4865.

Echuca.—Flooring in Engineering Workshop and construction of welding bays in Motor Mechanics' Shop, Technical School. (W.O., Shepparton; T.S., Echuca.)

Geelong.—Mechanical services in Bostock Hall and Engineering Block, Gordon Institute of Technology. (Amended specification). (W.O., Geelong; Gordon Institute of Technology, Geelong.)

Glenroy.—Supply and installation of aluminium windows, entrance doors, wall panels, sun blades, &c., Court House.

Goornong.—Repairs and renewals of fencing, Police Station. (W.O., Bendigo; P.S., Goornong.)

Irrewillipe East.—Out-office accommodation, drinking and washing facilities, S.S. 2357. (W.O., Camperdown; S.S., Irrewillipe.)

Jacana.—Fencing at school, S.S. 4839.

Kew.—H.W.S., plenum and floor heating to two new Dependant Wards, Mental Hospital. (W.O., Kew Mental Hospital.)

Koo-Wee-Rup.—Erection of shelter pavilion, S.S. 2629. (S.S., Koo-Wee-Rup.)

Kyneton.—Boundary fencing—non-party, S.S. 343. (W.O., Kyneton; S.S., Kyneton.)

Lara.—Supply of bedroom furniture, "Pirra", Children's Home, Children's Welfare Department.

Lara.—Supply of beds with no-sag base, "Pirra", Children's Home, Children's Welfare Department.

Lara.—Supply of all wool blankets, "Pirra", Children's Home, Children's Welfare Department.

Lara.—Supply of rubber mattresses and pillows, "Pirra", Children's Home, Children's Welfare Department.

Lara.—Electrical installation to various buildings, "Pirra", Children's Home, Children's Welfare Department.

Maryborough.—Renewal of spouting on main two-story building, Technical College. (W.O., Maryborough.)

Mont Park.—Supply and delivery of two fire tube packaged boilers, each of 200 H.P. capacity, Mental Hospital.

Morwell.—Additional class-rooms, &c., in concrete veneer timber-framed construction, High School. (W.O., Traralgon; H.S., Morwell.)

Nathalia.—Heating and H.W.S. equipment, High School. (W.O., Wangaratta; H.S., Nathalia.)

Niddrie.—Oil fired plenum heating in new school, S.S. 4849.

Ringwood.—Electrical installation in stages two and three, Composite Technical School.

Scoresby.—Supply and erection of farm shed, Research Station.

Sunbury.—Renewal of fittings and new storage tank at toilet block of Ward M.5, Mental Hospital. (Mental Hospital, Sunbury.)

Strathmore.—Erection of a new out-office block, S.S. 4612.

Swan Hill.—Electrical installation in stage 1, Technical School. (W.O., Swan Hill.)

Swan Hill.—Erection of 1st section of new school, Technical School. (W.O., Swan Hill.)

Tanjil South.—Erection of shelter pavilion, S.S. 2840. (W.O., Warragul; S.S., Tanjil South.)

Various.—Erection of twelve (12) additional class-rooms at various concrete veneer, timber-framed Primary Schools.

Violet Town.—Provision of woodshed and installation of septic closets, erection of a new laundry—toilet building, Police Station. (W.O., Benalla; P.S., Violet Town.)

Warrnambool.—Erection of two additional rooms (timber-framed), repairs and painting, Police Station. (W.O., Warrnambool.)

Wood's Point.—General repairs, external and internal painting of residence, Hurley-street, S.S. 789. (W.O., Alexandra; S.S., Wood's Point.)

25th October, 1960.

Bacchus Marsh.—Additions and alterations to residence, Soil Conservation Authority. (W.O., Ballarat; P.S., Bacchus Marsh.)

Ballarat.—New electrical installation to Ward F.3, Mental Hospital. (W.O., Ballarat; Mental Hospital, Ballarat.)

Baynton East.—Chalkboards, septic closet, &c., S.S. 4239. (W.O., Kyneton; S.S., Baynton East.)

Blakeville.—Repairs and painting, combined school and residence, erection of new out-office, woodshed block, install septic closets, S.S. 1247. (W.O., Ballarat; S.S., Blakeville.)

Brighton.—Internal and external repairs and renovations, Melbourne Teachers' College Hostel. (Amended specification.)

Brighton Beach.—Demolition of old shelter shed and erection of new shelter pavilion, S.S. 2048.

Buln Buln.—New out-office block and repairs to shelter sheds, S.S. 2017. (W.O., Warragul; S.S., Buln Buln.)

Campmeadows.—Erection of fencing, S.S. 4833. (S.S., Campmeadows.)

Dandenong.—Renewal of water service, High School. (H.S., Dandenong.)

Dingley.—New toilet block and connexion to existing septic tank system, S.S. 4257. (S.S., Dingley.)

Flemington.—Provision of new sewer extension, Travancore Developmental Centre.

Frankston East.—Erection of two shelter pavilions, High School.

Glenroy West.—Connexion to M.M.B.W. sewer, S.S. 4809. (S.S., Glenroy West.)

Hamilton.—Erection of hay-shed, Research Station. (W.O., Hamilton.)

Heatherton.—Additional out-offices for girls, S.S. 938. (S.S., Heatherton.)

Jindivick.—Septic closet installation, S.S. 1951 and residence. (W.O., Warragul; S.S., Jindivick.)

Kensington.—Electrical installations, S.S. 2374. (S.S., Kensington.)

Kerang.—Supply, delivery and installation of pump, tank and stand for drinking water supply, S.S. 1410. (S.S., Kerang.)

Melbourne.—Improvements to Passenger Lift, Government House.

Mordialloc.—Repairs and painting, Police Station. (P.S., Mordialloc.)

Mornington.—Renewal of water supply, S.S. 2033. (S.S., Mornington.)

North Melbourne.—Supply and installation of demountable partitions, Government Printing Office.

Purnim.—Residence: Installation of a septic closet. School: Septic installation, and new toilet block, S.S. 1016. (W.O., Warrnambool; S.S., Purnim.)

Richmond.—Roof re-slating, S.S. 1396.

Sandford.—Septic tank installation, school and residence and out-offices, S.S. 1654. (W.O., Hamilton; S.S., Sandford.)

Sunbury.—New toilet block at Artisans' Block, Mental Hospital. (Mental Hospital, Sunbury.)

Timboon.—Erection of two new timber shelter pavilions, Consolidated School. (W.O., Warrnambool; C.S., Timboon.)

Traralgon.—Erection of two shelter pavilions and store, Technical School. (W.O., Traralgon.)

1st November, 1960.

Glen Waverley.—Erection of 1st and 2nd sections, L.T.C., including supply and installation of mechanical and electrical services, High School.

T. K. MALTBY,
Commissioner of Public Works.

Public Works Department,
Melbourne, C.2., 4th October, 1960.

Forests Act 1958 (No. 6254).

FORESTS COMMISSION OF VICTORIA.

OFFERS FOR WATTLE BARK IN THE STATE FORESTS, ETC., 1960.

OFFERS, endorsed "Offer for Wattle Bark, lot ———," and addressed to the Secretary, Forests Commission, Melbourne, will be received at this office up to Twelve noon on Friday, 31st October, 1960, for the right to strip and remove wattle bark on and from the following areas. The general conditions hereunder will apply in every case where not expressly stated to the contrary, and special conditions will also apply where provided. Full particulars may be obtained from the officer in charge in each case, or on application to the Commission.

GENERAL CONDITIONS.

1. No offer will necessarily be accepted.

2. The deposit specified in Schedule must accompany each offer.

3. The licensee shall do everything within his power to strip and remove all bark available on the area upon which he is licensed to operate.

4. Stripping shall be commenced within six weeks from date of acceptance of offer unless otherwise authorized by the Commission.

5. No stripping shall be commenced until the applicant has lodged the deposit specified and is in possession of the requisite licence.

6. Notification, in writing, that stripping operations have been commenced must be forwarded to the officer in charge within 48 hours from date thereof.

7. No tree shall be felled or stripped on any area which the officer in charge directs is not to be operated upon, and no particular tree specially marked by him to remain standing shall be felled or stripped.

8. In the event of stripping being permitted on any area regarded as a tourist resort all tops must be lopped, stacked, and burned under the direction of and in accordance with the written conditions specified by the officer in charge.

9. No tree shall be felled so as to fall into any water-course or to obstruct any road or track.

10. Except with the permission of the officer in charge, no tree of less than 5 inches diameter shall be stripped when of the black or feather-leaved variety, or less than 2½ inches in diameter when of the broad-leaved species, unless otherwise stated in the licence. Wherever a size limit is stated it shall be at a height of 2 feet from the ground.

11. All stripping must cease by 31st March following the date of issue of licence unless otherwise authorized, in writing, by the officer in charge.

12. Bark must be properly bundled, securely tied, and stacked in heaps of not less than 10 cwt. in clear places only, and the licensee must take such precautions as the officer in charge may direct to safeguard such bark from loss by fire.

13. No bark shall be removed without the permission of the officer in charge, and it must be carted from the forest and weighed not later than one month from the date of stripping the bark unless otherwise authorized by the officer in charge.

14. The whole of the work shall be done under the supervision and to the satisfaction of the officer in charge and at a rate satisfactory to the Commission.

15. All bark must be weighed at the weighbridge stipulated in the licence, or at such other weighbridge as may be approved by the officer in charge, and in all cases at the expense of the licensee. Duplicate weighbridge tickets must be provided and, if so directed by him, the bark must be weighed in the presence of the officer in charge.

16. Prior to removal of the bark satisfactory arrangements must be made with the Commission for payment of royalty. The licensee shall pay such royalty at the rate tendered on weights as disclosed by the weighbridge dockets.

17. Camps must be pitched and fires lighted only in such places as shall be determined by the officer in charge, and the licensee shall, on demand of the officer, instantly dismiss from his employ any person or persons who shall carelessly use, leave, or light any fire otherwise than in accordance with the Forests Acts and Regulations.

18. The licensee shall forthwith comply with any direction given to him by the officer in charge for the effective protection from fire of the forest within the boundaries of the area upon which he is licensed to operate, and he shall do everything that is reasonably within his power to prevent from spreading and to extinguish any fire which may break out on such area or which may spread to it.

19. The violation of any of the above conditions will render the licence null and void, and the Forests Commission shall have absolute power to forfeit the whole or part of the deposit to the Crown and to seize all bark stripped to date of avoidance. The officer in charge shall have power to suspend operations pending the decision of the Forests Commission.

G. K. COCKBURN,
Secretary.

Forests Commission,
Melbourne, 26th September, 1960.

NOTE.—Preliminary deposit of 10s. must be forwarded in respect of each lot tendered for, otherwise the offer will be treated as informal.

SCHEDULE.

Stawell Forest District.

Officer in Charge.—E. K. Gidley, Stawell.

NOTE.—On all lots in this district all trees stripped are to be felled and tops neatly stacked to the satisfaction of the Officer in Charge.

Lot 1. Grampian State Forest, Parish of Burrong North. Bounded on the north by Carter's property, east by Carter's lease fence, south by Zumstein's Crossing over the Mackenzie River, and west by Horsham-Hall's Gap road. Black wattle, first quality, 20 tons. Size limit, 4 inches diameter. Weighbridge, Stawell or Horsham. Deposits: Preliminary, 10s.; final, £10.

Lot 2. Grampians State Forest, Parish of Boreang West, known as Gillespie's lease, and the northern wattle enclosure. Bounded on the north by the sheet of water, south and west by the State Rivers and Water Supply channel, and east by forest road. Black wattle, first quality, about 20 tons. Size limit, 4 inches diameter. Weighbridge, Stawell or Dunkeld. Deposits: Preliminary, 10s.; final, £10.

Lot 3. Grampians State Forest, Parish of Jalur. The fenced area known as the southern wattle enclosure. Black wattle, first quality, about 35 tons. Size limit, 4 inches diameter. Weighbridge, Dunkeld. Deposits: Preliminary, 10s.; final, £10.

Lot 4. Grampians State Forest, Parish of Wing Wing. Bounded on the north, south, and east by forest roads, and west by State Rivers and Water Supply channel. Black wattle, first quality, about 25 tons. Size limit, 4 inches diameter. Weighbridge, Horsham or Stawell. Deposits: Preliminary, 10s.; final, £10.

Lot 5. Grampians State Forest, Parishes of Jalur and Boreang West, lying to the north of Mt. Thackeray. Bounded on the south by the crossing over the Glenelg River at the Little Corduroy, east by the State Rivers and Water Supply channel, north to be defined by District Forest Officer, and west by Victoria Range. Black wattle, first quality, about 20 tons. Size limit, 4 inches diameter. Weighbridge, Stawell. Deposits: Preliminary, 10s.; final, £10.

Lot 6. Grampians State Forest, Parishes of Lambruk and Billiminah, in the northern portions of the Billywing area. Bounded on the north by Cultivation Creek, east by the Victoria Range, south by Mosquito Creek, and west by the Billywing-road. Black wattle, first quality, about 10 tons. Size limit, 4 inches diameter. Weighbridge, Cavendish. Deposits: Preliminary, 10s.; final, £10.

Lot 7. Grampians State Forest, Parish of Burrong South, in the vicinity of Roses Creek. Bounded on all sides by forest roads. Black wattle, first quality, about 10 tons. Size limit, 4 inches diameter. Weighbridge, Stawell. Deposits: Preliminary, 10s.; final, £10.

Lot 8. Grampians State Forest, Parish of Wing Wing, in central part of parish. Bounded on the west by Glenelg River, and north, south, and east boundaries are forest roads. Black wattle, first quality, about 5 tons. Size limit, 4 inches diameter. Weighbridge, Horsham. Deposits: Preliminary, 10s.; final, £7.

Lot 9. Grampians State Forest, Parish of Burrong South, in the vicinity of Boggy Creek. Bounded on north and west by private property, and south and east by Asses Ears Range. Black wattle, first quality, about 20 tons. Size limit, 4 inches diameter. Weighbridge, Horsham. Deposits: Preliminary, 10s.; final, £10.

Lot 10. Grampians State Forest, Parish of Wartook, Sheep Wash area. Bounded on the north by Lah-Arum-Brimpaen road, south by Boggy Creek, east and west by private property. Black wattle, first quality, about 10 tons. Size limit, 4 inches diameter. Weighbridge Horsham. Deposits: Preliminary, 10s.; final, £10.

Lot 11. Grampians State Forest, Parish of Burrong North, in the vicinity of Rosebrook. Bounded on the north by Roses Gap-road, on the south by Mt. Difficult Range, east and west by private fences. Black wattle, first quality, about 6 tons. Size limit, 4 inches diameter. Weighbridge, Horsham. Deposits: Preliminary, 10s.; final, £8.

Lot 12. Grampians State Forest, Parish of Lah-Arum, in the vicinity of Hawker's Gully. Boundary as defined by District Forester. Black wattle, first quality, about 20 tons. Size limit, 4 inches diameter. Weighbridge, Horsham. Deposits: Preliminary, 10s.; final, £10.

Bruthen Forest District.

Officer in Charge.—F. J. Halloran, Bruthen.

Lot 13. Parish of Boonderoot, Peter's Creek area. Bounded on the east by Stewart's Creek and Tambo River-road, north by Playgrounds-road, south by Stewart's Creek-road, and west by Omeo Highway. Black wattle, first quality, about 10 tons. Size limit, 4 inches diameter. Weighbridge, Bruthen Railway Station. Deposits: Preliminary, 10s.; final, £10.

Lot 14. Parish of Tambo, Deep Creek Catchment area. Black wattle, first quality, about 12 tons. Size limit, 4 inches diameter. Weighbridge, Bruthen Railway Station. Deposits: Preliminary, 10s.; final, £10.

Lot 15. Parish of Tambo, area known as Dixon's Block. Black wattle, first quality, about 5 tons. Size limit, 4 inches diameter. Weighbridge, Bruthen Railway Station. Deposits: Preliminary, 10s.; final, £6.

Lot 16. Parish of Tambo, Old Man Hill and Stony Creek area. Bounded by Nicholson River on west and south, Stony Creek on south and east, Donald's Knob-road and Nicholson Park-road on north. Black wattle, first quality, about 4 tons. Size limit, 4 inches diameter. Weighbridge, Bruthen Railway Station. Deposits: Preliminary, 10s.; final, £5.

Nowa Nowa Forest District.

Officer in Charge.—J. P. Brisbane, Nowa Nowa.

Lot 17. Parishes of Tildesley East and West, Monta's area. Bounded on north by Old Orbost-road, on east by Hospital Creek, on south the coast, on west Lake Tyers House-road. Black wattle, first quality, about 8 tons. Size limit, 4 inches diameter. Weighbridge, Bairnsdale. Deposits: Preliminary, 10s.; final, £10.

Lot 18. Parish of Tildesley West, Lake Tyers area. Bounded on the north by Princes Highway, on the east Lake Tyers House-road, on the south forest boundary, on the west Lake Tyers. Black wattle, first quality, about 20 tons. Size limit, 4 inches diameter. Weighbridge, Bairnsdale. Deposits: Preliminary, 10s.; final, £10.

Lot 19. Parish of Colquhoun North, Ostler's Track area. Bounded on the south by Berkley Square-Corduroy road, on the west Lakes-Colquhoun road, on the north Old Colquhoun-road, on the east parish boundary. Black wattle, first quality, about 10 tons. Size limit, 4 inches diameter. Weighbridge, Bairnsdale. Deposits: Preliminary, 10s.; final, £10.

Lot 20. Parish of Colquhoun North, Lyle's Bridge area. Bounded on the south by South Boundary-road, on the west by Lakes-Colquhoun road, north by Berkley Square-Corduroy road, on the east by Princes Highway. Black wattle, first quality, about 20 tons. Size limit, 4 inches diameter. Weighbridge, Bairnsdale. Deposits: Preliminary, 10s.; final, £10.

Lot 21. Parish of Colquhoun East, Blackfellow's Arm area. Bounded on the west by Princes Highway and Burnt Bridge-road, north by Mission Station-road, east Mission Station boundaries and south by private property. Black wattle, first quality, about 20 tons. Size limit, 4 inches diameter. Weighbridge, Bairnsdale. Deposits: Preliminary, 10s.; final, £10.

Orbost Forest District.

Officer in Charge.—G. Griffin, Orbost.

Lot 22. Curlip State Forest. Bounded by watershed of Light Wood Creek. Black wattle, first quality, about 4 tons. Size limit, 4 inches diameter. Weighbridge, Orbost. Deposits: Preliminary, 10s.; final, £3.

Lot 23. Waygara State Forest, Stoney Creek area. Bounded by Buchan-road, track to Wood's Point, Snowy River, and Mundy's fence. Black wattle, first quality, about 14 tons. Size limit, 4 inches diameter. Weighbridge, Orbost. Deposits: Preliminary, 10s.; final, £8.

Lot 24. Parish of Tildesley East, State Forest and Crown land. Bounded on north by Princes Highway, west by Wombat Creek, divide between Wombat and Dinner Creek on the east, and 2½ miles from Princes Highway on the south. Black wattle, first quality, about 3 tons. Size limit, 4 inches diameter. Weighbridge, Orbost. Deposits: Preliminary, 10s.; final, £3.

Briagolong Forest District.

Officer in Charge.—S. W. Calder, Briagolong.

Lot 25. Bow-worrung State Forest, bounded on the north by the Briagolong-Stockdale road and private property; east and south by private property; west by Stratford-Stockdale road and private property. Black wattle, first quality, about 40 tons. Size limit, 4 inches diameter. Weighbridge, Maffra or Sale. Deposits: Preliminary 10s.; final £10.

Lot 26. Gladstone Creek and Kennedy's Flat area. State Forest bounded on the north by Gladstone Creek; south by Briagolong-Stockdale road; east by Insolvent Track; west by Freestone Creek. Black wattle, first quality, about 30 tons. Size limit, 4 inches diameter. Weighbridge, Maffra or Sale. Deposits: Preliminary, 10s.; final, £10.

Yarram Forest District.

Officer in Charge.—H. B. Prewett, Yarram.

Lot 27. Alberton West, Coal Mine-road area. Within boundary of Alberton West Forest. Black wattle, first quality, about 4 tons. Size limit, 4 inches diameter. Weighbridge, Sale and Traralgon. Deposits: Preliminary, 10s.; final, £4.

Dunolly Forest District.

Officer in Charge.—H. H. Beer, Dunolly.

Lot 28. Parish of Koorooc—105 trees on area of approximately two acres in Plantation A. Black wattle, first quality, about 1 ton 4 cwt. Size limit, nil. Weighbridge, Bealiba. Deposits: Preliminary, 10s.; final, £1.

PRIVATE ADVERTISEMENTS**CITY OF BALLAARAT.**

NOTICE OF MAKING OF BY-LAW No. 154.

NOTICE is hereby given that the Council of the City of Ballarat has made and passed a By-law under the Local Government Acts and Uniform Building Regulations, Victoria, and numbered 154 for the purpose of repealing By-law No. 140 of the City and substituting therefor a By-law for permitting (subject to the provisions of this By-law) the construction of buildings of Class I. and II. Occupancy on land of a lesser area, depth and width of frontage than those specified in column 3 of Table 804 of the said Uniform Building Regulations, Victoria: And save as aforesaid for adopting the minimum area, depth and width of frontage specified in said column 3 of the said Table 804 as the minimum area, depth and width of frontage of land on which buildings of Class I. or II. Occupancy shall be constructed throughout the whole of the municipal district of the City. Such By-law has been approved by the Governor in Council.

A copy of the above-mentioned By-law has been deposited at the office of the said Council, Town Hall, Ballarat, and is open for inspection, free of charge, during office hours.

Dated the 30th day of September, 1960.

11457

H. R. MADDERN, Town Clerk.

CITY OF CHELSEA.

LOAN No. 31.

Notice of Intention to Borrow the Sum of £22,000 for Permanent Works and Undertakings.

NOTICE is hereby given that the Council of the City of Chelsea proposes to borrow the sum of Twenty-two Thousand Pounds on the credit of the Municipal Revenues of the Mayor, Councillors and Citizens of the said City, such sum to be raised by the grant of a mortgage in accordance with the provisions of the Local Government Act.

1. The maximum rate of interest that may be paid is £5 10s. 0d. per cent. per annum;

2. The purpose for which the loan is to be applied is the completion of the erection of Municipal Offices and Council Chambers—£22,000;

3. The period of the loan shall be thirty years;

4. The moneys borrowed shall be repayable by providing out of the Municipal Fund Sixty half-yearly instalments of £752 16s. 10d. each, including principal and interest, on the Twenty-second day of June and the Twenty-second day of December during the currency of the loan. The first instalment shall be payable on the Twenty-second day of June, 1961;

5. Such money shall be repayable at the Commonwealth Banking Corporation, Melbourne.

The plans and specifications and the estimate of the cost of the proposed works and a statement showing the proposed expenditure of the money to be borrowed are open for inspection at the Municipal Offices, Chelsea, during office hours.

Dated this Twenty-eighth day of September, 1960.

11446

H. D. HACKWELL, Town Clerk.

CITY OF FOOTSCRAY.

NOTICE is hereby given that the Council of the City of Footscray has, under the provisions of the Local Government Acts, altered the name of the street set out hereunder:—

Old Name; Ward; New Name.
 Perry-street; Middle; Perry-avenue.
 E. J. SMITH, Town Clerk.
 Town Hall, Footscray, 26th September, 1960. 11477

CITY OF GEELONG.

DEDICATION TO THE PUBLIC AS PUBLIC HIGHWAYS OF STREETS CONSTRUCTED TO THE SATISFACTION OF THE COUNCIL.

NOTICE is hereby given in accordance with Section 587 (3) of the Local Government Act 1958, that the Council of the City of Geelong having received a request from the Housing Commission of Victoria so to do hereby declares:—

Bendle-street from Walter-street to Boundary-road, McIntyre-street extending three hundred and fifty-two feet six inches northerly from McKillop-street, Patterson-street extending three hundred and seven feet four inches northerly from McKillop-street, in the City of Geelong to be dedicated to the public as public highways, the said streets having been constructed to the satisfaction of the Council.

27th September, 1960.

11447 L. L. WALTER, Town Clerk.

No. 436.

CITY OF NUNAWADING.

ALTERATION OF STREET NAMES.

NOTICE is hereby given that in pursuance of the powers conferred by the Local Government Acts, the Council of the City of Nunawading did, at a meeting held on the 5th September, 1960, order that the following alterations be made in the names of streets as under, and that such order take effect from the date of this publication in the *Victoria Government Gazette*:—

Old Name; New Name.

Ashleigh-street; Ashburn-place.
 Alwyn-street, from Rooks-road to Diosma-crescent; Diosma-crescent.
 Barnes-avenue; Bond-avenue.
 Canterbury-court; McLaughlan-court.
 Creek-street; Burnt-street.
 Elizabeth-court; Eliza-court.
 Gail-drive; Grant-drive.
 Glen-court; Glenfern-court.
 Glyn-court; Glyndon-court.
 Portion of Haros-avenue, off north side of Holberry-street; Wren-close.
 Helen-court; Troy-court.
 Koonung-street; Koroit-street.
 Millson-avenue; Mill-avenue.
 Orchid-street; Furness-street.
 Park-street, Vermont; Park-close.
 Railway-parade, Nunawading; Oval-way.
 Raymond-court; Brénda-court.
 Rose-avenue; Arbor-avenue.
 Simla-street, Nunawading; Ceylon-street.
 South-court; Southern-court.
 Steven-court; Alandale-court.
 Sunnyside-crescent; Lunar-crescent.

11506 A. ROY CHARLESWORTH, Town Clerk.

CITY OF NUNAWADING.

ALTERATION OF STREET NAMES.

NOTICE is hereby given that in pursuance of the powers conferred by the Local Government Acts, the Council of the City of Nunawading did, at a meeting held on the 3rd October, 1960, order that the following alterations be made in the names of the streets as under, and that such order take effect from the date of this publication in the *Victoria Government Gazette*:—

Old Name; New Name.

Gardiner-street; Banksia-street.
 Call-street; Gay-street.
 Hillcrest-avenue (entire length); Churinga-avenue.
 Hope-street; Hovea-street.
 Rodleigh-street; Raleigh-street.

11507 A. ROY CHARLESWORTH, Town Clerk.

No. 92.—8600/60.—4

CITY OF PRAHRAN.

LOAN No. 25—£32,000.

Notice of Intention to Borrow the Sum of £32,000 for Permanent Works and Undertakings.

NOTICE is hereby given that the Council of the City of Prahran proposes to borrow the sum of Thirty-two thousand pounds, on the credit of the municipal revenues of the Mayor, Councillors and Citizens of the said City, such sum to be raised by the grant of a mortgage, in accordance with the provisions of the *Local Government Act 1958*.

1. The maximum rate of interest that may be paid is 5½ per cent. per annum.

2. The purposes for which the loan is to be applied are:—

| | |
|-------------------------------|---------|
| Roadway construction | £15,000 |
| Car parking areas | 12,000 |
| Prahran Bowling Club Pavilion | 5,000 |
| | £32,000 |

3. The period of the loan shall be ten years.

4. The moneys borrowed shall be repayable by providing out of the municipal fund twenty half-yearly instalments of £2,101 9s. 11d. each, including principal and interest, on the 1st day of August and the 1st day of February during the currency of the loan. The first instalment shall be payable on the 1st day of August, 1961.

5. Such moneys shall be repayable at The National Bank of Australasia Ltd., Prahran.

The plans and specifications and the estimate of the cost of the proposed works, and a statement showing the proposed expenditure of the moneys to be borrowed, are open for inspection at the Town Hall, Chapel-street, Prahran.

HENRY T. JONES, Town Clerk.

3rd October, 1960.

11465

BOROUGH OF ECHUCA.

NOTICE is hereby given that the Council of the Borough of Echuca at its Meeting held on 26th September, 1960, decided on the following alteration to street name; viz:—

New Name.—Bolton-street.

Old Name.—Little Mitchell-street.

Description.—That portion of roadway along the entire length of the eastern boundary of allotment 4, section 3, Town of Echuca, Parish of Echuca North, County of Rodney.

11466

K. F. McCARTNEY, Town Clerk.

SHIRE OF ARAPILES.

LOAN No. 15.

Notice of Intention to Borrow the Sum of £3,000 for Permanent Works and Undertakings.

NOTICE is hereby given that the Council of the Shire of Arapiles proposes to borrow the sum of Three Thousand pounds on the credit of the municipal revenues of the President, Councillors and Ratepayers of the said Shire, such sum to be raised by the grant of a mortgage in accordance with the provisions of the *Local Government Act, 1958*.

1. The maximum rate of interest that may be paid is 5½ per cent. per annum.

2. The purpose for which the loan is to be applied is for the purchase of three trucks.

3. The period of the loan shall be 5 years.

4. The moneys borrowed shall be repayable by providing out of the municipal fund 10 half-yearly instalments, of approximately £346 2s. 0d., each including principal and interest, on the first day of January and first day of July during the currency of the loan. The first instalment shall be payable on the first day of July, 1961.

5. Such moneys shall be repayable at The State Savings Bank of Victoria, Melbourne.

The plans and specifications and the estimates of the cost of the proposed works and a statement showing the proposed expenditure of the moneys to be borrowed are open for inspection at the Shire Office, Natimuk.

11441

G. A. LITTLE Shire Secretary.

SHIRE OF CRANBOURNE.

LOAN No. 14.

Notice of Intention to Borrow the Sum of £15,000 for Permanent Works and Undertakings.

NOTICE is hereby given that the Council of the Shire of Cranbourne proposes to borrow the sum of Fifteen thousand pounds on the credit of the municipal

revenues of the President, Councillors, and Ratepayers of the said Shire, such sum to be raised by the grant of a mortgage, in accordance with the provisions of the *Local Government Act 1958*.

1. The maximum rate of interest that may be paid is 5½ per cent. per annum.
2. The purposes for which the loan is to be applied are—

| | |
|--|---------|
| Road and Drainage in Cranbourne Township | £5,000 |
| Purchase of One Power Grader | 6,500 |
| Purchase of Two Motor Trucks | 3,500 |
| | £15,000 |

3. The period of the loan shall be ten years.
4. The moneys borrowed shall be repayable by providing out of the municipal fund twenty half-yearly instalments of approximately £985 1s. 6d. each, including principal and interest, on the 1st day of January and the 1st day of July during the currency of the loan. The first instalment shall be payable on the 1st day of July, 1961.

5. Such moneys shall be repayable at The State Savings Bank of Victoria, Melbourne.

The plans and specifications and the estimate of the cost of the proposed works, and a statement showing the proposed expenditure of the moneys to be borrowed, are open for inspection at the Shire Offices, Cranbourne.

T. W. GRANT, Shire Secretary.

5th October, 1960. 11433

SHIRE OF DONALD.

LOAN No. 31.

Notice of Intention to Borrow the Sum of £6,000 for Permanent Works and Undertakings.

NOTICE is hereby given that the Council of the Shire of Donald proposes to borrow the sum of Six thousand pounds (£6,000) on the credit of the municipal revenues of the President, Councillors, and Ratepayers of the said Shire, such sum to be raised by the grant of a mortgage, in accordance with the provisions of the *Local Government Act 1958*.

1. The maximum rate of interest that may be paid is £5 8s. 9d. per centum per annum.
2. The purpose for which the loan is to be applied is—
Purchase of Road-making Plant.
3. The period of the loan shall be eight years.
4. The moneys borrowed shall be repayable by providing out of the municipal fund sixteen half-yearly instalments of approximately £467 9s. 2d. each, including principal and interest, on the 1st days of June and of December in each year during the currency of the loan. The first instalment shall be payable on the 1st day of June, 1961.

5. Such moneys shall be repayable at the Commercial Banking Company of Sydney Limited, Donald or Melbourne, or at the Council's bankers for the time being at Donald or Melbourne.

The plans, specifications, and the estimate of the cost of the proposed works, and a statement showing the proposed expenditure of the moneys to be borrowed, are open for inspection at the Shire Offices, Donald.

H. G. SMALE, Shire Secretary.

Dated at Donald 22nd September, 1960. 11434

SHIRE OF DONALD.

NOTICE OF INTENTION TO MAKE A BY-LAW TO CONTROL DERELICT MOTOR CARS, ETC.

NOTICE is hereby given that the Council of the Shire of Donald proposes to make a By-law No. 38 for the purposes of—

- (a) Prohibiting the leaving standing in any street or road in the municipal district, any unregistered and/or derelict motor car.
- (b) Prescribing the method of dealing with any motor car left standing in contravention of the By-law.
- (c) Prescribing the charges which may be levied for the dealing with any motor car left standing in contravention of the By-law.

And notice is further given that a true copy of the proposed By-law is deposited at the offices of the Council, McCulloch-street, Donald, for inspection by any interested person.

11438 H. C. SMALE, Shire Secretary.

Local Government Act 1958.

SHIRE OF EUROA.

DECLARATION OF PRIVATE STREET AS PUBLIC HIGHWAY.

IN pursuance of the power conferred by section 587 (3) of the *Local Government Act 1958*, the Council of the Shire of Euroa, on the application of the owners of all the premises as in rateable value are the greater part of all the premises fronting on the street within the municipal district of the Shire of Euroa more than 15 feet in width constructed to the satisfaction of the Council, but not constructed pursuant to Division 10 of Part XIX. or XLIX. of the *Local Government Act 1958* or any corresponding previous enactment, hereby declares such street to be dedicated to the public as a public highway.

The street in respect of which this declaration is made is:—

Elizabeth-street, Euroa.

In witness whereof the common seal of the President, Councillors and Ratepayers of the Shire of Euroa was hereto affixed this 19th day of September, 1960, in the presence of:—

H. H. ALEXANDER, President.
G. S. PATIENCE, Councillor.
R. L. MANLEY, Secretary.

11464

Local Government Act 1958.

SHIRE OF FERN TREE GULLY.

DECLARATION OF A PUBLIC HIGHWAY.

Whereas the Council of the Shire of Fern Tree Gully deems it advisable that certain land acquired by the Council, be declared a Public Highway, notice is hereby given that the Council of the Shire of Fern Tree Gully directs that the land comprising part of lots 65-79 and part of lot 86 on lodged plan 8825, part of Crown allotment 68, Parish of Scoresby and delineated by hatched lines on the attached plan, shall be a public highway.

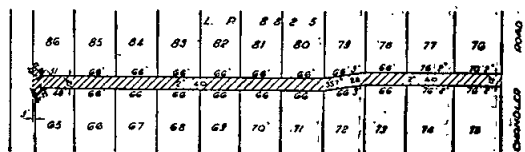

Scale 150' to 1"

The Resolution for the above Order was passed at an Ordinary Meeting of Council held on 26th September, 1960.

11456 D. J. BAKER, Shire Secretary.

SHIRE OF KANIVA.

BY-LAW No. 16.

A By-law of the Shire of Kaniva, made under the *Local Government Acts* and the *Building Regulations, Victoria*, and numbered 16, for the determining, applying, dispensing with, or regulating such matters or things as are left to be determined, applied, dispensed with, or regulated by the Council of the said Shire under the *Uniform Building Regulations of Victoria*.

IN pursuance of the powers conferred by the *Local Government Acts* and the *Uniform Building Regulations, Victoria* (hereinafter called the *Regulations*) and of any and every other power enabling the President, Councillors and Ratepayers of the Shire of Kaniva to order as follows:—

1. By-law No. 6 is hereby repealed.
2. *Brick Area*.—The area set out and prescribed in the First Schedule hereto is hereby prescribed as a brick area and no person shall in such area construct or cause to be constructed any building, the external walls of which are of materials other than masonry or concrete, and this clause shall apply to any addition or extension to existing buildings within the said area not having external walls of masonry or concrete.

3. *Minimum Area, Depth and Width of Frontage*.—The minimum area, depth and width of frontage specified in Column 3, Table 804 of the *Regulations* as amended are hereby adopted as the minimum area, depth and width of frontage of land on which a building of Class I, or Class II, occupancy shall be constructed throughout

that portion of the Municipal District to which the operation of the Regulations has been or shall hereinafter be extended by proclamation.

4. *Distance from Frontage.*—(a) The minimum distance from the frontage of any land of the Outer Walls of any building of Class I. or Class II. occupancy is hereby specified as 15 feet.

(b) No person shall construct any building of Class I. or Class II. occupancy closer to the frontage of any land than 15 feet.

5. *Rear Access.*—In the case of a building on any land forming part of a sub-division approved by the Council and lodged with the Office of Titles prior to the date of commencement of the Regulations, the requirements of Clause, 813 of the Regulations are hereby dispensed with.

6. *Penalties.*—Every person guilty of any wilful breach of any of the provisions of this By-law shall be liable to a penalty not exceeding Twenty pounds and to a further penalty, not exceeding Five pounds for each day such offence is continued or repeated after a conviction or order by any Court in relation to the offence.

The Schedule Above Referred to.—All that area on the North and South sides of Commercial-street, Township of Kaniva, to a depth of 80 lineal feet from the frontage thereof, lying between Baker-street and Madden-street.

Resolution for passing this By-law agreed to by the Council on the 17th day of May, 1960, and confirmed on the 21st day of June, 1960.

The common seal of the President, Councillors and Ratepayers of the Shire of Kaniva was hereto affixed, this 21st day of June, 1960, in the presence of—

(SEAL) W. C. SANDERS, President.
R. W. ROWE, Councillor.
N. G. HAYNES, Secretary.

Approved by the Governor in Council, 6th September, 1960.—A. MAHLSTEDT, Clerk of the Executive Council.
11439

SHIRE OF KEILOR.
NAME OF ROAD CHANGED.

NOTICE is hereby given that, in pursuance of the powers conferred by the *Local Government Act 1958*, the Council of the Shire of Keilor, at a Meeting held on the 6th day of September, 1960, did order—

“That the name of the under-mentioned section of the street referred to be changed as follows, namely:—

The portion of Hoffman's-road, Niddrie, north of Muriel-street, included on lodged plan of subdivision No. 10094, to be renamed Moushall-avenue”, such order to take effect from the date of publication in the *Victoria Government Gazette*.

By order,
11478 N. A. WOODS, Shire Secretary.

SHIRE OF MULGRAVE.
ORDER CHANGING NAMES OF STREETS.

NOTICE is hereby given that at a Meeting of the Council of the Shire of Mulgrave held on 20th September, 1960, the said Council, in pursuance of the provisions of the *Local Government Act 1958*, did make an Order changing the names of the streets set out hereunder:—

| Old Names. | New Name. |
|--|---------------|
| Walker-road—northerly from Leeds-road to Highbury-road | Leeds-road. |
| Railway-parade North—westerly from Dyke-street | Rose-avenue. |
| Dyke-street | Myers-avenue. |

F. S. BALES, Shire Secretary.
Shire Offices, Glen Waverley, 23rd September, 1960.
11437

Town and Country Planning Acts.
SHIRE OF MORWELL.

NOTICE THAT A PLANNING SCHEME HAS BEEN PREPARED AND IS AVAILABLE FOR INSPECTION.

Morwell Planning Scheme 1954, Amendment No. 4, 1960.

NOTICE is hereby given that the Council of the Shire of Morwell, in pursuance of its power under the Town and Country Planning Acts, has prepared a Planning Scheme for that part of the municipal district of the Shire of Morwell, in the Parish of Maryvale, and within the following boundaries:—

Having frontages of 66 feet to the Princes Highway (Station-street) and to Buckley-street and a depth of

368 feet; and being 132 feet east from Hopetoun-avenue—

for the purpose of rezoning the land as a “public purposes area” zone and amending existing Regulations accordingly.

All maps, plans, descriptions, and other data fully setting out and explaining the Planning Scheme have been deposited at the Shire Office, Commercial-road, Morwell, and at the office of the Town and Country Planning Board, Melbourne, and will be open for inspection without payment of any fee by all persons affected between the hours of 9 a.m. and 3.30 p.m. on all days of the week, except Saturdays, Sundays, and public holidays, until and including the 5th January, 1961.

Any persons affected by the Planning Scheme are required to set forth, in writing, all objections they may have, addressed to the Shire Secretary, Shire Office, Morwell, on or before the 5th January, 1961.

11449 W. K. MATHISON, Shire Secretary.

Town and Country Planning Acts.
SHIRE OF MORWELL.

NOTICE THAT A PLANNING SCHEME HAS BEEN PREPARED AND IS AVAILABLE FOR INSPECTION.

Morwell Planning Scheme 1954, Amendment No. 5, 1960.

NOTICE is hereby given that the Council of the Shire of Morwell, in pursuance of its power under the Town and Country Planning Acts, has prepared a Planning Scheme for that part of the municipal district of the Shire of Morwell, in the Parish of Maryvale, and within the following boundaries:—

Commencing at a point on the northern alignment of the Princes Highway 165 feet westerly from its intersection with the western alignment of Davey-street; thence generally westerly along the Princes Highway for a distance of 500 feet; thence by a line generally northerly at right angles to the Princes Highway for a distance of 330 feet to a line in prolongation of the southern alignment of Helen-street; thence easterly to a point on that line 165 feet from the western alignment of Davey-street; thence southerly to the point of commencement—

for the purpose of rezoning the land as a “public purposes area” zone and amending existing Regulations accordingly.

All maps, plans, descriptions, and other data fully setting out and explaining the Planning Scheme have been deposited at the Shire Office, Commercial-road, Morwell, and at the office of the Town and Country Planning Board, Melbourne, and will be open for inspection without payment of any fee by all persons affected between the hours of 9 a.m. and 3.30 p.m. on all days of the week, except Saturdays, Sundays, and public holidays, until and including the 5th January, 1961.

Any persons affected by the Planning Scheme are required to set forth, in writing, all objections they may have, addressed to the Shire Secretary, Shire Office, Morwell, on or before the 5th January, 1961.

11450 W. K. MATHISON, Shire Secretary.

Town and Country Planning Acts.
SHIRE OF MORWELL.

NOTICE THAT A PLANNING SCHEME HAS BEEN PREPARED AND IS AVAILABLE FOR INSPECTION.

Morwell Planning Scheme 1954, Amendment No. 6, 1960.

NOTICE is hereby given that the Council of the Shire of Morwell, in pursuance of its power under the Town and Country Planning Acts, has prepared a Planning Scheme for that part of the municipal district of the Shire of Morwell, in the Parish of Maryvale, and within the following boundaries:—

Crown allotments 5 and 5A, Parish of Maryvale, County of Buln Buln—
for the purpose of rezoning portions of the area as residential commercial, public purposes area, and public open spaces zones, and amending existing Regulations accordingly.

All maps, plans, descriptions, and other data fully setting out and explaining the Planning Scheme have been deposited at the Shire Office, Commercial-road, Morwell, and at the office of the Town and Country Planning Board, Melbourne, and will be open for inspection without payment of any fee by all persons affected between the hours of 9 a.m. and 3.30 p.m. on all days of the week, except Saturdays, Sundays, and public holidays, until and including the 5th January, 1961.

Any persons affected by the Planning Scheme are required to set forth, in writing, all objections they may have, addressed to the Shire Secretary, Shire Office, Morwell, on or before the 5th January, 1961.

11451 W. K. MATHISON, Shire Secretary.

SHIRE OF OTWAY.

NOTICE is hereby given that—
AUBREY CHARLES MCKAY
has been appointed Herdsman for the Shire of Otway.
T. J. FRY, Shire Secretary.
Beech Forest, 28th September, 1960. 11462

SHIRE OF PORTLAND.

LOAN No. 17.

Notice of Intention to Borrow the Sum of £10,000 for Permanent Works and Undertakings.

NOTICE is hereby given that the Council of the Shire of Portland proposes to borrow the sum of Ten thousand pounds on the credit of the municipal revenues of the President, Councillors and Ratepayers of the said Shire, such sum to be raised by the grant of a mortgage in accordance with the provisions of the *Local Government Act 1958*.

1. The maximum rate of interest that may be paid is 5½ per cent. per annum.
2. The purpose for which the loan is to be applied is:—
Part cost of construction of bridges .. £10,000
3. The period of the loan shall be six years.
4. The moneys borrowed shall be repayable by providing out of the municipal fund twelve half-yearly instalments of approximately £985 19s. 5d. each, including principal and interest on the 1st day of May and the 1st day of November during the currency of the loan. The first instalment shall be payable on the 1st day of May, 1961.

5. Such moneys shall be repayable at the State Savings Bank of Victoria, Melbourne.

The plans and specifications and the estimate of the cost of the proposed works and a statement showing the proposed expenditure of the moneys to be borrowed, are open for inspection at the Shire Office, Heywood, during office hours.

Dated 13th September, 1960.
11454 M. D. ALLARDICE, Shire Secretary.

SHIRE OF PORTLAND.

LOAN No. 18.

Notice of Intention to Borrow the Sum of £5,000 for Permanent Works and Undertakings.

NOTICE is hereby given that the Council of the Shire of Portland proposes to borrow the sum of Five thousand pounds on the credit of the municipal revenues of the President, Councillors and Ratepayers of the said Shire, such sum to be raised by the grant of a mortgage in accordance with the provisions of the *Local Government Act 1958*.

1. The maximum rate of interest that may be paid is 5½ per cent. per annum.
2. The purpose for which the loan is to be applied is:—
Purchase of land for, and the construction of a house, for Council Officers .. £5,000
3. The period of the loan shall be ten years.
4. The moneys borrowed shall be repayable by providing out of the municipal fund twenty half-yearly instalments of approximately £328 7s. 2d. each, including principal and interest on the 1st day of May and the 1st day of November during the currency of the loan. The first instalment shall be payable on the 1st day of May, 1961.
5. Such moneys shall be repayable at the State Savings Bank of Victoria, Melbourne.

The plans and specifications and the estimate of the cost of the proposed works and a statement showing the proposed expenditure of the moneys to be borrowed, are open for inspection at the Shire Office, Heywood, during office hours.

Dated 13th September, 1960.
11455 M. D. ALLARDICE, Shire Secretary.

SHIRE OF SHEPPARTON.

BY-LAW No. 69.

A By-law of the Shire of Shepparton, made under section 394 of the *Health Act 1958*, and numbered 69, for the following purposes:—

- (a) Fixing the fees for registration and renewal and transfer of registration of each of the classes of premises specified herein.
- (b) Repealing By-law No. 60.

IN pursuance of the powers conferred by the Health Acts and of every other power it thereunto enabling, the President, Councillors, and Ratepayers of the Shire of Shepparton order as follows:—

1. This By-law shall apply to and have operation in the whole of the municipal district of the Shire of Shepparton.
2. This By-law shall come into operation and have effect immediately upon publication of notice of the making hereof in the *Victoria Government Gazette*.
3. In this By-law "Council" means the Council of the Shire of Shepparton.
4. By-law No. 60 of the Shire of Shepparton is hereby repealed.
5. The following fees shall be paid for granting or annual renewal of registration of the following premises respectively:—

| | £ | s. | d. |
|--|----|----|----|
| (a) Offensive trades premises (other than those referred to below) | 5 | 0 | 0 |
| Offensive trades premises (being fat extracting or melting or rendering works which are conducted at premises occupied principally as a butcher's shop, and at which fat is extracted, melted, or rendered only from materials derived from such shop) | 1 | 0 | 0 |
| (b) Boarding-houses | 2 | 0 | 0 |
| (c) Common lodging-houses | 2 | 0 | 0 |
| (d) Eating-houses | 2 | 0 | 0 |
| (e) Premises at or in any part of which eggs for sale are received or stored for the purpose of being chilled | 2 | 0 | 0 |
| (f) Apartment-houses— | | | |
| containing not more than one apartment | 1 | 0 | 0 |
| containing more than one apartment | 2 | 0 | 0 |
| (g) Food premises— | | | |
| (i) where not more than five persons (including the proprietor and his family) are employed | 2 | 0 | 0 |
| (ii) where more than five such persons are employed additional for each person in excess of five | 0 | 2 | 6 |
| Provided that the maximum fee payable shall be | 25 | 0 | 0 |
| (h) Dangerous trades premises | 5 | 0 | 0 |
| (i) Camping areas | 2 | 0 | 0 |
| 6. For any transfer of registration. | 0 | 2 | 6 |

Resolution for passing this By-law was adopted by the Council on the 20th day of June, 1960. Confirmed the 18th day of July, 1960.

In witness whereof the common seal of the President, Councillors, and Ratepayers of the Shire of Shepparton was hereto affixed, in the presence of—

I. A. GEDDES, President.
(SEAL) L. A. PITHER, Councillor.
K. LITTLE, Shire Secretary.

Submitted to the Commission of Public Health this 16th day of August, 1960.—G. W. ROGAN, Secretary of the Commission.

Approved by the Governor in Council this 6th day of September, 1960.—A. MAHLSTEDT, Clerk of the Executive Council. 11452

SHIRE OF SOUTH BARWON.

BY-LAW No. 47.

A By-law of the Shire of South Barwon, made under the provisions of the *Local Government Acts*, and numbered 47, for regulating the use of private property at the junction of streets and roads for the growing of trees, shrubs or hedges, and for prohibiting to remain on any private property near the junction of streets or roads fences to a height exceeding 3 ft. 6 in., and providing for the removal or lopping of such trees, shrubs, hedges or fences.

IN pursuance of the powers conferred by the Local Government Acts and of any and every other power enabling them in that behalf, the President, Councillors and Ratepayers of the Shire of South Barwon order as follows:—

1. In this By-law, unless inconsistent with the context or subject-matter thereof—

"Street" or "road" shall have the same meaning as is provided in Act No. 6299 (*Local Government Act 1958*) or any statutory amendment thereof for "street" or "road".

"Council" means the President, Councillors and Ratepayers of the Shire of South Barwon.

2. The Council by notice in writing may order—

(a) the owner of private property situate at the junction of any streets or roads to remove or lop to a height determined by the Council any tree, shrub or hedge (whether planted before or after the passing of this By-law) from or on such private property where any such tree, shrub or hedge abuts on or is within 10 feet of either such street or road or is within a distance of 30 feet from the junction of such streets or roads;

(b) the owner of any portion of a fence within 30 feet of the junction of any streets or roads to reduce such portion of a fence to a height not exceeding 3 ft. 6 in.

3. Where any such tree, shrub or hedge shall not be so removed or so lopped or such portion of a fence shall not be so reduced in height in manner and within the time stated in the notice hereinbefore prescribed by this By-law, the Council, at the expense of the owner of such private property or of such portion of a fence, as the case may be, may—

(a) remove or lop any such tree, shrub or hedge,
(b) reduce in height any such portion of a fence, provided such removal, lopping or reduction in height is consistent with the order of the Council contained in the said notice.

4. Such notice hereinbefore prescribed—

(a) shall specify the removal, lopping or reduction in height ordered and state the time within which the same shall be done;

(b) may be served on such owner by—

(i) causing the same to be handed personally to such owner, or

(ii) posting the same in a prepaid registered letter, addressed to such owner at his last address appearing in the rate books of the Council, or

(iii) if no address of such owner appears in the said rate books, by posting such notice in a conspicuous position on such property or on such portion of a fence, as the case may be.

5. The expense hereinbefore referred to in clause 3 of this By-law may be recovered by the Council in a Court of Petty Sessions as a civil debt recoverable summarily.

6. Any such owner offending against the provisions of this By-law shall for any wilful act or default contrary thereto be guilty of an offence and, on conviction therefor, shall be liable to a penalty of not more than twenty pounds, in addition to any expense which may be recovered from him as aforesaid.

7. This By-law shall apply to and have operation throughout the whole of the municipal district of the Shire of South Barwon.

Resolution for passing this By-law was agreed to by the Council of the Shire of South Barwon on the 16th day of August, 1960, and confirmed on the 20th day of September, 1960.

The common seal of the President, Councillors and Ratepayers of the Shire of South Barwon was affixed hereto, in the presence of—

A. L. DEAN, Shire President.
H. C. HUNT, Councillor.
E. T. CORNISH, Shire Secretary.

11463

EIGHTH SCHEDULE TOWN AND COUNTRY PLANNING ACTS.

OCEAN ROAD PLANNING SCHEME 1955.

AMENDMENT No. 1.—1960. (SHIRE OF WINCHELSEA.)

NOTICE is hereby given that the Shire of Winchelsea in pursuance of its powers under the Town and Country Planning Acts has prepared a Planning Scheme for Part Crown Allotment 29D, and part Crown Allotment 29F, Parish of Kaangiang, for the purpose of re-zoning Rural to Residential and Public Reserve to Commercial.

All maps, plans, descriptions and other data fully setting out and explaining the Planning Scheme have been deposited at the office of the Shire of Winchelsea and at the office of the Town and Country Planning Board, Melbourne, and will be open for inspection without payment of any fee by all persons affected, between the hours of 9 a.m. and 5 p.m. on all days of the week except Saturdays, Sundays and Public Holidays until the 31st day of October, 1960.

Any persons affected by the Planning Scheme are required to set forth in writing all objections they may have, addressed to the Shire Secretary, Shire of Winchelsea, Shire Hall, Winchelsea, on or before the 31st day of October, 1960.

11445

W. W. WESTHORPE, Shire Secretary.

I, TRUE SINCERITY, of 14 Lyons-street, Ballarat, in the State of Victoria, married woman, heretofore called and known by the name of Frederina Rose Britnell, hereby give public notice that by a deed poll dated the 16th day of September, 1960, duly executed and attested and deposited with the Registrar-General of the said State on the 23rd day of September, 1960, I formally and absolutely renounced and abandoned the said name of Frederina Rose Britnell, and declared that I have assumed and adopted and intended thenceforth upon all occasions whatsoever to use and subscribe the name of True Sincerity instead of the said name of Frederina Rose Britnell, and so as to be at all times thereafter called, known and described by the said name of True Sincerity.

Dated the 28th day of September, 1960.

11458

TRUE SINCERITY.

Victoria.

OPTICIANS REGISTRATION BOARD.

PURSUANT to the *Opticians Registration Act 1958* and the *Opticians Regulations 1946*, notice is hereby given that an election for three certified opticians to be nominated as members of the Opticians Registration Board as from the 29th day of January, 1961, will be held on Friday, the 2nd day of December, 1960; and notice is further given that Friday, the 4th day of November, 1960, has been fixed as the date for receiving nominations for the election. All nominations must be in the form or to the effect of the form prescribed by the Regulations and must be lodged with the Registrar of the Board before Noon on the said 4th day of November, 1960.

Nomination forms may be obtained from the Registrar, at 422 Collins-street, Melbourne.

Dated this 3rd day of October, 1960.

NOEL J. ROWAN, Registrar, Opticians Registration Board, 422, Collins-street, Melbourne. 11472

Sewerage Districts Act 1958.

BENDIGO SEWERAGE AUTHORITY.

THE above-mentioned Sewerage Authority having made provision for the carrying off the sewage from each and every property which or any part of which is within the Sewerage Area hereinafter described, doth hereby declare that on and after the 1st day of November, 1960, each and every property which or any part of which is within the said Sewerage Area hereinafter described shall be deemed to be a seweraged property within the meaning of the *Sewerage Districts Act 1958*.

The boundaries of the Sewerage Area hereinbefore referred to are as follows:—

Sewerage Area No. 176.

Commencing at the easternmost corner of Sewerage Area No. 166; thence south-westerly along the south-eastern boundaries of lots 28, 27, 26, 25, 23 and 22 of plan of subdivision of Crown allotment 93A and part of Crown allotment 93, Parish of Sandhurst, to the southernmost corner of lot 22; thence westerly along the southern boundaries of lots 22 and 21 and south-westerly along the south-eastern boundary of lot 17 to Houlahan-street; thence north-westerly along Houlahan-street to the southernmost corner of Crown allotment 94; thence north-easterly along the south-western boundary of Crown allotment 94 to the boundary of Sewerage Area No. 166; thence north-easterly along boundary of Sewerage Area No. 166 to the point of commencement.

By order of the Bendigo Sewerage Authority,

H. W. SNELL, Chairman.
H. A. MOORS, Secretary.

11479

MOE SEWERAGE AUTHORITY.
GENERAL NOTICE.

THE above-mentioned Sewerage Authority, having made provision for carrying off sewage from each and every property which, or any part of which, is within the Sewerage Area hereinafter described, doth hereby declare that on and after the 4th day of October, 1960, each and every property which is within the said Sewerage Area shall be deemed to be a seweraged property within the meaning of the *Sewerage Districts Act 1928*. The said Sewerage Area shall be known as "Sewerage Area No. 21".

The boundary of the Sewerage Area hereinafter referred to is:—

Sewerage Area No. 21.

Commencing at the north-eastern corner of lot 17, part 166A, Moe, being a point on the existing boundary of Sewerage Area No. 19; thence westerly along the south building line of Lloyd-street to the north-western corner of lot 12, part 166A, Moe; thence southerly along the western boundary of the said lot 12 to the north-eastern corner of lot 24, part 166A, Moe; thence westerly and southerly along the northern and western boundaries of the said lot 24 to and across Brendan-street to the southern building line of Brendan-street; thence west along the said south building line of Brendan-street to the eastern building line of Roberts-street; thence southerly along the said eastern building line to and across Victoria-street to the south building line of Victoria-street; thence westerly along the said building line to the north-western corner of lot 100, part 166A, Moe; thence southerly along the western boundary to the south-west corner of the said lot 100; thence easterly along the southern boundaries of lots 100, 101, 102, part 166A, Moe, to the north-west corner of lot 124, part 166A, Moe; thence southerly along the western boundary of the said lot to the north building line of the new Princes Highway; thence easterly along the said building line to a point on the existing boundary of Sewerage Area No. 19; thence northerly, easterly, and northerly to the point of commencement.

By order of the said Sewerage Authority,

G. S. TABUTEAU, Chairman.
11448 W. H. BURRAGE, Secretary.

Victoria.

ACT 391.—FIRST SCHEDULE.

I, CHARLES KINGSTON DAWS, authorized representative of the denomination known as the Methodist Church of Australasia in Victoria, with the consent of Keith James Johnson, James Eustace Lethlean Jeffrey and Archibald William Skewes, trustees of the land described in the subjoined statement of trusts, and of Ernest Alfred Baker, being the person entitled to minister in or occupy a building or buildings upon the said land, hereby apply to the Governor of the State of Victoria for leave to dispose of the said land by the means and for the purposes mentioned in the said statement of trusts, and I hereby certify that the said land was temporarily reserved by Order in Council of the 8th day of February, 1855, for Wesleyan Methodist Church purposes: That the only trustees of the said land resident in the State of Victoria are Keith James Johnson, of 17 Magdala-street, Strathmore, James Eustace Lethlean Jeffrey, of 29 Renown-street, Essendon, and Archibald William Skewes, of 34A Kerford-street, North Essendon: That there are no buildings upon the said land: And that the only person entitled to minister in or occupy the same is the above-named Ernest Alfred Baker.

Signature of head or authorized representative—C. K. DAWS.

We consent to this application—

K. J. JOHNSON, Trustee.
J. E. L. JEFFREY, Trustee.
A. W. SKEWES, Trustee.

Signature of person entitled to minister in or occupy building or buildings—E. A. BAKER.

STATEMENT OF TRUSTS.

Description of Land.—2 acres, Township of Keilor, Parish of Maribyrnong, County of Bourke, being allotment 1, section 9: Commencing at the junction of the south-eastern boundary of Hunter-street and the north-eastern boundary of Church-street, bounded thence by Hunter-street bearing north 28 deg. 30 min. east 400 links; by allotments 10 and 9 bearing south 61 deg. 30 min. east 500 links; by Flora-street bearing south 28 deg. 30 min.

west 400 links; and thence by Church-street bearing north 61 deg. 30 min. west 500 links to the point of commencement.

Names of Trustees.—Keith James Johnson, James Eustace Lethlean Jeffrey and Archibald William Skewes.

Powers of Disposition.—Such powers of disposition, including powers of sale, lease or mortgage, as are contained in the model deed as defined by the *Methodist Union Act 1902*, under the trusts, powers and provisions of which deed the said property shall until disposed of be held.

Purposes to which Proceeds of Disposition are to be Applied.—To such Methodist Church purposes as shall be approved by the Trustees, or a majority thereof, with the consent of the Annual Conference of the Methodist Church of Australasia in Victoria. 11489

NOTICE is hereby given that the trustees of Koorngal Golf Club have applied for a lease, under section 134 of the *Land Act 1958*, for a term of ten years from 1st January, 1961, of Crown portions 7A and 7B, Parish of Truganina, containing 100 acres, as a site for amusement and recreation (golf course). 11508

NOTICE OF DISSOLUTION OF PARTNERSHIP.

RAYMOND JAMES LITTLE and Lindsay Gordon Scott, trading as "Airport Motors", at corner of Warrigal and Centre Dandenong roads, Cheltenham, in business of motor garage proprietors, service station and motor engineers, hereby give notice of dissolution of partnership on the 23rd day of September, 1960. Raymond James Little will continue the said business under the said name and will pay all liabilities and is entitled to all moneys owing to the said partnership.

Dated the 30th day of September, 1960.

L. SCOTT.
R. J. LITTLE.

Roy L. Yelland, solicitor, of 37 Swanston-street, Melbourne. 11500

NOTICE is hereby given that the partnership formerly existing between Bill Pappas and Miltrades Dimogiannis, carrying on business as confectioners and milk bar proprietors, at 50 Anderson-street, Yarraville, was dissolved by mutual consent on the 3rd day of September, 1960, when the said Bill Pappas retired from the said business. All amounts due to and payable by the said partnership will be received or paid by the said Miltrades Dimogiannis at the said address, and the said Miltrades Dimogiannis and his wife Marika Dimogiannis will henceforth carry on the said business in partnership at the said address.

Dated the 7th day of September, 1960.

BILL PAPPAS.
M. DIMOGIANNIS.
MARIKA DIMOGIANNIS.

W. B. and O. McCutcheon, solicitors, 150 Queen-street, Melbourne. 11504

NOTICE is hereby given that the partnership heretofore carried on at Hopetoun by Wheatley John Hosken, of Maryborough (as administrator of Mabel Hosken, deceased), Robert Sinclair Rivett and Joy Dawn Rivett, both of Hopetoun, as bakers and pastrycooks under the name of Hosken and Rivett, has been dissolved by mutual consent as from the 30th of June, 1960. Moneys owing to and by the partnership are being collected and paid by Robert Sinclair Rivett and Joy Dawn Rivett, who have purchased the business formerly owned by the partnership and who have now entered into partnership on their own account.

W. J. HOSKEN.
R. RIVETT.
J. RIVETT.

Herring, Bathurst, and Bruce, of Maryborough, solicitors for Wheatley John Hosken.

K. W. Entwisle, of Hopetoun, solicitor for Robert Sinclair Rivett and Joy Dawn Rivett. 11440

NOTICE is hereby given that the partnership heretofore subsisting between Leslie Bata and Bela Reichman, carrying on business as clothing manufacturer, at 15 Brighton-road, St. Kilda, in the State of Victoria, under the style or firm name of Milton Clothing Co., has been dissolved as from the 26th September, 1960.

Dated the 27th September, 1960.

Leslie Bata by his solicitors and agents:

MARASH & ZABLUD, 443 Little Collins-street, Melbourne. 11492

NOTICE OF DISSOLUTION OF PARTNERSHIP.

NOTICE is hereby given that the partnership heretofore subsisting between the undersigned Samuel Solomon Vinegrad and Ralph William Hock, carrying on business as service station proprietors at Creswick-road, Ballarat, under the name of "Creswick Road Service Station", has been dissolved by mutual consent as from the 1st day of July, 1960. All debts due to and owing by the said late firm will be received and paid by Ralph William Hock, who will continue to carry on business at the same place.

Dated at Ballarat this 1st day of July, 1960.

S. VINEGRAD.
R. W. HOCK.

Witness: N. E. ELLIS.

11436

NOTICE is hereby given that the partnership heretofore subsisting between Frederick Edward Stott, of 196 Yarra-street, Geelong; Harold Percival Stott, late of 96 Noble-street, Newtown, Geelong; and Reginald Walter Stott, late of 44 Meakin-street, East Geelong, carrying on business as jewellers at 98 Moorabool-street, Geelong, under the style or firm of "E. G. Stott and Sons" has been dissolved as from the 1st September, 1960, and that the said business is no longer being carried on.

Dated the 12th day of September, 1960.

FREDERICK EDWARD STOTT.
HELEN MARJORIBANKS STOTT,
as executrix of the will of Harold
Percival Stott.
GERTRUDE ELIZABETH STOTT,
as executrix of the will of Reginald
Walter Stott.

11443

ASSOCIATED AUSTRALIAN OILFIELDS NO LIABILITY.

Registered Office: Cook, Tomlins and Mirams, 360 Collins-street, Melbourne, C.I.

NOTICE is hereby given that a Call (the 9th) of Ninepence per share on all the issued Contributing Shares in the capital of the company (making the said shares paid to Seven shillings and sixpence each) has been made due and payable at the registered office of the company, 360 Collins-street, Melbourne, on Wednesday, 12th October, 1960.

Shares on which calls remain unpaid fourteen days after the due date of the call are liable to forfeiture.

By order of the Board,

R. R. SANDERSON, Secretary.

Melbourne, 27th September, 1960.

11485

In the Supreme Court of Victoria.—In the matter of C.A.T. CONSTRUCTIONS PROPRIETARY LIMITED.—Winding-up Order made the 26th day of September, 1960.

NAME and address of Official Liquidator—

John Kenneth Hull, of 390 Little Collins-street, Melbourne, C.I.

EVANS, MASTERS & GILBERT, solicitors for the petitioner. 11481

Companies Act 1958.

BUILDING AND ENGINEERING CONSTRUCTIONS (AUST.) PROPRIETARY LIMITED.

AT an Extraordinary General Meeting of Building and Engineering Constructions (Aust.) Proprietary Limited, convened and held at the offices of Fuller, King and Co., 83 William-street, Melbourne, on Monday, 3rd October, 1960, at 10.30 a.m., the following three special resolutions were duly passed:—

(1) That it has been proved to the satisfaction of the meeting that the company cannot by reason of its liabilities continue its business, and that it is therefore advisable to wind up the company forthwith, and that accordingly the company be wound up voluntarily.

(2) That Kenneth Harold Vial and Kenneth Conway Keown, of Fuller, King and Co., chartered accountants, be nominated to be the liquidators of the company for the purpose of winding up the affairs and distributing the assets of the company.

(3) That each of the two persons so nominated as liquidators may himself exercise every power given by the Companies Act 1958 to a liquidator.

Dated this 3rd day of October, 1960.

11487

W. J. CODY, Director.

Companies Act 1958.

YUKON BUILDING SUPPLIES PROPRIETARY LIMITED.

AT an Extraordinary General Meeting of Yukon Building Supplies Proprietary Limited, convened and held at the offices of Fuller, King and Co., 83 William-street, Melbourne, on Monday, 3rd October, 1960, at 10.45 a.m., the following three Special Resolutions were duly passed:—

(1) That it has been proved to the satisfaction of the meeting that the company cannot by reason of its liabilities continue its business, and that it is therefore advisable to wind up the company forthwith, and that accordingly the company be wound up voluntarily.

(2) That Kenneth Harold Vial and Kenneth Conway Keown, of Fuller, King and Co., chartered accountants, be nominated to be the liquidators of the company for the purpose of winding up the affairs and distributing the assets of the company.

(3) That each of the two persons so nominated as liquidators may himself exercise every power given by the Companies Act 1958 to a liquidator.

Dated this 3rd day of October, 1960.

11488

W. J. CODY, Director.

Companies Act 1958, Section 153 (1).

MARYBOROUGH KNITTING MILLS (CUTTLE) LTD.

Reg. Office: 98 Bourke-street, Maryborough, No. 8832/14878.

REGISTER OF UNCLAIMED MONEY HELD BY MARYBOROUGH KNITTING MILLS (CUTTLE) LTD.

Name of Owner on Books; Total Amount Due to Owner; Description of Unclaimed Money; Date of Last Claim.

J. A. Miller; £3 15s.; Dividend Nos. 8 to 13; no claim ever made—unable to trace.

Executors of C. L. Williams, Deceased; £3 15s.; Dividend Nos. 8 to 13; unable to trace executors. 11486

Companies Act 1958.

R. & E. H. SPARROW PROPRIETARY LIMITED.

NOTICE OF RESOLUTION, PURSUANT TO SECTION 195 (3).

AT an Extraordinary General Meeting of R. & E. H. Sparrow Proprietary Limited, duly convened and held at 40 Queen-street, Melbourne, on the 19th day of August, 1960, the following Resolution was duly passed as a Special Resolution, namely:—

"That the company be wound up voluntarily under the provisions of section 199 of the Companies Act 1958, and that Sidney Bertram Wills Cooke, chartered accountant, of 40 Queen-street, Melbourne be appointed liquidator at a fee to be arranged."

Dated this 19th day of August, 1960.

11503

S. B. WILLS COOKE, Liquidator.

Companies Act 1958.—In the matter of BELMORE MOTORS PROPRIETARY LIMITED.

AT an Extraordinary General Meeting of the members of Belmore Motors Proprietary Limited, duly convened and held at the office of Mills and Oakley, 10 Powlett-street, East Melbourne, on the 26th day of September, 1960, the following Special Resolution was duly passed:—

"That the company be wound up voluntarily and that Donald William Pearson, of 55 William-street, Melbourne, chartered accountant, be appointed liquidator for the purpose of conducting such winding up."

Dated this 26th day of September, 1960.

11499

JAMES H. MCGUIRE, Director.

No. 6390

In the Supreme Court of Victoria.—In the matter of Part VI. of the Companies Act 1958.—And in the matter of R. M. CARSON & COMPANY PROPRIETARY LIMITED.—NOTICE OF WINDING UP ORDER.

TAKE notice that a Winding Up Order was made against R. M. Carson and Company Proprietary Limited, the registered office of which is situate at 367-371 Bridge-road, Richmond, in the State of Victoria, on Monday the 26th day of September, 1960.

The official liquidator in the said winding up is Magnus Victor Anderson, of 377 Little Collins-street, Melbourne, in the State of Victoria.

D. L. CANAVAN, Deputy Commissioner of Taxation of the Commonwealth of Australia, Petitioner. 11501

The Companies Act 1958.

RE MODERN HOME COMFORTS PTY. LTD. (IN LIQUIDATION).

Section 210.

NOTICE is hereby given that a General Meeting of the members of the above-named company will be held at 62 Wellington-parade, East Melbourne, on Wednesday, the 9th day of November, 1960, for the purpose of having an account laid before them showing the manner in which the winding up has been conducted and the property of the company disposed of and of hearing any explanation that may be given by the liquidator.

Dated this 30th day of September, 1960.

11453 J. HENRY, Liquidator.

The Companies Act 1958.—In the matter of SOUTHDOWN KNITTING MILLS PTY. LTD. (in Voluntary Liquidation).

NOTICE is hereby given that at an Extraordinary Meeting of the members of the above-named company held on the 1st day of October, 1960, it was resolved that "the company be wound up voluntarily, and that Norman Robert Macaw, chartered accountant, of 31 Queen-street, Melbourne, be appointed liquidator for the purpose of such winding up."

Dated this 1st day of October, 1960.

11497 N. R. MACAW, Liquidator.

WILLIAM LLOYD MEYER, late of Grassdale, Paraparap, farmer, DECEASED, intestate.

CREDITORS, next of kin, and others having claims in respect of the estate of the deceased (who died on the 7th day of November, 1959), are required by the personal representative, Marcella Hilda Meyer, of Grassdale, Paraparap, widow, to send particulars to her, care of the under-mentioned solicitors, by the 7th day of December, 1960, after which date the personal representative may convey or distribute the assets, having regard only to the claims of which she then has notice.

WHYTE, JUST & MOORE, solicitors, 27 Malop-street, Geelong. 11442

THOMAS BAGNELL, late of Yarrowalla, via Pyramid Hill, farmer, DECEASED (who died on the 27th day of February, 1960).

CREDITORS, next of kin, and others having claims against his estate are required by the administrator, Farmers and Citizens Trustees Company Bendigo Limited, of Charing Cross, Bendigo, to send particulars thereof to it on or before the 6th day of December, 1960, after which date it will distribute the estate, having regard only to the claims of which it then has notice.

Dated the 29th day of September, 1960.

HYETT, WILLIS & HYETT, 51 Bull-street, Bendigo, solicitors for the administrator. 11444

ALL persons having claims against the estate of Annie Rice, formerly of Valencia Creek, late of Edenhope, spinster, deceased, letters of administration with the will annexed of whose estate have been applied for by National Trustees Executors and Agency Company Limited, of 95 Queen-street, Melbourne, the said company having been authorized by the residuary beneficiary, are hereby requested to send particulars thereof in writing to the said company, on or before the 30th day of November, 1960, after which date the said company will proceed to distribute the assets of the said deceased, having regard only to the claims of which it shall then have had notice, and the said company will not be liable for the assets so distributed or any part thereof to any person of whose claim it shall not then have had notice.

R. G. DOBSON & CO., of 52 Lydiard-street, Ballarat, solicitors for the said company. 11435

CREDITORS, next of kin, and others having claims against the estate of Samuel James Aston, late of 13 Frederick-street, Yarraville, retired gentleman (who died on the 10th July, 1958), are required to send particulars of their claims to Arthur Hurren, of 13 Latrobe-street, Footscray, minister of religion, the executor of deceased's will, care of the under-named solicitor, by the 18th day of December, 1960, after which the executor will distribute the assets, having regard only to the claims of which he then has notice.

JOHN GINNANE, solicitor, 153A Barkly-street, Footscray. 11502

CREDITORS, next of kin, and others having claims in respect of the estate of Edward Mann, formerly of No. 29 Vincent-street, Glen Iris, but late of No. 23 Through-road, Burwood, retired, deceased (who died on the 4th day of July, 1960), are to send particulars of their claims to The Trustees, Executors and Agency Company Limited, whose registered office is situated at 401 Collins-street, Melbourne, by the 6th day of December, 1960, after which date it will distribute the assets, having regard only to the claims of which it then has notice.

H. S. W. LAWSON, HUGHES & CO., 357 Little Collins-street, Melbourne, solicitors. 11505

CREDITORS, next of kin, and others having claims in respect of the estate of Henry Albert Pook, late, of 114 Elm-street, Northcote, in the State of Victoria, retired baker, deceased (who died on the 28th day of July, 1960), are required by the executor, Royston Charles Milton, of 33 Penola-street, Preston, in the said State, plumber, to send particulars of their claims to him, care of Rogers and Gaylard, solicitors, of 281 Collins-street, Melbourne, by the 14th day of December, 1960, after which date the said executor will distribute the assets of the deceased, having regard only to the claims of which he then shall have had notice.

ROGERS & GAYLARD, solicitors, 281 Collins-street, Melbourne. 11490

ROBERT CHARLES ESPINASSE BRODIE, late of 10 Kyeamba-grove, Toorak, in the State of Victoria, medical practitioner, DECEASED.

CREDITORS, next of kin, and others having claims in respect of the estate of the deceased (who died on the 10th February, 1960), are required by the personal representative, The Union Trustee Company of Australia Limited, of 333 Collins-street, Melbourne, to send particulars to it by the 9th December, 1960, after which date the said company may convey or distribute the assets, having regard only to the claims of which it then has notice.

HEDDERWICK, FOOKES & ALSTON, 103 William-street, Melbourne. 11491

CREDITORS, next of kin, and others having claims in respect of the estate of Raymond William Patrick Webb, late of 415 Mont Albert-road, Mont Albert, in the State of Victoria, gentleman (who died on the 16th day of October, 1959), are required by the trustees, John Archibald Harker and Catherine Ruby Harker, both of 9 Grange-street, Mont Albert, to send particulars to the trustees, the said John Archibald Harker and Catherine Ruby Harker, care of Purves and Purves, at 90 William-street, Melbourne, by the 7th day of December, 1960, after which date the trustees may convey or distribute the assets, having regard only to the claims of which they then have notice.

PURVES & PURVES, solicitors, 90 William-street, Melbourne, C.I. 11493

CREDITORS, next of kin, and others having claims in respect of the estate of Graeme Wilkinson, formerly of Noble-road, but late of Noble-street, Noble Park, in the State of Victoria, retired poultry farmer (who died on the 26th day of January, 1960), are required by the trustee, Lisle Wilkinson, of 23 Glenbrook-avenue, East Malvern, in the said State, to send particulars to the said Lisle Wilkinson, care of Purves and Purves, at 90 William-street, Melbourne, by the 7th day of December, 1960, after which date the trustee may convey or distribute the assets, having regard only to the claims of which he then has notice.

PURVES & PURVES, solicitors, 90 William-street, Melbourne, C.I. 11494

ALBERT WILLIAM HOGAN, of Pakenham, retired estate agent, DECEASED.

CREDITORS, next of kin, and others having claims in respect of the estate of the deceased (who died on the 30th day of June, 1959), are required by the trustees, The Trustees, Executors and Agency Company Limited, of 401 Collins-street, Melbourne, and David Joseph Bourke, of Racecourse-road, Pakenham, to send particulars to them, care of The Trustees, Executors and Agency Company Limited, of 401 Collins-street, Melbourne, by the 31st day of December, 1960, after which date the trustees may convey or distribute the assets, having regard only to the claims of which they then have notice.

Dated the 1st day of October, 1960.

JOHN P. RHODEN, solicitors, 376 Collins-street, Melbourne. 11495

CREDITORS, next of kin, and others having claims in respect of the estate of Harold George Carthew, late of Korumburra, retired farmer, deceased (who died on the 16th day of June, 1960), are to send particulars of their claims to William Louis Ross, care of the undersigned, by the 1st day of December, 1960, after which date he will distribute the assets, having regard only to claims of which he then has notice.

DIRCH, ROSS & ATKINSON, solicitors, Korumburra.
11476

FREDERICK CHARLES MAYDOM, late of 181 Cecil-street, Williamstown, brass finisher, DECEASED, intestate.

CREDITORS, next of kin, and others having claims in respect of the estate of the above-named deceased (who died on the 2nd day of October, 1959), are required by the administratrix, Emma Jane Green, of 16 Muntz-street, North Caulfield, widow, to send particulars to her, care of the undersigned, by the 10th day of December, 1960, after which date the administratrix may convey or distribute the assets, having regard only to the claims of which she then has notice.

S. W. MISSON & BARTLEY, solicitors, 59 Waverley-road, East Malvern.
11475

HORACE WILLIAM HAWKINS, formerly of 404 Glenferrie-road, Hawthorn, but late of 499 Glenferrie-road, Hawthorn, domestic engineer, DECEASED.

CREDITORS, next of kin, and others having claims in respect of the estate of the above-named deceased (who died on the 9th day of January, 1960), are required by the executors, Violet Hawkins, of 499 Glenferrie-road, Hawthorn, widow, and Alexander Stephen Hawkins, of 131 Ashburn-grove, Ashburton, engineer, to send particulars to them, care of the undersigned, by the 10th day of December, 1960, after which date the executors may convey or distribute the assets, having regard only to the claims of which they then have notice.

S. W. MISSON & BARTLEY, solicitors, 59 Waverley-road, East Malvern.
11474

CREDITORS, next of kin, and others having claims in respect of the estate of Florence Eliza Willet, formerly of 294 Riversdale-road, Hawthorn East, in the State of Victoria, but late of Orchard-road, Belgrave Heights, in the said State, widow, deceased (who died on the 1st day of July, 1960), are to send particulars of their claims to National Trustees, Executors and Agency Company of Australasia Limited, whose registered office is situate at 95 Queen-street, Melbourne, by the 14th day of December, 1960, after which date it will distribute the assets, having regard only to the claims of which it then has notice.

LEACH & THOMSON, solicitors, 472 Bourke-street, Melbourne.
11473

PURSUANT to the *Trustee Act 1958*, creditors, next of kin and all other persons having claims in respect of the estate of any deceased person named below are required to send particulars to the legal personal representative or representatives at the address stated, after which date the representative or representatives will distribute the assets, having regard only to the claims of which notice has been received:—

Richard Andrew Gibson, late of Port Fairy, agent, deceased.—Claims to the trustees, George Harold Gibson and Jack Whitehead Powling, care of J. W. Powling, solicitor, Port Fairy, by 22nd December, 1960.

Thomas Crow, late of Orford, grazier, deceased.—Claims to the trustees, Thomas James Crow and Basil George Down, care of J. W. Powling, solicitor, Port Fairy, by 22nd December, 1960.

William Joseph Crow, late of Orford, grazier, deceased.—Claims to the trustees, Ethel Jane Howell and William Murray Howell, care of J. W. Powling, solicitor, Port Fairy, by 22nd December, 1960.

Dulcie Isabel Roberts, late of Tyrendarra East, married woman, deceased.—Claims to the trustees, Gilbert Thomas Roberts and Samuel Richmond Kennedy, care of J. W. Powling, solicitor, Port Fairy, by 22nd December, 1960.

Ellen Marr Unkles, late of Port Fairy, married woman, deceased.—Claims to the trustee, Irene Mary Herbertson, care of J. W. Powling, solicitor, Port Fairy, by 22nd December, 1960.
11480

NOTICE TO CLAIMANTS.—*RE* JAMES EGAN, formerly of Gooroc, in the State of Victoria, but late of Charlton, in the said State, formerly dealer and retired farmer, but lately farmer, DECEASED.

MARY MARGARET PATTON, married woman, and National Trustees, Executors and Agency Company of Australasia Limited, the registered office of which is situate at No. 95 Queen-street, Melbourne, in the said State, the executors to whom probate of the will of the abovenamed deceased (who died on the 8th day of March, 1960, was granted by the Supreme Court of Victoria on the 6th day of September, 1960, require all creditors, and others having claims against the said deceased or the estate of the said deceased), to send to the said company at its registered office on or before the 17th day of December, 1960, particulars, in writing, of such claims, after which date the said Mary Margaret Patton and the said company intend to convey or distribute such property or estate to or amongst the persons entitled thereto, having regard only to the claims of which they shall have had notice.

Dated the 28th day of September, 1960.

H. L. DUNKLEY & KELLY, solicitors, 78 Napier-street, St. Arnaud.
11469

CREDITORS, next of kin, and others having claims in respect of the estate of James Harold Swannell, late of 13 Angle-road, Balwyn, retired butcher, deceased (who died on the 19th day of June, 1960), are to send the particulars of their claims to The Union Trustee Company of Australia Limited, whose registered office is situate at 333 Collins-street, Melbourne, by the 15th day of December, 1960, after which date it will distribute the assets, having regard only to the claims of which it then has notice.

MADDEN, BUTLER, ELDER & GRAHAM, solicitors, 99 Queen-street, Melbourne.
11496

CREDITORS, next of kin, and others having claims in respect of the estate of Frederick James Crichton Boyd, late of 10 Queen-street, Clayton, gentleman, deceased (who died on the 20th day of April, 1959), are to send the particulars of their claims to Daisy May Smith and Arthur Hunter Boyd, care of the undersigned, before the 17th day of December, 1960, after which date they will distribute the assets, having regard only to the claims of which they then have notice.

GORDON RENNICK & GAYNOR, solicitors, 473 Bourke-street, Melbourne.
11498

JAMES GODFREY STEVENSON, late of "Yalong," Stanley-avenue, Oakleigh, retired farmer, DECEASED.

CREDITORS, next of kin, and others having claims against the estate of the deceased (who died on the 10th June, 1960), are required by the executors, Ronald William Stevenson and Thelma Dorothy Stevenson to send particulars to them, care of 120 William-street, Melbourne, by the 8th December, 1960, after which date the executors may convey and distribute the assets, having regard only to the claims of which they then have notice.

BLAKE & RIGGALL, 120 William-street, Melbourne, solicitors.
11484

THOMAS CRAWFORD, late of Edenhope, farmer, DECEASED.

CREDITORS, next of kin, and others having claims in respect of the estate of the deceased (who died on the 11th day of July, 1960), are required by the executor and personal representative, Ian Tuson Bennett, of Horsham, solicitor, to send particulars to him by the 31st day of December, 1960, after which date the said Ian Tuson Bennett may convey or distribute the assets, having regard only to the claims of which he then has notice.

POWER & BENNETT, solicitor, Horsham.
11460

CREDITORS, next of kin, and others having claims in respect of the estate of Isabella Tait, formerly of Merino, but late of 700 North-road, Ormond, spinster, deceased (who died on the 15th day of May, 1960), are requested to send particulars of their claims to the executor, Charles William Brown, care of Kenneth J. Clements, solicitor, 269 Glenhuntly-road, Elsternwick, by the 1st day of January, 1961, after which date the executor will distribute the assets, having regard only to the claims of which he has notice.

KENNETH J. CLEMENTS, solicitor, 269 Glenhuntly-road, Elsternwick.
11470

CREDITORS, next of kin, and others having claims in respect of the estate of Ernest Bevin, late of Station-street, Bayswater, in the State of Victoria, pet shop proprietor, deceased (who died on the 19th day of July, 1959), are required by the executrix, Winifred Alison McCook, of 173 Whitehorse-road, Ringwood, in the said State, solicitor, to send particulars of their claims to her, at 173 Whitehorse-road, Ringwood, by the 6th day of December, 1960, after which date the said executrix will distribute the assets of the deceased, having regard only to the claims of which she then shall have had notice.

WINIFRED MCCOOK, LL.B., 173 Whitehorse-road, Ringwood. 11459

CREDITORS, next of kin, and others having claims in respect of the estate of Gladdys Louise Manly, late of 14 Hammerdale-avenue, East St. Kilda, widow, deceased (who died on the 23rd day of July, 1960), are requested to send particulars of their claims to the executor, Kenneth J. Clements, of 269 Glenhuntly-road, Elsternwick, solicitor, by the 15th day of December, 1960, after which date he will distribute the assets, having regard only to the claims of which he has notice.

KENNETH J. CLEMENTS, solicitor, 269 Glenhuntly-road, Elsternwick. 11471

CREDITORS, next of kin, and others having claims in respect of the estate of Ethel Maud Walliss, formerly of South Corowa, in the State of New South Wales, but late of 1 Inverness-avenue, Armadale, in the State of Victoria, widow (who died on the 29th day of February, 1960, and probate of whose will was granted to Percival James Walliss, of 1 Inverness-avenue, Armadale, in the State of Victoria, carpenter, and Henry Angus Walliss, of Post Office, South Corowa, in the State of New South Wales, shearer, the executors named in the said will), are to send particulars of their claims to the executors, care of the undersigned at his address mentioned hereunder, by 30th November, 1960, after which date the said executors will distribute the assets, having regard only to the claims of which he then has notice.

K. G. CRANAGE, solicitor, 273A Glenferrie-road, Malvern. 11467

CREDITORS, next of kin, and others having claims in respect of the estate of Beatrice Florence Hipwell, late of 20 Browning-street, South Yarra, married woman, deceased (who died on the 18th October, 1958, and letters of administration of whose estate were granted to Ernest Edward Solden Hipwell, of 20 Browning-street, South Yarra), are to send particulars of their claims to the administrator, care of the undersigned, by the 30th November, after which date the administrator will distribute the assets, having regard only to the claims of which he then has notice.

K. G. CRANAGE, solicitor, 273A Glenferrie-road, Malvern. 11468

IMPOUNDINGS

KEILOR.—Impounded in Keilor Pound.

1 chestnut pony gelding, has rug on, no visible brand
1 dark-brown gelding, star, had headstall on, no visible brand

If not claimed and expenses paid to be sold on 20th October, 1960.

11483—12/
D. PASCOE,
Poundkeeper.

SUNBURY.—Impounded in Sunbury Pound by A. Sloan.

1 bay gelding, 13 or 14 hands, 5-7 years, star on forehead, white blaze on left nostril, no visible brand

If not claimed and expenses paid, to be sold on 21st October, 1960.

11461—10/6
E. M. PHILLIPS,
Poundkeeper.

STATE ACTS, 1959.

COPIES of the following Acts of Parliament of Victoria may be obtained at the Government Printing Office, or from any bookseller, at the price set opposite to each:—

| No. | Price. |
|--|--------|
| | s. d. |
| 6490. Water (Contracts) | 0 6 |
| 6491. Property Law (Amendment) | 0 6 |
| 6492. Agricultural Education (Amendment) | 0 6 |
| 6493. Swan Hill Railway Land | 0 6 |
| 6494. Stamps (Amendment) | 0 6 |
| 6495. Justices (Amendment) | 0 6 |
| 6496. Consolidated Revenue | 0 6 |
| 6497. State Electricity Commission (Tourist Areas) | 0 6 |
| 6498. Aborigines (Houses) | 0 6 |
| 6499. Superannuation (Amendment) | 0 6 |
| 6500. Country Roads (Amendment) | 0 6 |
| 6501. Bendigo Land | 0 6 |
| 6502. University (Honorary Degrees) | 0 6 |
| 6503. Melbourne and Metropolitan Board of Works (Reconstitution) | 0 9 |
| 6504. Land (Charges) | 0 6 |
| 6505. Statute Law Revision | 1 0 |
| 6506. Legal Profession Practice (Amendment) | 0 6 |
| 6507. Health | 0 9 |
| 6508. Fisheries (Amendment) | 0 6 |
| 6509. Water (Irrigation Districts) | 0 6 |
| 6510. Broadmeadows (Rating on Unimproved Values) | 0 6 |
| 6511. Trustee (Amendment) | 0 6 |
| 6512. Nurses | 0 6 |
| 6513. Hairdressers Registration (Amendment) | 0 6 |
| 6514. Labour and Industry (Retail Trading Hours) | 0 6 |
| 6515. Milk Board (Amendment) | 0 6 |
| 6516. Stock Diseases (Amendment) | 0 9 |
| 6517. Hepburn Springs Land | 0 9 |
| 6518. Vermin and Noxious Weeds | 1 0 |
| 6519. The Constitution Act Amendment (Parliamentary Salaries) | 0 9 |
| 6520. Public Works Committee (Amendment) | 0 6 |
| 6521. Land (Plantation Areas) | 0 6 |
| 6522. National Art Gallery and Cultural Centre (Amendment) | 0 6 |
| 6523. Portland Harbor Trust (Amendment) | 0 6 |
| 6524. Revocation and Excision of Crown Reservations | 1 9 |
| 6525. Tourist (Amendment) | 0 6 |
| 6526. Town and Country Planning (Amendment) | 0 6 |
| 6527. Vegetation and Vine Diseases (Amendment) | 0 6 |
| 6528. Medical | 0 9 |
| 6529. Bread Industry | 1 0 |
| 6530. Cemeteries | 0 9 |
| 6531. Hire-Purchase | 2 3 |
| 6532. Motor Car (Amendment) | 0 9 |
| 6533. Motor Car (Hours of Driving) | 0 6 |
| 6534. Land Settlement | 1 9 |
| 6535. Local Government (Amendment) | 1 6 |
| 6536. Melbourne and Metropolitan Board of Works (Amendment) | 1 3 |
| 6537. Consolidated Revenue | 0 6 |
| 6538. War Veterans' Homes Trust | 1 3 |
| 6539. Frustrated Contracts | 0 6 |
| 6540. Evidence (Amendment) | 0 6 |
| 6541. Amendments Incorporation (Extension) | 0 6 |
| 6542. Melbourne and Richmond Lands | 0 9 |
| 6543. Local Government (Councillors' Declarations) | 0 6 |
| 6544. Transfer of Land (Amendment) | 0 6 |
| 6545. State Savings Bank (Amendment) | 0 6 |
| 6546. Country Roads (Offices and Buildings) | 0 6 |
| 6547. Statute Law Revision | 0 6 |
| 6548. Marriage (Fees) | 0 6 |
| 6549. State Electricity Commission (Hazelwood Power Station) | 0 6 |
| 6550. Fences (Amendment) | 0 6 |
| 6551. Coroners (Amendment) | 0 6 |
| 6552. Stamps | 0 6 |
| 6553. Motor Car (Insurance Surcharge) | 0 6 |
| 6554. Entertainments Tax (Reduction) | 0 6 |
| 6555. Melbourne and Metropolitan Tramways (Amendment) | 0 9 |
| 6556. Local Government (Municipalities Assistance Fund) | 0 6 |
| 6557. Police Offences (Penalties) | 0 6 |
| 6558. Consolidated Revenue | 0 6 |
| 6559. Road Traffic (Infringements) | 0 9 |
| 6560. Superannuation | 0 6 |
| 6561. Crimes (Penalties) | 0 6 |
| 6562. Alphington to East Preston Railway Construction (Housing) | 0 6 |
| 6563. Motor Car | 1 0 |
| 6564. Registration of Births, Deaths and Marriages | 2 3 |
| 6565. Coal Mines (Pensions) | 0 6 |
| 6566. Water Supply Loan Application | 1 3 |
| 6567. Game (Amendment) | 0 6 |

STATE ACTS, 1959—continued.

| No. | Price. s. d. |
|--|-----------------|
| 6568. Metropolitan Fire Brigades (Borrowing Powers) | 0 6 |
| 6569. Health (Amendment) | 0 6 |
| 6570. Police Regulation (Delegation of Powers) | 0 6 |
| 6571. Imprisonment of Fraudulent Debtors (Depositions) | 0 6 |
| 6572. Crimes (Sentences and Parole) | 0 6 |
| 6573. Gas and Fuel Corporation (Colonial Gas Association Undertakings) | 1 3 |
| 6574. Racing (Meetings) | 0 6 |
| 6575. Landlord and Tenant (Amendment) | 0 6 |
| 6576. Distribution of Population (Joint Committee) | 0 6 |
| 6577. Lifts and Cranes | 1 0 |
| 6578. Cemeteries (Investment of Funds) | 0 6 |
| 6579. Public Service (Amendment) | 0 6 |
| 6580. Trustee (Mortgages) | 0 6 |
| 6581. Justices (Amendment) | 0 6 |
| 6582. Water (Irrigation) | 1 9 |
| 6583. Country Fire Authority (Amendment) | 0 6 |
| 6584. Milk Board (Milk Shops) | 0 6 |
| 6585. Forests (Pulpwood Agreement) | 1 3 |
| 6586. Police Offences (Betting) | 0 6 |
| 6587. Revenue Deficit Funding | 0 6 |
| 6588. Geelong Trades Hall Council (Trustees) | 0 6 |
| 6589. Melbourne Harbor Trust (Commissioners) | 0 6 |
| 6590. Railway Loan Application | 1 3 |
| 6591. State Forests Loan Application | 0 6 |
| 6592. Land Tax (Rates) | 0 6 |
| 6593. Teaching Service (Amendment) | 0 6 |
| 6594. Land (Special Grants) | 0 9 |
| 6595. Labour and Industry (Motor Car Shops) | 0 6 |
| 6596. Home Finance (Financial) | 0 6 |
| 6597. Dromana Land (Arthur's Seat Public Park) | 0 6 |
| 6598. Money Lenders (Amendment) | 0 6 |
| 6599. Landlord and Tenant (Fair Rents) | 0 6 |
| 6600. Labour and Industry (Amendment) | 0 6 |
| 6601. Local Government | 0 9 |
| 6602. Public Works Loan Application | 0 6 |
| 6603. Soldier Settlement (Amendment) | 0 6 |
| 6604. Water (Land Reclamation) | 0 6 |
| 6605. Mental Health | 4 3 |
| 6606. Appropriation of Revenue | 7 0 |

Table of Acts and Enactments passed date of operation, &c. 0 6

A. C. BROOKS,
Government Printer.

STATE ACTS, 1960.

COPIES of the following Acts of Parliament of Victoria may be obtained at the Government Printing Office, or from any bookseller, at the price set opposite to each:—

| No. | Price. s. d. |
|--|-----------------|
| 6607. Anzac Day | 1 0 |
| 6608. Agricultural Lime (Amendment) | 0 6 |
| 6609. Motor Car (Commencement) | 0 6 |
| 6610. Fisheries (Change of Title) | 0 6 |
| 6611. Stamps (Amendment) | 0 6 |
| 6612. Land (Public Authorities) | 0 6 |
| 6613. Coal Canal Bridge | 0 6 |
| 6614. Metropolitan Fire Brigades (Borrowing Powers) | 0 6 |
| 6615. Wodonga Lands Exchange | 0 6 |
| 6616. Licensing (Fees) | 0 6 |
| 6617. Home Finance (Loans to Minors) | 0 6 |
| 6618. Co-operative Housing Societies (Amendment) | 0 6 |
| 6619. Racing (Totalizators Extension) | 1 0 |
| 6620. Companies | 0 6 |
| 6621. Judges Salaries and Allowances | 0 6 |
| 6622. Coal Mines (Pensions Contributions) | 0 6 |
| 6623. Landlord and Tenant (Further Amendment) | 0 6 |
| 6624. Public Officers Salaries and Allowances | 0 9 |
| 6625. Legal Profession Practice (Amendment) | 0 6 |
| 6626. Church of England in Australia Constitution | 1 9 |
| 6627. Companies (Fees) | 0 6 |
| 6628. Motor Car (Amendment) | 1 0 |
| 6629. Geelong Waterworks and Sewerage (Amendment) | 0 6 |
| 6630. Latrobe Valley (Financial) | 0 6 |
| 6631. Labour and Industry (Amendment) | 0 6 |
| 6632. Acts Interpretation | 0 6 |
| 6633. Children's Court (Enforcement of Awards) | 0 6 |
| 6634. Supreme Court (Proceedings before Master) | 0 6 |
| 6635. Melbourne and Metropolitan Board of Works (Borrowing Powers) | 0 6 |
| 6636. Electoral Provinces | 0 9 |
| 6637. Town and Country Planning (Amendment) | 0 6 |

STATE ACTS, 1960.—continued.

| No. | Price. s. d. |
|--|-----------------|
| 6638. Racing (Dog Races) | 0 6 |
| 6639. Industrial Safety Advisory Council | 0 6 |
| 6640. Administration and Probate (Offices) | 0 6 |
| 6641. Justices (Bail) | 0 6 |
| 6642. National Parks (Amendment) | 0 9 |
| 6643. Medical (Amendment) | 0 6 |
| 6644. Melbourne Harbor Trust Lands | 1 0 |
| 6645. Weights and Measures (Penalties) | 0 6 |
| 6646. Transfer of Land (Stratum Estates) | 0 6 |
| 6647. Local Government (Preston Streets Agreement) | 0 9 |
| 6648. John Storey Memorial Fund | 0 6 |
| 6649. Police Offences (Amendment) | 0 6 |
| 6650. Motor Car (Third-Party Insurance) | 0 6 |
| 6651. Social Welfare | 2 9 |
| 6652. City of Melbourne Underground Railway Construction | 1 0 |
| 6653. Valuation of Land | 1 3 |
| 6654. Milk Board (Amendment) | 0 6 |
| 6655. Victoria Racing Club (Amendment) | 0 6 |
| 6656. Consolidated Revenue | 0 6 |
| 6657. Consolidated Revenue | 0 6 |
| 6658. Motor Car (Driving) | 0 6 |
| 6659. Licensing (Amendment) | 1 0 |

A. C. BROOKS,
Government Printer.

THE "VICTORIA GOVERNMENT GAZETTE".

SUBSCRIPTIONS.—*The subscription, including postage, is £2 15s. per annum, £1 7s. 6d. half-yearly, or 13s. 9d. per quarter, payable in advance.*

Subscriptions are required to commence and terminate with a month.

A lesser period than three months cannot be subscribed for.

Subscribers do not receive the Acts of Parliament with the GAZETTE.

ADVERTISEMENTS are charged at the rate of 1s. 6d. per line single column, and 3s. per line double column.

The title (£5 Reward, Dissolution of Partnerships, &c.) forms one or more lines as a heading.

On an average, ten words make a line.

Every signature must likewise be counted as a line.

The final words of a paragraph, though only portion of a line, must be counted as one line.

SIGNATURES (in particular) and proper names must be written very plainly in the text; ONE SIDE ONLY of each slip of paper should be WRITTEN UPON.

ALL COMMUNICATIONS should be addressed to "The Government Printer, Melbourne".

ALL DOCUMENTS illegibly written will be returned unpublished, and where brands occur unprovided for by the ordinary letters of the alphabet, a worded explanatory description must be furnished.

THE VICTORIA GOVERNMENT GAZETTE is published on WEDNESDAY EVENING in each week, and Notices for insertion will be received by the Government Printer at or before Two p.m. at ordinary rates, and late advertisements between Two p.m. and Five p.m. at double rates on the day preceding the day of publication.

Single copies of the VICTORIA GOVERNMENT GAZETTE are One shilling, posted One shilling and five pence.

No GAZETTES prior to January, 1950, in stock.

****ALL PAYMENTS ARE REQUIRED IN ADVANCE.—Remittances should be made by postal note, money order, or draft in favour of the Government Printer. Advertisements unaccompanied by a remittance sufficient to cover the cost of insertion will be returned unpublished.*

PUBLICATION OF OFFICIAL MATTER.

ATENTION is invited to the following procedure in relation to the publication of official matter in the *Government Gazette*:—

1. *Matter submitted to the Executive Council.*

Matter submitted to the Executive Council which requires gazettal will normally be published in the issue of the following week.

Where urgent gazettal is required, special arrangements should be made with the *Gazette* Officer.

Publication will be facilitated by the submission of carbon copies for the use of the *Gazette* Officer.

2. Other matter.

(a) All other matter duly certified by a responsible officer for publication should be lodged with the *Gazette* Officer not later than half-past Ten a.m. on Tuesday.

(b) Lengthy or involved notices should be forwarded several days before publication.

(c) Proofs, which will be supplied only when specifically requested, or at the direction of the *Gazette* Officer, should be returned promptly to avoid delay in publication.

(d) No additions or amendments to matter for publication will be accepted by telephone.

TUFF'S SHEPPARTON NEWSAGENCY, 246 Wyndham-street, Shepparton.

C. F. & H. J. VERNON, 162 Bridge-road, Richmond.

VIEW POINT AUTHORIZED NEWSAGENCY, 4 View Point, Bendigo.

E. W. B. WELSH, Hogan-street, Tatura.

A copy of the *Gazette* filed at each place for public reference.

CONTENTS

| AGENTS FOR THE "VICTORIA GOVERNMENT GAZETTE". | PAGE |
|---|------|
| T HE following have been appointed agents to receive Advertisements and Subscriptions for the <i>Victoria Government Gazette</i> :— | |
| ARMSTRONG'S AGENCY, 205 Queen-street, Melbourne. | |
| ARMSTRONG BROS., Kyneton. | |
| MESSRS. ARNALL & JACKSON, 115 Barkly-street, West Brunswick. | |
| MR. WM. DAVIS, Mildura. | |
| A. J. DIGBY (B. S. and N. W. Cash), Main-street, Bairnsdale. | |
| EDGAR'S NEWSAGENCY, Hargreaves-street, Bendigo. | |
| MESSRS. HENRY FRANKS & CO., Booksellers and Stationers, Market-square, Geelong. | |
| MESSRS. GORDON & GOTCH, News Agents, 511 Little Collins-street, Melbourne; and corner Barrack and Clarence streets, Sydney. | |
| GULLAN'S NEWSAGENCY, 88 Bridge-street, Ballarat. | |
| A. C. HAMPTON, 243 Mitchell-street, Bendigo. | |
| MESSRS. HARSTON, PARTRIDGE, & CO., 455 Little Collins-street, Melbourne. | |
| MR. C. L. LATIMER, News Agent, Casterton. | |
| MARTHUR'S AUTHORIZED NEWSAGENCY, 345 Wyndham-street, Shepparton. | |
| MESSRS. R. H. & W. M. PETTY, News Agents, Wangaratta. | |
| MESSRS. POWELL & DIXON, 89 Firebrace-street, Horsham. | |
| J. PURDIE & CO., 138 Moorabool-street, Geelong. | |
| SALE AUTHORIZED NEWSAGENCY, 142 Raymond-street, Sale. | |
| SKINNER'S AUTHORIZED NEWSAGENCY, 49-51 Franklin-street, Traralgon. | |
| MESSRS. SMITH & DUNNON, Hamilton. | |
| THE MERCANTILE EXCHANGE, 380 Collins-street, Melbourne. | |
| A. C. THOMAS, 69 Bridge-street, Benalla. | |
| Acts of Parliament on sale at the Government Printing Office | 3272 |
| Appointments | 3241 |
| Auction Sales Act | 3234 |
| Bank Holidays | 3217 |
| Contracts | 3219 |
| Courts | 3218 |
| Estates of Deceased Persons | 3218 |
| Government Notices | 3217 |
| Holiday—Melbourne Cup Day | 3217 |
| Impoundings | 3272 |
| Lands | 3248 |
| Melbourne and Metropolitan Board of Works—Notice | 3239 |
| Melbourne Cup Day—Public Holiday | 3217 |
| Mining | 3238 |
| Notice to Mariners | 3240 |
| Orders in Council— | |
| Acts—Land | 3242 |
| Grain Elevators; Water; Local Government; Sewerage Districts; River Improvement; Soil Conservation and Land Utilization; Stamps; Landlord and Tenant. <i>et seq</i> | 3244 |
| Private Advertisements | 3262 |
| Proclamations | 3215 |
| Public Service Notices | 3255 |
| Regulations— | |
| Acts—Seeds | 3243 |
| Resignations | 3242 |
| State Rivers and Water Supply Commission | 3235 |
| Tenders | 3259 |
| Transport Regulation Board—Public Hearings | 3236 |
| Waterworks Trusts | 3241 |

[3275]



VICTORIA
GOVERNMENT GAZETTE

Published by Authority

[Registered at the General Post Office, Melbourne, for transmission by post as a newspaper.]

No. 93]

WEDNESDAY, OCTOBER 5

[1960

LEGISLATIVE ASSEMBLY.

THE HONORABLE THE CHIEF SECRETARY.

I HEREBY notify that I have this day issued a Writ for the Election of a Member to serve in the Legislative Assembly of Victoria for the Electoral District of Ballarat North.

| | | |
|---|---------|----------------------|
| Date of Writ | | 5th October, 1960. |
| Day before or on which nominations are to be made | | 24th October, 1960. |
| Day of Polling | | 12th November, 1960. |
| Return of Writ | | 25th November, 1960. |

W. J. F. McDONALD,
Speaker.

Legislative Assembly,
Melbourne, 5th October, 1960.

