



VICTORIA GOVERNMENT GAZETTE

Published by Authority

[Registered at the General Post Office, Melbourne, for transmission by post as a newspaper.]

No. 19]

WEDNESDAY, MARCH 24

[1965

EASTER HOLIDAYS.

It is hereby notified that on—

FRIDAY, THE 16TH,
SATURDAY, THE 17TH,
MONDAY, THE 19TH, and
TUESDAY, THE 20TH APRIL, 1965,

the Public Offices will be closed, such days being appointed by the *Public Service Act 1958* to be observed as holidays in the Public Offices throughout Victoria.

This notice relates only to the closing of the State Public Offices. All inquiries regarding holidays in other offices and in shops and industry should be directed to the Department of Labour and Industry, 110 Exhibition-street, Melbourne, C.1. (Telephone 63 0321, Extension 6158 or 6721.)

A. G. RYLAH,
Chief Secretary.

Chief Secretary's Office,
Melbourne, C.1, 22nd March, 1965.

PUBLICATION OF THE "VICTORIA GOVERNMENT GAZETTE".

EASTER HOLIDAYS.

BECAUSE of the Easter Holidays, the *Victoria Government Gazette* will be published on—

FRIDAY, THE 23RD APRIL, 1965,
instead of Wednesday, the 21st April, 1965.

All official matter for publication therein should be lodged with the *Gazette Officer*, Chief Secretary's Department (Telephone Extension 6282), not later than 10.30 a.m. on Thursday, the 22nd April, 1965.

A. C. BROOKS,
Government Printer.

POISONS ACT 1962 (No. 6889).

PROCLAMATION

By His Excellency the Governor of the State of Victoria and its Dependencies in the Commonwealth of Australia, &c., &c., &c.

WHEREAS by section 4 of the *Poisons Act 1962* it is amongst other things enacted that the Governor in Council may by Proclamation published in the *Government Gazette* amend any of Schedules One, Two, Three, Four, Five, Six, Seven or Eight to the said Act by adding to any such Schedule or removing therefrom any item:

Now, therefore, I, the Governor of the State of Victoria in the Commonwealth of Australia by and with the advice of the Executive Council of the said State do by this Proclamation—

1. Amend Schedule Two by deleting therefrom the following items—

CARBOLIC ACID (Phenol) or its homologues and substances containing more than 3 per centum by weight of Carboloc Acid or its homologues.

CREOSOTE and substances for therapeutic use containing more than 3 per centum of Creosote by weight.

CRESOL and substances containing more than 3 per centum of Cresol by weight.

and by adding thereto the following item—

CREOSOTE, cresol, phenol (carbolic acid), any homologue of phenol boiling below 220°C. and preparations containing more than 3 per centum by weight of such substances or homologues when such substances homologues or preparations are for therapeutic use.

2. Amend Schedule Four by adding thereto the following item—

DIOXYAMIDOPYRIN.

3. Amend Schedule Five by deleting therefrom the following item—

CARBOLIC ACID (Phenol) and its Homologues in substances containing 3 per centum or less by weight of Carboloc Acid or its homologues, except—

(a) Chlorinated derivatives of such poisons used for germicidal or antiseptic purposes; and

(b) Carvacol thymol and tertiary butyl-cresol.

4. Amend Schedule Six by adding thereto the following item—

CREOSOTE, cresol, phenol (carbolic acid), any homologue of phenol boiling below 220°C. and preparations containing more than 3 per centum by weight of such substances or homologues except when such substances homologues or preparations are included in Schedule Two.

Given under my Hand and the Seal of the State of Victoria aforesaid, at Melbourne, this sixteenth day of March in the year of our Lord One thousand nine hundred and sixty-five, and in the fourteenth year of the reign of Her Majesty Queen Elizabeth II.

(L.S.)

ROHAN DELACOMBE.

By His Excellency's Command,

R. W. MACK,
Minister of Health.

GOD SAVE THE QUEEN !

PUBLIC HIGHWAYS.—CITY OF OAKLEIGH.

PROCLAMATION

By His Excellency the Governor of the State of Victoria and its Dependencies in the Commonwealth of Australia, &c., &c., &c.

WHEREAS by the Local Government Act 1958, as amended, Section 519, it is amongst other things enacted that it shall be lawful for the Governor-in-Council at any time and from time to time upon request of the Council of any municipality by notice in the Government Gazette to proclaim any land reserved used or by purchase or exchange acquired for a street road highway thoroughfare bridge square court alley or right-of-way or any street road lane or passage made or laid out or proposed to be made or laid out on land of which a plan delineating that street road lane or passage has been lodged with the Registrar of Titles to be a public highway and that such land shall thereupon and thenceforth from the date of such proclamation become and be absolutely dedicated to the public as a public highway within the meaning of any law then or thereafter in force:

AND WHEREAS the Council of the City of Oakleigh has requested that the lands hereinafter mentioned, used for streets, be so declared to be public highways.

NOW THEREFORE I, the Governor of the State of Victoria in the Commonwealth of Australia, by and with the advice of the Executive Council of the said State, do by this Proclamation declare that the roads forming Burlington Square, Oakleigh, shown hatched on the plan hereunder, shall be public highways within the meaning of the said Act.

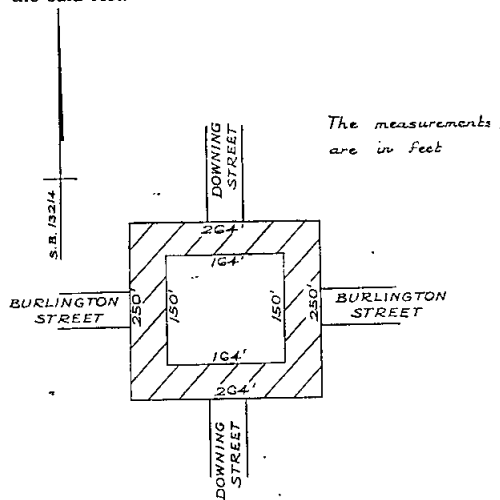

Given under my Hand and the Seal of the State of Victoria aforesaid, at Melbourne, this sixteenth day of March, in the year of Our Lord One thousand nine hundred and sixty-five, and in the fourteenth year of the reign of Her Majesty Queen Elizabeth II.

(L.S.) ROHAN DELACOMBE.

By His Excellency's Command,
R. J. HAMER,
Minister for Local Government.
GOD SAVE THE QUEEN!

PUBLIC HIGHWAY.—SHIRE OF FRANKSTON.

PROCLAMATION

By His Excellency the Governor of the State of Victoria and its Dependencies in the Commonwealth of Australia, &c., &c., &c.

WHEREAS by the Local Government Act 1958, as amended, Section 519, it is amongst other things enacted that it shall be lawful for the Governor-in-Council at any time and from time to time upon request of the Council of any municipality by notice in the Government Gazette to proclaim any land reserved used or by purchase or exchange acquired for a street road highway thoroughfare bridge square court alley or right-of-way or any street road lane or passage made or laid out

or proposed to be made or laid out on land of which a plan delineating that street road lane or passage has been lodged with the Registrar of Titles to be a public highway and that such land shall thereupon and thenceforth from the date of such proclamation become and be absolutely dedicated to the public as a public highway within the meaning of any law then or thereafter in force:

AND WHEREAS the Council of the Shire of Frankston has requested that the land hereinafter mentioned, being a street made or laid out or proposed to be made or laid out on land of which a plan delineating that street has been lodged with the Registrar of Titles, be so declared to be a public highway.

NOW THEREFORE I, the Governor of the State of Victoria in the Commonwealth of Australia, by and with the advice of the Executive Council of the said State, do by this Proclamation declare that all the piece of land, being part of Ashleigh Avenue, Frankston, shown hatched on the plan hereunder, shall be a public highway within the meaning of the said Act.

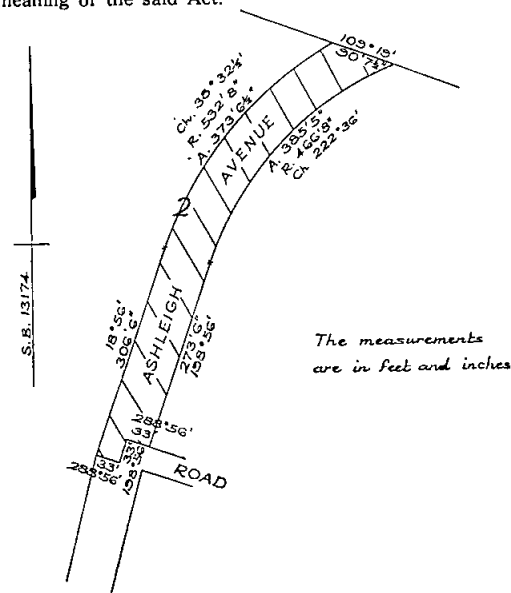

Given under my Hand and the Seal of the State of Victoria aforesaid, at Melbourne, this sixteenth day of March, in the year of Our Lord One thousand nine hundred and sixty-five, and in the fourteenth year of the reign of Her Majesty Queen Elizabeth II.

(L.S.) ROHAN DELACOMBE.

By His Excellency's Command,
R. J. HAMER,
Minister for Local Government.
GOD SAVE THE QUEEN!

PUBLIC HIGHWAY.—SHIRE OF FRANKSTON.

PROCLAMATION

By His Excellency the Governor of the State of Victoria and its Dependencies in the Commonwealth of Australia, &c., &c., &c.

WHEREAS by the Local Government Act 1958, as amended, Section 519, it is amongst other things enacted that it shall be lawful for the Governor-in-Council at any time and from time to time upon request of the Council of any municipality by notice in the Government Gazette to proclaim any land reserved used or by purchase or exchange acquired for a street road highway thoroughfare bridge square court alley or right-of-way or any street road lane or passage made or laid out or proposed to be made or laid out on any land of which a plan delineating that street road lane or passage has been lodged with the Registrar of Titles to be a public highway and that such land shall thereupon and thenceforth from the date of such proclamation become and be absolutely dedicated to the public as a public highway within the meaning of any law then or thereafter in force:

AND WHEREAS the Council of the Shire of Frankston has requested that the land hereinafter mentioned, being a street made or laid out or proposed to be made or laid out on land of which a plan delineating that street has been lodged with the Registrar of Titles, be so declared to be a public highway.

NOW THEREFORE I, the Governor of the State of Victoria in the Commonwealth of Australia, by and with the advice of the Executive Council of the said State, do by this Proclamation declare that portion of Railway Parade, Seaford, shown hatched on the plan hereunder, shall be a public highway within the meaning of the said Act.

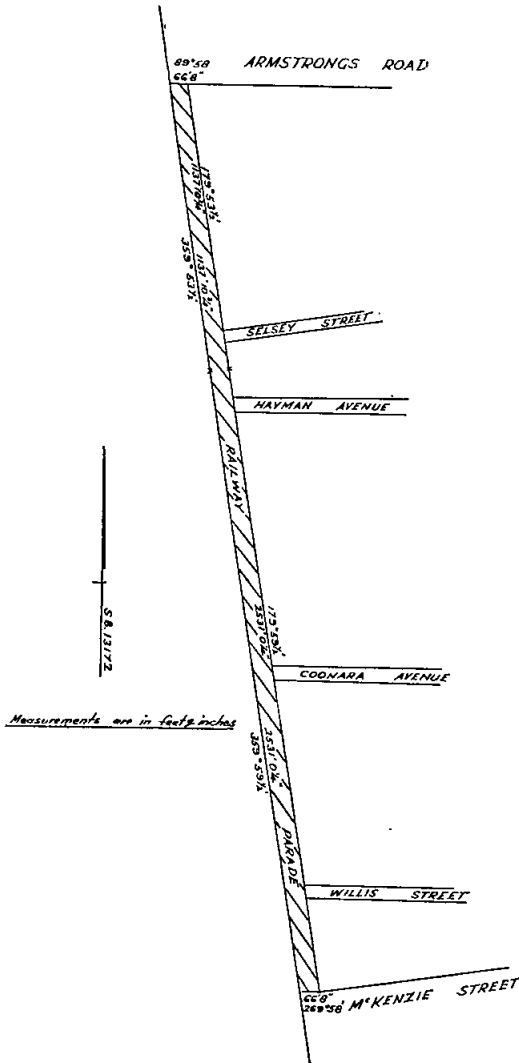

Measurements are in feet and inches

Given under my Hand and the Seal of the State of Victoria aforesaid, at Melbourne, this sixteenth day of March, in the year of Our Lord One thousand nine hundred and sixty-five, and in the fourteenth year of the reign of Her Majesty Queen Elizabeth II.

(L.S.) ROHAN DELACOMBE.

By His Excellency's Command,
R. J. HAMER,
Minister for Local Government.
GOD SAVE THE QUEEN!

PUBLIC HIGHWAYS.—SHIRE OF WARRACKNABEAL.

PROCLAMATION

By His Excellency the Governor of the State of Victoria and its Dependencies in the Commonwealth of Australia, &c., &c., &c.

WHEREAS by the Local Government Act 1958, as amended, Section 519, it is amongst other things enacted that it shall be lawful for the Governor-in-Council at any time and from time to time upon request of the Council of any municipality by notice in the Government Gazette to proclaim any land reserved used or by purchase or exchange acquired for a street road highway thoroughfare bridge square court alley or right-of-way or any street road lane or passage made or laid out or proposed to be made or laid out on any land of which a plan delineating that street road lane or passage has been lodged with the Registrar of Titles to be a public highway and that such land shall thereupon and thenceforth from the date of such proclamation become and be absolutely dedicated to the public as a public highway within the meaning of any law then or thereafter in force:

AND WHEREAS the Council of the Shire of Warracknabeal has requested that the lands hereinafter mentioned being streets laid out on land of which a plan delineating the said streets has been lodged with the Registrar of Titles be so declared to be public highways:

NOW THEREFORE I, the Governor of the State of Victoria in the Commonwealth of Australia, by and with the advice of the Executive Council of the said State, do by this Proclamation declare that all those pieces of land being Sherlinga Street and Dermal Street coloured brown on Plan of Subdivision No. 44858 lodged in the Office of Titles shall be public highways within the meaning of the said Act.

Given under my Hand and the Seal of the State of Victoria aforesaid, at Melbourne, this sixteenth day of March, in the year of Our Lord One thousand nine hundred and sixty-five, and in the fourteenth year of the reign of Her Majesty Queen Elizabeth II.

(L.S.) ROHAN DELACOMBE.

By His Excellency's Command,
R. J. HAMER,
Minister for Local Government.

GOD SAVE THE QUEEN!

BANK HALF-HOLIDAY.

PROCLAMATION.

By His Excellency the Governor of the State of Victoria and its Dependencies in the Commonwealth of Australia, &c., &c., &c.

IN pursuance of the provisions of the Bank Holidays Act 1958, I, the Governor of the State of Victoria, in the Commonwealth of Australia, do by this my Proclamation appoint the day and date named hereunder a special day to be observed as a Bank Half-Holiday at the place mentioned, that is to say:—

Bank Half-Holiday from the Hour of Eleven a.m.—

THURSDAY, THE 8TH APRIL, 1965, at Hamilton.

Given under my Hand and the Seal of the State of Victoria aforesaid, at Melbourne, this twenty-third day of March, in the year of our Lord One thousand nine hundred and sixty-five, and in the fourteenth year of the reign of Her Majesty Queen Elizabeth II.

(L.S.) ROHAN DELACOMBE.

By His Excellency's Command,
V. F. WILCOX,
for Chief Secretary.
GOD SAVE THE QUEEN!

Fisheries Act 1958.

NOTICE OF INTENTION TO PROHIBIT FISHING IN CERTAIN WATERS.

IT is hereby notified for general information that it is intended after the expiration of one month from the date of publication of this notice in the *Government Gazette* to move His Excellency the Governor in Council to make a Proclamation to provide as follows:—

A. Revoke the whole of all Proclamations previously published in the *Government Gazette* relating to closed periods for fishing in various streams and waters throughout the State for various periods of the year.

B. Prohibit all fishing in or the taking of fish from the under-mentioned waters and any waters which flow either directly or indirectly thereto and the waters impounded by any weir wall or dam constructed thereon during the period from the first day of May in each year to the last day preceding the first Saturday in September next following, both dates inclusive.

Agnes River—Above or upstream from the bridge over such river on the South Gippsland Highway.
 Aire River—Above or upstream from the bridge over such river on the Great Ocean-road.
 Albert River—Above or upstream from the bridge over such river on the South Gippsland Highway.
 Avoca River—Above or upstream from a point situated 50 yards below its junction with Mountain Creek.
 Avon River (Gippsland)—Above or upstream from the bridge over such river known as the Clydebank Bridge.
 Barham River—Above or upstream from an imaginary line from a post erected on the bank of such river adjacent to the Shire Pound to a post erected on the opposite bank of the said river.
 Barwon River—Above or upstream from a point situated 50 yards below its junction with the Moorabool River.
 Bet Bet or Deep Creek—Above or upstream from its junction with Carmanuel Creek.
 Boggy Creek—Above or upstream from its junction with the King River.
 Broken River—Above or upstream from the bridge over such river at Swanpool.
 Bruthen Creek—Above or upstream from the bridge over such creek on the Yarram-Sale road.
 Bunroy Creek—Above or upstream from its junction with the River Murray.
 Bunyip River (including Main Drain)—Above or upstream from the railway bridge over such river on the Melbourne-Yarram railway line, but not including Whisky, Gum Scrub, Dingley Dell, Muddy and Brandy Creeks (tributaries of the Tarago River) in which waters all fishing is prohibited during the whole year nor that portion of the Bunyip River and its tributaries upstream from a point 50 yards above its junction with the Tarago River and including Back Creek and its tributaries nor Ararat Creek above or upstream from the bridge over such Creek on the Princes Highway in which waters all fishing is prohibited from 1st May to the day preceding the second Saturday in December (both days inclusive) in each year.
 Burrowye Creek—Above or upstream from its junction with the River Murray.
 Campaspe River—Above or upstream from the bridge at Mia Mia (but not including the Lauriston, Malmsbury and Upper Coliban Reservoirs and the waters connecting these reservoirs, all of which are open to fishing for the whole year).
 Cardinia Creek—Downstream from Princes Highway.
 Carrum Creek—See Eumemmering Creek.
 Carisbrook Creek—Above or upstream from the bridge over such creek on the Great Ocean-road.
 Coliban River—Above or upstream from the bridge at Lyell.
 Cooyatong or Koetong Creek—Above or upstream from its junction with the River Murray.
 Creightons Creek—Above or upstream from the bridge over such creek on the Hume Highway.
 Cudgewa Creek—Above or upstream from its junction with the River Murray.
 Cumberland River—Above or upstream from the bridge over such river on the Great Ocean-road.
 Curdies River—Above or upstream from the bridge over such river on the Timboon-Nirranda road.
 Dandenong Creek—Above or upstream from Pillar's Bridge.
 Deep Creek—See Bet Bet Creek.
 Deep Creek—See Maribyrnong River.
 Eglinton or Johnson's Creek—Above or upstream from its junction with the Goulburn River.
 Erskine River—Above or upstream from the bridge over such river on the Great Ocean-road.
 Eumemmering Creek or Patterson River—Above or upstream from the Wells-road Bridge and including the cut from Dandenong Creek.
 Eumeralla River—Above or upstream from the bridge over such river on the Princes Highway.
 Fifteen Mile Creek—Above or upstream from the bridge over such creek on the Hume Highway.

Fitzroy River—Above or upstream from a point 50 yards below its junction with Darlot's Creek.
 Flaggy Creek—Above or upstream from its junction with the River Murray.
 Ford River—Above or upstream from the bridge over such river on the Great Ocean-road.
 Franklin River—Above or upstream from the bridge over such river on the South Gippsland Highway.
 Gellibrand River—Above or upstream from the bridge over such river on the Great Ocean-road to the bridge over it at Gellibrand on the Colac to Gellibrand-road.
 George River—Above or upstream from a point on such stream distant 200 yards above the bridge over such river on the Great Ocean-road.
 Geromal Creek or Jeremal Creek—See Jeremal Creek.
 Glenelg River—Above or upstream from a point 50 yards below its junction with the Crawford River, but not including the waters of Rocklands Reservoir.
 Goulburn River—Upstream from the Hume Highway Bridge near Seymour (but not including the Eildon Reservoir and the Pondage Dam at Eildon, which waters are open the whole year).
 Grey River—Above or upstream from the Great Ocean-road.
 Holland's Creek, sometimes called Hollands Branch—Above or upstream from its junction with the Broken River.
 Home Creek—Above or upstream from its junction with the Goulburn River.
 Honeysuckle Creek—Above or upstream from the bridge over such creek on the Hume Highway.
 Hopkins River—Above or upstream from the bridge over such river on the Princes Highway to the bridge over such river at Wickliffe.
 Hughes Creek—Above or upstream from the bridge over such creek on the Goulburn Valley Highway.
 Jeremal Creek or Geromal Creek—Above or upstream from its junction with the River Murray.
 Johnson's or Eglinton Creek—See Eglinton Creek.
 Joyce's Creek—Above or upstream from the bridge over such stream on the main Newstead-Maryborough road.
 Kennett River—Above or upstream from a point on such stream distant 200 yards above the bridge over such river on the Great Ocean-road.
 Kiewa River—Above or upstream from Keegan's Bridge, also known as Keighans Bridge, over such river at Dederang.
 King River—Above or upstream from the bridge over such river at Moyhu.
 Koetong or Cooyatong Creek—See Cooyatong Creek.
 Lang Lang River—Above or upstream from the bridge over such river on the South Gippsland Highway to the bridge over it at Heath Hill.
 Latrobe River—Above or upstream from Princes Highway Bridge at Rosedale (but not including the Yalourn Storage Dam and the Hazelwood Pondage Dam, in both of which waters fishing is permitted during the whole year).
 Little Snowy Creek—Above or upstream from its junction with the Mitta Mitta River.
 Loddon River—Above or upstream from the bridge over such river at the Township of Newstead.
 Mackenzie River—Above or upstream from the water distribution heads at Laharum, but not including Wartook Reservoir, which is open for the whole year.
 Maribyrnong River (or Saltwater River or Deep Creek)—Above or upstream from Solomon's Ford at Braybrook.
 Merrimans Creek—Above or upstream from the bridge over such creek on the Yarram-Sale road.
 Merri River—Above or upstream from the bridge over such river on the Princes Highway.
 Mitchell River—Above or upstream from the Wy-Yung-road Bridge.
 Mitta Mitta River—Above or upstream from the bridge over such river on the Eskdale-Mitta Mitta North road.
 Mt. Ida Creek—Above or upstream from the McIvor Highway Bridge at Derrinal.
 Mt. William Creek—Above or upstream from a point 50 yards below its junction with Fyans Creek.
 Moyne River—Above or upstream from the bridge over such river on the Princes Highway.
 Nicholson River—Above or upstream from the bridge over such river on the Omeo Highway.
 Omeo Creek—Above or upstream from its junction with the River Murray.
 Ovens River—Above or upstream from the bridge over such river at Rocky Point (but not including Lake Catani nor the new reservoir on Mt. Buffalo, in which waters fishing is permitted for the whole year).
 Patterson River—See Eumemmering Creek.
 Reedy or Young's Creek (sometimes called Wooragee Creek)—Above or upstream from its junction with Spring Creek (also known as Reid's Creek).

- Thomson River—Above or upstream from Pearson's Bridge near Sale (but not including Glenmaggie Weir, the waters of which are open for the whole year).
- Saltwater River—See Maribyrnong River.
- Seven Creeks—Above or upstream from the bridge over such creek at Morgan's Reserve, approximately 5 miles downstream from Euroa.
- Shaw River—Above or upstream from the bridge over such river on the Princes Highway.
- Sherbrook River—Above or upstream from the bridge over such river on the Great Ocean-road.
- Skenes Creek—Above or upstream from the bridge over such creek on the Great Ocean-road.
- Smythes Creek—Above or upstream from the bridge over such creek on the Great Ocean-road.
- Snowy River—Above or upstream from the bridge over such river on the Princes Highway.
- Stockyard Creek—Above or upstream from the bridge over such creek on the Princes Highway at Foster.
- Stony Creek—Above or upstream from the Great Ocean-road.
- Sunday Creek—Above or upstream from its junction with Sugarloaf Creek.
- Surry River—Above or upstream from the bridge over such river on the Princes Highway.
- Tallangatta Creek—Above or upstream from its junction with the Mitta Mitta River.
- Tambo River—Above or upstream from the bridge over such river at Tambo Upper.
- Tarra River—Above or upstream from the Yarram Water Trust Weir.
- Tarwin River—Above or upstream from the bridge over such river on the South Gippsland Highway.
- Tullaroop or Deep Creek—Above or upstream from its junction with the Loddon River (but not including Tullaroop or Newlyn Reservoirs, which are open to fishing for the whole year).
- Werribee River—Above or upstream from the Ford near Corpus Christi College at Werribee (but not including the waters of Melton Reservoir, also known as Exford Weir, nor the waters of Pykes Creek Reservoir, which waters are open for the whole year).
- Wild Dog Creek—Above or upstream from the bridge over such creek on the Great Ocean-road.
- Wild Duck Creek—Above or upstream from the new bridge on the McIvor Highway.
- Woody Yallock Creek—Above or upstream from its junction with Currajuruk Creek.
- Wye River—Above or upstream from a point on such stream distant 200 yards above the bridge over such river on the Great Ocean-road.
- Yackandandah Creek—Above or upstream from its junction with the Kiewa River.
- Yarra River—Above or upstream from the bridge over such river at Maroondah Highway, approximately 3 miles south of Healesville.
- C. Prohibit all fishing in or the taking of fish from the under-mentioned waters and any waters which flow either directly or indirectly thereto and the waters impounded by any weir wall or dam constructed thereon during the period in each year from the first day of May to the last day preceding the second Saturday in December next following both days inclusive.
- Ararat Creek—Above or upstream from the bridge over such creek on the Princes Highway.
- Bass River—Above or upstream from the bridge over such river at the Township of Bass.
- Bunyip River—Above or upstream from a point 50 yards above its junction with the Tarago River.
- Cardinia Creek—Above Princes Highway.
- Gellibrand River—Above or upstream from the bridge over such river at Gellibrand on the Colac to Gellibrand-road.
- Lang Lang River—Above or upstream from the Heath Hill Bridge.
- Tarra River—Above or upstream from the bridge over such river on the Pound-road to the Yarram Water Trust Weir.
- D. Prohibit all fishing in or the taking of fish from the under-mentioned waters and any waters which flow either directly or indirectly thereto and the waters impounded by any weir wall or dam constructed thereon during the period in each year from midnight on the last Sunday in August to the last day preceding the last Saturday in November (inclusive).
- Beveridge Anabranche (also known as the Little Murray)—The whole of such water from its junction with the River Murray near Swan Hill to its junction with the River Murray near Beverford.
- Broken Creek—The whole of such stream from its junction with the Broken River to its junction with the River Murray.
- Broken River—Downstream from the bridge over such river at Swanpool.
- Campaspe River—Downstream from the bridge over such river on the Murray Valley Highway.
- Chaika Creek—Upstream from its junction with the River Murray.
- Deegay Ponds—See Major's Creek.
- Gardiner's Creek—See Mitchell's Creek.
- Goulburn River—Downstream from the Hume Highway Bridge near Seymour, but not including the tributaries of such river, excepting Mitchell's Creek, Majors Creek or Deegay Ponds, Broken River and Hughes Creek, listed separately herein.
- Gunbower Creek—The whole of such creek.
- Hughes Creek—Downstream from the Goulburn Valley Highway.
- Kiewa River—Downstream from Keegan's Bridge, also known as Keighan's Bridge, over such river at Dederang.
- King River—Downstream from the bridge over such river at Moyhu.
- Loddon River—Downstream from a point 200 yards downstream from the Laanecoore Weir, but not including the tributaries of such portion of the river except the Marraboor River listed herein.
- Marraboor River (also known as the Little Murray)—The whole of such river downstream from its junction with the Loddon River to its junction with the River Murray.
- Major's Creek (or Deegay Ponds)—Upstream from its junction with the Goulburn River near Mitchellstown.
- Mitchell's Creek (or Gardiner's Creek)—Upstream from its junction with Major's Creek (near Mitchellstown).
- Mitta Mitta River—Downstream from the bridge over such river on the Eskdale-Mitta Mitta North road to the rail and road bridge at Tallangatta East, and in all that portion of the Mitta Mitta Arm of the Hume Reservoir and backwaters between such two bridges.
- Ovens River—Downstream from the bridge over such river at Rocky Point, but not including that portion of Reedy or Youngs Creek (sometimes called Wooragee Creek) and its tributaries upstream from its junction with Spring Creek (also known as Reids Creek) in which water all fishing is prohibited from the 1st day of May to the day preceding the first Saturday in September (both days inclusive) in each year.
- Taylor's Lake (near Horsham)—The whole of such lake.
- E. Prohibit all fishing in or the taking of fish from the under-mentioned waters and any waters which flow either directly or indirectly thereto, and the waters impounded by any weir wall or dam constructed thereon during the period in each year from the first day of January to the 31st day of December next following, both days inclusive.
- Bellarine Storage Reservoir, Parish of Bellarine.
- Big Hill Reservoir, Parish of Mandurang.
- Brandy Creek—Upstream from its junction with Tarago River.
- Crusoe Reservoir, Parish of Mandurang.
- Dingley Dell Creek—Upstream from its junction with Tarago River.
- Flagstaff Reservoir, Parish of Sandhurst.
- Golden Point Reservoir, Parish of Faraday.
- Gum Scrub Creek—Upstream from its junction with Tarago River.
- Lawson Reservoir, Parish of Maldon.
- Lower Reservoir, Parish of Maldon.
- Morton's Cutting, which enters Lake Learmonth.
- Muddy Creek—Upstream from its junction with Tarago River.
- No. 7 Reservoir, Parish of Mandurang.
- Poverty Gully Reservoir, Parish of Castlemaine.
- Specimen Hill Reservoir, Parish of Sandhurst.
- Upper Reservoir, Parish of Maldon.
- Waurm Ponds Service Basin, Parish of Duneed.
- Whisky Creek—Upstream from its junction with Tarago River.
- F. Prohibit all fishing in or the taking of fish from Lake Wendouree, Ballarat, between the hours of 10 p.m. on any day throughout the year and 4 a.m. on the following day.

A. G. RYLAH,
Chief Secretary.
A. DUNBAVIN BUTCHER,
Director of Fisheries and Wildlife.

The Fisheries Act.

NOTICE OF INTENTION TO REVOKE THE CLOSE SEASON FOR TROUT.

IT is hereby notified for general information that it is intended after the expiration of one month from the date of publication of this notice in the *Government Gazette* to move His Excellency the Governor in Council to make a Proclamation revoking the Proclamation made the 2nd day of October, 1951, and published in the *Government Gazette* of the 3rd day of October, 1951, respecting the Close Season for Trout.

A. G. RYLAH,
Chief Secretary.
A. DUNBAVIN BUTCHER,
Director of Fisheries and Wildlife.

Country Fire Authority Act 1958.

VARIATION OF SUMMER PERIOD IN RESPECT OF SPECIFIED PARTS OF THE COUNTRY AREAS OF VICTORIA.

WHEREAS by section 4 of the *Country Fire Authority Act 1958* it is enacted that the Chief Secretary of Victoria, after consultation with the Minister of Forests, may from time to time by declaration published in the *Government Gazette* declare any period to be the summer period in respect of the country area of Victoria, or any specified part or parts thereof and, without affecting the generality of the foregoing, may declare different periods to be the summer period in respect of different parts of the said country area:

And whereas by the said section it is further enacted that any declaration so published may be revoked, amended or varied by a subsequent declaration so published:

And whereas by declaration issued on the date stated in Schedule A annexed hereto, different summer periods expiring on the thirtieth day of April, 1965, were declared in respect of different parts of the country area of Victoria, including the parts of the said country area specified in Schedule B hereto:

And whereas the Chief Secretary and the Minister of Forests have consulted accordingly:

Now therefore I, the Chief Secretary of Victoria, do by this my declaration vary the aforesaid declaration by declaring that the summer period in respect of the parts of the country area of Victoria specified in Schedule B hereto shall end at midnight on the twenty-seventh day of March, 1965.

SCHEDULE A.

Date of Declaration; Date of Publication in "Government Gazette".

24th November, 1964; 25th November, 1964.
1st December, 1964; 2nd December, 1964.

SCHEDULE B.

Those portions of the Eighteenth Fire Control Region, comprised by the municipal districts of the City of Swan Hill and the Shires of Karkaroc, Swan Hill and Walpeup;

those portions of the Twentieth Fire Control Region, comprised by the municipal districts of the Shires of Birchip, Charlton, Donald and Wycheproof.

V. F. WILCOX,
for Chief Secretary.

Chief Secretary's Office,
Melbourne, 23rd March, 1965.

APPOINTMENT OF COMMITTEE OF MANAGEMENT OF "TANJIL BREN VILLAGE".

WHEREAS by section 50 of the *Forests Act 1958* (No. 6254), it is provided that the Minister of Forests may, on the recommendation of the Forests Commission, appoint any number of persons, not less than three, to be a Committee of Management of any land forming part of any reserved forest, such land being set aside and declared to be a site for a village, and may remove any of those persons: Now therefore, I, Lindsay Hamilton Simpson Thompson, Her Majesty's Minister of Forests in the State of Victoria, on the recommendation of the Forests Commission, do hereby appoint—

G. ROBERTS, and
J. H. COSSTICK,

vice H. F. McCay and J. M. Haig respectively, as members of the Committee of Management until the 23rd day of April, 1966, of the land forming part of the reserved forest in the Parish of Fumina North, County of Buln Buln, described in the accompanying Schedule, and known as the Tanjil Bren Village.

SCHEDULE ABOVE REFERRED TO.

Parish of Fumina North, County of Buln Buln, comprising 47 acres, more or less, as shown within red border on plan marked A60/1246, over 18.7.63, file of correspondence No. 60/1246, in the Forests Department.

Dated at Melbourne, the 19th day of March, 1965.

L. H. S. THOMPSON,
Minister of Forests.

SECOND UNITED PERMANENT BUILDING SOCIETY.

NOTICE is hereby given that by Order dated the 23rd March, 1965, and published in the *Government Gazette* of the 24th March, 1965, the Governor in Council has applied the provisions of section 21c (2) of the *Building Societies Act 1958* to the Second United Permanent Building Society, whose registered office is situated at 505 St. Kilda-road, Melbourne.

While this Order is in force the society may not, except with the consent of the Registrar of Building Societies—

- (a) accept the deposit of or otherwise borrow any money;
- (b) accept any payment representing the whole or any part of the amount due by way of subscription for a share in the society other than a payment—
 - (i) which fell due before the making of the Order applying this sub-section to the society; or
 - (ii) for a share in the society which is charged with the repayment of an advance made to a member; or
 - (iii) for any share upon which an advance has been made and which is payable in respect of such share under any mortgage or other security or under the rules of the society; or
- (c) dispose or deal with any property or assets of the society.

A. DOUGLAS,
Registrar of Building Societies.

UNITED PERMANENT BUILDING SOCIETY.

NOTICE is hereby given that by Order dated the 23rd March, 1965, and published in the *Government Gazette* of the 24th March, 1965, the Governor in Council has applied the provisions of section 21c (2) of the *Building Societies Act 1958* to the United Permanent Building Society, whose registered office is situated at 505 St. Kilda-road, Melbourne.

While this Order is in force the society may not, except with the consent of the Registrar of Building Societies—

- (a) accept the deposit of or otherwise borrow any money;
- (b) accept any payment representing the whole or any part of the amount due by way of subscription for a share in the society other than a payment—
 - (i) which fell due before the making of the Order applying this sub-section to the society; or
 - (ii) for a share in the society which is charged with the repayment of an advance made to a member; or
 - (iii) for any share upon which an advance has been made and which is payable in respect of such share under any mortgage or other security or under the rules of the society; or
- (c) dispose or deal with any property or assets of the society.

A. DOUGLAS,
Registrar of Building Societies.

Town and Country Planning Act 1961.

GEELONG PLANNING SCHEME 1959—AMENDMENT No. 4, 1963—(CITY OF GEELONG WEST).

NOTICE OF APPROVAL.

IN pursuance of the powers conferred by the *Town and Country Planning Act 1961*, the Governor in Council, on the 23rd March, 1965, approved a planning scheme entitled the Geelong Planning Scheme 1959, Amendment No. 4, 1963 (City of Geelong West), in respect of the municipal district of the City of Geelong West.

A copy of the planning scheme as approved may be inspected during office hours at the office of the Town and Country Planning Board, 179 Queen-street, Melbourne; at the office of the City of Geelong West, Geelong West; and, when available, at the Office of Titles, Melbourne, and at the Central Plan Office of the Department of Crown Lands and Survey, Melbourne.

W. H. CRAIG, Secretary,
Town and Country Planning Board.

CONTRACTS ACCEPTED.—(Series 1965-66.)

Table with 5 columns: Contract No., Particulars, Amount, Name of Contractor, Charge against Vote or Fund. It lists contract 1 for General Stores and sub-contractors 2-5 for Motor Spirit, Kerosene, and Lubricants.

Approved—H. E. BOLTE, Treasurer.—15.3.65

ANNEX TO CONTRACTS Nos. 1965/1 TO 1965/5. Schedule No. 56.

MOTOR SPIRIT, KEROSENE, AND LUBRICANTS.

CONTRACT FROM 1ST APRIL, 1965, TO 31ST MARCH, 1966.

- 1965/1.—BP Australia Ltd. Security, £200.
1965/2.—Castrol Ltd. Security, £200.
1965/3.—Esso Standard Oil Australia Ltd. Security, £200.
1965/4.—Mobil Oil Australia Ltd. Security, £200.
1965/5.—The Shell Co. of Australia Ltd. Security, £200.

The rates shown are F.O.R. Melbourne, and cover delivery within the Metropolitan Free Delivery Area ; for supplies outside that area, other than those forwarded on Stores and Transport Consignment Notes, freight differentials in accordance with the Contractors' differential lists are to be added.

Drums (4-gallon) become the property of the Government. Drums (44-gallon) will be charged at £2 each. This charge will be debited against Departments and credit will be allowed in full on return of drums in good order and condition.

Officers are required to return drums to the point of delivery within a reasonable time.

Main table with 4 columns: Item No., Description of Articles, Rate, Name of Contractor. Lists various oil products like Motor Spirit, Kerosene, Diesel Oil, and Greases with their respective rates and contractors.

* Rates Less 2½% for prompt payment.

† Rates calculated on prices for 45-gallon drums. (Drums credited 30s. on return). Differential rates for smaller containers. For 124-gallon containers add 1s. 8d. per gallon (Drums credited on 20s. return).

‡ Rates calculated on prices for 45-gallon drums. (Drums credited 30s. on return). Differential rates for smaller containers. For 100-lb. containers add 2½d. per lb.

Officers driving Government-owned vehicles must purchase supplies, other than those available from Government bulk storage, from distribution points controlled by Mobil Oil Australia Ltd. as listed hereunder:—

- Albury, Ararat, Archies Creek, Bairnsdale, Ballarat, Balmoral, Benalla, Bendigo, Brim, Camperdown, Casterton, Charlton, Colac, Corryong, Dimboola, Donald, Echuca, Fish Creek, Geelong, Hamilton, Hopetoun, Horsham, Jeparit, Kerang, Kyneon, Leongatha, Manangatang, Maryborough, Meringur, Mildura, Mt. Arnaud, Stawell, Swan Hill, Swifts Creek, Tocumwal, Traralgon, Wahgunyah, Wangaratta, Warracknabeal, Warragul, Warrnambool, Wentworth, N.S.W., Werrimull, Wonthaggi, Wycheproof, Yarraw.

Metropolitan Location will be published in Government Gazette of 31st March, 1965.

CONTRACTS ACCEPTED.—(Series 1964-65.)**CEREALS.**

Requirements under Sub-schedule 10 of Schedule No. 1 for the month of April, 1965, are to be purchased from the under-mentioned firms at the rates per cwt. respectively indicated, viz., H. S. K. Ward Pty. Ltd.—Barley, pearl, 35s.; Peas, split, yellow, 64s.; Robert Harper & Co. Ltd.—Oatmeal, plain, 44s. 6d.; Oatmeal, flaked, 46s. 3d.; Rice, dressed, 94s.; Rice, unpolished, 94s.; Tapioca, seed, 7½d. per lb.

H. COUTTS, Secretary to the Tender Board. 22.3.65.

SOIL CONSERVATION AUTHORITY.**CHARLEY COMBE CREEK PROJECT.**

3203. Construction of ten diversion and trainer banks, &c., £175 + £5 per hour for any additional work.—Start Bros., Landsborough.

R. D. HALL, Secretary.

PUBLIC WORKS.

3082. Brunswick, State School, adequacy of drinking facilities; original £240, additional £322, £562.—L. W. Booth.

3083. Wedderburn, State School, replacement of floors; original £474 10s., additional £26 10s., £501.—W. Chalmers.

3084. Colac, Technical School, fencing; original £487 11s., additional £56, £543 11s.—Altona Chain Mesh Fencing Co.

EXTRAS ON CONTRACTS.

- 3085. Serial No. 63/64-4108.—£78 1s.
- 3086. Serial No. 63/64-4362.—£171 16s.
- 3087. Serial No. 63/64-5213.—£368 5s.
- 3088. Serial No. 63/64-3265.—£503 14s.
- 3089. Serial No. 62/63-5018.—£775 7s.
- 3090. Serial No. 64/65-1287.—£66 2s. 9d.
- 3091. Serial No. 63/64-5309.—£66 5s. 3d.
- 3092. Serial No. 64/65-1298.—£14,050.
- 3093. Serial No. 63/64-988.—£316.
- 3094. Serial No. 63/64-5471.—£216.
- 3095. Serial No. 63/64-5350.—£54 19s. 6d.
- 3096. Serial No. 63/64-3897.—£120 2s. 6d.
- 3097. Serial No. 63/64-3389.—£144 10s. 6d.
- 3098. Serial No. 64/65-1262.—£47 5s.
- 3099. Serial No. 64/65-914.—£19 16s.
- 3100. Serial No. 64/65-753.—£120.
- 3101. Serial No. 63/64-5222.—£332.
- 3102. Serial No. 63/64-3717.—£429 2s. 7d.
- 3103. Serial No. 64/65-1002.—£1,485.
- 3104. Serial No. 63/64-976.—£59 10s.
- 3105. Serial No. 64/65-979.—£4,069 12s.
- 3106. Serial No. 64/65-1968.—£595.
- 3107. Serial No. 63/64-3452.—£385 15s.
- 3108. Serial No. 63/64-2164.—£168 3s.
- 3109. Serial No. 63/64-5179.—£40.
- 3110. Serial No. 63/64-4354.—£502 18s.
- 3111. Serial No. 62/63-3496.—£108 7s. 3d.
- 3112. Serial No. 64/65-780.—£394.
- 3113. Serial No. 62/63-3284.—£115 8s.
- 3114. Serial No. 64/65-748.—£128 10s. 9d.
- 3115. Serial No. 64/65-1011.—£307 11s. 6d.
- 3116. Serial No. 63/64-6558.—£74.
- 3117. Serial No. 60/61-3020.—£872 15s.
- 3118. Serial No. 64/65-949.—£169 5s.
- 3119. Serial No. 63/64-6426.—£61 15s. 2d.
- 3120. Serial No. 63/64-1358.—£511.
- 3121. Serial No. 63/64-3804.—£349.
- 3122. Serial No. 62/63-1920.—£19,914 19s. 11d.
- 3123. Serial No. 63/64-4111.—£150 15s. 2d.
- 3124. Serial No. 64/65-1910.—£840 16s.
- 3125. Serial No. 62/63-3526.—£2,080 6s.
- 3126. Serial No. 64/65-935.—£61 0s. 9d.
- 3127. Serial No. 63/64-3725.—£549 6s. 8d.
- 3128. Serial No. 63/64-2432.—£23 5s.
- 3129. Serial No. 64/65-1856.—£135 16s.
- 3130. Serial No. 63/64-5428.—£46 11s.
- 3131. Serial No. 64/65-481.—£247 4s. 11d.
- 3132. Serial No. 63/64-4124.—£487 19s.
- 3133. Serial No. 63/64-4123.—£1,837 6s. 5d.
- 3134. Serial No. 64/65-1339.—£60.
- 3135. Serial No. 64/65-4436.—£678 10s.
- 3136. Serial No. 63/64-5248.—£57 10s.
- 3137. Serial No. 63/64-5340.—£643.
- 3138. Serial No. 62/63-3778.—£14 15s.
- 3139. Serial No. 63/64-5229.—£2,975 10s.
- 3140. Serial No. 63/64-5240.—£79 16s.
- 3141. Serial No. 62/63-2217.—£185 12s. 7d.
- 3142. Serial No. 64/65-944.—£74 7s. 1d.
- 3143. Serial No. 64/65-802.—£3,497 15s.
- 3144. Serial No. 64/65-1308.—£587.
- 3145. Serial No. 62/63-2225.—£1,279 4s. 6d.

- 3146. Serial No. 63/64-984.—£2,726 14s. 6d.
- 3147. Serial No. 64/65-989.—£1,238 9s.
- 3148. Serial No. 62/63-5108.—£238 5s. 8d.
- 3149. Serial No. 62/63-2217.—£2,106 3s. 9d.
- 3150. Serial No. 64/65-1942.—£11,131.
- 3151. Serial No. 63/64-628.—£2,216.
- 3152. Serial No. 64/65-1371.—£43.
- 3153. Serial No. 64/65-1967.—£624.
- 3154. Serial No. 64/65-991.—£2,926 3s.
- 3155. Serial No. 64/65-989.—£1,032 2s.
- 3156. Serial No. 63/64-1718.—£60 5s. 7d.
- 3157. Serial No. 64/65-992.—£5,397 15s.
- 3158. Serial No. 64/65-993.—£1,048 4s.
- 3159. Serial No. 62/63-4047.—£92 8s. 10d.
- 3160. Serial No. 64/65-1296.—£2,753 2s.
- 3161. Serial No. 64/65-717.—£844.
- 3162. Serial No. 63/64-4105.—£33 3s. 6d.
- 3163. Serial No. 63/64-2311.—£109 11s. 2d.
- 3164. Serial No. 63/64-4121.—£83 8s. 6d.
- 3165. Serial No. 64/65-2118.—£1,131 10s.
- 3166. Serial No. 64/65-2217.—£1,536.
- 3167. Serial No. 63/64-5001.—£594 10s.
- 3168. Serial No. 63/64-5087.—£138 11s. 6d.
- 3169. Serial No. 64/65-990.—£7,647.
- 3170. Serial No. 64/65-2217.—£5,479 10s. 4d.
- 3171. Serial No. 64/65-4101.—£583 18s.
- 3172. Serial No. 63/64-2167.—£423 18s.
- 3173. Serial No. 64/65-2129.—£166 10s.
- 3174. Serial No. 64/65-2534.—£762.
- 3175. Serial No. 63/64-1068.—£1,185 7s. 11d.
- 3176. Serial No. 63/64-5333.—£323.
- 3177. Serial No. 62/63-2641.—£1,079.
- 3178. Serial No. 63/64-4449.—£11,555 16s. 6d.
- 3179. Serial No. 64/65-755.—£1,818 4s.
- 3180. Serial No. 63/64-3657.—£167 5s.
- 3181. Serial No. 62/63-1104.—£109 9s.
- 3182. Serial No. 63/64-624.—£895.
- 3183. Serial No. 63/64-5474.—£188 4s.
- 3184. Serial No. 63/64-5458.—£442.
- 3185. Serial No. 63/64-4110.—£1,359 9s.
- 3186. Serial No. 62/63-2964.—£1,344 1s. 4d.
- 3187. Serial No. 63/64-3765.—£565 15s.
- 3188. Serial No. 63/64-1718.—£1,883 19s.
- 3189. Serial No. 64/65-2534.—£1,199.
- 3190. Serial No. 63/64-5277.—£3,094 9s.
- 3191. Serial No. 64/65-2150.—£27 19s. 5d.
- 3192. Serial No. 64/65-989.—£2,524 5s. 6d.
- 3193. Serial No. 64/65-982.—£19.
- 3194. Serial No. 64/65-992.—£9,451.
- 3195. Serial No. 63/64-3392.—£76.
- 3196. Serial No. 64/65-998.—£4,521.
- 3197. Serial No. 62/63-5100.—£1,797 4s. 2d.
- 3198. Serial No. 62/63-2660.—£20,371 10s.
- 3199. Serial No. 64/65-2201.—£150 10s.
- 3200. Serial No. 64/65-943.—£151 5s. 11d.
- 3201. Serial No. 64/65-945.—£3,794 10s.
- 3202. Serial No. 61/62-4041.—£262 8s. 7d.

MURRAY PORTER, Minister of Public Works. 17.3.65.

ORDERS IN COUNCIL.—(Series 1964-65.)**PUBLIC WORKS.**

3072. Ararat, Mental Hospital, supply of 32 bedside lockers, £616.—Namco Furniture Contract Division.—(W.54225.)

3073. Carlton, Motor Registration Branch, repairs and renewals to Hot Water Boiler, £556 17s.—Wm. Kean Industries.—(M.304262.)

3074. Glenormiston Estate, supply of items shown hereunder:—

A/C piping, £1,717 13s.—James Hardie & Co. (Sales) Pty. Ltd.

G.W.I. piping, £736 7s. 8d.—Stewarts & Lloyds (Distributors) Pty. Ltd.—(S.W.54940.)

3075. Larundel, Mental Hospital, Staff Laundry, supply and installation of pipework and repositioning of machines, £540.—S. Franks (N.E.241157 "B").

3076. Melbourne, Latrobe Library, supply and installation of counters, cabinet stand and shelving, £628 1s. 4d.—N. A. Stewart & Co.—(M.48377 "C").

3077. Melbourne, State Land Tax Office, 179 Queen-street, electrical services, £1,300.—H. N. Butcher.—(M.309065 "B").

3078. Mont Park, Mental Hospital, supply of Diathermy Machine, £907.—Philips-Stanford Pty. Ltd.—(N.E.61435.)

3079. Mont Park, Larundel Mental Hospital, supply of one (1) duplicate geared motor unit for Ironing Machine, £928.—Hardie Trading Limited.—(N.E.40132.)

3080. Mont Park, Mental Hospital, supply of 6 easy chairs, 7 settees, 1 upholstered stool, 34 bridge chairs, 4 hall tables and 6 coffee tables.—£529.—G. G. Phillips.—(N.E.55104.)

3081. Yarraman Park, State School No. 4807, completion of Sports Oval, estimated cost, £1,007.—Dandenong City Council.—(S.E.288272.)

Approved by the Governor in Council, 16th March, 1965.—J. COLQUHOUN, Clerk of the Executive Council.

STATE ELECTRICITY COMMISSION.

3204. For the supply of one 230 kV and eight 220 kV transformers and spare parts for Morwell and Metropolitan Terminal Stations respectively, to Specification 64-65/59, £844,614.—A.S.E.A. Electric (Aust.) Pty. Ltd.

Approved by the Governor in Council, 9th February, 1965.—J. ROSSITER, Acting Clerk of the Executive Council.

3205. For the supply of 347 protective relays for system protection, to Specification 64-65/180, £12,473 10s.—English Electric Co. of Aust. Pty. Ltd.

3206. For the provision of accommodation and supply of meals to Morwell Project employees at Ridge Hostel, Morwell, for a period of one year, to Specification 60-61/104, at Schedule rates.—B. F. Brown Co. Inc.

3207. For the supply of electrical appliances and spare parts for merchandising for a period of twelve months, to Quotation 2283, at Schedule rates.—Hoover (Aust.) Pty. Ltd.

3208. For the construction of concrete and crushed rock pavements, concrete stairways and top-soiling of unpaved areas, Hazelwood Power Station, to Specification 64-65/239, £12,715, plus additional work at Schedule rates.—J. Jeffrey & Sons Pty. Ltd.

3209. For the removal and disposal of ashes from Newport Power Station for a period of two years, to Specification 64-65/124, at Schedule rates.—Matthews Bros. Newport Haulage Co.

3210. For civil engineering works and building construction at Substation 'LV', Laverton, to Specification 64-65/249, £44,860, plus additional work at Schedule rates.—T.W. Morris & Son Pty. Ltd.

3211. For the surveys for transmission lines in Melbourne and Metropolitan areas for a period of two years, to Specification 64-65/220, at Schedule rates.—O'Connor & Beveridge.

3212. For the supply of labour and materials for the fabrication and erection of structural steelwork in Melbourne and Metropolitan areas for a period of two years, to Specification 64-65/227, at Schedule rates.—Prosser Industries Pty. Ltd.

3213. For the supply and installation of service piping and equipment from the Commission Head Office Building, 22-32 William-street, to the Port Authority Building, 29 Market-street, as part of a district heating scheme, to Specification 64-65/291, £6,200.—A. E. Smith & Son Pty. Ltd.

3214. For the supply of 42,000 super feet or oregon timber for construction and maintenance work, to Quotation 3218, at Schedule rates.—J. Wright & Sons (Aust.) Pty. Ltd.

3215. For the supply of iron castings—pipes and miscellaneous hardware for a period of two years, to specification 64-65/171, at Schedule rates.—Cochrane & Scott Pty. Ltd.

3216. For the supply of iron castings for a period of two years, to Specification 64-65/171, at Schedule rates.—C. Ebeling & Son Pty. Ltd.

3217. For the supply of iron castings—pipes and miscellaneous hardware for a period of two years, to Specification 64-65/171, at Schedule rates.—H. Madden & Son.

3218. For the supply of iron castings for a period of two years, to Specification 64-65/171, at Schedule rates.—T. Main & Sons Pty. Ltd.

3219. For the acquisition of approximately three roods of land being part of Crown Portions 106 and 107 Parish of Jika Jika together with an easement over part of the land in the said Crown Portion 107 in connexion with the establishment of substation "NC", Northcote, £26,600. The Trustees of The Sisters of the Good Samaritan.

Approved by the Governor in Council, 24th February, 1965.—J. COLQUHOUN, Clerk of the Executive Council.

SALE OF MOTOR CAR.

AN owner is required for a Hillman sedan motor car, ex-registered No. BHX-756, engine No. 1897466WSO.

The motor car came into possession of Police on 16th August, 1964, and if not claimed, will be sold by public auction at Benalla Police Station, at 2 p.m., on Monday, 12th April, 1965.

R. H. ARNOLD,
Chief Commissioner of Police.

PUBLIC NOTICE.

AN auction of unclaimed and confiscated liquor in the possession of the Police will be held at premises of the Police Licensing Branch, 43 Bourke-street, Melbourne, on Tuesday, 6th April, 1965, at 10 a.m.

R. H. ARNOLD,
Chief Commissioner of Police.

APPOINTMENT OF SUMMONING OFFICERS.

UNDER section 5 of the Education Act 1958, I hereby appoint—

Senior Constable Donald Charles Edmonds,
First Constable Robert James McDougall,
First Constable Ronald Morton,
to summon parents within the State of Victoria.

JOHN BLOOMFIELD,
Minister of Education.

12th March, 1965.

Melbourne and Metropolitan
BOARD OF WORKS.

NOTICE TO THE OWNERS OF TENEMENTS IN THE UNDER-MENTIONED STREETS, AND THE PRIVATE STREETS, LANES, COURTS AND ALLEYS OPENING THERETO.

THE main pipe in the said streets being laid down, the owners of all tenements situated as under are hereby required, on or before the 26th April, 1965, to cause a proper pipe and stop cocks to be laid, so as to supply water within such tenements from the main pipe.

H. J. SNADDEN,
Secretary.

16th March, 1965.

STREET AND POSITION.

Altona.

Kyle-road, from Outfall Sewer southwards 4½ chains.

Dandenong.

Trende-street, from Fifth-avenue westwards and north-westwards 8½ chains.

Princes Highway (north-east side), from 7 chains south-east of Sunshine-avenue south-eastwards 5 chains.

Joan-court, from Princes Highway north-eastwards 8½ chains.

Doncaster and Templestowe.

Glenair-court, from MacRobertson-street northwards 5½ chains.

Eltham.

Bonds-road, from Rosehill-road to Cleveland-avenue.
Cleveland-avenue, from Bonds-road south-westwards, southwards and south-eastwards 91½ chains.
Stawell-road, from Cleveland-avenue eastwards 13½ chains.

Footscray.

Greene-street, from Moresby-street southwards 2½ chains.
Moresby-street, from Green-street south-eastwards 3½ chains.

Cawley-road, from Outfall Sewer northwards 8 chains.

Keilor.

Westminster-drive, from Lancaster-avenue to Military-road.
Lancaster-avenue, from Rogerson-street to Clarendon-street.

Biggs-street, from Arthur-street to Collins-street.

Moorabbin.

Forster-street, from 4½ chains north of Deakin-road northwards 2½ chains.

Preston.

Edwin-street, from 9½ chains east of Victoria-street eastwards 1½ chains.

Ringwood.

Yallamba-place, from The Boulevard westwards 5½ chains.

Sandringham.

Sarah-street, from Love-street northwards 1 chain.

Sunshine.

Collenso-street, from Glengala-road southwards 8 chains.

Whittlesea.

Alexander-avenue, from 9½ chains east of Marjory-street eastwards 11½ chains.

Williamstown.

Swan-court, from The Strand westwards 5½ chains.
Thompson-street, from Aitken-street to Cecil-street.

AUCTION SALES ACT 1958.

LIST of Persons to whom Auctioneers' Licences have been issued during the month of January, 1965.

Name.	Address.	Date of Issue.
Arthur, Lewis Paul	26 Hargreaves-street, Mornington	4.1.65
Bawden, Francis Bruce	c/o Dalgety and New Zealand Loan, Geelong	5.1.65
Cameron, Ewan Archibald	20 Pengelly-court, Sunshine	11.1.65
Clark, George Fleming	23 Dixon-street, Mentone	8.1.65
Cook, Alexander Austin	12 Glenard-drive, Heidelberg	4.1.65
Cullen, Terence Bruce	14 Spencer-street, Sebastopol	8.1.65
Davidson, Ian	12 Wells-road, Seaford	11.1.65
Fabretto, Benny	194 Hall-street, Spotswood	4.1.65
Hines, Thomas Kevin	20 Thorne-street, Wagga, N.S.W.	29.1.65
Julyan, Finlay Munro	23 Primrose-crescent, East Brighton	5.1.65
Lockwood, Neil	30 Belsen-street, East Malvern	8.1.65
Merrett, Leslie	37 Church-street, Drouin	29.1.65
Murray, Robert Baxter	23 Buckland-avenue, Newtown	14.1.65
O'Connor, Maxwell	114 Raleigh-street, Maribyrnong	5.1.65
Paparusia, David	49 Barkers-road, Kew	4.1.65
Reed, Robert William	34 The Avenue, Lower Fern Tree Gully	11.1.65
Sanders, John Braithwaite	72 Bradshaw-street, Essendon	8.1.65
Sharp, Barry John	Robb-street, Bairnsdale	14.1.65
Smith, Malcolm Gilbert	86 Nolan-street, Kerang	27.1.65
Stafford, Harry	575 Inkerman-road, Caulfield	11.1.65
Turner, Archibald Donald	12 Iris-street, Burwood	"
Warne, William Kenneth	109 Highett-street, Richmond	"
Whyte, Lloyd George	4 St. George-street, Stawell	20.1.65

The Treasury,
Melbourne, C.2, 16th March, 1965

E. W. COATES,
Director of Finance.

Process Servers and Inquiry Agents Act 1958.

APPLICATION FOR LICENCES LODGED WITH CLERKS OF COURTS.

By direction of the Chief Secretary, the subjoined lists of "new" applications for process servers and inquiry agents licences are published for general information.

Applicant.	Address.	Court.	Tentative Date of Hearing of Application.
<i>Process Servers Licences.</i>			
Holborow, William	Turnham-avenue, Rosanna	Heidelberg	6.4.65
Murphy, James Francis	58 St. Clems-road, East Doncaster	Box Hill	9.4.65

Attention is directed to the provisions of the above Act and regulations thereunder relating to the lodgment of objections to applications.

Chief Secretary's Office,
Melbourne, 19th March, 1965.

C. W. PHILLIPS, Registrar,
Process Servers and Inquiry Agents.

STATE RIVERS AND WATER SUPPLY COMMISSION.

LICENCES TO DIVERT WATER, PURSUANT TO THE PROVISIONS OF THE WATER ACT 1958.

LICENCES as detailed hereunder to divert water have been revoked by the Governor in Council as from the dates shown :—

Licence No.	Name of Licensee.	Source of Supply.	Term of Licence and Commencing Date.	Date of Revocation.
1458	R. C. Leishman and Son	Bullarook Creek	Fifteen years from 1.7.60	31.12.64
1524	Charles Leslie Bucknall	Tullaroop Creek	Fifteen years from 1.7.60	31.12.64

Office of the State Rivers and Water Supply Commission,
Melbourne, 23rd March, 1965.

G. W. Lewis, Acting Secretary,
State Rivers and Water Supply Commission.

STATE RIVERS AND WATER SUPPLY COMMISSION.

LICENCES TO DIVERT WATER AND CUT RACES, PURSUANT TO THE PROVISIONS OF THE WATER ACT 1958.

LICENCES as detailed hereunder to divert water and cut races have been revoked by the Governor in Council as from the dates shown :—

Licence No.	Name of Licensee.	Source of Supply.	Term of Licence and Commencing Date.	Date of Revocation.
1658/867	J. E. Cunningham and B. M. Cunningham	River Murray	Eight years from 1.7.62	30.6.63
1659/867	R. J. Heazlewood and L. Heazlewood	River Murray	Eight years from 1.7.62	30.6.63

Office of the State Rivers and Water Supply Commission,
Melbourne, 23rd March, 1965.

G. W. Lewis, Acting Secretary,
State Rivers and Water Supply Commission.

YARRA RIVER IMPROVEMENT TRUST.
 RATING BY-LAW 1965.

THE Yarra River Improvement Trust, in pursuance and exercise of the powers conferred by the River Improvement Act 1958, doth hereby make the By-law following:—

1. The following rate, to be called the "Yarra River Improvement District River Improvement Rate", is hereby made and shall be levied upon the occupiers or owners of all properties within the Yarra River Improvement District which are rateable to any municipality:—

A rate of Six pence (6d.) in the pound on the net annual municipal value of such properties. Provided that the sum of One shilling shall be the minimum amount of rate in respect of any property liable to be rated in the said district.

2. Such rate is made and shall be levied for the year beginning with the 1st January, 1965 and ending with the 31st day of December, 1965, and shall be payable on the 10th day of April, 1965, at the office of the Yarra River Improvement Trust, at Healesville.

3. Such person or persons as the Yarra River Improvement Trust may from time to time appoint for that purpose shall be and is or are hereby authorized to demand, receive, collect and recover the said rate.

The foregoing By-law was made by the Yarra River Improvement Trust on the 4th day of March, 1965, and the common seal of the Trust was hereunto affixed this 4th day of March, 1965 in the presence of:—

(SEAL) C. HILL, Chairman.
 W. M. OLIVER, Secretary.

Approved by the Governor in Council, 16th March, 1965.
 —J. COLQUHOUN, Clerk of the Executive Council.

SEYMOUR SHIRE RIVER IMPROVEMENT TRUST.
 BY-LAW No. 1.

THE Seymour Shire River Improvement Trust, in pursuance and exercise of the powers conferred by the River Improvement Act 1958, doth make the By-law following:—

1. The following rate, to be called the Seymour Shire River Improvement District River Improvement Rate, is hereby made and shall be levied upon the occupiers or owners of all properties within the Seymour Shire River Improvement District which are rateable to any municipality, a rate of Four pence in the £1 on the net annual value of such properties. Provided that the sum of One Shilling shall be the minimum amount payable in respect of any property liable to be rated in the said division.

2. Such rates are made and shall be levied for the period beginning with the 1st day of January, 1965 and ending with the 31st day of December, 1965, and shall be payable on the 9th day of April, 1965 at the office of the Seymour Shire River Improvement Trust at Seymour.

3. Such person or persons as the Seymour Shire River Improvement Trust may from time to time appoint for that purpose shall be and is or are hereby authorized to demand, receive, collect and recover the said rate.

The foregoing By-law was made by the Seymour Shire River Improvement Trust on the 2nd day of February 1965, and The Common Seal of the said Trust was hereunto affixed, this 2nd day of February, 1965 in the presence of—

(SEAL) R. H. THOMPSON, Chairman.
 E. C. L. HEAD, Commissioner.
 E. F. VAN LEEUWEN, Secretary.

Approved by the Governor in Council, 16th March, 1965.
 —J. COLQUHOUN, Clerk of the Executive Council.

WODONGA WATERWORKS TRUST.
 FIXING THE LIMIT OF A BANK OVERDRAFT.

HIS Excellency the Governor of the State of Victoria, by and with the advice of the Executive Council thereof, doth, by Order made on the 23rd day of March, 1965, in pursuance of the provisions of section 288 of the Water Act 1958 (No. 6413) fix the limit of the overdraft to be obtained by the Wodonga Waterworks Trust from the Commercial Banking Company of Sydney, Limited, Wodonga, at an amount not to exceed at any one time the sum of Fifteen thousand pounds (£15,000).

J. COLQUHOUN,
 Clerk of the Executive Council.
 At the Executive Council Chamber,
 Melbourne, 23rd March, 1965.

AVENEL WATERWORKS TRUST.

AUTHORITY TO OBTAIN BANK OVERDRAFT.

HIS Excellency the Governor of the State of Victoria, by and with the advice of the Executive Council thereof, doth, by Order made on the 23rd day of March, 1965, authorize the Avenel Waterworks Trust to obtain in pursuance of the provisions of section 286 of the Water Act 1958 (No. 6413) an advance or advances during the year 1965 from the Commercial Bank of Australia Limited, Nagambie, by overdraft of the Trust's current account thereat, such overdraft not to exceed at any one time the sum of Five hundred pounds (£500).

J. COLQUHOUN,
 Clerk of the Executive Council.

At the Executive Council Chamber,
 Melbourne, 23rd March, 1965.

SHIRE OF WOORAYL.
 ROAD DEVIATION ORDER.

IN pursuance of the powers conferred by sections 522 and 526 of the Local Government Act 1958, the Council of the Shire of Woorayl doth hereby direct that the land in the Parish of Korumburra, shown hatched on the plan hereunder, which has been purchased or acquired by it, shall be a public highway from and after the date of publication of this Order in the Government Gazette, and doth declare that such land shall be a public highway in lieu of the land in the said parish shown cross-hatched on the said plan.

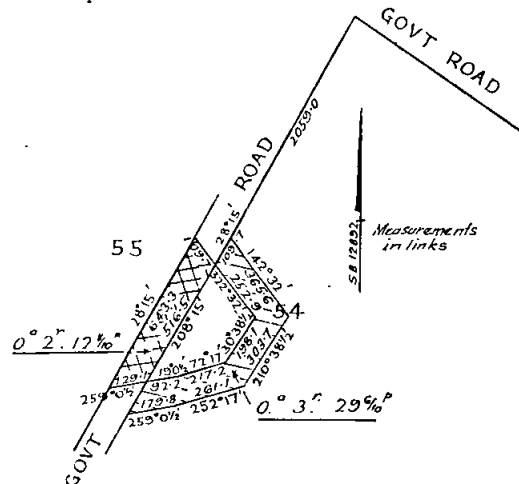

Dated the 11th day of September, 1964.

The common seal of the President, Councillors and Ratepayers of the Shire of Woorayl was hereunto affixed this 11th day of September, 1964, in the presence of—

(SEAL) H. KINNISH, Councillor.
 H. G. BIRD, Councillor.
 K. G. BRYDON, Secretary.

Confirmed by the Governor in Council, 16th March, 1965.
 —J. COLQUHOUN, Clerk of the Executive Council.

Dried Fruits Act 1958.
 STATE OF VICTORIA.

NOTICE.

I, GILBERT LAWRENCE CHANDLER, Minister of Agriculture, acting upon the recommendation of the Victorian Dried Fruits Board, hereby give notice that I have determined the proportions of Dried Vine Fruits produced in Victoria in the year One thousand nine hundred and sixty-five, that may be marketed within Victoria, are as follows:—

Dried Currants	37 per cent.
Dried Sultanas	16 per cent.
Dried Lexias	46 per cent.

G. L. CHANDLER,
 Minister of Agriculture.
 Department of Agriculture,
 Melbourne, 12th March, 1965.

Transport Regulation Act.
TRANSPORT REGULATION BOARD.

HEARING OF APPLICATIONS.

NOTICE is hereby given that the following applications will be considered by the Transport Regulation Board at its offices at Rathdown-street, Carlton, at 10.15 a.m., on Wednesday, 14th April, 1965.

BENDERS BUSWAYS PTY. LTD., Edol-street, North Geelong. Four commercial passenger vehicles (S/C. 36) to operate under the same terms and conditions as existing U.O. licences in the name of the applicant company.

BLACKSON, K. W., 47 Wells-road, Carrum. One commercial passenger vehicle (S/C. 5) to operate free of charge for the carriage of school children from Carrum to the Princess Elizabeth Kindergarten for deaf children, Burwood, via Wells-road, Edithvale-road, Springvale-road, Ann-street, Billings-street back to Springvale-road to Clifford-road, Glen Waverley; thence via Springvale-road, Burwood-road and Elgar-road to school.

TIME-TABLE.

Dep. Carrum 8.00 a.m.	Arr. School 9.15 a.m.
Dep. School 3.00 p.m.	Arr. Carrum 4.15 p.m.

HRIEK, A. and G., Tanjil Bren. One commercial passenger vehicle (S/C. 3) to operate between Noojee and Tanjil Bren as follows:—(a) For the carriage of mails under contract to the P.M.G. Department. (b) For the carriage of guests only of the applicant's Guest House, "Tanjil Lodge", free of charge.

LATROBE VALLEY BUS LINES, 2-10 Ryan-street, Morwell. One commercial passenger vehicle (S/C. 39) to operate under the same terms and conditions as existing C.O. licences in the name of the applicant.

MCMILLAN, H. F., 26 Benbow-street, Ararat. Two commercial passenger vehicles with large seating capacities to operate under the same terms and conditions as existing T.S. and C.O. licences in the name of the applicant.

VENTURA MOTORS PTY. LTD., 1037 Centre-road, South Oakleigh. A required number of C.O. licensed vehicles to operate Route 265A (Box Hill—Mount Waverley) as at present prescribed with the ability to extend service as follows:—From Mount Waverley Railway Station to Clayton Railway Station via Stephenson-road, The Highway, Mount Pleasant-drive, Waverley-road, Forster-road, Fern Tree Gully-road and Clayton-road. (Sections, fares and time-tables to be determined).

VENTURA MOTORS PTY. LTD., 1037 Centre-road, South Oakleigh. Application for permit authority to operate any one M.O. licensed vehicle Route 26A (Glen Iris—Ashburton—Glen Waverley) for the carriage of staff and students from Glen Iris Railway Station to Chadstone High School via High-street, Victory Boulevard, Warrigal-road and Batesford-road to school.

TIME-TABLE.

(School Days Only.)

Depart Glen Iris	8.25 a.m.
Depart School	4.00 p.m.

APPLICATIONS for renewal of licences as shown, by persons listed hereunder to operate under the same terms and conditions:—

BAILLIE, J. A., 25 Queen-street, Moe; C.T.382.
CUMMINS, J., 69 Lloyd-street, Heidelberg; M.H.1751.
CRELLIN, A. D., 42 Keith-street, Moorabbin; M.H.1782.
DOUGLAS, J. W., 103 Waiora-road, West Heidelberg; M.T.2116.
GALVIN, L. M., 53 Bolingbroke-street, Pascoe Vale; M.T.1487.
GEE, D. L., Flat 12, 11 Vasey-street, Ascot Vale; M.H.2362.
GIDLEY, R. R. G., 88 Tannock-street, North Balwyn; M.H.1774.
HELD, O., 5 Folkstown-road, Mount Waverley; M.H.2361.
HELLER, K., Block 2, Kenny-street, West Meadow; M.H.2193.
HOLDEN, G. H., 53 Wallara-crescent, Bundoora; M.O.604.
KAIROUZ, E., 11 McCracken-street, Essendon; M.T.1502.
KAY, C. F., Tawonga Roadside, via Wodonga; C.O.693; C.O.986.
KYRKILIS, A., 104 Westgarth-street, Fitzroy; M.T.1858.
LYTRA, G. L., 8 Peverill-street, Chadstone; M.T.1408.
MORWELL TAXIS, 14 Denise-street, Morwell; C.T.397.
PARKER, E. W., 129 Anzac-avenue, Seymour; C.T.236.
PETRIK, L., 67 Millawa-avenue, St. Albans; M.H.2192.
RAY, W. J. and E., 4 Lytleton-avenue, Castlemaine; C.O.291.

ROTHMANS OF PALL MALL (AUSTRALIA) LTD., Sunshine-road, Tottenham; T.P.58.

SPANO, P. N., 107 Dundas-street, Preston; M.T.1604.

TESORIERO, J., 2 Hawsleigh-avenue, East St. Kilda; M.T.2117.

UBL, V., 10 Perry-street, St. Albans; M.H.2234.

WATSON, W. F., 11 Ward-street, Wangaratta; C.T.372.

Notice of any objection should be forwarded to reach the Secretary of the Board not later than Wednesday, 7th April, 1965.

Applicants are advised that it will not be necessary to appear on the hearing date specified above, unless advised, in writing, by the Board.

B. P. KAY,
Secretary.

Exhibition Buildings, Rathdown-street, Carlton, N.3,
Wednesday, 24th March, 1965.

Commercial Goods Vehicles Act.
TRANSPORT REGULATION BOARD.

HEARING OF APPLICATIONS.

NOTICE is hereby given that the following applications will be considered by the Transport Regulation Board at its offices at Rathdown-street, Carlton, at 10.15 a.m. on Wednesday 14th April, 1965.

ASCOM PTY. LTD., 171 Fitzroy-street, St. Kilda. One commercial goods vehicle (L/C. 20 cwt.) to operate: (a) Within a 50-mile radius of own premises at St. Kilda in course of business as "Structural Engineers and Contractors"—own goods. (b) Throughout the State of Victoria—tools of trade and equipment incidental to own contracts. (c) Within a 20-mile radius of any contract currently engaged upon or from the nearest railway thereto—materials for use on such contract.

ASHTON, D. W. & N. E., Western Highway, Ballan. One commercial goods vehicle (L/C. 115 cwt.) to operate: (a) Within a 50-mile radius of Ballan—petroleum products on behalf of Caltex Oil Co. Pty. Ltd. (b) Within a 20-mile radius of Ballan—general goods.

BOURDON, G. C., 117 Princes Highway, Warrnambool. One commercial goods vehicle (L/C. 20 cwt.) to operate throughout the State of Victoria in the course of business as "Marine Dealer"—special wares, marine stores or old metals within the meaning of the *Marine Stores and Old Metals Act 1958* (No. 6303) but excluding the right to carry any such special wares, marine stores or old metals to wharves, docks or ships for shipment or export purposes.

BROWNE, R. D. & J. M., PTY. LTD., 6 Chapman-street, Swan Hill. One commercial goods vehicle (L/C. 71 cwt.) to operate: (a) Within a 50-mile radius of post office at Swan Hill in the course of business as "Agricultural Machinery Agents" agricultural merchandise. (b) Within a 50-mile radius of post office at Swan Hill on behalf of Esso Standard Oil (Aust.) Ltd.—petroleum products in prescribed types of containers and empty return containers.

CARTER, F. R., Box 185, Heywood. One commercial goods vehicle (L/C. 200 cwt.) to operate: (a) From forest landings within a 50-mile radius from the post office at Heathmere to own sawmill at Heathmere and G. J. Moore & Son's sawmill at Drumborg—logs. (b) From own sawmill at Heathmere to consignees within a 50-mile radius thereof—sawn timber.

CORIO MACHINERY CO. PTY. LTD., 32 Mercer-street, Geelong. Two commercial goods vehicles (L/C. 7 and 8 cwt.) to operate: (a) Within a 50-mile radius from the chief post office in the City of Geelong in the course of business as "Industrial Machinery Agents"—compressors, industrial machinery, abrasives and accessories; also tools of trade, spare parts and material incidental to the servicing and maintenance of such machinery. (b) Throughout the State of Victoria for the carriage of samples of goods for exhibition to prospective purchaser, with ability to leave a sample when required.

DONALDSON, K. D., 2 Moon-street, Eaglehawk. One commercial goods vehicle (L/C. 117 cwt.) to operate: (a) Within a 50-mile radius of post office at Bendigo as a "Road Contractor"—road-making plant and materials. (b) Within a 25-mile radius of post office at Bendigo—general goods.

DYER HOLDINGS PTY. LTD., 60 Lansdown-street, Sale. One commercial goods vehicle (L/C. 164 cwt.) to operate from and to the premises of Maffra Co-operative Milk Products Co. Ltd. at Maffra, Storey Davies and Co. Pty. Ltd., Sunkitts Engineering Works, Crystal Cordial Co. and S. Lacey and Sons Pty. Ltd. at Sale (approved decentralized secondary industries) to and from the Melbourne Metropolitan Area—goods and materials to and goods and materials from the said approved decentralized secondary industries.

- EDWARDS, P. C., Taggerty Motors, Taggerty. Application to vary the conditions of licence No. D.A.41947/6 (L/C. 115 cwt.) by adding as paragraph (b) "To operate within a 20-mile radius of the post office at Taggerty—general goods".
- FORBES-WILSON D., care of P.O. Box 1, Cabarita. One commercial goods vehicle (L/C. 30 cwt.) to operate within that part of Victoria north of an east/west line drawn through Tempy and west of a north/south line drawn through Swan Hill in course of business as "Engineering Contractor" on behalf of the P.M.G.'s Department—tools of trade, equipment and materials incidental to own contracts.
- FROZO FOOD CO. PTY. LTD., cnr. Cherry-lane and Maria-street, Derrimut. One commercial goods vehicle (L/C. 79 cwt.) to operate throughout the State of Victoria in a specially constructed refrigerated vehicle in the course of business as "Frozen Food Manufacturers"—frozen vegetables, fish, ice-cream, poultry, meat, Chinese food, waffles, and prepared meals at 0°F.
- GLENMIX PTY. LTD., Glenrowan. One commercial goods vehicle (L/C. 181 cwt.) to operate within a 50-mile radius of the Glenrowan post office in the course of business as "Premixed Concrete Manufacturer"—own premixed concrete in a specially constructed agitator vehicle.
- VLEKKERT, M., & D. DRAUSMAN (trading as G.M.D. Refrigeration), 2A Elm-street, Northcote. One commercial goods vehicle (L/C. 11 cwt.) to operate throughout the State of Victoria in course of business as "Refrigeration Manufacturers and Engineers" for the purpose of servicing and supervising installation of refrigeration equipment:—tools of trade, spare parts, refrigeration units for repair having been repaired and for installation and materials incidental thereto.
- GRANT, J. E., & D. J., 32 Albert-street, Daylesford. One commercial goods vehicle (L/C. 15 cwt.) to operate: (a) Within a 50-mile radius of Daylesford in the course of business as "Florists and Nurserymen"—seedlings, shrubs, cut flowers, ornamental tubs and pots. (b) From Dandenong and Melbourne to Daylesford—seedlings, shrubs, ornamental tubs and pots.
- MAJOR, J. (trading as Grovedale Auto Service), Torquay-road, Grovedale. One commercial goods vehicle (L/C. 8 cwt.) to operate throughout the State of Victoria in the course of business as "Motor Wrecker"—second-hand motor vehicle parts dismantled or removed from wrecked motor vehicles by self or employees and subject to the condition that the load capacity of the vehicle so licensed or of any vehicle substituted for such licensed vehicle during the currency period of the licence shall not at any time exceed eight hundred-weight (8 cwt.).
- GUY, J. A., Settlement-road, Cowes. One commercial goods vehicle (L/C. 62 cwt.) to operate: (a) Within a 20-mile radius of the post office at Cowes—general goods. (b) From and to the Caltex Oil (Aust.) Pty. Ltd. depot at Newport to and from Cowes—petroleum products in prescribed types of containers and empty return containers. (c) Between the Township of San Remo and the City of Melbourne—fresh fish, empty fish boxes, fishermen's gear for repair or having been repaired and fishermen's requisites.
- HOARE & KENNEDY, 27 Oak-street, Ballarat. One commercial goods vehicle (L/C. 221 cwt.) to operate: (a) Throughout the State of Victoria in the course of business as "Earth-moving and Excavation Contractors"—own excavation machines and sufficient fuel only for the operation of machinery on site. (b) Within a 20-mile radius of work—material in association with work undertaken.
- HOARE & KENNEDY PTY. LTD., 27 Oak-street, Ballarat. Application to vary the conditions of licence No. D.A.44696/4 (L/C. 201 cwt.) by deleting the present conditions and adding in lieu "To operate throughout the State of Victoria in the course of business as 'Earth-moving and Excavation Contractors'—own excavation machinery and sufficient fuel only for the operation of machinery on site."
- JAMES, R. W., 146 Lily-street, Bendigo. One commercial goods vehicle (L/C. 24 cwt.) to operate within a 100-mile radius from own premises at Bendigo in the course of business as "Builder", but excluding the carriage of any goods whatsoever from or to the City of Melbourne—tools of trade, equipment and small quantities of materials incidental to the supervision and completion of own contracts.
- JOHNSON, C. J., 17 Peacock-street, Burwood. One commercial goods vehicle (L/C. 6 cwt.) to operate within a 50-mile radius of G.P.O., Melbourne as a "Contract Window Fitter" on behalf of Stegbar Windows Pty. Ltd., of Springvale—tools of trade, windows, flywire screens and doors and materials incidental to the installation thereof.
- KELLY, H. E., 201 Walnut-avenue, Mildura. One commercial goods vehicle (L/C. 131 cwt.) to operate north of an east/west line through Murrayville and west of a north/south line through Robinvale, in the course of business as "Tractor Distributors"—own tractors and auxiliary equipment.
- KELLY, J. M. & J. C., Nowa Nowa. One commercial goods vehicle (L/C. 152 cwt.) to operate within a 50-mile radius from the post office at Nowa Nowa in the course of business as "Quarry Masters"—(i) own plant and equipment; (ii) sand, gravel, screenings and road-making materials from own quarry at Nowa Nowa.
- LETIZIA, V., 3 Vistula-avenue, North Geelong. One commercial goods vehicle (L/C. 25 cwt.) to operate within a 75-mile radius from the chief post office in the City of Geelong in the course of business as "Cartage Contractor"—own fuel, tires, spare parts and tools incidental to the servicing and maintenance of own vehicles.
- MACKLEY, E. C., 230 Baillie-street, Horsham. One commercial goods vehicle (L/C. 12 cwt., with 30-cwt. trailer when needed) to operate: (a) Within a 20-mile radius of the post office at Horsham—general goods. (b) Within a 50-mile radius of the post office at Horsham in the course of business as "Primary Producer"—own goods.
- MARTIN, L. J., 24 Bell-street, East Preston. One commercial goods vehicle (L/C. 14 cwt.) to operate throughout the State of Victoria in course of business as "House Removallist" as an escort vehicle—tools of trade, equipment and materials incidental to the removal of houses, sheds, &c., and their re-erection.
- MARTIN, L. J., 24 Bell-street, East Preston. One commercial goods vehicle (L/C. 192 cwt.) to operate throughout the State of Victoria in the course of business as "House Remover"—houses and sheds for removal from site to site and subsequent re-erection, also tools of trade and equipment incidental thereto.
- MEMBREY, J. & N., 22 Graham-road, Carrum. One commercial goods vehicle (L/C. 139 cwt.) to operate within a 30-mile radius of own premises at Carrum in course of business as "Sand and Screening Supplier"—own sand, screenings and soil.
- MILLIGAN, M. I., 1 Pine-grove, Malvern. One commercial goods vehicle (L/C. 174 cwt.) to operate within a 70-mile radius from the premises of the New Gamble Brick and Quarrying Co. Pty. Ltd. at Oakleigh—bricks on behalf of the said company.
- MITCHELL, V. L., Bridge-road, Rochester. One commercial goods vehicle (L/C. 146 cwt.) to operate: (a) Within a 50-mile radius of the post office at Rochester as a "Road Contractor"—road-making plant and materials. (b) Within a 20-mile radius of the post office at Rochester—general goods.
- MORAN & CATO PTY. LTD., 277 Brunswick-street, Fitzroy. Three commercial goods vehicles (L/C. 7 cwt. each) to operate throughout the State of Victoria in the course of business as "Grocers" for the purpose of supervising own country branch premises—tools of trade, shop equipment for repair or having been repaired, small quantity of stock for transfer between branches with the ability to return to Melbourne with any damaged or unsaleable stock.
- NANGLE, L. A., PTY. LTD., 5 Peel-street, Collingwood. One commercial goods vehicle (L/C. 8 cwt.) to operate throughout the State of Victoria in the course of business as "Advertising Agent"—tools of trade and materials incidental to the erection of advertising signs.
- PENINSULA HAULAGE PTY. LTD., 506 Nepean Highway, Frankston. One commercial goods vehicle (L/C. approximately 125 cwt.) to operate: (a) Within a 70-mile radius from the post office at Frankston—bricks on behalf of Colortone Brick Ltd. at Frankston. (b) From Melbourne and the Frankston Railway Station to the premises of Colortone Brick Ltd. at Frankston—Goods being the property of the said company. (c) From Melbourne wharves to the premises of Colortone Brick Ltd. at Frankston—goods being the property of the said company. (d) Within a 20-mile radius from the post office at Frankston—general goods. (e) Between the City of Melbourne and the City of Frankston—goods being the property of Colortone Brick Ltd. at Frankston.
- ROWLANDS, O., 21 Castlebar-road, Oakleigh. One commercial goods vehicle (L/C. 124 cwt.) to operate from own quarries situated at Castlemaine and Balliang to consignees throughout the State of Victoria—own pavement slate.
- RUNDELL, S. J., 18 Anne-street, Wodonga. One commercial goods vehicle (L/C. 189 cwt. approximately) to operate within a 50-mile radius of the post office at

- Wodonga in a specially constructed agitator vehicle—premixed concrete solely on behalf of Border Ready Mixed Concrete Pty. Ltd.
- SHEP. MIX. PTY. LTD., 201 Corio-street, Shepparton. One commercial goods vehicle (L/C. 144 cwt.) to operate within a 50-mile radius from own premises at Shepparton in the course of business as "Concrete Manufacturers"—own premixed concrete in a specially constructed agitator vehicle.
- SMITH, E. G., Koonwarra. One commercial goods vehicle (L/C. 105 cwt.) to operate: (a) Within a 70-mile radius of the post office at Yarram (Traralgon Division of C.R.B.) and within a 70-mile radius of the post office at Healesville (Dandenong Division of the C.R.B.) in the course of business as "Bridge Building Contractor"—own bridge building plant and equipment. (b) Within a 20-mile radius from the site of current contract or from the railway station nearest thereto—materials for use on such contract.
- SMITH, L. J. & J. M., 37 Sydenham-avenue, Geelong West. One commercial goods vehicle (L/C. 200 cwt.) to operate within a 50-mile radius from the chief post office in the City of Geelong solely on behalf of Pioneer Concrete (Vic.) Pty. Ltd.—premixed concrete in a specially constructed agitator vehicle.
- SPARKES, V. J., & P. J. BAKER, 53 Albion-street, Brunswick. One commercial goods vehicle (L/C. 107 cwt.) to operate within a 70-mile radius of the premises of Clifton Brick Holdings Ltd. at Brunswick—bricks solely on behalf of the said company.
- SPENCE, K. P. & K. (trading as K. P. Spence & Co.), Yanac, via Nhill. One commercial goods vehicle (L/C. 80 cwt.) to operate: (a) Within a 20-mile radius from the post office at Yanac—general goods. (b) From and to the Mobil Oil (Aust.) Pty. Ltd. depot at Dimboola, to and from own depot at Yanac—petroleum products in prescribed types of containers and empty return containers. (c) From and to the Shell Co. of Australia Ltd. depot at Horsham, to and from own depot at Yanac—petroleum products in prescribed types of containers and empty return containers.
- STILO, B. F., 37 Cecil-street, Benalla. One commercial goods vehicle (L/C. 116 cwt.) to operate within a 100-mile radius of the post office at Benalla for the purpose of operating the vehicle as a "Water Tanker Unit".
- STONE, H. N., Lot 72, Madeline-street, Glen Waverley. One commercial goods vehicle (L/C. 26 cwt.) to operate from Melbourne to Wodonga and towns *en route* including the Bright area and from Melbourne to Cobram and towns *en route* (the Goulburn Valley area)—cream cakes, sponges, iced cakes, shortbread, small quantity of block cake, pies, pasties and crumpets.
- STARLINER COACHES PTY. LTD. (trading as Thredbo Trading Agency), 2 Leo-street, Fawkner. One commercial goods vehicle (L/C. approximately 120 cwt.) to operate from Melbourne to hotels, motels and guest houses in the Townships of Benalla, Wangaratta, Rutherglen, Beechworth, Myrtleford and townships *en route* in the course of business as "Traders", but excluding the ability to sell directly to retail stores—fresh fish and vegetables, frozen foods, soaps, detergents and groceries.
- THOMPSON, J., Nyah West. Application to vary the conditions of licence No. D.A.30847 (L/C. 69 cwt.) by deleting from the present conditions paragraph (b) and adding in lieu as paragraph (b) "From places situated within a 50-mile radius from the post office at Nyah West—firewood and tools of trade, including tractor and sawbench."
- TIMMS, J. W., Moyhu. One commercial goods vehicle (L/C. 59 cwt.) to operate: (a) Within a 20-mile radius of the post office at Moyhu—general goods. (b) From the depot of Ampol Petroleum (Vic.) Pty. Ltd. at Benalla to places as defined within paragraph (a) above—petroleum products in prescribed types of containers and empty return containers together with agricultural sprays.
- TREGUPIS, F., Jindera, N.S.W. One commercial goods vehicle (L/C. 105 cwt.) to operate within a 50-mile radius of the post office at Wodonga—road-making materials.
- TURNER, T. E., PTY. LTD., 191 Mitchell-street, Bendigo. One commercial goods vehicle (L/C. 7 cwt.) to operate throughout the State of Victoria in the course of business as "Electrical Contractor"—tools of trade, materials and equipment incidental to own contracts, excluding any operations between the Cities of Bendigo and Melbourne.
- VICTORIA PAVEMENT & CONCRETE CO., 283 Timor-street, Warrnambool. One commercial goods vehicle (L/C. 184 cwt.) to operate within a 50-mile radius from own premises at Warrnambool—ready mixed concrete in a specially constructed agitator vehicle.
- WHITE, T., & SONS, corner Keilor-road and Knighton-avenue, Niddrie. One commercial goods vehicle (145 cwt.) to operate: (a) From own sawmill at Bullengarook to own timber yard at Niddrie and to building sites within a 25-mile radius of Melbourne—sawn timber. (b) Within a 25-mile radius of Melbourne in course of business as "Timber Millers and Merchants"—own goods.
- WRIGHT, K. G., Heathcote. One commercial goods vehicle (L/C. 247 cwt.) to operate within a 15-mile radius of Heathcote, and to and from Melbourne serving Tooborac, Pyalong, and High Camp *en route*—general goods.

TOW TRUCKS.

- DUFF, J., & R. POHLMAN (trading as Duff and Pohlman), 2 Preston-street, West Geelong. One commercial goods vehicle (L/C. 34 cwt.) to operate within a 50-mile radius of the chief post office in the City of Geelong for the purpose of lifting and carrying or towing and/or repairing wrecked or disabled vehicles—tools of trade, spare parts and materials incidental thereto.
- MOLLUSO, F., Gunbower. One commercial goods vehicle (L/C. 81 cwt.) to operate as a "Tow Truck" within a 75-mile radius of the post office at Gunbower for the purpose of lifting and carrying or towing and/or repairing wrecked or disabled vehicles—tools of trade, spare parts and materials incidental thereto.

RENEWALS.

- APPLICATION for renewal of licence as shown by persons listed hereunder to operate under the same terms and conditions from the date of expiry shown in each case.
- BASS, A. E., 10 Bond-street, Clayton; D.A.29802; 6th May, 1965; 165 cwt.
- BATSON, C. G., 52 Moore-street, Colac; D.A.29351; 13th May, 1965; 142 cwt.
- BASTON, F. O., F. C. & B. M. (trading as F. O. Baston & Co. Pty. Ltd.), 48 Rowans-road, Highett; D.A.29723; 24th June, 1965; 191 cwt.
- BEAUREPAIRE TYRE SERVICE PTY. LTD., 102 Victoria-street, Carlton; D.A.629/57; 13th June, 1965; 21 cwt.; D.A.629/58; 13th June, 1965; 18 cwt.
- CHARLTON BLUESTONE QUARRIES PTY. LTD., Box 81, Charlton; D.A.41631/1; 1st May, 1965; 138 cwt.
- CORKHILL, B. T. & G. M. (trading as Corkhill's Radio and Television Service), 51 Beetham-parade, Rosanna; D.A.42864; 5th June, 1965; 8 cwt.
- CROSBY, WILLIAM (MERCHANDISE) PTY. LTD., 266 King-street, Melbourne; D.A.916/3; 1st December, 1964; 57 cwt.
- DONALDSON, L. D., 24 Dryden-street, East Doncaster; D.A.39520; 10th May, 1965; 121 cwt.
- PILLEY, M. L. and B. C. ELLIS (trading as J. T. Dixon & Son), 125 Clarence-street, Geelong West; D.A.3704; 11th May, 1965; 113 cwt.
- EDGEELL, GORDON PTY. LTD., 49 William-street, Hawthorn; T.D.A.39800; 27th June, 1965; 23 cwt.
- ELDER, H., 15 Livingstone-parade, Preston; D.A.11704/2; 13th June, 1965; 88 cwt.
- EMBERY, D. & R. J. (trading as D. Embery & Son), Box 26, Corryong; D.A.1039; 15th May, 1965; 243 cwt.
- ENGLISH, THE ELECTRIC CO. OF AUSTRALIA PTY. LTD., 170 William-street, Melbourne; D.A.3412; 19th June, 1965; 9 cwt.
- GARDNER, R., 260 Victoria-street, Brunswick; D.A.43265; 5th June, 1965; 53 cwt.
- GORDON BROTHERS PTY. LTD., 110-120 Union-street, Brunswick; D.A.1172/3; 2nd June, 1965; 11 cwt.
- GORDON & COLE PTY. LTD., 60 Potter-street, Black Rock; D.A.29511; 3rd June, 1965; 57 cwt.
- HADDEN, JOHN E., PTY. LTD., 195 Lennox-street, Richmond; D.A.46051/6; 19th June, 1965; 17 cwt.
- HADDEN, JOHN E., PTY. LTD., 195 Lennox-street, Richmond; D.A.46051/5; 19th June, 1965; 17 cwt.
- HAMILTON, K. N., 3 Eyre-street, Box 132, Ararat; D.A.50761; 31st May, 1965; 234 cwt.
- HEIDELBERG SEPTIC TANKS PTY. LTD., 130-132 Northern-road, West Heidelberg; D.A.37348/3; 13th June, 1965; mobile crane.
- HYLAND, DAVID & SON PTY. LTD., 157 Salmon-street, Port Melbourne; T.D.A.39737/2; 16th June, 1965; 86 cwt.; T.D.A.39737/3; 16th June, 1965; 54 cwt.; T.D.A.39737/4; 16th June, 1965; 64 cwt.

JONES, D. W., PTY. LTD., 126 Cecil-street, Williamstown; D.A.1392/4; 25th June, 1965; 115 cwt.; D.A.1392/5; 25th June, 1965; 110 cwt.

KNOWLES, E., & SONS PTY. LTD., 1122 Sydney-road, Fawkner; D.A.29863; 24th June, 1965; 56 cwt.

LEWIS, S. D., 45 Clark-street, Prahran; D.A.2763; 4th May, 1965; 17 cwt.

LOWEN, L. H. L., Hume Highway, Benalla; T.D.A.35984/2; 18th May, 1965; 35 cwt.

MAPLES PTY. LTD., 258 Clarendon-street, South Melbourne; D.A.30136; 24th June, 1965; 11 cwt.

MILEAGE TYRE SERVICE PTY. LTD., 55 Market-road, West Footscray; D.A.43268/1; 5th June, 1965; 17 cwt.; D.A.43268/4; 5th June, 1965; 17 cwt.

MOBILE QUARRIES (VIC.) PTY. LTD., 23 Anderson-road, Thornbury; D.A.39954/5; 13th June, 1965; 224 cwt.; D.A.39954/6; 13th June, 1965; 224 cwt.

MOBILE QUARRIES (VIC.) PTY. LTD., 23 Anderson-road, Thornbury; D.A.39954/3; 5th June, 1965; 9 cwt.; D.A.39954/4; 5th June, 1965; 9 cwt.

MOOROODUC CO-OPERATIVE TRADING SOCIETY LTD., Tyabb-road, Moorooduc; D.A.9889/1; 24th June, 1965; 108 cwt.

NEON ELECTRIC SIGNS LTD., cnr. Cecil and Whiteman streets, South Melbourne; D.A.1713/5; 27th June, 1965; 53 cwt.; D.A.1713/6; 27th June, 1965; 39 cwt.

OAKLEY, G., 322 High-street, Windsor; D.A.30163; 24th June, 1965; 90 cwt.

PETERSVILLE AUSTRALIA LTD., Wellington-road, Clayton; T.D.A.1813/95; 16th June, 1965; 37 cwt.

PETERSVILLE AUSTRALIA LTD., Wellington-road, Clayton; D.A.1813/8; 23rd June, 1965; 11 cwt.; D.A.1813/9; 23rd June, 1965; 10 cwt.

REVELL, A. K., Archer-road, Garfield; D.A.33942/2; 1st May, 1965; 31 cwt.

STEEN, J., 20 Hudson-street, Coburg; D.A.8120/3; 13th June, 1965; 106 cwt.

SUNKIST SNAP—FROZEN DISTRIBUTORS PTY. LTD., 50 Nott-street, Port Melbourne; T.D.A.47865/9; 22nd June, 1965; 113 cwt.

TUBBS, K., & B., 22 Railway-avenue, Werribee; D.A.4882; 13th May, 1965; 241 cwt.; D.A.4882/1; 13th May, 1965; 242 cwt.

WALES, J., 13 Balmoral-avenue, Strathmore; D.A.2214; 27th June, 1965; 40 cwt.

WALKER, A. G., & N. MCQUALTER, 29-31 Carrier-street, Benalla; D.A.29523; 6th May, 1965; 15 cwt.

WEBB, M. C., Everett-street, West Brunswick; D.A.42325; 20th March, 1965; 11 cwt.

YENCKEN, E. L., & CO. PTY. LTD., 107-119 Kavanagh-street, South Melbourne; D.A.41277/1; 22nd May, 1965; 19 cwt.; D.A.41277/2; 22nd May, 1965; 21 cwt.; D.A.41277/3; 22nd May, 1965; 11 cwt.; D.A.41277/4; 22nd May, 1965; 70 cwt.

VICTORIAN OAT GROWERS POOL AND MARKETING COMPANY LIMITED, 528-538 Lonsdale-st., Melbourne; D.A.37996/2; 24th May, 1965; 11 cwt.

WESTCOTT, J. F., & E. T., (trading as F. Westcott & Sons), 24 Eva-street, Malvern; D.A.42499/2; 19th June, 1965; 161 cwt.

TOW TRUCKS.

RENEWALS.

FERRIS, J. H., & A. J. THOMSON (trading as Ferris & Thomson), Walwa; T.D.A.47642; 18th February, 1965; 25 cwt.

LITTLE, E. J., E. J., C. M., & J. E., (trading as Little's Black Rock Motors), 298 Beach-road, Black Rock; D.A.1506/1; 23rd June, 1965; 80 cwt.; D.A.1506/3; 5th June, 1965; 8 cwt.

MAINON MOTORS PTY. LTD., 173 Burke-road, East Malvern; D.A.43563/2; 13th June, 1965; 12 cwt.

PETTIGREW, W. J. (trading as Garden Motors), P.O. Box 37, Yallourn; D.A.42621; 20th March, 1965; 116 cwt.

RENEWALS WITH VARIATION.

BEAUREPAIRE TYRE SERVICE PTY. LTD., 102 Victoria-street, Carlton; D.A.629/25; 27th June, 1965. Application to renew and vary the conditions of licence No. D.A. 629/25 (L/C. 18 cwt.) by deleting the existing area of operation and adding in lieu "To operate within a 50-mile radius of own branch premises at Kerang."

DUNN, R. V., Kernot; D.A.42756; 25th April, 1965. Application to renew and vary the conditions of licence No. D.A.42756 (L/C. 213 cwt.) by adding to the existing conditions as an additional paragraph "Within a 50-mile radius of Kernot—goods solely in the course of business as a "Primary Producer."

HYLAND, DAVID, & SONS PTY. LTD., 157 Salmon-street, Port Melbourne; T.D.A.39737/1; 16th June, 1965. Application to vary and renew licence No. T.D.A.39737/1 (L/C. 59 cwt.) by deleting from paragraph (b)

"Within the Gippsland area of Victoria east of north/south line drawn through Melbourne and add in lieu to paragraph (b) "To operate throughout the State of Victoria."

WAITES, K. J., care of Wy Yung, P.O.; D.A.42993; 8th May, 1965. Application to renew and vary the conditions of licence No. D.A.42993 (L/C. 107 cwt.) by deleting from the existing conditions part of paragraph (a) "85 miles of the post office at Orbost" and from paragraph (b) "Nowa Nowa" and adding in lieu to paragraph (a) 95 miles of the post office at Orbost (Bairnsdale division of the C.R.B.) and to paragraph (b) "Wy Yung".

Notice of any objection should be forwarded to reach the Secretary of the Board not later than Wednesday, the 7th April, 1965.

Applicants are advised that it will not be necessary to appear on the hearing date specified above, unless advised in writing by the Board.

B. P. KAY,

Secretary.

Exhibition Buildings, Rathdown-street, Carlton, N.3, 24th March, 1965.

DEPARTMENT OF MINES.

MINING LEASES GRANTED.

9228, Ballarat; George Govan, Robert Govan and John Govan; 15a. 1r. 26p., City and Parish of Ballarat.

8135, Mineral; William Baden Powell Henry; 13a. 3r. 10p., Parish of Maldon.

8210, Mineral; Mildura Plaster Mills Proprietary Limited; 526a. 2r. 3p., Parish of Goonegul.

8215, Mineral; Mildura Plaster Mills Proprietary Limited; 586a. 0r. 36 p., Parish of Goonegul.

APPLICATION FOR LEASE DECLARED ABANDONED.

5618, Gippsland; M. J. Crawford, M. R. Thompson, P. Anglin, J. B. Griffiths, B. McMahon, C. W. Davis, and E. P. Smith; 173 acres, Parish of Waihalla.

TERM OF PETROLEUM EXPLORATION PERMITS EXTENDED.

38, Petroleum Prospecting Permit; Haematite Explorations Proprietary Limited; 4,450 square miles, in East Gippsland and off shore in Bass Strait.

39, Petroleum Prospecting Permit; Haematite Explorations Proprietary Limited; 3,600 square miles, off shore adjoining Wilson's Promontory.

REFUSING APPLICATIONS FOR MINERAL SEARCH LICENCES.

644, Mineral Search Licence; Henry Allan Green; 100 acres, Parish of Bungal.

645, Mineral Search Licence; Henry Allan Green; 100 acres, Parish of Bungal.

MINERAL SEARCH LICENCES EXPIRED.

533, Mineral Search Licence; Frederick Daniel Lloyd; 50 acres, Parish of Bullengarook.

555, Mineral Search Licence; James Henry Grant, 50 acres, Parish of Murrungee.

T. A. DARCY,

Minister of Mines.

MINING LEASES DECLARED VOID.

5607, Gippsland, Ronald Brian Bell; 54a. 0r. 14p., Parish of Mowamba.

8072, Mineral; Sydney Walter Nimbs and Cecil Withers; 14a. 0r. 32p., Parish of Wombat.

7226, Mineral; Bendigo Pottery Pty. Ltd.; 6a. 2r. 0p., Parish of Sandhurst.

The applicant for forfeiture of the above mentioned lease No. 7226 Mineral will be granted a new lease under section 57 of the Mines Act 1958.

E. CONDON,

Secretary for Mines.

NOTICE.

CREDITORS, next of kin, and others having claims against the estate of any of the under-mentioned deceased persons are required to send particulars of their claims to the Public Trustee, 256 Flinders-street, Melbourne, the personal representative, on or before the 25th May, 1965, after which date the Public Trustee may convey or distribute the assets, having regard only to the claims of which the Public Trustee then has notice:—

BOYD, HUGH WHITFIELD, late of 11 Tyndall-street, Surrey Hills, R.A.C.V. employee, died 6th January, 1965.

BROWN, ETHEL MARY, late of 308 Beaconsfield-parade, Middle Park, retired saleswoman, died 22nd October, 1964.

CHAPMAN, MARTHA MAUDE MARIA (in the will called Chapman, Martha Maud Maria), late of 9 Scott-street, Orbost, widow, died 1st September, 1964.

CLARKE, LESLIE WILLIAM, late of 50 Elizabeth-street, Elsternwick, labourer, died 29th November, 1964.

CLEMENTS, ISABELLA, late of Warrigal-road, Cheltenham, spinster, died 4th September, 1964.

DARBY, LOUISA, late of 2 Pohlman-avenue, Colonists Homes, Rushall-crescent, North Fitzroy, widow, died 9th October, 1964.

ENEVER, FRANK, late of 80A William-street, East St. Kilda, retired storeman, died 15th June, 1964.

FITZGERALD, ALFRED EDWARD, late of 86 Bridge-street, Port Melbourne, retired toolmaker, died 20th December, 1964.

GALLAND, FREDERICK WILLIAM, formerly of 24 Fulton-street, Armadale, Victoria, but late of Alexander Home, Castlemaine, Victoria, retired rubber worker, died 23rd December, 1964.

GAUNT, CHARLES EDWARD, late of Benevolent Asylum, Dunwich, Queensland, stockman, died 29th January, 1938.

HAMPTON, MARY, late of Ovens and Murray Home, Beechworth, pensioner, died 11th February, 1964.

HEALEY, STANLEY, late of 9 Thompson-street, South Melbourne, retired gardener, died 27th December, 1964.

HINCE, BERNADETTE, late of 55 Parer-street, Burwood, married woman, died 20th January, 1965.

MANLEY, HORACE EARNEST ESRIC, also known as Horace Esric Ernest Manley and Horace Earnest Manley, late of 12 Suffolk-avenue, Coburg, retired engineer, died 25th October, 1964.

MARTIN, ALBERT WALTER, also known as Albert Walter Patrick Joseph Martin, formerly of 140 Peel-street, Windsor, but late of 60 Upton-road, Windsor, school teacher, died 19th November, 1964.

MORROW, ROBERT HENRY, also known as Henry Morrow, late of 6 Pine-avenue, Camberwell, retired farmer, died 24th July, 1964.

PALMER, ELEANOR ELVESTON, late of 12 Ashlar-road, Moorabbin, married woman, died 25th December, 1964.

PILKERTON, GEORGE BENJAMIN, late of 121 Barkly-street, St. Kilda, pensioner, died 5th January, 1965.

RASMUSSEN, ALFRED, late of "The Grange" Hostel, Hamilton, pensioner, died 15th August, 1964.

READ, AUDREY STELLA, late of 10 Joyce-avenue, Greensborough, widow, died 5th January, 1965.

REGAN, MARGARET, formerly of 16 Monash-street, Oakleigh, and 17 Bowmans-parade, Oakleigh, but late of Kew, widow, died 1st March, 1964.

RENZI, NINA, late of 168 Osborne-street, Williamstown, cook, died between the 22nd September, 1964, and the 13th October, 1964.

SANDELLS, HENRY VALENTINE, late of 41 Home-road, Newport, retired railway employee, died 27th November, 1964.

SAUNDERS, NORMAN AUSTIN, late of 2 Sheffield-street, Preston, meat inspector, died 1st January, 1965.

SHERRIFF, AGNES, late of Baptist Aged People's Home, McLeod, spinster, died 25th April, 1964.

SOUTH, GEORGE EDWIN, formerly of 32 Brougham-street, North Melbourne, late of 86 Fitzgibbon-street, Parkville, newstype reader, died 5th January, 1965.

THOMSON, WEMYSS ANDREW, late of 18 Station-road, Williamstown, retired engineer, died 6th October, 1964.

TOGNALLA, MARY, late of 432 William-street, West Melbourne, spinster, died 16th December, 1964.

WINDRAM, MARGARET POLLOCK, late of 5 Cosy Gum-road, Carnegie, widow, died 2nd January, 1965.

A. D. DUNCAN,
Public Trustee.

Melbourne, 17th March, 1965.

PUBLIC TRUSTEE ACT 1958 (No. 6350), SECTION 17.

I HEREBY give notice that on the 4th March, 1965, the Public Trustee filed elections to administer the following deceased persons' estates, in accordance with section 17 of the Public Trustee Act 1958:—

CLEMENTS, ISABELLA, late of Warrigal-road, Cheltenham, spinster, died 4th September, 1964.

DARBY, LOUISA, late of 2 Pohlman-avenue, Colonists Homes, Rushall-crescent, North Fitzroy, widow, died 9th October, 1964.

FITZGERALD, ALFRED EDWARD, late of 86 Bridge-street, Port Melbourne, retired toolmaker, died 20th December, 1964.

GALLAND, FREDERICK WILLIAM, formerly of 24 Fulton-street, Armadale, Victoria, but late of Alexander Home, Castlemaine, Victoria, retired rubber worker, died 23rd December, 1964.

GAUNT, CHARLES EDWARD, late of Benevolent Asylum, Dunwich, Queensland, stockman, died 29th January, 1938.

HAMPTON, MARY, late of Ovens and Murray Home, Beechworth, pensioner, died 11th February, 1964.

HEALEY, STANLEY, late of 9 Thompson-street, South Melbourne, retired gardener, died 27th December, 1964.

I HEREBY give notice that on the 5th March, 1965, the Public Trustee filed elections to administer the following deceased persons' estates, in accordance with section 17 of the Public Trustee Act 1958:—

CLARKE, LESLIE WILLIAM, late of 50 Elizabeth-street, Elsternwick, labourer, died 29th November, 1964.

ENEVER, FRANK, late of 80A William-street, East St. Kilda, retired storeman, died 15th June, 1964.

MANLEY, HORACE EARNEST ESRIC, also known as Horace Esric Ernest Manley and Horace Earnest Manley, late of 12 Suffolk-avenue, Coburg, retired engineer, died 25th October, 1964.

MORROW, ROBERT HENRY, also known as Henry Morrow, late of 6 Pine-avenue, Camberwell, retired farmer, died 24th July, 1964.

RASMUSSEN, ALFRED, late of "The Grange" Hostel, Hamilton, pensioner, died 15th August, 1964.

RENZI, NINA, late of 168 Osborne-street, Williamstown, cook, died between the 22nd September, 1964, and the 13th October, 1964.

SHERRIFF, AGNES, late of Baptist Aged People's Home, McLeod, spinster, died 25th April, 1964.

SOUTH, GEORGE EDWIN, formerly of 32 Brougham-street, North Melbourne, late of 86 Fitzgibbon-street, Parkville, newstype reader, died 5th January, 1965.

I HEREBY give notice that on the 11th March, 1965, the Public Trustee filed an election to administer the following deceased person's estate, in accordance with section 17 of the Public Trustee Act 1958:—

CHAPMAN, MARTHA MAUDE MARIA (in the will called Chapman, Martha Maud Maria), late of 9 Scott-street, Orbost, widow, died 1st September, 1964.

A. D. DUNCAN,
Public Trustee.

256 Flinders-street, Melbourne, C.1., 17th March, 1965.

Country Fire Authority Act.

PERMISSION TO HOLD FIRE BRIGADE DEMONSTRATION.

IN pursuance with the provisions of section 103 of the Country Fire Authority Act 1958, the Country Fire Authority has granted permission for the holding of a fire brigade demonstration as under:—

RURAL FIRE BRIGADE.

At Longwarry, on Saturday, 20th March, 1965, in lieu of Monday, 8th March, 1965.

J. L. ALLEN,
Secretary.

17th March, 1965.

Cemeteries Act 1958.

SCALE OF FEES FOR WESTERN SUBURBS MEMORIAL PARK CREMATORIUM AND LAWN CEMETERY.

IN pursuance of the powers conferred upon them by the Cemeteries Act, the Trustees of the Williamstown Public Cemetery hereby make the following scale of fees which shall come into operation upon publication in the Government Gazette, and from and after such publication every scale of fees heretofore made by the said Trustees shall be and is hereby rescinded to the extent to which it conflicts with this scale.

Crematorium.		£	s.	d.
Cremation Fees.				
Children under one year	3 3 0
All others	10 10 0

	£	s.	d.
<i>Removal of Cremated Remains:</i>			
Cremated remains removed from Western Suburbs Memorial Park by authorized persons	1	10	0
Additional fee in case of mailing the cremated remains (within Australia)	0	10	0
<i>Lawn Cemetery.</i>			
Land 8 feet by 4 feet inclusive of first interment	35	0	0
Additional fee for rectangular or oversize casket/coffin	1	10	0
Flower containers, each	2	10	0
Fee for installing plaques supplied by Commonwealth War Graves Commission	2	0	0

ALEX. W. HICK, Deputy Chairman.
D. SMITH, Trustee.
F. SPEECHLEY, Trustee.
C. W. SIDWAY, Manager and Secretary.

13th February, 1965.

Approved by the Governor in Council 16th March, 1965.
J. COLQUHOUN, Clerk of the Executive Council.

APPOINTMENTS.

HIS Excellency the Governor of the State of Victoria, by and with the advice of the Executive Council thereof, has by Orders made on the 16th day of March, 1965, been pleased to make the under-mentioned appointments, viz.:—

CHIEF SECRETARY'S DEPARTMENT.

Electoral Registrars (Acting).

GEORGE LEO CHAMBERLAIN
to be Electoral Registrar (Acting) for the Burnley, Hawthorn and Richmond South Subdivisions of the Electoral District of Hawthorn; and for the Abbotsford, Collingwood and Richmond Subdivisions of the Electoral District of Richmond, to take effect on and from the 9th March, 1965, during the absence, on leave, of Leonard John Lubcke;

GORDON EDWIN HUTH
to be Electoral Registrar (Acting) for the Bentleigh and Moorabbin Subdivisions of the Electoral District of Moorabbin; and for the Highett and Sandringham Subdivisions of the Electoral District of Sandringham, to take effect on and from the 9th March, 1965, during the absence, on leave, of Nicholas Michael O'Donnell;

MAXWELL BARNET PERKINS
to be Electoral Registrar (Acting) for the Braxholme, Casterton, Hamilton, Harrow, Mortlake and Penshurst Subdivisions of the Electoral District of Dundas; and for the Allansford, Koroit, Port Fairy, Portland and Warrnambool Subdivisions of the Electoral District of Portland, to take effect on and from the 20th April, 1965, during the absence, on leave, of Leslie John Maxwell; and

JOHN WEBB
to be Electoral Registrar (Acting) for the Oakleigh and Oakleigh East Subdivisions of the Electoral District of Oakleigh; and for the Bentleigh North, Carnegie and Glenhuntly Subdivisions of the Electoral District of Ormond, to take effect on and from the 1st March, 1965, during the absence, on leave, of William John Champion Furlonger.

DEPARTMENT OF CROWN LANDS AND SURVEY.

Land Officer.

PETER THOMAS LEDGAR,
an Officer of the Department of Crown Lands and Survey, to be a Land Officer in and for the State of Victoria.

Officer Authorized to Grant a Right to Occupy Crown Lands.

PETER THOMAS LEDGAR,
an Officer of the Department of Crown Lands and Survey, to be a duly authorized person to grant to an applicant a right to occupy, as a residence area under the Land Act 1958 any Crown lands, as provided in section 165 of the Land Act 1958.

MINISTRY OF HEALTH.

Members of Committees of Management.

LINDSAY ARTHUR HEMLEY, J.P.;
to be a member of the Committee of Management of Benalla and District Hospital, pursuant to proviso (a) to section 48 (1) of the Hospitals and Charities Act 1958, for a period of three years; vice-C. Webb, resigned;

Professor SYDNEY SUNDERLAND, C.M.G., D.Sc., M.D., B.S., F.R.A.C.S., F.R.A.C.P., F.A.A.,
to be a member of the Committee of Management of Royal Melbourne Hospital, pursuant to proviso (c) to section 48 (1) of the Hospitals and Charities Act 1958 on the nomination of the University of Melbourne, for a period of three years;

Professor SYDNEY LANCE TOWNSEND, V.R.D., M.D., F.R.C.S.(Edin.), F.R.A.C.S., F.R.C.O.G., D.T.M. and H.,
to be a member of the Committee of Management of the Royal Women's Hospital, pursuant to proviso (c) to section 48 (1) of the Hospitals and Charities Act 1958 on the nomination of the University of Melbourne, for a period of three years;

Professor VERNON LESLIE COLLINS, M.B., B.S., M.B., B.Ch.(Lond.), M.R.C.P., F.R.A.C.P.,
to be a member of the Committee of Management of the Royal Children's Hospital, pursuant to proviso (c) to section 48 (1) of the Hospitals and Charities Act 1958, on the nomination of the University of Melbourne, for a period of three years;

Professor GERARD WILLIAM CROCK, M.B., B.S., F.R.C.S.,
to be a member of the Committee of Management of the Royal Victorian Eye and Ear Hospital, pursuant to proviso (c) to section 48 (1) of the Hospitals and Charities Act 1958, on the nomination of the University of Melbourne, for a period of three years;

Professor HUGH ARNOLD FREEMAN DUDLEY, M.B., Ch.M.(Edin.), F.R.C.S.(Edin.),
to be a member of the Committee of Management of the Alfred Hospital, pursuant to proviso (c) to section 48 (1) of the Hospitals and Charities Act 1958, on the nomination of Monash University, for a period of three years;

Professor BRYAN HUDSON, M.D., B.S., Ph.D.(Melb.), M.R.C.P., F.R.A.C.P., M.C.P.A.,
to be a member of the Committee of Management of the Prince Henry's Hospital, pursuant to proviso (c) to section 48 (1) of the Hospitals and Charities Act 1958, on the nomination of Monash University, for a period of three years; and

Professor RICHARD RODERICK ANDREW, M.D., B.S.(Melb.), F.R.C.P., F.R.A.C.P.,
to be a member of the Committee of Management of the Queen Victoria Memorial Hospital, pursuant to proviso (c) to section 48 (1) of the Hospitals and Charities Act 1958, on the nomination of Monash University, for a period of three years.

LAW DEPARTMENT.

Chairman of Judges of County Court.

NORMAN FREDERICK MITCHELL
to be the Chairman of Judges of the County Court, pursuant to the provisions of section 8 (5) of the County Court Act 1958, to take effect as from and inclusive of the 31st March, 1965.

Commissioners for Taking Declarations, &c.

PETER THOMAS LEDGAR, care of Department of Crown Lands and Survey, State Public Offices, Treasury place, Melbourne, and
MATTHEW BARRY WHITE, care of Department of Agriculture, Victoria, Treasury Gardens, Melbourne,

to be Commissioners for taking Declarations and Affidavits, pursuant to the provisions of the Evidence Act 1958, to refrain from charging fees, and to resign upon ceasing to occupy their present positions;

IVOR ANGLESEY JONES, 18 Queen-street, Melbourne,
KEVIN LEO DAVISON, 39 Leonard-street, Burwood, and
ROBERT PERRY, Deans Marsh,
to be Commissioners for taking Declarations and Affidavits, pursuant to the provisions of the Evidence Act 1958, to resign upon removing from the neighbourhood of the addresses stated; and

ERIC RAYMOND DU BOURG, care of Maryborough and District Hospital, Maryborough,
to be a Commissioner for taking Declarations and Affidavits, pursuant to the provisions of the Evidence Act 1958, to resign upon ceasing to occupy his present position.

Judge's Associate.

RICHARD LEON HORNBY LEWISOHN
to be Associate to His Honour, Mr. Justice Little, to take effect as on and from the 15th March, 1965.

Justices of the Peace.

BEN GRIBBIN, care of the English, Scottish and Australian Bank Ltd., 411 Nepean Highway, Chelsea,
to keep the Peace in the Central Bailiwick of the State of Victoria; and

CHARLES ALEXANDER DEMBY, Kinglake-road, Toolangi,
to Keep the Peace in the Central Bailiwick of the State of
Victoria.

J. COLQUHOUN,
Clerk of the Executive Council.

At the Executive Council Chamber,
Melbourne, 16th March, 1965.

APPOINTMENTS.

HIS Excellency the Governor of the State of Victoria,
by and with the advice of the Executive Council
thereof, has, by Orders made on the 23rd day of March,
1965, been pleased to make the under-mentioned appoint-
ments, viz.:—

DEPARTMENT OF WATER SUPPLY.

Waterworks Trust Commissioners.

PETER FREDERICK BARNETT
to be a Commissioner of the Myrtleford Waterworks Trust
to hold such position during the present term of office
of J. A. Jones as a Councillor of the Shire of Myrtleford,
subject to the provisions of the Water Act.

WILLIAM JACK FIDLER
to be a Commissioner of the Myrtleford Waterworks
Trust to hold such position during the present term
of office of C. J. Toner as a Councillor of the Shire of
Myrtleford, subject to the provisions of the Water Act.

WILLIAM JOHN LILLIS
to be a Commissioner of the Myrtleford Waterworks Trust
to hold such position during the present term of office
of J. W. Browne as a Councillor of the Shire of Myrtle-
ford, subject to the provisions of the Water Act.

THOMAS FORD BRENT
to be a Commissioner of the Warburton Waterworks
Trust to hold such position during the present term of
office of Sidney Colin Grieve as a Councillor for the East
Riding of the Shire of Upper Yarra, subject to the pro-
visions of the Water Act.

J. COLQUHOUN,
Clerk of the Executive Council.

At the Executive Council Chamber,
Melbourne, 23rd March, 1965.

RESIGNATIONS.

HIS Excellency the Governor of the State of Victoria,
by and with the advice of the Executive Council
thereof, has, by Orders made on the 16th day of March,
1965, accepted the resignations of the persons named
hereunder of the offices mentioned, viz.:—

CHIEF SECRETARY'S DEPARTMENT.

OWEN WILLIAM GIBBONS, as Electoral Registrar for the
Broadmeadows, Fawkner, Gisborne, Glenroy, Kil-
more, Lancefield, Sunbury, Whittlesea and
Woodend Subdivisions of the Electoral District
of Broadmeadows; and for the Altona, Deer
Park, Sunshine and Werribee Subdivisions of the
Electoral District of Grant, to date from and
inclusive of 4th March, 1965;

GEORGE MORRIS BOURKE, as Electoral Registrar for the
Ascot Vale and Newmarket Subdivisions of the
Electoral District of Flemington; and for the
Carlton South, Melbourne, North Melbourne and
Parkville Subdivisions of the Electoral District
of Melbourne, to date from and inclusive of 4th
March, 1965; and

FREDERICK MACAULAY, as Electoral Registrar for the
Brighton and Hampton Subdivisions of the Elec-
toral District of Brighton; and for the Brighton
East and Elsternwick Subdivisions of the Elec-
toral District of Elsternwick, to date from and
inclusive of 22nd July, 1964.

LAW DEPARTMENT.

EDWARD JOHN TEMPLE MILES, from the Commission
of the Peace for the Central Bailiwick of the
State of Victoria.

J. COLQUHOUN,
Clerk of the Executive Council.

At the Executive Council Chamber,
Melbourne, 16th March, 1965.

COUNTRY ROADS BOARD.

At the Executive Council Chamber, Melbourne, the
twenty-seventh day of January, 1965.

PRESENT:

His Excellency the Governor of Victoria.
Mr. Porter | Mr. Mack.
Mr. Meagher

DECLARATION OF A DEVIATION FROM THE FISH CREEK-FOSTER ROAD IN THE SHIRE OF SOUTH GIPPSLAND.

WHEREAS by sections 21 and 58 of the *Country Roads
Act 1958* (No. 6229) it is amongst other things en-
acted that when the Country Roads Board under the
provisions of the *Country Roads Act* has by Resolution
declared a deviation to be a main road the said Board
may also declare that such deviation shall be in lieu of
any existing road or part thereof named in such Resolu-
tion and that on publication in the *Government Gazette*
of the Order confirming such Resolution the existing road
or part thereof shall cease to be a main road or be dis-
continued as provided in the Resolution: And whereas
the said Board has by Resolution declared the deviation
on the land described in the First Schedule to such
Resolution to be a main road and has also declared that
such deviation shall be in lieu of the part of the existing
road being the land described in the Second Schedule
to the said Resolution and that such part of the said exist-
ing road shall be discontinued: Now therefore His Ex-
cellency the Governor of the State of Victoria by and
with the advice of the Executive Council thereof doth
hereby confirm the said Resolution.

Resolution for Declaration of a Deviation of a Main Road under the Country Roads Act.

Whereas the land the site of the road the course of
which is below set out was taken by the Board under the
provisions of the *Country Roads Act 1958* for the purpose
of constructing such road deviation which road deviation
has now been laid out and formed on the same: And
whereas the said Board (being the Country Roads Board
incorporated under the said Act) thinks that the road
aforesaid is fit to be used as a public highway such Board
at a meeting now holden acting under the authority
conferred upon it by sections 21 and 58 of the said Act
doth by this present Resolution hereby declare the said
road deviation the course of which is described in the First
Schedule hereto with the commencing and terminating
points thereof respectively specified to be part of a main
road within the meaning and for the purposes of, the
Country Roads Act 1958: And the said Board doth also
declare that such deviation shall be in lieu of the existing
road or part thereof described in the Second Schedule
hereto and that such part of the said existing road shall be
discontinued.

FIRST SCHEDULE.

Shire of South Gippsland.

17. *Fish Creek-Foster road* (15417).—All those pieces
of land in the Parish of Wonga Wonga South, the bound-
aries of which are as follow:—

- (a) Commencing at a point on the southern boundary
of allotment 32, section C, of the said parish,
distant 91 deg. 24 min. 230.3 links from the
south-western angle of the said allotment; thence
by lines bearing respectively 75 deg. 55
min. 1,337.8 links, 47 deg. 32 min. 502.3 links,
27 deg. 52 min. 344.9 links, 186 deg. 33 min.
143.8 links, 208 deg. 1 min. 689 links, 255 deg.
56 min. 955.4 links and 271 deg. 24 min. 562.6
links to the point of commencement.
- (b) Commencing at a point on the northern boundary
of allotment 33B, section C, of the said parish,
distant 278 deg. 58 min. 267.7 links from the
north-eastern angle of the said allotment; thence
by lines bearing respectively 254 deg. 0 min.
558 links, 221 deg. 29 min. 708.6 links, 207
deg. 14 min. 643.9 links, 6 deg. 44 min. 437.1
links, 27 deg. 23 min. 345.5 links, 41 deg. 29
min. 689.3 links, 69 deg. 11 min. 198.8 links
and 98 deg. 58 min. 453.3 links to the point
of commencement.
- (c) Commencing at the south-western angle of allot-
ment 27c, section C, of the said parish; thence
by lines bearing respectively 95 deg. 13 min.

980.9 links, 59 deg. 41 min. 95.4 links, 212 deg. 12 min. 133.5 links and 278 deg. 52 min. 1,000 links to the point of commencement.

- (d) Commencing at the south-western angle of allotment 27D, section C, of the said parish; thence by lines bearing respectively 32 deg. 12 min. 100 links, 67 deg. 13 min. 197.8 links, 65 deg. 58 min. 146.4 links, 49 deg. 27 min. 316.6 links, 40 deg. 21 min. 181.3 links, 22 deg. 41 min. 438.3 links, 49 deg. 56 min. 612.3 links, 38 deg. 49 min. 379.6 links, 39 deg. 30 min. 514 links, 40 deg. 20 min. 700.6 links, 58 deg. 16 min. 155.2 links, 37 deg. 50 min. 281 links, 47 deg. 25 min. 126.5 links, 64 deg. 30 min. 288.1 links, 100 deg. 21 min. 511.2 links, 80 deg. 39 min. 562 links, 257 deg. 32 min. 887 links, 199 deg. 30 min. 20 links, 247 deg. 7 min. 649.7 links, 220 deg. 28 min. 1,196.8 links, 217 deg. 53 min. 600 links, 190 deg. 56 min. 306.7 links, 236 deg. 9 min. 493.9 links, 220 deg. 4 min. 505.2 links, 230 deg. 3 min. 314.1 links, 246 deg. 17 min. 387.5 links, 244 deg. 25 min. 206.1 links and 31 deg. 19 min. 181 links to the point of commencement—

which said pieces of land are particularly delineated and shown coloured red on survey plans numbered 8473 and 8474, lodged in the office of the Country Roads Board.

SECOND SCHEDULE.

Shire of South Gippsland.

17. Fish Creek-Foster road (15417).—All those pieces of land in the Parish of Wonga Wonga South, the boundaries of which are as follow:—

- (a) Commencing at a point on the northern boundary of allotment 33B of the said parish, distant 91 deg. 23 min. 561.8 links from the north-western angle of the said allotment; thence by lines bearing respectively 247 deg. 50 min. 249.3 links, 91 deg. 24 min. 793.1 links, 28 deg. 1 min. 285 links, 75 deg. 56 min. 142.3 links, 207 deg. 45 min. 437.6 links and 271 deg. 23 min. 1,092.2 links to the point of commencement.
- (b) Commencing at a point on the northern boundary of allotment 33B, section C, of the said parish, distant 278 deg. 58 min. 721 links from the north-eastern angle of the said allotment; thence by lines bearing respectively 249 deg. 11 min. 422 links, 215 deg. 34 min. 657 links, 186 deg. 44 min. 210.9 links, 207 deg. 23 min. 302.2 links, 6 deg. 33 min. 506.2 links, 35 deg. 42 min. 732 links, 69 deg. 18 min. 476 links, 98 deg. 57 min. 154.1 links and 240 deg. 47 min. 162.7 links to the point of commencement.
- (c) Commencing at a point on the western boundary of allotment 27D, section C, of the said parish, distant 32 deg. 12 min. 100 links from the south-western angle of the said allotment; thence by lines bearing respectively 262 deg. 49 min. 129.4 links, 32 deg. 12 min. 343.5 links, 15 deg. 34 min. 372 links, 44 deg. 54 min. 868 links, 60 deg. 43 min. 416 links, 45 deg. 22 min. 517 links, 12 deg. 2 min. 158 links, 40 deg. 46 min. 450 links, 58 deg. 16 min. 670 links, 37 deg. 50 min. 271 links, 47 deg. 25 min. 396 links, 100 deg. 21 min. 293.6 links, 244 deg. 30 min. 170.7 links, 280 deg. 21 min. 105.8 links, 227 deg. 25 min. 211.5 links, 244 deg. 30 min. 113.4 links, 221 deg. 10 min. 329.6 links, 220 deg. 20 min. 120.5 links, 238 deg. 16 min. 517.8 links, 220 deg. 46 min. 409 links, 192 deg. 2 min. 162 links, 225 deg. 22 min. 560 links, 240 deg. 43 min. 416 links, 224 deg. 54 min. 828 links, 195 deg. 34 min. 361 links and 212 deg. 12 min. 276 links to the point of commencement—

which said pieces of land are particularly delineated and shown coloured blue on survey plans numbered 8473 and 8474, lodged in the office of the Country Roads Board.

The common seal of the Country Roads Board was hereto affixed, at Kew, this eighteenth day of January, One thousand nine hundred and sixty-five, in the presence of—

(SEAL) I. J. O'DONNELL, Chairman.
F. WEST, Member.
N. L. ALLANSON, Secretary.

And the Honorable Murray Victor Porter, Her Majesty's Commissioner of Public Works for the State of Victoria, shall give the necessary directions herein accordingly.

J. ROSSITER,
Acting Clerk of the Executive Council.

DEPARTMENT OF CROWN LANDS AND SURVEY.

At the Executive Council Chamber, Melbourne, the sixteenth day of March, 1965.

PRESENT:

His Excellency the Governor of Victoria.
Mr. Porter | Mr. Meagher.
Mr. Balfour

LANDS TEMPORARILY RESERVED AS SITES.

HIS Excellency the Governor of the State of Victoria, by and with the advice of the Executive Council thereof, doth hereby, in pursuance of the provisions of the Land Act 1958, reserve, temporarily, and also except from occupation for mining purposes under any miner's right, the lands hereinafter described:—

PORTLAND.—Site for Public purposes (Sewerage), 19 perches, Township of Portland, Parish of Portland, County of Normanby, as indicated by hachure on plan hereunder.—(P.69⁽⁶⁾) (Rs.8244).

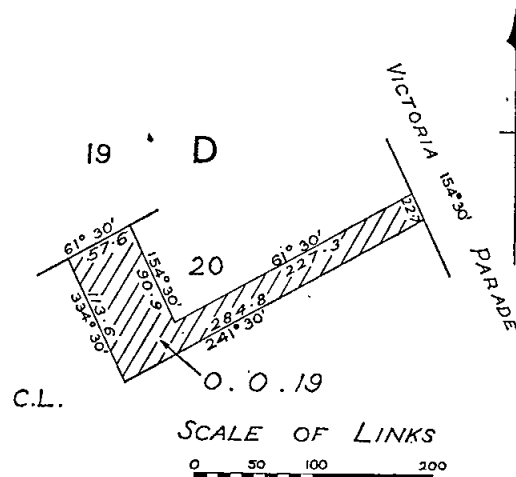

SANDHURST (BENDIGO).—Site for Water Supply purposes, 3 rods, at Bendigo, Parish of Sandhurst, County of Bendigo, as indicated by hachure on plan hereunder.—(S.372⁽¹¹⁰⁾) (Rs.8424).

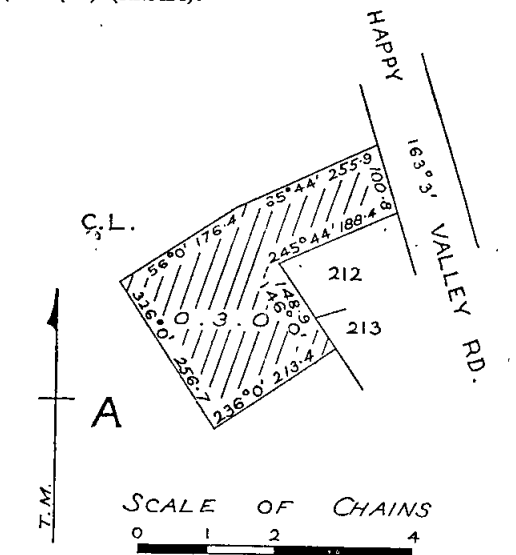

SANDHURST (BENDIGO).—Site for Public purposes (Pre-School Centre), 1 rood, more or less, at Bendigo, Parish of Sandhurst, County of Bendigo, as indicated by hachure on plan hereunder.—(S.372⁽¹¹⁰⁾) (Rs.8429).

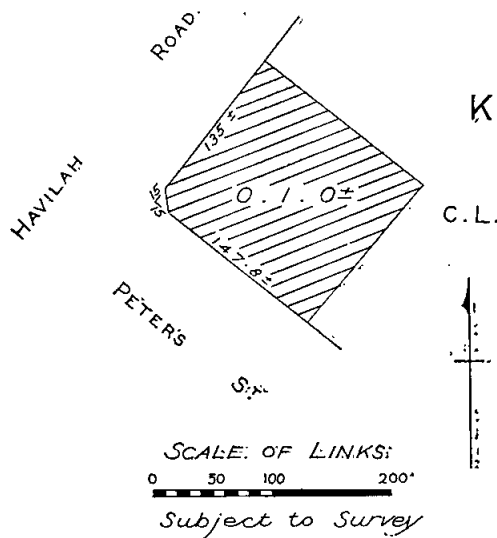

TORQUAY.—Site for Public purposes (Police purposes), in addition to and adjoining the site temporarily reserved therefor by Order in Council of the 30th January, 1957, 6 perches, Township of Torquay, Parish of Puebla, County of Grant, as indicated by hachure on plan hereunder.—(T.316⁽¹⁾). (Rs.7536).

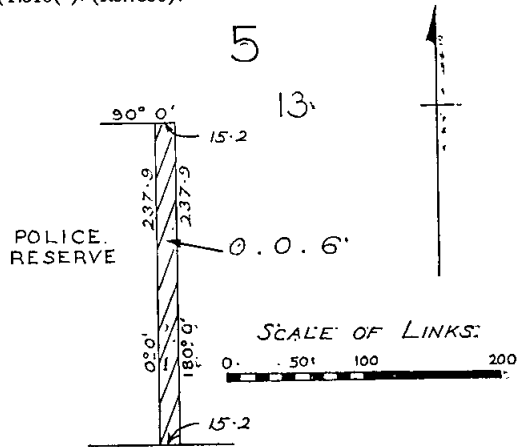

PRICE 270° 0' STREET

WOORINEN.—Site for Public Recreation, in addition to and adjoining the site temporarily reserved therefor by Order in Council of the 8th February, 1937, 6 acres 1 rood 20 perches, more or less, Township of Woorinen, Parish of Woorinen, County of Tatchera, as indicated by hachure on plan hereunder.—(W.391^(*)). (Rs.4657).

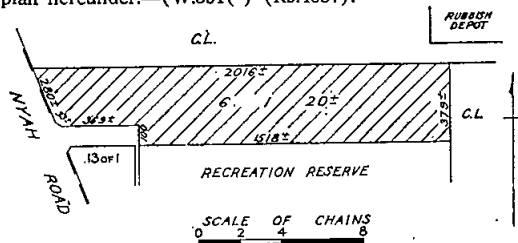

And the Honorable James Charles Murray Balfour, Her Majesty's Minister of Lands for the State of Victoria, shall give the necessary directions herein accordingly..

J. COLQUHOUN;
Clerk of the Executive Council.

DEPARTMENT OF CROWN LANDS AND SURVEY.

At the Executive Council Chamber, Melbourne, the sixteenth day of March, 1965.

PRESENT:

His Excellency the Governor of Victoria.
Mr. Porter | Mr. Meagher.
Mr. Balfour |

UNUSED ROADS CLOSED.

HIS Excellency the Governor of the State of Victoria, by and with the advice of the Executive Council thereof, doth hereby direct that, in pursuance of the provisions of section 349 of the Land Act 1958, the unused roads referred to hereunder be closed, viz.:

Township of Clunes, Parish of Clunes, County of Talbot, being the road indicated by hachure on plan hereunder.—(C.394^(*)); (J.31371).

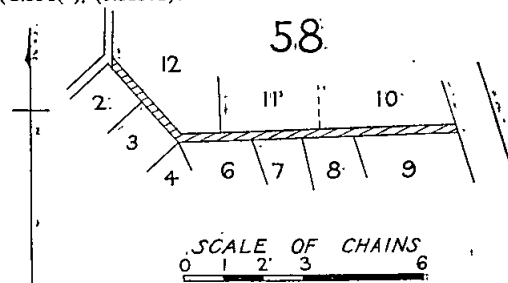

Parish of Eurandelong; County of Delatite, being the road between allotment 3b, section 17, and allotment 10, section 12.—(E.107^(*)) (904/44).

And the Honorable James Charles Murray Balfour, Her Majesty's Minister of Lands for the State of Victoria, shall give the necessary directions herein accordingly.

J. COLQUHOUN;
Clerk of the Executive Council.

LOCAL GOVERNMENT DEPARTMENT.

At the Executive Council Chamber, Melbourne, the sixteenth day of March, 1965.

PRESENT:

His Excellency the Governor of Victoria.
Mr. Porter | Mr. Meagher.
Mr. Balfour |

APPROVAL OF RATING AGREEMENT BETWEEN THE SHIRE OF COBRAM AND FOOTREST SHOES PTY. LTD.

WHEREAS..

- (a) Footrest Shoes Proprietary Limited is the registered proprietor of Lot 78 on Plan of subdivision No. 1834; lodged in the Office of Titles, and operates and desires to continue to operate a shoe factory on the said land, which land is not within a 25-mile radius of the General Post Office at Melbourne;
- (b) the Council of the Shire of Cobram is of the opinion that the maintenance of that industry within the municipality makes a substantial contribution toward the industrial development of the municipality and encourages the decentralization of industry within Victoria; and
- (c) The President, Councillors and Ratepayers of the Shire of Cobram and Footrest Shoes Proprietary Limited on the 21st December, 1964, entered into an agreement as to the amount of rates that will be payable on the above-described land under the Local Government Act 1958, during the period 1st October, 1964, to 30th September, 1966, and copies of such agreement have been submitted to the Minister for Local Government.

Now therefore, His Excellency the Governor of the State of Victoria; by and with the advice of the Executive Council thereof and in pursuance of the provisions of Part XIV of the Local Government Act 1958, hereby approves the said agreement.

And the Honorable Rupert James Hamer, Her Majesty's Minister for Local Government for the State of Victoria; shall give the necessary directions herein accordingly.

J. COLQUHOUN,
Clerk of the Executive Council.

LOCAL GOVERNMENT DEPARTMENT.

At the Executive Council Chamber, Melbourne, the sixteenth day of March, 1965.

PRESENT:

His Excellency the Governor of Victoria.
 Mr. Porter | Mr. Meagher.
 Mr. Balfour

APPOINTMENT OF A DEPUTY OF A MEMBER OF THE BUILDING REGULATIONS COMMITTEE.

WHEREAS for the purposes of Part XLIX, Division 2 of the Local Government Act 1958 it is enacted by section 920 of the said Act that there shall be a committee to be known as the Building Regulations Committee, consisting of eight members of whom one shall be appointed by the Governor in Council from a panel of three names submitted by the governing body of the Institution of Engineers (Australia):—

And whereas pursuant to section 920A (1) of the said Act the Minister for Local Government has granted Arthur Cedric Leith leave of absence from the 15th day of March, 1965, to the 28th day of October, 1965, both dates inclusive:

And whereas section 920A (2) of the said Act provides that where leave is granted by the Minister to any member of the committee the Governor in Council may appoint another person appropriately nominated to be the deputy of that member and that every such deputy shall during such period of leave have all the powers and perform all the duties of the member whose deputy he is:

Now therefore His Excellency the Governor of the State of Victoria, by and with the advice of the Executive Council thereof, doth by this Order appoint William Piper Brown from a panel of three names submitted by the governing body of the Institution of Engineers (Australia) to be the deputy of the said Arthur Cedric Leith for the period from the 15th day of March, 1965, to the 28th day of October, 1965, both dates inclusive.

And the Honorable Rupert James Hamer, Her Majesty's Minister for Local Government for the State of Victoria, shall give the necessary directions herein accordingly.

J. COLQUHOUN,
 Clerk of the Executive Council.

LOCAL GOVERNMENT DEPARTMENT.

At the Executive Council Chamber, Melbourne, the sixteenth day of March, 1965.

PRESENT:

His Excellency the Governor of Victoria.
 Mr. Porter | Mr. Meagher.
 Mr. Balfour

ROADS DISCONTINUED—CITY OF MARYBOROUGH.

WHEREAS it is provided in section 528 (2) of the Local Government Act 1958, as amended, that where a road (whether or not a public highway but not being a road set out on land of the Crown) or any part thereof is not required for public use, the Governor in Council, on the request of the Council of the municipality in which such road is situated made not less than one month after publishing in a newspaper generally circulating in the district and posting to the registered proprietor (if any) of the land and any person known to have an interest in the land notice of intention to make such a request may by Order published in the Government Gazette direct that such road or part shall be discontinued and thereupon such road or part shall be discontinued accordingly.

And whereas the Council of the City of Maryborough has requested that the Governor in Council direct that Daly-street, Simson-street, portion of Hill View-avenue and a right-of-way off Majorca-road be discontinued and not less than one month previously, has published in a newspaper generally circulating in the district and posted

to the registered proprietor of the land in the roads and to all persons known to have an interest in the said roads notice of intention to make such request:

Now therefore His Excellency the Governor of the State of Victoria, by and with the advice of the Executive Council thereof, hereby directs that the said roads, which are shown hatched on the plan hereunder, shall be discontinued and that the land may be sold by the Council of the City of Maryborough by agreement.

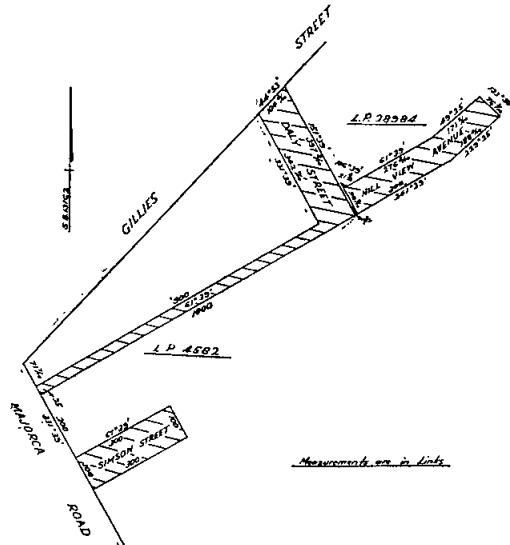

And the Honorable Rupert James Hamer, Her Majesty's Minister for Local Government for the State of Victoria, shall give the necessary directions herein accordingly.

J. COLQUHOUN,
 Clerk of the Executive Council.

LOCAL GOVERNMENT DEPARTMENT.

At the Executive Council Chamber, Melbourne, the sixteenth day of March, 1965.

PRESENT:

His Excellency the Governor of Victoria.
 Mr. Porter | Mr. Meagher.
 Mr. Balfour

ROAD DISCONTINUED.—SHIRE OF NARRACAN.

WHEREAS it is provided in section 528 (2) of the Local Government Act 1958 that where a road (whether or not a public highway but not being a road set out on land of the Crown) or any part thereof is not required for public use the Governor in Council on the request of the Council of the municipality in which such road is situated made not less than one month after publishing in a newspaper generally circulating in the district and posting to the registered proprietor (if any) of the land and any person known to have an interest in the land notice of intention to make such a request may by Order published in the Government Gazette direct that such road or part shall be discontinued and thereupon such road or part shall be discontinued accordingly.

And whereas the Council of the Shire of Narracan has requested that the Governor in Council direct that a right-of-way, off Rossmore-avenue, Yallourn North, be discontinued and not less than one month previously has published in a newspaper generally circulating in the district and posted to the registered proprietor of the land in the road and to all persons known to have an interest in the said land notice of intention to make such request.

Now therefore His Excellency the Governor of the State of Victoria, by and with the advice of the Executive Council thereof, hereby directs that the said road, which is shown by hachure on the plan hereunder, shall be discontinued and that the land may be sold by the Council of the Shire of Narracan by agreement.

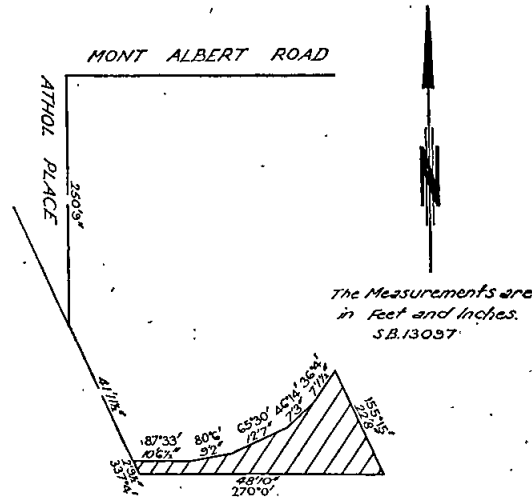
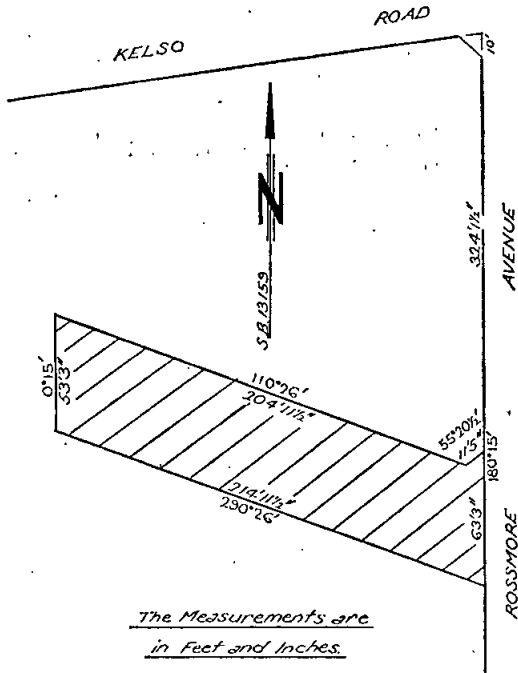

And the Honorable Rupert James Hamer, Her Majesty's Minister for Local Government for the State of Victoria, shall give the necessary directions herein accordingly.

J. COLQUHOUN;
Clerk of the Executive Council.

ROAD TRAFFIC ACT 1958.

At the Executive Council Chamber, Melbourne, the sixteenth day of March, 1965.

PRESENT:

His Excellency the Governor of Victoria.
Mr. Porter | Mr. Meagher.
Mr. Balfour

And the Honorable Rupert James Hamer, Her Majesty's Minister for Local Government for the State of Victoria, shall give the necessary directions herein accordingly.

J. COLQUHOUN,
Clerk of the Executive Council.

LOCAL GOVERNMENT DEPARTMENT.

At the Executive Council Chamber, Melbourne, the sixteenth day of March, 1965.

PRESENT:

His Excellency the Governor of Victoria.
Mr. Porter | Mr. Meagher.
Mr. Balfour

ORDER EXTENDING THE APPLICATION OF THE ROAD TRAFFIC ACT 1958, TO CERTAIN LAND OR PREMISES VESTED IN OR UNDER THE CONTROL OF THE CITY OF WAVERLEY.

IN pursuance of the powers conferred by the Road Traffic Act 1958, His Excellency the Governor of the State of Victoria, in the Commonwealth of Australia, by and with the advice of the Executive Council of the said State, and at the request of the Council of the City of Waverley doth by this Order extend the application of the provisions of the said Act to the land or premises vested in or under the control of the City of Waverley shown delineated and hachured on the plan attached hereunder.

ROAD DISCONTINUED.—CITY OF CAMBERWELL.

WHEREAS it is provided in section 528 (2) of the Local Government Act 1958, as amended, that where a road (whether or not a public highway but not being a road set out on land of the Crown) or any part thereof is not required for public use the Governor in Council on the request of the Council of the municipality in which such road is situated made not less than one month after publishing in a newspaper generally circulating in the district and posting to the registered proprietor (if any) of the land and any person known to have an interest in the land notice of intention to make such a request may by Order published in the Government Gazette direct that such road or part shall be discontinued and thereupon such road or part shall be discontinued accordingly.

And whereas the Council of the City of Camberwell has requested that the Governor in Council direct that portion of Athol-place, Camberwell, be discontinued and not less than one month previously has published in a newspaper generally circulating in the district and posted to the registered proprietor of the land in the road and to all persons known to have an interest in the said land notice of intention to make such request.

Now therefore, His Excellency the Governor of the State of Victoria, by and with the advice of the Executive Council thereof, hereby directs that the portion of the said road, which is shown by hachure on the plan hereunder, shall be discontinued and that the land may be sold by the Council of the City of Camberwell by agreement.

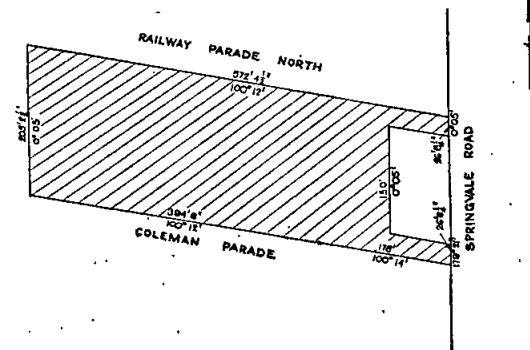

And the Honorable Arthur Gordon Rylah, Her Majesty's Chief Secretary for the State of Victoria, shall give the necessary directions herein accordingly.

J. COLQUHOUN,
Clerk of the Executive Council.

ROAD TRAFFIC ACT 1958.

At the Executive Council Chamber, Melbourne, the sixteenth day of March, 1965.

PRESENT:

His Excellency the Governor of Victoria.
Mr. Porter | Mr. Meagher.
Mr. Balfour

ORDER EXTENDING THE APPLICATION OF THE ROAD TRAFFIC ACT 1958 TO CERTAIN LAND OR PREMISES VESTED IN OR UNDER THE CONTROL OF THE CITY OF MELBOURNE.

IN pursuance of the power conferred by the Road Traffic Act 1958 His Excellency the Governor of the State of Victoria in the Commonwealth of Australia, by and with the advice of the Executive Council of the said State and at the request of the Council of the City of Melbourne, doth by this Order extend the application of the provisions of the said Act to the land or premises vested in or under the control of the City of Melbourne as shown delineated on the plan marked 8P.922/1 hereunder.

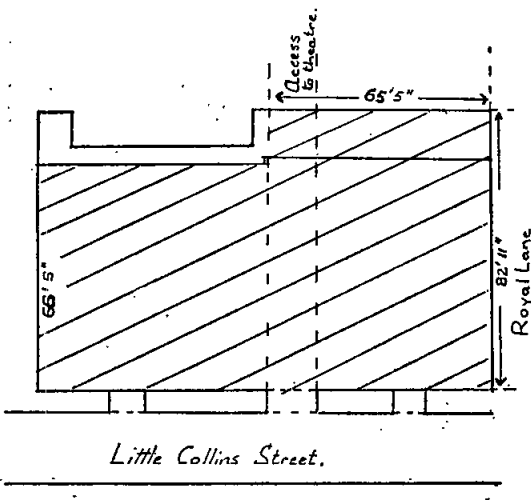

PLAN 8P922/1

And the Honorable Arthur Gordon Rylah, Her Majesty's Chief Secretary for the State of Victoria, shall give the necessary directions herein accordingly.

J. COLQUHOUN,
Clerk of the Executive Council.

LABOUR AND INDUSTRY ACT 1958.

At the Executive Council Chamber, Melbourne, the sixteenth day of March, 1965.

PRESENT:

His Excellency the Governor of Victoria.
Mr. Porter | Mr. Meagher.
Mr. Balfour

FIBROUS PLASTERERS BOARD—NUMBER OF MEMBERS INCREASED.

UNDER the powers in that behalf conferred by the Labour and Industry Act 1958, His Excellency the Governor of the State of Victoria by and with the advice of the Executive Council thereof doth hereby revoke the Order made on the second day of September, 1912, in so far as it specified that the Fibrous Plasterers Board should consist of six members and a Chairman and doth hereby specify that the Fibrous Plasterers Board shall consist of eight members and a Chairman.

And the Honorable George Oswald Reid, Her Majesty's Minister of Labour and Industry for the State of Victoria, shall give the necessary directions herein accordingly.

J. COLQUHOUN,
Clerk of the Executive Council.

SOIL CONSERVATION AND LAND UTILIZATION ACT 1958.

At the Executive Council Chamber, Melbourne, the sixteenth day of March, 1965.

PRESENT:

His Excellency the Governor of Victoria.
Mr. Porter | Mr. Meagher.
Mr. Balfour

APPOINTMENT OF A MEMBER TO ACT AS CHAIRMAN.

WHEREAS leave has been granted to RONALD GEOFFREY DOWNES, a Member and Chairman of the Soil Conservation Authority, to be absent from the State of Victoria so that he may act as a consultant in Israel to the Food and Agriculture Organisation of the United Nations and may inspect soil conservation projects in Asia, Europe and the United States of America: And whereas provision is made in the Soil Conservation and Land Utilization Act 1958 for the appointment by the Governor in Council of one of the Members of the Soil Conservation Authority to act as Chairman if the Chairman is so absent: Now therefore I, the Governor of the said State by and with the advice of the Executive Council thereof, do hereby appoint MALCOLM STEPTO WOOD Acting Chairman of the Soil Conservation Authority for a period of six months from and inclusive of the 16th day of April, 1965, or until the return to Victoria of RONALD GEOFFREY DOWNES, whichever first happens, and do hereby determine that the said MALCOLM STEPTO WOOD shall not receive any salary in respect of such appointment.

And the Honorable James Charles Murray Balfour, Her Majesty's Minister for Conservation for the State of Victoria, shall give the necessary directions herein accordingly.

J. COLQUHOUN,
Clerk of the Executive Council.

SOIL CONSERVATION AND LAND UTILIZATION ACT 1958.

At the Executive Council Chamber, Melbourne, the sixteenth day of March, 1965.

PRESENT:

His Excellency the Governor of Victoria.
Mr. Porter | Mr. Meagher.
Mr. Balfour

APPOINTMENT OF A PERSON TO ACT AS A MEMBER DURING THE ABSENCE OF THE CHAIRMAN.

WHEREAS leave has been granted to RONALD GEOFFREY DOWNES, a Member and Chairman of the Soil Conservation Authority, to be absent from the State of Victoria so that he may act as a consultant in Israel to the Food and Agriculture Organisation of the United Nations and may inspect soil conservation projects in Asia, Europe and the United States of America: And whereas provision is made in the Soil Conservation and Land Utilization Act 1958 for the appointment for a period of not more than six months of a qualified person to act in the place of any member who is absent from Victoria: Now therefore I, the Governor of the said State, by and with the advice of the Executive Council thereof, do hereby appoint ALEXANDER MITCHELL to act as a Member of the Soil Conservation Authority for a period of six months from and inclusive of the 16th day of April, 1965, or until the return to Victoria of RONALD GEOFFREY DOWNES, whichever first happens, and do hereby determine that the said ALEXANDER MITCHELL shall not receive any salary in respect of such appointment.

And the Honorable James Charles Murray Balfour, Her Majesty's Minister for Conservation for the State of Victoria, shall give the necessary directions herein accordingly.

J. COLQUHOUN,
Clerk of the Executive Council.

COUNTRY ROADS BOARD.

At the Executive Council Chamber, Melbourne, the
sixteenth day of March, 1965.

PRESENT:

His Excellency the Governor of Victoria.
Mr. Porter | Mr. Meagher.
Mr. Balfour

DECLARATION OF A DEVIATION FROM THE
LANCASTER-MOOROOPNA ROAD IN THE SHIRE
OF RODNEY.

WHEREAS by sections 21 and 58 of the *Country Roads Act 1958* (No. 6229) it is amongst other things enacted that when the Country Roads Board under the provisions of the *Country Roads Act* has by Resolution declared a deviation to be a main road the said Board may also declare that such deviation shall be in lieu of any existing road or part thereof named in such Resolution and that on publication in the *Government Gazette* of the Order confirming such Resolution the existing road or part thereof shall cease to be a main road or be discontinued as provided in the Resolution: And whereas the said Board has by Resolution declared the deviation on the land described in the First Schedule to such Resolution to be a main road and has also declared that such deviation shall be in lieu of the part of the existing road being the land described in the Second Schedule to the said Resolution and that such part of the said existing road as is described in the Third Schedule shall be discontinued: Now therefore His Excellency the Governor of the State of Victoria by and with the advice of the Executive Council thereof doth hereby confirm the said Resolution.

*Resolution for Declaration of a Deviation of a Main Road
under the Country Roads Act.*

Whereas the land the site of the road the course of which is below set out was taken by the Board under the provisions of the *Country Roads Act 1958* for the purpose of constructing such road deviation which road deviation has now been laid out and formed on the same: And whereas the said Board (being the Country Roads Board incorporated under the said Act) thinks that the road aforesaid is fit to be used as a public highway such Board at a meeting now holden acting under the authority conferred upon it by sections 21 and 58 of the said Act doth by this present Resolution hereby declare the said road deviation the course of which is described in the First Schedule hereto with the commencing and terminating points thereof respectively specified to be part of a main road within the meaning and for the purposes of the *Country Roads Act 1958*: And the said Board doth also declare that such deviation shall be in lieu of the existing road or part thereof described in the Second Schedule hereto and that such part of the said existing road as is described in the Third Schedule shall be discontinued.

FIRST SCHEDULE.
Shire of Rodney.

13. *Lancaster-Mooroopna road* (14313).—All that piece of land in the Parish of Mooroopna, the boundaries of which are as follow:—Commencing at a point on the southern boundary of allotment 88b of the said parish, distant 90 deg. 3 min. 2,384.2 links from the south-western angle of the said allotment; thence by lines bearing respectively 77 deg. 3 min. 732.5 links, 47 deg. 24 min. 797.2 links, 36 deg. 51 min. 1,002.7 links, 179 deg. 54 min. 915.5 links, 307 deg. 28 min. 218.4 links, 270 deg. 3 min. 227.3 links, 216 deg. 51 min. 905.1 links and 270 deg. 3 min. 960.4 links to the point of commencement—which said piece of land is particularly delineated and shown coloured red on survey plan numbered 8189, lodged in the office of the Country Roads Board.

SECOND SCHEDULE.
Shire of Rodney.

13. *Lancaster-Mooroopna road* (14313).—All that piece of land in the Parish of Mooroopna, being a roadway 1 chain wide, and commencing at a point on the northern boundary of allotment 53 of the said parish, distant 270 deg. 3 min. 1,019.5 links from the north-eastern angle of the said allotment; thence easterly and northerly to a point on the western boundary of allotment 55a, distant 179 deg. 54 min. 900 links from the north-western angle thereof—which said piece of land is more particularly

delineated and shown coloured light and dark blue on survey plan numbered 8189, lodged in the office of the Country Roads Board.

THIRD SCHEDULE.

Shire of Rodney.

13. *Lancaster-Mooroopna road* (14313).—All that piece of land in the Parish of Mooroopna, the boundaries of which are as follow:—Commencing at the north-eastern angle of allotment 53 of the said parish; thence by lines bearing respectively 270 deg. 3 min. 1,019.5 links, 36 deg. 51 min. 124.9 links, 90 deg. 3 min. 944.4 links and 179 deg. 54 min. 100 links to the point of commencement—which said piece of land is particularly delineated and shown coloured dark blue on survey plan numbered 8189, lodged in the office of the Country Roads Board.

The common seal of the Country Roads Board was hereto affixed, at Kew, this ninth day of March, One thousand nine hundred and sixty-five, in the presence of—

(SEAL) R. E. DONALDSON, Deputy Chairman.
F. WEST, Member.
N. L. ALLANSON, Secretary.

And the Honorable Murray Victor Porter, Her Majesty's Minister of Public Works for the State of Victoria, shall give the necessary directions herein accordingly.

J. COLQUHOUN,
Clerk of the Executive Council.

COUNTRY ROADS BOARD.

At the Executive Council Chamber, Melbourne, the
sixteenth day of March, 1965.

PRESENT:

His Excellency the Governor of Victoria.
Mr. Porter | Mr. Meagher.
Mr. Balfour

ORDER APPROVING OF WIDENING AN EXISTING
MAIN ROAD IN THE SHIRE OF MORWELL.

WHEREAS the Country Roads Board, constituted under the *Country Roads Act 1958* (No. 6229) has represented to His Excellency the Governor in Council that it appears to it desirable that the existing Jeeralang West-road in the Shire of Morwell (declared to be a main road under the said Act which declaration was confirmed by the Order in Council published in the *Government Gazette* of the 28th June, 1939, on page 2362) should be widened by the said Board: And whereas the said Board in accordance with the requirements of section 19 of the said cited Act has caused to be prepared a map plan and estimate showing the points between which and on and through what land the said widening is proposed to be made and the cost of acquiring the land: And whereas on an inspection of the said map and plan and a consideration of the said estimate His Excellency the Governor in Council is satisfied that there are funds legally available for acquiring the land: Now therefore be it known by this present Order that His Excellency the Governor of the State of Victoria with the advice of the Executive Council thereof doth hereby approve of the said road being widened, that is to say:—

All that piece of land in the Parish of Hazelwood, the boundaries of which are as follow:—Commencing at a point on the western boundary of allotment 9, section A in the said parish, distant 180 deg. 16 min. 1,498.3 links from the north-western angle of the said allotment; thence by lines bearing respectively 171 deg. 40 min. 158.3 links, 166 deg. 8 min. 270.8 links, 339 deg. 26 min. 252.5 links and 0 deg. 16 min. 183.2 links to the point of commencement—which said piece of land is particularly delineated and shown coloured red on survey plan numbered 10000, lodged in the office of the Country Roads Board.

And the Honorable Murray Victor Porter, Her Majesty's Minister of Public Works for the State of Victoria, shall give the necessary directions herein accordingly.

J. COLQUHOUN,
Clerk of the Executive Council.

COUNTRY ROADS BOARD.

At the Executive Council Chamber, Melbourne, the
sixteenth day of March, 1965.

PRESENT:

His Excellency the Governor of Victoria.
Mr. Porter | Mr. Meagher.
Mr. Balfour |

ORDER APPROVING OF WIDENING AN EXISTING
MAIN ROAD IN THE SHIRE OF LILLYDALE.

WHEREAS the Country Roads Board constituted under the Country Roads Act 1958 (No. 6229) has represented to His Excellency the Governor in Council that it appears to it desirable that the existing Lilydale-Monbulk road in the Shire of Lilydale (declared to be a main road under the said Act which declaration was confirmed by the Order in Council published in the Government Gazette of the 17th December, 1952, on page 7176) should be widened by the said Board: And whereas the said Board in accordance with the requirements of section 19 of the said cited Act has caused to be prepared a map plan and estimate showing the points between which and on and through what land the said widening is proposed to be made and the cost of acquiring the land: And whereas on an inspection of the said map and plan and a consideration of the said estimate His Excellency the Governor in Council is satisfied that there are funds legally available for acquiring the land: Now therefore, be it known by this present Order that His Excellency the Governor of the State of Victoria with the advice of the Executive Council thereof doth hereby approve of the said road being widened, that is to say:—

All those pieces of land in the Parish of Wandin Yallock, the boundaries of which are as follow:—

- (a) Commencing at a point on the eastern boundary of allotment 130 of the said parish, distant 153 deg. 35 min. 50.3 links from the north-eastern angle of the said allotment; thence by lines bearing respectively 153 deg. 35 min. 149.7 links, 190 deg. 50 min. 203.9 links, 1 deg. 44 min. 195.6 links and 346 deg. 10 min. 143 links to the point of commencement.
- (b) Commencing at an angle in the eastern boundary of allotment 130 of the said parish, formed by the intersection of lines bearing 59 deg. 14 min. and 23 deg. 19 min.; thence by lines bearing respectively 239 deg. 14 min. 91.7 links, 43 deg. 26 min. 156.4 links and 203 deg. 19 min. 72.6 links to the point of commencement.

Also, all those pieces of land in the Parish of Monbulk, the boundaries of which are as follow:—

- (a) Commencing at the north-western angle of allotment 13B, section N of the said parish; thence by lines bearing respectively 26 deg. 50 min. 106.6 links, 196 deg. 52 min. 174.4 links and 1 deg. 58 min. 71.8 links to the point of commencement.
- (b) Commencing at a point on the southern boundary of allotment 11, section N of the said parish, distant 92 deg. 31 min. 60.1 links from the south-western angle of the said allotment; thence by lines bearing respectively 76 deg. 43 min. 118.8 links, 60 deg. 6 min. 254.7 links, 31 deg. 56 min. 265.8 links, 8 deg. 31 min. 47.7 links, 182 deg. 31 min. 47.9 links, 207 deg. 2 min. 273.3 links, 238 deg. 54 min. 273.3 links and 272 deg. 31 min. 123.9 links to the point of commencement.
- (c) Commencing at the north-western angle of lot 3 on plan of subdivision numbered 34234, lodged in the Office of Titles, and being part of allotment 1, section B of the said parish; thence by lines bearing respectively 78 deg. 59 min. 112 ft. 9½ in., 92 deg. 31 min. 118 ft. 1½ in. and 265 deg. 54 min. 229 ft. 3½ in. to the point of commencement.
- (d) Commencing at the north-eastern angle of lot 5 on plan of subdivision numbered 34234, lodged in the Office of Titles, and being part of allotment 1, section B of the said parish; thence by lines bearing respectively 254 deg. 42 min. 60 ft. 2 in., 240 deg. 3 min. 94 ft. 4½ in., 227 deg. 18 min. 95 ft. 7½ in., 25 deg. 5 min. 105 ft. 7½ in. and 78 deg. 59 min. 168 ft. 5 in. to the point of commencement.
- (e) Commencing at a point in allotment 38, section A of the said parish, distant 178 deg. 39 min. 67 links and 198 deg. 41 min. 130 links from the north-western angle of the said allotment;

thence by lines bearing respectively 198 deg. 41 min. 430 links, 220 deg. 39 min. 150 links, 31 deg. 17 min. 142.5 links and 22 deg. 1 min. 430.7 links to the point of commencement.

- (f) Commencing at an angle in the eastern boundary of the existing Lilydale-Monbulk road through allotment 38, section A of the said parish, formed by the intersection of lines bearing 14 deg. 6 min. and 30 deg. 37 min.; thence by lines bearing respectively 30 deg. 37 min. 180 links, 203 deg. 3 min. 159.4 links, 203 deg. 17 min. 165.2 links and 14 deg. 6 min. 148 links to the point of commencement.
- (g) Commencing at the northern angle of lot 7 on plan of subdivision numbered 19113, lodged in the Office of Titles, and being part of allotment 96, section A of the said parish; thence by lines bearing respectively 215 deg. 32 min. 104.1 links, 225 deg. 36 min. 520.1 links, 20 deg. 16 min. 20 links, 44 deg. 20 min. 213.1 links and 44 deg. 53 min. 391.4 links to the point of commencement.
- (h) Commencing at a point on the western boundary of lot 1 on plan of subdivision numbered 19113, lodged in the Office of Titles, and being part of allotment 95, section A of the said parish, distant 16 deg. 6 min. 118.6 links from the south-western angle of the said lot; thence by lines bearing respectively 16 deg. 6 min. 51.4 links, 44 deg. 52 min. 86.4 links and 214 deg. 12 min. 133.8 links to the point of commencement.
- (i) Commencing at the eastern angle of lot 7 on plan of subdivision numbered 14386, lodged in the Office of Titles, and being part of allotment 87, section A of the said parish; thence by lines bearing respectively 211 deg. 53 min. 83.3 links, 17 deg. 0 min. 125.9 links, 135 deg. 44 min. 4 links and 174 deg. 37 min. 47 links to the point of commencement.
- (j) Commencing at the eastern angle of lot 5 on plan of subdivision numbered 14386, lodged in the Office of Titles, and being part of allotment 87, section A of the said parish; thence by lines bearing respectively 211 deg. 53 min. 124.7 links, 232 deg. 58 min. 166 links, 247 deg. 6 min. 163.7 links, 64 deg. 30 min. 135.5 links, 53 deg. 34 min. 131.2 links and 42 deg. 18 min. 180.3 links to the point of commencement—
- which said pieces of land are particularly delineated and shown coloured red on survey plans numbered 9918, 9919, 9920, 9921, 9922, 9923, 9924 and 9925, lodged in the office of the Country Roads Board.

And the Honorable Murray Victor Porter, Her Majesty's Minister of Public Works for the State of Victoria, shall give the necessary directions herein accordingly.

J. COLQUHOUN,
Clerk of the Executive Council.

COUNTRY ROADS BOARD.

At the Executive Council Chamber, Melbourne, the
sixteenth day of March, 1965.

PRESENT:

His Excellency the Governor of Victoria.
Mr. Porter | Mr. Meagher.
Mr. Balfour |

DECLARATION OF A DEVIATION FROM THE MIDLAND
HIGHWAY IN THE BOROUGH OF DAYLESFORD AND
SHIRE OF GLENLYON.

WHEREAS by sections 21 and 58 of the Country Roads Act 1958 (No. 6229) it is amongst other things enacted that when the Country Roads Board under the provisions of the Country Roads Act has by Resolution declared a deviation to be a main road the said Board may also declare that such deviation shall be in lieu of any existing road or part thereof named in such Resolution and that on publication in the Government Gazette of the Order confirming such Resolution the existing road or part thereof shall cease to be a main road or be discontinued as provided in the Resolution: And whereas the said Board has by Resolution declared the deviation on the land described in the First Schedule to such Resolution to be a main road and has also declared that such deviation

shall be in lieu of the part of the existing road being the land described in the Second Schedule to the said Resolution and that such part of the said existing road shall be discontinued: Now therefore His Excellency the Governor of the State of Victoria by and with the advice of the Executive Council thereof doth hereby confirm the said Resolution.

Resolution for Declaration of a Deviation of a State Highway under the Country Roads Act.

Whereas the land the site of the highway the course of which is below set out was taken by the Board under the provisions of the Country Roads Act 1958 for the purpose of constructing such highway deviation which highway deviation has now been laid out and formed on the same: And whereas the said Board (being the Country Roads Board incorporated under the said Act) thinks that the highway aforesaid is fit to be used as a public highway such Board at a meeting now holden acting under the authority conferred upon it by sections 74 and 58 of the said Act doth by this present Resolution hereby declare the said highway deviation the course of which is described in the First Schedule hereto with the commencing and terminating points thereof respectively specified to be part of a State highway within the meaning and for the purposes of the Country Roads Act 1958: and the said Board doth also declare that such deviation shall be in lieu of the existing highway or part thereof described in the Second Schedule hereto and that such part of the said existing highway shall be discontinued.

FIRST SCHEDULE.

Borough of Daylesford and Shire of Glenlyon.

9. *Midland Highway.*—All those pieces of land in the Parish of Wombat, the boundaries of which are as follow:—

- (a) Commencing at an angle in the western boundary of the existing Midland Highway, through portion 3, section 3, of the said parish, formed by the intersection of lines bearing 27 deg. 0 min. and 354 deg. 47 min.; thence by lines bearing respectively 207 deg. 0 min. 562.1 links, 15 deg. 36 min. 843.2 links and 174 deg. 47 min. 312.6 links to the point of commencement.
- (b) Commencing at an angle in the western boundary of allotment 2, section 3, of the said parish, formed by the intersection of lines bearing 141 deg. 22 min. and 174 deg. 47 min.; thence by lines bearing respectively 167 deg. 36 min. 1,146.2 links, 184 deg. 2 min. 891.5 links, 201 deg. 55 min. 861.4 links, 259 deg. 16 min. 96.5 links, 27 deg. 0 min. 917 links and 354 deg. 47 min. 2,017.2 links to the point of commencement.
- (c) Commencing at an angle in the eastern boundary of allotment 1, section 3, of the said parish, formed by the intersection of lines bearing 354 deg. 47 min. and 321 deg. 22 min.; thence by lines bearing respectively 174 deg. 47 min. 447 links, 337 deg. 52 min. 410.2 links, 329 deg. 23 min. 436.6 links, 323 deg. 40 min. 911 links, 326 deg. 7 min. 484.3 links, 142 deg. 59 min. 278.4 links and 141 deg. 22 min. 1,567.3 links to the point of commencement.
- (b) Commencing at the south-western angle of allotment 6, section 8, of the said parish; thence by lines bearing respectively 322 deg. 59 min. 1,688.3 links, 343 deg. 46 min. 422.6 links, 149 deg. 14 min. 1,003.3 links, 143 deg. 35 min. 1,107.2 links and 268 deg. 50 min. 36 links to the point of commencement.
- (e) Commencing at the north-eastern angle of allotment 4, section 8, of the said parish; thence by lines bearing respectively 184 deg. 40 min. 1,875.3 links, 163 deg. 46 min. 1,034.5 links, 336 deg. 40 min. 605 links, 347 deg. 43 min. 495.6 links, 356 deg. 34 min. 732.3 links and 13 deg. 1 min. 1,120.3 links to the point of commencement.
- (f) Commencing at the south-western angle of allotment 2, section 8, of the said parish; thence by lines bearing respectively 15 deg. 1 min. 1,180.8 links, 26 deg. 29 min. 636.1 links, 196 deg. 2 min. 2,276 links and 4 deg. 40 min. 479.2 links to the point of commencement.
- (g) Commencing at the south-western angle of allotment 1A, section 8, of the said parish; thence by lines bearing respectively 351 deg. 28 min. 209.7 links, 158 deg. 50 min. 222.1 links, 154 deg. 40 min. 110.4 links, 168 deg. 7 min. 579.7 links, 179 deg. 35 min. 665.3 links and 350 deg. 36 min. 1,350.3 links to the point of commencement.

- (h) Commencing at an angle in the eastern boundary of allotment 3, section 8, of the said parish, formed by the intersection of lines bearing 26 deg. 29 min. and 350 deg. 36 min.; thence by lines bearing respectively 206 deg. 29 min. 811.6 links, 14 deg. 52 min. 847 links, 6 deg. 12 min. 474.5 links and 170 deg. 36 min. 571.6 links to the point of commencement.
- (i) Commencing at the north-eastern angle of allotment 1F, section 8, of the said parish; thence by lines bearing respectively 153 deg. 14 min. 406.2 links, 171 deg. 31 min. 260 links, 170 deg. 36 min. 52.9 links, 338 deg. 9 min. 724.3 links and 90 deg. 15 min. 39.7 links to the point of commencement.
- (j) Commencing at the north-western angle of allotment 1A, section 8, of the said parish; thence by lines bearing respectively 89 deg. 42 min. 33.8 links, 157 deg. 16 min. 545.2 links, 333 deg. 19 min. 449.1 links and 337 deg. 5 min. 110 links to the point of commencement—

which said pieces of land are particularly delineated and shown coloured red and yellow on survey plans numbered 9113 and 9114, lodged in the office of the Country Roads Board.

SECOND SCHEDULE.

Shire of Glenlyon.

9. *Midland Highway.*—All that piece of land in the Parish of Wombat, the boundaries of which are as follow:— Commencing at a point on the western boundary of allotment 1, section 8, of the said parish, distant 170 deg. 36 min. 1,249 links from the north-western angle of the said allotment; thence by lines bearing respectively 170 deg. 36 min. 302.4 links, 206 deg. 29 min. 583.4 links, 16 deg. 2 min. 15.5 links, 16 deg. 2½ min. 749.4 links and 359 deg. 35 min. 85.4 links to the point of commencement— which said piece of land is particularly delineated and shown coloured blue on survey plan numbered 9114, lodged in the office of the Country Roads Board.

The common seal of the Country Roads Board was hereto affixed, at Kew, this ninth day of March, One thousand nine hundred and sixty-five, in the presence of—

R. E. DONALDSON, Deputy Chairman.
(SEAL) F. WEST, Member.
N. L. ALLANSON, Secretary.

And the Honorable Murray Victor Porter, Her Majesty's Minister of Public Works for the State of Victoria, shall give the necessary directions herein accordingly.

J. COLQUHOUN,
Clerk of the Executive Council.

COUNTRY ROADS BOARD.

At the Executive Council Chamber, Melbourne, the
sixteenth day of March, 1965.

PRESENT:

His Excellency the Governor of Victoria.
Mr. Porter | Mr. Meagher.
Mr. Balfour

DECLARATION OF A DEVIATION FROM THE
CHARLEYS CREEK - ROAD IN THE SHIRE OF
OTWAY.

WHEREAS by sections 21 and 58 of the Country Roads Act 1958 (No. 6229) it is amongst other things enacted that when the Country Roads Board under the provisions of the Country Roads Act has by Resolution declared a deviation to be a main road the said Board may also declare that such deviation shall be in lieu of any existing road or part thereof named in such Resolution and that on publication in the Government Gazette of the Order confirming such Resolution the existing road or part thereof shall cease to be a main road or be discontinued as provided in the Resolution: And whereas the said Board has by Resolution declared the deviation on the land described in the First Schedule to such Resolution to be a main road and has also declared that such deviation shall be in lieu of the part of the existing road being the land described in the Second Schedule to the said Resolution and that such part of the said existing road as is described in the Third Schedule shall be discontinued: Now therefore His Excellency the Governor

of the State of Victoria by and with the advice of the Executive Council thereof doth hereby confirm the said Resolution.

Resolution for Declaration of a Deviation of a Main Road under the Country Roads Act.

Whereas the land the site of the road the course of which is below set out was taken by the Board under the provisions of the *Country Roads Act 1958*, for the purpose of constructing such road deviation which road deviation has now been laid out and formed on the same: And whereas the said Board (being the *Country Roads Board* incorporated under the said Act) thinks that the road aforesaid is fit to be used as a public highway such Board at a meeting now holden acting under the authority conferred upon it by sections 21 and 58 of the said Act doth by this present Resolution hereby declare the said road deviation the course of which is described in the First Schedule hereto with the commencing and terminating points thereof respectively specified to be part of a main road within the meaning and for the purposes of the *Country Roads Act 1958*: And the said Board doth also declare that such deviation shall be in lieu of the existing road or part thereof described in the Second Schedule hereto and that such part of the said existing road as is described in the Third Schedule shall be discontinued.

FIRST SCHEDULE.

Shire of Otway.

17. *Charleys Creek-road (12817)*.—All those pieces of land in the Parish of Moorbanool, the boundaries of which are as follow:—

- (a) Commencing at an angle in the western boundary of the existing *Charleys Creek-road* through allotment 10c of the said parish, formed by the intersection of lines bearing 356 deg. 14 min. and 343 deg. 41 min.; thence by lines bearing respectively 176 deg. 14 min. 158.2 links, 348 deg. 8½ min. 466.3 links, 164 deg. 59 min. 84 links and 163 deg. 41 min. 226.5 links to the point of commencement.
- (b) Commencing at an angle in the eastern boundary of the existing *Charleys Creek-road* through allotment 10c of the said parish, formed by the intersection of lines bearing 163 deg. 32 min. and 153 deg. 16 min.; thence by lines bearing respectively 343 deg. 32 min. 202.9 links, 356 deg. 14 min. 220.5 links, 165 deg. 44 min. 566 links and 333 deg. 16 min. 150 links to the point of commencement.
- (c) Commencing at an angle in the western boundary of the existing *Charleys Creek-road* through allotment 10c of the said parish, formed by the intersection of lines bearing 2 deg. 19 min. and 333 deg. 16 min.; thence by lines bearing respectively 182 deg. 19 min. 193.7 links, 347 deg. 21 min. 386.7 links and 153 deg. 16 min. 205.8 links to the point of commencement.
- (d) Commencing at an angle in the western boundary of allotment 12a of the said parish, formed by the intersection of lines bearing 172 deg. 15 min. and 129 deg. 26 min.; thence by lines bearing respectively 352 deg. 15 min. 444.7 links, 159 deg. 36 min. 601.5 links and 309 deg. 26 min. 193.9 links to the point of commencement.
- (e) Commencing at an angle in the eastern boundary of allotment 12c of the said parish, formed by the intersection of lines bearing 20 deg. 12 min. and 345 deg. 51 min.; thence by lines bearing respectively 200 deg. 12 min. 33.2 links, 348 deg. 45 min. 163.1 links, 340 deg. 11 min. 694.3 links, 129 deg. 26 min. 195.4 links, 160 deg. 11 min. 200.4 links, 191 deg. 41 min. 130.2 links and 165 deg. 51 min. 352.5 links to the point of commencement.
- (f) Commencing at a point on the western boundary of allotment 12h of the said parish, distant 13 deg. 12 min. 28.7 links and 348 deg. 47 min. 122.7 links from the south-western angle of the said allotment; thence by lines bearing respectively 348 deg. 47 min. 227.3 links, 29 deg. 36 min. 256.5 links, 20 deg. 12 min. 836.8 links, 198 deg. 56½ min. 1,062 links and 186 deg. 43 min. 228.3 links to the point of commencement.
- (g) Commencing at the south-western angle of allotment 12h of the said parish; thence by lines bearing respectively 193 deg. 12 min. 107.3 links, 166 deg. 46 min. 220 links, 212 deg. 19 min. 108.4 links; 151 deg. 31½ min. 252.7 links,

111 deg. 37 min. 79.7 links, 134 deg. 46 min. 518 links, 133 deg. 20 min. 800 links, 186 deg. 42 min. 509.8 links, 219 deg. 52 min. 552.9 links, 202 deg. 35 min. 478.6 links, 169 deg. 6 min. 189.7 links, 146 deg. 47½ min. 242.6 links, 160 deg. 4 min. 190.7 links, 188 deg. 10½ min. 168.1 links, 193 deg. 3½ min. 508.3 links, 212 deg. 48½ min. 315 links, 224 deg. 50½ min. 625.4 links, 175 deg. 54 min. 324.3 links, 216 deg. 3 min. 601.6 links, 268 deg. 53 min. 154.9 links, 236 deg. 1 min. 393.2 links, 223 deg. 48½ min. 747.1 links, 201 deg. 31 min. 434 links, 178 deg. 43½ min. 248.7 links, 167 deg. 33 min. 565.4 links, 201 deg. 43½ min. 504.7 links, 194 deg. 8 min. 591 links, 175 deg. 52 min. 227.9 links, 157 deg. 36 min. 180 links, 164 deg. 39 min. 441 links, 179 deg. 14 min. 325 links, 214 deg. 14 min. 356 links, 246 deg. 43 min. 276 links, 262 deg. 5 min. 142.2 links, 60 deg. 56 min. 340 links, 34 deg. 14 min. 330 links, 358 deg. 42 min. 227 links, 1 deg. 24 min. 297.2 links, 340 deg. 25 min. 328 links, 355 deg. 59 min. 279.8 links, 338 deg. 3 min. 302.6 links, 24 deg. 31 min. 237.8 links, 21 deg. 5½ min. 617.9 links, 347 deg. 33 min. 532.6 links, 358 deg. 43½ min. 293.7 links, 21 deg. 31 min. 493.8 links, 43 deg. 48½ min. 792.7 links, 56 deg. 1 min. 117.5 links, 55 deg. 11 min. 238.4 links, 50 deg. 56 min. 360.9 links, 14 deg. 5 min. 406.2 links, 43 deg. 5 min. 779 links, 31 deg. 27½ min. 279.1 links, 16 deg. 14 min. 491.2 links, 6 deg. 28½ min. 168 links, 340 deg. 4 min. 138.2 links, 326 deg. 47½ min. 254.7 links, 349 deg. 6 min. 264.4 links, 22 deg. 35 min. 546.5 links, 39 deg. 52 min. 531 links, 6 deg. 42 min. 389.8 links, 313 deg. 20 min. 571.9 links, 313 deg. 45 min. 215.4 links, 311 deg. 58½ min. 483.9 links, 321 deg. 25 min. 335.9 links, 347 deg. 38 min. 100 links, 5 deg. 33 min. 304.5 links, 1 deg. 52 min. 252.4 links, 168 deg. 47 min. 120.2 links, 193 deg. 12 min. 50.5 links and 83 deg. 7 min. 159.7 links to the point of commencement.

- (h) Commencing at the south-western angle of allotment 82a of the said parish; thence by lines bearing respectively 269 deg. 54 min. 101.2 links, 10 deg. 19 min. 42 links, 36 deg. 38 min. 78 links, 53 deg. 11 min. 519 links, 82 deg. 5 min. 315.2 links, 243 deg. 1 min. 306.2 links, 233 deg. 11 min. 181 links, 224 deg. 25 min. 129.6 links, 222 deg. 12 min. 160.3 links and 269 deg. 54 min. 64.6 links to the point of commencement—

which said pieces of land are particularly delineated and shown coloured red and yellow on survey plans numbered 8733, 8734, 8735, 8736 and 8737, lodged in the office of the *Country Roads Board*.

SECOND SCHEDULE.

Shire of Otway.

17. *Charleys Creek-road (12817)*.—All that piece of land in the Parish of Moorbanool, the boundaries of which are as follow:—Commencing at an angle in the eastern boundary of allotment 77a of the said parish, formed by the intersection of lines bearing 40 deg. 47 min. and 74 deg. 36 min.; thence by lines bearing respectively 147 deg. 41 min. 156.8 links, 220 deg. 47 min. 386.4 links, 245 deg. 11 min. 298 links, 355 deg. 58 min. 160.5 links, 65 deg. 11 min. 208.7 links and 40 deg. 47 min. 399.6 links to the point of commencement—which said piece of land is particularly delineated and shown coloured light-blue on survey plan numbered 8736, lodged in the office of the *Country Roads Board*.

THIRD SCHEDULE.

Shire of Otway.

17. *Charleys Creek-road (12817)*.—All those pieces of land in the Parish of Moorbanool, the boundaries of which are as follow:—

- (a) Commencing at an angle in the western boundary of the existing *Charleys Creek-road* through allotment 10c of the said parish, formed by the intersection of lines bearing 176 deg. 14 min. and 163 deg. 32 min.; thence by lines bearing respectively 356 deg. 14 min. 216.3 links, 169 deg. 47½ min. 436.6 links and 343 deg. 32 min. 223 links to the point of commencement.
- (b) Commencing at an angle in the eastern boundary of the existing *Charleys Creek-road* through allotment 10c of the said parish, formed by the intersection of lines bearing 2 deg. 19 min. and

- 333 deg. 16 min.; thence by lines bearing respectively 182 deg. 19 min. 207.2 links, 354 deg. 54 min. 273.1 links and 153 deg. 16 min. 72.8 links to the point of commencement.
- (c) Commencing at the north-eastern angle of allotment 12c of the said parish; thence by lines bearing respectively 82 deg. 55 min. 103.2 links, 158 deg. 38 min. 102.5 links, 169 deg. 22 min. 105.9 links, 165 deg. 30 min. 670.8 links and 338 deg. 38 min. 898.4 links to the point of commencement.
- (d) Commencing at an angle in the eastern boundary of allotment 12c of the said parish, formed by the intersection of lines bearing 172 deg. 15 min. and 129 deg. 26 min.; thence by lines bearing respectively 352 deg. 15 min. 472 links, 159 deg. 36 min. 638.5 links and 309 deg. 26 min. 205.8 links to the point of commencement.
- (e) Commencing at the northern angle of allotment 12h of the said parish; thence by lines bearing respectively 191 deg. 41 min. 103.5 links, 165 deg. 51 min. 364.5 links, 200 deg. 12 min. 64.2 links, 340 deg. 11 min. 571.6 links, 11 deg. 41 min. 115.8 links, 309 deg. 26 min. 118.3 links, 340 deg. 11 min. 195.6 links, 129 deg. 26 min. 402.5 links and 191 deg. 41 min. 142.4 links to the point of commencement.
- (f) Commencing at a point on the eastern boundary of allotment 12c of the said parish, distant 13 deg. 12 min. 50.5 links and 348 deg. 47 min. 120.2 links from the south-eastern angle of the said allotment; thence by lines bearing respectively 348 deg. 47 min. 253.3 links, 29 deg. 36 min. 300 links and 190 deg. 59½ min. 518.9 links to the point of commencement.
- (g) Commencing at a point on the eastern boundary of a Forest Reserve in the said parish, distant 193 deg. 12 min. 87.7 links, 185 deg. 33 min. 304.5 links and 167 deg. 38 min. 100 links from the south-eastern angle of allotment 12c; thence by lines bearing respectively 141 deg. 25 min. 335.9 links, 291 deg. 37 min. 178.7 links and 347 deg. 38 min. 201.4 links to the point of commencement.
- (h) Commencing at the north-western angle of allotment 12b of the said parish; thence by lines bearing respectively 155 deg. 17 min. 321 links, 215 deg. 12 min. 301 links, 159 deg. 40 min. 629.1 links, 313 deg. 20 min. 75.1 links, 314 deg. 46 min. 157.5 links, 339 deg. 40 min. 471.7 links, 35 deg. 12 min. 296 links, 335 deg. 17 min. 295 links and 83 deg. 7 min. 105 links to the point of commencement.
- (i) A roadway 1½ chains wide, the western boundary of which forms part of the western boundary of land in certificate of title entered in the register book, volume 6367, folio 326, being part of allotment 12e of the said parish, commencing at an angle in the said boundary formed by the intersection of lines bearing 134 deg. 46 min. and 177 deg. 40 min. and finishing at its intersection with the southern boundary of the said allotment.
- (j) Commencing at the southern angle of allotment 12e of the said parish; thence by lines bearing respectively 42 deg. 27 min. 427 links, 344 deg. 6 min. 735 links, 31 deg. 36 min. 365 links, 70 deg. 41 min. 289 links, 25 deg. 25 min. 368 links, 339 deg. 40 min. 703.3 links, 133 deg. 20 min. 225.5 links, 159 deg. 40 min. 544.8 links, 25 deg. 25 min. 345.7 links, 219 deg. 52 min. 147.5 links, 250 deg. 41 min. 243.2 links, 211 deg. 36 min. 285 links, 164 deg. 6 min. 397.2 links, 169 deg. 6 min. 158 links, 146 deg. 47½ min. 46.3 links, 164 deg. 6 min. 148.2 links, 222 deg. 27 min. 427 links and 283 deg. 17 min. 114.5 links to the point of commencement.
- (k) Commencing at the north-western angle of allotment 77b of the said parish; thence by lines bearing respectively 131 deg. 48 min. 378.3 links, 201 deg. 50 min. 218 links, 238 deg. 51 min. 470.1 links, 148 deg. 39 min. 525.5 links, 187 deg. 36 min. 534.8 links, 228 deg. 39 min. 379.6 links, 254 deg. 36 min. 339.2 links, 327 deg. 41 min. 156.8 links, 74 deg. 36 min. 350.2 links, 48 deg. 39 min. 289 links, 7 deg. 36 min. 425.4 links, 328 deg. 39 min. 563 links, 58 deg. 51 min. 570.5 links, 318 deg. 51 min. 479.6 links, 10 deg. 57 min. 109.8 links, 126 deg. 32 min. 125.6 links and 110 deg. 9 min. 121 links to the point of commencement.
- (l) Commencing at the south-western angle of allotment 77b of the said parish; thence by lines bearing respectively 269 deg. 52 min. 160.3 links, 20 deg. 30 min. 405.4 links, 321 deg. 6 min. 347 links, 113 deg. 32 min. 286.4 links, 72 deg. 32 min. 288.1 links, 106 deg. 45 min. 220.3 links, 175 deg. 58 min. 160.5 links, 286 deg. 45 min. 231 links, 252 deg. 32 min. 157 links, 193 deg. 32 min. 127.7 links, 141 deg. 6 min. 358.9 links and 200 deg. 30 min. 434.5 links to the point of commencement.
- (m) Commencing at a point on the northern boundary of allotment 82b of the said parish, distant 269 deg. 54 min. 450 links from the north-eastern angle of the said allotment; thence by lines bearing respectively 189 deg. 44 min. 110.3 links, 142 deg. 40 min. 425.5 links, 191 deg. 26 min. 429 links, 222 deg. 40 min. 257 links, 156 deg. 16 min. 293 links, 204 deg. 31 min. 237.8 links, 186 deg. 19 min. 316.7 links, 338 deg. 3 min. 343.3 links, 24 deg. 31 min. 235 links, 336 deg. 16 min. 324 links, 42 deg. 40 min. 313.2 links, 11 deg. 26 min. 319.1 links, 322 deg. 40 min. 423 links, 9 deg. 44 min. 149.6 links and 89 deg. 54 min. 152.2 links to the point of commencement.
- (n) Commencing at a point on the southern boundary of allotment 82a of the said parish, distant 189 deg. 54 min. 233.5 links from the south-western angle of the said allotment; thence by lines bearing respectively 49 deg. 50 min. 247.5 links, 224 deg. 25 min. 201 links, 222 deg. 12 min. 21.6 links and 269 deg. 54 min. 33.9 links to the point of commencement—

which said pieces of land are particularly delineated and shown coloured dark-blue on survey plans numbered 8733, 8734, 8735, 8736 and 8737, lodged in the office of the Country Roads Board.

The common seal of the Country Roads Board was hereto affixed, at Kew, this ninth day of March, One thousand nine hundred and sixty-five, in the presence of—

(SEAL) R. E. DONALDSON, Deputy Chairman.
F. WEST, Member.
N. L. ALLANSON, Secretary.

And the Honorable Murray Victor Porter, Her Majesty's Minister of Public Works for the State of Victoria, shall give the necessary directions herein accordingly.

J. COLQUHOUN,
Clerk of the Executive Council.

COUNTRY ROADS BOARD.

At the Executive Council Chamber, Melbourne, the sixteenth day of March, 1965.

PRESENT:

His Excellency the Governor of Victoria.
Mr. Porter | Mr. Meagher.
Mr. Balfour |

ORDER APPROVING OF A DEVIATION FROM A MAIN ROAD IN THE SHIRE OF BASS.

WHEREAS the Country Roads Board constituted under the Country Roads Act 1958 (No. 6229) has represented to His Excellency the Governor in Council that it appears to it desirable that the deviation hereinafter referred to from the existing Wonthaggi-Loch road in the Shire of Bass (declared to be a main road under the said Act which declaration was confirmed by the Order in Council published in the Government Gazette of the 14th January, 1914, on page 93) should be made by the said Board: And whereas the said Board in accordance with the requirements of section 19 of the said cited Act has caused to be prepared a map plan and estimate showing the points between which and on and through what land the said deviation is proposed to be made and the cost of acquiring the land: And whereas on an inspection of the said map and plan and a consideration of the said estimate His Excellency the Governor in Council is satisfied that there are funds legally available for acquiring the land: Now therefore be it known by this present Order that His Excellency the Governor of the State of Victoria with the advice of the Executive Council thereof doth hereby approve of the said road being made, that is to say:—

All those pieces of land in the Parish of Jumbunna, the boundaries of which are as follow:—

- (a) Commencing at a point on the eastern boundary of allotment 52b² of the said parish, distant 17 deg. 16 min. 57.5 links and 344 deg. 27 min. 218.8 links from the south-eastern angle of the

- said allotment; thence by lines bearing respectively 205 deg. 13 min. 1,814.7 links, 215 deg. 30 min. 64.3 links, 226 deg. 29 min. 212.4 links, 199 deg. 42 min. 644.6 links, 15 deg. 41 min. 745.1 links, 25 deg. 13 min. 1,614 links, 16 deg. 14 min. 674.6 links, 164 deg. 27 min. 43.8 links, 164 deg. 42 min. 226 links and 164 deg. 27 min. 122.3 links to the point of commencement.
- (b) Commencing at the north-western angle of allotment 52c of the said parish; thence by lines bearing respectively 359 deg. 8 min. 112.5 links; 19 deg. 35 min. 200 links, 185 deg. 21 min. 645.1 links; and 359 deg. 8 min. 341.4 links to the point of commencement.
- (c) Commencing at the north-eastern angle of allotment 69B of the said parish; thence by lines bearing respectively 191 deg. 59 min. 303 links, 265 deg. 53 min. 341.9 links, 43 deg. 43 min. 582.6 links and 179 deg. 12 min. 100 links to the point of commencement.
- (d) Commencing at the north-western angle of allotment 69D of the said parish; thence by lines bearing respectively 85 deg. 53 min. 568.2 links, 245 deg. 28 min. 359.6 links, 237 deg. 19 min. 442 links, 207 deg. 51 min. 1,499.3 links, 359 deg. 33 min. 386.1 links, 27 deg. 53 min. 680.4 links, 64 deg. 10 min. 224.5 links and 28 deg. 17 min. 667 links to the point of commencement.
- (e) Commencing at the south-eastern angle of allotment 18B of the said parish; thence by lines bearing respectively 223 deg. 50 min. 615 links, 35 deg. 10 min. 736 links and 179 deg. 17 min. 158 links to the point of commencement.
- (f) Commencing at an angle in the western boundary of allotment 18C of the said parish formed by the intersection of lines bearing 214 deg. 58 min. and 195 deg. 59 min.; thence by lines bearing respectively 34 deg. 58 min. 593.4 links; 207 deg. 16 min. 948.1 links, 224 deg. 26 min. 125.3 links, 27 deg. 20 min. 265 links and 15 deg. 59 min. 219 links to the point of commencement.
- (g) Commencing at an angle in the southern boundary of allotment 18A of the said parish formed by the intersection of lines bearing 84 deg. 5 min. and 59 deg. 10 min.; thence by lines bearing respectively 264 deg. 5 min. 304 links, 70 deg. 20 min. 402.3 links, 40 deg. 9 min. 334.1 links, 207 deg. 20 min. 242 links, 222 deg. 2 min. 107 links and 239 deg. 10 min. 127 links to the point of commencement.
- (h) Commencing at an angle in the eastern boundary of allotment 18E of the said parish formed by the intersection of lines bearing 10 deg. 48 min. and 314 deg. 24 min.; thence by lines bearing respectively 190 deg. 48 min. 327.6 links; 212 deg. 9 min. 296 links, 237 deg. 52 min. 302.8 links and 32 deg. 57 min. 874 links to the point of commencement.
- (i) Commencing at an angle in the western boundary of allotment 18F of the said parish, formed by the intersection of lines bearing 196 deg. 52 min. and 160 deg. 58 min.; thence by lines bearing respectively 16 deg. 52 min. 289 links, 57 deg. 52 min. 57.6 links; 198 deg. 29 min. 370.5 links and 340 deg. 58 min. 46.7 links to the point of commencement.
- (j) Commencing at the south-eastern angle of allotment 18E of the said parish; thence by lines bearing respectively 183 deg. 35 min. 100 links, 188 deg. 27 min. 98.5 links, 175 deg. 34 min. 321 links, 164 deg. 38 min. 262.4 links, 195 deg. 3 min. 178.2 links; 238 deg. 13 min. 150.3 links; 3 deg. 40 min. 447.9 links, 5 deg. 38 min. 476.8 links; 3 deg. 18 min. 1,031.7 links, 160 deg. 58 min. 326.9 links, 182 deg. 54 min. 337.5 links and 203 deg. 36 min. 309.8 links to the point of commencement.
- (k) Commencing at the south-western angle of allotment 18F of the said parish; thence by lines bearing respectively 8 deg. 27 min. 101 links, 180 deg. 46 min. 500.8 links, 355 deg. 34 min. 300 links and 8 deg. 27 min. 102.9 links to the point of commencement.
- (l) Commencing at an angle in the eastern boundary of the existing Wonthaggi-Loch road through allotment 16 of the said parish, formed by the intersection of lines bearing 238 deg. 13 min. and 197 deg. 4 min.; thence by lines bearing respectively 58 deg. 13 min. 325.2 links, 190 deg. 28 min. 352.4 links; 207 deg. 23 min. 590.4 links; 359 deg. 0 min. 479.7 links and 17 deg. 4 min. 230 links to the point of commencement.
- (m) Commencing at an angle in the western boundary of the existing Wonthaggi-Loch road through allotment 15 of the said parish, formed by the intersection of lines bearing 35 deg. 35 min. and 359 deg. 0 min.; thence by lines bearing respectively 215 deg. 35 min. 304.2 links, 26 deg. 22 min. 394.4 links and 179 deg. 0 min. 106 links to the point of commencement.
- (n) Commencing at an angle in the eastern boundary of the existing Wonthaggi-Loch road through allotment 15 of the said parish, formed by the intersection of lines bearing 215 deg. 35 min. and 203 deg. 26 min.; thence by lines bearing respectively 35 deg. 35 min. 303.5 links, 201 deg. 53 min. 373.9 links, 212 deg. 44 min. 458 links and 23 deg. 26 min. 529 links to the point of commencement.
- (o) Commencing at an angle in the northern boundary of the existing Wonthaggi-Loch road through allotment 15 of the said parish, formed by the intersection of lines bearing 65 deg. 46 min. and 116 deg. 4 min.; thence by lines bearing respectively 245 deg. 46 min. 246 links, 50 deg. 21 min. 274.2 links, 72 deg. 11 min. 641.3 links, 54 deg. 20 min. 335.6 links, 203 deg. 26 min. 89.8 links, 232 deg. 23 min. 331 links, 205 deg. 10 min. 122 links, 250 deg. 49 min. 411.8 links and 296 deg. 4 min. 146.1 links to the point of commencement.
- (p) Commencing at an angle in the eastern boundary of the existing Wonthaggi-Loch road through allotment 15 of the said parish, formed by the intersection of lines bearing 245 deg. 46 min. and 207 deg. 58 min.; thence by lines bearing respectively 65 deg. 46 min. 169.7 links, 219 deg. 5 min. 539 links and 27 deg. 58 min. 394.8 links to the point of commencement—
- which said pieces of land are particularly delineated and shown coloured red and yellow on survey plans numbered 9865, 9866, 9867, 9868 and 9869, lodged in the office of the Country Roads Board.

And the Honorable Murray Victor Porter, Her Majesty's Minister of Public Works for the State of Victoria, shall give the necessary directions herein accordingly.

J. COLQUHOUN,
Clerk of the Executive Council:

COUNTRY ROADS BOARD.

At the Executive Council Chamber, Melbourne, the
sixteenth day of March, 1965.

PRESENT:

His Excellency the Governor of Victoria.	
Mr. Porter	Mr. Meagher.
Mr. Balfour.	

DECLARATION OF A DEVIATION FROM THE FOSTER NORTH-MIRBOO SOUTH ROAD IN THE SHIRE OF SOUTH GIPPSLAND.

WHEREAS by sections 21 and 58 of the *Country Roads Act 1958* (No. 6229) it is amongst other things enacted that when the Country Roads Board under the provisions of the *Country Roads Act* has by Resolution declared a deviation to be a main road the said Board may also declare that such deviation shall be in lieu of any existing road or part thereof named in such Resolution and that on publication in the *Government Gazette* of the Order confirming such Resolution the existing road or part thereof shall cease to be a main road or be discontinued as provided in the Resolution: And whereas the said Board has by Resolution declared the deviation on the land described in the First Schedule to such Resolution to be a main road and has also declared that such deviation shall be in lieu of the part of the existing road being the land described in the Second Schedule to the said Resolution: and that such part of the said existing road shall be discontinued: Now therefore His Excellency the Governor of the State of Victoria by and with the advice of the Executive Council thereof doth hereby confirm the said Resolution:

Resolution for Declaration of a Deviation of a Main Road under the *Country Roads Act*.

Whereas the land the site of the road the course of which is below set out was taken by the Board under the provisions of the *Country Roads Act 1958* for the purpose

of constructing such road deviation which road deviation has now been laid out and formed on the same: And whereas the said Board (being the Country Roads Board incorporated under the said Act) thinks that the road aforesaid is fit to be used as a public highway such Board at a meeting now holden acting under the authority conferred upon it by sections 21 and 58 of the said Act doth by this present Resolution hereby declare the said road deviation the course of which is described in the First Schedule hereto with the commencing and terminating points thereof respectively specified to be part of a main road within the meaning and for the purposes of the *Country Roads Act 1958*: And the said Board doth also declare that such deviation shall be in lieu of the existing road or part thereof described in the Second Schedule hereto and that such part of the said existing road shall be discontinued.

FIRST SCHEDULE.

Shire of South Gippsland.

12. *Foster North—Mirboo South road (15412)*.—All that piece of land in the Parish of Dumbalk, the boundaries of which are as follow:—Commencing at the north-eastern angle of allotment 50A² of the said parish; thence by lines bearing respectively 67 deg. 10 min. 466.7 links, 207 deg. 10 min. 930.4 links, 204 deg. 51 min. 534.5 links, 345 deg. 1 min. 468.3 links, 24 deg. 51 min. 181 links and 27 deg. 10 min. 579 links to the point of commencement—which said piece of land is particularly delineated and shown coloured red on survey plan numbered 784, lodged in the office of the Country Roads Board.

SECOND SCHEDULE.

Shire of South Gippsland.

12. *Foster North—Mirboo South road (15412)*.—All that piece of land in the Parish of Dumbalk, the boundaries of which are as follow:—Commencing at the north-eastern angle of allotment 50A² of the said parish; thence by lines bearing respectively 247 deg. 10 min. 108 links, 183 deg. 58 min. 124 links, 210 deg. 51 min. 498 links, 165 deg. 1 min. 88 links, 198 deg. 54 min. 166.2 links, 345 deg. 1 min. 276 links, 30 deg. 51 min. 506 links, 3 deg. 58 min. 161 links, 67 deg. 10 min. 289 links and 207 deg. 10 min. 155.6 links to the point of commencement—which said piece of land is particularly delineated and shown coloured blue on survey plan numbered 784, lodged in the office of the Country Roads Board.

The common seal of the Country Roads Board was hereto affixed, at Kew, this ninth day of March, One thousand nine hundred and sixty-five, in the presence of—

R. E. DONALDSON, Deputy Chairman.
(SEAL) F. WEST, Member.
N. L. ALLANSON, Secretary.

And the Honorable Murray Victor Porter, Her Majesty's Minister of Public Works for the State of Victoria, shall give the necessary directions herein accordingly.

J. COLQUHOUN,
Clerk of the Executive Council.

COUNTRY ROADS BOARD.

At the Executive Council Chamber, Melbourne, the sixteenth day of March, 1965.

PRESENT:

His Excellency the Governor of Victoria.
Mr. Porter | Mr. Meagher.
Mr. Balfour

ORDER APPROVING OF A DEVIATION FROM A MAIN ROAD IN THE SHIRE OF OMEO.

WHEREAS the Country Roads Board constituted under the *Country Roads Act 1958* (No. 6229) has represented to His Excellency the Governor in Council that it appears to it desirable that the deviation hereinafter referred to from the existing Ramrod Flat-road in the Shire of Omeo (declared to be a main road under the said Act which declaration was confirmed by the Order in Council published in the *Government Gazette* of the 6th August, 1947, on pages 4204-5) should be made by the said Board: And whereas the said Board in accordance with the requirements of section 19 of the said cited Act has caused to be prepared a map plan and estimate showing the points between which and on and through

what land the said deviation is proposed to be made and the cost of acquiring the land: And whereas on an inspection of the said map and plan and a consideration of the said estimate His Excellency the Governor in Council is satisfied that there are funds legally available for acquiring the land: Now therefore be it known by this present Order that His Excellency the Governor of the State of Victoria with the advice of the Executive Council thereof doth hereby approve of the said road being made, that is to say:—

All that piece of land in the Township of Ensay, Parish of Numbie Munjie, the boundaries of which are as follow:—

Commencing at the eastern angle of allotment 13 of the said township; thence by lines bearing respectively 247 deg. 42 min. 75 links, 338 deg. 31 min. 124 links, 32 deg. 11 min. 90 links and 157 deg. 42 min. 176 links to the point of commencement.

Also, all that piece of land in the Parishes of Numbie Munjie and Angora, the boundaries of which are as follow:—

Commencing at the south-western angle of allotment 12, Township of Ensay, Parish of Numbie Munjie; thence by lines bearing respectively 67 deg. 42 min. 38.8 links, 33 deg. 11 min. 481.9 links, 158 deg. 31 min. 273 links, 194 deg. 43 min. 407.8 links, 203 deg. 26 min. 492.5 links, 182 deg. 22½ min. 612.7 links, 165 deg. 33 min. 280 links, 164 deg. 46 min. 1,392.7 links, 212 deg. 14 min. 326 links, 199 deg. 53 min. 495 links, 214 deg. 24 min. 473 links, 222 deg. 33 min. 57 links, 336 deg. 47 min. 111.4 links, 37 deg. 16 min. 482.9 links, 1 deg. 25 min. 926.7 links, 344 deg. 46 min. 1,070.9 links, 353 deg. 41½ min. 780.8 links, 342 deg. 52 min. 100 links, 23 deg. 26 min. 480.9 links and 12 deg. 25 min. 331.4 links to the point of commencement—

which said pieces of land are particularly delineated and shown coloured red and yellow on survey plans numbered 9903 and 9904, lodged in the office of the Country Roads Board.

And the Honorable Murray Victor Porter, Her Majesty's Minister of Public Works for the State of Victoria, shall give the necessary directions herein accordingly.

J. COLQUHOUN,
Clerk of the Executive Council.

COUNTRY ROADS BOARD.

At the Executive Council Chamber, Melbourne, the sixteenth day of March, 1965.

PRESENT:

His Excellency the Governor of Victoria.
Mr. Porter | Mr. Meagher.
Mr. Balfour

ORDER APPROVING OF A DEVIATION FROM A MAIN ROAD IN THE SHIRE OF BULN BULN.

WHEREAS the Country Roads Board constituted under the *Country Roads Act 1958* (No. 6229) has represented to His Excellency the Governor in Council that it appears to it desirable that the deviation hereinafter referred to from the existing Main Neerim-road in the Shire of Buln Buln (declared to be a main road under the said Act which declaration was confirmed by the Order in Council published in the *Government Gazette* of the 21st September, 1932, on page 2177) should be made by the said Board: And whereas the said Board in accordance with the requirements of section 19 of the said cited Act has caused to be prepared a map plan and estimate showing the points between which and on and through what land the said deviation is proposed to be made and the cost of acquiring the land: And whereas on an inspection of the said map and plan and a consideration of the said estimate His Excellency the Governor in Council is satisfied that there are funds legally available for acquiring the land: Now therefore be it known by this present Order that His Excellency the Governor of the State of Victoria with the advice of the Executive Council thereof doth hereby approve of the said road being made, that is to say:—

All that piece of land in the Parish of Drouin West, the boundaries of which are as follow:—Commencing at a point on the northern boundary of lot 3 on plan of subdivision numbered 4044, lodged in the Office of Titles, and being part of allotment 47 of the said parish; distant 99 deg. 20 min. 166.1 links from the north-western angle of the said lot; thence by lines bearing respectively 13 deg.

40½ min. 298.6 links; 41 deg. 42 min. 217.5 links, 15 deg. 27 min. 1,478.6 links, 194 deg. 47 min. 1,444.8 links, 195 deg. 51 min. 2,237.7 links, 351 deg. 20 min. 241 links and 15 deg. 51 min. 1,490.3 links to the point of commencement—which said piece of land is particularly delineated and shown coloured red on survey plan numbered 9766, lodged in the office of the Country Roads Board.

And the Honorable Murray Victor Porter, Her Majesty's Minister of Public Works for the State of Victoria, shall give the necessary directions herein accordingly.

J. COLQUHOUN,
Clerk of the Executive Council.

COUNTRY ROADS BOARD.

At the Executive Council Chamber, Melbourne, the sixteenth day of March, 1965.

PRESENT:

His Excellency the Governor of Victoria.	
Mr. Porter	Mr. Meagher.
Mr. Balfour	

ORDER APPROVING OF A DEVIATION FROM A TOURISTS' ROAD IN THE SHIRE OF OTWAY.

WHEREAS the Country Roads Board constituted under the Country Roads Act 1958 (No. 6229) has represented to His Excellency the Governor in Council that it appears to it desirable that the deviation hereinafter referred to from the existing Ocean-road in the Shire of Otway (declared to be a tourists' road under the said Act which declaration was confirmed by the Order in Council published in the Government Gazette of the 2nd December, 1936, on page 3196) should be made by the said Board: And whereas the said Board in accordance with the requirements of sections 19 and 88 of the said cited Act has caused to be prepared a map plan and estimate showing the points between which and on and through what land the said deviation is proposed to be made and the cost of acquiring the land: And whereas on an inspection of the said map and plan and a consideration of the said estimate His Excellency the Governor in Council is satisfied that there are funds legally available for acquiring the land: Now therefore be it known by this present Order that His Excellency the Governor of the State of Victoria with the advice of the Executive Council thereof doth hereby approve of the said road being made, that is to say:—

All that piece of land in the Parish of Aire, the boundaries of which are as follow:—Commencing at the most easterly angle of allotment 23 of the said parish; thence by lines bearing respectively 241 deg. 8 min. 182 links, 219 deg. 8 min. 85 links, 324 deg. 15 min. 315.2 links and 104 deg. 24 min. 410.1 links to the point of commencement—which said piece of land is particularly delineated and shown coloured red on survey plan numbered 9945, lodged in the office of the Country Roads Board.

And the Honorable Murray Victor Porter, Her Majesty's Minister of Public Works for the State of Victoria, shall give the necessary directions herein accordingly.

J. COLQUHOUN,
Clerk of the Executive Council.

COUNTRY ROADS BOARD.

At the Executive Council Chamber, Melbourne, the sixteenth day of March, 1965.

PRESENT:

His Excellency the Governor of Victoria.	
Mr. Porter	Mr. Meagher.
Mr. Balfour	

ORDER APPROVING OF WIDENING AN EXISTING MAIN ROAD IN THE SHIRE OF METCALFE.

WHEREAS the Country Roads Board constituted under the Country Roads Act 1958 (No. 6229) has represented to His Excellency the Governor in Council that it appears to it desirable that the existing Bendigo-Sutton Grange road in the Shire of Metcalfe (declared to be a main road under the said Act which declaration was confirmed by the Order in Council published in the Government Gazette of the 16th July, 1947, on pages 3851-55)

should be widened by the said Board: And whereas the said Board in accordance with the requirements of section 19 of the said cited Act has caused to be prepared a map plan and estimate showing the points between which and on and through what land the said widening is proposed to be made and the cost of acquiring the land: And whereas on an inspection of the said map and plan and a consideration of the said estimate His Excellency the Governor in Council is satisfied that there are funds legally available for acquiring the land: Now therefore be it known by this present Order that His Excellency the Governor of the State of Victoria with the advice of the Executive Council thereof doth hereby approve of the said road being widened, that is to say:—

All that piece of land in the Parish of Sutton Grange, the boundaries of which are as follow:—Commencing at an angle in the eastern boundary of allotment 15, section 1 of the said parish, formed by the intersection of lines bearing 334 deg. 35 min. and 312 deg. 53 min.; thence by lines bearing respectively 154 deg. 35 min. 529.8 links, 323 deg. 40 min. 1,047.2 links and 132 deg. 53 min. 536.5 links to the point of commencement—which said piece of land is particularly delineated and shown coloured red on survey plan numbered 9950, lodged in the office of the Country Roads Board.

And the Honorable Murray Victor Porter, Her Majesty's Minister of Public Works for the State of Victoria, shall give the necessary directions herein accordingly.

J. COLQUHOUN,
Clerk of the Executive Council.

STAMPS ACT 1958 (No. 6375).

At the Executive Council Chamber, Melbourne, the twenty-third day of March, 1965.

PRESENT:

His Excellency the Governor of Victoria.	
Mr. Rylah	Mr. Thompson
Mr. Reid	Mr. Porter
Mr. Mack	Mr. Meagher
Mr. Hamer	Mr. Balfour.
Mr. Dickie	

DECLARATION OF APPROVED VENDOR.

HIS Excellency the Governor of the State of Victoria, by and with the advice of the Executive Council thereof, doth by this Order made pursuant to section 131C (1) of the Stamps Act 1958, declare the under-mentioned person carrying on business as a vendor of goods under instalment purchase agreements to be an "approved vendor" for the purposes of subdivision (14) of Division three of Part II. of the Stamps Act 1958.

220. JAMES N. KIRBY MANUFACTURING PTY. LIMITED.

And the Honorable Henry Edward Bolte, Her Majesty's Treasurer for the State of Victoria, shall give the necessary directions herein accordingly.

J. COLQUHOUN,
Clerk of the Executive Council.

STAMPS ACT 1958 (No. 6375).

At the Executive Council Chamber, Melbourne, the twenty-third day of March, 1965.

PRESENT:

His Excellency the Governor of Victoria.	
Mr. Rylah	Mr. Thompson
Mr. Reid	Mr. Porter
Mr. Mack	Mr. Meagher
Mr. Hamer	Mr. Balfour.
Mr. Dickie	

REVOCATION OF DECLARATION OF APPROVED VENDOR.

HIS Excellency the Governor of the State of Victoria, by and with the advice of the Executive Council thereof, doth by this Order made pursuant to section 131C of the Stamps Act 1958 (No. 6375) revoke the declaration made on the 4th August, 1959, and published in the Government Gazette of the 12th August, 1959, declaring

certain persons to be "approved vendors" for the purposes of subdivision (14) of Division three of Part II. of the *Stamps Act 1958* in so far as the said declaration refers to the under-mentioned person:—

97: COX BROTHERS (AUSTRALIA) LIMITED.

And the Honorable Henry Edward Bolte, Her Majesty's Treasurer for the State of Victoria, shall give the necessary directions herein accordingly.

J. COLQUHOUN,
Clerk of the Executive Council.

BENEFIT ASSOCIATIONS ACT 1958

At the Executive Council Chamber, Melbourne, the twenty-third day of March, 1965.

PRESENT:

His Excellency the Governor of Victoria:	
Mr. Rylah	Mr. Thompson
Mr. Reid	Mr. Porter
Mr. Mack	Mr. Meagher
Mr. Hamer	Mr. Balfour
Mr. Dickie	

ORDER EXEMPTING AN ASSOCIATION FROM PROVISIONS OF ACT.

IN pursuance of the provisions of the *Benefit Associations Act 1958*, His Excellency, the Governor of the State of Victoria, in the Commonwealth of Australia, by and with the advice of the Executive Council of the said State, after consideration by the Minister of reports, in writing, made by the Registrar of Sickness, Hospital, Medical and Funeral Benefit Associations and the Government Statist relative to the proposed exemption and to the terms and conditions to be imposed; doth, by this Order, declare the Association, known as the Hospitals Contribution Fund of New South Wales, to be exempt from the provisions of the *Benefit Associations Act 1958*, subject to the following terms and conditions:—

1. That the Hospitals Contribution Fund of New South Wales (hereinafter referred to as the Association) shall establish accounts for Victorian contributors in respect of hospital and medical benefits respectively (such accounts are hereinafter referred to as the Victorian Accounts) which shall be credited with contributions paid by such contributors and with interest at the average interest rate earned by the funds of the Association and which shall be debited with claims paid, in respect of such contributors and/or their dependants and an appropriate share of management charges.

2. That the current rules of the Association that apply to the contributors to the Victorian Accounts be filed with the Registrar before the 1st day of April, 1965.

3. (a) That such rules of the Association be not altered without the approval of the Minister. Applications for such alterations shall be submitted in the first place to the Government Actuary for report to the Minister.

(b) That as soon as is convenient, the Registrar and the Government Actuary shall examine such recorded rules and report to the Minister, who shall notify the Association regarding any alterations which he deems necessary after consideration of such reports.

4. That the Government Actuary shall as he deems necessary but not more frequently than once every three years, conduct an actuarial investigation into the Victorian Accounts of the Association. The Association shall furnish any information or statistics required by the Government Actuary to carry out such investigation.

5. Following an investigation pursuant to condition 4 hereof, the Minister after consideration of reports, in writing, made by the Registrar and the Government Actuary, shall have power to direct any changes in tables of contributions and/or benefits in such rules which in his opinion are deemed necessary to protect the contributors.

6. Upon notice, in writing, being given by the Minister to the Association requiring any change in the rules pursuant to conditions 3 and 5 hereof, the Association shall subject to the provisions of the Commonwealth National Health Act amend such rules and file with the Registrar within six months of the date of such notice a copy of the rules so amended.

7. Any information or statistics required by the Government Actuary from time to time shall be made available by the Association.

8. That audited annual returns of the nature specified in section 14 of the *Benefit Associations Act 1958* and duplicates of all auditors' reports on the books and

accounts of the Association shall, within three months of the closing of the financial year, be furnished yearly to the Government Actuary.

9. (a) Not later than the 31st day of December, 1965, the Association shall deposit with the Treasurer of Victoria an amount of Commonwealth Inscribed Stock, at least equal to one-quarter of the total amount of contribution receipts shown in the Victorian Accounts for the year ended the 30th day of June, 1965.

Not later than the 31st day of December in any succeeding calendar year in which the amount of the said stock so deposited with and held by the said Treasurer is less than one-quarter of the total amount of contribution receipts shown in the Victorian Accounts for the year ended on the immediately preceding 30th day of June, the Association shall deposit with the said Treasurer such additional amount of the said stock as is necessary to make the total amount of the said stock so deposited with and held by the Treasurer at least equal to one-quarter of the total amount of contribution receipts shown in the Victorian Accounts for the year ended on the last-mentioned 30th day of June.

(b) The Association shall covenant under seal with the said Treasurer that it will not withdraw without his consent any of the said stock until the Association ceases to carry on hospital and/or medical benefit business in Victoria and all liabilities of the Association to contributors shown in the Victorian Accounts have been discharged with the intent that the said stock shall be available for ensuring the discharge of such liabilities provided that the Association shall be entitled to any amounts from time to time payable as interest or dividend on the said stock.

10. That the Association shall furnish the Registrar with the name and address of the Public Officer of the Association from time to time.

11. The fees to be paid for each investigation by the Government Actuary pursuant to condition 4 hereof shall be fixed by the Minister. Such fees shall be a charge against the Management Account of the Association.

And the Honorable Arthur Gordon Rylah, Her Majesty's Chief Secretary for the State of Victoria, shall give the necessary directions herein accordingly.

J. COLQUHOUN,
Clerk of the Executive Council.

BUILDING SOCIETIES ACT 1958

At the Executive Council Chamber, Melbourne, the twenty-third day of March, 1965.

PRESENT:

His Excellency the Governor of Victoria.	
Mr. Rylah	Mr. Thompson
Mr. Reid	Mr. Porter
Mr. Mack	Mr. Meagher
Mr. Hamer	Mr. Balfour
Mr. Dickie	

WHEREAS pursuant to the provisions of sub-section (4) of section 21c of the *Building Societies Act 1958* the Registrar of Building Societies has served on the Second United Permanent Building Society a notice dated the 17th February, 1965, stating that he proposed to make a report to the Governor in Council pursuant to sub-section (1) of the said section 21c:

And whereas pursuant to the provisions of sub-section (1) of section 21c of the *Building Societies Act 1958* the Registrar of Building Societies has reported to the Governor in Council by notice dated the 11th March, 1965, that he considers it expedient in the interests of persons who have invested or deposited or may invest or deposit money with the Second United Permanent Building Society, that the provisions of sub-section (2) of the said section 21c should be applied to the said Society:

Now therefore His Excellency the Governor of the State of Victoria, by and with the advice of the Executive Council of the said State and in pursuance of the powers conferred by sub-section (1) of section 21c of the *Building Societies Act 1958*, and all powers him thereunto enabling, doth by this Order, apply the provisions of sub-section (2) of section 21c of the said Act to the Second United Permanent Building Society.

And the Honorable Arthur Gordon Rylah, Her Majesty's Chief Secretary for the State of Victoria, shall give the necessary directions herein accordingly.

J. COLQUHOUN,
Clerk of the Executive Council.

BUILDING SOCIETIES ACT 1958.

At the Executive Council Chamber, Melbourne, the twenty-third day of March, 1965.

PRESENT:

His Excellency the Governor of Victoria.	
Mr. Rylah	Mr. Thompson
Mr. Reid	Mr. Porter
Mr. Mack	Mr. Meagher
Mr. Hamer	Mr. Balfour.
Mr. Dickie	

WHEREAS pursuant to the provisions of sub-section (4) of section 21c of the *Building Societies Act 1958* the Registrar of Building Societies has served on the United Permanent Building Society a notice dated the 17th February, 1965, stating that he proposed to make a report to the Governor in Council pursuant to sub-section (1) of the said section 21c:

And whereas pursuant to the provisions of sub-section (1) of section 21c of the *Building Societies Act 1958* the Registrar of Building Societies has reported to the Governor in Council by notice dated the 11th March, 1965, that he considers it expedient in the interests of persons who have invested or deposited or may invest or deposit money with the United Permanent Building Society, that the provisions of sub-section (2) of the said section 21c should be applied to the said Society:

Now therefore His Excellency the Governor of the State of Victoria, by and with the advice of the Executive Council of the said State and in pursuance of the powers conferred by sub-section (1) of section 21c of the *Building Societies Act 1958*, and all powers him thereunto enabling, doth by this Order, apply the provisions of sub-section (2) of section 21c of the said Act to the United Permanent Building Society.

And the Honorable Arthur Gordon Rylah, Her Majesty's Chief Secretary for the State of Victoria, shall give the necessary directions herein accordingly.

J. COLQUHOUN,
Clerk of the Executive Council.

COMPANIES ACT 1961.

At the Executive Council Chamber, Melbourne, the twenty-third day of March, 1965.

PRESENT:

His Excellency the Governor of Victoria.	
Mr. Rylah	Mr. Thompson
Mr. Reid	Mr. Porter
Mr. Mack	Mr. Meagher
Mr. Hamer	Mr. Balfour.
Mr. Dickie	

NOTICE UNDER SECTION 38 OF THE COMPANIES ACT 1961.

WHEREAS by sub-section (4) of section 38 of the *Companies Act 1961* it is provided that nothing in the said section 38 shall apply to a prescribed corporation and nothing in the *Companies Act 1961* shall require a prospectus to be issued in connexion with any invitation to the public to deposit money with a prescribed corporation.

And whereas by paragraph (b) of sub-section (5) of the said section 38 a prescribed corporation means (*inter alia*) a corporation that is declared by the Governor in Council by notice in the *Government Gazette* to be an authorized dealer in the short term money market.

And whereas the Prudential Assurance Company Limited and Prudential Australian Superannuation Limited are desirous of being declared to be authorized dealers in the short term money market under the said paragraph (b) of sub-section (5) of section 38.

Now therefore the Governor of the State of Victoria, by and with the advice of the Executive Council thereof, doth hereby declare that the said—

THE PRUDENTIAL ASSURANCE COMPANY LIMITED and PRUDENTIAL AUSTRALIAN SUPERANNUATION LIMITED for the purposes of the said section 38 of the *Companies Act 1961* are authorized dealers in the short term money market.

And the Honorable Arthur Gordon Rylah, Her Majesty's Attorney-General for the State of Victoria, shall give the necessary directions herein accordingly.

J. COLQUHOUN,
Clerk of the Executive Council.

LANDLORD AND TENANT ACT 1958.

At the Executive Council Chamber, Melbourne, the twenty-third day of March, 1965.

PRESENT:

His Excellency the Governor of Victoria.	
Mr. Rylah	Mr. Thompson
Mr. Reid	Mr. Porter
Mr. Mack	Mr. Meagher
Mr. Hamer	Mr. Balfour.
Mr. Dickie	

ORDER EXCLUDING CERTAIN PREMISES FROM THE OPERATION OF CERTAIN OF THE PROVISIONS CONTAINED IN PART V. OF THE LANDLORD AND TENANT ACT 1958.

IN pursuance of the powers conferred upon him by the *Landlord and Tenant Act 1958*, His Excellency the Governor of the State of Victoria, by and with the advice of the Executive Council thereof, doth hereby declare that the premises known as Number 13 Cambridge-street, Caulfield, shall be excluded from the operation of the whole of the provisions contained in Divisions 2 and 3 of Part V. of the *Landlord and Tenant Act 1958*.

And the Honorable Arthur Gordon Rylah, Her Majesty's Attorney-General for the State of Victoria, shall give the necessary directions herein accordingly.

J. COLQUHOUN,
Clerk of the Executive Council.

LANDLORD AND TENANT ACT 1958.

At the Executive Council Chamber, Melbourne, the twenty-third day of March, 1965.

PRESENT:

His Excellency the Governor of Victoria.	
Mr. Rylah	Mr. Thompson
Mr. Reid	Mr. Porter
Mr. Mack	Mr. Meagher
Mr. Hamer	Mr. Balfour.
Mr. Dickie	

ORDER EXTENDING APPLICATION OF PART V. OF THE LANDLORD AND TENANT ACT 1958 TO CERTAIN PREMISES.

IN pursuance of the powers conferred by section 44 of the *Landlord and Tenant Act 1958*, His Excellency the Governor of Victoria, by and with the advice of the Executive Council thereof, doth hereby declare that the application of Part V. of the *Landlord and Tenant Act 1958* shall extend to the following premises:—

1. The premises known as Number 14 Pascoe-avenue, Springvale.
2. The premises known as Number 10 Cumberland-street, Newtown, Geelong.

And the Honorable Arthur Gordon Rylah, Her Majesty's Attorney-General for the State of Victoria, shall give the necessary directions herein accordingly.

J. COLQUHOUN,
Clerk of the Executive Council.

MORNINGTON SEWERAGE AUTHORITY.

At the Executive Council Chamber, Melbourne, the twenty-third day of March, 1965.

PRESENT:

His Excellency the Governor of Victoria.	
Mr. Rylah	Mr. Thompson
Mr. Reid	Mr. Porter
Mr. Mack	Mr. Meagher
Mr. Hamer	Mr. Balfour.
Mr. Dickie	

AMENDMENT OF ORDER.

UNDER the powers conferred by the Sewerage Districts Act and all other powers enabling him in that behalf, His Excellency the Governor of the State of Victoria, by and with the advice of the Executive Council of the said

State, doth hereby amend as follows the Order in Council proclaiming the Sewerage District and constituting the Mornington Sewerage Authority made on 21st March, 1939, as amended by Orders in Council made on 22nd August, 1956, 15th January, 1957, and 15th May, 1962, and published in the *Victoria Government Gazette*, dated 22nd March, 1939, 29th August, 1956, 16th January, 1957, and 16th May, 1962, respectively.

In clause (a) for the expression "Twelve thousand pounds (£12,000)" there shall be substituted the expression "Twenty-six thousand pounds (£26,000)".

And the Honorable Thomas Anthony Darcy, Her Majesty's Minister of Water Supply for the State of Victoria, shall give the necessary directions herein accordingly.

J. COLQUHOUN,
Clerk of the Executive Council.

MORNINGTON SEWERAGE AUTHORITY.

At the Executive Council Chamber, Melbourne, the
twenty-third day of March, 1965.

PRESENT:

His Excellency the Governor of Victoria.	
Mr. Rylah	Mr. Thompson
Mr. Reid	Mr. Porter
Mr. Mack	Mr. Meagher
Mr. Hamer	Mr. Balfour.
Mr. Dickie	

REPEAL OF ORDER.

UNDER the powers conferred by the Sewerage Districts Act and all other powers enabling him in that behalf, His Excellency the Governor of the State of Victoria, by and with the advice of the Executive Council of the said State, doth hereby repeal the Order made by the Governor in Council on 16th August, 1955, and published in the *Victoria Government Gazette* dated 24th August, 1955, consenting to the Mornington Sewerage Authority borrowing by way of overdraft the sum of Ten thousand pounds (£10,000) and as on and from the date hereof the said Order of the Governor in Council shall be deemed to be repealed accordingly.

And the Honorable Thomas Anthony Darcy, Her Majesty's Minister of Water Supply for the State of Victoria, shall give the necessary directions herein accordingly.

J. COLQUHOUN,
Clerk of the Executive Council.

MAFFRA SEWERAGE AUTHORITY.

At the Executive Council Chamber, Melbourne, the
twenty-third day of March, 1965.

PRESENT:

His Excellency the Governor of Victoria.	
Mr. Rylah	Mr. Thompson
Mr. Reid	Mr. Porter
Mr. Mack	Mr. Meagher
Mr. Hamer	Mr. Balfour.
Mr. Dickie	

EXTENT OF DISTRICT INCREASED.

UNDER the powers conferred by the Sewerage Districts Act and all other powers enabling him in that behalf, His Excellency the Governor of the State of Victoria, by and with the advice of the Executive Council of the said State, doth hereby declare, order and direct that the extent of the Sewerage District of the Maffra Sewerage Authority be increased by adding thereto the lands within the boundaries described in the Schedule hereto and as on and from the date hereof the extent of the said Sewerage District shall be deemed to be increased accordingly.

SCHEDULE.

Commencing at the north-western angle of lot 185 on lodged plan of subdivision No. 9946, Parish of Wa-De-Lock, County of Tanjil, being a point on the boundary of the existing Sewerage District; thence easterly along the northern boundary of the said lot 185 to its north-eastern angle; thence northerly along the eastern boundaries of lots 186 and 187 to a point in line with the northern

boundary of lot 183; thence easterly across a road and along the northern boundaries of the said lot 183 and of lot 180 and by a line being the continuation thereof across a road to a point on the western boundary of lot 179; thence southerly along the western boundaries of the said lot 179 and of lots 176 and 175 to the south-western angle of the said lot 175, being a point on the boundary of the existing Sewerage District; thence westerly, southerly, westerly, northerly, westerly and northerly along the boundary of the existing Sewerage District to the point of commencement.

All of which land is shown on a plan approved by the Governor in Council and deposited in the office of the State Rivers and Water Supply Commission, Melbourne.—(Corr. 59/2006/62.)

And the Honorable Thomas Anthony Darcy, Her Majesty's Minister of Water Supply for the State of Victoria, shall give the necessary directions herein accordingly.

J. COLQUHOUN,
Clerk of the Executive Council.

MORNINGTON SEWERAGE AUTHORITY.

At the Executive Council Chamber, Melbourne, the
twenty-third day of March, 1965.

PRESENT:

His Excellency the Governor of Victoria.	
Mr. Rylah	Mr. Thompson
Mr. Reid	Mr. Porter
Mr. Mack	Mr. Meagher
Mr. Hamer	Mr. Balfour.
Mr. Dickie	

POWER TO BORROW £26,000.

UNDER the powers conferred by the *Sewerage Districts Act 1958* and all other powers enabling him in that behalf, His Excellency the Governor of the State of Victoria, by and with the advice of the Executive Council of the said State, doth hereby consent to the Mornington Sewerage Authority borrowing at interest a sum of Twenty-six thousand pounds (£26,000) for the carrying out of works in accordance with the provisions of sections 95, 130 and 137 of the *Sewerage Districts Act 1958*, the said sum to be borrowed by way of overdraft from the National Bank of Australasia Limited. All moneys received by the said Authority in repayment of costs and expenses of the said works, or any of them, shall be set aside for the purpose of and applied in repayment of the said sum so borrowed.

And the Honorable Thomas Anthony Darcy, Her Majesty's Minister of Water Supply for the State of Victoria, shall give the necessary directions herein accordingly.

J. COLQUHOUN,
Clerk of the Executive Council.

BENALLA SEWERAGE AUTHORITY.

At the Executive Council Chamber, Melbourne, the
twenty-third day of March, 1965.

PRESENT:

His Excellency the Governor of Victoria.	
Mr. Rylah	Mr. Thompson
Mr. Reid	Mr. Porter
Mr. Mack	Mr. Meagher
Mr. Hamer	Mr. Balfour.
Mr. Dickie	

APPROVAL TO EXTENSION OF SITE OF TREATMENT WORKS AND DISPOSAL AREA AND TO THE ACQUISITION OF LAND.

UNDER the powers conferred by the Sewerage Districts Acts and all other powers enabling him in that behalf, His Excellency the Governor of the State of Victoria, by and with the advice of the Executive Council of the said State, doth hereby consent to an extension of the site of sewage treatment works and disposal area of the Benalla Sewerage Authority as described in the

Schedule hereto and to the said Sewerage Authority acquiring these lands which are situated without its Sewerage District.

SCHEDULE.

Commencing at a point on the northern boundary of Crown allotment 5, section D, Parish of Benalla, County of Delatite, distant 625 links westerly from its north-eastern angle, such point being on the boundary of the Authority's existing treatment works and disposal area as described in an Order in Council dated 2nd April, 1936, and published in the *Victoria Government Gazette* of 29th April, 1936; thence westerly along the northern boundaries of the said Crown allotment 5 and of Crown allotments 6, 7 and 8 to the north-western angle of the said Crown allotment 8; thence southerly along the western boundary of the said Crown allotment 8 to its south-western angle; thence generally south-easterly along the south-western boundary of the said Crown allotment 8 to a point due north of the western-most extremity of the lands described in certificate of title, volume 5862, folio 272; thence due south by a line across a watercourse to a point on the boundary of the said lands described in certificate of title, volume 5862, folio 272 being also a point on the right bank of the Broken River; thence generally south-easterly along the said right bank of the Broken River to a point on a line parallel to and distant 625 links westerly from the eastern boundary of the aforesaid Crown allotment 5, being a point on the aforesaid boundary of the Authority's existing treatment works and disposal area; thence northerly by the said line parallel to and distant 625 links westerly from the eastern boundary of Crown allotment 5 to a point on its northern boundary being the point of commencement.

All of which lands are shown on a plan approved by the Governor in Council and deposited in the office of the State Rivers and Water Supply Commission, Melbourne.—(Corres. 59/2406/112.)

And the Honorable Thomas Anthony Darcy, Her Majesty's Minister of Water Supply for the State of Victoria, shall give the necessary directions herein accordingly.

J. COLQUHOUN,
Clerk of the Executive Council.

SHIRE OF BEECHWORTH—WATER SUPPLY DISTRICT.

At the Executive Council Chamber, Melbourne, the twenty-third day of March, 1965.

PRESENT:

His Excellency the Governor of Victoria.	
Mr. Rylah	Mr. Thompson
Mr. Reid	Mr. Porter
Mr. Mack	Mr. Meagher
Mr. Hamer	Mr. Balfour.
Mr. Dickie	

CONSENT TO BORROWING £18,000.

UNDER the powers conferred by the Water Act and all other powers enabling him in that behalf, His Excellency the Governor of the State of Victoria, by and with the advice of the Executive Council of the said State, doth hereby consent to the Council of the Shire of Beechworth borrowing at interest at the rate of £5 10s. per centum per annum the sum of Eighteen thousand pounds (£18,000) to meet the cost of water supply works.

And the Honorable Thomas Anthony Darcy, Her Majesty's Minister of Water Supply for the State of Victoria, shall give the necessary directions herein accordingly.

J. COLQUHOUN,
Clerk of the Executive Council.

WODONGA WATERWORKS TRUST.

At the Executive Council Chamber, Melbourne, the twenty-third day of March, 1965.

PRESENT:

His Excellency the Governor of Victoria.	
Mr. Rylah	Mr. Thompson
Mr. Reid	Mr. Porter
Mr. Mack	Mr. Meagher
Mr. Hamer	Mr. Balfour.
Mr. Dickie	

REPEAL OF ORDER.

UNDER the powers conferred by the Water Act and all other powers enabling him in that behalf, His Excellency the Governor of the State of Victoria, by and with the advice of the Executive Council of the said State, doth hereby repeal the Order made by the Governor in Council on 20th December, 1955, and published in the *Victoria Government Gazette* dated 21st December, 1955, fixing the limit of the overdraft to be obtained by the Wodonga Waterworks Trust, and as on and from the date hereof the said Order of the Governor in Council shall be deemed to be repealed accordingly.

And the Honorable Thomas Anthony Darcy, Her Majesty's Minister of Water Supply for the State of Victoria, shall give the necessary directions herein accordingly.

J. COLQUHOUN,
Clerk of the Executive Council.

TARWIN RIVER IMPROVEMENT TRUST.

At the Executive Council Chamber, Melbourne, the twenty-third day of March, 1965.

PRESENT:

His Excellency the Governor of Victoria.	
Mr. Rylah	Mr. Thompson
Mr. Reid	Mr. Porter
Mr. Mack	Mr. Meagher
Mr. Hamer	Mr. Balfour.
Mr. Dickie	

CONSENT TO BORROWING £3,085.

UNDER the powers conferred by the *River Improvement Act 1958* and all other powers enabling him in that behalf, His Excellency the Governor of the State of Victoria, by and with the advice of the Executive Council of the said State, doth hereby consent to the Tarwin River Improvement Trust borrowing at interest at the rate of Five pounds seven shillings and six pence per centum per annum the sum of Three thousand and eighty-five pounds (£3,085) for the conversion of Loan No. 3.

And the Honorable Thomas Anthony Darcy, Her Majesty's Minister of Water Supply for the State of Victoria, shall give the necessary directions herein accordingly.

J. COLQUHOUN,
Clerk of the Executive Council.

STATE RIVERS AND WATER SUPPLY COMMISSION.

At the Executive Council Chamber, Melbourne, the twenty-third day of March, 1965.

PRESENT:

His Excellency the Governor of Victoria.	
Mr. Rylah	Mr. Thompson
Mr. Reid	Mr. Porter
Mr. Mack	Mr. Meagher
Mr. Hamer	Mr. Balfour.
Mr. Dickie	

AMENDMENT OF ORDER.

UNDER the powers conferred by the *Sewerage Districts Act* and all other powers enabling him in that behalf, His Excellency the Governor of the State of Victoria, by and with the advice of the Executive Council of the said State, doth hereby amend as follows the Order in Council

made on 27th October, 1964, and published in the *Victoria Government Gazette* of 28th October, 1964, appointing certain persons to audit and report upon the accounts of Sewerage Authorities for the years 1964 and 1965.

For the expression "Yarram, 31st December, 1964, L. R. Shepherd, 540 Little Collins-street, Melbourne", there shall be substituted the expression "Yarram, 30th September, 1964, L. R. Shepherd, 540 Little Collins-street, Melbourne".

And the Honorable Thomas Anthony Darcy, Her Majesty's Minister of Water Supply for the State of Victoria, shall give the necessary directions herein accordingly.

J. COLQUHOUN,
Clerk of the Executive Council.

APPROACHING LAND SALES.

SALES of Crown lands, in fee-simple, will be held at the under-mentioned places and dates, viz.:—

	No. of Gazette.
Echuca.—Wednesday, 21st April, 1965	15
Horsham.—Monday, 3rd May, 1965	19
Seymour.—Friday, 26th March, 1965	11

SALE OF CROWN LAND BY AUCTION.

The land will be offered for sale in fee-simple, and subject to the provisions of the Land Act and Regulations thereunder.

The upset price is the sum at which bidding will start, and no bid below that sum can be accepted. The highest bidder at or above that sum shall be the purchaser, subject to signature of contract and any necessary payment.

TERMS:

A deposit of at least 12½% of the purchase price must be paid at the sale, either in cash or by cheque.

The residue is payable in half-yearly instalments, in accordance with the following scale, or may be paid off at any earlier time.

Over £50, and not exceeding £100, 10 instalments.
Over £100, and not exceeding £200, 12 instalments.
Over £200, and not exceeding £300, 14 instalments.
Over £300, and not exceeding £400, 16 instalments.
Over £400, and not exceeding £500, 18 instalments.
Over £500, 20 instalments.

Interest at the rate of 5% per annum is payable with all payments of residue, and is computed for each instalment from the date of sale to the date of such payment. Additional interest is charged if any instalment is not paid on or before the due date.

If paid off within 30 days of sale, no interest is payable.

FEES, ETC.:

Also payable at the sale, in addition to the deposit, are the survey fee and, if applicable, the valuation of improvements (if purchaser be not the owner thereof).

Payable with balance of purchase money—

Crown Grant fee—50 acres and under	£1 10s.
Over 50 acres	£2
Purchase money £5 or under	£1

Assurance Fund contribution.—One halfpenny for each £1 of purchase price. (This is a fund established to guarantee the validity of freehold titles.)

Transfer of interest prior to completion of payment may be allowed on payment of £1 fee and subject to stamp duty.

If unable to attend personally, a prospective purchaser may arrange for another person to bid as his agent.

Attention is drawn to section 95, Land Act 1958, which provides that the purchaser shall be deemed to be the owner for the purposes of other Acts; also to an amendment to the Local Government Act providing for Government roads in certain circumstances, to be declared "private streets" thus making the purchaser liable to contribute to the cost of street construction.

J. C. M. BALFOUR,
Minister of Lands.

Office of Crown Lands and Survey,
Melbourne, 24th March, 1965.

HORSHAM.—Sale (No. 11775) of Crown land in fee-simple, by auction, will be held at the LAND OFFICE, MCLACHLAN-STREET, HORSHAM, on MONDAY, the 3rd MAY, 1965, at ELEVEN o'clock a.m. To be conducted by E. M. FLOYD, Land Officer, Horsham.

Lot 1.

PARISH OF GYMBOWEN, COUNTY OF LOWAN.

Fronting the south side of a Government road about 2½ miles south-east of the Gymbowen railway station.

Upset price £726 the lot. Survey fee £36 6s.

Area 725a. 3r., allotment 108.

Valuation of improvements £5,360 (buildings, fencing, land development, &c.) (D. R. Finlayson).—(M.60429.)

Lot 2.

PARISH OF MORTAT, COUNTY OF LOWAN.

About 8 miles west of Goroke.

Upset price £200 the lot. Survey fee £30 2s. 6d.

Area 130 acres, subject to survey, allotments 18B, 18C and 18D.—(M.44631.)

PROPOSED PERMANENT RESERVATIONS OF LANDS AS SITES.

IN pursuance of the provisions of the Land Act 1958, notice is hereby given that it is the intention of the Governor in Council to permanently reserve as sites the lands hereunder referred to:—

The following Notices were published 1° on the 3rd March, 1965, pursuant to Orders of the 24th February, 1965.

CHILTERN.—Land proposed to be permanently reserved as a site for a Racecourse, also excepted from occupation for mining purposes under any miner's right, 109 acres 2 roods 20 perches, Township of Chiltern, Parish of Chiltern, County of Bogong, being the sites temporarily reserved therefor by Orders in Council of the 6th August, 1894, 11th February, 1897, and 17th April, 1924.—(C.225⁽⁸⁾) (Rs.2437).

CHILTERN WEST.—Land proposed to be permanently reserved as a site for Public Recreation, also excepted from occupation for mining purposes under any miner's right, 2 acres 2 roods 31 perches, Parish of Chiltern West, County of Bogong, being the site temporarily reserved therefor by Order in Council of the 14th May, 1957, and known as the Chiltern Valley Recreation Reserve.—(C.381⁽⁹⁾) (Rs.7570).

KYABRAM EAST (MERRIGUM).—Land proposed to be permanently reserved as a site for Public Park and Recreation, also excepted from occupation for mining purposes under any miner's right, 10 acres 3 roods 6 perches, Parish of Kyabram East, County of Rodney, being the site temporarily reserved therefor by Order in Council of the 23rd October, 1962, and known as Merrigum Park.—(K.115⁽⁹⁾) (Rs.8165).

MOOROOPNA (ARDMONA).—Land proposed to be permanently reserved as a site for Public Recreation, also excepted from occupation for mining purposes under any miner's right, 14 acres 3 roods 10 perches, Parish of Mooroopna, County of Rodney, being the site temporarily reserved therefor by Order in Council of the 7th June, 1949, and known as the Ardmona Recreation Reserve.—(M.458⁽¹⁰⁾) (Rs.6350).

TATURA.—Land proposed to be permanently reserved as a site for Public Gardens and Public Recreation, also excepted from occupation for mining purposes under any miner's right, 8 acres 2 roods 33 6/10 perches, Township of Tatura, Parish of Toolamba West, County of Rodney, being the remaining portion of the site temporarily reserved for Public Gardens by Order in Council of the 21st October, 1889, and temporarily reserved for the additional purpose of Public Recreation by Order in Council of the 21st June, 1949.—(T.252⁽⁹⁾) (Rs.651).

TATURA.—Land proposed to be permanently reserved as a site for Show Yards and Public Recreation, also excepted from occupation for mining purposes under any miner's right, 24 acres 3 roods 9 perches, Township of Tatura, Parish of Toolamba West, County of Rodney, being the site temporarily reserved therefor by Order in Council of the 21st July, 1959.—(T.252⁽⁹⁾) (Rs.1111).

J. C. M. BALFOUR,
Commissioner of Crown Lands and Survey.

PROPOSED PERMANENT RESERVATION OF LAND AS A SITE.

IN pursuance of the provisions of the Land Act 1958, notice is hereby given that it is the intention of the Governor in Council to permanently reserve as a site the land hereunder referred to:—

The following Notice was published 1° on the 24th March, 1965, pursuant to Order of the 23rd March, 1965.

COLQUHOUN EAST (LAKE TYERS).—Land proposed to be permanently reserved as a site for the use of Aborigines, also excepted from occupation for mining purposes under any miner's right, 4,000 acres 2 roods 11 perches of land in the Parish of Colquhoun East (Lake Tyers), County of Tambo, being the sites temporarily reserved therefor by Orders in Council of the 4th May, 1863, and the 3rd November, 1879.—(C.383⁽¹⁾) (Rs.8279).

J. C. M. BALFOUR,
Minister of Lands.

LOCAL LAND BOARDS.

IN pursuance of the provisions of section 34 of the Land Act 1958, notice is hereby given that public hearings at the following places and times, will be conducted by the persons respectively mentioned, being duly appointed in that behalf.

J. C. M. BALFOUR,
Minister of Lands.

Department of Crown Lands and Survey,
Melbourne.

SCHEDULE.

TONGALA LAND INSPECTOR'S OFFICE, Monday, 5th April, 1965, at 11.00 a.m., Tuesday, 6th, Wednesday, 7th, Thursday, 8th, and Friday 9th, April, 1965, at 9.00 a.m. each day.—G. E. Harpin and D. O'Connor.

Land Act 1958.

PERMIT CANCELLED.

NOTICE is hereby given that the Permit mentioned in the Schedule hereunder has been cancelled.

District.	Corr. No.	Name of Permit Holder.	Parish.	Allotment.	Section.	Area.
Beechworth ..	9/155	Ronald Patrick Bryant ..	Everton	9	8	A. R. P. 603 1 16

Department of Crown Lands and Survey,
Melbourne, 22nd March, 1965.

J. C. M. BALFOUR,
Minister of Lands.

PROPOSED REVOCATIONS OF TEMPORARY RESERVATIONS OF LANDS BY ORDERS IN COUNCIL

IN pursuance of the provisions of the Land Act 1958, notice is hereby given that it is the intention of the Governor in Council to revoke the temporary reservations of lands by Orders in Council hereunder referred to, viz.:—

The following Notices were published 1° on the 17th March, 1965, pursuant to Orders of the 10th March, 1965.

HEYTESBURY.—The temporary reservation, by Order in Council of the 18th August, 1873 (see Government Gazette of the 22nd August, 1873, page 1497) of certain land in the County of Heytesbury together with the adjacent islands as a site for Public purposes, revoked as to part by various Orders is about to be revoked so far only as the following portions are concerned:—(1) The portion within the Parish of Narrawaturk eastward from the mouth of Curdies Inlet together with the adjacent islands. (2) The portions within the Parishes of Paaratte and Waarre together with the adjacent islands. (3) The remaining portion within the Township of Port Campbell together with the adjacent islands.—(N.94⁽⁴⁾) (P.147⁽²⁾) (P.160^(A11)) (W.360⁽⁵⁾) (Rs.2362).

MALDON.—The temporary reservation, by Order in Council of the 25th August, 1873, (see Government Gazette of the 29th August, 1873, page 1540), of 1 acre 3 roods 12 perches of land in the Township of Maldon as a site for State School purposes and the temporary reservation by Order in Council of the 22nd March, 1875 (see Government Gazette of the 25th March, 1875, page 606) of 3 roods 19 perches of land as an extension thereto are about to be revoked.—(M.449⁽¹²⁾) (C.85813).

MALDON.—The temporary reservation by Order in Council of the 11th November, 1868, of 3 acres 14 perches of land in the Township of Maldon as a site for Public Gardens revoked as to part by Order of the 20th November, 1957, is about to be revoked so far as the balance thereof containing 2 acres 3 roods 32 perches more or less is concerned.—(M.449⁽¹²⁾) (Rs.3677).

MALDON.—The temporary reservation, by Order in Council of the 18th December, 1930, of 2 acres 31 perches of land in the Township of Maldon as a site for Public purposes is about to be revoked.—(M.449⁽¹²⁾) (Rs.4066).

PORT CAMPBELL.—The temporary reservation, by Order in Council of the 20th January, 1898, of 6 acres more or less of land in the Township of Port Campbell as a site for a Public Park is about to be revoked so far only as

the portion containing 4 acres 2 roods 30 perches more or less, indicated by hachure on plan hereunder, is concerned.—(P.147⁽²⁾) (Rs.991).

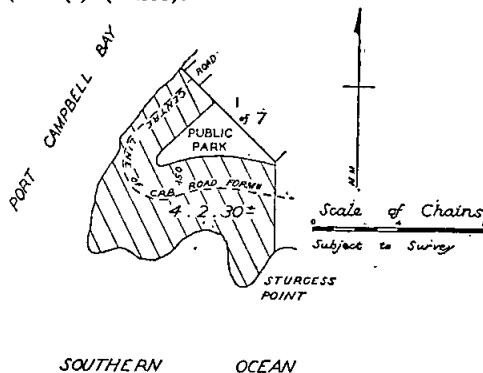

PORT CAMPBELL.—The temporary reservation, by Order in Council of the 27th August, 1894, of 4 acres 1 rood 32 perches of land in the Township of Port Campbell, as a site for Public Recreation.—(P.147⁽²⁾) (Rs.2226).

PORT CAMPBELL.—The temporary reservation, by Order in Council of the 14th May, 1913, of 34 acres of land in the Township of Port Campbell as a site for Public purposes is about to be revoked so far only as the portion containing 25 acres 1 rood more or less, indicated by hachure on plan hereunder, is concerned.—(P.147⁽²⁾) (Rs.2283).

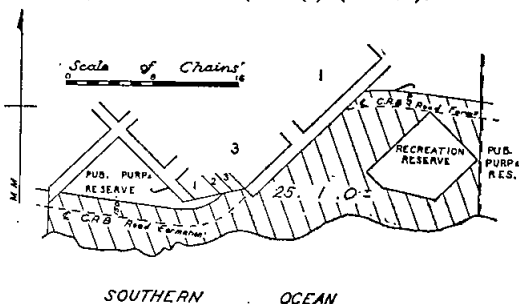

PORT CAMPBELL.—The temporary reservation, by Order in Council of the 24th August, 1909, of 36 acres more or less of land in the Township of Port Campbell as a site for Public purposes, revoked as to part by various Orders is about to be revoked so far only as the portion containing 26 acres 3 roods 10 perches more or less, indicated by hachure on plan hereunder, is concerned.—(P.147⁽²⁾) (Rs.2308).

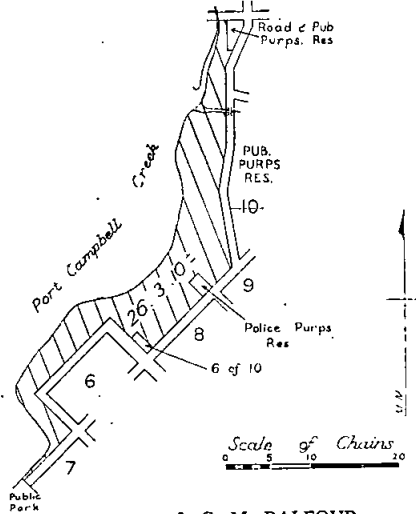

J. C. M. BALFOUR,
Commissioner of Crown Lands and Survey.

PROPOSED REVOCATIONS OF TEMPORARY RESERVATIONS OF LANDS BY ORDERS IN COUNCIL.

IN pursuance of the provisions of the Land Act 1958, notice is hereby given that it is the intention of the Governor in Council to revoke the temporary reservations of lands by Orders in Council hereunder referred to, viz.:

The following Notices were published 1^o on the 3rd March, 1965, pursuant to Orders of the 24th February, 1965.

OAKLEIGH.—The temporary reservation, by Order in Council of the 2nd December, 1947, of 1 acre 17 7/10 perches of land in the Township of Oakleigh (City of Oakleigh) as a site for Public Park and Recreation, is about to be revoked so far only as the portion containing 10 perches indicated by hachure on plan hereunder is concerned.—(O.1⁽²⁾) (Rs.1121).

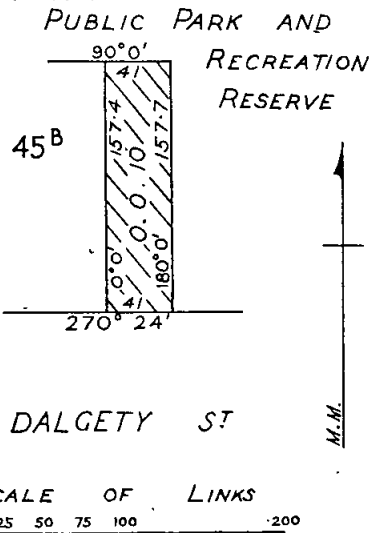

J. C. M. BALFOUR,
Commissioner of Crown Lands and Survey.

ROKEWOOD.—The temporary reservation, by Order in Council of the 12th January, 1872, of 26 acres 2 roods, more or less, of land in the Township of Rokewood, as a site for a Public Garden.—(R.51⁽²⁾) (Rs.7199).

PROPOSED REVOCATIONS OF TEMPORARY RESERVATIONS OF LANDS BY ORDERS IN COUNCIL.

IN pursuance of the provisions of the Land Act 1958, notice is hereby given that it is the intention of the Governor in Council to revoke the temporary reservations of lands by Orders in Council hereunder referred to, viz.:

The following Notices were published 1^o on the 10th March, 1965, pursuant to Orders of the 2nd March, 1965.

BRALAK.—The temporary reservation, by Order in Council of the 28th January, 1905, of 9 acres 2 roods 0 perches of land in the Parish of Maramingo, now Bralak, as a site for a Cemetery, revoked as to part by Order of the 27th August, 1918, is about to be revoked so far only as the portion containing 1 acre 1 rood 30 perches, indicated by hachure on plan hereunder, is concerned.—(M.547⁽²⁾) (Rs.8315).

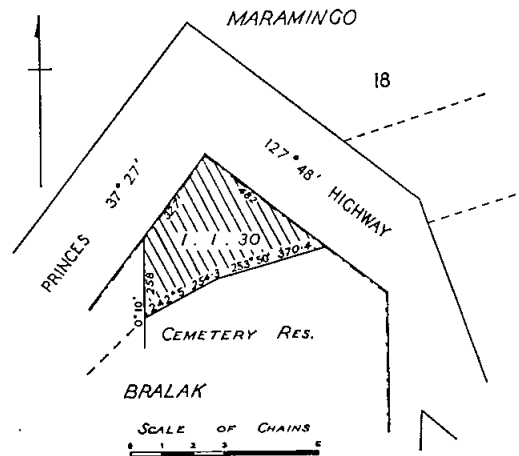

BULGA.—The temporary reservation, by Order in Council of the 29th July, 1947, of 175 acres 2 roods 10 perches of land in the Parish of Bulga, as a site for a Timber Reserve.—(B.714⁽⁸⁾) (Rs.5998).

MIRBOO SOUTH.—The temporary reservation, by Order in Council of the 29th July, 1947, of 128 acres 2 roods 4 perches of land in the Parish of Mirboo South as a site for a Timber Reserve, revoked as to part by Order of the 11th April, 1962, is about to be revoked so far as the balance thereof containing 72 acres 2 roods 4 perches more or less, is concerned.—(M.517⁽¹⁰⁾) (Rs.5997).

MIRBOO SOUTH.—The temporary reservation, by Order in Council of the 29th July, 1947, of 129 acres 0 roods 11 perches of land in the Parish of Mirboo South as a site for a Timber Reserve.—(M.517⁽¹⁰⁾) (Rs.5999).

MULCRA.—The temporary reservation by Order in Council of the 2nd July, 1923, of 2 acres of land in the Parish of Mulcra as a site for a Public Hall, revoked as to part by Order of the 22nd of July, 1930, is about to be revoked so far as the balance thereof containing 1 acre is concerned.—(M.576⁽⁴⁾) (Rs.2774).

PENSHURST.—The temporary reservation, by Order in Council of the 16th July, 1873 (see Government Gazette of the 25th July, 1873, page 1318), of 1 acre 2 roods 0 perches of land in the Township of Peshurst, as a site for State School purposes.—(P.29^(*)) (C.99631).

REDCASTLE.—The temporary reservation, by Order in Council of the 23rd August, 1927, of 3 acres 3 roods 19 perches of land in the Parish of Redcastle, as a site for a State School.—(R.16^(E1)) (Rs.3533).

WONYIP.—The temporary reservation, by Order in Council of the 29th July, 1947, of 355 acres 2 roods 0 perches of land in the Parish of Wonyip, as a site for a Timber Reserve.—(W.369^(*)) (Rs.5996).

WONYIP.—The temporary reservation, by Order in Council of the 29th July, 1947, of 152 acres 0 roods 14 perches of land in the Parish of Wonyip, as a site for a Timber Reserve.—(W.369^(*)) (Rs.6001).

J. C. M. BALFOUR,
Commissioner of Crown Lands and Survey.

PROPOSED REVOCATION OF TEMPORARY RESERVATION, AND THE WITHHOLDING FROM SALE, LEASING, AND LICENSING OF LAND BY ORDER IN COUNCIL.

IN pursuance of the provisions of the Land Act 1958, notice is hereby given that it is the intention of the Governor in Council to revoke the temporary reservation, and the withholding from sale, leasing and licensing of land by Order in Council hereunder referred to, viz.:—

The following Notice was published 1° on the 10th March, 1965, pursuant to Order of the 2nd March, 1965.

WAGGARANDALL.—The temporary reservation as a site for Water Supply purposes and the withholding from sale, leasing and licensing by Order in Council of 24th July, 1882, of 113 acres 0 roods 19 perches of land in the Parish of Waggarandall, revoked as to part by various Orders, are about to be revoked so far only as the portion containing 1 acre 2 roods 30 perches, indicated by hachure on plan hereunder, is concerned.—(W.303⁽⁹⁾) (Rs.4012).

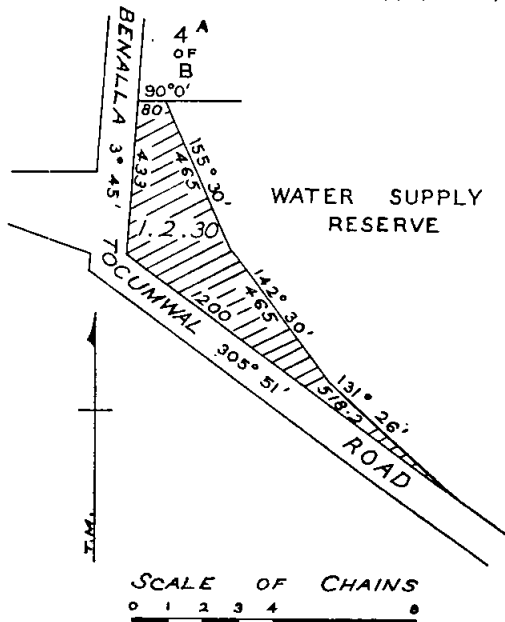

J. C. M. BALFOUR,
Commissioner of Crown Lands and Survey.

PROPOSED REVOCATIONS OF TEMPORARY RESERVATIONS, AND THE WITHHOLDING FROM SALE, LEASING, AND LICENSING OF LANDS BY ORDERS IN COUNCIL.

IN pursuance of the provisions of the Land Act 1958, notice is hereby given that it is the intention of the Governor in Council to revoke the temporary reservations, and the withholding from sale, leasing and licensing of lands by Orders in Council hereunder referred to, viz.:—

The following Notices were published 1° on the 17th March, 1965, pursuant to Orders of the 10th March, 1965.

MALDON.—The temporary reservation as a site for Public purposes and the withholding from sale, leasing and licensing by Order in Council of the 14th May, 1878 (see Government Gazette of the 17th May, 1878, page 1124) of 2 roods 26 perches of land in the Township of Maldon.—(M.449⁽¹²⁾) (C.85813).

MALDON.—The temporary reservation as a site for Public Recreation and the withholding from sale, leasing and licensing by Order in Council of the 14th May, 1878, of 3 acres 2 roods 5 perches of land in the Township of Maldon.—(M.449⁽¹²⁾) (Rs.3677).

MALDON.—The temporary reservation as a site for Police purposes and the withholding from sale, leasing and licensing by Order in Council of the 14th May, 1878, of 5 acres 23 perches of land in the Township of Maldon, revoked as to part by Order of the 18th December, 1930, are about to be revoked so far as the balance thereof containing 2 acres 3 roods 32 perches, is concerned.—(M.449⁽¹²⁾) (Rs.4065).

J. C. M. BALFOUR,
Commissioner of Crown Lands and Survey.

COMMON ABOUT TO BE DIMINISHED.

IN pursuance of the provisions contained in the Land Act 1958, notice is hereby given that it is the intention of the Governor in Council to diminish the common herein-after mentioned, viz.:—

The following Notice was published 1° on the 3rd March, 1965, pursuant to Order of the 24th February, 1965.

The Rokewood Common, proclaimed as such on the 14th July, 1890, and the 6th August, 1903, is about to be diminished by the excision therefrom of the land in the Township of Rokewood temporarily reserved as a site for a Rubbish Depot by Order in Council of the 26th August, 1940, and containing 1 rood 25 1/10 perches.—(Rs.503.)

J. C. M. BALFOUR,
Commissioner of Crown Lands and Survey.

PROPOSED PERMANENT RESERVATIONS OF LANDS AS SITES.

IN pursuance of the provisions of the Land Act 1958, notice is hereby given that it is the intention of the Governor in Council to permanently reserve as sites the lands hereunder referred to:—

The following Notices were published 1° on the 10th March, 1965, pursuant to Orders of the 2nd March, 1965.

BARNAWARTHA NORTH.—Land proposed to be permanently reserved as a site for Camping and Watering purposes, also excepted from occupation for mining purposes under any miner's right, 12 acres 1 rood 3 perches, Parish of Barnawartha North, County of Bogong, being the remaining portion of the site temporarily reserved therefor by Order in Council of the 23rd March, 1886.—(B.56⁽⁹⁾) (Rs.324).

BARRARBOOL.—Land proposed to be permanently reserved as a site for Public Park and Gardens, also excepted from occupation for mining purposes under any miner's right, 102 acres 1 rood 20 perches more or less, Parish of Barrarbool, County of Grant, as indicated by hachure on plan hereunder.—(B.34⁽⁹⁾) (Rs.2131).

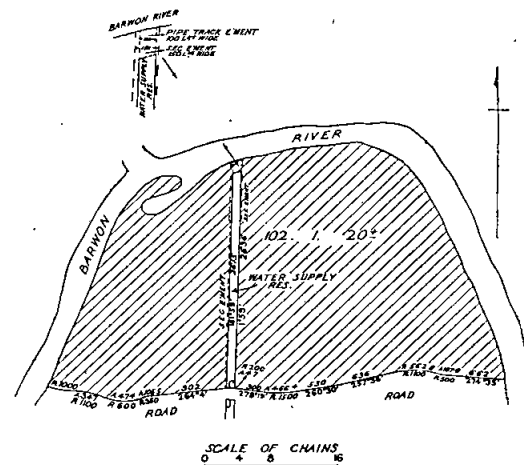

J. C. M. BALFOUR,
Commissioner of Crown Lands and Survey.

TENDERS—PUBLIC WORKS DEPARTMENT

TENDERS will be received at the Head Office of the Public Works Department, Treasury-place, Melbourne, until TEN a.m. on the dates shown and for the purposes mentioned hereunder.

Particulars and tender forms may be obtained at the Contracts Office, Room 7, Building Division, Parliament-place, and at the places indicated in brackets after certain items.

The abbreviations shown in the brackets mean the following:—W.O.—Inspector of Works Office; P.S.—Police Station; C.S.—Consolidated School; H.E.S.—Higher Elementary School; H.S.—High School; S.S.—State School; T.S.—Technical School.

Tenders should be submitted on the Department's printed Tender Form and will not be received by telephone. All tenders must be on a "Firm Tender" basis. The lowest or any tender will not necessarily be accepted.

Tenders are to be addressed to the Minister of Public Works, and the envelopes containing the tender is to be clearly marked "Tender for _____, closing Tuesday, _____".

No preliminary deposit is to be lodged with any tender, but a successful tenderer will be required to pay a deposit for any accepted tender of the value of £1,500 or over.

Tuesday, 30th March, 1965.

Building, Electrical and Mechanical Works.

Brown Hill.—Repairs and painting, Police Station and residence. (W.O., Ballarat.)

Brunswick.—Alternative water supply, additional drinking and washing facilities, Girls' Secondary School.

Carlton.—Conversion of former Pathology Laboratories to two residences, St. Nicholas Hospital.

Carlton.—Electrical installation in two residences, St. Nicholas Hospital.

Charlton.—Erection of type 300 High School in concrete tile veneer, L.T.C. (W.O., Ballarat and Bendigo.)

Coburg.—Supply, delivery, installation and testing of steam, condensate, hot water, fuel oil and ventilation services for the new kitchen and bakery, Pentridge Gaol.

Dimboola.—Additional sanitary accommodation, High School. (W.O., Warracknabeal; H.S., Dimboola.)

Fairway.—Party fencing, S.S. 4830.

Healesville.—Renovations to houses 1, 2, 3 and out-buildings, Potato Research Station. (Potato Research Station, Healesville.)

Kerang.—New water service, repairs and painting, Court House. (W.O., Swan Hill; P.S., Kerang.)

Kyabram.—Repairs and painting, Court House. (W.O., Shepparton; P.S., Kyabram.)

Leongatha.—Alterations to Boiler Room, mechanical equipment, High School. (W.O., Korumburra, Traralgon and Warragul.)

Mansfield.—Erection of brick veneer residence for Clerk of Courts. (W.O., Alexandra; P.S., Mansfield and Seymour.)

Melbourne.—Provision of exit door, steel ramp, emergency showers and steel hoist, Explosives Branch.

Melbourne.—New air-conditioning system in Radio-Carbon Laboratory, Institute of Applied Science, 304 Swanston-street.

Mt. Macedon.—Erection of a shelter pavilion, Memorial Cross Reserve. (W.O., Bendigo and Kyneton.)

Sandringham East.—Electrical installation for L.T.C. extensions, &c., S.S. 4429.

Wareek.—Erection of out-offices and installation of septic tank, S.S. 1419. (W.O., Maryborough; S.S., Wareek.)

Yarram.—Erection of a ten class-room, brick veneer Primary School, S.S. 693. (W.O., Traralgon.)

Site Works.

Upper Fern Tree Gully.—Earthwork, drainage (surface and underground) and paving for new S.S. 3926.

Miscellaneous.

Maryborough.—Supply of Rockwell testing machine and heat treatment equipment, Technical College. (W.O., Maryborough.)

North Melbourne.—Melbourne School of Printing and Graphic Arts—

- (1) Supply and delivery of stereo and electrotyping machinery.
- (2) Supply and delivery of Letterpress printing machinery.
- (3) Supply and delivery of lithographic printing and plate making machinery.
- (4) Supply and delivery of photo-engraving equipment.
- (5) Supply and delivery of flexographic printing machines and equipment.
- (6) Supply and delivery of cameras and accessories.
- (7) Supply of hand composing equipment.

(8) Supply and delivery of linotype machinery and equipment.

(9) Supply and delivery of bookbinding and paper-ruling equipment.

(10) Supply and delivery of screen printing machine.

Tuesday, 6th April, 1965.

Building, Electrical and Mechanical Works.

Ararat.—Electrical installation, Gaol. (W.O., Ararat and Ballarat.)

Ararat.—Mechanical services and supply and installation of laundry equipment, Gaol. (W.O., Ballarat.)

Ararat.—Supply, delivery, installation and testing of refrigeration plant in kitchen cool rooms, Gaol. (W.O., Ararat and Ballarat.)

Box Hill South.—Erection of non-party fencing and gates, S.S. 4138.

Carlton.—Demolition of portion of former Out-patients Clinic, St. Nicholas Hospital.

Carlton.—Alterations and additions to heating services, Melbourne Teachers College Hostel.

Charlton.—Electrical installation in new type "300" High School. (W.O., Bendigo and Maryborough; P.S., Charlton.)

Charlton.—Supply and installation of heating and hot-water services, L.P. gas system and fresh water pump in new "300" type High School. (W.O., Bendigo.)

Cobram.—Provide additional room, new porch, repairs and painting, Police Station. (W.O., Benalla; P.S., Cobram.)

Coburg.—Electrical installation for main kitchen and bread bakery, Pentridge Gaol.

Frankston.—Supply and installation of new boiler and extension of heating system, S.S. 1464.

Gonn Crossing.—Toilet block, septic tank installation, S.S. 4566 and residence. (W.O., Swan Hill and S.S., Gonn Crossing.)

Horsham.—Extension of heating to two additional classrooms and rest room, High School. (W.O., Horsham.)

Irrewillipe.—Erection of out-offices and installation of septic tank, S.S. 1039. (W.O., Camperdown; S.S., Irrewillipe.)

Kyabram.—Erection of non-party fencing, High School. (W.O., Shepparton; H.S., Kyabram.)

Mentone.—New brick storeroom and repairs and painting, S.S. 2950.

Mordialloc.—Erection of second story, timber extension over existing Police Station.

Parkville.—Brick and concrete fencing, new entrance, &c., University High School.

Royal Park.—Extension to Library building in light timber construction, external and internal renovations to existing L.T.C. building, including plumbing installation, &c., Receiving House.

Stawell.—Erection of additional class-rooms in concrete veneer, High School. (W.O., Ballarat and Ararat; H.S., Stawell.)

Sunbury.—Erection of new piggery, Mental Hospital.

Various.—Erection of additional class-rooms to five timber-framed Primary Schools at Clayton, Bulleen, Heatherdale, Greenslopes and Rosanna Golf Links.

Various.—Erection of 69 timber class-rooms, staff rooms and stores in 26 sub-district contracts, comprising from one to twelve class-rooms, Schools. (W.O., Alexandra, Ararat, Ballarat, Bairnsdale, Benalla, Bendigo, Geelong, Horsham, Shepparton, Swan Hill, Traralgon, Warracknabeal and Warragul.)

Yarram.—Electrical installation in new building of ten (10) L.T.C. class-rooms, &c., S.S. 693. (W.O., Bairnsdale and Traralgon; P.S., Yarram.)

Yarram.—Supply and installation of plenum heating in new ten (10) class-rooms, S.S. 693. (W.O., Traralgon.)

Site Works.

Doveton West.—Site works, including asphalt paving, concrete works, drainage, &c., S.S. 4820.

Malmsbury.—Grading and sealing existing gravel roads, provision of kerb and channel and associated works, Youth Training Centre. (W.O., Bendigo and Kyneton.)

Terang.—Construction of asphalt paving, asphalt repairs, concrete paving, and drainage works, S.S. 617. (W.O., Camperdown and Warrnambool.)

Various (Mount Beauty-Tawonga).—Surface and under-ground drainage, concrete and sealed gravel pavements at Mount Beauty H.S., Mount Beauty S.S. 4644, Tawonga S.S. 2282, Mount Beauty H.S. residences (2 No.), and Mount Beauty P.S. (W.O., Wangaratta; H.S. Mount Beauty.)

Williamstown.—Earthworks, asphaltting, concreting, drainage and associated works, Technical School.

Miscellaneous.

Dookie.—Supply of fencing wire, Agricultural College.

Tuesday, 13th April, 1965.

Building, Electrical and Mechanical Works.

Ballarat.—Erection of shelter pavilion in brickwork, S.S. 1256. (W.O., Ballarat.)

Beaumaris.—Connexion to sewerage, High School.

Brunswick.—Additional toilets and drinking troughs, S.S. 1213.

Coburg.—Supply and installation of refrigeration system for new kitchen and bakery, Pentridge Gaol.

Cornish Town.—Demolition and removal of old timber residence, S.S. 802. (W.O., Wangaratta.)

Lake Meran.—New shelter pavilion, tank, repairs and painting, S.S. 3564. (W.O., Swan Hill; S.S., Lake Meran.)

Melbourne.—Renewal of roofs and gutters, external renovations, including sewerage plumbing, "Milton House", Health Department.

Mildura.—Repairs to walls, &c., Police Station. (W.O., Mildura.)

Moonee Ponds.—Enclosing balcony, repairs and painting, Central School 3987.

Moorabbin.—Erection of new fencing, High School.

Preston.—Supply and installation of central heating system and hot-water services, "Pleasant View", Psychiatric Hospital.

Preston.—Supply and installation of boiler room equipment and associated mechanical services, Technical School.

Watsonia.—Supply and installation of exhaust systems, oxy-welding equipment and extensions to heating and hot-water services, Technical School.

Werribee.—Erection of brick two-story dormitory and flat, Research Farm.

Wodonga.—Erection of first stage single-story Court House and for two-story Police Station with two attached residences. (W.O., Wangaratta; P.S., Wangaratta.)

Wodonga.—Electrical installation, Court House and Police Station. (W.O., Wangaratta.)

Site Works.

Noble Park.—Earthworks, asphaltting, concreting, graveling, drainage and associated works, S.S. 3675.

Tongala.—Construction of asphalt and concrete paving, drainage, fire service, beautification and associated works, Consolidated School. (W.O., Bendigo and Shepparton.)

Miscellaneous.

Coburg.—Supply, delivery and placing in position of baking equipment for Pentridge Gaol Bakery.

Various.—Supply of woodworking machines, 1st July, 1965, to 30th June, 1966, Schools and other Government buildings.

Various.—Supply of centre lathes and equipment, period 1st July, 1965, to 30th June, 1966, Schools and other Government buildings.

Various.—Supply of sheet-metal machines, period 1st July, 1965, to 30th June, 1966, Schools and other Government buildings.

Tuesday, 27th April, 1965.

Building, Electrical and Mechanical Works.

Melbourne.—Erection of a new toilet block, State Library, National Gallery and Museum.

Parkville.—Re-surface two concrete stairs, University High School.

South Melbourne.—Erection of two shelter sheds, including demolition of existing sheds, S.S. 1852.

M. V. PORTER,
Minister of Public Works.

Public Works Department,
Melbourne, C.2, 22nd March, 1965.

TENDERS FOR THE SERVICE, 1964-65.

PROVISIONS.

TENDERS will be received until Eleven o'clock a.m., on Friday, 30th April, 1965, from persons willing to furnish the under-mentioned supplies, in such quantities as may be ordered by the Victorian Government—delivery to be made at the under-mentioned places—during the period from 1st July, 1965, to 30th June, 1966.

The prices tendered must not include sales tax.

In all cases, the total cost of each item must be extended in the columns provided.

The places for which tenders will be received and the security required for the due fulfilment of each contract, are as follows:—

PROVISIONS.

	Security.
Schedule No. 1.	
Bread—	£
Kew Mental Hospital ..	75
Children's Cottages, Kew	50
Children's Welfare Depot,	
Royal Park; Psychiatric	
Hospital, Royal Park;	
Travancore Developmental	
Centre, Flemington ..	30
"Winlaton" Juvenile	
School, 186 Springvale-	
road, Nunawading and	
"Allambie" Reception	
Centre, 70 Elgar-road,	
Burwood	5
Teachers' College, Grattan-	
street, Carlton; Teachers'	
College Hostels, 93 Drum-	
mond-street, Carlton, 470,	
481, and 572 St. Kilda-	
road, Melbourne, 19	
Queen's-road, Melbourne,	
152 Toorak-road, West,	
South Yarra; Frank Tate	
House, 373 Dandenong-	
road, Armadale;	
"Redcourt", No. 6,	
"Larnook", No. 10A	
and 13 Orrong-road,	
Armadale; 11 Patterson-	
street, Hawthorn; 174	
Punt-road, Prahran; 221	
Burwood-road, Burwood;	
John Cannon House, 32	
Belmont-avenue, Kew;	
17 Moule-avenue, Bright-	
on and Hastings-road,	
Frankston; Police Hospi-	
tal, St. Kilda-road,	
Melbourne; Mental	
Hygiene Clinic, 321	
Glenferrie-road, Malvern	20
Flour	90
Jams	20
Tea	150
Coffee	100
Schedule No. 2.	
Mont Park, Bundoora, Breadstuffs	190
Larundel, Janefield, Jams	23
Gresswell, and Meat—Mont Park	35
Pleasant View, Wood- Meat—Preston	5
street, Preston Meat—Gresswell	15
Schedule No. 5.	
Heatherton Sanator- Bread	15
ium, Cheltenham Milk	20
Schedule No. 6.	
Ararat District Breadstuffs	75
Schedule No. 7.	
Ballarat District Breadstuffs	100
Milk—Mental Hospital and Teachers' Hostels ..	30

PROVISIONS—continued.

		Security.
Schedule No. 8.	Breadstuffs	£ 100
Beechworth District ..	Milk	12
Schedule No. 9.	Bread	14
Bendigo District ..	Milk—Sandhurst Boys' Centre ..	5
	.. Teachers' Hostels ..	5
Schedule No. 10.	Bread	5
Castlemaine District ..		
Schedule No. 11.	Breadstuffs	3
School of Forestry, ..	Milk	3
Croswick		
Schedule No. 12.	Breadstuffs	15
Agricultural College, ..		
Dookie		
Schedule No. 13.	Bread	12
McLeod Settlement, ..		
French Island		
Schedule No. 14.	Bread	30
Geelong District ..		
Schedule No. 15.	Bread	3
Coorimunglee Prison ..		
Camp, Heytesbury ..		
Forest		
Schedule No. 16.	Breadstuffs	25
Aboriginal Station, ..		
Lake Tyers		
Schedule No. 17.	Bread	3
Langi Kal Kal Training ..		
Centre		
Schedule No. 18.	Breadstuffs	5
Agricultural College, ..		
Longerenong		
Schedule No. 19.	Bread	3
Research Station, ..		
Rutherglen		
Schedule No. 20.	Bread	3
Sale Gaol ..		
Schedule No. 21.	Breadstuffs	10
Pleasant Creek Special ..	Milk	5
School, Stawell		
Schedule No. 22.	Breadstuffs	112
Sunbury District ..	Jams	20
Schedule No. 23.	Breadstuffs	5
Warrnambool District ..	Milk	3
Schedule No. 24.	Breadstuffs	5
Hobson Park Hospital, ..	Milk	3
Traralgon District		

Printed forms of tender and the conditions of contract may, in all cases, be obtained from the Secretary to the Tender-Board, 107 Russell-street, Melbourne, by whom also any information or explanation will be afforded to persons tendering.

Security will be required either in Commonwealth Treasury Bonds, or approved bank guarantee, fixed deposit receipt, Savings Bank deposit book, or non-negotiable cheque in favour of the Secretary to the Tender Board, as the tenderer may elect.

The security must be completed and the contract signed within ten days of acceptance of the tender, failing which the service may be again advertised, or another tender accepted.

Preference will be given by the Tender Board to tenders for articles manufactured within the Commonwealth, provided the quality of such articles is satisfactory and the prices tendered are considered reasonable.

The lowest or any tender will not necessarily be accepted.

In the event of tenderers withdrawing or attempting to withdraw their tenders before notification of acceptance of same, or failing to take up their accepted tenders

within the prescribed period after notification of acceptance, they may be disqualified from tendering or holding any future contracts for Government supplies for a period of twelve months, such disqualification to date from the notification of acceptance of tender. It is also stipulated that, if a tenderer be a member of a firm and such firm be interested in the contract, the tender shall be in the name of the firm and not in that of the individual, and that, for a breach of this condition, the tender will be declared informal.

Tenders, enclosed in a separate envelope, and having the words "Tender for at" (as the case may be) written thereon, must be deposited in the Tender-box at the Tender Board Office, 107 Russell-street, Melbourne, or if sent by post, postage must be prepaid, and the tenders addressed to the Chairman of the Tender Board, Tender Board Offices, 107 Russell-street, Melbourne, C.1, which office they must reach not later than by first post on the date of closing of tenders.

CONDITIONS OF CONTRACT.

1. All the articles are to be of the best quality of the several kinds, in the best conditions, and in conformity with the Health Acts, and to be delivered in sound packages, free from all charges for cartage, freight, &c. The goods shall be delivered as may be directed by the officer ordering the supply.

2. As the exact quantity of any article which may be required cannot be stated, the estimate being approximate only, the Government will not be bound by the quantity stated in the Schedule, but will be at liberty to order more or less, according to circumstances, and the contractor will be bound to supply the same as ordered.

The Government reserves the right to purchase otherwise than from the contractor any of the articles specified in the Schedule in the event of an emergency.

3. Supplies for country districts for which no local contract may have been taken, or for which the contract has been terminated, may be ordered under the Melbourne contract.

4. The Melbourne District will include places within a radius of 12 miles from the Elizabeth-street Post Office with the exception of places for which separate contracts are provided; the Mont Park District will include the Mental Hospitals, Janefield Colony, the Sanatorium, Gresswell, and Pleasant View, Preston; the Ararat, Ballarat, Beechworth, Bendigo, Castlemaine, Geelong and Sunbury Districts will include Mental Hospitals, Penal Institutions and Teachers' Hostels at any of those places. Delivery must be made at the places, institutions, &c., named in the Schedules, or as directed by the officer ordering the supply.

5. Packages suitable for transport of goods supplied must be provided by the contractor free of expense, and the value of these packages, whether in bulk or otherwise, is to be included in the rate tendered, except butter boxes and soap boxes (not including fancy soaps), jam jars, flour, meal, and potato bags, which will remain the property of the contractor, and only the actual net weight or quantity received will be paid for; the empties to be removed from the place of delivery at the contractor's expense.

6. The meat supplied under these conditions must, if practicable, be slaughtered at abattoirs which are under authorized inspection and supervision. Any infringement of this condition will subject the contractor, on report from the Tender Board to such mulct, not exceeding Fifty pounds, as the Treasurer may direct, and the amount will be deducted from the contractor's account, or from the security money.

7. The supplies coming under the head of Rations and Medical Comforts are to be delivered direct to the establishment entitled thereto on the written order of the officer in charge. All other supplies will be ordered by the head of the Department concerned or any officer authorized by him, and shall be delivered as may be directed by the officer ordering the supply.

8. At the time of delivering the supplies, the contractor shall produce the order for the same to the officer authorized to accept delivery, and such officer shall acknowledge thereon the receipt of the stores accepted, and shall return the order to the contractor, who shall render his account as soon as possible after the delivery of the supplies, accompanied by the receipted delivery order. The rates or quantities quoted in the orders cannot be exceeded.

9. Where railway facilities are available, the contractor shall use the Railways for the transport of the goods. When a contractor is required to make delivery of goods at a railway station for transmission by rail, except for Commonwealth Departments, he shall obtain a receipt for

the goods in duplicate on the Stores and Transport consignment note at the same time handing in the triplicate and quadruplicate of the form as an authority for the Railways to act as agent for, and charge the freight to, the Stores and Transport Office. He shall as soon as possible, and not later than twenty-four hours thereafter, deliver at the Tender Board Offices the original, the duplicate to be forwarded to the consignees and the quintuplicate retained by himself. Should the goods thus forwarded be rejected, the contractor must bear the cost of replacing such goods, for which services the departmental consignment note is not to be used. Any infringement of this condition may subject the contractor to such mulct as the Tender Board may recommend under clause 18 of these conditions.

10. Orders must receive prompt execution; in the event of the goods not being delivered at the time mentioned in the order or within such other time as the officer ordering the supply may specify for delivery, it will be competent for such officer, or the head of the Department to whom the goods are to be supplied, on giving the contractor twenty-four hours' notice, to purchase the supplies, or any like supplies that are suitable for the service, at the contractor's risk, and the extra expense incurred over and above the contract price (if any) will be deducted from the contractor's account or from the security money.

11. The acceptance of the supplies shall be subject to the approval of the officer authorized to take delivery of the stores, or such other officer as shall be named in the conditions.

12. If the officer in charge of stores be not satisfied as to the quantity or quality of the stores, or if, after taking delivery of any stores or material, he shall discover any deficiency or defect therein, he may return such deficient or defective stores or material to the contractor, and shall report the same to the head of his department and to the Tender Board.

13. In the event of a difference of opinion between the contractor and the officer receiving the supplies as to the quality, the same is to be decided, in cases where the article is not of a perishable nature, by a Board of Survey composed of persons named by the Treasurer of the State for the time being; and the decision of the Board is to be considered final. In the event of the decision being against the contractor, the survey fees and expenses (if any) will be deducted as in clause 10.

14. In cases where the article is of a perishable nature, or when from some other cause injury would be sustained either by the person to whom the rations or stores are due or by the contractor in waiting for a Board to survey, the head of the Department or officer authorized to take delivery will have power to reject such article or articles as are, obviously of inferior quality, it being understood that he will be responsible to the Government for so doing, and that the contractor must take back the rejected article and supply good in its stead; failing which it, or any like supply suitable for the Service, will be obtained by the officer requiring it as in clause 10. In case of the rejection or return of any supplies, the contractor shall bear the whole cost of replacing the supplies so rejected or returned.

15. If the Board shall decide that the article is not of proper quality it must be immediately replaced by the contractor; failing which it, or any like supply suitable for the Service, will be procured by the officer requiring it, and the expense charged as in clause 10.

16. In the case of supplies for Mental Hospitals, it will be competent for a Board of Survey, consisting of the medical superintendent (or, in his absence, of the medical officer) and any two officers named by him, to examine and reject any supplies that may be objected to. It must be distinctly understood, however, that the contractor will have a right of appeal to the Treasurer of the State for the time being, such appeal to be made in writing within 24 hours of the rejection; but, pending such appeal, he must at once supply others of approved quality; failing which, the supplies required, or any like supplies suitable for the Service, may be obtained by the officer concerned, and the expense charged as in clause 10.

17. In the case of supplies for Mental Hospitals, it will also be competent for two or more of the official visitors, in conjunction with the medical superintendent, to reject any supplies that they may consider not in accordance with contract; and in such cases the reference to a Board of Survey will not be deemed to be necessary.

18. A refusal to execute orders, irregularity in the quantity or quality of the supplies, or delay in delivering or replacing them when required, will subject the contractor, upon report from the Tender Board, to such mulct, not exceeding Fifty pounds, as the said Treasurer may direct, and the amount may be deducted as in clause 10. It will also be in the power of the said Treasurer, upon such refusal, irregularity or delay, to terminate the contract forthwith, and forfeit the whole or any part of the

security money; and, in addition, the contractor will be disqualified from tendering or holding any future contract or contracts for a period of twelve months from the date of such disqualification.

19. Contractors are not at liberty to transfer their contracts under cover of power of attorney, coupled with an interest or otherwise, and no such transfer will be recognized by the Government. *If it is found during the currency of the contract that the contractor has not conformed to the condition of advertisement—which stipulates that if a tenderer be a member of a firm and such firm be interested in the contract, the tender shall be in the name of the firm and not in that of the individual—then the Treasurer may, on the recommendation of the Tender Board, determine the contract, and forfeit the security money.*

20. It will be competent for the Tender Board to terminate the contract, without notice, should there be reason to know that the contractor takes advantage of his contract to communicate with a prisoner.

21. The contract entered into under these conditions is not to be considered as being broken, infringed, or vitiated by the importation of stores for the Government service, or by any contracts or purchases made by the Imperial Commissariat; or by the consumption of the produce or surplus stock of any Government establishment, or by any article being made at and supplied for the use of any Government establishment.

22. Notwithstanding anything contained to the contrary in section 152 of the Customs Act 1901-36, it is hereby expressly provided that upon any alteration of the duty collected affecting the goods included in this contract, the contract price shall not be altered, and the contract may be terminated at the option of either party by two months' notice in writing from the first day of the calendar month next ensuing, and within the period for which the contract is made. The contract for the unaffected items shall remain in full force and effect. Any notice to be served under this condition shall be deemed to have been duly served if sent to the contractor in a registered letter to his last known place of business or abode.

23. Under no circumstances other than those mentioned in clause 22 will a contractor be permitted to abandon his contract. In the event of the contractor failing to carry on the contract, the contract security money will in that case be absolutely forfeited and, in addition, the contractor will be held liable for any loss which the Government may sustain in consequence of such failure.

24. For the purposes of these contracts the word "Government" shall mean the Government of the State of Victoria; and the word "Treasurer" shall mean the Treasurer of the said State.

H. E. BOLTE,
Treasurer.

The Treasury,
Melbourne, 22nd March, 1965.

PUBLIC SERVICE NOTICES

PUBLIC SERVICE OF VICTORIA.—VACANCIES.

APPLICATIONS will be received by the Public Service Board up to Wednesday, the 7th April, 1965, from persons employed in the Public Service of Victoria, who are eligible and qualified for appointment to the under-mentioned positions.

ADMINISTRATIVE DIVISION.

Class "B", Department of Agriculture.

Yearly Salary.—£2,028, minimum; £2,148, maximum.

Duties.—To act as Senior Clerk of the Agricultural Education Division; to be in charge of staff matters, correspondence, and students' records; to compile Divisional Estimates of Revenue and Expenditure and Public Works Estimates; to be "Vouching Officer" of the Division; to act as Secretary to the Advisory Committee on Agricultural Education.

Qualifications.—Organizing ability and experience in the control of staff; a good knowledge of the requirements of Agricultural Colleges, and of the Public Service Act and the Regulations thereunder.

Classes "C2"—"B", Hobson Park Hospital, Traralgon, Mental Hygiene Branch, Department of Health.

Yearly Salary.—£1,788, minimum; £2,148, maximum.

Duties.—To be Secretary of the Hospital.

Qualifications.—Experience in organization of a Mental Hospital, including control of stores, clothing, provisions, &c.; a good knowledge of the Mental Hygiene Act and Regulations; ability to control staff.

Assistant Training Officer, Class "C2", Office of the Public Service Board, Premier's Department.

Yearly Salary.—£1,788, minimum; £1,908, maximum.

Duties.—To assist with the planning, organization and conduct of training courses within the Public Service.

Qualifications.—An appropriate University qualification or the Diploma in Public Administration of the Royal Melbourne Institute of Technology, or some progress towards the completion of one such qualification; a good knowledge of the Victorian Governmental administrative structure.

Class "C1", Water Supply Department.

Yearly Salary.—£1,558, minimum; £1,668, maximum.

Duties.—To be responsible for the compilation of the records of officers and employees, including the preparation of schedules for salary variations; to prepare reports, to conduct correspondence and to take charge of the general staff office as required.

Qualifications.—A good knowledge of the Public Service Acts and Regulations and of the rates of pay of officers and employees employed under the Public Service Acts and preferably of the organization, activities and staff establishment requirements of the Commission capable of preparing reports.

Inspector of Factories and Shops (Male), Grade II., Classes "C"—"C1", Department of Labour and Industry. (Six vacancies.)

Yearly Salary.—£1,283, minimum; £1,668, maximum.

Duties.—As an Inspector of Factories and Shops under the *Labour and Industry Act 1958* to inspect factories, shops and other work places for the purpose of advising on and enforcing the provisions of the *Labour and Industry Act 1958* and other relevant legislation, particularly in relation to the payment of wages and the health and safety of employees and generally in relation to conditions of employment as required by law.

Qualifications.—To be of adult age and mature personality and to be confident of approach. To have capacity for investigation work and report writing. To be willing to reside, if required, within the district to which he may from time to time be assigned. A general knowledge of industrial matters would be an advantage.

Class "C", State Motor Car Insurance Office, Chief Secretary's Department.

Salary.—£1,283, minimum; £1,448, maximum.

Duties.—To supervise and control staff dealing with the public and assist generally in the Policy Department.

Qualifications.—A good knowledge of Comprehensive and Statutory Motor Vehicle Insurance. Ability to control staff and to advise the public on motor insurance.

Class "C", Office of the Housing Commission, Treasury.

Salary.—£1,283, minimum; £1,448 maximum.

Duties.—Under direction of the Officer in Charge, Payment of Accounts Section, to assist in the preparation and examination of vouchers covering expenditures incurred by the Commission, and to charge the expenditure to appropriate accounts.

Qualifications.—A good knowledge of the Public Accounts and Stores Regulations under the *Audit Act 1958*. Knowledge of the accounting system of the Housing Commission would be an advantage.

Class "C", Nyah West Centre, Water Supply Department.

Salary.—£1,283, minimum; £1,448 maximum.

Duties.—To assist the District Accounting Officer in the issue of rate assessment notices and the receipt of revenue, the preparation of wages sheets, district costing data and returns and statements.

Qualifications.—A knowledge of the incidence of rating and experience in rate collecting and other Commission activities; ability to conduct negotiations and correspondence.

NOTE.—A residence is available for the successful applicant, if married, for which a rental of 10 per cent. of total emolument, inclusive of the amount payable under Regulation 74, less £36 6s. a year will be charged. Occupancy will be subject to a formal tenancy agreement being entered into. Particulars available from the Water Supply Department.

PROFESSIONAL DIVISION.

Superintending Medical Inspector (Surveys), Class "A1", Maternal and Child Welfare Branch, Department of Health.

Yearly Salary.—£3,635.

Duties.—To carry out special surveys relating to child health including statistical analysis of medical records of school children and special medical examinations as required; to assist in the induction training of medical staff and other duties as required.

Qualifications.—A legally qualified medical practitioner of Victoria with special knowledge and experience in child health and preferably with an appropriate post graduate degree or diploma.

Chief of the Division of Forestry Education and Research, Class "A1", State Forests Department.

Yearly Salary.—£3,360.

Duties.—To direct and supervise forest research and to submit to the Commission prescriptions relating to field practice; to advise the Commission on matters relating to professional training in forestry; to develop public relations and to further public education in forestry.

Qualifications.—A University degree, preferably post graduate in Science or Forestry; experience in the conduct of forest research, both laboratory and field; ability to control and direct staff.

Senior Psychologist, Class "A", Mental Hygiene Branch, Department of Health.

Yearly Salary.—£2,613, minimum; £2,763, maximum.

Duties.—To undertake diagnostic testing, to conduct psychological surveys and to assist in the direction of training courses for intellectually defective children, to formulate and conduct research programmes in psychology.

Qualifications.—A Degree in Psychology and qualifications for Associateship of the British Psychological Society; approved experience in psychological testing of children, and in vocational guidance, and ability to formulate and conduct research programming in psychology.

Assistant Superintendent of Floating Plant, Classes "B"—"B1", Ports and Harbours Branch, Public Works Department.

Yearly Salary.—£2,028, minimum; £2,443, maximum.

Duties.—Under the direction of the Superintendent of Floating Plant, to direct work associated with the maintenance and repair of all classes of vessels, propelling engines, and sand pumps, and to prepare working sketches and specifications for dredging equipment.

Qualifications.—A first-class certificate of qualification as a Marine Engineer for both steam and motor, and experience in ship building and survey of all classes of vessels, including suction dredges; competent to direct engineers and other members of crews employed on floating plant, including dredges, steamships, tugs, motor boats, and priestman grabs, &c.

Assistant Engineer, Class I., State Forests Department.

Yearly Salary.—£1,461, minimum; £2,293, maximum. (Commencing salary will be determined according to qualifications and experience.)

Duties.—To be responsible within a region for the survey, design and construction supervision of road systems, bridges and other civil engineering works. To advise Forest Officers on engineering matters and supervise mechanical personnel as directed by Mechanical Engineer.

Qualifications.—A University Degree or Diploma in Civil Engineering and approved field experience particularly in mountain country.

Draughtsman, Class "C", Water Supply Department.

Yearly Salary.—£1,283, minimum; £1,448, maximum.

Duties.—Under the direction of the Superintending Draughtsman to examine field notes of surveys for land acquisitions and easements and prepare plans for submission to the Titles Office.

Qualifications.—To be a good penman with a good knowledge of engineering and land survey practice in the field and of the preparation of plans from field notes.

TECHNICAL AND GENERAL DIVISION.

Technical Officer, Visual Education Centre, Education Department.

Yearly Salary.—£1,591, minimum; £1,643, maximum.

Duties.—To be responsible for the testing, servicing and maintenance of school and departmental projection and film library equipment. To assist in training teachers in the operation of motion picture projectors and to advise on the installation of projection equipment in schools.

Qualifications.—Experience in workshop supervision and organization and in the servicing and maintenance of 16 m.m. and 35 m.m. sound projectors, tape recorders, sound systems and camera equipment. Possession of a full Cinematograph Operator's Licence or its equivalent.

Fisheries Liaison Officer, Fisheries and Wildlife Branch, Chief Secretary's Department.

Yearly Salary.—£1,295, minimum; £1,435, maximum.

Duties.—To conduct meetings at fishing ports, to liaise with the fishing industry on questions of regulations and departmental activities; to prepare informative articles for publication; to perform other duties as directed.

Qualifications.—A sufficient knowledge of the fishing industry. Ability to conduct meetings and to establish and maintain good relations with all sections of the fishing industry. A current motor driver's licence. The possession of a certificate from Australian Fisheries School at Cronulla would be an advantage.

Senior Prison Officer, Prisons Division, Social Welfare Branch, Chief Secretary's Department.

Yearly Salary.—£1,295, minimum; £1,383, maximum.

Duties.—To assist the Governor of Her Majesty's Prison, Sale, in the control and management of the prison and in his absence to act as Governor; to perform other duties as directed including those of storekeeper or to fill any position of equivalent rank as may be directed.

Qualifications.—To have passed the prescribed examination for promotion to Senior Prison Officer; to have a satisfactory record of service with qualities of leadership required of a senior officer in the management of staff and prisoners and to have the experience and ability to assume responsibility.

Officer-in-Charge, Port Fairy Depot, Ports and Harbours Branch, Public Works Department.

Yearly Salary.—£1,241, minimum; £1,383, maximum.

Duties.—To be Officer-in-Charge of the Departmental Depots at Port Fairy and Warrambool; to supervise dredging, boat slipping and launching operations; to exhibit signals, as required; to supervise maintenance, repairs and replacements to wharves, jetties, &c.; to maintain automatic and fixed lights.

Qualifications.—Appropriate experience in supervising the construction and maintenance of harbour structures; boating experience; conversant with mechanism of automatic and fixed lights, and dredging; capable of undertaking the duties involved and preferably experienced in slipping boats.

Cash Register Operator, Stamp Duties Office, Treasury.

Yearly Salary.—£1,223, minimum; £1,331, maximum.

Qualifications.—Ability to handle moneys and to operate a multiple cash register.

Reservoir Keeper, Grade III., Eildon Reservoir, Water Supply Department.

Yearly Salary.—£1,223, minimum; £1,331, maximum.

Duties.—Under direction to be responsible for the maintenance and operation of the reservoir structures and improvements on adjoining lands; to take an active part in these works.

Qualifications.—Experience in the operation and maintenance of a major headworks structure incorporating heavy machinery and electrical equipment. A trade certificate or a completed apprenticeship in automotive engineering or fitting and turning is desirable. To be physically capable of carrying out reservoir structure maintenance works. A knowledge of horticulture would be an advantage. Able to keep records and prepare comprehensive reports.

(This advertisement is in lieu of that for a Reservoir Keeper, Grade II., Eildon Reservoir, which appeared on page 595, of the *Government Gazette*, dated 17th March, 1965.)

Mechanic, Electrical, Senior, Public Works Department.

Yearly Salary.—£1,169, minimum; £1,241 maximum.

Duties.—To carry out maintenance and repairs on electrical equipment and carry out minor variations and extensions to electrical installations in State Government buildings in the Metropolitan area.

Qualifications.—An "A" Grade Electrical Mechanics Licence issued by the State Electricity Commission of Victoria; good practical experience in the installation and maintenance of all types of electric light and power installations.

Assistant (Male), Grade II., Fisheries and Wildlife Branch, Chief Secretary's Department.

Yearly Salary.—£1,097, minimum; £1,133, maximum.

Duties.—To be responsible for records and statistics in respect of native fauna killed under permits and of dealers' skin returns. To supervise the staff issuing and recording Game and other licences. Other duties as required.

Qualifications.—Experience in the keeping of records and ability to control and direct staff.

NOTE.—To be eligible to apply for this position, temporary employees or officers of the Technical and General Division other than Assistants (Male) must have passed the Board's examination for registration for appointment as Assistant (Male), Grade I., Technical and General Division.

Water Bailiff, Senior, Section 8, Tongala Centre, Water Supply Department.

Yearly Salary.—£1,133.

Duties.—To control a section of the main channel and subsidiary channels; to regulate supplies between Water Bailiffs; to supervise water distribution, repairs and maintenance of channels within the section.

Qualifications.—Experience in the regulation and distribution of water; a good knowledge of water requirements for orchards, crops, pastures and grasses grown under irrigation in the district; experience in channel and drain construction and maintenance.

NOTE.—The successful applicant will be required to occupy the official residence provided and vacation of the residence will not be permitted without the express approval of the Water Supply Department. A rental of 10 per cent. of total emolument less £36 6s. a year will be charged. Occupancy will be subject to formal tenancy agreement being entered into. Particulars are available from the Water Supply Department.

(This advertisement is in lieu of that for a Water Bailiff, Senior, which appeared on page 532, of the *Government Gazette*, dated 10th March, 1965.)

Shorthand Writer and Typist (Female), Senior, National Gallery, Chief Secretary's Department.

Yearly Salary.—£1,007, minimum; £1,043, maximum.

Duties.—To act as confidential stenographer to the Director, National Gallery; to supervise staff when required.

Qualifications.—To be a competent shorthand-typist who has passed the 100 words a minute shorthand test; secretarial experience would be an advantage.

Cook (Female), Senior, "Turana" Youth Welfare Division, Social Welfare Branch, Chief Secretary's Department.

Yearly Salary.—£881, minimum; £899, maximum.

Duties.—To be responsible for the preparation of meals for staff and children at "Turana", Parkville. To exercise supervision over the kitchen staff, and to have charge of the kitchen equipment and stores.

Qualifications.—Competent and experienced in large scale cooking and capable of controlling a small staff.

Youth Officer (Female), "Winlton", Youth Training Centre, Nunawading, Youth Welfare Division, Social Welfare Branch, Chief Secretary's Department. (Three vacancies.)

Yearly Salary.—£776, minimum; £827, maximum.

Duties.—To assist in the management and control of girls in a Youth Training Centre.

Qualifications.—Good personality, understanding and capacity for supervision and control of teenage girls. To have passed the examinations prescribed in Regulation 34 (4) of the Public Service (Public Service Board) Regulations.

NOTE.—Quarters and rations provided, if required, at a charge of £166 a year.

Telephonist (Female), Grade II., State Accident Insurance Office, Chief Secretary's Department.

Yearly Salary.—£845, minimum; £863, maximum.

Duties.—To be in charge of the Switchboard and to act as Telephonist for the State Insurance Offices.

Qualifications.—A competent Telephonist preferably familiar with the organization of the State Insurance Offices.

NOTE.—The salary rates quoted above do not include the additional amount which is payable under Regulation 74 of the Board's Regulations.

By order,

V. P. SCULLY,
Secretary.

Office of the Public Service Board,
Melbourne, 23rd March, 1965.

PUBLIC SERVICE OF VICTORIA—VACANCIES.

(TEMPORARY APPOINTMENTS.)

APPLICATIONS will be received by the Public Service Board up to Wednesday, the 7th April, 1965, from persons who are qualified for appointment to the under-mentioned positions:—

Housekeeper, Grade III., Secondary Teachers' College Hostel, 12 Orrong-road, Armadale, Education Department.

Yearly Salary.—£881, minimum; £953, maximum (less £166 a year for board and lodging). An allowance of £111 a year is paid for extra supervisory and other duties.

Duties.—To be responsible to the Principal, Secondary Teachers' College, for organization and administration of the hostel, including engaging and dismissing domestic staff, ordering supplies, assisting in general supervision of students.

Qualifications.—To be alert, of good personality, and experienced in controlling staff.

Mechanical Assistant, Grade II., Robinvale Pumping Station, Water Supply Department.

Yearly Salary.—£1,151, minimum; £1,259, maximum.

Duties.—Repair and maintenance of steam boilers, steam and diesel engine driven pumps, and auxiliary mechanical plant at the Robinvale pumping station, and the supervision of persons employed on the operation and maintenance of such plant.

Qualifications.—To have served an apprenticeship as a fitter and turner, with not less than ten years' subsequent experience in the repair and maintenance of steam and diesel engines and associated plant.

NOTE.—A residence is available for the successful applicant, if married, for which a rental of 10 per cent. of standard salary, inclusive of the amount payable under Regulation 74, less £36 6s. a year will be charged. Occupancy will be subject to a formal tenancy agreement being entered into. Particulars available from the Water Supply Department.

NOTE.—The salary rates quoted above do not include the additional amount which is payable under Regulation 74 of the Board's Regulations.

By order,

V. P. SCULLY,
Secretary.

Office of the Public Service Board,
Melbourne, 23rd March, 1965.

PUBLIC SERVICE OF VICTORIA—VACANCIES.

DEPARTMENT OF HEALTH.

MENTAL HYGIENE BRANCH.

TECHNICAL AND GENERAL DIVISION.

APPLICATIONS will be received by the Public Service Board up to Wednesday the 14th April, 1965, from persons employed in the Public Service of Victoria, who are eligible and qualified for appointment to the under-mentioned positions.

Principal Nurse (Male), Ballarat.

Yearly Salary.—£1,695, minimum; £1,747, maximum.

Duties.—To have charge of Male Division—Staff and Patients.

Qualifications.—Current practising certificate for Mental Nursing. Experience in a senior position in a Mental Hospital, ability to control patients and staff, compile reports and records relating to these duties, and give lectures to Student Nurses and others.

Tutor (Male).

Yearly Salary.—£1,435.

Duties.—To organize and undertake education of Student Nurses in psychiatric nursing; to establish post-graduate training in psychiatric nursing.

Qualifications.—A current practising certificate for Mental and General Nursing. Experience in tutorial duties is desirable.

Head Nurse (Female), Ballarat.

Yearly Salary.—£1,327 minimum; £1,379 maximum.

Duties.—To assist Principal Nurse in management of female division and to prepare leave sheets and other records as directed by the Principal Nurse; to give lectures to Student Nurses and others.

Qualifications.—A current practising certificate for mental nursing. Ability to direct and control staff and patients and to keep records relating thereto.

Anaesthetic and Operating Theatre Technician (Male), Mont Park.

Yearly Salary.—£938 minimum; £1,043 maximum.

Duties.—To assist in the theatre care and operation. To be responsible for the care, cleanliness and sterilization of theatre equipment.

Qualifications.—Experience in nursing and hospital work and aptitude for surgical theatre work. To have passed or willing to undertake course for anaesthetic and operating theatre technicians.

Deputy Charge Nurse (Male). (Three vacancies.)

1 vacancy Royal Park.
1 vacancy Sunbury.
1 vacancy Plenty.

Yearly Salary.—£1,151 minimum; £1,187 maximum.

Duties.—To be second in charge of a ward.

Qualifications.—A current practising certificate for Mental Nursing and approved experience.

NOTE.—Separate applications must be submitted for these positions.

Painter, Grade II., Kew.

Yearly Salary.—£1,061 minimum; £1,187 maximum.

Duties.—To carry out general painting and glazing, and the training of patients to help in painting work.

Qualifications.—A competent and qualified painter (conversant with mixing and using of paints) and glazier, and experienced in the control of mental patients.

Charge Nurse (Female), Dandenong.

Yearly Salary.—£1,007 minimum; £1,079 maximum.

Duties.—To take charge or sub-charge of a ward in a Mental Hospital.

Qualifications.—A current practising Certificate for Mental Nursing and experience as a Deputy Charge Nurse in a Mental Hospital.

NOTE.—The successful applicant will be required to work an eight hour roster.

General Assistant, Janefield Colony.

Yearly Salary.—£921 minimum; £1,007 maximum.
Duties.—To give general assistance in the various artisan activities connected with the hospital services and maintenance.
Qualifications.—A semi-skilled worker in good physical condition. Knowledge of some trade desirable.

Kitchenman, Larundel.

Yearly Salary.—£904 minimum; £1,007 maximum.
Duties.—To assist Cooks generally in preparation of vegetables and other foodstuffs. Attending to cleanliness of kitchen.
Qualifications.—Some knowledge of cooking is desirable.

Deputy Charge Nurse (Female), Sunbury. (Two vacancies.)

Yearly Salary.—£935 minimum; £971 maximum.
Duties.—To be second in charge of a ward.
Qualifications.—A current practising certificate for Mental Nursing and approved experience.

NOTE.—The salary rates quoted above do not include the additional amount which is payable under Regulation 74 of the Board's Regulations.

By order,
 V. P. SCULLY,
 Secretary.

Office of the Public Service Board,
 Melbourne, 23rd March, 1965.

PUBLIC SERVICE (PUBLIC SERVICE BOARD) REGULATION 52.—VACANCY.

THE Permanent Head of the Department shown has recommended the officer named hereunder for appointment to the under-mentioned vacancy.

Office and Classification.	Duties.	Qualifications.	Officer Recommended for Appointment.		
			Name	Classification.	Date of Classification.
PROFESSIONAL DIVISION. DEPARTMENT OF AGRICULTURE.					
Senior Executive Officer, Class "A1" (£3,360)	To assist in professional aspects of the Central Administration of the Department, to examine and report on agricultural research and extension projects	Degree in Agricultural Science or Veterinary Science; a detailed knowledge of the functions of the Department of Agriculture and a wide knowledge of Victorian agriculture	Kefford, R. O.	Assistant Senior Executive Officer, Class "A1" (£2,895)	17.12.63

Appeals against such recommendation should be lodged with the Secretary to the Public Service Board not later than Saturday, the 3rd April, 1965.

Office of the Public Service Board,
 Melbourne, 23rd March, 1965.

By order,
 V. P. SCULLY,
 Secretary.

PUBLIC SERVICE OF VICTORIA.—RECLASSIFICATIONS.

THE Public Service Board has raised the classification of the under-mentioned offices as shown, and appointed thereto the respective officers named hereunder.

Office and Former Classification.	Revised Classification.	Duties.	Qualifications.	Officer Appointed.
ADMINISTRATIVE DIVISION. STATE FORESTS DEPARTMENT.				
Class "E"	Class "D" (with right of progression to Class "C")	To act as assistant to the officer in charge of the Industrial Section; to maintain records of "exempt" employees, check wages rates and fire fighting overtime payments and deal with applications for leave.	Preferably familiar with the organization and activities of the Department and with district office procedures; a knowledge of Industrial Awards and Determinations and their implementation would be an advantage	Nathan, J. A.
PROFESSIONAL DIVISION. TREASURY. Taxation (Land Tax) Office.				
Class "E", Administrative Division	Cadet Valuer, Class "D"	To assist valuers in field and office work in connexion with the valuation of properties for State Land Tax, Probate Duty and Stamp Duty purposes	The School Leaving Certificate or equivalent qualification (if not a member of the Administrative Division). A general knowledge of the Land Tax Act; competent to make simple plans of buildings and farm holdings	Harvey, A. M.

Office of the Public Service Board,
 Melbourne, 23rd March, 1965.

By order,
 V. P. SCULLY,
 Secretary.

PRIVATE ADVERTISEMENTS

CITY OF CAMBERWELL.

BY-LAW No. 138.

Building.

A By-law of the City of Camberwell made under section 926 of the *Local Government Act 1958* and the Uniform Building Regulations, Victoria, and numbered 138 for determining applying dispensing with or regulating certain matters left to be determined applied dispensed with or regulated by the Council of the said City or in respect of which powers are conferred or duties are imposed on the Council under the Uniform Building Regulations, Victoria.

IN pursuance of the powers conferred by the *Local Government Act 1958*, the Uniform Building Regulations, Victoria and any and every other power it thereunto enabling the Mayor, Councillors and Citizens of the City of Camberwell order as follows:—

1. This By-law shall come into operation and have effect immediately upon its publication in the *Victoria Government Gazette*.
2. This By-law shall from the time of its coming into operation be read and construed as one with By-law No. 115.
3. Clause 2 of By-law No. 115 is hereby amended by including therein after the words "Schedule 'A' and Schedule 'B' thereto" the words "and Schedule 'A' of By-law No. 138".
4. Each of the areas of land in the said Municipal District set out and described in Schedule "A" hereto is hereby prescribed as an area of land on which a building or buildings of Class II Occupancy shall contain in the aggregate not more than the number of flats as set out against the particular area.
5. In this By-law unless inconsistent with the context or subject matter—
 - (a) "Building of Class II Occupancy" has the meaning assigned to that expression in Chapter 6 of the Uniform Building Regulations, Victoria.
 - (b) "Flat" has the meaning assigned thereto in Chapter 1 of the said Regulations.
 - (c) "Site" shall have the same meaning as in Clause 815 of the said Regulations.

SCHEDULE "A".

LAND—Durham-road—East Side—commencing 167 ft. 1½ in. south from Canterbury-road and having a frontage of 75 ft. 2 in. by a depth of 160 feet and being the land more particularly described in Certificate of Title Volume 3956, Folio 016 and Volume 3083, Folio 494. 5 flats.

Boston-road—West Side—commencing 459 ft. 7 in. north from Mont Albert-road and having a frontage of 147 ft. 7 in. by a depth of 320 ft. 6½ in. and being the land more particularly described in Certificate of Title Volume 2400, Folio 902. 10 flats.

Resolution for passing this By-law agreed to by the Council the 14th day of December, 1964.

Confirmed the 8th day of February, 1965.

The common seal of the Mayor, Councillors and Citizens of the City of Camberwell was hereto affixed by order of the Council the 8th day of February, 1965, in the presence of—

(SEAL) W. M. FORDHAM, Mayor.
RALPH L. DEAR, Councillor.
L. F. CHEFFERS, Town Clerk.

Approved by the Governor in Council, the 10th day of March, 1965.—J. COLQUHOUN, Clerk of the Executive Council. 5108

CITY OF CAULFIELD.

LOAN No. 45.

Notice of Intention to Borrow the Sum of £60,000 for Permanent Works and Undertakings.

NOTICE is hereby given that the Council of the City of Caulfield proposes to borrow the sum of £60,000 on the credit of the municipal revenues of the Mayor, Councillors and Citizens of the said City, such sum to be raised by the grant of a mortgage in accordance with the provisions of the *Local Government Act 1958*.

1. The maximum rate of interest that may be paid is £5.6s. 3d. per centum per annum.

2. The purposes for which the loan is to be applied are:—

(a) Construction of roads	£25,000
(b) Construction of drains	35,000
		<u>£60,000</u>

3. The period of the loan shall be nine years.

4. The moneys borrowed shall be repayable by providing out of the municipal fund eighteen half-yearly instalments of £4,236 14s. 7d., including principal and interest, on the 15th day of June and the 15th day of December during the currency of the loan. The first instalment shall be payable on the 15th day of December, 1965.

5. Such moneys shall be repayable at the Commonwealth Savings Bank of Australia, Melbourne.

The plans and specifications and the estimate of the cost of the proposed works and a statement showing the proposed expenditure of the moneys to be borrowed are open for inspection at the Town Hall, corner of Glen Eira and Hawthorn roads, Caulfield.

Dated the 18th day of March, 1965.

5092

H. G. NELSON, Town Clerk.

CITY OF CAULFIELD.

BY-LAW No. 133.

A By-law of the City of Caulfield, made under Section 197 of the *Local Government Act 1958* as amended, and numbered 133 for adopting certain provisions of the Fifteenth Schedule to the said Act and carrying out certain purposes provided for in the said Schedule.

IN pursuance of the powers conferred by the *Local Government Act 1958*, as amended, and of all other powers enabling them in this behalf, the Mayor, Councillors and Citizens of the City of Caulfield do order as follows:—

1. Clauses 1-7, 10-14, 17-40, 44-49 of By-law No. 7 of the said City (then Shire) adopting Part 1 of the Thirteenth Schedule to the *Local Government Act 1874*, By-law No. 8 of the said City (then Shire) adopting Part 11 of the Thirteenth Schedule to the *Local Government Act 1874*, Clauses 1 and 2 of By-law No. 9 of the said City (then Shire) adopting Part IV of the Thirteenth Schedule to the *Local Government Act 1874*, By-law No. 10 of the said City (then Shire) adopting Subdivision 2 of Part V of the Thirteenth Schedule of the *Local Government Act 1874*, By-law No. 11 of the said City (then Shire) adopting Part VI of the Thirteenth Schedule to the *Local Government Act 1874*, By-law No. 12 of the said City (then Shire) adopting subdivision 2 of Part VII of the Thirteenth Schedule of the *Local Government Act 1874*, Clauses 2-16 of By-law No. 13 of the said City (then Shire) adopting Part VIII of the Thirteenth Schedule to the *Local Government Act 1874*, Clauses 1, 3-6 of By-law No. 14 of the said City (then Shire) adopting Part IX of the Thirteenth Schedule of the *Local Government Act 1874*, By-law No. 15 of the said City (then Shire) adopting Section 36, Subdivision 1, Section 71, Subdivision 2, Part X of the Thirteenth Schedule to the *Local Government Act 1874*, By-law No. 17 of the said City (then Shire) adopting Subdivision 7, Part XVI of the *Local Government Act 1874*, Clauses 4 and 5 of By-law No. 19 made by the said City (then Shire) for suppressing nuisances, By-law No. 22 of the said City (then Town) adopting Part V of the Thirteenth Schedule to the *Local Government Act 1890* and Regulation No. 3 made under such By-law, Clauses 1-2, 5-8, 12-20, 22-23, 27-33 of By-law No. 23 of the said City (then Town) for carrying out certain of the purposes provided for in Part V of the Thirteenth Schedule to the *Local Government Act 1890*, all clauses not previously repealed of By-law No. 24 of the said City (then Town) adopting Part I, Clause Numbered 1 of Part VIII and Clause 2 of Part IX of the Thirteenth Schedule of the *Local Government Act 1903* and Regulation No. 8 made under such By-law, Clause 1 of By-law No. 26 of the said City (then Town), By-law No. 27 of the said City (then Town), made under Section 197 of the *Local Government Act 1903* for regulating places of improvement and recreation etc. All Clauses not previously repealed of By-law No. 40 of the said City, By-law No. 68 of the said City adopting Subdivision (4) and Clauses 15 to 26 both inclusive of Part I of the Thirteenth Schedule to the *Local Government Act 1928*, By-law No. 73 of the said City adopting certain of the provisions of the

Thirteenth Schedule of the *Local Government Act 1928* as amended by the *Local Government Act 1941* be and they are hereby repealed.

2. Such of the provisions of the Fifteenth Schedule to the *Local Government Act 1958*, as amended by the *Local Government (Amendment) Act 1962* as are set out hereunder are hereby adopted, namely:—

PART I. Streets and Footways.

- (2) Naming Streets, Exhibiting Traffic Control signs—Clauses 8, 8 (a), 10 and 11.
- (3) Spouts and drains from Houses etc.—Clauses 12-14 both inclusive.
- (4) Crossings and Footways and Channels—Clauses 15-26 both inclusive.
- (5) Deposit or Discharge of Rubbish Liquid etc. on streets etc.—Clause 27.
- (6) Depositing Building Materials, Excavations etc.—Clauses 29-37 both inclusive.
- (7) Lighting etc. of Obstructions generally—Clauses 38 and 39.
- (8) Houses etc. encroaching on streets etc.—Clause 40.
- (9) Obstructions etc. to streets etc. by Cattle etc.—Clauses 41 (a), 42-45 both inclusive.
- (10) Undermining Streets—Clause 46.
- (11) Miscellaneous—Clauses 47-49 both inclusive.

PART II. Waterworks Drains etc.—Clause 6.

PART IV. Places of Improvement and Recreation etc.

- (1) Public Libraries and Museums—Clauses 1 and 2.
- (2) Public Gardens—Clauses 3-11 both inclusive.

PART V. Regulation etc. of Buildings.

- (2) Ruinous or Dangerous Buildings etc.—Clauses 5-8 both inclusive.

PART VI. Buildings etc. for Public Meetings etc.—Clauses 1-4 both inclusive.

PART VII. Fire Prevention.

- (1) Foul Chimneys—Clauses 1 and 2.
- (2) Deposit etc. of Inflammable Materials etc.—Clauses 3-7 both inclusive.

PART VIII. Goats—Clauses 1-8 both inclusive.

PART IX. Miscellaneous matters—Clauses 2-5 both inclusive.

3. (a) The owners or occupiers of houses or buildings shall, on the gate or gatepost or on the letter box or on a place on the front fence immediately adjacent to the entrance of the houses or buildings, mark such houses or buildings with such numbers or names for the purpose of distinguishing the same, as the Council may from time to time direct or approve.
- (b) In addition to complying with the requirements of paragraph (a) of this clause, the owners or occupiers of buildings in which there are two or more separate dwellings shall on the front door of each such separate dwelling or in such other conspicuous position as the Council determines mark such separate dwelling with such numbers or names for the purpose of distinguishing the same as the Council may from time to time direct or approve.
- (c) Such owners or occupiers shall renew the numbers or names of such houses, buildings or separate dwellings as often as they are obliterated or defaced.
- (d) If any owner or occupier of any such house, building or separate dwelling neglects for one week after notice to him from the Council to mark such house, building or separate dwelling with such number or name as the Council may direct or approve, or to renew the number or name thereof as aforesaid, he shall forfeit a sum not exceeding Forty shillings; and the Council may cause such number or name to be so marked or renewed, and recover the expense thereof from the owner or occupier of such house, building or separate dwelling before any justice; and where such expense is paid by or recovered from the occupier he may deduct the same from any rent payable by him to the owner.

4. This By-law shall apply to and have operation throughout the whole of the municipal district of the City of Caulfield.

Resolution for passing this By-law agreed to by the Council of the City of Caulfield on the 9th day of February, 1965, and confirmed on the 9th day of March, 1965.

The common seal of the Mayor, Councillors and Citizens of the City of Caulfield was hereunto affixed in the presence of:—

(SEAL) ERNEST E. GUNN, Councillor.
H. G. NELSON, Town Clerk.

CITY OF CAULFIELD.

BY-LAW No. 134.

Regulation of Proceedings of Council, Officers, Etc.

- A By-law of the City of Caulfield made under section 197 of the *Local Government Act 1958* (as amended) and numbered 134 for adopting certain provisions of the 15th Schedule to the Act and carrying out certain purposes provided for in the said Schedule.

IN pursuance of the powers conferred by the *Local Government Act 1958* (as amended), and of any and every other power it thereunto enabling the Mayor Councillors and Citizens of the City of Caulfield order as follows:—

1. By-law No. 16 of the Shire (now City) of Caulfield adopting Part XI of the 13th Schedule to the *Local Government Act 1874* and By-law No. 13 of the Shire (now City) of Caulfield amending the same are hereby repealed.

2. Such of the Clauses of Part XI of the 15th Schedule to the *Local Government Act 1958* (as amended), entitled "Regulation of Proceedings of Council, Officers, etc." as are set out hereunder are hereby adopted, namely:

- Clause 1,
- Clauses 4-30 (both inclusive)
- Clauses 32-39 (both inclusive)
- Clauses 41-44 (both inclusive)
- Clauses 46-51 (both inclusive)
- Clause 53.

3. At every meeting of the Council the first business thereof shall be:—

- (a) If a copy of the minutes of the preceding meeting shall have been delivered to each Councillor at least forty-eight hours before such meeting the putting a question for the confirmation of such minutes;
- (b) If a copy of the minutes of such preceding meeting has not been so delivered, the reading and putting a question for the confirmation of such minutes. No discussion shall be permitted on such minutes except as to their accuracy as a record of the proceedings, and the said minutes of the proceedings at the preceding meeting shall then be signed as by this Act required.

4. (1) After the signing of the minutes as aforesaid the order of business of an ordinary meeting shall be as follows, or as near thereto as may be practicable, but for the greater convenience of the Council at any particular meeting thereof it may be altered by resolution to that effect:—

- (i) Resumption of debate on motions or orders of the day lapsed at previous meeting.
- (ii) Reading the summary of correspondence referred to in Clause 5 hereof and considering and ordering thereon.
- (iii) Reception and reading of petitions and memorials.
- (iv) Presentation of reports.
- (v) Payments.
- (vi) Ordinary business not elsewhere included.
- (vii) Orders of the day, including subjects continued from proceedings of former meetings.
- (viii) Extraordinary business not elsewhere included.
- (ix) Other motions of which previous notice has been given.
- (x) Notices of motion.

- (2) The order of business at a special meeting shall be the order in which such business stands in the notice thereof.

5. The Town Clerk shall prepare and shall place before each meeting of the Council a summary of correspondence received since the last preceding meeting of the Council.

6. (1) A motion moved at a meeting of the Council need not be reduced into writing by the mover unless the Chairman of the meeting so directs.

- (2) The Town Clerk shall cause to be recorded in the rough minutes all motions moved and seconded at a meeting of the Council.

7. (1) It shall not be necessary to keep minutes of the proceedings of any Committee.

- (2) All reports of Committees shall be entered into a Committees Report Book, signed by the Chairman of the Committee and shall contain a recommendation to the Council on the matters considered.

8. Every petition presented to the Council shall be in writing (other than in pencil) typing or printing, and shall contain the prayer of the petitioners at the end thereof, and be signed by at least one petitioner on every sheet on which it is written.

9. (1) Subject to as in hereinafter provided, plans and specifications for any public work shall be laid before the Council at least six days prior to the same being considered and ordered upon, and be open for inspection by any ratepayer during that time.
- (2) Notwithstanding anything hereinbefore provided, plans and specifications for any public work which the Council may resolve to be urgent may be considered and ordered upon at any meeting of the Council.
10. The common seal of the municipality shall be kept in the custody of the Town Clerk and it shall not be affixed to any document except in the presence of one Councillor and the Town Clerk.
11. Any one or more of the rules or regulations in Clauses 3 to 10, both inclusive, of this By-law or in those provisions of Part XI of the 15th Schedule hereby adopted (including Clauses 49 and 50 thereof) may be suspended for a special purpose on motion upon notice duly given or (without notice of motion) by a unanimous vote of the whole of the Councillors present at the meeting.
12. Every person guilty of an offence under this By-law shall be liable to a penalty not exceeding Twenty pounds.
13. This By-law shall apply to and have operation throughout the whole of the municipal district of the City of Caulfield.

Resolution for passing this By-law agreed to by the Council on the 9th day of February 1965 and Confirmed on the 9th day of March 1965.

The Common Seal of the Mayor, Councillors and Citizens of the City of Caulfield was hereunto affixed in the presence of:—

(SEAL) ERNEST E. GUNN, Councillor.
H. G. NELSON, Town Clerk.

5153

CITY OF CAULFIELD.

BY-LAW No. 135.

A By-law of the City of Caulfield made under Section 197 of the *Local Government Act 1958*, as amended, and numbered 135 for suppressing nuisances, regulating traffic and processions, regulating or prohibiting the writing, painting, printing, stencilling, placing or affixing of any letter, figure, device, poster, sign or advertisement upon any footpath, street or road, and generally for maintaining the good rule and government of the municipality.

IN pursuance of the powers conferred by the *Local Government Act 1958*, as amended, and of every other power enabling them in this behalf the Mayor Councillors and Citizens of the City of Caulfield do hereby order as follows:—

1. That the following By-laws of the City of Caulfield be and they are hereby repealed—
- (a) By-law No. 1 made by the said City (then Shire) for the prevention of injuries to roads.
- (b) By-law No. 5 made by the said City (then Shire) for regulating traffic and processions.
- (c) By-law No. 21 of the said City (then Shire) for regulating the traffic through and over the roads and streets of the shire and for preserving order therein.
- (d) By-law No. 28 of the said City (then Town) for suppressing nuisances, regulating traffic and generally for maintaining the good rule and government of the municipality.
- (e) By-law No. 30 of the said City (then Town) for regulating traffic and processions.
- (f) By-law No. 34 of the said City for regulating traffic along the roads and streets of the City—for regulating or prohibiting the writing, painting, printing, stencilling, placing or affixing of any letter, figure, device, poster, sign or advertisement upon any footpath, street or road, for suppressing nuisances and generally for maintaining the good rule and government of the municipality.
- (g) By-law No. 36 of the said City for prohibiting or regulating the locking of the wheels of any vehicle when descending a hill.
- (h) By-law No. 45 of the said City for regulating traffic and processions.
- (i) By-law No. 47 of the said City for regulating traffic and to regulate the heavy motor vehicles used in the said City and for other purposes.
- (j) By-law No. 56 of the said City for prohibiting the standing of vehicles in Hawthorn-road, east side, between North-road and Sheffield-street.

- (k) By-law No. 83 of the said City for prohibiting the leaving of motor cars or other vehicles standing unattended between the hours of 2 o'clock and 5 o'clock in the forenoon of any day in specified streets and roads.
- (l) By-law No. 98 of the said City for the purposes of regulating traffic.
- (m) By-law No. 115 of the said City appointing standing places for motor cars.
- (n) Regulation No. 7 of the said City for regulating traffic on the Dandenong-road.
2. No person shall permit or allow any cart, carriage, motor car or other vehicle to remain in or on any street, road, lane or right-of-way so as to obstruct any such street, road, lane or right-of-way or so as to impede or interfere with the traffic therein or thereon.
3. No person shall tie, secure or fasten any horse to any tree or tree guard in or on any street, road, lane, or right-of-way nor to any fence abutting on any such street, road, lane or right-of-way.
4. No person shall spill or permit material to be spilt or to fall from any motor car or other vehicle on or upon any street or road or to be deposited on any street or road in any manner whatsoever except in terms of any contract which any such person aforesaid shall have with the said Council or with the written consent of the Council.
5. No person shall drive, ride, or impel any vehicle or any motorcycle, bicycle or like means of locomotion upon any footway made or set apart for the use of pedestrians, provided however that such vehicle or any motorcycle bicycle or like means of locomotion may be taken across any footway direct to or from any premises abutting thereon by means of a crossing.
6. No procession of persons or of vehicles, or both, for other than funeral purposes shall parade or pass through any street or road, unless with the previous consent in writing of the Council and only by the route specified in such consent.
7. No person shall without the previous consent of the Council in writing, write, paint, print, stencil, place or affix any letter, figure, device, poster, sign or advertisement upon any footpath, street or road, or upon any building, fence or other property vested in the municipality or under the control and management of the Council.
8. Every person who is guilty of an offence against this By-law shall be liable, on conviction, to a penalty not exceeding Twenty pounds.
9. This By-law shall apply to and have operation throughout the whole of the municipal district of the City of Caulfield.

Resolution for passing this By-law agreed to by the Council of the City of Caulfield on the 9th day of February, 1965, and confirmed on the 9th day of March, 1965.

The common seal of the Mayor Councillors and Citizens of the City of Caulfield was hereunto affixed in the presence of—

(SEAL) ERNEST E. GUNN, Councillor.
H. G. NELSON, Town Clerk.

5154

CITY OF CAULFIELD.

BY-LAW No. 136.

A By-law numbered 136 made under section 197 of the *Local Government Act 1958*, as amended, for prohibiting the throwing placing or leaving upon any public highway of orange peel, banana peel, or other vegetable matter and for prohibiting the deposit or leaving of refuse or rubbish on streets roads lanes or passages or on any land and also for requiring the removal or destruction by the owner or occupier of any land of refuse or rubbish thereon (other than refuse or rubbish the removal of which the Council has undertaken or contracted for under section forty-eight of the *Health Act 1958*).

IN pursuance of the powers conferred by the *Local Government Act 1958* (as amended by the *Local Government (Amendment) Act 1962*) and of every other power enabling them in this behalf the Mayor Councillors and Citizens of the City of Caulfield do hereby order as follows:—

1. Throughout this By-law, unless inconsistent with the context or subject matter—
“City” shall mean the City of Caulfield.
“Council” shall mean the Council of the City of Caulfield.

2. By-law No. 69 and By-law No. 104 are hereby repealed.
3. No person shall throw place or leave upon any public highway orange peel, banana peel, or other vegetable matter.
4. No person shall deposit or leave refuse or rubbish—
(a) on any street road lane or passage; or
(b) on any land.
5. The Council may, by notice in writing to be served on the owner or occupier of any land, require the removal or destruction by such owner or occupier of refuse or rubbish thereon (other than refuse or rubbish the removal of which the Council has undertaken or contracted for under Section 48 of the *Health Act 1958*) within the number of days to be set forth in such notice and, if the person so served shall fail to comply with such notice, he shall be guilty of an offence against this By-law.
6. Any person guilty of an offence against this By-law shall be liable to a penalty of not less than Ten pounds nor more than Twenty pounds, and in the case of a continuing offence to a penalty of not more than Five pounds for each day on which an offence against the By-law is continued after a conviction or an Order by any Court.
7. This By-law shall have force and apply throughout the whole of the municipal district of the City of Caulfield.

Resolution for passing this By-law agreed to by the Council of the City of Caulfield on the 9th day of February, 1965, and confirmed on the 9th day of March, 1965.

The common seal of the Mayor Councillors and Citizens of the City of Caulfield was hereunto affixed in the presence of—

(SEAL) ERNEST E. GUNN, Councillor.
H. G. NELSON, Town Clerk.

5106

CITY OF FITZROY.

LOAN No. 23.

(Re-Advertized).

Notice of Intention to Borrow the Sum of £27,500 for Permanent Works and Undertakings.

NOTICE is hereby given that the Council of the City of Fitzroy proposes to borrow the principal sum of Twenty-seven thousand five hundred pounds (£27,500) on the credit of the municipal revenues of the Mayor, Councillors and Citizens of the said City, such sum to be raised by the grant of a mortgage in accordance with the provisions of the *Local Government Act 1958*.

(1) The maximum rate of interest that may be paid is £5 10s. per centum per annum.

(2) The purpose for which the loan is to be applied is as follows:—

£16,000—Amenities Block—Baths.
£11,500—Renovations—Town Hall.

(3) The period of the loan shall be twenty-five (25) years.

(4) The loan shall be repayable by fifty (50) equal half-yearly instalments, including principal and interest, of approximately £1,081 12s. 7d. each, on the 1st day of May and the 1st day of November, in each respective year, during the currency of the loan. The first instalment shall be payable at the Commonwealth Bank of Australia, Melbourne, or at the Council's bankers, for the time being in Melbourne.

(5) The plans, specifications and estimate of the cost of the works referred to above, and statement showing the proposed expenditure of the money to be borrowed, are open for inspection at the Town Hall, Fitzroy, during office hours.

Dated this 16th day of March, 1965.

5054 J. O'HALLORAN, Town Clerk.

CITY OF MELBOURNE.

AMENDED HYDRAULIC SUPPLY TARIFFS.

Schedule of Amended Tariffs.

NOTICE is hereby given that the Council of the City of Melbourne at a meeting held on 1st March, 1965, adopted the under-mentioned Schedule of Amended Tariffs for Hydraulic Supply and Services, provided by the Corporation's Hydraulic Supply Department, and the tariffs as amended will be effective on all accounts, rendered on and after 15th April, 1965.

WATER.

First—30,000 gallons per quarter 28s. 6d. per 1,000 gallons.
Next—40,000 gallons per quarter 20s. 6d. per 1,000 gallons.
All further consumption per quarter 14s. per 1,000 gallons.
Minimum charge—£30 per quarter.

SERVICES.

Hydrants £30 per quarter.
Sprinklers £30 per quarter.

5094

GEO. SMITH, Acting Town Clerk.

(Twelfth Schedule).

Town and Country Planning Act 1961.

CITY OF MALVERN PLANNING SCHEME 1957.

NOTICE THAT A PLANNING SCHEME HAS BEEN PREPARED AND IS AVAILABLE FOR INSPECTION.

Amendment No. 3.

NOTICE is hereby given that the Council of the City of Malvern in pursuance of its powers under the *Town and Country Planning Act 1961* has prepared a Planning Scheme for the whole of the municipal district of the City of Malvern (bounded by Kooyong-road, Dandenong-road, Warrigal-road, Gardiner's Creek and the River Yarra) for the purpose of:—

- (1) restricting and regulating the number of flats which may be erected on any one site and the creation of four new residential zones (to replace the existing Residential Zone under the Council's adopted Planning Scheme) for this purpose and
- (2) alterations to the permitted uses to which land may be put in various zones and
- (3) alterations to the existing boundaries of various zones.

A copy of the scheme has been deposited at the office of the Council at the corner of Glenferrie-road and High-street, Malvern and at the office of the Town and Country Planning Board, 179 Queen-street, Melbourne, and will be open for inspection during office hours (9 a.m. to 4.30 p.m.—Mondays to Fridays—public holidays excepted) by any person free of charge.

Any persons affected by the Planning Scheme are required to set forth in writing all objections they may have, addressed to

The Town Clerk, City of Malvern, City Hall, Malvern, S.E.4.

on or before the 26th day of April, 1965, and to state whether they wish to be heard in respect of their objections.

D. W. LUCAS, Town Clerk.

19th March, 1965.

5093

CITY OF PORT MELBOURNE.

BY-LAW No. 150.

A By-law of the City of Port Melbourne numbered 150 made under the powers conferred by the *Local Government Acts* and every other power thereto enabling for the purpose of—

- (a) Prohibiting on from and after a date specified herein the erection or placing against or in front of any house or building abutting on any public footway in any street or part thereof specified herein of any verandah over or across such footway, unless such verandah is supported by cantilevers, brackets, or projecting supports and not otherwise, and
- (b) requiring the pulling down and removal before a date specified herein of all verandahs erected or placed against or in front of any house or building abutting on any public footway which verandahs are upon or across such footway and are supported otherwise than by cantilevers, brackets or projecting supports.

IN pursuance of the powers aforesaid the Mayor, Councillors and Citizens of the City of Port Melbourne hereby makes the following by-law and doth order as follows:—

1. "That regulation No. 29 of the said City shall be and the same is hereby repealed."

2. No person shall on from or after the first day of April, 1965, erect or place against or in front of any house or building abutting upon any public footway in any street or part thereof within the Municipal District of the City of Port Melbourne any verandah over or across such footway unless such verandah is supported by cantilevers, brackets or projecting supports and not otherwise.

3. The owner of any verandah erected or placed before the first day of April, 1965, against or in front of any house or building abutting upon any such public footway which verandah is upon over or across such footway and is supported otherwise than by cantilevers brackets or projecting supports shall pull down and remove such verandah before the first day of April, 1975.

4. This by-law shall apply to and have operation throughout the Municipal District of the City of Port Melbourne.

5. Every person who is guilty of an offence against this By-law shall be liable on conviction to a penalty of not more than £20 and in case of a continuing offence to a penalty of not more than £5 for each day on which such offence is continued after a conviction by any Court.

Resolution for the passing of this By-law was agreed to by the Council of the City of Port Melbourne on the Fifteenth day of December, 1964, and was confirmed at a meeting of the said Council held on the Second day of February, 1965.

The Common Seal of the Mayor, Councillors and Citizens of the City of Port Melbourne was hereto affixed this Second day of February, 1965, in the presence of—

(SEAL) T. T. BUCKINGHAM, Mayor.
L. S. TURNER, Councillor.
A. T. AANESSEN, Town Clerk.

Approved by the Governor-in-Council on the 10th day of March, 1965.—J. COLQUHOUN, Clerk of the Executive Council. 5107

CITY OF PRAHRAN.

LOAN No. 37.

Notice of Intention to Borrow the Sum of £75,000 for Permanent Works and Undertakings.

NOTICE is hereby given that the Council of the City of Prahran proposes to borrow the principal sum of Seventy-five thousand pounds on the credit of the municipal revenues of the Mayor, Councillors and Citizens of the said City, such sums to be raised by the grant of a mortgage in accordance with the provisions of the Local Government Act 1958.

1. The maximum rate of interest that may be paid is 5½ per cent. per annum.

2. The purpose for which the loan is to be applied is housing and reclamation.

3. The period of the loan shall be fifteen years.

4. The moneys borrowed shall be repayable by providing out of the municipal fund 30 half-yearly instalments of approximately £3,703 16s. 7d. each, including principal and interest, on the 1st day of July and the 1st day of January, during the currency of the loan. The first instalment shall be payable on the 1st day of January, 1966.

5. Such moneys shall be repayable to the Housing Commission, Victoria Death Benefits Fund, 179 Queen-street, Melbourne.

The plans and specifications and the estimate of the cost of the proposed works and a statement showing the proposed expenditure of the moneys to be borrowed, are open for inspection at the office of the Council of the City of Prahran, at Chapel-street, Prahran.

Dated 16th January, 1965.

5055 H. T. JONES, Town Clerk.

SHIRE OF ALEXANDRA.

BY-LAW No. 42.

A By-law of the Shire of Alexandra, made under the Dog Act 1958 as amended by any Act, and numbered 42 for fixing registration and other fees and amounts thereunder and for repealing By-laws Numbers 32 and 40.

IN pursuance of the powers conferred by the Dog Act 1958 as amended by any Act and of any and every other power it thereunto enabling, the President Councillors and Ratepayers of the Shire of Alexandra order as follows:—

1. By-law Number 32 entitled "A By-law of the Shire of Alexandra, made under the Dog Acts and numbered 32, for fixing registration and other fees thereunder" and By-law Number 40 entitled "A By-law of the Shire of Alexandra, made under the Dog Acts and numbered 40 for amending By-law 32 fixing the fees and sums payable pursuant to the Dog Acts" are hereby repealed.

2. The following registration and other fees and amounts are hereby fixed pursuant to the Dog Act 1958 as so amended (hereinafter called "the said Act")—

	£	s.	d.
(a) Registration fee, pursuant to Section 6 of the said Act	7	6	
(b) For the particulars of any dog, for the name of the registered owner thereof and for a certified copy of the receipt mentioned in Section 11 of the said Act, amount of fee, pursuant to Section 12 of the said Act	2	6	
(c) Amount payable to the registration officer on reclamation of a dog, pursuant to Sub-section (4) of Section 15 of the said Act	3	0	0
(d) Amount payable to the registration officer for the cost of keeping a dog, pursuant to Section 16 of the said Act	3	0	0

3. This by-law shall apply to and have operation throughout the whole of the municipal district of the Shire of Alexandra.

Resolution for passing this by-law agreed to by the Council of the Shire of Alexandra on the 10th day of February, 1965, and confirmed on the 10th day of March, 1965.

The common seal of the President, Councillors and Ratepayers of the Shire of Alexandra was hereto affixed this 10th day of March, 1965 in the presence of—

(SEAL) J. W. POLLOCK, President.
T. COOKE, Councillor.
R. G. HATFIELD, Shire Secretary.

5056

SHIRE OF ALTONA.

LOAN 56.

Notice of intention to borrow the sum of Fifty Thousand Pounds for Permanent Works and Undertakings.

NOTICE is hereby given—

(a) That the Council of the Shire of Altona proposes to borrow the principal sum of Fifty thousand pounds on the credit of the municipal reserves of the President, Councillors and Ratepayers of the said Shire by the grant of a mortgage under the provisions of the Local Government Act.

(b) The maximum rate of interest to be paid is £5 7s. 6d. per centum per annum.

(c) The period of the loan shall be ten years, and such moneys shall be repayable at the office of the Australian Natives Association at 28 Elizabeth-street, Melbourne, or at such other place or places as the Association may from time to time require.

(d) The purposes for which the loan is to be applied are as follows:—

(a) Road making plant purchase	£15,000
(b) Depot building at 151 Civic-parade Altona	5,000
(c) Additions to Altona Civic Offices	15,000
(d) Purchase of Dental Clinic equipment	1,000
(e) Part cost of Millers-road pedestrian underpass	4,000
(f) Purchase of office equipment	3,000
(g) Altona rubbish tip access roadway	2,000
(h) Construction of Kyle-road, Altona North.	5,000
	£50,000

(e) The moneys borrowed shall be repayable by providing out of the municipal fund approximately £4,068 18s. 10d. annually for ten years, to be invested in accordance with the said Act to form a sinking fund, and interest to be paid annually during the currency of the loan. The first payments shall be on 1st June, 1966.

The plans, specifications and estimates of the cost of the proposed works and a statement showing the proposed expenditure of the moneys to be borrowed, are open for inspection at the Civic Offices, 115 Civic-parade, Altona, during office hours.

5179

JAMES W. WATERS, Shire Secretary.

Dog Act 1958.

SHIRE OF BARRABOOL.

THE Council of the Shire of Barrabool orders that the following areas be specified for the purpose of section 17 of the Dog Act 1958:—

1. The shopping area commencing at the intersection of Ocean-road and McDougall-street, Anglesea, to the intersection of Camp-road and Ocean-road, Anglesea.

2. The shopping area commencing at the intersection of Noble-street and the Ocean-road to the intersection of Tonge-street and the Ocean-road, Anglesea.

3. The bathing beaches of Anglesea, Fairhaven, Aireys Inlet, Eastern View, Moggs Creek, Bells Beach and Jan Juc.

5174

G. L. PEARCE, Shire Secretary.

SHIRE OF BARRABOOL.

PROSECUTING OFFICER.

NOTICE is given that Senior Constable G. Hyde of the Belmont Police Station, Geelong, has been appointed Prosecuting Officer for the Shire of Barrabool in lieu of Senior Constable F. Marsh, Retired.

5175

G. L. PEARCE, Shire Secretary.

SHIRE OF BARRABOOL.

BY-LAW No. 24.

A By-law of the Shire of Barrabool made in pursuance of the powers conferred by the Local Government Act 1958 and Numbered 24 for the adoption of Part of the Fifteenth Schedule.

IN pursuance of the powers conferred by the Local Government Act 1958, the President, Councillors and Ratepayers of the Shire of Barrabool order as follows:—

That Part I. of the XVth Schedule of the Local Government Act 1958 shall apply and have operation throughout the Municipal district of the Shire of Barrabool.

Resolution for passing this By-law agreed to by the Council on the 17th day of February, 1965, and confirmed on the 17th day of March, 1965.

G. W. F. MCINTYRE, Shire President.

R. W. PETTITT, Councillor.

G. L. PEARCE, Shire Secretary.

5176

SHIRE OF BARRABOOL.

LOAN No. 1.

Private Street Construction.

NOTICE is given that at a meeting of the Council of the Shire of Barrabool held on Wednesday, 17th February, 1965, the Council did agree to a resolution for the borrowing of £19,000 by the grant of a mortgage in accordance with the provisions of the Local Government Act 1958.

The rate of interest to be paid shall be £5 7s. 6d. per centum per annum, and the said loan shall be liquidated by 20 half-yearly instalments of £1,240 9s. 9d. covering principal and interest at the Australia and New Zealand Bank Limited, 2 Malop-street, Geelong, on the several days and in the several amounts specified in the Schedule of Repayments.

The purpose for which the said loan shall be applied are for the construction of private streets under the provision of Division 10 of Part XIX. of the Local Government Act 1958, and the loan shall be liquidated from the receipts of money payable under schemes under the said Division.

Notice is given that at a meeting of the said Council held at the Shire Hall, Mount Moriac, on the 17th March, 1965, the said resolution was confirmed.

5177

G. L. PEARCE, Shire Secretary.

SHIRE OF BARRABOOL.

LOAN No. 16.

Notice of Intention to Borrow the Sum of £5,000 for Permanent Works and Undertakings.

NOTICE is hereby given that the Council of the Shire of Barrabool proposed to borrow the principal sum of Five thousand pounds on the credit of the municipal revenues of the President, Councillors and Ratepayers of the said Shire, such sum to be raised by the grant of a mortgage, in accordance with the provisions of the Local Government Act 1958.

1. The maximum rate of interest that may be paid is £5 5s. per centum per annum.

2. The purpose for which the loan is to be applied is—
Purchase of Plant: £5,000.

3. The period of the loan shall be five years.

4. The moneys borrowed shall be repayable by providing out of the municipal fund ten half-yearly instalments of approximately £574 19s. 10d. each, including principal and interest, on the 1st day of December and 1st day of June during the currency of the loan. The first instalment shall be payable on the 1st day of December, 1965.

5. Such moneys shall be repayable at the Australia and New Zealand Bank Limited, 2 Malop-street, Geelong, or at the Council's bankers for the time being in Melbourne.

The plans and specifications and the estimate of the cost of the proposed works, and a statement showing the proposed expenditure of the moneys to be borrowed, are open for inspection at the office of the Council of the Shire of Barrabool, 441 Moorabool-street, South Geelong.

Dated 17th March, 1965.

5178

G. L. PEARCE, Shire Secretary.

SHIRE OF BULN BULN.

BY-LAW No. 66.

A By-law of the Shire of Buln Buln made under the Dog Acts and numbered 66 for amending By-law No. 40 and for fixing fees under the said Acts.

IN pursuance of the powers conferred by the Dog Acts and of any and every other power it thereunto enabling the President, Councillors and Ratepayers of the Shire of Buln Buln, order as follows:—

1. Sub-clauses (c) and (d) of clause 2 of By-law No. 40 shall be and are hereby repealed and the following sub-clauses substituted therefor:—

“(c) Sum payable to the Registration Officer pursuant to section 15 of the Dog Act 1958 £1 0 0.

(d) Sum payable to the Registration Officer pursuant to section 16 of the Dog Act 1958 £1 0 0.”

2. This By-law shall apply to and have operation throughout the whole of the municipal district of the Shire of Buln Buln.

Resolution for passing this By-law agreed to by the Council of the Shire of Buln Buln on the 15th day of February 1965, and confirmed on the 15th day of March, 1965.

The common seal of the President Councillors and Ratepayers of the Shire of Buln Buln was hereto affixed in pursuance of an Order of the Council made on the 15th day of March 1965—

5182

(SEAL)

W. L. KRAFT, Shire President.

B. M. CONDON, Councillor.

K. A. PRETTY, Shire Secretary.

SHIRE OF CRANBOURNE.

NOTICE OF INTENTION TO TAKE LAND COMPULSORILY.

NOTICE is hereby given that it is the intention of the Council of the Shire of Cranbourne, in exercise of the powers conferred on it by the Local Government Act 1958, to take compulsorily “the whole of the land contained in Certificate of Title, volume 6211, folio 1242160 (being the site of the former Langwarrin Tennis Courts).”

The said land is required for and being taken for the following work or undertaking by the said Council.

Providing a site for a place of public resort and recreation.

The Council has caused to be prepared a map and other papers showing the nature and extent of such work or undertaking and more particularly describing the said land and the exact site and measurements thereof, and the names of the owners or reputed owners, lessees, or reputed lessees, mortgagees and occupiers of that land so far as those names are known to or can be ascertained by the Council.

The said map and other papers have been approved by the Council and are now deposited for inspection by all persons interested, at the office of the Shire of Cranbourne, situated at Cranbourne, and may be inspected there during office hours.

All persons affected by the proposed work or undertaking are hereby required to set forth, in writing, addressed to the said Council or to the Shire Secretary within 40 clear days from the publication of this notice in the Victoria Government Gazette, all objections which they may have to such work or undertaking.

Dated this 19th day of March, 1965.

By Order of the Council,

5111

T. W. GRANT, Shire Secretary.

SHIRE OF CROYDON.

LOAN No. 43.

Notice of Intention to Borrow the Sum of £10,000 for Permanent Works and Undertakings.

NOTICE is hereby given that the Council of the Shire of Croydon proposes to borrow the principal sum of Ten thousand pounds (£10,000) on the credit of the municipal revenues of the President, Councillors and Ratepayers of the said Shire, such sum to be raised by the grant of a mortgage in accordance with the provisions of the Local Government Act 1958.

1. The maximum rate of interest that may be paid is £5 7s. 6d. per centum per annum.

2. The purpose for which the loan is to be applied is—

Item 1.—Construction of Roads, Kerbs, Channels and Footpaths at Kitchener-road Mena-avenue, Mt. Dandenong-road, Croydon-road	£2,850
Item 2.—Construction of drains at Hughes Park, Hinkley-avenue, Valentino-drive, Donald-street, Canterbury-road—Gracedale-avenue, Greenhill-road—Wattle-road, Bayswater-road—Central-avenue, Bayswater-road, adjacent Cheong Park, and Kent-avenue	£7,150
Total	£10,000

3. The period of the loan shall be ten years.

4. The moneys borrowed shall be repayable by providing out of the municipal fund twenty half-yearly instalments of approximately £652 17s. 9d. each, including principal and interest, on the 1st day of January and the 1st day of July, during the currency of the loan. The first instalment shall be payable on the 1st day of January, 1966.

5. Such moneys shall be repayable to the Commissioners of the State Savings Bank of Victoria at the office of the said Commissioners, 139-165 Elizabeth-street, Melbourne.

The plans and specifications and the estimate of the cost of the proposed works and a statement showing the proposed expenditure of the moneys to be borrowed are open for inspection at the office of the Council of the Shire of Croydon at 1-3 Railway-crescent, Croydon.

K. A. McKAY, Shire Secretary.

5109

SHIRE OF FRANKSTON.

LOAN No. 96.—£25,000.

Special Order.

NOTICE is hereby given that the Council of the Shire of Frankston did at a meeting held on Monday, 22nd February, 1965, agree to the following resolution—

1. That this Council borrow the sum of £25,000 by the grant of a mortgage for such amount secured on the credit of the President, Councillors and Ratepayers of the Municipality in accordance with the provisions of section 585 of the Local Government Act 1958, as amended.

2. That the rate of interest to be paid be £5 7s. 6d. per centum per annum.

3. That the period of the loan be ten (10) years and that the moneys borrowed be repayable by half yearly instalments of £1,632 4s. 5d. approximately, including principal and interest, on the 1st day of April and the 1st day of October, during the currency of the loan, the first instalment being payable on the 1st day of October, 1965.

4. That such moneys be repayable at the Commonwealth Savings Bank of Australia, Melbourne.

5. That the loan be applied for the purpose of constructing private streets within the Shire of Frankston in pursuance of and in accordance with the provisions of Division 10 of Part XIX. of the Local Government Act 1958.

And notice is hereby further given that the said Council did at a meeting held on Monday, 22nd March, 1965, confirm such resolution.

G. C. PENTLAND, Shire Secretary.

Shire Office, Frankston. 5110

SHIRE OF NARRACAN.

NOTICE is hereby given that First Constable James Baden Philp, No. 11333, has been appointed Prosecuting Officer for the Waihalla Riding of the Shire of Narracan, vice First Constable J. T. Bourke, transferred.

5063

W. F. NELSON, Shire Secretary.

SHIRE OF SWAN HILL.

BY-LAW No. 58.

Unightly Land.

A By-law of the Shire of Swan Hill made under section 197 of the Local Government Acts, and numbered 58 requiring that any land in the municipal district, which the Council by notice in writing to the owner or occupier has declared to be unsightly or destructive of the amenity of the neighbourhood, shall be enclosed with a sufficient fence of such material and in such manner as is prescribed by this By-law.

IN pursuance of the powers conferred by the Local Government Acts, the President, Councillors and Ratepayers of the Shire of Swan Hill order as follows:—

1. In this By-law unless inconsistent with the context or subject-matter "Council" means the Council of the Shire of Swan Hill, "Municipality" means the municipal district of the Council.

2. Every owner or occupier of land within the municipality on being served with a notice in writing from the Council declaring such land to be unsightly or destructive of the amenity of the neighbourhood shall enclose such land with a sufficient fence of such material and in such manner as is hereinafter prescribed within 30 days of the service of such notice.

3. It is hereby prescribed that every fence shall be of the materials and constructed in the following manner:—

- (i) posts—5" by 3" red gum or jarrah suitably constructed 2' 0" in the ground and centres not to exceed 9' 0";
- (ii) rails—top, bottom and centre, 3" by 2" hardwood;
- (iii) plinth—6" by 1";
- (iv) palings—fence to be covered by new ½" sawn palings lapped 1" on each side;
- (v) height—not less than 6' 3" above ground level trimmed to a line on top;
- (vi) general—lands situated at the intersection of two streets, fence to be splayed for a distance of 30' from the intersection of the building line of such streets.

Provided that the Council may approve an application made in writing by any owner or occupier for permission to have a fence constructed of other suitable materials or to vary any of the above provisions.

4. Any person guilty of a wilful act or default contrary to this By-law shall be liable to a penalty of not less than £5 nor more than £20 and to a further penalty of not more than £5 for each day on which such offence is continued after conviction or order is made by any Court.

5. This By-law shall apply to and have operation throughout the whole of the municipal district of the Shire of Swan Hill.

Resolution for passing this By-law agreed to by the Council of the Shire of Swan Hill on the 7th day of October, 1964, and confirmed on the 11th day of November, 1964.

The common seal of the President, Councillors and Ratepayers of the Shire of Swan Hill was affixed hereto this 12th day of November, 1964, in the presence of—

E. F. BUTLER, Shire President.

(SEAL) T. BRIGHT, Councillor.

5180

J. D. LAURITZ, Shire Secretary.

SHIRE OF SWAN HILL.

BY-LAW No. 59.

Uniform Building Regulations.

A By-law of the Shire of Swan Hill made under the provisions of the Local Government Act and the Uniform Building Regulations and numbered 59, for determining, applying, dispensing with or regulating such matters or things as are left to be determined, applied, dispensed with or regulated by the Council of the said Shire under the Uniform Building Regulations, Victoria.

IN pursuance of the powers conferred by the Local Government Acts and the Uniform Building Regulations, Victoria, and of any and every power it thereunto

enabling, the President, Councillors and Ratepayers of the Shire of Swan Hill order as follows:—

1. OPERATION.

This By-law shall apply to and have operation in those parts of the Shire of Swan Hill known as Nyah, Nyah West and Woorinen and more particularly described as follows:—

- (i) Crown allotments 34 and 35, section 2, Parish of Tyntynder North. Crown allotment 11, Parish of Tyntynder West, the Township of Nyah West (Gaz. 15-2981), Parish of Tyntynder West and Crown allotments 1 and 1A, section 1, Parish of Tyntynder West.
- (ii) Township of Nyah (Gaz. 94-869, 4340), Crown allotments 20, 12, 13, 6, 7 and 1 of B, section 2, Parish of Tyntynder North and all that area bounded by a line commencing at the north-east corner of Crown allotment 12, section 2, Parish of Tyntynder North; thence westerly to north-west corner of Crown allotment 10A, section 2, Parish of Tyntynder North; thence due north by a line to the southern boundary of Crown allotment 6, section 1, Parish of Tyntynder North; thence east along such southern boundary to the south-east corner of such allotment; thence generally south-easterly and southerly to the point of commencement.
- (iii) All that area being the Township of Woorinen and those parts of the Parishes of Woorinen, Tyntynder and Castle Donnington bounded by a line commencing at the north-east corner of Crown allotment 75, Parish of Woorinen; thence southerly by a road to a point opposite the north-west corner of Crown allotment 44, section G, Parish of Tyntynder; thence generally easterly, southerly and westerly by a line and the boundary of Crown allotment 44, section G, Parish of Tyntynder to the north-east corner of Crown allotment 20, section A, Parish of Tyntynder; thence southerly by the eastern boundary of that allotment and its continuation to a point on the north boundary of Crown allotment 64, section B, Parish of Castle Donnington; thence generally easterly and southerly by the boundary of Crown allotment 64, section B, Parish of Tyntynder to its eastern corner; thence westerly by a road forming the southern boundaries of Crown allotment 64, section B, Parish of Castle Donnington and Crown allotment 18, Parish of Woorinen to the south-western corner of Crown allotment 18, Parish of Woorinen; thence northerly by the western boundary of that allotment, and westerly by the northern boundary of that allotment to a road; thence north-westerly by that road to the north-western corner of Crown allotment 75, Parish of Woorinen; thence easterly by the northern boundary of that allotment to the point of commencement.

2. MINIMUM AREA, DEPTH AND WIDTH OF FRONTAGE.

The minimum area, depth and width of frontage specified in Column 4 of Table 804 of the Uniform Building Regulations, Victoria, are hereby adopted as the minimum area, depth and width of frontage of land on which a building of Class 1 or Class 2 occupancy as defined by the said Uniform Building Regulations, Victoria, shall be constructed throughout those portions of the Shire of Swan Hill set out and described in Clause 1 hereof.

3. DISTANCE FROM STREET FRONTAGE.

No person shall construct a building of Classes 1 and 2 occupancy, the outer walls of which are closer to the frontage of any land than 25 feet throughout those portions of the Shire of Swan Hill set out and described in Clause 1 hereof.

Resolution for passing this by-law agreed to by the Council of the Shire of Swan Hill on the 11th day of November, 1964, and confirmed on the 9th day of December, 1964.

The common seal of the President, Councillors and Ratepayers of the Shire of Swan Hill was affixed hereto this 10th day of December, 1964, in the presence of—

(SEAL) E. F. BUTLER, Shire President.
T. BRIGHT, Councillor.
J. D. LAURITZ, Shire Secretary.

Approved by the Governor in Council, 9th February, 1965.—J. ROSSITER, Acting Clerk of the Executive Council.

5181

Town and Country Planning Act 1961 (Twelfth Schedule).
SHIRE OF WERRIBEE.—PLANNING SCHEME 1963.

NOTICE THAT A PLANNING SCHEME HAS BEEN PREPARED AND IS AVAILABLE FOR INSPECTION.

Extension of Objection Period.

NOTICE is hereby given that the Shire of Werribee, in pursuance of its powers under the Town and Country Planning Act 1961, has prepared a Planning Scheme for:

- (a) Land described as Crown allotments 1, 1A, 2, 3, 19, 20, 21, 22, 23, 24, section 18, and Crown allotment 2, section 19, Parish of Mambourin, County of Grant, for the purpose of re-zoning the said land from Agricultural to Residential and Commercial "B".

A copy of the scheme has been deposited at the Municipal Offices, Watton-street, Werribee, and at the offices of the Town and Country Planning Board, 179 Queen-street, Melbourne, and will be open for inspection during office hours by any person free of charge.

Any persons affected by the Planning Scheme are required to set forth, in writing, all objections they may have, addressed to the Shire Secretary, Shire of Werribee, Municipal Offices, Werribee, on or before the 24th day of June, 1965, and to state whether they wish to be heard in respect of their objections.

19th March, 1965.

5121

N. G. MINNS, Shire Secretary.

COBRAM SEWERAGE AUTHORITY.

PURSUANT to the Sewerage Districts Act the Cobram Sewerage Authority gives notice:—

- (a) that the nature of works in respect of which the land hereinafter described is proposed to be taken is to Construct Sewerage Treatment Ponds, and an Effluent Irrigation Area,
- (b) a plan or description of the proposed work will be open for inspection at the Shire Offices of the Shire of Cobram on 15th March, 1965, to 15th April, 1965, both inclusive from 9 a.m. to 5.15 p.m. each day,
- (c) the quantity of the land the Sewerage Authority requires for the purpose of works described above, is 338 acres, 2 roods and 13 perches or thereabouts and,
- (d) the land proposed to be taken is Crown Allotments 20, 20A, 21A, and 21B, Section D, Parish of Yarroweyah, County of Moira, including such part of Easement No. 1893303, to the State Rivers and Water Supply Commission, as affects the land proposed to be taken compulsorily.

Dated the 24th day of February, 1965.

The common seal of the Chairman, Members and Ratepayers of the Cobram Sewerage Authority was hereunto affixed this 24th day of February, 1965, in the presence of—

(SEAL) JOHN E. C. RADCLIFFE, Chairman.
M. H. SINCLAIR, Member.
RONALD T. CUTTS, Secretary.

4945

WODONGA SEWERAGE AUTHORITY.

GENERAL NOTICE.

THE above-mentioned Sewerage Authority, having made provision for carrying off the sewage from each and every property which, or any part of which, is within the sewerage areas hereinafter described, doth hereby declare that on and after the 1st day of April, 1965, each and every property which, or any part of which, is within the said sewerage areas shall be deemed to be a sewered property within the meaning of the Sewerage Districts Act 1958.

The boundaries of the Sewerage Areas hereinbefore referred to are:—

1. Commencing from a point being the intersection between western side of Snowdon-street and northern side of Woodland-street; thence westerly along northern side of Woodland-street to and across Beardmore-street and continuing in same westerly direction till intersection with House Creek; thence following the course of House Creek in general northerly direction to and across Lawrence-street; thence northerly to and across Hume Highway; thence northerly along the same course till intersection of House Creek with railway lines; thence along southern side of railway lines south-easterly to a point 260 feet north-west of the western side of High-street; thence 280 feet in a southerly direction to a point 100 feet south-east of the eastern side of Hume-street on

the southern side of Elgin-street; thence north-westerly along southern side of Elgin-street to and across Hume-street; thence continuing in a north-westerly and westerly direction to the point of intersection with eastern side of Smythe-street; thence along eastern side of Smythe-street to and across Stanley-street to the point being intersection between southern side of Stanley-street and eastern side of Smythe-street; thence westerly across Smythe-street and along southern side of Stanley-street to and across Railway-street; thence westerly along southern side of Stanley-street till intersection with eastern side of Watson-street; thence southerly along eastern side of Watson-street to and across Lawrence-street intersecting the southern side of Lawrence-street at a distance of 130 feet west of western side of Lyndren-street; thence westerly along southern side of Lawrence-street to and across Watson-street; thence continuing westerly along southern side of Lawrence-street to and across Snowdon-street to the point being intersection between southern side of Lawrence-street and western side of Snowdon-street; thence southerly along western side of Snowdon-street to the point of commencement.

2. Commencing from a point being the intersection between southern side of Brockley-street and western side of Lindsay-street; thence southerly along western side of Lindsay-street to and across Strathmore-street; thence southerly along western side of Lindsay-street till the intersection of northern side of James-street; thence westerly along northern side of James-street to intersection with eastern side of Hereford-street; thence northerly along eastern side of Hereford-street to and across Strathmore-street; thence northerly along the eastern side of Hereford-street till intersection with southern side of Brockley-street; thence easterly along southern side of Brockley-street to the point of commencement.

3. Commencing from a point being the intersection between western side of Gordon-street and northern side of Pearce-lane; thence westerly along the northern side of Pearce-lane to and across Lawry-street; thence westerly along Pearce-lane to and across Margaret-street; thence continuing westerly along Pearce-lane to and across Gilbert-street; thence westerly along northern side of Pearce-lane till the intersection with House Creek; thence in a general northerly direction following the course of House Creek and western boundary of Martin Park Recreation Reserve to the point being intersection between southern and western boundaries of Wodonga Hospital; thence easterly along the northern boundary of Martin Park Recreation Reserve for a distance of 1,400 feet intersecting western side of Gordon-street at a point 1,060 feet south from southern side of Wilson-street; thence southerly along western side of Gordon-street to and across Elm-street; thence continuing southerly along western side of Gordon-street to the point of commencement.

J. S. HORE, Chairman.

G. J. MORTON, Secretary.

5105

WESTERNPORT WATERWORKS TRUST.

NOTICE to owners of tenements and land in the under-mentioned streets in the Westernport Waterworks Trust are and private streets, lanes, courts and alleys opening thereto:—

Highland-avenue, between Church-street and lot 99, Highland-avenue.

Raywood-avenue, between Church-street and lot 107, Raywood-avenue.

Seascape-avenue, between Church-street and lot 137, Seascape-avenue.

Kedah-road, between Church-street and approximately 1 chain south Perlis-avenue.

Perlis-avenue, between Kedah-road and McKenzie-road.

Roydon-road, between Church-street and approximately 10 chains south Church-street.

Road, between Roydon-road and Wyndham-avenue.

Wyndham-road, between Church-street and 9½ chains south Church-street.

Alexander-avenue, between Church-street and Settlement-road.

Osborne-avenue, between Church-street and Settlement-road.

Anderson-road, between lot 6, south to Church-street.

Devon-avenue, between lot 38, south to Church-street.

Cornwall-avenue, between lot 25, south to Church-street.

McHaffie-drive, between 2 chains south of Esplanade to Church-street.

McKenzie-road, between 1 chain south of Esplanade, to 2 chains south Perlis-avenue.

Beach-street, between McKenzie-road and Osborne-road.

Vaughan-street, between Church-street and Osborne-road.

Genesta-street, between Church-street and Kennon-court.

Dunsmore-road, between Stradbroke-avenue to 3 chains south, Church-street.

Broughton-avenue, between Stradbroke-avenue and Perry-avenue.

Perry-avenue, between from lot 15 east to Rose-avenue.

Rose-avenue, between Stradbroke-avenue and south to lot 25 Rose-avenue.

Gordon-street, between Dunsmore-road and Broughton-avenue.

Stradbroke-avenue, between Dunsmore-road to 4 chains east Rose-avenue.

Church-street, between Anderson-road and Dunsmore-road.

Chapel-street, between Osborne-road and Dunsmore-road.

Osborne-road, between Esplanade and Church-street.

Walpole-street, between Esplanade and Chapel-street.

Warley-avenue, between Esplanade and lot 3 south Genesta-street.

Bass-avenue, between Esplanade and Chapel-street.

Findlay-street, between Esplanade and Chapel-street.

Steele-street, between Esplanade and Church-street.

Esplanade, between Steele-street and Osborne-road.

Thompson-avenue, between Esplanade and Nobbies-road.

Settlement-road, between Anderson-road to 17 chains east Thompson-avenue.

Hartley-street, between Anderson-road and Bellavista-road.

Bellavista-road, between lot 446, Bellavista-road south to Hartley-street.

Langard-road, between lot 474, Langard-road, south to Chillingworth-avenue.

Medina-road, between lot 481, Medina-road, south to Chillingworth-avenue.

Justice-road, between lot 485, Justice-road, south for 14 chains.

Chillingworth-avenue, between Justice-road and Bellavista-road.

Newhaven.

Forrest-avenue, between Newhaven Boys' Home and Beach-crescent.

School-avenue, between Forrest-avenue and Cleeland-street.

Grant-road, between School-avenue and Fowler-grove.

Fowler-grove, between Cleeland-street and Grant-road.

Cleeland-street, between School-avenue to 6 chains east, Forrest-avenue.

Beach-crescent, between Forrest-avenue to 2 chains east, Seaview-crescent.

Seaview-crescent, between Beach-crescent and Anderson-street.

Anderson-street, between Newhaven-road, to 2 chains east, Seaview-crescent.

San Remo.

Bergin-grove, between Marine-parade to 3 chains south, Thomas-grove and Ocean-grove.

Thomas-grove, between Bergin-grove and Ocean-grove.

Edgar-road, between Marine-parade and Hazelwood-road.

Wynne-avenue, between Marine-parade and Hazelwood-road.

Shelley Beach-road, between Marine-parade, south to Hazelwood-road.

Panorama View-drive, between Marine-parade to 7 chains south, Anderson-street.

Keam-avenue, between Panorama View-drive to 10½ chains east.

Mount-drive, between Keam-avenue and Anderson-street.

Cassell-court, between Mount-drive to 3 chains east.

Anderson-street, between Panorama View-drive and Mount-drive.

Hazelwood-road, between Edgar-road and Shelley Beach-road.

Ocean-grove, between Thomas-grove to 9 chains south.

Woolamai-grove, between Marine-parade, south for 11 chains.

Marine-parade, between 2 chains east of Suspension Bridge, east to Water Trust Boundary.

Bass.

School-road, between Bass Highway, south-east for 3 chains.

Woolamai-road, between 8 chains south-east, thence 21½ chains east.

Bass Highway, starts 5 chains north Water Trust Boundary to 21 chains north-east, thence 10 chains north-west, veers north-east for 15 chains to lot 3, section 2.

Missens-lane, between Water Trust Boundary to Woolamai-road.

The main pipe in the streets being laid down the owners of all tenements situated as above are hereby required, on or before the 1st day of May, 1965, to cause a proper pipe and stop cocks to be laid, so as to supply water within such tenements from the main pipes.

STAN A. HARRIS, Secretary,
Westernport Waterworks Trust.

Trust Office, Thompson-avenue, Cowes, 17th March, 1965. 5102

**LORNE FISHERMEN'S CO-OPERATIVE SOCIETY
LIMITED.**

NOTICE is hereby given that the Lorne Fishermen's Co-operative Society Limited, of Lorne, has applied for a lease under section 134 of the *Land Act 1958*, for a term of twenty years over allotment 11, section 5, Township of Lorne, Parish of Lorne, containing 23 perches, as a site for Fish Freezing Works.

4745

L. B. ROGERS, Secretary.

I REGINALD ALFRED NICHOLLS, of 9 Jarrah-court, Frankston, Vic., will not be responsible for debts incurred in my name without my written authority.

5083

R. A. NICHOLLS.

LAND ACT 1958 (No. 6284, AS AMENDED BY ACT
No. 7075).

WHEREAS:

I. Application has been made pursuant to sub-section (1) of section 22c of the *Land Act 1958* by Bernard Flamank Egan and Ernest William Robert Hollis, the trustees for the time being of the land described in the Schedule hereto for permission to surrender the said land to Her Majesty Queen Elizabeth the Second.

II. By the said sub-section (1) it is provided that the Attorney-General may by notice published in the *Government Gazette* grant permission to the trustees to surrender the land to Her Majesty pursuant to the said section 22c and by sub-section (4) of the said section 22c it is further provided that the Attorney-General shall specify the purpose mentioned in section 14 of the *Land Act 1958* for which the land was vested in the trustees or was used or to which the purpose for which it was vested in the trustees or was used is in his opinion substantially similar.

Now I, the Honorable Arthur Gordon Rylah in my capacity as Her Majesty's Attorney-General for the State of Victoria—

- (a) Grant permission to the said trustees to surrender the said land to Her Majesty, pursuant to section 22c of the *Land Act 1958*; and
- (b) specify pursuant to sub-section (4) of section 22c aforesaid the following purpose mentioned in section 14 of the *Land Act* aforesaid, namely—
"the recreation convenience or amusement of the people"

SCHEDULE.

All that piece of land being part of Crown allotment C, section 14, Parish of Bolwarra, and being the whole of the land described in certificate of title, volume 7708, folium 098.

Given under my hand this 15th day of March, One thousand nine hundred and sixty-five—

A. G. RYLAH,
Attorney-General.

5192

I FRANCESCO PECAR, of 6 Charles-street, Newcomb, Geelong, in the State of Victoria, leading hand, heretofore called and known by the name of Francesco Pecchiar, hereby give public notice that by a deed poll dated the 26th day of February, 1965, duly executed, attested and deposited with the Registrar-General of the said State on the 11th day of March, 1965, I formally and absolutely renounced and abandoned on behalf of myself and of my wife, Denise Louise Pecar, the surname of Pecchiar, and declared that I and the said Denise Louise Pecar, had assumed and adopted and intended henceforth upon all occasions whatsoever, to use and subscribe the surname of Pecar, instead of the said surname of Pecchiar, and so as to be at all times thereafter called, known and described by the said surname of Pecar.

Dated the 12th day of March, 1965.

FRANCESCO PECAR.

Witness—J. A. CRAWCOUR, solicitor, Geelong. 5058

NOTICE OF INTENTION TO APPLY FOR A LICENCE TO DIVERT WATER AND CUT RACE FROM THE STEAVENSON RIVER, AT BUXTON.

I HEREBY give notice that I intend to apply for a licence empowering me to divert water for a term of six years to the extent of 8 acre-feet per annum at a maximum rate of 1 acre-foot per day of 24 hours for the irrigation of 3½ acres, being part of allotment 10, Parish of Buxton, County of Anglesey, and to occupy certain Crown lands for works of diversion, and to cut a race thereon.

Any objection to such application must be forwarded, in writing, to reach the State Rivers and Water Supply Commission, Melbourne, before 11th April, 1965, being 30 days from the first publication of this notice.

KATHLEEN WINSOME FERGUSON PARKES, per H. F. Parkes.

Maroondah Highway, Buxton, Victoria.

5156

NOTICE OF INTENTION TO APPLY FOR A LICENCE TO DIVERT WATER AND CUT RACE (RE-ISSUE) FROM THE OVENS RIVER, AT TARRAWINGEE.

I HEREBY give notice that I intend to apply for a licence empowering me to divert water for a term of eight years to the extent of 21 acre-feet per annum at a maximum rate of 1 acre-foot per day of 24 hours for the irrigation of 14 acres of tobacco, being part of allotment 7, Parish of Tarrawingee, and to occupy certain Crown lands for works of diversion, and to cut a race thereon.

Any objection to such application must be forwarded, in writing, to reach the State Rivers and Water Supply Commission, Melbourne, before 9th April, 1965, being 30 days from the first publication of this notice.

STANLEY JAMES DIFFEY.

Tarrawingee.

5157

NOTICE OF INTENTION TO APPLY FOR A LICENCE TO DIVERT WATER AND CUT RACE FROM THE OVENS RIVER, AT EUROBIN.

I HEREBY give notice that I intend to apply for a licence empowering me to divert water for a term of eight years to the extent of 22½ acre-feet per annum at a maximum rate of 1½ acre-feet per day of 24 hours for the irrigation of 15 acres of tobacco, being part of allotments 6 and 6a, section 31, Parish of Barwidgee, and to occupy certain Crown lands for works of diversion, and to cut a race thereon.

Any objection to such application must be forwarded, in writing, to reach the State Rivers and Water Supply Commission, Melbourne, before 8th April, 1965, being 30 days from the first publication of this notice.

FRANKLIN HEATHCOTE DAWSON.

"Lynton", Eurobin.

5158

NOTICE OF INTENTION TO APPLY FOR A LICENCE TO DIVERT WATER AND CUT RACE FROM THE OVENS RIVER, AT WHOROULY.

I HEREBY give notice that I intend to apply for a licence empowering me to divert water for a term of eight years to the extent of 90 acre-feet per annum at a maximum rate of 1½ acre-feet per day of 24 hours for the irrigation of 60 acres of tobacco and pasture, being part of allotment 72b and 72c, Parish of Whorouly, and to occupy certain Crown lands for works of diversion, and to cut a race thereon.

Any objection to such application must be forwarded, in writing, to reach the State Rivers and Water Supply Commission, Melbourne, before 23rd April, 1965, being 30 days from the first publication of this notice.

VINCENT VACCARO.

Prince-street, Myrtleford.

5159

NOTICE OF INTENTION TO APPLY FOR A LICENCE TO DIVERT WATER AND CUT RACE (RE-ISSUE) FROM THE OVENS RIVER, AT MYRTLEFORD.

I HEREBY give notice that I intend to apply for a licence empowering me to divert water for a term of eight years to the extent of 10½ acre-feet per annum at a maximum rate of 1½ acre-feet per day of 24 hours for the irrigation of 7 acres of tobacco, being part of allotments 5, 6, 7 and 9, section H, Parish of Myrtleford, and to occupy certain Crown lands for works of diversion, and to cut a race thereon.

Any objection to such application must be forwarded, in writing, to reach the State Rivers and Water Supply Commission, Melbourne, before 22nd April, 1965 being 30 days from the first publication of this notice.

PASQUALE TUCCI.

Myrtleford.

5160

NOTICE OF INTENTION TO APPLY FOR A LICENCE TO DIVERT WATER AND CUT RACE FROM THE COWANNA BILLABONG, RIVER MURRAY, AT YELTA.

I HEREBY give notice that I intend to apply for a licence empowering me to divert water for a term of four years to the extent of 42 acre-feet per annum at a maximum rate of 3 acre-feet per day of 24 hours for the irrigation of 14 acres, being part of allotments 9 and 10, section G, Parish of Merbein, and to occupy certain Crown lands for works of diversion, and to cut a race thereon.

Any objection to such application must be forwarded, in writing, to reach the State Rivers and Water Supply Commission, Melbourne, before 20th April, 1965, being 30 days from the first publication of this notice.

DAVE THOMAS HOPKINS.
Box 6, Merbein, Victoria. 5161

NOTICE OF INTENTION TO APPLY FOR A LICENCE TO DIVERT WATER AND CUT RACE FROM THE KIEWA RIVER, AT TAWONGA SOUTH.

I HEREBY give notice that I intend to apply for a licence empowering me to divert water for a term of fifteen years to the extent of 2 acre-feet per annum at a maximum rate of 1½ acre-feet per day of 24 hours for the irrigation of 25 acres of tobacco, being part of allotment 6, section 18, Parish of Mullindolingong, and to occupy certain Crown lands for works of diversion, and to cut a race thereon.

Any objection to such application must be forwarded, in writing, to reach the State Rivers and Water Supply Commission, Melbourne, before 27th March, 1965, being 30 days from the first publication of this notice.

RICHARD KYRAN MARUM.
Tawonga South. 5162

NOTICE OF INTENTION TO APPLY FOR A LICENCE TO DIVERT WATER AND CUT RACE (RE-ISSUE) FROM THE BUFFALO RIVER, AT BUFFALO RIVER.

WE hereby give notice that we intend to apply for a licence empowering us to divert water for a term of eight years to the extent of 195 acre-feet per annum at a maximum rate of 5 acre-feet per day of 24 hours for the irrigation of 130 acres of tobacco, being part of allotments 165, 165A and 165C, Parish of Whorouly, and to occupy certain Crown lands for works of diversion, and to cut a race thereon.

Any objection to such application must be forwarded, in writing, to reach the State Rivers and Water Supply Commission, Melbourne, before 23rd April, 1965, being 30 days from the first publication of this notice.

ROSO & PATERRA, per Mario Roso.
Hall's-road, Myrtleford, Victoria. 5163

NOTICE OF INTENTION TO APPLY FOR A LICENCE TO DIVERT WATER AND CUT RACE FROM THE OVENS RIVER AT WANGARATTA SOUTH.

I HEREBY give notice that I intend to apply for a licence empowering me to divert water for a term of eight years to the extent of 40 acre-feet per annum at a maximum rate of 1½ acre-feet per day of 24 hours for the irrigation of 20 acres of tobacco, being part of allotment part of 4, section 16, Parish of Wangaratta South, and to occupy certain Crown lands for works of diversion, and to cut a race thereon.

Any objection to such application must be forwarded, in writing, to reach the State Rivers and Water Supply Commission, Melbourne, before 23rd April, 1965, being 30 days from the first publication of this notice.

J. MORASCO.
Yarrowonga Roadside, via Wangaratta. 5085

NOTICE OF INTENTION TO APPLY FOR A LICENCE TO DIVERT WATER AND CUT RACE (RE-ISSUE) FROM THE GOULBURN RIVER AT ALEXANDRA.

WE hereby give notice that we intend to apply for a licence empowering us to divert water for a term of six years to the extent of 100 acre-feet per annum at a maximum rate of 2 acre-feet per day of 24 hours for the irrigation of pasture, being part of allotments 13A and 13B, Parish of Alexandra, and to occupy certain Crown lands for works of diversion, and to cut a race thereon.

Any objection to such application must be forwarded, in writing, to reach the State Rivers and Water Supply Commission, Melbourne, before 28th March, 1965, being 30 days from the first publication of this notice.

E. N. & M. R. MACRAE.
31 Kambrook-road, Caulfield. 5087

NOTICE OF INTENTION TO APPLY FOR A LICENCE TO DIVERT WATER AND CUT RACE (RE-ISSUE) FROM THE KIEWA RIVER AT TAWONGA.

I HEREBY give notice that I intend to apply for a licence empowering me to divert water for a term of fifteen years to the extent of 50 acre-feet per annum at a maximum rate of 2 acre-feet per day of 24 hours for the irrigation of 25 acres of pasture and summer crops, being part of allotments 5 and 7, section 13, Parish of Mullindolingong, and to occupy certain Crown lands for works of diversion, and to cut a race thereon.

Any objection to such application must be forwarded, in writing, to reach the State Rivers and Water Supply Commission, Melbourne, before 15th April, 1965, being 30 days from the first publication of this notice.

JOHN HENRY RYDER.
Tawonga, via Bright. 5086

NOTICE OF INTENTION TO APPLY FOR A LICENCE TO DIVERT WATER AND CUT RACE (RE-ISSUE) FROM THE BUFFALO RIVER AT BUFFALO RIVER.

I HEREBY give notice that I intend to apply for a licence empowering me to divert water for a term of eight years to the extent of 240 acre-feet per annum at a maximum rate of 3½ acre-feet per day of 24 hours for the irrigation of 160 acres tobacco and pasture, being part of allotments 3B, 3E, 3F, 3H, 4, 4A, section 7, Parish of Eurandelong, and to occupy certain Crown lands for works of diversion, and to cut a race thereon.

Any objection to such application must be forwarded, in writing, to reach the State Rivers and Water Supply Commission, Melbourne, before 25th April, 1965, being 30 days from the first publication of this notice.

W. A. MOORE, PASTORAL CO.
Buffalo River, Myrtleford. 5088

NOTICE OF INTENTION TO APPLY FOR A LICENCE TO DIVERT WATER AND CUT RACE FROM THE OVENS RIVER AT MYRTLEFORD.

I HEREBY give notice that I intend to apply for a licence empowering me to divert water for a term of eight years to the extent of 37½ acre-feet per annum at a maximum rate of 1½ acre-feet per day of 24 hours for the irrigation of tobacco and pasture 25 acres, being part of allotments 24A, 1A, 2A, 6, 7, 1, section Q1, Parish of Myrtleford, and to occupy certain Crown Lands for works of diversion, and to cut a race thereon.

Any objection to such application must be forwarded, in writing, to reach the State Rivers and Water Supply Commission, Melbourne, before 23rd April, 1965, being 30 days from the first publication of this notice.

NICHOLAS W. CLEMENS.
Box 68, Myrtleford. 5089

NOTICE OF INTENTION TO APPLY FOR A LICENCE TO DIVERT WATER AND CUT RACE FROM THE KIEWA RIVER AT MONGANS BRIDGE.

I HEREBY give notice that I intend to apply for a licence empowering me to divert water for a term of fifteen years to the extent of 50 acre-feet per annum at a maximum rate of 2 acre-feet per day of 24 hours for the irrigation of pasture and tobacco, being part of allotment 6, section XI, Parish of Mullagong, and to occupy certain Crown lands for works of diversion, and to cut a race thereon.

Any objection to such application must be forwarded, in writing, to reach the State Rivers and Water Supply Commission, Melbourne, before 18th April, 1965, being 30 days from the first publication of this notice.

HENERY ELLIS LARKIN.
Mongans Bridge, via Wodonga. 5090

NOTICE OF INTENTION TO APPLY FOR A LICENCE TO DIVERT WATER AND CUT RACE FROM THE OVENS RIVER, AT MURMUNGEE.

WE hereby give notice that we intend to apply for a licence empowering us to divert water for a term of eight years to the extent of 45 acre-feet per annum at a maximum rate of 1½ acre-feet per day of 24 hours for the irrigation of 30 acres of tobacco, being part of allotment 3B, section K, Parish of Murmungee, and to occupy certain Crown lands for works of diversion, and to cut a race thereon.

Any objection to such application must be forwarded, in writing, to reach the State Rivers and Water Supply Commission, Melbourne, before 16th April, 1965, being 30 days from the first publication of this notice.

S. COBBE.
I. COBBE.
(per I. Cobbe).
Box 78, Myrtleford. 5060

NOTICE OF INTENTION TO APPLY FOR A LICENCE TO DIVERT WATER AND CUT RACE FROM THE KIEWA RIVER, AT TAWONGA.

I HEREBY give notice that I intend to apply for a licence empowering me to divert water for a term of fifteen years to the extent of 50 acre-feet per annum at a maximum rate of 2 acre-feet per day of 24 hours, for the irrigation of 25 acres of crops, pastures and garden, being part of

allotments 9b and 9c, section 1, Parish of Mullindol, and to occupy certain Crown lands for works of diversion, and to cut a race thereon.

Any objection to such application must be forwarded, in writing, to reach the State Rivers and Water Supply Commission, Melbourne, before 3rd day of April, 1965, being 30 days from the first publication of this notice.

MILTON LESLIE COOPER.

M.R.B. 118, Tawonga Roadside, via Wodonga, Vic. 5061

NOTICE is hereby given that the partnership heretofore subsisting between Hersz Witman and Izak Zawoznik, carrying on business as fruiterers at 117 and 139 High-street, Kew, has been dissolved by mutual consent, as from the 25th day of January, 1965.

All debts due and owing by the said firm will be received and paid by Hersz Witman, who will continue to carry on the business at the same places.

DAVID THOMAS & FRENKEL, of 104 Queen-street, Melbourne, solicitors for the said Hersz Witman. 5131

NOTICE is hereby given that the partnership heretofore subsisting between Peter Prineas, of Horsham, café proprietor, and Minas John Prineas, late of Horsham, café proprietor, deceased, at the 40 Lounge, 40 Firebrace-street, Horsham, under the name of Prineas Bros., has been dissolved, and the said Peter Prineas will continue to carry on the said business and will pay all the debts of the said business.

P. PRINEAS.
A. PRINEAS.

Power & Bennett, solicitors, 12 Pynsent-street, Horsham.
5101

NOTICE is hereby given that Leslie Purton Smith is no longer a partner in Associated Displays of 18 Armstrong-street, Middle Park.

R. G. LEAR.
L. R. BRUCE.

5209

YELLOW ROBINS PTY. LTD. (IN VOLUNTARY LIQUIDATION).

NOTICE is hereby given, pursuant to section 272 of the Companies Act 1961, that a meeting of the creditors and contributories of the above-named company will be held at 118 Queen-street, Melbourne, on Monday, 26th April, 1965, at 10.30 a.m., for the purpose of having an account laid before them, showing the manner in which the winding up has been conducted, and the property of the company disposed of, and of hearing any explanation that may be given by the liquidator.

Dated this 16th day of March, 1965.

5080

BRYAN HOY, Liquidator.

The Companies Act 1961.—In the matter of R. MCNAUGHTON & SON PTY. LTD.—Notice of Meeting of Creditors, Pursuant to Section 260.

NOTICE is hereby given that a meeting of creditors of the above-named company will be held at Room 516, 342 Flinders-street, Melbourne, on Monday, 5th April, 1965, at 10.30 a.m., the company having convened a meeting of its members for the same day for the purpose of considering a Resolution that the company be wound up voluntarily.

Dated this 15th day of March, 1965.

BASTIAN, BENT & COUGLE, public accountants, Suite 18, 545 St. Kilda-road, Melbourne, S.C.3. 5064

In the matter of the Companies Act 1961.—And in the matter of HARTLEYS (WHOLESALE) PROPRIETARY LIMITED (in Voluntary Liquidation).—Notice of Final Meeting of Members, Pursuant to Section 272.

NOTICE is hereby given in pursuance of section 272 of the Companies Act that a General Meeting of the members of the above-named company will be held at the office of Cooper Brothers & Co., 360 Collins-street, Melbourne, on Friday, 30th April, 1965, at 10 o'clock in the forenoon, for the purpose of having an account laid before it showing the manner in which the winding up has been conducted and the property of the company disposed of, and hearing any explanation that may be given by the liquidators.

Dated this 20th day of March, 1965.

N. W. BUCKLEY, Liquidator.
J. L. MAFFEY, Liquidator.

360 Collins-street, Melbourne, C.1. 5203

WILLIAM STOTT PROPRIETARY LIMITED (IN VOL. LIQ.).

NOTICE OF FINAL MEETING IN VOLUNTARY WINDING UP.

TAKE notice that the affairs of the above-named company are now fully wound up and that, in pursuance of section 272 (1) of the Companies Act 1961, a General Meeting of the company will be held at 8 p.m. on Monday, the 26th day of April, 1965, at 303 Shannon-avenue, Newtown, Geelong, for the purpose of laying before it an account showing how the winding up has been conducted and the property of the company disposed of and giving any explanation thereof.

Dated at Geelong, the 15th day of March, 1965.

G. T. PYLE, A.A.S.A., Liquidator, 54 Malop-street, Geelong. 5062

CLINIC INVESTMENTS PTY. LTD. (IN VOLUNTARY LIQUIDATION).

NOTICE is hereby given, pursuant to section 272 of the Companies Act 1961, that a General Meeting of the members of the above-named company will be held at 118 Queen-street, Melbourne, on Monday, 26th April, 1965, at 10 a.m., for the purpose of having an account laid before them showing the manner in which the winding up has been conducted and the property of the company disposed of, and of hearing any explanation that may be given by the liquidator.

Dated this 16th day of March, 1965.

5066

BRYAN HOY, Liquidator.

The Companies Act 1961.—In the matter of MELWER ROLLER PRODUCTS PTY. LTD.—Notice of Meeting of Creditors, Pursuant to Section 260.

NOTICE is hereby given that a meeting of creditors of the above-named company will be held at Suite 18, 545 St. Kilda-road, Melbourne, on Monday, 5th April, 1965, at 3.30 p.m. The company having convened a meeting of its members for the same day for the purpose of considering a Resolution that the company be wound up voluntarily.

Dated this 22nd day of March, 1965.

BASTIAN, DENT & COUGLE, public accountants, Suite 18, 545 St. Kilda-road, Melbourne, S.C.3. 5183

In the matter of CRYSTAL CAKES PROPRIETARY LIMITED.—And in the matter of the Companies Act 1961.

NOTICE is hereby given, pursuant to section 260, that a meeting of creditors of the above-named company will be held at the office of John P. Rhoden, solicitor, 376 Collins-street, Melbourne, on Friday the 2nd day of April, 1965, at Eleven o'clock in the forenoon, for the purposes set out in sections 260, 261 and 262 of the above Act.

By order of the Board,

SOUVERIO CURCIO, Director.

Dated this 25th day of March, 1965. 5208

Companies Act 1961.

M. E. & R. ALLAN & CO. PROPRIETARY LIMITED.
NOTICE OF MEETING OF CREDITORS.

NOTICE is hereby given that a meeting of creditors of M. E. & R. Allan & Co. Proprietary Limited will be held at the office of Lewis Luckins & Co., chartered accountants, 397 Little Collins-street, Melbourne, on the 31st day of March, 1965, at Ten o'clock in the forenoon for the purpose of submitting a Statement of Assets and Liabilities of the company under section 202 (2) as provided in Part IX. of the Companies Act 1961.

Dated this 23rd day of March, 1965.

LEWIS LUCKINS & CO. (Lewis Luckins, Official Manager). 5207

The Companies Act 1961.—In the matter of JAYHART INVESTMENTS PROPRIETARY LIMITED (in Liquidation).

NOTICE is hereby given that pursuant to section 272 of the Companies Act a Final Meeting of the creditors of the above company will be held at the offices of Kennedy, Smail and Middlemiss, 296 Little Lonsdale-street, Melbourne, on Wednesday, the 21st day of April, 1965, at 10 a.m.

Business:—To receive the liquidator's accounts.

Dated this 17th day of March, 1965.

NORMAN ERIC STRETTON, Liquidator.

Kennedy, Smail and Middlemiss, 296-300 Little Lonsdale-street, Melbourne. 5133

Unclaimed Moneys Act 1962.

REGISTER of Unclaimed Moneys held by the—

Name of Owner on Books and Last Known Address.	Total Amount Due to Owner.	Description of Unclaimed Moneys.	Date when Amount first became Payable.
	£ s. d.		
E. Z. INDUSTRIES LIMITED.			
Anderson, Neil R. (address unknown)	13 16 0	Dividend	3.5.63
Bird, Margaret S. (address unknown)	27 0 0	"	"
Black, Helena H., East Melbourne	14 8 0	"	"
Burrill, Thomas O., "Rannock", East Devonport, Tas.	29 8 0	"	"
Butland, John T. (address unknown)	6 12 0	"	"
Carey, Harriet C. (address unknown)	52 4 0	"	"
Carr, Thomas J. (estate of) (address unknown)	34 16 0	"	"
Clark, James (estate of), Mayne-street, Invermay, Launceston, Tas.	9 0 0	"	"
Cox, Harold R. (estate of), 8 St. Georges Square, Launceston, Tas.	5 8 0	"	"
Currell, Jessie M., 4 Sargood-street, Toorak	12 0 0	"	"
Dalley, Julian F. (address unknown)	9 0 0	"	"
Duncan, Minnie E., West Hobart, Tas.	7 4 0	"	"
Fetherston, Gerald R. (address unknown)	27 12 0	"	"
Fitzgerald, Olga R. (address unknown)	69 0 0	"	"
Hall, George (address unknown)	11 8 0	"	"
Howes, F. E., c/o 55 Cameron-street, Hobart, Tas.	5 8 0	"	"
Jackson, Selina J. (estate of), c/o H. G. Stutterd, 14 Jackson-street, Wynyard, Tas.	9 12 0	"	"
Jones, A., Trevallyn, Tas.	6 12 0	"	"
Kermode, Georgine E. (estate of), Mona Vale, Ross, Tas.	7 4 0	"	"
Kidd, Robert H. (address unknown)	23 8 0	"	"
Moore, Dorothy V., Auburn	5 8 0	"	"
Nield, Ernest M., "Carthona", Cambridge-road, Drummoyne, N.S.W.	12 0 0	"	"
Pyne, T. V. (address unknown)	5 8 0	"	"
Scott, Eliza (address unknown)	5 8 0	"	"
Simmons, Winston (estate of) (address unknown)	9 12 0	"	"
Spraggon, Percy, c/o J. N. Lawson, Dunedin, N.Z.	18 0 0	"	"
Stenhouse, Andrew (address unknown)	7 4 0	"	"
Sykes, Pattie H., Deloraine, Tas.	5 8 0	"	"
Thomas, Mary (estate of) (address unknown)	9 0 0	"	"
Tindall, Edgar W. (address unknown)	11 8 0	"	"
Tope, Leila (estate of), c/o Cooke and McCallum, 422 Collins-street, Melbourne	69 0 0	"	"
Turner, Herbert K. (address unknown)	30 0 0	"	"
Turner, Maude (estate of), c/o 411 Collins-street, Melbourne	8 8 0	"	"
Alexander, Judith A. S. (Mrs.), Flat 9, 22 Westbury-street, St. Kilda	7 10 0	"	29.11.63
Allingham, Elizabeth J. (estate of), c/o Hordern Utz and Bode, 33 Hunter-street, Sydney, N.S.W.	103 19 0	"	"
Alston, Mary (Mrs.), Hyndford, Lanark, U.K.	22 4 0	"	3.5.63
Anthoness, Leacia H. (Mrs.), 220 Kooyong-road, Toorak	7 10 0	"	"
Armstrong, Elsie M. (Mrs.), 3 Malcolm-street, Perth, W.A.	34 13 0	"	29.11.63
Atkins, Andre B., 44 Glossop-street, Balmain, N.S.W.	10 0 0	"	3.5.63
Atkins, Keith D. (estate of), Harold Bushby, Esq., P.O. Box 584, Launceston, Tas.	15 0 0	"	"
Baldwin, Cecil W. (estate of), c/o Mrs. Frances E. R. Baldwin, c/o Box 185c, G.P.O., Hobart, Tas.	129 0 0	"	"
Berkowitz, Barnie (estate of), c/o Russell Kennedy and Cook, 401 Collins-street, Melbourne	50 0 0	"	"
Bibby, James H. (estate of), c/o Mrs. Joseph Sarah, 141 Elizabeth-street, Sydney, N.S.W.	17 8 0	"	"
Bradshaw, Leslie R., 9 Grange-road, Toorak	5 0 0	"	"
Brickle, Heather K. (Miss), P.O. Box 2369, Auckland, N.Z.	25 10 0	"	"
Campbell, Donald McL. (estate of), c/o Scannell and Bramwell, Queen-street, Hastings, N.Z.	34 4 0	"	"
Campbell, James K. (estate of), c/o L. H. Halliday and Co., P.O. Box 1, Scone, N.S.W.	55 0 0	"	"
Carrick, William B. (estate of), c/o Mrs. Jean Carrick, 14 Bridges-avenue, Croydon	45 0 0	"	"
Chambers, Clara M. (Mrs.), Monkton Lodge, Cranbrook-lane, Bellevue Hill, N.S.W.	50 0 0	"	"
Comfort, Sydney F., 11 Lawry-street, Frankston	5 0 0	"	"
Cooper, John W. (estate of), c/o Clayton Utz and Co., 136 Liverpool-street, Sydney, N.S.W.	11 5 0	"	29.11.63
Cowling, Alfred (estate of), c/o Sladden and Stuart, Box 734, Wellington, N.Z.	16 4 0	"	3.5.63
Cramsie, Charles H. W. (estate of), c/o Max H. Cramsie, 29 Cecil-street, Gordon, N.S.W.	45 0 0	"	"
Crosbie, Alexandra V. (estate of), c/o Perpetual Trustee Co. Ltd., 33 Hunter-street, Sydney, N.S.W.	225 0 0	"	29.11.63
Daniell, John A., c/o Mrs. Charlotte E. Williams, Albion, Burwood-road, East Burwood	16 4 0	"	3.5.63
Denning, Ethel M. B. (estate of), c/o Leon C. Magrin, 6 Murchison-street, St. Ives, N.S.W.	10 0 0	"	"
Didsbury, Harold G. (estate of), c/o Herbert Webb, P.O. Box 208, Wellington, C.I., N.Z.	74 5 0	"	29.11.63
Dudgeon, Charles E. R. (estate of), c/o Morris Fletcher and Cross, G.P.O. Box 204c, Brisbane, Qld.	25 0 0	"	3.5.63
Eastwood, James H. (estate of), c/o A. W. M. Dickinson, 33 Hunter-street, Sydney, N.S.W.	69 0 0	"	"
Elkington, Horace G. (estate of), c/o Warren L. Elkington, 61 Hatfield-street, Blakehurst, N.S.W.	309 16 0	"	"
Fell, Ian B. (estate of), c/o Densley and Downing, 147 Castlereagh-street, Sydney, N.S.W.	250 0 0	"	"

Unclaimed Moneys Act 1962.

REGISTER of Unclaimed Moneys held by the—

Name of Owner on Books and Last Known Address.	Total Amount Due to Owner.		Description of Unclaimed Moneys.	Date when Amount first became Payable.
	£	s. d.		
<i>E. Z. INDUSTRIES—continued.</i>				
Fogarty, Marilyn G. (Mrs.), The Tor Walk, Castlecrag, N.S.W. . .	7	10 0	Dividend	29.11.63
Forge, Herbert C. (estate of), c/o National Trustees E. and A. Co. of Australasia Ltd., 95 Queen-street, Melbourne	69	0 0	"	3.5.63
Foster, Mark R., c/o Bank of Adelaide, 279 George-street, Sydney, N.S.W.	11	5 0	"	29.11.63
Friend, William S. (estate of), c/o Manning Riddle and Co., 14 Martin-place, Sydney, N.S.W.	93	15 0	"	"
Fuller, Ada L. (estate of), c/o Vincent J. Brady Donald and Co., enr. Hunter and Bligh streets, Sydney, N.S.W.	7	10 0	"	"
Fuller, Mary L. (estate of), c/o Lovingrove Turner Hopkins and Jamieson, 70 Queen-street, Auckland, N.Z.	34	16 0	"	3.5.63
Gilbert, Gladys M., 87 High-street, Glen Iris	5	12 6	"	29.11.63
Gubb, Athol L., 23 Merchiston-street, Andersons Bay, Dunedin, N.Z.	10	12 7	"	3.5.63
Hall, Victor C. (estate of), c/o Jack D. Bushby, 5 Quorn-street, Sandy Bay, Hobart, Tas.	6	15 0	"	29.11.63
Hayes, Clarice E. (Mrs.), Cambrian, Kongwak, Vic.	14	17 0	"	"
Hey, Harry (estate of), c/o Sparke, Helmore, and Withycombe, P.O. Box 466E, Newcastle, 2N, N.S.W.	18	15 0	"	"
Hing, Albert (estate of), c/o Geoffrey See Gillis and Co., 28 Martin-place, Sydney, N.S.W.	75	0 0	"	"
Huret, Pierre G. (estate of), c/o Perpetual Trustee Co. Ltd., 33 Hunter-street, Sydney, N.S.W.	120	0 0	"	3.5.63
Jacobs, John F. (estate of), c/o McKenzie-McHarg and Moran, P.O. Box 138, Albury, N.S.W.	69	0 0	"	"
Johnstone, Dinah J. (Mrs.), 576 Inkerman-road, Caulfield North ..	37	10 0	"	29.11.63
Klijn, Anne C. (Mrs.), 43 Fendalton-road, Christchurch, N.Z. . .	6	7 6	"	"
Knuচেy, Marie E. (Miss), 757 Old South Head-road, Vaucluse, N.S.W.	7	10 0	"	"
Little, Charles C. (estate of), c/o Charles G. Little, Cracrin, Corfield, Qld.	200	0 0	"	3.5.63
Long, Jeffrey, c/o Wesley College, St. Kilda-road, Prahran .. .	10	0 0	"	"
Lyell, Arthur L. (estate of), c/o Mrs. Hilda E. Lyell, Flat 2, 40 Coonan-barra-road, Wahroonga, N.S.W.	42	15 0	"	29.11.63
MacLennan, Effie W. (estate of), c/o Jackson Russell Tunks and West, P.O. Box 176, Auckland, C.1, N.Z.	51	15 0	"	"
Magrin, Gwen (estate of), c/o Iceteton Faithfull and Baldock, 28 O'Connell-street, Sydney, N.S.W.	40	0 0	"	3.5.63
Maloney, John L. (estate of), c/o Mrs. Enid Scougall, c/o Arthur Robinson and Co., 360 Collins-street, Melbourne	11	5 0	"	29.11.63
Masefield, William N. (estate of), c/o Perpetual Trustee Co. Ltd., 33 Hunter-street, Sydney, N.S.W.	69	0 0	"	3.5.63
Mason, Lucy F. (estate of), c/o O. L. Blyth, 50 George-street, Croydon, Surrey, England	39	3 0	"	29.11.63
Maurice, Hilary B. (Mrs.), Gillinghall, Wellington, N.Z. . . .	25	10 0	"	3.5.63
Maylor, Helen L. (estate of), c/o Towle and Cooper, P.O. Box 42, Auckland, N.Z.	22	10 0	"	29.11.63
Mendelsohn, Gwen E. (Miss), 11 Charnwood-road, St. Kilda .. .	33	15 0	"	"
Montgomery, May F. B. (estate of), c/o Molomby and Molomby, 99 Queen-street, Melbourne	30	0 0	"	3.5.63
Mullens, Florence E. (Miss), P.O. Box 358, Haymarket, Sydney, N.S.W.	15	12 0	"	"
Murray, Reginald J. (estate of), c/o Hunter Warnock and Blair, 18 Elizabeth-street, Hobart, Tas.	40	0 0	"	"
Murray, William A. K., c/o Ure and Macrae, 173 St. Vincent-street, Glasgow, Scotland	7	2 11	"	"
Muston, Blanche E. (estate of), c/o Hunt and Hunt, 15 Bligh-street, Sydney, N.S.W.	187	10 0	"	29.11.63
McDowall, Robert G. (estate of), c/o Public Trustee, 19 O'Connell-street, Sydney, N.S.W.	22	10 0	"	"
McIntyre, Ida M. (estate of), c/o Carruthers Hunter and Co., Hooker House, Angel-place, Sydney, N.S.W.	67	10 0	"	"
McKenzie, Morris G., 7 Lundie-street, Roslyn, Dunedin, N.Z. . .	6	7 6	"	"
Nairn, Eva B. (estate of), c/o John G. McDonald, P.O., Box 186, Murwillumbah, N.S.W.	135	12 0	"	3.5.63
Nash, Katie F. G. (estate of), c/o Ivor A. Thomas and Sheffield, 1 Bridge-road, Belmore, N.S.W.	60	0 0	"	"
Neave, Patricia M. (estate of), c/o Allen Allen and Hemsley, 53 Martin-place, Sydney, N.S.W.	15	0 0	"	"
Newman, Eric L. (estate of), c/o A. W. M. Dickinson and Son, 33 Hunter-street, Sydney, N.S.W.	150	0 0	"	"
Nock, Sir Norman L., c/o Claude Neon Ltd., 965 Botany-road, Mascot, N.S.W.	22	10 0	"	29.11.63
Norton-Jowitt, Adele (estate of), c/o Raymond Tobias, c/o Wm. Lieberman and Tobias, 56 Hunter-street, Sydney, N.S.W.	15	0 0	"	3.5.65
O'Connor, Mary L. (Miss), 96 Milson-road, Cremorne, N.S.W. . .	25	0 0	"	"
Ost, Reginald E. (estate of), c/o Louis P. Le Grand and Randles, 660 Sydney-road, Brunswick	11	5 0	"	29.11.63
Palmer, Edward F., 20 Station-street, Oakleigh	9	18 0	"	"
Parks, Florence R. (estate of), c/o Bagots Exor. and Trustee Co. Ltd., 198 North-terrace, Adelaide, S.A.	39	0 0	"	3.5.63
Paspalas, Eustace, 56 Margaret-street, Sydney, N.S.W.	5	0 0	"	"
Penny, Violet M. (estate of), c/o Exor. Trustee and Agency Co. of S.A. Ltd., 22 Grenfell-street, Adelaide, S.A.	22	10 0	"	29.11.63
Peters, Elizabeth (estate of), c/o Tasmanian Permanent Exors and Trustees Assn. Ltd., 23 Paterson-street, Launceston, Tas.	138	12 0	"	3.5.63
Phillips, Amy I. (estate of), c/o Minter Simpson and Co., G.P.O. Box 521, Sydney, N.S.W.	270	0 0	"	"

Unclaimed Moneys Act 1962.

REGISTER of Unclaimed Moneys held by the—

Name of Owner on Books and Last Known Address.	Total Amount Due to Owner.	Description of Unclaimed Moneys.	Date when Amount first became Payable.
	£ s. d.		
E. Z. INDUSTRIES—continued.			
Pocock, Frances M. (estate of), c/o Perpetual Trustee Co. Ltd., 33 Hunter-street, Sydney, N.S.W.	240 0 0	Dividend	3.5.63
Pogue, Gordon L. (estate of), c/o Cameron and Cameron, Shepparton	22 10 0	"	29.11.63
Pollock, William E., c/o 256 Barkers-road, Hawthorn, E.2	10 0 0	"	3.5.63
Purchas, Arthur J. M. (estate of), c/o E. R. Caldwell, P.O. Box 10, Young, N.S.W.	22 10 0	"	29.11.63
Reuben, Aaron E., 143 Grand-promenade, Inglewood, W.A.	5 0 0	"	3.5.63
Rosenfeld, Elizabeth (estate of), c/o Max Rosenfeld, 33 Weongaroad, Dover Heights, N.S.W.	98 12 0	"	"
Rudduck, Samuel A. (estate of), c/o Perpetual Exors. Trustees and Agency Co. W.A. Ltd., G.P.O. Box A3, Perth, W.A.	71 8 0	"	"
Rutherford, Isabella M. (Miss), 57 South Guildry-street, Elgin, Moray, Scotland	5 17 4	"	"
Scanlan, William (estate of), c/o Murphy and Moloney, 79 Elizabeth-street, Sydney, N.S.W.	15 0 0	"	"
Schmidt, Rudolph (estate of), c/o Union-Fidelity Trustee Co. (Canberra) Ltd., P.O. Box 590, Canberra, A.C.T.	50 0 0	"	"
Shain, Barbara M. (Miss), 1223 Pacific Highway, Turramurra, N.S.W.	9 7 6	"	29.11.63
Shoobridge, Rupert O. (estate of), c/o National E. and T. Co. of Tas. Ltd., 140 Collins-street, Hobart, Tas.	10 4 0	"	3.5.63
Silverston, Lewis (estate of), c/o Mrs. Beryl Silverston, 65 Mount-street, Perth, W.A.	40 0 0	"	"
Sleight, Kitty B. (estate of), c/o Union-Fidelity Trustee Co. of Aust. Ltd., 333 Collins-street, Melbourne	60 0 0	"	"
Smith, Mabelle I. (estate of), c/o Mrs. Thea H. Robilliard, 41 Bland-street, Port Kembla, N.S.W.	127 10 0	"	29.11.63
Smith, Sidney (estate of), c/o Oakes, Belk and Skinner, 11 East-parade, Sheffield, 1, England	6 17 6	"	3.5.63
Smith, Basil O., 126 Phillip-street, Sydney, N.S.W.	5 8 0	"	"
Stewart, William (estate of), c/o Mrs. Margaret G. M. Cocker, 70 St. John-street, Launceston, Tas.	210 0 0	"	"
Stirzaker, John G. (estate of), c/o R. N. Matulich, 32 Currie-street, Adelaide, S.A.	30 0 0	"	"
Taubman, Alan C., c/o Lochinvar Laurel Pty. Ltd., Laurel Hill, via Batlow, N.S.W.	7 10 0	"	29.11.63
Thomas, Alfred H. L. (estate of), c/o Stanley E. Thomas, 11 Ada-avenue, Strathfield, N.S.W.	5 0 0	"	3.5.63
Thomas, Ian R., 28 St. Leonards Court, South Yarra	7 10 0	"	29.11.63
Togget, Frank H., 13 Reid-street, Balwyn	48 15 0	"	"
Townend, Harry (estate of), c/o Geoffrey H. Townend, 6 Fern-street, Pymble, N.S.W.	25 0 0	"	3.5.63
Vandenbergh, Martha B. (estate of), c/o John Dickson, c/o Asher Old and Jones, 5 Bligh-street, Sydney, N.S.W.	19 16 0	"	"
Wallace, Gerrard St. J., 515 Nepean Highway, North Brighton	51 15 0	"	29.11.63
Ward, Harry L. (estate of), c/o Mrs. Mary E. Shepherd, 53 Edenlee-street, Epping, N.S.W.	38 5 0	"	"
White, Charles G., P.O. Box 834, Wellington, N.Z.	35 0 0	"	3.5.63
Wilkinson, Raymond H. (estate of), c/o Francis Taylor and Ferguson, 58 Margaret-street, Sydney, N.S.W.	37 10 0	"	29.11.63
Woodburn, George (estate of), c/o John P. Francis, P.O. Box 25, Charters Towers, Qld.	12 2 3	"	"
Worley, Ralph P., 20 Arney-road, Remuera, Auckland, N.Z.			
5044	NORTH BROKEN HILL LIMITED.		
Rose, Jean H., c/o 614 Toorak-road, Toorak	10 0 0	Dividend	29.11.63
5018	EAST AFRICAN COFFEE PLANTATIONS LIMITED.		
Hewitt, Dorothea Ada (Mrs.), Galston, via Hornsby, N.S.W.	5 12 6	Dividend	1963
Hewitt, William Leslie, Galston, via Hornsby, N.S.W.	6 19 6	"	"
Loudon, Edith Mary, 32 Jamieson-street, Sydney, N.S.W.	5 12 6	"	"
McLean, Margaret, Mycumbeni (late Ferndale), Gilgandra, N.S.W.	5 12 6	"	"
Wilson, Joseph Phipps, c/o Wilson and Thomas, Hargreaves-st., Bendigo	7 17 6	"	"
5026	AUTOMOTIVE AND GENERAL INDUSTRIES LTD.		
Bennett, David G. (Esq.), 15 Kendall-street, Elwood	3 0 0	Dividend	30.11.63
Cook, Victoria G. (Mrs.), 12 Selwood-street, Hawthorn	3 0 0	"	"
Dott, Janet A. (Miss), 14 Maribyrnong-road, Moonee Ponds	15 0 0	"	"
Duncan, Jessie G. (Miss), 40 Orrong-road, Armadale	2 5 0	"	"
Gibson, Lindsay M. (Esq.), 9 Rose-street, Armadale	7 10 0	"	"
Gough, Margaret A. (Miss), 17 Millicent-avenue, Toorak, S.E.2	18 15 0	"	"
Hanlon, Enice A. (Mrs.), 693 Hampton-street, Brighton	4 10 0	"	"
Hunt, Theodora M. (Mrs.), 51 Mount-street, Perth, W.A.	2 5 0	"	"
Lambert, Ronald L. F. (Esq.), c/o A.N.Z. Bank, Lambton Quay, Wellington, N.Z.	2 11 0	"	"
Ogilvie, Evelyn (Miss), 4 Cumberland Court, Bowen-crescent, Melbourne	4 10 0	"	"
Scutt, John R. (Esq.), 30 Hotham-street, East St. Kilda	1 10 0	"	"
Smith, Denis G. (Esq.), c/o Parbury Henty and Co. Pty. Ltd., 522 Little Collins-street, Melbourne, C.1	3 0 0	"	"
Thomson, Dorothy M. (Mrs.), Flat No. 2, 9 Coppin-grove, Hawthorn	7 10 0	"	"
Westacott, John B. (Esq.), 49 Kensington-road, South Yarra	0 15 0	"	"
5014			

Unclaimed Moneys Act 1962.

REGISTER of Unclaimed Moneys held by—

Name of Owner on Books and Last Known Address.	Total Amount Due to Owner.	Description of Unclaimed Moneys.	Date when Amount first became Payable.
	£ s. d.		
PLASTALON PTY. LTD.			
Hughes, P. (Mrs.), 11 Sydenham-street, Highett	12 18 0	Wages	21.11.63
Blazeley, K. (Mrs.), 13 Dalgetty-street, St. Kilda 5068	6 16 0	„	13.11.63
A.B. REAL ESTATE CO. PTY. LTD.			
Hawtin, —	10 0 0	Option on lots 1, 2, and 3, Elmvale Estate, Templestowe	25.11.61
5069			
ESANDA LIMITED.			
Kohl, H. G., Flat 1, Latines-grove, Elwood	19 8 0	Surplus payment on hire purchase contract	19.4.63
Smith, L. G., 16 Kingsford-avenue, Merlynston	18 0 0	„	23.4.63
Crean, R. W. and N., "Gloandeanlodge", Clive-avenue, c/o P.O., Healesville	8 11 0	Surplus after completion of hire purchase contract	9.5.63
Bell, J. S., cnr. Hampton-road and Beryl-street, Essendon	8 10 0	Surplus payments on hire purchase contract	18.6.63
Arnold, E., 31 Henry-street, Traralgon	6 18 0	Rebate of insurance on hire purchase contract	15.8.63
Pacourelia, M., 478 Brunswick-street, North Fitzroy	5 0 10	Surplus after completion of hire purchase contract	28.8.63
King, R.	14 13 0	Misposted entry became apparent on completion of another hire purchase contract	—10.63
Zelen, J., 322 Bay-street, Brighton	10 5 0	Rebate of hiring charges and insurance on hire purchase contract	11.10.63
Burwash, J. E., 244 Ferrars-street, South Melbourne	15 18 0	Rebate of hiring charges on hire purchase contract	8.11.63
Barnes, D. H., 685 David-street, Albury, N.S.W.	7 8 6	Rebate of hiring charges on hire purchase contract also insurance charges	12.11.63
Doon, K. J., 365 Koornang-road, Carnegie	10 16 0	Rebate of hiring charges and insurance on hire purchase contract	12.11.63
Gregory, D., 46 Tulip-crescent, Boronia	22 2 0	Surplus payment on hire purchase contract	23.1.63
5070			
NATIONAL AND GENERAL INSURANCE COMPANY LIMITED.			
Chan, O., 32 Chrystobel-crescent, Hawthorn	5 6 1	Reimbursement for repairs paid	29.4.63
Lehrman, R. H., 329 Punt-road, Richmond	12 0 0	Return premium	21.10.63
5071			
THE NEPTUNE OIL COMPANY PROP. LIMITED.			
Skene, T. A., Swanpool, via Benalla	8 0 0	Value of drums returned	29.3.62
5073			
PLASTALON HOLDINGS LIMITED.			
Morton, Charlotte J. (estate of), c/o Maddock Lonie and Chisholm, 339 Collins-street, Melbourne, C.I. 5075	12 10 0	Dividend	—10.63
THE SHELL COMPANY OF AUSTRALIA LIMITED.			
Boyes, R. D., c/o 50 Baillie-street, Horsham	5 6 10	Wages	—11.62
5076			
CONZINC RIOTINTO OF AUSTRALIA LIMITED.			
Tankard, Henry Arthur, 15 Lynwood-avenue, Killara, N.S.W.	6 0 0	Dividend	10.5.63
Ryan, Elizabeth Ann Jane (estate of), 16 Barrett-street, East Ipswich, Queensland	6 0 0	„	„
Sproxtton, Colin Frankland, Hunt-street, Coolgardie, W.A.	19 10 0	„	„
Trott, Richard Gregory, Box 32, P.O., McLaren Vale, S.A.	16 10 0	„	10.10.63
Ford, Edward Francis, Mary Kathleen, Queensland	9 0 0	„	30.4.64
L.P.J. Holdings Pty. Ltd. (address unknown)	7 10 0	„	10.5.63
5077			
THE RIOTINTO-ZINC CORPORATION LTD.			
Byanda Pty. Ltd., 23 Kingston-street, East Malvern	5 10 7	Dividend	1.1.64
Gilkison, Mrs. F., c/o I. F. MacRae, 125 Wattle-Valley-road, Camberwell	8 6 1	„	„
Skinner, Sarah (estate of), c/o J. W. Walker and Co., 48 Macquarie-street, Parramatta, N.S.W.	276 15 3	„	„
Spurway, Michael, Bank of West Africa, Lagos, West Africa	18 5 4	„	„
Howe, June M., 9 Smith-street, Lindfield, N.S.W.	8 2 0	„	1.1.64
Koffyberg, Marion, 30 Prince Edward-parade, Redcliffe, Qld.	10 13 1	„	1.7.63
Browning, Margaret (Mrs.), "Riverslea", Yarrowonga	5 10 7	„	1.1.64
5078			
NEW BROKEN HILL CONSOLIDATED LIMITED.			
Deslandes, Llewellyn A., 720 Port-road, Beverley, S.A.	6 4 7	Dividend	1.1.64
Oxbrow, Joan H., 667 Yambla-avenue, Albury, N.S.W.	6 4 7	„	„
Addicoat, Louisa (estate of), c/o Albert E. Addicoat, 104 Grant-avenue, Toorak, S.A.	5 2 1	„	„
5079			

Unclaimed Moneys Act 1962.

REGISTER of Unclaimed Moneys held by the—

Name of Owner on Books and Last Known Address.	Total Amount Due to Owner.	Description of Unclaimed Moneys.	Date when Amount first became Payable.
	£ s. d.		
HOYTS THEATRES (N.S.W.) LIMITED.			
Duncan, J. G. and W. D. Weston (estate of) 4975	840 0 0	Debenture Interest	31.12.56-63
ROBERT BRYCE AND COMPANY LIMITED.			
Chandler, Victor Ewart, 483 Sydney-road, Brunswick 4977	8 6 3	Dividend	15.8.63
CONSOLIDATED QUARRIES LIMITED.			
Gumley, R. V. (Mrs.), c/o 2nd Floor, 527 Collins-street, Melbourne, C.1	0 6 6	Dividend	20.5.63
Anderson, L. W., 340 Barkers-road, Kew	3 15 0	"	—,10.63
Leech, A. C., 10 Glen-road, Ashburton	18 15 0	"	—,10.63
Leech, P. M. (Mrs.), 10 Glen-road, Ashburton	3 15 0	"	—,10.63
Ryan, M. R. (Miss), 217 Highfield-road, Camberwell	1 17 6	"	—,10.63
Rigutto, O., 550 Nepean Highway, East Brighton 5013	9 7 6	"	—,10.63
ROOTES (AUSTRALIA) LIMITED.			
Drakos, D., 15 Ward-street, South Melbourne	17 15 9	Wages	2.2.64
Pascoe, Miriam (Miss), 16 Oak-street, Hawthorn	9 0 0	Dividend	31.8.63
Erskine, Samuel, 32 Trafalgar-street, Brighton-Le-Sands, N.S.W.	5 0 0	"	22.12.63
Mahon, Josephine Alice (Mrs.), Flat 4, 695 Burke-road, Camberwell	5 0 0	"	11.12.63
Beath, Marjorie Eunice (Miss), Flat 3, 158 Wattletree-road, Malvern	10 0 0	"	11.12.63
Tucker, Edna Whitby (Mrs.), 48 Townson-street, Blakehurst, N.S.W.	9 0 0	"	28.2.64
Pascoe, Miriam (Miss), 16 Oak-street, Hawthorn 5000	9 0 0	"	28.2.64
AUSTRALIAN PAPER MANUFACTURERS LIMITED.			
Chircop, A., 121 Comas-street, Morwell	10 10 0	Wages	7.9.63
Bloomfield, B., 12 Farncomb-street, Ascot Vale	9 9 0	Holiday pay	7.9.63
	17 2 0	Wages	7.3.64
	2 14 0	"	14.3.64
W. D. AND H. O. WILLS (AUSTRALIA) LIMITED.			
O'Meagher, Lynton, 3 Bonanza-street, Beaumaris 5015	6 4 6	Accrued holiday pay	10.6.63
AUSTRALIAN CONSOLIDATED INDUSTRIES LIMITED.			
Doherty, Lillian P. (estate of), c/o Maquire and McInerney, Crown-street, Wollongong, N.S.W.	44 15 10	Dividends	1961
Hamilton, Macdonald R., Goondiwindi, Q'ld.	11 8 0	"	1962
Holmes, Bertha M. (estate of), c/o D. R. Dooley, Dooley and Breen, 31 Queen-street, Melbourne, C.1	8 5 0	"	1962
McLean, Catherine S. (estate of), c/o J. E. A. Florance and Florance, Commonwealth Bank Chambers, 35 The Corso, Manly, N.S.W.	27 8 0	"	1962
O'Dea, Thomas J., Box 212, P.O., Bendigo	6 15 0	"	1962
Villiers, Ursule L., c/o Mrs. G. A. Youl, 6 Kenyon-street, Launceston, Tas.	5 19 1	"	1962
Young, Lenard, Wau, New Guinea, T.P.N.G.	10 8 4	"	1962
Cummins, Reginald B., Box 5, Benalla	5 0 0	"	1963
Dale, Ann H., c/o Harveys, 137 Liverpool-street, Sydney, N.S.W.	15 0 0	"	1963
Doherty, Lillian P. (estate of), c/o Maquire and McInerney, Crown-street, Wollongong, N.S.W.	15 14 0	"	1963
Holmes, Bertha M. (estate of), c/o D. R. Dooley, Dooley and Breen, 31 Queen-street, Melbourne, C.1	8 5 0	"	1963
Hupfau, Yvonne R., Flat 1, Alma-road, Caulfield	47 4 0	"	1963
Johnston, Hugo R., P.O. Box 332, Auckland, N.Z.	22 16 9	"	1963
Lamb, Irene E., 4 Glenferrie-place, Epsom, Auckland, N.Z.	15 6 0	"	1963
Wood, Jean D., 16 The Crescent, Avalon Beach, N.S.W. 5017	8 5 0	"	1963
CAMORLEY HOLDINGS PTY. LTD. (trading as LAMINEX INDUSTRIES).			
Chapman, H., 42 Poplar-street, South Caulfield 5019	7 10 3	Wages	29.10.63
AUSTRALIAN GLASS MANUFACTURERS COMPANY.			
Chau, F. C., 15 Watt-avenue, Pascoe Vale	7 7 9	Wages	24.1.64
Arnone, G., 56 Benbow-street, Yarraville	6 8 6	"	24.1.64
WESTERN MINING CORPORATION LIMITED.			
Back, Joan E., 246 Hawkin-drive, St. Lucia, Qld.	5 0 0	Dividend	9.8.63
De Lynden, Caroline S. F. (estate of), c/o Lovell White and King, 1 Serjeants Inn, Fleet-street, London, E.C.4, England	5 0 0	"	"
Higgins, Terrence, 6 Rush-street, Woollahra, N.S.W.	10 0 0	"	14.2.64
Hill, John E. (estate of), c/o Aitken Walker and Strachan, 123 William-street, Melbourne	10 0 0	"	"
Iles, Moya F., Flat 2, 3 Woorisocket-court, St. Kilda	15 0 0	"	9.8.63
McNeill, Jessie G. (estate of), c/o Dean A. McNeill, 5 Bon Vue-avenue, Beaumont, S.A.	10 0 0	"	14.2.64
Schalit, Ids J., 7 The Barbette, Castlecrag, N.S.W.	5 0 0	"	9.8.63
Shrimpton, George E., 10 Little College-street, Westminster, London, E.C.1, England 5045	5 0 0	"	14.2.64

Unclaimed Moneys Act 1962.

REGISTER of Unclaimed Moneys held by the—

Name of Owner on Books and Last Known Address.	Total Amount Due to Owner.	Description of Unclaimed Moneys.	Date when Amount first became Payable.
	£ s. d.		
ECHUCA NORTHERN DISTRICT CO-OPERATIVE BUTTER FACTORY AND TRADING COMPANY LIMITED.			
Musgrove, W. A., 544 Burke-road, Camberwell 5118	5 12 6	Dividend	—3.59
THE LEVIATHAN LIMITED.			
Carroll, Vada (Mrs.), "Marartha", Clifford-street, Surfers Paradise	2 10 0	Dividend	3.4.63
	4 7 6	"	27.9.63
Pullen, Dorothy E. (Mrs.), 6 Testar-grove, Caulfield	3 15 0	"	3.4.63
	3 15 0	"	29.7.63
Ramage, Frances Mary, 69 The Boulevard, North Balwyn 5119	6 11 3	"	27.9.63
McPHERSON'S LIMITED.			
Wolf, E., 24 Dalgety-street, St. Kilda	17 2 2	"E" Share Equity	26.8.63
Buxton, F. N., 331 Glenhuntly-road, Elsternwick	11 16 8	Dividend	23.10.63
Pennexe, N., Devon Park, Sunbury 5120	5 11 7	Refund	17.10.62
BRITISH TOBACCO COMPANY (AUSTRALIA) LIMITED.			
Gaudry, Ellen V. (Miss), 97 Abercrombie-street, near Myrtle-street, Chippendale, N.S.W.	17 10 0	Dividend	14.1.64
	17 10 0	"	12.7.63
Bates, Henry W., 10 Vicliffe-avenue, Campsie, N.S.W.	5 0 0	"	14.1.64
Bauer, Kurt, 183 Pacific Highway, Hornsby, N.S.W.	5 0 0	"	"
Bayne, Anne M. (Mrs.), Greenhills, Willow Tree, N.S.W.	7 7 0	"	"
	7 7 0	"	12.7.63
Bell, Isabel M. (Mrs.), 92 Empire Circuit, Deakin, A.C.T.	10 9 0	"	14.1.64
Blaxland, Guy H. G., 6 Collings-street, Wahroonga, N.S.W.	8 6 0	"	12.7.63
	8 6 0	"	14.1.64
Brell, Graham A., 51 Conadilly-street, Gunnedah, N.S.W.	10 0 0	"	"
Brennan, Jessie K. (Miss), 29 Mona-road, Edgecliff, N.S.W.	9 1 0	"	"
Bristow, John M., 68 Boundary-road, Wahroonga, N.S.W.	50 0 0	"	"
Campbell, Jacqueline H. (Mrs.), 33 Hay-street, Collaroy, N.S.W.	11 10 0	"	"
	11 10 0	"	12.7.63
Carter, Alexander (Dr.), 5 Delecta avenue, Clareville Beach, N.S.W.	37 9 0	"	14.1.64
Cotman, Helen T. A. (Mrs.), 343 Edgecliff-road, Edgecliff, N.S.W.	30 0 0	"	"
Denison, Mary J. (Miss), c/o D. P. Dickson and Son, 19 Bridge-street, Sydney	15 0 0	"	"
Gillespie, Mary J. (Mrs.), Kendall-street, Beresfield, via Newcastle, N.S.W.	8 1 0	"	12.7.63
	8 1 0	"	14.1.64
McHugh, Evelyn A. (Mrs.), c/o Commonwealth Trading Bank, Auburn, N.S.W.	10 0 0	"	"
Mason, Toni E. (Miss), 5 Canrobert-street, Mosman, N.S.W.	10 0 0	"	"
Nixon, Isabel A. (estate of), G.P.O. Box 795, Sydney	7 2 0	"	"
Kemp, Mary S. (Miss), 17 Sunburst-avenue, North Balwyn	5 0 0	"	"
Hill, Raymond, c/o Bank of N.S.W., 341 George-street, Sydney, N.S.W.	5 0 0	"	"
Smith, Mary Ross (Mrs.), c/o J. D. Jones, Price Waterhouse and Co., 31 Macquarie-place, Sydney, N.S.W.	30 0 0	"	"
	10 0 0	"	12.7.63
Snellgrove, Marion J. (Mrs.), 30-96 Elizabeth Bay-road, N.S.W.	5 0 0	"	14.1.64
Vitali, Lucia (Miss), 99 Darling Point-road, Darling Point, N.S.W.	10 0 0	"	"
Willcocks, Hilda W. (Mrs.), c/o Commercial Banking Co. of Sydney Ltd., Elizabeth-street, Sydney, N.S.W.	21 0 0	"	"
Whittaker, Joan E. (Mrs.), 11 Dudley-street, Randwick, N.S.W.	5 0 0	"	12.7.63
Barclay, John (estate of), c/o P.O. Box 499, Wellington, N.Z.	12 3 11	"	14.1.64
Cooper, Ethel L. (Miss), 136 Southampton-road, Eastleigh, Hants, England	7 7 11	"	"
Greenslade, John W. (estate of), c/o Hannan and Seddon, P.O. Box 8, Greymouth, N.Z.	14 16 8	"	"
Hackforth-Jones, Susan (Mrs.), Walford House, Suarden, Kent, England	8 10 0	"	"
Greenslade, John W. (estate of), c/o Hannan and Seddon, P.O. Box 8, Greymouth, N.Z.	11 5 3	"	"
MASSEY FERGUSON (AUSTRALIA) LIMITED.			
Ertelt, Wilfried Anton Siegwad, 197 Gertrude-street, Fitzroy 5184	11 0 7	Wages	19.8.63
TATURA MILK PRODUCTS LIMITED.			
Anderson, A. B., Box 49, Mooroopna	8 11 3	Dividend and proceeds of sale of shares	"
Height, H. A. and C. G., "Kiota", Dhurringile	6 19 3	Proceeds of sale of shares	"
Wentworth, W. W. and R. D., Cranbourne-road, Dandenong	7 9 9	Dividend and proceeds of sale of shares	"
Wright, K. R. and L. A., c/o P.O., Finley, N.S.W.	6 8 3	"	"
Threfall, W. G. (estate of), R.S.D., Shepparton	5 6 9	"	"
THE MOE CO-OPERATIVE DAIRYING COMPANY LIMITED.			
Alexander, Walter Henry, 10 Joy-street, Morwell 5186	16 8 0	Dividend	1963.
BURNIE BOARD PROCESSORS PTY. LTD.			
Edwards, M. B., 57 Park-street, St. Kilda 5187	6 7 7	Wages	28.1.64

Unclaimed Moneys Act 1962.

REGISTER of Unclaimed Moneys held by the—

Name of Owner on Books and Last Known Address.	Total Amount Due to Owner.	Description of Unclaimed Moneys.	Date when Amount first became Payable.
	£ s. d.		
ASSOCIATED PULP AND PAPER MILLS LIMITED.			
Baldwin, Cecil W. (estate of), c/o Butler McIntyre and Butler, G.P.O. Box 980k, Hobart, Tas.	10 8 10	Dividend	25.10.63
Christie, Maggie (estate of), c/o Burns Philp Trust Co. Ltd., 7 Bridge-street, Sydney, N.S.W.	27 0 0	"	26.4.63
Dowden, Kenneth F. (estate of), c/o H. R. Hoare, P.O. Box 3, Strathfield, N.S.W.	7 0 0	"	"
Fell, Ian B. (estate of), c/o Densley and Downing, 157 Castlereagh-street, Sydney, N.S.W.	224 0 0	"	"
Ferres, Leslie W. (estate of), c/o Baker McEwin Millhouse and Co., Box 337c, Adelaide, S.A.	25 18 0	"	"
Finlayson, Norman B. (estate of), c/o Russell McLelland and Brown, 116 Crown-street, Wollongong, N.S.W.	129 12 0	"	"
Hancock, Harry E. (estate of), c/o Osborne Allan and Son, 75 Pitt-street, Sydney, N.S.W.	70 0 0	"	"
Harvey, Elsie I. (estate of), c/o Thomson Muirhead Ross and McCarthy, 47 Waymouth-street, Adelaide, S.A.	36 0 0	"	25.10.63
Huret, Pierre G. (estate of), c/o Perpetual Trustee Co. Ltd., 33 Hunter-street, Sydney, N.S.W.	48 12 0	"	"
Hyde, William H. C. (estate of), c/o Darbyshire, Gillett and Huellin, 42 St. Georges-terrace, Perth, W.A.	48 12 0	"	26.4.63
Joyce, Emily A. (estate of), c/o C. Roberts Thomson, P.O. Box 89, Burnie, Tas	24 0 0	"	"
Machin, William F. (estate of), c/o Crouch and Crouch, G.P.O. Box 21n, Brisbane, Qld.	32 8 0	"	"
Marshall, Elizabeth C. R. (Mrs.), 9 Rickley-road, South Yarra ..	18 0 0	"	25.10.63
Moore, William B, Flat 6, 87 Alma-road, East St. Kilda ..	6 0 0	"	"
Morpheitt, George C. (estate of), c/o Elders Trustee and Exor. Co. Ltd., G.P.O. Box 494e, Adelaide, S.A.	121 8 10	"	"
Naughton, Mary A. (estate of), c/o James L. Garvey, P.O. Box 27, Braidwood, N.S.W.	18 0 0	"	26.4.63
Neave, Patricia M. (estate of), c/o Allen, Allen and Hemsley, G.P.O. Box 50, Sydney, N.S.W.	50 0 0	"	"
Neill, Evelyn A. (estate of), c/o National Trustees E. and A. Co. of A/asia Ltd., Farmers and Citizens Divn., Charing Cross, Bendigo	40 10 0	"	"
Morris, Gertrude E. (Mrs., nee Newing), 22 Riverside-avenue, North Balwyn	60 0 0	"	"
Penny, Violet M. (estate of), c/o Executor Trustee and Agency Co. of S.A. Ltd., 22 Grenfell-street, Adelaide, S.A.	21 15 7	"	25.10.63
Perry, Minnie P. (estate of), c/o Arthur Phillips and Just, 472 Bourke-street, Melbourne, C.1	18 19 2	"	"
Polley, Lucienne L. S. (Mrs.), 39 Windrest-avenue, Aspley, Qld. ..	13 6 0	"	26.4.63
Raine, Duncan, c/o Mr. L. Pyne, 106 Cambridge-terrace, Malvern, S.A.	10 0 0	"	"
Richards, Margaret E. (estate of), c/o F. J. Church and Grace, 133 Pitt-street, Sydney, N.S.W.	45 0 0	"	"
Schmidt, Rudolph (estate of), c/o Union Trustee Co. (Canberra) Ltd., P.O. Box 590, Canberra, A.C.T.	40 0 0	"	"
Stabler, Leslie J. D. (estate of), c/o Queensland Trustees Ltd., 395 Queen-street, Brisbane, Qld.	48 12 0	"	"
Taylor, Laurence W., c/o Francis Taylor and Ferguson, 58 Margaret-street, Sydney, N.S.W.	18 0 0	"	"
Thomson, Anne (estate of), c/o Morris Fletcher and Cross, G.P.O. Box 204c, Brisbane, Qld.	48 12 0	"	"
Vicars, Thomas H. W., 10 Wedderburn-road, London, N.W.3 ..	14 0 0	"	"
Wall, Gerald E. (estate of), Frank B. Edwards, 46 Reibey-street, Ulverstone, Tas.	14 10 5	"	25.10.63
White, Thomas H. (estate of), c/o Bagots E. and T. Co. Ltd., 198 North-terrace, Adelaide, S.A.	139 16 0	"	"
Baldwin, Cecil W. (estate of), c/o Mrs Frances E. R. Baldwin, c/o Box 185c, G.P.O., Hobart, Tas	11 6 10	Interest Payment	31.7.63
Christoe, Phoebe L. (estate of), c/o Morris Fletcher and Cross, G.P.O. Box 204c, Brisbane, Qld.	10 0 2	"	31.1.64
Clark, Isabella (estate of), c/o Gillott Moir and Ahern, 95 Queen-street, Melbourne, C.1	7 1 4	"	31.7.63
Hancock, Harry E. (estate of) c/o Osborne Allen and Son, 75 Pitt-street, Sydney, N.S.W.	14 0 0	"	"
Harvey, Elsie I. (estate of), c/o Thomson Muirhead Ross and McCarthy, G.P.O. Box 279d, Adelaide, S.A.	5 5 0	"	31.1.64
Huret, Pierre G. (estate of), c/o Perpetual Trustee Co. Ltd., 33 Hunter-street, Sydney, N.S.W.	7 1 5	"	"
Hyde, William H. C. (estate of), c/o Darbyshire Gillett and Huellin, 42 St. Georges-terrace, Perth, W.A.	8 9 4	"	31.7.63
Joseph, Walter S. (estate of), c/o Arthur Robinson and Co., 360 Collins-street, Melbourne, C.1	38 18 4	"	"
Machin, William E. (estate of), c/o Crouch and Crouch, G.P.O. Box 21a, Brisbane, Qld.	5 13 4	"	"
McLaren, William (estate of), c/o D. Bruce Tunnock Clarke and Casey, 452 Lonsdale-street, Melbourne.	14 0 0	"	"
Neill, Evelyn A. (estate of), c/o National Trustees E. and A. Co. of Aust. Ltd., Farmers and Citizens Div., Charing Cross, Bendigo	7 1 4	"	"
Penny, Violet (estate of), c/o Executor Trustee and Agency Co. of S.A. Ltd., 22 Grenfell-street, Adelaide, S.A.	6 6 0	"	"
Richardson, John W., 16 Havering-street, Apsley, Qld.	8 9 4	"	"
Robertson, William A. (estate of), c/o Norman J. Favaro, Equity Chambers, Deakin-avenue, Mildura	15 5 11	"	"

Unclaimed Moneys Act 1962.

REGISTER of Unclaimed Moneys held by the—

Name of Owner on Books and Last Known Address.	Total Amount Due to Owner.	Description of Unclaimed Moneys.	Date when Amount first became Payable.
	£ s. d.		
ASSOCIATED PULP AND PAPER MILLS LIMITED.—continued.			
Robinson, George L (estate of), c/o Field Morrissey and Co., P.O. Box 143, Dandenong	7 0 0	Interest Payment	31.7.63
Schmidt, Rudolph (estate of), c/o Union Fidelity Trustee Co. of Canberra Ltd., P.O. Box 590, Canberra, A.C.T.	7 0 0	" "	"
Stabler, Leslie J. D. (estate of), c/o Queensland Trustees Ltd., 395 Queen-street, Brisbane, Qld.	8 9 4	" "	"
Stevenson, Daisy (estate of), c/o John O. Stevenson, 369 George-street, Sydney, N.S.W.	6 6 0	" "	"
Thomson, Anne, (estate of), c/o Morris Fletcher and Cross, G.P.O. Box 204c, Brisbane, Qld.	8 9 4	" "	"
White, Thomas H. (estate of), c/o Bagots E. and T. Co. Ltd., G.P.O. Box 1812N, Adelaide, S.A.	119 9 10	" "	"
Bennett, William R. (estate of), c/o Public Trustee, G.P.O. Box 504e, Hobart, Tas.	18 15 0	" "	31.1.64
Moloney, James F. (address unknown)	12 10 0	" "	31.7.63
Montgomery, May F. B. (estate of), c/o Molomby and Molomby, 99 Queen-street, Melbourne	25 0 0	" "	"
Mulvany, Andrew J. B. (address unknown)	18 15 0	" "	"
Penny, Violet M. (estate of), c/o Exor. Trustee and Agency Co. of S.A. Ltd., 22 Grenfell-street, Adelaide, S.A.	15 12 6	" "	"
Perry, Minnie P. (estate of), c/o Arthur Phillips and Just, 472 Bourke-street, Melbourne	6 5 0	" "	31.1.64
White, Eva R., Wrightville Store, Redcliffs 5049	6 5 0	" "	31.7.63
COMMONWEALTH AIRCRAFT CORPORATION PTY. LTD.			
Pettigrew, J. D., 101 Coronation-street, West Footscray	9 5 10	Unclaimed Wages	10.4.63
Williams, W., 71 Princes-street, North Williamstown	11 8 1	" "	1.5.63
	22 1 9	" "	26.6.63
McLean, R. D. (estate of), 136 Park-street, St. Kilda	8 3 5	" "	25.12.63
Williams, P. R. (estate of), (address unknown)	40 15 4	" "	29.1.64
	28 18 0	" "	12.2.64
5046			
ROCKMANS LIMITED (RECEIVER APPOINTED).			
Martin, John (address unknown)	12 19 3	Amount due on purchase of shares in Archer and Laing Holdings Limited	9.7.57
5047			
PATONS AND BALDWIN'S (AUSTRALIA) LIMITED.			
Davidson, Dr. A. L. C., c/o Simpson Brookman, 35 Grenfell-street, Adelaide, S.A.	275 0 0	Due to ex Stockholder under Section 185 of Companies Act	22.12.61
Dudgeon, C. E. R. (estate of), c/o Blackman and Butler, P.O. Box 117, Nambour, Qld.	1,375 0 0	" " " "	"
Freeman, J. A., 1 Skene-street, Geelong	375 0 0	" " " "	"
French, E. C. J. (Mrs.) (estate of), 13A Hillside-crescent, Launceston, Tas.	550 0 0	" " " "	"
Mansfield, E. R., 19 Bulkara-road, Bellevue Hill, N.S.W.	275 0 0	" " " "	"
5048			
CENTRAL NORSEMAN GOLD CORPORATION NO LIABILITY.			
Deane, T., Central Hotel, Wellington-street, Perth, W.A.	40 8 0	Dividend	21.6.63
Gordon, S. D., Box 16, P.O., King-street, Sydney, N.S.W.	20 0 0	" "	"
Keast, Marie Z., 1 Monomeath-avenue, Canterbury	40 0 0	" "	"
Neale, Arthur K. (address unknown)	60 0 0	" "	"
Newell, David G. (estate of), c/o National Trustees E. and A. Co. of Aust. Ltd., Farmers and Citizens Divn., P.O. Box 219, Bendigo	10 0 0	" "	6.12.63
5050			
GOLD MINES OF KALGOORLIE (AUST.) Limited.			
Crabb, Richard T. W., 3 Lucas-street, South Caulfield	10 11 0	Dividend	14.6.63
McGlasson, George E. (estate of), c/o Farmers Co-operative Exors. and Trustees Ltd., G.P.O. Box 365D, Adelaide, S.A.	15 0 0	" "	"
Macintosh, Gerald A., 19 Fullarton-road, Highgate, S.A.	22 10 0	" "	"
McNeill, Jessie G. (Mrs.), Springfield-avenue, Springfield, S.A.	12 10 0	" "	6.12.63
Simmie, Eileen C (estate of), c/o Miss S. Simmie, 54 Dendy-street, Brighton	16 5 0	" "	"
5051			
OLYMPIC CONSOLIDATED INDUSTRIES LTD.			
Miller, Thomas, 6 Hodder-street, Brighton, S.5	12 7 6	Dividend	11.10.63
O'Sullivan, E. M. (estate of), c/o Roscoe, W. G. Hoyle and Co., Challis Hduse, 10 Martin-place, Sydney, N.S.W.	11 2 6	" "	"
Weylandt, G. H. (estate of), c/o Mrs. F. W. Weylandt, 93 Northgate-street, Unley Park, S.A.	5 10 0	" "	"
Whitford, W. H., 24 Alvan-street, Mt. Lawley, W.A.	6 17 6	" "	"
Armstrong, E. B. (estate of), 5 Shirley-road, Roseville, N.S.W.	45 7 6	" "	"
Sarkissian, Armen, c/o S. C. Canfield Prudential Assoc. Co., Martin-place, Sydney, N.S.W.	14 17 0	" "	28.2.64
Whitford, W. H., 24 Alvan-street, Mt. Lawley, W.A.	5 12 6	" "	"
Crawford, O. M. A. (Mrs.), "Berthong", Wallendbeen, N.S.W.	6 15 0	" "	"
Miller, Thomas, 6 Hodder-street, Brighton, S.5	10 2 6	" "	"
Armstrong, E. B. (estate of), 5 Shirley-street, Roseville, N.S.W.	37 2 6	" "	"
Blackwood, Edward A., c/o Weld Club, Barrack-street, Perth, W.A.	12 0 0	" "	31.1.64
5072			

Unclaimed Moneys Act, 1962.

REGISTER of Unclaimed Moneys held by the—

Name of Owner on Books and Last Known Address.	Total Amount Due to Owner.	Description of Unclaimed Moneys.	Date when Amount first became Payable.
	£ s. d.		
PETERSVILLE AUSTRALIA LIMITED.			
Adet, Alfred (estate of), 20 Boulevard Suchet, Paris, France	72 4 10	Dividend	6.11.63
Ahern, Michael Francis, 2 Leonie-court, North Brighton	28 3 0	"	29.3.63
Ashworth, Rose (Mrs.), 7 Martin-avenue, Nedlands, W.A.	6 0 0	"	16.11.62
Baker, Anthony, 68 Bondi-road, Bondi Junction, N.S.W.	6 14 9	"	16.11.62
	6 17 8	"	6.11.63
Begg, Mollie Glen (Mrs.), 25 Raheen-drive, Kew	18 0 0	"	16.11.62
Bett, Esther Joan (Mrs) and John Raymond, 31 Riverside-avenue, North Balwyn	10 16 0	"	6.11.63
Brown, Albert John, Bridge-street, Gilgandra, N.S.W.	8 5 11	"	16.11.62
Buckley, Clifford, 20 Surrey-street, Box Hill South, E.11	6 4 2	"	6.11.63
Cameron, Zecrust Kathleen (Mrs.), Lowestoft, Berriedale, Tas.	7 19 0	"	16.11.62
Cane, Alan Anthony, 250 Chisholm-street, Greenwich, N.S.W.	20 14 0	"	6.11.63
Chettle, Ethel Mary (Mrs.), Flat 3, 204 Clovelly-road, Randwick, N.S.W.	18 0 0	"	6.11.63
Ciddor, Clara (Mrs.), c/o Mr. H. Ciddor, 424 Bluff-road, Hampton	9 15 0	"	26.10.61
Creswell, Phillip Allan, 21 MacDonald-street, Harbord, N.S.W.	6 19 1	"	29.3.63
Crosky, Pauline Brayshaw (Mrs.), 2/42 Pine-street, Cammeray, N.S.W.	12 3 0	"	16.11.62
Daniher, John Patrick, Royal Hotel, Koo-Wee-Rup	125 2 6	"	6.11.63
Dawes, Ronald Richard (estate of), c/o Densley and Downing, 147-153 Castlereagh-street, Sydney, N.S.W.	12 8 5	"	29.3.63
Ditchburn, Elsie Marion (Mrs.), Fiat 3, 378 Orrong-road, North Caulfield	7 9 0	"	6.11.63
Duffy, Dorothy Jemina (M/s), 7 Cambridge-street, Gladesville, N.S.W.	27 12 8	"	16.11.62
Eastman, Joan Dolores (estate of), c/o Laurence and Laurence, 44 Martin-place, Sydney, N.S.W.	9 13 2	"	29.3.63
Edwards, Joyce Lillian (Mrs.), 28 Beach-road, Beaumaris	6 0 0	"	12.4.62
Exkay Pty. Ltd., 70 Collins-street, Melbourne	59 8 0	"	26.10.61
Feeney, Patrick Joseph, 21 Morwick-street, Strathfield, N.S.W.	6 14 9	"	16.11.62
Forrest, Muriel Adele (Miss), 36 Burns-road, Wahroonga, N.S.W.	7 16 0	"	29.3.63
Hall, Dorothy Lucas (Mrs.), 41 Mountain View-road, North Balwyn	9 0 0	"	6.11.63
Hughes, Dulcie Nell (Mrs.), 26 Salisbury-street, Balwyn	15 8 1	"	16.11.62
Hurst, Iris Vivienne (Mrs.) and John, 5 Gilpin-street, Camperdown, N.S.W.	5 0 0	"	12.4.62
Keirle, Arthur Atyeo, 306 Little Collins-street, Melbourne	12 15 0	"	16.11.62
	9 0 0	"	29.3.63
	13 10 0	"	6.11.63
Leith, Fanny May (Mrs.), 3 Chatsworth-avenue, Brighton	5 8 0	"	26.10.61
Morris, Jill Lloyd, (Mrs.), 128 Broughton-road, Surrey Hills	18 0 0	"	6.11.63
Mullhall, Rosanna Lillian (Mrs.), Commonwealth Bank of Australia, Redfern, N.S.W.	6 18 1	"	16.11.62
Newton, Evelyn (Mrs.), cnr. River and Kerr streets, Ballina, N.S.W.	11 5 0	"	9.11.61
Newing, Gertrude Elizabeth (Miss), 22 Riverside-avenue, North Balwyn	24 16 10	"	6.11.63
Naokes, Louis Foley (estate of), c/o Maurice Isaacs and Glass, 149 Castlereagh-street, Sydney, N.S.W.	5 4 3	"	6.11.63
Park Steele Investment Pty. Ltd., c/o D. P. Dickson and Co., 119 Bridge-street, Sydney, N.S.W.	24 6 0	"	16.11.62
Parkes, Kingsley, c/o Estate of the late A. J. Parkes, 24 Kirkwood-street, Sandringham	16 4 0	"	26.10.61
	5 9 1	"	23.9.59
	5 9 1	"	22.9.60
Paulsen, Eliza (Mrs.), Council Chambers, Marine-parade, Watson's Bay, N.S.W.	5 9 1	"	9.11.61
	6 2 7	"	16.11.62
	6 5 3	"	6.11.63
	7 10 0	"	16.11.62
Pye, Henry Hilton (estate of), c/o John J. Paine Ross and Co., cnr. George and Kable streets, Windsor		"	
Rosevic Estate Pty. Ltd., c/o Brents Pty. Ltd., 442 Oxford-street, Bondi Junction, N.S.W.	14 18 1	"	6.11.63
Ross, William George, Box 90, P.O., Narrabri, N.S.W.	24 9 3	"	6.11.63
Rumax Investments Pty. Ltd., P.O. Box 383, Canberra City, A.C.T.	34 1 7	"	12.4.62
	67 6 1	"	16.11.62
Runting, Gladys Louise (Miss), 61 St. Georges-road, Elsternwick	5 15 5	"	16.11.62
Savige, Patricia Agnes (Mrs.), 9 Hayward-court, Vermont	7 6 4	"	6.11.63
Scriviner, Margaret Anne (Mrs.), 6 Waimea-avenue, Woollahra, N.S.W.	42 10 6	"	16.11.62
Sutcliffe, Gladys Bessie (Mrs.), 9A Ebdon-avenue, Black Rock	23 16 10	"	6.11.63
Taplin, Evelyn Lyle (Mrs.), P.O. Box 6, Nagambie	12 8 5	"	6.11.63
Tatchell, Muriel Marie Dingle, 10 Struan-street, Toorak	14 18 1	"	6.11.63
Temple-Smith, John, The Slipway, Percy-street, Devonport, Tas.	5 6 6	"	16.11.62
Turner, Arthur Stephen, Lynden House Hotel, College-road, Epsom, Surrey, England	11 9 6	"	6.11.63
Van Lierop, Gerry, Permanent Mess, M.I.M., Mt. Isa, Q'land	5 9 11	"	12.4.62
Wildan Holdings Pty. Ltd., c/o Phillip S. Benjamin and Co., 51 Queen-street, Melbourne	11 3 8	"	29.3.63
Williams, Jenkyn Lawrence (Dr.), 42 Hillcrest-parade, Highfields, 2N, N.S.W.	6 0 0	"	29.3.63
5016			
CALTEX OIL (AUSTRALIA) PTY. LIMITED.			
James, A., Dunolly	5 6 4	Unpresented cheque	30.12.63
Phillips, W. J. and D. J., Gapstead	11 2 0	"	17.10.63
Rayner Bros., Pallet-street, North Coburg	6 0 0	"	12.8.63
Smith, J. G., "Orana", P.B., Horsham	21 9 0	"	16.7.63
Smith, G. J., "Orana", P.B., Horsham	5 15 6	"	29.10.63
Warren, D. E., Halls Gap	16 6 4	"	24.6.63
Walker, J., Beulah	15 0 8	"	24.6.63
4976			

Unclaimed Moneys Act-1962.

REGISTER of Unclaimed Moneys held by the—

Name of Owner on Books and Last Known Address.	Total Amount Due to Owner.	Description of Unclaimed Moneys.	Date when Amount first became Payable.
	£ s. d.		
PHILLIP MORRIS (AUSTRALIA) LIMITED.			
Dumergue, Peter Philippe, 58 Goderich-street, Perth, W.A. 5115	5 0 0	Dividend	1.2.64
FORD MOTOR COMPANY OF AUSTRALIA LIMITED, GEELONG.			
Sesak, I., 23 Elsie-street, Bell Park, Geelong	5 8 5	Wages	—2.63
Baxendale, N. D., 28 Victoria-street, North Geelong	5 15 10	"	—8.63
Bower, L. M., 25 Bailey-street, Belmont, Geelong	13 15 0	"	—4.63
Bishop, O. L., Bristol-road, Torquay	5 14 4	"	—7.63
Barry, V. H., 284 Bellérine-street, Geelong	5 2 9	"	—4.63
Barbaro, V., 96 Albert-street, West Geelong	5 5 4	"	—10.63
Clark, B. P., 29 Bellbird-avenue, Norlane, Geelong	5 19 5	"	—4.63
Bergman, H., 96 Glamis-street, Newtown, Geelong	5 19 5	"	—4.63
Boschma, S., 1 Pizer-street, West Geelong	5 15 10	"	—6.63
Stupkiewicz, F. (address unknown)	5 1 1	"	—5.63
Lyzwa, E., 146 Thompson-street, North Geelong	5 5 9	"	—11.63
KRAFT FOODS LIMITED.			
Radojevic, M., 236 Barkly-street, East Brunswick	10 7 6	Wages	5.3.64
Brown, D. F., 128 Ingles-street, Port Melbourne	19 9 5	"	4.2.64
Hardy, R. J., Flat 8, 56 High-street, St. Kilda	10 11 3	"	5.2.64
Gourley, I. R., 118 Canterbury-road, Middle Park	7 13 8	"	11.3.64
Glazner, R. A., 125 Park-street, East Brunswick	9 11 11	"	3.4.64
McAlister, K. W., 140 Kerferd-road, Albert Park	16 6 9	"	28.2.64
Ahlades, G., 6 Ferrars-place, South Melbourne	21 1 5	"	—3.63
Hansen, L., 517A Chapel-street, South Yarra	7 5 0	"	"
Smith, B., 35 Drummond-street, Carlton	19 8 11	"	"
Wright, N. L., 24 Curran-street, North Melbourne	10 14 11	"	—4.63
Laxton, N., 35 Nicholson-street, Abbotsford	5 2 3	"	—12.63
Ellis, D., 118 Bank-street, South Melbourne	15 17 6	"	"
Ballard, J., 17 Mills-street, Albert Park	5 15 1	"	8.10.63
Clancy, J., Strathmerton	7 3 11	"	—12.63
Emmerson, E., 297 High-street, St. Kilda	5 1 9	"	27.11.63
Turner, R., 51 Dow-street, South Melbourne	8 14 9	"	3.12.63
THE PERPETUAL EXECUTORS AND TRUSTEES ASSOCIATION OF AUSTRALIA LIMITED.			
Attenborough, W. (estate of), P.O., Kinglake	30 4 4	Dividends and sale of shares	23.2.12
COMALCO STAFF SUPERANNUATION FUND.			
Muste, P. G. M., George Town, Tasmania	9 19 8	Refund of Contributions	—8.63
GENERAL MOTORS HOLDEN'S PTY. LTD.			
Manolacos, Theodoros (address unknown)	6 17 7	Wages	20.8.63
Wilkinson, Robert John, 469 Princes Highway, Dandenong	7 0 0	Suggestion award	—12.63
WALLACE H. SMITH AND CO.			
Ritchie, W. R., P.O. Box 23, Cobram	80 0 0	Repayment by S. T. Leigh Co. re take-over of P. C. Grosser Ltd.	1962
INDUSTRIAL ACCEPTANCE CORPORATION LIMITED.			
Noe, Oscar, Flat 1, 7 Avoca-court, Elwood	20 0 0	Interest	31.8.63
I.A.C. (HOLDINGS) LIMITED.			
Atherton, W. C. S. and Mrs. I., 486 Hawthorn-road, Caulfield	22 10 4	Dividend	25.10.63
SIGMA COMPANY LIMITED.			
Pickford, J. C. (estate of), c/o J. P. Rhoden, 376-380 Collins-street, Melbourne	21 2 3	Dividends	1960-63
Pickford, C. A. (estate of), c/o J. P. Rhoden, 376-380 Collins-street, Melbourne	16 17 4	Dividends	1960-63
TOM PIPER LIMITED.			
Scott, Paul, 34 Durham-street, Richmond, E.1	5 17 6	Wages	26.3.63
Belton, W. L., Boronia Carrying Co., Boronia	6 15 0	Cartage due	1.5.63
MALCOLM MOORE INDUSTRIES LIMITED.			
Roberts, Edward P.H., 20 Belgrave-road, East Malvern	8 0 0	Dividend	18.10.63
BLUE MOON (SHEPPARTON) PTY. LTD.			
Elliott, Bruce Douglas, P.O. Box 20, Moura, Qld.	10 5 3	Wages	13.3.63
Elliott, Gordon Walter, P.O. Box 20, Moura, Qld.	10 5 3	"	"
Whalley, Mervyn, Mails Service 108, Bundaberg, Qld.	6 4 4	"	20.3.63

Unclaimed Moneys Act 1962.

REGISTER of Unclaimed Moneys held by—

Name of Owner on Books and Last Known Address.	Total Amount Due to Owner.	Description of Unclaimed Moneys.	Date when Amount first became Payable.
	£ s. d.		
CROFT BANK DAIRIES LIMITED			
White, Edward James, 4 Lake-street, Carnegie 5074	6 10 0	Dividend	8.5.63
MELBOURNE STEAMSHIP CO. LTD.			
Rankin, A. E. (Mrs.), 34 Oleander-street, Brighton, S.A. 5091	262 10 0	Acquisition of Shareholdings	—3.62
KYABRAM FRUIT PACKERS LTD.			
Ringuet, A., 17 Short-street, North Mackay, Qld. 5095	13 5 11	Wages	15.3.62
PERMEWAN WRIGHT LIMITED.			
Fox, Ronald Godfrey, 33 Princes-street, Croydon, S.A.	15 12 6	Dividend	21.8.63
McEwan, Winifred H. (estate of), 14 Margaret-street, Benalla	26 5 0	"	"
Chapman, Allan Winston, P.O. Box 35, Wingham, N.S.W.	9 11 0	"	"
Kiley, Lucy Veronica and Bridget Kiley, 3 Forest-road, Double Bay, N.S.W.	8 6 0	"	"
Walker, John Keith, 13 Haig-avenue, Coburg 5097	25 0 0	"	"
PATERSONS (AUSTRALIA) LIMITED.			
Goodkind, H. (estate of), c/o 619 St. Kilda-road, Melbourne	12 2 0	Deposit Interest	31.8.63
Rickards, M. J. (estate of), c/o T. F. Rickards, 118 Centre-road, East Brighton	5 0 0	Dividend	"
Cutmore, C. G., c/o Mordialloc and Cheltenham Community Hospital, Nepean Highway, Parkdale	6 0 0	"	16.9.63
Dibdin, E. J. (estate of), 137 Wellington-street, Windsor	7 9 7	"	"
Green, P. S. M., 1191 Dandenong-road, East Malvern	6 0 0	"	"
Griffith, L. E., 24 Stud-road, Dandenong	9 0 0	"	"
Harvey, B. M., "Grange", 53 Alfred-street, Kew	14 0 0	"	"
Howard, J. M., 18 Collings-street, Hartwell	5 0 0	"	"
Lorney, E. M., c/o I. R. Anderson, 3 Callanish-road, Burwood	6 0 0	"	"
McKenzie, S. M., 717 Glenhuntly-road, Caulfield	7 9 7	"	"
McMillan, P. M., "Nalderswood Cottage", Old Warrandyte-road, Donvale	6 16 0	"	"
Wraith, G. F. (estate of), c/o K. F. Wraith, Taurus-street, North Balwyn, Vic. 5098	10 0 0	"	"

The Companies Act 1961.—In the matter of WAKEFIELD ENGINEERING COMPANY PTY. LTD.

NOTICE is hereby given that at an Extraordinary Meeting of the members of the above named company held on Wednesday, the 10th day of March, 1965, it was resolved that the company be wound up voluntarily and at a Meeting of Creditors held on the same day pursuant to section 260, it was resolved that for such purpose Norman Eric Stretton, of 296 Little Lonsdale-street, Melbourne, accountant, be appointed liquidator.

Notice is also given that after 21 days from this date I shall proceed to distribute the assets. All creditors having any claims against the company should furnish particulars of same by that date, otherwise I shall proceed to distribute the assets without regard to their claim.

Dated this 22nd day of March, 1965.

N. E. STRETTON, Liquidator.

Kennedy, Smail and Middlemiss, 296-300 Little Lonsdale-street, Melbourne, C.I. 5146

The Companies Act 1961.—In the matter of LONDON ENGINEERING PROPRIETARY LIMITED.

NOTICE is hereby given that at an Extraordinary Meeting of the members of the above-named company held on the 16th March, 1965, it was resolved that the company be wound up voluntarily, and at a Meeting of Creditors held on the same day pursuant to section 260, it was resolved that for such purpose Norman Eric Stretton, of 296 Little Lonsdale-street, Melbourne, accountant, be appointed liquidator.

Notice is also given that after 21 days from this date I shall proceed to distribute the assets. All creditors having any claims against the company should furnish particulars of same by that date, otherwise I shall proceed to distribute the assets without regard to their claim.

Dated this 18th day of March, 1965.

N. E. STRETTON, Liquidator.

Kennedy, Smail and Middlemiss, 296 Little Lonsdale-street, Melbourne. 5147

LUMREEKIE PROPRIETARY LIMITED.

NOTICE CONVENING FINAL MEETING, PURSUANT TO SECTION 272.

NOTICE is hereby given pursuant to section 272 of the Companies Act 1961 that a General Meeting of the members of the above named company will be held at 419 Lonsdale-street, Melbourne, on Monday, the 26th day of April, 1965, at 10 o'clock in the forenoon, for the purpose of having an account laid before them showing the manner in which the winding up has been conducted and the property of the company disposed of and of hearing any explanation that may be given by the liquidator.

5143 NORMAN FRANK HENNING, Liquidator.

The Companies Act 1961.—In the matter of WAGANT DEVELOPMENTS PROPRIETARY LIMITED (in Voluntary Liquidation).

NOTICE is hereby given that the following Special Resolution was passed on the 15th day of March, 1965.

"Resolved as a Special Resolution that the company be wound up voluntarily and that Kathleen Rankin be and is hereby appointed liquidator."

5144 KATHLEEN RANKIN, Secretary.

BATMANS HILL HOTEL PROPRIETARY LIMITED (IN VOLUNTARY LIQUIDATION).

PURSUANT to section 272 of the Companies Act 1961 notice is hereby given that a General Meeting of the members of the above named company will be held at the office of C. O. E. Webster, 317 Collins-street, Melbourne, at 10.30 a.m., on the 30th day of April, 1965, for the purpose of receiving the liquidators account showing how the winding up has been conducted and the property of the company disposed of and the hearing of any explanation thereon.

Dated this 22nd day of March, 1965.

5145 C. O. E. WEBSTER, Liquidator.

Companies Act 1961, Section 254 (2) (b).

BLOCKEY STONE & COMPANY PROPRIETARY LIMITED.

NOTICE is hereby given that at an Extraordinary General Meeting of the above-named company, duly convened and held at 268A Lonsdale-street, Melbourne, on Tuesday, 16th March, 1965, the following Special Resolution was duly passed—

"That the company be wound up voluntarily and that Rex Stanley Prime, of 330 Collins-street, Melbourne, accountant, be appointed liquidator for the purposes of such winding up."

Dated the 18th day of March, 1965.

5206

R. S. PRIME, Liquidator.

In the Supreme Court of Victoria (1964 No. COY7003).—In the matter of the *Companies Act 1961*; and in the matter of BRIDGER CABLES PTY. LTD.

NOTICE is hereby given that a petition for the winding up of the above-named company by the Supreme Court was on the 17th day of March, 1965, presented by Neonasia Cables Pty. Ltd.: And that the said petition is directed to be heard before the court sitting at the Fourteenth Court, Law Courts, William-street, Melbourne, on the 13th day of April, 1965, at the hour of 10.30 o'clock in the forenoon, and any creditor contributory of the said company desiring to support or oppose the making of an order on the said petition may appear at the time of hearing by himself or his counsel for that purpose, and a copy of the petition will be furnished to any creditor or contributory of the said company requiring the same by the undersigned on payment of the regulated charge of the same.

The petitioner's address is corner Moray and Dorcas streets, South Melbourne.

The petitioner's solicitors are Corr and Corr, of 290 Latrobe-street, Melbourne.

CORR & CORR, solicitors for the petitioner.

NOTE.—Any person who intends to appear on the hearing of the said petition must serve on or send by post to the above-named solicitors, notice, in writing, of his intention so to do. The notice must state the name and address of the person, or if a firm, the name and address of the firm and must be signed by the person or firm, or his or their solicitor (if any) and must be served, or if posted, must be sent by post in sufficient time to reach the above named not later than Four o'clock in the afternoon of the 12th day of April, 1965.

5188

In the matter of the *Companies Act 1961*.—And in the matter of G. M. DAWSON (CHINA & GLASS) PROPRIETARY LIMITED (in Voluntary Liquidation).—Notice of Final Meeting of Members, Pursuant to Section 272.

NOTICE is hereby given in pursuance of section 272 of the *Companies Act* that a General Meeting of the members of the above-named company will be held at the office of Cooper Brothers & Co., 360 Collins-street, Melbourne, on Friday, 30th April, 1965, at 10.30 o'clock in the forenoon, for the purpose of having an account laid before it showing the manner in which the winding up has been conducted and the property of the company disposed of, and hearing any explanation that may be given by the liquidators.

Dated this 22nd day of March, 1965.

N. W. BUCKLEY, Liquidator.
J. L. MAFFEY, Liquidator.

360 Collins-street, Melbourne, C.1.

5202

Companies Act 1961.

FREIGHTERS OVERSEAS CORPORATION PTY. LIMITED.

MEMBERS VOLUNTARY WINDING UP.

AT an extraordinary general meeting of the members of Freighters Overseas Corporation Pty. Limited, duly convened and held at Melbourne, on the 9th day of March, 1965, the following special resolution was duly passed:—

"Resolved that the company be wound up voluntarily, and that A. F. Campbell of Cook, Tomlins & Mirams, chartered accountants, 447 Collins-street, Melbourne, having notified, in writing, his consent to act as liquidator of the company, be and is hereby appointed liquidator of the company."

Dated this twelfth day of March, 1965.

5139

B. FELLER, Secretary.

Companies Act 1961.

**CAMERON AND SUTHERLAND (STEEL) PTY. LIMITED.
MEMBERS VOLUNTARY WINDING UP.**

AT an extraordinary general meeting of the members of Cameron and Sutherland (Steel) Pty. Limited, duly convened and held at Melbourne, on the 9th day of March, 1965, the following special resolution was duly passed:—

"Resolved that the company be wound up voluntarily, and that A. F. Campbell of Cook, Tomlins & Mirams, chartered accountants, 447 Collins-street, Melbourne, having notified, in writing, his consent to act as liquidator of the company, be and is hereby appointed liquidator of the company."

Dated this twelfth day of March, 1965.

5138

B. FELLER, Secretary.

Companies Act 1961.

B. DAVID IMPORT COMPANY PROPRIETARY LIMITED.

NOTICE is hereby given that at an Extraordinary Meeting of the company the following Resolution was duly passed:—

"That the company be wound up voluntarily".

Dated the 13th March, 1965.

5099

B. DAVID, Liquidator.

Companies Act 1961.

**FREIGHTERS PROPERTY PTY. LIMITED.
MEMBERS VOLUNTARY WINDING UP.**

AT an extraordinary general meeting of the members of Freighters Property Pty. Limited, duly convened and held at Melbourne, on the 9th day of March, 1965, the following special resolution was duly passed:—

"Resolved that the company be wound up voluntarily, and that A. F. Campbell of Cook, Tomlins & Mirams, chartered accountants, 447 Collins-street, Melbourne, having notified, in writing, his consent to act as liquidator of the company, be and is hereby appointed liquidator of the company."

Dated this twelfth day of March, 1965.

5140

B. FELLER, Secretary.

Companies Act 1961.

**TRAILER SALES AND SERVICE PTY. LIMITED.
MEMBERS VOLUNTARY WINDING UP.**

AT an extraordinary general meeting of the members of Trailer Sales and Service Pty. Limited, duly convened and held at Melbourne, on the 9th day of March, 1965, the following special resolution was duly passed:—

"Resolved that the company be wound up voluntarily, and that A. F. Campbell of Cook, Tomlins & Mirams, chartered accountants, 447 Collins-street, Melbourne, having notified, in writing, his consent to act as liquidator of the company, be and is hereby appointed liquidator of the company."

Dated this twelfth day of March, 1965.

5141

B. FELLER, Secretary.

The *Companies Act 1961*.—In the matter of D. M. P. ENGINEERING PTY. LTD.—Notice of Meeting of Creditors, Pursuant to Section 260.

NOTICE is hereby given that a meeting of creditors of the above-named company will be held at the Institute of Chartered Accountants of Australia, 23 McKillop-street, Melbourne, in the State of Victoria, at 9.30 o'clock in the forenoon, on Thursday the 1st April, 1965, the company having convened a meeting of its members for the same day for the purpose of considering a resolution that the company be wound up voluntarily.

ROBERT R. SMITH, Official Manager.

O. W. Parkinson & Son, 343 Little Collins-street, Melbourne. 5151.

W.M.B. INVESTMENTS PTY. LTD.

THE following Special Resolution was passed at an Extraordinary General Meeting of the members of the above-named company, held on 11th of March, 1965, at 401 Collins-street, Melbourne:—

"That the company be wound up voluntarily."

Dated this 18th day of March, 1965.

A. W. OGILVY, Liquidator.

Edwin V. Nixon and Partners, 401 Collins-street, Melbourne. 5134

Companies Act 1961.

T.E.L. TELEVISION SERVICES PROPRIETARY LIMITED.
PURSUANT TO SECTION 260 OF THE COMPANIES ACT 1961.

NOTICE is hereby given that a Meeting of Creditors of T.E.L. Television Services Pty. Ltd. will be held at the offices of M. V. Anderson & Co., chartered accountants, 7th Floor, 277 William-street, Melbourne, on Thursday, 25th March, at 10 a.m., for the purpose of considering the companies affairs, the company having convened a Meeting of Members for the same day for the purpose of considering a Resolution that the company be wound up voluntarily.

Dated this 15th day of March, 1965.

R. D. BLACKWELL, Director.

M. V. Anderson & Co., chartered accountants, 277 William-street, Melbourne. 5142

VICTOR JAMES MILLS, late of "Plum Tree Cottage", Don-road, Healesville, gentleman, DECEASED.

CREDITORS, next of kin and others having claims in respect of the estate of the deceased (who died on the 8th day of October, 1964), are required by the executrix, Ruby Merie Heaton, of Don-road, Healesville, widow, to send particulars to her, care of the undersigned, on or before the 31st day of May, 1965, after which date she will distribute the assets, having regard only to the claims of which she then has notice.

R. P. BAYLOR & CO., solicitors, Healesville. 5155

MARY AGNES CHRISTIE, late of Barnard-street, Bendigo, Spinster, DECEASED, intestate.

CREDITORS, next of kin and all others having claims against the estate of the above-mentioned deceased are required by the administrator thereof, Herbert Alexander Christie, of 212 High-street, Bendigo, retired dentist, to send particulars to him, care of the under-mentioned solicitors, on or before the 18th day of May, 1965, after which date he will distribute the assets of the estate, having regard only to the claims of which it then has notice.

Dated this 16th day of March, 1965.

HYETT & HYETT, 51 Bull-street, Bendigo, solicitors for the administrator. 5067

CREDITORS, next of kin and others having claims in respect of the estate of Gladys Muriel Barnes, late of 4 Lucy-street, Gardenvale, home duties, deceased (who died on the 23rd September, 1963), are requested to send particulars of their claims to George Meredith Griffett, of 150 Nepean Highway, Gardenvale, dental mechanic, the executor appointed by deceased's will to the care of the under-mentioned solicitor by the 31st day of May, 1965, after which date the executor will distribute the assets, having regard only to the claims of which he shall then have had notice.

R. T. BREEN, LL.B., solicitor, 118 Church-street, Middle Brighton. 5057

VICTOR FRANCIS ARTHUR PAYNTER, formerly of Yarragon, but late of 107 Tambat-street, East Bentleigh, farmer, DECEASED.

CREDITORS, next of kin and others having claims in respect of the estate of the deceased (who died on the 4th July, 1964), are required by the trustee, Evelyn Dorothea Paynter, to send particulars to her, care of the undersigned solicitors by the 14th June, 1965, after which date the trustee may convey or distribute the assets, having regard only to the claims of which she then has notice.

GRAY, FRIEND & LONG, solicitors, Warragul. 5059

NATIONAL TRUSTEES, EXECUTORS AND AGENCY COMPANY OF AUSTRALASIA LIMITED, of 95 Queen-street, Melbourne, and John Hocking, of 29 Grandview-road, Chadstone, inspector, the executors of the will of Harry Ford, late of Harcourt, orchardist, deceased (who died on the 9th day of April, 1964), require all creditors, next of kin and others having claims against the property or estate of the said deceased to send to the said executors, in the care of the said company, on or before the 1st day of June, 1965, particulars, in writing, of such claims, after which date the said executors intend to convey or distribute such property or estate to or among the persons entitled thereto, having regard only to the claims of which they shall then have had notice.

H. S. W. LAWSON & CO., solicitors, Castlemaine.

5104

CREDITORS, next of kin and others having claims against the estate of Eric Barker, late of 178 Beach-road, Sandringham, retired, deceased (who died on the 20th day of June, 1964), are required by the executors, Marie Barker, of 178 Beach-road, Sandringham, widow, and Alfred Newton Super, of 366 Bourke-street, Melbourne, solicitor, to send particulars of their claims, care of Sylvia Rothstadt, solicitor, at the address set out below, by 25th day of May, 1965, after which date they will distribute the assets, having regard only to the claims of which they then shall have had notice.

SYLVIA ROTHSTADT, M.A., LL.B.; barrister and solicitor, of 366 Bourke-street, Melbourne. 5065

CREDITORS, next of kin and others having claims against the estate of Charles William Kerry, late of 191 Mitcham-road, Mitcham, accountant, deceased (who died on the 4th January, 1965), are requested to send particulars of their claims to the executors, Mavis Joan Kerry and James Kneale Proudfoot, care of the undersigned solicitors, by the 25th May, 1965, after which date the said executors will distribute the assets, having regard to claims only of which they then have notice.

PROUDFOOT, HORTON & COOKE, solicitors, 452 Lonsdale-street, Melbourne. 5129

PURSUANT to the provisions of the Trustee Act 1958, creditors, next of kin and all other persons having claims in respect of the estate of Jean Alice Brodie, late of No. 274 The Avenue, Parkville, spinster (who died on the 7th January, 1965), are required to send particulars of their claims to the executor, the Union-Fidelity Trustee Company of Australia Limited, the registered office of which is situate at 333 Collins-street, Melbourne, by the 2nd June, 1965, after which date the company will distribute the assets, having regard only to the claims of which it shall then have had notice.

MADDOCK, LONIE & CHISHOLM, solicitors, 339 Collins-street, Melbourne. 5130

CREDITORS, next of kin and others having claims in respect of the estate of Alice Edna Roberts (known also as Ena Rosina Roberts), late of 23 Flinders-street, Mentone, spinster, deceased (who died on the 23rd day of March, 1953), are to send particulars of their claims to the executrix, Hazel Charlwood, care of the under-mentioned solicitors, by the 28th day of May, 1965, after which date the executrix will distribute the assets, having regard only to the claims of which she then has notice.

MARTIN & MARTIN, solicitors, 37 Queen-street, Melbourne. 5136

CREDITORS, next of kin and others having claims in respect of the estate of Laurence Charles Kinsella, late of 86 Rowe-street, North Fitzroy, retired, deceased (who died on the 25th November, 1964), are required to send particulars of their claims to National Trustees, Executors and Agency Company of Australasia Limited, of 95 Queen-street, Melbourne, the administrator of the estate of the said deceased, having been duly authorized by Margaret Mary Carmody, daughter of the said deceased, by the 31st day of May, 1965, after which date it will distribute the assets, having regard only to the claims of which it then has notice.

HERBERT, GEER & RUNDLE, solicitors, 113 William-street, Melbourne. 5135

ETHEL MAY DAVIS, formerly of Brandy Creek-road, Warragul, but late of Fairview Homes for the Aged, Warragul, gentlewoman, DECEASED.

CREDITORS, next of kin and others having claims in respect of the estate of the deceased (who died on the 6th October, 1964), are required by the trustees, Harry Alexander Davies and William Alexander Davies, to send particulars to them, care of the undersigned solicitors, by the 18th day of June, 1965, after which date the trustees may convey or distribute the assets, having regard only to the claims of which they then have notice.

GRAY, FRIEND & LONG, solicitors, Warragul. 5100

CREDITORS, next of kin and others having claims in respect of the estate of John Wightman Hardie, late of Traralgon, paper mill employee, deceased (who died on 12th August, 1964), are required to send particulars of their claims to the trustee, Mary Hardie, care of the undersigned by 31st May, 1965, after which date she will distribute the assets, having regard only to the claims of which she then has notice.

C. H. FORD, LL.M., solicitor, Traralgon.

5084

CREDITORS, next of kin and other persons having claims against the estate of William Elderslie Sloggett, formerly of 29 Williams-road, Windsor, but late of Keswick Private Hospital, Mentone, in the State of Victoria, retired insurance broker, deceased (who died on the 28th day of December, 1964), are to send particulars of their claims to the executor, National Trustees, Executors and Agency Company of Australasia Limited, of 95 Queen-street, Melbourne, by the 26th May, 1965, after which date the company will distribute the assets, having regard only for the claims of which it then has notice.

JAMES P. OGG & CO., solicitors, 165 Greville-street, Prahran. 5122

CREDITORS, next of kin and other persons having claims against the estate of Sarah Anne Connell, late of 46 Patterson-street, East Coburg, in the State of Victoria, widow, deceased (who died on the 2nd day of January, 1965), are to send particulars of their claims to the executor, National Trustees, Executors and Agency Company of Australasia Limited, of 95 Queen-street, Melbourne, by the 26th May, 1965, after which date the company will distribute the assets, having regard only for the claims of which it then has notice.

JAMES P. OGG & CO., solicitors, 165 Greville-street, Prahran. 5123

CREDITORS, next of kin and all others having claims against the estate of Andrew Gordon Wilson, late of 18 Kendall-street, Coburg, retired clergyman (who died on 2nd January, 1965), are required to send particulars thereof to The Trustees Executors and Agency Company Limited of 401 Collins-street, Melbourne, executor of his will, on or before 28th May, 1965, after which date it will distribute the assets, having regard only to the claims of which it then has notice.

NEWELL, MARSH & LEWIS, 360 Collins-street, Melbourne, solicitors for the executor. 5137

ALBERT ERNEST CONGDON, late of 126 Orrong-road, Toorak, dentist, DECEASED.

CREDITORS, next of kin and others having claims against the estate of the above-named deceased (who died on 13th December, 1964), are to send particulars of their claims to National Trustees Executors and Agency Company of Australasia Limited, addressed to the office of the said company at 95 Queen-street, Melbourne, by the 30th day of May, 1965, after which date the said company will distribute the assets, having regard only to the claims of which it then has notice.

H. H. HOARE, solicitor, 118 Queen-street, Melbourne. 5124

JEAN MCKAY PITT, late of 64 Lytton-street, Castlemaine, widow, DECEASED.

CREDITORS, next of kin and others having claims in respect of the estate of the above-named deceased (who died on the 28th day of June, 1964), are required by the executor of her will, John Horwood Wightman Lawson, of Castlemaine, solicitor, to send particulars to him in care of the undersigned solicitors by the 31st day of May, 1965, after which date the executor may convey and distribute the assets, having regard only to the claims of which he then has notice.

Dated the 18th day of March, 1965.

H. S. W. LAWSON & CO., solicitors, Castlemaine. 5103

ALL persons having claims against the estate of Mary Dorothea Whitelaw, late of Wellington, in the Dominion of New Zealand, married woman, deceased (who died on the 31st day of March, 1964, and probate of whose will was on the 20th day of May, 1964, granted by the Supreme Court of New Zealand to The Guardian Trust and Executors Company of New Zealand Limited, and application to the Supreme Court of Victoria (probate jurisdiction) The Perpetual Executors and Trustees Association of Australia Limited to seal such probate having been granted on the 17th day of February 1965), are hereby required to send particulars of such claims to The Perpetual Executors and Trustees Association of Australia Limited, at its registered office, at 100-104 Queen-street, Melbourne, on or before the 1st day of June, 1965, after which date the said company will proceed to transfer, convey or distribute the said estate to or among the persons entitled thereto, having regard only to the claims of which it shall then have had notice, and will not be liable for the assets so transferred, conveyed or distributed to any persons of whose claim it shall not then have had notice.

ELLISON, HEWISON & WHITEHEAD, solicitors, 421 Bourke-street, Melbourne. 5204

No. 19.—2147/65.—6

CREDITORS, next of kin and others having claims in respect of the estate of Frederick Humphrey Allen, late of 8 Phipps Crescent, Diamond Creek in the State of Victoria, gentleman, deceased (who died on the 8th day of June, 1964), are to send the particulars of their claims to The Perpetual Executors and Trustees Association of Australia Limited, at its registered office, 100-104 Queen-street, Melbourne, by the 1st day of June, 1965, after which date it will distribute the assets, having regard only to the claims of which it then has notice.

BEST, HOOPER, RINTOUL & SHALLARD, solicitors, 100 Queen-street, Melbourne. 5205

CREDITORS, next of kin and others having claims in respect of the estate of Douglas David Hall, late of 6 Electra-street, Williamstown, printer, deceased (who died on the 5th day of February, 1963), are to send the particulars of their claims to The Perpetual Executors and Trustees Association of Australia Limited, of 100-104 Queen-street, Melbourne, by the 2nd day of June, 1965, after which date it will distribute the assets, having regard to the claims of which it then has notice.

READ & READ, solicitors, 422 Collins-street, Melbourne. 5196

CREDITORS, next of kin and others having claims in respect of the estate of Peter James Hay, late of 7 Cook-street, Ivanhoe West, apprentice sheetmetal worker, deceased, intestate (who died on the 11th day of January, 1965), are to send particulars of their claims to Royston Thomas Cahir, solicitor, of 475 Collins-street, Melbourne, by the 25th day of May, 1965, after which date the administrator will distribute the assets of the said estate, having regard only to claims of which he then has notice.

ROYSTON T. CAHIR, barrister and solicitor, 475 Collins-street, Melbourne. 5198

CREDITORS, next of kin and others having claims in respect of the estate of Albert Cummings, late of 333 Nott-street, Port Melbourne, cleaner, deceased (who died on the 25th day of November, 1964), are to send particulars of their claims to Royston Thomas Cahir, solicitor, of 475 Collins-street, Melbourne, by the 25th day of May, 1965, after which date the executrix will distribute the assets of the said estate, having regard only to claims of which she then has notice.

ROYSTON T. CAHIR, barrister and solicitor, 475 Collins-street, Melbourne. 5199

CREDITORS, next of kin and others having claims in respect of the estate of Joseph Harold Mellor, late of 52 Campbell-grove, Hawthorn, engineer, deceased (who died on the 31st day of January, 1965), are to send the particulars of their claims to The Perpetual Executors and Trustees Association of Australia Limited, of 100-104 Queen-street, Melbourne, by the 1st day of June, 1965, after which date it will distribute the assets, having regard to the claims of which it then has notice.

READ & READ, solicitors, 422 Collins-street, Melbourne. 5189

CREDITORS, next of kin and others having claims in respect of the estate of Ripley Elkin Bowden, late of Phoenix, Arizona, United States of America, director, deceased (who died on the 24th day of April, 1963), are to send the particulars of their claims to The Perpetual Executors and Trustees Association of Australia Limited, of 100-104 Queen-street, Melbourne, by the 2nd day of June, 1965, after which date it will distribute the assets, having regard to the claims of which it then has notice.

READ & READ, solicitors, 422 Collins-street, Melbourne. 5190

CREDITORS, next of kin and others having claims in respect of the estate of Victoria Ellen Pynor, late of 38 Marine-parade, St. Kilda, in the State of Victoria, widow (who died on the 17th day of January, 1965), at Melbourne, are to send particulars of their claims to Marjorie Clare Glover, of 38 Marine-parade, St. Kilda, married woman, Dorothy Beatrice Stahel, of 198 Balcombe-road, Mentone, married woman and Nancy Vere Field, of 60 Lindens-way, Castlecrag, Sydney, in the State of New South Wales, care of their solicitors, Messrs. Cole and O'Heare, 465 Collins-street, Melbourne, by the 1st day of June, 1965, after which date the above-named Marjorie Clare Glover, Dorothy Beatrice Stahel and Nancy Vere Field will distribute the assets, having regard only to the claims of which they have been given notice.

5191

CREDITORS, next of kin and others having claims in respect of the estate of Dougald Thomson, late of Strathkellar, in the State of Victoria, farmer, deceased (who died on the 25th day of April, 1964), and probate of whose will was granted to Jean Marion Thomson, of Strathkellar, in the said State, widow, and Douglas Howie Kerr, of "Urapunga", Bransholme, in the said State, farmer, the executors named in the said will, are to send particulars of their claims to the executors, care of the undersigned, at their address mentioned hereunder by the 22nd day of June, 1965, after which date the said executors will distribute the assets, having regard only to the claims of which they then have notice.

CAMERON & LOWENSTERN, solicitors, 62 Thompson-street, Hamilton. 5193

CREDITORS, next of kin and others having claims in respect of the estate of William Frederick Muir, formerly of 185 Mont Albert-road, Canterbury, but late of 25 Box Hill-crescent, Box Hill, share clerk, deceased (who died on the 27th November, 1964), are to send particulars of their claims to The Equity Trustees, Executors and Agency Company Limited, at 472 Bourke-street, Melbourne, by the 2nd June, 1965, after which date it will distribute the assets, having regard only to the claims of which it then has notice.

LEACH & THOMSON, solicitors, 472 Bourke-street, Melbourne. 5194

CREDITORS, next of kin and others having claims in respect of the estate of Hanora Helena Crow, late of 54 Martin-street, Hamilton, in the State of Victoria, spinster, deceased (who died on the 3rd day of December, 1964), and probate of whose will was granted to Robert Maxwell Hunter, of Hamilton, in the said State, solicitor, the executor named in the said will, are to send particulars of their claims to the executor, care of the undersigned at their address mentioned hereunder, by the 21st day of June, 1965, after which date the said executor will distribute the assets, having regard only to the claims of which he then has notice.

CAMERON & LOWENSTERN, solicitors, 62 Thompson-street, Hamilton. 5195

THOMAS HENRY SMITH, late of 28 Queensville-street, Footscray, in the State of Victoria, retired, DECEASED.

CREDITORS, next of kin and others having claims in respect of the estate of the deceased (who died on the 8th day of November, 1964), are required by the trustee, The Trustees, Executors and Agency Company Limited, of 401 Collins-street, Melbourne, to send particulars to it, at 401 Collins-street, Melbourne, by the 31st day of May, 1965, after which date the trustee may convey or distribute the assets, having regard only to the claims of which it then has notice.

Dated the 9th day of March, 1965.

JOHN P. RHODEN, solicitor, 376 Collins-street, Melbourne. 5132

CREDITORS, next of kin and others having claims in respect of the estate of Maria Camakaris, late of corner of Beaconsfield-parade and Kerferd-road, Albert Park, in the state of Victoria, married woman, deceased (who died on the 27th October, 1964), are to send particulars of their claims to the executor, Harilaos Camakaris, care of the under-mentioned solicitors, before the 26th day of May, 1965, after which date the executor will distribute the assets, having regard only to the claims of which he then has notice.

BRENDAN MCGUINNES & CO., solicitors, 118 Queen-street, Melbourne. 5125

ALEXANDER JAMES FRASER, late of 5 Montgomery-street, Mordialloc, carrier, DECEASED.

CREDITORS, next of kin and others having claims in respect of the estate of the deceased (who died on the 6th day of December, 1964), are required by his personal representative, Norman Francis Fraser, of Flat 8, Normanby Court, Number 23 Chapman-street, North Melbourne, french polisher, to send particulars to him, care of the undersigned, at their address mentioned hereunder, by the 26th day of May, 1965, after which date the personal representative may convey or distribute the assets, having regard only to the claims of which he then has notice.

RIGBY & FIELDING, solicitors, 90 William-street, Melbourne. 5149

CREDITORS, next of kin and others having claims in respect of the estate of Francis Donald Treacey, late of 93 Barkers-road, Kew, in the State of Victoria, retired clothing manufacturer, deceased (who died on the 26th day of November, 1964), are to send particulars of their claims to the executrix, Helen Elizabeth Hobson, care of the under-mentioned solicitors, before the 26th of May, 1965, after which date the executrix will distribute the assets, having regard only to the claims of which she then has notice.

BRENDAN MCGUINNES & CO., solicitors, 118 Queen-street, Melbourne. 5126

CREDITORS, next of kin and others having claims in respect of the estate of John Henry Morgan, formerly of Burrumbeet, in the State of Victoria, farmer, but late of Taminick, in the said State, retired farmer, deceased (who died on the 19th day of September, 1964), are to send particulars of their claims to the executor, Thomas Patrick Morgan, care of the under-mentioned solicitors, before the 27th day of May, 1965, after which date the executor will distribute the assets, having regard only to the claims of which he then has notice.

BRENDAN MCGUINNES & CO., solicitors, 118 Queen-street, Melbourne. 5127

CREDITORS, next of kin and others having claims in respect of the estate of Robert French, late of 213 Napier-street, Essendon, retired assistant stores officer, deceased (who died on the 6th day of December, 1964), are to send the particulars of their claims to The Trustees, Executors and Agency Company Limited, of 401 Collins-street, Melbourne, by the 28th day of May, 1965, after which date it will distribute the assets, having regard only to the claims of which it then has notice.

W. B. & O. McCUTCHEON, solicitors, 150 Queen-street, Melbourne. 5128

CREDITORS, next of kin and others having claims in respect of the estate of Ethel Stowe St. John Clarke, late of 1 Yarra-grove, Hawthorn, gentlewoman (who died on the 29th day of August, 1964), are to send particulars of their claim to the executors of the said estate, care of The National Trustees, Executors and Agency Company of Australasia Limited, of 95 Queen-street, Melbourne, by the 2nd June, 1965, after which date the executors will distribute the assets, having regard only to the claims of which they then have notice.

Dated the 22nd day of March, 1965.

ERIC S. VANCE, solicitor, 357 Little Collins-street, Melbourne. 5148

In the Supreme Court of the State of Victoria.

SALE BY THE SHERIFF.

ON Wednesday, the 5th day of May, 1965, at Ten a.m., at the Police Station, Greensborough (unless process be stayed or satisfied):—

All the estate and interest (if any) of Winifred Geer, of 8 Patterson-crescent, Greensborough, married woman, as proprietor of an estate in fee simple in the land described in certificate of title, volume 7394, folio 631, upon which is erected a triple-fronted eight-roomed white weatherboard house, together with the usual outbuildings and also a joinery shop, known as No. 8 Patterson-crescent, Greensborough.

Registered mortgages Nos. C.111051 and C.111052 affect the said estate and interest.

Terms: Cash only.

DAVID J. JOHNSTON, Sheriff's Officer.
22nd March, 1965. 5197

IMPOUNDINGS

BRANXHOLME.—Impounded in Bransholme Pound.

1 Red Poll bull, 2 years, no visible brand or markings
If not claimed and expenses paid, to be sold on 10th April, 1965.

V. LATHER,
5112—12/ Poundkeeper.

DIAMOND VALLEY.—Impounded in Diamond Creek Pound.

1 black and white bull calf, no visible brand
If not claimed and expenses paid, to be sold on 8th April, 1965.

B. J. MORGAN,
5114—14/ Shire Secretary.

LARA.—Impounded in Lara Pound, from Dunlow-avenue, Norlane.

1 nanny goat, brown and black, limp hind leg, no visible brand

Impounded from Bacchus Marsh-road, Corio—

2 lambs, no visible brand

If not claimed and expenses paid, to be sold on 10th April, 1965.

5172—20/

RONALD W. ELLIS,
Poundkeeper.

MAFFRA.—Impounded in Maffra Pound from Boisdale.

1 Friesian heifer, split out of top off ear, red tag in off ear, No. Rotatag npl pat. app., branded on near rump like 5 and 2 backwards

If not claimed and expenses paid, to be sold on 9th April, 1965.

5113—16/

F. GIESCHEN,
Poundkeeper.

NATHALIA.—Impounded in Nathalia Pound.

1 red cow, earmark left ear, tag in right ear, branded "J" over "U"

1 black bullock, earmark left and right ears, no visible brand

1 red and white cow, earmark left and right ears, branded, "J" over "U"

1 black cow, earmark left ear, tag in right ear, branded "J" over "U"

1 black cow, earmark left ear, tag in right ear, branded "J" over "U"

1 black cow (de-horned), earmarks left and right ears, no visible brand

1 black and white bull calf, earmark right ear, no visible brand

If not claimed and expenses paid, to be sold on 8th April, 1965.

5213—38/

R. D. MORGAN,
Poundkeeper.

ROSEDALE.—Impounded in Rosedale Pound from private property.

1 Border Leicester ram, full mouth, two punch holes right ear, yoke attached, no visible brand

If not claimed and expenses paid, to be sold on 8th April, 1965.

5082—16/

W. R. THIRDE,
Poundkeeper.

TOONGABBIE.—Impounded in Toongabbie Pound from private property.

1 Jersey Shorthorn crossbred heifer, notch out of tip of left ear, no visible brand

If not claimed and expenses paid, to be sold on 8th April, 1965.

5081—16/

C. COLEMAN,
Poundkeeper.

Subordinate Legislation Act 1962.

NOTICE OF MAKING OF STATUTORY RULES.

In pursuance of the provisions of the *Subordinate Legislation Act 1962* and the Regulations made thereunder, notice is given of the making of the following statutory rules:—

No.	Apprenticeship Act 1958.	Price.
		s. d.
43/1965.	Apprenticeship (Motor Mechanics Trades) Regulations 1965	1 6
44/1965.	Apprenticeship (Electroplating Trade) Regulations 1965	1 0
	<i>Evidence Act 1958.</i>	
45/1965.	Court Reporting (Fees) Regulations 1965	1 0

Copies of these statutory rules may be purchased at the Sale of Publications Section of the Government Printing Office, located at Macarthur-street, Melbourne, C.2. If ordered by mail, remittance should be addressed to "The Government Printer, Box 203, P.O., North Melbourne, N.1.", and should include 6d. extra for postage.

A. C. BROOKS,
Government Printer.

ACTS REPRINTED IN ACCORDANCE WITH THE AMENDMENTS INCORPORATION ACT 1958 (No. 6422), AND FOR SALE AT THE SALE OF PUBLICATIONS BRANCH OF THE GOVERNMENT PRINTING OFFICE, MACARTHUR-STREET, MELBOURNE.

No.	Price.	
	s. d.	
6189.	Acts Interpretation (Incorporating amendments up to No. 7146)	1 6
6191.	Administration and Probate (<i>Second Reprint</i> —Incorporating amendments up to No. 6920)	3 6
6209.	Boiler Inspection (Incorporating amendments up to No. 7072)	1 9
6218.	Children's Court (Incorporating amendments up to No. 7084)	2 0
6219.	Children's Welfare (Incorporating amendments up to No. 6812)	2 6
6220.	Clean Air (Incorporating amendments up to No. 6886)	1 0
6222.	Commercial Goods Vehicles (Incorporating amendments up to No. 6886)	1 9
6225.	Co-operation (<i>Second Reprint</i> —Incorporating amendments up to No. 7083)	4 3
6226.	Co-operative Housing Societies (Incorporating amendments up to No. 7097)	4 0
6228.	Country Fire Authority (Incorporating amendments up to No. 7065)	4 0
6229.	Country Roads (Incorporating amendments up to No. 6943)	4 0
6231.	Crimes (Incorporating amendments up to No. 6958)	13 3
6236.	Dog (<i>Second Reprint</i> —Incorporating amendments up to No. 7065)	1 6
6242.	Employers and Employee's (Incorporating amendments up to No. 6740)	1 9
6245.	Estate Agents (<i>Second Reprint</i> —Incorporating amendments up to No. 7134)	3 9
6246.	Evidence (Incorporating amendments up to No. 6758)	3 6
6249.	Fences (Incorporating amendments up to No. 6550)	1 3
6251.	Firearms (Incorporating amendments up to No. 6716)	2 3
6259.	Gaols (Incorporating amendments up to No. 6651)	1 6
6265.	Goods (<i>Second Reprint</i> —Incorporating amendments up to No. 7006)	2 6
6270.	Health (Incorporating amendments up to No. 6886)	14 6
6274.	Hospitals and Charities (Incorporating amendments up to No. 6716)	3 6
6279.	Instruments (<i>Second Reprint</i> —Incorporating amendments up to No. 6886)	3 9
6282.	Justices (Incorporating amendments up to No. 6961)	11 3
6283.	Labour and Industry (<i>Second Reprint</i> —Incorporating amendments up to No. 7143)	7 6
6285.	Landlord and Tenant (<i>Second Reprint</i> —Incorporating amendments up to No. 6996)	5 0
6289.	Land Tax (Incorporating amendments up to No. 7099)	3 3
6291.	Legal Profession Practice (Incorporating amendments up to No. 7065)	4 6
6293.	Licensing (Incorporating amendments up to No. 6659)	9 3
6295.	Limitation of Actions (Incorporating amendments up to No. 6845)	1 6
6298.	Local Authorities Superannuation (Incorporating amendments up to No. 6894)	2 6
6299.	Local Government (Incorporating amendments up to No. 7052)	35 0
5309.	Medical (Incorporating amendments up to No. 6837)	3 9
6310.	Melbourne and Metropolitan Board of Works Act 1958 (Incorporating amendments up to No. 7054)	8 6
6315.	Metropolitan Fire Brigades (Incorporating amendments up to No. 6886)	2 9
6317.	Milk and Dairy Supervision (Incorporating amendments up to No. 6964)	4 0
6318.	Milk Board Act (Incorporating amendments up to No. 7093)	2 3
6324.	Money Lenders (Incorporating amendments up to No. 6886)	2 6
6325.	Motor Car (Incorporating amendments up to No. 6867)	6 6
6328.	Nurses (Incorporating amendments up to No. 6716)	2 0
6330.	Partnership	1 6
6337.	Police Offences (Incorporating amendments up to No. 7145)	8 3
6338.	Police Regulation (Incorporating amendments up to No. 7081)	4 6

ACTS REPRINTED IN ACCORDANCE WITH THE AMENDMENTS
INCORPORATION ACT 1958 (No. 6422)—*continued.*

No.	Price. s. d.
6343. Process Servers and Inquiry Agents (Incorporating amendments up to 7126) ..	1 3
6344. Property Law (Incorporating amendments up to No. 6867) ..	9 0
6349. Public Service (Incorporating amendments up to No. 6886) ..	2 9
6350. Public Trustee (Incorporating amendments up to No. 6961) ..	3 6
6359. Road Traffic (Incorporating amendments up to No. 6999) ..	1 6
6363. Second-Hand Dealers ..	1 3
6367. Settled Land (Incorporating amendments up to No. 6505) ..	4 0
6372. Soil Conservation and Land Utilization Act 1958 (Incorporating amendments up to No. 6961) ..	2 0
6375. Stamps (<i>Second Reprint</i> —Incorporating amendments up to No. 7142) ..	7 0
6377. State Electricity Commission (Incorporating amendments up to No. 7054) ..	5 0
6379. State Savings Bank (Incorporating amendments up to No. 6886) ..	4 3
6399. Transfer of Land (<i>Second Reprint</i> —Incorporating amendments up to No. 7130) ..	5 3
6401. Trustee (<i>Second Reprint</i> —Incorporating amendments up to No. 6963) ..	4 3
6419. Workers Compensation (Incorporating amendments up to No. 7063) ..	5 0
6577. Lifts and Cranes (Incorporating amendments up to No. 6886) ..	1 3
6605. Mental Health (Incorporating amendments up to No. 7135) ..	4 6
6651. Social Welfare (<i>Second Reprint</i> —Incorporating amendments up to No. 7084) ..	3 6
6653. Valuation of Land (Incorporating amendments up to No. 7019) ..	1 6
6832. Motor Boating (Incorporating amendments up to No. 6961) ..	1 6
6839. Companies (Incorporating amendments up to No. 7142) ..	22 6
6879. Unclaimed Moneys (Incorporating amendments up to No. 6961) ..	1 3
6886. Subordinate Legislation (Incorporating amendments up to No. 6961) ..	1 6
6889. Poisons (Incorporating amendments up to No. 7065) ..	3 6
6890. Probate Duty (Incorporating amendments up to No. 6970) ..	3 9

A. C. BROOKS,
Government Printer.

AGENTS FOR THE "VICTORIA GOVERNMENT
GAZETTE".

THE following have been appointed agents to receive Advertisements and Subscriptions for the *Victoria Government Gazette*—

- ARMSTRONG BROS. PTY. LTD., Mollison-street, Kyneton.
- ARMSTRONG'S AGENCY, 205 Queen-street, Melbourne.
- ARNALL & JACKSON, 390 Barkly-street, Brunswick, N.10.
- BAIRNSDALE AUTHORIZED NEWSAGENCY, 132 Main-street, Bairnsdale.
- COOKE, F. R. & E. M., & SONS, 69 Bridge-street, Benalla.
- DAVIES, G. & M. V., 112 Gray-street, Hamilton.
- DAVIS, WM. (MILDURA) PTY. LTD., 126 Eighth-street, Mildura.
- DIXON'S NEWSAGENCY, 89 Firebrace-street, Horsham.
- EDGAR'S NEWSAGENCY PTY. LTD., 293 Hargreaves-street, Bendigo.
- FRANKS, H., & CO., 184 Ryrrie-street, Geelong.

- GORDON & GOTCH AUSTRALASIA LTD., 511 Little Collins-street, Melbourne.
 - GULLAN'S NEWSAGENCY, 88 Bridge-street, Ballarat.
 - HALES, D. & N., Henty-street, Casterton.
 - HAMPTON, A. C., 243 Mitchell-street, Bendigo.
 - HARSTON, PARTRIDGE & CO. PTY. LTD., 455 Little Collins-street, Melbourne.
 - THE MERCANTILE EXCHANGE, 90 Queen-street, Melbourne.
 - MCGILL'S AUTHORIZED NEWSAGENCY, 183-5 Elizabeth-street, Melbourne.
 - PETTY, R. H. & W. M., 83 Murphy-street, Wangaratta.
 - PURDIE, J., & CO., 138 Moorabool-street, Geelong.
 - SALE AUTHORIZED NEWSAGENCY, 142 Raymond-street, Sale.
 - SKINNER'S AUTHORIZED NEWSAGENCY, 49-51 Franklin-street, Traralgon.
 - TUFF'S SHEPPARTON NEWSAGENCY, 246 Wyndham-street, Shepparton.
 - VERNON, C. F. & H. J., 162 Bridge-road, Richmond.
 - VIEW POINT AUTHORIZED NEWSAGENCY, 4 View-Point, Bendigo.
- A copy of the *Gazette* filed at each place for public reference.

CONTENTS

	PAGE
Acts of Parliament on sale at the Government Printing Office	689
Appointments	631
Auction Sales Act	624
Bank Half-Holiday	617
Cemetery—Scale of Fees	630
Contracts	621
Easter Holidays	615
Estates of Deceased Persons	630
Government Notices	620
Impoundings	688
Lands	650
Melbourne and Metropolitan Board of Works—Notice	623
Mining	629
Notice of Making of Statutory Rules	689
Orders in Council—	
Acts—Country Roads; Land; Local Government; Road Traffic; Labour and Industry; Soil Conservation and Land Utilization; Country Roads; Stamps; Benefit Associations; Building Societies; Companies; Landlord and Tenant; Sewerage Districts; Water; River Improvement.	632 et seq
Police Sale	623
Private Advertisements	662
Proclamations	615
Publication of the "Victoria Government Gazette"	615
Public Service Notices	657
Resignations	632
State Rivers and Water Supply Commission ..	624
Tenders	653
Transport Regulation Board—Public Hearings ..	626
Waterworks Trusts	625