

[4009]



# VICTORIA GOVERNMENT GAZETTE

Published by Authority

[Registered at the General Post Office, Melbourne, for transmission by post as a newspaper.]

No. 107]

WEDNESDAY, DECEMBER 3

[1969

## PUBLICATION OF THE "VICTORIA GOVERNMENT GAZETTE".

### Christmas and New Year Holidays.

Because of the Christmas and New Year Holidays, the last issue of the Victoria Government Gazette for 1969 will be published on Friday, the 19th December, 1969, instead of Wednesday, the 17th December, 1969.

All official matter for publication therein should be lodged with the Gazette Officer, Chief Secretary's Department (Telephone Extension 6282), not later than 9.30 a.m. on Thursday, the 18th December, 1969.

The next Gazette, the first for 1970, will be published on Friday, the 9th January, 1970, and thereafter on each Wednesday, as usual.

**A. C. BROOKS,  
GOVERNMENT PRINTER.**

## PROCLAMATIONS

Land Act 1958, Section 153.  
AMENDMENT OF PROCLAMATION.

### PROCLAMATION

By His Excellency the Governor of the State of Victoria and its Dependencies in the Commonwealth of Australia &c., &c., &c.

IN pursuance of the provisions of Section 153 of the Land Act 1958, and by Proclamation dated the 9th September, 1969, published in the *Government Gazette* of the 17th September, 1969, at page 3177, I, the Governor of the State of Victoria, by and with the advice of the Executive Council of the said State, did declare the Crown lands comprising 90 acres and being Allotment 8b of Section C, Parish of Tildesley West, County of Tambo, to be available for Settlement under improvement purchase leases at a land valuation of \$7.00 per acre, I do now hereby amend the said Proclamation to the effect that the valuation of the said land shall be \$10.00 per acre.—(H.031772.)

Given under my Hand and the Seal of the State of Victoria aforesaid, at Melbourne, this twenty-fifth day of November, in the year of our Lord One thousand nine hundred and sixty-nine and in the eighteenth year of the reign of Her Majesty Queen Elizabeth II.

(L.S.)

ROHAN DELACOMBE.

By His Excellency's Command,

W. J. F. McDONALD,  
Minister of Lands.

GOD SAVE THE QUEEN!

*Land Act 1958.*

AREA OF LAND COMPRISED IN CERTAIN CLASSES DIMINISHED OR INCREASED.

PROCLAMATION

By His Excellency the Governor of the State of Victoria and its Dependencies in the Commonwealth of Australia, &c., &c., &c.

WHEREAS by the *Land Act 1958* it is amongst other things enacted that the Governor in Council may, by Proclamation to be published in the *Government Gazette*, at any time diminish or increase the area of land comprised in any of the classes mentioned in Part 1., Division 1, Section 5, of the said *Land Act 1958*, but that the area of lands which may be sold by auction (Class 6), shall not be increased except as in certain cases in the said Act provided: Now therefore I, the Governor of the State of Victoria, in the Commonwealth of Australia, by and with the advice of the Executive Council of the said State, and in accordance with the provisions of Sections 94 and 117 of the *Land Act 1958* aforesaid, do hereby diminish or increase (as the case may be) the areas of Crown lands comprised in Class 6 of the classes mentioned in Section 5 of the *Land Act 1958* aforesaid, to the extent set forth in the subjoined Schedule (that is to say):—

Schedule referred to.

CLASSES DIMINISHED OR INCREASED.

County.	Parish.	Allotment.	Section.	Area.	Diminished.	Increased.	Description.
					Class.	Class.	
				A. R. P.			
Bogong ..	Barwidgee ..	1G	21	1 0 29	..	6	In the East of the Parish
Bogong ..	Barwidgee ..	1F	21	2 1 20	..	6	In the East of the Parish
Tanjil ..	Bundalaguah	E1	25	0 1 14	..	6	In the South of the Parish

Given under my Hand and the Seal of the State of Victoria, aforesaid, at Melbourne, this twenty-fifth day of November, in the year of our Lord One thousand nine hundred and sixty-nine, and in the eighteenth year of the reign of Her Majesty Queen Elizabeth II.

ROHAN DELACOMBE.

(L.S.)

By His Excellency's Command,

W. J. F. McDONALD,

Minister of Lands.

GOD SAVE THE QUEEN !

*Land Act 1958.*

UNALIENATED CROWN LAND AVAILABLE FOR SETTLEMENT UNDER IMPROVEMENT PURCHASE LEASES.

PROCLAMATION

By His Excellency the Governor of the State of Victoria and its Dependencies in the Commonwealth of Australia &c., &c., &c.

IN pursuance of the provisions of Section 153 of the *Land Act 1958*, I, the Governor of the State of Victoria, in the Commonwealth of Australia, by and with the advice of the Executive Council of the said State, do by this Proclamation declare the unalienated Crown lands mentioned in the subjoined schedule, to be available for settlement under improvement purchase leases.

SCHEDULE.

County.	Parish.	Allotment.	Section.	Area.	Land Valuation.
				A. R. P.	
Dundas .. .. .	Ganoo Ganoo .. ..	36	A	425 0 0	\$6.00 per acre (727/155)
Follett .. .. .	Kinkella .. .. .	23A*	..	810 0 0	\$7.00 per acre (J31367)
Follett .. .. .	Kinkella .. .. .	24B	..	515 0 0	\$6.00 per acre (J31589)

Given under my Hand and the Seal of the State of Victoria aforesaid, at Melbourne, this fifth day of November, in the year of our Lord One thousand nine hundred and sixty-nine, and in the eighteenth year of the reign of Her Majesty Queen Elizabeth II.

ROHAN DELACOMBE.

(L.S.)

By His Excellency's Command,

W. J. F. McDONALD,

Minister of Lands.

GOD SAVE THE QUEEN !

Land Act 1958, Section 153.  
AMENDMENT OF PROCLAMATION.

## PROCLAMATION

By His Excellency the Governor of the State of Victoria and its Dependencies in the Commonwealth of Australia &c., &c., &c.

IN pursuance of the provisions of Section 153 of the Land Act 1958, I, the Governor of the State of Victoria, by and with the advice of the Executive Council of the said State, do hereby amend the Proclamation made on 21st October, 1969 and published in the *Government Gazette* of 29th October, 1969 at page 3622, whereby certain Crown lands were made available for settlement under improvement purchase leases, by the deletion of the county name "Towong" and do hereby substitute the county name "Benambra".—(H.032750.)

Given under my Hand and the Seal of the State of Victoria aforesaid, at Melbourne, this twenty-fifth day of November, in the year of our Lord One thousand nine hundred and sixty-nine and in the eighteenth year of the reign of Her Majesty Queen Elizabeth II.

(L.S.) ROHAN DELACOMBE.

By His Excellency's Command,  
W. J. F. McDONALD,  
Minister of Lands.

GOD SAVE THE QUEEN!

APPRENTICESHIP (COMMISSION) ACT 1969.  
DATE OF COMING INTO OPERATION OF ACT.

## PROCLAMATION

By His Excellency the Governor of the State of Victoria and its Dependencies in the Commonwealth of Australia &c., &c., &c.

WHEREAS by an Act of the Parliament of the State of Victoria passed in the eighteenth year of the reign of Her Majesty Queen Elizabeth II. intitled the *Apprenticeship (Commission) Act 1969*, it is amongst other things enacted that the said Act shall come into operation on a day fixed by proclamation of the Governor in Council published in the *Government Gazette*:

NOW THEREFORE I, the Governor of the State of Victoria, in the Commonwealth of Australia, by and with the advice of the Executive Council of the said State, do by this my proclamation fix the thirteenth day of February, 1970 as the day upon which the said Act shall come into operation.

Given under my Hand and the Seal of the State of Victoria aforesaid, at Melbourne, this twenty-fifth day of November, in the year of our Lord One thousand nine hundred and sixty-nine and in the eighteenth year of the reign of Her Majesty Queen Elizabeth II.

(L.S.) ROHAN DELACOMBE.

By His Excellency's Command,  
J. F. ROSSITER,  
Minister of Labour and Industry.  
GOD SAVE THE QUEEN!

## PUBLIC HIGHWAYS.—CITY OF OAKLEIGH.

## PROCLAMATION

By His Excellency the Governor of the State of Victoria and its Dependencies in the Commonwealth of Australia &c., &c., &c.

WHEREAS by the *Local Government Act 1958*, Section 519 it is amongst other things enacted that it shall be lawful for the Governor in Council at any time and from time to time upon the request of the Council of any municipality by notice in the *Government Gazette* to proclaim any land reserved used or by purchase or exchange acquired for a street, road, highway, thoroughfare, bridge, square, court, alley, or right-of-way or any street, road lane or passage made or laid out or proposed to be made or laid out on any land of which a plan of subdivision delineating that street, road, land or passage has been sealed with the seal of the municipality under subdivision (3) of Division 9 of Part XIX of the *Local Government Act 1958*, or a corresponding previous enactment to be a public highway and that such land shall thereupon and

thenceforth from the date of such proclamation become and be absolutely dedicated to the public as a public highway within the meaning of any law then or thereafter in force.

AND WHEREAS the Council of the City of Oakleigh has requested that the lands hereinafter mentioned, being streets roads lanes or passages made or laid out or proposed to be made or laid out on land of which plans of subdivision delineating the streets, roads, lanes or passages have been sealed with the seal of the municipality under subdivision (3) of Division 9 of Part XIX of the *Local Government Act 1958*, or a corresponding previous enactment, be so declared to be public highways.

NOW THEREFORE, I, the Governor of the State of Victoria in the Commonwealth of Australia, by and with the advice of the Executive Council of the said State, do by this Proclamation declare that Collier Avenue and part of Houghton Road, Huntingdale shown on the plan hereunder shall be public highways within the meaning of the said Act.

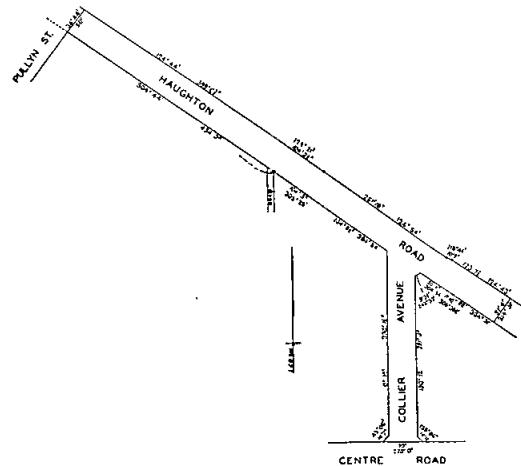

Given under my Hand and the Seal of the State of Victoria aforesaid, at Melbourne, this twenty-fifth day of November, in the year of our Lord One thousand nine hundred and sixty-nine and in the eighteenth year of the reign of Her Majesty Queen Elizabeth II.

(L.S.) ROHAN DELACOMBE.

By His Excellency's Command,  
R. J. HAMER,  
Minister for Local Government.  
GOD SAVE THE QUEEN!

## PUBLIC HIGHWAYS.—SHIRE OF TRARALGON.

## PROCLAMATION

By His Excellency the Governor of the State of Victoria and its Dependencies in the Commonwealth of Australia, &c., &c., &c.

WHEREAS by the *Local Government Act 1958*, Section 519 it is amongst other things enacted that it shall be lawful for the Governor in Council at any time and from time to time upon the request of the Council of any municipality by notice in the *Government Gazette* to proclaim any land reserved used or by purchase or exchange acquired for a street road highway thoroughfare bridge square court alley or right-of-way or any street road lane or passage made or laid out or proposed to be made or laid out on any land of which a plan of subdivision delineating that street, road lane or passage has been sealed with the seal of the municipality under subdivision (3) of Division 9 of Part XIX of the *Local Government Act 1958*, or a corresponding previous enactment to be a public highway and that such land shall thereupon and thenceforth from the date of such proclamation become and be absolutely dedicated to the public as a public highway within the meaning of any law then or thereafter in force.

And whereas the Council of the Shire of Traralgon has requested that the lands hereinafter mentioned, being streets roads lanes or passages made or laid out or proposed to be made or laid out on land of which plans of subdivision delineating the streets roads lanes or passages have

been sealed with the seal of the municipality under subdivision (3) of Division 9 of Part XIX of the *Local Government Act 1958*, or a corresponding previous enactment, be so declared to be public highways.

Now therefore, I, the Governor of the State of Victoria, in the Commonwealth of Australia by and with the advice of the Executive Council of the said State, do by this Proclamation declare that Village Avenue, Valley Drive and land coloured brown abutting Princes Highway on Plan of Subdivision No. 67735 lodged in the Office of Titles and the road coloured brown and blue on Plan of Subdivision No. 82825 lodged in the Office of Titles shall be public highways within the meaning of the said Act.

Given under my Hand and the Seal of the State of Victoria aforesaid, at Melbourne, this twenty-fifth day of November, in the year of our Lord One thousand nine hundred and sixty-nine, and in the eighteenth year of the reign of Her Majesty Queen Elizabeth II.

(L.S.) ROHAN DELACOMBE.

By His Excellency's Command,  
R. J. HAMER,  
Minister for Local Government.  
GOD SAVE THE QUEEN !

**PUBLIC HIGHWAY.—CITY OF HEIDELBERG.**

**PROCLAMATION**

By His Excellency the Governor of the State of Victoria and its Dependencies in the Commonwealth of Australia, &c., &c., &c.

WHEREAS by the *Local Government Act 1958*, Section 519 it is amongst other things enacted that it shall be lawful for the Governor in Council at any time and from time to time upon the request of the Council of any municipality by notice in the *Government Gazette* to proclaim any land reserved used or by purchase or exchange acquired for a street road highway thoroughfare bridge square court alley or right-of-way or any street road lane or passage made or laid out or proposed to be made or laid out on any land of which a plan of subdivision delineating that street road lane or passage has been sealed with the seal of the municipality under subdivision (3) of Division 9 of Part XIX of the *Local Government Act 1958*, or a corresponding previous enactment to be a public highway and that such land shall thereupon and thenceforth from the date of such proclamation become and be absolutely dedicated to the public as a public highway within the meaning of any law then or thereafter in force.

And whereas the Council of the City of Heidelberg has requested that the land hereinafter mentioned, used for a street, road, lane or passage be so declared to be a public highway.

Now therefore, I, the Governor of the State of Victoria, in the Commonwealth of Australia, by and with the advice of the Executive Council of the State, do by this proclamation declare that a right-of-way, off Cape Street, Heidelberg, shown hatched on the plan hereunder, shall be a public highway within the meaning of the said Act.

*The fee of the land shown hatched hereon was contained in Certificate of Title No. 5210 Fol. 614 of S. 11 1960*

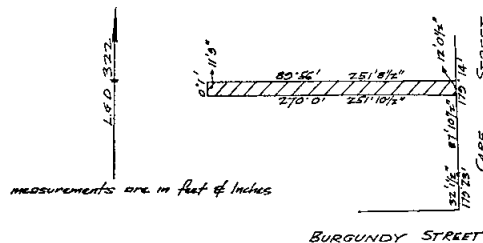

Given under my Hand and the Seal of the State of Victoria aforesaid, at Melbourne, this twenty-fifth day of November, in the year of our Lord One thousand nine hundred and sixty-nine, and in the eighteenth year of the reign of Her Majesty Queen Elizabeth II.

(L.S.) ROHAN DELACOMBE.

By His Excellency's Command,  
R. J. HAMER,  
Minister for Local Government.  
GOD SAVE THE QUEEN !

**ACTS OF PARLIAMENT.**

**PROCLAMATION**

By His Excellency the Governor of the State of Victoria and its Dependencies in the Commonwealth of Australia &c., &c., &c.

I, THE Governor of the State of Victoria, in the Commonwealth of Australia, do hereby declare that I have this day assented, in Her Majesty's name, to the Bills passed by the Parliament of the said State, the titles whereof are hereunder set forth, together with the short titles, that is to say:—

- No. 7876. "An Act to amend the *Justices Act 1958*." (*Justices (Amendment) Act 1969*.)
- No. 7877. "An Act to amend the *Country Fire Authority Act 1958*." (*Country Fire Authority (Amendment) Act 1969*.)
- No. 7878. "An Act to amend the *Coal Mines Act 1958*." (*Coal Mines (Accidents Relief) Act 1969*.)
- No. 7879. "An Act to make Provision concerning certain Land at Preston formerly used for the purposes of a School of Design and Free Library." (*Preston School of Design and Free Library Land Act 1969*.)
- No. 7880. "An Act to re-enact with Amendments Section 47 of the *Lands Compensation Act 1958*." (*Lands Compensation (Costs and Expenses) Act 1969*.)
- No. 7881. "An Act to amend the *Evidence Act 1958* with respect to Bankers' Books." (*Evidence (Bankers' Books) Act 1969*.)
- No. 7882. "An Act to amend Section 41 of the *Transport Regulation Act 1958*." (*Transport Regulation (Financial) Act 1969*.)
- No. 7883. "An Act to amend Section 76 of the *Railways Act 1958*." (*Railways (Surplus Lands) Act 1969*.)

Given under my Hand and the Seal of the State of Victoria aforesaid, at Melbourne, this twenty-fifth day of November, in the year of our Lord One thousand nine hundred and sixty-nine and in the eighteenth year of the reign of Her Majesty Queen Elizabeth II.

(L.S.) ROHAN DELACOMBE.

By His Excellency's Command,  
HENRY BOLTE,  
Premier.  
GOD SAVE THE QUEEN !

**MAINTENANCE (AMENDMENT) ACT 1969 No. 7860.**

**DATE OF COMING INTO OPERATION.**

**PROCLAMATION**

By His Excellency the Governor of the State of Victoria and its Dependencies in the Commonwealth of Australia, &c., &c., &c.

WHEREAS by an Act of Parliament of the State of Victoria passed in the eighteenth year of the reign of Her Majesty Queen Elizabeth II. intitled the *Maintenance (Amendment) Act 1969* No. 7860 it is amongst other things enacted that the several provisions of the said Act shall come into operation on the day or the respective days to be fixed by proclamation or successive proclamations of the Governor in Council published in the *Government Gazette*: Now therefore I, the Governor of the State of Victoria, acting by and with the advice of the Executive Council thereof, do by this my Proclamation fix Wednesday the 3rd day of December one thousand nine hundred and sixty-nine as the day upon which the *Maintenance (Amendment) Act 1969* No. 7860 shall come into operation.

Given under my Hand and the Seal of the State of Victoria, aforesaid, at Melbourne, this second day of December, in the year of our Lord One thousand nine hundred and sixty-nine, and in the eighteenth year of the reign of Her Majesty Queen Elizabeth II.

(L.S.) ROHAN DELACOMBE.

By His Excellency's Command,  
G. O. REID,  
Attorney-General.  
GOD SAVE THE QUEEN !

**GOVERNMENT NOTICES****CHRISTMAS AND NEW YEAR HOLIDAYS.**

It is hereby notified that on—

THURSDAY, THE 25TH DECEMBER, 1969,  
FRIDAY, THE 26TH DECEMBER, 1969,  
THURSDAY, THE 1ST JANUARY, 1970, and  
FRIDAY, THE 2ND JANUARY, 1970,

the Public Offices will be closed, such days having been appointed by the Public Service Act 1958 to be observed as holidays in the Public Offices throughout the State of Victoria.

This notice relates only to the closing of the State Public Offices. All inquiries regarding holidays in other offices and in shops and industry should be directed to the Department of Labour and Industry, 110 Exhibition-street, Melbourne (Telephone 63 0321, Extension 6158, or 6721 or 6859).

A. G. RYLAH,  
Chief Secretary.

Chief Secretary's Office,  
Melbourne, 3000, 30th October, 1969.

**LOCAL GOVERNMENT DEPARTMENT.****ORDER CONFIRMED.—TOWN OF PORTLAND.**

THE Minister of the Crown administering the Local Government Act 1958, on the 1st day of December, 1969, confirmed the Order hereinafter referred to in pursuance of section 514 of the said Act namely:—

An Order of the Council of the Town of Portland made on the 28th October, 1969 directing the compulsory taking of the land described hereunder for the purpose of a site for the erection of Housing Commission of Victoria low rental units and recreational purposes:

All that piece of land having a frontage of 265 feet 5 inches to Bentinck-street, a frontage of 363 feet to Hood-street, a western boundary of 330 feet 5 inches abutting a Public Purposes Reserve and allotment 3, section 44, Town and Parish of Portland and a southern boundary of 180 feet 2 inches abutting the said allotment 3, such land being more particularly described by survey in application No. 54881 lodged with the Office of Titles on the 30th April, 1969.

R. J. HAMER,  
Minister for Local Government.

Local Government Department,  
Melbourne.

**NOTICE TO MARINERS.**

[No. 19 of 1969.]

**AUSTRALIA.—VICTORIA.****GIPPSLAND LAKES.—LIGHTS ESTABLISHED.**

Date.—On or about 2nd December, 1969.

1. Position.—Mt. Barkly Lt., Lat. 37 deg. 53 min., Long. 147 deg. 58 min. E. (approx.).

Position of Lights.—(a) 247 degrees distant 995 feet from the above position.

(b) 174 degrees distant 1,315 feet from the above position.

On the outer end of the northern and central rubble groynes respectively abutting the eastern shore of Rigby Island.

Details.—(a) A red light flashing every 5 seconds (Fl. R. 5 secs.).

(b) A quick flashing red light (Qk. Fl. R.).

2. A light is to be established on the single pile beacon at the eastern end of the approach channel to McLennans Strait in Lake Victoria.

Details.—A red light flashing every 3 seconds (Fl. R. 3 secs.).

Publication Affected.—Sailing Directions, Victoria, 1959, page 583 (1); page 626 (2).

A. J. WAGGLEN,  
Port Officer.

Public Works Department,  
Ports and Harbors Division,  
Melbourne, Vic., 3002, 19th November, 1969.

**NOTICE TO MARINERS.**

[No. 20 T of 1969.]

**AUSTRALIA.—VICTORIA.****WESTERNPORT.—HARBOR WORKS IN PROGRESS.**

THE area referred to in (1) of former Notice No. 13(T) of 1969 has been extended.

Position.—Hastings Jetty Light 38 deg. 19 min. S., Long. 145 deg. 12 min. E.

Dredging and other harbor works are in progress in an area within the following boundaries:—

From a position on shore 069 degrees 4,000 feet from the above light in a 180 degrees direction for 4,400 feet; thence 135 degrees to Hastings Channel Beacon; thence 090 degrees 2,600 feet; thence 180 degrees 8,000 feet; thence 090 degrees 2,200 feet; thence 000 degrees 20,000 feet; thence 270 degrees to the shore.

Mariners are warned to keep clear of the area described above as unlighted mooring buoys, submerged piles and other underwater obstructions may be encountered.

Charts Affected.—Aus. 156, 788.

A. J. WAGGLEN,  
Port Officer.

Public Works Department,  
Ports and Harbors Division,  
Melbourne, Vic., 3002, 19th November, 1969.

**NOTICE TO MARINERS.**

[No. 21 T of 1969.]

**AUSTRALIA.—VICTORIA.****PORT PHILLIP.—DISPLAY OF FESTOON LIGHTING.**

MARINERS are advised that coloured lights will be visible during the hours of darkness for approximately two months from 15th December, 1969, from a tall tree between Queenscliff and Point Lonsdale and located 012 degrees, distant 1.14 miles from Point Lonsdale lighthouse (Lat. 38 deg. 17 min. S., Long. 144 deg. 37 min. E. approx.). A cluster of white lights may also be visible.

A. J. WAGGLEN,  
Port Officer.

Public Works Department,  
Ports and Harbors Division,  
Melbourne, Vic., 3002, 19th November, 1969.

**DEPARTMENT OF MINES.****EXPLORATION LICENCE GRANTED.**

154, Exploration Licence; Coopers Creek Mines Pty. Limited; 26 square miles, Parishes of Malkara, Mowamba.

**TERM OF PETROLEUM EXPLORATION PERMIT EXTENDED.**

26, Petroleum Exploration Permit; Planet Exploration Company Pty. Ltd.

J. C. M. BALFOUR,  
Minister of Mines.

**Co-operation Act 1958.****FREEWAY CO-OPERATIVE CREDIT SOCIETY LIMITED.**

NOTICE is hereby given, in pursuance of section 78 (7) of the Co-operation Act 1958 and section 308 (2) of the Companies Act 1961 that, at the expiration of three months from the date hereof, the name of the aforementioned society will, unless cause is shown to the contrary, be struck off the register and the society will be dissolved.

Dated this 24th day of November, 1969.

M. V. HAMMOND,  
Deputy Registrar of Co-operative Societies.

**Co-operation Act 1958.****VICTORIAN FISHERMEN'S CO-OPERATIVE SOCIETY LIMITED.**

NOTICE is hereby given, in pursuance of section 78 (7) of the Co-operation Act 1958 and section 308 (2) of the Companies Act 1961 that, at the expiration of three months from the date hereof, the name of the aforementioned society will, unless cause is shown to the contrary, be struck off the register and the society will be dissolved.

Dated this 25th day of November, 1969.

M. V. HAMMOND,  
Deputy Registrar of Co-operative Societies.

Transport Regulation Act.  
 TRANSPORT REGULATION BOARD.  
 HEARING OF APPLICATIONS.

NOTICE is hereby given that the following applications will be considered by the Transport Regulation Board at its offices at the corner of Lygon and Princes streets, Carlton, at 10.15 a.m. on Monday, 22nd December, 1969.

CALDERWOOD COACHES PTY. LTD., 130 Melbourne-road, Williamstown. Application for permit authority to operate any one M.C. licensed vehicle for the carriage of students between the Williamstown Migrant Hostel and North Williamstown State School via Kororoit Creek and Station roads under contract to the Williamstown Migrant Hostel Parents' Association.

*Time-table. (School Days Only.)*

Depart Williamstown Migrant Hostel 8.15 a.m.  
 Depart North Williamstown State School 3.20 p.m.

CROYDON BUS SERVICE PTY. LTD., Maroondah Highway, Croydon. Application for permit authority to operate a required number of the applicant company's C.O. licensed vehicles for the carriage of passengers at separate and distinct fares between Lilydale, Croydon, Ringwood, Wantirna and the V.F.L. Park, Waverley via Maroondah Highway, Croydon-road, Mt. Dandenong-road, Wantirna-road and thence to the Park via the most convenient route. Fares and time-table to be determined.

GREYDA'S BUS SERVICE, SHAVES BUS SERVICES PTY. LTD., VENTURA MOTORS PTY. LTD., U.S. MOTORS (BELGRAVE) PTY. LTD., W. SINCLAIR & SONS PTY. LTD., care of 9 Foster-street, Dandenong. Application to operate shuttle bus services from Glen Waverley and from Springvale or Noble Park to V.F.L. Park on occasions when League football matches are played at the Park. The precise route to the Park has yet to be determined, sections and fares have also to be settled. (The services are to be operated on a roster basis.)

GREYDA'S BUS SERVICES, 9 Foster-street, Dandenong. Application for permit authority to extend route 220A (Oakleigh-Valewood) from the corner of Wellington and Lum roads via Wellington-road to the V.F.L. Park, Waverley, on occasions when League football matches are being played. Time-tables and fares to be determined.

GREYDA'S BUS SERVICES, 9 Foster-street, Dandenong. Application for permit authority to operate for the carriage of passengers at separate and distinct fares from Chelsea and Mentone to the V.F.L. Park, Waverley, on occasions when League matches are being played, via the following route:—Commencing in Nepean Highway, Chelsea, via Nepean Highway, Beach-road, Como-avenue, Balcombe-road, Lower Dandenong-road and Springvale-road; thence via a route to be finally determined to the Park. Fares and time-tables to be determined.

GREYDA'S BUS SERVICES, 9 Foster-street, Dandenong. Application for permit authority to operate at separate and distinct fares for the carriage of passengers from Frankston to the V.F.L. Park, Waverley, on occasions when League matches are being played via the Dandenong-Frankston road, Thomas-street, Clow-street, Princes Highway, James-street, Gladstone-road and Police-road; thence via a route to be finally determined to the Park. Fares and time-tables to be determined.

HOWLETT, J. T., care of 431 Bourke-street, Melbourne. One commercial passenger vehicle (S/C. 12) to operate for the carriage of passengers, ski equipment and goods between Slaty Cutting Car Park and Hotham Heights Alpine Village as and when required.

FARES.

Car park to village 50c per person, 50c luggage.

LATROBE VALLEY BUS LINES, 2-10 Ryan-street, Morwell. Application for two commercial passenger vehicles to operate as country stage omnibuses between Traralgon, Morwell, Yallourn, Newborough, Moe, Trafalgar and the V.F.L. Park, Waverley, via the most direct route.

Fares and time-tables to be determined.

METROPOLITAN SPECIAL SERVICE OMNIBUS DIVISION, BUS PROPRIETORS' ASSOCIATION (VIC.), 592 City-road, South Melbourne. Application for permit authority to operate for the carriage of passengers at separate and distinct fares to the V.F.L. Park, Waverley, from the City of Melbourne and from the suburbs of the two visiting teams (excluding Geelong). The service to be operated from a pool of operators in the suburbs concerned on a roster basis with pick-up points at the teams home grounds. Fares and time-tables to be determined.

NUGENT, D. J. & J. E., 334 Mountain Highway, Bayswater. Application for authority to operate for the carriage of passengers at separate and distinct fares between Bayswater, The Basin, Boronia and Wantirna South to the V.F.L. Park, Waverley, on occasions when League football matches are being played via the following route:—Commencing at the corner of Mountain Highway and Dorset-road; thence via Mountain Highway, Forest-road, Boronia-road, Lewis-road, Coleman-road and Stud-road; thence via a route to be determined to V.F.L. Park.

*Pick-up and set down points.*

1. Cnr. Mountain Highway and Dorset-road.
2. Cnr. Mountain Highway and Albert-avenue.
3. The Basin Progress Hall.
4. Cnr. Boronia-road and Underwood-road.
5. Cnr. Boronia and Scoresby roads.
6. Cnr. Lewis and Coleman roads.
7. Studfield Shopping Centre.
8. Cnr. Stud and Burwood roads.

SHAVE BUS SERVICE PTY. LTD., 12-14 Ricketts-road, Notting-hill. Application to extend route 27A St. Kilda-Chadstone-Glen Waverley to V.F.L. Park, express from Glen Waverley on occasions when League football matches are played at the Park via a route to be finally determined between Glen Waverley and the Park. Sections and fares have yet to be settled.

SINCLAIR, W., & SONS PTY. LTD., 983 North-road, Murrumbena. Application for permit authority to extend Route 30A (Elwood Beach-Gardenvale-East Oakleigh-Monash University) on a number of trips to the V.F.L. Park, Waverley, via a route to be determined on occasions when League football matches are being played at the Park. Fares and time-tables to be determined.

SMITH, N. M., & L. T. SUHR, 559 Centre-road, Bentleigh. Application for permit authority to operate any one M.C. licensed vehicle for the carriage of passengers at separate and distinct fares between the Bentleigh Post Office and the V.F.L. Park, Wellington-road, Waverley, via the most direct route. Time-tables and fares to be determined.

U.S. MOTORS (BELGRAVE) PTY. LTD., Monbulk-road, Belgrave. One commercial passenger vehicle with large seating capacity to operate under the same terms and conditions as existing C.O. licences held by the applicant company.

U.S. MOTORS (BELGRAVE) PTY. LTD., Monbulk-road, Belgrave. Application for authority to extend the Dandenong-Belgrave bus service from the corner of Wellington and Stud roads to V.F.L. Park on occasions when League football matches are being played at the Park. The precise routing to the Park has yet to be determined, sections and fares have also to be finally settled.

VENTURA MOTORS PTY. LTD., 1037 Centre-road, South Oakleigh. Application to operate a service from the Burwood tram terminus to V. F. L. Park on occasions when League football matches are played at the Park, via Burwood Highway and Springvale-road; thence via a route to be finally determined. Sections, time-tables and fares to be settled.

VENTURA MOTORS PTY. LTD., 1037 Centre-road, South Oakleigh. Application for permit authority to operate a required number of the applicant company's C.O. licensed vehicles for the carriage of passengers at separate and distinct fares between Mitcham Railway Station and the V.F.L. Park, Waverley, via Whitehorse-road, Springvale-road to the Nunawading Railway Station; thence via Springvale-road to Glen Waverley Railway Station; and thence via a route to be determined to the Park. Fares and time-tables to be determined.

WILLIS BUS SERVICE PTY. LTD., 518 Canterbury-road, Vermont. Application for permit authority to operate a required number of the applicant company's C.O. licensed vehicles for the carriage of passengers at separate and distinct fares between Mitcham Railway Station and the V.F.L. Park, Waverley, via Whitehorse-road, Springvale-road to the Nunawading Railway Station; thence via Springvale-road to Glen Waverley Railway Station; and thence via a route to be determined to the Park, with pick-up rights to the corner of Springvale and High Street roads, Glen Waverley. Fares and time-tables to be determined.

HAMPTON GREEN BUS LINES PTY. LTD., 2 Willis-lane, Hampton. Application for variation of M.O. licence conditions on Route 36A (Hampton-Highett-Bluff road) to deviate the service at the corner of Highett and Graham roads to Highett State School, via Graham-road. To constitute an additional section.

BLUE & SILVER BUS LINES PTY. LTD., 250 Balcombe-road, Mentone. Application for variation of C.O. licence conditions on Route 204A (Mordialloc—Mentone—Cheltenham) to operate the 4.45 p.m. trip ex Cheltenham Railway Station only to the corner of Cobham-street and Nepean Highway.

**A**PPPLICATIONS for renewal of licences as shown, by persons listed hereunder to operate under the same terms and conditions:—

BUGGE, J. C., 53 Drysdale-avenue, Hamlyn Heights, North Geelong; U.T.634.

CAULFIELD, G. M., 8 Riviera-street, Mentone; M.H.2624.

COLLINGS, A. L., 9 Panorama-avenue, Highett; M.T.1373.

EASTMAN, J. D., 2 Tennyson-street, Sandringham; M.H.2622.

KOOP, A. F., 432 Ryrie-street, Geelong; U.T.653.

MOONEE VALLEY BUS LINES PTY. LTD., 70 Dawson-street, Brunswick; M.O.403.

PRITCHARD, O. F., 38 Dromana-avenue, East Bentleigh; M.H.2623.

SEIFFERT, N. J., 13 Victoria-terrace, Belmont, Geelong; U.T.686.

Notice of any objection should be forwarded to reach the Secretary of the Board not later than Wednesday, 17th December, 1969.

Applicants are advised that it will not be necessary to appear on the hearing date specified above, unless advised, in writing, by the Board.

B. P. KAY,  
Secretary.

Corner Lygon and Princes streets, Carlton, Wednesday, 3rd December, 1969.

Commercial Goods Vehicles Act.  
TRANSPORT REGULATION BOARD.

HEARING OF APPLICATIONS.

**N**OTICE is hereby given that the following applications will be considered by the Transport Regulation Board at its offices at the corner Lygon and Princes streets, Carlton, at 10.15 a.m., on Monday, 22nd December, 1969.

HYLAND, B. J. & S. F., & K. C. & F. A. BARNES (trading as K. & B. Adams Agricultural Services), Lot 22, Amay-crescent, Ferntree Gully, 3156. Two commercial goods vehicles (L/C. 32 and 8 cwt.) to operate: (a) Within a 50-mile radius of own premises at Ferntree Gully in course of business as "Chemical Distributors and Fumigation Contractors"—own goods. (b) Throughout the State of Victoria for the purpose of completing own fumigation contracts—tools of trade, spraying equipment and a small quantity of chemical to complete a contract.

ALBON, J. H., 10 Langlands-street, Horsham, 3400. One commercial goods vehicle (L/C. 138 cwt.) to operate: (a) Within a 50-mile radius of the post office at Horsham as a "Road Contractor"—road-making plant and materials. (b) Within a 25-mile radius of the post office at Horsham—general goods provided that no goods shall be carried whether by one stage or by more than one stage between places within the above radius which are more than 30 road miles apart by the nearest practicable route.

ALPINE AVIATION PTY. LTD., 6th Floor, 37 Queen-street, Melbourne, 3000. One commercial goods vehicle (L/C. 14 cwt.) to operate throughout the State of Victoria in the course of business as "Aerial Spraying Contractors" for the purposes of servicing own equipment and supervising own contracts—tools of trade, spare parts and a quantity not exceeding 10 cwt. at any one time of fuel and chemicals.

ARNOTT-BROCKHOFF-GUEST PTY. LTD., 53 Huntingdale-road, Burwood, 3125. One commercial goods vehicle (L/C. 24 cwt.) to operate within a 50-mile radius of own branch premises at Bairnsdale in course of business as "Biscuit Manufacturer"—own goods.

NOTE.—All goods shall be initially forwarded to Bairnsdale by rail.

BANBURY ENGINEERING PTY. LTD., 85 Banbury-road, Reservoir, 3073. Three commercial goods vehicles (L/C. 14, 14 & 11 cwt.) to operate throughout the State of Victoria in the course of business as "Engineers" for the purpose of servicing company manufactured equipment—tools of trade, spare parts and small quantity of material incidental to the completion of servicing contracts in the field only.

BANBURY ENGINEERING PTY. LTD., 85 Banbury-road, Reservoir, 3073. Three commercial goods vehicles (L/C. 11, 10 & 11 cwt.) to operate throughout the State of Victoria in the course of business as "Air-conditioning Engineers" for the purpose of servicing air-conditioning equipment—tools of trade, spare parts and small quantity of material incidental to the completion of servicing contracts in the field only.

BANDAG COLD TREAD PROCESS (VIC.) PTY. LTD., 490-492 Geelong-road, West Footscray, 3012. One commercial goods vehicle (L/C. 25 cwt.) to operate within a 50-mile radius of own premises at Brooklyn in the course of business as "Tyre Recappers and Retreaders"—new and used tyres and tubes, used tyres and tubes for recapping or repair or having been repaired or recapped and also tools of trade and materials incidental thereto.

BATTY, A. C., 107-113 Gertrude-street, Geelong West, 3218. One commercial goods vehicle (L/C. 80 cwt.) to operate throughout the State of Victoria in course of business as "Marine Collector"—special wares, marine stores and old metals as designated in the *Marine Stores and Old Metals Act 1958* (No. 6303), Part I, Section 3:

NOTE.—Load capacity of both prime mover and any trailer attached thereto shall not exceed 120 cwt.

BREMNER, R. J., 221 Westblade-avenue, Kerang, 3579. One commercial goods vehicle (L/C. 245 cwt.) to operate: (a) Within a 50-mile radius from the post office at Kerang as a "Road Contractor"—road-making plant and materials. (b) Within a 25-mile radius of the post office at Kerang—general goods provided that no goods shall be carried whether by one stage or by more than one stage between places within the above radius which are more than thirty (30) road miles apart by the nearest practicable route.

BRUNT, R. TRANSPORT PTY. LTD., 61 Beverin-street, Sebastopol, 3356. Application to vary conditions of licence No. D.A.62211/4 (L/C. 224 cwt.) by deleting the word "Shepparton" from the existing conditions where appearing and adding in lieu the word "Wodonga", and also adding to the existing conditions after the word "Ballarat" where appearing the words "and Wangaratta".

CHAPMAN, J. A., 4 Ozone-avenue, Beaumaris, 3193. One commercial goods vehicle (L/C. 211 cwt.) to operate within a 50-mile radius of the premises of Pioneer Concrete (Vic.) Pty. Ltd. at Brunswick solely on behalf of the said company—premixed concrete in a specially constructed agitator vehicle.

COCA-COLA BOTTLERS (MELBOURNE) PTY. LTD., Levanswell-road, Moorabbin, 3189. Two commercial goods vehicles (L/C. 145 and 155 cwt.) to operate within a 50-mile radius of the G.P.O. at the corner of Bourke-street and Elizabeth-street in the City of Melbourne, in course of business as "Aerated Water Manufacturers"—own aerated waters in bottles and cans and empty return containers, but excluding any operations to the Geelong Urban District (as defined in the *Transport Regulation Act 1958*).

COMPOSITE BUYERS PTY. LTD., 1400 Centre-road, Clayton, 3168. One commercial goods vehicle (L/C. 13 cwt.) to operate throughout the State of Victoria in the course of business as "Wholesale Grocers" for the purpose of sales promotion of own goods—tools of trade, advertising materials and samples of own goods.

DE STEFANIS, F., 6 Second-avenue, Kew East, 3102. One commercial goods vehicle (L/C. 210 cwt.) to operate within a 50-mile radius of the premises of Pioneer Concrete (Vic.) Pty. Ltd., at Brunswick solely on behalf of the said company—premixed concrete in a specially constructed agitator vehicle.

DEUTZ AUSTRALIA PTY. LTD., 4 Cochranes-road, Moorabbin, 3189. Three commercial goods vehicles (L/C. 21, 13 and 11 cwt.) to operate throughout the State of Victoria in course of business as "Diesel Engine Manufacturers and Importers"—tools of trade and spare parts for servicing or maintenance contracts in the field only.

DUIKER, W. J., 4 Pinewood-avenue, Dandenong, 3175. One commercial goods vehicle (L/C. 116 cwt.) to operate: (a) Within a 25-mile radius of own yard at Dandenong in course of business as "Sand, Soil and Garden Supplier"—own goods. (b) From Bacchus Marsh to places within paragraph (a) above—own river pebbles. (c) From Diggers Rest to places within paragraph (a) above—own scoria and own honeycomb rock. (d) From Healesville to places within paragraph (a) above—own mountain soil. (e) From Beveridge to places within paragraph (a) above—own scoria.

- DUNSTON, C. G., Falls-road, Marysville, 3779. One commercial goods vehicle (L/C. 254 cwt.) to operate: (a) From forest landings within a 20-mile radius of Marysville to J. L. Gould's sawmill at Marysville—logs. (b) From J. L. Gould's sawmill at Marysville to the railway siding at Healesville or to places within a 20-mile radius of the post office at Healesville—sawn timber. (c) From J. L. Gould's sawmill at Marysville to consignees within a 25-mile radius of the G.P.O. in the City of Melbourne—sawn timber.
- EMMETT, M. E., (trading as W. H. Emmett & Co.), Birdwood-street, Stanhope, 3623. One commercial goods vehicle (L/C. 110 cwt.) to operate within a 30-mile radius from the post office at Stanhope in the course of business as "General Merchants"—own goods and petroleum products in prescribed types of containers and empty return containers.
- FRANCOMBE, W. R., 65 Mt. Dandenong-road, Ringwood East, 3135. One commercial goods vehicle (L/C. 195 cwt.) to operate within a 50-mile radius of the plant of Albion Reid Pty. Ltd. at Montrose solely on behalf of the said company—premixed concrete in a specially constructed agitator vehicle.
- FRANCOMBE, W. R., 65 Mt. Dandenong-road, Ringwood East, 3135. One commercial goods vehicle (L/C. 215 cwt.) to operate within a 50-mile radius of the premises of Albion Reid Pty. Ltd., at North Melbourne on behalf of the said company—road-making plant, hot asphalt, premix and road-making materials but excluding the carriage of cement and lime from the Geelong Urban District (as defined in the *Transport Regulation Act 1958*).
- GRAY, A. J., 5 Middleborough-road, Burwood, 3125. Application to vary the conditions of licence No. D.A.61882 (L/C. 195 cwt.) by deleting the existing conditions and adding in lieu—"Within a 50-mile radius of the G.P.O., Melbourne solely on behalf of Consolidated Quarries Ltd.—premixed concrete in a specially constructed agitator vehicle."
- GUTHRIE, J. J., P.O. Box 139, Casterton, 3311. One commercial goods vehicle (L/C. 175 cwt.) to operate within a 50-mile radius of own premises at Casterton—own premixed concrete in a specially constructed agitator vehicle.
- HEAVY TRUCK SERVICES PTY. LTD., 70 Renver-road, Clayton, 3168. One commercial goods vehicle (L/C. 14 cwt.) to operate: (a) Within a 50-mile radius of own premises at Clayton in course of business as "Truck Servicers"—own goods. (b) Throughout the State of Victoria in the course of business as "Truck Servicers"—tools of trade and spare parts incidental to servicing in the field only.
- HUSTWAYTE, C., Box 19, Gisborne, 3437. One commercial goods vehicle (L/C. 239 cwt.) to operate within a 50-mile radius of the post office at Gisborne as a "Low-Loader"—own earth-moving plant, and earth-moving plant and builders' huts the property of the Country Roads Board.
- HUXTABLE, K. J., 202 Station-street, Koo-Wee-Rup, 3981. Application to vary the conditions of licences numbered D.A.34833/4 and D.A.34833/7 (L.C. 229, 147 cwt.) by deleting paragraph (d) of the existing conditions and adding in lieu paragraph (d)—"(d) From the premises of S.E.C. at Morwell to consignees within a 10-mile radius of own premises at Koo-Wee-Rup—briquettes" and also adding as an additional paragraph (f)—"(f) From railway yards at Warragul to consignees within a 10-mile radius of own premises at Koo-Wee-Rup—briquettes."
- HUXTABLE, K. J., 202 Station-street, Koo-Wee-Rup, 3981. Application to vary the conditions of licence No. D.A.34833/6 (L/C. 141 cwt.) by adding as an additional paragraph (d)—"(d) Within a 50-mile radius from own farms at Cardinia and Dalmore in the course of business as 'Primary Producers'—own goods".
- HUXTABLE, K. J., 202 Station-street, Koo-Wee-Rup, 3981. Application to vary the conditions of licence No. D.A.34833/8 (L/C. 146 cwt.) by deleting paragraphs (d) and (e) of the existing conditions and adding in lieu as paragraphs (d), (e) and (f)—"(d) From the premises of S.E.C. at Morwell to consignees within a 10-mile radius of own premises at Koo-Wee-Rup—briquettes. (e) Within a 50-mile radius of own farms at Cardinia and Dalmore in the course of business as 'Primary Producer'—own goods. (f) From railway yards at Warragul to consignees within a 10-mile radius of own premises at Koo-Wee-Rup—briquettes".
- INGUANTI, J. J., 14 King-street, Werribee, 3030. One commercial goods vehicle (L/C. 138 cwt.) to operate: (a) Within a 25-mile radius of the G.P.O., Melbourne solely on behalf of Conmac Asphalt Pty. Ltd.—raw materials for the manufacture of asphalt. (b) From sand pits at Cranbourne and Garfield to the plant of Conmac Asphalt Pty. Ltd. at Clarinda—sand. (c) Within a 50-mile radius of Conmac Asphalt Pty. Ltd. at Brooklyn—hot asphalt.
- INTERNATIONAL HARVESTER CO. OF AUST. PTY. LTD., The Esplanade, North Shore, Geelong, 3214. Application to vary the conditions of licence No. D.A.1351/70 (L/C. 18 cwt.) by adding to the existing conditions as an additional paragraph (c)—"(c) Throughout the State of Victoria in the course of business as 'Truck, Tractor and Farm Implement Manufacturer'—farm implements and accessories for experimental and demonstration purposes only, also tools of trade incidental to the servicing and maintenance of own machinery and equipment and also such spare parts only as are required for use on the site of the machinery being serviced".
- JONES, G. L., "Glenrae", Wattle Glen, 3096. One commercial goods vehicle (L/C. 184 cwt.) to operate within a 50-mile radius of the G.P.O. in the City of Melbourne solely on behalf of Consolidated Quarries Ltd.—premixed concrete in a specially constructed agitator vehicle.
- KEOGH, P., PTY. LTD., 371 Francis-street, West Footscray, 3012. Two commercial goods vehicles (L/C. 297 and 305 cwt.) to operate: (a) Within a 25-mile radius of the G.P.O., Melbourne—general goods. (b) Throughout the State of Victoria in course of business as "Erection Engineers and Contractors"—tools of trade, erection equipment, machinery and materials incidental thereto, with sufficient fuel oil and grease to operate machinery on site.
- LACEY, J. H., Copelands-road, Warragul, 3820. One commercial goods vehicle (L/C. 42 cwt.) to operate: (a) Within a 25-mile radius of the post office at Warragul—general goods provided that no goods shall be carried whether by one stage or by more than one stage between places within the above radius which are more than thirty (30) miles apart by the nearest practicable route. (b) From and to points within a 25-mile radius of the post office at Warragul specified in paragraph (a) above to and from places outside that radius but wholly within a 50-mile radius of the said post office—livestock.
- LEE, I. J., 35 Saint-street, Castlemaine, 3450. One commercial goods vehicle (L/C. 263 cwt.) to operate: (a) Within a 20-mile radius of the post office at Castlemaine—general goods. (b) Within a 50-mile radius of the post office at Castlemaine—road-making and bridge building plant and materials.
- LIANOS, J., 4 Gedye-street, Doncaster East, 3109. One commercial goods vehicle (L/C. 214 cwt.) to operate within a 35-mile radius of the G.P.O. in the City of Melbourne solely on behalf of Consolidated Quarries Ltd.—sand, soil, screenings, premix and quarry products.
- LIFE SAVERS (AUSTRALASIA) LTD., 2 Bromham-place, Richmond, 3121. One commercial goods vehicle (L/C. 10 cwt.) to operate within a 50-mile radius of own depot at Wangaratta and to Shepparton, Echuca, Swan Hill, Broadford and Eildon and places *en route* in course of business as "Confectionery Manufacturers and Distributors" as a "Travellers Vehicle" for the purpose of booking orders and sales promotion—confectionery, display and advertising materials.
- Note.—All goods to be initially consigned by rail to Wangaratta.
- LIFE SAVERS (AUSTRALASIA) LTD., 2 Bromham-place, Richmond, 3121. One commercial goods vehicle (L/C. 10 cwt.) to operate within a 50-mile radius of own depot at Moe and to Orbost and Mallacoota and places *en route* in course of business as "Confectionery Manufacturers and Distributors" as a "Travellers Vehicle" for the purpose of booking orders and sales promotion—confectionery, display and advertising materials.
- NOTE.—All goods to be initially consigned by rail to Moe.
- LOADMASTER TRAILERS PTY. LTD., Brook-street, Woodend, 3442. One commercial goods vehicle (L/C. 17 cwt.) to operate throughout the State of Victoria in course of business as "Manufacturer and Distributor of Trailers" for the purpose of servicing own manufactured trailers in the field only—tools of trade, and spare parts incidental thereto.
- LOE, A. G., (trading as A. M. Loe & Co.), 13-15 Broomfield-street, Shepparton, 3630. Two commercial goods vehicles (L/C. 159 and 310 cwt.) to operate: (a) Within a 50-mile radius of own premises at Shepparton in course of business as "Case Manufacturers"—own goods. (b) From sawmills at Macedon, Harcourt, Mansfield and Beranduda, to own premises at Shepparton in course of business as "Case Manufacturers"—case timber and case shocks. (c) From properties



- and consignors within a 50-mile radius or shepparton to premises of Shepparton and Ardmona canneries—fresh fruit and empty return cases and bins. (d) From properties within a 50-mile radius of Shepparton to McLennan's Flour Mill at Mooroopna—grain.
- MARTIN, R. H., 58 Mountain View-road, Kilsyth, 3137. One commercial goods vehicle (L/C. 243 cwt.) to operate from forest landings situated within a 20-mile radius of the post office at Jamieson and on the King Basin area to the sawmills of Mr. Feiglin & Son and D.S.M. Timber Mills Pty. Ltd., at Mansfield and J. A. Terrett & Co., at Benalla—sawmill logs.
- MIDDLING, G. G., Flat 7, 17 Royal-avenue, Springvale, 3171. One commercial goods vehicle (L/C. 160 cwt.) to operate within a 70-mile radius of the premises of Atlas Industries Aust. Ltd. at Springvale solely on behalf of the said company—roofing tiles and tile fixing battens.
- MILLS, P. R., 142 Lonsdale-street, Hamilton, 3300. One commercial goods vehicle (L/C. 6 cwt.) to operate in the course of business as "Antique and Second-hand Dealer" as follows:—(a) From auction sales and private vendors within that part of the State of Victoria, west of a line drawn due north and south through the City of Dandenong and south of a line drawn due east and west through the City of St. Arnaud to own premises at Hamilton antique articles for return to own premises at Hamilton. (b) Within that part of the State of Victoria, west of a line drawn north and south through the City of Geelong and south of a line drawn east and west through the City of St. Arnaud—second-hand goods for return to own premises at Hamilton. (c) From own place of business at Hamilton to points within paragraph (a)—antiques for delivery to purchasers. (d) From own place of business at Hamilton to points within paragraph (b) above—second-hand goods for delivery to purchasers.
- MOTOR SPARES LTD., Fraser-street, Shepparton, 3630. One commercial goods vehicle (L/C. 14 cwt.) to operate within a 50-mile radius of own branch premises at Shepparton in course of business as "Automotive Parts Distributors"—own goods.
- MURRAY GOULBURN TRADING PTY. LTD., Merino, 3310. One commercial goods vehicle (L/C. 74 cwt.) to operate: (a) Within a 25-mile radius of the post office at Merino—general goods, provided that no goods shall be carried whether by one stage or by more than one stage between places within the above radius which are more than thirty (30) road miles apart by the nearest practicable route. (b) From the depot of Mobil Oil Aust. Pty. Ltd. at Portland to places within a 50-mile radius thereof—petroleum products in prescribed types of containers and empty return containers.
- MCCUSKEY, B. A. (trading as McCuskey's Farm Tyre Service), 163 Hargreaves-street, Bendigo, 3550. One commercial goods vehicle (L/C. 14 cwt.) to operate: (a) Within a 50-mile radius of the chief post office in the City of Bendigo—tyres, tubes, batteries, petrol, oil and greases. (b) From and to own premises at Bendigo, to and from the Cities of Echuca and Shepparton and the Townships of Kilmore, Daylesford, Avoca, St. Arnaud, Charlton, Wycheproof and Kerang serving places *en route*—trucks and tractor tyres for recapping or retreading provided that all goods collected for consignment to Bendigo shall be forwarded by rail from the nearest or most convenient railway station with the exception that on return journeys to Bendigo on completion of each trading period one pay-load of tyres may be carried on the vehicle.
- MCKENZIE, N. A., Murchison-street, Marysville, 3779. Application to vary the conditions of licence No. D.T.1261 (L/C. 298 cwt.) by deleting from paragraph (a) of the existing conditions the words "To the sawmills of J. L. Gould Pty. Ltd. at Marysville".
- NEW HOLLAND DIVISION SPERRY RAND AUSTRALIA LTD., 232 Princes Highway, Dandenong, 3175. One commercial goods vehicle (L/C. 18 cwt.) to operate in the course of business as "Farm Machinery Manufacturers"—(a) Within a 20-mile radius from own premises at Dandenong—own goods. (b) Throughout the State of Victoria—own manufactured farm Machinery for demonstration and experimental purposes only.
- NORTH EASTERN READYMIXED CONCRETE PTY. LTD., Ely-street, Wangaratta, 3677. One commercial goods vehicle (L/C. 230 cwt.) to operate within a 50-mile radius of the post office at Wangaratta in the course of business as "Pre-Mixed Concrete Manufacturers"—own pre-mixed concrete, sand, gravel, screenings and aggregate.
- QUARRELL, N. E., Needham-street, Stawell, 3380. One commercial goods vehicle (L/C. 241 cwt.) to operate: (a) Within a 50-mile radius from the post office at Stawell—plant the property of a contractor and required by him for use in connexion with the construction or maintenance of some specific, existing or proposed road, street, footpath, bridge, pier, wharf, weir or channel and also the following materials, viz.: metal, stones, screenings, ashes, gravel, sand and earth. (b) Within a 20-mile radius from the site of any construction or maintenance work performed pursuant to paragraph (a) above, or from the railway station nearest thereto—any other materials required for such work.
- READY MIXED CONCRETE (VIC.) PTY. LTD., 68 Burwood-road, Burwood, 3125. One commercial goods vehicle (L/C. 332 cwt.) to operate: (a) Within a 25-mile radius of the post office situated at the corner of Bourke and Elizabeth streets in the City of Melbourne and to and from the Township of Bittern—raw materials for the use in the manufacture of concrete. (b) From suppliers situated within a 20-mile radius of the post office situated at Bittern to own premises at Bittern—sand and screenings. (c) To own plant at Geelong from quarries situated within a 10-mile radius of the said plant and from pits in the You Yangs Area—sand and screenings. (d) From pits at Bacchus Marsh to own plants within a 25-mile radius of Melbourne and to own plant at Geelong—own sand. (e) From pits at Tynong and Nar-Nar-Goon to own plant at Vermont—own sand. (f) From quarries at Anakie to own plants within a 25-mile radius of Melbourne—own rock.
- ROGERSON, J. G., Mill-street, Horsham, 3400. One commercial goods vehicle (L/C. 131 cwt.) to operate: (a) Within a 25-mile radius of the post office at Horsham—general goods provided that no goods shall be carried whether by one stage or by more than one stage between places within the above radius which are more than thirty (30) road miles apart by the nearest practicable route. (b) Within a 50-mile radius of the post office at Horsham solely on behalf of Esso Standard Oil (Aust.) Ltd.—petroleum products in bulk and in prescribed types of containers and empty return containers.
- SANDERS, O. J., 15 Palk-street, Horsham, 3400. Application to vary conditions of licence No. D.A.49749 (L/C. 215 cwt.) by deleting the existing conditions and adding in lieu—(a) Within a 25-mile radius from the main post office at Horsham—general goods, provided that no goods shall be carried whether by one stage or by more than one stage between places within the above radius which are more than thirty (30) miles apart by the nearest practicable route. (b) Within a 50-mile radius from the main post office at Horsham in course of business as "Agricultural Contractors"—own goods, machinery and equipment.
- SCHREENAN, W. D., 377 Forest-street, Ballarat, 3350. One commercial goods vehicle (L/C. 173 cwt.) to operate within a 50-mile radius of the premises of Pioneer Concrete (Vic.) Pty. Ltd. at Ballarat solely on behalf of the said company—premixed concrete in a specially constructed agitator vehicle.
- SEVEN X BEVERAGES CENTRAL PTY. LTD., 16 First-avenue, Sunshine, 3020. Three commercial goods vehicles (L/C. 65 cwt. each) to operate within a 50-mile radius of own branch premises at Ballarat in course of business as "Aerated Water Distributors"—aerated waters and empty return containers.
- SEVEN X BEVERAGES CENTRAL PTY. LTD., 16 First-avenue, Sunshine, 3020. One commercial goods vehicle (L/C. 65 cwt.) to operate within a 50-mile radius of own branch premises at Shepparton in course of business as "Aerated Water Distributors"—aerated waters and empty return containers.
- SEVEN X BEVERAGES CENTRAL PTY. LTD., 16 First-avenue, Sunshine, 3020. One commercial goods vehicle (L/C. 65 cwt.) to operate within a 50-mile radius of own branch premises at Bendigo in course of business as "Aerated Water Distributors"—aerated waters and empty return containers.
- SEVEN X BEVERAGES CENTRAL PTY. LTD., 16 First-avenue, Sunshine, 3020. One commercial goods vehicle (L/C. 65 cwt.) to operate within a 50-mile radius of own branch premises at Seymour in course of business as "Aerated Water Distributors"—aerated waters and empty return containers.
- SEVEN X BEVERAGES CENTRAL PTY. LTD., 16 First-avenue, Sunshine, 3020. One commercial goods vehicle (L/C. 65 cwt.) to operate within a 50-mile radius of own branch premises at Benalla in course of business as "Aerated Water Distributors"—aerated waters and empty return containers.

SEVEN X BEVERAGES PTY. LTD., 19 Wright-street, Sunshine, 3020. Two commercial goods vehicles (L/C. 63 cwt. each) to operate within a 50-mile radius of own branch premises at Colac in course of business as "Aerated Water Distributors"—aerated waters and empty return containers.

SHEPPARTON BLUESTONE CARTAGE PTY. LTD., P.O. Box 16, Shepparton, 3630. One commercial goods vehicle (L/C. 270 cwt.) to operate: (a) Within a 50-mile radius of the post office at Shepparton as a "Road Contractor"—road-making plant and materials. (b) Within a 25-mile radius of the post office at Shepparton—general goods provided that no goods shall be carried whether by one stage or by more than one stage between places within the above radius which are more than thirty (30) road miles apart by the nearest practicable route. (c) Within a 50-mile radius of own quarry at Cosgrove in the course of business as "Quarry Masters"—metal, stones, screenings, stone dust and crushed rock.

SUTHERLAND, A. H., Toora, 3962. Application to vary the conditions of licence No. D.A.61021 (L/C. 247 cwt.) by adding to the existing conditions as an additional paragraph (b)—"(b) From the premises of the State Electricity Commission at Yallourn and Morwell to—(i) Places situated within a 20-mile radius of the post office at Leongatha—bulk briquettes. (ii) The premises of South Gippsland Milk Industries Ltd., at Leongatha and Fish Creek—briquettes. (iii) The premises of Rocla Pipes Ltd. at Traralgon—briquettes. (iv) The premises of South Eastern Milk Products at Heyfield—bulk briquettes. (v) The premises of South Gippsland Milk Industries at Korumburra—briquettes."

TATSIDIS, D., 19 Lake-street, Avondale Heights, 3034. One commercial goods vehicle (L/C. 140 cwt.) to operate within a 35-mile radius of the G.P.O., Melbourne solely on behalf of Consolidated Quarries Ltd.—sand, soil, screenings and premix.

THORPE, L. M., 12 Menzies-court, West Brunswick, 3055. One commercial goods vehicle (L/C. 182 cwt.) to operate within a 50-mile radius of the premises of Supermix Concrete Pty. Ltd. at Brooklyn solely on behalf of the said company—premix concrete in a specially constructed agitator vehicle.

TREMUL, A. F., 5 Settlement-road, Belmont, 3216. One commercial goods vehicle (L/C. 102 cwt.) to operate: (a) Within a 50-mile radius of the chief post office in the City of Geelong in the course of business as "Excavation and Drainage Contractors"—tools of trade and equipment incidental thereto. (b) From the site of any project currently engaged upon within the radius specified in part (a) above to places situated within a 20-mile radius of the particular site—earth.

WIMPEY, GEORGE & CO. LTD., 1257 Sydney-road, Fawkner, 3060. One commercial goods vehicle (L/C. 14 cwt.) to operate: (a) Within a 50-mile radius of own premises at Fawkner in the course of business as "Building and Civil Engineering Drilling and Site Investigation Contractors"—own goods. (b) Throughout the State of Victoria for purpose of supervising own contracts—tools of trade drilling and construction equipment and a small quantity of materials incidental to the completion or repair of a contract.

YOUNGER, R. N., Greta South, 3675. One commercial goods vehicle (L/C. 149 cwt.) to operate: (a) Within a 50-mile radius of own premises at Greta South as a "Road Contractor"—road-making plant and materials. (b) Within a 25-mile radius of the post office at Greta South—general goods provided that no goods shall be carried whether by one stage or by more than one stage between places within the above radius which are more than thirty (30) road miles apart by the nearest practicable route.

#### TOW TRUCK.

COLLEY, H. F. (trading as Colley Towing Service), 311 A and B Middleborough-road, Box Hill South, 3128. One commercial goods vehicle (L/C. 31 cwt.) to operate throughout the State of Victoria as a "Tow Truck" solely—(a) For the purpose of lifting and carrying or towing of wrecked or disabled motor vehicles and the carriage of tools and equipment necessary for such purposes. (b) The carriage of spare parts necessary for the repair of a disabled motor vehicle to and from the place at which such disablement has occurred.

Note.—(i) That operations shall only occur from the scene of a motor car accident if the licensed owner or certified driver of the said tow truck has been

previously bespoken but not at the scene of such accident by the owner of the damaged or disabled motor car, or his agent, or the person in charge of the said damaged motor car or disabled motor car. (ii) The licensed vehicle shall at all times exhibit a black plate 9 in. x 2½ in. on which appears in white letters 1½-in. high the word "Restricted" to be affixed immediately above the front and rear registration plates.

#### RENEWALS.

APPLICATIONS for renewal of licences as shown by persons listed hereunder to operate under the same terms and conditions from the expiry shown in each case.

AUTOCARE PTY. LTD., 117-119 Gilbert-road, Preston, 3072; D.A.45365; 19th February, 1970; 80 cwt.

BANDAG COLD TREAD PROCESS (VIC.) PTY. LTD., 490-492 Geelong-road, West Footscray, 3012; D.A.58176/1; 31st January, 1970; 25 cwt.; D.A.58176/2; 31st January, 1970; 25 cwt.

BEAGLEY, K. M., Kenilworth-avenue, Wonga Park, 3136; D.A.41540/3; 19th February, 1970; 128 cwt.

BOON SPA PTY. LTD., 264 Geelong-road, West Footscray, 3012; D.A.28769/12; 31st January, 1970; 104 cwt.

CAL, B. A., Kamarooka, 3570; D.A.45353; 19th February, 1970; 69 cwt.

DOWSON, A. E., 215 White-road, Wonthaggi, 3995; D.A.4391; 11th September, 1969; 69 cwt.

DOWSON, A. E., 215 White-road, Wonthaggi, 3995; D.A.4391/1; 23rd June, 1969; 70 cwt.

DUNLOP TYRE SERVICE (HAMILTON) PTY. LTD., cnf. French and Cox streets, Hamilton, 3300; D.A.60416/27; 30th January, 1970; 9 cwt.

GLASSON, W. A., 14 Witta-street, Sebastopol, 3356; D.A.45375; 19th February, 1970; 158 cwt.

HASSETT, E., & SONS PTY. LTD., 24 Maroondah Highway, Ringwood, 3134; D.A.58056; 24th January, 1970; 11 cwt.

FRANK HOGAN PTY. LTD., Main-road, Emerald, 3782; D.A.61884; 16th October, 1969, 300 cwt.

VAN DIEMEN, M. J. (trading as Kellock & Van Diemen), Princes Highway, Pakenham, 3810; D.A.31238/1; 10th February, 1970; 148 cwt.

MACKENZIE, C. A., 12 Banool-street, Horsham, 3400; D.A.45516; 10th February, 1970; 8 cwt.

NEAVE, L. & B. M., (TRARALGON) PTY. LTD., Carrarung Lower, 3844; D.A.44081; 21st August, 1969; 242 cwt.

NORTON, F., PTY. LTD., Sargood-street, Altona, 3018; D.A.31887; 17th February, 1970; 10 cwt.

#### TOW TRUCKS.

BREWSTER & MADDERN PTY. LTD., Allan-street, Kyabram, 3620; T.D.A.45968; 10th February, 1970; 60 cwt.

THOMSON, A. J., (trading as Ferris & Thomson), Main-street, Walwa, 3709; T.D.A.47642; 18th February, 1970; 25 cwt.

#### RENEWAL WITH VARIATION.

APPLICATION by the person listed hereunder for renewal of the licence listed with variation of conditions in the manner set out opposite the name.

WARREN, H., 35 Crisp-street, Wangaratta, 3677; D.A.58152; 31st January, 1970; Application to renew and vary the conditions of licence No. D.A.58152 (L/C. 7 cwt.) by deleting "A. C. Hobbly (Electrical Retailer)" from the existing conditions and adding in lieu—"Home-crafts Pty. Ltd."

Notice of any objection should be forwarded to reach the Secretary of the Board not later than 17th December, 1969.

Applicants are advised that it will not be necessary to appear on the hearing date specified above, unless advised in writing by the Board.

B. P. KAY,

Secretary.

Corner Lygon and Princes streets, Carlton, 3053, Monday, 24th November, 1969.

*Private Agents Act 1966.*

NOTICE OF RECEIPT OF APPLICATIONS FOR LICENCES UNDER THE PROVISIONS OF THE PRIVATE AGENTS ACT 1966.

THE Clerk(s) of the Court(s) of Petty Sessions as listed hereunder hereby give notice that applications, as under, have been lodged for hearing by the said Court(s) on the date(s) specified.

Any person desiring to object to any of such applications must—

- (a) lodge with the respective Clerk of Petty Sessions a notice in the prescribed form of his objection and of the grounds thereof ;
- (b) cause a copy of such notice to be served personally or by post upon the applicant at least three days before the hearing of the application ; and
- (c) send or deliver—
  - (i) where the objection is not made by the officer in charge of the police district in which the Court is situated—a copy of the notice to such officer ; and
  - (ii) where the objection is not made by the Registrar or Deputy Registrar—a copy to the Registrar.

Full Name of Applicant or in the case of a Firm or Corporation, of the Nominee.	Place of Abode of Applicant or Nominee.	Name of Firm or Corporation.	Address for Registration.	Type of Licence.	Date of Hearing of Application.
---	---	------------------------------	---------------------------	------------------	---------------------------------

COURT OF PETTY SESSIONS, FOOTSCRAY.

Schiena, Michael .. ..	12 Bromyard-street, Yarraville	.. ..	12 Bromyard-street, Yarraville	Process Server ..	16.12.69
------------------------	--------------------------------	-------	--------------------------------	-------------------	----------

Dated at Footscray this 21st day of November, 1969.

J. A. BARNES, Clerk of Petty Sessions.

COURT OF PETTY SESSIONS, PRAHRAN.

Tizzoni, Gianfranco ..	29 Springhall-parade, Pascoe Vale South	.. ..	Suite 12, 614 St. Kilda-road, Melbourne	Process Server ..	9.1.70
------------------------	---	-------	---	-------------------	--------

Dated at Prahran this 20th day of November, 1969.

H. V. BOARDER, Clerk of Petty Sessions.

COURT OF PETTY SESSIONS, HASTINGS.

Malloy, Francis Joseph ..	38 Park-street, Seaford	.. ..	Hastings ..	Watchman ..	10.12.69
---------------------------	-------------------------	-------	-------------	-------------	----------

Dated at Hastings this 19th day of November, 1969.

T. O'KEEFE, Clerk of Petty Sessions.

*Childrens Court Act 1958.*

CHILDRENS COURTS—DAYS APPOINTED IN LIEU.

HIS Excellency the Governor of the State of Victoria, by and with the advice of the Executive Council thereof doth by Order made on the 25th day of November, 1969, pursuant to the provisions of the *Children's Court Act 1958*, appoint the days and hours contained in the Schedule below for the holding of Childrens Courts at the places named in such Schedule in lieu of the days and hours heretofore appointed—to take effect as from the dates shown.

SCHEDULE.

Court.	Days and Hours.
BALLARAT ..	Every Monday, Wednesday and Friday at 2 p.m., as from the 5th January, 1970.
COBURG ..	The second and fourth Monday in each month at 2 p.m., as from the 12th January, 1970.
FITZROY ..	The second and fourth Wednesday in each month at 2 p.m., as from the 14th January, 1970.
KEW ..	The first and third Wednesday in each month at 2 p.m., as from the 7th January, 1970.
PRAHRAN ..	The first and third Wednesday in each month at 10 a.m., as from the 7th January, 1970.

J. ROSSITER,  
Clerk of the Executive Council.

At the Executive Council Chamber,  
Melbourne, 25th November, 1969.

*Children's Welfare Act 1958.*

DECLARATION OF AN INSTITUTION AS AN APPROVED CHILDREN'S HOME.

IN accordance with the provisions of Regulation 42 of Division 1 of the Social Welfare Regulations 1962, notice is hereby given that, on the twenty-seventh day of November, 1969, acting in pursuance of the powers conferred by sub-section (1) of section 14 of the *Children's*

*Welfare Act 1958*, I declared the premises situated at 5 Torrbay-court, Frankston, as an Approved Children's Home for the purposes of the said Act.

A. G. RYLAH,  
Chief Secretary.

Chief Secretary's Office,  
Melbourne, 27th November, 1969.

*Justices Act 1958.*

COURTS OF PETTY SESSIONS—DAYS APPOINTED IN ADDITION OR IN LIEU.

HIS Excellency the Governor of the State of Victoria, by and with the advice of the Executive Council thereof doth by Order made on the 25th day of November, 1969, pursuant to the provisions of section 64 of the *Justices Act 1958*, appoint the days and hours contained in the Schedule below for the holding of Courts of Petty Sessions at the places named in such Schedule in lieu of or in addition to the days and hours heretofore appointed.

SCHEDULE.

Place.	Days and Hours.
FOSTER ..	Every Thursday at 10.30 a.m. as from the 8th January, 1970, and every eighth Friday at 10.30 a.m., as from the 20th February, 1970, except Public Holidays, in lieu of the days heretofore appointed.
TOORA ..	Friday the 3rd April, 1970, at 10.30 a.m. in addition to the days heretofore appointed.

J. ROSSITER,  
Clerk of the Executive Council.

At the Executive Council Chamber,  
Melbourne, 25th November, 1969.

*Crimes Act 1958.*

CURATOR OF CONVICT'S PROPERTY.

HIS Excellency the Governor of the State of Victoria, by and with the advice of the Executive Council thereof doth by Order made on the 25th day of November, 1969, pursuant to the provisions of section 550 of the *Crimes Act 1958*, commit the custody and management of

the property of the convict Barrie Haydn Walters, to Fay Pauline Walters, of 294 Nepean Highway, Edithvale, as a curator hereby appointed in that behalf.

J. ROSSITER,  
Clerk of the Executive Council.

At the Executive Council Chamber,  
Melbourne, 25th November, 1969.

## LAW DEPARTMENT.

## JUSTICE OF THE PEACE REMOVED.

**HIS** Excellency the Governor of the State of Victoria, by and with the advice of the Executive Council thereof doth by Order made on the 25th day of November, 1969, remove Shalom Benzion Gurewicz from the Commission of the Peace for the State of Victoria.

J. ROSSITER,  
Clerk of the Executive Council.

At the Executive Council Chamber,  
Melbourne, 25th November, 1969.

## CAULFIELD-MALVERN REGIONAL LIBRARY SERVICE.

## NOTICE OF APPROVAL OF AGREEMENT.

**THE** agreement made between the Mayors, Councillors and Citizens of the Cities of Caulfield and Malvern for the provision of a joint library service in the municipal districts of the said municipalities was approved by the Governor in Council pursuant to the provisions of section 799 of the *Local Government Act 1958* on the twenty-fifth day of November, 1969.

J. ROSSITER,  
Clerk of the Executive Council.

At the Executive Council Chamber,  
Melbourne, 25th November, 1969.

*Country Fire Authority Act 1958.*

## FIRE DANGER PERIOD IN RESPECT OF SPECIFIED PARTS OF THE COUNTRY AREA OF VICTORIA.

**WHEREAS** by section 4 of the *Country Fire Authority Act 1958*, it is enacted that the Chief Secretary of Victoria, after consultation with the Minister of Forests, may from time to time by declaration published in the *Government Gazette*, declare any period to be the fire danger period in respect of the country area of Victoria, or any specified part or parts thereof and, without affecting the generality of the foregoing, may declare different periods to be the fire danger period in respect of different parts of the said country area:

And whereas the Chief Secretary and the Minister of Forests have consulted accordingly:

Now therefore I, the Chief Secretary of Victoria, do hereby declare the period commencing at midnight on the 7th December, 1969, and ending at midnight on the 30th April, 1970, to be the fire danger period in respect of the parts of the country area of Victoria situated within the municipal districts or parts of municipal districts, and being portion of the Twenty-second Fire Control Region specified in the Schedule hereunder—

## SCHEDULE (No. 8).

Cities of Echuca and Shepparton.  
Borough of Kyabram.  
Shires of Cobram, Deakin, Goulburn, Numurkah, Rodney, Shepparton, Tungamah and Waranga.

A. G. RYLAH,  
Chief Secretary.

Chief Secretary's Office,  
Melbourne, 2nd December, 1969.

*Country Fire Authority Act 1958.*

## FIRE DANGER PERIOD IN RESPECT OF SPECIFIED PARTS OF THE COUNTRY AREA OF VICTORIA.

**WHEREAS** by section 4 of the *Country Fire Authority Act 1958*, it is enacted that the Chief Secretary of Victoria, after consultation with the Minister of Forests, may from time to time by declaration published in the *Government Gazette*, declare any period to be the fire danger period in respect of the country area of Victoria, or any specified part or parts thereof and, without affecting the generality of the foregoing, may declare different periods to be the fire danger period in respect of different parts of the said country area:

And whereas the Chief Secretary and the Minister of Forests have consulted accordingly:

Now therefore I, the Chief Secretary of Victoria, do hereby declare the period commencing at midnight on the 5th December, 1969, and ending at midnight on the 30th April, 1970, to be the fire danger period in respect of the parts of the country area of Victoria situated within the municipal districts or parts of municipal districts, being portions of the Twelfth, Fifteenth and Twenty-first Fire Control Regions specified in the Schedule hereunder—

## SCHEDULE (No. 7).

City of Maryborough.  
Shires of Huntly, Marong, Newstead, Pyalong, Strathfieldsaye, Tullaroop and Yea.

A. G. RYLAH,  
Chief Secretary.

Chief Secretary's Office,  
Melbourne, 2nd December, 1969.

*Country Fire Authority Act 1958.*

## VARIATION OF FIRE DANGER PERIOD IN RESPECT OF SPECIFIED PARTS OF THE COUNTRY AREAS OF VICTORIA.

**WHEREAS** by section 4 of the *Country Fire Authority Act 1958*, it is enacted that the Chief Secretary of Victoria, after consultation with the Minister of Forests, may from time to time by declaration published in the *Government Gazette*, declare any period to be the fire danger period in respect of the country area of Victoria, or any specified part or parts thereof and, without affecting the generality of the foregoing, may declare different periods to be the fire danger period in respect of different parts of the said country area:

And whereas by the said section it is further enacted that any declaration so published may be revoked, amended or varied by a subsequent declaration so published:

And whereas by declaration issued on the date stated in Schedule A hereunder, different fire danger periods expiring on the thirtieth day of April, 1970, were declared in respect of different parts of the country area of Victoria, situated within the municipal districts or parts of municipal districts specified in Schedule B hereunder; being portion of the Eighteenth Fire Control Region:

And whereas the Chief Secretary and the Minister of Forests have consulted accordingly:

Now therefore I, the Chief Secretary of Victoria, do by this my declaration vary the aforesaid declaration by declaring that the fire danger period in respect of the parts of the country area of Victoria situated within the municipal districts or parts of municipal districts specified in Schedule B hereunder shall end at midnight on the 5th December, 1969.

## SCHEDULE A.

*Date of Declaration; Date of Publication in  
"Government Gazette".*

6th November, 1969; 7th November, 1969.

## SCHEDULE B.

The Shire of Mildura (that portion within the Soldier Settlement Subdivision of the Robinvale Irrigation District).

A. G. RYLAH,  
Chief Secretary.

Chief Secretary's Office,  
Melbourne, 2nd December, 1969.

## COUNTRY FIRE AUTHORITY ACT.

## PERMISSION TO HOLD FIRE BRIGADE DEMONSTRATIONS.

**IN** pursuance of the provisions of section 103 of the *Country Fire Authority Act 1958*, the Country Fire Authority has granted permission for the holding of fire brigade demonstrations as under—

## Rural Fire Brigades.

At Lilydale, on Saturday, 6th December, 1969.  
At Patchewollock, on Saturday, 14th March, 1970.  
At Ballarat, on Saturday, 11th April, 1970.

J. L. ALLEN,  
Secretary.

26th November, 1969.

SHIRE OF HEYTESBURY WATERWORKS TRUST.

RATING BY-LAW FOR THE YEAR ENDED 30 SEPT. 1970.

THE Shire of Heytesbury Waterworks Trust in pursuance of and in exercise of the powers conferred by the Water Act 1958 and of any and every other power it thereunto enabling doth hereby make a By-Law as follows:—

1. The Trust hereby makes and levies rates in respect of all the lands and tenements within the respective Urban Districts of such amount in the dollar on the net annual value set out in the valuation at present in force of such lands and tenements for the purposes of the municipal rate of the Shire of Heytesbury which is hereby adopted as the valuation of such lands and tenements respectively, as is set out in Column 2 opposite the name of the respective Urban Districts in Column 1 of the Schedule hereto.

2. Such rate shall be made and levied upon the occupiers and owners of such lands and tenements for the year commencing on the first day of October 1969 and shall be payable on the 9th day of December 1969 at the Office of the said Trust.

3. In no case shall the rate payable hereunder in respect of any land on which there is a building be less than the sum set down in Column 3 opposite the name of the respective Urban Districts in Column 1 of the Schedule hereto and in respect of land in which there is no building be less than the sum set down in Column 4 opposite the name of the respective Urban Districts in Column 1 of the said Schedule.

SCHEDULE.

Name of Respective Urban Districts.	Amount of Rate in the \$1 of Municipal Valuation of Tenements. (Subject to the Minimum Amount of Rates as set out in columns 3 and 4).	Minimum Amount of Rate per Year in respect of Tenements (other than lands on which there is no building).	Minimum Amount of Rate per Year in respect of land on which there is no building.
Column 1.	Column 2.	Column 3.	Column 4.
	cents	\$	\$
Timboon ..	12.0	13.00	5.00
Port Campbell	17.5	18.00	5.00

Passed this 20th day of November, 1969.

W. J. LONG, Chairman.  
P. J. NORTHEAST, Secretary.

Approved 24th November, 1969.—W. BORTHWICK, Minister of Water Supply.

ROSEDALE WATERWORKS TRUST.

RATING BY-LAW FOR YEAR 1969.

THE Rosedale Waterworks Trust in pursuance of and in exercise of the powers conferred by the Water Act 1958 and of any and every other power it thereunto enabling doth hereby make a By-law as follows:—

1. The Trust hereby makes and levies a rate in respect of all the lands and tenements within the Rosedale Urban District, of nine cents in the dollar on the Net Annual Value set out in the valuation at present in force of such lands and tenements for the purposes of the Municipal rate of the Shire of Rosedale which is hereby adopted as the valuation of such lands and tenements respectively.

2. Such rate shall be made and levied upon the occupiers and owners of such lands and tenements for the year commencing on the 1st day of January, 1969, and shall be payable on the 5th December, 1969 at the office of the said Trust.

3. In no case shall the rate payable hereunder in respect of any land on which there is a building be less than fifteen dollars and in respect of land on which there is no building be less than two dollars.

Passed this 12th day of August, 1969.

(SEAL) N. FARRINGTON, Chairman.  
C. BURLEY, Commissioner.  
G. W. THOMSON, Secretary.

Approved, 20th November, 1969.—W. BORTHWICK, Minister of Water Supply.

Water Act 1958.

STATE RIVERS AND WATER SUPPLY COMMISSION.  
LOCKINGTON AND SEA LAKE URBAN DISTRICTS.

NOTICE to owners of tenements in the under-mentioned streets in the above-mentioned Urban Districts and the private streets, lanes, courts and alleys opening thereto:—

LOCKINGTON URBAN DISTRICT.

Lockington.

Prairie-road, from end of existing main (opposite lot 35) to a point opposite lot 38, about 3½ chains southerly from Lucas-crescent.

SEA LAKE URBAN DISTRICT.

Sea Lake.

Sutcliffe-street, from end of existing main (opposite lot 29, about 2½ chains northerly from Hughes-street) to Tyrrell-street.

Tyrrell-street, from Sutcliffe-street to a point opposite lot 5, about 3 chains easterly.

The main pipe in the said streets being laid down, the owners of all tenements situated as above are hereby required, on or before the 1st day of February next, to cause proper pipes and stop cocks to be laid, so as to supply water within such tenements from the main pipe.

G. W. LEWIS, Secretary,  
State Rivers and Water Supply Commission.

Melbourne, 28 November, 1969.

ORDERS IN COUNCIL.—(Series 1969-70.)

STATE ELECTRICITY COMMISSION.

975. For the supply of road metal, concrete aggregate and sand in the Melbourne and metropolitan area, for a period of two years, with optional extension of three months, to Specification No. 69/252, at Schedule rates.—Albion Reid Pty. Ltd.

Approved by the Governor in Council, 28th October, 1969.—J. ROSSITER, Clerk of the Executive Council.

976. For the supply of boiler suits, overalls and dust-coats, for a period of two years, with optional extension of three months, to Specification No. 69/278, at Schedule rates.—Cushen Clothing Co. Pty. Ltd.

977. For the supply of 45 amp. 500 volt service fuse boxes, for a period of two years, with optional extension of three months, to Specification No. 69/289, at Schedule rates.—Gordon Faine & Sons Pty. Ltd.

978. For the supply of 37 22 kV 500 MVA outdoor capacitor breakers for capacitor switching in extra-metropolitan main substations, to Specification No. 69/125, \$158,844.—A. Reyrolle & Co. (Australia) Pty. Ltd.

Approved by the Governor in Council, 5th November, 1969.—J. ROSSITER, Clerk of the Executive Council.

979. For the excavation of pole, guy, earth pin holes and earthing trenches in Metropolitan Electricity Supply Branch, for a period of two years, with optional extension of three months, to Specification No. 69/249, at Schedule rates.—J. & I. Mitchell Pty. Ltd.

Approved by the Governor in Council, 11th November, 1969.—J. ROSSITER, Clerk of the Executive Council.

CONTRACTS ACCEPTED.—(Series 1969-70.)

PUBLIC WORKS.

980. Preston, Social Welfare Department, Suburban Office, maintenance cleaning for the period 4th August, 1969, to 31st July, 1972, \$743.60 per annum.—Crothall & Co. Pty. Ltd.

981. Portland, erection of new Police Station, \$60,950.00.—B. N. England.

982. Ballarat, Lakeside Hospital, renovations to roofs, Wards 4, 6, 7, 8, 9, 10, 11, 12 and 18, \$5,939.00.—George Stone & Sons (Vic.) Pty. Ltd.

983. Research, State School No. 2959, erection of two (2) prefabricated class-rooms, \$11,730.00.—A. V. Jennings Industries (Aust.) Ltd.

984. Various, Schools, erection of 100 portable class-rooms, \$396,550.00.—A. V. Jennings Industries (Aust.) Ltd.

985. Fawkner, High School, erection of new concrete veneer Science Wing, \$46,689.00.—Marshall Bros. Builders.

986. Sunbury, Mental Hospital, conversion of bedrooms into toilet areas, Ward F.2, \$4,980.00.—Impact Building Service.

987. Fawcner, High School, mechanical services, \$10,550.00.—Thermic Heating & Ventilation.

988. Bairnsdale, Technical School, erection of Craft Room and Modelling Room, \$22,049.00.—Willcroft-Terrapin Pty. Ltd.

G. SERPELL, Secretary for Public Works. 26.11.69.

#### TOOLS (GENERAL).

Gazette No. 33, 20th April, 1969, Schedule No. 52, Tools (General).—For rate shown opposite Item No. 252, substitute \$2.28 each, as from 3rd November, 1969.

For rate shown opposite Item No. 105, substitute 16 oz., \$1.85, 20 oz., \$1.88, as from 8th October, 1969.

#### GENERAL STORES.

Gazette No. 59, 10th July, 1969, Schedule No. 64, Polishes, Dusters, &c.—For rate shown opposite Item No. 19, substitute 99 cents.

E. P. WATSON, Secretary to the Tender Board. 1.12.69.

#### Housing Act 1958.

#### NOTICE OF RESOLUTION UNDER SECTION 99 (4) OF ACT No. 6275.

NOTICE is hereby given that Housing Commission on the 1st day of December, 1969, resolved as follows:—

"Whereas Housing Commission in respect of the lands described in the Schedule hereto has given notice to the parties interested under Section 9 of the *Lands Compensation Act 1958*, as incorporated with the *Housing Act 1958*, Housing Commission hereby resolves that the lands described in the Schedule hereto are finally appropriated for the purposes of the *Housing Act 1958*."

#### SCHEDULE.

*First*.—So much of the land comprised in certificates of title, volume 8790, folio 054, and volume 8790, folio 053, as is situate within Crown allotment 14A, section A, Parish of Hazelwood.

*Secondly*.—The land comprised in certificates of title, volume 4272, folio 347, and volume 8671, folio 474.

A. L. BOHN, Secretary.

#### Survey Co-ordination (Place Names) Act No. 7360.

#### NOTICE OF INTENTION.

PURSUANT to the powers conferred under section 28 of the above Act, the Place Names Committee hereby gives notice of its intention to assign the following name to the Reserve mentioned hereunder:—

*Municipality*.—Shire of Korumburra.

*Location*.—Commencing at the intersection of the western alignment of the Old South Gippsland Highway and the eastern alignment of the New South Gippsland Highway; bounded thence by the eastern alignment of the New South Gippsland Highway bearing generally southerly to the northern alignment of the road forming the southern boundary of the Township of Korumburra; thence easterly by that alignment to the western alignment of the Old South Gippsland Highway; and thence generally northerly by that alignment to the point of commencement.

*Proposed Name*.—Silkstone Park.

Any person who objects to the proposed name may give notice of objection, in writing, stating the reasons therefor, to the Secretary of the Committee, not more than two months following the publication of this notice.

By order of the Committee,

C. E. E. BARLOW, Secretary.

#### THE LIQUOR CONTROL ACT 1968.

WHEREAS the Hotelkeeper's Licence for the licensed premises, known as the Williams Hotel, situate at Gordon, has been surrendered as from midnight on the 11th September, 1969, notice is hereby given that the amount of compensation payable to the owner of such premises pursuant to the provisions of the *Liquor Control Act 1968* is as under:—

Owner . . . . . \$20,250.

Dated at Melbourne this 27th day of November, 1969.

J. CROWE, Secretary,  
Liquor Control Commission.

PUBLIC TRUSTEE ACT 1958 (No. 6250), SECTION 17.  
I HEREBY give notice that on the 12th November, 1969, the Public Trustee filed elections to administer the following deceased persons' estates in accordance with section 17 of the *Public Trustee Act 1958*:—

ALLEN, IRWIN, late of 10 Campbell-street, Burnley, retired boilerman, died 14th September, 1969.

BISSET, PHYLLIS EMILY, formerly of 109 Waverley-street, Moonee Ponds, but late of Flat 15, 2 Maroona-road, Carnegie, spinster, died 4th August, 1969.

CANHAM, JOHN, late of Lyonville, pensioner, died 3rd July, 1969.

CASALE, VITO, late of Flat 4, 233 Dandenong-road, Prahran, chef, died 18th February, 1969.

COOPER, LESLIE GORDON, late of 17 Miller-street, Brunswick, accountant, died 23rd May, 1969.

PAUL, OLIVER PERCIVAL, formerly of Ward 2, McLeod Repatriation Hospital, McLeod, but late of 14 The Grove, Coburg, military pensioner, died 22nd September, 1969.

REMNAINT, LOUISE CATHERINE, late of 4 Young-avenue, West Hindmarsh, South Australia, married woman, died 11th July, 1967.

N. P. BRODY,

Public Trustee.

256 Flinders-street, Melbourne, 3000, 27th November, 1969.

#### NOTICE.

CREDITORS, next of kin and others having claims against the estate of any of the under-mentioned deceased persons, are required to send particulars of their claims to the Public Trustee, 256 Flinders-street, Melbourne, Vic. 3000, the personal representative, on or before the 10th February, 1970, after which date the Public Trustee may convey or distribute the assets, having regard only to the claims of which the Public Trustee then has notice:—

ALLEN, IRWIN, late of 10 Campbell-street, Burnley, retired boilerman, died 14th September, 1969.

BISSET, PHYLLIS EMILY, formerly of 109 Waverley-street, Moonee Ponds, but late of Flat 15, 2 Maroona-road, Carnegie, spinster, died 4th August, 1969.

BLOTT, DUDLEY JOSHUA, late of 3 Levien-street, Essendon, retired public servant, died 14th August, 1968.

CALLAGHAN, MARGARET, late of 12 Edward-street, Elsternwick, married woman, died 14th July, 1969.

CANHAM, JOHN, late of Lyonville, pensioner, died 3rd July, 1969.

CARVER, JOANNA LOUISE, also known as Louisa Carver, formerly of 26 Forster-avenue, East Malvern, but late of the Larundel Hospital, Bundoora, widow, died 14th December, 1968.

CASALE, VITO, late of Flat 4, 233 Dandenong-road, Prahran, chef, died 18th February, 1969.

COOPER, LESLIE GORDON, late of 17 Miller-street, Brunswick, accountant, died 23rd May, 1969.

FITZ-GERALD, ELIZABETH, also known as Elizabeth Fitzgerald, late of 24 Birch-street, West Preston, spinster, died 7th June, 1969.

GRAY, OLIVE MAY, formerly of 20 Church-street, Hastings, but late of 32 Banks-street, Yarralumla, A.C.T., widow, died 29th January, 1969.

HARVEY, JAMES, also known as James Leonard Harvey, late of 5 Mons-street, Glen Iris, retired builder, died 22nd September, 1969.

HOLLINGWORTH, WILLIAM JAMES, also known as William Hollingworth, late of Yarrowonga-road, Marungi, farmer, died 28th August, 1969.

HUME, LILY, late of 15 Barton-street, Reservoir, widow, died 23rd August, 1969.

KING, MARY MARGARET, also known as Mary King, formerly of 65 (formerly 171) Brunswick-road, East Brunswick, but late of "Kanella" Private Hospital, 35 Mitchell-street, Brunswick, spinster, died 29th May, 1968.

LAING, WILLIAM REGINALD, late of 4 Bendigo-street, Hampton, retired motor mechanic, died 5th August, 1969.

MITCHELL, FLORENCE MABEL, late of 31 Gillies-street, Fairfield, spinster, died 15th July, 1969.

MOXHAM, ARTHUR, formerly of No. 3262, 67th Battalion, Australian Imperial Forces, but late of Bundoora, retired serviceman, died 25th January, 1969.

MCDONALD, MONA, late of 85 River-street, Newport, widow, died 4th September, 1969.

NEWTS, ETHEL VERONICA, late of Cheltenham, Home and Hospital for the Aged, Cheltenham, widow, died 8th July, 1969.

PARANT, JESSIE MAY, late of 118 Bent-street, Northcote, married woman, died 21st September, 1969.

PAUL, OLIVER PERCIVAL, formerly of Ward 2, McLeod Repatriation Hospital, McLeod, but late of 14 The Grove, Coburg, military pensioner, died 22nd September, 1969.

REMNAINT, LOUISE CATHERINE, late of 4 Young-avenue, West Hindmarsh, South Australia, married woman, died 11th July, 1967.

RICHARDS, JOHN DAVID, late of 15 Commercial-road, South Yarra, driver, died 25th September, 1969.

RUSSELL, ALBERT EDWARD, late of 13 Shamrock-street, West Brunswick, retired railway employee, died 18th September 1969.

STANBURY, MABEL LAURA, late of 21 Lloyd-street, West Heidelberg, widow, died 24th August, 1969.

TAIT, FRANCES ROSIE, also known as Rosie Frances Tait and Rosie Tait, formerly of 52 (formerly 18) Lenna-street, East Burwood, but late of 119 Winfield-road, North Balwyn, widow, died 17th August, 1969.

WAKEHAM, JOHN GEORGE VERNON, late of 14 Charles-street, Elsternwick, sheet metal worker, died 1st August, 1969.

WALTON, CHARLES THOMAS, late of 19 Wheatley-road, Bentleigh, pensioner, died 21st September, 1961.

WARDLEY, JOHN EDWARD, late of 181 Victoria-parade, Fitzroy, tradesman's assistant, died 20th June, 1969.

WEHSACK, DORIS LILIAN, formerly of VF 345516 Victorian Line of Communication Audit and Stocktaking and 24 Villeroy-street, Hampton, but late of Kew, widow, died 16th May, 1969.

WATSON, RONALD GORDON, late of Auckland, New Zealand, engineer, died 13th June, 1968.

Melbourne, 27th November, 1969.

N. P. BRODY,  
Public Trustee.

*Town and Country Planning Act 1961.*

MORWELL PLANNING SCHEME 1954.

AMENDMENT No. 26, 1968.

*Notice of Approval.*

IN pursuance of the powers conferred by the *Town and Country Planning Act 1961*, the Governor in Council on the 25th November, 1969, approved a planning scheme entitled the Morwell Planning Scheme 1954, Amendment No. 26, 1968, in respect of part of the municipal district of the Shire of Morwell and such planning scheme comes into operation on the date this notice of approval is published in the *Government Gazette*.

A copy of the planning scheme as approved may be inspected free of charge during office hours at the office of the Town and Country Planning Board, 235 Queen-street, Melbourne; at the Office of the Morwell Shire Office at Morwell and when available, at the Office of Titles, Melbourne, and at the Central Plan Office of the Department of Crown Lands and Survey, Melbourne.

W. H. CRAIG, Secretary,  
Town and Country Planning Board.

*Town and Country Planning Act 1961.*

SHIRE OF CROYDON PLANNING SCHEME 1961.

AMENDMENT No. 10, 1967.

*Notice of Approval.*

IN pursuance of the powers conferred by the *Town and Country Planning Act 1961*, the Governor in Council on the 25th November, 1969, approved a planning scheme entitled the Shire of Croydon Planning Scheme 1961, Amendment No. 10, 1967, in respect of part of the municipal district of the Shire of Croydon and such planning scheme comes into operation on the date this notice of approval is published in the *Government Gazette*.

A copy of the planning scheme as approved may be inspected free of charge during office hours at the office of the Town and Country Planning Board, 235 Queen-street, Melbourne; at the office of the Croydon Shire Council at Croydon and when available, at the Office of Titles, Melbourne, and at the Central Plan Office of the Department of Crown Lands and Survey, Melbourne.

W. H. CRAIG, Secretary,  
Town and Country Planning Board.

*Town and Country Planning Act 1961.*

CITY OF SHEPPARTON PLANNING SCHEME 1953.

AMENDMENT No. 20, 1969.

*Notice of Amendment.*

IN pursuance of the powers conferred by sub-section 6 of section 32 of the *Town and Country Planning Act 1961*, the Governor in Council, by and with the advice of the Executive Council on the 25th November, 1969, amended the City of Shepparton Planning Scheme 1953 to permit the establishment of a restaurant in association with a service station in the Special Uses Zone "D", and to correct a number of minor errors in Clause 16.

A copy of the amendment may be inspected during office hours at the office of the Town and Country Planning Board, 235 Queen-street, Melbourne; at the Office of the Council of the City of Shepparton at Shepparton and when available at the Office of Titles, Melbourne; and at the Central Plan Office of the Department of Crown Lands and Survey, Melbourne.

W. H. CRAIG, Secretary,  
Town and Country Planning Board.

## APPOINTMENTS AND RESIGNATIONS

### APPOINTMENTS.

HIS Excellency the Governor of the State of Victoria, by and with the advice of the Executive Council thereof, has, by Orders made on the 25th day of November, 1969, been pleased to make the under-mentioned appointments, viz.:—

#### CROWN LANDS AND SURVEY DEPARTMENT.

*Bailiff of Crown Lands.*

ALBERT JOHN FREDERICK LODDING,  
pursuant to section 30 of the *Land Act 1958*, to be a Bailiff of Crown lands in the place of James Alan Jennings, resigned.

*Managers of Common.*

GEORGE F. ALLEN,  
MAX BODDINGTON,  
KEITH ALLEN,  
DOUGLAS SIMPSON, and  
JAMES BARRIE,

to be Managers of the Shelford United Town and Farmer's Common for a period from 1st January, 1970, to 31st December, 1971, pursuant to section 182 of the *Land Act 1958*.

*Secretary of Yarra Bend Park.*

WILLIAM JULIUS ROTHERHAM  
to be Secretary of the Trustees of the land in the Parishes of Boroondara and Jika Jika, permanently reserved by Order in Council of the 26th March, 1935, as a site for Public Park and Recreation, pursuant to section 7 (5) of the *Kew and Heidelberg Lands Act 1933*, No. 4194, in the place of William John Cox, resigned.

#### MINISTRY OF HEALTH.

*Chairman of Hospitals and Charities Commission (Acting).*

ALEXANDER JAMES MCLELLAN, A.A.S.A.,  
to be Chairman of the Hospitals and Charities Commission, pursuant to section 12 of the *Hospitals and Charities Act 1958* to act from and inclusive of the 9th October, 1969, until the return to Victoria of Dr. J. H. Lindell.

*Deputy Chairman of Hospitals and Charities Commission (Acting).*

ROBERT LEONARD EDWIN THOMAS, B. Comm., A.A.S.A.,  
to be Deputy Chairman of the Hospitals and Charities Commission, pursuant to section 12 of the *Hospitals and Charities Act 1958* to act for the period during which A. J. McLellan, is acting as Chairman of the Hospitals and Charities Commission.

*Member of the Victorian Nursing Council.*

DR. ALAN STOLLER, M.R.C.S., L.R.C.P., F.A.N.Z.C.P.,  
D.P.M.,  
to be a Member of the Victorian Nursing Council, pursuant to section 4 (2) (e) (iii) of the *Nurses Act 1958*, for period ending 28th September, 1971, vice Dr. E. C. Dax, resigned.

*Secretary, Mental Hospital, Larundel.*

JOHN WARWICK BARTLETT  
to be Secretary, Larundel Psychiatric and Mental Hospital, pursuant to section 26 of the *Mental Health Act 1959*, vice R. J. Bates, on leave.

*Secretary, Mental Hospital, Beechworth.*

IAN LITCHFIELD ARNEL  
to be Secretary, Mental Hospital and Training Centre, Beechworth, pursuant to section 26 of the *Mental Health Act 1959*, vice A. J. McDonald.

*Trustees of Public Cemeteries.*

GEOFFRY ROSSETTI  
to be a Trustee of the Sale Public Cemetery, vice A. McLachlan, resigned.

ROBERT ALEXANDER GERDTZ, and  
JAMES DONALD HAMILTON  
to be Trustees of the Murtoa Public Cemetery, vice L. Smith, resigned and V. Edwards, deceased.

CECIL H. GRAY  
to be a Trustee of the Lilydale Public Cemetery, vice A. Fish, resigned.

KELVIN CONRAD DECKERT, and  
ALFRED JOHN McMARTIN  
to be Trustees of the Netherby Public Cemetery, vice E. Deckert and E. Bethke, resigned.

LAW DEPARTMENT.

*Commissioners for Taking Declarations, &c.*  
RONALD EDWIN CLAPHAM, 82 Glenburnie-road, Vermont,  
MICHAEL FREDERICK TILSON, 8 Pearcedale-grove, Nuna-  
wading,  
ERNESTO ANGERAME, 63 Victoria-street, East Brunswick,  
CHRISTIAN FREDERICK WACHTER, 46 Douglas-street,  
Noble Park,  
FRANCIS GRAHAM ETHELL, 9 Sidwell-avenue, East St.  
Kilda,  
ANDREW SAGE FERRY, 7 Auburn-grove, Armadale,  
FREDERICK WILLIAM BENNETT, 42 Railway-crescent,  
Williamstown,  
ARTHUR ALFRED GEORGE EATON, 19 Alison-avenue,  
Bulleen,  
WILLIAM ALEXANDER CALDER, 4 Lyell-road, Boronia  
West,  
DAVID GREENHILL BRYDEN, 31 Sanderson-street, Yarra-  
ville, and  
FREDERICK RONALD DODD, Kilcunda,  
to be Commissioners for taking Declarations and Affi-  
davits, pursuant to the provisions of the Evidence Act 1958,  
to resign upon removing from the neighbourhood of the  
addresses stated; and

WILLIAM JOSEPH MACKINTOSH, care of Department of  
Crown Lands and Survey, Treasury-place,  
Melbourne,  
to be a Commissioner for taking Declarations and Affi-  
davits, pursuant to the provisions of the Evidence Act  
1958, to refrain from charging fees and to resign upon  
ceasing to occupy his present position; and

PETER DANIEL TIRPKOU, care of Peter Daniels & Co.,  
699 High-street, Thornbury,  
HAROLD VICTOR FEEHAN, care of Victorian College of  
Pharmacy, 381 Royal-parade, Parkville,  
DEREK WYNNE ALLOM, care of The Shell Company of  
Australia Limited, 163 William-street, Melbourne,  
and  
ROBERT JOHN CUNNING, care of Ships Chandler Cor-  
poration Pty. Ltd., 44-60 Stokes-street, Port  
Melbourne,  
to be Commissioners for taking Declarations and Affidavits,  
pursuant to the provisions of the Evidence Act 1958,  
to resign upon ceasing to occupy their present positions.

*Justices of the Peace.*

JOHN FRANCIS SIMPSON, 36 Camp-street, Chelsea, and  
SAMUEL THICKINS, 101 Reynard-street, Coburg,  
to Keep the Peace in the State of Victoria.

PUBLIC WORKS DEPARTMENT.

*Wharf Manager.*

Senior Constable ERNEST ROBERT KERSHAW, No. 10061,  
to be Wharf Manager at Marlo, to carry out that portion of  
Part II. of the Marine Act 1958, which relates to the  
management of Public Wharfs, and to be an officer under  
section 19 of such Act to levy and collect wharfage rates  
thereat, vice Senior Constable Thomas Ross Holdsworth,  
No. 9181, transferred.

DEPARTMENT OF WATER SUPPLY.

*Sewerage Authority Members.*

ARTHUR DEXTER MASON  
to be a Member of the Anglesea Sewerage Authority to  
hold such position during the present term of office of  
Willis John Hunt as a Councillor of the Shire of Barrabool,  
subject to the provisions of the Sewerage Districts Act; and  
HARRY WESLEY IDDLES  
to be a Member of the Rochester Sewerage Authority, to  
hold such position from the date hereof until the 9th  
December, 1972, subject to the provisions of the Sewerage  
Districts Act.

*Waterworks Trust Commissioners.*

HERBERT CROMMELIN FITZROY, and  
RONALD JAMES McDONALD  
to be Commissioners of the Alexandra Waterworks Trust  
to hold such positions for a period of four years, from 28th  
November, 1969, subject to the provisions of the Water  
Act; and

RODNEY CHARLES PASCOE  
to be a Commissioner of the Cohuna Waterworks Trust  
to hold such position for the period from the date hereof  
until 4th August, 1973, subject to the provisions of the  
Water Act.

J. ROSSITER,  
Clerk of the Executive Council.

At the Executive Council Chamber,  
Melbourne, 25th November, 1969.

APPOINTMENT.

HIS Excellency the Governor of the State of Victoria,  
by and with the advice of the Executive Council  
thereof, has, by Order made on the 2nd day of Decem-  
ber, 1969, been pleased to make the under-mentioned  
appointment, viz.:—

LAW DEPARTMENT.

*Judge of the Supreme Court.*

WILLIAM CHARLES CROCKETT, LL.M., Q.C., a Barrister  
of the Supreme Court of the State of Victoria of  
not less than eight years standing,  
to be a Judge of the Supreme Court of the State of Vic-  
toria, pursuant to the provisions of section 7 of the  
Supreme Court Act 1958, to take effect from the 2nd  
December, 1969.

J. ROSSITER,  
Clerk of the Executive Council.

At the Executive Council Chamber,  
Melbourne, 2nd December, 1969.

*Liquor Control Act 1968.*

APPOINTMENT OF LICENSING INSPECTORS.

IN accordance with the authority conferred upon me by  
sub-section (1) of Section 22 of the Liquor Control Act 1968,  
I, Noel Wilby, Chief Commissioner of Police, hereby appoint  
the following Officers of Police as Licensing Inspectors for the  
Divisions of the Police Districts as shown :

Division Number.	Police District.	Rank and Name.
3	Melbourne ..	Inspector Arthur Hugh O'Meara (From 24th November, 1969, to 12th December, 1969)
2	Mallee ..	Inspector Thomas Weymouth Williams vice Inspector Currie
1	Wimmera ..	Superintendent Harry Parker vice Superintendent Payne

N. WILBY,  
Chief Commissioner of Police.

21st November, 1969.

*Liquor Control Act 1968.*

APPOINTMENT OF LICENSING INSPECTOR.

IN accordance with the authority conferred upon me by  
sub-section (1) of Section 22 of the Liquor Control Act 1968,  
I, Noel Wilby, Chief Commissioner of Police, hereby appoint  
the following Officer of Police as Licensing Inspector for the  
Division of the Police District as shown :

Division Number.	Police District.	Rank and Name.
3	Henty .. ..	Inspector Henry Robert Hutchins vice Inspector Kennedy

N. WILBY,  
Chief Commissioner of Police.

26th November, 1969.

GREEN'S LAKE RECREATIONAL AREA.

APPOINTMENT OF MEMBER TO MANAGEMENT COMMITTEE.

HIS Excellency the Governor of the State of Victoria by  
and with the advice of the Executive Council thereof  
doth by Order made on the 2nd day of December, 1969,  
appoint Barry John Speer of Corop to be a member of the  
Green's Lake Recreational Area Management Committee  
for a period of three years from the date hereof, in  
accordance with the provisions of the Water (Green's  
Lake Recreational Area) Regulations 1969 approved by the  
Governor in Council on 26th August, 1969.

J. ROSSITER,  
Clerk of the Executive Council.

At the Executive Council Chamber,  
Melbourne, 2nd December, 1969.



## FORESTS DEPARTMENT.

## APPOINTMENT OF COMMITTEE OF MANAGEMENT OF STATE SCHOOL FOREST PLANTATION—MELBOURNE HIGH SCHOOL.

WHEREAS by section 92 of the Forests Act 1958 (No. 6254) it is provided that the Minister of Forests may, on the recommendation of the Forests Commission, appoint a Committee of Management over any land forming part of any reserved forest, such land being set aside for the purpose of a State school forest plantation:

Now, therefore, I, Edward Raymond Meagher, Her Majesty's Minister of Forests in the State of Victoria, on the recommendation of the Forests Commission, do hereby appoint—

GLENN NUTTALL SMITH,  
REUBEN EDWARD THOMPSON,  
Dr. HAROLD ROBINSON,  
ALFRED JOHN KEAM, and  
JOHN CHARLES ELDEN

as members of the Committee of Management until 30th September, 1972, of the land forming part of the reserved forest in the Parish of Monbulk, County of Mornington, comprising 19 acres, more or less, as shown by brown colour on plan marked A over 62/947, file of correspondence No. 66/2337 in the Forests Department.

Dated at Melbourne the 24th day of November, 1969.

E. R. MEAGHER,  
Minister of Forests.

## RESIGNATIONS.

HIS Excellency the Governor of the State of Victoria, by and with the advice of the Executive Council thereof, has, by Orders made on the 25th day of November, 1969, accepted the resignations of the persons named hereunder of the offices mentioned, viz.:—

## LAW DEPARTMENT.

*Commissioners for Taking Declarations, &c.*

SIMON PEREGRINE DESBOROUGH,  
MERVYN WALTER BANNON,  
ALEXANDER OLD CORNE, and  
HARRY CARNIE

as Commissioners for Taking Declarations and Affidavits, pursuant to the provisions of the Evidence Act 1958.

*Justices of the Peace.*

LEOPOLD DAVIDSON,  
DAVY EDWARD WEDGE, and  
WILLIAM JAMES STRANG DONALD  
from the Commission of the Peace for the State of Victoria.

J. ROSSITER,  
Clerk of the Executive Council.

At the Executive Council Chamber,  
Melbourne, 25th November, 1969.

**ORDERS IN COUNCIL**

## DEPARTMENT OF CROWN LANDS AND SURVEY.

At the Executive Council Chamber, Melbourne, the twenty-fifth day of November, 1969.

## PRESENT:

His Excellency the Governor of Victoria.  
Mr. Chandler | Mr. Hamer.

## REVOCATION OF TEMPORARY RESERVATION OF LAND BY ORDER IN COUNCIL.

HIS Excellency the Governor of the State of Victoria, by and with the advice of the Executive Council thereof, doth hereby, in pursuance of the provisions of the

Land Act 1958, revoke the temporary reservation of land by Order in Council hereinafter referred to, viz.:—

PORTLAND.—Order in Council of 26th October, 1914, of 2 acres 1 rood of land in the Township of Portland, as a site for Municipal purposes.—(Rs.249.)

QUAMBATOOK.—Order in Council of 19th August, 1895, of 1 acre 2 roods 8 perches of land in the Township of Quambatook, as a site for Police purposes so far only as regards the portion thereof comprised within the boundaries published in the *Government Gazette* of 22nd October, 1969, and containing 1 rood 6 perches.—(Rs.2476.)

SANDHURST.—Order in Council of 4th April, 1918, of 1 rood of land in the Parish of Sandhurst, as a site for a Public Hall.—(Rs.1755.)

And the Honorable Sir William John Farquhar McDonald, Her Majesty's Minister of Lands for the State of Victoria, shall give the necessary directions herein accordingly.

J. ROSSITER,  
Clerk of the Executive Council.

## HOSPITALS AND CHARITIES ACT 1958.

## SECTION 52.

At the Executive Council Chamber, Melbourne, the twenty-fifth day of November, 1969.

## PRESENT:

His Excellency the Governor of Victoria.  
Mr. Chandler | Mr. Hamer.

## VARIATION OF THE OBJECTS OR PURPOSES OF THE VICTORIAN SOCIETY FOR THE PREVENTION OF CRUELTY TO CHILDREN.

WHEREAS The Victorian Society for the Prevention of Cruelty to Children is an incorporated benevolent society within the meaning of the *Hospitals and Charities Act 1958*:

And whereas the Committee of Management of the said benevolent society has agreed that the objects or purposes of the said benevolent society should be varied:

And whereas the Hospitals and Charities Commission after inquiring has recommended that the objects or purposes should be varied:

Now therefore His Excellency the Governor of the State of Victoria, by and with the advice of the Executive Council of the said State, and by virtue of the powers conferred on him by section 52 of the *Hospitals and Charities Act 1958*, and all other powers enabling him in that behalf, hereby varies the objects or purposes of The Victorian Society for the Prevention of Cruelty to Children by deleting the following object:—

“(e) to maintain a hostel for the care of neglected children”

and substituting therefor:—

“(e) to maintain hostels for the care of needy and/or neglected children”.

And the Honorable Vance Oakley Dickie, Her Majesty's Minister of Health for the State of Victoria, shall give the necessary directions herein accordingly.

J. ROSSITER,  
Clerk of the Executive Council.

## FORESTS ACT 1958.

At the Executive Council Chamber, Melbourne, the twenty-fifth day of November, 1969.

## PRESENT:

His Excellency the Governor of Victoria.  
Mr. Chandler | Mr. Hamer.

## EXCHANGE OF FOREST AREAS FOR CROWN LANDS.

IN pursuance of the provisions of section 49 of the *Forests Act 1958*, No. 6254, His Excellency the Governor of the State of Victoria, by and with the advice of the Executive Council, doth hereby order that the area of Reserved Forest situated in the Parishes of Kentbruck and Cobboboonee described in the Excision Schedule No. 168 and comprising 980 acres, more or less, be excised from the Forest Reserves and that the areas of unoccupied Crown Lands situated in the Parishes of Gunyah Gunyah and Noojee East, described in the Dedication Schedule No. 208 and comprising 1,097 acres, more or less, be dedicated as Reserved Forest in lieu thereof.

Such excisions and dedications to take effect on the fourteenth day after the publication of this order in the *Government Gazette*.

# EXCISION SCHEDULE N° 168

69/1897

C1004-16

## KENTBRUCK & COBBOBOONEE

County of Normanby  
0 20 40 60 80 100 120 140 160  
CHAINS

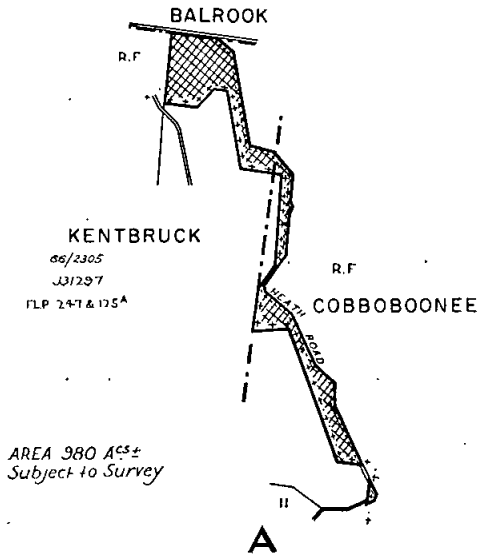

# DEDICATION SCHEDULE N° 208

## GUNYAH GUNYAH

County of Buln Buln  
0 20 40  
CHAINS

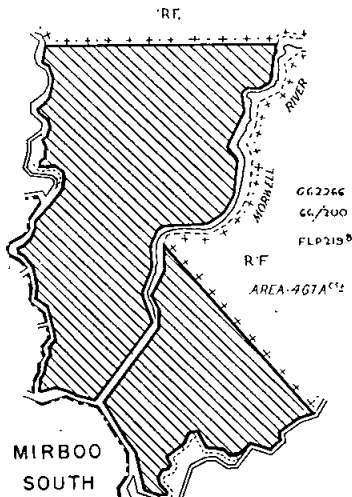

975

## NOOJEE EAST

County of Buln Buln  
0 20 40  
CHAINS

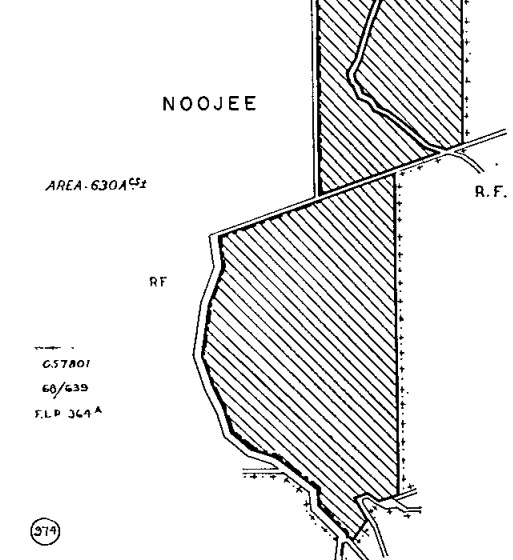

979

And the Honorable Edward Raymond Meagher, Her Majesty's Minister of Forests for the State of Victoria, shall give the necessary directions herein accordingly.

J. ROSSITER,  
Clerk of the Executive Council.

LAND ACT 1958.

At the Executive Council Chamber, Melbourne, the twenty-fifth day of November, 1969.

PRESENT:

His Excellency the Governor of Victoria.  
Mr. Chandler | Mr. Hamer.

UNUSED ROAD CLOSED.

IN pursuance of the provisions of section 349 of the Land Act 1958, His Excellency the Governor of the State of Victoria, by and with the advice of the Executive Council thereof and with the concurrence in writing of the Council of the City of Port Melbourne and the owners of the adjoining land doth hereby close the road referred to hereunder, viz.:-

City of Port Melbourne, Parish of Melbourne South, County of Bourke, being the road indicated by hatching on plan hereunder.—(M.334<sup>(10)</sup>) (G.69761).

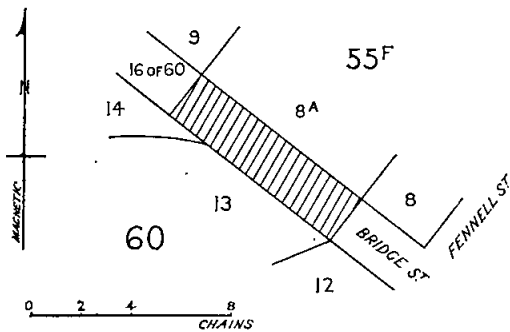

And the Honorable Sir William John Farquhar McDonald, Her Majesty's Minister of Lands for the State of Victoria, shall give the necessary directions herein accordingly.

J. ROSSITER,  
Clerk of the Executive Council.

LOCAL GOVERNMENT DEPARTMENT.

At the Executive Council Chamber, Melbourne, the twenty-fifth day of November, 1969.

PRESENT:

His Excellency the Governor of Victoria.  
Mr. Chandler | Mr. Hamer.

ROAD DISCONTINUED—CITY OF BRIGHTON.

WHEREAS it is provided in section 528 (2) of the Local Government Act, that where a road (whether or not a public highway but not being a road set out on land of the Crown) or any part thereof is not required for public use the Governor in Council on the request of the Council of the Municipality in which such road is situated made not less than one month after publishing in a newspaper generally circulating in the district and posting to the registered proprietor (if any) of the land and the owners and occupiers (if any) of the lands abutting or immediately adjacent to the road notice of intention to make such request may by Order published in the Government Gazette direct that such road or part shall be discontinued and thereupon such road or part shall be discontinued accordingly:

And whereas the Council of the City of Brighton has requested that the Governor in Council direct that a right-of-way, off Elwood-street, Brighton, be discontinued and not less than one month previously has published in a newspaper generally circulating in the district and posted to the registered proprietor of the land in the road and to the owners and occupiers of lands abutting or immediately adjacent to the road notice of intention to make such request:

Now therefore, His Excellency the Governor of the State of Victoria, by and with the advice of the Executive Council, thereof, hereby directs that the portion of the said road, which is shown hatched on the plan hereunder, shall be discontinued and that the land may be sold by the Council of the City of Brighton by agreement.

*Measurements are in feet and inches*

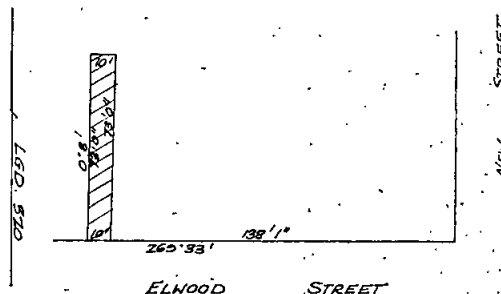

*The fee of the land shown hatched hereon was contained in Certificate of Title*

*Vol. 4501 Fol. 181 on 31.10.1963*

And the Honorable Rupert James Hamer, Her Majesty's Minister for Local Government for the State of Victoria, shall give the necessary directions herein accordingly.

J. ROSSITER,  
Clerk of the Executive Council.

LOCAL GOVERNMENT DEPARTMENT.

At the Executive Council Chamber, Melbourne, the twenty-fifth day of November, 1969.

PRESENT:

His Excellency the Governor of Victoria.  
Mr. Chandler | Mr. Hamer.

EXTENSION OF VALUATION—SHIRE OF YARRAWONGA.

WHEREAS it is provided by section 256A of the Local Government Act 1958, that where on the application of the Council the Minister is satisfied that it is not reasonably practicable for the Council to extend by special order pursuant to section 256 the period of use of the last valuation he may recommend to the Governor in Council that the said period be extended for such period as the Minister thinks fit not exceeding one year from the date of the expiration of the last valuation or any extension thereof pursuant to section 256 and the Governor in Council may approve such extension:

And whereas a general valuation of all rateable property in the Shire of Yarrawonga was due to be returned in 1969 and the Council of the said Shire has applied for an extension of the use of the existing valuation and the Minister is satisfied that it is not reasonably practicable for the Council to extend by special order pursuant to section 256 the period of use of the last valuation:

Now therefore, His Excellency the Governor of the State of Victoria, by and with the advice of the Executive Council thereof, doth by this Order extend the period of use of the last valuation for the Shire of Yarrawonga until the 30th September, 1970.

And the Honorable Rupert James Hamer, Her Majesty's Minister for Local Government for the State of Victoria, shall give the necessary directions herein accordingly.

J. ROSSITER,  
Clerk of the Executive Council.

LOCAL GOVERNMENT DEPARTMENT.

At the Executive Council Chamber, Melbourne, the  
twenty-fifth day of November, 1969.

PRESENT:

His Excellency the Governor of Victoria.  
Mr. Chandler | Mr. Hamer.

ROAD DISCONTINUED—CITY OF SPRINGVALE.

WHEREAS it is provided in section 528 (2) of the Local Government Act 1958, that where a road (whether or not a public highway but not being a road set out on land of the Crown) or any part thereof is not required for public use, the Governor in Council on the request of the municipality in which such road is situated made not less than one month previously after publishing in a newspaper generally circulating in the district and posting to the registered proprietor (if any) of the land and the owners and occupiers (if any) of lands abutting or immediately adjacent to the road notice of intention to make such a request, may by Order published in the Government Gazette direct that such road or part shall be discontinued and thereupon such road or part shall be discontinued accordingly:

And whereas the Council of the City of Springvale has requested that Methylene-avenue, Springvale, be discontinued and not less than one month previously has published in a newspaper generally circulating in the district and posted to the registered proprietor of the land in the road and to the owners and occupiers of lands abutting or immediately adjacent to the said road notice of intention to make such request:

Now therefore, His Excellency the Governor of the State of Victoria, by and with the advice of the Executive Council thereof, hereby directs—

- (a) that the said road which is shown by hachure and cross-hachure on the plan hereunder, shall be discontinued;
- (b) that notwithstanding such discontinuance the State Electricity Commission of Victoria shall continue to have and possess the same right title power authority or interest in or in relation to the land shown by cross-hachure on the said plan as it had or possessed prior to such discontinuance with respect to or in connexion with any wires or cables laid or erected in on or over such lands for the purposes of the supply of electricity; and
- (c) that, subject to any such right title power authority or interest the land in the said road may be sold by the Council of the City of Springvale by agreement.

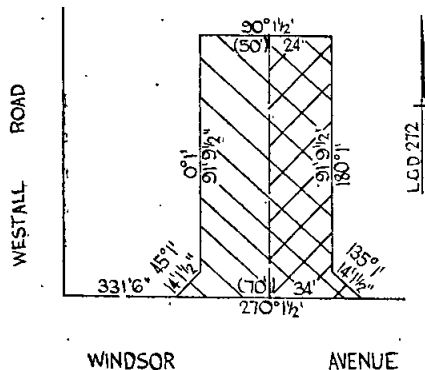

The land shown hatched and crosshatched was on the 29-10-1969 contained in C/T 6304-611.

And the Honorable Rupert James Hamer, Her Majesty's Minister for Local Government for the State of Victoria, shall give the necessary directions herein accordingly.

J. ROSSITER,  
Clerk of the Executive Council.

LOCAL GOVERNMENT DEPARTMENT.

At the Executive Council Chamber, Melbourne, the  
twenty-fifth day of November, 1969.

PRESENT:

His Excellency the Governor of Victoria.  
Mr. Chandler | Mr. Hamer.

ALTERATION OF TIME FOR CLOSING POLL AT MUNICIPAL ELECTIONS—SHIRE OF BROADFORD.

HIS Excellency the Governor of the State of Victoria, by and with the advice of the Executive Council thereof, in pursuance of the powers conferred by section 134 of the Local Government Act 1958, and in compliance with the prayer of a petition presented by the Council of the Shire of Broadford hereby declares that the hour for closing the poll at municipal elections for the said Shire shall be six o'clock in the afternoon.

And the Honorable Rupert James Hamer, Her Majesty's Minister for Local Government for the State of Victoria, shall give the necessary directions herein accordingly.

J. ROSSITER,  
Clerk of the Executive Council.

LOCAL GOVERNMENT DEPARTMENT.

At the Executive Council Chamber, Melbourne, the  
twenty-fifth day of November, 1969.

PRESENT:

His Excellency the Governor of Victoria.  
Mr. Chandler | Mr. Hamer.

FIXATION AND DECLARATION OF BREADTHS OF A FOOTWAY—CITY OF WARRNAMBOOL.

IN pursuance of the provisions of section 520 of the Local Government Act 1958, His Excellency the Governor of the State of Victoria, by and with the advice of the Executive Council thereof, and in compliance with a request of the Council of the City of Warrnambool, hereby fixes and declares the breadth of the southern footway of Evans and Dickson streets, Warrnambool, shown on the plan hereunder, in the manner indicated on the said plan:

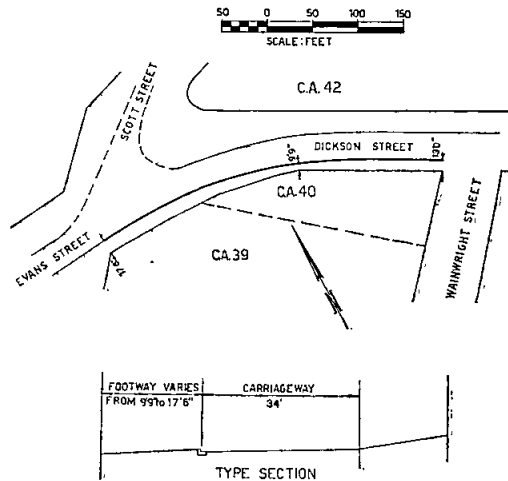

And the Honorable Rupert James Hamer, Her Majesty's Minister for Local Government for the State of Victoria, shall give the necessary directions herein accordingly.

J. ROSSITER,  
Clerk of the Executive Council.

LOCAL GOVERNMENT DEPARTMENT.

At the Executive Council Chamber, Melbourne, the twenty-fifth day of November, 1969.

PRESENT:

His Excellency the Governor of Victoria.  
Mr. Chandler | Mr. Hamer.

EXTENSION OF VALUATION—SHIRE OF KARKAROOC.

WHEREAS it is provided by section 256A of the Local Government Act 1958, that where on the application of a Council the Minister is satisfied that it is not reasonably practicable for the Council to extend by special order pursuant to section 256 the period of use of the last valuation he may recommend to the Governor in Council that the said period be extended for such period as the Minister thinks fit not exceeding one year from the date of the expiration of the last valuation or any extension thereof pursuant to section 256 and the Governor in Council may approve such extension:

And whereas a general valuation of all rateable property in the Shire of Karkaroc was due to be returned in 1969 and the Council of the said Shire has applied for an extension of the use of the existing valuation and the Minister is satisfied that it is not reasonably practicable for the Council to extend by special order pursuant to section 256 the period of use of the last valuation:

Now therefore His Excellency the Governor of the State of Victoria, by and with the advice of the Executive Council thereof, doth by this Order extend the period of use of the last valuation for the Shire of Karkaroc until the 30th September, 1970.

And the Honorable Rupert James Hamer, Her Majesty's Minister for Local Government for the State of Victoria, shall give the necessary directions herein accordingly.

J. ROSSITER,  
Clerk of the Executive Council.

LOCAL GOVERNMENT DEPARTMENT.

At the Executive Council Chamber, Melbourne, the twenty-fifth day of November, 1969.

PRESENT:

His Excellency the Governor of Victoria.  
Mr. Chandler | Mr. Hamer.

ROAD DISCONTINUED—CITY OF SOUTH MELBOURNE.

WHEREAS it is provided in section 528 (2) of the Local Government Act 1958, that where a road (whether or not a public highway but not being a road set out on land of the Crown) or any part thereof is not required for public use, the Governor in Council, on the request of the Council of the Municipality in which such road is situated made not less than one month after publishing in a newspaper generally circulating in the district and posting to the registered proprietor (if any) of the land and the owners and occupiers (if any) of lands abutting or immediately adjacent to the road notice of intention to make such a request may by Order published in the Government Gazette direct that such road or part shall be discontinued and thereupon such road or part shall be discontinued accordingly:

And whereas the Council of the City of South Melbourne has requested that the Governor in Council direct that Gabo-place, off Clarendon-street, South Melbourne, be discontinued and not less than one month previously has published in a newspaper generally circulating in the district and posted to the registered proprietor of the land in the road and to the owners and occupiers of lands abutting or immediately adjacent to the road notice of intention to make such request:

Now therefore, His Excellency the Governor of the State of Victoria, by and with the advice of the Executive Council thereof, hereby directs that the said road, which is shown hatched on the plan hereunder, shall be discontinued and that the land may be sold by the Council of the City of South Melbourne by agreement.

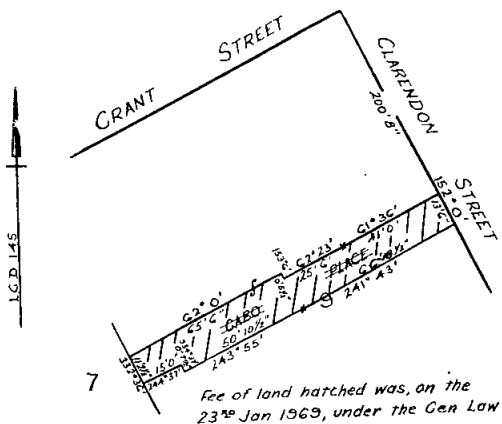

THE MEASUREMENTS ARE IN feet & inches

And the Honorable Rupert James Hamer, Her Majesty's Minister for Local Government for the State of Victoria, shall give the necessary directions herein accordingly.

J. ROSSITER,  
Clerk of the Executive Council.

LOCAL GOVERNMENT DEPARTMENT.

At the Executive Council Chamber, Melbourne, the twenty-fifth day of November, 1969.

PRESENT:

His Excellency the Governor of Victoria.  
Mr. Chandler | Mr. Hamer.

ROAD DISCONTINUED—CITY OF BRIGHTON.

WHEREAS it is provided in section 528 (2) of the Local Government Act 1958, that where a road (whether or not a public highway but not being a road set out on land of the Crown) or any part thereof is not required for public use the Governor in Council on the request of the Council of the municipality in which such road is situated made not less than one month after publishing in a newspaper generally circulating in the district and posting to the registered proprietor (if any) of the land and the owners and occupiers (if any) of the lands abutting or immediately adjacent to the road notice of intention to make such request may by Order published in the Government Gazette direct that such road or part shall be discontinued and thereupon such road or part shall be discontinued accordingly:

And whereas the Council of the City of Brighton has requested that the Governor in Council direct that portion of a right-of-way, off Wallace-grove, Brighton, be discontinued and not less than one month previously has published in a newspaper generally circulating in the district and posted to the registered proprietor of the land in the said road and to the owners and occupiers of lands abutting or immediately adjacent to the road notice of intention to make such request:

Now therefore, His Excellency the Governor of the State of Victoria, by and with the advice of the Executive Council thereof, hereby directs—

- (a) that the said road, which is shown by hachure and cross-hachure on the plan hereunder, shall be discontinued;
- (b) that notwithstanding such discontinuance the Melbourne and Metropolitan Board of Works shall continue to have and possess the same right title power authority or interest in or in relation to the whole of the land shown by cross-hachure on the said plan as it had or possessed prior to such discontinuance with respect to or in connexion with any drains or pipes laid or erected in on or over such land for the purposes of drainage or sewerage; and
- (c) that, subject to any such right title power authority or interest, the land in the said road may be sold by the Council of the City of Brighton by agreement.

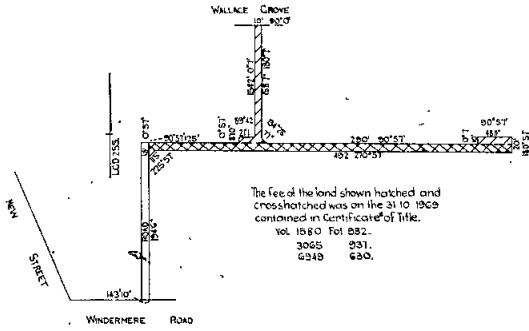

And the Honorable Rupert James Hamer, Her Majesty's Minister for Local Government for the State of Victoria, shall give the necessary directions herein accordingly.

J. ROSSITER,  
Clerk of the Executive Council.

COUNTRY ROADS BOARD.

At the Executive Council Chamber, Melbourne, the twenty-fifth day of November, 1969.

PRESENT:

His Excellency the Governor of Victoria.  
Mr. Chandler | Mr. Hamer.

ORDER APPROVING OF LAND BEING ACQUIRED AND ROADS DEVIATIONS OR WIDENINGS BEING MADE.

HIS Excellency the Governor of the State of Victoria, by and with the advice of the Executive Council thereof, being satisfied that there are funds legally available for acquiring the land, doth hereby approve the acquiring of the land described in the schedule hereunder and the making of new roads and deviations from and widenings of existing roads referred to in the said schedule.

SCHEDULE.

State Highway.

The land shown hatched on Plans numbered G.P.11862, G.P.11863, and G.P.11864 hereunder required for the widening of the Midland Highway in the Shire of Alberton and making of the widening thereon.

STATE HIGHWAY  
MIDLAND HIGHWAY  
SHIRE OF ALBERTON

Measurements in links

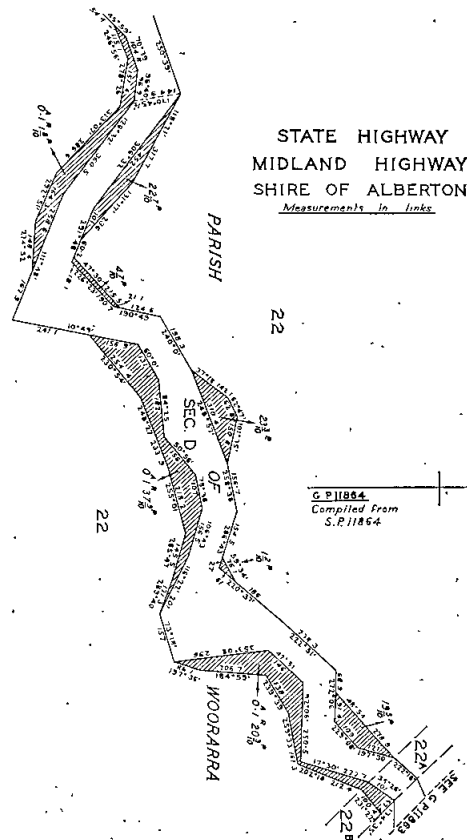
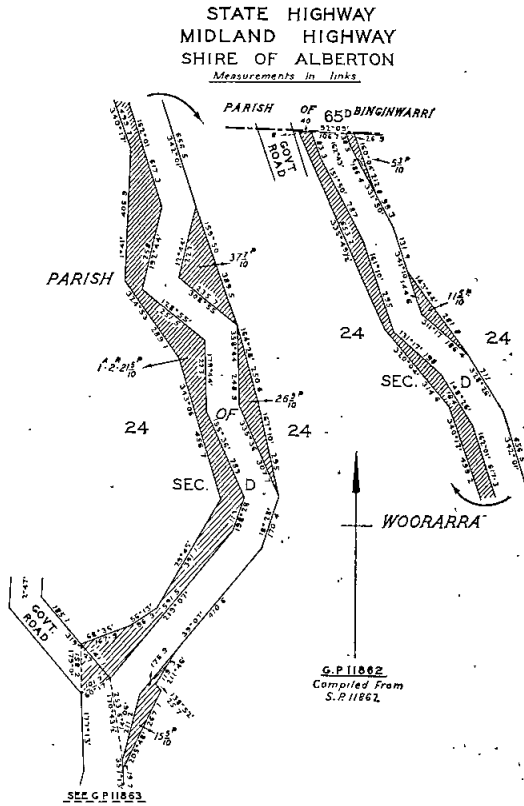
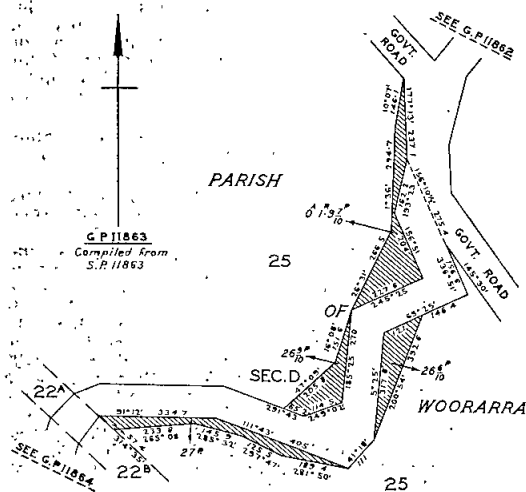

**Main Roads.**

The land shown hatched on Plan numbered G.P.11843 hereunder required for the deviation from the Natimuk-Hamilton road in the Shire of Dundas and making of the deviation thereon.

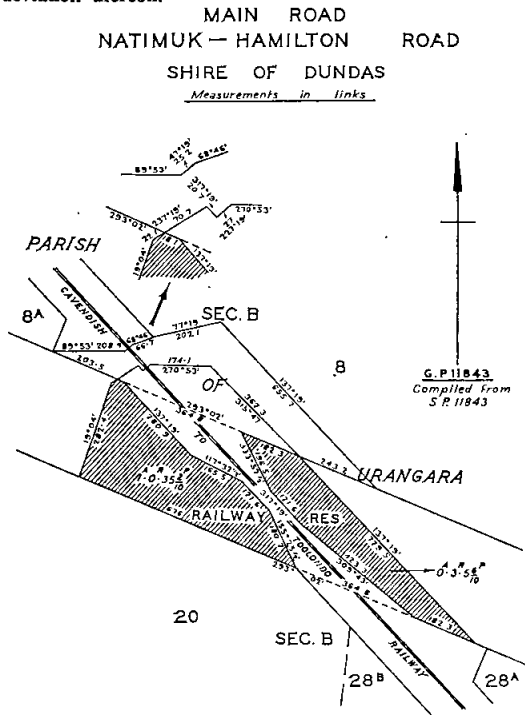

The land shown hatched on Plan numbered G.P.11844 hereunder required for the deviation from the Dunkeld-Cavendish road in the Shire of Dundas and making of the deviation thereon.

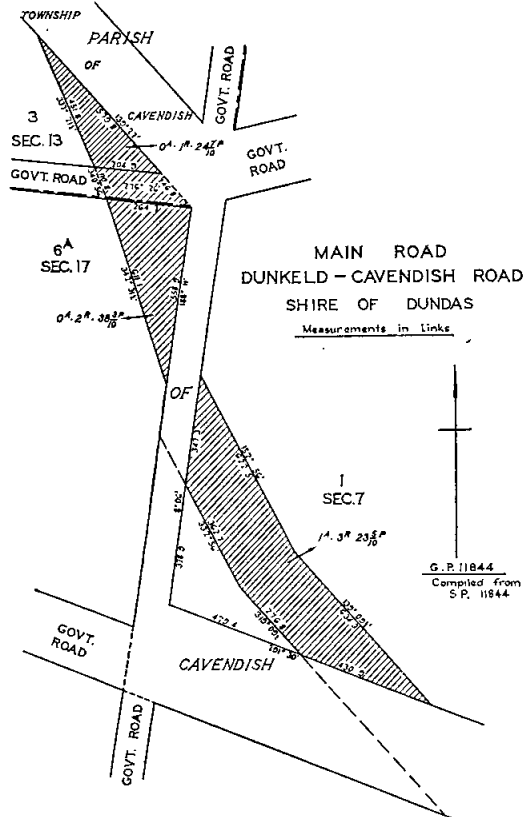

The land shown hatched on Plan numbered G.P.11937 hereunder required for the widening of the Eltham-Yarra Glen road in the Shire of Eltham and making of the widening thereon.

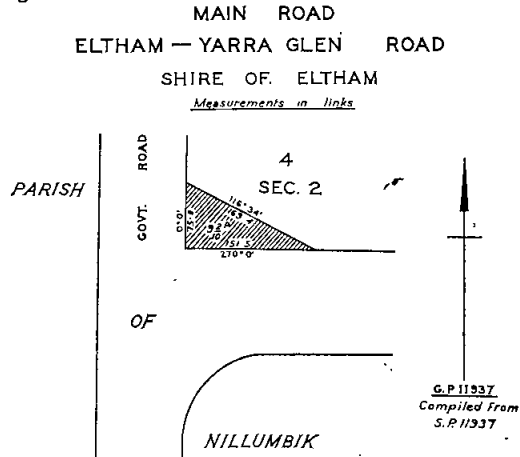

And the Honorable Murray Victor Porter, Her Majesty's Minister of Public Works for the State of Victoria, shall give the necessary directions herein accordingly.

J. ROSSITER,  
Clerk of the Executive Council.

HOUSING ACT 1958.

At the Executive Council Chamber, Melbourne, the  
second day of December, 1969.

PRESENT:

His Excellency the Governor of Victoria.  
Mr. Reid | Mr. Hamer.

**DECLARATION OF PRIVATE STREETS AS PUBLIC HIGHWAYS WITHIN THE TOWN OF PORTLAND.**

WHEREAS pursuant to section 107 of the Housing Act 1958 it is among other things enacted that where works have been carried out in accordance with an agreement for the full construction of any roads, pavements, culverts or drains made pursuant to the provisions of the said section 107 such roads, pavements, culverts or drains shall be under the care and management of the Municipality which shall be liable for the cost of any maintenance, repair, alteration or reconstruction thereof and the Governor in Council may by order published in the *Government Gazette* declare any road so constructed to be a public highway.

And whereas by Orders dated the twentieth day of February, 1968, and the twenty-third day of April, 1968, the Governor in Council consented to agreements between the Housing Commission and the Town of Portland regarding street and drainage construction in Wattle-crescent, Service-road—Orana-drive, Hakea-court, Kauri-crescent, Banyan-crescent and Road Widening—Shopping Centre Corner Wattle-crescent and Cape Nelson-road, in the Portland (Hunt's Land) Estate situate in the municipality of the Town of Portland and the carrying out of the works enumerated in the said Agreement.

And whereas the works of road pavements, culvert and drainage construction have now been carried out in accordance with the said agreements between the Housing Commission and the Town of Portland.

Now therefore His Excellency the Governor of the State of Victoria by and with the advice of the Executive Council of the said State and in pursuance of the powers conferred by section 107 of the Housing Act and upon recommendation of the Housing Commission doth by this order declare the streets more particularly delineated and shown hatched on the plan hereunder to be absolutely dedicated to the public as Public Highways, within the meaning of any law now or hereafter in force and that the Council of the Municipality in which the streets are situate shall hereafter be liable for all cost of any maintenance, repair, alteration or reconstruction thereof.

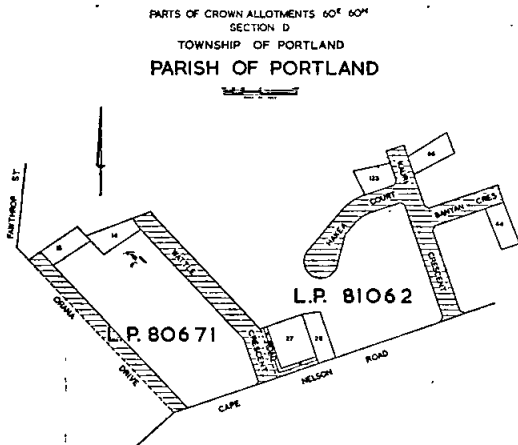

And the Honorable Edward Raymond Meagher, Her Majesty's Minister of Housing for the State of Victoria, shall give the necessary directions herein accordingly.

J. ROSSITER,  
Clerk of the Executive Council.

#### MOTOR CAR ACT 1958.

*At the Executive Council Chamber, Melbourne, the  
second day of December, 1969.*

PRESENT:

His Excellency the Governor of Victoria.  
Mr. Reid | Mr. Hamer.

#### MOTOR CAR TRIALS OF SPEED WITHIN THE SHIRE OF KERANG.

WHEREAS it is enacted by sub-section (2) of section eighty-three of the Motor Car Act 1958 that, if a motor car is used on a highway for purposes of racing or of trial of speed, the driver or the person in charge thereof shall be liable to a penalty of not more than One hundred dollars, provided that the said sub-section (2) shall not apply to a motor car used as aforesaid on any highway or portion thereof specified by Order in Council published in the *Government Gazette* and on such days and during such hours as are specified in the Order:

And whereas the Kerang Urban Fire Brigade has requested that such an Order be made to enable motor car trials of speed to be conducted by the said Club on the Boort-Kerang Road on Sunday, the fourteenth day of December, 1969:

Now therefore His Excellency the Governor of the State of Victoria, by and with the advice of the Executive Council thereof, and in pursuance of the powers conferred by the Motor Car Act 1958, doth by this Order specify that portion of the Boort-Kerang Road, between 6.5 miles and 7.5 miles from the Kerang Post Office as a highway in respect of which any motor car may, without being subject to the application of the said sub-section (2) of section 83 of the Motor Car Act, be used for purposes of trials of speed under the control of the said Kerang Urban Fire Brigade on Sunday, the fourteenth day of December, 1969, between the hours of nine o'clock in the forenoon and five o'clock in the afternoon provided that the Officer in Charge of Police in attendance is satisfied that the highway is in a satisfactory condition for racing purposes and that adequate arrangements have been made for the safety of the public.

And the Honorable Sir Arthur Gordon Rylah, Her Majesty's Chief Secretary for the State of Victoria, shall give the necessary directions herein accordingly.

J. ROSSITER,  
Clerk of the Executive Council.

#### THE CONSTITUTION ACT AMENDMENT ACT 1958.

*At the Executive Council Chamber, Melbourne, the  
second day of December, 1969.*

PRESENT:

His Excellency the Governor of Victoria.  
Mr. Reid | Mr. Hamer.

WHEREAS in consequence of a Writ issued pursuant to the provisions of *The Constitution Act Amendment Act 1958* a poll for the election of a Member for the Electoral District of Dandenong will be held on the 6th December, 1969;

And whereas the Chief Electoral Officer has certified in writing that it is necessary that a polling place be appointed within the City of Melbourne to be a polling place for the Dandenong Subdivision of the aforementioned District;

Now therefore, His Excellency the Governor of the State of Victoria by and with the advice of the Executive Council thereof and in pursuance of the provisions of sub-section 4 of section 148 of *The Constitution Act Amendment Act 1958* and all other powers him thereunto enabling doth hereby appoint Spring-street within the City of Melbourne to be a polling place for the Dandenong Subdivision of the Electoral District of Dandenong at the election to be held on the 6th day of December, 1969.

And the Honorable Sir Arthur Gordon Rylah, Her Majesty's Chief Secretary for the State of Victoria, shall give the necessary directions herein accordingly.

J. ROSSITER,  
Clerk of the Executive Council.

#### LANDS DEPARTMENT NOTICES

##### APPROACHING LAND SALES.

SALES of Crown Lands, in fee-simple, will be held at the under-mentioned places and dates, viz.:-

	No. of Gazette.
Bendigo.—Thursday, 18th December, 1969 ..	103
Daylesford.—Tuesday, 9th December, 1969 ..	99
Horsham.—Monday, 22nd December, 1969 ..	104
Inglewood.—Thursday, 15th January, 1969 ..	104
Sea Lake.—Thursday, 15th January, 1969 ..	104
Wangaratta.—Thursday, 18th December, 1969 ..	103

##### SALE OF FREEHOLD LAND BY AUCTION.

Melbourne.—Monday, 15th December, 1969 .. 99

##### AUCTION OF RIGHT TO LEASE CROWN LAND.

Melbourne.—Monday, 15th December, 1969 .. 99

##### LOCAL LAND BOARDS.

IN pursuance of the provisions of section 34 of the *Land Act 1958*, notice is hereby given that public hearings at the following places and times, will be conducted by the persons respectively mentioned, being duly appointed in that behalf.

W. J. F. McDONALD,  
Minister of Lands.

Department of Crown Lands and Survey,  
Melbourne.

##### SCHEDULE.

HAMILTON, LAND OFFICE, on Wednesday, 17th December, 1969, at 10.30 a.m.—E. M. Floyd and K. C. Gittins.  
CASTERTON, GLENELG SHIRE OFFICES, on Wednesday, 17th December, 1969, at 1 p.m.—E. M. Floyd and K. C. Gittins.  
EDENHOPE, KOWREE SHIRE OFFICES, on Thursday, 18th December, 1969, at 10 a.m.—E. M. Floyd and K. C. Gittins.



**PROPOSED REVOCATIONS OF TEMPORARY RESERVATIONS OF LANDS BY ORDERS IN COUNCIL.**

IN pursuance of the provisions of the *Land Act 1958*, notice is hereby given that it is the intention of the Governor in Council to revoke the temporary reservations of lands by Orders in Council hereunder referred to, viz.:—

The following Notices were published 1° on the 12th November, 1969, pursuant to Orders of the 5th November, 1969.

**TALLYGAROPNA.**—The temporary reservation as a site for Watering purposes and the withholding from sale, leasing and licensing by Order in Council of the 8th May, 1876 (see *Government Gazette* 12th May 1876, page 894), of 39 acres of land in the Parish of Tallygaroopna, revoked as to part by order of the 6th September, 1966 are about to be revoked so far as the balance containing 7 acres 2 roods more or less is concerned.—(T.234<sup>(3)</sup>) (C.99924).

**TIMBOON.**—The temporary reservation, by Order in Council of the 30th September, 1889, of 125 acres, more or less, of land in the Parish of Timboon as a site for Public purposes, revoked as to part by various Orders, is about to be revoked so far only as the balance containing 20 acres 10 perches, more or less, is concerned.—(T.182<sup>(10)</sup>) (Rs.2617).

W. J. F. McDONALD,  
Minister of Lands.

**PROPOSED REVOCATION OF TEMPORARY RESERVATION OF LAND BY ORDER IN COUNCIL.**

IN pursuance of the provisions of the *Land Act 1958*, notice is hereby given that it is the intention of the Governor in Council to revoke the temporary reservation of land by Order in Council hereunder referred to, viz.:—

The following Notices were published 1° on the 3rd December, 1969, pursuant to Orders of the 25th November, 1969.

**CARPENDAIT.**—The temporary reservation by Order in Council of the 4th November, 1889, of 134 acres 2 roods 16 perches of land in the Parish of Carpendait, as a site for Watering purposes, is about to be revoked.—(C.386<sup>(3)</sup>) (G.72966.)

W. J. F. McDONALD,  
Minister of Lands.

**COMMONS ABOUT TO BE DIMINISHED.**

IN pursuance of the provisions contained in the *Land Act 1958*, notice is hereby given that it is the intention of the Governor in Council to diminish the commons hereinafter mentioned, viz.:—

The following Notices were published 1° on the 5th November, 1969, pursuant to Orders of the 28th October, 1969.

The Amherst United Town and Gold Field Common, now designated the Amherst United Borough and Gold Field Common, proclaimed as such on the 17th October, 1862, the 13th November, 1862, and the 10th November, 1863, is about to be diminished by the excision therefrom of the portions containing 81 acres 1 rood 8 perches, more or less, indicated by hatching on plan hereunder.—(Rs.35.)

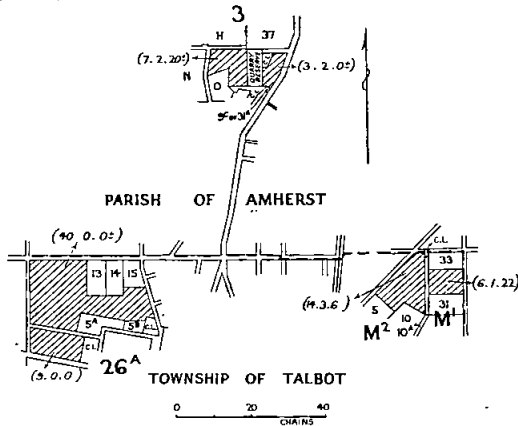

Total Area of Hatched Portions:—81.1.8<sup>2</sup>

The Ballarat West Town Common, proclaimed as such by the Governor in Council on the 28th January, 1861 (see *Government Gazette*, 6th February, 1861, page 256) is about to be diminished by the excision therefrom of allotments 21A and 21B, section 4, Parish of Dowling Forest and containing 13 acres 2 roods 13 perches.—(C.91998.)

The Maldon Shire Common, proclaimed as such by the Governor in Council on the 2nd April, 1889, and altered by Order in Council of the 23rd April, 1912, is about to be diminished by the excision therefrom of the portion in the Township of Maldon containing 3 roods 28 perches, indicated by hatching on plan hereunder.—(Rs.353.)

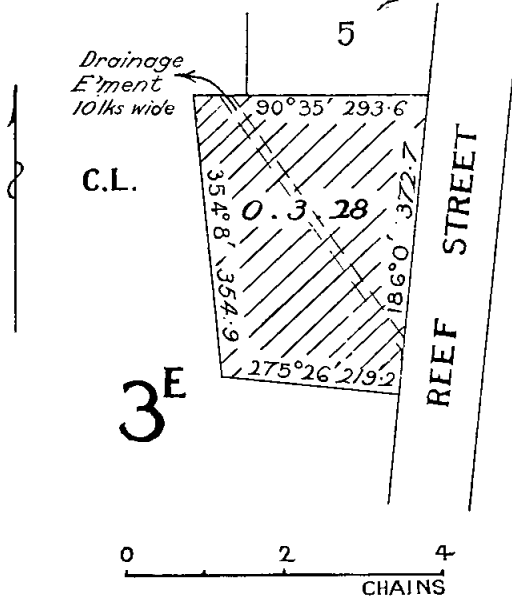

The Maldon Shire Common, proclaimed as such by the Governor in Council on the 2nd April, 1889, and altered by Order in Council of the 23rd April, 1912, is about to be diminished by the excision therefrom of the portion in the Parish of Maldon containing 1 acre 1 rood 38 perches, indicated by hatching on plan hereunder.—(Rs.353.)

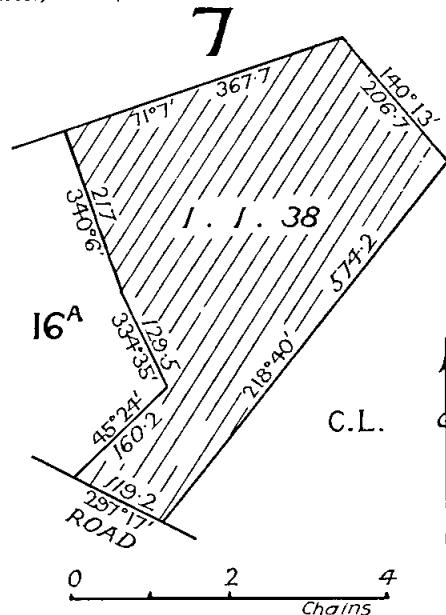

W. J. F. McDONALD,  
Minister of Lands.

**PROPOSED REVOCATIONS OF TEMPORARY RESERVATIONS OF LANDS BY ORDERS IN COUNCIL.**

IN pursuance of the provisions of the *Land Act 1958*, notice is hereby given that it is the intention of the Governor in Council to revoke the temporary reservations of lands by Orders in Council hereunder referred to, viz.:

The following Notices were published 1° on the 26th November, 1969, pursuant to Orders of the 18th November, 1969.

**NEWBRIDGE.**—The temporary reservation by Order in Council of the 2nd April, 1906 (see *Government Gazette*, 11th April, 1906, page 1776) of 24 acres 3 roods 38 perches of land in the Township of Newbridge as a site for Water Supply is about to be revoked.—(N.56(1) (W.86527).

**SANDHURST, AT BENDIGO.**—The temporary reservation by Order in Council of the 26th July, 1949, of 5 acres 2 roods of land in the Parish of Sandhurst, at Bendigo, as a site for Public Recreation is about to be revoked.—(S.372(123) (Rs.6386).

**OMEQ.**—The temporary reservation, by Order in Council of the 4th November, 1889, of certain Crown land situate within a distance of 3 chains from the banks of the Livingstone Creek for the supply of gravel and sand,

is about to be revoked as to part by various Orders, is about to be revoked so far only as the portion in the Township of Omeo containing 2 acres 25 perches, more or less, indicated by hatching on plan hereunder, is concerned.—(O.19(9) (C.86890).

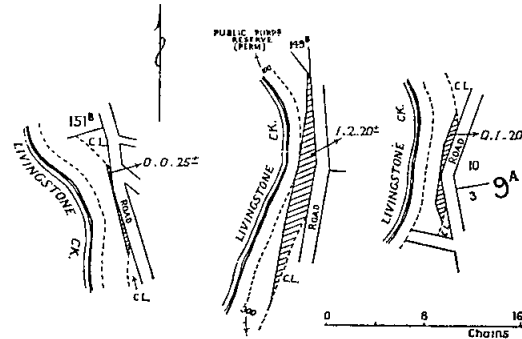

TOTAL AREA OF HATCHED PORTIONS: 2.0.252

W. J. F. McDONALD,  
Minister of Lands.

*Land Act 1958.*

**LICENCE UNDER THE LAND ACT DECLARED VOID.**

NOTICE is hereby given that the licence in the Schedule hereunder has been Declared Void for the reason specified.

District.	Corr. No.	Name of Licensee.	Section of Land Act 1958 under which Licensed.	Parish.	Allotment.	Section.	Area.	Annual Rental.	Reason for Voiding.
Northern	01038/138	Estate of Walter A. Beevers	138	Sandhurst (at Eaglehawk)	286	M	A. R. P. 0 1 0	\$ 3.00	Non-compliance with conditions

Department of Crown Lands and Survey,  
Melbourne, 27th November, 1969.

W. J. F. McDONALD,  
Minister of Lands.

**TENDERS**

**PUBLIC WORKS DEPARTMENT**

TENDERS will be received at Public Works Department, 2 Treasury-place, Melbourne, until TWO p.m. on dates shown and for purposes mentioned hereunder.

Particulars and tender forms available at Contracts Office, Room 7, Building Division, Parliament-place and at places indicated in brackets hereunder.

Abbreviations in brackets mean:—W.O.—Inspector of Works Office; P.S.—Police Station; C.S.—Consolidated School; H.E.S.—Higher Elementary School; H.S.—High School; S.S.—State School; T.S.—Technical School.

Tenders to be submitted on the Department's printed Tender Form and will not be received by telephone. All tenders must be on a "Firm Tender" basis. The lowest or any tender will not necessarily be accepted.

Address tenders to the Minister of Public Works, and endorse the envelope containing the tender "Tender for closing Tuesday,"

Hand delivered tenders to be placed in the Tender Box of the Public Works Department, located on the wall of the centre entrance foyer, Ground Floor, 2 Treasury-place, Melbourne.

No preliminary deposit is required with any tender, but a successful tenderer will be required to pay a deposit for any accepted tender of \$4,000 or over.

**Tuesday, 9th December, 1969.**

**Building, Electrical and Mechanical Works.**

Doveton.—Erection of L.T.C. Science extensions, Technical School.

Doveton.—Mechanical services, Technical School.

Fawkner.—Erection of L.T.C. Science extensions, Technical School.

Fawkner.—Mechanical services, Technical School.

Frankston.—Mechanical services, High School.

Geelong East.—Erection of L.T.C. Science extensions, Technical School (W.O. Geelong.)

Geelong East.—Mechanical services, Technical School. (W.O. Geelong.)

Oakleigh.—Erection of new glasshouse, potting shed and security fencing, Technical School.

Strathmore.—Erection of standard school hall type "572C", High School.

Strathmore.—Electrical installation, High School.

Strathmore.—Mechanical services, High School.

Tower Hill.—Erection of office and toilet building, State Game Reserve. (W.O. Warrnambool.)

Tower Hill.—Water supply pump and water softening plant, State Game Reserve. (W.O. Hamilton and Warrnambool.)

**Site Works.**

Puckapunyal.—Concrete, drainage and earthworks, &c., S.S. 1855. (W.O. Shepparton: S.S. Puckapunyal.)

**Miscellaneous.**

Williamstown.—Construction of a 50-ft. single screw fisheries research vessel, Ports and Harbours Dredging Depot. (Dredging Depot.)

**Tuesday, 16th December, 1969.**

**Building, Electrical and Mechanical Works.**

Broadmeadows.—Erection of brick incinerator, "Attwood" Veterinary Laboratory.

Broadmeadows.—Electrical installation, "Attwood" Veterinary Laboratory.

Broadmeadows.—Refrigeration system for cool room, "Attwood" Veterinary Laboratory.

Colac.—Demolition of existing Court House and erection of new Court House, stage 2. (W.O., Geelong.)

Colac.—Electrical installation, Court House. (W.O., Camperdown and Geelong.)

Colac.—Mechanical services, Court House. (W.O., Ballarat and Geelong.)  
 Lallat Plains.—Removal of building from Ashens S.S. 1761 to Lallat Plains, repairs and external painting, S.S.1686. (W.O., Warracknabeal.) (Re-advertised.)  
 Noble Park.—Erection of a standard school hall type "800C", High School.  
 Noble Park.—Electrical installation, High School.  
 Noble Park.—Mechanical services, High School.  
 Point Lonsdale.—New Timber Toilet Block and Covered Way, S.S. 3322. (W.O., Geelong.)  
 Royal Park.—External painting and repairs of Pre-fabricated Aluminium Building and L.T.C. Building, Mental Hospital. (Amended Specification.)  
 Tottenham North.—Renovations to Junior and Senior toilet blocks, S.S.4703.  
 Werribee.—Renovations to Residences Nos. 2, 15, 17, 22, 27, 26, 3—State Research Farm.

**Furniture and Furnishings.**

Box Hill.—Supply of 190 items of school furniture, Girls' Technical School.

**Site Works.**

Benalla.—Concrete, drainage and gravel works, &c., High School. (W.O., Benalla and Wangaratta.)  
 Corryong.—Concrete, drainage, earthworks and gravel works, &c., High School, Consolidated School, and Residences. (W.O., Shepparton and Wangaratta; High School, Corryong.)

Various.—Asphalt repairs and re-surfacing, High Schools Rutherglen, Beechworth, Tallangatta and Wodonga. (W.O., Wangaratta.)

**Tuesday, 23rd December, 1969.**

**Miscellaneous.**

Hastings.—Dredging, Westernport, Ports and Harbours Branch. (Buoy Depot, Stony Point.)

**Tuesday, 20th January, 1970.**

**Building, Electrical and Mechanical Works.**

Myrtleford.—Erection of a Brick Court House. (W.O., Wangaratta and Benalla.)

**Tuesday, 3rd February, 1970.**

**Building, Electrical and Mechanical Works.**

Glennormiston.—Electrical installation for existing Mansion, Glennormiston Estate. (W.O., Warrnambool.)

M. V. PORTER,  
 Minister of Public Works.

Public Works Department,  
 Melbourne, 3002, 1st December, 1969.

**PUBLIC SERVICE NOTICES**

**EXAMINATION FOR LICENCE AS SHORTHAND WRITER.**

It is hereby notified that the under-mentioned persons passed the examination, held on the 29th November, 1969, for licence as shorthand writers under the Evidence Act:—

Courtman, Gloria.  
 Glew, Catherine M. (Mrs.).  
 McEwan, Neil John.  
 McGregor, Jim.  
 Warren, Trevor.  
 Wight, Ronald M.

By order,

V. P. SCULLY,  
 Secretary.

Office of the Public Service Board,  
 Melbourne, 1st December, 1969.

**No. 362.**

*Public Service Act 1958, Section 39.*

**REGULATIONS—PART IV.—SALARIES AND INCREMENTS.**

THE Public Service Board, in pursuance of the powers conferred by the *Public Service Act 1958*, hereby amends its Regulations as shown below:—

**FIRST SCHEDULE.  
 PROFESSIONAL DIVISION.**

*Amount of Salary Assigned to Offices in "Special Class"*

Office.	Yearly Rate of Salary.
	\$
<b>LAW DEPARTMENT.</b>	
<i>Delete—</i>	
Chief Stipendiary Magistrate .. .. .	10,350
Deputy Chief Stipendiary Magistrate .. .. .	9,800
<i>Add—</i>	
Chief Stipendiary Magistrate .. .. .	11,800
Deputy Chief Stipendiary Magistrate .. .. .	11,250

*This Regulation shall have effect as on and from the 16th November, 1969.*

F. E. CAHILL, Chairman.  
 V. P. SCULLY, Secretary.

Office of the Public Service Board,  
 Melbourne, 14th November, 1969.

**No. 364.**

*Public Service Act 1958, Section 50.*

**REGULATIONS—PART IV.—SALARIES AND INCREMENTS.**

THE Public Service Board, in pursuance of the powers conferred by the *Public Service Act 1958*, hereby amends its Regulations as shown below:—

**SIXTH SCHEDULE.  
 TEMPORARY EMPLOYEES.**

*Designations of Positions and Rates of Salaries.*

Department and Designation of Position.	Yearly Rate of Salary.		Increments (Annual).
	Minimum.	Maximum.	
	\$	\$	
<i>Delete the existing yearly rates of salary for the following positions and insert the rates shown hereunder in lieu thereof—</i>			
<b>PUBLIC WORKS DEPARTMENT.</b>			
Inspector of Works, Senior .. .. .	4,625	5,125	Σ
Inspector of Works .. .. .	4,313	4,563	Σ
Technical Works Officer .. .. .	3,994	4,438	Σ
<b>TREASURY.</b>			
<i>Housing Commission.</i>			
Maintenance Supervisor .. .. .		4,313	
Maintenance Supervisor, Assistant .. .. .	4,108	4,190	Σ
Technical Works Officer .. .. .	3,994	4,190	Σ
Works Officer .. .. .	4,108	4,313	Σ
<b>WATER SUPPLY DEPARTMENT.</b>			
Electrical Supervisor, Grade I .. .. .	3,776	4,108	Σ
Inspector of Works .. .. .	4,108	4,313	Σ
Σ See Regulation 97 (2)			

*This Regulation shall have effect as on and from the 16th November, 1969.*

F. E. CAHILL, Chairman.  
 V. P. SCULLY, Secretary.

Office of the Public Service Board,  
 Melbourne, 14th November, 1969.

No. 361.

*Public Service Act 1958, Section 50.*

**REGULATIONS—PART IV.—SALARIES AND INCREMENTS.**

THE Public Service Board, in pursuance of the powers conferred by the *Public Service Act 1958*, hereby amends its Regulations as shown below—

**THIRD SCHEDULE.**

**PART B.**

**PROFESSIONAL DIVISION.**

*Scale of Rates of Annual Salaries.*

**STIPENDIARY MAGISTRATES.**

The salary scale shown is deleted and the following salary scale is inserted in lieu thereof—

Class.	Annual Salary of Each Class.
	\$
SM-1 .. .. .	9,950
SM-2 .. .. .	10,700

*This Regulation shall have effect as on and from the 16th November, 1969.*

F. E. CAHILL, Chairman.  
V. P. SCULLY, Secretary.

Office of the Public Service Board,  
Melbourne, 14th November, 1969.

No. 363.

*Public Service Act 1958, Section 50.*

**REGULATIONS—PART IV.—SALARIES AND INCREMENTS.**

THE Public Service Board, in pursuance of the powers conferred by the *Public Service Act 1958*, hereby amends its Regulations as shown below:—

**SIXTH SCHEDULE.**

**TEMPORARY EMPLOYEES.**

*Designations of Positions and Rates of Salaries.*

Department and Designation of Position.	Yearly Rate of Salary.		Increments (Annual).
	Minimum.	Maximum.	
CHIEF SECRETARY'S DEPARTMENT.	\$	\$	
Add— Legal Officer, Grade I.**	3,934	5,430	y (ii)

\*\* Employees must possess the Degree of Bachelor of Laws, or be a Barrister and Solicitor of the Supreme Court of Victoria; or possess a Certificate from the Board of Examiners under the Legal Profession Practice Act indicating eligibility for admission as a Barrister and Solicitor of the Supreme Court of Victoria.

y (ii) Increments in accordance with the scale of rates of salaries as set out for Legal Officer, Class "LO-3", in Part B of the Third Schedule.

F. E. CAHILL, Chairman.  
V. P. SCULLY, Secretary.

Office of the Public Service Board,  
Melbourne, 17th November, 1969.

**PRIVATE ADVERTISEMENTS**

*River Improvement Act 1958.*  
**SHIRE OF GORDON.**

PROPOSED RIVER IMPROVEMENT DISTRICT.  
*Bullock Creek.*

NOTICE is hereby given that the Council of the Shire of Gordon has forwarded to the Minister of Water Supply an application for the constitution of a river improvement district under the jurisdiction and control of a river improvement trust and comprising an area along the river, under the provisions of the *River Improvement Act 1958*.

Copies of the application and general plan and description of the proposed works have been deposited for inspection at the offices of—

- (a) The Minister of Water Supply, State Rivers and Water Supply Commission, 90 Orrong-road, Armadale, 3143.
- (b) The Shire of Gordon, at Boort.
- (c) The Shire of East Loddon, at Serpentine.
- (d) The Shire of Kerang, at Kerang.

1354 D. D. WRIGHT, Shire Secretary.

*Marketing of Primary Products Act 1958 (No. 630).*  
**THE EGG AND EGG PULP MARKETING BOARD.**  
RECEIVING AND SELLING DEPOTS.  
*Metropolitan.*

THE Egg and Egg Pulp Marketing Board, by this public notice, supplements the list published in the *Government Gazette* on 20th August, 1969, by adding the following Receiving Depot:—

Bayswater—W. Parry, Greenhill-road.  
1557 K. G. LEE, Secretary.

I YVONNE DOROTHY McCORMACK, of 52 Alfred-street, Kew, in the State of Victoria, trained nurse, do hereby give notice that I have assumed and intend henceforth upon all occasions and at all times to use and be called and known by the surname of McCormack in lieu of the surname of Prendergast, and to use the name of Yvonne Dorothy McCormack as my full name, and that such intended change is declared and evidenced by a Deed Poll dated the 20th day of November, 1969, and deposited in the Office of the Registrar-General in the State of Victoria.

Dated the 20th day of November, 1969.

YVONNE DOROTHY McCORMACK.  
Arthur E. McSwiney, solicitor, Wangaratta. 1490

**OPTICIANS REGISTRATION BOARD, VICTORIA.**

PURSUANT to the *Opticians Registration Act 1958*, and the *Opticians Regulations*, notice is hereby given that an election for three certified opticians to be nominated by certified opticians for appointment as members of the Opticians Registration Board as from the 29th day of January, 1970, will be held on Friday, the 9th day of January, 1970, and notice is further given that Wednesday, the 10th day of December, 1969, has been fixed as the date for receiving nominations for the election. All nominations must be in the form or to the effect of the form prescribed by the Regulations and must be lodged with the Registrar of the Board before noon on the said 10th day of December, 1969. Nomination forms may be obtained from the Registrar.

BRIAN M. MORRIS, Registrar, Opticians Registration Board, Third Floor, 108 Queen-street, Melbourne, Vic., 3000. 1596

NOTICE is hereby given that Kobla Ski Club has applied for a lease under section 134 of the *Land Act 1958*, for a term of 21 years in respect of an area of 1 rood, 8 perches, being allotment 19, section I, Parish of Yertoo, as a site for a Ski Club Lodge. (H.03318.)

J. M. FLEMING, Secretary.  
Kobla Ski Club. 1169

NOTICE is hereby given that Wongungarra Alpine Ski Club, has applied for a lease under section 134 of the *Land Act 1958*, for a term of 21 years in respect of an area of approximately 0 acres 1 rood 37 perches, being allotment 11, section I, Parish of Yertoo, as a site for a ski club lodge.—(HO.33321.)

Secretary, Wongungarra, Alpine Ski Club. 1240

NOTICE is hereby given that Manangatang and District Bowling Club has applied for a lease under section 134 of the Land Act 1958 for a term of twenty-one (21) years of an area of Crown land containing 0.8 acres more or less, being portion of the former Manangatang Public Recreation Reserve No. 6008, Township of Manangatang.

1474

## GEELONG WATERWORKS AND SEWERAGE TRUST.

THE above-mentioned Trust having made provision for carrying off the sewage from each and every property which or any part of which is within the sewerage area hereinafter described doth hereby declare that on or after the 1st day of December, 1969, each and every property which or any part of which is within the said sewerage area shall be deemed and taken to be seweraged property within the meaning of the *Geelong Waterworks and Sewerage Act 1958*.

## SEWERAGE AREA No. 429.

*Shire of Corio, Parish of Moorpanyal, County of Grant.*

Commencing at a point being the south-west corner of the intersection of Seaforth-street and Sea Breeze-parade, North Shore, the said point being also on the boundary of Sewerage Area No. 140; thence easterly, southerly, westerly, southerly, westerly, southerly and westerly following the boundaries of Sewerage Areas Nos. 140, 182 and 240 and crossing Seaforth-street and Seabright-street to the west side of Seabright-street; thence northerly along the west side of Seabright-street to the south-west corner of the intersection of Seabright-street and Sea Breeze-parade; thence easterly across Seabright-street and continuing easterly along the south side of Sea Breeze-parade to the point of commencement.

## SEWERAGE AREA No. 430.

*Shire of Corio, Parish of Moorpanyal, County of Grant.*

Commencing at a point being the north-west corner of the intersection of Wolseley-grove and Eagleview-crescent, Bell Post Hill, the said point being also on the boundary of Sewerage Area No. 428; thence southerly and easterly following the boundary of Sewerage Area No. 428 and crossing Wolseley-grove, Eagleview-crescent and Chanel-avenue to the south-west corner of the intersection of Wolseley-grove and Lower Anakie-road; thence southerly along the west side of Lower Anakie-road and crossing Peter-street to the south-east corner of lot No. 56 Peter-street, which is also on the boundary of Sewerage Area No. 287 and on the west side of Lower Anakie-road; thence westerly following the boundaries of Sewerage Areas Nos. 287 and 356 to the south-west corner of lot No. 10 Eagleview-crescent, this point being also on the boundary of Sewerage Area No. 356; thence northerly, north-easterly and northerly along the western boundaries of lots Nos. 10 to 3 inclusive Eagleview-crescent to the southern boundary of lot No. 2 Eagleview-crescent; thence westerly along the southern boundary of the said lot No. 2 to the south-west corner of the said lot No. 2; thence northerly along the western boundary of the said lot No. 2 to the south-east corner of lot No. 146 Wolseley-grove; thence westerly along the southern boundary of the said lot No. 146 to the south-west corner of the said lot No. 146; thence northerly along the western boundary of the said lot No. 146 and crossing Wolseley-grove to the north side of Wolseley-grove; thence easterly along the north side of Wolseley-grove to the point of commencement.

## SEWERAGE AREA No. 431.

*Shire of South Barwon, Parish of Barrarbool, County of Grant.*

Commencing at a point being the south-west corner of allotment No. 4 St. Elmo-crescent, Highton, which is also on the boundaries of Sewerage Areas Nos. 376 and 323; thence northerly, south-easterly, southerly and easterly following the boundaries of Sewerage Areas Nos. 323 and 294 and crossing St. Elmo-crescent en route to the north-east corner of allotment No. 20 St. Elmo-crescent; thence southerly along the eastern boundaries of allotments Nos. 20 and 19 St. Elmo-crescent and crossing St. Elmo-crescent to the south side of St. Elmo-crescent, which is also on the boundary of Sewerage Area No. 340; thence westerly, north-westerly and westerly following the boundaries of Sewerage Areas Nos. 340 and 376 to the point of commencement.

## SEWERAGE AREA No. 432.

*Shire of Corio, Parish of Moorpanyal, County of Grant.*

Commencing at a point being the south-west corner of allotment No. 89 Webber-street, Bell Post Hill, the said point being also on the boundary of Sewerage Area No. 428 and on the north side of Webber-street; thence

northerly along the western boundaries of the said allotment No. 89 and allotment No. 72 Wolseley-grove and crossing Wolseley-grove to the north side of Wolseley-grove; thence easterly along the north side of Wolseley-grove to the prolongation of the eastern boundary of allotment No. 78 Wolseley-grove, which is also on the boundary of Sewerage Area No. 428; thence southerly and westerly following the boundary of Sewerage Area No. 428 and crossing Wolseley-Grove to the point of commencement.

## SEWERAGE AREA No. 433.

*Shire of Corio, Parish of Moranghurk, County of Grant.*

Commencing at a point being on the south side of Rimula-road, Corio, which is also on the boundaries of Sewerage Areas Nos. 216 and 418; thence westerly along the south side of Rimula-road to the prolongation of the western boundary of lot No. 8 Rimula-road; thence northerly across Rimula-road and continuing northerly along the western boundary of the said lot No. 8 to the north-west corner of lot No. 8; thence easterly along the northern boundary of the said lot No. 8 to the south-west corner of lot No. 70 Amanda-avenue; thence northerly along the western boundary of the said lot No. 70 to the south side Amanda-avenue; thence westerly, south-westerly, north-westerly, north-easterly and northerly along the south side of Amanda-avenue and west side of Teresa-avenue to the prolongation of the northern boundary of lot No. 117 Teresa-avenue, which is also on the boundary of Sewerage Area No. 418; thence easterly, southerly, south-easterly, southerly, westerly and southerly following the boundary of Sewerage Area No. 418 and crossing Teresa and Rosemary-avenues and Rimula-road to the point of commencement.

1534

B. C. HENSHAW, Secretary.

## APOLLO BAY WATERWORKS TRUST.

## BY-LAW No. 6.

THE Apollo Bay Waterworks Trust, in pursuance of and in exercise of the powers conferred by the *Water Act 1958*, and of any and every other power it thereunto enabling, doth hereby make By-law No. 6 relating to the following:—

1. Interpretation of the subject matter.
2. Licensing of Plumbers.
3. Construction and Arrangements of Works.
4. Materials.
5. Connections to Mains.
6. Repairs to Private Streets.
7. Meters.
8. Misuse and Waste of Water.
9. Private Fire Service.
10. Inspections by Authorised Persons.
11. Penalties.

A copy of the said By-law can be inspected at the Trust's offices in Collingwood Street, Apollo Bay, during office hours.

Such By-law was approved by the Governor in Council on 16th September, 1969.

1585

T. J. FRY, Secretary.

## WARRNAMBOOL SEWERAGE AUTHORITY.

## GENERAL NOTICE.

THE above-mentioned Sewerage Authority, having made sewers for carrying off the sewage from each and every property which, or any part of which abuts on the streets or parts of streets, in which such sewers are laid, and which are included within the Sewerage Areas hereinafter described, doth hereby declare that, on and after the 1st day of January, 1970, each and every property which, or any part of which abuts on the said streets or part of streets shall be deemed to be seweraged property within the meaning of the *Sewerage Districts Act 1958*.

The boundaries of the Sewerage Areas hereinbefore referred to are:—

*Sewerage Area No. 72.*

That part of the Warrnambool Sewerage District bounded on the west by declared Sewerage Area No. 25, on the north by areas No. 28 and 46, on the east by Area No. 46, on the south-east by Area No. 26 and on the south by Area No. 24, and which includes all those properties not previously declared in Maxwell-grove and Alison-avenue.

*Sewerage Area No. 73.*

That part of the Warrnambool Sewerage District bounded by a line which commences at the point where the south-western side of Flaxman-street is intersected by the eastern boundary of the Declared Sewerage Area No. 30 and then proceeds in a clockwise direction across Flaxman-street to and then along the southern boundary of Area No. 24 as far as its intersection with the south side of Bostock-street, then east along the south side of Bostock-street, south along the east side of Simpson-street and east along the south side of Otway-road to its intersection with the western bank of the Hopkins River, then south-westerly along the west bank of the Hopkins River to the north-east corner of Area No. 53, then generally westerly and northerly along the north boundaries of Areas Nos. 53 and 67 and the south sides of Otway-road and Flaxman-street to the point of commencement. This area includes Crown allotments 1, 2 and 3 the Warrnambool Cemetery and those parts of Crown allotments 1A, 2A, 92 and 93 not previously declared.

(SEAL) R. A. MITCHELL, Chairman.  
1477 K. L. ARNEL, Secretary.

## PORT FAIRY SEWERAGE AUTHORITY.

## NOTICE OF INTENTION TO ACQUIRE LAND COMPULSORILY.

THE Port Fairy Sewerage Authority deems it expedient to exercise its powers of taking land compulsorily under section 111 of the *Sewerage Districts Act 1958*, No. 6368, for the work mentioned hereunder.

(a) The construction of Sewerage Pumping Stations.

(b) A plan of the proposed works can be inspected at the Borough Chambers, Bank-street, Port Fairy, between the hours of 9 a.m. and 4 p.m., Monday to Friday inclusive.

(c) The areas of land to be acquired are:—

- (i) That portion of land having a frontage of 30.3 links to Osmonds-lane, Port Fairy, with an area of 20 7/10 perches, being portion of lot 3, lodged plan 1035, Atkinsons Crown Special Survey, Parish of Belfast, County of Villiers.
- (ii) That portion of land having a frontage of 31.3 links to Princes Highway, Port Fairy, with an area of 24 perches being portion of lot 21, lodged plan 1035, Atkinsons Crown Special Survey, Parish of Belfast, County of Villiers.
- (iii) That portion of land having a frontage of 75.8 links to Philip-street, Port Fairy, with an area of 10 1/10 perches, being portion of Atkinsons Crown Special Survey, Parish of Belfast, County of Villiers.
- (iv) That portion of land having a frontage of 30.3 links to College-street, Port Fairy, with an area of 14 9/10 perches, being portion of lot 69 lodged plan 1035, Atkinsons Crown Special Survey, Parish of Belfast, County of Villiers.
- (v) That portion of land having a frontage of 68.2 links to Griffith-street, Port Fairy, with an area of 7 4/10 perches, being portion of C.A. 3, section 3, Town of Port Fairy, Parish of Belfast, County of Villiers.
- (vi) That portion of land having a frontage of 75.8 links to Manifold-street, Port Fairy, with an area of 8 3/10 perches, being portion of C.A. 26, Town of Port Fairy, Parish of Belfast, County of Villiers.

1500 JOHN W. PHILLIPS, Secretary.

## SPRINGVALE AND NOBLE PARK SEWERAGE AUTHORITY.

## GENERAL NOTICE.

THE above-mentioned Sewerage Authority having made provision for carrying off the sewage from each and every property which, or any part of which, is within the Sewerage Areas hereinafter described, doth hereby declare that on and after the 1st day of December, 1969, each and every property which, or any part of which, is within the said Sewerage Areas shall be deemed to be a seweraged property within the meaning of the *Sewerage Districts Act*.

The boundaries of the Sewerage Areas hereinbefore referred to are:—

*Sewerage Area No. 268—Noble Park.*

All those pieces of land being lots 1 to 8 inclusive on lodged plan of subdivision No. 84785 and lots 9 to 22 inclusive on lodged plan of subdivision No. 84786.

Streets and parts of streets included in this area are Lynette-court, Chandler-road and Douglas-street.

*Sewerage Area No. 269—Springvale.*

Commencing at a point being the intersection of the northern side of Bournemouth-avenue and the eastern side of Large-street; thence westerly along the northern side of Bournemouth-avenue to its intersection with the eastern side of McKirdy-street; thence northerly along the eastern side of McKirdy-street to its intersection with the southern side of Heritage-drive; thence easterly along the southern side of Heritage-drive to its intersection with the western side of Ellen-street; thence southerly along the western side of Ellen-street to the south-eastern angle of lot 15 on lodged plan of subdivision No. 64780; thence westerly by a line parallel to Heritage-drive to the eastern side of Large-street; thence southerly along the eastern side of Large-street to the point of commencement.

*Sewerage Area No. 270—Noble Park.*

All those pieces of land being lots 37 and 38 on lodged plan of subdivision No. 17712, such lots having frontages to the southern side of Racecourse-road.

The lodged plans of subdivision hereinbefore referred to shall be taken as those lodged at the Office of Titles, Melbourne.

By order of the Springvale and Noble Park Sewerage Authority.

I. R. HETHERINGTON, Chairman.

1529 J. G. BERRYMAN, Acting Secretary.

## DANDENONG SEWERAGE AUTHORITY.

## GENERAL NOTICE.

THE above-mentioned Sewerage Authority having made provision for carrying off the sewage from each and every property which, or any part of which is within the sewerage areas hereinafter described, doth hereby declare that on and after the 1st day of December, 1969, each and every property which, or any part of which is within the said sewerage areas shall be deemed to be a seweraged property within the meaning of the *Sewerage Districts Act, 1958*.

The boundaries of the sewerage areas hereinbefore referred to are:—

*Sewerage Area No. 202.*

Commencing at a point being the intersection of the northern side of McFees-road and the eastern side of Hawdon-street; thence northerly along the eastern side of Hawdon-street to its intersection with the southern side of Sylvia-street; thence easterly along the southern side of Sylvia-street to its intersection with the eastern side of Pearson-street; thence southerly along the eastern side of Pearson-street a distance of 340 feet; thence easterly by a line parallel to Sylvia-street a distance of 140 feet; thence southerly by a line parallel to Pearson-street to the northern side of McFees-road; thence westerly along the northern side of McFees-road to the point of commencement.

*Sewerage Area No. 203.*

All those pieces of land being lots 87 and 90 to 94 inclusive on lodged plan of subdivision No. 10380.

Parts of streets included in this area are Hilton-street, Claredale-road and Patrona-street.

*Sewerage Area No. 204.*

All those pieces of land being lot 53 and lots 59 to 72 inclusive on lodged plan of subdivision No. 85015 and lots 81 to 108 inclusive on lodged plan of subdivision No. 82314 and lots 1 to 34 inclusive on lodged plan of subdivision No. 86017.

Parts of streets included in this area are Woomera-avenue, Popes-road, Springside-road and Eldo-street.

*Sewerage Area No. 205.*

All those pieces of land being lots 53 to 60 inclusive on lodged plan of subdivision No. 81933.

Parts of streets included in this area are Apex-street and Ailsa-street.

*Sewerage Area No. 206.*

All those pieces of land being lots 36 to 41 inclusive and lots 44 to 47 inclusive on lodged plan of subdivision No. 84533.

Parts of streets included in this area are Juliet-court and Sabine-avenue.

For the purpose of these descriptions the lodged plans of subdivision hereinbefore referred to shall be taken as those lodged at the Office of Titles, Melbourne.

By order of the Dandenong Sewerage Authority.

1533 M. G. JARVIS, Chairman.  
A. R. EDWARDS, Secretary.

## LILYDALE SEWERAGE AUTHORITY.

## CONSTRUCTION OF SEWERS AND OTHER WORKS.

THE Lilydale Sewerage Authority gives notice that it intends to construct sewers and other works in the areas detailed below. Maps showing details of the proposed works may be inspected, during normal office hours at the Authority's Office, by owners or occupiers of land or premises affected.

## Areas in which proposed works are located:—

1. The area bounded by Victoria-road, Buggyride-lane, Breakaway Pass, Valley Ho, Roseman-road, Chirnside Park Golf Club, Grandvalley-drive and Maroondah Highway.

2. Albert Hill-road.

3. Summit-road, and Alexandra-road—Bastow-road area.  
1527 F. O. KENT, Secretary.

## NOTICE OF INTENTION TO APPLY FOR A LICENCE TO DIVERT WATER AND CUT RACE FROM THE RIVER MURRAY, AT COWANNA BILLABONG.

I HEREBY give notice that I intend to apply for a licence empowering me to divert water for a term of four years to the extent of 117 acre-feet per annum at a maximum rate of 23 acre-feet per day of 24 hours for the irrigation of 39 acres of vines, being part of allotment 17, section H, Parish of Merbein, and to occupy certain Crown lands for works of diversion, and to cut a race thereon.

Any objection to such application must be forwarded, in writing, to reach the State Rivers and Water Supply Commission, Melbourne, before 2nd January, 1970, being 30 days from the first publication of this notice.

MICHAEL ERNEST O'HALLORAN.

Box 166, Merbein. 1505

## NOTICE OF INTENTION TO APPLY FOR A LICENCE TO DIVERT WATER AND CUT RACE (RE-ISSUE) FROM THE RIVER MURRAY AT WAKOOL JUNCTION.

I HEREBY give notice that I intend to apply for a licence empowering me to divert water for a term of fifteen years to the extent of 200 acre-feet per annum at a maximum rate of 25 acre-feet per day of 24 hours for the irrigation of 66½ acres of orchard and pastures, being part of allotments 17 and 33, Parish of Piambie, and to occupy certain Crown lands for works of diversion, and to cut a race thereon.

Any objection to such application must be forwarded, in writing, to reach the State Rivers and Water Supply Commission, Melbourne, before 2nd January, 1970, being 30 days from the first publication of this notice.

PERCY BENFIELD.

Private Bag, Piangil, 3597. 1506

## NOTICE OF INTENTION TO APPLY FOR A LICENCE TO DIVERT WATER AND CUT RACE (RE-ISSUE) FROM THE GOULBURN RIVER, AT THORNTON.

I HEREBY give notice that I intend to apply for a licence empowering me to divert water for a term of fifteen years to the extent of 60 acre-feet per annum at a maximum rate of 2 acre-feet per day of 24 hours for the irrigation of 30 acres, being part of allotment 21, section A, Parish of Eildon, and to occupy certain Crown lands for works of diversion, and to cut a race thereon.

Any objection to such application must be forwarded, in writing, to reach the State Rivers and Water Supply Commission, Melbourne, before 2nd January, 1970, being 30 days from the first publication of this notice.

ROBERT JOHN FINDLAY.

Glengarry, Thornton, 3712. 1508

## NOTICE OF INTENTION TO APPLY FOR A LICENCE TO DIVERT WATER AND CUT RACE (RE-ISSUE) FROM THE RIVER MURRAY, AT NANGILOC.

WE hereby give notice that we intend to apply for a licence empowering us to divert water for a term of fifteen years to the extent of 80 acre-feet per annum at a maximum rate of 4 acre-feet per day of 24 hours for the irrigation of 20 acres of vines, citrus and vegetables, being part of allotment 19, Parish of Carwarp, and to occupy certain Crown lands for work of diversion, and to cut a race thereon.

Any objection to such application must be forwarded, in writing, to reach the State Rivers and Water Supply Commission, Melbourne, before 2nd January, 1970, being 30 days from the first publication of this notice.

DONALD WALTER LAMPARD.

ALMA LYNETTE LAMPARD. 1509  
Nangiloc.

## NOTICE OF INTENTION TO APPLY FOR A LICENCE TO DIVERT WATER AND CUT RACE (RE-ISSUE) FROM THE RIVER MURRAY, AT PENTAL ISLAND.

WE hereby give notice that we intend to apply for a licence empowering us to divert water for a term of five years to the extent of 400 acre-feet per annum at a maximum rate of 15 acre-feet per day of 24 hours for the irrigation of 200 acres, being part of allotments 32 and 33, Parish of Pental Island, and to occupy certain Crown lands for works of diversion, and to cut a race thereon.

Any objection to such application must be forwarded, in writing, to reach the State Rivers and Water Supply Commission, Melbourne, before 2nd January, 1970, being 30 days from the first publication of this notice.

JOHN ALAN CADD.  
ERNEST JOHN CADD.  
MARGARET CADD.

Beverford, via Swan Hill. 1507

## NOTICE OF INTENTION TO APPLY FOR A LICENCE TO DIVERT WATER AND CUT RACE (RE-ISSUE) FROM THE RIVER MURRAY, AT NICHOLS POINT.

WE hereby give notice that we intend to apply for a licence empowering us to divert water for a term of fifteen years to the extent of 9 acre-feet per annum at a maximum rate of 2 acre-feet per day of 24 hours for the irrigation of 3 acres of vines, being part of allotment 3, section 6, Parish of Mildura, Block F, and to occupy certain Crown lands for works of diversion, and to cut a race thereon.

Any objection to such application must be forwarded, in writing, to reach the State Rivers and Water Supply Commission, Melbourne, before 2nd January, 1970, being 30 days from the first publication of this notice.

JOHN DAVID OXENHAM.  
LORNA RUTH OXENHAM.

Keating-avenue, Mildura. 1564

## NOTICE OF INTENTION TO APPLY FOR A LICENCE TO DIVERT WATER AND CUT RACE (RE-ISSUE) FROM THE RIVER MURRAY, AT GOORAMADDA.

I HEREBY give notice that I intend to apply for a licence empowering me to divert water for a term of fifteen years to the extent of 2 acre-feet per annum at a maximum rate of 1.25 acre-feet per day of 24 hours for the irrigation of 15 acres of oats, being part of allotment 1c, 1e, 1j and 1k, section C, Parish of Gooramadda, and to occupy certain Crown lands for works of diversion, and to cut a race thereon.

Any objection to such application must be forwarded, in writing, to reach the State Rivers and Water Supply Commission, Melbourne, before 2nd January, 1970, being 30 days from the first publication of this notice.

LESLIE WILLIAM WEIDMEIR.

"Riverdale", Howlong. 1563

## NOTICE OF INTENTION TO APPLY FOR A LICENCE TO DIVERT WATER AND CUT RACE (RE-ISSUE) FROM THE RIVER MURRAY, AT BOUNDARY BEND.

WE hereby give notice that we intend to apply for a licence empowering us to divert water for a term of fifteen years to the extent of 150 acre-feet per annum at a maximum rate of 5 acre-feet per day of 24 hours for the irrigation of citrus pastures and market garden, being part of allotment 2, lot 12, Parish of Narrung, and to occupy certain Crown lands for works of diversion, and to cut a race thereon.

Any objection to such application must be forwarded, in writing, to reach the State Rivers and Water Supply Commission, Melbourne, before 2nd January, 1970, being 30 days from the first publication of this notice.

VITTORIO STEPHANIE GROTTA.  
ANGALA GROTTA.

Box 21, Boundary Bend. 1565

## NOTICE OF INTENTION TO APPLY FOR A LICENCE TO DIVERT WATER AND CUT RACE (RE-ISSUE) FROM THE RIVER MURRAY, AT ROBINVALE.

I HEREBY give notice that I intend to apply for a licence empowering me to divert water for a term of fifteen years to the extent of 165 acre-feet per annum at a maximum rate of 10 acre-feet per day of 24 hours for the irrigation of 55 acres of pastures and vegetables, being part of allotment 3, Parish of Tol Tol, and to occupy certain Crown lands for works of diversion, and to cut a race thereon.

Any objection to such application must be forwarded, in writing, to reach the State Rivers and Water Supply Commission, Melbourne, before 2nd January, 1970, being 30 days from the first publication of this notice.

MYRTLE MARGARET STOLL.

Robinvale.

1528

NOTICE OF INTENTION TO APPLY FOR A LICENCE TO DIVERT WATER AND CUT RACE (RE-ISSUE) FROM THE RIVER MURRAY, AT WODONGA WEST.

I HEREBY give notice that I intend to apply for a licence empowering me to divert water for a term of fifteen years to the extent of 100 acre-feet per annum at a maximum rate of 2 acre-feet per day of 24 hours for the growing of vegetables and pasture irrigation, being part of allotment 2, section 4A, Parish of Belvoir West, and to occupy certain Crown lands for works of diversion, and to cut a race thereon.

Any objection to such application must be forwarded, in writing, to reach the State Rivers and Water Supply Commission, Melbourne, before 2nd January, 1970, being 30 days from the first publication of this notice.

FRANK S. MCFARLAND.

P.O. Box 94, Wodonga.

1512

NOTICE OF INTENTION TO APPLY FOR A LICENCE TO DIVERT WATER AND CUT RACE (RE-ISSUE) FROM THE RIVER MURRAY, AT ROBINVALE.

I HEREBY give notice that I intend to apply for a licence empowering me to divert water for a term of fifteen years to the extent of 7½ acre-feet per annum at a maximum rate of 2 acre-feet per day of 24 hours for the irrigation of 2½ acres of vegetables, being part of allotment 69, Township and Parish of Bumbang, and to occupy certain Crown lands for works of diversion, and to cut a race thereon.

Any objection to such application must be forwarded, in writing, to reach the State Rivers and Water Supply Commission, Melbourne, before 2nd January, 1970, being 30 days from the first publication of this notice.

FRED CRAMP.

P.O. Box 253, Robinvale, Victoria.

1510

NOTICE OF INTENTION TO APPLY FOR A LICENCE TO DIVERT WATER AND CUT RACE (RE-ISSUE) FROM THE RIVER MURRAY, AT YELTA.

WE hereby give notice that we intend to apply for a licence empowering us to divert water for a term of fifteen years to the extent of 18 acre-feet per annum at a maximum rate of 2 acre-feet per day of 24 hours for the irrigation of 6 acres of vegetables, being part of allotments 4B and 4C, section G, Parish of Merbein, and to occupy certain Crown lands for works of diversion, and to cut a race thereon.

Any objection to such application must be forwarded, in writing, to reach the State Rivers and Water Supply Commission, Melbourne, before 2nd January, 1970, being 30 days from the first publication of this notice.

M. A. BACKSHALL.

D. G. BACKSHALL.

Box 289, Merbein, Vic., 3505.

1511

NOTICE OF INTENTION TO APPLY FOR A LICENCE TO DIVERT WATER AND CUT RACE (RE-ISSUE) FROM THE RIVER MURRAY, AT WODONGA WEST.

WE hereby give notice that we intend to apply for a licence empowering us to divert water for a term of fifteen years to the extent of 140 acre-feet per annum at a maximum rate of 2 acre-feet per day of 24 hours for the irrigation of pasture and vegetable growing, being part of allotment 1, section 4A, Parish of Belvoir West, and to occupy certain Crown lands for works of diversion, and to cut a race thereon.

Any objection to such application must be forwarded, in writing, to reach the State Rivers and Water Supply Commission, Melbourne, before 2nd January, 1970, being 30 days from the first publication of this notice.

F. S. MCFARLAND.

R. A. MCFARLAND.

P.O. Box 94, Wodonga, Vic., 3690.

1513

#### CITY OF KNOX.

##### NOTICE OF CHANGE IN STREET NAMES.

NOTICE is hereby given that in pursuance of the powers conferred by the *Local Government Act 1958*, the Council of the City of Knox at a meeting held on the 5th November, 1969, resolved to make the following changes in street names:—

##### Old Name; Location; New Name.

Paton-road; Boronia; Paton-crescent.

Windsor-road; Boronia; Paton-crescent.

Eastbourne-road; Boronia; Paton-crescent.

1496

N. G. HAYNES, Town Clerk.

#### CITY OF PRAHRAN.

NOTICE is hereby given that the Council of the City of Prahran has made and passed a By-law under Section 781 of the *Local Government Act 1958* and numbered 251 for:

(a) Regulating the Market Place and the buildings, stalls, pens and standings on which the Market shall be held.

(b) Fixing the days and hours during each day on which the Market shall be held.

(c) Preventing the sale or exposure for sale of unwholesome provisions in the Market.

(d) Repealing all By-laws and regulations inconsistent therewith including By-law No. 205.

A copy of the above mentioned By-law has been deposited at the office of the Council, Chapel Street, Prahran and is open for inspection free of charge during office hours.

Dated 24th day of November, 1969.

1541

JOHN A. LUCAS, Town Clerk.

#### CITY OF WARRNAMBOOL.

##### LOAN No. 84.

*Notice of Intention to Borrow the Sum of \$80,000 for Permanent Works and Undertakings.*

NOTICE is hereby given that the Council of the City of Warrnambool proposes to borrow the sum of Eighty Thousand Dollars (\$80,000) secured by a charge over the general rates of the municipality, such sums to be raised by the grant of a mortgage in accordance with the provisions of the *Local Government Act 1958*.

1. The maximum rate of interest that may be paid is 6.40 per cent. per annum.

2. The purpose for which the loan is to be applied is for the following:

##### (a) Re-Construction of Roads and Drainage—

(i) Cramer-street ..	\$33,442
(ii) Howard-street ..	16,184
(iii) Kelp-street ..	6,440
(iv) Morriss-road ..	8,520
(v) Woodend-road ..	2,500
(vi) Merrivale Main-road ..	2,630

69,716

(b) Installation of fire plugs .. .. . 2,798

(c) Purchase Land from Housing Commission for recreation purposes & Lone Person Flats .. .. . 7,486

\$80,000

3. The period of the loan shall be fifteen years.

4. The money borrowed shall be repayable by providing out of municipal fund 30 half-yearly instalments of approximately \$4,187.77 each, including principal and interest on the 1st day of August and the 1st day of February, during the currency of the loan. The first instalment shall be payable on the 1st August, 1970.

5. Such money shall be repayable to the C.B.C. Savings Bank Limited, Melbourne.

6. A statement showing the proposed expenditure of the money to be borrowed, is open for inspection at the Municipal Office, Timor-street, Warrnambool.

1519

K. L. ARNEL, Town Clerk.

#### SHIRE OF AVOCA.

##### LOAN No. 27.

*Notice of Intention to Borrow the Sum of \$7,000 for Permanent Works and Undertakings.*

NOTICE is hereby given that the Council of the Shire of Avoca proposes to borrow the principal sum of \$7,000 secured by a charge over the general rates of the



municipality, such sum to be raised by the grant of a mortgage in accordance with the provisions of the *Local Government Act 1958*.

1. The maximum rate of interest that may be paid is 6.15 per centum per annum.

2. The purposes for which the loan is to be applied are—

- |  |         |
|--|---------|
| (a) Purchase of swimming pool site ..      | \$3,000 |
| (b) Part cost of heavy duty road grader .. | 4,000   |
|  | \$7,000 |

3. The period of the loan shall be seven years.

4. The moneys borrowed shall be repayable by providing out of the municipal fund fourteen equal half-yearly instalments of approximately \$622.86 each, including principal and interest, on the 1st day of March, and the 1st day of September, during the currency of the loan. The first instalment shall be payable on the 1st day of September, 1970.

5. Such moneys borrowed shall be repayable to the C.B.C. Savings Bank Ltd., Melbourne.

The plans and specifications and the estimate of the cost of the proposed works and a statement showing the proposed expenditure of the moneys to be borrowed, are open for inspection during office hours at the Shire Office, Rutherford-street, Avoca.

Dated the 28th day of November, 1969.

1524 F. C. S. EDWARDS, Shire Secretary.

#### SHIRE OF BULN BULN.

##### LOAN No. 37.

*Notice of Intention to Borrow the Sum of \$30,000 for Permanent Works and Undertakings.*

NOTICE is hereby given that the Council of the Shire of Buln Buln proposes to borrow the principal sum of \$30,000, secured by a charge over the general rates of the municipality, such sum to be raised by the grant of a mortgage in accordance with the provisions of the *Local Government Act 1958*.

1. The maximum rate of interest that may be paid is 6.3 per cent. per annum.

2. The purpose for which the loan is to be applied is the purchase of road-making plant.

3. The period of the loan shall be ten years.

4. The moneys borrowed shall be repayable by providing out of the municipal fund twenty half-yearly instalments of approximately \$2,044 each, including principal and interest on the 1st day of February and the 1st day of August, during the currency of the loan. The first instalment shall be payable on the 1st day of August, 1970.

5. Such moneys shall be repayable to the Commissioners of the State Savings Bank of Victoria at the office of the said Commissioners, corner Elizabeth and Bourke streets, Melbourne.

The plans and specifications and the estimate of the cost of the proposed works and a statement showing the proposed expenditure of the moneys to be borrowed, are open for inspection at the office of the Council of the Shire of Buln Buln, at Drouin.

Dated the 3rd December, 1969.

1587 K. A. PRETTY, Shire Secretary.

#### SHIRE OF BULN BULN.

##### BY-LAW No. 81.

A By-law of the Shire of Buln Buln made under Section 800 of the *Local Government Act 1958* and numbered 81 for the purpose of repealing By-law No. 73 and for further amending By-law No. 57.

IN pursuance of the powers conferred by the *Local Government Act 1958* and in pursuance of an agreement dated 18th September 1961 between the President Councillors and Ratepayers of the Shire of Buln Buln and the President Councillors and Ratepayers of the Shire of Warragul, the President Councillors and Ratepayers of the Shire of Buln Buln orders as follows:—

1. By-law No. 73 of the Shire of Buln Buln shall be and is hereby repealed.

2. Sub-clauses (a) and (b) of Clause 2 of By-law No. 57 shall be and are hereby repealed and the following sub-clauses substituted therefor:—

" (a) Camping Fees—

- (i) For every tent or caravan—Seventy-five cents (75c.) per night; Four Dollars fifty cents (\$4.50) per week.

No. 107.—10720/69.—3

(ii) For the supply of electricity to any such tent or caravan—Twenty-five cents (25c.) per night; One Dollar fifty cents (\$1.50) per week.

(b) Parking Fees—

(i) For every car—Twenty cents (20c.) per day or part thereof;

(ii) For every bus—Fifty cents (50c.) per day or part thereof;

(iii) For the supply of electricity to any such car or bus or to any person—Twenty-five cents (25c.) per day."

3. This By-law shall apply, to and have operation throughout that part of the Shire of Buln Buln consisting of Glen Cromie Park as described in By-law No. 57.

Resolution for passing this By-law agreed to by the Council of the Shire of Buln Buln on the 15th day of September, 1969, and confirmed on the 20th day of October, 1969.

The common seal of the President, Councillors and Ratepayers of the Shire of Buln Buln was hereunto affixed in the presence of—

(SEAL) H. F. McCAY, Shire President.  
JOHN E. DELZOPPO, Councillor.  
K. A. PRETTY, Shire Secretary.

Approved by the Governor in Council, 11th November, 1969.—J. ROSSITER, Clerk of the Executive Council. 1498

#### SHIRE OF CHARLTON.

##### PROSECUTING OFFICER.

NOTICE is hereby given that Senior Constable E. J. Manning, No. 11854, has been appointed Prosecuting Officer for the Shire of Charlton, in lieu of Senior Constable L. V. Cody, No. 10393, deceased.

1532 A. F. HELYAR, Shire Secretary.

#### SHIRE OF KORUMBURRA.

##### LOAN No. 53.

*Notice of Intention to Borrow the Sum of \$27,000 for Permanent Works and Undertakings.*

NOTICE is hereby given that the Council of the Shire of Korumburra proposes to borrow the principal sum of \$27,000, secured by a charge over the general rates of the municipality, such sum to be raised by the grant of a mortgage in accordance with the provisions of the *Local Government Act 1958*.

1. The maximum rate of interest that may be paid is 6.4 per cent. per annum.

2. The purpose for which the loan is to be applied is—  
Erection of building for South Gippsland Cordial Company under the Decentralized Industry provisions of the *Local Government Act 1958*.

3. The period of the loan shall be fifteen years.

4. The moneys borrowed shall be repayable by providing out of the municipal fund half-yearly instalments of approximately \$1,413 each, including principal and interest on the 1st day of February and the 1st day of August, during the currency of the loan. The first instalment shall be payable on the 1st day of August, 1970.

5. Such moneys shall be repayable to the Commissioners of the State Savings Bank of Victoria, at the office of the said commissioners, corner Elizabeth and Bourke streets, Melbourne.

The plans and specifications and the estimate of the cost of the proposed works and a statement showing the proposed expenditure of the moneys to be borrowed, are open for inspection at the office of the Council of the Shire of Korumburra, at Commercial-street, Korumburra.

Dated 27th November, 1969.

1526 W. O. CLARK, Shire Secretary.

#### SHIRE OF KORUMBURRA.

##### LOAN No. 52.

*Notice of Intention to Borrow the Sum of \$8,000 for Permanent Works and Undertakings.*

NOTICE is hereby given that the Council of the Shire of Korumburra proposes to borrow the principal sum of \$8,000, secured by a charge over the general rates of the municipality, such sum to be raised by the grant of a mortgage in accordance with the provisions of the *Local Government Act 1958*.

1. The maximum rate of interest that may be paid is 6.15 per cent. per annum.

2. The purpose for which the loan is to be applied is—  
Purchase of plant.
3. The period of the loan shall be seven years.
4. The moneys borrowed shall be repayable by providing out of the municipal fund half-yearly instalments of approximately \$712 each, including principal and interest on the 1st day of February and the 1st day of August, during the currency of the loan. The first instalment shall be payable on the 1st day of August, 1970.

5. Such moneys shall be repayable to the Commissioners of the State Savings Bank of Victoria, at the office of the said commissioners, corner Elizabeth and Bourke streets, Melbourne.

The plans and specifications and the estimate of the cost of the proposed works and a statement showing the proposed expenditure of the moneys to be borrowed, are open for inspection at the office of the Council of the Shire of Korumburra, at Commercial-street, Korumburra.

Dated 27th November, 1969.

1525

W. O. CLARK, Shire Secretary.

#### SHIRE OF MALDON.

##### LOAN No. 22.

*Notice of Intention to Borrow the Sum of \$6,250 for Permanent Works and Undertakings.*

NOTICE is hereby given that the Council of the Shire of Maldon proposes to borrow the principal sum of Six thousand two hundred and fifty dollars, secured by a charge over the general rates of the municipality, such sum to be raised by the grant of a mortgage in accordance with the provisions of the *Local Government Act 1958*.

1. The maximum rate of interest that may be paid is 6.1 per cent. per annum.
2. The purpose for which the loan is to be applied is for purchase of road making plant.
3. The period of the loan shall be five years.
4. The moneys borrowed shall be repayable by providing out of the municipal fund half-yearly instalments of approximately \$735 each, including principal and interest on the 1st day of March and the 1st day of September during the currency of the loan. The first instalment shall be payable on the 1st day of September, 1970.

5. Such moneys shall be repayable to the Commissioners of the State Savings Bank of Victoria at the office of the said Commissioners, corner Elizabeth and Bourke streets, Melbourne.

The plans and specifications and the estimate of the cost of the proposed works and a statement showing the proposed expenditure of the moneys to be borrowed, are open for inspection at the office of the Council of the Shire of Maldon at Maldon.

1478

S. R. BEACH, Shire Secretary.

#### SHIRE OF RODNEY.

##### CHANGE OF STREET NAME.

NOTICE is hereby given that pursuant to the provisions of the *Local Government Act 1958*, the Council of the Shire of Rodney has caused the following alteration to street name to be made:—

*Old Name.*—Station-street, Mooroopna.

*New Name.*—Doonan-street.

1493

R. PERRY, Shire Secretary.

NOTICE is hereby given that the partnership heretofore subsisting between the undersigned Walter Douglas Mather, Betty Isobel Mather, Geoffrey Paul and Shirley Lois Paul, carrying on business as radio, television and electrical merchants, at 179 Darling-road, East Malvern, under the name of "Douglas Radio Co.", has been dissolved by mutual consent as from the first day of October, 1969. All debts due to and owing by the said firm will be received and paid by Geoffrey Paul and Shirley Lois Paul, who will continue to carry on the business at the same place and under the same firm name.

Dated at Melbourne the 1st day of December, 1969.

WALTER DOUGLAS MATHER.  
BETTY ISOBEL MATHER.  
GEOFFREY PAUL.  
SHIRLEY LOIS PAUL.

Witness—R. J. DOUTCH.

H. S. W. Lawson Hughes & Co., solicitors, of 357 Little Collins-street, Melbourne.

1571

NOTICE is hereby given that the partnership heretofore until the 31st day of October, 1969, subsisting between Louey Sew Ping and Loy Poon, carrying on business as restaurateur, at 229 Beach-road, Mordialloc, under the firm name of "Sun Wah Café", has been dissolved as from the 31st day of October, 1969.

Dated the 20th day of November, 1969.

DAVID TING & BYRNE, 224 Queen-street, Melbourne, 3000, for and on behalf of the former partners. 1482

NOTICE is hereby given that the partnership heretofore subsisting between Valentine Corcoran and Lawrence Ronald Reynolds, carrying on business as motor vehicle mechanical and body repairers from premises situated at 116-118 Douro-street, North Geelong, under the business name of "Douro Auto Specialists", has been dissolved from the 3rd day of April, 1969. All debts due to or owing by the said late partnership will be received and paid by the said Valentine Corcoran and Margaret Dorothy Corcoran, who will continue to carry on the said business from the said premises under the same business name.

VIVIAN HILL, LL.B., solicitor, 71 Yarra-street, Geelong.

1504

NOTICE is hereby given that the partnership heretofore subsisting between Desmond Leonard Tinsley, of 40 Millers-road, Altona, and Stanley Arthur Eagland, of 2 Garden-grove, Altona, carrying on business as dry cleaners, from premises situated at 122 Pier-street, Altona, under the business name of "Altona Dry Cleaners", has been dissolved by mutual consent as and from the 31st October, 1969. All debts due to or owing by the said late partnership will be received and paid by the said Stanley Arthur Eagland, who will continue to carry on the said business from the said premises under the same business name.

T. A. RANK & ROBINSON, solicitors, 388 Bourke-street, Melbourne, 3000. 1486

NOTICE is hereby given that the partnership of Lewis, Orr & Gibson, whose legal practice has been conducted at 406 Lonsdale-street, Melbourne, 825 Burke-road, Camberwell, and Suite 3, Southland Shopping Centre, Cheltenham, has been dissolved.

As from 1st October, 1969, William Graham Orr and Stanley Radcliffe Lewis, in partnership with Percy Brusey, are continuing to practise at 406 Lonsdale-street, Melbourne, and Suite 3, Southland Shopping Centre, Cheltenham, under the firm name of "Lewis, Orr & Brusey".

James Samuel Gibson, in partnership with Joan McIntosh, is continuing to practise at 825 Burke-road, Camberwell, under the firm name of "Gibson, McIntosh & Associates".

Dated the 31st day of October, 1969.

J. S. GIBSON.  
WILLIAM G. ORR.  
RADCLIFFE LEWIS.

1494

NOTICE is hereby given that the partnership heretofore subsisting between the undersigned, Eftichios Pendaris and Eftichios Bobolakis, carrying on business as milk bar proprietors, under the name of the "Carioca Café", at 253 Elizabeth-street, Melbourne, has been dissolved by mutual consent as from 6th November, 1969.

All debts due to and owing by the said late firm will be received and paid by Eftichios Bobolakis, who will continue to carry on the business at the same place.

Dated at Melbourne, this 6th day of November, 1969.

EFTICHIOS PENDARIS.  
EFTICHIOS BOBOLAKIS.

1544

NOTICE is hereby given that the partnership heretofore subsisting between the undersigned Edward Dean Gowling and Frederick James Ives, carrying on business as joiners, at Myrtleford, under the name of "Myrtleford Joinery Works", has been dissolved by mutual consent, as from the 30th day of June, 1969. All debts due to and owing by the said late firm will be received and paid by Frederick James Ives and Heather Jean Ives, who will continue to carry on the business at the same place.

Dated at Myrtleford, the 19th day of November, 1969.

E. D. GOWLING.  
F. J. IVES.  
H. J. IVES.

1491

I JOHN WILLIAM ANTHONY DRAKE hereby give notice that I have retired from the partnership formerly existing between Alan John Cummins and myself, and known as "A. John Cummins and Company".

1530

J. W. DRAKE.

NOTICE is hereby given that the partnership heretofore subsisting between Dudley James Aitken and Marion Louise Kemp, carrying on a riding school business under the style or firm name of "Emerald Riding School", at Monbulk-road, Emerald, has been dissolved as from the 6th day of November, 1969. The said Marion Louise Kemp will continue to carry on business under the said firm name.

REGINALD C. BUTLER & CO., solicitors, 312 Centre-road, Bentleigh. 1584

WADDING PRODUCTS PTY. LTD. (IN LIQUIDATION).

NOTICE is hereby given, pursuant to section 254 (2) (b) of the Companies Act 1961 that at a meeting of members held on 28th November, 1969, it was resolved by Special Resolution to wind-up the company voluntarily. Mr. W. B. McMahon, chartered accountant, of 346 Little Collins-street, Melbourne, was appointed liquidator. This appointment was confirmed at a meeting of creditors held on the same day.

Dated this 1st day of December, 1969.

1556 W. B. McMAHON, Liquidator.

The Companies Act 1961.—In the matter of EQUESTRIAN ESTATES PTY. LTD. (IN VOLUNTARY LIQUIDATION).

A FIRST and Final Dividend is intended to be declared in the above-mentioned matter. Creditors who have not proved their debts by the 18th day of December, 1969, will be excluded from the dividend.

Dated this 25th day of November, 1969.

A. M. HORSBURGH, Liquidator.  
Kennedy, Smail & Middlemiss, 296 Little Lonsdale-street, Melbourne, 3000. 1558

Companies Act 1961.—In the matter of OVERSEAS ELECTRICAL PROPRIETARY LIMITED.—Notice Re Meeting of Creditors, Pursuant to Section 260.

NOTICE is hereby given that a meeting of creditors of the above-named company will be held at Princes Gate, East Tower, 3rd Floor, Higginson Room, 151 Flinders-street, Melbourne, on Friday, 5th December, 1969, at 11.15 a.m., the company having convened an Extraordinary Meeting of its members for the same day for the purpose of considering a Special Resolution that the company be wound up voluntarily.

Dated this 26th day of November, 1969.

MRS. V. ARROWSMITH, Director.  
Lewis Luckins & Co., chartered accountants, 289 Flinders-lane, Melbourne, 3000, telephone 63 8827. 1559

In the Supreme Court.—1969 Co. 7837.—In the matter of the Companies Act 1961; and in the matter of NORMAN H. CORNFOOT PROPRIETARY LIMITED.

NOTICE is hereby given that a petition for the winding up of the above-named company was, on the 14th day of November, 1969, presented by Mobile Quarries (Vic.) Pty. Ltd.: And that the said petition is directed to be heard before the Court, sitting in the Fourteenth Court, Law Courts, William-street, Melbourne, at the hour of 10.30 o'clock in the forenoon on the 16th day of December, 1969; and any creditor or contributory of Norman H. Cornfoot Proprietary Limited desiring to support or oppose the making of an order on the said petition may appear at the time of the hearing by himself or his counsel for that purpose; and a copy of the petition will be furnished to any creditor or contributory of the said Norman H. Cornfoot Proprietary Limited requiring the same by the undersigned on payment of the required charge for the same.

The petitioner's address is Anderson-road, Thornbury.  
The petitioner's solicitors are Messrs. Evans, Masters & Gilbert, of 34 Queen-street, Melbourne.

EVANS, MASTERS & GILBERT.

NOTE.—Any person who intends to appear on the hearing of the said petition must serve on or send by post to the above named Messrs. Evans, Masters & Gilbert, notice, in writing, of his intention so to do. This notice must state the name and address of the person or, if a firm, the name and address of the firm, and must be signed by the person or firm or his or their solicitor (if any), and must be served or, if posted, must be sent by post in sufficient time to reach the above named not later than 4 o'clock in the afternoon of the 15th day of December, 1969. 1581

PERCY BOYDEN (VICTORIA) PROPRIETARY LIMITED (IN LIQUIDATION).

FINAL MEETING.

NOTICE is hereby given that in terms of section 272 of the Companies Act 1961 (as amended), a Final General Meeting of the members and creditors of the company being a redundant company, will be held at the offices of the liquidator, 13th Level, 20 O'Connell-street, Sydney, at 10 a.m., on Monday, 5th January, 1970, for the purpose of having laid before it, by the liquidator an account showing how the winding up has been conducted and the property of the company disposed of.

J. G. DUFF, Liquidator.

Dated 28th November, 1969. 1562

The Companies Act 1961.—In the matter of PADDINGS PTY. LTD. (in Voluntary Liquidation).—Members' Winding Up.

NOTICE is hereby given that at an Extraordinary General Meeting of the above company, duly convened and held on 28th November, 1969, the following Resolution was proposed and passed as a Special Resolution:—

"That the company be wound up voluntarily and that Ernest Harding Niemann, of 44 Market-street, Melbourne, be appointed liquidator for the purpose of such winding up, and that he be authorized to draw as remuneration for his services as liquidator, his normal hourly charges in respect thereto."

Dated the 28th November, 1969.

1588 G. A. PARKER, Secretary.

The Companies Act 1961.—In the matter of B. F. ANDERSON FENCING PTY. LTD., 8 Cambria-street, Noble Park.—Notice Re Meeting of Creditors, Pursuant to Section 260.

NOTICE is hereby given that a meeting of creditors of the above-named company will be held at Room 316, 151 Flinders-street, Melbourne, on Wednesday, 10th December, 1969, at 10.30 a.m., the company having convened a meeting of its members for earlier the same day for the purpose of considering a Resolution that the company be wound up voluntarily.

Dated this 1st day of December, 1969.

B. F. ANDERSON, Director.  
Bent & Cogle, Public Accountants, Suite 18, 545 St. Kilda-road, Melbourne, 3004. 1586

Companies Act 1961.

PARLOR CARS PROPRIETARY LIMITED (IN VOLUNTARY LIQUIDATION).

NOTICE OF MEETING OF MEMBERS AND CREDITORS.

NOTICE is hereby given that the adjourned Annual General Meeting of the members and creditors of Parlor Cars Proprietary Limited (in Voluntary Liquidation) will be held at 10.30 a.m. on Thursday, the 11th day of December, 1969, at Room 328, Victorian Employers' Federation, Princes Gate, East Tower, 151 Flinders-street, Melbourne, as required by section 271 (1) of the Victorian Companies Act 1961.

1597

E. JOHN BROWN, Liquidator.

Companies Act 1961.

WITHERS TRANSPORT INDUSTRIES PROPRIETARY LIMITED (IN VOLUNTARY LIQUIDATION).

NOTICE OF MEETING OF MEMBERS AND CREDITORS.

NOTICE is hereby given that the adjourned Annual General Meeting of the members and creditors of Withers Transport Industries Proprietary Limited (in Voluntary Liquidation) will be held at 9.30 a.m. on Thursday, the 11th day of December, 1969, at Room 328, Victorian Employers' Federation, Princes Gate, East Tower, 151 Flinders-street, Melbourne, as required by section 271 (1) of the Victorian Companies Act 1961.

1598

E. JOHN BROWN, Liquidator.

ATOORA PTY. LTD. (IN VOLUNTARY LIQUIDATION).

NOTICE is hereby given, in pursuance of section 272 of the Companies Act 1961, that a General Meeting of the members of the above-mentioned company will be held at the offices of Morris Cohen, Glen & Co., 26 Commercial-road, Prahran, on Thursday, 8th January, 1970, at 9.30 a.m., for the purpose of receiving the liquidator's account showing how the winding up has been conducted and the company's property disposed of.

Dated 28th day of November, 1969.

1516

ERIC M. COHEN, Liquidator.

The *Companies Act 1961*.—In the matter of PARMA MANSIONS PROPRIETARY LIMITED (in Liquidation).

NOTICE is hereby given that, pursuant to section 272 of the *Companies Act 1961*, a Final Meeting of the members of the above company will be held at the office of H. Guest & Associates, public accountants, 207B Balaclava-road, Caulfield, on Wednesday, the 7th January, 1970 at 10.30 a.m.

Business: To receive the liquidator's accounts.

Dated this 26th day of November, 1969.

H. GUEST, Liquidator.

H. Guest & Associates, public accountants, 207B Balaclava-road, Caulfield. 1475

The *Companies Act 1961*.—In the matter of REMY COURT PROPRIETARY LIMITED (in Liquidation).

NOTICE is hereby given that, pursuant to section 272 of the *Companies Act 1961*, a Final Meeting of the members of the above company will be held at the office of H. Guest & Associates, public accountants, 207B Balaclava-road, Caulfield, on Wednesday, the 7th January, 1970 at 10 a.m.

Business: To receive the liquidator's accounts.

Dated this 26th day of November, 1969.

H. GUEST, Liquidator.

H. Guest & Associates, public accountants, 207B Balaclava-road, Caulfield. 1476

The *Companies Act 1961*.—In the matter of WILLIAM R. SHEARS & CO. PTY. LTD.

NOTICE is hereby given that at an Extraordinary Meeting of the members of the above-named company held on the 25th day of November, 1969, it was resolved that the company be wound up voluntarily and at a meeting of creditors held on the same day, pursuant to section 260, it was resolved that for such purpose Everett Thomson Bent, of Suite 18, 545 St. Kilda-road, Melbourne, accountant, be appointed liquidator.

Notice is also given that after 21 days from this date I shall proceed to distribute the assets. All creditors having any claims against the company should furnish particulars of same by that date, otherwise I shall proceed to distribute the assets, without regard to their claim.

Dated this 25th day of November, 1969.

E. T. BENT, Liquidator.

Bent & Cogle, public accountants, Suite 18, 545 St. Kilda-road, Melbourne. 3004. 1479

*Companies Act 1961*.—Notice of Final Meeting.

G.N. ENGINEERING PROPRIETARY LIMITED  
(IN VOLUNTARY LIQUIDATION).

NOTICE is hereby given that a General Meeting of creditors and members will be held at the office of Betty G. Meagher, Suite 18, Queens-road, Melbourne, on 9th December, 1969, at 10 a.m., for the purpose of laying before it a final account of the liquidation and report of the conduct of the winding up in accordance with section 272 of the *Companies Act 1961*.

BETTY G. MEAGHER, liquidator, 58 Queens-road, Melbourne. 1480

The *Companies Act 1961*.—In the matter of TERMINAL SYNDICATE PTY. LTD. (in Liquidation).

NOTICE is hereby given that, pursuant to section 272 of the *Companies Act 1961*, a Final Meeting of members of the above-named company will be held in the offices of S. L. Williams, 486 Nepean Highway, Frankston, on 5th January, 1970, at 10 a.m., for the purpose of laying before the meeting an account, showing the manner in which the winding up has been conducted and the property of the company disposed of and hearing any explanation that may be given by the liquidator.

1484 S. L. WILLIAMS, Liquidator.

N.M. SUPERANNUATION SERVICES PTY. LTD.

NOTICE is hereby given, pursuant to section 254 (2) (b) of the *Companies Act 1961*, that at an Extraordinary General Meeting of the members of N.M. Superannuation Services Pty. Ltd., held at 447 Collins-street, Melbourne, on the 24th day of November, 1969, the following Special Resolution was passed:—

"That the company be voluntarily wound up."

1485 CLIVE HUMPHREY JARMAN, Secretary.

CREDITORS of Vivian Tom Bidwell, trading as B.P. Tamboon Inlet Service Station, Cann River, of Billa-bong Roadhouse, Princes Highway, Fernbank, are hereby advised that the debtor has executed a deed of assignment as requested by the provisions of the Resolution passed at a meeting of creditors held at the Honorary Justices Association, on 13th November, 1969.

Creditors are requested to lodge their completed proof of debt forms with the trustee at P.O. Box 19, Warragul.

E. P. TAYLOR, Trustee.

Downie & Taylor, P.O. Box 19, Warragul, 3820. 1487

CREDITORS, next of kin and others having claims in respect of the estate of Charles Harold Gay, late of 25 Yungera-street, Fawkner, bookmaker, deceased (who died on the 24th day of June, 1967), are to send particulars of their claims to Royston T. Cahir & Martin, solicitors, 17 Queen-street, Melbourne, by the 5th day of February, 1970, after which date the executor will distribute the assets of the estate, having regard only to claims of which he then has notice.

ROYSTON T. CAHIR & MARTIN, solicitors, 17 Queen-street, Melbourne. 1540

CREDITORS, next of kin and others having claims in respect of the estate of John Joseph O'Connell, late of Flat 4, 29 Chapel-street, St. Kilda, company director, deceased, intestate (who died on the 5th day of August, 1969), are required to send particulars to the administrator, National Trustees, Executors and Agency Company of Australasia Limited at 95 Queen-street, Melbourne, by the 10th day of February, 1970, after which date it will distribute the assets, having regard only to the claims of which it then has notice.

BERNARD NOLAN & CO., solicitors, 595 Bourke-street, Melbourne. 1542

CREDITORS, next of kin and others having claims in respect of the estate of Mary Elizabeth Coffey, late of 95 Princes-street, Carlton, spinster (who died on the 19th July, 1969), are to send particulars of their claims to National Trustees, Executors and Agency Company of Australasia Limited, the registered office of which is situate at 95 Queen-street, Melbourne; by the 10th February, 1969, after which date it will distribute the assets, having regard only to the claims of which it then has notice.

R. P. BARRETT & SON, solicitors, 472 Bourke-street, Melbourne. 1543

CREDITORS, next of kin and others having claims in respect of the estate of Florence Pauline Weston, late of 160 Blyth-street, East Brunswick, in the State of Victoria, married woman, deceased (who died on the 21st of July, 1969), are to send particulars of their claim to Frank Norman Weston, of 8 Gloucester-drive, Rosanna, the executor appointed by the will of the said deceased, by the 10th day of February, 1970, after which date the executor will distribute the assets, having regard only to the claims of which he shall then have notice.

H. L. YUNCKEN & YUNCKEN, solicitors, 443 Little Collins-street, Melbourne. 1546

CREDITORS, next of kin and others having claims in respect of the estate of Rae Kingston, late of 36 Walsh-street, South Yarra, in the State of Victoria, widow, deceased (who died on the 12th of July, 1969), are to send particulars of their claims to Leigh Maurice Kingston, of "The Grove", Cootamundra, care of Post Office Box 141, Cootamundra, in the State of New South Wales, grazier, and Keith Bennett Kingston, of Flat 7, 60 Queens-road, Melbourne, in the State of Victoria, student, the executors appointed by the will of the said deceased, by the 10th day of February, 1970, after which date the executors will distribute the assets, having regard only to the claims of which they shall then have notice.

H. L. YUNCKEN & YUNCKEN, 443 Little Collins-street, Melbourne, 3000. 1547

CREDITORS, next of kin and others having claims in respect of the estate of Flora Mary Henderson, late of 5 Stanley-street, Brighton, widow, deceased (who died on the 22nd July, 1969), are to send particulars of their claims to the Union-Fidelity Trustee Company of Australia Limited, of 100 Exhibition-street, Melbourne, by the 16th February, 1970, after which date it will distribute the assets, having regard only to the claims of which it then has notice.

MOULE HAMILTON & DERHAM, solicitors, 224 Queen-street, Melbourne. 1552

MURIEL FAIRLIE MOUNTFORD, late of Flat 2, 24 Belmont-avenue North, Glen Iris, in the State of Victoria, widow, DECEASED.

CREDITORS, next of kin and others having claims in respect of the estate of the deceased (who died on the 7th day of June, 1969), are required to send particulars of such claims to the executors, Kenneth William Mountford and Muriel Fairlie Brooke, care of the under-mentioned solicitor, by the 14th day of February, 1970, after which date the executors may confer or distribute the assets, having regard only to the claims of which they then have notice.

M. JOHN KELLY, solicitor, 422 Collins-street, Melbourne. 1549

CREDITORS, next of kin and others having claims in respect of the estate of Helen Alice Elder, late of "Yuulong", Princes Highway, Berwick, gentlewoman, deceased (who died on 25th July, 1969), are to send particulars of their claims to the Union-Fidelity Trustee Company of Australia Limited, of 100 Exhibition-street, Melbourne, by 6th February, 1970, after which date it will distribute the assets, having regard only to the claims of which it then has notice.

MOULE HAMILTON & DERHAM, solicitors, 224 Queen-street, Melbourne. 1553

CREDITORS, next of kin and others having claims in respect of the estate of Margaret Isabel Nanson, late of 207 Charman-road, Cheltenham, in the State of Victoria, spinster, deceased (who died on the 24th day of September, 1969), are to send particulars of their claims to the Trustees, Executors and Agency Company Limited, of 401 Collins-street, Melbourne, in the said State, by the 5th day of March, 1970, after which date it will distribute the assets, having regard only to the claims of which it then has notice.

BEST, HOOPER, RINTOUL & SHALLARD, 100 Queen-street, Melbourne. 1554

HARRY YOUNG, late of 56 Barton-street, Reservoir, french polisher, DECEASED.

CREDITORS, next of kin and others having claims in respect of the estate of the deceased (who died on 13th May, 1969), are required by Amy Lainson Tyrrell, of 2 Hayward-street, Pascoe Vale South, married woman (the administratrix, to whom letters of administration with the will annexed were granted on 18th September, 1969), to send particulars to her, in care of the undersigned solicitors, by the 4th day of February, 1970, after which date the administratrix may convey or distribute the assets, having regard only to the claims of which she then has notice.

DUDLEY TREGENT & CO., solicitors, 422 Collins-street, Melbourne. 1560

JOSEPH LEIGHTON DEARIE, late of 33 Scotia-street, Moonee Ponds, retired engineer, DECEASED.

CREDITORS, next of kin and others having claims in respect of the estate of the deceased (who died on the 15th day of November, 1969), are required by the trustees, Ronald Leighton Dearie and Marjorie Doreen Chandler, to send particulars of their claims to the trustees, care of Messrs. M. John Dent & Co., of 8 Margaret-street, Moonee Ponds, by the 10th day of February, 1970, after which day the trustees may convey or distribute the assets, having regard only to the claims of which they have then notice.

Dated this 26th day of November, 1969.

M. JOHN DENT & CO., barristers & solicitors of 8 Margaret-street, Moonee Ponds. 1488

ALBERT BIRD, late of 33 Lincoln-road, Essendon, builder, DECEASED.

CREDITORS, next of kin and others having claims in respect of the estate of the deceased (who died on the 28th day of June, 1969), are required by the trustee, National Trustees, Executors and Agency Company of Australasia Limited, of 95 Queen-street, Melbourne, to send particulars of their claims to the trustee, by the 10th day of February, 1970, after which day the trustee may convey or distribute the assets, having regard only to the claims of which he has then notice.

Dated this 26th day of November, 1969.

M. JOHN DENT & CO., barristers & solicitors, of 8 Margaret-street, Moonee Ponds. 1489

CREDITORS, next of kin and others having claims in respect of the estate of Reginald David Gray, late of River-road, Boolarra, in the State of Victoria, dairy farmer, deceased (who died on the 19th day of July, 1969), are to send particulars of their claims to the Trustees, Executors and Agency Company Limited, care of the undersigned, by the 10th day of February, 1970, after which date they will distribute the assets, having regard only to the claims of which they then have notice.

AMBROSE & ASSOCIATES, solicitors, Morwell. 1492

CREDITORS, next of kin and others having claims in respect of the estate of Irene Dawson, late of Gillies-street, Ballarat, in the State of Victoria, spinster, deceased, intestate (who died on the 15th day of June, 1969), are to send the particulars of their claims to The Union-Fidelity Trustee Company of Australia Limited, of 101 Lydiard-street, North, Ballarat, by the 10th day of February, 1970, after which date it will distribute the assets, having regard only to the claims of which it then has notice.

POWER & BENNETT, solicitors, Horsham. 1495

CREDITORS, next of kin and others having claims in respect of the estate of Heather Jessie Smith, late of 31 North-street, Kerang, home duties, deceased (who died on the 10th day of March, 1969), are required to send particulars of their claims to the Sandhurst and Northern District Trustees, Executors and Agency Company Limited, of 18 View-street, Bendigo, by the 28th day of January, 1970, after which date it will distribute the assets, having regard only to the claims of which it then has notice.

SANDHURST AND NORTHERN DISTRICT TRUSTEES, EXECUTORS AND AGENCY COMPANY LIMITED, 18 View-street, Bendigo, 3550. 1481

CREDITORS, next of kin and others having claims in respect of the estate of Sydney Bertram Burns, late of Goroke, in the State of Victoria, farmer, deceased (who died on the 2nd day of July, 1969), are required to send the particulars of their claims to The Union-Fidelity Trustee Company of Australia Limited, of 100 Exhibition-street, Melbourne, in the said State, by the 10th day of February, 1970, after which date it will distribute the assets, having regard only to the claims of which it then has notice.

STEWART F. BROWN & PROUDFOOT, 74 Wilson-street, Horsham, solicitors for the applicant. 1483

CREDITORS, next of kin and others having claims in respect of the estate of Colin Steven Burgess, late of Golf Links-road, Baxter, in the State of Victoria, livestock carrier, deceased, intestate (who died on the 18th day of December, 1968), are required to send particulars of their claims to Edward James Burgess, care of the under-mentioned address, by the 5th day of February, 1970, after which date he will distribute the assets, having regard only to the claims of which he has notice.

HARGRAVE & HARGRAVE, solicitors, Yarrowonga. 1499

CREDITORS, next of kin and others having claims in respect of the estate of August Kael, formerly of 30 Claremont-street, South Yarra, but late of 223 Park-street, South Melbourne, in the State of Victoria, pensioner, deceased (who died on the 13th day of April, 1969), are required by the executor, Robert Albert Kael, of flat 10, 224 Alma-road, East St. Kilda, to send particulars to the said executor, care of the under-mentioned firm of solicitors, by the 6th day of February, 1970, after which date the executor will distribute the assets, having regard only to the claims of which he then has notice.

KENNETH J. CLEMENTS & SON, solicitors, 255 Glenhuntly-road, Elsternwick. 1501

LEANNE JENNIFER WARREN, late of Swan Hill, in the State of Victoria, infant, DECEASED, intestate (who died on the 23rd day of March, 1968).

CREDITORS, next of kin and all other persons having claims against the estate of the deceased are required by the administrator, Francis Robert Warren, to send particulars to him, care of the undersigned on, or before the 26th day of February, 1970, after which date he will distribute the assets, having regard only to the claims of which he then has notice.

GARDEN & GREEN, solicitors, 4 McCallum-street, Swan Hill. 1502

AGNES SHORT BROWN WILLIAMS, late of Swan Hill, in the State of Victoria, widow, DECEASED (who died on the 30th August, 1969).

CREDITORS, next of kin and all other persons having claims against the estate of the deceased, are required by the executors of the will, James Wilson and Ian Francis Thomas Williams, to send particulars to them, care of the undersigned on or before the 26th day of February, after which date they will distribute the assets, having regard only to the claims of which they then have notice.

GARDEN & GREEN, solicitors, 4 McCallum-street, Swan Hill. 1503

CREDITORS, next of kin and other persons having claims against the estate of Thomas Connell, formerly of Centre Dandenong-road, Dingley, but late of 76 Gillies-street, Fairfield, gentleman, deceased (who died on the 21st September, 1969), are required to send particulars thereof to The Trustees, Executors and Agency Company Limited, of 401 Collins-street, Melbourne, by the 12th day of February, 1970, after which date the said company will distribute the assets, having regard only to the claims of which it then has notice.

MORRISSEY & HARDY, solicitors, 25 Langhorne-street, Dandenong, 3175. 1572

MINNIE OSBORNE, late of 63 Addison-street, Elwood, in the State of Victoria, spinster, DECEASED.

CREDITORS, next of kin and others having claims in respect of the estate of the deceased (who died on the 8th day of October, 1969), are required by the National Trustees, Executors and Agency Company of Australasia Limited, of 95 Queen-street, Melbourne, to send particulars of their claims to the said company, by the 27th day of February, 1970, after which date it will convey or distribute the assets, having had regard only to the claims of which the company then has notice.

H. S. W. LAWSON, HUGHES & CO., solicitors, 357 Little Collins-street, Melbourne. 1570

MALCOLM WILLIAM McMILLAN, late of 27 High-road, South Camberwell, retired company director, DECEASED.

CREDITORS, next of kin and others having claims in respect of the estate of the deceased (who died on the 6th day of September, 1969), are required by the executor, Donald Semmens McMillan, of 1 Amelia-crescent, Doncaster East, clerk, to send particulars to him, care of Keith Hercules & Sons, at the address under-named, by the 18th day of February, 1970, after which date he may convey or distribute the assets, having regard only to the claims of which he then has notice.

MESSRS. KEITH HERCULES & SONS, of 443 Little Collins-street, Melbourne. 1569

CREDITORS, next of kin and others having claims against the estate of Teresa Smith, late of 19 Birdwood-avenue, Elwood, widow, deceased (who died 10th September, 1969), are required to send particulars to the executor, National Trustees, Executors and Agency Company of Australasia Limited, at 95 Queen-street, Melbourne, by the 10th day of February, 1970, after which date it will distribute the assets, having regard only to the claims of which it then has notice.

BERNARD NOLAN & CO., solicitors, 595 Bourke-street, Melbourne. 1567

CREDITORS, next of kin and others having claims against the estate of Joseph Sawicki, also known as Jozef Sawicki, late of 50 Garton-street, Princes Hill, in the State of Victoria, labourer, deceased (who died on the 14th September, 1969), are required to send particulars of their claims to the executor of his will, Mieczyslaw Zycinski, care of the under-mentioned solicitors, before the 10th February, 1970, after which date the said executor will distribute the estate of the said deceased, having regard only to the claims of which he has then had notice.

J. OKNO & CO., solicitors, of 390 Lonsdale-street, Melbourne. 1568

CREDITORS, next of kin and other persons having claims against the estate of Eileen Weston, late of 13 Stawell-street, Prahran, in the State of Victoria, home duties, deceased (who died on the 5th day of August, 1969), are required to send particulars of their claims to the executrix, Edith Joan MacNaughton, care of the under-mentioned solicitors by the 8th day of February, 1970, after which date the executrix will distribute the assets, having regard only to the claims of which she then has had notice.

JAMES P. OGGE & Co., solicitors, of 165 Greville-street, Prahran. 1535

CREDITORS, next of kin and others having claims in respect of the estate of Frances Mary Riddell, late of "Rocroy", Koroit, in the State of Victoria, married woman, deceased (who died on the 6th August, 1967), are to send the particulars of their claims to the executors Kenneth James Riddell, Peter Partridge and Donald Geoffrey Beard, in care of D. Madden & Co., 1A Liebig-street, Warrnambool, by the 13th day of February, 1970, after which date they will distribute the assets, having regard only to claims of which they then have notice.

Dated the 27th day of November, 1969.

D. MADDEN & CO., solicitors, 1A Liebig-street, Warrnambool. 1517

CREDITORS, next of kin and others having claims in respect of the estate of Arthur Francis Lousada, late of 39 Ewart-street, East Malvern, in the State of Victoria, formerly driver but then retired gentleman, deceased (who died on the 28th day of April, 1969), are to send particulars of their claims to Athol Elwyn Lousada and Marjorie Irene Lousada, care of the under-mentioned solicitors, by the 3rd day of February, 1970, after which date they will distribute the assets, having regard only to the claims to which they then have notice.

Dated the 27th day of November, 1969.

REGINALD C. BUTLER & CO., solicitors, 312 Centre-road, Bentleigh. 1520

CREDITORS, next of kin and others having claims in respect of the estate of Walter James Douglas, late of Illowa, labourer, deceased (who died on the 4th day of January, 1954 intestate and letters of administration of whose estate were granted to Catherine Mary Eccles, of 240 Koroit-street, Warrnambool, married woman), are requested to send particulars of their claims, in writing, to the said Catherine Mary Eccles, care of the undersigned, on or before the 4th day of February, 1970, after which date the said Catherine Mary Eccles will distribute the assets of the said estate, having regard only to the claims of which she then has notice as aforesaid.

DESMOND DUNNE & DWYER, solicitors, Warrnambool. 1518

WILSON WILSON SMITH, late of 8 O'Hara-street, Blackburn, in the State of Victoria, minister of religion, DECEASED.

CREDITORS, next of kin and others having claims in respect of the estate of the above deceased (who died on the 31st day of May, 1969), are required by the Equity Trustees, Executors and Agency Company Limited, of 472 Bourke-street, Melbourne, to send particulars of their claims to the said company by the 4th February, 1970, after which date the company will convey or distribute the assets, having regard only to the claims of which the company then has notice.

WEIGALL AND CROWTHER, 83 William-street, Melbourne, solicitors for the executors. 1538

CREDITORS, next of kin and others having claims in respect of the estate of Albert James Campbell, late of 57 Gilbert-road, West Preston, miller, deceased (who died on the 27th day of June, 1969), are to send particulars of their claims to Royston T. Cahir & Martin, solicitors, 17 Queen-street, Melbourne, by the 5th day of February, 1970, after which date the executor will distribute the assets of the estate, having regard only to claims of which she then has notice.

ROYSTON T. CAHIR & MARTIN, solicitors, 17 Queen-street, Melbourne. 1539

NOTICE PURSUANT TO TRUSTEE ACT 1958 SECTION 33.  
Re estate of CYRIL RUPERT WATCHORN, late of 2 Mountain-grove, Kew, retired assistant collector of customs, DECEASED.

CREDITORS, next of kin and others having claims in respect of the assets and estate of the above-named deceased (who died on the 16th day of August, 1969), are required by The Trustees, Executors and Agency Company Limited, of 401 Collins-street, Melbourne, the executor to whom probate of the will of the said deceased was granted by the Supreme Court of Victoria on the 25th day of November, 1969, to send particulars of their claims to the said company by the 4th day of February, 1970, after which date the said company will convey and distribute the said assets, having regard only to the claims of which it then has notice.

F. R. E. DAWSON & SON, 84 William-street, Melbourne, solicitors for the executor. 1545

WILLIAM JAMES SINCLAIR, late of 64 McCallum-street, Swan Hill, in the State of Victoria, retired municipal clerk and engineer, DECEASED (who died on the 9th of September, 1969).

CREDITORS, next of kin and all other persons having claims against the estate of the deceased, are required by the executors of the will, Robert Henry Hill and Edgar McCahon, to send particulars to them, care of the undersigned on or before the 27th day of February, 1970, after which date they will distribute the assets, having regard only to the claims of which they then have notice.

GARDEN & GREEN, solicitors, 4 McCallum-street, Swan Hill. 1521

CREDITORS, next of kin and other persons having claims against the estate of Kathleen Veronica Bolger, late of 32 Eva-street, Malvern, in the State of Victoria, spinster, deceased (who died on the 3rd day of October, 1969), are required to send particulars of their claims to the executor, National Trustees, Executors and Agency Company of Australasia Limited, whose registered office is situated at 95 Queen-street, Melbourne, by the 8th day of February, 1970, after which date the executor will distribute the assets, having regard only for the claims of which it then has had notice.

JAMES P. OGGE & Co., solicitors, of 165 Greville-street, Prahran. 1536

CREDITORS, next of kin and others having claims in respect of the estate of Keith Johnstone Martin (in the will called Keith John Martin), late of 81 Lonsdale-street, Mount Yokine, in the State of Western Australia, gardener, deceased (who died on the 7th day of January, 1969), are required to send particulars of their claims to The Union-Fidelity Trustee Company of Australia Limited, of 100 Exhibition-street, Melbourne, by 13th February, 1970, after which date it will distribute the assets, having regard only to the claims of which it then has notice.

RODDA BALLARD & VROLAND, solicitors, 697 Burke-road, Camberwell. 1591

CREDITORS, next of kin and others having claims in respect of the estate of Sarah Margaret Lane Wilson, late of 513 Main-road, Tecoma, widow (who died on the 16th October, 1969), are to send particulars of their claims to Amy Roselie Wilson, care of the undersigned by the 7th day of February, 1970, after which date she will distribute the assets, having regard only to the claims of which she then has notice.

COOK & McCALLUM, solicitors, 422 Collins-street, Melbourne. 1590

JULIA CHARLOTTE SARGOOD, late of Chevron Hotel, 519 St. Kilda-road, Melbourne, spinster, DECEASED.

CREDITORS, next of kin and others having claims in respect of the estate of the deceased (who died on the 31st August, 1969), are required by the trustees, Geoffrey Denis Herbert Sargood, of 7 Scotsburn-grove, Toorak, company director, and Brien Herbert Sargood, of 1 Valley View-road, Glen Iris, company director, to send particulars to them at 7 Scotsburn-grove, Toorak, by the 11th February, 1970, after which date they may convey or distribute the assets, having regard only to the claims of which they then have notice.

MESSRS. WEIGALL & CROWTHER, solicitors, 83 William-street, Melbourne. 1574

CREDITORS, next of kin and others having claims in respect of the estate of Alice Vera McDowell, late of 34 Princes-street, Korumburra, spinster, deceased (who died on the 3rd day of March, 1969), are to send particulars of their claims to Robert Albert McDowell, care of the undersigned by the 2nd day of February, 1970, after which date he will distribute the assets, having regard only to the claims of which he then has notice.

BIRCH, ROSS, BARLOW & WOINARSKI, solicitors, Korumburra. 1575

CREDITORS, next of kin and others having claims in respect of the estate of Mabel Violet Kemp, formerly of 5 Melcombe-road, Ivanhoe, but late of 320 Wattle-tree-road, East Malvern, spinster, deceased (who died on the 24th day of July, 1969), are required by The Equity Trustees Executors and Agency Company Limited, of 472 Bourke-street, Melbourne, to send particulars to it by the 4th day of February, 1970, after which date the said company may convey or distribute the assets, having regard only to the claims of which it then has notice.

LEACH & THOMSON, solicitors, 472 Bourke-street, Melbourne. 1576

CREDITORS, next of kin and others having claims against the estate of Hilda Alexandra Steven, late of 32 Darling-street, South Yarra, spinster, deceased (who died on the 5th day of June, 1969), are requested to send particulars of their claims to the executors appointed by the will of the said deceased, The Equity Trustees Executors and Agency Company Limited, of 472 Bourke-street, Melbourne, Elfrieda Gardner, of "Cherry Garth", East-avenue, Mount Evelyn, married woman and Doyna Taft, of 11 Rose-avenue, Surrey Hills, married woman, care of The Equity Trustees Executors and Agency Company Limited, at its registered office, 472 Bourke-street, Melbourne, by the 10th day of February, 1970, after which date they will distribute the assets, having regard only to the claims of which they shall then have notice.

R. GRANT TAYLOR, solicitor, 443 Little Collins-street, Melbourne. 1589

EVA FRANCES ELIZABETH DAVEY, late of 14 Irving-street, Malvern, spinster, DECEASED.

CREDITORS, next of kin and others having claims in respect of the estate of the deceased (who died on 1st May, 1969), are required by the trustee, Roy Clive Hopetoun Beattie, of 61 Union-street, Armadale, solicitor, to send particulars to him by 6th February, 1970, after which date he may convey or distribute the assets, having regard only to the claims of which he then has notice.

R. C. H. BEATTIE, solicitor, 509 Collins-street, Melbourne. 1577

NORMAN JOHN WILLIAM ROGERSON, late of 8 Seaton-street, Glen Iris, retired musician, DECEASED.

CREDITORS, next of kin and others having claims in respect of the estate of the deceased (who died on 16th October, 1969), are required by the trustee, Roy Clive Hopetoun Beattie, of 61 Union-street, Armadale, solicitor, to send particulars to him by 6th February, 1970, after which date he may convey or distribute the assets, having regard only to the claims of which he then has notice.

R. C. H. BEATTIE, solicitor, 509 Collins-street, Melbourne. 1580

CREDITORS, next of kin and others having claims against the estate of Stella Trawin Dawson, formerly of 9 Rae-street, Ironbark, but late of Heidelberg, in the State of Victoria, widow, deceased (who died on the 24th day of April, 1969), are required to send particulars thereof to Sandhurst and Northern District Trustees, Executors and Agency Company Limited, of 18 View-street, Bendigo, in the State of Victoria, by the 12th day of February, 1970, after which date the said company will distribute the assets of the said deceased, having regard only to the claims of which it then has notice.

WATSON, JAMES & ROGERS, solicitors, 61 Bull-street, Bendigo. 1582

FREDERICK ALOYSIUS BOWDEN, late of 64 Shannon-avenue, West Geelong, secondhand dealer, DECEASED.

CREDITORS, next of kin and others having claims in respect of the estate of the deceased (who died on the 10th day of January, 1969), are required by the personal representatives, John Welford Stubbs and Niel Lindsay Davidson, both of 27 Malop-street, Geelong, solicitors, to send particulars to them, care of the under-mentioned solicitors by the 13th day of February, 1970, after which date the personal representatives may convey or distribute the assets, having regard only to the claims of which they then have notice.

WHYTE, JUST & MOORE, solicitors, 27 Malop-street, Geelong. 1583

ARVIDS VOLDEMARS LAUVA, formerly of 2 Willsmere-road, Kew, secretary, but late of 13 Briggs-street, Box Hill North, pensioner, deceased, intestate. Erika Lida Lauva, of 13 Briggs-street, Box Hill North, widow, to whom grant of letters of administration of the estate of the said deceased were granted (the deceased having died on the 14th April, 1969), requires all creditors, next of kin and others having claims against the property or estate of the said deceased to send to her, care of the under-mentioned solicitors, on or before the 2nd February, 1970, particulars, in writing, of such claims after which date the said administratrix intends to convey or distribute such property or estate, to or among the persons entitled thereto, having regard only to the claims of which she shall have had notice.

Dated this 26th November, 1969.

I. DIZGALVIS & CO., solicitors, 390 Lonsdale-street, Melbourne. 1548

## Trustee Act 1958.

## NOTICE TO CLAIMANTS.

**P**URSUANT to the Trustee Act 1958, creditors, next of kin and all other persons having claims in respect of the estate of any deceased person named below are required to send particulars to the legal personal representative or representatives at the addresses stated, after which date the representative or representatives will distribute the assets, having regard only to the claims of which notice has been received:—

Alice Maud Fisher, late of 4 James-street, Footscray, married woman, deceased, died on the 20th day of September, 1969.—Claims to the executor, Joseph Fisher, of 4 James-street, Footscray, retired labourer, care of John F. Carroll, of 4 Paisley-street, Footscray, solicitor, by the 5th day of February, 1970. John F. Carroll, LL.B., solicitor, 4 Paisley-street, Footscray. 1578

Ira Edmond Davies, late of 86 North-road, Newport, gentleman, deceased, died on the 15th day of September, 1969.—Claims to the executors, Raymond James Davies, of 56 Farm-street, Newport, manager and Ralph Ira Davies, of 126 Eleanor-street, Footscray, manager, care of John F. Carroll, of 4 Paisley-street, Footscray, solicitor, by the 5th day of February, 1970. John F. Carroll, LL.B., solicitor, 4 Paisley-street, Footscray. 1579

Mary Jane Moloney, late of 7 McConnell-street, Warrnambool, widow, deceased, died 27th April, 1969. Claims to the executors, Patrick Aubrey Moloney, of High-street, Koroit and Leonard Thomas Moloney, of "Lurnea," Koroit, farmers, care of Conlan & Leishman, solicitors, 38 Bank-street, Port Fairy, by 14th February, 1970. 1522

HELEN MARY HENDY, late of Flat 4, 286 Glenferrie-road, Malvern, retired secretary, DECEASED.

**C**REDITORS, next of kin and others having claims against the estate of the said deceased (who died on the 19th July, 1969), are to send particulars of their claims to National Trustees, Executors and Agency Company of Australasia, Limited, at its registered office, 95 Queen-street, Melbourne, by the 5th February, 1970, after which date it will convey or distribute the assets, having regard only to the claims of which it then has notice.

LEWIS ORR & BRUSEY, solicitors, Suite 3, Southland Shopping Centre, Cheltenham. 1537

**C**REDITORS, next of kin and others having claims in respect of the estate of Annie Louisa Brown, late of 88 Orrong-road, Elsternwick, in the State of Victoria, widow, deceased (who died on the 10th day of May, 1969), are to send particulars of their claims to The Equity Trustees, Executors and Agency Company Limited, of 472 Bourke-street, Melbourne, by the 14th February, 1970, after which date the said company will distribute the assets, having regard only to the claims of which it then has notice.

MICHAEL NIALL & CO., solicitors, 395 Collins-street, Melbourne. 1555

**A**LL persons having claims against the estate of Alice Isabel Holdsworth, late of Heathcote, near Christchurch in the Dominion of New Zealand, deceased (who died on the 6th day of July, 1967, and probate of whose will was on the 27th day of March, 1969, granted by the Supreme Court of New Zealand to the Guardian Trust and Executors Company of New Zealand Limited and application to the Supreme Court of Victoria (probate of jurisdiction) by The Perpetual Executors & Trustees Association of Australia Limited to seal such probate having been granted on the 18th day of November, 1969), are hereby required to send particulars of such claims to The Perpetual Executors & Trustees Association of Australia Limited at its registered office at 100-104 Queen-street Melbourne, on or before the 4th day of February, 1970, after which date the said company will proceed to transfer, convey or distribute the said estate to or among the persons entitled thereto, having regard only to the claims of which it shall then have had notice and will not be liable for the assets so transferred, conveyed or distributed to any persons of whose claim it shall not then have had notice.

A. L. POWELL & CO., solicitors, 406 Lonsdale-street, Melbourne. 1550

**C**REDITORS, next of kin and all other persons having claims against the estate of Sophia Annie Usher, formerly of 45 Dorrington-avenue, Glen Iris, but late of 11 Florence-avenue, Kew, spinster, deceased, are required to send particulars of their claims to The Trustees Executors and Agency Company Limited, of 401 Collins-street, Melbourne, by the 4th day of February, 1970, after which date it will distribute the assets, having regard only to the claims of which it then has notice.

JOHN D. MUSTOW & CO., solicitors, 89 Queen-street, Melbourne. 1595

GLADYS EVELYN BLACKWELL, late of Flat 2, 663 Burke-road, East Hawthorn, in the State of Victoria, spinster, DECEASED.

**C**REDITORS, next of kin and others having claims in respect of the estate of the above-named deceased (who died on the 2nd August, 1969), are required by the executor, William James Griffiths, to send particulars to him, care of the undermentioned solicitor, by the 5th February, 1970, after which date the executor may convey or distribute the assets, having regard only to the claims of which he then has notice.

K. P. REES, B.A., LL.B., solicitor, 89 Queen-street, Melbourne. 1594

CHARLES HENRY BARNETT, late of 11 Weatherstone-road, Seaford, in the State of Victoria, gentleman, DECEASED.

**C**REDITORS, next of kin and others having claims in respect of the estate of the above-named deceased (who died on 28th June, 1968), are required by the executors, Desmond Haldred Rankine and George Cyril Grace, to send particulars to them, care of the undermentioned solicitor, by the 5th February, 1970, after which date the executors may convey or distribute the assets, having regard only to the claims of which they then had notice.

K. P. REES, B.A., LL.B., solicitor, 89 Queen-street, Melbourne. 1593

ALFRED WILLIAM ROBINSON, late of 17 Norman-road, Caulfield in the State of Victoria, retired clerk, DECEASED.

**C**REDITORS, next of kin and others having claims in respect of the estate of the above-named deceased (who died on the 28th day of September, 1969), are required by the executrix, Elsie O'Callaghan, to send particulars to her, care of the under-mentioned solicitor, by the 5th February, 1970, after which date the executrix may convey or distribute the assets, having regard only to the claims of which she then had notice.

K. P. REES, B.A., LL.B., solicitor, 89 Queen-street, Melbourne. 1592

**C**REDITORS, next of kin and other persons having claims in respect of the estate of Jessie Matilda Rintoule, late of Nhill, in the State of Victoria, spinster, deceased, are required to send particulars of their claims to her executors, care of Trumble & Palmer, solicitors, of 45 Victoria-street, Nhill, Victoria, on or before the 8th day of February, 1970, after which date the executors will distribute the assets, having regard only to the claims of which notice has been received.

TRUMBLE & PALMER, solicitors, 45 Victoria-street, Nhill. 3418. 1514

**C**REDITORS, next of kin and others having claims against the estate of Charles Henry Cahill, late of 30 Donald-street, Brunswick, newsagent, deceased (who died on the 11th day of May, 1969), are required to send particulars of their claims to the executors, Harry Kearns McCleery and William Allan George Lugg, care of the under-mentioned solicitor, not later than the 19th day of February, 1970, after which date the executors will proceed to distribute the estate of the deceased, having regard only to the claims of which they shall then have notice.

B. T. E. FLYNN, LL.B., solicitor, 125 Bell-street, Coburg. 1515

**C**REDITORS, next of kin and others having claims against the estate of Tilly Slonimski, late of 41 Neerim-road, Caulfield, married woman, deceased (who died on 2nd July, 1969), are requested to send particulars of their claims to the executors, Chuna Slonimski and James Noel Bird, care of J. N. Bird, of 96 High-street, St. Kilda, solicitor, by the 15th February, 1970, after which date they will distribute the assets, having regard only to the claims of which they then have notice.

J. N. BIRD, solicitor, 96 High-street, St. Kilda. 1551



In the Supreme Court of the State of Victoria.  
**SALE BY THE SHERIFF.**

ON Friday, the 6th of February, 1970, at 10 a.m., at the Police Station, Clayton (unless process be stayed or satisfied):—

All the estate and interest (if any) of Ivar Rüd, of 27 Saniky-street, Notting Hill, as joint proprietor with Torborg Rüd, of an estate in fee-simple in the land described in certificate of title, volume 8460, folio 713, upon which is erected a dwelling-house known as No. 27 Saniky-street, Notting Hill.

Registered mortgages Nos. B.682101 and B.695104 affect the said estate and interest.

Terms: Cash only.

N. FROGLEY, Sheriff's Officer.

2nd December, 1969.

1573

**INSOLVENCY NOTICE**

The *Bankruptcy Act 1966*.—Part X.

NOTICE OF MEETING OF GEORGE DOUGLAS WILLIAMS TRADING AS "WILLIAMS HARDWARE".

NOTICE is hereby given that the above-named debtor signed an authority under section 188 (1) of the Act authorizing Alex Neville Bird to take over control of his property and further take notice that a meeting of creditors will be held at the Board Room, Institute of Chartered Accountants, 23 McKillop-street, Melbourne, at 10.30 a.m., on Friday, the 12th day of December, 1969.

Dated this 29th day of November, 1969.

A. NEVILLE BIRD, Controlling Trustee.

A. Neville Bird & Co., chartered accountants, 289 Flinders-lane, Melbourne, telephone No. 63 2874. 1561

**IMPOUNDINGS**

**DIGBY.**—Impounded in Digby Pound.

1 aged Merino wether, top notch off ear, blue H brand on rump

If not claimed and expenses paid, to be sold on 18th December, 1969.

1566—\$1.75

D. SIMKIN,  
Poundkeeper.

**ECHUCA.**—Impounded in Echuca Pound, by A. B. Burtchell, Impounding Officer.

1 Jersey heifer, with hole in right ear, no visible brand  
 1 yellow and white Jersey heifer, no visible brand  
 1 dark-brown Jersey heifer, no visible brand

If not claimed and expenses paid, to be sold on 18th December, 1969.

1497—\$2.25

B. CLEE,  
Poundkeeper.

**MELTON.**—Impounded in Melton Pound, on 15th November, 1969.

1 bay gelding branded like Z.M.C. on near-side shoulder

If not claimed and expenses paid, to be sold on 19th December, 1969.

1523—\$1.75

F. CHALLIS,  
Poundkeeper.

**MORWELL.**—Impounded in Morwell Pound.

1 Hereford cow, like V out of right ear, like piece out of left ear with heifer calf at foot, no visible brand

If not claimed and expenses paid, to be sold on 16th December, 1969.

1531—\$1.75

S. HUGUENIN,  
Poundkeeper.

*Subordinate Legislation Act 1962.*

**NOTICE OF MAKING OF STATUTORY RULES.**

IN pursuance of the provisions of the *Subordinate Legislation Act 1962* and the Regulations made thereunder, notice is given of the making of the following statutory rules:—

No.	Goods Act 1958.	Price.
243/1969.	Goods (Trade Descriptions) (Amendment) Regulations 1969	10c

No. 107.—10720/69.—4

No.	Aboriginal Affairs Act 1967.	Price.
244/1969.	Aboriginal Affairs (Cadetships) Regulations 1969	15c
	Aboriginal Affairs Act 1967.	
245/1969.	Aboriginal Affairs (Allowances and Fees Amendment) Regulations 1969	10c
	Marine Act 1958	
246/1969.	Amendment to Port Rule Applicable to Westernport Harbor Services (Rates and Charges)	10c
	Melbourne Harbor Trust Act 1958.	
247/1969.	Melbourne Harbor Trust Regulations (Amendment No. 4/69)	15c

Copies of these statutory rules may be purchased at the Sale of Publications Section of the Government Printing Office, located at Macarthur-street, Melbourne, 3002. If ordered by mail, remittance should be addressed to "The Government Printer, Box 203, P.O., North Melbourne, 3051", and should include 5c extra for postage. If a credit account is held at this office, no remittance is required with the mail order.

The annual subscription rate for Statutory Rules (including a Bound Volume) is \$15, payable in advance. The subscription year commences on 1st January.

A. C. BROOKS,  
Government Printer.

ACTS REPRINTED IN ACCORDANCE WITH THE AMENDMENTS INCORPORATION ACT 1958 (No. 6422), AND FOR SALE AT THE SALE OF PUBLICATIONS BRANCH OF THE GOVERNMENT PRINTING OFFICE, MACARTHUR-STREET, MELBOURNE, 3002

(These prices do not include postage.)

No.		Price.
6189.	Acts Interpretation (Second Reprint—Incorporating amendments up to No. 7681)	\$0.28
6191.	Administration and Probate (Third Reprint—Incorporating amendments up to No. 7332)	\$0.38
6194.	Agricultural Colleges (First Reprint—Incorporating amendments up to No. 7302)	\$0.15
7117.	Appeal Costs Fund Act 1964 (First Reprint—Incorporating amendments up to No. 7488)	\$0.25
6199.	Apprenticeship (First Reprint—Incorporating amendments up to No. 7312)	\$0.25
6203.	Audit (First Reprint—Incorporating amendments up to No. 7377)	\$0.35
6209.	Boiler Inspection (Incorporating amendments up to No. 7072)	\$0.18
6529.	Bread Industry Act 1959 (First Reprint—Incorporating amendments up to No. 7728)	\$0.30
6210.	Building Societies (Incorporating amendments up to No. 7125)	\$0.25
6217.	Cemeteries (First Reprint—Incorporating amendments up to No. 7672)	\$0.30
6218.	Children's Court (Incorporating amendments up to No. 7084)	\$0.20
6219.	Children's Welfare (Second Reprint—Incorporating amendments up to No. 7084)	\$0.35
6220.	Clean Air (Incorporating amendments up to No. 6886)	\$0.10
6221.	Coal Mines (First Reprint—Incorporating amendments up to No. 7628)	\$1.05
6222.	Commercial Goods Vehicles (Second Reprint—Incorporating amendments up to No. 7358)	\$0.22
6839.	Companies Act 1961 (Second Reprint—Incorporating amendments up to No. 7332)	\$2.32
6225.	Co-operation (Second Reprint—Incorporating amendments up to No. 7083)	\$0.42
6226.	Co-operative Housing Societies (Second Reprint—Incorporating amendments up to No. 7575)	\$0.53
6228.	Country Fire Authority (Second Reprint—Incorporating Amendments up to No. 7476)	\$0.50
6229.	Country Roads (Second Reprint—Incorporating Amendments up to No. 7506)	\$0.60
6230.	County Court Act (First Reprint—Incorporating amendments up to No. 7420)	\$0.35
6231.	Crimes (Second Reprint—Incorporating amendments up to No. 7407)	\$1.33
7060.	Dandenong Valley Authority Act 1963 (First Reprint—Incorporating amendments up to No. 7523)	\$0.35
6236.	Dog (Second Reprint—Incorporating amendments up to No. 7065)	\$0.15
6239.	Dried Fruits Act 1968 (First Reprint—Incorporating amendments up to No. 7337)	\$0.25

ACTS REPRINTED IN ACCORDANCE WITH THE AMENDMENTS  
INCORPORATION ACT 1958 (No. 6422)—*continued.*

No.	Price.
6240. Education ( <i>First Reprint</i> —Incorporating amendments up to No. 7533)	\$0.45
6241. Electric Light and Power ( <i>First Reprint</i> —Incorporating amendments up to No. 7315)	\$0.30
6242. Employers and Employés (Incorporating amendments up to No. 6740)	\$0.18
6243. Entertainments Tax ( <i>First Reprint</i> —Incorporating amendments up to No. 7315)	\$0.25
6245. Estate Agents Act ( <i>Third Reprint</i> —Incorporating amendments up to No. 7425)	\$0.50
6246. Evidence ( <i>Second Reprint</i> —Incorporating amendments up to No. 7366)	\$0.42
7499. Extractive Industries Act 1966 ( <i>First Reprint</i> —Incorporating amendments up to No. 7632)	\$0.35
6249. Fences (Incorporating amendments up to No. 6550)	\$0.12
6250. Fertilizers (Incorporating amendments up to No. 7142)	\$0.25
6251. Firearms ( <i>Second Reprint</i> —Incorporating amendments up to No. 7484)	\$0.40
6252. Fisheries Act ( <i>First Reprint</i> —Incorporating amendments up to No. 7389)	\$0.35
6916. Foreign Judgments Act 1962 ( <i>First Reprint</i> —including amendments made by No. 7332)	\$0.15
6585. Forests (Pulpwood Agreement) (Incorporating amendments up to No. 6886)	\$0.15
6254. Forests ( <i>First Reprint</i> —Incorporating amendments up to No. 7356)	\$0.60
6255. Friendly Societies ( <i>First Reprint</i> —Incorporating amendments up to No. 7554)	\$0.60
6256. Fruit and Vegetables ( <i>First Reprint</i> —incorporating amendments up to No. 6944)	\$0.30
6258. Game—( <i>First Reprint</i> —Incorporating amendments up to No. 7389)	\$0.30
6259. Gaols (Incorporating amendments up to No. 6651)	\$0.15
6260. Gas and Fuel Corporation ( <i>First Reprint</i> —Incorporating amendments up to No. 7422)	\$0.70
6261. Gas Regulation ( <i>First Reprint</i> —Incorporating amendments up to No. 7580)	\$0.30
6262. Geelong Harbor Trust ( <i>First Reprint</i> —Incorporating amendments up to No. 7547)	\$0.45
6263. Geelong Waterworks and Sewerage ( <i>First Reprint</i> —Incorporating amendments up to No. 7547)	\$0.75
6265. Goods ( <i>Third Reprint</i> —Incorporating amendments up to No. 7131)	\$0.35
6266. Grain Elevators ( <i>First Reprint</i> —Incorporating amendments up to No. 7486)	\$0.35
6270. Health ( <i>Second Reprint</i> —Incorporating amendments up to No. 7490)	\$1.65
6933. Home Finance Act 1962 ( <i>First Reprint</i> —Incorporating amendments up to No. 7363)	\$0.25
6274. Hospitals and Charities ( <i>Second Reprint</i> —Incorporating amendments up to No. 7455)	\$0.50
6275. Housing ( <i>First Reprint</i> —Incorporating amendments up to No. 7507)	\$0.85
6279. Instruments ( <i>Third Reprint</i> —Incorporating amendments up to No. 7315)	\$0.38
6282. Justices ( <i>Second Reprint</i> —Incorporating amendments up to No. 7369)	\$1.23
6283. Labour and Industry ( <i>Third Reprint</i> —Incorporating amendments up to No. 7410)	\$1.00
6284. Land (Incorporating amendments up to No. 7360)	\$1.53
6534. Land Settlement Act 1959 ( <i>First Reprint</i> —Incorporating amendments up to No. 7328)	\$0.30
6289. Land Tax ( <i>Second Reprint</i> —Incorporating amendments up to No. 7466)	\$0.40
6285. Landlord and Tenant ( <i>Third Reprint</i> —Incorporating amendments up to No. 7332)	\$0.68
6286. Lards Compensation—( <i>First Reprint</i> —incorporating amendments up to No. 7332)	\$0.25
6290. Latrobe Valley ( <i>First Reprint</i> —Incorporating amendments up to No. 7332)	\$0.35
6291. Legal Profession Practice ( <i>Second Reprint</i> —Incorporating amendments up to No. 7539)	\$0.70
6295. Limitation of Actions ( <i>Second Reprint</i> —Incorporating amendments up to No. 7457)	\$0.25
7145. Litter Act 1964 ( <i>First Reprint</i> —Incorporating amendments up to No. 7608)	\$0.15
6298. Local Authorities Superannuation (Incorporating amendments up to No. 6894)	\$0.25
6299. Local Government ( <i>Second Reprint</i> —Incorporating amendments up to No. 7689)	\$4.00
6302. Marine (Incorporating amendments up to No. 7350)	\$0.72
6301. Margarine Act ( <i>First Reprint</i> —Incorporating amendments up to No. 7714)	\$0.18

ACTS REPRINTED IN ACCORDANCE WITH THE AMENDMENTS  
INCORPORATION ACT 1958 (No. 6422)—*continued.*

No.	Price.
6304. Marketing of Primary Products ( <i>First Reprint</i> —Incorporating amendments up to No. 7491)	\$0.45
6306. Marriage ( <i>First Reprint</i> —Incorporating amendments up to No. 6959)	\$0.25
6309. Medical ( <i>Second Reprint</i> —Incorporating amendments up to No. 7408)	\$0.40
6310. Melbourne and Metropolitan Board of Works ( <i>Second Reprint</i> —Incorporating amendments up to No. 7547)	\$1.10
6311. Melbourne and Metropolitan Tramways ( <i>First Reprint</i> —Incorporating amendments up to No. 7622)	\$0.70
6312. Melbourne Harbor Trust ( <i>First Reprint</i> —Incorporating amendments up to No. 7356)	\$0.48
6605. Mental Health (Incorporating amendments up to No. 7135)	\$0.45
6315. Metropolitan Fire Brigades (Incorporating amendments up to No. 6886)	\$0.28
6316. Mildura Irrigation and Water Trusts ( <i>First Reprint</i> —Incorporating amendments up to No. 7448)	\$0.75
6317. Milk and Dairy Supervision (Incorporating amendments up to No. 6964)	\$0.40
6318. Milk Board (Incorporating amendments up to No. 7093)	\$0.22
6319. Milk Pasteurization ( <i>First Reprint</i> —Incorporating amendments up to No. 7480)	\$0.15
7840. Mines (Abolition of Courts)	\$0.30
6320. Mines ( <i>First Reprint</i> —Incorporating amendments up to No. 7499)	\$1.90
6184. Monash University ( <i>First Reprint</i> —Incorporating amendments up to No. 7533)	\$0.30
6324. Money Lenders (Incorporating amendments up to No. 6886)	\$0.25
6832. Motor Boating (Incorporating amendments up to No. 6961)	\$0.15
6325. Motor Car ( <i>Third Reprint</i> —Incorporating amendments up to No. 7777)	\$1.03
6326. National Parks (Incorporating amendments up to No. 7275)	\$0.25
6328. Nurses (Incorporating amendments up to No. 6716)	\$0.20
6330. Partnership ( <i>Second Reprint</i> —Incorporating amendments up to No. 7315)	\$0.25
6331. Patriotic Funds ( <i>First Reprint</i> —Incorporating amendments up to No. 7338)	\$0.25
6257. Pesticides Act 1968 ( <i>First Reprint</i> —Incorporating amendments up to No. 7595)	\$0.15
6889. Poisons Act 1962 ( <i>Second Reprint</i> —Incorporating amendments up to No. 7588)	\$0.50
6337. Police Offences ( <i>Second Reprint</i> —Incorporating amendments up to No. 7678)	\$0.28
6338. Police Regulation (Incorporating amendments up to No. 7081)	\$0.45
6340. Portland Harbor Trust ( <i>First Reprint</i> —Incorporating amendments up to No. 7475)	\$0.35
6341. Pounds ( <i>First Reprint</i> —Incorporating amendments up to No. 7315)	\$0.25
7494. Private Agents Act 1966 ( <i>First Reprint</i> —Incorporating amendments in No. 7646)	\$0.35
6890. Probate Duty Act 1962 ( <i>Second Reprint</i> —Incorporating amendments up to No. 7762)	\$0.48
6344. Property Law ( <i>Second Reprint</i> —Incorporating amendments up to No. 7750)	\$1.15
6349. Public Service ( <i>Second Reprint</i> —Incorporating amendments up to No. 7356)	\$0.40
6350. Public Trustee (Incorporating amendments up to No. 6961)	\$0.35
6353. Racing ( <i>Second Reprint</i> —Incorporating amendments up to No. 7691)	\$0.85
6355. Railways ( <i>First Reprint</i> —Incorporating amendments up to No. 7475)	\$0.75
6564. Registration of Births Deaths and Marriages Act 1959 ( <i>First Reprint</i> —Incorporating amendments up to No. 7332)	\$0.25
6359. Road Traffic ( <i>Second Reprint</i> —Incorporating amendments up to No. 7332)	\$0.18
6360. Rural Finance ( <i>First Reprint</i> —Incorporating amendments up to No. 7328)	\$0.15
6846. Rural Finance and Settlement Commission Act 1961 ( <i>First Reprint</i> —Incorporating amendments up to No. 7332)	\$0.30
2596. River Murray Waters Act 1915 ( <i>First Reprint</i> —Incorporating amendments up to No. 7061)	\$0.35
6917. Sale of Human Blood Act 1962 ( <i>First Reprint</i> —Incorporating amendments from No. 7332)	\$0.10
6975. Sale of Land Act 1962 ( <i>First Reprint</i> —Incorporating amendments up to No. 7332)	\$0.18

ACTS REPRINTED IN ACCORDANCE WITH THE AMENDMENTS  
INCORPORATION ACT 1958 (NO. 6422)—*continued.*

No.	Price
6363. Second-hand Dealers ( <i>First Reprint—Incorporating amendments up to No. 7529</i> )	\$0.25
6367. Settled Land ( <i>Second Reprint—Incorporating amendments up to No. 7065</i> )	\$0.50
6368. Sewerage Districts ( <i>Second Reprint—Incorporating amendments up to No. 7547</i> )	\$0.75
6651. Social Welfare Act 1960 ( <i>Third Reprint—Incorporating amendments up to No. 7332</i> )	\$0.20
6372. Soil Conservation and Land Utilization ( <i>Incorporating amendments up to No. 6961</i> )	\$0.20
6373. Soldier Settlement ( <i>First Reprint—Incorporating amendments up to No. 7328</i> )	\$0.42
6375. Stamps ( <i>Fourth Reprint—Incorporating amendments up to No. 7698</i> )	\$1.18
6377. State Electricity Commission ( <i>Second Reprint—Incorporating Amendments up to No. 7421</i> )	\$0.65
6378. State Relief Committee ( <i>First Reprint—Incorporating amendments from No. 6886</i> )	\$0.10
6379. State Savings Bank ( <i>Incorporating amendments up to No. 6886</i> )	\$0.42
6383. Stock Foods ( <i>First Reprint—Incorporating amendments up to No. 7607</i> )	\$0.28
6381. Stock and Share Brokers ( <i>First Reprint—Incorporating amendments up to No. 7444</i> )	\$0.15
6886. Subordinate Legislation ( <i>Incorporating amendments up to No. 6961</i> )	\$0.15
6386. Superannuation ( <i>First Reprint—Incorporating amendments up to No. 7417</i> )	\$0.60
6387. Supreme Court ( <i>First Reprint—Incorporating amendments up to No. 7522</i> )	\$0.75
6391. Teaching Service ( <i>First Reprint—Incorporating amendments up to No. 7536</i> )	\$0.35
4989. The Discharged Servicemen's Preference Act 1943 ( <i>First Reprint—Incorporating amendments up to No. 7788</i> )	\$0.20
7223. Tomato Processing Industry (Uniform Agreement) Act 1964 ( <i>First Reprint—Incorporating amendments up to No. 7342</i> )	\$0.15
6395. Tourist ( <i>First Reprint—Incorporating amendments up to No. 7335</i> )	\$0.15
6849. Town and Country Planning ( <i>Second Reprint—incorporating amendments up to No. 7819</i> )	\$0.55
6397. Trade Unions ( <i>First Reprint—Incorporating amendments up to No. 6839</i> )	\$0.20
6399. Transfer of Land Act ( <i>Third Reprint—Incorporating amendments up to No. 7551</i> )	\$0.65
6400. Transport Regulation ( <i>First Reprint—Incorporating amendments up to No. 7358</i> )	\$0.22
6401. Trustee ( <i>Second Reprint—Incorporating amendments up to No. 6963</i> )	\$0.42
6879. Unclaimed Moneys ( <i>Incorporating amendments up to No. 6961</i> )	\$0.12
6653. Valuation of Land Act 1960 ( <i>Second Reprint—Incorporating amendments up to No. 7333</i> )	\$0.22
6407. Vegetation and Vine Diseases ( <i>First Reprint—Incorporating amendments up to No. 7423</i> )	\$0.30
6409. Vermin and Noxious Weeds ( <i>First Reprint—Incorporating amendments up to No. 7463</i> )	\$0.35
6410. Veterinary Surgeons ( <i>First Reprint—Incorporating amendments up to No. 7343</i> )	\$0.15
7291. Victoria Institute of Colleges Act 1965 ( <i>First Reprint—Incorporating amendments up to No. 7644</i> )	\$0.25
6413. Water ( <i>Second Reprint—Incorporating amendments up to No. 7590</i> )	\$1.95
6414. Weights and Measures ( <i>Second Reprint—Incorporating amendments up to No. 7332</i> )	\$0.32
6416. Wills ( <i>First Reprint—Incorporating amendments up to No. 7238</i> )	\$0.25
6419. Workers Compensation ( <i>Third Reprint—Incorporating amendments up to No. 7455</i> )	\$0.65
6421. Youth Organizations Assistance ( <i>First Reprint—Incorporating amendments from No. 6651</i> )	\$0.10

## FIRST NOTIFICATION OF REPRINT.

6299. Local Government. New Parts X. and XI. (being a reprint of portion of No. 7835, as amended by No. 7847)	\$0.50
---	--------

A. C. BROOKS,  
Government Printer.

AGENTS FOR THE "VICTORIA GOVERNMENT  
GAZETTE".

THE following have been appointed agents to receive Advertisements and Subscriptions for the *Victoria Government Gazette*:—

ARMSTRONG'S AGENCY, 205 Queen-street, Melbourne, Victoria 3000.
ARNALL & JACKSON, 390 Barkly-street, Brunswick, Victoria 3056.
BAIRNSDALE AUTHORIZED NEWSAGENCY, 132 Main-street, Bairnsdale, Victoria 3875.
BICKNELL, M. J., Authorized Newsagent, 196 Timor-street, Warrnambool, Victoria 3280.
BLANE'S AUTHORIZED NEWSAGENTS, 162 Murray-street, Colac, Victoria 3250.
CARTER, R. G., ADVERTISING SERVICE PTY. LTD., Suite 24, 65 Queens-road, Melbourne, Victoria 3004.
DAVIES, G. & M. V., 112 Gray-street, Hamilton, Victoria 3300.
DAVIS, WM. (MILDURA) PTY. LTD., 126 Eighth-street, Mildura, Victoria 3500.
DIXON'S NEWSAGENCY, 89 Firebrace-street, Horsham, Victoria 3400.
EDGAR'S NEWSAGENCY PTY. LTD., 293 Hargreaves-street, Bendigo, Victoria 3550.
EDGARS' AUTHORIZED NEWSAGENCY, 45 Bridge-street, Benalla, Victoria 3672.
FRANKS, H., & CO., 184 Ryrrie-street, Geelong, Victoria 3220.
GATLEY, A. & J., 250 Lonsdale-street, Dandenong, Victoria 3175.
GORDON & GOTCH AUSTRALASIA LTD., 511 Little Collins-street, Melbourne, Victoria 3000.
GULLAN'S NEWSAGENCY, 88 Bridge-street, Ballarat, Victoria 3350.
HAMPTON, A. C., 243 Mitchell-street, Bendigo, Victoria 3550.
HARSTON, PARTRIDGE & CO. PTY. LTD., 455 Little Collins-street, Melbourne, Victoria 3000.
KYNETON GUARDIAN PTY. LTD., P.O. Box 18, Kyneton, Victoria 3444.
LATIMER'S, Newsagents, 45 Station-street, Malvern, Victoria 3144.
LIVINGSTON'S SHEPPARTON NEWSAGENCY, 246 Wyndham-street, Shepparton, Victoria 3630.
THE MERCANTILE EXCHANGE, 67 Queen-street, Melbourne, Victoria, 3000.
MCGILL'S AUTHORIZED NEWSAGENCY, 183-5 Elizabeth-street, Melbourne, Victoria 3000.
PHILLIPS AUTHORIZED AGENCY, 83 Murphy-street, Wangaratta, Victoria 3677.
PURDIE, J., & CO., 138 Moorabool-street, Geelong, Victoria 3220.
SALE AUTHORIZED NEWSAGENCY, 142 Raymond-street, Sale, Victoria 3850.
SKINNER'S AUTHORIZED NEWSAGENCY, 49-51 Franklin-street, Traralgon, Victoria 3844.
STEVENSON, A. C. & M., NEWSAGENTS, 132 Henty-street, Casterton, Victoria 3311.
VERNON, C. F. & H. J., 162 Bridge-road, Richmond Victoria 3121.
VIEW POINT AUTHORIZED NEWSAGENCY, 4 View-Point, Bendigo, Victoria 3550.

A copy of the *Gazette* filed at each place for public reference.

## PUBLICATION OF OFFICIAL MATTER.

ATTENTION is invited to the following procedure in relation to the publication of official matter in the *Government Gazette*:—

Publication will be facilitated by the submission of carbon copies for the use of the *Gazette* Officer.

1. *Matter submitted to the Executive Council.*

Matter submitted to the Executive Council which requires gazettal will normally be published in the issue of the following week.

Where urgent gazettal is required, special arrangements should be made with the *Gazette* Officer, Room 9, first floor, Old Treasury Building.

2. *Other matter.*

(a) All other matter duly certified by a responsible officer for publication should be lodged with the *Gazette* Officer not later than half-past Nine a.m. on Tuesday.

(b) Lengthy or involved notices should be forwarded several days before publication.

(c) Proofs, which will be supplied only when specifically requested or at the direction of the *Gazette* Officer, should be returned promptly to avoid delay in publication.

(d) No additions or amendments to matter for publication will be accepted by telephone.

THE "VICTORIA GOVERNMENT GAZETTE".

SUBSCRIPTIONS.—The subscription, including postage, is \$10 per annum, or \$5 per half year, payable in advance.

Subscriptions are required for whole months, and must cover at least a half year.

Single copies are 20 cents, posted 25 cents. Subscribers do not receive the Acts of Parliament with the GAZETTE.

GAZETTES are held in stock for five years only.

PRIVATE ADVERTISEMENTS.—The charge for insertion is 25 cents per line single column, and 50 cents per line double column. The title forms one or more lines as a heading. On an average ten words make a line of single column. Every signature must likewise be counted as a line. The final words of a paragraph, though only portion of a line, must be counted as one line. Signatures (in particular) and proper names must be written very plainly in the text; ONE SIDE ONLY of each sheet of paper should be WRITTEN UPON.

All documents illegibly written will be returned unpublished, and where brands occur unprovided for by the ordinary letters of the alphabet, a worded explanatory description must be furnished.

THE VICTORIA GOVERNMENT GAZETTE is published on WEDNESDAY EVENING in each week, and Notices for insertion will be received by the Government Printer at or before ONE p.m. at ordinary rates, and late advertisements between ONE p.m. and FOUR p.m. at double rates on the day preceding the day of publication.

PAYMENTS.—Unless the advertiser has a credit account, all payments are required in advance. Remittances should be made by cheque, postal order, or money order payable to "GOVERNMENT PRINTER".

ADDRESS.—All communications should be addressed to "The Government Printer, Box 203, P.O., North Melbourne", 3051.

CONTENTS

	PAGE
Acts of Parliament	4012
Acts of Parliament on Sale at the Government Printing Office	4049
Appointments	4023
Christmas and New Year Holidays	4013
Contracts	4021
Courts	4019
Estates of Deceased Persons	4022
Government Notices	4013
Impoundings	4049
Insolvency Notice	4049
Lands	4032
Mining	4013
Notices to Mariners	4013
Notice of Making of Statutory Rules	4049
Orders in Council—	
Acts—Land; Hospitals and Charities; Forests; Local Government; Country Roads; Housing; Motor Car; The Constitution Act Amendment.	et seq
Private Advertisements	4036
Proclamations	4009
Publication of the "Victoria Government Gazette"	4009
Public Service Notices	4035
Resignations	4025
State Rivers and Water Supply Commission	4021
Tenders	4034
Transport Regulation Board—Public Hearings	4014
Waterworks Trusts	4021