

[1397]



VICTORIA GOVERNMENT GAZETTE

Published by Authority

[Registered at the General Post Office, Melbourne, for transmission by post as a newspaper.]

No. 50]

WEDNESDAY, MAY 20

[1970

PROCLAMATIONS

Land Act 1958.

AREA OF LAND COMPRISED IN CERTAIN CLASSES DIMINISHED OR INCREASED.

PROCLAMATION

By His Excellency the Governor of the State of Victoria and its Dependencies in the Commonwealth of Australia,
&c., &c., &c.

WHEREAS by the *Land Act 1958* it is amongst other things enacted that the Governor in Council may, by Proclamation to be published in the *Government Gazette*, at any time diminish or increase the area of land comprised in any of the classes mentioned in Part I., Division 1, Section 5, of the said *Land Act 1958*, but that the area of lands which may be sold by auction (Class 6), shall not be increased except as in certain cases in the said Act provided: Now therefore I, the Governor of the State of Victoria, in the Commonwealth of Australia, by and with the advice of the Executive Council of the said State, and in accordance with the provisions of Sections 94 and 117 of the *Land Act 1958* aforesaid, do hereby diminish or increase (as the case may be) the areas of Crown lands comprised in Class 6 of the classes mentioned in Section 5 of the *Land Act 1958* aforesaid, to the extent set forth in the subjoined Schedule (that is to say):—

Schedule referred to.

CLASSES DIMINISHED OR INCREASED.

County.	Parish.	Allotment.	Section.	Area.	Diminished.	Increased.	Description.
					Class.	Class.	
				A. R. P.			
Bogong ..	Carlyle ..	37B	41	0 3 1	..	6	North of the Township of Rutherglen (H019689) In the East of the Parish
Karkaroc ..	Mildura ..	9	67 Block E	20 0 3	..	6	

Given under my Hand and the Seal of the State of Victoria, aforesaid, at Melbourne, this thirteenth day of May, in the year of our Lord One thousand nine hundred and seventy, and in the nineteenth year of the reign of Her Majesty Queen Elizabeth II.

(L.S.)

ROHAN DELACOMBE.

By His Excellency's Command,

W. J. F. McDONALD,
Minister of Lands.

GOD SAVE THE QUEEN!

FARM PRODUCE MERCHANTS AND COMMISSION-
AGENTS (AMENDMENT) ACT 1969.

DATE OF COMING INTO OPERATION.

PROCLAMATION

By His Excellency the Governor of the State of Victoria and its Dependencies in the Commonwealth of Australia, &c., &c., &c.

WHEREAS by an Act of Parliament of the State of Victoria passed in the eighteenth year of the reign of Her Majesty Queen Elizabeth II entitled the *Farm Produce Merchants and Commission Agents (Amendment) Act 1969*, it is amongst other things enacted that the several provisions of the said Act shall come into operation on a day or the respective days to be fixed by proclamation or successive proclamations of the Governor in Council published in the *Government Gazette*:

Now therefore, I, the Governor of the State of Victoria, in the Commonwealth of Australia, by and with the advice of the Executive Council of the said State, do by this my proclamation fix Wednesday, the first day of July, One thousand nine hundred and seventy as the day on which the several provisions of the said *Farm Produce Merchants and Commission Agents (Amendment) Act 1969* shall come into operation.

Given under my Hand and the Seal of the State of Victoria aforesaid, at Melbourne, this thirteenth day of May, in the year of our Lord One thousand nine hundred and seventy, and in the nineteenth year of the reign of Her Majesty Queen Elizabeth II.

(L.S.) ROHAN DELACOMBE.

By His Excellency's Command,

G. L. CHANDLER,
Minister of Agriculture.

GOD SAVE THE QUEEN!

Health Act 1958 (No. 6270).

EXTENSION OF THE PORT FAIRY MEAT AREA.

PROCLAMATION

By His Excellency the Governor of the State of Victoria and its Dependencies in the Commonwealth of Australia, &c., &c., &c.

BY virtue of the powers conferred by the *Health Act 1958* (No. 6270), I, His Excellency the Governor of the State of Victoria in the Commonwealth of Australia, on the recommendation of the Commission of Public Health and by and with the advice of the Executive Council of the said State, do by this my Proclamation extend the Port Fairy Meat Area so as to include the whole of the municipal district of the Shire of Belfast.

Given under my Hand and the Seal of the State of Victoria aforesaid, at Melbourne, this thirteenth day of May, in the year of our Lord One thousand nine hundred and seventy, and in the nineteenth year of the reign of Her Majesty Queen Elizabeth II.

(L.S.) ROHAN DELACOMBE.

By His Excellency's Command,

VANCE DICKIE,
Minister of Health.

GOD SAVE THE QUEEN!

LOCAL GOVERNMENT DEPARTMENT.

PROCLAMATION EXTENDING THE OPERATION OF THE
UNIFORM BUILDING REGULATIONS

By His Excellency the Governor of the State of Victoria and its Dependencies in the Commonwealth of Australia, &c., &c., &c.

WHEREAS Section 916 of the *Local Government Act 1958*, provides—*inter alia*—that the Governor in Council may, by proclamation published in the *Government Gazette*, at the request of the Council of any municipality (not being a city or town) extend the operation of Part XLIX of the said Act to the municipal district of such municipality or any part thereof:

And whereas by Proclamation published in the *Government Gazette* on the 18th October 1967 the operation of the said Part was extended to parts of the municipal district of the Shire of Ballan.

And whereas the Council of the Shire of Ballan has requested that the operation of the said Part be extended to a further part of the municipal district of the Shire of Ballan.

Now therefore, I, the Governor of the State of Victoria by and with the advice of the Executive Council thereof, by this, my Proclamation, do hereby extend the operation of the Regulations made under Part XLIX of the *Local Government Act 1958*, to the portion of the municipal district of the Shire of Ballan described hereunder:

"Those portions of the Parish of Blackwood included within Crown Sections 6, 8, 9A, 10, 11, Crown Allotments 2A, 3A, 4, 5, 6, 7, 8, 9, 10, 11, 12, 13, 14, 15, 16, 17, 18, 19A, 20, 20A, 21, 21c, 22c, 23c, 23, all of no section, and Crown Sections 6 and 7, Town of Greendale, County of Bourke."

And order that the said Regulation shall come into operation in the above described part of the municipal district of the Shire of Ballan on publication of this Proclamation in the *Government Gazette* provided that parts I and II of Chapter 8 thereof shall be deemed not to come into operation till the 20th August, 1970 except in so far as may be necessary to enable the Council of the said municipality to make by-laws pursuant to the powers conferred by Part III of the said Chapter and provided further that no such by-law shall come into operation before the 20th August, 1970.

Given under my Hand and the Seal of the State of Victoria aforesaid, at Melbourne, this thirteenth day of May, in the year of our Lord One thousand nine hundred and seventy, and in the nineteenth year of the reign of Her Majesty Queen Elizabeth II.

(L.S.) ROHAN DELACOMBE.

By His Excellency's Command,

R. J. HAMER,
Minister for Local Government.

GOD SAVE THE QUEEN!

CARRIERS AND INNKEEPERS (AMENDMENT) ACT
1970, No. 7971.

DATE OF COMING INTO OPERATION.

PROCLAMATION

By His Excellency the Governor of the State of Victoria and its Dependencies in the Commonwealth of Australia, &c., &c., &c.

WHEREAS by an Act of Parliament of the State of Victoria passed in the nineteenth year of the reign of Her Majesty Queen Elizabeth II, intituled the *Carriers and Innkeepers (Amendment) Act 1970* (No. 7971) it is amongst other things enacted that the several provisions of the said Act shall come into operation on a day to be fixed by proclamation of the Governor in Council published in the *Government Gazette*:

Now therefore I, the Governor of the State of Victoria in the Commonwealth of Australia, by and with the advice of the Executive Council of the said State do by this my proclamation fix Monday, the first day of June, One thousand nine hundred and seventy as the day on which the whole of the said *Carriers and Innkeepers (Amendment) Act 1970*, No. 7971, shall come into operation.

Given under my Hand and the Seal of the State of Victoria aforesaid, at Melbourne, this thirteenth day of May, in the year of our Lord One thousand nine hundred and seventy, and in the nineteenth year of the reign of Her Majesty Queen Elizabeth II.

(L.S.) ROHAN DELACOMBE.

By His Excellency's Command,

A. G. RYLAH,
Chief Secretary.

GOD SAVE THE QUEEN!

GOVERNMENT NOTICES

PUBLIC HOLIDAY.—QUEEN'S BIRTHDAY.

IT is hereby notified that on—

MONDAY, THE 15TH JUNE, 1970,

the Public Offices will be closed, such day having been appointed by the Public Service Act 1958, to be observed as a holiday in the Public Offices throughout the State of Victoria.

This notice relates only to the closing of the State Public Offices. All inquiries regarding the holiday in other offices and in shops and industry should be directed to the Department of Labour and Industry, 110 Exhibition-street, Melbourne, 3000. (Telephone 63 0321, Extension 6158, 6721 or 6859.)

A. G. RYLAH,
Chief Secretary's Office, Chief Secretary.
Melbourne, 18th May, 1970.

PUBLIC TRUSTEE ACT 1958 (No. 6350), SECTION 17.

I HEREBY give notice that on the 30th April, 1970, the Public Trustee filed elections to administer the following deceased persons' estates in accordance with section 17 of the Public Trustee Act 1958:—

KELLEHER, WILLIAM JAMES JOSEPH, late of 14 Yardley-street, Maidstone, sheet metal worker, died 14th February, 1970.

I HEREBY give notice that on the 6th May, 1970, the Public Trustee filed elections to administer the following deceased persons' estates in accordance with section 17 of the Public Trustee Act 1958:—

CTIBOR, SVAVOJ, late of Flat 3, 109 Manningham-street, West Parkville, cook, died 25th October, 1969.

EDGEELL, RUTH GRAHAM, late of 51 Canberra-street, Brunswick, school teacher, missionary, died 27th October, 1969.

MCLEAN, WILLIAM HUGH, also known as Hugh McLean, late of 24 Odessa-street, St. Kilda, retired gardener, died 13th December, 1969.

TIVENDALE, WILLIAM HENRY, formerly of 14 Nichol-street, East Preston, but late of 93 Canterbury-road, Middle Park, retired chauffeur, died 24th March, 1970.

N. P. BRODY,
Public Trustee.
256 Flinders-street, Melbourne, 3000, 13th May, 1970.

NOTICE.

CREDITORS, next of kin and others having claims against the estate of any of the under-mentioned deceased persons are required to send particulars of their claims to the Public Trustee, 256 Flinders-street, Melbourne, Vic. 3000, the personal representative, on or before the 27th July, 1970, after which date the Public Trustee may convey or distribute the assets, having regard only to the claims of which the Public Trustee then has notice:—

ATKINSON, THOMAS, late of 52 Wood-street, Mary Port, Cumberland, England, retired representative, died 2nd August, 1967.

BROWN, ADA ALMA, late of 50 Gordon-street, Alphington, widow, died 6th March, 1970.

CASTELLI, ACHILLE SALVATORE, late of 106 Ivanhoe-parade, Ivanhoe, ward attendant, died 20th January, 1970.

COLLEY, FLORENCE MAY, late of 23 Allan-street, Berwick, widow, died 20th January, 1970.

COWMEADOW, DORIS LILLIAN, also known as Doris Cowmeadow, late of School-road, Ferny Creek, married woman, died 20th February, 1970.

COX, HARRY JAMES, late of 52 Park-street, Abbotsford, retired masseur, died 24th January, 1970.

CTIBOR, SVAVOJ, late of Flat 3, 109 Manningham-street, West Parkville, cook, died 25th October, 1969.

DANKS, HENRY JOSEPH, formerly of 8 De Carle-street, Coburg, but late of 8 Clifton-grove, Coburg, retired carpenter, died 18th November, 1969.

EDGEELL, RUTH GRAHAM, late of 51 Canberra-street, Brunswick, school teacher, missionary, died 27th October, 1969.

ENGDAL, ARNE PEDER, late of 8 Emilton-avenue, St. Kilda, rigger, died 4th August, 1968.

FELLOWS, BERTHA ALICE DAISY, late of 9 Rae-street, Hawthorn, home duties, died 14th December, 1969.

FINNIGAN, MAY, late of 47 Chute-street, Mordialloc, widow, died 13th September, 1969.

FRANZI, ALICE EILEEN, also known as Alice Franzi, formerly of 43 Austral-avenue, Preston, but late of Plenty-road, Bundoora, spinster, died 2nd July, 1969.

GALLAGHER, AGNES NANCY, also known as Agnes Gallagher, late of Mont Park, widow, died 2nd January, 1970.

GRAHAM, BRUCE ROBINSON, late of 3 Evon-avenue, East Ringwood, contractor, died 7th January, 1970.

GRANT, ETHEL MARGARET, formerly of Main-road, Selby, but late of 21A William-street, Abbotsford, widow, died 16th January, 1970.

HARGREAVES, IVY GERTRUDE MARY, also known as Irene Hargreaves, Ivy May Hargreaves and Louis Mary James, late of 8 Boonan-street, Springvale, widow, died 25th January, 1970.

KELLEHER, WILLIAM JAMES JOSEPH, late of 14 Yardley-street, Maidstone, sheet metal worker, died 14th February, 1970.

KENNEDY, EILEEN, late of Wattle-street, Manangatang, widow, died 5th July, 1969.

KING, PERCY, formerly of 30 Donald-street, Highett, but late of Cheltenham Home and Hospital for the Aged, Cheltenham, retired carpenter, died 16th December, 1969.

LIGHTFOOT, OLIVE CLARE, formerly of 33 Reid-street, Beaumaris, but late of Bethlehem Hospital, Caulfield South, widow, died 20th December, 1969.

MCLEAN, WILLIAM HUGH, also known as Hugh McLean, late of 24 Odessa-street, St. Kilda, retired gardener, died 13th December, 1969.

O'CONNELL, HONORAH, late of 137 Maribymong-road, Ascot Vale, spinster, died 24th March, 1969.

ROBINSON, DIAMOND JENNESS, formerly of Hokianga, New Zealand, but late of Wellington, New Zealand, formerly school teacher, but latterly civil servant, died 27th June, 1969.

STEEL, EDWARD VICTOR, also known as Edwin Victor Steel, late of 47 Felix-crescent, Ringwood, driver, died 23rd October, 1969.

TIVENDALE, WILLIAM HENRY, formerly of 14 Nichol-street, East Preston, but late of 93 Canterbury-road, Middle Park, retired chauffeur, died 24th March, 1970.

WELLINGTON, ERIC GORDON, late of 1 Bischoll-street, West Preston, retired plan recorder, died 19th January, 1970.

N. P. BRODY,
Public Trustee.
Melbourne, 13th May, 1970.

Victoria.

SHIRE OF GLENELG.

ROAD DEVIATION ORDER.

IN pursuance of the powers conferred by sections 522 and 526 of the Local Government Act 1958, the Council of the Shire of Glenelg doth hereby direct that the land in the Parish of Killara shown hatched on the plan hereunder shall be used as a Public Highway after the date of publication of this Order in the Government Gazette and doth hereby direct that such land shall be a highway in lieu of the land in the said Parish of Killara shown cross-hatched on the said plan.

Dated this twentieth day of April, 1970.

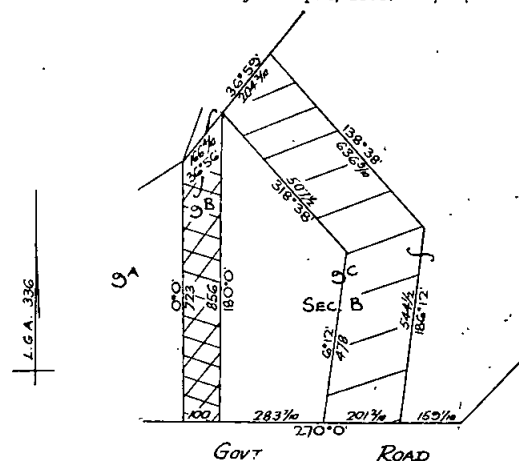

THE LAND SHOWN HATCHED AND CROSS-HATCHED WAS ON 12-2-1969 CONTAINED IN 4/63 V-2838 F-433 AND V-2405 F-824 RESPECTIVELY.

The common seal of the President, Councillors and Ratepayers of the Shire of Glenelg was hereunto affixed, in the presence of—

C. M. CARMICHAEL, President.
S. W. HILLIER, Councillor.
E. N. WIDDICOMBE, Acting Secretary.

Confirmed by the Governor in Council, 13th May, 1970.
—J. ROSSITER, Clerk of the Executive Council.

Transport Regulation Act.
TRANSPORT REGULATION BOARD.
 HEARING OF APPLICATIONS.

NOTICE is hereby given that the following applications will be considered by the Transport Regulation Board at its offices at the corner of Lygon and Princes streets, Carlton, at 10.15 a.m., on Wednesday, 3rd June, 1970.

BELL STREET BUS CO. PTY. LTD., 326 Bell-street, Preston. Application for a required number of commercial passenger vehicles with large seating capacity to operate as metropolitan stage omnibuses on a route as follows:—Westbreen-Coburg via Oak Park and Pascoe Vale. Commencing at the corner of Northumberland-road and Rhodes-parade, Westbreen via Rhodes-parade, Watt-avenue, Snell and Nerissa groves, Devon, Northumberland and Fawkner roads, Railway-parade, Gaffney, Cope, O'Heas; Gilmour and Bell streets to a stand on the north side of Bell-street, east of Sydney-road. Turning procedure at Westbreen to be via Pascoe-street, Lake-avenue and Northumberland-road to Rhodes-parade. Turning procedure at Coburg to be via Bell-street, Elm-grove, Urquhart-street, Drummond-street to Bell-street. Sections, fares and time-table to be determined. Subject to the cancellation of existing M.O. licences operating on Route 6A Part B (Westbreen-Olive-grove via Pascoe Vale).

LATROBE VALLEY BUS LINES, 2-10 Ryan-street, Morwell. Application to vary licence No. T.S.1019 to include the ability to operate as a country special service omnibus with a pick up radius of one (1) mile of Thorpdale.

McHARRY, A. M. & N. J., 23 Catherine-street, Geelong West. One commercial passenger vehicle (S/C. 41) to operate under the same terms and conditions as licence No. C.O.941 in the name of Geelong Associated Buses Pty. Ltd.

SMITH, J. H., 101 Wyndham-street, Shepparton. Application to vary licence No. T.P.67 to include the ability to operate tours from Shepparton to the Shepparton Preserving Company and to prominent orchards that supply Shepparton Preserving Company with fruit.

SOUTHLAND BUS SERVICE PTY. LTD., corner Keys and Kilpa roads, Moorabbin. Application for variation of C.O. licence conditions on Route 218A (Moorabbin-Heather-ton Sanatorium-Cheltenham-Clayton) to operate a school service from the corner of Old Dandenong-road and Norwood-street to the Heather-ton State School via Norwood-street, Washington-drive and Old Dandenong-road to the school.

Sections.

1. Corner Old Dandenong-road and Norwood-street—Corner Old Dandenong-road and Bunny's-lane.
2. Corner Old Dandenong-road and Bunny's-lane—Garner's property.
3. Garner's property—Heather-ton State School.

TIME-TABLE (School Days Only).

Depart corner Old Dandenong-road and Norwood-street—8.30 a.m.

Depart School—3.30 p.m.

TENTAU, N. J., Dereel. One commercial passenger vehicle (S.C. 17) to operate for the carriage of school children only between Dereel and Rokewood, under contract to the Education Department.

APPLICATION for renewal of licences as shown, by persons listed hereunder to operate under the same terms and conditions.

ALTONA BUS LINES PTY. LTD., 13 Slough-road, Altona West; M.O.34, M.O.38, M.O.53, M.O.54, M.O.55, M.O.72, M.O.130, M.O.164, M.O.256, M.O.279, M.O.287, M.O.605, M.O.644, M.O.648, M.O.655, M.O.685.

DYSONS, L. C., Bus Service Pty. Ltd., 753 Plenty-road, Reservoir; M.O.681.

FOOTSCRAY DELPHIC TAXIS PTY. LTD., The Manager, 38 Geelong-road, Footscray; M.H.946, M.H.947, M.H.952, M.H.1245, M.H.1329.

IMPERIAL CHEMICAL INDUSTRIES OF AUSTRALIA AND NEW ZEALAND LTD., 1 Nicholson-street, Melbourne; T.P.28.

KOOROORA CHALET PTY. LTD., Alpine Village, Mount Buller; T.P.171.

MALIKOUN, A., 79 Davies-street, Brunswick; M.T.4204.

MARTIN, S. J. H., 106 Christmas-street, Northcote; M.T.435.

MASTOS, E., 79 Thomson-street, South Melbourne; M.H.4014.

MEE, R. E. & B. E. (trading as Mee's Bus Lines), 1 Percy-street, West Heidelberg; M.C.409.

McGEARY'S PARLOR COACHES PTY. LTD., 207 New-street, Brighton; M.C.28, M.C.29, M.C.30, M.C.31, M.C.526, M.C.600.

PLUMMER, K. D. & W. S., 11 Whyte-grove, Mont Albert; M.C.430.

SHEPHARD, B. F., 6 Well-street, Middle Brighton; M.T.1332.

SHIPSIDES, C. L., 10 McPherson-street, Regent; M.H.1867.

SINCLAIR, A. J. & M., 249 Glen Eira-road, Caulfield; M.T.777,

M.T.780, M.T.1124.

WRIGHT, N. Y. (Mrs.), 426 Balcombe-road, Beaumaris;

M.C.12, M.C.13, M.C.605.

YIANNI, G., 20 Folkstone-street, Glen Waverley; M.T.1724.

APPLICATIONS by the persons listed hereunder, each for the issue of a Suburban Taxi licence to operate in the Zone as shown, in lieu of each existing M.H., C.T. or C.H. licence held by the persons named.

Zone "A".

ANKER, J. M.	LIVISSIANOS, G.
ARMSTRONG, G. W.	LOTT, L. S.
ATKINSON, K. R.	LUFF, W. H.
BEASLEY, A. A.	MAGLARAS, C.
BEASLEY, S. C.	MALONEY, O.
BLACHFORD, A. L.	MASTOS, E.
BLACKKEY, J. C.	MILLS, E. A. K.
BOEHM, R. A.	MOSES, H.
BOURNE, F. B.	MCDONELL, W. A.
CAULFIELD, G. B.	NOTMAN, R. C.
CLARKE, S. M.	ORCHARD, D. R.
CONNELLAN, K. G.	OVISS, F.
CONNOR, F. R.	PARASKEVAS, E.
COURBETIS, A.	PHILLIPS, E.
DARAXOGLU, A.	PUGLIESE, P.
DURSO, C.	PUGLIESE, R.
FERGUSON, K.	REBROVIC, A.
FISHER, L. G.	RICHARDSON, G. W.
FORSYTH, R. S.	SHAW, R.
GAMBETTA, N. C.	SKEAT, R. P.
GIDDENS, W. H.	SOLOMON, L. D.
GILDER, R. F.	SORBELLO, S.
GLEN, R. V.	SPARKS, C. C.
GONTOPOULOS, G.	SPILBERG, A. H.
HARRIS, M.	SULLIVAN, V. J.
HEWISH, J.	TAYLOR, M. A.
JENKINS, A. C.	WHINFIELD, J. A.
KLUGER, H. K.	WHITE, R. B.
KOUKOUNAS, G.	WHYTE, A. J.
KOUTLEMANIS, D.	WILSON, C. J. P.
LEE, N. F.	

Zone "B".

AUSTIN, A. J.	KELLY, W. M.
BARRY, V. J.	KENNEDY, J.
BERTA, B.	KIRK, H. A.
BRETT, F. A.	KLOOGER, K. B.
BROWN, E. S.	KUPFER, R.
BRYAR, C. J.	LYNCH, E.
BURNS, K. W.	McCOY, J. P.
BYERS, G. J.	MACDONALD, J. E.
BYERS, H. H.	McFARLANE, R. A.
CAULFIELD, G. M.	McGEARY, G. A.
CHERNY, H.	McINERNEY, J. C.
CHRISTENSEN, J. W.	MACQUIRE, D. E.
CLOUTANG, D. E.	MANSFIELD, G. A.
COLES, J. M.	MAVROS, G.
COLLINS, W. J.	MENDELOVITS, M. I.
CONSTANDELLOS, A.	MICALLEF, P.
CONSTANDELLOS, S.	MILES, A. G.
COOPER, O. E.	MONCREIFF, C. W.
CORBETT, B. S.	MORGAN, R. W.
COWEN, A. B.	MORRIS, P. D.
CROFT, R. M.	MORTIMORE, B.
CUMMINS, A. A.	NEWMAN, F. D. J., Jnr.
CUMMINS, B. J.	NOLAN, L. G.
DJANKOVIC, A.	NORRIS, C. T.
DOLPHIN, W. A.	Ogilvie, N. F.
DONOVAN, M. E.	O'HALLORAN, J. A.
DORMAN, B. S.	PAPADOPOULOS, A.
DRUCKER, H.	PAULING, T.
DUNN, G. F.	PARKER, R. J.
EASTMAN, J. D.	PHILLIPS, A. L.
EDWARDS, E. D.	POPE, E. C.
ESPIE, A. A.	POWELL, R. E.
FELDHEIM, I.	PRATT, D. F.
FENECH, L. J.	PRITCHARD, O. F.
GAMBAS, G.	RAYNOR, A. M. A.
GEORGE, C.	RENDALL, D. A.
GORS, W. C.	ROBINSON, H. E.
HADEN, G. W.	ROSSON, P. F.
HARDEMAN, L. J.	ROWE, G. R.
HART, W. D.	ROZEN, E.
HODSON, W. F.	RUDD, F. S.
HOLLINGWORTH, W. J.	SEARCHFIELD, A.
JONES, R. W.	SENIOR, C. I. H.
KEITH, M. P.	SHATTER, H.
KELLY, J. J.	SHAW, L. V.

Zone "B"—continued.

SHAW, W. R.
SIEGEL, O. B.
SKOCZEK, K.
SMYTH, J. F.
STEER, D. E.
STEWART, S.
STOKES, R. A.
TALBOT, W. H.
TAYLOR, E. M., Mrs.
TAYLOR, K. A.
TRICKEY, P. L.

Zone "C".

ANDRICOPOULOS, P.
BALDOCK, C. C., Jnr.
BALDOCK, C. C.
BANKS-SMITH, G. A., Mrs.
BERRY, C. F.
BIBBY, R. S.
BODY, J. T.
CARVER, L. F.
CIVITELLA, B.
CLEARY, N. F.
CLEMENTS, C. A. J.
CLYNES, M. J.
COCHRANE, W. J.
CRANBOURNE, N.
DARWALL, K. A.
DAVEY, R. H. W.
DAVID, R. E.
D'ENYAR, M. W., Mrs.
DICKINSON, J. G.
FARNELL, R. P.
FOTINIOTIS, P.
FRANKLIN, A. J.
GOONAN, A. D.
GOW, N.
GROVER, H. & D. E.
HEDGER, E. S.
HEIB, K. A.
HILL, R.
HODGES, B. F.
HUME, C. J. D.
HUXTABLE, K. H.
IPAVEC, E.
KALIDOUDIS, X.
KIRBY, N. G.
KARANTZOULIS, D.
KOUBIVOLIS, D.
KORFIATIS, N.
LANDER, P.
LANGFORD, K. A.
LOCKE, V.
LOTHERINGTON, E. R., Est. of
LOWE, W. S.
LYONS, H. W.
LYTRAS, G. L.

Zone "S".

BARAGWANATH, V.
BERTA, B.
BETHELL, C. J.
BOLTON, A.
BRADD, G. F.
CHANCE, L. J.
CONWAY, B. W.
DONOVAN, M. E.
HANISCH, A. A.
HARDEMAN, C. L.
JONES, V. W.
LAMBERT, A. H.
LEWIS, I. M.
LIDDELL, J. C.

Zone "E".

ANDRETTA, A.
ARMSTRONG, S.
BAILEY, L.
BARKER, J. S.
BARNETT, S. J.
BATCH, R. C.
BECIC, S.
BLYTHE, A. J.
BROMAGE, R. H.
BROWN, J. A.
BUCCI, S.
CHETCUTI, I. M.
COX, C. J.
CRANSTON, W. G.
CROFTS, D. H.
CUMMINGS, A. M.
DALEY, J. A.
EASTON, M. J.
ELLIOTT, R. C.

TSAOUSIDIS, A.
VAN DER KRANS, W.
WATSON, D. G.
WEIGHT, A.
WHITTAM, W.
WILLMOTT, G. J.
WISE, J. R.
WYNN, H.
ZELTNER, H.
ZIGAS, T.
ZMOOD, R.

MAY, R. S.
MCDONALD, A. D.
MCVEIGH, W. W.
MACALISTER, W. N.
MACARTNEY, J. F.
MESINZ, R.
MIDDLETON, S. E.
MIFSUD, E. H.
MOUTAFIS, D.
NELSON, M. A.
NIKOLETOS, X.
NUGENT, D. J. & J. E.
O'HARE, R. B.
O'SHEA, C. D. V.
PARKER, A. C.
PARTRIDGE, A. J.
PEARCE, E. I.
PHILLIPS, R. G.
PETRONIO, S.
PETERSON, T. B.
PICKEN, D. W.
PORTER, T. W.
POUZOULIS, A.
REID, R. A. J.
REKER, R. G.
ROGERS, G. J. C.
RYAN, D. N.
SANGSTON, G. L. F.
SCHNABEL, S.
SEVADEI, A.
SHANNON, E. M.
SMITH, W. J.
SNEESBY, S. G.
SPIRASON, T.
SZREJDER, J.
TAIT, K. K.
TZIOUVELIS, B.
VINEN, L. H.
WANZENBOECK, G.
WATSON, B. H.
WATSON, C. J.
WILLIAMS, A. J.
WIMBORNE, H.
WRIGHT, D. F.

MARRIOTT, S. G.
MCGUIRE, J. E.
MEADE, J. J.
MOONEY, J. E.
MORTIMORE, B.
OLSEN, K.
ROBERTS, A. T. A.
RONEY, J. M.
RUST, J. W. C.
SHAW, L. V.
STANCER, A. L. & A. R.
TAYLOR, K. A.
WALL, A. E.

EVANS, J. K.
FAIMAN, J. J.
FRANK, W.
GABRIEL, G.
GIALELLIS, G.
GIDLEY, R. R. G.
GONDPOULOS, C.
GREEN, N.
HAMMETT, A. G.
HANCOX, C. A.
HATSIMONOLIS, K.
HORKINGS, R. L.
HYAMS, M. E., Mrs.
JACOBSON, P.
JENKINS, J. H.
JENKINS, W. E.
JENSEN, R. N.
JUPP, M. J.
KAGAN, J. W.

KING, G. A. K.
LEWIS, D. B.
LYNCH, F. A.
MAISEL, F.
MALOUF, R. F.
MANDEMAKER, W. J.
MILSOM, D. G.
MINSTER, W. A.
MOFFITT, A. D.
MACLEAN, K. J.
MCCURRIE, W.
MCCOLL, A. J.
O'DONOHUE, M.
PERKINS, G. A.
PETER-BUDGE, W. J.
PETERSEN, S. A.
PETERSON, K. F.
PRESTON, O.
REID, J. B.
RYAN, R. E.
SCHWIND, L. J.

ABRAHAMS, L. M.
ARMSTRONG, N. T.
BERMAN, M.
BRIZZI, R. G.
BROWN, L. J.
CLOSTER, B. A.
CUNNINGHAM, N. J. R.
DASHWOOD, L. L.
DE ANGELIS, A.
DIXON, L. P.
FITZSIMONS, A. L.
GENTLE, A. J.
GRIFFIN, R. K.
HOLT, K. P.
HURLEY, D. R.
HURREN, J. M.
HURREN, M. G.
JONES, R. T., Mrs.
KELLEHER, J. T.
KERY, K.

BAYLISS, J. C.
BROWN, J. M.
CANT, K. R.
CUZENS, R. C. & D. M.
DONOVAN, G.
FLOOD, R. S.
FLOOD, R. S. & F. M.
HAM, K. E. & A. R.
JOHNSON, G. W.
KESSON, C. J.
MAY, K. O.
MILNE, R. C. & E. J.
MILNER, T. J.

BENNETT, H. W.
BRAIN, C. A.
CARSON, P. J.
CINCOTTA, D.
COLE, S. J. R.
CORNELL, R. J.
CRONIN, L. G.
CUMMINGS, T. P.
CUMMINS, J.
DAVIES, T. W.
DUVIANI, S.
ENSABELLA, A.
FORD, A. R.
FOX-CROFT, N. G. R.
GALEA, P.
GAY, M. W.
GRENNELL, J. P.
HEATHCOTE, N. L.
HESKETH, W. J.
HITTI, N.
JEBSON, R. G.
JUBBER, C. S.
KHODER, J.
LACEY, H.
LOW, D. R.
LOWTHER, J. H.
MCDONALD, A. T.
MARSHALL, R. G.
MARTIN, G. R.
MATTHIES, H. C.
MURPHY, R. B.
MURRAY, K. T.
NICHOLS, G. R.
PANGRAZZI, R.

Zone "E"—continued.

SCOBIE, L. J.
SEIKIS, A.
SHAW, D. G.
SHEEN, W. R.
SIMKO, J.
SMITH, H. W.
SMITH, L. G.
STANFIELD, K. S.
SEPSAKOS, P.
THORP, R. E.
TOLL, R. A.
WERNERT, R. J.
WHITELAW, I. B.
WICKER, D. L.
WILLIAMS, F.
WILLIAMS, R. G. S.
WILLIAMSON, E. F. J.
WOLF, E.
WOODS, T. J.
YOUNG, R. D.

Zone "T".

LOY, J. R.
MOLLOY, J. W.
NAJIM, F.
OXNAM, F. G.
PAGE, F. H.
PINKERTON, W. F. J.
RAWICKI, A.
RAWLINSON, J.
ROBERTSON, J. R.
ROGERS, T.
RUSSELL, K. S.
SCHERPF, H.
SCHIPP, R. L.
SMITH, A. R.
SMITH, C. W.
STRATTON, G. F.
UR, B.
WOOD, N. K.
WOOLLEY, G. D.
ZEMEL, T.

Zone "R".

MILNER, T. J. & V. A.
MCMURRAY, W.
O'CONNOR, M. L. & M. A.
PACKER, G. G.
PENDERGAST, R. N. & D. E.
PHILLIPS, W. C. A.
PHILLIPS, W. C. A. & J. L.
PINK, T. S.
PLUIM, L.
PLUIM, M. H.
TUBMAN, J.
VON DER LIPPE, P. D.
YOUNG, G. E. B.

Zone "N".

PAPAVASSILOU, E.
PAPAKOTSIAS, E.
PAYNE, H. W.
PEAKE, C. M.
PERUGIA, R. E. G.
PINKNEY, R. J.
PINKNEY, V. T.
PLOTKIN, I.
SANFILIPPO, G.
SCHOTTLER, H. P.
SEARLE, J. K. M.
SIDNEY, B. D.
STAVROU, C.
STREET, S. B.
SZAPORA, S.
TODD, D. A.
TOMBS, J. H.
TRAYNOR, M. L.
USTICK, W. A.
WALSH, J. E.
WHITFIELD, T. B.
ANTHONSEN, N. I.
ARMSTRONG, E. R.
BAHO, A.
BARR, V. A.
BENNS, J. R.
BISHOP, W. A.
BLACK, A. G.
BOAG, E. A.
BOLLARD, R. F.
BRAZIER, C. N.
BROWN, R. B.
BURGOYNE, W. F.
CARLYON, J. B.

Zone "N"—continued.

CELLI, A. C.
 CERINI, J. L.
 CHAPMAN, F. C.
 CHRISTIE, G. B.
 CHRISTOPOULOS, G.
 CLARKE, R. J.
 COCHRAN, B. E.
 COLSON, E. F.
 CONDICK, H. E.
 CRAWFORD, R. J.
 CRAWFORD, W. R.
 CROMBIE, R. O.
 DAISLEY, P. P., Mrs.
 DANIELS, R. T.
 DEBATTISTA, J.
 DOO, R.
 DOYLE, W. J.
 EDWARDS, F. W.
 EICENS, J.
 ENGLISH, P. T.
 EVANS, R. A.
 FILES, J. W.
 FRANGOS, C. W.
 GEDLING, K. M.
 GLOSTER, J. A.
 GODFREY, D.
 GRAFF, V. E.
 GRIMES, J. V.
 HALEY, L. W.
 HODSON, R.
 HUTCHINSON, B. I.
 ISSA, T. M.
 JACK, A.
 JACKSON, J. W.
 JONES, A. H.
 KING, J. H.
 LANGFORD, M. A.
 LEAHY, G. L., Miss.
 LEGGE, A. J. G.
 LINDSAY, D. G. T.
 LOGAN, J.

Zone "J".

AGG, F. R.
 ALDER, J. L.
 ANDERSON, A. J.
 ARCHIBALD, D. T.
 AUSTIN, D. G.
 BAKER, S. J.
 BARLOW, A. R.
 BARRY, I. J.
 BAUER, A. U. L.
 BRAIN, J. E.
 BRENNAN, J. A.
 BURLISON, A. R.
 CAMILLER, F. C.
 CARR, R. H.
 CONNOR, T. J.
 DAVIS, H. C.
 DINEEN, B. H. J.
 DOWLING, B. M.
 DUNSTAN, N. O.
 ELIADES, C.
 ELLIS, D.
 ELLIS, G.
 FIRER, J. L.
 FRYLINK, J.
 GAY, W. M.
 GEE, D. L.
 HANCOCK, R. K.
 HART, J. S.
 HENDERSON, D. H.
 HENDERSON, W. J.
 JONES, A.

Zone "K".

AINALIS, E.
 ANDERSON, C. C.
 ANDERSON, D. A.
 ASHWEIRTH, W. B.
 BALTAS, P.
 BLACK, S.
 BLAKEY, H. V.
 BOURKE, V. V.
 BROWN, R. A.
 BUCHANAN, G. T.
 CAMERON, K.
 CHENHALL, J. T.
 CHRISANT, C.
 CLYMO, J. C.
 CONNELLY, J. F.
 COOK, R. A.
 COOKE, K. J.
 COOPER, W. L.

LYNDON, H. S.
 MACKENZIE, P. A. K., Mrs.
 MASON, L. R.
 MERLO, J. G.
 MICHAELIDES, C.
 MORROW, L. J.
 NAGEL, W. R.
 NELSON, K. P.
 O'GRADY, W. J.
 PAPA KYRIAKOPOULOS, K.
 PARK, N. J.
 PAUWELS, D. L.
 PYRROS, J.
 RANK, R. A. W.
 REGAN, R. B.
 REVELY, E. T.
 ROUMANOS, P.
 SHEPHERD, S. W.
 SHIPSIDES, C. L.
 SMART, V. R.
 SMITH, C. E.
 SMITH, W. H.
 STAMMERS, R. R.
 STEVENS, D. H.
 STRATFORD, N. E.
 THOMSON, P. W. J.
 THOMPSON, W. J.
 TOUSSAINT, C. A.
 TRON, S. B.
 TROTTA, A.
 TROTTO, A. D.
 TSEROS, D.
 VARRASSO, F.
 VERGA, S.
 VERNON, E. F.
 WALTERS, D.
 WILMOT, F. R.
 WILSON, J. B.
 WINDRAM, G. J.
 WOON, A.
 YOUNG, R. C.

Zone "K"—continued.

HILL, C. W.
 JANUSIK, W.
 JESENSEK, L.
 KOUGIAS, C.
 LANGE, M. A.
 LEONARD, J.
 MCINTYRE, R. M.
 MACALISTER, A. F.
 MAROT, K.
 MARRIOTT, A. T. G.
 MATHESON, O. H.
 MERRITT, M. G.
 MOLONEY, B. F.
 MULLENGER, J. W. C.
 MURNANE, D. A.
 NEW, H. G. V.
 OLIVER, J. E.
 PARSONS, R. E.
 POINT COOK-WERRIBEE PAS-
 Senger Service Pty. Ltd.
 POTTLE, A. F.
 POWELL, W. J.
 PRESTON, J. T.
 PYERS, R. S.
 REID, A. L.

ROBERTS, V. F.
 RODGERS, S.
 SBOUNIAS, V.
 SCHIER, R. N.
 SHIELDS, C. E.
 SMITH, R. L.
 THOMAS, H. A.
 UBL, V.
 VADAS, A.
 VANSTON, J. D.
 VARSAMAKIS, A.
 VIOLARIS, J.
 VOGAN, N.
 WALDRON, W. R.
 WAY, N. D.
 WEBB, F. G. H.
 WELSH, C. E.
 WHELDON, P. N.
 WHELAN, B. V.
 WILLIAMS, R. V.
 WILSON, H. V.
 WRIGHT, W. N.
 YACOB, F.
 ZERPINO, G.

APPLICATIONS by persons listed hereunder each to operate one commercial passenger vehicle with seating capacity for five (5) persons as a country taxi cab at Springvale/Noble Park/Dandenong. (Zone "Z").

ALKEMADE, T., 117 Langhorne-street, Dandenong.
 ALLEN, C. W., 7 Peppermint-street, Doveton.
 AMATO, F., 34 Ross-street, Westgarth.
 BATTISCOMBE, N. W., 1 David-street, Dandenong.
 BOOTH, A. E., 5 Windsor-avenue, Springvale.
 CAMERON, A. J., 4 Easterleigh-court, Dandenong.
 COOK, T. A., Flat 11, 35 Herbert-street, Dandenong.
 CORTIE, J. F., 10 Latham-crescent, Dandenong.
 CRIPPS, P. M., Flat 6, 60 Potter-street, Dandenong.
 DAVIDSON, I. L., 6 Hakea-street, Doveton.
 DICKINSON, J. L. & B. L., 3 Ingrid-street, Dandenong.
 DOYLE, V. W., 7 Ash-street, Doveton.
 EVERETT, D. J., Lot 37, Wallarano-drive, Noble Park.
 HAMILL, M. J., 1 Ian-grove, East Oakleigh.
 HAYRES, L. P., 35 Canberra-avenue, Dandenong.
 HINE, R. K., 86 McFees-road, Dandenong.
 HOXHA, N. S., 21 Rebecca-street, Doveton.
 IDE, G. L., 30 Menzies-avenue, Dandenong.
 KENDY, J., Flat 16, 11 Balaclava-road, Balaclava.
 MANKS, G. E., 28 James-street, Dandenong.
 MORRISON, J., 34 Prior-road, Noble Park.
 MCKINNON, G. E., 210 Power-road, Doveton.
 NASH, T. N., 8 Bergins-road, Rowville.
 O'DELL, D. W., Boundary-road, Braeside.
 O'SHEA, J. V., 7 Yileen-court, Ashwood.
 PATCHING, L. A., 3 Dorothy-court, Clayton.
 POULTON, A. V., 67 Beauford-street, Huntingdale.
 RICKARDS, G. H., 24 Ora-street, Hampton Park.
 RIDDIFORD, W. F., 56 Chandler-road, Noble Park.
 SAVVA, A., Lot 129, Denver-crescent, Rowville.
 STREETS, R. F., 2 Sabine-street, Dandenong North.
 THIEL, J. & P., 124 Gladstone-road, Dandenong.
 THORNE, R. R., 27 Lawn-road, Noble Park.
 TOWNER, L. J., 10 Cornwall-street, Hallam.
 WARE, T. E., 47 View-road, Springvale.
 WHITE, I. C., Cadles-road, Carrum Downs.
 WILLIAMS, R. M., 54 Stud-road, Dandenong.
 WRIGHT, D. F., 6 Gatum-court, Noble Park.
 ZONNEVELDT, J. M., 187 Gladstone-road, Dandenong.

Notice of any objection should be forwarded to reach the Secretary of the Board not later than Monday, 1st June, 1970.

Applicants are advised that it will not be necessary to appear on the hearing date specified above, unless advised in writing by the Board.

B. P. KAY,
 Secretary.

Corner Lygon and Princes streets, Carlton, Wednesday, 20th May, 1970.

Commercial Goods Vehicles Act.
 TRANSPORT REGULATION BOARD.
 HEARING OF APPLICATIONS.

NOTICE is hereby given that the following applications will be considered by the Transport Regulation Board at its offices at the corner of Lygon and Princes streets, Carlton, at 10.15 a.m. on the 17th June, 1970.

- ALUSTIZA, J., P.O. Box 509, Morwell, 3840. One commercial goods vehicle (L/C. 150 cwt. approx.) to operate from forest and private landings situated within a 25-mile radius of the premises of Australian Paper Manufacturers Ltd. at Maryvale to the said premises at Maryvale—pulpwood.
- AUSTRALIAN PAPER MANUFACTURERS LTD., 4 South Gate, South Melbourne, 3205. Two commercial goods vehicles (L/C. 14 cwt. each) to operate throughout the State of Victoria in course of business as "Paper Manufacturers"—own engineering supplies, logging and forestry equipment road making equipment and supplies required for use in connexion with own forestry, logging and limestone quarrying projects.
- AUSTRALIAN PAPER MANUFACTURERS LTD., 4 South Gate, South Melbourne, 3205. One commercial goods vehicle (L/C. 14 cwt.) to operate throughout the State of Victoria for the purposes of servicing and maintaining own machinery—tools of trade, spare parts and incidental forestry supplies, with the proviso that all spare parts carried are for on site servicing and maintenance only.
- BANDAG COLD TREAD PROCESS (VIC.) PTY. LTD., 490-492 Geelong-road, West Footscray, 3012. Application to vary the conditions of licence No. D.A.58176/9 (L/C. 25 cwt.) by deleting the present conditions and adding in lieu—"Within a 50-mile radius of own depot at Bendigo and to and from Charlton and Shepparton and places en route in course of business as 'Tyre Distributors' and 'Tyre Reconditioners'—new tyres and tubes and tyres and tubes for reconditioning or having been reconditioned with proviso that all new tyres and tubes are to be initially consigned by rail to Bendigo and that all tyres for reconditioning or having been reconditioned are to be consigned by rail through Bendigo or the nearest railway to the customer."
- BEATON, P. H. D., Flat 2, Forest-lane, Bendigo, 3550. Application to vary the conditions of licence No. D.A.62127 (L/C. 203 cwt.) by deleting the existing conditions and adding in lieu—"Within a 50-mile radius of the plant of Readymix Group (Vic.) at Bendigo in a specially constructed agitator vehicle solely on behalf of the said company—premixed concrete."
- BENSTEAD, G. J., 13 Beauty-avenue, Mt. Beauty, 3699. One commercial goods vehicle (L/C. 103 cwt.) to operate: (a) Within a 25-mile radius of the post office at Mt. Beauty—general goods, provided that no goods shall be carried whether by one stage or by more than one stage between places within the above radius which are more than thirty (30) road miles apart by the nearest practicable route. (b) Within a 50-mile radius of own depot at Mt. Beauty as an "Agent" on behalf of B.P. Co. of Australia Ltd.—petroleum products in prescribed types of containers and empty return containers.
- BEVERIDGE, H. R., 91 Wanda-street, Springvale North, 3170. One commercial goods vehicle (L/C. 226 cwt.) to operate within a 35-mile radius of the G.P.O., Melbourne on behalf of Consolidated Quarries Ltd.—sand, soil, screenings, premix and quarry materials.
- CARSTEIN, R. J., 55 Lafayette-street, Traralgon, 3844. One commercial goods vehicle (L/C. 174 cwt.) to operate: (a) From forest and private landings situated within a 25-mile radius of the premises of Australian Paper Manufacturers Ltd. at Maryvale to the said premises at Maryvale—pulpwood. (b) From forest and private landings situated within a 15-mile radius of the post office situated at Heyfield to the premises of Australian Paper Manufacturers Ltd. at Maryvale—pulpwood. (c) From forest and private landings situated within a 10-mile radius of the post office situated at Noojee to the premises of Australian Paper Manufacturers Ltd. at Maryvale—pulpwood. (d) From forest landings situated within a 5-mile radius of the post office situated at Matlock to the premises of Australian Paper Manufacturers Ltd. at Maryvale—pulpwood.
- CHRISTAKIS, V. & S. J., 21 Harlington-street, Clayton, 3168. One commercial goods vehicle (L/C. 140 cwt. approximately), to operate within a 35-mile radius of the G.P.O., Melbourne on behalf of Consolidated Quarries Ltd.—sand, soil, screenings premix and quarry materials.
- CLARKE, R. J., Private Bag 20, Rupanyup, 3388. One commercial goods vehicle (L/C. 248 cwt.) to operate: (a) Within a 50-mile radius of the post office at Rupanyup as a "Road Contractor"—road-making plant and materials. (b) Within a 25-mile radius of the post office at Rupanyup—general goods provided that no goods shall be carried whether by one stage or by more than one stage between places within the above radius which are more than thirty (30) road miles apart by the nearest practicable route.
- DENHAM, A. J., 4 Rainbow-road, Warracknabeal, 3393. One commercial goods vehicle (L/C. 10 cwt. and 40 cwt. trailer) to operate within a 50-mile radius of the post office at Warracknabeal in the course of business as "Motor Body Repairers"—own goods, wrecked, damaged or disabled vehicles for wrecking purposes or for repair or having been repaired, but excluding the ability to attend the scene of an accident.
- DENT & SONS PTY. LTD., Princes Highway, Warragul, 3820. Two commercial goods vehicles (L/C. 9 cwt. and 18 cwt.) to operate: (a) Goods associated with own approved decentralized secondary industry (manufacture of Dent Pumping Plant) at Warragul as follows:—(i) To own factory of such decentralized industry at Warragul from the Metropolitan area as defined in the *Transport Regulation Act 1958* and to or from own branch premises at Korumburra and Bairnsdale—raw materials and other goods required solely for use in the manufacturing process of such decentralized industry. (ii) From the said factory at Warragul to the said Metropolitan area and also to branch premises at Korumburra and Bairnsdale—own manufactured articles and products of such decentralized industry. (b) Within a 50-mile radius of the post office at Warragul in the course of business as "Merchants and Agents"—own agency lines. (c) For the servicing of own manufactured equipment and also of agency lines in the Gippsland area east of a line drawn north and south through the Township of Drouin—tools of trade, spare parts and incidental servicing equipment.
- DONOHUE, K. N., Hardings-road, Wallington, 3221. One commercial goods vehicle (L/C. 14 cwt.) to operate within a 50-mile radius of the chief post office in the City of Geelong in the course of business as a "Carpet Laying Contractor"—tools of trade and small quantities of carpet for laying purposes only.
- DRYSDALE, D. W., 32 Raglan-street, Sale, 3850. Application to vary the conditions of licence No. D.A.42234/2 (L/C. 228 cwt.) by deleting the existing conditions and adding in lieu—"Within a 50-mile radius of the post office at Sale in course of business as 'Fuel Merchant and contractor'—own briquettes and gravel."
- FAYLE'S MOTORS PTY. LTD., 65 Clifton-street, North Balwyn, 3104. One commercial goods vehicle (L/C. 199 cwt.) to operate within a 50-mile radius of the G.P.O., Melbourne on behalf of Consolidated Quarries Ltd.—premixed concrete in a specially constructed agitator vehicle.
- FLETCHER, B. T., 45 Coppards-road, Newcomb, 3219. Application to vary the conditions of licences numbered D.A.53030, D.A.53030/2, D.A.53030/3, D.A.53030/4 and D.A.53030/5 by deleting from the existing conditions "solely on behalf of A. V. Jennings Industries (Australia) Ltd."
- FORSYTH CARPET SERVICES PTY. LTD., 39 Huntingdale-road, Burwood, 3125. One commercial goods vehicle (L/C. 10 cwt.) to operate throughout the State of Victoria in course of business as "Contract Carpet Layer"—tools of trade, equipment, and floor coverings for laying purposes only.
- GEE, A. D., Carroll's-road, Bullengarook, 3437. One commercial goods vehicle (L/C. 258 cwt.) to operate from forest landings and private properties at Bullengarook to General Paper Mills Pty. Ltd. at Brooklyn—pulpwood logs.
- GERRISH, A. D., Woods Point-road, Warburton East, 3799. One commercial Goods vehicle (L/C. 117 cwt.) to operate: (a) Within a 70-mile radius of the post office at Healesville (Dandenong Division of the Country Roads Board)—road contracting plant used in the construction or maintenance of a road, street, footpath, bridge, wharf, pier, weir or channel. (b) Within a 20-mile radius from site of construction or maintenance work performed pursuant to paragraph (a) above, or from the railway station nearest thereto—metal, stones, screenings, ashes, gravel, sand, earth and any other materials required for such work.
- GOICOA, V., care of P.O., Neerim Junction, 3831. One commercial goods vehicle (L/C. 160 cwt. approximately) to operate from places situated within a 10-mile radius of any point on the Natural Gas Pipeline Constructed by Snam Progetti (Aust.) Ltd. between Dandenong and Trafalgar to the site of the said pipeline—materials necessary for the maintenance and repair of the pipeline easement solely when operating under contract to the said company.
- GREEN, H., 5 Hastings-street, Boronia, 3155. Application to vary the conditions of licence No. D.A.62644 (L/C. 11 cwt.) by deleting the existing conditions and adding in lieu—"Within a 50-mile radius of the G.P.O. in the City of Melbourne solely on behalf of Fabtile Industries Pty. Ltd.—tools of trade, imitation brick facing battens, fixing materials and insulating materials."

- HALL, C. E., "Goodwin", Ombersley, via Winchelsea, 3241. One commercial goods vehicle (L/C. 10 cwt.) to operate throughout the State of Victoria in the course of business as a "Herd Tester"—herd testing gear and equipment.
- HAVLICEK, M., 21 Gillies-street, Benalla, 3672. Application to vary the conditions of licence No. D.T.228 (L/C. 256 cwt.) by deleting the present conditions and adding in lieu—"From forest landings situated within a 50-mile radius of the post office at Mansfield to sawmills situated in the township of Mansfield and City of Benalla—sawmill logs."
- HEENAN, W. T., 167 Liddiard-road, Traralgon, 3844. One commercial goods vehicle (L/C. 273 cwt.) to operate from forest and private landings situated within a 25-mile radius of the post office situated at Traralgon—(i) To the premises of Duff's Sawmill at Morwell—mill logs. (ii) To the premises of Kent's Sawmill at Longwarry—mill logs. (iii) To the premises of the State Electricity Commission of Victoria at Bairnsdale—poles.
- HOWELL, B. E., 15 Mills-street, Heyfield, 3858. Application to vary the conditions of licence No. D.T.583/4 (L/C. 217 cwt.) by adding to the existing conditions—"Within a 50-mile radius of Heyfield as a loader in course of business as 'Logging Contractors'—own logging equipment and own earth-moving equipment and earth-moving equipment on behalf of other contractors."
- JOHNSON, P. G. (trading as Johnson & Sibly), 8 Rudds-road, Korumburra, 3950. One commercial goods vehicle (L/C. 139 cwt.) to operate: (a) Within a 50-mile radius of the post office situated at Korumburra as a "Road Contractor"—road-making plant and materials. (b) Within a 20-mile radius of the site of any construction or maintenance work performed pursuant to paragraph (a) above or from the railway station nearest thereto—any other materials required for such work.
- K.M.M. PTY. LTD., 461 Bourke-street, Melbourne, 3000. One commercial goods vehicle (L/C. 200 cwt.) to operate: (a) Within a 50-mile radius of own premises at Kensington in the course of business as "Stockfeed and Flour Millers" in a specially constructed bulk vehicle—own goods in bulk. (b) From own premises at Kensington to places within that part of an 80-mile radius of the G.P.O. Melbourne, situated east of a line drawn due north and south through the City of Melbourne and to the City of Morwell—own bulk stockfeed in a specially constructed bulk unit.
- LEHMANN, M. M., 72 Darlot-street, Horsham, 3400. Application to vary the conditions of licences numbered D.A.61524 and D.A.61524/1 (L/C. 56 and 10 cwt.) by deleting the present conditions and adding in lieu—"Within that part of the State of Victoria bounded by a north/south line drawn through the Town of St. Arnaud, south of a line drawn east/west through the Town of Rainbow, north of a line drawn east/west through the City of Ararat and to the South Australian border in course of business as 'Wholesale Distributor'—own agency lines and biscuits on behalf of Nabisco Pty. Ltd. Depot at Horsham, subject to the condition that all such goods carried on the vehicle shall have been initially consigned by rail to Horsham."
- MAREILLE CARPET EXPERTS, 48 Berkshire-road, North Sunshine, 3020. One commercial goods vehicle (L/C. 17 cwt.) to operate within a 50-mile radius of own premises at North Sunshine as a "Contract Carpet Layer"—tools of trade, floor coverings for laying purposes only, and materials incidental to completion of such contracts.
- MARSHALL, R. & K. F., Private Bag 2, Neerim, 3821. Application to vary the conditions of licence No. D.A.18834/1 (L/C. 164 cwt.) by deleting from the existing conditions paragraph (b) and adding in lieu—"From and to places situated within the City of Melbourne and within a distance of 8 miles from the corporate limits thereof and from the premises of Foodlands Pty. Ltd. at Glen Waverley and/or the premises of Rocla Concrete Pipes Ltd. at Springvale and/or Thermal Traders (Vic.) Pty. Ltd. at Dandenong and/or David Mitchell Estate Ltd. at Lilydale directly by the route referred to hereunder to and from the Townships of Yarra Junction, Powelltown and points within a 5-mile radius of the post office situated at Neerim and places situated within two (2) miles of the main road between the aforesaid Townships—general goods."
- MASON, R. S., 47 Richardson-street, Portland, 3305. One commercial goods vehicle (L/C. 274 cwt.) to operate: (a) Within a 25-mile radius of the post office at Portland—general goods provided that no goods shall be carried whether by one stage or by more than one stage between places within the above radius which are more than thirty (30) miles apart by the nearest practicable route. (b) From and to places in paragraph (a) above, to and from places within a 50-mile radius of the post office at Portland—livestock.
- JONES, C. H. (trading as Melton Transport Service), Western Highway, Melton, 3337. One commercial goods vehicle (L/C. 30 cwt.) to operate: (a) Within a 20-mile radius of the post office at Melton—general goods. (b) Within a 50-mile radius of the depot of Shell Co. of Aust. Ltd. at Newport—petroleum products in prescribed types of containers and empty return containers solely on behalf of the said company.
- MILLS, G. D., 25 Palm Beach-crescent, Oakleigh East, 3166. One commercial goods vehicle (L/C. 8 cwt.) to operate throughout the State of Victoria in course of business as "Contract Carpet Layer"—tools of trade, equipment and floor-coverings for laying purposes only.
- McKEE, J. B., 106 Melbourne-street, Mulwala, N.S.W., 2647. One commercial goods vehicle (L/C. 247 cwt.) to operate: (a) Within a 50-mile radius of the post office at Yarrowonga as a "Road Contractor"—road-making plant and materials. (b) Within a 20-mile radius from the site of any construction or maintenance work performed pursuant to paragraph (a) above or from the railway station nearest thereto—any other materials required for such work. (c) Within a 25-mile radius of the post office at Yarrowonga—superphosphate.
- MYER SOUTHERN STORE LTD. (trading as Myer Ballarat), 301 Sturt-street, Ballarat, 3350. One commercial goods vehicle (L/C. 14 cwt.) to operate within that part of the State of Victoria bounded on the east by a line drawn north and south through the Cities of Geelong and Bendigo on the north by a line drawn east and west through the Cities of Bendigo and Horsham and on the west by an irregular line extending in a north-westerly direction from the City of Warrnambool to the City of Hamilton and from thence in a northerly direction to the City of Horsham for the purposes of completing carpet laying contracts—tools of trade and floor coverings for laying purposes only.
- NORMAN, A. & E. J., Wy Yung via Bairnsdale, 3875. Application to vary the conditions of licence No. D.T.678/1 (L/C. 262 cwt.) by adding to paragraph (d) of the existing conditions after the words "sawmills of Collins and Sons at Bairnsdale" "and Stratford".
- PARFETT, L. K., 3 Burgess-street, Horsham, 3400. One commercial goods vehicle (L/C. 8 cwt. approximately) to operate within that part of the State of Victoria west of a north/south line drawn through the City of Ballarat in the course of business as "Carpet Contractor"—tools of trade, carpet tiles and lino for laying purposes only.
- PARK AVENUE LAUNDRY & DRY CLEANERS PTY. LTD., 8 Peace-avenue, Warragul, 3820. Three commercial goods vehicles (L/C. 9, 19 and 11 cwt.) to operate within a 50-mile radius of the post office situated at Sale and between Stratford, East Sale, Sale, Maffra and Warragul in the course of business as "Launders and Dry Cleaners"—articles for laundering or dry cleaning or having been laundered or dry cleaned and own cleaning equipment and cleaning materials.
- PARKER, G. J., Box 15, Colac, 3250. One commercial goods vehicle (L/C. 140 cwt. approximately, car carrying unit to be purchased) to operate: (a) From the premises of General Motors Holden's Pty. Ltd. at Melbourne to the premises of Henderson Motors Pty. Ltd. at Colac, Parker Bros. Motor Co. Colac and Parker Bros. Auto Co. Warrnambool—new motor cars from General Motors Holden's Pty. Ltd. (b) From motor dealers in the Cities referred to in paragraph (a) to the City of Melbourne—second-hand motor cars.
- PHILLIPS, D. G., 175 Commercial-road, Yarram, 3971. One commercial goods vehicle (L/C. 10 cwt.) to operate throughout the State of Victoria as a Mortuary Vehicle in the course of business as "Funeral Director".
- REPANIS, G. & E., 633 High-street, East Kew, 3102. One commercial goods vehicle (L/C. 156 cwt.) to operate within a 35-mile radius of the G.P.O., Melbourne solely on behalf of Consolidated Quarries Ltd.—sand, soil, screenings, premix and quarry materials.
- RICE, D. S. G., 44 Lawson-street, Essendon, 3040. One commercial goods vehicle (L/C. 7 cwt.) to operate throughout the State of Victoria in the course of applicants business as "Marine Collector"—marine goods as designated in the *Marine Stores and Old Metals Act 1958* (No. 6303), but excluding the carriage of any such goods to wharves, docks or ships for shipment or export purposes.

NOTE.—The combined load capacities of the prime mover and any trailer attached thereto shall not exceed 120 cwt.

- ROWLANDS ASPHALT PTY. LTD.**, 87 High-street, Prahran, 3181. One commercial goods vehicle (L/C. 50 cwt.) to operate: (a) Within a 50-mile radius of own premises at Clayton in the course of business as "Quarrymasters and Road Contractors"—own goods. (b) Throughout the State of Victoria—tools of trade and road-making plant and equipment. (c) Within a 20-mile radius of the site of any contract currently engaged upon or from the railway station nearest thereto—materials for use on such contracts. This application replaces licence No. D.A.58955 held in the name of Rowlands Asphalt Pty. Ltd.
- SILLERY ELECTRICS PTY. LTD.**, 7 Market-court, Reservoir, 3073. One commercial goods vehicle (L/C. 11 cwt.) to operate: (a) Within a 50-mile radius of the G.P.O., Melbourne in course of business as "Electrical Contractor"—tools of trade and electrical goods for repair or having been repaired. (b) Throughout the State of Victoria in course of business as "Electrical Contractor"—tools of trade, electrical switch boards for installation and a quantity of fittings and spare parts not exceeding one hundredweight (1 cwt.) at any one time incidental to installation and repair work.
- SIMPSON, R. J.**, 8 Cartledge-way, Sale, 3850. One commercial goods vehicle (L/C. 205 cwt.) to operate within a 50-mile radius of the plants of Pioneer Concrete (Vic.) Pty. Ltd. at Morwell, Sale and Bairnsdale solely on behalf of the said company—premixed concrete in a specially constructed agitator vehicle.
- SKADINS, J.**, 7 Nebel-street, Lalor, 3075. One commercial goods vehicle (L/C. 173 cwt.) to operate within a 70-mile radius of the premises of The Barkly Brick Co. Pty. Ltd. at Brunswick on behalf of the said company—bricks.
- SMITH, A. W.**, 18 Carr-street, Shepparton, 3630. One commercial goods vehicle (L/C. 10 cwt. and 25 cwt. trailer) to operate: (a) Within a 100-mile radius of the post office at Shepparton in the course of business as "Amusement Machine Hirer"—own coin amusement machines for repair or having been repaired, spare parts and servicing equipment. (b) Within a 50-mile radius of the post office at Shepparton in the course of business as "Clothing Manufacturer"—own fabrics and materials. (c) Within a 50-mile radius of the post office at Shepparton in the course of business as "Advertising and Distribution Agent"—fruit juices, empty return bottles and cases. (d) Within a 50-mile radius of the post office at Shepparton on behalf of Cyclone K.M. Products—glazed aluminium windows and fly-wire doors.
- SOLOMON, A. W.**, 23 George-street, Oakleigh, 3166. One commercial goods vehicle (L/C. 159 cwt.) to operate: (a) Within a 70-mile radius of the post office at Healesville (Dandenong Division of the Country Roads Board)—road contracting plant used in the construction or maintenance of a road, street, foot-path, bridge, wharf, pier, weir or channel. (b) Within a 20-mile radius from site of construction or maintenance work performed pursuant to paragraph (a) above or from a railway station nearest thereto—materials required for such work. (c) Within a 25-mile radius of the post office at Oakleigh—general goods, provided that no goods shall be carried whether by one stage or by more than one stage between places within the above radius, which are more than thirty (30) road miles apart by the nearest practicable route.
- STEPHEN, J.**, Won Wron, 3844. Application to vary the conditions of licence No. D.A.41382/1 (L/C. 141 cwt.) by deleting the existing conditions and adding in lieu:—"Within a 50-mile radius of the post office at Won Wron in the course of business as 'Marine Collector'—special wares, marine stores and old metals as designated in the *Marine Stores and Old Metals Act 1958*, No. 6303, Part 1, Section (3) but excluding the carriage of any such goods to wharves, docks or ships for shipment or export purposes".
- SUTHERLAND, A. P.**, TYRES PTY. LTD., 175 Sturt-street, South Melbourne, 3205. One commercial goods vehicle (L/C. 13 cwt.) to operate within that part of the State of Victoria bounded on the west by a north/south line drawn through the Township of Hallam on the north by an east/west line drawn through the township of Warburton and the Eastern Border of the State of Victoria in the course of business as "Automotive Tyre Distributors and Retreaders"—automotive tyres for retreading with the proviso that the said tyre may only be carried to the Railway Station nearest to the point where the tyres are picked up.
- TERRILL, J. S.**, 12 Johnson-drive, Ferntree Gully, 3156. Application to vary the conditions of licence No.

D.A.61773 (L/C. 160 cwt.) by adding to the existing conditions as paragraph (b)—"Within a 25-mile radius of the G.P.O. Melbourne—general goods."

- WEBB, A. J.**, Yambuk, 3285. One commercial goods vehicle (L/C. 39 cwt.) to operate:—(a) Within a 50-mile radius of the post office at Yambuk in the course of business as "Garage Proprietor and General Store"—own goods. (b) Within a 25-mile radius of the post office at Yambuk—general goods subject to the condition that no goods shall be carried whether in one or more stages from any one point within the said radius to any other point within the said radius situated more than thirty (30) miles apart by the nearest and most practicable route.
- WIFFEN, D. G.**, 6 Fenwick-street, Portarlington, 3223. One commercial goods vehicle (L/C. 198 cwt.) to operate within a 50-mile radius of the chief post office in the township of Bacchus Marsh solely on behalf of Ready Mixed Concrete Victoria Pty. Ltd.—premixed concrete in a specially constructed agitator vehicle.
- WOOLLARD, S. D.**, 3 Boxley-grove, Box Hill North, 3129. One commercial goods vehicle (L/C. 137 cwt.) to operate within a 70-mile radius of the premises of "The City Brick Works Co. Pty. Ltd." at Scoresby on behalf of the said company—bricks.
- WOOLWORTHS (Vic.) LTD.**, 300 Albert-street, Brunswick, 3056. One commercial goods vehicle (L/C. 121 cwt.) to operate within a 25-mile radius of own premises at Brunswick and to and from the Mornington Peninsula, Healesville and Geelong in course of business as "General Merchants and Retailers" in a specially constructed refrigerated vehicle—frozen processed vegetables, frozen poultry, frozen meat, frozen fish, frozen prepared meals, frozen pastry lines, cheese, butter and margarine with the proviso that no more than a total of 20 cwt. of margarine, butter and cheese may be carried on the vehicle at any one time.

RENEWALS.

- APPLICATIONS** for renewal of licences as shown by persons listed hereunder to operate under the same terms and conditions from the expiry shown in each case.
- ABBOTT, C. H.**, 6 Tallowwood-street, Frankston, 3199; D.A.60138; 29th August, 1970; 6 cwt.
- BRINSMEAD, R. H.** (trading as Agricultural and Domestic sprays), 36 Menin-road, Nunawading, 3131; D.A.10588/18; 26th July, 1970; 58 cwt.
- ASCOM PTY. LTD.**, 63 Queensbridge-street, South Melbourne, 3205; D.A.34589/51; 12th September, 1970; 163 cwt.
- ASCOM PTY. LTD.**, 63 Queensbridge-street, South Melbourne, 3205; D.A.34589/52; 12th September, 1970; 12 cwt.
- BABCOCK & WILCOX AUST. LTD.**, 84 William-street, Melbourne, 3000; D.A.32605/1; 22nd September, 1970; 16 cwt.
- BALLARAT METAL PTY. LTD.**, 1600 Hume Highway, Campbellfield, 3061; D.A.23741/5; 11th August, 1970; 167 cwt.
- BARCLAY, C. A.**, King William-street, Broadmeadows, 3047; D.T.754; 29th August, 1970; 130 cwt.
- BATTEL, A.**, 23 Salisbury-street, Orbst, 3888; D.T.670; 29th August, 1970; 415 cwt.
- BENDIGO DE LUXE CATERING SERVICE PTY. LTD.**, Woodbury House, McIvor-road, Bendigo, 3550; D.A.30962/6; 27th August, 1970; 65 cwt.
- BENNETT, W. A., & Co. PTY. LTD.**, 197 High Street-road; Ashwood, 3147; D.A.5694/2; 26th September, 1970; 127 cwt.
- BOVE, A.**, Stand 275, Wholesale Market, 542 Footscray-road, Footscray, 3011; D.A.47128; 3rd September, 1970; 173 cwt.
- BROWN, E. & J. B., PTY. LTD.**, 8 Richardson-street, Box Hill South, 3128; D.A.60100; 29th August, 1970; 11 cwt.
- BRUHN, F. & N.**, P.O. Box 217, Cohuna, 3568; D.A.37161/7; 29th August, 1970; 42 cwt.
- BULLER, R. A.**, Surman-avenue, Warburton East, 3799; D.T.1339; 1st August, 1970; 267 cwt.
- MICHAEL CARLSON PTY. LTD.**, Room 7, 6th Floor, 340 Little Collins-street, Melbourne, 3000; D.A.60116; 29th August, 1970; 290 cwt.
- COCHRANE, B. D.**, 198 Clayton-road, Clayton, 3168; D.A.47315; 17th September, 1970; 114 cwt.
- COLE, C. H.** (trading as Cole's Motors), 266-276 Murray-street, Colac, 3250; D.A.14901; 9th August, 1970; 29 cwt.
- COLES, G. J., & Co. LTD.**, 236 Bourke-street, Melbourne, 3000; D.A.867/3; 22nd September, 1970; 14 cwt.
- COOMBS, A. G.**, SERVICING PTY. LTD., 26 Cochranes-road, Moorabbin, 3189; D.A.891/16; 29th August, 1970; 10 cwt.
- DERITE PTY. LTD.**, 222 Ingles-street, Port Melbourne, 3207; D.A.974; 23rd August, 1970; 117 cwt.; D.A.974/2; 23rd August, 1970; 114 cwt.; D.A.974/3; 23rd August, 1970; 76 cwt.

- DEVONDALE CREAM (VIC.) PTY. LTD., 99 Bell-street, Preston, 3072; D.A.54730/3; 30th May, 1970; 105 cwt.
- DONCHI BROS., 39 Reed-street, Orbst, 3888; D.T.440; 14th June, 1970; 269 cwt.
- EDWARD EVETTS PTY. LTD., 357 Heidelberg-road, Northcote, 3070; D.A.60137; 29th August, 1970; 133 cwt.
- EDWARD EVETTS PTY. LTD., 357 Heidelberg-road, Northcote, 3070; D.A.60137/1; 29th August, 1970; 142 cwt.
- FAULKNER, L. H. (trading as L. H. Faulkner Sales & Service), 189 Fairy-street, Warrambool, 3280; D.A.59745/2; 8th August, 1970; 27 cwt.
- FOSTER, G., 6 Rita-street, Essendon, 3040; D.A.53967/1; 1st August, 1970; 19 cwt.
- GARLICK, A. C., High-street, Yea, 3717; D.A.46111; 7th May, 1970; 152 cwt.
- GIRGARRE CHEESE CO. PTY. LTD., 179 Macaulay-road, North Melbourne, 3051; D.A.14433; 6th September, 1970; 10 cwt.
- GILLESPIE, J. O., 12 Reynolds-avenue, Ringwood, 3134; D.A.60030; 1st August, 1970; 231 cwt.
- HANSEN, D. A., 89 Wimble-street, Seymour, 3660; T.D.A.62999; 11th August, 1970; 150 cwt.
- HARBOUR, R., Yendon, 3332; D.A.59074; 16th May, 1970; 233 cwt.
- HEIMS, H. W., 5 Alfred-street, Heidelberg, 3081; D.T.230; 15th August, 1970; 107 cwt.
- HIGGINS, H. L., Calder Highway, Woodend, 3442; D.T.236; 8th August, 1970; 243 cwt.
- HIGGINS, N. M., Calder Highway, Woodend, 3442; D.T.491; 8th August, 1970; 233 cwt.
- HIGGINS, N. M., Calder Highway, Woodend, 3442; D.T.491/1; 8th August, 1970; 234 cwt.
- HUTTON, J. C., PTY. LTD., 65 High-street, Preston; D.A.48355/19; 8th August, 1970; 48 cwt.
- JOHNSON, H. M. & E. M., Moore-street, Robinvale, 3549; D.A.59672; 11th July, 1970; 228 cwt.
- JOHNSON, N. M., Moore-street, Robinvale, 3549; D.A.59673; 11th July, 1970; 113 cwt.
- KELLY, P., Chapel-street, Kangaroo Flat, 3555; D.A.46725; 16th July, 1970; 10 cwt.
- KNIGHT, W. I. & P. M., Bartley-street, Moyhu, 3732; D.A.60068; 15th August, 1970; 147 cwt.
- KUPKE, H. A., Nepean Highway, Dromana, 3936; D.A.47195; 3rd September, 1970; 119 cwt.
- LATOOF & CALIL PTY. LTD., 17-27 Brunswick-road, East Brunswick, 3057; D.A.43609/1; 1st August, 1970; 242 cwt.
- LEVERETT, K. J., 702 Macarthur-street, Ballarat, 3350; D.A.33064; 11th August, 1970; 138 cwt.
- MACKAY, ROBERT, & SONS PTY. LTD., Mackay-street, Springvale South, 3172; D.A.54986/2; 15th August, 1970; 148 cwt.
- MAHER, C. A. J., 1138 Greenville-road, Wendouree, 3355; D.A.46980; 6th August, 1970; 129 cwt.
- MAZZOLINI, S., 35 Roslyn-street, Burwood, 3125; D.A.60029; 1st August, 1970; 201 cwt.
- MILLER, W. F., & CO. PTY. LTD., Wills-street, Bright, 3741; T.D.A.14742/1; 19th August, 1970; 321 cwt.
- MOORFOOT, P. L., 15 Helmer-crescent, East Geelong, 3219; D.A.33542; 11th August, 1970; 253 cwt.
- MORRIS, B. A., 38 Fenwick-street, North Carlton, 3054; D.A.47286; 17th September, 1970; 20 cwt.
- MUIR, E. E., & SONS PTY. LTD., Melbourne Wholesale Fruit and Vegetable Market, 542 Footscray-road, Footscray, 3011; D.A.53927/2; 8th August, 1970; 145 cwt.
- MCCASHNEY, W. E., & SON PTY. LTD., P.O. Box 41, Alexandra, 3714; D.T.1137; 15th August, 1970; 263 cwt.
- MCCRAITH REFRIGERATION SERVICE PTY. LTD., 491 Keilor-road, Niddrie, 3042; D.A.42638/3; 1st August, 1970; 10 cwt.
- MCDUGALL-IRELAND PTY. LTD., 9 Morton-avenue, Carnegie; 3163; D.A.1672/3; 12th September, 1970; 145 cwt.
- MCNEE, J. E., 21 Ash-grove, East Malvern, 3145; D.A.5193/1; 27th August, 1970; 21 cwt.
- NICHOLAS PTY. LTD., 699 Warrigal-road, Chadstone, 3148; D.A.56963/34; 15th August, 1970; 8 cwt.; D.A.56963/27; 15th August, 1970; 8 cwt.; D.A.56963/33; 15th August, 1970; 8 cwt.
- ORCHARD, R. E., 547-549 Keilor-road, Niddrie, 3042; D.A.60085; 15th August, 1970; 160 cwt.
- PARKER BROS. EARTHMOVING, 52 Wimble-street, Seymour, 3660; D.A.60002; 26th July, 1970; 201 cwt.
- PATERSONS PTY. LTD., 152 Bourke-street, Melbourne, 3000; D.A.1782/30; 11th August, 1970; 11 cwt.
- POOWONG BUTTER FACTORY PTY. LTD., Bridge-road, Dandenong, 3175; D.A.55740/10; 29th August, 1970; 179 cwt.
- RASO, P., 159 Dow-street, Port Melbourne, 3207; D.A.60077; 15th August, 1970; 201 cwt.
- REPLACEMENT PARTS PTY. LTD., 618 Elizabeth-street, Melbourne, 3000; D.A.1907/40; 12th September, 1970; 9 cwt.
- RITE-MIX CONCRETE PTY. LTD., 127 Fyans-street, Newtown, 3220; D.A.60097; 15th August, 1970; 195 cwt.
- ROBINS, J. H., 176 Ballarat-road, Hamlyn Heights, 3215; D.A.33712/1; 18th August, 1970; 217 cwt.
- ROCK PRODUCTS PTY. LTD., McKimmies-lane, Bundoora, 3083; D.A.60094; 26th September, 1970; 156 cwt.
- SAISI, S., 2 Bastow-road, Lilydale, 3140; D.A.53739; 26th October, 1969; 13 cwt.
- SCHRADER, R. H. & J. M., 6 Smith-street, Bairnsdale, 3875; D.T.807; 29th August, 1970; 366 cwt.
- SCROFANI, M., 4 Colin-street, Sunshine, 3020; D.A.60137/1; 29th August, 1970; 156 cwt.
- SHELLEY, P. E., PTY. LTD., Labilliere-street, Bacchus Marsh, 3340; D.A.2022/3; 22nd September, 1970; 233 cwt.
- SHELLEY, P. E., PTY. LTD., Labilliere-street, Bacchus Marsh, 3340; D.A.2022/12; 26th September, 1970; 10 cwt.
- SINCLAIR, L., FIBROUS PLASTER PTY. LTD., 94 Gillies-street, Maryborough, 3465; D.A.9040; 9th August, 1970; 74 cwt.
- SLATTERY, R. J., 62 Arnold-street, Bendigo, 3550; T.D.A.43973/1; 28th August, 1970; 8 cwt.
- SOUTHWELL, J. H. & L. G., 10 Taylor-street, Wangaratta, 3677; D.A.52092/1; 15th August, 1970; 10 cwt.; D.A.52092/2; 15th August, 1970; 10 cwt.
- SQUIRES, C. T. & M. C., High-street, Avoca, 3467; D.A.2089/1; 31st July, 1970; 109 cwt.
- TINNEY, W. D., High-street, Lancefield, 3435; D.A.30247/1; 12th September, 1970; 128 cwt.
- UNIGATE AUSTRALIA PTY. LTD., Bridge-road, Dandenong, 3175; D.A.27168/24; 29th August, 1970; 14 cwt.
- UNILEVER AUSTRALIA PTY. LTD., 164-220 Ingles-street, Port Melbourne, 3207; D.A.46545/23; 6th September, 1969; 141 cwt.
- WATERS, S. H., & CO. PTY. LTD., G.P.O., Box 4027, Melbourne, 3001; D.A.2247; 23rd August, 1970; 29 cwt.
- WESTERN PORT WOOLS, Princes Highway, Beaconsfield, 3807; D.A.60047; 8th August, 1970; 30 cwt.
- WILSON, B., 5 Farren-street, Corryong, 3707; D.A.60096; 15th August, 1970; 125 cwt.

TOW TRUCK RENEWALS.

- AARJENT TOWING & SALVAGE SERVICE PTY. LTD., 136 Chetwynd-street, North Melbourne, 3051; D.A.35190/5; 1st August, 1970; 58 cwt.
- WELLS, F. E. (trading as Griffith Panel Works), Lot 2, Keys-road, Moorabbin, 3189; D.A.60117/1; 29th August, 1970; 25 cwt.
- WILLIAMS, A. P. (trading as New Auto Service), Champion-road, Newport, 3015; D.A.47287/1; 15th August, 1970; 56 cwt.
- SMITH, J. A., 32 Rose-street, Brunswick, 3056; D.A.36850/1; 12th September, 1970; 70 cwt.
- UNITED TOWING SERVICE PTY. LTD., 628 High-street, Thornbury, 3071; D.A.58930/9; 15th August, 1970; 33 cwt.

RENEWALS WITH VARIATION.

- APPLICATIONS by the persons listed hereunder for renewal of the licences listed with variation of conditions in the manner set out opposite the names.
- EVANS, D. C. F., Roadside Delivery, via Broadford, 3658; D.T.749; 26th July, 1970; Application to renew and vary the conditions of licence No. D.T.749 (L/C. 322 cwt.) by deleting from paragraph (a) of the existing conditions "Flowerdale" and by adding as an additional paragraph "(c) in course of trade as a logging contractor and earthmoving contractor within a 50-mile radius of own premises at Flowerdale—bulldozer, associated equipment and tools of trade."
- PESTCO PTY. LTD., 1008 Sturt-street, Ballarat, 3350; D.A.48423/2; 18th July, 1970; Application to renew and vary the conditions of licence D.A.48423/2 (L/C. 14 cwt.) by deleting from the existing conditions "Bendigo" and adding in lieu "Seymour" and to and from the township of Mansfield.
- SHERLOCK, A., 200 Moore-street, Warrambool, 3280; D.A.47045; 27th August, 1970; Application to renew and vary the conditions of licence No. D.A.47045 (L/C. 10 cwt.) by deleting from paragraph (a) of the existing conditions "St. Helens" and adding in lieu Yambuk and by adding as an additional paragraph (b) "Within a 50-mile radius of the post office at Yambuk in course of business as 'Windmill and Pump Engineer'—irrigation equipment, pumps for installation, repair or having been repaired and plumbers requisites provided that all such goods have been initially railed to Warrambool or Port Fairy Railway Stations."
- TIBB, C. G., 7 Walter-street, Bulleen, 3105. D.A.60181; 12th September, 1970; Application to renew and vary the conditions of licence No. D.A.60181 (L/C. 201 cwt.) by deleting from the existing conditions "Pronto Mixed Concrete Pty. Ltd." and adding in lieu "Blue Metal Concrete".

TRETHOWAN, C., 51 Queenscliff-road, Newcomb, 3219; D.A.37871/1; 15th August, 1970; Application to renew and vary the conditions of licence No. D.A.37871/1 (L/C. 48 and trailer 22 cwt.) by adding to the existing conditions—(a) (vii) Honda Australia Pty. Ltd. at Collingwood; (viii) Grand Prix Motors Pty. Ltd. at Hawthorn; (ix) Spencer Motors Pty. Ltd. at South Melbourne; (x) Volkswagen (Distribution) Pty. Ltd. at Clayton.

Notice of any objection should be forwarded to reach the Secretary of the Board not later than 10th June, 1970.

Applicants are advised that it will not be necessary to appear on the hearing date specified above, unless advised in writing by the Board.

B. P. KAY,
Secretary.

Corner Lygon and Princes streets, Carlton.

Pipelines Act 1967, No. 7541.

APPLICATION FOR A PERMIT TO OWN AND USE
A PIPELINE.

MINISTRY OF FUEL AND POWER.

NOTICE.

1. In accordance with the provisions of section 11 (1) of the *Pipelines Act 1967*, notice is given that an application has been received by me from The Geelong Gas Company for a permit to own and use a system of pipelines for the purpose of conveying natural gas throughout the Geelong area.

2. The proposed route of the pipeline system is as follows—

Line 1, a steel pipeline 5.7 miles long with an outer diameter of 14 inches and designed to operate at a maximum pressure of 400 p.s.i.g., commencing at a valve at the Victorian Pipelines Commission's City Gate Station at Corio situated on allotments 255 to 276, 280, 281 and 282, Parish of Moranghurk, and proceeding in a southerly direction along Railway-avenue to School-road; thence turning to enter and continue in a westerly direction along School-road to the Princes Highway; thence turning to enter and continue in a south-westerly direction along the eastern side of such highway to the junction of Refinery-road and Station-street; thence turning to cross Refinery-road to enter and continue in a southerly direction along Station-street to St. Georges-road; thence turning to enter and continue in an easterly direction along such road to Seabeach-parade, Norlane, crossing the Melbourne to Geelong rail line *en route*; thence turning to enter and continue in a southerly direction along Seabeach-parade to Sparks-road; thence turning to enter and continue in a westerly direction along such road to Seaside-parade; thence turning to enter and continue in a southerly direction along such parade to The Esplanade, crossing the rail siding line to the Phosphate Co-operative Company of Australia Limited *en route*; thence turning to enter and continue in a westerly direction along The Esplanade to Corio Quay-road; thence turning to enter and continue in a generally southerly and westerly direction along Corio Quay-road to a point approximately 100 feet north of Cowies Creek; thence turning to continue in a westerly direction through allotment 3A, Parish of Moorpanyal, owned by the Ford Motor Company of Australia Limited, to the Princes Highway crossing the Melbourne to Geelong rail line *en route*; thence turning to enter and continue in a southerly direction along the eastern side of the Princes Highway to a point opposite Cowie-street; thence turning to cross the highway to enter and continue in a westerly direction along Cowie-street to Edol-street; thence turning to enter and continue in a southerly direction along Edol-street, crossing the Geelong to Ballarat rail line and the rail siding line to Australia Portland Cement Limited, to Roseneath-street; thence continuing in a southerly direction along such street to Enmore-street; thence turning to enter and continue in an easterly direction along Enmore-street to enter land occupied by the Victorian Railways; thence turning to continue in a southerly direction across such land to enter and terminate at a valve inside the boundary of The Geelong Gas Company's gas works situated on the west side of the Princes Highway, North Geelong.

Line 2, a steel pipeline 8.6 miles long with an internal diameter of 10 inches and designed to operate at a maximum pressure of 400 p.s.i.g., commencing at a valve located at the Geelong Gas Company's gas works at North Geelong, and proceeding in a southerly direction along Benmore-street to Victoria-street; thence crossing such street to enter

and continue in a southerly direction along Baxter-road to a point 4 feet north of the south boundary of lot 14, part of Crown allotments 66 and 71, Parish of Moorpanyal, owned by The Geelong Gas Company; thence turning to continue in an easterly direction through such property to the Geelong to Melbourne rail line; thence crossing such rail line and the Princes Highway, to turn and continue in a southerly direction along the eastern side of such highway to Bell-parade; thence turning to enter and continue in an easterly direction along the northern side of such parade to The Esplanade, Geelong West; thence turning to enter and continue in a generally southerly and easterly direction along such esplanade, Western Beach and Eastern Beach, crossing the Cunningham Pier rail spur line *en route*; thence continuing along Eastern Beach to Yarra-street; thence turning to enter and continue in a southerly direction along such street to Brougham-street; thence turning to enter and continue in an easterly direction along such street to Bellarine-street; thence turning to enter in a southerly direction along such street to Malop-street, City of Geelong; thence turning to enter and continue in an easterly direction along such street to cross Swanston, Fitzroy and Garden streets to enter the Eastern Park Crown Reserve and continue in an easterly direction across such reserve to Glen-avenue; thence entering and continuing in an easterly direction along such avenue to Limeburners-road; thence turning to continue in a southerly direction along such road to Ryrie-street; thence turning to enter and continue in an easterly direction along such street to Boundary-road; thence crossing such road to enter and continue in an easterly direction along the Drysdale-Portarlington road, East Geelong, to Point Henry road; thence turning to continue in a north-easterly, northerly and westerly direction along such road to terminate at a valve located inside the boundary of Alcoa of Australia Limited at Point Henry, and situated on allotment 10, Parish of Moolap.

Line 3, a steel pipeline totalling 5 miles in length, initially with an internal diameter of 8 inches, and designed to operate at a maximum pressure of 400 p.s.i.g., commencing at the junction of Malop and Swanston streets, City of Geelong and proceeding for a distance of 1.5 miles in a southerly direction along Swanston-street to the Barwon River, Geelong South; thence crossing such river, and, at a line flange located on the south bank inside the Belmont Common Recreation Reserve, reducing the internal diameter of the pipe to 6 inches, and then for a total distance of 3.5 miles, proceeding in a south-westerly direction across Belmont Common Recreation Reserve to Barwon Heads road; thence turning to enter and continue in a southerly direction along such road to Bailey-street; thence opposite Breakwater-road diverting to enter and continue in a southerly, south-westerly and westerly direction along Settlement-road to the Princes Highway; thence turning to enter and continue in a south-westerly direction along such highway to Colac-grove; thence turning to enter and continue in a westerly direction along such grove to Colac-grove West; thence turning to enter and continue in a northerly direction along such grove to Fryers-road; thence turning to enter and continue in a westerly direction along such road to Valley-road South; thence turning to enter and continue in a northerly direction along such road to Gwyther-street, Highton; thence turning to enter and continue in a westerly direction along such street to Thornhill-road; thence turning to enter and continue in a southerly direction for approximately 150 feet along such road to terminate at a valve adjacent to the north-east corner of Highton Service Basin.

3. Plans of the proposed route of the pipeline system may be inspected, commencing Friday, 15th May, 1970, between the hours of 10 a.m. and 4 p.m., on Mondays to Fridays (excluding public holidays) at—

- (a) Ministry of Fuel and Power,
15th Floor, 171 Flinders-street, Melbourne.
- (b) The Geelong Gas Company,
161-165 Ryrie-street, Geelong, and
- (c) Municipal offices at—
North Geelong, Geelong West, City of Geelong,
Belmont and Drysdale.

Additional copies of plans are not available and detailed route plans can be seen only at the Geelong Gas Company's Head Office, 161-165 Ryrie-street, Geelong.

4. Any objections to the proposed route of the pipeline system must be addressed to me and reach the Office of the Ministry no later than Monday, 22nd June, 1970.

J. C. M. BALFOUR,
15th May, 1970. Minister for Fuel and Power.

Stamps Act 1958.
ANNUAL LICENCES.

NOTIFICATIONS PURSUANT TO SECTION 97.

I HEREBY notify that stamp duty has been paid for licences under section 96 of the Stamps Act to carry on assurance and insurance business in Victoria during the year ending 31st December, 1970, by the following:—

- A.C.I. Insurances Proprietary Limited.
 Affiliated Reinsurances Proprietary Limited.
 Ajax Insurance Company Limited.
 Albion Insurance Company Limited.
 Alliance Insurance Company Limited (with which is united the Imperial Insurance Company Limited).
 American Home Assurance Company.
 American International Assurance Co. Ltd.
 American Life Insurance Company.
 A.M.P. Fire and General Insurance Company Limited.
 Ansvar Insurance Company Limited.
 Antony Gibbs (Insurance) Pty. Ltd.
 Antony Gibbs (Reinsurance) Pty. Ltd.
 A.P.A. Fire and General Insurance Company Limited.
 Arthur Weller and Company Proprietary Limited.
 Associated General Contractors Insurance Company Limited.
 Associated National Insurance Company Limited.
 Atlas Assurance Company Limited (with which is incorporated the Manchester Assurance Company).
 Australasian Temperance and General Mutual Life Assurance Society Limited.
 Australian Associated Motor Insurers Ltd.
 Australian Alliance Assurance Company.
 Australian and Eastern Insurance Company Limited.
 Australian and International Insurances Limited.
 Australian General Insurance Company Limited.
 Australian Metropolitan Life Assurance Company Limited.
 Australian Mutual Fire Insurance Society Limited.
 Australian Mutual Provident Society.
 Australian National Assurance Company Limited.
 Australian Natives' Association Insurance Company Limited.
 Australian Provincial Assurance Association Limited.
 Australian Reinsurance Company Limited.
 Automobile Fire and General Insurance Company of Australia Limited.
 B. T. Insurance Proprietary Limited.
 Baillieu Insurances (Vic.) Proprietary Limited.
 Baillieu Reinsurances Proprietary Limited.
 Baltica Insurance Company Limited.
 Bankers and Traders' Insurance Company Limited.
 Bishopsgate Insurance Company Limited.
 British and Foreign Marine Insurance Company Limited.
 British Crown Assurance Corporation Limited.
 British Equitable Assurance Company Limited.
 British General Insurance Company of Australia Limited.
 British Medical Insurance Company of Victoria Limited.
 British Traders' Insurance Company Limited.
 Caledonian Insurance Company.
 Car Owners' Mutual Insurance Company Limited.
 Casualty Insurance and Guarantee Corporation Pty. Ltd.
 Catholic Church Insurances Limited.
 Central Insurance Company Limited.
 Century Insurance Company Limited.
 C.G.A. Fire and Accident Insurance Company Limited.
 Chamber of Manufactures Insurance Limited.
 C.I.C. Insurance Pty. Ltd.
 City Mutual Fire Insurance Company Limited.
 City Mutual General Insurance Limited.
 Club Motor Insurance Agency Proprietary Limited.
 C.M.L. Fire and General Insurance Company Limited.
 Colonial Mutual Fire Insurance Company Limited.
 Colonial Mutual Life Assurance Society Limited.
 Combined Insurance Company of America.
 Commercial and Industrial Insurance Limited.
 Commercial of Australia Insurance Company Limited.
 Commercial Union Assurance Company of Australia Limited.
 Consolidated Insurances of Australia Limited.
 Continent of Australia Insurance Company Limited.
 Co-operative Insurance Company of Australia Limited.
 Copenhagen Reinsurance Company (Aust.) Limited.
 Cornhill Insurance Company Limited.
 Coronet Insurance Co. (Australia) Ltd.
 Cosmopolitan Insurance Coy. Ltd.
 Country Traders' Mutual Insurance Limited.
 C. T. Bowring and Swain (Professional Indemnity) Pty. Ltd.
 C. T. Bowring and Swain Reinsurance Pty. Ltd.
 C. T. Bowring and Swain (Vic.) Proprietary Limited.
 Cumis Insurance Society Inc.
 Derwent and Tamar Assurance Company Limited.
 Dominion Insurance Company Limited.
 Eagle Star Insurance Company Limited.
 Eastern Insurance Brokers Proprietary Limited.
 Ecclesiastical Property Insurance Company Proprietary Limited.
 Edward Lumley and Sons (Vic.) Proprietary Limited.
 Employers Liability Assurance Corporation of Australia Ltd.
 Equitable Life and General Insurance Company Limited.
 Farmers' and Graziers' Co-operative Company Limited.
 Farmers' and Settlers' Co-operative Insurance Company of Australia Limited.
 Federal Mutual Insurance Company of Australia Limited.
 Federation Insurance Limited.
 Fire and All Risks Insurance Company Limited.
 General Accident Fire and Life Assurance Corporation Limited.
 General Mutual Insurance Co. Ltd.
 Glanvill Holland Proprietary Limited.
 Godfrey Orton Insurances Pty. Ltd.
 Gray Dawes Australia Proprietary Limited.
 Gresham Fire and Accident Insurance Society Limited.
 Grieve and Irwin (Aust.) Pty. Ltd.
 Guardian Assurance Company Limited.
 Guild Insurance Company Limited.
 Guildhall Insurance Company Limited.
 Hanover Insurance Company.
 Hartford Fire Insurance Company.
 Harvey Trinder (Victoria) Proprietary Limited.
 H. G. Poland (Australia) Proprietary Limited.
 H. J. Heinz Company Australia Limited.
 Hogg Robinson and Gardner Mountain (Aust.) Pty. Ltd.
 Home Insurance Company.
 Indemnity Marine Assurance Company of Australia Ltd.
 Insurance Commissioner (State Accident Insurance Office and State Motor Car Insurance Office).
 Insurance Company of North America.
 Insurance Corporation of Ireland Limited.
 Insurance Office of Australia Limited.
 Interstate Steamship Insurance Company Proprietary Limited.
 Invincible Life and General Insurance Company Limited.
 Ipec Insurance Limited.
 J. H. Minet and Company (ANZ) Proprietary Limited.
 J. H. Wackerbarth (Australasia) Proprietary Limited.
 John Forsaith (Vic.) Pty. Ltd.
 Law Union and Rock Insurance Company Limited.
 Legal and General Assurance Society Limited.
 Legal Insurance Company Limited.
 Lep Insurance Brokers Proprietary Limited.
 Leslie N. Allen Proprietary Limited.
 Leslie N. Allen (Reinsurance) Pty. Ltd.
 Licences and General Insurance Company Limited.
 Liverpool and London and Globe Insurance Company Limited.
 Lombard Insurance Company Limited.
 London and Lancashire Insurance Company Limited.
 London and Overseas Insurance Company Limited.
 London and Provincial Marine and General Insurance Company Limited.
 London and Scottish Assurance Corporation of Australia Ltd.
 London Assurance.
 London Guarantee and Accident Company Limited.
 L'Union Des Assurances De Paris.
 Manchester Unity Fire Insurance Company of Victoria Limited.
 Manufacturers Mutual Insurance Limited.
 Marine Hull and Liability Insurance Company Proprietary Limited.
 Maritime Insurance Company Limited.
 Marsh and McLennan Proprietary Limited.
 Marshall, Golding, Adam Re-Insurance Proprietary Limited.
 Master Builders' Insurance Company Limited.
 Matthews Wrightson and Strapp Proprietary Limited.
 Melbourne Fire Office Limited.
 Mercantile and General Re-Insurance Company of Australia Limited.
 Mercantile Mutual Insurance Company Limited.
 Mid-Pacific and International Insurance Company Proprietary Limited.
 Milford Insurance Company Limited.
 M.L.C. Fire and General Insurance Company Proprietary Limited.
 Monarch Insurance Company Limited.
 Mortgage Guaranty Insurance Corporation of Australia Limited.
 Motor Marine and General Insurance Company Limited.
 Motorists' Mutual Insurance Company Limited.
 Munich Reinsurance Company of Australia Limited.
 Mutual Life and Citizens' Assurance Company Limited.
 M. W. Payne Liability Agencies Pty. Ltd.
 National and General Insurance Company Limited.
 National Co-operative Insurance Society Limited.
 National Employers' Mutual General Insurance Association Limited.

National Insurance Company of New Zealand Limited.
 National Mutual Casualty Insurances Limited.
 National Mutual Fire Insurance Company Limited.
 National Union Insurance Society.
 New Zealand Insurance Company Limited.
 New Zealand Victoria Life Limited.
 Nippon Fire and Marine Insurance Company Limited.
 North British and Mercantile Insurance Company of Australia Limited.
 Northern Assurance Company of Australia Ltd.
 Northumberland Insurance Company Limited.
 Norwich Union Fire Insurance Society Limited.
 Ocean Accident and Guarantee Corporation of Australia Limited.
 Ocean Marine Insurance Company Limited.
 Omnibus and General Insurance Brokers Proprietary Limited.
 Orion Insurance Company Limited.
 Pacific Insurance Company Limited.
 Palatine Insurance Company of Australia Limited.
 Pan Australian Insurance Proprietary Limited.
 Patriotic Assurance Company Limited.
 Pearl Assurance Company Limited.
 Phoenix Assurance Company Limited.
 Phoenix Life Assurance Company of Australia Ltd.
 Price Forbes Leslie (Proprietary) Limited.
 Price, Forbes, Leslie (Reinsurance) Pty. Ltd.
 Provident Fire Insurance Company Limited.
 Provincial Insurance Company Limited.
 Prudential Assurance Company Limited.
 Queensland Insurance Company Limited.
 Real Australia Insurance Company Limited.
 Regent Insurance Limited.
 Reinsurance Company of Australasia Limited.
 Reliance Marine Insurance Company Limited.
 R. H. Tolley and Gardner Proprietary Limited.
 Royal Exchange Assurance.
 Royal Insurance Company Limited.
 R. S. Bucknell and Co. Pty. Ltd.
 Scottish Insurance Corporation Limited.
 Scottish Union and National Insurance Company.
 Sea Insurance Company Limited.
 Security and General Insurance Company Limited.
 Security Life Assurances Limited.
 Skandia Insurance Company Limited.
 South Australian Insurance Company Limited.
 South British Insurance Company Limited.
 Southern Star General Insurance Company Proprietary Limited.
 Southern Union Insurance Company of Australia Limited.
 Stanley Taylor and Company.
 State Assurance Company Limited.
 Steadfast Insurance Company Limited.
 Steel Brothers and Harlock Pty. Ltd.
 Steeves, Agnew and Company (Victoria) Proprietary Limited.
 Stenhouse Reinsurance Proprietary Limited.
 Stenhouse, Scott, North Australia Limited.
 Stewart Smith and Company (Victoria) Proprietary Limited.
 Sun Insurance Office Limited.
 Surrey Insurance Company Limited.
 Swann Insurance Limited.
 Swiss Reinsurance Company.
 Switzerland General Insurance Company Limited.
 Taisho Marine and Fire Insurance Company Limited.
 T. & G. Fire and General Insurance Company Limited.
 Thames and Mersey Marine Insurance Company Limited.
 Tokio Marine and Fire Insurance Company Limited.
 T. P. Clark and Chapman Proprietary Limited.
 Trade Indemnity Company Limited.
 Traders Prudent Insurance Company Limited.
 Transport and General Insurance Company Limited.
 Triton Insurance Company Limited (with which is incorporated the Eastern Insurance Company).
 Underwriting and Insurance Limited.
 Union Assurance Society of Australia Limited.
 Union Insurance Society of Canton Limited.
 United Insurance Company Limited.
 Vehicle and General Insurance Company (Australia) Limited.
 Victor Aghion and Sons Pty. Ltd.
 Victoria Insurance Company Limited.
 V.A.C.C. Insurance Coy. Ltd.
 Victorian Wheatgrowers Corporation Limited trading as Wheatgrowers and General Insurance Company.
 Victory Reinsurance Company of Australia Limited.
 Waltons Insurance Company Limited.
 Westchester Fire Insurance Company.
 Western Assurance Company.
 Western Australian Insurance Company (Canberra) Limited.
 Westminster Insurance Company Limited.
 Willis Faber and Nickolls (Vic.) Pty. Ltd.
 World Auxiliary Insurance Corporation Limited.

World Marine and General Insurance Company Limited.
 Y.C.W. Co-operative Society Limited (Insurance Division).
 Yorkshire Insurance Company Limited.

R. M. PHIBBS,
 Comptroller of Stamps.

Chief Office for Stamp Duties,
 Melbourne, 20th May, 1970.

Stamps Act 1958.
 ANNUAL LICENCE.

NOTIFICATION PURSUANT TO SECTION 97.

I HEREBY notify that stamp duty has been paid for a licence under section 96 of the Stamps Act to carry on assurance and insurance business in Victoria from 1st May, 1970, to 31st December, 1970, by the following:—

AUSTRALIAN MARINE UNDERWRITING AGENCY PTY. LTD.

R. M. PHIBBS,
 Comptroller of Stamps.

Chief Office for Stamp Duties,
 Melbourne, 20th May, 1970.

Farm Produce Merchants and Commission Agents Act 1965
 (No. 7274).

LIST OF NAMES AND ADDRESSES OF PERSONS TO WHOM LICENCES HAVE BEEN GRANTED DURING APRIL, 1970.

IN accordance with the above Act, those issued with a Merchant's or Commission Agent's licence have lodged a fidelity bond. All licences, unless earlier cancelled, shall continue in force until 30th June, 1970.

D. S. WISHART,
 Director of Agriculture.

MERCHANTS.

Name, Principal Place of Business.

Accurso, Guiseppe, 70 Shorts-road, North Coburg, 3058.
 Hutchinson, Robert, Ltd., Hartington-street, Glenroy, 3046.
 Marangan Packers Pty. Ltd., Murray Valley Highway, Nyah, 3594.
 Pirrie Bros., 31 New Footscray-road, West Melbourne, 3003.
 Pitt, A. B., Pty. Ltd., Melbourne Wholesale Fruit and Vegetable Market, Footscray-road, West Melbourne, 3003.
 Presti, Lorenzo, 92 Paisley-street, Footscray, 3011.
 Ridolfi, Antonio, 141 Albert-street, Brunswick, 3056.
 Southland Packers Pty. Ltd., 22 Ebden-street, Moorabbin, 3189.

COMMISSION AGENTS.

B. and P. Sunshot Exports Pty. Ltd., 118 Queen-street, Melbourne, 3000.
 Brown, A. J., Melbourne Wholesale Fruit and Vegetable Market, Footscray-road, West Melbourne, 3003.
 D'Aloisio, P., 7 Clyde-street, Lilydale, 3140.
 Enbom, P. W., 56 Radovick-street, Korumburra, 3950.
 Evans, C. W., 4 Gordon-street, Korumburra, 3950.
 Lankester, M. G., Stand 265, Melbourne Wholesale Fruit and Vegetable Market, Footscray-road, West Melbourne, 3003.

SECONDARY WHOLESALERS.

Downey, G. A., "Avondale", Bellarine, 3221.
 Gollin and Company Limited, 58 Queen's Bridge-street, South Melbourne, 3205.
 Patricks Smallgoods, 248 Williams-road, Toorak, 3142.
 Selby, G. S. & Co., 234 Collins-street, Melbourne, 3000.
 Somerset Poultry, Brandy Creek-road, Warragul, 3820.

THE LIQUOR CONTROL ACT 1968.

WHEREAS the Hotelkeeper's Licence for the licensed premises known as the Rosebery Hotel, situate at Rosebery, has been surrendered as from 28th February, 1970, notice is hereby given that the amount of compensation payable to the owner of such premises pursuant to the provisions of the *Liquor Control Act 1968* is as under:—

Owner \$10,750.

Dated at Melbourne, this 18th day of May, 1970.

J. CROWE, Secretary,
 Liquor Control Commission.

Private Agents Act 1966.

NOTICE OF RECEIPT OF APPLICATIONS FOR LICENCES UNDER THE PROVISIONS OF THE PRIVATE AGENTS ACT 1966.

THE Clerk(s) of the Magistrates' Court(s) as listed hereunder hereby give notice that applications, as under, have been lodged for hearing by the said Court(s) on the date(s) specified.

Any person desiring to object to any of such applications must—

- (a) lodge with the respective Clerk of the Magistrates' Court a notice in the prescribed form of his objection and of the grounds thereof;
- (b) cause a copy of such notice to be served personally or by post upon the applicant at least three days before the hearing of the application; and
- (c) send or deliver—
 - (i) where the objection is not made by the officer in charge of the police district in which the Court is situated—a copy of the notice to such officer; and
 - (ii) where the objection is not made by the Registrar or Deputy Registrar—a copy to the Registrar.

Full Name of Applicant or in the Case of a Firm or Corporation, of the Nominee.	Place of Abode of Applicant or Nominee.	Name of Firm or Corporation.	Address for Registration.	Type of Licence.	Date of Hearing of Application.
MAGISTRATES' COURT, MELBOURNE.					
Bailey, John Edward	9 Oak-avenue, Doveton	Australian Watching Co. Pty. Ltd.	340 Abbotsford-street, North Melbourne	Watchman	3.6.70
Boghikian, Edgar	60 Regent-street, West Preston	" "	" "	"	"
Bohnenberg, Klaus Werner	158 Dean-street, Moonee Ponds	" "	" "	"	"
Browne, Gordon Roberts	13 Lowen-road, Glen Waverley	" "	" "	"	"
Cabret, Cornelis Anthonius	Silvan-road, Monbulk	" "	" "	"	"
Carew, Leo Coghill	748 High-street, Armadale	" "	" "	"	"
Coffey, John Patrick	35 Carramar-drive, Frankston	" "	" "	"	"
Corneille, Gary Brian	Flat 69, 72 Derby-street, Kensington	" "	" "	"	"
Culbert, William	Flat 12, 35 Boyd-crescent, West Heidelberg	" "	" "	"	"
Downs, Victor Eric	Bayliss-road, Lyndhurst	" "	" "	"	"
Forbes, Robert Norman	10 Thomas-street, Eltham	" "	" "	"	"
Gillespie, Rodney	18 Glenora-road, East Coburg	" "	" "	"	"
Harding, Ronald William	31 Charles-street, Footscray	" "	" "	"	"
Harris, William	10 Yungera-street, Fawkner	" "	" "	"	"
Humphreys, Harold Victor	17 Alison-street, Thomastown	" "	" "	"	"
La Rocca, Anthony	89 Essex-road, Mount Waverley	" "	" "	"	"
Leacy, Brian Francis	33 Booran-avenue, Glen Waverley	" "	" "	"	"
Lee, Archibald	Flat 3, 23 Ashby-street, Reservoir	" "	" "	"	"
Lehmann, Lindsay Harold	81 Essex-street, Pascoe Vale	" "	" "	"	"
Logan, Thomas	215 Lower Dandenong-road, Mordialloc	" "	" "	"	"
Mathews, Douglas Wingfield	Flat 5, 1 Cooper-street, West Brunswick	" "	" "	"	"
Murnane, Mervyn Bernard	12A Dalgety-street, St. Kilda	" "	" "	"	"
Noe, Richard	3 Lower Plenty-road, Rosanna	" "	" "	"	"
Parker, Alan Ernest	451 Holmsglen Hostel, Warrigal-road, Ashburton	" "	" "	"	"
Pollard, Robert Thomas William	Flat 7, 103 Liardet-street, Port Melbourne	" "	" "	"	"
Prictor, Sydney	126 Smith-street, Thornbury	" "	" "	"	"
Radin, John	101 St. Hellier's-street, West Heidelberg	" "	" "	"	"
Robinson, Richard John	4 Beatty-street, Reservoir	" "	" "	"	"
Ros, Cornelis	23 Simms-road, Greensborough	" "	" "	"	"
Ryder, Ambrósé Walter	617 Bell-street, Pascoe Vale	" "	" "	"	"
Senini, John Stephen	43 Ruthven-street, Macleod West	" "	" "	"	"
Soliman, Ezzat Samuel Migalaa	304 Bank-street, South Melbourne	" "	" "	"	"
Stanley, Robert Edward	3 Waites-court, North Altona	" "	" "	"	"
Stidworthy, Peter	100 Brambleberry-lane, Lilydale	" "	" "	"	"
Trutwein, Walter	29 Bermuda-drive, Blackburn South	" "	" "	"	"
Wilkinson, John Charles	31 St. Leonard's-road, Ascot Vale	" "	" "	"	"

Filed at Melbourne this 14th day of May 1970

G. I. WEBSTER, Clerk of the Magistrates' Court.

PRIVATE AGENTS—*continued.*

Full Name of Applicant or in the Case of a Firm or Corporation, of the Nominee.	Place of Abode of Applicant or Nominee.	Name of Firm or Corporation.	Address for Registration.	Type of Licence.	Date of Hearing of Application.
MAGISTRATES' COURT, MORWELL.					
Webster, John Wallace ..	10 June-street, Morwell	340 Abbotsford-street, North Melbourne	Watchman ..	9.6.70
Dated at Morwell this 13th day of May, 1970.			D. L. CROFT, Clerk of the Magistrates' Court.		
MAGISTRATES' COURT, OAKLEIGH.					
Deacon, Daryl Lionel ..	1554 Dandenong-road, Huntingdale	Process Server ..	5.6.70
Dated at Oakleigh this 11th day of May, 1970.			G. MEEHAN, Clerk of the Magistrates' Court.		
MAGISTRATES' COURT, OAKLEIGH.					
Watts, Kevin Albert ..	59 Spring-road, Dingley	Watchman ..	5.6.70
Dated at Oakleigh this 13th day of May, 1970.			G. MEEHAN, Clerk of the Magistrates' Court.		
MAGISTRATES' COURT, RINGWOOD.					
Le Fevre, David Edward ..	6 Yarra-road, Wonga Park, 3136	6 Yarra-road, Wonga Park, 3136	Inquiry Agent ..	8.6.70
Dated at Ringwood this 15th day of May, 1970.			L. T. GOULD, Clerk of the Magistrates' Court.		
MAGISTRATES' COURT, PRAHRAN.					
Maher, James Joseph ..	12/614 St. Kilda-road, Melbourne	12/614 St. Kilda-road, Melbourne	Commercial Sub-agent	5.6.70
Dated at Prahran this 15th day of May, 1970.			H. V. BOARDER, Clerk of the Magistrates' Court.		
MAGISTRATES' COURT, PRAHRAN.					
McInnes, Robin ..	62 Phillips-street, Coburg West	Factory Guard Service Pty. Ltd.	Suite 17/562 St. Kilda-road, Melbourne	Watchman ..	4.6.70
Dated at Prahran this 13th day of May, 1970.			H. V. BOARDER, Clerk of the Magistrates' Court.		

STATE RIVERS AND WATER SUPPLY COMMISSION.

LICENCE TO DIVERT WATER PURSUANT TO THE PROVISIONS OF SECTION 204 OF THE WATER ACT 1958 (AS AMENDED).

THE Schedule of Licence as detailed hereunder to divert water has been revoked by the Governor in Council.

SCHEDULE.

Licence No.	Term of Licence and Commencing Date.	Name and Address of Person to Whom Licence Granted.	Source of Supply.
252	Fifteen years from 1.7.57 ..	Frederick Charles Toll, Gunbower (but now held by Reginald Frederick Toll, Gunbower)	Taylor's Creek

Office of the State Rivers and Water Supply Commission,
Melbourne, 13th May, 1970.G. W. LEWIS, Secretary,
State Rivers and Water Supply Commission.

STATE RIVERS AND WATER SUPPLY COMMISSION.

LICENCE TO DIVERT WATER AND CUT RACE PURSUANT TO THE PROVISIONS OF SECTION 204 OF THE WATER ACT 1958 (AS AMENDED).

THE Schedule of Licence as detailed hereunder to divert water and cut race has been revoked by the Governor in Council as from the date shown :—

SCHEDULE.

Licence No.	Term of Licence and Commencing Date.	Name and Address of Person to Whom Licence Granted.	Source of Supply.
44	Fifteen years from 1.7.57 ..	Lindsay Matthew Pollock, Gunbower	Gunbower Creek

Office of the State Rivers and Water Supply Commission,
Melbourne, 13th May, 1970.G. W. LEWIS, Secretary,
State Rivers and Water Supply Commission.

Health Act 1958.
VICTORIA—DEPARTMENT OF HEALTH.

NOTICE TO ATTEND FOR RADIOLOGICAL EXAMINATION.

To all persons aged twenty-one years and over enrolled or resident in the subdivisions specified hereunder in the State Electoral District of Reservoir.

TAKE notice that you are required to attend at a Department of Health X-ray unit sited in the public street at or as near as possible to the main entrance to the premises specified in this notice, at any time between the hours specified on one of the days specified and during the period specified in respect of those premises, and thereat to submit yourself to radiological examination of the chest for the purpose of ascertaining whether you may be suffering from pulmonary tuberculosis. If you have had a Chest X-ray within the last twelve months and for that reason do not wish to be examined now, you should attend the unit as directed and submit particulars of the previous examination.

SPECIFIED SUBDIVISIONS, PREMISES, PERIODS, DAYS AND HOURS.

Subdivision.	Premises.	Period.	Days.	Hours.
Reservoir East	Gamble's Pharmacy, 39 Crevelli-street, Preston East	Thursday, 4th June, 1970, to Tuesday, 9th June, 1970 (inclusive)	Each day during the period except Saturday, Sunday and Public Holidays	From 10 a.m. to 8.30 p.m.
	Summerhill Auto Port, Plenty-road, Reservoir East	Thursday, 4th June, 1970, to Monday, 8th June, 1970 (inclusive)	Each day during the period except Saturday, Sunday and Public Holidays	From 10 a.m. to 8.30 p.m.
Reservoir ..	Cnr. Spring and Rona streets, Regent	Thursday, 4th June, 1970, to Monday, 8th June, 1970 (inclusive)	Each day during the period except Saturday, Sunday and Public Holidays	From 10 a.m. to 8.30 p.m.
	Shopping Centre, Strathmerton-street, Reservoir East	Tuesday, 9th June, 1970, to Friday, 12th June, 1970 (inclusive)	Each day during the period except Public Holidays	From 10 a.m. to 8.30 p.m.
..	Cnr. High-street and Broadway, Reservoir	Tuesday, 9th June, 1970, to Wednesday, 17th June, 1970 (inclusive)	Each day during the period except Saturday, Sunday and Public Holidays	From 10 a.m. to 8.30 p.m.
	Amoco Service Station, Cnr. Boldrewood-parade and Gisborne-crescent, Reservoir East	Wednesday, 10th June, 1970, to Friday, 12th June, 1970 (inclusive)	Each day during the period except Public Holidays	From 10 a.m. to 8.30 p.m.
Reservoir West	Caltex Service Station, Cnr. Spring and Cleeland streets, Reservoir	Tuesday, 9th June, 1970, to Friday, 19th June, 1970 (inclusive)	Each day during the period except Saturday, Sunday and Public Holidays	From 10 a.m. to 8.30 p.m.
	Coulton's Pharmacy, 130 Regent-street, Preston West	Thursday, 18th June, 1970, to Tuesday, 23rd June, 1970 (inclusive)	Each day during the period except Saturday, Sunday and Public Holidays	From 10 a.m. to 8.30 p.m.
..	Albon's Pharmacy, 18 Gellibrand-crescent, Reservoir North	Friday, 19th June, 1970, to Tuesday, 23rd June, 1970 (inclusive)	Each day during the period except Saturday, Sunday and Public Holidays	From 10 a.m. to 8.30 p.m.
	Cnr. Carson and Lindelow streets, Keon Park	Monday, 22nd June, 1970, and Tuesday, 23rd June, 1970	Monday, 22nd June, 1970 Tuesday, 23rd June, 1970	From 10 a.m. to 8.30 p.m. From 10 a.m. to 8.30 p.m.
..	Mayhew's Pharmacy, 743b Gilbert-road, Reservoir West	Monday, 22nd June, 1970, to Wednesday, 24th June, 1970 (inclusive)	Each day during the period except Public Holidays	From 10 a.m. to 8.30 p.m.
	Highland Service Station, Cnr. McFadzean and Broadhurst avenues, Reservoir	Tuesday, 23rd June, 1970, and Wednesday, 24th June, 1970	Tuesday, 23rd June, 1970 Wednesday, 24th June, 1970	From 10 a.m. to 8.30 p.m. From 10 a.m. to 8.30 p.m.
Reservoir North	B.P. Service Station, Cnr. Johnson-street and Arundel-avenue, Keon Park	Tuesday, 16th June, 1970, to Thursday, 18th June, 1970 (inclusive)	Each day during the period except Public Holidays	From 10 a.m. to 8.30 p.m.
	Shopping Centre, Elsey-road, Reservoir North	Tuesday, 16th June, 1970, and Wednesday, 17th June, 1970	Tuesday, 16th June, 1970 Wednesday, 17th June, 1970	From 10 a.m. to 8.30 p.m. From 10 a.m. to 8.30 p.m.
..	Plenty Park Shell Service Station, Cnr. Plenty-road and Keats-avenue, Kingsbury	Tuesday, 16th June, 1970, and Wednesday, 17th June, 1970	Tuesday, 16th June, 1970 Wednesday, 17th June, 1970	From 10 a.m. to 8.30 p.m. From 10 a.m. to 8.30 p.m.
	Peters' Milk Bar, Cnr. Invermay and Banff streets, Keon Park	Thursday, 18th June, 1970, and Friday, 19th June, 1970	Thursday, 18th June, 1970 Friday, 19th June, 1970	From 10 a.m. to 8.30 p.m. From 10 a.m. to 8.30 p.m.
..	Shopping Centre, Cnr. Link-street, and Green-avenue, Kingsbury	Thursday, 18th June, 1970, to Monday, 22nd June, 1970 (inclusive)	Each day during the period except Saturday, Sunday and Public Holidays	From 10 a.m. to 8.30 p.m.

NOTE.—Any person to whom this notice applies and who without reasonable excuse fails to comply with the requirements of the notice shall be guilty of an offence, and shall be liable to a penalty of not more than Forty dollars.

Dated this twenty-eighth day of April, One thousand nine hundred and seventy.

R. J. FARNBACH, Chief Health Officer.

MUNICIPAL ELECTRICAL ENGINEERS BOARD.

EXAMINATION—1970.

THE annual examination for the Certificate of Qualification as Municipal Electrical Engineer will be held during the month of June, 1970.

Applications for permission to sit should reach the Secretary to the Board not later than 31st May, 1970.

K. B. WILKINSON, Secretary,
Municipal Electrical Engineers Board.

Local Government Department, 61 Spring-street, Melbourne, 3000.

POLICE OFFENCES ACT 1958.

IN pursuance of the powers conferred upon the Chief Secretary by sub-section (3) of section 184 of the *Police Offences Act 1958*, I do by this notice grant exemption from compliance with sub-sections (1) and (2) of section 184 of the said Act with respect to the publication "The Us or Them War" distributed by Colorgravure Publications, 61 Flinders-lane, Melbourne.

A. G. RYLAH,
Chief Secretary.

Chief Secretary's Office,
Melbourne, 13th May, 1970.

Melbourne and Metropolitan
BOARD OF WORKS.

NOTICE TO THE OWNERS OF TENEMENTS IN THE UNDER-
MENTIONED STREETS AND THE PRIVATE STREETS, LANES,
COURTS AND ALLEYS OPENING THERETO.

THE main pipe in the said streets being laid down, the
owner of all tenements situated as under are hereby
required on or before the 22nd June, 1970, to cause a
proper pipe and stopcocks, to be laid so as to supply
water within such tenements from the main pipe.

R. H. ENGELSMAN,
Acting Secretary.

12th May, 1970.

STREET AND POSITION.

Berwick.

Kathryn-street, from Marie-street, westwards 180 feet.

Coburg.

Warner-street, from Lygon-street to Ulm-street.

Croydon.

Ulysses-avenue, from 110 feet north of Reilly-court, north-
wards 40 feet.

Bennison-street, from 430 feet south of Mount Dandenong-
road, southwards 80 feet.

Dandenong.

Sylvia-street, from Devira-street, westwards 550 feet.

Devira-street, from 80 feet north of Sandala-court north-
wards 280 feet.

McFees-road, from Barton-street eastwards 930 feet.

Hillside-avenue, from McFees-road to Tooronga-street.

Dane-court, from Hillside-avenue north-eastwards 260 feet.

Diamond Valley.

David-crescent, from Luton-way eastwards 1,100 feet.

Robbins-court, from David-crescent northwards 300 feet.

Flinders-court, from David-crescent southwards 340 feet.

Handel-court, from David-crescent northwards 300 feet.

Hastings-street, from David-crescent southwards 120 feet.

Hayden-court, from David-crescent northwards 300 feet.

Verdi-court, from David-crescent southwards 220 feet.

Purcell-court, from David-crescent northwards 300 feet.

Trafalgar-crescent, from David-crescent southwards 110
feet.

Lea-crescent, from 850 feet northwards and eastwards of
Nola-court eastwards 590 feet.

Gleeson-drive, from Lea-crescent southwards, eastwards
and northwards 1,280 feet.

Doncaster and Templestowe.

Bowen-road, from Tunstall-road to Grevillea-road.

Grevillea-road, from Bowen-road to Tunstall-road.

Tandarook-crescent, from Beckett-road northwards and
north-eastwards 1,570 feet.

Eltham.

Montpelier-drive, from Bonds-road north-eastwards 1,710
feet.

River View-road, from Davey-road south-eastwards and
southwards 720 feet.

Footscray.

New-street, from Watson-street southwards 500 feet.

Keilor.

Derwent-avenue, from St. Albans-road westwards 1,170
feet.

St. Albans-road, from 60 feet south of Tambo-court south-
wards 590 feet.

Tanjil-court, from St. Albans-road westwards 310 feet.

Buckland-crescent, from Loddon-avenue southwards 770
feet.

Campaspe-crescent, from Loddon-avenue southwards 600
feet.

Loddon-avenue, from Kiewa-crescent westwards 370 feet.

Loddon-avenue, from Kiewa-crescent eastwards 340 feet.

Kiewa-crescent, from Loddon-avenue northwards 330 feet.

Tarnar-court, from Kiewa-crescent north-westwards 300
feet.

Tumut-court, from Derwent-avenue northwards 360 feet.

Knox.

Ramage-street, from Dorset-road, westwards 910 feet.

Sheppard-drive, from 520 feet west of Stud-road, west-
wards 360 feet.

Ramage-street, from 910 feet west of Dorset-road to
Clare-street.

Clare-street, from Ramage-street, southwards 180 feet.

Jordan-court from Scoresby-road, north-eastwards 700
feet.

Golden-grove, from Bowen-avenue, eastwards 460 feet.

Fern-street, from Bowen-avenue, westwards 280 feet.

Bowen-avenue, from 120 feet south-east of Fern-street,
southwards 120 feet.

Lane-road, from Williamson-road to Renown-street.

Halsey-street, from Williamson-road to Renown-street.

Prince-street, from Williamson-road northwards 420 feet.

Renown-street, from Lane-road south-westwards 50 feet.

Lilydale.

Lancaster-road, from 120 feet south of Clive-court, south-
wards and westwards 520 feet.

Cowley-court, from Lancaster-road, southwards 310 feet.

Manchester-road, from Maroondah Highway, south-west-
wards 1,260 feet.

Maroondah Highway, from Manchester-road, south-east-
wards 125 feet.

Maroondah Highway, from 2,050 feet northeast of Bellara-
drive south-eastwards 350 feet.

Moorabbin.

McFarlane-court, from Nepean Highway, eastwards 450
feet.

Warren-road, from 480 feet east of Cavanagh-street,
eastwards 320 feet.

Nunawading.

Eley-road, from O'Brien-crescent, westwards 700 feet.

O'Brien-crescent, from Eley-road, northwards and east-
wards 900 feet.

Hetrel-street, from O'Brien-crescent, eastwards 150 feet.

Dawe-road, from Quarry-road, southwards 520 feet.

Preston.

Tormey-street, from Mahoneys-road to Pallant-avenue.

Pallant-avenue, from Tormey-street to Dredge-street.

Dredge-street, from Tormey-street, north-eastwards 450
feet.

Kurnai-avenue, from Malua-street, southwards 470 feet.

Cumberland-court, from Tyler-street, southwards 470 feet.

Ringwood.

Malcolm-court, from Alexandra-road, southwards 780 feet.

Isabel-avenue, from Lynwood-avenue, northwards 910 feet.

Nicholson-street, from Morcom-avenue, south-westwards
380 feet.

Springvale.

Wilberton-drive, from Windsor-avenue, northwards 110
feet.

Norman-avenue, from Seventh-avenue, northwards 410
feet.

Home-court, from Norman-avenue, eastwards 250 feet.

Simon-avenue, from 70 feet east of Shelley-street, east-
wards 310 feet.

Jeffery-avenue, from Simon-avenue, northwards 160 feet.

Halinka-court, from Simon-avenue, southwards 400 feet.

Sunshine.

Roussac-court, from Ford-avenue, north-westwards 780
feet.

Surman-court, from Roussac-court, north-eastwards 500
feet.

Ford-avenue, from 30 feet north of Alvina-street, north-
wards 850 feet.

Tennant-street, from Ford-avenue to McIntyre-road.

Tyres-court, from Tennant-street, northwards 240 feet.

Sproul-street, from Ford-avenue to McIntyre-road.

McIntyre-road, from 100 feet north of Alvina-street, north-
wards 780 feet.

Waverley.

Torwood-avenue, from 100 feet south of Creswick-drive,
southwards 410 feet.

Appletree-drive, from 60 feet east of Torwood-avenue to
Links-avenue.

Lexi-court, from Appletree-drive, southwards 310 feet.

Appletree-drive, from Torwood-avenue, eastwards and
northwards to Links-avenue.

Miles-street, from Springvale-road, westwards 1,310 feet.

Kernot-avenue, from 300 feet east of Monash-drive, east-
wards 270 feet.

Elaine-court, from Viggers-parade, north-westwards 310
feet.

Lum-road, from 50 feet north of Andelana-avenue north-
wards 360 feet.

Richard-road, from Alice-street to Sunhill-road.

Waverley-road, from 950 feet east of Winterton-crescent,
eastwards 950 feet.

Northam-street, from Waverley-road, northwards 860
feet.

Wenden-court, from Northam-street, westwards 180 feet.

Chapman Boulevard, from Northam-street, north-westwards 660 feet.
O'Brien-close, from Chapman Boulevard north-eastwards 250 feet.

Werribee.

Old Geelong-road, from Tyquin-street north-eastwards 220 feet.
Tyquin-street, from Henderson-street to Old Geelong-road.

Whittlesea.

Mahoneys-road, from Aylward-avenue, westwards 150 feet.
Mahoneys-road, from Aylward-avenue, eastwards 180 feet.
Aylward-avenue, from Mahoneys-road, northwards 910 feet.
Pinewood-drive, from 400 feet west of Banksia-avenue, westwards 600 feet.
Tilbury-street, from Pinewood-drive, northwards 690 feet.

Williamstown.

Ponting-street, from Kororoit Creek-road, southwards 390 feet.
Swanston-street, from Kororoit Creek-road, southwards 350 feet.

GAS AND FUEL CORPORATION OF VICTORIA.

THE following notice was published 1^o on the 29th April, 1970, re: Gas Odorization Plant, Parish of Coolungoolun.

"Notice is hereby given that the Gas and Fuel Corporation of Victoria has applied for a lease under section 134 of the Land Act 1958 for a term of 21 years in respect of an area of 0 acres 0 roods 27 5/10 perches more or less, being portion of the Black Swamp, Parish of Coolungoolun, as a site for Gas Odorization plant and ancillary purposes.—(H.033469.)"

LAW DEPARTMENT.

MAGISTRATES' COURT.—ADDITIONAL DAYS APPOINTED.

HIS Excellency the Governor of the State of Victoria, by and with the advice of the Executive Council thereof, doth by Order made on the 13th day of May, 1970, and pursuant to the provisions of section 64 of the Justices Act 1958, appoint the days and hours contained in the Schedule below for the holding of Magistrates' Courts at the place named in such Schedule in lieu of the days and hours heretofore appointed, to take effect as from the dates shown.

SCHEDULE.

Place.	Days and Hours.
Bendoc	Every fourth Tuesday at 10 a.m., as from and inclusive of 9th June, 1970, and Wednesday, 2nd September, 1970, at 10 a.m.

J. ROSSITER,
Clerk of the Executive Council.

At the Executive Council Chamber,
Melbourne, 13th May, 1970.

Wheat Marketing Act 1969.

DETERMINATION OF FORMULA FOR ALLOCATION OF WHEAT QUOTAS FOR THE SEASON 1970-1971.

IN pursuance of the powers conferred upon me by section 17 (3) of the *Wheat Marketing Act 1969*, I, Gilbert Lawrence Chandler, the Minister of Agriculture for the time being of the State of Victoria, after consultation with the Victorian Farmers' Union, do hereby determine that the formula in accordance with which the Wheat Quota Committee shall allocate to landowners in respect of their land quotas for deliveries of wheat in respect of the season 1970-1971 shall be as follows:—

49.4	Q	where Q is the landowner's quota or quota entitlement in respect of the season 1969-1970 plus any special quota allocated to him for that season under sub-paragraph 1 and 2 of section 34 (1) (a) of the <i>Wheat Marketing Act 1969</i> .
63	x 1	

G. L. CHANDLER,
Minister of Agriculture.

19th May, 1970.

CONTRACTS ACCEPTED.—(Series 1969-70.)
VICTORIAN RAILWAYS.

88. Provision of filling and formation and consolidation of embankments for a crossing loop on the north side of the Sunshine to Serviceton Railway, between Kiata and Salisbury (241M 29C 00L to 242M 18C 00L), for the amount of \$3,329.75 (Contract 63513).—A. D. Hillgrove.
89. Removal of prefabricated Departmental Residence No. 3554, from Moriac and reassembling at Camperdown, together with out-building, for the amount of \$850.00 (Contract 63518).—K. E. Black & Sons.

By order of the Victorian Railways Commissioners,
W. WALKER, Secretary for Railways. 15.5.1970.

PUBLIC WORKS.

- 1379. Melbourne School of Hairdressing, electrical work; original \$3,290.00, extra \$1,891.00, \$5,181.00.—L. F. Smith Pty. Ltd.
 - 1380. Plenty Mental Hospital, external renovations, Wards A and B; original \$3,558.00, additional \$1,429.38, \$4,987.38.—R. & N. Fraser Pty. Ltd.
 - 1381. Pembroke Primary School, site works; original \$3,515.50, additional \$3,822.95, \$7,338.45.—D. Saathoff.
 - 1382. Melbourne School of Painting and Decorating, electrical re-wiring; original \$3,630.00, additional \$5,632.00, \$9,262.00.—J. Newall Pty. Ltd.
 - 1383. Williamstown P.W.D. Dredging Depot, supply steel pipes, \$6,337.78.—Rayner Trading Pty. Ltd.
 - 1384. Wangaratta, Junior Technical School, internal and external repairs, renovations and painting, \$21,550.00.—C. B. Bramich.
 - 1385. Heatherton, Sanatorium, supply and delivery of laundry equipment, \$30,326.00.—Hardie Trading Ltd.
 - 1386. Kew, Mental Hospital, supply and delivery of two (2) 100 lb. drying tumblers, \$9,580.00.—Hardie Trading Ltd.
 - 1387. Kew, Mental Hospital, supply and delivery of Ironer, Foler and Feedmaster machines, \$34,958.00.—Hardie Trading Ltd.
 - 1388. Strathmore, High School, erection of standard school hall, type "572 C", \$87,690.00.—Hosie Constructions Pty. Ltd.
 - 1389. Malmesbury, Youth Training Centre, erection of single-story Group Cottage Block, \$146,680.00.—A. V. Jennings Industries (Aust.) Ltd.
 - 1390. Boronia, High School, internal and external repairs and painting, \$9,000.00.—N. Peshut.
 - 1391. Bulleen, Primary School 4869, asphalt, concrete and drainage works, \$4,962.45.—D. Saathoff.
 - 1392. Mount Waverley, High School, site works, \$28,763.19.—Sheffield Paving & Construction Co. Pty. Ltd.
- G. SERPELL, Director-General of Public Works. 15.5.70.

ORDERS IN COUNCIL.—(Series 1969-70.)

PUBLIC WORKS.

- 1373. Collingwood, High School, demolition of fire damaged buildings, \$4,175.00.—R. N. Collins.—(C.21432.)
- 1374. Collingwood, High School, supply and erection of a Terrapin Unit Building, \$16,643.00.—Willcroft Terrapin Pty. Ltd.—(C.021246.)
- 1375. Mont Albert, Primary School 3943, supply and installation of gas heating, \$4,970.62.—The Colonial Gas Association Ltd.—(E.137823.)
- 1376. Mount Buller, erection of additional staff quarters for Police purposes, \$9,500.00.—Aurel Forras Pty. Ltd.—(N.163781.)
- 1377. Timboon, High School and Residences, connexion of school and five residences to town water supply, \$4,150.00.—Warmambool Plant Hire Pty. Ltd.—(W.116290.)
- 1378. West Melbourne, Government Cool Stores, supply and delivery of twenty forced draught cooler units, \$12,630.00.—J. Wildridge & Sinclair Pty. Ltd.—(C.165672.)

Approved by the Governor in Council, 13th May, 1970.—
J. ROSSITER, Clerk of the Executive Council.

Police Regulation Act 1958, Section 122.

SALE OF UNCLAIMED MOTOR VEHICLE.

AN owner is required for a 1961 Ford Fairlane sedan, ex-registered No. HLS-716, engine No. AZM 13279.

The vehicle came into the possession of Police on 9th September, 1969, and if not claimed will be sold by public auction, at the Heidelberg Police Station, Jika-street, Heidelberg, at 2.00 p.m. on 17th June, 1970.

N. WILBY,
Chief Commissioner of Police.

Town and Country Planning Act 1961.
SHIRE OF CROYDON PLANNING SCHEME 1961.
AMENDMENT No. 39, 1970.

Notice of Amendment.

IN pursuance of the powers conferred by sub-section 6 of section 32 of the *Town and Country Planning Act 1961*, the Governor in Council, by and with the advice of the Executive Council on the 13th May, 1970, amended the Shire of Croydon Planning Scheme 1961, in respect of the provisions relating to the garden treatment of land in the General Industrial Zone.

A copy of the amendment may be inspected during office hours at the office of the Town and Country Planning Board, 235 Queen-street, Melbourne; at the office of the Council of the Shire of Croydon, at Croydon, and when available at the Office of Titles, Melbourne; and at the Central Plan Office of the Department of Crown Lands and Survey, Melbourne.

W. H. CRAIG, Secretary,
Town and Country Planning Board.

Town and Country Planning Act 1961.
SHIRE OF BARRABOOL PLANNING SCHEME.
AMENDMENT No. 1, 1970.

Notice of Amendment.

IN pursuance of the powers conferred by sub-section 6 of section 32 of the *Town and Country Planning Act 1961*, the Governor in Council, by and with the advice of the Executive Council on the 13th May, 1970, amended the Barrabool Planning Scheme to permit the erection of a dwelling and ancillary buildings on the following allotments:—

- Lots 2 to 5 on lodged plan of subdivision 77299.
- Lots 6 to 9 on lodged plan of subdivision 77300.

A copy of the amendment may be inspected during office hours at the office of the Town and Country Planning Board, 235 Queen-street, Melbourne; at the office of the Council of the Shire of Barrabool, Moorabool-street, Geelong, and when available at the Office of Titles, Melbourne; and at the Central Plan Office of the Department of Crown Lands and Survey, Melbourne.

W. H. CRAIG, Secretary,
Town and Country Planning Board.

Town and Country Planning Act 1961.
CITY OF KNOX PLANNING SCHEME 1965.
AMENDMENT No. 61, 1969.

Notice of Approval.

IN pursuance of the powers conferred by the *Town and Country Planning Act 1961*, the Governor in Council on the 13th May, 1970, approved a Planning Scheme entitled the City of Knox Planning Scheme 1965, Amendment No. 61, 1969, in respect of part of the municipal district of the City of Knox and such Planning Scheme comes into operation on the date this notice of approval is published in the *Government Gazette*.

A copy of the Planning Scheme as approved may be inspected, free of charge, during office hours at the office of the Town and Country Planning Board, 235 Queen-street, Melbourne; at the office of the City of Knox, at Fern Tree Gully, and when available, at the Office of Titles, Melbourne, and at the Central Plan Office of the Department of Crown Lands and Survey, Melbourne.

W. H. CRAIG, Secretary,
Town and Country Planning Board.

Town and Country Planning Act 1961.
SHIRE OF SHERBROOKE PLANNING SCHEME 1965.
AMENDMENT No. 24, 1969.

Notice of Approval.

IN pursuance of the powers conferred by the *Town and Country Planning Act 1961*, the Governor in Council on the 13th May, 1970, approved a Planning Scheme entitled the Shire of Sherbrooke Planning Scheme 1965, Amendment No. 24, 1969, in respect of part of the municipal district of the Shire of Sherbrooke and such Planning Scheme comes into operation on the date this notice of approval is published in the *Government Gazette*.

A copy of the Planning Scheme as approved may be inspected, free of charge, during office hours at the office of the Town and Country Planning Board, 235 Queen-street, Melbourne; at the office of the Shire of Sherbrooke, at Upwey, and when available, at the Office of Titles, Melbourne, and at the Central Plan Office of the Department of Crown Lands and Survey, Melbourne.

W. H. CRAIG, Secretary,
Town and Country Planning Board.

Town and Country Planning Act 1961.
SHIRE OF UPPER MURRAY (CORRYONG) PLANNING SCHEME 1960.

AMENDMENT No. 3, 1969.

Notice of Approval.

IN pursuance of the powers conferred by the *Town and Country Planning Act 1961*, the Governor in Council on the 13th May, 1970, approved a Planning Scheme entitled the Shire of Upper Murray (Corryong) Planning Scheme 1960, Amendment No. 3, 1969, in respect of part of the municipal district of the Shire of Upper Murray and such Planning Scheme comes into operation on the date this notice of approval is published in the *Government Gazette*.

A copy of the Planning Scheme as approved may be inspected, free of charge, during office hours at the office of the Town and Country Planning Board, 235 Queen-street, Melbourne; at the office of the Shire of Upper Murray, at Corryong, and when available, at the Office of Titles, Melbourne, and at the Central Plan Office of the Department of Crown Lands and Survey, Melbourne.

W. H. CRAIG, Secretary,
Town and Country Planning Board.

Town and Country Planning Act 1961.
CITY OF BENDIGO PLANNING SCHEME 1962.
NOTICE OF APPROVAL.

IN pursuance of the powers conferred by the *Town and Country Planning Act 1961*, the Governor in Council on the 13th May, 1970, approved a Planning Scheme entitled the City of Bendigo Planning Scheme 1962, in respect of the whole of the municipal district of the City of Bendigo and such Planning Scheme comes into operation on the date this notice of approval is published in the *Government Gazette*.

A copy of the Planning Scheme as approved may be inspected, free of charge, during office hours at the office of the Town and Country Planning Board, 235 Queen-street, Melbourne; at the office of the Bendigo City Council, at Bendigo; and when available, at the Office of Titles, Melbourne, and at the Central Plan Office of the Department of Crown Lands and Survey, Melbourne.

W. H. CRAIG, Secretary,
Town and Country Planning Board.

Survey Co-ordination (Place Names) Act No. 7360.
NOTICE OF INTENTION TO ALTER A NAME.

PURSUANT to the powers conferred under section 28 of the above Act, the Place Names Committee hereby gives notice of its intention to alter the name of the under-mentioned mountain:—

Municipality.—Shire of Bright.

Location.—Approximately two (2) miles south-westerly from Mt. Emu, Parish of Werमतong, County of Bogong.

Present Name.—Mt. Little Emu.

Proposed Name.—Little Mount Emu.

Any person who objects to the above proposal may give notice of objection, in writing, to the Secretary of the Committee not more than two (2) months following the publication of this notice.

By order of the Committee,
C. E. E. BARLOW,
Secretary.

Survey Co-ordination (Place Names) Act No. 7360.
NOTICE OF INTENTION TO ALTER A NAME.

PURSUANT to the powers conferred under section 28 of the above Act, the Place Names Committee hereby gives notice of its intention to alter the name of the under-mentioned mountain:—

Municipality.—Shire of Bright.

Location.—Approximately $\frac{1}{2}$ of a mile south-westerly from Mt. Feathertop, Parish of Harrietteville, County of Bogong.

Present Name.—Mt. Little Feathertop.

Proposed Name.—Little Mount Feathertop.

Any person who objects to the above proposal may give notice of objection, in writing, to the Secretary of the Committee not more than two (2) months following the publication of this notice.

By order of the Committee,
C. E. E. BARLOW,
Secretary.

DEPARTMENT OF MINES.
MINING LEASE GRANTED.

8826, Mineral; Leslie Edward Sheil; 14a. Or. 1p., Parish of Clarkesdale.

APPLICATION FOR MINING LEASE DECLARED
ABANDONED.

8964, Mineral; Edward Arthur Knox; 300 acres, Parish of Brimbonga.

APPLICATION FOR MINERAL SEARCH LICENCE
REFUSED.

986, Mineral Search Licence; Francis Anthony Astill; 42 square miles, Parish of Flowerdale.

APPLICATION FOR EXTRACTIVE INDUSTRY LEASE
REFUSED.

86, Extractive Industry Lease; Kevin Thomas Wilson; ¼ acre, Parish of Faraday.

EXPLORATION LICENCE GRANTED.

157, Exploration Licence; Mines Exploration Proprietary Limited; 41 square miles, Counties of Delatite, Anglesey.

APPLICATION FOR EXPLORATION LICENCE REFUSED.

141, Exploration Licence; Ian Hubert Warwick Jones, David Douglas Haig, Russell Samuel McInnes, Henry Hammond; 128 square miles, Counties of Borung, Ripon.

MINERAL SEARCH LICENCES GRANTED.

829, Mineral Search Licence; Coopers Creek Mining & Exploration N.L.; 265 acres, Parishes of Moondarra, Numbruk.

870, Mineral Search Licence; Andrew Firth; 224 acres, Parish of Bittern.

960, Mineral Search Licence; George Milton; 4.1 square miles, Parish of Gelantipy West.

TAILINGS LICENCES GRANTED.

3637, Tailings Licence; Ernest Godfrey Derrick; 4.5 acres, Parish of Queenstown.

3651, Tailings Licence; Bendigo Pottery Pty. Ltd.; Slum deposit, situated at Collins-street, Golden Square.

3672, Tailings Licence; The President, Councillors and Ratepayers of the Shire of Yackandandah; Emery's Pit situated at Yackandandah.

3675, Tailings Licence; Forests Commission of Victoria; Scottish dump at Cambrian Hill.

3681, Tailings Licence; Malcolm John McClure; "Ajax Shaft" situated at South Castlemaine.

3682, Tailings Licence; William Akers; "Sydenham Mine" dump situated at Burnt Gully, Dunolly.

3683, Tailings Licence; William Akers; "Calédonia Mine" dump situated in the Gravel Reserve between Bromley and Betley.

3687, Tailings Licence; The President, Councillors and Ratepayers of the Shire of Ripon; "Koren Kopier" and other dumps at Snake Valley.

3691, Tailings Licence; Alan Heywood Sutherland; old Toora Tin Mine situated in Parish of Toora.

3692, Tailings Licence; The Mayor, Councillors and Citizens of the City of Bendigo; Cornish Shaft dump situated at Long Gully.

3693, Tailings Licence; The Mayor, Councillors and Citizens of the City of Bendigo; "Confidence Shaft Site" in the Parish of Sandhurst.

3696, Tailings Licence; Country Roads Board; eastern half of the "old Austral Coal Mine" dump situated at Korumburra East.

EXTRACTIVE INDUSTRY LICENCES GRANTED.

140, Extractive Industry Licence; Victorian Agricultural Lime Limited; 253 acres, more or less, Parish of Timboun.

403, Extractive Industry Licence; Springvale Washed Sand Proprietary Limited; 1a. 11r. 28p., Parish of Mordialloc.

J. C. M. BALFOUR,
Minister of Mines.

MINING LEASE DECLARED VOID.

8680, Mineral; Nicholas William John Walsh; 6a. Or. 1p., Parish of Castlemaine.

E. CONDON,
Secretary for Mines.

PLENTY-YARRAMBAT WATERWORKS TRUST.

BY-LAW No. 9.

THE Plenty-Yarrambat Waterworks Trust in pursuance and exercise of the powers and authorities conferred by the Water Acts, doth hereby make the by-law following for its Waterworks District—

1. That by-law No. 3 is repealed hereby.

2. That by-law No. 2 be amended as follows:—

(a) in sub-section (b) of clause 17 for the words "twenty-shillings" there shall be substituted the words "twelve dollars"

(b) in sub-section (b) of clause 23 wherever appearing for the words "one pound" there shall be substituted the words "ten dollars".

Passed this 26th day of August, 1969.

(SEAL) G. T. UPTON, Chairman.
ALFRED SPRY, Commissioner.
F. PHILLIPS, Secretary.

Approved by the Governor in Council, 19th May, 1970.—
JOHN A. HORLOCK, Acting Clerk of the Executive Council.

REDBANK WATERWORKS TRUST.

AUTHORITY TO OBTAIN BANK OVERDRAFT.

HIS Excellency the Governor of the State of Victoria, by and with the advice of the Executive Council thereof doth by Order made on the 19th day of May, 1970, authorize the Redbank Waterworks Trust to obtain in pursuance of the provisions of section 286 of the Water Act 1958 (No. 6413) an advance or advances during the year 1970, by overdraft of the Trust's current account, such overdraft not to exceed at any one time the sum of Four hundred dollars (\$400).

JOHN A. HORLOCK,
Acting Clerk of the Executive Council.

At the Executive Council Chamber,
Melbourne, 19th May, 1970.

SWAN HILL WATERWORKS TRUST.

AUTHORITY TO OBTAIN BANK OVERDRAFT.

HIS Excellency the Governor of the State of Victoria, by and with the advice of the Executive Council thereof, doth by Order made on the 13th day of May, 1970, authorize the Swan Hill Waterworks Trust to obtain during the year, 1970, in pursuance of the provisions of section 286 of the Water Act 1958 (No. 6413) an advance or advances by overdraft of the Trusts current account, the amount owing in respect of such overdraft not to exceed at any one time the sum of Forty thousand dollars (\$40,000).

J. ROSSITER,
Clerk of the Executive Council.

At the Executive Council Chamber,
Melbourne, 13th May, 1970.

MANSFIELD WATERWORKS TRUST.

AUTHORITY TO OBTAIN BANK OVERDRAFT.

HIS Excellency the Governor of the State of Victoria, by and with the advice of the Executive Council thereof, doth by Order made on the 13th day of May, 1970, authorize the Mansfield Waterworks Trust to obtain during the year, 1970, in pursuance of the provisions of section 286 of the Water Act 1958 (No. 6413) an advance or advances by overdraft of the Trust's current account, the amount owing in respect of such overdraft not to exceed at any one time the sum of Five thousand dollars (\$5,000).

J. ROSSITER,
Clerk of the Executive Council.

At the Executive Council Chamber,
Melbourne, 13th May, 1970.

MANSFIELD WATERWORKS TRUST.

INCREASING THE LIMIT OF BANK OVERDRAFT.

HIS Excellency the Governor of the State of Victoria, by and with the advice of the Executive Council thereof, doth by Order made on the 13th day of May, 1970, increase the sums which the Mansfield Waterworks Trust may owe at any one time, in respect of moneys borrowed by overdraft of current account, pursuant to the provisions of section 288 of the Water Act 1958, fixed by the Governor in Council on 27th April, 1954, at Four thousand pounds (£4,000) to Twenty-five thousand dollars (\$25,000).

J. ROSSITER,
Clerk of the Executive Council.

At the Executive Council Chamber,
Melbourne, 13th May, 1970.

NOTICE TO MARINERS.

[No. 14 of 1970.]

AUSTRALIA.—VICTORIA.

PORT PHILLIP.—WEST CHANNEL.

Former Notice.—No. 8(T) of 1970 hereby cancelled.

MARINERS are advised that the shoal, the centroid of which lay 052 deg. distant 1,650 feet from No. 3 (Tuckey) Light Beacon has been reduced by dredging. A least depth of 19½ feet now occurs between the leading line and a parallel line 340 feet normal to and westward of the leading line. Between 340 feet and 425 feet westward of the leading line the least depth is 18½ feet.

Charts Affected.—B.A. 309; 2747 and 1171.

A. J. WAGGLEN,
Port Officer.

Public Works Department,
Ports and Harbours Division,
2 Treasury-place, Melbourne, Vic. 3002.
5th May, 1970.

LOCAL GOVERNMENT DEPARTMENT.

ORDER CONFIRMED.—SHIRE OF BULN BULN.

THE Minister of the Crown administering the *Local Government Act 1958*, on the 15th day of May, 1970, confirmed the Order hereinafter referred to in pursuance of section 514 of the said Act namely:

An Order of the Council of the Shire of Buln Buln made on the 16th March, 1970, directing the compulsory taking of the land described hereunder for the purpose of deviating a public highway:

All that piece of land being part of Crown allotment 123, Parish of Drouin West, commencing at a point distant 256.4 links bearing south 80 deg. 44 min. east from the south-western corner of the said Crown allotment; thence bounded by lines bearing north 7 deg. 28 min. west for 890.4 links; north 9 deg. 16 min. east for 347.3 links; south 7 deg. 28 min. east for 1,253.1 links, and north 80 deg. 44 min. west for 104.4 links to the point of commencement.

R. J. HAMER,
Minister for Local Government.

Local Government Department,
Melbourne, (1351312.)

LOCAL GOVERNMENT DEPARTMENT.

ORDER CONFIRMED.—SHIRE OF BET BET.

THE Minister of the Crown administering the *Local Government Act 1958*, on the 12th day of May, 1970, confirmed the Order hereinafter referred to, in pursuance of section 514 of the said Act namely—

An Order of the Council of the Shire of Bet Bet made on the 22nd April, 1970, directing the compulsory taking of the land described in certificate of title, volume 1872, folio 301, for the purpose of providing public buildings and conveniences in the Township of Newbridge.

R. J. HAMER,
Minister for Local Government.

Local Government Department
Melbourne.

PUBLIC NOTICE.

ALL persons, who as producers of farm produce, including honey, have any claims against Willco Honey Pty. Ltd., formerly carrying on business at 13 Calder Highway, Keilor East, Victoria, arising from any failure on its part to pay or account for any moneys payable to them by the said Willco Honey Pty. Ltd. for farm produce, including honey, are invited to forward particulars and proof of such claims to The Director of Agriculture, Treasury-place, Melbourne, on or before 10th June, 1970. (Postal address: Department of Agriculture, Box 4041, G.P.O., Melbourne, Victoria, 3001.)

RACING ACT 1958, SECTION 7.

I, ARTHUR GORDON RYLAH, Chief Secretary, in pursuance of the powers conferred by section 7 of the *Racing Act 1958*, do hereby declare that from the number of race meetings for horse races specified in the licence as the maximum allowed in respect of Sandown Racecourse for the year ending 31st July, 1971, there shall for that year be transferred three to the number of such meetings specified in the licence in respect of Caulfield Racecourse.

A. G. RYLAH,
Chief Secretary.

Chief Secretary's Office,
Melbourne, 13th May, 1970.

ESTATE AGENTS ACT 1958 (No. 6245).

WHEREAS pursuant to the provisions of sub-section (2) of section 11A of the *Estate Agents Act 1958*, No. 6245 a notice, was published in the *Government Gazette* of 25th June, 1969, declaring that estate agency work is a minor part of the work of Dalgety Australia Rural Limited, 461 Bourke-street, Melbourne: And whereas pursuant to the said sub-section (2) the Estate Agents Committee has recommended that the said declaration be revoked: Now therefore, I, Henry Edward Bolte, the Treasurer for the State of Victoria, do hereby revoke such declaration.

Dated at Melbourne, this fourteenth day of May, 1970.

H. BOLTE,
Treasurer.

APPOINTMENTS AND RESIGNATIONS

APPOINTMENTS.

HIS Excellency the Governor of the State of Victoria, by and with the advice of the Executive Council thereof, has, by Orders made on the 13th day of May, 1970, been pleased to make the under-mentioned appointments, viz.:—

CHIEF SECRETARY'S DEPARTMENT.

Postal Voting Officers.

STEPHEN ALBERTO GIUGNI
to be Postal Voting Officer within the State of Queensland, pursuant to *The Constitution Act Amendment Act 1958*;

KENNETH JAMES DICKSON,
ROBERT GEORGE LAYTHAM, and
KENNETH WILLIAM LOCK,
to be Postal Voting Officers within the State of New South Wales, pursuant to *The Constitution Act Amendment Act 1958*; and

JOHN GREVILLE McNALLY, Australian Embassy, Bangkok,
JOHN EDGAR MILLINGTON, Australian High Commission, Ottawa,
HENRY JAMES HOGAN, Australian High Commission, Singapore, and
DAVID WALLACE, Australian High Commission, New Delhi,

to be Postal Voting Officers for the conjoint Parliamentary Election to be held on the 30th May, 1970, pursuant to section 147A of *The Constitution Act Amendment Act 1958*.

Stipendiary Probation Officers, &c.

MAURICE JOHN DAWES,
JOHN HANAN HALL,
ISABELLA ELIZABETH KEUSTER,
JOHN LEATHERLAND,
RUSSELL TREVOR SMITH,
CARA LENNOX SPEIRS, and
ANGELA MARGARET WERE,
pursuant to the provisions of sections 507 (1) and 533 (3) of the *Crimes Act 1958*, section 9 (2) of the *Children's Court Act 1958*, and section 36 (1) of the *Social Welfare Act 1960*, to be Stipendiary Probation Officers for every Children's Court, Stipendiary Probation Officers and Stipendiary Parole Officers and Stipendiary Youth Parole Officers, respectively.

CROWN LANDS AND SURVEY DEPARTMENT.

Bailliff of Crown Lands.

GEOFFREY CHARLES COOKE
to be a Bailliff of Crown lands, without additional salary, in pursuance of section 30 of the *Land Act 1958*.

MINISTRY OF HEALTH.

Member of the Foreign Practitioners Qualifications Committee.

DOUGLAS ROBERT LESLIE, M.B., M.S., F.R.C.S., F.R.A.C.S.,
to be a member of the Foreign Practitioners Qualifications Committee, pursuant to clause 2 (5) of the Twelfth Schedule of the *Medical Act 1958*, for the period, ending 30th day of June, 1971, vice Mr. C. Brosnan, resigned.

Government Appointee on Committee of Management of Hospital.

JAMES WINTERS PATTERSON
to be a Government appointee on the Committee of Management of the William Anglis Hospital, Upper Ferntree Gully for a further term of three years from 6th June, 1970, pursuant to section 48, (1) (a) (ii) of the *Hospitals and Charities Act 1958*.

Trustees of Public Cemeteries.

NORMAN W. SCHNIEDER, and
WALTER E. EFFRETT,
to be Trustees of the Lorquon Public Cemetery, vice V. Palm, deceased and K. Palm, resigned;
JOSEPHINE MURPHY, and
JAMES DUNCAN,
to be Trustees of the Granite Flat Public Cemetery, vice J. Scales and Mrs. J. Duncan, deceased; and
THOMAS JAMES RICHMOND
to be a Trustee of the Rothwell Public Cemetery, vice J. Gillett, resigned, pursuant to section 3 (1) of the *Cemeteries Act 1958*.

LAW DEPARTMENT.

Commissioners for Taking Declarations, &c.

MICHAEL MCKEOWN, 3 Base Ordnance Depot, Kensington-road, South Kensington,
ALLEN ALGREEN-USSING, Post Office, Caramut,
STANLEY LEWIS WILLIAMS, 5 Woodlea-drive, Glen Waverley,
BRUCE ROBERT VALPIED, 36 Beaufort-avenue, Ballarat, and
JOHN SYDNEY BARRETT, 28 Prendergast-street, Pascoe Vale South,
to be Commissioners for taking Declarations and Affidavits, pursuant to the provisions of the *Evidence Act 1958*, to resign upon removing from the neighbourhood of the addresses stated; and
KENNETH SPENCER NALL, care of Myer Geelong, Myer Southern Stores Limited, 105-121 Malop-street, Geelong,
GARTH WILLIS PALAMOUNTAIN, care of Melbourne Club, 36 Collins-street, Melbourne, and
ROBERT GEORGE STEWART, care of Wright, Stephenson & Co. Ltd., Wrightson House, 330 St. Kilda-road, Melbourne,
to be Commissioners for taking Declarations and Affidavits, pursuant to the provisions of the *Evidence Act 1958*, to resign upon ceasing to occupy their present positions.

Justices of the Peace.

ROBERT BRUCE COMBEN, 9 Ascot-street, Laverton, and
BETTY BILTON McDONELL, Glengarry, Darraweit Guim,
to keep the Peace in the State of Victoria.

Assistant Registrar of Probates.

GEORGE ARTHUR IVAN SMITH
to act as Assistant Registrar of Probates and Administrations during the absence of N. D. May on approved leave, to take effect from the date of commencement of duty.

Deputy Prothonotary, Sale.

JOHN ANTHONY BARNES
to be Deputy Prothonotary at Sale during the absence of D. R. Walker, on recreation and long service leave, to take effect from the date of commencement of duty.

DEPARTMENT OF THE TREASURER.

Receiver of Revenue (Acting).

THOMAS CHARLES WARD
to act temporarily as Receiver of Revenue, State Land Tax and Probate Duties Office, vice I. M. Green, on leave.

DEPARTMENT OF WATER SUPPLY.

Waterworks Trust Commissioners.

HOWARD FLETCHER CHAPMAN
to be a Commissioner of the Avoca Township Waterworks Trust, to hold such position for a period of four years from the date hereof, subject to the provisions of the *Water Act*; and
JAMES FREDERICK DARMODY
to be a Commissioner of the Marysville Waterworks Trust, to hold such position for a period of four years from the date hereof, subject to the provisions of the *Water Act*.

J. ROSSITER,
Clerk of the Executive Council.

At the Executive Council Chamber,
Melbourne, 13th May, 1970.

Vermin and Noxious Weeds Act 1958.

APPOINTMENT OF INSPECTOR.

IT is hereby notified that the Public Service Board in exercise of its powers has appointed the under-mentioned person as an Inspector under the provisions of section 4 of the *Vermin and Noxious Weeds Act 1958* without additional salary:

GEOFFREY CHARLES COOKE.

A. J. HOLT,
Secretary for Lands.

Melbourne, 18th May, 1970.

RESIGNATIONS.

HIS Excellency the Governor of the State of Victoria, by and with the advice of the Executive Council thereof, has, by Orders made on the 13th day of May, 1970, accepted the resignations of the persons named hereunder of the offices mentioned, viz.:—

CHIEF SECRETARY'S DEPARTMENT.

Honorary Probation Officers.

RONALD FRANCIS ADAMS, St. George's Manse, Queens-cliff,
ALLAN AINLEY, 124 Kirkham-road, Dandenong,
BRIAN ASHWORTH, St. James Vicarage, Pender-street, Thornbury,
FRANK ERNEST BARDWELL, Post Office Ballendella, via Echuca,
JOHN ARNOLD BOOTH, 52 Short-street, Bendigo,
KENNETH WILLIAM BRADFIELD, 45 Marks-street, Coburg,
ERIC MURRAY BROADFOOT, 183 Deakin-avenue, Mildura,
ALAN ERNEST BROWN, 197 Foster-street, Dandenong,
LESLIE WALLACE BULL, 9 Bear-street, Mordialloc,
HAROLD ARTHUR BURGESS, 62 Drummond-street, Carlton,
RALPH BURGIN, 21 Barkly-street, Maryborough,
LINDSAY WILLIAM BURNSIDE, 13 Rachele-road, East Keilor,
EDMOND CANTLON, 6 Osborne-avenue, Preston,
IAN CATHIE, 698 Nepean Highway, Carrum,
ALBERT GEORGE CHURCH, 22 High-street, Frankston,
VERNON LESLIE COHEN, 18 Edward-street, Mitcham,
THOMAS ROY COLLIS, The Parsonage, 13 Church-street, Wodonga,
MICHAEL LEO COYNE, 3 Wallace-street, Maidstone,
ERIC ALAN CREIGHTON, High School, Numurkah,
RONALD CULLIN, St. Mary's Presbytery, Myrtleford,
JOHN THOMAS CURRIE, 121 St. Georges-road, North Fitzroy,
ROBERT IAN DAVIDSON, 239 North-road, South Caulfield,
HARVEY ARTHUR DINEEN, 43 Powell-street, Regent,
OWEN DOUGLAS DOWLING, 287 Bell-street, West Heidelberg,
EGAN EGGLESTON, 70 Macrae-street, Dandenong,
DEBRAEL FADEL, 176 Simpson-street, East Melbourne,
WALTER LEONARD FEHMEI, 44 Sycamore-street, South Caulfield,
LEO LESLIE FOSTER, 26 Nottingham-street, Syndal,
HAROLD THOMAS GARDINER, 14 Furzer-street, West Preston,
BRAMWELL MILTON GEE, Forest-street, Woodend,
SIDNEY OSCAR GREGORY, P.O. Box 33, Cobram,
COLIN MAKENZIE HALL, 16 Iona-street, Belmont,
JOSEPH ANTHONY HOY, 236 Mansfield-street, Thornbury,
ARTHUR ERNEST HURREN, "Blue Hills", Cleghorn-road, Kallista,
OWEN HERBERT JACKSON, Post Office Box 7, Yea,
OSBORNE KEEN, 57 Murray-street, Fawkner,
JOHN MICHAEL KENNEDY, 10 Marian-street, Glenferrie,
WILLIAM ALBERT LANDERYOU, 108 Eglinton-street, Moonee Ponds,
MARIO LATTANZI, "Dunluce", Silvan,
HUGH LENNON, Duke-street, Myrtleford,
RICHARD CECIL LEONE, Opportunity Club, corner Peel and Oxford streets, Collingwood,
FRANCIS LEVY, 371 St. Kilda-road, Brighton,
JOSEPH LOPEZ, 73 Glengale-road, Sunshine Heights,
BRIAN MCCARTHY, 47 Centre-road, East Brighton,
DONALD BRUCE MCINTOSH, 4 Litani-street, Shepparton,
CHARLES WALTER MCLEOD, 17 Stanley-street, Woodville,
JOSEPH ARTHUR EDWARD MARRIAGE, Ironbark-road, Diamond Creek,
JOHN MARR, 31 Bloomfield-road, Ascot Vale,
ROBERT MILLER, 192 Lygon-street, Carlton,
FRANCIS CHARLES MOYLE, Lydiard-street, Ballarat,
ALLAN HAROLD MULLER, 81 Canterbury-road, Heathmont,
RONALD MULLER, 80 Rostrevor-parade, Box Hill,
ALAN EDWARD NUNN, 129 Kidd-road, Doveton,

GORDON EUGENE OWENS, Flat 1, 1553 High-street, Glen Iris,
 WILLIAM PATON, The Manse, Mia Mia, via Kyneton,
 JAMES VERNON PHILLIP, 34 Arthur-street, South Yarra,
 ROBERT SUTTON, Salvation Army, Westwood-place, Melbourne,
 RONALD SUNDERLAND, 54 Barkly-street, Mornington,
 STANLEY JAMES STEWART, 49 Waiora-road, West Heidelberg,
 DAVID CAMPBELL STARK, "The Manse", Noel-street, Apollo Bay,
 CLIVE RANDOLPH SPEED, 389 Hawthorn-road, Caulfield,
 EDWARD SMITH, 31 Grandison-street, Moonee Ponds,
 CHARLES ALLAN SMITH, Box 188, Swan Hill,
 FRANK ALBERT SLUTZKIN, 25 Fosbery-avenue, Caulfield,
 JAMES LAWRENCE REEVE, 26 Abbeygate-street, Oakleigh,
 DOUGLAS WALTER THOMSON, St. Stephen's Rectory, High-street, Rutherglen,
 WILKIE JAMES THOMSON, 11 Jacksons-street, Croydon,
 DAVID WARREN TOWNSEND, 300 Blackshaws-road, Altona North,
 JOHN DANIEL WADE, 31 Percy-street, Balwyn,
 ARTHUR JOHN WAGSTAFF, 390 Canterbury-road, Surrey Hills,
 ARTHUR STANLEY WALTER, 256 McKenzie-street, Broadford,
 IAN HAMILTON WELCH, 150 Leila-road, Murrumbeena,
 FRANK BRAMLEY WHARTON, 3 Withers-street, Sunshine,
 JEFF NEWNHAM WILKINSON, 258 Springvale-road, Nunawading,
 EARLE FREDERICK WILLIAMS, 144 Hoddle-street, Abbotsford,
 KENNETH IRVAN WILLIAMS, 12 Nerisse-street, Burwood,
 RAYMOND GEORGE WILLIS, 20 Balwyn-road, Canterbury, and
 RAYMOND GEORGE WHITING, 7 Barkly-terrace, Mitcham, as Honorary Probation Officers, pursuant to the provisions of section 10 (1) of the *Children's Court Act 1958*, for all Children's Courts in Victoria.

Stipendiary Probation and Parole Officers.

GRAEME FREDERICK BREWER,
 GRAHAM JAMES McLAINE, and
 PETER JAMES ROBERT REDDING,
 as Stipendiary Probation and Parole Officers, pursuant to sections 507 (1) and 533 (3) of the *Crimes Act 1958*, section 9 (2) of the *Children's Court Act 1958*, and section 36 (1) of the *Social Welfare Act 1960*.

LAW DEPARTMENT.

Commissioner for Taking Declarations, &c.

WILLIAM ALPHONSUS O'HARA, as a Commissioner for taking Declarations and Affidavits, pursuant to the provisions of the *Evidence Act 1958*.

J. ROSSITER,
 Clerk of the Executive Council.

At the Executive Council Chamber,
 Melbourne, 13th May, 1970.

ORDERS IN COUNCIL

STAMPS ACT 1958, No. 6375.

At the Executive Council Chamber, Melbourne, the thirteenth day of May, 1970.

PRESENT:

His Excellency the Governor of Victoria.
 Mr. Manson | Mr. Borthwick.

HIS Excellency the Governor of the State of Victoria, by and with the advice of the Executive Council thereof, doth by this Order made pursuant to Section 131c of the *Stamps Act 1958* (No. 6375) revoke the declaration made on the 10th February, 1959, and published in the *Government Gazette* on the 11th February, 1959, declaring certain persons to be "approved vendors" for the purposes of subdivision (14) of Division three of Part II of the *Stamps Act 1958* in so far as the said declaration refers to the under-mentioned person—

68. EQUIPMENT INVESTMENT PTY. LTD.

And the Honorable Sir Henry Edward Bolte, Her Majesty's Treasurer for the State of Victoria, shall give the necessary directions herein accordingly.

J. ROSSITER,
 Clerk of the Executive Council.

SOIL CONSERVATION AND LAND UTILIZATION ACT 1958.

At the Executive Council Chamber, Melbourne, the thirteenth day of May, 1970.

PRESENT:

His Excellency the Governor of Victoria.
 Mr. Manson | Mr. Borthwick.

SOIL CONSERVATION DISTRICTS.

WHEREAS in pursuance of the powers conferred by section 15 of the Soil Conservation and Land Utilization Act an Order constituting the Southern Gippsland Soil Conservation District was approved by His Excellency the Governor in Council on the fourth day of October, 1960.

Now therefore His Excellency the Governor of the State of Victoria upon the recommendation of the Soil Conservation Authority by and with the advice of the Executive Council of the said State does hereby subdivide the aforesaid district thus—

- Subdivision No. 1.—Comprising the Shire of Rosedale.
- Subdivision No. 2.—Comprising the Shire of South Gippsland.
- Subdivision No. 3.—Comprising the Shire of Alberton.
- Subdivision No. 4.—Comprising the Shire of Traralgon and the City of Traralgon.
- Subdivision No. 5.—Comprising the Shire of Morwell and the Yallourn Works Area.

And the Honorable Sir William John Farquhar McDonald, Her Majesty's Minister for Conservation for the State of Victoria, shall give the necessary directions herein accordingly.

J. ROSSITER,
 Clerk of the Executive Council.

MILK AND DAIRY SUPERVISION ACT 1958.

At the Executive Council Chamber, Melbourne, the thirteenth day of May, 1970.

PRESENT:

His Excellency the Governor of Victoria.
 Mr. Manson | Mr. Borthwick.

APPOINTMENT OF MEMBERS OF THE DAIRY PRODUCE BOARD.

IN pursuance of the powers conferred by section 6 of the *Milk and Dairy Supervision Act 1958* and all other powers him thereunto enabling His Excellency the Governor of the State of Victoria, by and with the advice of the Executive Council thereof, doth by this Order hereby appoint the under-mentioned persons as members of the Dairy Produce Board for a period of one (1) year from and inclusive of the 14th May, 1970—

COLIN EGERTON COLE
 RUSSELL IAN HOWEY, and
 STANLEY BOLITHO
 as Officers of the Department of Agriculture;
 GEORGE JOSEPH SADLER, and
 JAMES CAMPBELL GLEESON
 as Representatives of persons owning factories within the meaning of Part I. of the said Act;
 JOSEPH ARTHUR FORD
 as a Representative of managers of such factories; and
 COSMO BOND GARDINER
 as a Dairyman supplying milk or cream to a factory.
 and doth appoint the said COLIN EGERTON COLE to be the Chairman of the said Dairy Produce Board.

And the Honorable Gilbert Lawrence Chandler, Her Majesty's Minister of Agriculture for the State of Victoria, shall give the necessary directions herein accordingly.

J. ROSSITER,
 Clerk of the Executive Council.

COUNTRY ROADS BOARD.

At the Executive Council Chamber, Melbourne, the thirteenth day of May, 1970.

PRESENT:

His Excellency the Governor of Victoria.
Mr. Manson | Mr. Borthwick.

ORDER APPROVING OF LAND BEING ACQUIRED AND ROADS, DEVIATIONS OR WIDENINGS BEING MADE.

HIS Excellency the Governor of the State of Victoria, by and with the advice of the Executive Council thereof, being satisfied that there are funds legally available for acquiring the land, doth hereby approve the acquiring of the land described in the schedule hereunder and the making of new roads and deviations from and widenings of existing roads referred to in the said schedule.

SCHEDULE.

State Highway.

The land shown hatched on Plan numbered G.P.12027 hereunder required for the deviation from the Warburton Highway in the Shire of Lillydale and making of the deviation thereon.

STATE HIGHWAY
WARBURTON HIGHWAY
SHIRE OF LILLYDALE

Measurements in links

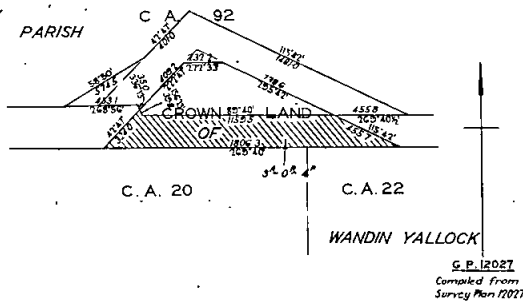

Main Roads.

The land shown hatched on Plans numbered G.P.12036 and G.P.12037 hereunder required for the deviation from and Grantville—Glen Alvie road in the Shire of Bass and making of the deviation thereon.

MAIN ROAD
GRANTVILLE — GLEN ALVIE ROAD
SHIRE OF BASS

Measurements in links

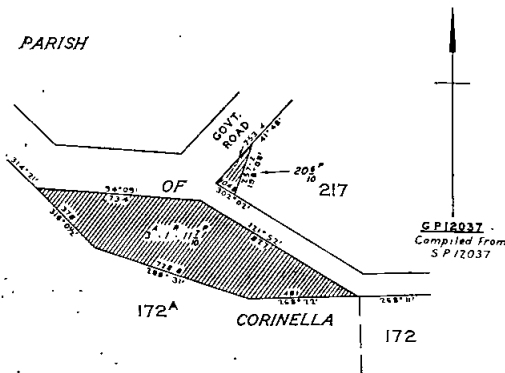

MAIN ROAD
GRANTVILLE — GLEN ALVIE ROAD
SHIRE OF BASS

Measurements in links

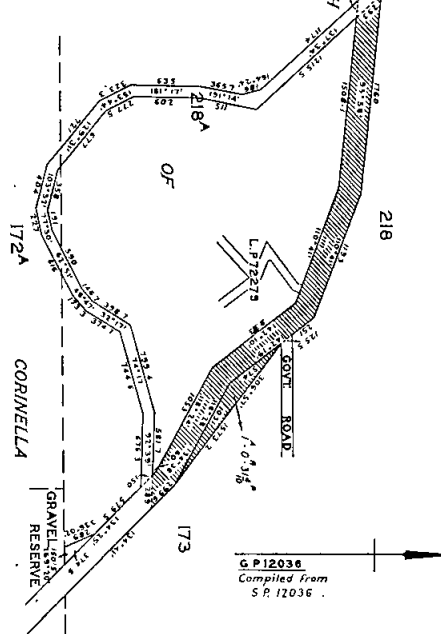

The land shown hatched on Plan numbered G.P.12023 hereunder required for the deviation from the Marnoo—Donald road in the Shires of Donald and Dunmunkle and making of the deviation thereon.

MAIN ROAD
MARNOO — DONALD ROAD
SHIRES OF DONALD & DUNMUNKLE

Measurements in links

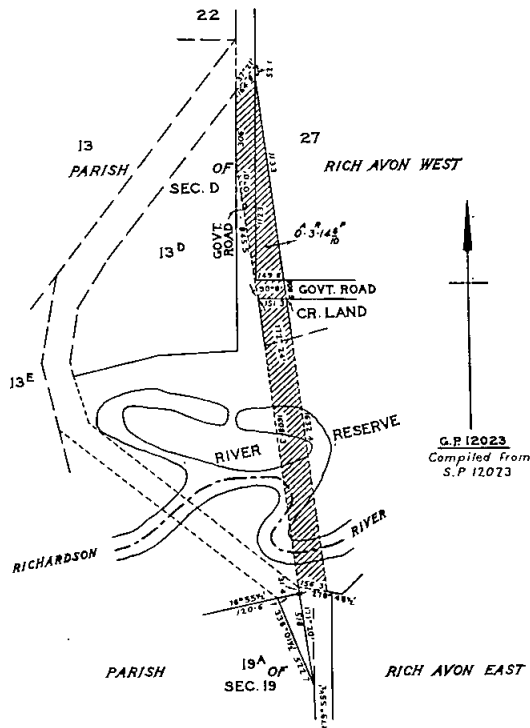

The land shown hatched on Plan numbered G.P.12125 hereunder required for the widening of the Gisborne-Melton road in the Shire of Melton and making of the widening thereon.

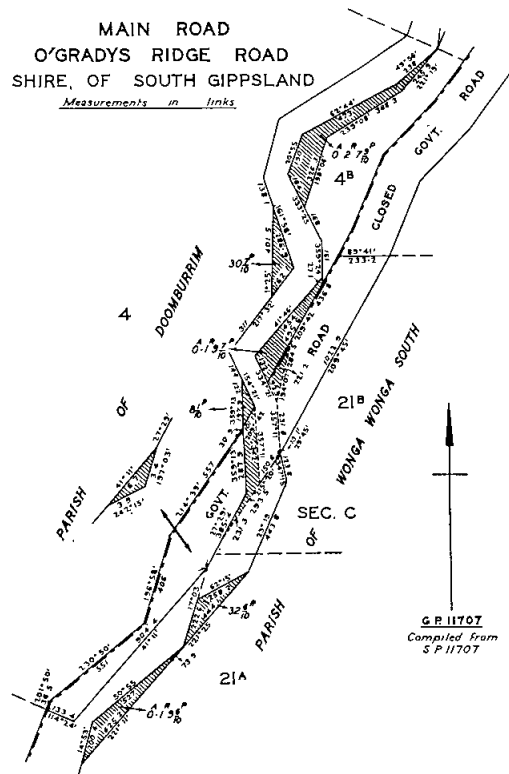
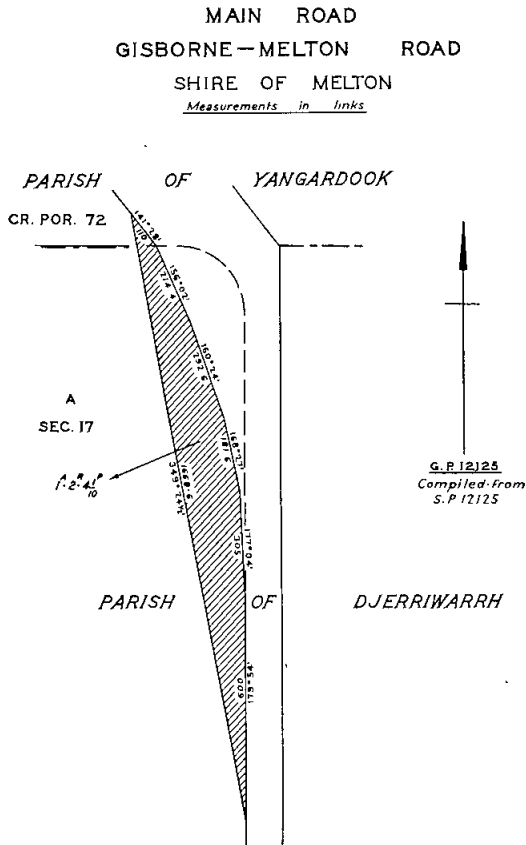

The land shown hatched on Plans numbered G.P.11705A, G.P.11705B, G.P.11706 and G.P.11707 hereunder required for the deviation from O'Grady's Ridge-road in the Shire of South Gippsland and making of the deviation thereon.

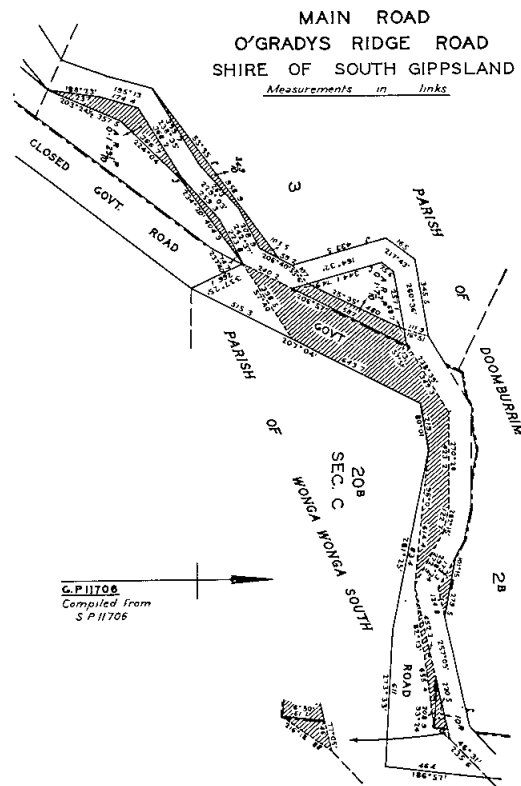
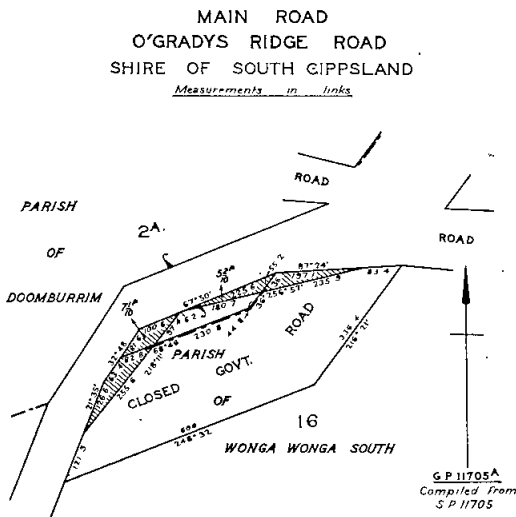

MAIN ROAD
O'GRADYS RIDGE ROAD
SHIRE OF SOUTH GIPPSLAND
Measurements in links

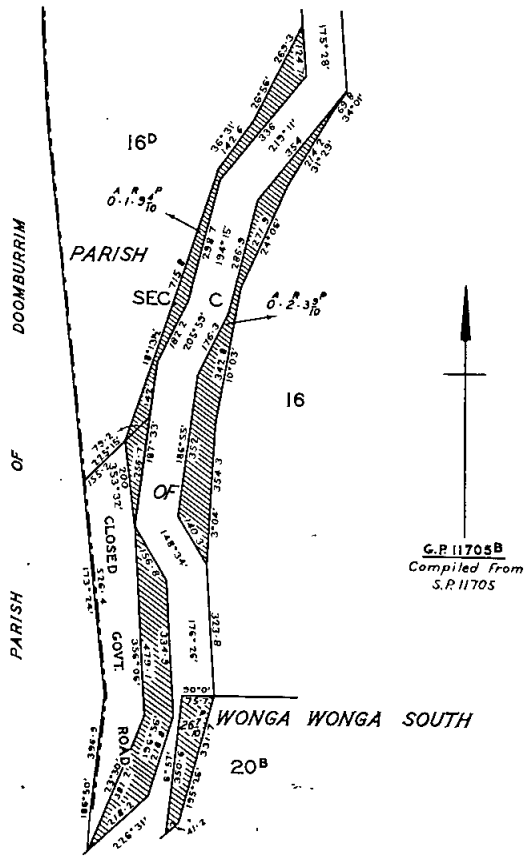

The land shown hatched on Plan numbered G.P.12121 hereunder required for the widening of the Yackandandah-Wodonga road in the Shire of Yackandandah and making of the widening thereon.

MAIN ROAD
YACKANDANDAH—WODONGA ROAD
SHIRE OF YACKANDANDAH
Measurements in links

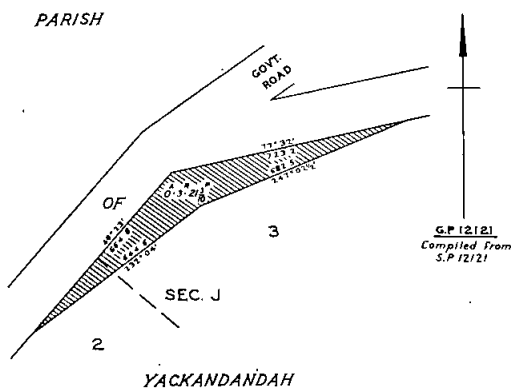

And the Honorable Rupert James Hamer, Her Majesty's Minister of Public Works for the State of Victoria, shall give the necessary directions herein accordingly.

J. ROSSITER,
Clerk of the Executive Council.

DEPARTMENT OF CROWN LANDS AND SURVEY.

At the Executive Council Chamber, Melbourne, the thirteenth day of May, 1970.

PRESENT:

His Excellency the Governor of Victoria.
Mr. Manson | Mr. Borthwick.

UNUSED ROADS CLOSED.

HIS Excellency the Governor of the State of Victoria, by and with the advice of the Executive Council thereof, doth hereby direct that, in pursuance of the provisions of section 349 of the Land Act 1958, the unused roads referred to hereunder be closed, viz.:—

Township of Berringa, Parish of Clarkesdale, County of Grenville, being the road indicated by hatching on plan hereunder.—(B.634(*) (J.33363).

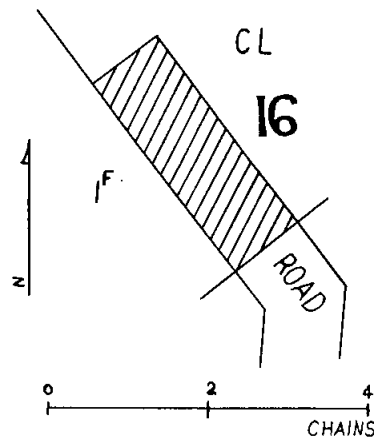

Parish of Katyil, County of Borung, being the portion of the width of the road indicated by hatching on plan hereunder.—(K.142(*) (M.48841).

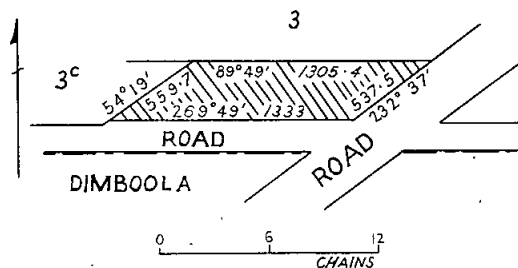

And the Honorable Sir William John Farquhar McDonald, Her Majesty's Minister of Lands for the State of Victoria, shall give the necessary directions herein accordingly.

J. ROSSITER,
Clerk of the Executive Council.

DEPARTMENT OF CROWN LANDS AND SURVEY.

At the Executive Council Chamber, Melbourne, the thirteenth day of May, 1970.

PRESENT:

His Excellency the Governor of Victoria.
Mr. Manson | Mr. Borthwick.

REVOCATION OF TEMPORARY RESERVATION OF LAND BY ORDER IN COUNCIL.

HIS Excellency the Governor of the State of Victoria, by and with the advice of the Executive Council thereof, doth hereby, in pursuance of the provisions of the *Land Act 1958*, revoke the temporary reservation of land by Order in Council hereinafter referred to, viz.:—

CRAIGIE AND EGLINTON.—Order in Council of the 5th August, 1872, of certain land in the Parishes of Craigie and Eglinton (now in the Parishes of Craigie and Eglinton and the Township of Majorca) as a site for Reservoirs and Catchment Area purposes (revoked as to part by various Orders) so far as the balance is concerned.—(C.77910) (C.330(?) (E.18(4) (M.425(9)).

ILLAWARRA.—Order in Council of the 28th August, 1939, of 1 acre 3 roods 24 perches of land in the Parish of Illawarra, as a site for Water Supply purposes.—(I.13(9) (Rs.4961).

SANDHURST (AT BENDIGO).—Order in Council of 10th July, 1917, of 77 acres 3 roods of land in the Parish of Sandhurst (at Bendigo), as a site for Supply of Gravel, so far only as regards the portion thereof comprised within the boundaries published in the *Government Gazette* of 25th March, 1970, and containing 11 acres 15 perches, more or less.—(S.372(114) (Rs.3837).

CASTERTON.—Order in Council of 13th December, 1886, of 3 acres 34 perches of land in the Township of Casterton as a site for Water Supply purposes, so far only as regards the portion thereof comprised within the boundaries published in the *Government Gazette* of 15th April, 1970, and containing 2 acres 2 roods 9 8/10 perches.—(C.177(2) (Rs.5258).

MINDAI AND CLARKESDALE.—Order in Council of 20th October, 1879 of 473 acres 32 perches of land in the Parishes of Mindai and Clarkesdale as a site for Water Supply purposes and the withholding from sale, leasing and licensing so far only as regards the portion thereof comprised within the boundaries published in the *Government Gazette* of 15th April, 1970, and containing 8 acres 2 roods 10 perches.—(C.480(1) (M.122(9) (Rs.5263).

MOE.—Order in Council of 10th April, 1940, of 2 roods, more or less, of land in the Parish of Moe as a site for Public purposes, so far only as regards the portion thereof comprised within the boundaries published in the *Government Gazette* of 8th April, 1970, and containing 15 perches, more or less.—(M.498(11) (Rs.5029).

TATONGA.—Order in Council of 30th September, 1958, of 56 acres 2 roods, more or less, of land in the Parish of Tatonga as a site for Public Recreation, so far only as regards the portion thereof comprised within the boundaries published in the *Government Gazette* of 15th April, 1970, and containing 6 perches.—(T.256(9) (Rs.4176).

And the Honorable Sir William John Farquhar McDonald, Her Majesty's Minister of Lands for the State of Victoria, shall give the necessary directions herein accordingly.

J. ROSSITER,
Clerk of the Executive Council.

DEPARTMENT OF CROWN LANDS AND SURVEY.

At the Executive Council Chamber, Melbourne, the thirteenth day of May, 1970.

PRESENT:

His Excellency the Governor of Victoria.
Mr. Manson | Mr. Borthwick.

LANDS TEMPORARILY RESERVED AS SITES.

HIS Excellency the Governor of the State of Victoria, by and with the advice of the Executive Council thereof, doth hereby, in pursuance of section 14 of the

Land Act 1958, reserve temporarily from sale, from being leased and from having a licence granted in respect thereof, and also except from occupation for mining purposes under any miner's right, the land hereinafter described:—

POREPUNKAH.—Site for Supply of Gravel, 3 roods 39 perches, Parish of Porepunkah, County of Bogong, as indicated by hatching on plan hereunder.—(P.70(A⁸) (Rs.9228).

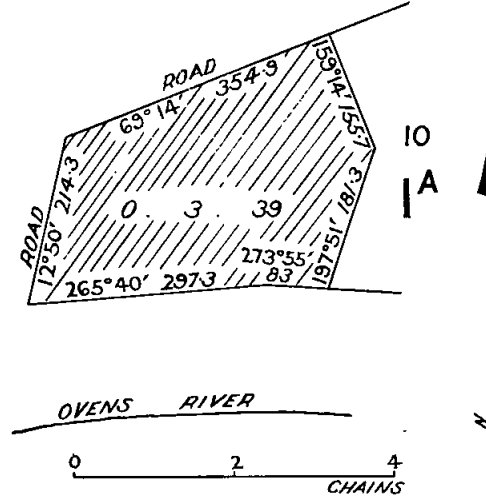

WANGARATTA SOUTH.—Site for Public purposes (Departmental Residence), 25 perches, Parish of Wangaratta South, County of Moira, as indicated by hatching on plan hereunder.—(W.85(9) (Rs.9315).

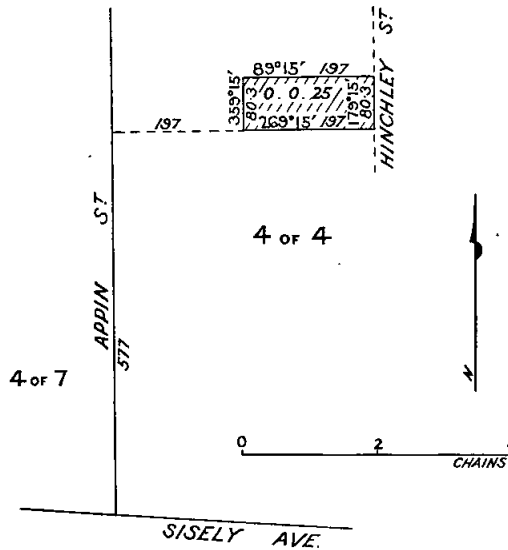

And the Honorable Sir William John Farquhar McDonald, Her Majesty's Minister of Lands for the State of Victoria, shall give the necessary directions herein accordingly.

J. ROSSITER,
Clerk of the Executive Council.

DEPARTMENT OF CROWN LANDS AND SURVEY.

At the Executive Council Chamber, Melbourne, the thirteenth day of May, 1970.

PRESENT:

His Excellency the Governor of Victoria.
Mr. Manson | Mr. Borthwick.

LAND PERMANENTLY RESERVED AS A SITE.

HIS Excellency the Governor of the State of Victoria, by and with the advice of the Executive Council thereof, doth hereby, in pursuance of Section 14 of the Land Act 1958, reserve permanently from sale and from being leased and from having a licence granted in respect thereof and also except from occupation for mining purposes under any miner's right, the land hereunder described.

TRUGANINA (ALTONA)—Land permanently reserved as a site for Public Recreation, 25 acres 3 roods more or less, Parish of Truganina, County of Bourke, as indicated by hatching on plan hereunder.—(T109(6) (Rs.7827).

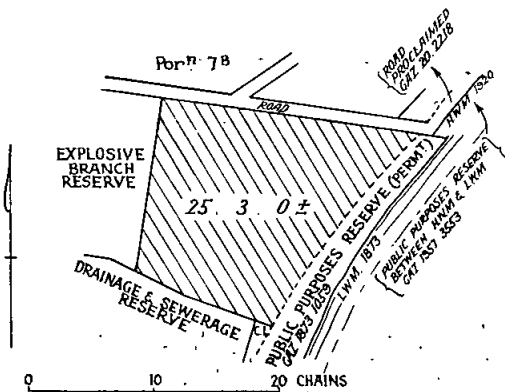

And the Honorable Sir William John Farquhar McDonald, Her Majesty's Minister of Lands for the State of Victoria, shall give the necessary directions herein accordingly.

J. ROSSITER,
Clerk of the Executive Council.

HOUSING ACT 1958.

At the Executive Council Chamber, Melbourne, the thirteenth day of May, 1970.

PRESENT:

His Excellency the Governor of Victoria.
Mr. Manson | Mr. Borthwick.

DECLARATION OF PRIVATE STREETS AS PUBLIC HIGHWAYS WITHIN THE CITY OF TRARALGON.

WHEREAS pursuant to section 107 of the Housing Act 1958 it is among other things enacted that where works have been carried out in accordance with an agreement for the full construction of any roads, pavements, culverts or drains made pursuant to the provisions of the said section 107 such roads, pavements, culverts or drains shall be under the care and management of the municipality which shall be liable for the cost of any maintenance, repair, alteration or reconstruction thereof, and the Governor in Council may by Order published in the Government Gazette declare any road so constructed to be a public highway.

And whereas by Order dated the seventeenth day of November, 1964, the Governor in Council consented to an agreement between the Housing Commission and the City of Traralgon regarding street and drainage construction in part of Cooper-street, part of Jones-court, part of Furlonger-street, part of Cameron-street in the Traralgon East Estate situate in the municipality of the City of Traralgon and the carrying out of the works enumerated in the said agreement.

And whereas the works of road pavements, culvert and drainage construction have now been carried out in accordance with the said agreement between the Housing Commission and the City of Traralgon.

Now, therefore, His Excellency the Governor of the State of Victoria by and with the advice of the Executive Council of the said State and in pursuance of the powers conferred by section 107 of the Housing Act and upon recommendation of the Housing Commission doth by this Order declare the streets more particularly delineated and shown hatched on the plan hereunder to be absolutely dedicated to the public as Public Highways within the meaning of any law now or hereafter in force: And that the Council of the municipality in which the streets are situate shall hereafter be liable for all cost of any maintenance, repair, alteration or reconstruction thereof.

PART OF CROWN ALLOTMENT 4^A SEC A

PARISH OF LOY YANG

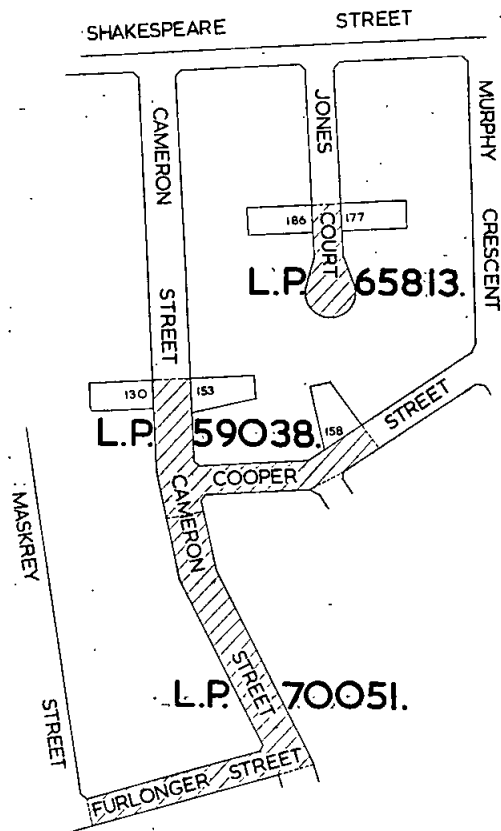
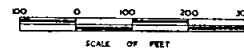

And the Honorable Edward Raymond Meagher, Her Majesty's Minister of Housing for the State of Victoria, shall give the necessary directions herein accordingly.

J. ROSSITER,
Clerk of the Executive Council.

LOCAL GOVERNMENT DEPARTMENT.

At the Executive Council Chamber, Melbourne, the thirteenth day of May, 1970.

PRESENT:

His Excellency the Governor of Victoria.
Mr. Manson | Mr. Borthwick.

DETERMINATION OF CERTAIN MATTERS AFFECTING THE MUNICIPALITIES OF THE SHIRE OF BAIRNSDALE AND THE TOWN OF BAIRNSDALE.

WHEREAS it is provided by section 27 of the *Local Government Act 1958*, that where pursuant to section 18 of the said Act, part of a municipal district is severed therefrom, the Governor in Council may, from time to time by Order apportion settle adjust or determine any property income assets rights liabilities expenses or matters which have not been apportioned settled adjusted or determined by agreement duly made and approved by the councils of the municipalities affected:

And whereas by an Order made on the eighteenth day of April, 1967, a part of the municipal district of the Shire of Bairnsdale was severed and constituted a town under the name of the Town of Bairnsdale and in consequence thereof unresolved matters require determination:

Now therefore, His Excellency the Governor of the State of Victoria, by and with the advice of the Executive Council thereof hereby determines as follows:—

1. That the moneys now held by the Council of the Shire of Bairnsdale and known as the Civic Centre (Town Hall) Trust Fund shall be dealt with and apportioned between the two municipalities in the following manner:—

- (a) Administration of the Fund shall be undertaken by the Council of the Shire of Bairnsdale, and the Shire shall be allowed 2½ per cent. on the associated costs of administration, plus 2½ per cent. on all disbursements from the Fund, (other than on payments to the Shire), which shall be allowed to the Shire as an allowance for administration.
- (b) Donations made by individual persons shall be refunded to such persons or their legal representatives upon proof of claim to the satisfaction of the Council of the Shire of Bairnsdale.
- (c) All other moneys and all donations against which no claim has been lodged on or before 30th September, 1972, shall during October, 1972, be apportioned as follows:—
 - (i) Donations made by individual persons then resident in what is now the municipal district of the Town of Bairnsdale shall be paid to the Council of the Town of Bairnsdale.
 - (ii) Donations made by individual persons then resident in what is now the municipal district of the Town of Bairnsdale shall be paid to the Council of the Shire of Bairnsdale.
 - (iii) After calculation and deduction of the administration allowance to the Shire of Bairnsdale as referred to in paragraph (a) above the balance of moneys remaining shall be apportioned between the two municipalities in the same proportions as the total of donations identifiable as made by persons then resident within the municipal district of the Town and the total of donations by persons then resident within the present municipal district of the Shire bear to the total amount of all donations received from individuals. An administration allowance of 2½ per cent. on that proportion payable to the Town shall be allowed to the Shire.

2. That the claim for the sum of \$2,388 by the Council of the Shire of Bairnsdale against the Council of the Town of Bairnsdale for administration costs in connexion with preparation of the severance agreement shall be disallowed.

3. That in respect of a claim by the Shire of Bairnsdale for \$2,517 representing interest on delayed payments due from the Town of Bairnsdale the sum of \$1,809 shall be payable by the Council of the Town of Bairnsdale to the Council of the Shire of Bairnsdale.

And the Honorable Rupert James Hamer, Her Majesty's Minister for Local Government for the State of Victoria, shall give the necessary directions herein accordingly.

J. ROSSITER,
Clerk of the Executive Council.

LOCAL GOVERNMENT DEPARTMENT.

At the Executive Council Chamber, Melbourne, the thirteenth day of May, 1970.

PRESENT:

His Excellency the Governor of Victoria.
Mr. Manson | Mr. Borthwick.

ROAD DISCONTINUED.—CITY OF FOOTSCRAY.

WHEREAS it is provided in section 528 (2) of the *Local Government Act 1958*, that where a road (whether or not a public highway but not being a road set out on land of the Crown) or any part thereof is not required for public use, the Governor in Council on the request of the municipality in which such road is situated made not less than one month after publishing in a newspaper generally circulating in the district and posting to the registered proprietor (if any) of the lands and the owners and occupiers (if any) of lands abutting or immediately adjacent to the road notice of intention to make such a request may by Order published in the *Government Gazette* direct that such road or part shall be discontinued and thereupon such road or part shall be discontinued accordingly.

And whereas the Council of the City of Footscray has requested that portion of a right-of way off Barkly-place, Footscray, be discontinued and not less than one month previously has published in a newspaper generally circulating in the district and posted to the registered proprietor of the land in the road and to the owners and occupiers of lands abutting or immediately adjacent to the said road notice of intention to make such request.

Now therefore, His Excellency the Governor of the State of Victoria, by and with the advice of the Executive Council thereof, hereby directs:—

- (a) that the said road which is shown by hachure on the plan hereunder, shall be discontinued;
- (b) that notwithstanding such discontinuance the Melbourne and Metropolitan Board of Works shall continue to have and possess the same right title power authority or interest in or in relation to the whole of the land shown by hachure on the said plan as it had or possessed prior to such discontinuance with respect to or in connexion with any pipes or drains laid or erected in on or over such land for the purposes of drainage or sewerage; and
- (c) that, subject to any such right title power authority or interest, the land in the said road may be sold by the Council of the City of Footscray by agreement.

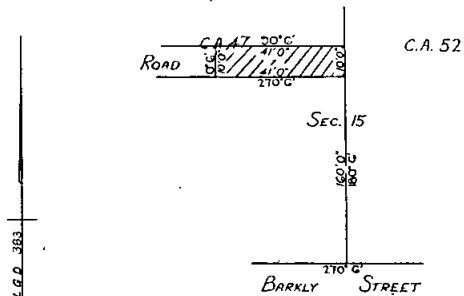

The fee of the land shown hatched was on 3-4-1970 contained in V 2771 F137

MEASUREMENTS ARE IN FEET AND INCHES

And the Honorable Rupert James Hamer, Her Majesty's Minister for Local Government for the State of Victoria, shall give the necessary directions herein accordingly.

J. ROSSITER,
Clerk of the Executive Council.

LOCAL GOVERNMENT DEPARTMENT.

At the Executive Council Chamber, Melbourne, the
thirteenth day of May, 1970.

PRESENT:

His Excellency the Governor of Victoria.
Mr. Manson | Mr. Borthwick.

REFUSAL OF AN APPLICATION FOR SEVERANCE OF
PORTION OF THE UNITED SHIRE OF BEECHWORTH
AND ANNEXATION THEREOF TO THE SHIRE OF
MYRTLEFORD.

HIS Excellency the Governor of the State of Victoria, by and with the advice of the Executive Council thereof and in pursuance of the powers conferred by section 23 of the *Local Government Act 1958*, hereby refuses to grant an Application by the Council of the Shire of Myrtleford for severance of portion of the municipal district of the United Shire of Beechworth and the annexation thereof to the Shire of Myrtleford.

And the Honorable Rupert James Hamer, Her Majesty's Minister for Local Government for the State of Victoria, shall give the necessary directions herein accordingly.

J. ROSSITER,
Clerk of the Executive Council.

LOCAL GOVERNMENT DEPARTMENT.

At the Executive Council Chamber, Melbourne, the
thirteenth day of May, 1970.

PRESENT:

His Excellency the Governor of Victoria.
Mr. Manson | Mr. Borthwick.

ALTERATION OF TIME FOR CLOSING POLL AT
MUNICIPAL ELECTIONS—SHIRE OF MELTON.

HIS Excellency the Governor of the State of Victoria, by and with the advice of the Executive Council thereof, in pursuance of the powers conferred by section 134 of the *Local Government Act 1958* and in compliance with the prayer of a petition presented by the Council of the Shire of Melton hereby declares that the hour for closing the poll at municipal elections for the said Shire shall be eight o'clock in the afternoon.

And the Honorable Rupert James Hamer, Her Majesty's Minister for Local Government for the State of Victoria, shall give the necessary directions herein accordingly.

J. ROSSITER,
Clerk of the Executive Council.

LOCAL GOVERNMENT DEPARTMENT.

At the Executive Council Chamber, Melbourne, the
thirteenth day of May, 1970.

PRESENT:

His Excellency the Governor of Victoria.
Mr. Manson | Mr. Borthwick.

ALTERATION OF TIME FOR CLOSING POLL AT
MUNICIPAL ELECTIONS—SHIRE OF KILMORE.

HIS Excellency the Governor of the State of Victoria, by and with the advice of the Executive Council thereof, in pursuance of the powers conferred by section 134 of the *Local Government Act 1958*, and in compliance with the prayer of a petition presented by the Council of the Shire of Kilmore hereby declares that the hour for closing the poll at municipal elections for the said Shire shall be six o'clock in the afternoon.

And the Honorable Rupert James Hamer, Her Majesty's Minister for Local Government for the State of Victoria, shall give the necessary directions herein accordingly.

J. ROSSITER,
Clerk of the Executive Council.

LOCAL GOVERNMENT DEPARTMENT.

At the Executive Council Chamber, Melbourne, the
thirteenth day of May, 1970.

PRESENT:

His Excellency the Governor of Victoria.
Mr. Manson | Mr. Borthwick.

ADJUSTMENT OF COMMON BOUNDARY.—SHIRE OF
WARANGA AND SHIRE OF MCLIVOR.—SHIRE OF
WARANGA AND SHIRE OF RODNEY.

PURSUANT to the provisions of section 18 (1) (i) of the *Local Government Act 1958*, His Excellency the Governor of the State of Victoria by and with the advice of the Executive Council thereof and with effect on and from the 31st May, 1970, hereby orders that for the purpose of adjustment:—

- (a) the boundaries of the Shire of Waranga shall be altered and re-defined as set forth hereunder;
- (b) the boundaries of the Shire of Mclvor shall be altered and re-defined as set forth hereunder; and
- (c) the boundaries of the Shire of Rodney shall be re-defined as set forth hereunder.

SHIRE OF WARANGA.

Commencing at a point on the Campaspe River where the road forming the western boundary of allotment 34, Parish of Bonn, abuts thereon; thence south by the said road to the north-west angle of allotment 35; thence east by a road to the north-east angle of the latter allotment; thence north-easterly by the Runnymede and Echuca road to the north-west angle of allotment 44A; thence east by a road to the north-east angle of allotment 74, Parish of Corop; thence north by a road to the north-west angle of allotment 45, Parish of Corag Corag; thence easterly by a road to the eastern boundary of the Parish of Girgarre; thence south by that boundary and easterly by the southern boundary of the Parish of Girgarre East to the north-east angle of the Parish of Waranga; thence south by a road to the north-west angle of the Parish of Murchison; thence easterly, southerly, easterly, north-easterly and south-easterly by the boundary between the Parishes of Murchison and Murchison North to the Goulburn River; thence south-westerly by that river to the southern corner of allotment 1240A, Parish of Noorlim; thence north-westerly by a road and north-easterly by the road forming the parish boundary to the north-eastern angle of allotment 13, Parish of Murchison; thence westerly by a road to the south-eastern angle of allotment 11A; thence northerly by a road to the north-eastern angle of that allotment and westerly by a road to the eastern boundary of the Parish of Whroo; thence further westerly, north-westerly and generally south-westerly by the permanent forest boundary to the southern boundary of that parish; thence westerly by that boundary and southerly by the western boundary of the Parish of Wirrate to the boundary between the Counties of Rodney and Dalhousie; thence westerly by that boundary and a line to the north-eastern angle of allotment 27, section A, Parish of Redcastle; thence further westerly by a road forming the northern boundaries of allotments 27, 29 and 19 and a line to the Redcastle Creek; thence northerly by that creek to the Cornella Creek; thence westerly by that creek to a road forming the north-eastern boundary of allotment 5, section 23; thence north-westerly by that boundary to a road forming the north-western boundary of that allotment; thence westerly by that road to the road forming the western boundaries of allotment 24, section C and allotment 3, section D, Parish of Crosbie; thence northerly by that road to the road forming the northern boundary of the last-named parish and the northern boundary of the Parishes of Weston and Axedale; thence westerly by that road to the Campaspe River; thence northerly by that river to the point of commencement.

(Previous gazettal 1956/2666.)

SHIRE OF MCLIVOR.

Commencing on the Campaspe River where it is intersected by the road forming the north boundary of the Parish of Axedale; thence easterly by the said road to the road forming the west boundary of allotments 2 and 3, section D, Parish of Crosbie; thence south by that road to the road forming the north boundary of allotment 24, section C; thence easterly by that road to its intersection with the road running north-easterly through the Mount Camel pre-emptive section; thence north-easterly by the last-mentioned road to the west angle of allotment 5, section 23, Parish of Redcastle; thence north-easterly and

south-easterly by a road to the Red Castle Creek; thence southerly by that creek to the road forming the northern boundary of allotment 19, section A, Parish of Redcastle; thence easterly by that road to the north-eastern angle of allotment 27, section A, Parish of Redcastle; thence due east by a line to the boundary between the Counties of Rodney and Dalhousie; thence easterly by that boundary to the western boundary of the Parish of Wirrate; thence southerly by that parish boundary and the western boundary of the Parish of Moormbool East to the road forming the north-western boundary of allotment 2 in the last-mentioned parish; thence north-easterly and easterly by the permanent forest boundary and further easterly by a road to the north-eastern angle of allotment 16; thence south-easterly by a road to the western boundary of allotment 49A; thence southerly by that boundary and easterly and northerly by the southern and eastern boundaries of that allotment to the northern boundary of allotment 19; thence easterly by that boundary and southerly by the eastern boundary of that allotment to Majors Creek; thence easterly by that creek to a point on the western boundary of allotment 47, Parish of Mitchell, such point bearing S. 9 deg. 9 min. E. 106 links from the intersection of lines bearing N. 9 deg. 9 min. W. and N. 77 deg. 46 min. E.; thence by lines bearing N. 83 deg. 52 min. E. 428.2 links; S. 87 deg. 33 min. E. 4007.7 links to the western boundary of allotment 24F; thence northerly by that boundary a distance of 1,001.3 links and easterly by a direct line to the northern angle of allotment 15c; thence south-easterly by a road to the western boundary of allotment 12A; thence northerly by that boundary and the western boundary of allotment 12 and easterly by a road to the north-eastern angle of allotment 11; thence northerly by a watercourse to Majors Creek; thence south-easterly and southerly by the most western course of that creek forming the eastern boundary of allotment 4 to the north-western angle of allotment 35c; thence easterly by the northern boundaries of that allotment and allotment 35 and southerly by a road to the northern angle of allotment 38; thence south-easterly by a road to the south-eastern angle of that allotment; thence westerly by a road to a point distant 3,371.6 links from the north-eastern angle of allotment 31A; thence south-westerly by a direct line to the south-western angle of allotment 31b; thence westerly, southerly and westerly by the northern boundary of the Parish of Northwood and the northern boundary of allotment 1, section C in that parish to Hawker's Creek; thence southerly by that creek to the north boundary of allotment 54; thence west, south and east by that allotment to the north-east angle of allotment 63A; thence south by a road to the south-east angle of allotment 63b; thence west by allotment 64 and allotment 55, Parish of Puckapunyal, and south-westerly by allotments 30 and 29 to the north-west angle of the last-mentioned allotment; thence southerly by a road to the north boundary of allotment 57c; thence west by that allotment to the east boundary of allotment 57A; thence south by that boundary; west by the south boundary of allotments 57A and 58b; south by the east boundaries of allotments 59A and 59b, west by the south boundary of the last-mentioned allotment, south by the east boundary of allotment 76, Parish of Warrawitue, and west by the south boundaries of allotments 76 and 75 to the east boundary of allotment 4, section 1, in the last-named parish; thence southerly by the east boundaries of that allotment and allotment 29 to the north-east angle of allotment 1, section B, Parish of Panyule; thence south by the east boundary of that allotment and allotment 2A to the south-east angle of the allotment last named; thence west by the south boundary of the said allotment 2A to the east boundary of allotment 3; thence south by the east boundary and west by the south boundary of the last-named allotment to the east boundary of allotment 4; thence south by the east boundary of allotments 4 and 4A to the south-east angle of the last-named allotment; thence west by a road being the south boundary of allotments 4A, 6 and part of 7 to the east boundary of J. Martin's 19th section block; thence south and south-westerly by the east and south-eastern boundary of said block to the south-east angle of allotment 41; thence west by the south boundary of said allotment to the east boundary of allotments 5 to 8, Parish of Tooborac; thence south by the east boundary and west by the south boundary of the said allotment to the north-east boundary of allotment 1 of section 8; thence south-easterly and south-westerly by the north-eastern and south-eastern boundaries of said allotment 1 to a road forming the eastern boundary of section IX.; thence following said road south-easterly to the south-east angle of said section; thence south-westerly by the said section IX. to its south-west angle; thence north-westerly by a road being the eastern boundary of allotment 10A to its intersection with a road forming the eastern boundary of allotment 13k; thence southerly by the last-named road to the south-east angle of allotment 13k; thence westerly by the south boundary of the last-named allotment to its

south-west angle; thence south-westerly by a road being the western boundaries of allotments 13H, 13G, 13F, 13D and the eastern boundaries of allotments 13C, 13 and 6 to the south-east angle of the allotment last named; thence westerly by a road forming the southern boundaries of allotments 16, 14 and D18 to the road forming the east boundary of allotment D²; thence south-westerly and southerly by that road to the road forming the south boundary of allotments D¹⁴ and D⁷; thence westerly and south-westerly by that road to the road forming the east boundary of allotments 6 and 4, section C, Parish of Glenhope; thence southerly by that road to the road forming the north boundaries of allotments 73v and 73r, Parish of Baynton and allotments D⁴ and D⁷, section C, Parish of Glenhope; thence westerly, southerly, westerly and southerly by that road to the north boundary of the Parish of Baynton; thence westerly by that boundary to the road forming the eastern boundary of allotment A¹², in the last-named parish; thence south-westerly by that road to Piper's Creek; and thence northerly by that creek and the Campaspe River to the point of commencement.

(Previous gazettal 1956/2664.)

SHIRE OF RODNEY.

Commencing on the Goulburn River at a point where the western boundary of the Parish of Undera abuts thereon; thence southerly by that boundary and westerly by the northern boundary of the Parish of Kyabram East to the north-western angle of allotment 14 in the last-mentioned parish; thence southerly by a road to the south-eastern angle of allotment 22A; thence westerly by a road to the western boundary of the parish; thence southerly by that boundary and the western boundary of the Parish of Gargarre East, easterly by the southern boundary of the last-mentioned Parish, and southerly by the western boundary of the Parish of Murchison North; thence easterly, southerly, easterly, north-easterly, and south-easterly by the boundary between the Parishes of Murchison North and Murchison to the Goulburn River; thence generally north-easterly by that river to a point in line with the most eastern boundary of the reserve for Public Recreation in the Township of Mooroopna; thence northerly by a line and that boundary and north-easterly by the Shepparton-Tatura road to the eastern angle of allotment 91, Parish of Mooroopna; thence north-westerly by the north-eastern boundary of that allotment and allotments 91b and 91c, and northerly by the eastern boundaries of allotments 75 and 184; thence north-westerly by a 3-chain road to a point due south of the southern angle of allotment 10, section B, Parish of Shepparton; thence north by a line to the Goulburn River and thence generally north-westerly by that river to the point of commencement.

(Previous gazettal 1954/1505.)

And the Honorable Rupert James Hamer, Her Majesty's Minister for Local Government for the State of Victoria, shall give the necessary directions herein accordingly.

J. ROSSITER,
Clerk of the Executive Council.

VICTORIA INSTITUTE OF COLLEGES ACT 1965.

At the Executive Council Chamber, Melbourne, the thirteenth day of May, 1970.

PRESENT:

His Excellency the Governor of Victoria.
Mr. Manson | Mr. Borthwick.

CONSTITUTION OF COUNCIL TO MANAGE AND CONTROL THE BENDIGO INSTITUTE OF TECHNOLOGY.

WHEREAS sub-section (2) of section 29b of the *Victoria Institute of Colleges Act 1965* provides that, where the governing body of an institution to which Division 4A of that Act applies makes an application in writing to the Minister for the incorporation of a council to manage and control the institution the Governor in Council may on the recommendation of the Minister by Order published in the *Government Gazette* constitute a council by such name as is specified in the Order as a body corporate to manage and control the institution and exercise the several other powers set out in the said sub-section in relation to the council so constituted:

And whereas the Bendigo Institute of Technology (formerly known as the School of Mines and Industries Bendigo and later as the Bendigo Technical College) is an institution to which the said Division applies:

And whereas the governing body of the Bendigo Institute of Technology has applied in writing to the Minister for the incorporation under the *Victoria Institute of Colleges Act 1965* of a council to manage and control the Bendigo Institute of Technology:

Now therefore His Excellency the Governor of the State of Victoria by and with the advice of the Executive Council thereof, and on the recommendation of the Minister, doth by this Order provide as follows:—

Constitution of Governing Council.

1. There shall be a council to be known as the "Governing Council of the Bendigo Institute of Technology" (hereinafter called "the Council") which shall be a body corporate to manage and control the Bendigo Institute of Technology.

Membership of Council.

2. (1) The Council shall consist of not more than twenty-six members and shall be constituted as follows:—

- (a) Twelve shall be persons elected by the Life Governors and Subscribers of the Institute as shall be defined from time to time by the Council.
- (b) Not more than five shall be appointed by the Governor in Council to represent commerce and industry;
- (c) One member shall be appointed by the Council of the Victoria Institute of Colleges;
- (d) One shall be a person appointed by the Minister of Education, being either the Director of Technical Education or a deputy for the Director;
- (e) The Principal of the Institute shall be a member *ex officio*;
- (f) One shall be a member of the full-time academic staff of the Institute elected by the full-time academic staff in a manner determined by the Council;
- (g) Where there is a Board of Studies (whether called by that or any other name) of the Institute, one shall be a member of the Board appointed by the Board;
- (h) Not more than three shall be persons associated with or having a special interest in tertiary education and having a special interest in, in particular, its relationship with commerce and industry from time to time appointed by co-option by the Council.

(2) The Council, if it thinks fit, may provide for the election of a member who shall be a tertiary student of the Institute and who shall be elected by the tertiary students of the Institute in a manner to be determined by the Council, and any member so elected shall hold office until the thirty-first day of December in the year for which he is elected.

(3) A member appointed by the Governor in Council may be removed by the Governor in Council.

(4) Members of the Council (other than the Principal and any member elected under sub-clause (2) of this clause) shall be entitled to hold office for three years from the dates of their respective appointments and elections: Provided that, in the case only of the first appointments not more than four of the members appointed pursuant to paragraph (a) of sub-clause (1) may be appointed to hold office for one year, and not more than four for two years and not more than two of the members appointed pursuant to paragraph (b) of sub-clause (1) may be appointed to hold office for two years.

(5) A member of the Council shall be eligible to be re-appointed or re-elected (as the case may be) but no member (other than a member appointed pursuant to paragraph (d) of sub-clause (1) of this clause) shall be elected or appointed for more than four successive terms unless he is appointed by co-option for a further term under paragraph (h) of sub-clause (1) of this clause.

(6) If a member of the Council (other than the Principal)—

- (a) resigns his office by writing under his hand directed to the President of the Council;
- (b) becomes of unsound mind or becomes a person whose person or estate is liable to be dealt with in any way under the law relating to mental health;
- (c) becomes bankrupt;
- (d) is convicted of any indictable offence;
- (e) without special leave previously granted by the Council absents himself from four consecutive meetings of the Council;

(f) ceases to hold any qualification required for his becoming or being a member of the Council;

(g) being a member appointed by the Governor in Council is removed from office; or

(h) dies—

his office shall become vacant so as to create a casual vacancy.

(7) A member appointed or elected to fill a casual vacancy shall be entitled to hold office for the unexpired portion of the original term of office only.

(8) Notwithstanding anything to the contrary in sub-clauses (1) and (2) of this clause, the said Council shall be properly constituted where there is a deficiency in the number of members or of members of any class whether originally or as the result of the occurrence of a vacancy.

(9) No member of the Council shall be entitled to vote either in the Council or in a committee of the Council or in a joint committee of members of the Council and of officers of the Institute on any subject in which he has a direct pecuniary interest, and if any member does vote on any such subject his vote shall be disallowed.

Proceedings of Council.

3. The following provisions shall apply to the Council of the Institute:—

(a) Nine members of the Council shall constitute a quorum at any meeting.

(b) The Council shall each year, or where a vacancy occurs during any year, on the occurrence of the vacancy, elect a member to be President of the Council and the President or, in his absence, another member elected to preside, shall preside at any meeting of the Council.

(c) The Council shall meet at least six times in each year.

(d) The decision of the majority of those present at any meeting of the Council shall be the decision of the Council.

(e) In the event of equality of votes on any question, the member presiding shall have a second or casting vote.

(f) The Council shall provide for the safe custody of the Seal, which shall only be used by authority of the Council, and every instrument to which the seal is affixed shall be signed by two members of the Council and shall be countersigned by the Secretary (if any) to the Council or by some other person appointed by the Council for that purpose.

Powers of Council.

4. The Council shall have power to—

(a) from time to time determine the terms and conditions on which students of the Institute and any other persons may attend classes or make use of any premises or equipment of the Institute;

(b) employ members of the academic staff of the Institute on such terms and conditions as are for the time being fixed in respect of them by the Governor in Council on the recommendation of the Council of the Victoria Institute of Colleges;

(c) employ teachers in connexion with education other than tertiary education provided by the Institute on such terms and conditions as are for the time being fixed in respect of them by the Minister of Education;

(d) employ members of the administrative technical and other staff of the Institute on such terms and conditions as are for the time being fixed in respect of them by the Governor in Council on the recommendation of the Council of the Victoria Institute of Colleges;

(e) from time to time define the duties of members of the academic teaching administrative technical and other staff of the Institute;

(f) suspend or dismiss any member of the academic teaching administrative technical or other staff of the Institute (but, in the case of dismissal of a member of the academic staff, only on a resolution of the Council passed by a majority consisting of not less than two-thirds of the total number of members of the Council);

(g) charge fees in connexion with education provided, examinations held, and any other services provided by, the Institute;

(h) from time to time hold examinations in the several subjects and courses offered by the Institute, and award diplomas certificates and

other awards (except degrees) to students who reach the required standard in any subject or course;

- (i) grant scholarships on such terms and conditions as it thinks fit;
- (j) purchase take on lease or in exchange or hire, and sell mortgage lease or dispose of any real or personal property (which power to sell mortgage lease or dispose of property may, in the case of any real property, be exercised only with the consent of the Council of the Victoria Institute of Colleges) and enter into agreements for the supply of services for the Institute;
- (k) engage architects and other professional advisers, and enter into contracts, for the erection of buildings, the making of improvements or alterations, or the carrying out of repairs, on any land or buildings vested in or occupied or used by the Institute;
- (l) borrow on overdraft of current account at any bank;
- (m) invest any moneys of the Institute not immediately required for its purposes in any securities which are authorized investments within the meaning of any law relating to trustees or, with the consent of the Council of the Victoria Institute of Colleges, in any other manner;
- (n) accept gifts of real or personal property to the Institute;
- (o) delegate, subject to such conditions as it thinks fit, any powers vested in the said Council to any member or committee of members of the Council, any officer or committee of officers of the Institute, or any joint committee of members of the Council and officers of the Institute;
- (p) do all such things as advance the interests of the staff and students of the Institute;
- (q) do all such things as may be required to be done in order to render the Institute eligible to receive grants under any law of the Commonwealth of Australia or of the State of Victoria which provides for the making of grants to educational institutions; and
- (r) do all such other things as are necessarily incidental to the proper management and control of the Institute or the effective exercise of the powers conferred on the Council.

Duties of Council.

5. It shall be the duty of the Council to:—

- (a) invite tenders by publishing an advertisement in a newspaper circulating generally throughout the State for the supply of any goods or services or the carrying out of any work the cost of which is estimated by the Council to exceed \$5,000; and
- (b) keep or cause to be kept proper books of account and have them audited at least once in each year.

And the Honorable Lindsay Hamilton Simpson Thompson, Her Majesty's Minister of Education for the State of Victoria, shall give the necessary directions herein accordingly.

J. ROSSITER,
Clerk of the Executive Council.

Water Act 1958.
MOOROPNA WATERWORKS TRUST.

At the Executive Council Chamber, Melbourne, the thirteenth day of May, 1970.

PRESENT:
His Excellency the Governor of Victoria.
Mr. Manson | Mr. Borthwick.

**EXTENT OF WATERWORKS DISTRICT INCREASED—
AREA OF URBAN DISTRICT INCREASED.**

UNDER the powers conferred by the *Water Act 1958* and all other powers enabling him in that behalf, His Excellency the Governor of the State of Victoria, with the advice of the Executive Council of the said State, doth hereby declare, order, and direct that the extent of the Waterworks District of the Mooropna Waterworks Trust and the area of the Mooropna Urban District be

increased by adding to such Districts the land shown by blue colour on a plan approved by the Governor in Council and deposited in the Office of the State Rivers and Water Supply Commission, Melbourne (Corr. No. 67/4561) and as on and from the 1st day of July, 1970, the extent of the said Waterworks District and the area of the said Urban District shall be deemed to be so increased.

And the Honorable William Archibald Borthwick, Her Majesty's Minister of Water Supply for the State of Victoria, shall give the necessary directions herein accordingly.

J. ROSSITER,
Clerk of the Executive Council.

WATER ACT 1958.

At the Executive Council Chamber, Melbourne, the thirteenth day of May, 1970.

PRESENT:
His Excellency the Governor of Victoria.
Mr. Manson | Mr. Borthwick.

KYABRAM WATER SUPPLY DISTRICT—LOCAL GOVERNING BODY, KYABRAM BOROUGH COUNCIL—AREA OF DISTRICT INCREASED.

UNDER the powers conferred by the *Water Act 1958* and all other powers enabling him in that behalf, His Excellency the Governor of the State of Victoria, with the advice of the Executive Council of the said State, doth hereby declare, order and direct as follows:—

That the area of the Kyabram Water Supply District, under the control of the Kyabram Borough Council, as a local governing body, be increased by adding thereto the lands set out and described in the Schedule hereto, and as on and from the 1st day of July, 1970 the area of such District shall be deemed to be so increased.

SCHEDULE.

The whole of lots 1 to 16 (both inclusive) on lodged plan of subdivision No. 88038 being parts of allotment 3, Parish of Kyabram East.

The lands set out and described in the foregoing Schedule are shown on a plan approved by the Governor in Council, and deposited in the Office of the State Rivers and Water Supply Commission, Melbourne (Corr. No. 69/1727).

And the Honorable William Archibald Borthwick, Her Majesty's Minister of Water Supply for the State of Victoria, shall give the necessary directions herein accordingly.

J. ROSSITER,
Clerk of the Executive Council.

COBRAM SEWERAGE AUTHORITY.

At the Executive Council Chamber, Melbourne, the thirteenth day of May, 1970.

PRESENT:
His Excellency the Governor of Victoria.
Mr. Manson | Mr. Borthwick.

REPEAL OF PORTION I. OF ORDER APPROVING OF SITE OF PUMPING STATION AND LAND TO BE COMPULSORILY ACQUIRED AND APPROVAL TO EXTENSION TO SEWERAGE DISTRICT AND NEW SITE OF PUMPING STATION.

HIS Excellency the Governor of the State of Victoria, by and with the advice of the Executive Council thereof, doth hereby repeal Portion I. of Order made on 29th day of August, 1967, giving approval to Site of Pumping Station and Land to be Compulsorily Acquired shown on a plan accompanying that Order and described as Portion I. (Corr. No. 61/4550/48), and in accordance with the provisions of the Sewerage Districts Act and all other powers enabling him in that behalf, doth hereby declare, order and direct that the extent of the Sewerage District of the Cobram Sewerage Authority be increased by adding thereto the land as shown on a plan deposited

in the office of the State Rivers and Water Supply Commission, Melbourne, and also doth approve the new site of pumping station as shown on the said plan (Corr. No. 55/1628/27).

And the Honorable William Archibald Borthwick, Her Majesty's Minister of Water Supply for the State of Victoria, shall give the necessary directions herein accordingly.

J. ROSSITER,
Clerk of the Executive Council.

STAWELL SEWERAGE AUTHORITY.

At the Executive Council Chamber, Melbourne, the thirteenth day of May, 1970.

PRESENT:

His Excellency the Governor of Victoria.
Mr. Manson | Mr. Borthwick.

AMENDMENT OF ORDER CONSTITUTING THE AUTHORITY AND FIXATION OF OVERDRAFT LIMIT.

UNDER the powers conferred by the Sewerage Districts Act and all other powers enabling him in that behalf, His Excellency the Governor of the State of Victoria, by and with the advice of the Executive Council of the said State, doth hereby amend the Order in Council proclaiming the Sewerage District and constituting the Stawell Sewerage Authority made on 23rd March, 1948, as amended by Orders in Council made on 13th September, 1955, 24th February, 1959 and 11th August, 1959, and published in the *Victoria Government Gazette* dated 2nd April, 1948, 21st September, 1955, 25th February, 1959, and 12th August, 1959, respectively, by deleting from Clause (a) the expression "and the amount which may be borrowed by way of overdraft shall be Fifteen thousand pounds (£15,000)" and doth hereby order that the principal moneys owing on overdraft of current account obtained by the Stawell Sewerage Authority pursuant to the provisions of section 78 of the Sewerage Districts Act shall not at any time exceed Forty-five thousand dollars (\$45,000).

And the Honorable William Archibald Borthwick, Her Majesty's Minister of Water Supply for the State of Victoria, shall give the necessary directions herein accordingly.

J. ROSSITER,
Clerk of the Executive Council.

RIVER IMPROVEMENT ACT, 1958.

At the Executive Council Chamber, Melbourne, the thirteenth day of May, 1970.

PRESENT:

His Excellency the Governor of Victoria.
Mr. Manson | Mr. Borthwick.

BULLOCK CREEK IMPROVEMENT TRUST CONSTITUTED.

UNDER the powers conferred by the River Improvement Act 1958 and all other powers enabling him in that behalf, His Excellency the Governor of the State of Victoria, by and with the advice of the Executive Council of the said State, doth hereby declare, order and direct as follows:—

1. That the area included within the red boundaries on the plan titled "Bullock Creek Improvement Trust Constituted" approved by the Governor in Council and deposited in the office of the State Rivers and Water Supply Commission, Melbourne, shall be and the same is hereby constituted a river improvement district to be known as the Bullock Creek Improvement District, under the jurisdiction and control of a river improvement trust to be known as the Bullock Creek Improvement Trust, and as on and from the date of this Order such District and Trust shall be deemed to be so constituted.

2. That the proposed works of the Trust shall comprise river improvement works within the Bullock Creek Improvement District.

3. That the said Trust shall be comprised of seven Commissioners, and that of these, one shall be appointed by the Governor in Council, one elected by the Council of

the Shire of Gordon, one elected by the Council of the Shire of East Loddon, one elected by the Council of the Shire of Kerang and three elected by the ratepayers of the said River Improvement District.

And the Honorable William Archibald Borthwick, Her Majesty's Minister of Water Supply for the State of Victoria, shall give the necessary directions herein accordingly.

J. ROSSITER,
Clerk of the Executive Council.

Water Act 1958.

STATE RIVERS AND WATER SUPPLY COMMISSION.

At the Executive Council Chamber, Melbourne, the thirteenth day of May, 1970.

PRESENT:

His Excellency the Governor of Victoria.
Mr. Manson | Mr. Borthwick.

GOULBURN-MURRAY IRRIGATION DISTRICT—DISTRICT EXTENDED.—COHUNA IRRIGATION AREA—BOUNDARIES VARIED.

UNDER the powers conferred by the Water Act 1958 and all other powers enabling him in that behalf, His Excellency the Governor of the State of Victoria, with the advice of the Executive Council of the said State, on the recommendation of the State Rivers and Water Supply Commission, doth hereby declare, order, and direct as follows:—

That the Goulburn-Murray Irrigation District be extended and the boundaries of the Cohuna Irrigation Area be varied by adding to the said District and Area the lands set out and described in the Schedule hereto, and as on and from the first day of July, 1970 such District shall be deemed to be so extended and the boundaries of such Area shall be so varied.

SCHEDULE.

1. The whole of allotments 21, 22, 23, 24 and 24a, section 8, Parish of Gunbower, together with those portions of a road adjoining the eastern boundaries of allotments 29 and 29a, said section and parish.

2. The whole of allotment 8b, section 8, Parish of Gunbower, together with that portion of a road adjoining the southern boundary of that allotment.

The lands set out and described in the foregoing Schedule are shown on a plan approved by the Governor in Council, and deposited in the office of the State Rivers and Water Supply Commission, Melbourne.—(Corr. Nos. 65/1463, 69/640).

And the Honorable William Archibald Borthwick, Her Majesty's Minister of Water Supply for the State of Victoria, shall give the necessary directions herein accordingly.

J. ROSSITER,
Clerk of the Executive Council.

Water Act 1958.

STATE RIVERS AND WATER SUPPLY COMMISSION.

At the Executive Council Chamber, Melbourne, the thirteenth day of May, 1970.

PRESENT:

His Excellency the Governor of Victoria.
Mr. Manson | Mr. Borthwick.

GOULBURN-MURRAY IRRIGATION DISTRICT—DISTRICT EXTENDED.—COHUNA IRRIGATION AREA—BOUNDARIES VARIED.

UNDER the powers conferred by the Water Act 1958 and all other powers enabling him in that behalf, His Excellency the Governor of the State of Victoria, with the advice of the Executive Council of the said State, on the recommendation of the State Rivers and Water Supply Commission, doth hereby declare, order, and direct as follows:—

That the Goulburn-Murray Irrigation District be extended and the boundaries of the Cohuna Irrigation Area be varied by adding to the said District and Area the

lands set out and described in the Schedule hereto, and as on and from the first day of July, 1970 such District shall be deemed to be so extended and the boundaries of such Area shall be so varied.

—
SCHEDULE.

Part of allotment 85, parish of Mincha being that part of the allotment remaining in certificate of title volume 8740, folio 973 and part of allotment 87, said parish being the whole of the land comprised in certificate of title volume 8740, folio 974.

The lands set out and described in the foregoing Schedule are shown on a plan approved by the Governor in Council, and deposited in the Office of the State Rivers and Water Supply Commission, Melbourne (Corr. Nos. 66/4642, 66/4682).

And the Honorable William Archibald Borthwick, Her Majesty's Minister of Water Supply for the State of Victoria, shall give the necessary directions herein accordingly.

J. ROSSITER,
Clerk of the Executive Council.

Water Act 1958.

STATE RIVERS AND WATER SUPPLY COMMISSION.

*At the Executive Council Chamber, Melbourne, the
thirteenth day of May, 1970.*

PRESENT:

His Excellency the Governor of Victoria.
Mr. Manson | Mr. Borthwick.

GOULBURN-MURRAY IRRIGATION DISTRICT—
PORTION EXCISED.—RODNEY IRRIGATION AREA—
BOUNDARIES VARIED.

UNDER the powers conferred by the *Water Act 1958* and all other powers enabling him in that behalf, His Excellency the Governor of the State of Victoria, with the advice of the Executive Council of the said State, on the recommendation of the State Rivers and Water Supply Commission, doth hereby declare, order and direct:—

1. That there be excised from the Goulburn-Murray Irrigation District; and
2. That the boundaries of the Rodney Irrigation Area be varied to excise therefrom

the land shown by green colour on a plan approved by the Governor in Council and deposited in the office of the State Rivers and Water Supply Commission, Melbourne (Corr. 67/4561) which land shall be deemed to be excised from the said Irrigation District and Irrigation Area as from the 30th day of June, 1970.

And the Honorable William Archibald Borthwick, Her Majesty's Minister of Water Supply for the State of Victoria, shall give the necessary directions herein accordingly.

J. ROSSITER,
Clerk of the Executive Council.

Water Act 1958.

STATE RIVERS AND WATER SUPPLY COMMISSION.

*At the Executive Council Chamber, Melbourne, the
thirteenth day of May, 1970.*

PRESENT:

His Excellency the Governor of Victoria.
Mr. Manson | Mr. Borthwick.

FRANKSTON-MORNINGTON URBAN DISTRICT—AREA
OF DISTRICT INCREASED.

UNDER the powers conferred by the *Water Act 1958* and all other powers enabling him in that behalf, His Excellency the Governor of the State of Victoria, with the advice of the Executive Council of the said State,

on the recommendation of the State Rivers and Water Supply Commission, doth hereby declare, order and direct as follows:—

That the area of the Frankston-Mornington Urban District be increased by adding to the same the lands set out and described in the Schedule hereto, and as on and from the 1st day of July, 1970, the area of such district shall be deemed to be so increased.

—
SCHEDULE.

The whole of lots 24, 25, 26, 27, 66, 67, 68 and 69 on lodged plan of subdivision No. 11717 being part of allotment 80, Parish of Lyndhurst, together with that portion of James Street between the southern boundaries of said lots 24, 25, 26 and 27 and the northern boundaries of said lots 66, 67, 68 and 69.

The lands set out and described in the foregoing Schedule are shown on a plan approved by the Governor in Council, and deposited in the office of the State Rivers and Water Supply Commission, Melbourne (Corr. No. 62/5760).

And the Honorable William Archibald Borthwick, Her Majesty's Minister of Water Supply for the State of Victoria, shall give the necessary directions herein accordingly.

J. ROSSITER,
Clerk of the Executive Council.

Water Act 1958.

STATE RIVERS AND WATER SUPPLY COMMISSION.

*At the Executive Council Chamber, Melbourne, the
thirteenth day of May, 1970.*

PRESENT:

His Excellency the Governor of Victoria.
Mr. Manson | Mr. Borthwick.

GOULBURN-MURRAY IRRIGATION DISTRICT—
PORTION EXCISED.—RODNEY IRRIGATION AREA—
BOUNDARIES VARIED.

UNDER the powers conferred by the *Water Act 1958* and all other powers enabling him in that behalf, His Excellency the Governor of the State of Victoria, with the advice of the Executive Council of the said State, on the recommendation of the State Rivers and Water Supply Commission, doth hereby declare, order and direct as follows:—

That there shall be excised from the Goulburn-Murray Irrigation District that portion of the same set out and described in the Schedule hereto and that the boundaries of the Rodney Irrigation Area be varied to excise from the said Area the aforesaid portion, which portion shall be deemed to be excised from the said Irrigation District and Irrigation Area as from the 30th day of June, 1970.

—
SCHEDULE.

The whole of lots 1 to 16 (both inclusive) on lodged plan of subdivision No. 88038 being parts of allotment 3, Parish of Kyabram East.

The lands set out and described in the foregoing Schedule are shown on a plan approved by the Governor in Council, and deposited in the Office of the State Rivers and Water Supply Commission, Melbourne (Corr. No. 69/1727).

And the Honorable William Archibald Borthwick, Her Majesty's Minister of Water Supply for the State of Victoria, shall give the necessary directions herein accordingly.

J. ROSSITER,
Clerk of the Executive Council.

SOIL CONSERVATION AND LAND UTILIZATION ACT
1958.

At the Executive Council Chamber, Melbourne, the
thirteenth day of May, 1970.

PRESENT:

His Excellency the Governor of Victoria.
Mr. Manson | Mr. Borthwick.

DISTRICT ADVISORY COMMITTEE.—GLENELG SOIL
CONSERVATION DISTRICT.

WHEREAS a vacancy exists on the Glenelg Soil Conservation District Advisory Committee due to the resignation of Percy John Munro, being the person elected to represent grazing, agricultural and other relevant interests in the district: Now, therefore, I, the Governor of the State of Victoria, by and with the advice of the Executive Council thereof, and in pursuance of the provisions of section 15 of the Soil Conservation and Land Utilization Act, do hereby remove the said Percy John Munro from office and appoint the following person to such vacancy for a period up to and including the twenty-sixth day of March, 1971.

HAMILTON KITCHENER COWLAND

being a person appointed to represent grazing, agricultural and other relevant interests in the district.

And the Honorable Sir William John Farquhar McDonald, Her Majesty's Minister for Conservation for the State of Victoria, shall give the necessary directions herein accordingly.

J. ROSSITER,
Clerk of the Executive Council.

HEALTH ACT 1958, No. 6270.

At the Executive Council Chamber, Melbourne, the
thirteenth day of May, 1970.

PRESENT:

His Excellency the Governor of Victoria.
Mr. Manson | Mr. Borthwick.

APPOINTMENT OF A HEALTH INSPECTOR.

HIS Excellency the Governor of the State of Victoria, by and with the advice of the Executive Council thereof, has been pleased to appoint, under Section 377 (1) of the Health Act 1958, without additional pay, the following Dairy Produce Inspector of the Department of Agriculture, Victoria, to execute the powers and fulfil the duties of Health Inspector of the Department of Health in so far as such powers and duties relate to the position held by him as Dairy Produce Inspector, Department of Agriculture, Victoria, and only for such time as he continues to hold such position.

NORMAN KEITH WILSON.

And the Honorable Vance Oakley Dickie, Her Majesty's Minister of Health for the State of Victoria, shall give the necessary directions herein accordingly.

J. ROSSITER,
Clerk of the Executive Council.

MANSFIELD WATERWORKS TRUST.

At the Executive Council Chamber, Melbourne, the
nineteenth day of May, 1970.

PRESENT:

His Excellency the Governor of Victoria.
Mr. Hamer | Mr. Balfour.
Mr. Wilcox

APPROVAL OF PLAN SHOWING SITE OF PIPELINE.

UNDER the powers conferred by the Water Act and all other powers enabling him in that behalf, His Excellency the Governor of the State of Victoria, by and with the advice of the Executive Council of the said State doth hereby approve a Plan showing the Site of a Pipeline

to be constructed by the Mansfield Waterworks Trust without its Water Supply District, such plan to be deposited in the office of the State Rivers and Water Supply Commission, Melbourne. (Corr. No. 64/1392/140).

And the Honorable William Archibald Borthwick, Her Majesty's Minister of Water Supply for the State of Victoria, shall give the necessary directions herein accordingly.

JOHN A. HORLOCK,
Acting Clerk of the Executive Council.

LATROBE VALLEY WATER AND SEWERAGE BOARD.

At the Executive Council Chamber, Melbourne, the
nineteenth day of May, 1970.

PRESENT:

His Excellency the Governor of Victoria.
Mr. Hamer | Mr. Balfour.
Mr. Wilcox

APPROVAL OF PLAN SHOWING SITE OF PIPELINE
AND CARRIAGEWAY EASEMENT AND CONSENT TO
COMPULSORY ACQUISITION OF EASEMENT.

UNDER the powers conferred by the Latrobe Valley Act and all other powers enabling him in that behalf, His Excellency the Governor of the State of Victoria, by and with the advice of the Executive Council of the said State, doth hereby approve the site of the Saline Outfall Pipeline to be constructed by the Latrobe Valley Water and Sewerage Board as shown on the plan, and doth hereby consent to the compulsory acquisition of an easement over private land in allotment 79, Parish of Maryvale, as shown on the plan, the said plan being approved by the Governor in Council by and with this Order and deposited in the office of the State Rivers and Water Supply Commission, Melbourne. (Corr. No. 59/3136/223).

And the Honorable William Archibald Borthwick, Her Majesty's Minister of Water Supply for the State of Victoria, shall give the necessary directions herein accordingly.

JOHN A. HORLOCK,
Acting Clerk of the Executive Council.

River Improvement Act 1958.
LOUGH CALVERT DRAINAGE TRUST.

At the Executive Council Chamber, Melbourne, the
nineteenth day of May, 1970.

PRESENT:

His Excellency the Governor of Victoria.
Mr. Hamer | Mr. Balfour.
Mr. Wilcox

ACQUISITION OF EASEMENTS.

UNDER the provisions of the River Improvement Act 1958 and all other powers thereunto him enabling, His Excellency the Governor of the State of Victoria, by and with the advice of the Executive Council of the said State, doth hereby consent to the compulsory acquisition of easements for drainage purposes by the Lough Calvert Drainage Trust over lands being:—

(a) Part of Crown portion 1, section 14 and part of Crown portions 3 and 4, section 13, Parish of Irrewarra and being part of the land more particularly described in certificates of title, volume 3805, folios 963 and 964.

(b) Part of Crown portions 1 and 2, section 14, Parish of Irrewarra and being part of the land more particularly described in certificates of title, volume 8750, folios 304 and 305.

(c) Part of Crown portions 1 and 2, section 15, Parish of Irrewarra and being part of the land more particularly described in certificate of title, volume 8750, folio 302.

(d) Part of subdivisions A and B of Crown allotments 6B and 6C and part of Crown allotments 5E and 6A³, Parish of Irrewarra and being part of the land more particularly described in certificates of title, volume 8598, folio 138 and volume 8550, folio 778.

And the Honorable William Archibald Borthwick, Her Majesty's Minister of Water Supply for the State of Victoria, shall give the necessary directions herein accordingly.

JOHN A. HORLOCK,
Acting Clerk of the Executive Council.

GEELONG WATERWORKS AND SEWERAGE TRUST.

At the Executive Council Chamber, Melbourne, the
nineteenth day of May, 1970.

PRESENT:

His Excellency the Governor of Victoria.

Mr. Hamer		Mr. Balfour.
Mr. Wilcox		

REPEAL OF ORDER APPROVING OF PLAN SHOWING
SITE OF DIVERSION WEIR ON EAST BARWON
RIVER, PIPELINES, PUMPING STATION AND
ACCESS ROAD AND APPROVAL OF PLAN SHOWING
NEW SITE OF DIVERSION WEIR, PUMPING
STATION AND PIPELINE.

HIS Excellency the Governor of the State of Victoria, by and with the advice of the Executive Council thereof, doth hereby repeal the Order made on the 20th day of August, 1968, showing the site of diversion weir on the East Barwon River, Pipelines, Pumping Station and Access Road on a plan accompanying that Order (Corr. No. 67/2114/115), and doth hereby approve in accordance with the provision of the Water Act and all other powers enabling him in that behalf the work comprising a diversion weir on the East Barwon River, pumping station and pipeline in the Parishes of Barwon Down and Gerangamete, County of Polwarth, as shown on a plan deposited in the office of the State Rivers and Water Supply Commission, Melbourne.—(Corres. No. 69/216/42.)

And the Honorable William Archibald Borthwick, Her Majesty's Minister of Water Supply for the State of Victoria, shall give the necessary directions herein accordingly.

JOHN A. HORLOCK,
Acting Clerk of the Executive Council.

WATER ACT 1958.

At the Executive Council Chamber, Melbourne, the
nineteenth day of May, 1970.

PRESENT:

His Excellency the Governor of Victoria.

Mr. Hamer		Mr. Balfour.
Mr. Wilcox		

POOWONG, LOCH AND NYORA WATERWORKS TRUST
CONSTITUTED.

HIS Excellency the Governor of the State of Victoria, by and with the advice of the Executive Council thereof, doth hereby approve, in accordance with the provisions of the Water Act, of the construction of works for the water supply to the townships of Poowong, Loch and Nyora as set out in the application of the Councillors of the Shire of Korumburra for the constitution of a Waterworks Trust to construct, manage and maintain the said works in accordance with the provisions of the said Act and doth hereby order and appoint as follows:—

1. That a Waterworks Trust is hereby constituted and its corporate name shall be Poowong, Loch and Nyora Waterworks Trust.
2. That the Commissioners of the Trust shall comprise the Councillors for the time being of the Jeetho and Poowong Ridings of the Shire of Korumburra and one person elected by the Governor in Council.
3. That the estimated cost of carrying out the proposed waterworks shall be Three hundred and ninety thousand dollars (\$390,000).
4. That the principal works to be constructed or carried out by the said Trust shall be a storage reservoir on the Little Bass River, a pumping station and rising main, a secondary storage reservoir, supply mains, three service basins and reticulation.
5. The lands within the boundaries as shown on the plan accompanying this Order shall be the Waterworks District of the said Trust to be known as Poowong, Loch and Nyora Waterworks District, such lands being within the municipal district of the Shire of Korumburra.

The location of the said works and the boundaries of the said Waterworks District are shown on the plans approved by the Governor in Council by and with this Order and deposited in the office of the State Rivers and Water Supply Commission, Melbourne (59/8807/24).

And the Honorable William Archibald Borthwick, Her Majesty's Minister of Water Supply for the State of Victoria, shall give the necessary directions herein accordingly.

JOHN A. HORLOCK,
Acting Clerk of the Executive Council.

WARRNAMBOOL SEWERAGE AUTHORITY.

At the Executive Council Chamber, Melbourne, the
nineteenth day of May, 1970.

PRESENT:

His Excellency the Governor of Victoria.

Mr. Hamer		Mr. Balfour.
Mr. Wilcox		

EXTENT OF SEWERAGE DISTRICT INCREASED.

UNDER the powers conferred by the Sewerage Districts Act and all other powers enabling him in that behalf, His Excellency the Governor of the State of Victoria, by and with the advice of the Executive Council of the said State, doth hereby declare, order and direct that the extent of the Sewerage District of the Warrnambool Sewerage Authority be increased by adding thereto the lands as shown on a plan approved by the Governor in Council by and with this Order and deposited in the office of the State Rivers and Water Supply Commission, Melbourne (Corr. 64/1108/127), and as on and from the date hereof the extent of such District shall be and be deemed to be increased accordingly.

And the Honorable William Archibald Borthwick, Her Majesty's Minister of Water Supply for the State of Victoria, shall give the necessary directions herein accordingly.

JOHN A. HORLOCK,
Acting Clerk of the Executive Council.

WARRAGUL WATERWORKS TRUST.

At the Executive Council Chamber, Melbourne, the
nineteenth day of May, 1970.

PRESENT:

His Excellency the Governor of Victoria.

Mr. Hamer		Mr. Balfour.
Mr. Wilcox		

EXTENT OF WATERWORKS AND URBAN DISTRICTS
INCREASED.

UNDER the powers conferred by the Water Act and all other powers enabling him in that behalf, His Excellency the Governor of the State of Victoria, by and with the advice of the Executive Council of the said State, doth hereby declare, order and direct that the extent of the Warragul Waterworks and Warragul Urban Districts of the Warragul Waterworks Trust be increased by adding to the same the lands comprised within the boundaries shown on the accompanying plan approved by the Governor in Council by and with this Order and deposited in the office of the State Rivers and Water Supply Commission, Melbourne (Corr. 68/4281/74) and as on and from the date hereof, the extent of such Districts shall be and be deemed to be increased accordingly.

And the Honorable William Archibald Borthwick, Her Majesty's Minister of Water Supply for the State of Victoria, shall give the necessary directions herein accordingly.

JOHN A. HORLOCK,
Acting Clerk of the Executive Council.

MYRTLEFORD WATERWORKS TRUST.

At the Executive Council Chamber, Melbourne, the nineteenth day of May, 1970.

PRESENT:

His Excellency the Governor of Victoria.
Mr. Hamer | Mr. Balfour.
Mr. Wilcox

AMENDMENT OF ORDER.

UNDER the powers conferred by the Water Act and all other powers enabling him in that behalf, His Excellency the Governor of the State of Victoria, by and with the advice of the Executive Council of the said State, doth hereby amend as follows the Order in Council approving of a plan showing works comprising a reservoir and pipeline to be constructed by the Myrtleford Waterworks Trust, made on the 2nd December, 1968, and published in the *Victoria Government Gazette* dated the 4th December, 1968:—

For the plan approved by and with the said Order there shall be substituted an amended plan approved by the Governor in Council and deposited in the office of the State Rivers and Water Supply Commission, Melbourne. (Corr. No. 70/667/12).

And the Honorable William Archibald Borthwick, Her Majesty's Minister of Water Supply for the State of Victoria, shall give the necessary directions herein accordingly.

JOHN A. HORLOCK,
Acting Clerk of the Executive Council.

Water Act 1958.

STATE RIVERS AND WATER SUPPLY COMMISSION.

At the Executive Council Chamber, Melbourne, the nineteenth day of May, 1970.

PRESENT:

His Excellency the Governor of Victoria.
Mr. Hamer | Mr. Balfour.
Mr. Wilcox

GOULBURN-MURRAY IRRIGATION DISTRICT—
DISTRICT EXTENDED.—DINGEE IRRIGATION
AREA—BOUNDARIES VARIED.

UNDER the powers conferred by the Water Act 1958 and all other powers enabling him in that behalf, His Excellency the Governor of the State of Victoria, with the advice of the Executive Council of the said State, on the recommendation of the State Rivers and Water Supply Commission, doth hereby declare, order, and direct as follows:—

That the Goulburn-Murray Irrigation District be extended and the boundaries of the Dingee Irrigation Area be varied by adding to the said District and Area the land set out and described in the Schedule hereto, and as on and from the 1st day of July, 1970, such District shall be deemed to be so extended and the boundaries of such Area shall be so varied.

SCHEDULE.

The whole of allotment 40A, section 2, Parish of Tandarra.

The land set out and described in the foregoing Schedule is shown on a plan approved by the Governor in Council, and deposited in the office of the State Rivers and Water Supply Commission, Melbourne (Corr. No. 61/4481).

And the Honorable William Archibald Borthwick, Her Majesty's Minister of Water Supply for the State of Victoria, shall give the necessary directions herein accordingly.

JOHN A. HORLOCK,
Acting Clerk of the Executive Council.

Water Act 1958.

STATE RIVERS AND WATER SUPPLY COMMISSION.

At the Executive Council Chamber, Melbourne, the nineteenth day of May, 1970.

PRESENT:

His Excellency the Governor of Victoria.
Mr. Hamer | Mr. Balfour.
Mr. Wilcox

BELLARINE PENINSULA WATERWORKS DISTRICT—
PORTION EXCISED.

UNDER the powers conferred by the Water Act 1958 and all other powers enabling him in that behalf, His Excellency the Governor of the State of Victoria, with the advice of the Executive Council of the said State, on the recommendation of the State Rivers and Water Supply Commission, doth hereby declare, order and direct that there shall be excised from the Bellarine Peninsula Waterworks District that portion of the same shown by green colour on a plan approved by the Governor in Council and deposited in the office of the State Rivers and Water Supply Commission, Melbourne (Corr. No. 61/2405) and as on and from the 30th day of June, 1970, such portion shall be deemed to be excised accordingly.

And the Honorable William Archibald Borthwick, Her Majesty's Minister of Water Supply for the State of Victoria, shall give the necessary directions herein accordingly.

JOHN A. HORLOCK,
Acting Clerk of the Executive Council.

WHEAT MARKETING ACT 1969.

At the Executive Council Chamber, Melbourne, the nineteenth day of May, 1970.

PRESENT:

His Excellency the Governor of Victoria.
Mr. Hamer | Mr. Balfour.
Mr. Wilcox

IN pursuance of the powers conferred by section 5 of the *Wheat Marketing Act 1969* and all other powers him thereunto enabling, His Excellency the Governor of the State of Victoria, by and with the advice of the Executive Council thereof and on the recommendation of the Minister of Agriculture after consultation with the Victorian Farmers' Union, doth hereby determine that the quantity of the Victorian Wheat Quota for the season 1970-1971 shall be 52,000,000 bushels and, of that quantity, doth hereby specify that 49,400,000 bushels shall be available for allocation by the Wheat Quota Committee as quotas and 1,600,000 bushels shall be available for allocation by the Wheat Quota Review Committee as special quotas.

And the Honorable Gilbert Lawrence Chandler, Her Majesty's Minister of Agriculture for the State of Victoria, shall give the necessary directions herein accordingly.

JOHN A. HORLOCK,
Acting Clerk of the Executive Council.

SUPERANNUATION ACT 1958.

At the Executive Council Chamber, Melbourne, the nineteenth day of May, 1970.

PRESENT:

His Excellency the Governor of Victoria.
Mr. Hamer | Mr. Balfour.
Mr. Wilcox

PURSUANT to the provisions of sub-section (1) of section 3 of the *Superannuation Act 1958*, as amended by paragraph (a) of sub-section (2) of section 18 of the *Pensions Supplementation Act 1966* No. 7417, His Excellency the Governor of the State of Victoria by and with the advice of the Executive Council thereof, doth by this Order declare that the provisions of the *Superannuation Act* shall apply to ALFRED JAMES, an officer of the Victorian

WEDDERBURNE.—The temporary reservation, by Order in Council of the 15th July, 1912, of 95 acres 31 perches of land in the Parish of Wedderburne, as a site for Supply of Material for Road-making, is about to be revoked, so far only as the portion containing 2 roods 32 perches, indicated by hatching on plan hereunder is concerned.—(W.116⁽¹⁴⁾) (Rs.6880).

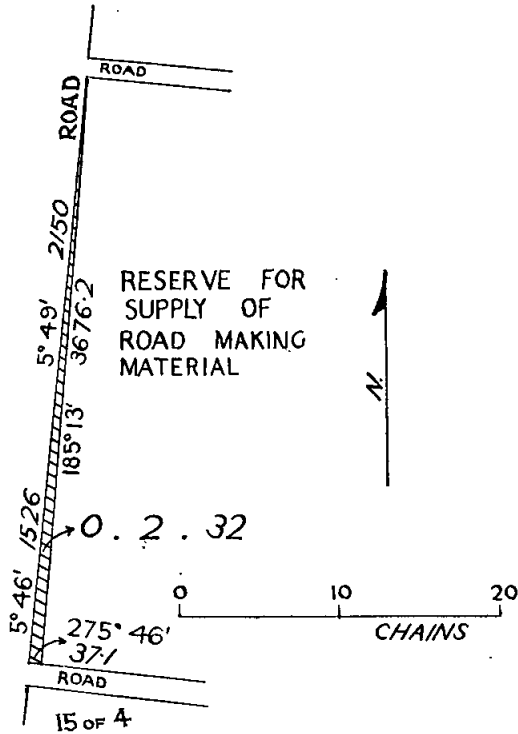

BALLAN.—The temporary reservation, by Order in Council of the 9th December, 1872 (see *Government Gazette* 13th December, 1872, page 2262), of 1 acre of land in the Township of Ballan, as a site for a Court House, is about to be revoked, so far only as the portion containing 2 roods, indicated by hatching on plan hereunder is concerned.—(B.23⁽⁴⁾) (C.75794).

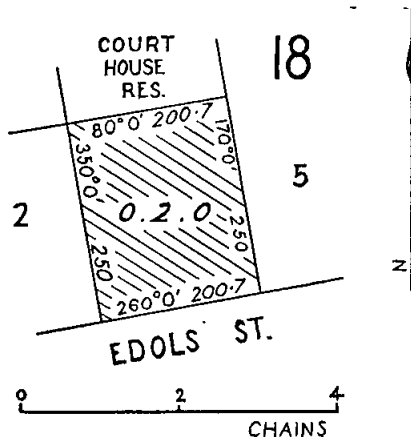

W. J. F. McDONALD,
Minister of Lands.

PROPOSED REVOCATIONS OF TEMPORARY RESERVATIONS OF LANDS BY ORDERS IN COUNCIL.

IN pursuance of the provisions of the *Land Act* 1958, notice is hereby given that it is the intention of the Governor in Council to revoke the temporary reservations of lands by Orders in Council hereunder referred to, viz.:—

The following Notices were published 1^o on the 6th May, 1970, pursuant to Orders of the 28th April, 1970.

BEECHWORTH.—The temporary reservation by Order in Council of the 21st January, 1931, of 6 acres 3 roods 34 perches of land in the Parish of Beechworth, as a site for Public Recreation is about to be revoked.—(B.349⁽²⁴⁾) (Rs.4089).

ST. KILDA AND ELWOOD.—The temporary reservation by Order in Council of the 5th May, 1964, of certain lands at St. Kilda and at Elwood in the Parish of Melbourne South as a site for Public Recreation, revoked as to part by Order of the 24th October, 1967, is about to be revoked so far as the balance is concerned.—(M.333⁽²⁵⁾) (Rs.8333).

TYNTYNDER NORTH.—The temporary reservation by Order in Council of the 30th May, 1916, of 10 acres of land in the Parish of Tyntynder North as a site for a Sanitary Depot is about to be revoked.—(T.244⁽¹⁸⁾) (Rs.1042).

LAWLOIT.—The temporary reservation, by Order in Council of the 30th September, 1889, of 100 acres 4 perches of land in the Parish of Lawloit as a site for Water Supply purposes, revoked as to part by various Orders, is about to be revoked so far as the portion containing 19 acres 2 roods 24 perches, indicated by hatching on plan hereunder, is concerned.—(L.137⁽²⁾) (Rs.6447).

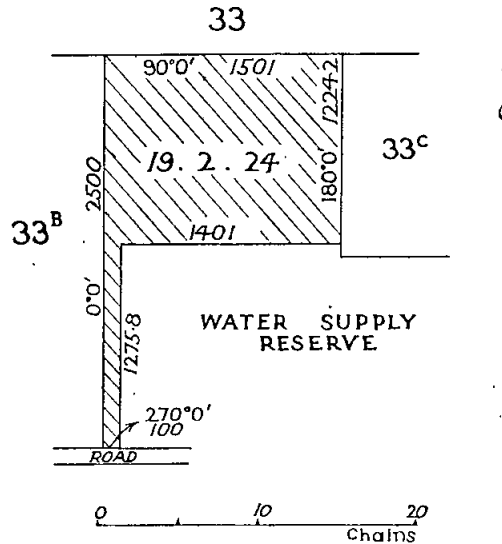

Subject to Survey

MELBOURNE SOUTH (POINT ORMOND).—The temporary reservation by Order in Council of the 30th November, 1915 (see *Government Gazette*, 8th December, 1915, page 4902) of 3 acres 3 roods, more or less, of land in the Parish of Melbourne South (named City of St. Kilda, at Elwood in order) as a site for Public Recreation, revoked as to part by order of the 24th October, 1967, is about to be revoked so far only as the portion containing 2 roods more or less indicated by hatching on plan hereunder is concerned.—(M.333⁽²⁵⁾) (Rs.444).

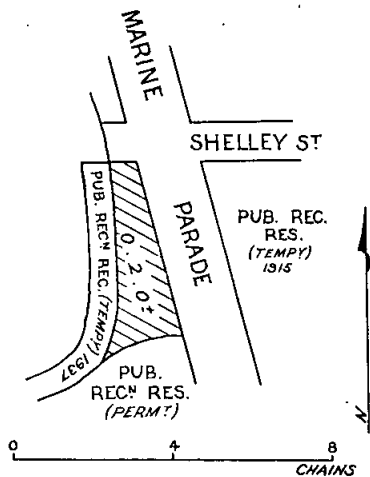

MELBOURNE SOUTH (POINT ORMOND).—The temporary reservation by Order in Council of the 7th April, 1937 (see *Government Gazette*, 14th April, 1937, page 1091), of 5 acres, more or less, of land in the Parish of Melbourne South (named City of St. Kilda at Elwood in Order) as a site for Public Recreation is about to be revoked so far only as the portion containing 2 roods, more or less, indicated by hatching on plan hereunder, is concerned.—(M.333⁽²⁵⁾) (Rs.444).

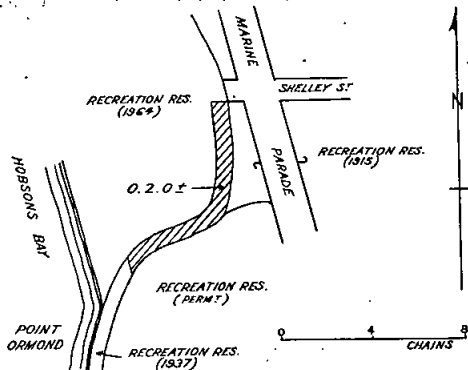

W. J. F. McDONALD,
Minister of Lands.

PROPOSED REVOCATIONS OF TEMPORARY RESERVATIONS OF LANDS BY ORDERS IN COUNCIL.

IN pursuance of the provisions of the *Land Act 1958*, notice is hereby given that it is the intention of the Governor in Council to revoke the temporary reservations of lands by Orders in Council hereunder referred to, viz.:

The following Notices were published 1^o on the 13th May, 1970, pursuant to Orders of the 5th May, 1970.

SANDHURST (AT BENDIGO).—The temporary reservation, by Order in Council of the 14th February, 1939, of 1 acre 2 roods 21 perches of land, at Bendigo, Parish of Sandhurst, as a site for Public purposes (Children's Playground) is about to be revoked.—(S.372⁽¹²²⁾) (Rs.4919).

MOE.—The temporary reservation, by Order in Council of the 21st November, 1887, of 82 acres 36 perches of land in the Parish of Moe, as a site for Railway purposes, revoked as to part by Order of the 26th March, 1935, is about to be revoked so far as the balance thereof containing 80 acres 3 roods 11 5/10 perches is concerned.—(M.498⁽¹²⁾) (C.81835).

MOE.—The temporary reservation, by Order in Council of the 12th February, 1935, of 1 acre 20 1/10 perches of land in the Parish of Moe, as a site for Railway purposes, is about to be revoked.—(M.498⁽¹²⁾) (C.81835).

WARRNAMBOOL.—The temporary reservation, by Order in Council of the 13th February, 1893, of 1 acre 8 perches of land in the Township of Warrnambool, as a site for Cattle Yards and General Market purposes, is about to be revoked.—(W.99⁽⁷⁾) (Rs.110).

MURCHISON.—The temporary reservation, by Order in Council of the 6th November, 1968, of 15 acres, more or less, of land in the Township and Parish of Murchison,

as a site for Public Recreation, is about to be revoked, so far only as the portion containing 29 perches, more or less, indicated by hatching on plan hereunder, is concerned.—(M.272⁽²⁾) (Rs.9051).

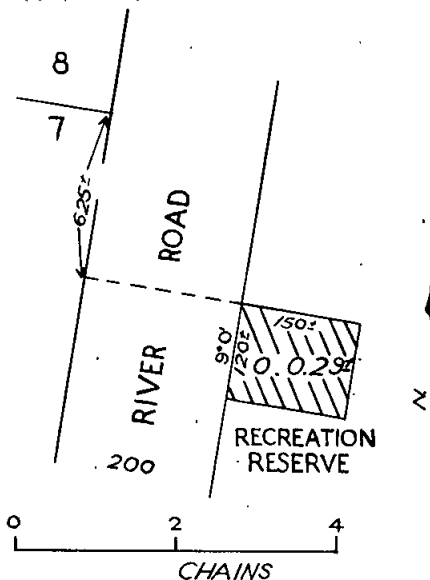

SUBJECT TO SURVEY.

WOMBAT.—The temporary reservation, by Order in Council of the 29th June, 1914, of 7 acres of land in the Parish of Wombat, as a site for Watering purposes and for a Quarry, is about to be revoked, so far only as the portion containing 6 perches, indicated by hatching on plan hereunder is concerned.—(W.179⁽³⁸⁾) (Rs.9238).

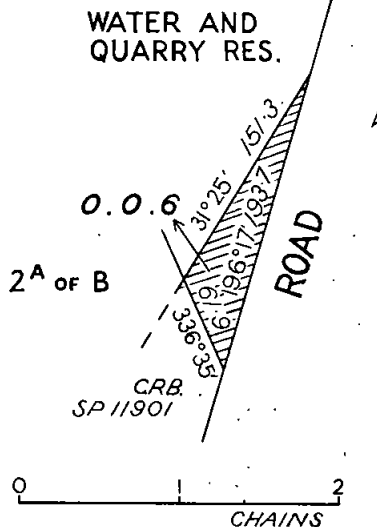

W. J. F. McDONALD,
Minister of Lands.

PROPOSED REVOCATIONS OF TEMPORARY RESERVATIONS OF LANDS BY ORDERS IN COUNCIL.

IN pursuance of the provisions of the *Land Act 1958*, notice is hereby given that it is the intention of the Governor in Council to revoke the temporary reservations of lands by Orders in Council hereunder referred to, viz.:

The following Notices were published 1^o on the 20th May, 1970, pursuant to Orders of the 13th May, 1970.

ARARAT.—The temporary reservation, by Order in Council of the 31st January, 1871, of 2 acres of land in the Parish of Ararat as a site for a Common School and the temporary reservation, by Order of the 27th October, 1910, of 2 acres of land as an extension thereto are about to be revoked.—(A.149⁽²⁰⁾) (C.49133).

"ALLAMBEE EAST PUBLIC PURPOSES RESERVE."

The Corporation of the Shire of Narracan as the Committee of Management of the land in the Parish of Allambee East temporarily reserved by Order in Council dated 24th February, 1970, as a site for Public purposes as shown by hatching on plan A.1/5/70 on Lands Department correspondence Rs.9239.—(Corres. No. Rs.9239.)

"ALLANSFORD RECREATION RESERVE."

John McLean, John L. Morgan, Raymond Byron, Vivian Grant McKean, Graham Johnstone, Arthur Chilton, James Mahony, Herbert Chilton and Roger Halsh as a Committee of Management for a period of three (3) years from the 10th March, 1970, of the land in the Parish of Tallangatta temporarily reserved by Order in Council dated the 24th September, 1912, as a site for Public Recreation, and known as the "Allansford Recreation Reserve".—(Corres. No. Rs.4293.)

"BENNISON PUBLIC HALL RESERVE."

John T. Doran, Ronald L. Lay, Michael O'Sullivan, Donald H. Taylor, Edwin F. Tyers and Kenneth J. Humphries as a Committee of Management for a period of three (3) years of the land in the Township of Franklin temporarily reserved by Order in Council dated the 23rd November, 1914, as a site for a Mechanics' Institute and Free Library, and known as "Bennison Public Hall Reserve".—(Corres. No. Rs.343.)

"BLAIRGOWRIE FORESHORE RESERVE."

Percy Walter Stynes (as Chairman) (for as long only as he shall continue to be a Councillor and the elect of the Council of the Shire of Flinders), Peter Ploog, John Ross Crown, Kenneth Milton Simes, Arthur Roy Tapson, John Raymond Parkin, Herbert Charles Marshall and Leon O'Donoghue as a Committee of Management for a period of three (3) years of the land in the Parish of Nepean indicated by red colour on plan marked 'N' 1.12.53 attached to Lands Department correspondence Rs.7223, and known as the "Blairgowrie Foreshore Reserve".—(Corres. No. Rs.7223.)

"BOOLITE PUBLIC RECREATION AND PUBLIC HALL RESERVE."

John Frederick Kent, Gordon Edward Habel, James William Barber, Henry Cecil Blackley, Graeme Ernst Tegelhuter and Luis Carl Tegelhuter as a Committee of Management for a period of three (3) years of the land in the Parish of Dunmunkle temporarily reserved by Orders in Council dated the 26th May, 1902, and 7th September, 1948, as a site for Public Recreation and a Public Hall, and known as the "Boolite Public Recreation and Public Hall Reserve".—(Corres. No. Rs.6221.)

"BRIMPAEN PUBLIC HALL AND RECREATION RESERVES."

Garth Ellis Owen Rees, Louis Conard Pipkorn, Lindsay Desmon Pipkorn, Edgar H. Zerbst, Terrence Edgar Zerbst, John Arthur Matthews, Ivan John Hill, Ivan Edward Smith and Ivan Stanley Smith as a Committee of Management for a period of three (3) years of the lands in the Parish of Mockinya temporarily reserved as sites for Recreation purposes and Public Recreation by Orders in Council dated the 25th September, 1923 and 27th February, 1951, respectively, and of the land in the said Parish temporarily reserved as a site for a Public Hall by Order in Council dated the 25th September, 1923, such lands together known as the "Brimpaen Public Hall and Recreation Reserves".—(Corres. No. Rs.2835, Rs.2836.)

"BULLA CRICKET AND RECREATION RESERVE."

Alan Ronald Condie, John Charles McKenzie, John Alexander McKenzie, Alfred Norman Prior, Sydney James Gellie and George Cook as a Committee of Management for a period of three (3) years of the land in the Township of Bulla, permanently reserved by Order in Council dated 11th February, 1964, as a site for Cricket Ground and other purposes of Public Recreation.—(Corres. No. Rs.1941.)

"CLEAR LAKE RECREATION RESERVE."

Alexander Francis Pekin, John Munro Pollock, Archibald McIntyre Scott, William Alexander Pekin, Reginald Keith Emmerson, Thomas Albert McClure, Arthur William Hickmott, Kenneth Norman Scott and Alfred Frank Watson as a Committee of Management for a period of three (3)

years of the land in the Parish of Carchap temporarily reserved by Order in Council dated the 10th September, 1963, as a site for Public Recreation, and known as the "Clear Lake Recreation Reserve".—(Corres. No. Rs.8257.)

"CORIO (BELMONT COMMON) PUBLIC RECREATION RESERVE", PARISHES OF CONEWARRE AND CORIO.

John Desmond Podbury, for as long only as he continues to be a Councillor and the elect of the Council of the Shire of South Barwon, in the place of Leonard William Sprague (who has ceased to be the elect of the said Council) as a member of the Committee of Management of the Land in the Parishes of Conewarre and Corio temporarily reserved by Order in Council dated 7th June, 1966, as a site for Public Recreation.—(Corres. No. Rs.8658.)

"HOPETOUN RACECOURSE AND RECREATION RESERVE."

John Thomas Collins, Keith Thomas Roberts, Lester Clarence Mitchell, Herbert George Hilton, William Conway, Fitzgerald Maurice Conway and Brian Raymond Decker as a Committee of Management for a period ending the 26th November, 1972, of the reserved Crown lands in the Parish of Goyura as shown by blue colour on plan marked "G/20.5.63" attached to Lands Department correspondence Rs. 1887, together with the land in the same parish temporarily reserved by Order in Council dated the 17th January, 1967, and known as the "Hopetoun Racecourse and Recreation Reserve".—(Corres. No. Rs.1887.)

"LAKE BOGA RECREATION RESERVE."

The Corporation of the Shire of Swan Hill as the Committee of Management of the land in the Township of Lake Boga, Parish of Kunat Kunat, temporarily reserved by Orders in Council dated 28th April, 1897, and the 16th October, 1934, as a site for Public Recreation, and known as the "Lake Boga Recreation Reserve".—(Corres. No. Rs.1025.)

"MACCLESFIELD PUBLIC PURPOSES (PUBLIC HALL) RESERVE."

Derek Wood, Val Richman, Maithland Neil, John Passmore, Lynnette Neil, Denis Smith, Alex Strathdee, Syd Gay and Brian Francis as a Committee of Management for a period of three (3) years of the land in the Parish of Nangana temporarily reserved by Order in Council of the 29th July, 1969, and known as the "Macclesfield Public Purposes (Public Hall) Reserve".—(Corres. No. Rs.2022.)

"MURTOA SHOW YARDS RESERVE."

Leslie Rudolph Sudholz, Emil Theodore Kosch, Otto Noelker, Kevin Abram Mills and Kenneth Leslie Schulz as a Committee of Management for a period of three (3) years of the land temporarily reserved by Order in Council dated the 14th May, 1895, as a site for Show Yards in the Parish of Ashens, and known as the "Murtoa Show Yards Reserve".—(Corres. No. Rs.2627.)

"NOOJEE CROWN RESERVES ("LOCH VALLEY FALLS RESERVE")."

William Athol Forbes, Ronald George Costin, Henry Down, Ronald Fox, Vincent Joseph Dalton, Karl Proebsting, Charles Ernest Wilson, Ralph Henry Cornwall and George Albert Selwood as a Committee of Management for a period of three (3) years from the 16th April, 1970, of the land in the Parish of Noojee East temporarily reserved by Order in Council dated the 26th September, 1910, as a site for Public purposes, and known as the "Loch Valley Falls (Precott's Reserve)".—(Corres. No. Rs.74.)

"NOOJEE CROWN RESERVES."

William Athol Forbes, Ronald George Costin, Henry Down, Ronald Fox, Vincent Joseph Dalton, Karl Proebsting, Charles Ernest Wilson, Ralph Henry Cornwall and George Albert Selwood as a Committee of Management for a period of three (3) years from the 16th April, 1970, of the under-mentioned Reserves:—

1. The land in the Parish of Noojee temporarily reserved as a site for Public purposes by Order in Council dated the 16th May, 1911, and known as the "Myrtle Bower Reserve".—(Rs.3834.)

2. The land in the Parish of Noojee East temporarily reserved as a site for Public Recreation by Order in Council dated the 10th August, 1914, and the land in the said

parish temporarily reserved as a site for Public purposes by Order in Council dated the 24th February, 1915, the whole known as the "Loch Valley Recreation Reserve".—(Rs.1264, Rs.214.)—(Corres. Nos. Rs.3834, Rs.1264, Rs.214.)

"NOOJEE CROWN RESERVES."

William Athol Forbes, Ronald George Costin, Henry Down, Ronald Fox, Vincent Joseph Dalton, Karl Proebsting, Charles Ernest Wilson, Ralph Henry Cornwall and George Albert Selwood as a Committee of Management for a period of three (3) years from the 16th April, 1970, of the under-mentioned Reserves:—

1. Such portions of the frontages along both sides of the Latrobe and Loch Rivers in the Parishes of Neerim and Noojee East as are indicated by red colour on plan marked N.E./4.10.22 attached to Lands Department correspondence Rs.3630, also the remaining portion of Crown land in the Township of Noojee temporarily reserved as a site for Public purposes by Order in Council dated the 21st February, 1928, and known as the "Loch Valley Reserve" and "Noojee Camping Park".—(Rs.3630.)

2. The lands in the Township of Noojee, Parish of Neerim temporarily reserved by Orders in Council dated the 20th January, 1923, as a site for Recreation purposes, and the 20th May, 1927, as a site for Public Recreation, and known as the "Noojee Recreation Reserve".—(Rs.2660.)—(Corres. Nos. Rs.3630, Rs.2660.)

"NORADJUHA RECREATION RESERVE."

James Henry Northfield, Alan Cossar Hood, Edwin Robert Northfield, Alvin Charles Walker, Donald James Leslie, Neil S. McDonald, Melville Gustav Nitschke, John Donald Light and George Ambrose Walter as a Committee of Management for a period of three (3) years of the lands in the Parish of Darragan, Township of Noradjuha, temporarily reserved by Orders in Council dated the 11th July, 1922, for Recreation purposes, and 30th December, 1927, and 4th September, 1956, for Public Recreation, and known as the "Noradjuha Recreation Reserve".—(Corres. No. Rs.2536.)

"ST. HELENS RECREATION RESERVE."

Brian Patrick Smith, Victor Charles Humphrys, Winston Graeme Edwards, Otto J. Carter, Alec Victor Edwards and Edwin Norman Dyson as a Committee of Management for a period of three (3) years of the land in the Parish of St. Helens temporarily reserved by Order in Council dated the 21st June, 1960, as a site for Public Recreation, and known as the "St. Helens Recreation Reserve".—(Corres. No. Rs.2006.)

"ST. LEONARDS PUBLIC RECREATION RESERVE."

The Corporation of the Shire of Bellarine as the Committee of Management of the land in the Township of St. Leonards temporarily reserved by Order in Council dated 24th February, 1970, as a site for Public Recreation.—(Corres. No. Rs.9278.)

"TEAL POINT RECREATION RESERVE."

Edward Anthony Lancaster, Kenneth Alfred Oram, Barry William Osbrough, Frank Mitchell Jobling, Bernard John Thompson, Keith William Jobling, Graeme Kenneth Oram, James William Forster and Ronald Alan Peatling as a Committee of Management for a period of three (3) years of the land in the Parish of Gannawarra temporarily reserved by Order in Council dated the 20th January, 1970, as a site for Public Recreation, and known as the "Teal Point Recreation Reserve".—(Corres. No. Rs.3740.)

"TOORA RECREATION RESERVE."

Raymond Todd, Alfred Richard Hughes, Gacobus Antonius Toonen, George Donald Light, Raymond Wheeler, Cyril Meade Gratton, Edward James Coad, Ian Albert Nicholls and Edward Everitt as a Committee of Management for a period of three (3) years of the land in the Township and the Parish of Toora temporarily reserved by Order in Council dated the 3rd October, 1892, as a site for Public Recreation, and known as the "Toora Recreation Reserve".—(Corres. No. Rs.1300.)

MAJORCA "VICTORIA PARK" PUBLIC GARDENS AND PUBLIC HALL RESERVES.

Eric Elwyn Bucknall, Bruce Eyres Buick, George William Svensen, James Norman Adams, George Thomas Johnson, Marjorie Olive Snow and William Ivor Stewart as a Com-

mittee of Management for a period of three (3) years of the land in the Parish of Craigie, at Majorca, temporarily reserved by Order in Council dated the 28th February, 1876, as a site for Public Gardens, and the lands in the same parish, at Majorca, temporarily reserved for Racecourse Recreation purposes and Public Park, together with the land temporarily reserved by Order in Council dated the 25th May, 1965, as a site for Public Purposes (Public Hall) in the Parish of Craigie, at Majorca.—(Corres. No. Rs.8423.)

"VICTORIA PARK" (YARRAWONGA).

William J. Ryan, Thomas McLeod Carmichael, John J. Lawless, John M. Gardiner, Leo Michael Clarke, Michael A. Lawless, Francis J. Keenan, Lionel Pierce and John J. Dowling as a Committee of Management for a period of three (3) years of the remaining portion of the land in the Township of Yarrowonga temporarily reserved by Order in Council dated the 16th July, 1886, as a site for a Park for the Recreation and Convenience of the People, and known as "Victoria Park".—(Corres. No. Rs.2055.)

"WARRACKNABEAL RACECOURSE AND RECREATION RESERVE" (ADDITIONAL AREA).

John Henry Brennan, Thomas Archer Callaway, Peter Norman Clode, Ian Nicholson Fisher, Andrew Keith Hart, John Laurence McLean, Walter Wilhelm Stephan and Wesley Francis Woodward as a Committee of Management for a period ending the 13th March, 1972, of the land in the Township of Warracknabeal, Parish of Werriagar, temporarily reserved by Order in Council dated the 2nd April, 1970, as a site for a Racecourse and other purposes of Public Recreation, being an addition to the site known as the "Warracknabeal Racecourse and Recreation Reserve".—(Corres. No. Rs.916.)

"WHITLANDS PUBLIC HALL AND RECREATION RESERVE."

Leonard James Maples in the place of Graham Enders Hardy (resigned) as a member of the Committee of Management for the period ending the 13th August, 1971, of the land in the Parish of Whitfield, at Whitlands, temporarily reserved by Order in Council dated the 4th February, 1936, as a site for Public Hall and Recreation, and known as "Whitlands Public Hall and Recreation Reserve".—(Corres. No. Rs.4524.)

VARIOUS MENTAL HYGIENE PURPOSES RESERVES.

Alan Stoller, Jack Evans and Wilfred John Woods as a Committee of Management in respect of the reserved Crown lands referred to in the attached Schedule. This appointment is made in lieu of all previous appointments, in respect of the said lands, which are hereby revoked.—(Corres. No. Rs.4172.)

SCHEDULE.	
Area.	Reserved by Order in Council of:
Ararat Mental Hospital Reserve (Rs.4026).	18th July, 1864. 20th March, 1888. 24th June, 1930. 19th September, 1938.
Ballarat Mental Hospital Reserve (Rs.7814).	26th June, 1959.
Mental Hospital Purposes Reserve, Parishes of Cardigan and Dowling Forest (Rs.4761).	24th January, 1938. 24th January, 1938. 15th January, 1963.
Beechworth Mental Hospital Reserves (Rs.770).	26th September, 1864. 21st July, 1911. 2nd December, 1912. 1st December, 1924. 17th June, 1935. 8th August, 1938. 30th June, 1959.
Kew Mental Hospital Reserves (Rs.7734).	5th July, 1869. 26th March, 1935. Remaining portions only.
Mont Park Mental Hospital Reserve (Rs.1436).	23rd April, 1912. Remaining portion only.

Area.	Reserved by Order in Council of:
Bundoora Mental Hospital Reserve (Rs.5380).	11th January, 1943. Remaining portion only.
Sunbury Mental Hospital Reserve (Rs.7215).	18th July, 1864. 23rd February, 1954. Remaining portion only.
Warrnambool Mental Hospital Reserve (Rs.7493).	18th September, 1956. 12th July, 1960.
Warrnambool Mental Hospital Reserve (Asylum) (Rs.1463).	27th May, 1888. Remaining portion only.
Royal Park Mental Hospital Reserve (Rs.4172).	16th January, 1940. Remaining portion only.
Janefield Colony Reserve (Rs.4218).	9th August, 1932.
Pleasant View Psychiatric Hospital Reserve (Rs.7573).	25th June, 1957.
Travancore Developmental Centre Reserve (Rs.4907).	23rd May, 1939. 9th November, 1948.
Malvern Clinic Reserve (Rs.7938).	7th June, 1960.

W. J. F. McDONALD,
Minister of Lands.

Department of Crown Lands and Survey,
Melbourne, 7th May, 1970.

LOCAL LAND BOARDS.

IN pursuance of the provisions of section 34 of the Land Act 1958, notice is hereby given that public hearings at the following places and times, will be conducted by the persons respectively mentioned, being duly appointed in that behalf.

WILLIAM JOHN FARQUHAR McDONALD,
Minister of Lands.
Department of Crown Lands and Survey,
Melbourne.

SCHEDULE.

BALLARAT LAND OFFICE, Tuesday, 16th June, 1970, at 9 a.m.—N. J. Fitzgerald and D. M. O'Connor.

PUBLIC SERVICE NOTICES

No. 467.
Public Service Act 1958, Section 50.
REGULATIONS.—PART IV.—SALARIES AND INCREMENTS.

THE Public Service Board, in pursuance of the powers conferred by the *Public Service Act 1958*, hereby amends its Regulations as shown below:—

THIRD SCHEDULE.

PART B.

PROFESSIONAL DIVISION.

Scale of Rates of Annual Salaries.

SUPERVISOR OF WORKS, PUBLIC WORKS DEPARTMENT.

The salary scale shown is deleted and the following salary scale is inserted in lieu thereof:—

Class.	Annual Salary of Each Subdivision.					
	1.	2.	3.	4.	5.	6.
SP-1	\$ 5,211	\$ 5,341	\$ 5,471	\$ 5,601	\$ 5,731	\$ 5,792

This Regulation shall have effect as on and from the 3rd May, 1970.

F. E. CAHILL, Chairman.
V. P. SCULLY, Secretary.

Office of the Public Service Board,
Melbourne, 1st May, 1970.

No. 468.

PUBLIC SERVICE ACT 1958.

THE Public Service Board, in pursuance of the powers conferred by the *Public Service Act 1958*, hereby amends the Public Service (Public Service Board) Regulations as follows:—

PART II.—APPOINTMENTS TO THE PUBLIC SERVICE.

DIVISION IV.—TECHNICAL AND GENERAL DIVISION.

Chief Secretary's Department—Social Welfare Branch.

Regulation 38.

Sub-regulations (3), (4) and (5) are revoked and the following sub-regulations are inserted in lieu thereof:—

"(3) No person shall be appointed to the office of Child Care Officer, Family Welfare Division, unless he has passed an examination in—

- (i) Child Care Method;
- (ii) Psychology;
- (iii) Social Organization;
- (iv) Practical Work for Child Care Workers.

(4) No person shall be appointed to the office of Youth Officer, Youth Welfare Division, unless he has passed an examination in—

- (i) Youth Work Method;
- (ii) Psychology;
- (iii) Social Organization;
- (iv) Practical Work for Youth Workers.

(5) No person shall be appointed to the office of Prison Officer, Prisons Division, unless he has passed an examination in—

- (i) Prison Method;
- (ii) Psychology;
- (iii) Social Organization;
- (iv) Practical Work for Prison Officers."

F. E. CAHILL, Chairman.
V. P. SCULLY, Secretary.

Office of the Public Service Board,
Melbourne, 1st May, 1970.

No. 470.

Public Service Act 1958, Section 50.

REGULATIONS.—PART IV.—SALARIES AND INCREMENTS.

THE Public Service Board, in pursuance of the powers conferred by the *Public Service Act 1958*, hereby amends its Regulations as shown below:—

SIXTH SCHEDULE.

TEMPORARY EMPLOYEES.

Designations of Positions and Rates of Salaries.

Department and Designation of Position.	Yearly Rate of Salary.		Increments (Annual).
	Minimum.	Maximum.	
MINES' DEPARTMENT.	\$	\$	
<i>Delete—</i>			
Drill Assistant, Leading Hand	2,658.	2,952	Σ
Drill Foreman, Grade III.	4,318	4,440	Σ
Drill Foreman, Grade II.	..	4,185	Σ
Drill Foreman, Grade I.	3,736	3,811	Σ
Drill Sub-Foreman, Senior	4,318	4,440	Σ
Drill Sub-Foreman, Grade III.	..	3,811	..
Drill Sub-Foreman, Grade II.	..	3,811	..
Drill Sub-Foreman, Grade I.	3,568	3,642	Σ
Pump Foreman	..	4,185	..
<i>Add—</i>			
Driller, Grade IV.	4,318	4,440	Σ
Driller, Grade III.	..	4,185	..
Driller, Grade II.	..	3,811	Σ
Driller, Grade I.	..	3,642	Σ
Test Driller	..	4,185	..

Σ See Regulation 97 (2)

F. E. CAHILL, Chairman.
V. P. SCULLY, Secretary.

Office of the Public Service Board,
Melbourne, 24th April, 1970.

No. 471.

Public Service Act 1958.

THE Public Service Board, in pursuance of the powers conferred by the *Public Service Act 1958*, hereby amends the Public Service (Public Service Board) Regulations as follows:—

PART V.—ALLOWANCES.

TECHNICAL AND GENERAL DIVISION.

General—Machinists (Female).

Regulation 112 is revoked and the following Regulation is substituted therefor—

“112. A Machinist (Female), Grade I., Junior, who is performing the duties of a Machinist (Female), Grade II. or Grade III., shall, while engaged in the duties be paid a total emolument in accordance with the following scales:—

Age.	Annual Rate of Total Emolument.	
	Machinist (Female) Grade II.	Machinist (Female) Grade III.
	\$	\$
At 17 years and under	1,808	1,966
At 18 years	1,947	2,117
At 19 years	2,225	2,419
At 20 years	2,503	2,721

General—Machinists (Data Processing) (Female).

Regulation 113 is revoked and the following Regulation is substituted therefor—

“113. (1) (a) A Machinist (Data Processing) (Female), Grade I., who has attained a standard of output and accuracy which has been approved by the Board shall be paid an allowance at the rate of \$52 a year.

(b) A Machinist (Data Processing) (Female), Grade I., who has attained an advanced standard of output and accuracy which has been approved by the Board and who is in receipt of an allowance under the provisions of sub-clause (a) of this sub-regulation shall be paid an additional allowance at the rate of \$62 a year.

(2) A Machinist (Data Processing) (Female), Grade I., Junior, who is performing the duties of a Machinist (Data Processing) (Female), Grade II., shall, while engaged in the duties, be paid a total emolument, which shall include any allowance payable under the provisions of sub-clauses (a) and (b) of sub-regulation (1), in accordance with the following scale:—

Age.	Annual Rate of Total Emolument.
	\$
At 17 years and under	1,988
At 18 years	2,141
At 19 years	2,447
At 20 years	2,753

General—Stenographers.

Regulation 114 is revoked and the following regulation is substituted therefor—

“114. (1) Any person who satisfies the Board, by test, of her ability to write shorthand at the rate of 100 words a minute shall, from the date of the test and while engaged on shorthand and typing duties—

(a) if an adult, be reclassified or redesignated to Stenographer, Grade II.; or

(b) if a minor, be paid a total emolument in accordance with the following scale:—

Age.	Annual Rate of Total Emolument.
	\$
At 17 years and under	1,966
At 18 years	2,117
At 19 years	2,419
At 20 years	2,721

and, on attaining the age of 21 years, be reclassified or redesignated to Stenographer, Grade II.

(2) Any person who satisfies the Board, by test, of her ability to write shorthand at the rate of 120 words a minute shall, from the date of the test and while engaged on shorthand and typing duties—

(a) if a Stenographer, Grade III. or Stenographer, Grade II., be paid an allowance at the rate of \$110 a year; or

(b) if a Stenographer, Grade I., Junior, be paid an allowance at the rate of \$110 a year, in addition to the total emolument payable under the provisions of sub-regulation (1) (b) of this Regulation.

General—Typists (Female) and Education Department—Typists (Female) in Schools.

Regulation 115 is revoked and the following regulation is substituted therefor—

“115. Any person who satisfies the Board, by test, of her ability to type at the rate of 42 words a minute shall, from the date of the test—

(a) if an adult, be reclassified or redesignated to Typist (Female), Grade II.; or

(b) if a minor, be paid a total emolument in accordance with the following scales:—

Age.	Annual Rate of Total Emolument.	
	General—Typists (Female).	Education Department—Typists (Female) in Schools.
	\$	\$
At 17 years and under	1,820	1,784
At 18 years	1,960	1,921
At 19 years	2,240	2,195
At 20 years	2,520	2,469

and, on attaining the age of 21 years, be reclassified or redesignated to Typist (Female), Grade II.

Education Department—Schools.

Regulation 119 is revoked and the following regulation is substituted therefor—

“119. A Typist (Female), Grade I., Junior, who is performing the duties of a Clerical Assistant (Female), shall, while engaged in the duties, be paid a total emolument in accordance with the following scales:—

Age.	Clerical Assistant (Female) Grade I.	Clerical Assistant (Female) Grade II.	Clerical Assistant (Female) Grade III.
	\$	\$	\$
At 17 years and under	1,844	1,919	2,024
At 18 years	1,986	2,066	2,180
At 19 years	2,270	2,361	2,491
At 20 years	2,554	2,656	2,802

This Regulation shall have effect as on and from the 22nd March, 1970.

F. E. CAHILL, Chairman.
V. P. SCULLY, Secretary.

Office of the Public Service Board,
Melbourne, 8th May, 1970.

No. 469.

Public Service Act 1958, Section 50.

REGULATIONS.—PART IV.—SALARIES AND INCREMENTS.

THE Public Service Board, in pursuance of the powers conferred by the *Public Service Act 1958*, hereby amends its Regulations as shown below:—

THIRD SCHEDULE.

PART B.

PROFESSIONAL DIVISION.

Scale of Rates of Annual Salaries.

ARCHIVISTS.

The salary scale shown is deleted and the following salary scale is inserted in lieu thereof—

Class.	Annual Salary of Each Subdivision of Each Class.						
	1.	2.	3.	4.	5.	6.	7.
	\$	\$	\$	\$	\$	\$	\$
AV-1 ..	3,844	4,092	4,350	4,650	4,908	5,223	5,502
AV-2 ..	5,673	5,841	6,002
AV-3 ..	7,596

This Regulation shall have effect as on and from the 3rd May, 1970.

F. E. CAHILL, Chairman.
V. P. SCULLY, Secretary.

Office of the Public Service Board,
Melbourne, 1st May, 1970.

TENDERS**PUBLIC WORKS DEPARTMENT**

TENDERS will be received at Public Works Department, 2 Treasury-place, Melbourne, until **TWO** p.m. on dates shown and for purposes mentioned hereunder.

Particulars and tender forms available at Contracts Office, Room 8, Building Division, Parliament-place and at places indicated in brackets hereunder.

Abbreviations in brackets mean:—W.O.—Inspector of Works Office; P.S.—Police Station; C.S.—Consolidated School; H.E.S.—Higher Elementary School; H.S.—High School; Pr.S.—Primary School; T.S.—Technical School.

Tenders to be submitted on the Department's printed Tender Form and will not be received by telephone. All tenders must be on a "Firm Tender" basis. The lowest or any tender will not necessarily be accepted.

Address tenders to the Minister of Public Works, and **endorse the envelope containing the tender "Tender for , closing Tuesday,**

Hand delivered tenders to be placed in the Tender Box of the Public Works Department, located on the wall of the centre entrance foyer, Ground Floor, 2 Treasury-place, Melbourne.

No preliminary deposit is required with any tender, but a successful tenderer will be required to pay a deposit for any accepted tender of \$4,000 or over.

Tuesday, 26th May, 1970.

Building, Electrical and Mechanical Works.

Glenormiston.—Refrigeration system for three cool rooms, Agricultural College. (W.O., Warrambool.)

Moonee Ponds.—Re-building of toilet block and erection of new shelter sheds, Central School 3987.

St. Arnaud.—External and internal renovations and painting, H.S. (W.O., Maryborough.)

Williamstown.—Erection of standard school hall type "800C", H.S.

Williamstown.—Electrical services, H.S.

Williamstown.—Mechanical services, H.S.

Wodonga.—Erection of a standard school hall type "800C", H.S. (W.O., Wangaratta.) (Re-advertised.)

Tuesday, 2nd June, 1970.

Building, Electrical and Mechanical Works.

Burwood.—Erection of new science wing in concrete veneer and provision of additional staff accommodation, High School.

Burwood.—Electrical installation, High School.

Burwood.—Mechanical services, High School.

Cheltenham.—External and internal renovations, High School.

Hawksburn.—Internal repairs and painting, Pr.S. 1467. (Amended Specification.)

Merrilands.—Internal renovations, High School.

Mornington.—Installation of fire service, High School. (W.O., Mornington.)

Sale.—Erection of new primary school in brick veneer, Pr.S. 5021. (W.O., Bairnsdale, Warragul and Traralgon.)

Sale.—Electrical installation, Pr.S. 5021. (W.O., Bairnsdale, Traralgon and Warragul.)

Sale.—Mechanical services, Pr.S. 5021. (W.O., Traralgon, Warragul and Bairnsdale.)

Miscellaneous.

Coburg.—Supply and placing in position of kitchen equipment in cafeteria, Teachers' College.

Tuesday, 9th June, 1970.

Building, Electrical and Mechanical Works.

Bonbeach.—Erection of a standard school hall type "800", High School.

Bonbeach.—Electrical services, High School.

Bonbeach.—Mechanical services, High School.

Malmsbury.—Supply and installation of laundry press and drying cabinet, Youth Training Centre.

Nhill.—Erection of new Science Wing in brick veneer, High School. (W.O., Horsham.)

Nhill.—Mechanical services, High School. (W.O., Bendigo.)

R. J. HAMER,
Minister of Public Works.

Public Works Department,
Melbourne, 3002, 18th May, 1970.

PRIVATE ADVERTISEMENTS**CITY OF BRIGHTON.**

LOAN No. 85.

Notice of Intention to Borrow the Sum of \$120,000 for Permanent Works and Undertakings.

NOTICE is hereby given that the Council of the City of Brighton proposes to borrow the principal sum of \$120,000 secured by a charge over the general rates of the municipality, such sum to be raised by the grant of a mortgage in accordance with the provisions of the *Local Government Act 1958*.

1. The maximum rate of interest that may be paid is 7.4 per cent. per annum.

2. The purpose for which the loan is to be applied is—
Construction of Sports Pavilion, Dendy Park (Contract in course)—\$40,000.00.
Reconstruction of Roads—(Contracts in course and programmed)—\$80,000.00.

3. The period of the loan shall be fifteen years.

4. The moneys borrowed shall be repayable by providing out of the municipal fund half-yearly instalments of approximately \$6,689.07 each, including principal and interest on the 15th day of January and the 15th day of July, during the currency of the loan. The first instalment shall be payable on the 15th day of January, 1971.

5. Such moneys shall be repayable to The Commonwealth Trading Bank of Australia, North Brighton.

The plans and specifications and the estimate of the cost of the proposed works and a statement showing the proposed expenditure of the moneys to be borrowed are open for inspection at the office of the Council of the City of Brighton, at Boxshall-street, Brighton.

A. C. G. DE GARIS, Town Clerk.

Municipal Offices, Boxshall-street, Brighton, 3186. 4312

CITY OF BRUNSWICK.

BY-LAW No. 185.

A By-law of the City of Brunswick made under the *Local Government Act 1958*, the *Motor Car Act 1958* and the *Summary Offences Act 1966* and numbered 185 for amending By-law No. 146 of the City of Brunswick:

IN pursuance of the powers conferred by the *Local Government Act 1958*, the *Motor Car Act 1958*, the *Summary Offences Act 1966* and all other powers it enabling the Mayor, Councillors and Citizens of the City of Brunswick order as follows:—

1. The definitions of "Hand Truck", "Horse", "Licensed", "Major Street", "Minor Street", "Motor Car", "Parking Area", "Safety Zone", "Scooter, Whizzer or Coaster", "Stop Mark", "Traffic Control Signal", where they appear in paragraph 1 of By-law No. 146 relating to traffic are hereby repealed.

2. The following paragraphs of By-law No. 146 relating to traffic are hereby repealed, namely: Paragraphs 5, 6, 7, 8, Paragraph 9 Sub-Paragraphs 1 to 28 inclusive and Sub-Paragraphs 32 to 36 inclusive, 10, 11, Sub-Paragraph 1 (d) of Paragraph 12, Sub-Paragraphs 2 to 6 inclusive of Paragraph 12, Paragraphs 13, 14, 17, 18, 19, 20, 21, 23, 28, 31, 32 and 45.

3. Sub-Paragraph (c) (ii) of Paragraph 47 is hereby amended by deleting the words "Police Offences Act 1928" and inserting in lieu thereof "Summary Offences Act 1966".

4. In lieu of Sub-Paragraph 6 of Paragraph 12 hereby repealed the following paragraph is hereby enacted:—

"(6) Being the driver of any vehicle on the request of any member of the Police Force or officer of the Council produce to him for inspection any order or leave whether issued by the Council or by any other authorised public body and held by such person."

5. Paragraph 24 relating to street processions is hereby amended by deleting sub-paragraph (c).

6. Paragraph 50 relating to penalties is hereby amended by deleting the expression "£10" and inserting in lieu thereof the expression "\$40".

7. This by-law shall apply to and have operation throughout the whole of the Municipal District of the City of Brunswick.

Resolution for passing this By-law was agreed to by the Council on the 8th day of December, 1969, and confirmed the 23rd day of February, 1970.

In witness whereof the common seal of the Mayor, Councillors and Citizens of the City of Brunswick was hereunto affixed this 23rd day of February, 1970.

(SEAL) N. G. W. ANDERSON, Mayor.
G. R. GILPIN, Councillor.
C. G. BARKER, Town Clerk.

Approved by the Governor in Council this 28th day of April, 1970.—J. ROSSITER, Clerk of the Executive Council.
4329

CITY OF CAMBERWELL.

BY-LAW No. 187.

A BY-LAW of the City of Camberwell made under section 197 of the *Local Government Act 1958* and numbered 187 for repealing By-law No. 169 relating to suppressing nuisances and the keeping of bees.

1. By-law No. 169 of the City of Camberwell is hereby repealed.

2. This By-law shall apply to and have operation throughout the whole of the City of Camberwell.

3. This By-law shall come into operation and have effect immediately upon its publication in the *Victoria Government Gazette*.

Resolution for passing this By-law agreed to by the Council the 23rd day of March, 1970, and confirmed the 4th day of May, 1970.

The common seal of the Mayor, Councillors and Citizens of the City of Camberwell was affixed hereto, in the presence of—

(SEAL) J. B. JACKSON, Mayor.
W. G. BOUNDY, Councillor.
L. F. CHEFFERS, Town Clerk.
4313

CITY OF KEW.

LOAN No. 61.

Notice of Intention to Resolve to Borrow Principal Moneys Amounting to \$100,000 for Permanent Works and Undertakings.

NOTICE is hereby given that the Council of the City of Kew proposes to resolve to borrow principal moneys amounting to \$100,000 secured by a charge over the general rates of the municipality, such moneys to be raised by the grant of a mortgage in accordance with the provisions of the *Local Government Acts*.

1. The maximum rate of interest that may be paid is 7.4 per centum per annum.

2. The period of the loan shall be 40 years.

3. The moneys borrowed shall be repayable by providing out of the municipal fund 80 half-yearly instalments of \$3,913.95 each, including principal and interest, on the 5th day of February and the 5th day of August during the currency of the loan. The first instalment shall be payable on the 5th day of February, 1971.

4. Such moneys shall be repayable to the Australian Mutual Provident Society, at the office of the said Society, for the time being in Melbourne.

5. The purpose for which the loan is to be applied is the erection of new municipal offices (part cost).

The plans and specifications and the estimate of the cost of the proposed works, and a statement showing the proposed expenditure of the moneys to be borrowed, are open for inspection at the Town Hall, Walpole-street, Kew.

Dated this 18th day of May, 1970.

4340 J. L. JOHNSON, Town Clerk.

CITY OF KNOX.

BY-LAW No. 14.

A By-law of the City of Knox made under Section 197 and Section 198 of the *Local Government Act 1958* as amended and every and any other power it thereunto enabling, and numbered 14, for the purpose of—

- (a) prohibiting, or regulating the placing of caravans on private property;
- (b) regulating restricting or prohibiting the use of caravan or camping parks or sites and regulating the conduct or management thereof; and
- (c) providing for the health of the residents in the municipal district and against the spreading of contagious or infectious diseases.

IN pursuance of the powers conferred by the *Local Government Act 1958* as amended and every and any other Power it thereunto enabling The Mayor Councillors and Citizens of the City of Knox order as follows:

No. 50.—4210/70.—4

1. In this By-law unless inconsistent with the context or subject matter—

'Camper' includes each and every person camping in tents, caravans or similar temporary accommodation on any caravan or camping park or site with or without the permission of the proprietor and with or without the payment of any fee or the giving of any consideration to the proprietor.

'Caravan' includes any object or structure having the general characteristics of a caravan, a house on wheels, a covered van, and any vehicle used or adapted for living purposes whether the wheels or axles thereof have been removed or not and whether it is resting directly on the ground or is placed on blocks or other supports; and any structure, awning, verandah, lean-to, carport or other enclosed or partly enclosed area used or capable of being used in conjunction with or appurtenant to a caravan.

'Caravan or camping park or site' means and includes premises registered or required to be registered with the Council as a camping area pursuant to the provisions of the Regulations.

'Council' means the Council of the City of Knox.

'On-site caravan' means a caravan which is owned or under the control of the proprietor and which is made available on the caravan or camping park or site by the proprietor for the use of a camper.

'Private property' shall have the same meaning as the expression has in Section 197 (1) (xxxi) (g) of the *Local Government Act 1958* and includes vacant land, but shall not include a caravan or camping park or site which is duly registered with the Council pursuant to this By-law.

'Proprietor' means and includes the owner or occupier or the person having the control or management of any land upon which is a caravan or camping park or site.

'The Regulations' means the 'Camping Regulations 1965'.

2. By-law No. 4 of the Shire of Knox is hereby repealed.

3. (1) No person shall place or permit or suffer to be placed any caravan on any private property (other than for the purpose of sale or hire for use other than on such private property or the storing or parking of the same) for more than fourteen days whether consecutive or not during any period of one year without the consent in writing of the Council.

(2) No person shall place or permit or suffer to be placed more than one caravan on any private property at any time without the consent in writing of the Council.

4. (1) No person shall occupy any caravan placed on any private property for more than fourteen days whether consecutive or not during any period of one year without the consent in writing of the Council.

(2) Every person applying for such consent shall make application in writing to the Council and supply such information as the Council may by notice reasonably require.

(3) The Council may grant or refuse its consent to the application as it sees fit.

(4) If the Council gives its consent then the permit to issue as a result shall be—

- (a) for a period not exceeding six months; and
- (b) absolutely conditional upon proper sanitation facilities to the satisfaction of a Health officer of the Council being at all times available for the use of the occupant or occupants.

(5) In the event of such sanitation facilities at any time ceasing to be so available then any permit granted under sub-clause (1) hereof shall be immediately cancelled on service on the holder of such permit of a notice under the signature of a Health officer of the Council that such facilities have ceased to be available.

5. No person shall use any land or permit or suffer to be used any land of which he is the proprietor for a caravan or camping park or site unless such caravan or camping park or site is registered with the Council as a camping area pursuant to the provisions of the Regulations and of this By-law.

6. (1) The Council may grant or refuse an application for the registration or renewal of registration of a caravan or camping park or site, or may grant the application subject to such conditions as it sees fit.

(2) Without restricting the generality of the provisions of Clause 6 (1) hereof, an application for the registration or renewal of registration of a caravan or camping park or site shall not be granted unless the Council is satisfied that in respect of such caravan or camping park or site there has been full compliance with the provisions of the Health Act 1958, the Regulations made thereunder and of this By-law.

7. (1) The proprietor of a caravan or camping park or site shall not permit or suffer to remain thereon any caravan (other than an on-site caravan) or any tent marquee or camp during any period of one year for a period or periods exceeding in total 10 weeks.

(2) The proprietor of a caravan or camping park or site shall not permit or suffer any camper to reside at such caravan or camping park or site during any period of one year for a period or periods exceeding in total 10 weeks.

8. (1) (a) No camper in charge of any caravan (other than an on-site caravan) or any tent marquee or camp in any caravan or camping park or site shall allow such caravan tent marquee or camp to remain therein for more than 10 weeks whether consecutive or not during any period of one year.

(b) No camper shall reside in any on-site caravan for more than 10 weeks whether consecutive or not during any period of one year.

(2) No camper shall reside in any caravan or camping park or site for more than 10 weeks whether consecutive or not during any period of one year.

9. No person shall remove or cause to be removed any of the wheels of a caravan whilst such caravan shall be in or upon any caravan or camping park or site except for the purpose of and for the period necessary to effect repairs thereto.

10. The proprietor of a caravan or camping park or site shall not permit or suffer to be or remain therein any caravan unless such caravan is fitted with wheels and is in such condition and state of roadworthiness that it may be driven or towed on a public highway.

11. Any person who uses or permits or suffers to be used any land as a caravan or camping park or site contrary to any condition imposed by this By-law or by the Council on the granting or renewal of the registration of such land as a caravan or camping park or site shall be guilty of an offence against this By-law.

12. The proprietor or some adult person nominated by him shall maintain on the caravan or camping park or site and keep available for inspection at all reasonable times by a Health officer of the Council a properly written up-to-date register in which all the individual sites shall be numbered and in which shall be recorded by reference to each of such numbered sites the registered number of every caravan and of every towing vehicle placed on such site, the name and address of the owner thereof and the names and addresses of all persons accommodated therein, the dates on which such caravan was placed on and was removed from such site and the dates on which each person accommodated in a caravan at the caravan or camping park or site commenced and ceased to be so accommodated.

13. Any notice or permit given by the Council under this By-law may be given under the hand of the Town Clerk or any Health officer of the Council.

14. This By-law shall apply to and have operation throughout the municipal district of the City of Knox.

15. Any person guilty of a wilful act or default contrary to the provisions of this By-law shall, on conviction, be liable to a penalty of not more than \$40.00 and not less than \$10.00, and in the case of a continuing offence shall be liable to a penalty of not more than \$10.00 for each day on which an offence against this By-law is continued after a conviction or order by any Court.

Resolution for passing this By-law agreed to by the Council of the City of Knox on the 3rd day of March, 1970.

And confirmed on the 7th day of April, 1970.

The common seal of The Mayor Councillors and Citizens of the City of Knox was hereto affixed in the presence of:

(SEAL) A. R. GROGAN, Mayor.
B. M. SEEBECK, Councillor.
M. G. HAYNES, Town Clerk.

Approved by the Governor in Council, 28th April, 1970.
—J. ROSSITER, Clerk of the Executive Council. 4294

CITY OF MILDURA.

NOTICE is hereby given that the Council of the City of Mildura, on 14th May, 1970, appointed Mr. Gregory Owen Francis, as Prosecuting Officer, for the City of Mildura, vide Mr. Pat Saunders, who has retired.

W. J. DOWNIE, Town Clerk.

Civic Buildings, Mildura, 15th May, 1970. 4296

CITY OF MOE.

NOTICE is hereby given that the name of the road formerly known as Service-road east, Moe, has been changed to Drew-street, Moe, as from Wednesday, 20th May, 1970.

R. J. PUGSLEY, Town Clerk.

4373

CITY OF MOORABBIN.

LOAN No. 166.

Notice of Intention to Borrow the Sum of \$100,000 for Permanent Works and Undertakings.

NOTICE is hereby given that the Council of the City of Moorabbin proposes to borrow the principal sum of One hundred thousand dollars secured by a charge over the general rates of the municipality, such sum to be raised by the grant of a mortgage in accordance with the provisions of the Local Government Act 1958.

1. The maximum rate of interest that may be paid is 7.4 per cent. per annum.

2. The purposes for which the loan is to be applied are—

Improvements to recreational reserves ..	\$27,000
Construction of roads	73,000
	<u>\$100,000</u>

3. The period of the loan shall be 40 years.

4. The moneys borrowed shall be repayable by providing out of the municipal funds eighty equal half-yearly instalments of \$3,913.95 each including principal and interest on the fifth days of February and August during the currency of the loan. The first instalment shall be payable on the fifth day of February, 1971.

5. Such moneys shall be repayable to the Australian Mutual Provident Society, 535 Bourke-street, Melbourne, or at such other place as the Society may require.

The plans and specifications and the estimate of the cost of the proposed works and a statement showing the proposed expenditure of the moneys to be borrowed are open for inspection at the office of the Council of the City of Moorabbin at Nepean Highway, Moorabbin.

Dated the 18th day of May, 1970.

4374

V. A. SMITH,
Town Clerk.

CITY OF PRAHRAN.

BY-LAW No. 253.

A By-Law of the City of Prahran made under Section 197 of the Local Government Act 1958 and numbered 253 for:—

(a) Prohibiting or regulating the placing of caravans on private property.

(b) Prohibiting or regulating camping on roads.

IN pursuance of the powers conferred by the Local Government Act 1958 and of any and every power it thereunto enabling the Mayor, Councillors and Citizens of the City of Prahran order as follows:—

1. In this By-Law unless inconsistent with the context or subject matter—

“Caravan” means any object or structure having the general characteristics of a caravan, a house on wheels, a covered van, and any vehicle used or adapted for living purposes whether the wheels or axles thereof have been removed or not and whether it is resting directly on the ground or is placed on blocks or other supports, and any structure, awning, verandah, lean-to, carport or other enclosed or partly enclosed area used or capable of being used in conjunction with or appurtenant to a caravan.

“Council” means the Council of the City of Prahran.

2. No person shall place or permit or suffer to be placed any caravan on any private property other than for the purpose of sale, or hire for use other than on such private property, or the storing or parking of the same.

3. No person shall occupy or permit or suffer to be occupied any caravan placed on any private property.

4. No person shall occupy any caravan on any street within the Municipal District of the City of Prahran.

5. This By-Law shall apply to and have operation throughout the whole of the Municipal District of the City of Prahran.

6. Any person guilty of any wilful act or default contrary to this By-Law shall be liable on conviction to a penalty of not less than \$20.00 nor more than \$40.00 for each and every offence and in the case of a continuing offence to a further penalty of not more than \$10.00 for each day on which an offence against this By-Law is continued after a conviction or order by any Court.

Resolution for making and passing this By-Law was agreed to by the Council of the said City the 9th day of February, 1970.

Confirmed the 10th day of March, 1970.

The common seal of the Mayor, Councillors and Citizens of the City of Prahran was hereto affixed, in the presence of—

(SEAL) C. C. E. GAHAN, Mayor.
GEO. GAHAN, Councillor.
JOHN A. LUCAS, Town Clerk.

Approved by the Governor in Council, the 28th day of April, 1970.—J. ROSSITER, Clerk of the Executive Council. 4317

CITY OF RINGWOOD.

LOAN No. 99.

Notice of Intention to Borrow the Sum of \$100,000 for Permanent Works and Undertakings.

NOTICE is hereby given that the Council of the City of Ringwood proposes to borrow the sum of \$100,000 (One hundred thousand dollars) secured by a charge over the general rates of the Municipality such sum to be raised by the grant of a mortgage in accordance with the provisions of the Local Government Act, for Permanent Works and Undertakings within the Municipality.

1. That the maximum rate of interest that may be paid is 6.4 per centum per annum.
2. The purpose for which the loan is to be applied is:—
Construction of new Swimming Centre, Jubilee Park (part cost)—\$100,000.
3. The period of the loan shall be twenty years.
4. The moneys borrowed shall be repayable by providing out of the municipal fund thirty-nine (39) half-yearly instalments including principal and interest of approximately \$3,769.51 each, on the 30th days of June and December in each year, and a final payment of approximately \$58,827.45 on the 30th day of June, 1990, and the first instalment shall be payable on the 30th day of December, 1970.
5. Such moneys shall be repayable at the E.S. & A. Savings Bank Limited, of 287 Collins-street, Melbourne, at the office of the said Bank.

The plans and specification and an estimate of the cost of the proposed works are open for inspection at the office of the Council, Civic Centre, Ringwood, during office hours.

4306 J. N. WEBSTER, Town Clerk.

BOROUGH OF KOROIT.

LOAN No. 10.

Notice of Intention to Borrow the Sum of \$20,000 for Permanent Works and Undertakings.

NOTICE is hereby given that the Council of the Borough of Koroit proposes to borrow the principal sum of Twenty thousand dollars, secured by a charge over the general rates of the municipality, such sum to be raised by the grant of a mortgage in accordance with the provisions of the Local Government Act 1958.

1. The maximum rate of interest that may be paid is 7.4 per cent. per annum.
2. The purpose for which the loan is to be applied is:—
Renovations and extensions to the Town Hall, provision of necessary furniture and fittings.
3. The period of the loan shall be fifteen years.
4. The moneys borrowed shall be repayable by providing out of the municipal fund thirty (30) half-yearly instalments of approximately \$1,115.00 each, including principal and interest, on the 1st day of July and the 1st day of January during the currency of the loan. The first instalment shall be payable on the 1st day of January, 1971.
5. Such moneys shall be repayable to the Commissioners of the State Savings Banks of Victoria, at the office of the said Commissioners, Corner Elizabeth and Bourke streets, Melbourne.

The plans and specifications and the estimate of the cost of the proposed works and a statement showing the proposed expenditure of the moneys to be borrowed are open for inspection at the office of the Council of the Borough of Koroit, at the Town Hall, Koroit.

Dated this 13th day of May, 1970.

4319 S. LONDON, Town Clerk.

Town and Country Planning Act 1961.

SHIRE OF BANNOCKBURN—GEELONG PLANNING SCHEME 1959.

NOTICE THAT A PLANNING SCHEME HAS BEEN PREPARED AND IS AVAILABLE FOR INSPECTION.

Amendment No. 2.

NOTICE is hereby given that in accordance with the Town and Country Planning Act 1961, a planning scheme has been prepared for the re-zoning of the following area from Agricultural A to Industrial B:—

All that piece of land, being part of Crown Section 6, Parish of Gheringhap, commencing in the south-west corner of section 6, running north-westerly 1,880 links along Government road, then easterly 2,870 links, then southerly 2,109 4/10 links and westerly 1,919.0 links back to south-west corner of section 6, comprising an area of 41 acres 1 rood 15 1/10 perches.

A copy has been deposited at the Shire Office, High-street, Bannockburn, 3331, and at the office of the Town and Country Planning Board, 235 Queen-street, Melbourne, and may be inspected during office hours by any person, free of charge.

Any objections to the scheme should be sent in writing, together with advice as to whether your Authority/Department/Municipality, desires to be heard in respect of such objection, to the Shire Secretary, Shire Office, High-street, Bannockburn, 3331, on or before the 9th July, 1970, for consideration by the Shire of Bannockburn.

Dated 15th May, 1970.

4332 GEO. COCKS, J.P., Shire Secretary.

SHIRE OF CRANBOURNE.

LOAN No. 33.

Notice of Intention to Borrow the Sum of \$25,000 for Permanent Works and Undertakings.

NOTICE is hereby given that the Council of the Shire of Cranbourne proposes to borrow the principal sum of \$25,000 secured by a charge over the general rates of the municipality, such sum to be raised by the grant of a mortgage in accordance with the provisions of the Local Government Act 1958.

1. The maximum rate of interest that may be paid is 6.15 per cent per annum.
2. The purposes for which the loan is to be applied are—
Extensions to the Shire Offices, Cranbourne \$23,000
Furniture and Office Equipment 2,000
\$25,000
3. The period of the loan shall be nine years.
4. The moneys borrowed shall be repayable by providing out of the municipal fund 18 half-yearly instalments of \$1,829.26 each, including principal and interest, on the 1st day of February and the 1st day of August during the currency of the loan. The first instalment shall be payable on the 1st day of February, 1971.
5. Such moneys shall be repayable to The National Bank Savings Bank Limited, 271-285 Collins-street, Melbourne.

The plans and specifications and the estimate of the cost of the proposed works and a statement, showing the proposed expenditure of the moneys to be borrowed, are open for inspection at the office of the Council of the Shire of Cranbourne, at Cranbourne.

Dated 22nd May, 1970.

4331 T. W. GRANT, Shire Secretary.

SHIRE OF DIAMOND VALLEY.

LOAN No. 26.

Construction of Private Streets.

NOTICE is hereby given that at the meeting of the Council of the Shire of Diamond Valley held at the Shire Office, Greensborough, on 13th April, 1970, the said Council did agree to the following Resolution, that is to say:—

“That the Council do by Special Order and it does hereby resolve to borrow the sum of \$100,000 by the grant of a mortgage secured by a charge over the

general rates of the municipality, in accordance with the provisions of the *Local Government Act 1958* and amendments.

The rate of interest to be paid shall be 6.3 per cent. per annum and the said loan shall be liquidated by twenty equal half-yearly repayments of principal together with interest from time to time accruing on so much thereof as is unpaid at the Commonwealth Savings Bank of Australia, Melbourne, on the 1st day of June and the 1st day of December in each year during the currency of the loan.

The purpose for which the said loan shall be applied is for the construction of private streets under the provisions of Division 10 of Part XIX. of the *Local Government Act 1958* and amendments and the loan shall be liquidated from the receipts of money payable under the schemes under the said Division."

Notice is hereby further given that at the ordinary meeting of the Council held at the Shire Office, Greensborough, on 11th May, 1970, the said Resolution was confirmed.

4333

B. J. MORGAN, Shire Secretary.

SHIRE OF GRENVILLE.

NOTICE OF INTENTION TO TAKE LAND COMPULSORILY.

NOTICE is hereby given that it is the intention of the Council of the Shire of Grenville, in exercise of the powers conferred on it by the *Local Government Act 1958*, No. 6299, to take compulsorily the following land:—

All that piece of land containing 2 roods and 20 perches, being Crown allotment 7 in section 6, Township of Cape Clear, Parish of Mindai, County of Grenville, being more particularly that area of land contained in Crown grant volume 1178, folio 235485.

The said land is required to provide a place for public resort and recreation.

The Council has caused to be prepared plans and other necessary documents showing the nature and extent of such work or undertaking and more particularly describing the said land and the exact site and admeasurements thereof and stating the names of the owners, or reputed owners, lessees or reputed lessees, mortgagees and occupiers of the said land.

The said plans and other documents have been approved by the Council and are now deposited for inspection by all persons interested, at the offices of the Shire of Grenville, situated at Sussex-street, Linton, and may be inspected there during office hours.

All persons affected by the proposed taking of the land are hereby required to set forth, in writing, addressed to the said Council or to the Shire Secretary, within 40 clear days of the publication of this notice in the *Government Gazette*, all objections which they may have to the taking of the land.

4303

L. OLDHAM, Shire Secretary.

SHIRE OF HASTINGS.

ORDER NAMING STREETS.

IN accordance with the provisions of the *Local Government Act 1958*, the Council of the Shire of Hastings has made an order naming the following streets within the municipal district.

1. *Firth-road.*

Location.—Runs in a westerly direction off the west side of Coolart-road, approximately half a mile south of Eramosa-road.

2. *Austin-road.*

Location.—Runs in a northerly direction off the north side of Bungower-road, approximately one third of a mile west of Jones-road.

3. *Graf-road.*

Location.—Runs in a southerly direction off the south side of Eramosa-road, approximately half a mile west of Jones-road.

4. *Shaw-road.*

Location.—Runs in a northerly direction off the north side of Morningson-Tyabb road, approximately half a mile west of Coolart-road.

L. A. WALKER, Shire Secretary.

Municipal Offices, Hastings, 13th May, 1970. 4309

SHIRE OF HASTINGS.

LOAN No. 32.

Notice of Intention to Borrow the Sum of \$50,000 for Permanent Works and Undertakings.

NOTICE is hereby given that the Council of the Shire of Hastings proposes to borrow the principal sum of Fifty thousand dollars secured by a charge over the general rates of the municipality, such sum to be raised by the grant of a mortgage in accordance with the provisions of the *Local Government Act 1958*.

1. The maximum rate of interest that may be paid is 7.4 per cent. per annum.

2. The purpose for which the loan is to be applied is—
Road Construction—Contributions to the Country Roads Board.

3. The period of the loan shall be 20 years.

4. The loan is to be liquidated by the creation of a sinking fund, pursuant to the provisions of section 428A of the *Local Government Act 1958*.

5. The moneys borrowed shall be repayable at the expiration of the loan at the National Mutual Life Association of Australasia Limited, 447 Collins-street, Melbourne.

The plans and specifications and the estimate of the cost of the proposed works and a statement showing the proposed expenditure of the moneys to be borrowed are open for inspection at the office of the Council of the Shire of Hastings at Marine-parade, Hastings.

Dated 12th May, 1970.

4323

L. A. WALKER, Shire Secretary.

SHIRE OF HASTINGS.

LOAN No. 33.

Notice of Intention to Borrow the Sum of \$20,000 for Permanent Works and Undertakings.

NOTICE is hereby given that the Council of the Shire of Hastings proposes to borrow the principal sum of Twenty thousand dollars secured by a charge over the general rates of the municipality, such sum to be raised by the grant of a mortgage in accordance with the provisions of the *Local Government Act 1958*.

1. The maximum rate of interest that may be paid is 7.3 per cent. per annum.

2. The purposes for which the loan is to be applied are—
\$

1. C.R.B. contributions Road Construction	1,300
2. Footpath, Kerbing and Channel	15,800
3. Land Acquisition	1,500
4. Completion Hall Construction	400
5. Underground Drainage	500
6. Basketball Courts	500

3. The period of the loan shall be 10 years.

4. The moneys borrowed shall be repayable by providing out of the municipal fund half-yearly instalments of approximately \$1,426.39 each including principal and interest on the 1st day of January and the 1st day of July during the currency of the loan. The first instalment shall be payable on the 1st day of January, 1971.

5. Such moneys shall be repayable to the Commissioners of the State Savings Bank of Victoria at the office of the said Commissioners, corner Elizabeth and Bourke streets, Melbourne.

The plans and specifications and the estimate of the cost of the proposed works and a statement showing the proposed expenditure of the moneys to be borrowed are open for inspection at the office of the Council of the Shire of Hastings at Marine-parade, Hastings.

Dated 12th May, 1970.

4324

L. A. WALKER, Shire Secretary.

SHIRE OF HASTINGS.

LOAN No. 34.

Notice of Intention to Borrow the Sum of \$100,000 for Permanent Works and Undertakings.

NOTICE is hereby given that the Council of the Shire of Hastings proposes to borrow the principal sum of One hundred thousand dollars secured by a charge over the general rates of the municipality, such sum to be raised by the grant of a mortgage in accordance with the provisions of the *Local Government Act 1958*.

1. The maximum rate of interest that may be paid is 7.3 per cent. per annum.

2. The purposes for which the loan is to be applied are—

	\$
1. Road Construction	95,000
2. Public Toilets, Hastings	5,000

3. The period of the loan shall be 10 years.

4. The moneys borrowed shall be repayable by providing out of the municipal fund half-yearly instalments of approximately \$7,131.95 each including principal and interest on the 1st day of July and the 1st day of January during the currency of the loan. The first instalment shall be payable on the 1st day of January, 1971.

5. Such moneys shall be repayable to the National Bank Savings Bank Limited, 271 Collins-street, Melbourne.

The plans and specifications and the estimate of the cost of the proposed works and a statement showing the proposed expenditure of the moneys to be borrowed are open for inspection at the office of the Council of the Shire of Hastings at Marine-parade, Hastings.

Dated 13th May, 1970.

4325 L. A. WALKER, Shire Secretary.

SHIRE OF HASTINGS.

LOAN No. 35.

Notice of Intention to Borrow the Sum of \$50,000 for Permanent Works and Undertakings.

NOTICE is hereby given that the Council of the Shire of Hastings proposes to borrow the principal sum of Fifty thousand dollars secured by a charge over the general rates of the municipality, such sum to be raised by the grant of a mortgage in accordance with the provisions of the *Local Government Act 1958*.

1. The maximum rate of interest that may be paid is 7.4 per cent. per annum.

2. The purposes for which the loan is to be applied are—

	\$
1. Footpath, Kerbing and Channel	8,350
2. Road Construction	41,400
3. Cricket Pitch	250

3. The period of the loan shall be 20 years.

4. The moneys borrowed shall be repayable by providing out of the municipal fund half-yearly instalments of \$2,414.52 each including principal and interest on the 1st day of September and the 1st day of March during the currency of the loan. The first instalment shall be payable on the 1st day of March, 1971.

5. Such moneys shall be repayable to Australian Mutual Provident Society, 535 Bourke-street, Melbourne.

The plans and specifications and the estimate of the cost of the proposed works and a statement showing the proposed expenditure of the moneys to be borrowed are open for inspection at the office of the Council of the Shire of Hastings at Marine-parade, Hastings.

Dated 12th May, 1970.

4326 L. A. WALKER, Shire Secretary.

SHIRE OF KORUMBURRA.

WHEREAS the Council of the Shire of Korumburra deems it expedient to exercise its powers of taking compulsorily the land described in the Schedule hereto for road widening purposes: And whereas the Council has caused to be prepared a map and other papers setting out the general description of the work or undertaking for which the land proposed to be taken is to be used the description of the land to be taken and the names of the owners or reputed owners, lessees or reputed lessees, mortgagees and occupiers of the land so far as those names are known to or can be ascertained by the Council: And whereas the said map and other papers are deposited at the office of the said Council at Korumburra and are and shall be open for inspection by all persons interested at all reasonable hours for the space of 40 clear days after the publication of this notice in the *Government Gazette*: Now notice is hereby given to all persons affected by the proposed taking of the said land to set forth, in writing, addressed to the Council or the Shire Secretary within 40 clear days of the publication of this notice in the *Government Gazette*, all objections which they may have to the taking of the said land.

SCHEDULE HEREINBEFORE REFERRED TO.

All that piece of land being Crown allotment 30, section 4, Township of Nyora, Parish of Lang Lang East, County of Mornington, more particularly described in certificate of title volume 2800, folio 802.

4305 W. O. CLARK, Shire Secretary.

SHIRE OF MORWELL.

LOAN No. 46.

Notice of Intention to Borrow the Sum of \$45,000 for Permanent Works and Undertakings.

NOTICE is hereby given that the Council of the Shire of Morwell proposes to borrow the principal sum of \$45,000 secured by a charge over the general rates of the municipality, such sum to be raised by the grant of a mortgage, in accordance with the provisions of the *Local Government Act 1958*.

1. The maximum rate of interest that may be paid is 6.3 per centum per annum.

2. The purpose for which the loan is to be applied is:—

Holmes-road reconstruction	\$2,600
Commercial-road reconstruction	5,000
Bituminous sealing	5,000
Construction of main drains	19,000
Construction of footpaths and kerb & channel	10,000
Council proportion private streets	450
Construction of footpaths in reserves	2,950

\$45,000

3. The period of the loan shall be ten years.

4. The moneys borrowed shall be repayable by providing out of the municipal fund half-yearly instalments of approximately \$3,067.00 each, including principal and interest, on the 1st day of February and the 1st day of August during the currency of the loan. The first instalment shall be payable on the 1st day of February, 1971.

5. Such moneys shall be repayable to the Commissioners of the State Saving Bank of Victoria, at the office of the said Commissioners, corner Elizabeth and Bourke-streets, Melbourne.

The plans and specifications and the estimate of the cost of the proposed works, and a statement showing the proposed expenditure of the moneys to be borrowed, are open for inspection at the office of the Council of the Shire of Morwell, Shire Office, Commercial-road, Morwell.

Dated 15th May, 1970.

4338 R. J. LORD, Shire Secretary.

SHIRE OF MORWELL.

LOAN No. 47.

Notice of Intention to Borrow the Sum of \$45,000 for Permanent Works and Undertakings.

NOTICE is hereby given that the Council of the Shire of Morwell proposes to borrow the principal sum of \$45,000 secured by a charge over the general rates of the municipality, such sum to be raised by the grant of a mortgage in accordance with the provisions of the *Local Government Act 1958*.

1. The maximum rate of interest that may be paid is 6.1 per centum per annum.

2. The purpose for which the loan is to be applied is:—

The purchase of plant and equipment \$45,000

3. The period of the loan shall be five years.

4. The moneys borrowed shall be repayable by providing out of the municipal fund half-yearly instalments of approximately \$5,289.00 each, including principal and interest, on the 1st day of February and the 1st day of August during the currency of the loan. The first instalment shall be repayable on the 1st day of February, 1971.

5. Such moneys shall be repayable to the National Bank Savings Bank Limited, Melbourne.

The plans and specifications and the estimate of the cost of the proposed works and the statement showing the proposed expenditure of the money to be borrowed, are open for inspection at the office of the Council of the Shire of Morwell, Shire Offices, Commercial-road, Morwell.

Dated 15th May, 1970.

4339 R. J. LORD, Shire Secretary.

SHIRE OF NATHALIA.

LOAN No. 45.

Notice of Intention to Borrow the Sum of \$4,000 for Permanent Works and Undertakings.

NOTICE is hereby given that the Council of the Shire of Nathalia proposes to borrow the principal sum of \$4,000 secured by a charge over the general rates of the municipality, such sum to be raised by the grant of a mortgage, in accordance with the provisions of the *Local Government Act 1958*.

1. The maximum rate of interest that may be paid is 7.4 per cent. per annum.
2. The purpose for which the loan is to be applied is:—

(a) Purchase of land	\$3,500
(b) Street construction	500
Total	\$4,000
3. The period of the loan shall be 15 years.
4. The moneys borrowed shall be repayable by providing out of the municipal fund half-yearly instalments of approximately \$223 each including principal and interest, on the 1st day of August and the 1st day of February during the currency of the loan. The first instalment shall be payable on the 1st day of February, 1971.
5. Such moneys shall be repayable to the Commissioners of the State Savings Bank of Victoria, at the office of the said Commissioners, corner Elizabeth and Bourke-streets, Melbourne.

The plans and specifications and the estimate of the cost of the proposed works and a statement showing the proposed expenditure of the moneys to be borrowed, are open for inspection at the office of the Council of the Shire of Nathalia, at Nathalia.

Dated 18th May, 1970.
4330 J. K. DANCOCKS, Shire Secretary.

SHIRE OF WYCHEPROOF.

NAMING OF STREETS.

NOTICE is hereby given that pursuant to the provisions of the *Local Government Act 1958*, Council has resolved that the following streets be renamed:—

1. *Name*.—Greer-street.
Location.—That section of Old Calder Highway between Hannon-street and Calder Highway.
2. *Name*.—McManus-street.
Location.—Unnamed street between Railway-avenue and Horace-street.
3. *Name*.—Frazier-lane.
Location.—Lane between Horace-street and Mudge-street.

G. R. DRYDEN, Shire Secretary.
Shire Offices, Wycheproof, 14th May, 1970. 4336

NOTICE OF INTENTION TO APPLY FOR A LICENCE TO DIVERT WATER AND CUT RACE (RE-ISSUE) FROM THE RIVER MURRAY, AT WHARPARILLA.

I HEREBY give notice that I intend to apply for a licence empowering me to divert water for a term of fifteen years to the extent of 400 acre-feet per annum at a maximum rate of 10 acre-feet per day of 24 hours for 200 acres of pasture, being part of allotments 110, 111, 112, 112A, section A of Echuca West and allotments 113 and 114 and Crown pre-emptive, Parish of Wharparilla, and to occupy certain Crown lands for works of diversion, and to cut a race thereon.

Any objection to such application must be forwarded in writing to reach the State Rivers and Water Supply Commission, Melbourne, before 19th June, 1970, being 30 days from the first publication of this notice.

FRANCIS JOHN MILLAR.
P.O. Box 178, Echuca. 4393

NOTICE OF INTENTION TO APPLY FOR A LICENCE TO DIVERT WATER AND CUT RACE FROM THE RIVER MURRAY, AT ECHUCA.

WE hereby give notice that we intend to apply for a licence empowering us to divert water for a term of four years to the extent of two acre feet per annum plus domestic at a maximum rate of two acre-feet per day of 24 hours plus domestic, for the irrigation of 19 acres, being part of allotments 126 and 129, Parish of Wharparilla, and to occupy certain Crown lands for works of diversion, and to cut a race thereon.

Any objection to such application must be forwarded, in writing, to reach the State Rivers and Water Supply Commission, Melbourne, before 19th June, 1970, being 30 days from the first publication of this notice.

ERIC GEORGE HOCKING.
ADELAIDE HOCKING. 4322
Wharparilla.

NOTICE OF INTENTION TO APPLY FOR A LICENCE TO DIVERT WATER AND CUT RACE (RE-ISSUE) FROM THE MOORABOOL RIVER, AT BATESFORD.

I HEREBY give notice that I intend to apply for a licence empowering me to divert water for a term of fifteen years to the extent of 20 acre-feet per annum at a maximum rate of ½ acre-foot per day of 24 hours for the irrigation of 10 acres, being part of allotments 59 and 60, section 25, Parish of Gheringhap, and to occupy certain Crown lands for works of diversion, and to cut a race thereon.

Any objection to such application must be forwarded, in writing, to reach the State Rivers and Water Supply Commission, Melbourne, before 19th June, 1970, being 30 days from the first publication of this notice.

GARRY GEORGE HILL, by his solicitors and agents: Whyte, Just & Moore, 27 Malop-street, Geelong. 4316

Water Act.

SHIRE OF SHEPPARTON WATERWORKS TRUST.

EXTENSION OF WATERWORKS DISTRICT AND CONSTRUCTION OF WORKS FOR THE SUPPLY OF WATER TO DOOKIE.

NOTICE is hereby given that the Shire of Shepparton Waterworks Trust has made application to the Minister of Water Supply for the extension of its Waterworks District and the construction, maintenance, and continuance of Water Supply Works within that extended District to supply the town of Dookie under the provisions of the Water Act.

A general plan and description of the proposed works have been submitted with the application, and copies of same may be seen at the Shepparton Shire Office at Nixon-street, Shepparton, during office hours.

Dated at Shepparton, the 1st day of May, 1970.
4012 J. W. REED, Secretary.

DANDENONG VALLEY AUTHORITY.

DECLARATION OF ARTERIAL DRAINS.

THE Dandenong Valley Authority, in pursuance and exercise of the powers conferred by the *Dandenong Valley Authority Act 1963*, doth hereby declare that the rivers, creeks, watercourses and drains, and new arterial drains proposed within the district of the Authority as set out and described in the Schedule hereto shall be arterial drains under and for the purposes of the Act.

SCHEDULE.

1. Nunawading Outfall Drain No. 5211—commencing at the outlet of the East Burwood Drain No. 5214 in the City of Waverley, generally south-easterly to its junction with Dandenong Creek No. 5200.
2. Larpent-street Drain No. 5212—commencing at a point at the rear of properties abutting the eastern boundary of Westlands-road in the City of Waverley approximately 400 feet south of the extension of Campbell-street, generally easterly to its junction with the Nunawading Outfall Drain No. 5211.
3. Un-named Drain No. 5050A—commencing at the south-easterly corner of Crown allotment 36, section A, Parish of Mordialloc, easterly along Governor-road to its junction with Dunlops Drain No. 5050.
4. Un-named Drain No. 5050B—commencing at the south-easterly corner of Crown allotment 27, section A, Parish of Mordialloc, easterly to its junction with Dunlops Drain No. 5050.
5. Un-named Drain No. 5050C—commencing at a point on the eastern boundary of Crown allotment 21, section A, Parish of Mordialloc, approximately 530 feet north of Malcolm-road then southerly to easterly along Malcolm-road to its junction with Dunlops Drain No. 5050.
6. Un-named Drain No. 5050D—commencing at the south-easterly corner of lot 1 on lodged plan 71617, Parish of Mordialloc in the City of Springvale, easterly along Mills-road to its junction with Dunlops Drain No. 5050.
7. Un-named Drain No. 5050E—commencing at the south-western corner of Crown allotment 1, section A, Parish of Mordialloc, generally westerly to its junction with Dunlops Drain No. 5050.
8. Un-named Drain No. 5050F—commencing at the south-westerly corner of lot 10, plan of subdivision 12959, Parish of Mordialloc in the City of Springvale, westerly to its junction with Dunlops Drain No. 5050.

9. Gartsides Drain No. 5051—commencing at its junction with the north boundary of the Centre Dandenong-road reserve in the City of Springvale, approximately 1,600 feet west of Marcus-road, generally south-westerly and southerly to its junction with Dunlops Drain No. 5050.

10. Un-named Drain No. 5051A—commencing at the south boundary line of Centre Dandenong-road approximately 500 feet south-east of Tootals-road, generally southerly to its junction with Gartsides Drain No. 5051.

11. Howard-road Drain No. 5051B—commencing at a point in Howard-road in the City of Springvale, approximately 900 feet south of Centre Dandenong-road, southerly to its junction with Gartsides Drain No. 5051.

12. Goodwins Drain No. 5311—commencing near the junction of Albert-avenue with Mountain Highway in the City of Knox, generally north-westerly and northerly to its junction with Dandenong Creek No. 5300.

13. Wantirna North Drain No. 5301—commencing at the southern boundary of the Boronia-road reserve in the City of Knox, approximately 2,350 feet west of Stud-road generally northerly to its junction with Dandenong Creek No. 5300.

4311

K. G. ABBERTON, Secretary.

BEECHWORTH SEWERAGE AUTHORITY.

GENERAL NOTICE.

THE above-mentioned Sewerage Authority having made provision for carrying off sewage from each and every property which or any part of which is within the sewerage area hereinafter described, doth hereby declare that on and after the 1st day of May, 1970, each and every property which is within the said sewerage area shall be deemed to be a sewered property within the meaning of the *Sewerage Districts Act 1958*.

The said sewerage area shall be known as "Sewerage Area No. 1".

Sewerage Area No. 1.

Commencing at the northern most angle of C.A.9, section A.7, Township and Parish of Beechworth, County of Bogong; thence in a south-easterly direction along the north-eastern boundary of C.A.9 to the most easterly angle thereof; thence in a south-westerly and south-easterly direction along the north-western and south-western boundaries of C.A.8 to the most southerly angle thereof; thence north-easterly along the north-western boundary of C.A.7 to a point on the boundary, distant 5 chains from the most westerly angle of C.A.7; thence south-easterly by a line across C.A.7 for a distance of 3 chains at a bearing of 139 deg. 25 min.; thence south-westerly by a line bearing 229 deg. 25 min. to a point on the south-western boundary of C.A.7; thence south-easterly along the south-western boundaries of C.A.'s 7, 6, 5 and 4 to a point on the south-western boundary of C.A.4, distant 2 chains from the most southerly angle thereof; thence north-easterly by a line parallel to and at an offset of 2 chains from the south-eastern boundary of C.A.4, through C.A.4, continuing through C.A.3, section A and across Balaclava-road to the north-eastern boundary thereof; thence south-easterly along the north-eastern boundary of Balaclava-road to a point on the projection of the north-western boundary of C.A.1, section A; thence south-westerly across Balaclava-road, along the north-western boundary to the most westerly angle of C.A.1; thence south-easterly along the north-east boundary of lot 26, section C.A.1, section A.7 to the most easterly angle thereof; thence south-westerly along the south-eastern boundary of lot 26 to the most southerly angle thereof; thence generally south-westerly along the north-western boundary of Le Couther-avenue continuing by a line across Junction-road to its south-western boundary; thence south-easterly along said boundary of Junction-road to the north-western boundary of High-street; thence south-westerly along said boundary of High-street to the most eastern angle of Public Park and Recreation Reserve; thence north-westerly along the north-eastern boundary of said Public Park to the most northern angle thereof; thence north-westerly by a line across Sydney-road to the most eastern angle of C.A.11, section 27; thence south-westerly along the north-western boundary of Sydney-road across Kars-street to the most eastern angle of C.A.11, section 21; thence south-easterly by a line across Loch-street to the most northern angle of C.A.1, section 22; thence southerly along the western boundary of Sydney-road to the most southern angle of C.A.10; thence south-westerly by a line across William-street to the most eastern corner of C.A.11, section 9; thence south-westerly along the north-western boundary of Ford-street across Camp-street and Church-street to the most eastern angle of C.A.1, section 7; thence north-westerly along the south-western boundary of Church-street across Finch-street, Last-street and Wood-street and continuing along

the extension of the south-western boundary of Church-street to a point on the south-western projection of the north-western boundary of C.A.3, section 29; thence north-easterly by a line across Church-street, along the north-western boundaries of C.A.'s 3, 5, 6, and 7, across a lane, along the north-western boundaries of C.A.'s 8, 9, 10 and 12, section 29, across Camp-street, along the north-western boundaries of C.A.'s 3, 5, 6 and 7, section 30, across a lane, along the north-western boundaries of C.A.'s 8, 9, 10 and 12, continuing across William-street to a point on the north-eastern boundary thereof; thence south-easterly along the said boundary of William-street to its intersection with the north-western boundary of Wood-street; thence north-easterly along the north-western boundary of Wood-street across Kars-street, continuing along the north-western boundary of Wood-street to the southern angle of C.A.8, section 32; thence north-westerly and north-easterly along the south-western and north-western boundaries of C.A.8 to the northern angle thereof; thence north-westerly along the south-western boundary of Frederick-street and by a line in continuation thereof to a point on the western boundary of Barnard-street; thence northerly along said boundary of Barnard-street to a point on the south-eastern boundary of C.A.5, section I, distant 224 links from the most easterly angle thereof; thence north-westerly by a line bearing 319 deg. 25 min. for a distance of 227 links across C.A.5; thence north-easterly by a line across C.A.5 to a point on the north-eastern boundary distant 125 links from the most easterly angle thereof; thence north-westerly along the north-eastern boundary of C.A.5 to the most northerly angle thereof; thence easterly by a line across Sydney-road to the most southerly angle of C.A.1, section K; thence north-eastwards along the south-eastern boundary of C.A.1 for a distance of 250 links; thence south-easterly by a line parallel to and at an offset of 250 links from the north-eastern boundary of Sydney-road, across a road and across C.A.10, section A.7 to a point on the north-western boundary of C.A.9; thence north-easterly along the north-western boundary of C.A.9 to the point of commencement.

By order of the said Sewerage Authority.

D. A. MCKENZIE MCHARG, Chairman.
G. T. GRAY, Secretary.

Shire Hall, Beechworth.

4318

NOTICE is hereby given that Chorki Ski Club has applied for a lease under section 134 of the *Land Act 1958*, for a term of 21 years in respect of an area of 1 rood 10 perches, more or less, being allotment 4, section A, Parish of Hotham, as a site for a ski lodge.—(H.O.33691.)

T. C. TATTON, Secretary,
Chorki Ski Club.

4130

NOTICE is hereby given that as from the 31st day of March, 1970, the partnership heretofore subsisting between Mervyn George Lukies, Bertha May Lukies and William George Lukies, all of 2 Greendale-road, East Bentleigh, carrying on business of butchers, under the name of M. G. Lukies, butcher, at 397 Glenhunting-road, Elsternwick, has been dissolved by mutual consent.

All debts due to and owing by the said late firm will be received and paid by the said Mervyn George Lukies and the said Bertha May Lukies, who will carry on business under the same name at the same place.

Dated this 15th day of May, 1970.

MERVYN GEORGE LUKIES.
BERTHA MAY LUKIES.
WILLIAM GEORGE LUKIES.McCay & Thwaites, solicitors, of 374 Little Collins-street,
Melbourne, 3000. 4390

The Companies Act 1961.—In the matter of C. A. R. PLASTICS PTY. LTD., Reg. Office, 580 High-street, Thornbury; factory, Elizabeth-street, Richmond (rear Golden Fleece Service Station).—Notice re Meeting of Creditors, Pursuant to Section 260.

NOTICE is hereby given that a meeting of creditors of the above-named company will be held at Suite 18, 545 St. Kilda-road, Melbourne, on Thursday, the 28th day of May, 1970, at 11 a.m., the company having convened a meeting of its members for the same day and prior to this meeting for the purpose of considering a Resolution that the company be wound up voluntarily.

Dated this 18th day of May, 1970.

A. BOWDEN, Director.

Bent & Cogle, public accountants, Suite 18, 545
St. Kilda-road, Melbourne, 3004. 4375

The Companies Act 1961.

L. C. L. HOLDINGS PTY. LTD.

AT an Extraordinary General Meeting of Members of the above-named company, duly convened and held at 238 Elizabeth-street, Melbourne, on the 15th May, 1970, the following Special Resolution was duly passed.

"That the company be wound up voluntarily and that Alvin Allen Armitage, of 1B Regent-street, Brighton, be appointed liquidator for the purposes of winding up."

Dated this 18th day of May, 1970.

4376 C. G. LEHMANN, Director.

Companies Act 1961.—In the matter of D. F. BRAUN & CO. PROPRIETARY LIMITED.—Notice re Meeting of Creditors, Pursuant to Section 260.

NOTICE is hereby given that a meeting of creditors of the above-named company will be held at Princes Gate, East Tower, 3rd Floor, Room 320, 151 Flinders-street, Melbourne, on Thursday, 28th May, 1970, at 3 p.m., the company having convened an extraordinary meeting of its members for the same day for the purpose of considering a Special Resolution that the company be wound up voluntarily.

Dated this 19th day of May, 1970.

D. F. BRAUN, Director.

Lewis Luckins & Co., chartered accountants, 289 Flinders-lane, Melbourne, 3000. Telephone 63 8827. 4377

In the matter of B.S.T. PTY. LIMITED.

NOTICE is hereby given that at an Extraordinary General Meeting of the above-named company duly convened and held at 344 St. Kilda-street, Brighton, at 5 o'clock in the afternoon on the 11th day of May, 1970, the following Special Resolution was duly passed viz.:

"That the company be wound up voluntarily, and that Paul Lister Swan, of 339A Toorak-road, South Yarra, be appointed liquidator for the purposes of such winding up and that the remuneration of the said liquidator be fixed by a general meeting of shareholders."

Dated the 11th day of May, 1970.

4378 MARTIN BLAKEY, Chairman.

The Companies Act 1961.

FRISMAG ELECTRICAL ENGINEERS PTY. LTD. (IN LIQUIDATION).

LIGHTS PTY. LTD. (IN LIQUIDATION) formerly trading as "Rite-Lite".

NOTICE CONVENING FINAL MEETING OF MEMBERS AND CREDITORS, PURSUANT TO SECTION 272.

NOTICE is hereby given, in pursuance of section 272 of the Companies Act 1961, that a meeting of the members and creditors of the above-named company will be held on the 16th day of June, 1970, at the office of A. Neville Bird & Co., chartered accountants, 289 Flinders-lane, Melbourne, at 2.30 p.m., for the purpose of having an account laid before them showing the manner in which the winding up has been conducted and the property of the company disposed of, and of hearing any explanations that may be given by the liquidator.

Dated this 15th day of May, 1970.

A. NEVILLE BIRD, Liquidator.

A. Neville Bird & Co., chartered accountants, 289 Flinders-lane, Melbourne, 3000. Telephone No. 63 2874. 4367

KYNETON AND DISTRICT CO-OPERATIVE HOUSING SOCIETY LIMITED (IN LIQUIDATION).

NOTICE OF FINAL MEETING IN VOLUNTARY WINDING-UP.

TAKE notice that the affairs of the above-named Society are now fully wound up and that in pursuance of section 272 (1) of the Companies Act 1961 and of the Co-operative Housing Societies Act 1958, a General Meeting of the Society will be held at 4 Bowen-street, Kyneton, on the 30th day of June, at 8 p.m., for the purposes of—

(1) laying before it an account showing how the winding up has been conducted and the property of the Society disposed of and giving any explanations thereof; and

(2) passing a Resolution that the books and papers of the said Society and of the liquidator relevant to the affairs of the Society be destroyed after a period of twelve months from the date of the meeting.

Dated the 18th day of May, 1970.

4369 P. STEWART, Liquidator.

No. of company: 55074.

Companies Act 1961.

CALDER PARK INVESTMENTS PTY. LTD. (IN VOLUNTARY LIQUIDATION).

NOTICE is hereby given that the Final Meeting of the members of the above-named company will be held at the office of Trans City Ltd., corner Swanston and Collins streets, on Thursday, 18th June, 1970, at 12.30 in the afternoon, to consider the manner in which the winding up has been effected.

O. G. UNKENSTEIN, Liquidator.

O. G. Unkenstein & Son, chartered accountants, 422 Collins-street, Melbourne. 4350

Companies Act 1961, Section 260.

NOTTINGHILL JOINERY AND TIMBER CO. PTY. LTD.

NOTICE OF MEETING OF CREDITORS.

NOTICE is hereby given that a meeting of creditors of the above-named company will be held at the meeting room of the Institute of Chartered Accountants in Australia, 23 McKillop-street, Melbourne, on 11th June, 1970, at 2 p.m., the company having convened a meeting of its members for the previous day for the purpose of considering a Resolution that the company be wound up voluntarily.

AGENDA.

To consider and if thought fit, resolve:

1. The company be wound up voluntarily and that Mr. Peter William Harvey, chartered accountant, of 7th Floor, 440 Collins-street, Melbourne, be appointed liquidator.

2. The liquidator be paid remuneration in accordance with the scale of fees from time to time paid by the Institute of Chartered Accountants in Australia.

Dated this 14th day of May, 1970.

W. WOODWARD, Director.

A. L. Royce and Warne-Smith, chartered accountants, 440 Collins-street, Melbourne, 3000. 4391

The Companies Act 1961.—In the matter of F. WOOLLEY & SON PTY. LTD. (in Voluntary Liquidation).

NOTICE is hereby given that at an Extraordinary General Meeting of Shareholders of the above-named company held on the 18th day of May, 1970, it was resolved that the company be wound up voluntarily and that Douglas Orson Oldfield, chartered accountant, of 395 Collins-street, Melbourne, be and is hereby appointed liquidator for the purpose of such winding up.

Dated this 18th day of May, 1970.

D. O. OLDFIELD, Liquidator, 395 Collins-street, Melbourne, 3000. 4392

The Companies Act 1961.—In the matter of BLAIR HAULAGE PTY. LTD. (in Liquidation).

A FIRST and final dividend is intended to be declared in the above-mentioned matter. Creditors who have not proved their debts by the 11th day of June, 1970, will be excluded from the dividend.

Dated this 21st day of May, 1970.

A. M. HORSBURGH, Liquidator.

Kennedy, Smail & Middlemiss, 296 Little Lonsdale-street, Melbourne, 3000. 4389

The Companies Act 1961.—In the matter of PRINCIPAL HANDCRAFT INDUSTRIES PTY. LTD., of 230 Princes-street, Port Melbourne.

NOTICE is hereby given that at an Extraordinary Meeting of the members of the above-named company held on the 6th day of May, 1970, it was resolved that the company be wound up voluntarily and at a meeting of creditors held on the 6th day of May, 1970, pursuant to section 260, it was resolved that for such purpose, Everett Thomson Bent, of Suite 18, 545 St. Kilda-road, Melbourne, accountant, be appointed liquidator.

Notice is also given that after 21 days from this date I shall proceed to distribute the assets. All creditors having any claims against the company should furnish particulars of same by that date, otherwise I shall proceed to distribute the assets without regard to their claim.

Dated this 6th day of May, 1970.

E. T. BENT, Liquidator.

Bent & Cogle, public accountants, Suite 18, 545 St. Kilda-road, Melbourne, 3004. 4295

Unclaimed Moneys Act 1962.

REGISTER of Unclaimed Moneys held by the—

Name of Owner on Books and Last Known Address.	Total Amount Due to Owner.	Description of Unclaimed Money.	Date when Amount first became Payable.
S			
E.Z. INDUSTRIES LIMITED.			
Adams, Rose M. R., 18 Phoenix-street, Lane Cove, N.S.W.	16.00	Dividend on 200 Shares	22.11.68
Albright, Valerie B., 89 The Boulevard, Lakemba, N.S.W.	78.00	Dividend on 1,200 Shares	19.4.68
Alexander, Albert E., 178 Raglan-street, Mosman, N.S.W.	16.00	Dividend on 200 Shares	22.11.68
Alford, Robert G., 34 Wolseley-road, Mosman, N.S.W.	13.00	Dividend on 200 Shares	19.4.68
Anderson, Hugh C., 140 Wycombe-road, Neutral Bay, N.S.W.	26.00	Dividend on 400 Shares	..
Anderson, William T. (estate of), c/o Permanent Trustee Co. of N.S.W., 23 O'Connell-street, Sydney, N.S.W.	110.40	Dividend on 1,380 Shares	22.11.68
Anspach, Herman, 71 Ivor Court, Gloucester-place, London, N.W.1, U.K.	34.00	Dividend on 500 Shares	..
Archer, Kathleen M., P.O. Box 120, Applecross, W.A. 6153	12.00	Dividend on 150 Shares	..
Armstrong, Elsie M., c/o J. W. Armstrong & Sons, G.P.O. Box N.1012, Perth, W.A. 6001	120.12	Dividend on 1,848 Shares	19.4.68
Atkins, Keith D. (estate of), c/o G. W. O. Atkins, 30 Mona-street, Hobart, Tas. 7000	39.00	Dividend on 600 Shares	..
Baker, Arthur A., c/o Hogg, Gillespie, Carter, and Oakley, P.O. Box 241, Wellington, N.Z.	40.80	Dividend on 600 shares	22.11.68
Ballardie, Jane M., Linfield, Linton-lane, Wetherby, U.K.	20.40	Dividend on 300 shares	..
Barlow, Alice M. R., 149 Elizabeth-street, Sydney, N.S.W.	65.00	Dividend on 1,000 shares	19.4.68
Bastow, John A., 12 Berkeley-avenue, Heidelberg	16.00	Dividend on 200 shares	22.11.68
Batchelor, Edward R., 107 Queens-parade East, Newport, N.S.W. 2106	24.00	Dividend on 300 shares	..
Bayly, John P. (estate of), c/o Sly & Russell, G.P.O. Box 3872, Sydney, N.S.W.	260.00	Dividend on 4,000 shares	19.4.68
Beauchamp, Agatha M. (estate of), c/o McGuren & Co., 82 Elizabeth- street, Sydney, N.S.W.	56.00	Dividend on 700 shares	22.11.68
Beard, Joan A., c/o Eric Rowley Rogers & Co., 109 Elizabeth-street, Sydney, N.S.W.	156.00	Dividend on 2,400 shares	19.4.68
Bennett, Nancy (estate of), c/o N.Z. Insurance Co. Ltd., P.O. Box 481, Rotorua, N.Z.	48.00	Dividend on 600 shares	22.11.68
Berry, Olive J. (estate of), c/o Darbys Lire Gillett & Huelin, 42 St. George's-terrace, Perth, W.A.	260.00	Dividend on 4,000 shares	19.4.68
Biggs Investments Pty. Ltd., c/o Cumberland Tile & Brick Pty. Ltd., Blacktown-road, Blacktown, N.S.W. 2148	40.00	Dividend on 500 shares	22.11.68
Bilger, Edward, Gilmore-road, Woodbridge, Brisbane, Qld. 4114	16.00	Dividend on 200 shares	..
Bladen, Edith E., 6 Cliff-street, Torquay, 3228	88.00	Dividend on 1,100 shares	..
Blenkison, Joan M. I., 356 Bradford-road, Stanningley, Pursey, York- shire, U.K.	34.00	Dividend on 500 shares	..
Bligh, Keith H. R., c/o Corrie & Co., The Walk, Surfers Paradise, Qld. 4217	10.00	Dividend on 200 shares	19.4.68
Blomfield, Helen T. (estate of), c/o Maxwell & Boyd, 141 Elizabeth- street, Sydney, N.S.W.	360.36	Dividend on 5,544 shares	..
Boundy, Amelia J., 1 Wentworth-street, Point Piper, N.S.W., 2027	15.00	Dividend on 300 shares	..
Brade, Desmond V., c/o McCoy Grove & Atkinson, 82 Elizabeth- street, Sydney, N.S.W.	117.00	Dividend on 1,800 shares	..
also: 97 Fern-street, Randwick, N.S.W.			
Broadhurst, Catherine, c/o Cornwall Stodart & Co., 222 Queen-street, Melbourne, 3000	26.00	Dividend on 400 shares	..
Browning, Robert H., c/o McIntosh McPhillamy & Co., P.O. Box 33, Bathurst, N.S.W.	179.40	Dividend on 2,760 shares	..
Bucknell, Hazell, Shantalla, Marine-parade, Narooma, N.S.W.	65.00	Dividend on 1,000 shares	..
Bull, Florence M., c/o Box 421, Sydney, N.S.W.	25.00	Dividend on 600 shares	..
Cale, Mabel (estate of), c/o Jennings Jennings & Barnett, 129 Pitt-street, Sydney, N.S.W.	179.40	Dividend on 2,760 shares	..
Campbell Cullen Pty. Ltd., c/o W. B. Lynam, 21 Stuart-crescent, Blakelhurst, N.S.W.	13.00	Dividend on 200 shares	..
Campbell, George (estate of), c/o A. & J. C. Allan & Co., Newmarket- street, Falkirk, Scotland	21.84	Dividend on 336 shares	..
Campbell, William C. (estate of), c/o G. K. Campbell, P.O. Box 258, Wanganui, N.Z.	179.40	Dividend on 2,760 shares	..
Cane, Alan A., 74 Pitt-street, Sydney, N.S.W.	20.00	Dividend on 400 shares	..
Carr, Ruby F. P., c/o E. M. Carr, 5 Bessell-avenue, Wollongong, N.S.W. 2500	48.00	Dividend on 600 shares	22.11.68
Chambers, Clara M. (address unknown)	130.00	Dividend on 2,000 shares	19.4.68
Cherney, Hans M., 126 Franklin-street, Melbourne	16.00	Dividend on 200 shares	22.11.68
Cherrey, June A., 254 The Boulevard, East Ivanhoe	30.00	Dividend on 600 shares	19.4.68
Cherrey, Thomas W., 254 The Boulevard, East Ivanhoe	10.00	Dividend on 200 shares	..
Clark, Cecil O. (estate of), c/o J. P. Sullivan, 14 Main-street, Black- town, N.S.W. 2148	16.00	Dividend on 200 shares	22.11.68
Clark-Hutchinson, George I., 16 Webster Coates-gardens, Edinburgh 12, Scotland	17.00	Dividend on 400 shares	19.4.68
Clifton, Bruce S., Unit 51, 650 Pacific Highway, Killara, N.S.W.	82.56	Dividend on 1,032 shares	22.11.68
Cohen, Beryl, c/o A. L. Cohen, 180 Kurraba-road, Neutral Bay, N.S.W. 2089	65.00	Dividend on 1,000 shares	19.4.68
Cohen, Morton B. (estate of), c/o Geoffrey Lee Gillis & Co., 70 Castlereagh-street, Sydney, N.S.W.	65.00	Dividend on 1,000 shares	..
Cook, Heather B., 69 Murrarar-road, Towradgi, N.S.W.	26.00	Dividend on 400 shares	..
Corbett, Flora C., 40 North Rocks-road, North Rocks, N.S.W.	52.00	Dividend on 800 shares	..
Cowling, Alfred (estate of), c/o Sladden & Stuart, Box 734, Wellington, N.Z.	42.12	Dividend on 648 shares	..
Cox, Florence M., c/o Lane Buck & Co., 56 William-street, Perth, W.A.	26.00	Dividend on 400 shares	..
Craig, William J., 94 Strathalbyn-street, Kew	39.00	Dividend on 600 shares	..
Creal, Patricia J., 36 Brentwood-avenue, Turrumurra, N.S.W.	68.64	Dividend on 1,056 shares	..
Cudbey, Donald H., c/o Commercial Hotel, Bell-street, Wanganui, N.Z.	11.05	Dividend on 200 shares	..
Darcey, Jill, 13 Rothesay-avenue, East Malvern	39.00	Dividend on 600 shares	..

Unclaimed Moneys Act 1962.

REGISTER of Unclaimed Moneys held by the—

Name of Owner on Books and Last Known Address.	Total Amount Due to Owner.	Description of Unclaimed Moneys.	Date when Amount first became Payable.
E.Z. INDUSTRIES LIMITED—continued.			
Darcy, Eileen, c/o O'Keefe Jaques & Sleeman, P.O. Box 342, Geelong, 3220	48.00	Dividend on 1,200 shares	22.11.68
Dawson, Roma M. (address unknown)	89.70	Dividend on 1,380 shares	19.4.68
Elias, Jacob H. D., c/o Chartered Bank Ltd., 2 Regent-street, London, S.W.1, U.K.	17.00	Dividend on 400 shares	"
E.M.G. Pty. Limited, 47 McIntyre-street, Goondiwindi, Qld., 4390	27.84	Dividend on 348 shares	22.11.68
Evans, Myrtle, 12 Fairview-street, Hawthorn, 3122	10.00	Dividend on 200 shares	19.4.68
Field, Charles R. S., Cressy, Tas.	11.60	Dividend on 232 shares	"
Fogarty, Marilyn G. (address unknown)	26.00	Dividend on 400 shares	"
Freeman, William A. A. (estate of), c/o Maxwell & Boyd, 155 Castlereagh-street, Sydney, N.S.W.	160.00	Dividend on 2,000 shares	22.11.68
Fryer, Frederic R., 76 Little-street, Forster, N.S.W., 2428	88.72	Dividend on 1,109 shares	"
Fysh, Ellen M. (estate of), c/o Tasmanian Permanent E. & T. Assn. Ltd., P.O. Box 286c, Launceston, Tas.	13.00	Dividend on 200 shares	19.4.68
Fysh, Philip O. (estate of), c/o Tasmanian Permanent E. & T. Assn. Ltd., P.O. Box 286c, Launceston, Tas.	52.00	Dividend on 800 shares	"
Garbutt, Isabella, 36 Tedder-street, Musselburgh, Dunedin, N.Z.	917.59	Dividend on 16,608 shares	"
Garland, Nancy J., 6 Edward-street, Gordon, N.S.W., 2072	10.00	Dividend on 200 shares	"
Gedclin Pty. Ltd., c/o Cooper Bros. & Co., Pacific House, Queens-road, Central Hong Kong	56.00	Dividend on 1,000 shares	22.11.68
Gibbons, Elsie M. (estate of), c/o Pappriell Frampton & Hadfield, 84 Hereford-street, Christchurch 1, N.Z.	135.72	Dividend on 2,088 shares	19.4.68
Gibbons, Yvonne S., 13A Box Hill, Khand Allah, Wellington, N.Z.	16.32	Dividend on 240 shares	22.11.68
Gibson, Joyce M., 24 Melbourne-avenue, Forrest, Canberra, A.C.T.	16.00	Dividend on 200 shares	"
Gibson, Macey J., 27 Gallipoli-street, Long Jetty, N.S.W., 2262	32.00	Dividend on 400 shares	"
Goran, Leila M. (estate of), c/o Wall Abbott & White, 187 Macquarie-street, Sydney, N.S.W.	26.00	Dividend on 400 shares	19.4.68
Gorman, Eric F., 105A Hackthorne-road, Cashmere, Christchurch, N.Z.	61.20	Dividend on 900 shares	22.11.68
Goulstone, Henry W., 13 Bradenham-place, Penorth, Glamorgan, South Wales	397.80	Dividend on 7,200 shares	19.4.68
Graham, George K., 8 Mooltan-avenue, East St. Kilda, 3182	24.00	Dividend on 300 shares	22.11.68
Graham, Richard (estate of), c/o Perpetual Trustee Co. Ltd., 33 Hunter-street, Sydney, N.S.W.	40.00	Dividend on 500 shares	"
Harman, Herbert D. (estate of), c/o L. G. Christie & Co., 117 Pitt-street, N.S.W.	168.00	Dividend on 2,100 shares	"
Harrison, Simon, Flat 2, 8 Templewood-avenue, London N.W.3, U.K.	34.00	Dividend on 500 shares	"
Hibberd, Joan L., 17 Sorret-avenue, Malvern, 3144	26.00	Dividend on 400 shares	19.4.68
Hickey, Helen M., Berrigan, N.S.W.	45.24	Dividend on 696 shares	"
Hill, Malcolm, 15 Were-street, Brighton Beach	13.00	Dividend on 200 shares	"
Hiscox, Patricia J., 8 Centenary-avenue, Hunters Hill, N.S.W.	13.00	Dividend on 200 shares	"
Hughes, Elsie M. K. (estate of), c/o M. W. Bednall & Co., 44 Grenfell-street, Adelaide, S.A.	96.00	Dividend on 1,200 shares	22.11.68
Hughes, Gillian M., c/o 64 Bancroft-avenue, Roseville, N.S.W.	13.00	Dividend on 200 shares	19.4.68
Hulme, William E., 47A Roxton-road, Claremont, W.A.	48.00	Dividend on 600 shares	22.11.68
Hunter, William J. (estate of), Mrs. B. H. Hunter, c/o Hornblow Cooper, Shires & Carran, G.P.O. Box 20, Wellington C.1, N.Z.	78.00	Dividend on 1,200 shares	19.4.68
Huppert, Gustav (estate of), c/o 22 Flinders-lane, Melbourne	120.00	Dividend on 1,500 shares	22.11.68
Hutton, Blanche H., 47 New-street, Brighton Beach	32.00	Dividend on 400 shares	"
Ingleton, Isabella A. (estate of), c/o Mr. J. I. Ingleton, c/o M. H. C. Westall, P.O. Box 254, Crows Nest, N.S.W. 2065	156.00	Dividend on 2,400 shares	19.4.68
Jackson, Joseph K., Draigside-siding, Llandudno, Caernarvonshire, U.K.	13.60	Dividend on 200 shares	22.11.68
Jenkins, Helen E., 1 June-crescent, Glen Iris, 3146	18.30	Dividend on 366 shares	19.4.68
Johnson, Patricia A., 18 Glenbrook-avenue, East Malvern	10.00	Dividend on 200 shares	19.4.68
Jones, Annie, c/o Barbour & Arnold, 405 Bourke-street, Melbourne	13.00	Dividend on 200 shares	22.11.68
Kaleski, John H. F. (estate of), c/o Perpetual Trustee Co. Ltd., 33 Hunter-street, Sydney, N.S.W.	24.00	Dividend on 300 shares	"
Kedge, Judith E., Flat 49, 116 Blamey-crescent, Campbell, A.C.T. 2601	15.00	Dividend on 300 shares	19.4.68
Kidd, Jean E., 1259 Malvern-road, Malvern, 3144	26.00	Dividend on 400 shares	22.11.68
Killen, Adelaide A., 45 Bower-street, Manly, N.S.W.	15.00	Dividend on 300 shares	19.4.68
Knuckey, Marie E. (address unknown)	26.00	Dividend on 400 shares	22.11.68
Kohane, Beryl M., 23 Waldemar-road, Heidelberg, 3084	24.00	Dividend on 300 shares	"
Kubale, Ralph, 137 Springfield-road, Blackburn	30.00	Dividend on 600 shares	19.4.68
Lamb, James I., 16 Woodhall-avenue, Whitefield, Manchester, U.K.	10.20	Dividend on 150 shares	22.11.68
Laughlin, William H., 6 Hunter-street, Deniliquin, N.S.W.	10.00	Dividend on 200 shares	19.4.68
Leahy, John, c/o Mr. B. P. Woodward, 9 Hunter-street, Sydney, N.S.W.	26.00	Dividend on 400 shares	22.11.68
Lewington, Kenneth B., 57 Killeaton-street, St. Ives, N.S.W.	24.00	Dividend on 300 shares	"
Lightfoot, Eleanor F., 1 Lucas-street, Brighton	60.00	Dividend on 1,200 shares	19.4.68
Lincoln, Ernest R., Unonville, Tas.	24.00	Dividend on 300 shares	22.11.68
Linwood, John M., 2 Muller-road, Heathmont, 3133	20.00	Dividend on 250 shares	"
Lockhart, Annie E., 6 Beatrice-street, Burwood	13.00	Dividend on 200 shares	"
McDougall, Agnes B. (estate of), c/o A. C. Ellison & Co., 2 O'Connell-street, Sydney, N.S.W.	24.00	Dividend on 300 shares	"
MacWhirter, Arthur, R., 35 Glen-road, Glen Waverley	26.00	Dividend on 400 shares	"
Maddox, Frederick J. (estate of), c/o Button Williams & Co., 66 Best-street, Devonport, Tas. 7310	20.32	Dividend on 254 shares	"
Magarey, Clarice E., 135A Stephen-terrace, Walkerville, S.A. 5081	48.00	Dividend on 600 shares	"
Marquet, Anthony L., P.O. Box 3487, Auckland, N.Z.	76.84	Dividend on 1,130 shares	"
Marston, Samuel A. R. (estate of), c/o Churchward Horton & Hill, P.O. Box 18, Blenheim, N.Z.	156.00	Dividend on 2,400 shares	"
Millar, Annie R., 5 Johnston-street, Narrabundah, A.C.T.	16.00	Dividend on 200 shares	"
Miller, Frederick W., 7 Highbridge-road, Killara, N.S.W.	13.00	Dividend on 200 shares	"
Miller, John (estate of), Mr. L. D. Cotterill, c/o Tripp Rolleston & Co., P.O. Box 27, Timaru, N.Z.	181.54	Dividend on 2,964 shares	"

Unclaimed Moneys Act 1962.

REGISTER of Unclaimed Moneys held by the—

Name of Owner on Books and Last Known Address.	Total Amount Due to Owner.	Description of Unclaimed Moneys.	Date when Amount first became Payable.
5			
E.Z. INDUSTRIES LIMITED—continued.			
Mitchellhill, Colin P., c/o Hickson Lakeman & Halcombe, 42 Hunter-street, Sydney, N.S.W.	40.00	Dividend on 500 shares ..	22.11.68
Morris, Isabella C. (estate of), c/o Frank Grey Smith & Son, 360 Collins-street, Melbourne	135.72	Dividend on 2,088 shares ..	"
Morrison, Robert, Bardwells, Roydon, Essex, U.K.	12.75	Dividend on 300 shares ..	19.4.68
Muir, May E. (estate of), c/o Shipway & Berne, G.P.O. 1870, Sydney, N.S.W.	104.00	Dividend on 1,600 shares ..	22.11.68
Murphy, Margaret C., 8 View-street, Waverley, N.S.W.	24.00	Dividend on 300 shares ..	"
Murray, Douglas R. A., 4 Bridge-street, Sydney, N.S.W.	36.48	Dividend on 456 shares ..	"
Murray, William A. K., 173 St. Vincent-street, Glasgow, Scotland	18.56	Dividend on 336 shares ..	"
Mutton, John V., 89 Cowles-road, Mosman, N.S.W. 2088	55.68	Dividend on 696 shares ..	"
McCauley, Joan E. (address unknown)	13.00	Dividend on 200 shares ..	"
McDonoch, Dorothy M., 7 Darling Point-road, Darling Point, N.S.W.	13.00	Dividend on 200 shares ..	"
McFarlane, Hazel J. L., 53 Ocean-avenue, Double Bay, N.S.W.	16.00	Dividend on 200 shares ..	"
McInnes, Uisdein A., c/o Lloyds Bank Ltd., Sidney-street, Cambridge, U.K.	20.40	Dividend on 300 shares ..	"
McMahon, Martin W., 35 Centre Dandenong-road, Cheltenham, 3192	25.92	Dividend on 324 shares ..	"
McQueen, Ewen N. (estate of), c/o Garland Seaborn & Abbott, 4/6 Blyth-street, Sydney, N.S.W.	104.00	Dividend on 1,600 shares ..	"
Nash, Katie F. G. (estate of), c/o Ivor A. Thomas & Sheffield, 1 Bridge-road, Belmore, N.S.W.	156.00	Dividend on 2,400 shares ..	"
Netheim, Gwendolen M. (estate of), Permanent Trustee Co. of N.S.W., G.P.O., Box 4270, Sydney, N.S.W.	151.68	Dividend on 1,896 shares ..	"
Newenham, William A., P.O. Box 8057, Newton, Auckland, N.Z.	17.00	Dividend on 400 shares ..	19.4.68
Newstead, Max, c/o Mr. E. J. Barker, Rattray Daniel & Weatherley, 251 George-street, Sydney, N.S.W.	25.00	Dividend on 500 shares ..	"
Nimmo, Aileen K., Flat 4, Block 8, Northbourne Flats, Turner, A.C.T.	16.00	Dividend on 200 shares ..	22.11.68
O'Loughlin, Marguerite, 8 Eighth-street, Gawler, S.A. 5118	10.00	Dividend on 200 shares ..	19.4.68
Palframan, Gwynneth M., c/o Hilton R. Gordon & Co., 133 Pitt-street, Sydney, N.S.W.	16.16	Dividend on 202 shares ..	22.11.68
Parsons, James S., 277 Auburn-road, Hawthorn, 3122	10.00	Dividend on 200 shares ..	19.4.68
Pratt, Hilda (estate of), c/o Francis, Taylor & Ferguson, 120 Clarence-street, Sydney, N.S.W. 2000	268.00	Dividend on 3,350 shares ..	22.11.68
Pratt, Hilda and Stella (estate of), c/o Francis, Taylor & Ferguson, 120 Clarence-street, Sydney, N.S.W. 2000	305.50	Dividend on 4,700 shares ..	"
Prescott, Alwyn W., The Rectory, Browley-street, Moss Vale, N.S.W.	26.00	Dividend on 400 shares ..	"
Prescott, Dora M. (estate of), c/o G. D. Campbell & Co., 92 Pitt-street, Sydney, N.S.W.	26.00	Dividend on 400 shares ..	"
Preston, Harold R., P.O. Box 137, Timaru, N.Z.	11.05	Dividend on 200 shares ..	"
Preudhomme, Dolones, 6 Holroyd-street, Kew	72.00	Dividend on 900 shares ..	"
P. S. Gale Malta Ltd., Casa Gale, St. Georges-street, Marsascala, Malta	18.20	Dividend on 400 shares ..	"
Quinlan, Evelyn V., 528 The Esplanade, Mount Martha, 3934	30.00	Dividend on 600 shares ..	19.4.68
Rabbin, David C. C., 36 Granard-avenue, Putney, London S.W.15, U.K.	20.40	Dividend on 300 shares ..	22.11.68
Rackemann, Egmont H., 4 Pollock-street, Gympie, Qld.	24.00	Dividend on 300 shares ..	"
Raimes, James R., 15 Abingdon-square, New York, 10014, U.S.A.	17.00	Dividend on 400 shares ..	19.4.68
Reinbach, Hans P., c/o Lignite Authority, Samsen-road, Bangkok, Thailand	28.00	Dividend on 500 shares ..	22.11.68
Renton, Mary R., 16 Shawfield-street, London S.W.3, U.K.	13.60	Dividend on 200 shares ..	"
Robson, Miriam C., 57 Trevallyn-terrace, Trevallyn, Launceston, Tas.	12.48	Dividend on 192 shares ..	"
Rocklea Building & Investment Co. Pty. Ltd., 15 Cowdroy-avenue, Cammeray, N.S.W.	20.00	Dividend on 400 shares ..	19.4.68
Rodriguez, Enid S., 28 Stanhope-road, Killara, N.S.W.	16.00	Dividend on 200 shares ..	22.11.68
Ryan, Delia G. (estate of), c/o Mr. H. B. Chapman, Gawler-street, Mount Barker, S.A.	190.32	Dividend on 2,928 shares ..	19.4.68
Seger, George, 11 Wynnstay-crescent, Ivanhoe, 3079	15.00	Dividend on 300 shares ..	"
Shain, Barbara M. (address unknown)	32.50	Dividend on 500 shares ..	"
Shaw, Michael S., 136 Ballantyne-avenue South, Montreal 28, Quebec, Canada	33.15	Dividend on 600 shares ..	"
Sheil, Wilhelmina R. A. (estate of), c/o Maxwell & Boyd, 155 Castlereagh-street, Sydney, N.S.W.	390.00	Dividend on 6,000 shares ..	"
Shorhills Investments Pty. Ltd., 11 Chester-street, Surrey Hills	15.00	Dividend on 300 shares ..	"
Simpson, Annie B. (estate of), c/o Mackenzie & Cormack, 1 Tower-street, Tain, Scotland	10.92	Dividend on 168 shares ..	"
Smart, George L. (estate of), c/o Icton Faithfull & Bladock, 28 O'Connell-street, Sydney, N.S.W.	110.40	Dividend on 1,380 shares ..	22.11.68
Smith, Charles B., 25 Fleetwood-crescent, Mt. Eliza	41.08	Dividend on 632 shares ..	19.4.68
Smith, Chester W. G. Mcl. (estate of), c/o Permanent Trust Co. of N.S.W. Ltd., G.P.O. Box 4270, Sydney, N.S.W.	104.52	Dividend on 1,608 shares ..	"
Stevenson, Douglas B., c/o Wairarapa Farm of Instruction, Masterton, N.Z.	10.20	Dividend on 150 shares ..	22.11.68
Suffern, Eileen M., 1 Findon-crescent, Kew, 3101	24.00	Dividend on 300 shares ..	"
Sunderland, Douglas (estate of), c/o E. R. Henry Wherrett & Benjamin, G.P.O. Box 454E, Hobart, Tas.	91.00	Dividend on 1,400 shares ..	19.4.68
Symes, Cecil R. T. (estate of), c/o C. W. E. Hough, Vulcan Buildings, Vulcan-lane, Auckland, N.Z.	132.60	Dividend on 2,040 shares ..	"
Taubman, Alan C. (address unknown)	78.00	Dividend on 1,200 shares ..	"
Tenn, Anthony E., 17 Karoola-street, Hampton, 3188	54.40	Dividend on 680 shares ..	22.11.68
Turner, Florence (estate of), c/o Laurence Laurence, G.P.O. Box 1616, Sydney, N.S.W.	91.00	Dividend on 1,400 shares ..	19.4.68
Valentine, Ranald J. H. (estate of), c/o Jones, Jones & Jones, G.P.O. Box 4943, Sydney, N.S.W.	13.00	Dividend on 200 shares ..	"

Unclaimed Moneys Act 1962.

REGISTER of Unclaimed Moneys held by the—

Name of Owner on Books and Last Known Address.	Total Amount Due to Owner.	Description of Unclaimed Money.	Date when Amount first became Payable.
\$			
E.Z. INDUSTRIES LIMITED—continued.			
Vasey, Robert A., 49 Lisson-grove, Hawthorn, 3122	24.00	Dividend on 300 shares ..	22.11.68
Wakelin, Vincent J. (address unknown)	26.91	Dividend on 414 shares ..	19.4.68
Ward, Margaret J., c/o Mr. D. K. Ward, G.P.O. Box 492, Sydney, N.S.W.	30.00	Dividend on 600 shares ..	"
Wark, Susan T. (estate of), c/o Aspinall Joel & Hall, P.O. Box 1384, Dunedin, N.Z.	54.40	Dividend on 800 shares ..	22.11.68
Webb, Victor R., c/o George A. Raves & Poole, 109 Pitt-street, Sydney, N.S.W.	24.00	Dividend on 300 shares ..	"
Wedemeyer, Wilhelm (estate of), c/o Permanent Trust Co. of N.S.W., 25 O'Connell-street, Sydney, N.S.W.	65.00	Dividend on 1,000 shares ..	19.4.68
Wellish, Margaret A., 15 Belgium-avenue, Roseville, N.S.W.	16.00	Dividend on 2,200 shares ..	22.11.68
Wheeler, Arthur B., 35 Queens-court, Clifton, Bristol 8, U.K.	21.25	Dividend on 500 shares ..	19.4.68
Wildie, Thomas R. (estate of), c/o Mr. D. Keith Donald, 362A Pacific Highway, Lindfield, N.S.W. 2070	52.00	Dividend on 800 shares ..	"
Winsor Bond Investments Ltd., Sands Farm, Old Warwick-road, Lapworth, Warwickshire, U.K.	13.60	Dividend on 200 shares ..	22.11.68
Wollongong Holdings Pty. Ltd., 79 Minibah-road, Northbridge, N.S.W.	30.00	Dividend	19.4.68
4184			
WESTERN MINING CORPORATION LIMITED.			
Allan, Keith, 317A Ligar-street, Ballarat, 3350	12.75	Dividend on 1,275 shares ..	23.8.68
Bank of Ireland Nominees Ltd., Bank of Ireland, College Green, Dublin 2, Eire	56.50	Dividend on 5,650 shares ..	"
Chaytor, John L. C., "Marshlands", No. 3 R.D., Blenheim, N.Z.	10.00	Dividend on 1,000 shares ..	"
Clarke, Stanley (estate of), c/o Mr. Eric D. Elwing, Commercial Bank Chrs., Mary St., Gympie, Qld. 4570	13.95	Dividend on 1,395 shares ..	"
Cohen, Morton B. (estate of), c/o Suite 301, 20 Bridge-street, Sydney, N.S.W. 2000	30.00	Dividend on 3,000 shares ..	"
Eckstein, Kurt (estate of), c/o Constable and Co., G.P.O. Box 7033, Sydney, N.S.W. 2001	26.00	Dividend on 2,600 shares ..	"
Freer Investments Private Ltd., 57 Jameson Park, Salisbury, C.1., Rhodesia	11.90	Dividend on 1,190 shares ..	"
Goode, Mathew E. (estate of), c/o Dorothy C. Somerville, Epworth Building, Pirie-street, Adelaide, S.A. 5000	138.60	Dividend on 13,860 shares ..	"
Gruen, Kurt (estate of), c/o K. Gruen and Co., 581 Little Collins-street, Melbourne, 3000	13.80	Dividend on 1,380 shares ..	"
Harvard Development Pty. Ltd., 100 Collins-street, Melbourne, 3000	21.40	Dividend on 2,140 shares ..	"
Huppert, Gustav (estate of), c/o 22 Flinders-lane, Melbourne, 3000	260.75	Dividend on 26,075 shares ..	"
Isaacs, Donald, 231 Princes Highway, St. Peters, N.S.W. 2044	50.00	Dividend on 5,000 shares ..	"
Keng, Chee S. (estate of), c/o Richard Chuan Hoe Lim and Co., 34A Market-street, Singapore	97.50	Dividend on 9,750 shares ..	"
Lansell, Horace, P.O. Box 1900R, Melbourne, 3001	10.00	Dividend on 1,000 shares ..	"
Cleizin, Jules F. A., 65 North-road, Bassendean, W.A. 6054	60.00	Dividend on 6,000 shares ..	"
Lithgow, Thomas G., Unit 6, 16 Joyce-street, Brisbane, Qld. 4000	26.00	Dividend on 2,600 shares ..	"
Marsden, Douglas H. (estate of), Nora F. Marsden and Perpetual Trustees and Co. Ltd., 33 Hunter-street, Sydney, N.S.W. 2000	104.00	Dividend on 10,400 shares ..	"
Meacle, Francis M. (estate of), c/o Kelly and Antill, 24 Miller-street, Gilgandra, N.S.W. 2827	21.00	Dividend on 2,100 shares ..	"
Ross, James R. H., c/o Bank of N.S.W., Hannan-street, Kalgoorlie, W.A. 6430	43.75	Dividend on 4,375 shares ..	"
St. Lawrence, John F. G., Howth Castle, Howth, Dublin, Ireland ..	50.00	Dividend on 5,000 shares ..	"
Walker, Ellen L. (estate of), c/o Cooke and Cussens, 477 Bourke-street, Melbourne, 3000	10.00	Dividend on 1,000 shares ..	"
Waterman, Maria S., 44 Mona-road, Darling Point, N.S.W. 2027	10.40	Dividend on 1,040 shares ..	"
Cohan, Vera (Mrs.), Flat 3c, 60 Park-lane, London, W.1, England	10.28	Dividend on 1,750 shares ..	"
Jones, David Thomas, c/o National Provincial Bank Ltd., 156 Fleet-street, London, E.C.4, England	35.26	Dividend on 6,000 shares ..	"
Langton, Andrew, Windmill Cottage, Farnham Common, Bucks., England	11.75	Dividend on 2,000 shares ..	"
Martin, Norman J., 14 Brompton Square, London, S.W.3, England	12.78	Dividend on 2,175 shares ..	"
Martin, Norman J., 14 Brompton Square, London, S.W.3, England	27.61	Dividend on 4,700 shares ..	"
Millico Nominees Limited, Pinners Hall, Austin Friars, London, E.C.2, England	27.90	Dividend on 4,750 shares ..	"
Pelham, Barbara H. (Mrs.), c/o Barclays Bank Ltd., 1 Market Hill, Huntingdon, England	14.69	Dividend on 2,500 shares ..	"
Reuben, Isaac, 12 Farrar-road, Bangor, North Wales	18.33	Dividend on 3,120 shares ..	"
Samuelson, Rupert F. H., Flat 271, 9 Collins-street, Melbourne, 3000	12.50	Dividend on 1,250 shares ..	"
4207			
WESTERN MINING CORPORATION LIMITED.			
Allen, Harvey, 45 Cornhill, London, E.C.3, U.K.	15.00	Dividend on 1,500 shares ..	28.2.69
Anderson, William T. (estate of), c/o Perm. Trust Co. of N.S.W. Ltd., 23/25 O'Connell-street, Sydney, N.S.W. 2000	38.85	Dividend on 3,885 shares ..	"
Bernshaw, Hyman S., 58 Howitt-road, Caulfield, 3162	15.00	Dividend on 1,500 shares ..	"
Brown, Geoffrey C., Unit 4, Currawang, Sandford-street, St. Lucia, Qld. 4067	20.00	Dividend on 2,300 shares ..	"
Carrigan, Louise, Clonacody, Clonmel, Tipperary, Ireland	10.00	Dividend on 1,000 shares ..	"
Clarke, Stanley (estate of), c/o Mr. Eric D. Elwing, Commercial Bank Chrs., Mary-street, Gympie, Qld. 4570	26.40	Dividend on 2,640 shares ..	"
Coghlan, William G., 238 Flinders-lane, Melbourne, 3000	13.00	Dividend on 1,300 shares ..	"
Cohen, Morton B. (estate of), Suite 310, 20 Bridge-street, Sydney, N.S.W. 2000	50.00	Dividend on 5,000 shares ..	"
Darch, Lennard J., 40 Thomas-street, Cottesloe, W.A. 6011	38.15	Dividend on 3,815 shares ..	"

Unclaimed Moneys Act 1962.

REGISTER of Unclaimed Moneys held by the—

Name of Owner on Books and Last Known Address.	Total Amount Due to Owner.	Description of Unclaimed Moneys.	Date when Amount first became Payable.
§			
WESTERN MINING CORPORATION LIMITED—continued.			
De Zoete and Gorton Nominees Ltd., 360 Collins-street, Melbourne 3000	25.00	Dividend on 2,500 shares ..	28.2.69
Djernal, Moise J., via Luciano Manara 15, Milan, Italy ..	14.05	Dividend on 1,405 shares ..	"
Evans, Gary C., 51 Cheetham-street, Kalgoorlie, W.A. 6430 ..	10.00	Dividend on 1,000 shares ..	"
Freeman, William A. A. (estate of), c/o Maxwell and Boyd, 155 Castlereagh-street, Sydney, N.S.W. 2000	900.00	Dividend on 90,000 shares ..	"
Gardner, Nigel E., Paternosters, Warninglid, N.R. Haywards Heath, Sussex, U.K.	18.00	Dividend on 1,800 shares ..	"
Goldfinch, Arthur D. A. (estate of), c/o J. Dudley Kenihan, 178 North-terrace, Adelaide, S.A. 5000	14.00	Dividend on 1,400 shares ..	"
Goldfinch, Peter C. W., c/o J. Dudley Kenihan, 178 North-terrace, Adelaide, S.A. 5000	43.00	Dividend on 4,300 shares ..	"
Coombs, Molly, c/o J. Dudley Kenihan, 178 North-terrace, Adelaide, S.A. 5000	15.00	Dividend on 1,500 shares ..	"
Goode, Mathew E. (estate of), c/o Dorothy C. Somerville, Epworth Building, Pirie-street, Adelaide, S.A. 5000	180.20	Dividend on 18,020 shares ..	"
Gruen, Kurt (estate of), c/o K. Gruen and Co., 581 Little Collins-street, Melbourne, 3000	13.80	Dividend on 1,380 shares ..	"
Gurling, George L. (estate of), c/ Morrissey and Hardy, 25 Langhorne-street, Dandenong, 3175	20.00	Dividend on 2,000 shares ..	"
Hayres, Vida M., 10 Oliver-road, Roseville, N.S.W. 2069 ..	30.50	Dividend on 3,050 shares ..	"
Holbrook, Walter M. S. 39 Drummoyne-avenue, Drummoyne, N.S.W. 2047	17.65	Dividend on 1,765 shares ..	"
Huppert, Gustav (estate of), 22 Flinders-lane, Melbourne, 3000 ..	339.00	Dividend on 33,900 shares ..	"
Hyson, Colin (estate of), c/o Greagh O'Brien and Co., P.O. Box 569, Tamworth, N.S.W. 2340	25.00	Dividend on 2,500 shares ..	"
Invesco Nominees Pty. Ltd., 87 St. Georges-terrace, Perth, W.A. 6000	16.00	Dividend on 1,600 shares ..	"
Jacob, Hans (estate of), c/o Liberman and Tobias, 56 Hunter-street, Sydney, N.S.W. 2000	42.50	Dividend on 4,250 shares ..	"
Jepson, Mary P. H., 112 Barnard-street, North Adelaide, S.A. 5006	25.35	Dividend on 2,535 shares ..	"
Keng, Chee S. (estate of), c/o Richard Chuan Hoe Lim, and Co., 34A Market-street, Singapore	126.75	Dividend on 12,675 shares ..	"
Kennedy, Ronald F., 20 Ludwell-crescent, Bentleigh, 3204 ..	10.00	Dividend on 1,000 shares ..	"
Lindsjo, Eva C., Anders Pers Vag 7, Glumslöv, Sweden ..	10.75	Dividend on 1,075 shares ..	"
Livingston, Kenneth S. H. (estate of), c/o W. A. Cole and Sons, 63 Frome-street, Moree, N.S.W. 2400	26.00	Dividend on 2,600 shares ..	"
Marsden, Douglas H. (estate of), c/o Perpetual Trustee Co. Ltd., 33 Hunter-street, Sydney, N.S.W. 2000	135.20	Dividend on 13,520 shares ..	"
Meacle, Francis M. (estate of), c/o Kelly and Astill, 24 Miller-street, Gilgandra, N.S.W. 2827	21.00	Dividend on 2,100 shares ..	"
Oliver, David H., East Point-road, Fannie Bay, Darwin, N.T. ..	12.50	Dividend on 1,250 shares ..	"
Panco Nominees Pty. Ltd. Limited, c/o Clarke and Co., 392 Little Collins-street, Melbourne, 3000	39.00	Dividend on 3,900 shares ..	"
Plunkett, William R., Jingellic-road, Holbrook, N.S.W. 2644 ..	156.00	Dividend on 15,600 shares ..	"
Radford, Herbert W. J., 12 Harvey-road, Goring-By-Sea, Sussex, U.K.	25.00	Dividend on 2,500 shares ..	"
Randell, Leslie W. (estate of), c/o Executor Trustee and Agency Co. of S.A. Ltd., 22 Grenfell-street, Adelaide, S.A. 5000	25.05	Dividend on 2,505 shares ..	"
Randell, Florence M., c/ Executor Trustee and Agency Co. of S.A. Ltd., 22 Grenfell-street, Adelaide, S.A. 5000	25.00	Dividend on 2,500 shares ..	"
Rutherford, Norah M., 6 Roger-street, Muswellbrook, N.S.W. 2333	25.00	Dividend on 2,500 shares ..	"
Seales, Alexander K., Wattletree-road, Bunyip, 3815 ..	11.50	Dividend on 1,150 shares ..	"
Servaes, Michael M., 385 Sefton House, Exchange Buildings, Liverpool, U.K.	10.00	Dividend on 1,000 shares ..	"
Sloane, Sylvia L. (estate of), c/o Darbyshire Gillett and Huelin, 42 St. George's-terrace, Perth, W.A. 6000	10.00	Dividend on 1,000 shares ..	"
Walker, Ellen L. (estate of), c/o Cooke and Cussen, 472 Bourke-street, Melbourne, 3000	13.00	Dividend on 1,300 shares ..	"
Wicarr Nominees Limited; 31 Gresham-street, London, E.C.2, England	26.70	Dividend on 2,670 shares ..	"
Willcocks, Peter W., 177 Burt-street, Boulder, W.A. 6432 ..	36.45	Dividend on 3,645 shares ..	"
Worrall, David T. (estate of), c/o Mrs. K. Z. Worrall, Cat Jump-road, Donvale, 3111	15.35	Dividend on 1,535 shares ..	"
Wimbush, Samuel H., c/o A.N.Z. Nominees Ltd., 394/6 Collins-street, Melbourne, 3000	10.00	Dividend on 1,000 shares ..	"
Cocking, Jane A. E. M., 17 Heath-road, Undercliff, Bradford, Yorkshire, U.K.	13.22	Dividend on 2,250 shares ..	"
Evans, Evan H. G., 5 Nott Square, Carmarthen, U.K. ..	20.27	Dividend on 3,450 shares ..	"
Plunkett-Green, Mary, 52b Draycott Place, London S.W.3, England	14.39	Dividend on 2,450 shares ..	"
Jones, David Thomas, c/o National Provincial Bank Ltd., 156 Fleet-street, London E.C.4, England	35.25	Dividend on 6,000 shares ..	"
Martin, Norman J., 14 Brompton Square, London S.W.3, England	27.61	Dividend on 4,700 shares ..	"
Pelham, Barbara H., c/o Barclays Bank Ltd., 1 Market Hill, Huntingdon, U.K.	20.56	Dividend on 3,500 shares ..	"
Wilson, Henry E. R., Broomhead Hall, Bolster Stone, Sheffield, U.K.	14.69	Dividend on 2,500 shares ..	"
C. P. Estates Limited, La Cote Au Palier, St. Martin, Jersey, C.I.	10.00	Dividend on 1,000 shares ..	"
Redmond, Cora, Tuskar, Laburnum, Lawn, Cork, U.K. ..	10.00	Dividend on 1,000 shares ..	"

CHEETHAM SALT LIMITED.

Port, Leonard Lawrence (estate of), address unknown ..	56.41	Wages and Holiday pay due at date of death	23.4.68
--	-------	--	---------

Unclaimed Moneys Act 1962.

REGISTER of Unclaimed Moneys held by the—

Name of Owner on Books and Last Known Address.	Total Amount Due to Owner.	Description of Unclaimed Moneys.	Date when Amount First Became Payable.
\$			
ASSOCIATED PULP AND PAPER-MILLS LIMITED.			
Baird, William A. (estate of), c/o Duncan Barron and Co., 10 Martin-place, Sydney, N.S.W. 2000	76.94	Dividend on 1,563 shares	25.10.68
Berry, Olive J. (estate of), c/o Carbyshire Gillett and Huelin, 42 St. Georges-terrace, Perth W.A. 6000	60.93	Dividend on 1,350 shares	26.4.68
Blayney, Mary L. (estate of), c/o Mr. Stuart McP. Chambers, 112 Glass-street, Essendon, 3040	33.60	Dividend on 672 shares	26.4.68
Blayney, Thomas E. (estate of), c/o Mr. Stuart McP. Chambers, 112 Glass-street, Essendon, 3040	134.80	Dividend on 1,348 shares	26.4.68
Bottle, Gwendolyn E. (estate of), c/o B. S. Sproule and Co., P.O. Box 209, Burnie Tas., 7320	32.28	Dividend on 538 shares	25.10.68
Broadhurst, Catherine, c/o Cornwall Stodart and Co., 222 Queen-street, Melbourne 3000	40.00	Dividend on 400 shares	26.4.68
Cavaghan, Henry D., 24 Austin Friars, London, England	15.55	Dividend on 608 shares	25.10.68
Clifford, Nina (estate of), c/o Bowen and Packham, 187 Macquarie-street, Sydney, N.S.W. 2000	86.17	Dividend on 1,750 shares	25.10.68
Collie, David (estate of), c/o The Public Trustee, 20 Macquarie-street, Parramatta, N.S.W. 2150	61.55	Dividend on 1,250 shares	26.10.68
Coombe, Stanley M. (estate of), c/o Peter Sowry, William-street, Berri, S.A. 5343	91.40	Dividend on 2,025 shares	26.4.68
Curtis, Anthony, Butlers-court, Beaconsfield, Bucks, England	48.45	Dividend on 950 shares	25.10.68
Darby, Percy (estate of), c/o 16 Lord-street, Sandy Bay, Tas. 7005	40.62	Dividend on 900 shares	26.4.68
Deger, Dorothy A. F., c/o Taylor, Bottomley and Ricketson, 115 Pitt-street, Sydney 2000	30.78	Dividend on 625 shares	25.10.68
Denduyts, Harold A., c/o Henry D. Cavaghan, 24 Austin Friars, London, E.C.2, U.K.	55.08	Dividend on 1,080 shares	25.10.68
Dowden, Kenneth F., c/o H. R. Hoare, P.O. Box 3, Strathfield, N.S.W. 2135	14.00	Dividend on 280 shares	26.4.68
Drew, Phillipa (estate of), c/o Middletons, 224 Queen-street, Melbourne 3000	15.00	Dividend on 150 shares	26.4.68
Duckworth, Beryl K. (estate of), c/o McLaughlin Gordon and Lennon, 3070 Gold Coast, Highway, Surfers Paradise, Qld. 4217	12.31	Dividend on 250 shares	25.10.68
Falk, Fritz S. (estate of), c/o Gilbert M. Johnstone and Co., 8A Castlereagh-street, Sydney, N.S.W. 2000	73.12	Dividend on 900 shares	26.4.68
Fisher, Joseph, 26 Hopetoun-street, Elsternwick 3185	18.60	Dividend on 186 shares	26.4.68
Gibbons, Nora B. (estate of), c/o 47 Brassey-road, Wanganui, N.Z.	11.47	Dividend on 150 shares	26.4.68
Goddard, Thomas H., c/o Murdoch, Clarke, Neasey and Cosgrove, 135 Macquarie-street, Hobart, Tas. 7000	45.72	Dividend on 762 shares	25.10.68
Goddard, Thomas H., c/o Murdoch, Clarke, Neasey and Cosgrove, 135 Macquarie-street, Hobart, Tas. 7000	19.30	Dividend on 360 shares	26.4.68
Greene, Cuthbert F. C. (estate of), c/o Saunders and Ritchie, P.O. Box 20, Deloraine, Tas. 7304	36.00	Dividend on 360 shares	26.4.68
Hammond-Chambers, Robert H. R. (estate of), c/o Whiting and Byrne, 166 Queen-street, Melbourne 3000	14.40	Dividend on 240 shares	25.10.68
Hellier, Paul J., c/o Commonwealth Trading Bank of Aust., George and Market-streets, Sydney, N.S.W. 2000	24.00	Dividend on 400 shares	25.10.68
Henty, Janet L., Flat 4, 16 Murphy-street, South Yarra 3141	10.00	Dividend on 100 shares	26.4.68
Hodgetts, Maxwell G. 15 Grainger-street, Lambton, N.S.W. 2299	26.00	Dividend on 650 shares	26.4.68
Hughes, Helena M., Devon, Casterton 3311	12.31	Dividend on 250 shares	25.10.68
Jackson, Berenice A., 7 Rankin-parade, Main Beach, Southport, Qld. 4215	40.00	Dividend on 400 shares	26.4.68
Joyce, Emily A. (estate of), c/o Mrs. G. M. Roberts-Thomson, 165 Kissing Point-road, Turrumurra South, N.S.W. 2074	48.00	Dividend on 480 shares	26.4.68
Jukes, Alan G. H., c/o Westminster Bank Ltd., 21 High-street, Reigate, Surrey, U.K.	136.00	Dividend on 4,000 shares	26.4.68
Lancaster, Beatrice M., 1 Fredben-avenue, Cammeroy, N.S.W. 2062	54.84	Dividend on 675 shares	26.4.68
Larke, Russell A. (estate of), c/o B. S. Sproule and Co., P.O. Box 209, Burnie, Tas. 7320	40.62	Dividend on 500 shares	26.4.68
Lay, Harold K., 13 Hoyt-street, Hampton 3188	16.00	Dividend on 400 shares	26.4.68
Lees, Arthur G., c/o Mrs. Kresser K. Butterworth, 3A Carthowen-avenue, Lane Cove, N.S.W. 2066	87.36	Dividend on 1,456 shares	25.10.68
Mitchell, Hilda M. (estate of), c/o O'Loughlin, Robertson and Co., 118 King William-street, Adelaide, S.A. 5000	60.00	Dividend on 1,000 shares	25.10.68
Morris, Isabella C. (estate of), c/o W. R. Fincham and Palmer, 84 Pitt-street, Sydney, N.S.W. 2000	11.78	Dividend on 145 shares	26.4.68
Naughton, Mary A. (estate of), c/o James L. Garney, P.O. Box 27, Braidwood, N.S.W. 2622	36.00	Dividend on 360 shares	26.4.68
Nelson, Alice B. (estate of), c/o Malleasons, 105 King-street, Melbourne 3000	40.44	Dividend on 674 shares	25.10.68
Neo, Mary T. J., 6 Oxley-road, Singapore 9	25.39	Dividend on 821 shares	26.4.68
Oates, Phyllis E., G.P.O. Box 1514N, Melbourne 3001	17.40	Dividend on 174 shares	26.4.68
O'Connell, Keith E., 182 Homebush-road, Strathfield, N.S.W. 2135	24.00	Dividend on 600 shares	26.4.68
Paice, Marie C., 32 Montagu-street, Hobart, Tas. 7000	24.00	Dividend on 400 shares	25.10.68
Polley, Luceinne L. S., 39 Windrest-avenue, Aspley, Qld.	26.60	Dividend on 266 shares	26.4.68
Potter, Caroline S., 44 Fourth-avenue, St. Peters, S.A. 5069	20.00	Dividend on 200 shares	26.4.68
Sambell, Alice R. (estate of), c/o Mr. F. T. Sambell, 401 Elgar-road, Box Hill 3128	33.40	Dividend on 334 shares	26.4.68
Sara, Archer J. (estate of), c/o Mr. Gordon J. Sara, 18 Coppin-street, Glengowrie, S.A. 5044	18.48	Dividend on 308 shares	25.10.68
Solomon, Enid M. (estate of), c/o 22 Morion-street, Wollstonecraft, N.S.W. 2065	12.00	Dividend on 200 shares	25.10.68
Suffern, Eileen M., 1 Findon-crescent, Kew 3101	12.00	Dividend on 200 shares	25.10.68
Tall, Fernleigh S. (estate of), c/o Genders, Wilson and Abbott, P.O. Box 1593M, Melbourne 3001	36.40	Dividend on 364 shares	26.4.68
Vicars, Thomas H. W., 10 Wedderburn-road, London, U.K.	20.00	Dividend on 200 shares	26.4.68

Unclaimed Moneys Act 1962.

REGISTER of Unclaimed Moneys held by the—

Name of Owner on Books and Last Known Address.	Total Amount Due to Owner.	Description of Unclaimed Moneys.	Date when Amount first became Payable.
S			
ASSOCIATED PULP AND PAPER MILLS LIMITED—continued.			
Will, Nancy M., 321 South-road, Everard Park, S.A. 5035	145.60	Dividend on 1,456 shares	26.4.68
Williamson, Mary J., 35 Granston-street, Andersons Bay, Dunedin, N.Z.	10.20	Dividend on 200 shares	25.10.68
Witts, Constance C. (estate of), c/o Dr. Louis B. Witts, 30 Binnie-street, Brighton, 3186	16.20	Dividend on 270 shares	25.10.68
Woodhouse, George (estate of), c/o Walsh and Blair, 28 Johnston-street, Wagga Wagga, N.S.W. 2650	54.00	Dividend on 900 shares	25.10.68
Wyllie, Ronald A. (estate of), c/o Tasman M. Larnach, Flat 107, 9 Elizabeth-street, Sydney, N.S.W. 2000	20.00	Dividend on 200 shares	26.4.68
Baugh, Elizabeth M., c/o Tasmanian Permanent E. and T. Assn. Ltd., P.O. Box 2860, Launceston, Tas. 7250	25.00	Interest on 400 notes	31.7.68
Firmage, Edward, c/o Blake and Ring, 4 Castlereagh-street, Sydney, N.S.W. 2000	16.50	Interest on 264 notes	31.7.68
Gillett, Eric W., 27 Parry-street, Claremont, W.A. 6010	12.50	Interest on 200 notes	31.7.68
Griffiths, Anne, Glynn Fryn, Pipers River, East Tamar, Tas.	12.50	Interest on 200 notes	31.1.69
Hooper, Harley E., 25 Park-terrace, Gilberton, S.A.	12.50	Interest on 200 notes	31.1.69
Maynard, Farnham E., St. Peters Vicarage, Eastern Hill	25.00	Interest on 400 notes	31.7.68
Nunn-Pendle, Adelaide F., c/o Mrs. Cefae, 37 Bullecourt-avenue, Mosman, N.S.W. 2088	25.00	Interest on 400 notes	31.1.69
Osborne, Edwin M., 113 L'Estrange-street, Glenunga, S.A. 5064	12.50	Interest on 200 notes	31.1.69
Ryan, Delia G., c/o Mr. H. B. Chapman, Gawler-street, Mount Barker, S.A. 5251	12.50	Interest on 200 notes	31.7.68
Will, Nancy M., 321 South-road, Everard Park, S.A. 5035	12.50	Interest on 200 notes	31.7.68
Wraith, Francis V., 54 Sussex-street, Brighton, 3186	15.63	Interest on 250 notes	31.1.69
Curtis, Anthony, 25 McDougall-street, Kirribilli, N.S.W. 2061	40.37	Unclaimed dividend	14.4.69
Osborne, Edwin M., 113 L'Estrange-street, Glenunga, S.A. 5064	25.00	Unclaimed note interest	7.5.69
Kimberly, Zoe (Miss), 57 Dennis-street, Baigowah, N.S.W. 2093	18.00	Unclaimed dividend	14.4.69
4183			
PELACO LIMITED.			
Stearns, Evelyn C., 189 Gold-street, Clifton Hill	17.50	Half yearly dividend on 250 'A' Pref. Shares	8.4.68
Macdonald, Elizabeth I., 32 Poath-road, Hughesdale	18.00	Half yearly dividend on 200 'B' Pref. Shares	21.10.68
4300			

The Companies Act 1961.

P. A. QUINLAN PTY. LTD.

NOTICE TO CREDITORS OF INTENTION TO DECLARE DIVIDEND.

To the Creditors of P. A. Quinlan Pty. Ltd.

TAKE notice that I, Alex Neville Bird, the trustee of the scheme of arrangement made between the company and its creditors and approved by the Supreme Court of Victoria on the 6th day of October, 1969, now give you notice that if you do not, on or before the 28th day of May, 1970, deliver to me a statutory declaration satisfactorily establishing your debt I shall proceed to declare a first dividend without regard to your claim.

Dated this 14th day of May, 1970.

A. NEVILLE BIRD, Trustee.

N.B.—Statutory Declarations should be submitted to the office of A. Neville Bird & Co., 289 Flinders-lane, Melbourne, 3000, before 4.00 p.m., on the 28th day of May, 1970.

4364

STARLANDS PROPRIETARY LIMITED (IN LIQUIDATION).

NOTICE is hereby given that an Extraordinary General Meeting of the above company will be held at the registered office, 360 Collins-street, Melbourne, on Monday, the 22nd June, 1970, at 11 a.m. for the purpose of laying before the meeting the account showing how the winding up has been conducted and the property of the company disposed of.

4365

G. B. MACKAY, Liquidator.

Companies Act 1961.—In the matter of BRADFORD HALL PROPRIETARY LIMITED.—Notice Re Meeting of Creditors, pursuant to section 260.

NOTICE is hereby given that a Meeting of Creditors of the above-named Company will be held at Princes Gate, East Tower, 4th Floor, Room 481, 151 Flinders-street, Melbourne, on Wednesday, 27th May, 1970, at 10.30 a.m., the company having convened an Extraordinary Meeting of its members for the same day for the purpose of considering a Special Resolution that the company be wound up voluntarily.

Dated this 15th day of May, 1970.

K. PORTER, Director.

Lewis Luckins & Co., chartered accountants, 289 Flinders-lane, Melbourne, 3000, telephone 63 8827. 4366

LUTANA INVESTMENTS PTY. LTD. (IN VOLUNTARY LIQUIDATION).

NOTICE is hereby given in pursuance of section 272 (2) of the Companies Act 1961, that a general meeting of the members of the above-named company will be held at the offices of Offner, Hadley & Company, chartered accountants, 395 Collins-street, Melbourne, on Monday, 22nd June, 1970, at 3 o'clock in the afternoon for the purpose of having an account laid before them showing the manner in which the winding up has been conducted and the property of the company disposed of and hearing any explanation that may be given by the liquidator.

Dated this 5th day of May, 1970.

4302

B. W. RUFFELS, Liquidator.

Companies Act 1961.

CONLAN'S HOTEL PTY. LTD.

AT an Extraordinary General Meeting of the Members of the above-named company duly convened and held at 146 Kilby-road, East Kew, on Sunday, the 10th day of May, 1970, the following Special Resolution was passed:—

“That the company be wound up voluntarily and that Kevin William Liston, public accountant, of 2 Claremont-avenue, Malvern, be appointed liquidator for the purpose of the winding up.”

Dated this 11th day of May, 1970.

4308

G. D. CONLAN, Director.

Companies Act 1961.

MARY MAXIM PROPRIETARY LIMITED.

NOTICE is hereby given that, pursuant to section 272 of the Companies Act 1961, a Final Meeting of the members of the company will be held at 49 Coppin-street, Richmond, on Monday, the 22nd June, 1969, at 10.00 in the forenoon, for a purpose of having an account laid before them showing the manner in which the winding up has been conducted and the property of the company disposed of and of hearing any explanation that may be given by the liquidator.

Dated this 19th day of May, 1970.

L. W. E. CHARLTON, Liquidator, 249 William-street, Melbourne. 4327

Companies Act 1961.

ESPLANADE MOTORS PROPRIETARY LIMITED (IN VOLUNTARY LIQUIDATION).

AT an Extraordinary General Meeting of the above-named company duly convened and held on 9th May, 1970, at 11 Glencairn-avenue, Brighton, the following Special Resolution was passed:—

“That Esplanade Motors Pty. Ltd. be placed in voluntary liquidation under section 254 (1) of the *Companies Act 1961*, and that Alan Leigh Middleton, of 11 Bank-place, Melbourne, be appointed liquidator.”

Dated 11th May, 1970.

4299 A. L. MIDDLETON, Liquidator.

LIONEL J. ROUGH INVESTMENTS PTY. LTD. (IN VOLUNTARY LIQUIDATION).

NOTICE is hereby given in pursuance of section 272 (2) of the *Companies Act 1961*, that a general meeting of the members of the above-named company will be held at the offices of Offner, Hadley & Company, chartered accountants, 395 Collins-street, Melbourne, on Monday, 22nd June, 1970, at 2 o'clock in the afternoon for the purpose of having an account laid before them showing the manner in which the winding up has been conducted and the property of the company disposed of and hearing any explanation that may be given by the liquidator.

Dated this 5th day of May, 1970.

4301 B. W. B. RUFFELS, Liquidator.

The Companies Act 1961.

BERITA PROPRIETARY LIMITED (IN VOLUNTARY LIQUIDATION).

NOTICE OF FINAL MEETING.

NOTICE is hereby given that, pursuant to section 272 of the *Companies Act 1961*, a General Meeting of the members of Berita Proprietary Limited, will be held on the 12th Floor, 447 Collins-street, Melbourne, on Monday, 22nd June, 1970, at 10.30 o'clock in the forenoon. The purpose of the meeting is to lay accounts before it showing the manner in which the winding up has been conducted and the property of the company disposed of, and of hearing any explanation that may be given by the liquidator.

4388 J. M. POULTON, Liquidator.

Companies Act 1961.—In the matter of MOUNTAIN DISTRICT PAINTING SERVICE PROPRIETARY LIMITED.—Notice Re Meeting of Creditors, Pursuant to Section 260.

NOTICE is hereby given that a meeting of creditors of the above-named company will be held at Princes Gate, East Tower, 3rd Floor, Room 320/21, 151 Flinders-street, Melbourne, on Monday, 25th May, 1970, at 2.30 p.m., the company having convened an Extraordinary Meeting of its members for the same day for the purpose of considering a Special Resolution that the company be wound up voluntarily.

Dated this 15th day of May, 1970.

A. L. MATTHEWS, Director.

Lewis Luckins & Co., chartered accountants, 289 Flinders-lane, Melbourne, 3000. Telephone 63 8827. 4363

The Companies Act 1961.—In the matter of BARCLAY & PORTER PTY. LTD., of Howey Court, 234 Collins-street, Melbourne.—Notice Re Meeting of Creditors, Pursuant to Section 260.

NOTICE is hereby given that a meeting of creditors of the above-named company will be held at Suite 18, 545 St. Kilda-road, Melbourne, on Tuesday, the 26th day of May, 1970, at 11.30 a.m., the company having convened a meeting of its members for the same day and prior to this meeting for the purpose of considering a Resolution that the company be wound up voluntarily.

Dated this 15th day of May, 1970.

J. HOLTkamp, Director.

Bent & Cogle, public accountants, Suite 18, 545 St. Kilda-road, Melbourne. 4328

In the matter of the *Companies Act 1961* and in the matter of TECHNAPRINT PTY. LTD.

NOTICE is hereby given that a meeting of creditors of Technaprint Pty. Ltd. will be held in the Board Room, Honorary Justices Association, 3rd Floor, 528 Collins-street, Melbourne, on Thursday, 28th May, 1970, at Ten o'clock in the forenoon, the company having convened a

meeting of its members for the same day for the purpose of considering a Resolution that the company be wound up voluntarily.

Note that a person is not entitled to vote as a creditor at the meeting unless he has lodged with the Chairman of the meeting a proof of the debt which he claims to be due to him from the company.

Dated this 13th day of May, 1970.

E. H. EAST, Director.

Martin & Associates, chartered accountants, 545 St. Kilda-road, Melbourne, 3004. 4361

The Companies Act 1961.—In the matter of A. & R. MOTORS PROPRIETARY LIMITED (in Voluntary Liquidation).

NOTICE is hereby given that, at an Extraordinary Meeting of the members of the above-named company, held on Thursday, the 14th day of May, 1970, it was resolved that the company be wound up voluntarily and at a meeting of creditors held on Thursday, the 14th day of May, 1970, it was resolved that for such purposes Gordon Kenneth Scambler, of 1 Palmerston-crescent, South Melbourne, be appointed liquidator.

Notice is also given that, after 21 days from this date, I shall proceed to distribute the assets. All creditors having any claims against the company should furnish particulars of same by that date, otherwise I shall proceed to distribute the assets without regard to their claim.

Dated this 15th day of May, 1970.

G. K. SCAMBLER, Liquidator.

Norman, Cartledge and Browne, chartered accountants, 1 Palmerston-crescent, South Melbourne, Vic. 3205. 4362

NOTICE is hereby given that a Meeting of the Creditors of Peninsula Marine and Land Services Pty. Ltd. will be held at the Fitzgerald Meeting Room, 1st Floor, Accountants House, 49 Exhibition-street, Melbourne, on Monday, 25th May, 1970, at 11 a.m. Inquiries to John Ruffin, and Brian Capon, 100 Mount Eliza Way, Mount Eliza, 787 2429. 4307

ROBERT WILLIAM PRENDERGAST MONTGOMERY, late of Plenty Mental Hospital, retired, DECEASED.

CREDITORS, next of kin and others having claims against the estate of the said deceased (who died on 12th October, 1969), are to send particulars of their claims to Harold Thomas Payne, C/o 120 William-street, Melbourne, by the 24th day of July, 1970, after which date he will distribute the assets, having regard only to the claims of which he then has notice.

BLAKE & RIGGALL, solicitors, 120 William-street, Melbourne. 4351

CREDITORS, next of kin and others having claims in respect of the estate of Catherine Aitken Lukey, late of Flat 102, Princes Hill Village, Pigdon-street, Carlton, widow, deceased (who died on the 20th day of February, 1970), are requested to send particulars of their claim to National Trustees, Executors and Agency Company of Australasia Limited, of 95 Queen-street, Melbourne, by the 24th day of July, 1970, after which date it will distribute the assets, having regard only to the claims of which it then has notice.

J. McD. JONES & PURCELL, 540 Lonsdale-street, Melbourne. 4347

CREDITORS, next of kin and others having claims in respect of the estate of Edith Maud Sarah Perrotet, late of Flat 4, 71 Ormond-road, Elwood, in the State of Victoria, widow, deceased (who died on the 12th December, 1969), are to send particulars of their claims to Royston T. Cahir & Martin, solicitors, 17 Queen-street, Melbourne, by the 20th day of July, 1970, after which date the administratrix will distribute the assets of the estate, having regard only to claims of which she then has notice.

ROYSTON T. CAHIR & MARTIN, 17 Queen-street, Melbourne, 3000. 4382

CREDITORS, next of kin and others having claims in respect of the estate of William Emmett Minogue, late of 21 Daventry-street, Reservoir, in the State of Victoria, motor driver, deceased (who died on the 9th December, 1969), are to send particulars of their claims to Royston T. Cahir & Martin, solicitors, 17 Queen-street, Melbourne, by the 20th day of July, 1970, after which date the executrix will distribute the assets of the estate, having regard only to claims of which she then has notice.

ROYSTON T. CAHIR & MARTIN, 17 Queen-street, Melbourne, 3000. 4383

CREDITORS, next of kin and others having claims in respect of the estate of Carl Streiff, late of 1 Hutchinson-street, East Coburg, retired council employee, deceased (who died on the 13th day of December, 1969), are required by the executor, Kevin Leslie Streiff, of 10 Sturdee-street, Reservoir, storeman, to send particulars of their claims to him, in care of the under-mentioned solicitors, by the 22nd day of July, 1970, after which date he will distribute the assets, having regard only to the claims of which he then has notice.

MCCAY & THWAITES, solicitors, 374 Little Collins-street, Melbourne. 4352

CREDITORS, next of kin and all other persons having claims against the estate of Kathleen Ellen Dunstan, late of Central-avenue, Mooroolbark, widow (who died on the 23rd day of March, 1970), are to send particulars of such claims to Kevin George Cooke, of 472 Bourke-street, Melbourne, solicitor, the executor appointed by deceased's will, by the 30th day of July, 1970, after which date the executor will distribute the assets, having regard only to the claims of which he shall then have had notice.

COOKE & CUSSEN, solicitors, 472 Bourke-street, Melbourne. 4349

LYDIA ANN NICHOLS, late of 197 Lennox-street, Richmond, married woman, DECEASED (who died on the 15th December, 1969).

CREDITORS, next of kin and all other persons having claims against the estate of the deceased are required by the executor of her will, Clement Roy Nichols, of 12 Finhaven-court, Kew, director, to send particulars thereof to him, care of the under-mentioned solicitors, before the 28th day of July, 1970, after which date he may distribute the assets of the deceased, having regard only to the claims of which he then has notice.

COLTMAN, WYATT & ANDERSON, solicitors, of 578 Bourke-street, Melbourne. 4348

CREDITORS, next of kin and others having claims against the estate of Eileen O'Connell, late of "Lindisfarne", Noble-street, Newtown, Geelong, spinster, deceased (who died on 27th January, 1970), are required to send particulars to the executors, National Trustees, Executors and Agency Company of Australasia Limited, of 95 Queen-street, Melbourne, Patricia Franklin, housewife, and Mary Katrine Franklin, spinster, both of 6 Bryce-avenue, Newtown, Geelong, care of the said company at its address aforesaid by the 27th day of July, 1970, after which date the said executors will distribute the assets, having regard only to the claims of which they then have notice.

BERNARD NOLAN & CO., solicitors, 595 Bourke-street, Melbourne. 4380

BENJAMIN WALLACE ROWELL, late of 10 Warner-street, Essendon, formerly wood machinist, but latterly retired wood machinist, DECEASED.

CREDITORS, next of kin and others having claims against the estate of the deceased (who died on 21st March, 1970), are required by the executor, The Trustees, Executors and Agency Company Limited, of 401 Collins-street, Melbourne, to send particulars of their claims to the said company on or before the 22nd July, 1970, after which date it will convey or distribute the assets, having regard only to the claims of which it then has notice.

HOME, WILKINSON & LOWRY, solicitors, of 401 Collins-street, Melbourne. 4386

CREDITORS, next of kin and others having claims in respect of the estate of Ernestine Reid, late of 8 River-avenue, Ascot Vale, widow, deceased (who died on the 6th day of October, 1969), are required to send particulars of their claims to the executor of the estate, Ernest Raymond Gillett, care of Hayvatt & Steward, solicitors, of 472 Bourke-street, Melbourne, by the 20th day of July, 1970, after which date the executor will distribute the assets of the deceased, having regard only to the claims of which he then has notice. 4298

CREDITORS, next of kin and others having claims in respect of the estate of Donald William Ford, late of Ararat, ward assistant, deceased (who died on the 20th day of August, 1969), are to send particulars of their claims to the executrix, Nellie Christina McDonald, care of Messrs. Briggs & O'Driscoll, solicitors, 94 Barkly-street, Ararat, by the 29th day of July, 1970, after which date she will distribute the assets, having regard only to the claims of which she then has notice.

BRIGGS & O'DRISCOLL, solicitors, 94 Barkly-street, Ararat. 4394

No. 50.—4210/70.—5

ROBERT FITZCLARENCE, late of 43 Roadknight-street, Lakes Entrance, in the State of Victoria, municipal employee, DECEASED.

CREDITORS, next of kin and others having claims in respect of the will of the estate of the deceased (who died on the 24th February, 1970), are required by the applicant for a grant of letters of administration with the will annexed, Eliza Morrison, of Olive-avenue, Harkaway, in the said State, widow, to send particulars to the applicant, care of her solicitors, Messrs. William Lasica & Co., of 343 Little Collins-street, Melbourne, by the 30th day of July, 1970, after which date the applicant for a grant of letters of administration with the will annexed may convey or distribute the assets, having regard only to the claims of which she then has notice. 4297

ALBERT EDWARD GRIFFITHS, late of 175 Glen Eira-road, East St. Kilda, in the State of Victoria, gentleman, DECEASED.

CREDITORS, next of kin and others having claims in respect of the estate of the deceased (who died on the 2nd day of February, 1970), are to send particulars of their claims to the executor, John Edward Edmonds, care of the undersigned solicitor, by the 28th day of July, 1970, after which date he will proceed to distribute the estate, having regard only to the claims of which he then has notice.

JOHN I. SULLIVAN, solicitor, corner of Kooyong and Glenhantly roads, Caulfield. 4320

LESLIE ROBERT HOKIN (generally known as Robert Hokin), formerly of 15 McIlwraith-street, North Carlton, in the State of Victoria, clerk, but late of "Oberon", in the State of New South Wales, retired clerk, DECEASED.

CREDITORS, next of kin and others having claims in respect of the estate of the deceased (who died on the 12th day of January, 1968), are required by the executor, Sandhurst and Northern District Trustees, Executors and Agency Company Limited, of 18 View-street, Bendigo, in the State of Victoria, to send particulars to it, care of the undersigned, by the 20th day of July, 1970, after which date the executor may convey or distribute the assets, having regard only to the claims of which it then has notice.

ALEC M. HAYES, solicitor, 148 Campbell-street, Swan Hill. 4304

JOHN RONALD MARSHALL, late of 31 Nott-street, East Malvern, Victoria, insurance broker, DECEASED.

CREDITORS, next of kin and others having claims in respect of the estate of the deceased (who died on 12th January, 1970), are required by the personal representative, Alban David Marshall, of 11 Richards-avenue, Glen Iris, Victoria, insurance broker, to send particulars to him by 31st July, 1970, after which date he may convey or distribute the assets, having regard only to the claims of which he then has notice.

HEDDERWICK, FOOKES & ALSTON, 121 William-street, Melbourne, 3000. 4353

HAZELINE VERONICA AUSTIN, late of "The Pines", Princes Highway, Trafalgar, married woman, DECEASED.

CREDITORS, next of kin and others having claims in respect of the estate of the deceased (who died on the 29th day of December, 1969), are required by the trustees, Pauline Lazarus, of 76 Spencer-street, Melbourne, solicitor, and Celeste Green, of Mole Creek, in the State of Tasmania, married woman, to send particulars to them by the 27th day of July, 1970, after which date the trustees may convey or distribute the assets, having regard only to the claims of which they then have notice.

Dated the 20th day of May, 1970.

LOUIS S. LAZARUS, solicitor, 76 Spencer-street, Melbourne. 4358

CREDITORS, next of kin and others having claims in respect of the estate of James Gibson, late of 46 Sandringham-road, Sandringham, retired grazier, deceased (who died on the 24th January, 1970), are to send particulars of their claims to The Union-Fidelity Trustee Company of Australia Limited, 100 Exhibition-street, Melbourne, by the 31st July, 1970, after which date it will distribute the assets, having regard only to the claims of which it then has notice.

Dated this 20th day of May, 1970.

MALESONS, solicitors, 121 William-street, Melbourne. 4359

ALAN LESLIE CLARK, late of 30 Elm-grove, Brighton, retired, DECEASED.

CREDITORS, next of kin and others having claims against the estate of the said deceased (who died on 7th May, 1969), are to send particulars of their claims to Ian Dejardin Mackinnon and Colin Arthur Johnson, care of 120 William-street, Melbourne, by the 24th day of July, 1970, after which date they will distribute the assets, having regard only to the claims of which they then have notice.

BLAKE & RIGGALL, solicitors, 120 William-street, Melbourne. 4354

ALICE AILEEN DENNIS, late of 3 Viewbank-road, Glen Iris, widow.

CREDITORS, next of kin and others having claims in respect of the estate of the deceased (who died on the 2nd day of April, 1970), are required by the trustee, Patricia Talbot Rhoden, of 8 Viewbank-road, Glen Iris, married woman, to send particulars to her at 8 Viewbank-road, Glen Iris, by the 31st day of July, 1970, after which date the trustee may convey or distribute the assets, having regard only to the claims of which she then has notice.

Dated the 13th day of May, 1970.

JOHN P. RHODEN, solicitors, 376 Collins-street, Melbourne. 4355

GWENDA MARIE PHILLIPS, late of 9 Glyndon-road, Camberwell, married woman, DECEASED.

CREDITORS, next of kin and others having claims in respect of the estate of the deceased (who died on the 3rd day of January, 1970), are required by The Perpetual Executors and Trustees Association of Australia Limited, of 100-104 Queen-street, Melbourne, to send particulars of their claims to the said company, by the 24th day of July, 1970, after which date it will convey or distribute the assets, having regard only to the claims of which the company then has notice.

RODDA, BALLARD & VROLAND, solicitors, 697 Burke-road, Camberwell. 4356

CREDITORS, next of kin and others having claims in respect of the estate of Frank Waddell Wallace, late of 266 Essex-street, West Footscray, in the State of Victoria, clerk, deceased, intestate (who died on the 3rd day of December, 1969), are required to send particulars of their claims to the administrator, Colin Douglas Wallace, care of the under-mentioned solicitors, by the 21st day of July, 1970, after which date the administrator will distribute the assets of the deceased, having regard only to the claims of which he then has had notice.

J. McDONALD SMITH & CO., solicitors, of 59-61 Irving-street, Footscray. 4357

ISABELLA WATSON McSWAIN, late of Ballangeich, in the State of Victoria, married woman, DECEASED.

CREDITORS, next of kin and others having claims in respect of the estate of the above-named deceased (who died on 11th December, 1969), are required by the executors, Hugh Allan McSwain, of Ballangeich, farmer, and the Union-Fidelity Trustee Company of Australia Limited, of 8 Malop-street, Geelong, to send particulars to them, care of the undersigned solicitors, by the 31st day of July, 1970, after which date they may convey or distribute the assets, having regard only to the claims of which they then have notice.

Dated 13th May, 1970.

D. MADDEN & CO., solicitors, 1A Liebig-street, Warrnambool. 4334

IDA SOPHIA DAWSON, late of Sir Henry Barkly Hotel, Burgundy-street, Heidelberg, in the State of Victoria, widow, DECEASED.

CREDITORS, next of kin and others having claims in respect of the estate of the deceased (who died on the 14th day of October, 1969), are required by the executors John Inglis Dawson, of Sir Henry Barkly Hotel, aforesaid manager and Alan John Robinson, of 388 Bourke-street, Melbourne, in the said State, solicitor, to send particulars of their claims to them care of the under-mentioned solicitors on or before the 31st day of July, 1970, after which date the executors will distribute the assets of the said deceased, having regard only to the claims of which they shall then have notice.

T. A. RANK & ROBINSON, solicitors, 388 Bourke-street, Melbourne, 3000. 4372

MARY ANN CALLAHAN, formerly of Gerangamete but late of 4 Inglis-court, Colac, widow, DECEASED.

CREDITORS, next of kin and others having claims in respect of the estate of the deceased (who died on the 27th day of October, 1969), are required by the trustee, The Trustees, Executors and Agency Company Limited, of 401 Collins-street, Melbourne, to send particulars to them by the 4th day of August, 1970, after which date the trustee may convey or distribute the assets, having regard only to the claims of which it then has notice.

SEWELL & SEWELL, solicitors, Colac. 4341

ERIC DAVID HUNTER, late of 241 Station-street, Fairfield, precision engineer, DECEASED.

CREDITORS, next of kin and others having claims in respect of the estate of the deceased (who died on the 14th March, 1970), are required by the applicant for grant of probate of the will of the deceased, James Samuel Gibson, of 42 Berkeley-street, Hawthorn, solicitor, to send particulars to him, care of the undersigned solicitors, by the 24th July, 1970, after which date he may convey or distribute the assets, having regard only to the claims of which he then has notice.

Dated 11th May, 1970.

GIBSON McINTOSH & ASSOCIATES, 825 Burke-road, Camberwell. 4343

LILIAN DORIS WESTAWAY, late of 290A Beaconfield-parade, Middle Park, in the State of Victoria, widow, DECEASED.

CREDITORS, next of kin and others having claims in respect of the estate of the deceased (who died on the 24th day of April, 1970), are required to send particulars of their claims to the executor, Kevin Hayes Westaway, care of Messrs. Gerald E. Delany & Co., solicitors, 452 Lonsdale-street, Melbourne, by the 20th day of July, 1970, after which date he will distribute the assets, having regard only to the claims of which he then has notice.

GERALD E. DELANY & CO., solicitors, 452 Lonsdale-street, Melbourne. 4344

CLAUDE CROSBY PEACE, late of 160 High-street, Ashburton, investor, DECEASED.

CREDITORS, next of kin and others having claims in respect of the estate of the deceased (who died on the 21st day of November, 1969), are required by The Perpetual Executors and Trustees Association of Australia Limited, of 100-104 Queen-street, Melbourne, the applicant for a grant of administration, to send particulars of its claims to the said applicant, in the care of the said company by the 24th July, 1970, after which date it will convey or distribute the assets, having regard only to the claims of which it then has notice.

R. P. BARRETT & SON, solicitors, 472 Bourke-street, Melbourne. 4345

CREDITORS, next of kin and other persons having claims against the estate of Alice Muriel Westwood, late of 63 Wilsons-road, Mornington, in the State of Victoria, married woman, deceased (who died on the 12th day of April, 1969), are required to send particulars of their claims to the executor, Geoffrey John Ogge, care of the under-mentioned solicitors, by the 27th July, 1970, after which date the executor will distribute the assets, having regard only for the claims of which he then has had notice.

JAMES P. OGGE & CO., solicitors, of 165 Greville-street, Prahran. 4342

LYLE DERRICK, formerly of Illowa but late of 6 Gordon-court, Swan Hill, in the State of Victoria, school teacher, DECEASED.

CREDITORS, next of kin and other persons having claims against the estate of the said deceased (who died on the 21st day of February, 1970), are required to send particulars of same to the executrix, Gloria Mavis Derrick, in care of the undersigned, on or before the 24th day of July, 1970, after which date they will distribute the assets, having regard only to the claims of which they then have notice.

DELANY & DWYER, barristers & solicitors, 201 Campbell-street, Swan Hill. 4346

CREDITORS, next of kin and others having claims in respect of the estate of Frank Richard Dunk Rogerson, late of 193 North-road, Elsternwick, gentleman (who died on the 10th March, 1970), are to send particulars of their claims to the executor, Peter Borland Nugent, care of the undersigned, by the 25th July, 1970, after which date he will commence to distribute the assets, having regard only to the claims of which he then has notice.

RENNICK & GAYNOR, solicitors, 491 Bourke-street, Melbourne. 4384

CREDITORS, next of kin and others having claims in respect of the estate of William Mazoletti, late of 1376 Centre-road, Clayton, retired (who died on the 28th December, 1969), are to send particulars of their claims to the executors, William Mazoletti and Mabel Minnie Campbell, care of the undersigned, by the 25th July, 1970, after which date they will commence to distribute the assets, having regard only to the claims of which they then have notice.

RENNICK & GAYNOR, solicitors, 327 Clayton-road, Clayton. 4385

CREDITORS, next of kin and others having claims in respect of the estate of Irvine Samuel Eager, late of 20 Riley-street, South Oakleigh, retired paymaster, deceased (who died on the 3rd June, 1969), are required by the administratrix, Doreen Eager, of 20 Riley-street, South Oakleigh, widow, to send particulars of their claims to her, in care of the under-mentioned solicitors, prior to 29th July, 1970, after which date the said administratrix will distribute the assets of the deceased, having regard only to the claims of which she then shall have had notice.

ROGERS & GAYLARD, solicitors, 51 Queen-street, Melbourne. 4387

CREDITORS, next of kin and others having claims in respect of the estate of Alexander Ernest David, late of Flat 13, 3 Herbert-street, St. Kilda, in the State of Victoria, retired engineer, deceased (who died on the 10th day of January, 1970), are required to send particulars of their claims to National Trustees, Executors and Agency Company of Australasia Limited, of 95 Queen-street, Melbourne, one of the executors appointed by the will of the said deceased by the 21st day of July, 1970, after which date the executors will distribute the assets of the deceased having regard only to the claims of which they then had had notice.

MARASH & CO., solicitors, of 443 Little Collins-street, Melbourne. 4368

CREDITORS, next of kin and others having claims in respect of the estate of Elizabeth Priscilla Eades, late of 1 Shamrock-street, Essendon, spinster, deceased (who died on the 31st day of January, 1970), are required by The Trustees, Executors and Agency Company Limited, of 401 Collins-street, Melbourne, to send particulars of their claims to the company by the 24th day of July, 1970, after which date it will distribute the assets, having regard only to the claims of which it then has notice.

DAVID THOMAS & FRENKEL, of 104 Queen-street, Melbourne. 4379

In the Supreme Court of the State of Victoria.

SALE BY THE SHERIFF.

ON Thursday, the 16th day of July, 1970, at 2 p.m., at the Post Office, Blampied (unless process be stayed or satisfied):—

All the estate and interest (if any) of Harold John Louis Hall, of Wayside, Eganstown, solicitor, as proprietor of an estate in fee-simple in the land described in certificate of title, volume 8451, folio 680, upon which are erected a dwelling, dairy, hayshed and wool shed.

The property comprises approximately 200 acres, and is approximately 2 miles north-east of the Swiss Mountain Hotel, at Blampied.

Registered mortgage No. D.330592 affects the said estate and interest.

Terms: Cash only.

SEN. CONST. J. F. JEE, Sheriff's Officer, Daylesford.

15th May, 1970. 4381

INSOLVENCY NOTICE

Commonwealth of Australia.

Bankruptcy Act 1966-1969.

Assigned Estate, A. B. THOMAS and L. THOMAS (trading as A. B. Thomas, Plumbers).

No. 24 of 1970.

NOTICE TO CREDITORS OF INTENTION TO DECLARE DIVIDEND.

A FIRST Dividend is intended to be declared in the above matter. Creditors who have not proved their debt by the 10th day of June, 1970, will be excluded from this dividend.

The date on which the estate was assigned was the 6th March, 1970.

Dated this 19th day of May, 1970.

H. K. CARTLEDGE, Trustee.

Norman, Cartledge and Browne, chartered accountants, 1 Palmerston-crescent, South Melbourne, Vic., 3205. 4360

IMPOUNDINGS

BALLARAT.—Impounded in Ballarat City Pound.

1 white male goat, collar and chain, no visible brand

If not claimed and expenses paid, to be sold on 2nd June, 1970.

R. A. GILES,
Poundkeeper.

4335—\$1.50

DONALD.—Impounded in Donald Pound, from Corack district, on Tuesday, 12th May, 1970.

5 Merino type ewes, blurred brands

1 Border Leicester crossbred lamb, blurred brand

1 Border Leicester crossbred ram, blurred brand

If not claimed and expensed paid, to be sold on 5th June, 1970, and, if not sold, at next monthly Associated Agents sheep sale.

W. A. CAMERON,
Poundkeeper.

4337—\$2.50

EDENHOPE.—Impounded in Edenhope Pound, off the Apsley-road, on the 8th May.

1 Corriedale ram, aged, ear tag inscribed "Sunnymeade" on left ear, no visible brand

If not claimed and expenses paid, to be sold on 20th May, 1970.

PETER P. CARTER,
Poundkeeper.

4314—\$2.00.

RUTHERGLEN.—Impounded in Rutherglen Pound by Mr. M. D. Campbell, from the Parish of Carlyle.

1 Border Leicester ram lamb, no visible brand or earmark

If not claimed and expenses paid, to be sold on 30th May, 1970.

ERIC MILLER,
Poundkeeper.

4310—\$1.75.

UPWEY.—Impounded in Upwey Pound, on 15th May, 1970, from Emerald.

1 black gelding, white star on forehead, no visible brand
1 roan gelding, no visible brand

If not claimed and expenses paid, to be sold on 2nd June, 1970, at the Dandenong Saleyards.

H. P. MEANEY,
Poundkeeper.

4395—\$2.00

WHITTLESEA.—Impounded in Epping Pound by Ranger.

2 Merino cross ewes, no visible brands

If not claimed and expenses paid, to be sold on 5th June, 1970.

W. HERD,
Poundkeeper.

4371—\$1.50

WINCHELSEA.—Impounded in Winchelsea Pound by Country Roads Board Inspector, Mr. A. E. Wilson.

- 1 ewe, shorn, no visible brand
- Impounded by Shire Ranger, Mr. C. E. Mawson.
- 2 lambs, no visible brand
- 1 lamb ewe, double notch back of right ear, no visible brand
- 1 lamb ewe, horns, no visible brand
- 1 wether, 4 tooth, horns, notch back of right ear, no visible brand
- 1 comeback ewe, aged, notch hole in right ear, no visible brand
- 1 ewe, crossbred, aged, notch front and back of right ear, notch back of left ear, no visible brand

If not claimed and expenses paid, to be sold on 8th June, 1970.

4315—\$4.50.

W. HOLE,
Poundkeeper.

Subordinate Legislation Act 1962.

NOTICE OF MAKING OF STATUTORY RULES.

IN pursuance of the provisions of the *Subordinate Legislation Act 1962* and the Regulations made thereunder, notice is given of the making of the following statutory rules:—

No.	Price.
94/1970. Regulations Governing the Expenditure of Commissions and Boards of Inquiry (Amendment No. 2) 1970	10c
<i>Explosives Act 1960.</i>	
95/1970. Classification of Explosives Amendment No. 1/1970	10c
<i>Health Act 1958.</i>	
96/1970. Poisonous Substances (Amendment) Regulations 1970	10c
<i>Farm Produce Merchants and Commission Agents Act 1965.</i>	
97/1970. Farm Produce Merchants and Commission Agents (Amendment) Regulations 1970	15c

Copies of these statutory rules may be purchased at the Sale of Publications Section of the Government Printing Office, located at Macarthur-street, Melbourne, 3002. If ordered by mail, remittance should be addressed to "The Government Printer, Box 203, P.O., North Melbourne, 3051", and should include 5c extra for postage. If a credit account is held at this office, no remittance is required with the mail order.

The annual subscription rate for Statutory Rules (including a Bound Volume) is \$15, payable in advance. The subscription year commences on 1st January.

C. H. RIXON,
Government Printer.

AGENTS FOR THE "VICTORIA GOVERNMENT GAZETTE".

THE following have been appointed agents to receive Advertisements and Subscriptions for the *Victoria Government Gazette*:—

- ARMSTRONG'S AGENCY, 205 Queen-street, Melbourne, Victoria 3000.
- ARNALL & JACKSON, 390 Barkly-street, Brunswick, Victoria 3056.
- BAIRNSDALE AUTHORIZED NEWSAGENCY, 132 Main-street, Bairnsdale, Victoria 3875.
- BICKNELL, M. J., Authorized Newsagent, 196 Timor-street, Warrambool, Victoria 3280.
- BLANE'S AUTHORIZED NEWSAGENTS, 162 Murray-street, Colac, Victoria 3250.
- CARTER, R. G., ADVERTISING SERVICE PTY. LTD., Suite 24, 65 Queens-road, Melbourne, Victoria 3004.
- DAVIES, G. & M. V., 112 Gray-street, Hamilton, Victoria 3300.
- DAVIS, WM. (MILDURA) PTY. LTD., 126 Eighth-street, Mildura, Victoria 3500.
- DIXON'S NEWSAGENCY, 89 Firebrace-street, Horsham, Victoria 3400.
- EDGAR'S NEWSAGENCY PTY. LTD., 293 Hargreaves-street, Bendigo, Victoria 3550.

- EDGAR'S AUTHORIZED NEWSAGENCY, 45 Bridge-street, Benalla, Victoria 3672.
- FRANKS, H., & CO., 184 Ryrle-street, Geelong, Victoria 3220.
- GATLEY, A. & J., 250 Lonsdale-street, Dandenong, Victoria 3175.
- GORDON & GOTCH AUSTRALASIA LTD., 467 Collins-street, Melbourne, Victoria 3000.
- GULLAN'S NEWSAGENCY, 88 Bridge-street, Ballarat, Victoria 3350.
- HAMPTON, A. C., 243 Mitchell-street, Bendigo, Victoria 3550.
- HARSTON, PARTRIDGE & CO. PTY. LTD., 455 Little Collins-street, Melbourne, Victoria 3000.
- KYNETON GUARDIAN PTY. LTD., P.O. Box 18, Kyneton, Victoria 3444.
- LATIMER'S, Newsagents, 45 Station-street, Malvern, Victoria 3144.
- LIVINGSTON'S SHEPPARTON NEWSAGENCY, 246 Wyndham-street, Shepparton, Victoria 3630.
- THE MERCANTILE EXCHANGE, 67 Queen-street, Melbourne, Victoria, 3000.
- McGILL'S AUTHORIZED NEWSAGENCY, 183-5 Elizabeth-street, Melbourne, Victoria 3000.
- PHILLIPS AUTHORIZED AGENCY, 83 Murphy-street, Wangaratta, Victoria 3677.
- PURDIE, J., & CO., 138 Moorabool-street, Geelong, Victoria 3220.
- SALE AUTHORIZED NEWSAGENCY, 142 Raymond-street, Sale, Victoria 3850.
- SKINNER'S AUTHORIZED NEWSAGENCY, 49-51 Franklin-street, Traralgon, Victoria 3844.
- STEVENSON, A. C. & M., NEWSAGENTS, 132 Henty-street, Casterton, Victoria 3311.
- VERNON, C. F. & H. J., 162 Bridge-road, Richmond, Victoria 3121.
- VIEW POINT AUTHORIZED NEWSAGENCY, 4 View-Point, Bendigo, Victoria 3550.

A copy of the Gazette filed at each place for public reference.

CONTENTS

	PAGE
Appointments	1417
Contracts	1414
Courts	1414
Estates of Deceased Persons	1399
Government Notices	1399
Impoundings	1463
Insolvency Notice	1463
Lands	1435
Melbourne and Metropolitan Board of Works— Notice	1413
Mining	1416
Notice to Attend for Radiological Examination	1412
Notice of Making of Statutory Rules	1464
Orders in Council—	
Acts—Stamps; Soil Conservation and Land Utilization; Milk and Dairy Supervision; Country Roads; Land; Housing; Local Government; Victoria Institute of Colleges; Water; Sewerage Districts; River Improvement; Soil Conservation and Land Utilization; Health; Latrobe Valley; River Improvement; Wheat Marketing; Superannuation; Housing.	1419 et seq
Pipelines Act	1407
Police Sale	1414
Private Advertisements	1444
Proclamations	1397
Public Holiday—Queen's Birthday	1399
Public Service Notices	1442
Resignations	1418
State Rivers and Water Supply Commission	1411
Tenders	1444
Transport Regulation Board—Public Hearings	1400
Waterworks Trusts	1416