

[1839]



VICTORIA GOVERNMENT GAZETTE

Published by Authority

No. 54]

WEDNESDAY, JUNE 2

[1971

Government House,
Melbourne.

LEVEE AT PARLIAMENT HOUSE, MELBOURNE.

In honour of the Birthday of Her Majesty the Queen, His Excellency the Governor of Victoria, Major-General Sir Rohan Delacombe, K.C.M.G., K.C.V.O., K.B.E., C.B., D.S.O., K.St.J., will hold a Levee at Parliament House, Spring-street, Melbourne, at 9.45 a.m. on Saturday, 12th June, 1971.

On the occasion of the celebration of The Queen's Birthday, His Excellency is anxious to receive as many citizens as possible.

In accordance with previous custom, there will be no precedence in the order of presentation, but it is requested that members of services and all public bodies group themselves together for presentation, as far as possible.

It is requested that those entitled to wear uniform or official dress will do so on this occasion, but His Excellency will be pleased to receive those not entitled to wear uniform or official dress in their ordinary morning or business dress.

For the guidance of those attending the Levee, it will be appropriate, for those who wish to do so, to wear Honours, Decorations and Awards.

Private Entree Cards will admit recipients to the South Door of the Spring-street Entrance at Parliament House at 9.30 a.m. All other citizens are requested to enter by the North Door of the Spring-street Entrance at 10.15 a.m.

It is particularly desired that gentlemen attending the Levee should provide themselves with a card on which should be printed or typed in capitals, or written in block letters, their styles of address for presentation in order to facilitate announcement to His Excellency.

By His Excellency's Command,

W. H. A. BECKE, Lieutenant Colonel,
Private Secretary and Comptroller.

PROCLAMATIONS

Land Act 1958.

AREA OF LAND COMPRISED IN CERTAIN CLASSES DIMINISHED OR INCREASED.

PROCLAMATION

By His Excellency the Governor of the State of Victoria and its Dependencies in the Commonwealth of Australia, &c., &c., &c.

WHEREAS by the *Land Act 1958* it is amongst other things enacted that the Governor in Council may, by Proclamation to be published in the *Government Gazette*, at any time diminish or increase the area of land comprised in any of the classes mentioned in Part I., Division 1, Section 5, of the said *Land Act 1958*, but that the area of lands which may be sold by auction (Class 6), shall not be increased except as in certain cases in the said Act provided: Now therefore I, the Governor of the State of Victoria, in the Commonwealth of Australia, by and with the advice of the Executive Council of the said State, and in accordance with the provisions of Sections 94 and 117 of the *Land Act 1958* aforesaid, do hereby diminish or increase (as the case may be) the areas of Crown lands comprised in Class 6 of the classes mentioned in Section 5 of the *Land Act 1958* aforesaid, to the extent set forth in the subjoined Schedule (that is to say) :—

Schedule referred to.

CLASSES DIMINISHED OR INCREASED.

County.	Parish.	Allotment.	Section.	Area.	Diminished.	Increased.	Description.
					Class.	Class.	
				A. R. P.			
Moira	Naringaningolook	20A	F	2 0 0	..	6	In the south of the Parish (H031907)
Karkaroc	Ouyen	26C	..	1 0 30	..	6	Adjacent to West side of Township of Ouyen. (M 62044).
Karkaroc	Ouyen	26D	..	1 0 10	..	6	Adjacent to West side of Township of Ouyen. (M 62044).

Given under my Hand and the Seal of the State of Victoria, aforesaid, at Melbourne, this twenty-fifth day of May, in the year of our Lord One thousand nine hundred and seventy-one, and in the twentieth year of the reign of Her Majesty Queen Elizabeth II.

ROHAN DELACOMBE.

(L.S.)

By His Excellency's Command,
W. BORTHWICK,
Minister of Lands.

GOD SAVE THE QUEEN !

BARLEY MARKETING ACT 1971.

DATE OF COMING INTO OPERATION OF SECTIONS 1, 3, 4 AND 5.

PROCLAMATION

By His Excellency the Governor of the State of Victoria and its Dependencies in the Commonwealth of Australia, &c., &c., &c.

WHEREAS by an Act of Parliament of the State of Victoria passed in the twentieth year of the reign of Her Majesty Queen Elizabeth II entitled the *Barley Marketing Act 1971*, it is amongst other things enacted that the several provisions of the said Act shall come into operation on a day or the respective days to be fixed by proclamation or successive proclamations of the Governor in Council published in the *Government Gazette*:

Now therefore I, the Governor of the State of Victoria, in the Commonwealth of Australia, by and with the advice of the Executive Council of the said State, do by this my Proclamation fix Wednesday, the ninth day of June, One thousand nine hundred and seventy-one as the day on which sections 1, 3, 4 and 5 of the said *Barley Marketing Act 1971* shall come into operation.

Given under my Hand and the Seal of the State of Victoria aforesaid, at Melbourne, this first day of June, in the year of our Lord One thousand nine hundred and seventy-one and in the twentieth year of the reign of Her Majesty Queen Elizabeth II.

(L.S.) ROHAN DELACOMBE.

By His Excellency's Command,
W. BORTHWICK,
Acting Minister of Agriculture.

GOD SAVE THE QUEEN !

Milk and Dairy Supervision Act 1958.

DEFINED URBAN DISTRICTS.

PROCLAMATION

By His Excellency the Governor of the State of Victoria and its Dependencies in the Commonwealth of Australia, &c., &c., &c.

IN pursuance of the powers conferred by section 99 of the *Milk and Dairy Supervision Act 1958* and all other powers enabling me in that behalf, I, the Governor of the State of Victoria, in the Commonwealth of Australia, by and with the advice of the Executive Council of the said State, do by this my Proclamation hereby define the portions of the municipal districts specified in the Schedule hereto as urban districts on and after the first day of July, 1971.

SCHEDULE.

(a) All those portions of the municipal district of the Shire of Dimboola within the Parishes of Dimboola and Watchegatcheca.

(b) All those portions of the municipal district of the Shire of Lowan within the Parishes of Balrootan and Kinimakatka.

Given under my Hand and the Seal of the State of Victoria aforesaid, at Melbourne, this twenty-fifth day of May in the year of our Lord One thousand nine hundred and seventy-one, and in the twentieth year of the reign of Her Majesty Queen Elizabeth II.

(L.S.) ROHAN DELACOMBE.

By His Excellency's Command,
W. BORTHWICK,
Acting Minister of Agriculture.

GOD SAVE THE QUEEN !

Milk and Dairy Supervision Act 1958.
MILK AREAS PROCLAIMED.

PROCLAMATION

By His Excellency the Governor of the State of Victoria and its Dependencies in the Commonwealth of Australia, &c., &c., &c.

WHEREAS by sub-section (1) of section 65 of the *Milk and Dairy Supervision Act 1958* it is provided that on the recommendation of the Minister any portion of Victoria may be proclaimed a milk area by the Governor in Council: And whereas by paragraph (b) of sub-section (1) of section 55 of the said Act it is provided that Part II of the said Act shall have effect as regards any milk area other than the Metropolitan Milk Area and the milk areas of Ballarat, Bendigo, Geelong, Castlemaine and Port Fairy on such day after the constitution thereof as is fixed by the Governor in Council: Now, therefore I, the Governor of the State of Victoria by and with the advice of the Executive Council thereof and on the recommendation of the Honorable the Acting Minister of Agriculture of the said State do by this my proclamation—

I. Declare the portions of Victoria defined in the Schedule hereto to be milk areas as specified on and after the first day of July, 1971; and

II. Do further declare that the first day of July, 1971 shall be the day on which Part II of the said Act shall have effect in such milk areas and all Regulations and Orders made thereunder now in operation shall be of full force and effect in such milk areas.

SCHEDULE.

Name of Milk Area.	Portion of Victoria.
Dimboola ..	All those portions of the municipal district of the Shire of Dimboola within the Parishes of Dimboola and Watchegatcheca.
Lowan ..	All those portions of the municipal district of the Shire of Lowan within the Parishes of Balrootan and Kinimakatka.

Given under my Hand and the Seal of the State of Victoria aforesaid, at Melbourne, this twenty-fifth day of May in the year of our Lord One thousand nine hundred and seventy-one, and in the twentieth year of the reign of Her Majesty Queen Elizabeth II.

(L.S.) ROHAN DELACOMBE.

By His Excellency's Command,
W. BORTHWICK,
Acting Minister of Agriculture.
GOD SAVE THE QUEEN!

GAS AND FUEL CORPORATION (PIPELINES) ACT 1971.

DATE OF COMING INTO OPERATION.

PROCLAMATION

By His Excellency the Governor of the State of Victoria and its Dependencies in the Commonwealth of Australia, &c., &c., &c.

IN pursuance of the powers conferred by the *Gas and Fuel Corporation (Pipelines) Act 1971*, No. 8122, and all other powers thereunto enabling, I, the Governor of the State of Victoria in the Commonwealth of Australia, by and with the advice of the Executive Council thereof do by this my Proclamation, fix the first day of July One thousand nine hundred and seventy-one as "the appointed day" for the purposes of the said Act.

Given under my Hand and the Seal of the State of Victoria aforesaid, at Melbourne, this twenty-fifth day of May in the year of our Lord One thousand nine hundred and seventy-one, and in the twentieth year of the reign of Her Majesty Queen Elizabeth II.

(L.S.) ROHAN DELACOMBE.

By His Excellency's Command,
JIM BALFOUR,
Minister for Fuel and Power.
GOD SAVE THE QUEEN!

Marine Act 1958.

AMENDMENT TO PORT RULE APPLICABLE TO WESTERNPORT HARBOR SERVICES (RATES AND CHARGES).

PORT RULE 132.

PROCLAMATION

By His Excellency the Governor of the State of Victoria and its Dependencies in the Commonwealth of Australia, &c., &c., &c.

WHEREAS by Part II. of the *Marine Act 1958* it is amongst other things enacted that the Governor in Council by Proclamation published in the *Government Gazette*, may from time to time define the limits and boundaries of ports in Victoria and frame rules and regulations for the governance and preservation of the said ports respectively and for the regulation of shipping in the same (including the imposition of charges for the use of mooring sites and other facilities):

And that any such regulation may from time to time be in like manner altered, amended or repealed and others substituted in their stead:

Now, therefore, I, the Governor of the State of Victoria in the Commonwealth of Australia by and with the advice of the Executive Council thereof, and in the exercise of the powers conferred by the said Act, by this Proclamation do hereby amend the Proclamation dated the 31st day of May, 1966, as follows:—

Delete the proviso added at the end of the Schedule to Clause 2 by amendment dated 24th November, 1970, and substitute therefor the following:—

"Provided that during the period between the 1st June, 1971, and 30th November, 1971, both dates inclusive, the tolls, rates or charges set forth in paragraphs (A), (B), (C) and (D) of this Schedule shall be reduced by fifty per cent., unless the Governor in Council by Proclamation determines otherwise."

Given under my Hand and the Seal of the State of Victoria aforesaid, at Melbourne, this twenty-fifth day of May, in the year of our Lord One thousand nine hundred and seventy-one, and in the twentieth year of the reign of Her Majesty Queen Elizabeth II.

(L.S.) ROHAN DELACOMBE.

By His Excellency's Command,
MURRAY BYRNE,
Minister of Public Works.

GOD SAVE THE QUEEN!

Firearms Act 1958.

APPLICATION OF PROVISIONS OF PART IIIA OF THE FIREARMS ACT 1958 TO THE SHIRE OF RODNEY.

PROCLAMATION

By His Excellency the Governor of the State of Victoria and its Dependencies in the Commonwealth of Australia, &c., &c., &c.

IN pursuance of the powers conferred by the *Firearms Act 1958*, I, the Governor of the State of Victoria, in the Commonwealth of Australia, by and with the advice of the Executive Council of the said State and on the application of the Council of the Shire of Rodney do by this my Proclamation declare the municipal district of the Shire of Rodney to be a district to which Part IIIA of the *Firearms Act 1958* applies.

Given under my Hand and the Seal of the State of Victoria aforesaid, at Melbourne, this twenty-fifth day of May in the year of our Lord One thousand nine hundred and seventy-one, and in the twentieth year of the reign of Her Majesty Queen Elizabeth II.

(L.S.) ROHAN DELACOMBE.

By His Excellency's Command,
IAN SMITH,
Acting Chief Secretary.

GOD SAVE THE QUEEN!

APPEAL COSTS FUND ACT 1964.

PROCLAMATION

By His Excellency the Governor of the State of Victoria and its Dependencies in the Commonwealth of Australia, &c., &c., &c.

WHEREAS by an Act of the State of Victoria intituled the *Appeal Costs Fund Act 1964* it is provided in Sections 14, 19 and 19A that the Governor in Council may by proclamation published in the *Government Gazette* fix amounts in lieu of the respective sums of money referred to in the said Sections.

Now therefore I, the Governor of the said State of Victoria, by and with the advice of the Executive Council thereof, do by this my proclamation

- (a) fix the sum of \$4000 in lieu of the sum of \$2000 referred to in paragraph (b) of sub-section (3) of Section 14 of the said Act;
- (b) fix the sum of \$200 in lieu of the sum of \$120.00 referred to in sub-section (2) of Section 14B of the said Act;
- (c) fix the sum of \$4000 in lieu of the sum of \$2000 referred to in sub-section (1) of Section 19 of the said Act; and
- (d) fix the sum of \$4000 in lieu of the sum of \$2000 referred to in sub-section (1) of Section 19A of the said Act.

Given under my Hand and the Seal of the State of Victoria aforesaid, at Melbourne, this first day of June, in the year of our Lord One thousand nine hundred and seventy-one, and in the twentieth year of the reign of Her Majesty Queen Elizabeth II.

(L.S.) ROHAN DELACOMBE.

By His Excellency's Command,

G. O. REID,
Attorney-General.

GOD SAVE THE QUEEN !

Summary Offences Act 1966.

APPLICATION OF PROVISIONS OF SECTION 50A OF THE SUMMARY OFFENCES ACT 1966 TO THE SHIRE OF BALLARAT.

PROCLAMATION

By His Excellency the Governor of the State of Victoria and its Dependencies in the Commonwealth of Australia, &c., &c., &c.

IN pursuance of the powers conferred by the *Summary Offences Act 1966*, I, the Governor of the State of Victoria, in the Commonwealth of Australia, by and with the advice of the Executive Council of the said State and on the application of the Council of the Shire of Ballarat do by this my Proclamation declare the municipal district of the Shire of Ballarat to be a district to which Section 50A of the *Summary Offences Act 1966* applies.

Given under my Hand and the Seal of the State of Victoria aforesaid, at Melbourne, this twenty-fifth day of May in the year of our Lord One thousand nine hundred and seventy-one, and in the twentieth year of the reign of Her Majesty Queen Elizabeth II.

(L.S.) ROHAN DELACOMBE.

By His Excellency's Command,

IAN SMITH,
Acting Chief Secretary.

GOD SAVE THE QUEEN !

Summary Offences Act 1966.

APPLICATION OF PROVISIONS OF SECTION 50A OF THE SUMMARY OFFENCES ACT 1966 TO THE SHIRE OF EUROA.

PROCLAMATION

By His Excellency the Governor of the State of Victoria and its Dependencies in the Commonwealth of Australia, &c., &c., &c.

IN pursuance of the powers conferred by the *Summary Offences Act 1966*, I, the Governor of the State of Victoria, in the Commonwealth of Australia, by and with the advice of the Executive Council of the said State and

on the application of the Council of the Shire of Euroa do by this my Proclamation declare the municipal district of the Shire of Euroa to be a district to which Section 50A of the *Summary Offences Act 1966* applies.

Given under my Hand and the Seal of the State of Victoria aforesaid, at Melbourne, this twenty-fifth day of May in the year of our Lord One thousand nine hundred and seventy-one, and in the twentieth year of the reign of Her Majesty Queen Elizabeth II.

(L.S.) ROHAN DELACOMBE.

By His Excellency's Command,

IAN SMITH,
Acting Chief Secretary.

GOD SAVE THE QUEEN !

Summary Offences Act 1966.

APPLICATION OF PROVISIONS OF SECTION 50A OF THE SUMMARY OFFENCES ACT 1966 TO THE SHIRE OF BUNINYONG.

PROCLAMATION

By His Excellency the Governor of the State of Victoria and its Dependencies in the Commonwealth of Australia, &c., &c., &c.

IN pursuance of the powers conferred by the *Summary Offences Act 1966*, I, the Governor of the State of Victoria, in the Commonwealth of Australia, by and with the advice of the Executive Council of the said State and on the application of the Council of the Shire of Buninyong do by this my Proclamation declare the municipal district of the Shire of Buninyong to be a district to which section 50A of the *Summary Offences Act 1966* applies.

Given under my Hand and the Seal of the State of Victoria aforesaid, at Melbourne, this twenty-fifth day of May in the year of our Lord One thousand nine hundred and seventy-one, and in the twentieth year of the reign of Her Majesty Queen Elizabeth II.

(L.S.) ROHAN DELACOMBE.

By His Excellency's Command,

R. J. HAMER,
Chief Secretary.

GOD SAVE THE QUEEN !

PUBLIC HALF-HOLIDAY.

PROCLAMATION

By His Excellency the Governor of the State of Victoria and its Dependencies in the Commonwealth of Australia, &c., &c., &c.

IN pursuance of the provisions contained in Part III. of the *Public Service Act 1958*, I, the Governor of the State of Victoria, in the Commonwealth of Australia, by and with the advice of the Executive Council of the said State, do by this my Proclamation appoint the day and date hereunder mentioned to be observed as a Public Half-Holiday at the place specified, viz.:—

Public Half-Holiday from the Hour of Twelve o'clock noon:—

Wednesday, the 21st July, 1971 throughout the City of Bendigo.

Given under my Hand and the Seal of the State of Victoria aforesaid, at Melbourne, this first day of June, in the year of our Lord One thousand nine hundred and seventy-one and in the twentieth year of the reign of Her Majesty Queen Elizabeth II.

(L.S.) ROHAN DELACOMBE.

By His Excellency's Command,

R. J. HAMER,
Chief Secretary.

GOD SAVE THE QUEEN !

BANK HALF-HOLIDAY.

PROCLAMATION

By His Excellency the Governor of the State of Victoria and its Dependencies in the Commonwealth of Australia, &c., &c., &c.

IN pursuance of the provisions of the *Bank Holidays Act 1958, 1*, the Governor of the State of Victoria, in the Commonwealth of Australia, do by this my Proclamation appoint the day and date named hereunder a special day to be observed as a Bank Half-Holiday at the place mentioned, that is to say:—

Bank Half-Holiday from the Hour of Eleven o'clock a.m.:—

Friday the 18th June, 1971 at Donald.

Given under my Hand and the Seal of the State of Victoria aforesaid, at Melbourne, this first day of June, in the year of our Lord One thousand nine hundred and seventy-one and in the twentieth year of the reign of Her Majesty Queen Elizabeth II.

(L.S.) ROHAN DELACOMBE.

By His Excellency's Command,
R. J. HAMER,
Chief Secretary.

GOD SAVE THE QUEEN!

GOVERNMENT NOTICES

PUBLIC HOLIDAY.—QUEEN'S BIRTHDAY.

IT is hereby notified that on—

MONDAY, THE 14TH JUNE, 1971,

the Public Offices will be closed, such day having been appointed by the *Public Service Act 1958*, to be observed as a holiday in the Public Offices throughout the State of Victoria.

This notice relates only to the closing of the State Public Offices. All inquiries regarding the holiday in other offices and in shops and industry should be directed to the Department of Labour and Industry, 110 Exhibition-street, Melbourne, 3000. (Telephone 63 0321, Extension 6158, 6859 or 6924.)

R. J. HAMER,
Chief Secretary.

Chief Secretary's Office,
Melbourne, 18th May, 1971.

NOTICE TO MARINERS.

[No. 11 of 1971.]

AUSTRALIA.—VICTORIA.

PORT PHILLIP.—ALTERATION IN LIGHT.

Date.—On or about 3rd June, 1971.

Position.—Portarlington Breakwater Head, Lat. 38 deg. 07 min. S., Long. 144 deg. 39 min. E. (approx.).

Remarks.—The fixed red electric light in the above position will be changed to a flashing white gas light. The new light will be shown from a wooden post 12 feet high.

Characteristics.—Flashing white every 6.0 seconds, flash 1.0 seconds, eclipse 5.0 seconds.

Elevation.—19 feet (5m8).

Visibility.—6 miles.

Abridged Description.—Fl. 6.0 sec. 19 ft. 9 m.

Charts Affected.—Aus. 157, B.A. 1171.

Publication.—*Sailing Directions*, Victoria, 1970, pages 228 and 607.

A. J. WAGGLEN,
Port Officer.

Public Works Department,
Ports and Harbors Division,
2 Treasury-place,
Melbourne, Vic., 3002, 19th May, 1971.

SHIRE OF LEXTON.
ROAD DEVIATION ORDER.

PURSUANT to the provisions of sections 522 and 526 of the *Local Government Act 1958*, the Council of the Shire of Lexton hereby directs that the land in the Parish of Glenlogie indicated by hatching on the diagram hereunder, which has been purchased, taken or occupied by it, shall be a public highway on and from the date of publication of this Order in the *Government Gazette* and declares that such land shall be a public highway in lieu of the land indicated by cross-hatching on the said diagram.

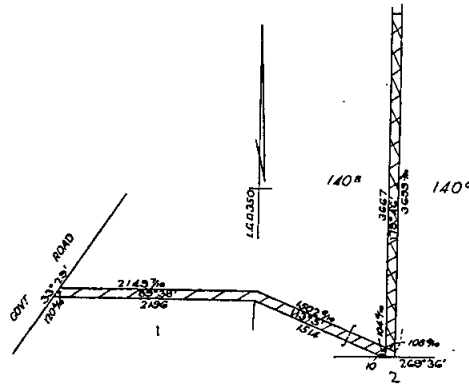

MEASUREMENTS ARE IN LINKS

The common seal of the President, Councillors and Ratepayers of the Shire of Lexton was hereunto affixed this seventh day of October, 1970, in the presence of—

(SEAL) W. P. MOLLOY, President.
J. G. KAYE, Councillor.
H. L. TEAGUE, Secretary.

Confirmed by the Governor in Council, 25th May, 1971.
—JOHN A. HORLOCK, Acting Clerk of the Executive Council.

SHIRE OF WARRNAMBOOL.
ROAD DEVIATION ORDER.

PURSUANT to the provisions of sections 522 and 526 of the *Local Government Act 1958*, the Council of the Shire of Warrnambool hereby directs that the land in the Parish of Wangoom indicated by hatching on the diagram hereunder, which has been taken, purchased or acquired by it, shall be a public highway on and from the date of publication of this Order in the *Government Gazette*, and declares that such land shall be a public highway in lieu of the land indicated by cross-hatching on the said diagram.

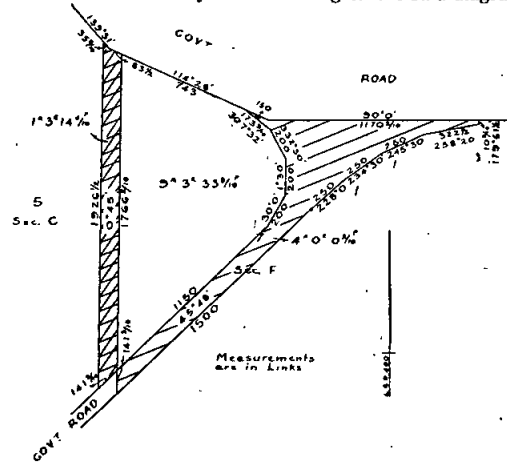

MEASUREMENTS ARE IN LINKS

The common seal of the President, Councillors and Ratepayers of the Shire of Warrnambool was hereunto affixed this 10th day of March, 1971, in the presence of—

(SEAL) A. WARBURTON, President.
R. A. CROTHERS, Councillor.
A. J. BOWES, Secretary.

Confirmed by the Governor in Council, 25th May, 1971.
—JOHN A. HORLOCK, Acting Clerk of the Executive Council.

Transport Regulation Act.

TRANSPORT REGULATION BOARD.

HEARING OF APPLICATIONS.

NOTICE is hereby given that the following applications will be considered by the Transport Regulation Board at its offices at the corner of Lygon and Princes streets, Carlton, at 10.15 a.m. on Wednesday, 23rd June, 1971.

- MCKENZIES TOURIST SERVICES PTY. LTD., 53 Barkers-road, Kew. One commercial passenger vehicle (S/C. 45) to operate as a metropolitan special service omnibus.
- NORTHERN BUS LINES PTY. LTD., Walter-street, Glenroy. One commercial passenger vehicle (S/C. 45) to operate as a touring omnibus on the following tours: 1. (a) Half-days to city sights, Healesville and Dandenong Ranges. (b) Full days to Phillip Island, Eildon, Lorne and Ocean-road. (c) Seasonal and specialized tours to be carried out under permit. 2. As a metropolitan special service omnibus.
- NUGENT, D. J. & J. E., 852 Mountain Highway, Bayswater. One commercial passenger vehicle with large seating capacity to operate as a metropolitan special service omnibus.
- NUGENT, D. J. & J. E., 852 Mountain Highway, Bayswater. Two commercial passenger vehicles (S/C. 16 and 14) to operate as Touring Omnibuses on the following tours: 1. Half-day tours to City and Suburbs, Airports and Sunbury (Emu Bottom), Dandenong Ranges. 2. Full day tours to Marysville—Acheron Way—Warburton, Healesville Sanctuary and Maroondah Dam, Phillip Island, Lorne and Ocean Beaches. 3. Seasonal and specialized day tours under permit authority. 4. As metropolitan special service omnibuses.

APPLICATION for renewal of licences as shown, by persons listed hereunder to operate under the same terms and conditions.

- ANDREWS, A. J., 207 Sussex-street, North Coburg; S.T.7876.
- ANGELINI, M. M., 21 Langham-street, Avondale Heights; S.T.7885.
- BRAY, L. D., 13 Rupert-street, East Brunswick; M.T.2737.
- CAMBOURNE, J. T., 356 Somerville-road, West Footscray; S.T.7879.
- CHRISTIANA, F. A., 26 Joyhill-avenue, Box Hill; S.T.7891.
- COLLINS, A. L., 9 Panorama-avenue, Highett; M.T.1406.
- CUNNINGHAM, W. R., 12 Halsbury-street, Hadfield; S.T.7902.
- DAVIES, C. G., 155 Hope-street, West Brunswick; M.T.2743.
- DENGL, S. (ESTATE OF THE LATE), 53 Haig-street, Box Hill; M.T.1358.
- ELLSON, E. F., 67 Lloyd-street, West Heidelberg; S.T.7862.
- GAZELAKIS, A., 181 Stephen-street, Yarraville; S.T.7880.
- GILBERT, L. (Mrs.), 3 Carlyle-crescent, West Heidelberg; M.T.2749T.
- HUGHES, H. T., 16 Eclipse-avenue, Watsonia; S.T.7898.
- INGRAM, R. C., 18 Richmond-street, Glenroy; S.T.7883.
- ISAACS, J. S., 45 Mackie-road, East Bentleigh; M.T.2741.
- LILLYCRAPP, R. W., 4 Pinewood-avenue, East Ringwood; S.T.7892.
- MCLANE, R. J., 266 Mary-street, Richmond; S.T.7900.
- MCDERMOTT, R. L., 8 Byron-court, West Heidelberg; S.T.7893.
- MCDONNELL, A. L., 42 Donald-street, Footscray; S.T.7887.
- MCPHERSON, N. A., 130 Summerhill-road, Glen Iris; M.T.1256.
- NIKAS, S., 40 East-street, Glenroy; S.T.7897.
- SHEPPARD, R. L., 48 Headingley-road, Mount Waverley; S.T.7875.
- SPADA, F., 46 Hamilton-street, Mont Albert; S.T.7870.
- TSATSARIS, K., 1 Fairmont-road, East Hawthorn; M.T.4274.
- VULETIC, A., 15 Sherwood-road, Ivanhoe; S.T.7895.
- WATSON, E. H., Flat 6, 468 Glenferrie-road, Hawthorn; S.T.7886.
- WATSON, G. MCN., 36 Salisbury-avenue, Ivanhoe; M.T.1260.
- WOODALL, J. F., 122 Cardinal-road, Glenroy; S.T.7882.
- YARR, P. N., 273 Nicholson-street, East Brunswick; M.T.2752.
- ZOIS, N., Flat 2, 124 Brighton-road, Elsternwick; M.T.4244.

Notice of any objection should be forwarded to reach the Secretary of the Board not later than Wednesday, 16th June, 1971.

Applicants are advised that it will not be necessary to appear on the hearing date specified above, unless advised in writing by the Board.

B. P. KAY,
Secretary.

Corner Lygon and Princes streets, Carlton, Wednesday, 2nd June, 1971.

Commercial Goods Vehicles Act.

TRANSPORT REGULATION BOARD.

HEARING OF APPLICATIONS.

NOTICE is hereby given that the following applications will be considered by the Transport Regulation Board at its offices at the corner of Lygon and Princes streets, Carlton, at 10.15 a.m. on Wednesday, 23rd June, 1971.

- ABERFELDIE QUARRIES & SAND SUPPLY PTY. LTD., Knighton-avenue, East Keilor, 3042. One commercial goods vehicle (L/C. 212 cwt.) to operate: (a) Within a 25-mile radius of the General Post Office in the City of Melbourne—general goods. (b) From pits at Cranbourne to places situated within a radius as defined in paragraph (a) above—sand. (c) From pits at Bacchus Marsh to places within paragraph (a) above—own sand and river gravel.
- ATKINS, K. C., 653 Chapel-street, South Yarra, 3141. One commercial goods vehicle (L/C. 13 cwt.) to operate throughout the State of Victoria in the course of business as "Frozen Food Distributors" in a specially constructed insulated and refrigerated vehicle—frozen processed meat, frozen poultry, frozen fish, frozen prepared meals and frozen processed vegetables.
- BRUNI & BISOGNI PTY. LTD., P.O. Box 251, Cobram, 3644. Two commercial goods vehicles (L/C. 10, 14 cwt.) to operate: (a) Within a 50-mile radius from the post office at Cobram in the course of business as "Building Contractors"—own goods. (b) Throughout the State of Victoria in the course of business as "Building Contractors"—own tools of trade and equipment. (c) Within a 20-mile radius from the site of any contract upon which the applicant is currently engaged—materials required for use in such contract.
- CALCIMO PTY. LTD., Willung South, 3844. One commercial goods vehicle (L/C. 139 cwt.) to operate: (a) Within a 50-mile radius respectively of any of own pits at Merriman's Creek, Longford, Yanakie or Bairnsdale to consignees within the said radius of each particular pit—own bulk lime. (b) Throughout the total combined area covered by the radii specified in part (a) of this application in the course of business as "Lime Contractor"—own equipment.
- CLEANAIR PTY. LTD., 19 Park-road, Cheltenham, 3192. One commercial goods vehicle (L/C. 10 cwt.) to operate: (a) Within a 50-mile radius of own premises at Cheltenham in course of business as "Air Conditioning Contractors"—own goods. (b) Throughout the State of Victoria for the purpose of installing and servicing of heating and air-conditioning units—tools of trade, ductwork for installation and spare parts incidental to servicing heating and air-conditioning plants on the site only.
- CONTRACT BOTTLERS PTY. LTD., 1317 North-road, Huntingdale, 3166. Three commercial goods vehicles (L/C. 78, 77, 77 cwt.) to operate within a 25-mile radius of the G.P.O., Melbourne, and to and from places on the Mornington Peninsula solely on behalf of associated companies, Loy Bros. Pty. Ltd., Crystal Softdrinks Pty. Ltd., and Riverside Distributors Pty. Ltd.—aerated waters and empty return containers.
- CORRADIN, T., 107 High-street, Seymour, 3660. One commercial goods vehicle (L/C. 232 cwt.) to operate: (a) Within a 50-mile radius from the post office at Seymour but excluding any operations south of an east/west line drawn through the Township of Craigieburn as a "Road Contractor"—road-making plant and materials. (b) Within a 25-mile radius of the post office at Seymour—general goods, provided that no goods shall be carried whether by one stage or by more than one stage between places within the above radius, which are more than thirty (30) road miles apart by the nearest practicable route.
- DERITE PTY. LTD., Commercial-road, Morwell, 3840. One commercial goods vehicle (L/C. 10 cwt.) to operate in that part of the State of Victoria situated east of a line drawn due north and south through the City of Geelong in the course of business as "Fibrous Plaster Manufacturers and Plaster Craftsmen"—(a) Own plaster sheets, plaster moulds, tiles, boards, suspended ceilings, tools of trade and sufficient plaster, battens, nails, sisal for the fixing of plaster sheets, plaster boards, mouldings, tiles and suspended ceilings. (b) As solid plasterers—sufficient plaster and cement only for use in affixing materials specified in part. (a) of this application.
- DIRECT MIX CONCRETE (SALES) PTY. LTD., Western Highway, Stawell, 3380. Two commercial goods vehicles (L/C. 145, 199 cwt.) to operate within a 50-mile radius of own premises at Stawell in the course of business as "Pre-Mixed Concrete Manufacturers"—premixed concrete in a specially constructed agitator vehicle.

- DIRECT MIX CONCRETE (SALES) PTY. LTD.**, Western Highway, Stawell, 3380. One commercial goods vehicle (L/C. 137 cwt.) to operate: (a) Within a 25-mile radius of the post office at Stawell—general goods, provided that no goods shall be carried whether by one stage or by more than one stage between places within the above radius, which are more than thirty (30) road miles apart by the nearest practicable route. (b) Within a 50-mile radius of own premises at Stawell in the course of business as "Pre-Mixed Concrete Manufacturers"—own goods.
- HUNT, L.**, (trading as Drouin West Sawmill), C/o Drouin West Sawmill, Drouin West, 3818. Application to vary the conditions of licences numbered D.T.1364, D.T.1364/1 (L/C. 295, 305 cwt.) by deleting paragraph (b) from the existing conditions and adding in lieu a new paragraph (b) and also adding a paragraph (e)—"(b) From own sawmill at Drouin West to consignees within a 50-mile radius thereof—own sawn timber. (e) From own sawmill at Drouin West to consignees within a 50-mile radius thereof and to consignees within a 25-mile radius of the post office situated at the corner of Bourke and Elizabeth streets in the City of Melbourne—own pallets."
- DUFF, A. J.**, 9 Charles-street, Koo-wee-rup, 3981. Application to vary the conditions of licence No. D.A.46415 (L/C. 137 cwt.) by deleting paragraph (a) from the existing conditions and adding in lieu: "(a) Within a 25-mile radius of the post office at Koo-Wee-Rup—general goods subject to the condition that no goods shall be carried whether in one or more stages from any one point within the said radius situated more than thirty (30) miles apart by the nearest practicable route."
- ECLIPSE RADIO PTY. LTD.**, 289 Elizabeth-street, Melbourne, 3000. One commercial goods vehicle (L/C. 14 cwt.) to operate within a 50-mile radius of own branch premises at Leongatha in the course of business as "Hardware and Electrical Appliance Retailer"—own goods, subject to the conditions that every journey made is confined wholly within the said radius and that no goods are carried on the vehicle to any point within that radius for the purpose of transfer or transhipment to another vehicle (whether licensed in the name of the applicant or not) for the carriage to a destination outside that radius.
- NOTE.—Nothing contained above shall be deemed to authorise the rights thereby granted to be linked with the franchise area held by the applicant under any other licence with a view to enlarging the franchise area specified above.
- F.F.E. GROUP LTD.**, 203 Bouverie-street, Carlton, 3053. One commercial goods vehicle (L/C. 20 cwt.) to operate throughout the State of Victoria in the course of business as "Fire Protection Engineers"—fire fighting appliances and fire protection and detection equipment, also tools of trade and materials incidental to on site servicing of fire fighting appliances and equipment.
- FOODLAND STORES PTY. LTD.**, 619 Springvale-road, Glen Waverley, 3150. One commercial goods vehicle (L/C. approximately 240 cwt.) to operate from bulk store of Foodland Stores Pty. Ltd. at Glen Waverley to associated retail grocery stores of the Foodland group situated within a 25-mile radius of Foodland Warehouse in Springvale-road, Glen Waverley and/or in the Mornington Peninsula, Koo-Wee-Rup, Warburton, Healesville, Wesburn and Bunyip—groceries solely on behalf of the said Foodland Stores Pty. Ltd.
- FREEMANTLE, R. W. & M. J.**, "Glenvale", Eddington, 3472. One commercial goods vehicle (L/C. 240 cwt.) to operate: (a) Throughout the State of Victoria in the course of business as an approved Decentralized Secondary Industry (Stock Feed Manufacturer) carried on at own premises at Eddington as follows:—(i) To such premises—own goods and materials for use in the manufacturing processes of such decentralized secondary industry; (ii) From such premises—own manufactured products of such decentralized secondary industry for delivery to consumers. (b) Within a 50-mile radius of the post office at Eddington in the course of business as "Primary Producer"—own goods.
- FRYERS, H. T.**, Koallah, 3257. Two commercial goods vehicles (L/C. 240, 63 cwt.) to operate: (a) Within a 25-mile radius of the post office at Koallah—general goods, provided that no goods shall be carried whether by one stage or by more than one stage between places within the above radius which are more than thirty (30) road miles apart by the nearest practicable route. (b) Within a 50-mile radius of the post office at Koallah in the course of business as "Primary Producer"—own goods. (c) Within a 50-mile radius of the post office at Koallah—livestock.
- GIANNALLI, V. & D.**, 14 O'Donnell-street, Reservoir, 3073. One commercial goods vehicle (L/C. 209 cwt.) to operate within a 35-mile radius of the G.P.O. Melbourne on behalf of Pioneer Quarries (Vic.) Pty. Ltd. sand, soil, screenings, premix and quarry products.
- GUZZARDI, J.**, 4 Hiam-court, Morwell, 3840. One commercial goods vehicle (L/C. 274 cwt.) to operate from the sawmill of "Thompson River Sawmills" at Erica to consignees situated within the Melbourne Metropolitan Area—sawn timber.
- HILL, D. F.**, (trading as D. F. & E. A. Hill), 4 Wentworth-road, Wonthaggi, 3995. Two commercial goods vehicles (L/C. 320, 170 cwt.) to operate throughout that part of the State of Victoria situated east of a north/south line drawn through Brooklyn, west of a north/south line drawn through Maffra and south of an east/west line drawn through Maffra, and to places situated on the Mornington Peninsula in the course of business as "Animal By-Products Processors"—offal, bones, fat, chicken feathers, carcasses, inedible meat, animal runners, animal waste materials and blood in drums for collection and return to own premises at Lance Creek.
- PADDY HOARE PTY. LTD.**, 271 Church-street, West Geelong, 3218. One commercial goods vehicle (L/C. 282 cwt.) to operate throughout the State of Victoria in the course of business as "Excavation Contractors"—own tools of trade, plant and equipment.
- PADDY HOARE PTY. LTD.**, 271 Church-street, West Geelong, 3218. One commercial goods vehicle (L/C. 17 cwt.) to operate: (a) Within a 50-mile radius of own premises at West Geelong in the course of business as "Excavation Contractors"—own goods. (b) Throughout the State of Victoria for the purpose of completing own contracts—tools of trade and own concrete cutting machine.
- HOBSON, M. R.**, Lexton, 3352. One commercial goods vehicle (L/C. 236 cwt.) to operate: (a) Within a 25-mile radius of the post office at Lexton—general goods subject to the condition that no goods shall be carried whether in one or more stages from any one point within the said radius to any other point within the said radius situated more than thirty (30) miles apart by the nearest and most practicable route. (b) From and to places situated within a 25-mile radius of the post office at Lexton to and from places outside that radius but wholly within a 50-mile radius of the post office at Lexton—livestock.
- HOVEY, R. C.** (trading as Hoveys Transport Service), Thompsons-road, North Geelong, 3215. One commercial goods vehicle (L/C. 400 cwt.) to operate: (a) Within a 25-mile radius of the chief post office in the City of Geelong—general goods. (b) From and to places situated within the radius defined in paragraph (a) above to and from places outside that radius of fifty (50) miles of the chief post office in the City of Geelong—livestock.
- HUNT, L.**, care of Drouin West Sawmill, Drouin West, 3818. Application to vary the conditions of licence No. D.T.1245 by deleting paragraph (b) from existing conditions and adding in lieu a new paragraph (b) and also adding a paragraph (e)—"(b) From own sawmill at Drouin West to consignees within a 50-mile radius thereof—own sawn timber. (e) From own sawmill at Drouin West to consignees within a 50-mile radius thereof and to consignees within a 25-mile radius of the post office situated at the corner of Bourke and Elizabeth streets, in the City of Melbourne—own pallets."
- IRWIN, G. F.**, 6 Powell-street, East Geelong, 3219. One commercial goods vehicle (L/C. 8 cwt.) to operate throughout the State of Victoria in the course of business as "Tree Remover"—own plant and own equipment incidental to own contracts.
- KING, H. C., PTY. LTD.**, Yinnar, 3869. Application to vary the conditions of licences numbered D.A.28096/3, D.A.28096/5, D.A.28096/6 (L/C. 73, 79, 170 cwt.) by deleting paragraph (d) and adding in lieu as paragraph (d) "Within a 50-mile radius of the railway station at Yinnar—stock feed and manufactured products solely on behalf of K.M.M. Stock Feeds Pty. Ltd."
- KING, H. C., PTY. LTD.**, Yinnar, 3869. Application to vary the conditions of licence No. D.A.28096/4 (L/C. 72 cwt.) by deleting paragraph (a) and adding in lieu—"(a) Within a 50-mile radius of the railway station at Yinnar—stock feed and manufactured products solely on behalf of K.M.M. Stock Feeds Pty. Ltd."
- LOGAN, A. N.**, 29 Hilda-street, Essendon, 3040. One commercial goods vehicle (L/C. 119 cwt.) to operate: (a) Within a 25-mile radius of the G.P.O., Melbourne—general goods. (b) Within a 50-mile radius of G.P.O., Melbourne—livestock.

MALCOLM, J. H., 462 Dorset-road, South Croydon, 3136. One commercial goods vehicle (L/C. 114 cwt.) to operate within a 70-mile radius from the premises of Brick and Pipe Industries Ltd. at Auburn on behalf of the said company—bricks and empty pallets for return.

MANN, J., & SON PTY. LTD., 118-120 High-street, Wodonga, 3690. One commercial goods vehicle (L/C. 141 cwt.) to operate: (a) Within a 25-mile radius of own premises at Wodonga in the course of business as "General Merchants and Steel Wholesalers"—own goods. (b) Within a 50-mile radius of the post office at Wodonga—steel, steel tubing and reinforcing wire mesh on a specially constructed vehicle.

MILLER, JAMES, & CO. PTY. LTD., 29 Dawson-street, Brunswick, 3056. One commercial goods vehicle (L/C. 10 cwt.) to operate within a 50-mile radius from own premises at Brunswick and to and from own approved decentralized secondary industry premises at Warragul in course of business as "Flax and Hemp Spinners, Rope, Twine and Thread Manufacturers"—own goods.

MCCLUSKEY, M. J., 195 Westblade-avenue, Kerang, 3579. Two commercial goods vehicles (L/C. approximately 150, 200 cwt.) to operate: (a) Within a 50-mile radius from the post office at Kerang as a "Road Contractor"—road-making plant and materials. (b) Within a 25-mile radius from the post office at Kerang—general goods, provided that no goods shall be carried whether by one stage or by more than one stage between places within the above radius which are more than thirty (30) road miles apart by the nearest practicable route.

PEARCE, J., 7 Gray-street, Springvale, 3171. One commercial goods vehicle (L/C. 140 cwt.) to operate from own sawmill at Bunyip to building sites within a 25-mile radius of the post office situated at the corner of Bourke and Elizabeth streets in the City of Melbourne—own sawn timber.

RENTON, G. C., care of Village Drive-in, Thompson-road, Moe, 3825. One commercial goods vehicle (L/C. 15 cwt.) to operate: (a) Between the Village Drive-in Theatres situated at Moe and Morwell and the premises of Village Theatre supplies at North Richmond—urgently required projector parts, projection equipment and film carbons. (b) Within a 25-mile radius from the post office at Moe—general goods, provided that no goods shall be carried whether by one stage or by more than one stage between places within the above radius which are more than thirty (30) miles apart by the nearest practicable route.

ROWE, GAVIN, & CO. PTY. LTD., Coleraine-road, Hamilton, 3300. One commercial goods vehicle (L/C. 139 cwt.) to operate: (a) From forest landings within a 75-mile radius of the post office at Hamilton to own sawmill at Hamilton—logs. (b) From own timber yard at Hamilton to places within a 50-mile radius of the post office at Hamilton—sawn timber. (c) Within a 25-mile radius of the post office at Hamilton—general goods, provided that no goods shall be carried whether by one stage or by more than one stage between places within the above radius which are more than thirty (30) road miles apart by the nearest and most practicable route. (d) Within a 75-mile radius of the post office at Hamilton—own tractors, logging equipment and tools of trade incidental to the repair of own equipment.

SIMPSON, F. N., Box 120, Wycheproof, 3527. One commercial goods vehicle (L/C. 235 cwt.) to operate within that part of the State of Victoria west of a north/south line drawn through the Township of Bacchus Marsh in the course of business as a "Road Contractor"—own tools of trade, plant and equipment, and sufficient fuel and lubricants (not exceeding 3 x 44 gallon capacity drums at any one time) for the operation of own machinery in the field only.

STEVENSON, G. R., Licola-road, Heyfield, 3858. One commercial goods vehicle (L/C. 271 cwt.) to operate: (a) From forest landings in the Connors Plains, Mt. McDonald and Mt. Tamboritha area to sawmills at Heyfield—mill logs. (b) Within a 25-mile radius of the post office at Heyfield with the proviso that no goods shall be carried whether by one stage or by more than one stage between places within the above radius which are more than thirty (30) road miles apart by the nearest practicable route—general goods.

THOMAS, L. J., 35 Gilbank-street, Reservoir, 3073. One commercial goods vehicle (L/C. 12 cwt.) to operate within a 75-mile radius of the G.P.O., Melbourne as a "Service Agent" solely on behalf of Simpson Pope Ltd. for the purpose of servicing washing machines, stoves and home appliances—tools of trade, spare parts and appliances for repair or having been repaired.

TRARALGON JOINERY & TRADING PTY. LTD., Clift-street, Traralgon, 3844. One commercial goods vehicle (L/C. 134 cwt.) to operate within a 35-mile radius of the post office situated at Traralgon in the course of own business as "Cabinet Makers and Joiners"—own goods.

WILSON, A. E., 75 Mine-road, Korumburra, 3950. One commercial goods vehicle (L/C. 125 cwt.) to operate throughout the State of Victoria in the course of business as "House Remover"—houses and sheds for removal and subsequent re-erection and also tools of trade and equipment incidental thereto.

RENEWALS.

APPLICATIONS for renewal of licences as shown by persons listed hereunder to operate under the same terms and conditions from the expiry shown in each case.

ALBION REID PTY. LTD., 83 Riversdale-road, Hawthorn, 3122; D.A.520/106; 13th November, 1971; 167 cwt.

POLITES, A. (trading as Aleck Seafoods), No. 2 South Wharf, South Melbourne, 3205; T.D.A.63573; 26th October, 1971; 140 cwt.

ALFA-LAVAL PTY. LTD., 56-60 Keon-parade, Keon Park, 3073; D.A.22799/6; 17th November, 1971; 6 cwt.

BEAUREPAIRE TYRE SERVICE PTY. LTD., 102 Victoria-street, Carlton, 3053; D.A.629/82; 9th September, 1971; 21 cwt.

BENDIGO INVESTMENTS LTD., 27 Queen-street, Bendigo, 3550; D.A.61251; 20th November, 1971; 12 cwt.

BLACKNEY, C. A., K., & R. (trading as C. A. Blackney & Sons) BASS HIGHWAY, The Gurdies, via Lang Lang, 3984; D.A.683/1; 3rd November, 1971; 247 cwt.; D.A.683/2; 3rd November, 1971; 109 cwt.

BLENNER HASSETT, J. & L. C., 33 Koonwarra-road, Leon-gatha, 3953; D.A.60464/3; 20th November, 1971; 261 cwt.

BONE, R. S. (trading as S. H. Bone & Son), Breakwater-road, East Belmont, 3216; D.A.22951; 21st November, 1971; 119 cwt.

BRANSON, L. N., 17 Theodore-avenue, Noble Park, 3174; D.A.36990; 3rd November, 1971; 11 cwt.

BROOKS, JACK, & CO., 996 Wewak-street, Albury, New South Wales, 2640; D.A.61201; 16th October, 1971; 227 cwt.; D.A.61201/1; 16th October, 1971; 159 cwt.

BROWN'S OFFICE CLEANING SERVICES PTY. LTD.; 367 High-street, Kew, 3101; D.A.750/39; 20th November, 1971; 20 cwt.

DENHAM CONSTRUCTION PTY. LTD., 53 Tyabb-road, Morning-ton, 3931; D.A.37214; 16th November, 1971; 139 cwt.

CARLESSO, E., 28 Church-street, Werribee, 3030; D.A.61242; 13th November, 1971; 36 cwt.

CHISHOLM, R. A., 25 Briggs-street, East Oakleigh, 3166; D.A.22647/1; 9th November, 1971; 139 cwt.

DETNOR MOTORS PTY. LTD., 20 Chisholm-street, Wangaratta, 3677; D.A.49502; 18th November, 1971; 20 cwt.

DONELAN, A. L., Eskdale P.O., 3701; D.A.988/3; 20th November, 1971; 148 cwt.

DOODT, N., & SONS PTY. LTD., Creswick-road, Ballarat, 3350; D.A.24214/1; 9th November, 1971; 299 cwt.

DUNLOP TYRE SERVICE (VIC.) PTY. LTD., Colac Branch, 108 Flinders-street, Melbourne, 3000; D.A.60416/41; 18th November, 1971; 14 cwt.

FLYNN, F. H., 21 Spearing-street, Wangaratta, 3677; D.A.37345; 16th November, 1971; 10 cwt.

GILBARCO AUST. LTD., 11 Anderson-road, Thornbury, 3071; D.A.1144/30; 10th November, 1971; 14 cwt.

GREEN, F. L., Standish-street, Myrtleford, 3737; D.A.48511/1; 5th November, 1971; 33 cwt.

GUNN, B. J., 62 Vine-street, Bendigo, 3550; D.A.50474; 18th November, 1971; 11 cwt.

KIMBERLEY, C. R., Tennyson-street, Quambatook, 3540; D.A.50710; 18th November, 1971; 11 cwt.

KEOGH, P., PTY. LTD., 371 Francis-street, Yarraville, 3013; D.A.6989/1; 31st October, 1971; 300 cwt.

KEOGH, P., PTY. LTD., 371 Francis-street, Yarraville, 3013; T.D.A.6989/16; 29th June, 1971; 307 cwt.

KEOGH, P., PTY. LTD., 371 Francis-street, Yarraville, 3013; D.A.6989/7; 3rd September, 1971; 10 cwt.

MARSHALL, L. K. & M. L., 23 Lee-avenue, Springvale North, 3171; D.A.49998; 3rd September, 1971; 18 cwt.

MAWSON, E. B., & SONS PTY. LTD., 141 King George-street, Cohuna, 3568; D.A.30119/17; 3rd November, 1971; 14 cwt.

MCGARVIE, B. W., 170 Edgar-street, Portland, 3305; D.A.50460; 18th November, 1971; 10 cwt.

McMULLEN'S TRANSPORT PTY. LTD., Tyndall-street, Orbost, 3888; T.D.A.64331/4; 16th November, 1971; 316 cwt.

McMULLEN'S TRANSPORT PTY. LTD., Tyndall-street, Orbost, 3888; D.T.620/17; 20th November, 1971; 134 cwt.

McMULLEN'S TRANSPORT PTY. LTD., Tyndall-street, Orbost, 3888; D.T.1423/15; 20th November, 1971; 350 cwt.; D.T.1423/8; 20th November, 1971; 381 cwt.; D.T.1423/7;

20th November, 1971; 314 cwt.; D.T.1423/5; 20th

November, 1971; 332 cwt.; D.T.1423/4; 20th November, 1971; 319 cwt.; D.T.1423/3; 20th November, 1971; 418 cwt.; D.T.1423/2; 20th November, 1971; 391 cwt.; D.T.1423/1; 20th November, 1971; 438 cwt.; D.T.1423; 20th November, 1971; 381 cwt.

NEON ELECTRIC SIGNS LTD., 1-9 Cecil-street, South Melbourne, 3205; D.A.1713; 24th October, 1971; 45 cwt.

PHELAN, W., & SONS PTY. LTD., 157 High-street, Maryborough, 3465; D.A.3633/21; 18th November, 1971; 15 cwt.; D.A.3633/22; 18th November, 1971; 16 cwt.; D.A.3633/23; 18th November, 1971; 12 cwt.

PHILLIPS, L. D., Glenfyne Wayside via Cobden, 3266; D.A.41241/1; 14th October, 1971; 15 cwt.

PULLEN, P., Box 157, Casterton, 3311; D.A.49971; 5th November, 1971; 232 cwt.

RICKEY, A. H., 8 Symons-street, Wendouree, 3355; D.A.5921/3; 18th November, 1971; 123 cwt.

ROCHE BROS. PTY. LTD., 22 Dynon-road, South Kensington, 3031; D.A.1941/27; 3rd November, 1971; 30 cwt.

SANITARIUM HEALTH FOOD CO., 118 Union-street, Windsor, 3181; D.A.1984/11; 23rd October, 1971; 144 cwt.

SCHADE, W. L., 6 Henkel-street, Bendigo, 3550; D.A.59477/3; 13th November, 1971; 30 cwt.

SCHWEPPE (AUST.) LTD., P.O. Box 12, Sebastopol, 3356; T.D.A.34505/57; 3rd November, 1971; 110 cwt.; T.D.A.34505/58; 3rd November, 1971; 141 cwt.

SHEPPARTON PLASTER WORKS, 2 Mason-street, Shepparton, 3630; D.A.13047/3; 27th November, 1971; 61 cwt.; D.A.13047/6; 27th November, 1971; 108 cwt.; D.A.13047/7; 27th November, 1971; 85 cwt.; D.A.13047/8; 27th November, 1971; 9 cwt.; D.A.13047/9; 27th November, 1971; 33 cwt.; D.A.13047/10; 27th November, 1971; 60 cwt.

SUTTONS PTY. LTD., 107 Little Malop-street, Geelong, 3220; D.A.44115/4; 16th October, 1971; 11 cwt.

THERMAL TRADERS (VIC.) PTY. LTD., 999 Rathdowne-street, North Carlton, 3054; D.A.31801/37; 28th October, 1971; 14 cwt.

TRANCO DELIVERY PTY. LTD., Lennon-street, South Kensington, 3031; D.A.35236/10; 20th November, 1971; 139 cwt.

TRANCO DELIVERY PTY. LTD., Lennon-street, South Kensington, 3031; D.A.35236/4; 3rd November, 1971; 248 cwt.

UNITED STEVEDORING PTY. LTD., THE, 88-102 Normandy-road, South Melbourne, 3205; D.A.37197; 16th November, 1971; 105 cwt.

WALSH, R. D., 16 Naretha-street, Swan Hill, 3585; D.A.37371; 12th October, 1971; 248 cwt.

WISEMAN, J. H., & SONS PTY. LTD., 69 Gipps-street, Collingwood, 3066; D.A.37454; 3rd November, 1971; 10 cwt.; D.A.37454/1; 3rd November, 1971; 8 cwt.; D.A.37454/2; 3rd November, 1971; 10 cwt.

YOUNG, H. A., Swifts Creek P.O., 3896; D.A.61391; 20th November, 1971; 8 cwt.

TOW TRUCK RENEWALS.

FLAMINI'S MOTORS, 50 Reid-street, North Fitzroy, 3068; D.A.47752/2; 11th November, 1971; 25 cwt.

G.M.D. REFRIGERATION, 14-16 Kolora-road, West Heidelberg, 3081; D.A.55573/1; 13th November, 1971; 10 cwt.

GRIFFIOEN, P., Midland Highway, Creswick, 3363; D.A.61153; 13th November, 1971; 36 cwt.

KEIDON FORD PTY. LTD., 44 Godfrey-street, Boort, 3537; D.A.34043/3; 27th November, 1971; 74 cwt.

ONE MILE MOTORS, 10 Templeton-street, Wangaratta, 3677; D.A.50704; 18th November, 1971; 49 cwt.

SEARS TOWING SERVICE, 101-107 York-street, South Melbourne, 3205; D.A.34439/5; 16th November, 1971; 47 cwt.

RENEWALS WITH VARIATION.

APPLICATIONS made by the persons listed hereunder for renewal of the licences listed with variation of conditions in the manner set out opposite the names.

BEAUREPAIRE TYRE SERVICE PTY. LTD., 102 Victoria-street, Carlton, 3053; D.A.629/83; 9th September, 1971; Application to renew and vary the conditions of licence No. D.A.629/83 by deleting from the existing conditions "Mitcham" and adding in lieu "Dandenong".

CIVENG CONSTRUCTIONS PTY. LTD., 108 Little Malop-street, Geelong, 3220; D.A.61171; 9th October, 1971; Application to vary the conditions of licence No. D.A.61171 (L/C. 186 cwt.) by deleting the existing conditions and adding in lieu:—(a) Throughout the State of Victoria in the course of business as 'Civil Engineering Contractors'—tools of trade and equipment incidental to own contracts. (b) Within a 20-mile radius of any contract currently engaged upon in the

course of business as 'Contractors and Civil Engineers'—materials required for the completion of such contracts."

Notice of any objection should be forwarded to reach the Secretary of the Board not later than 16th June, 1971.

Applicants are advised that it will not be necessary to appear on the hearing date specified above, unless advised in writing by the Board.

B. P. KAY,
Secretary.

Corner Lygon and Princes streets, Carlton, 3053, 2nd June, 1971.

Survey Co-ordination Act 1958, No. 6388.

NOTICE OF ASSIGNMENT OF A NAME.

PURSUANT to the powers conferred under section 29 of the above Act, the Place Names Committee hereby gives notice that it has assigned the following name to the under-mentioned locality:—

Municipality.—City of Altona.

Location.—Sited in the south-western corner of the City of Altona.

Name Assigned.—Altona Meadows.

By order of the Committee,
C. E. E. BARLOW,
Secretary.

Survey Co-ordination Act 1958, No. 6388.

NOTICE OF ASSIGNMENT OF A NAME.

PURSUANT to the powers conferred under section 29 of the above Act, the Place Names Committee hereby gives notice that it has assigned the following name to the Reserve mentioned hereunder:—

Municipality.—Shire of Narracan.

Location.—Sited in the north-western corner of the Parish of Tanjil, between the roads forming the northern and western boundaries of that Parish and the Tanjil River, and comprising an area of 368 acres, more or less.

Name Assigned.—Old Tanjil Public Park Reserve.

By order of the Committee,
C. E. E. BARLOW,
Secretary.

Survey Co-ordination Act 1958, No. 6388.

NOTICE OF THE ALTERATION OF A NAME.

PURSUANT to the powers conferred under section 29 of the above Act, the Place Names Committee hereby gives notice of the alteration of the name of the coastal feature mentioned hereunder:—

Municipality.—Shire of South Barwon.

Location.—Sited within the municipal district of the Shire of South Barwon on the shore of Bass Strait at the mouth of the Barwon River.

Old Name.—Point Flinders.

New Name.—Barwon Head.

By order of the Committee,
C. E. E. BARLOW,
Secretary.

HONOURS.

ADVICE has been received from the Secretary of State for Commonwealth Affairs that The Queen has been graciously pleased to award the Imperial Service Medal to the following officers of the Victorian Public Service on their retirement:—

LUNN, BENJAMIN FREDERICK,
Senior Inspector of Works, Public Works
Department, and
MILLS, ALFRED RANDALL,
Senior Draftsman, Public Works Department.

Notification of the Awards appeared in the Supplement to the *London Gazette*, dated 11th May, 1971, page 4857.

A. G. COULTHARD, Secretary,
Premier's Department.
26th May, 1971.

Private Agents Act 1966.

NOTICE OF RECEIPT OF APPLICATIONS FOR LICENCES UNDER THE PROVISIONS OF THE PRIVATE AGENTS ACT 1966.

THE Clerk(s) of the Magistrates' Court(s) as listed hereunder hereby give notice that applications, as under, have been lodged for hearing by the said Court(s) on the date(s) specified.

Any person desiring to object to any of such applications must—

- (a) lodge with the respective Clerk of the Magistrates' Court a notice in the prescribed form of his objection and of the grounds thereof;
- (b) cause a copy of such notice to be served personally or by post upon the applicant at least three days before the hearing of the application; and
- (c) send or deliver—
 - (i) where the objection is not made by the officer in charge of the police district in which the Court is situated—a copy of the notice to such officer; and
 - (ii) where the objection is not made by the Registrar or Deputy Registrar—a copy to the Registrar.

Full Name of Applicant or in the Case of a Firm or Corporation, of the Nominee.	Place of Abode of Applicant or Nominee.	Name of Firm or Corporation.	Address for Registration.	Type of Licence.	Date of Hearing of Application.
MAGISTRATES' COURT, MELBOURNE.					
McGowan, William James	44 Brisbane-street, Berwick	Australian Watching Co. Pty., Ltd.	340 Abbotsford-street, North Melbourne	Watchman	16.6.71
McLean, James John	Unit 1, Anderson-street, Yarraville	" "	" "	"	"
O'Connell, William Edward	23 Wisewold-street, Ascot Vale	" "	" "	"	"
Price, Graham Arthur	Flat 17, 27 Southey-street, Elwood	" "	" "	"	"
Tennyson, Allan Bruce	10 Ormond Ruby-street,	" "	" "	"	"
Van Der Wal, John	15 Grace-street, St. Albans	" "	" "	"	"
West, Stanley Clifford	12 Neal-court, North Altona	" "	" "	"	"
Angus, Donald Armstrong	11 Sandy-street, Nunawading	" "	" "	"	"
"	"	"	"	Inquiry Agent	"

Dated at Melbourne this 26th day of May, 1971.

G. L. WEBSTER, Clerk of the Magistrates' Court.

MAGISTRATES' COURT, MELBOURNE.					
Anderson, Michael Alan	18 Russell-street, Werribee	Australian Watching Co. Pty., Ltd.	340 Abbotsford-street, North Melbourne	Watchman	16.6.71
Angell, Warwick Miles	89 Roberts-street, Essendon	" "	" "	"	"
Bell, John	9 Knox-street, East Malvern	" "	" "	"	"
Benson, Alfred	63 Dundas-place, Albert Park	" "	" "	"	"
Campbell, William Colin	62 Andrew-street, Glenroy	" "	" "	"	"
Charlton, Matthew Calvert	9 Dane-street, Seddon	" "	" "	"	"
Fawcett, Kenneth	34 Drake-street, Brighton	" "	" "	"	"
Houston, Samuel	Flat 1, 21 Herbert-street, St. Kilda	" "	" "	"	"
Jones, Claude Buck	12 Towong-court, Broadmeadows	" "	" "	"	"
Laycock, Aaron	Empire Hotel, Latrobe-street, Melbourne	" "	" "	"	"
Logan, Robert Patrick	10 Kathryn-street, Doveton	" "	" "	"	"

Dated at Melbourne this 26th day of May, 1971.

G. L. WEBSTER, Clerk of the Magistrates' Court.

MAGISTRATES' COURT, BOX HILL.					
Boyd, Patrick	1 Alexander-street, Box Hill	"	1 Alexander-street, Box Hill	Process Server	18.6.71

Dated at Box Hill this 27th day of May, 1971.

A. J. JOHNSON, Clerk of the Magistrates' Court.

MAGISTRATES' COURT, CAMBERWELL.					
Bellchambers, Roger Lindsay	117 Toorak-road, South Camberwell	"	117 Toorak-road, South Camberwell	Process Server	17.6.71

Dated at Camberwell this 26th day of May, 1971.

J. C. TOBIN, Clerk of the Magistrates' Court.

MAGISTRATES' COURT, FITZROY.					
Gounaris, George	169 Alexandra-parade, North Fitzroy	"	169 Alexandra-parade, North Fitzroy	Inquiry Agent	17.6.71

Dated at Fitzroy this 25th day of May, 1971.

G. S. HOARE, Clerk of the Magistrates' Court.

PRIVATE AGENTS—continued.

Full Name of Applicant or in the Case of a Firm or Corporation, of the Nominee.	Place of Abode of Applicant or Nominee.	Name of Firm or Corporation.	Address for Registration.	Type of Licence.	Date of Hearing of Application.
---	---	------------------------------	---------------------------	------------------	---------------------------------

MAGISTRATES' COURT, SUNSHINE.

Mallon, Gerald	32 Bird-street, Deer Park	32 Bird-street, Deer Park	Guard Agent ..	18.6.71
------------------------	---------------------------	---------	---------------------------	----------------	---------

Dated at Sunshine this 26th day of May, 1971.

O. BOURKE, Clerk of the Magistrates' Court.

MAGISTRATES' COURT, PORT MELBOURNE.

Boyd, Dennis David	470 Whitehorse-road, Mitcham	Mayne Nickless Ltd.	538 Williamstown-road, Port Melbourne	Watchman ..	17.6.71
Stride, Ralph Barrie	20 Shirley-avenue, Seaford	" "	" "	" ..	"
Grimes, Malcolm John	1/51 Brook-street, Hawthorn	" "	" "	" ..	"
Gillam, James Allen	9 Church-street, Campbellfield	" "	" "	" ..	"
Davis, Malcolm	5/30 Kelsby-street, Reservoir	" "	" "	" ..	"

Dated at Port Melbourne this 27th day of May, 1971.

J. A. GIDLEY, Clerk of the Magistrates' Court.

MAGISTRATES' COURT, CAMBERWELL.

Letet, Robert Trevor	3 Taylor-court, East Malvern	600 Burke-road, Camberwell	Process Server ..	3.6.71
------------------------------	------------------------------	---------	----------------------------	-------------------	--------

Dated at Camberwell this 20th day of May, 1971.

L. KING, Clerk of the Magistrates' Court.

NOTICE.

CREDITORS, next of kin, and others having claims against the estate of any of the under-mentioned deceased persons are required to send particulars of their claims to the Public Trustee, 256 Flinders-street, Melbourne, Vic. 3000, the personal representative, on or before the 9th August, 1971, after which date the Public Trustee may convey or distribute the assets, having regard only to the claims of which the Public Trustee then has notice:—

ANGUS, HENRY SCOTT, late of 99 Kenmare-street, Box Hill North, retired electrical engineer, died 19th February, 1971.

BENNETT, ARTHUR COLLINS, also known as Arthur Collin Bennett, formerly of 18 Palm-avenue, Caulfield North but late of Flat 7, 8 Te Arai-avenue, East St. Kilda, engineer, died 15th August, 1970.

BENNETT, THELMA MARJORIE, late of Flat 3, 4 Wahroonga-court, Glen Iris, retired public servant, died 2nd December, 1970.

BICKLEY, HECTOR, formerly of Normanby-street, Cranbourne, but late of Melbourne Home and Hospital for the Aged, Cheltenham, pensioner, died 18th July, 1961.

BICKLEY, SYDNEY, late of Lot 11, Barmah-court, Baxter, medical bacteriologist, died 21st November, 1970.

BOBOVNIK, STEFAN, late of 5 Simpson-court, Traralgon, plant operator, died 24th October, 1970.

BOORMAN, LEILA ROSAMUND, also known as Leila Rosamond Bootman, late of 14 Watson-grove, Glenhuntly, widow, died 14th March, 1971.

CHRISTIE, DAVID, formerly of 17 Moonya-road, Carnegie, but late of 14 Olinda-street, South Caulfield, retired moulder, died 9th June, 1970.

CLEARY, JOHN JOSEPH, late of 33 Clifton-street, Richmond, retired accounts clerk, died 18th January, 1971.

DACY, HAROLD, late of 56 Buckley-street, Essendon, retired station master, died 1st March, 1971.

FIELD, JOHN, late of Kingston Centre, Cheltenham, pensioner, died 26th August, 1968.

FLAVELL, JOHN, formerly of 160 Smith-street, Thornbury, but late of 22 Jean-street, Lower Templestowe, produce manager, died 27th December, 1970.

FRASER, JAMES MCINTOSH, late of Flat 2, 48 Power-street, Hawthorn, tram driver, died 18th February, 1970.

FREHSE, LUCY FLORA, also known as Lucie Flora Frehse, formerly of 36 Collins-street, Melbourne, but late of 51 Newgrove-road, Healesville, home duties, died 28th February, 1971.

GALLIVAN, HANNAH MARIE, also known as Gallivan Hannah Maria and Gallivan Hannah, late of 46 Wright-street, Middle Park, widow, died 7th November, 1970.

GRIFFITHS, ANTHONY JAMES, late of Flat 4, 25 Bruce-street, Dandenong, bank officer, died 20th February, 1971.

HALLIGAN, ROBERT HENRY, also known as Halligan Robert, formerly of 30 Edmund-street, Clifton Hill, but late of 41 Windsor-avenue, Mount Waverley, retired laboratory assistant, died 5th March, 1971.

HEITHERSAY, KEITH ST. CLAIR, late of 24 Selbourne-street, Hawthorn East, retired clerk, died 7th March, 1971.

HENLEY, STELLA PAULINE, late of 29 Dally-street, Clifton Hill, widow, died 5th March, 1971.

MASSEY, ALFRED, late of 19 Holmes-street, East Brunswick, retired engineer, died 1st March, 1971.

MORRISH, CATHERINE MURIEL, formerly of 75 Pender-street, Thornbury, but late of 36 Pridham-street, Maidstone, spinster, died 27th February, 1971.

NELSON, OLIVE MARY, late of 6 Loch-street, Mont Albert, spinster, died 5th November, 1970.

NIELSEN, VICTORIA, late of 190 Tucker-road, Bentleigh, married woman, died 11th March, 1954.

O'CONNOR, MARGUERITA TORTAROLO, late of 1 Lincoln-street, Yarraville, married woman, died 9th December, 1970.

PRETTY, AGNES EDNA, late of corner Cairns and Cranbourne roads, Hampton Park, married woman, died 16th October, 1970.

SCOTT, MORRIS ALEXANDER, also known as Maurice Scott, late of 61 Mitchell-street, Northcote, retired wool sampler, died 16th October, 1968.

SEATH, SARAH EMMA, formerly of 29 Maverston-street, Burwood, but late of 20 Gilmour-street, Burwood, widow, died 7th February, 1971.

SMITH, KENNETH WILLIAM LESLIE, late of 92 Langston-street, Bendigo, invalid pensioner, died 20th February, 1970.

STEPHENS, HARRY, late of 38 Gray-street, St. Kilda, retired rubber worker, died 23rd September, 1970.

SWALES, ARCHIBALD, late of 1 Bunalbo-avenue, South Yarra, retired gardener, died 30th December, 1970.

VINICOMBE, WALTER, late of 3 Lucas-street, South Caulfield, retired public servant, died 22nd January, 1971.

WARD, BESSIE, late of 28 Willesden-road, Oakleigh, widow, died 11th February, 1971.

WILLOUGHBY, FREDERICK GORDON, formerly of 74 Patterson-street, Princes Hill and 35 Fifth-avenue, Rosebud, but late of Belvedere Private Hospital, 352 Princes Highway, Noble Park, retired motor engineer, died 23rd January, 1971.

N. P. BRODY,
Public Trustee.

Melbourne, 25th May, 1971.

WORKERS COMPENSATION ACT 1958, SECTION 72.

HIS Excellency the Governor of the State of Victoria, by and with the advice of the Executive Council thereof, doth by Order made on the 25th day of May, 1971, and pursuant to the provisions of section 72 of the Workers Compensation Act 1958, approve of The Permanent Insurance Company Limited as an insurer for the period ending 30th June, 1971.

JOHN A. HORLOCK,
Acting Clerk of the Executive Council.

At the Executive Council Chamber,
Melbourne, 25th May, 1971.

COUNTRY ROADS BOARD.

RESOLUTIONS OF THE COUNTRY ROADS BOARD.

THE Country Roads Board, in pursuance of the provisions of the *Country Roads Act 1958*, has passed Resolutions the dates whereof and the terms of which are scheduled hereunder:—

SCHEDULE.

State Highways.

Resolution dated the Twelfth day of May, One thousand nine hundred and seventy-one, made pursuant to sections 21, 58 and 74 of the *Country Roads Act 1958*, declaring the deviation from the Goulburn Valley Highway in the Shires of Broadford and Yea as indicated by diagonal and horizontal hatching on Plan numbered G.P.11490 hereunder to be part of a State highway within the meaning and for the purposes of the said Act, and also declaring that such deviation shall be in lieu of the existing road or part thereof indicated by cross-hatching on the said plan and that such part of the said existing road shall be discontinued.

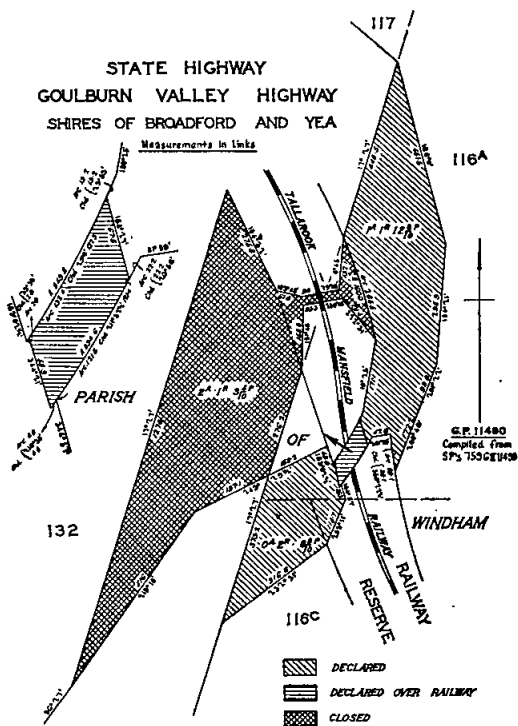

STATE HIGHWAY
WESTERN HIGHWAY
SHIRES OF BUNINYONG & BUNGAREE
Measurements in links.

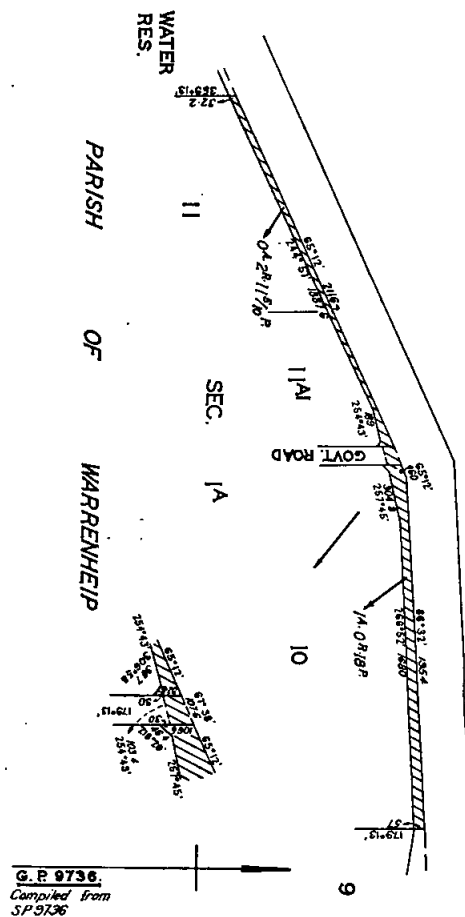

Resolution dated the Twelfth day of May, One thousand nine hundred and seventy-one, made pursuant to sections 21 and 74 of the *Country Roads Act 1958*, declaring the widening of the Western Highway in the Shires of Buninyong and Bungaree as shown hatched on Plans numbered G.P.9736, G.P.9737 and G.P.9738 hereunder to be part of a State highway within the meaning and for the purposes of the said Act.

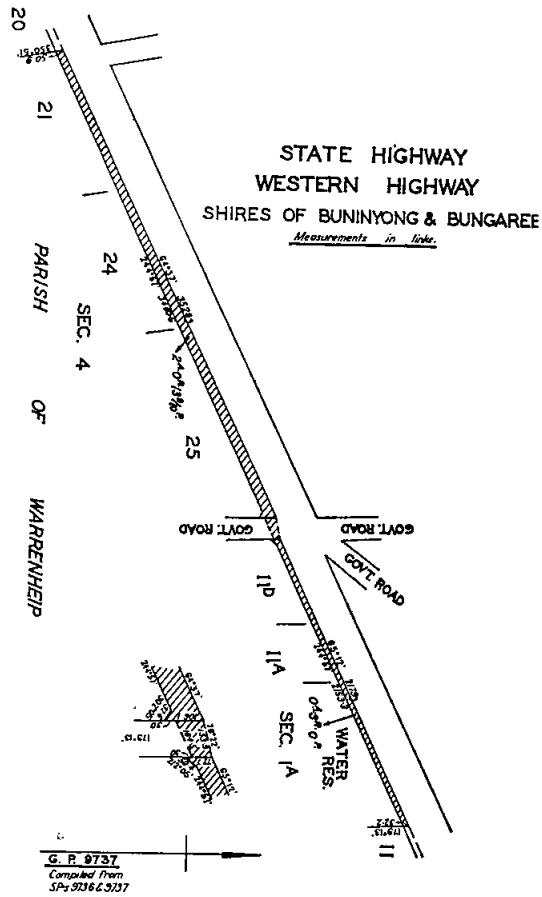

Resolution dated the Twelfth day of May, One thousand nine hundred and seventy-one, made pursuant to sections 21 and 74 of the *Country Roads Act 1958*, declaring the widening of the Goulburn Valley Highway in the Shire of Goulburn as shown hatched on Plan numbered G.P.9811 hereunder to be part of a State highway within the meaning and for the purposes of the said Act.

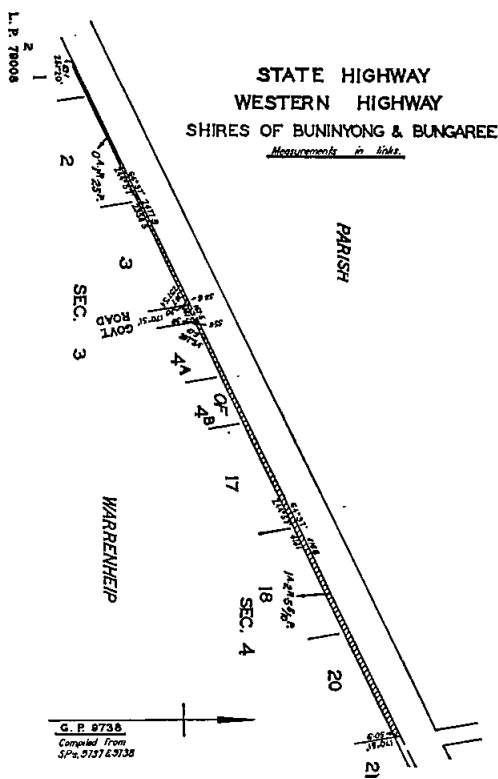
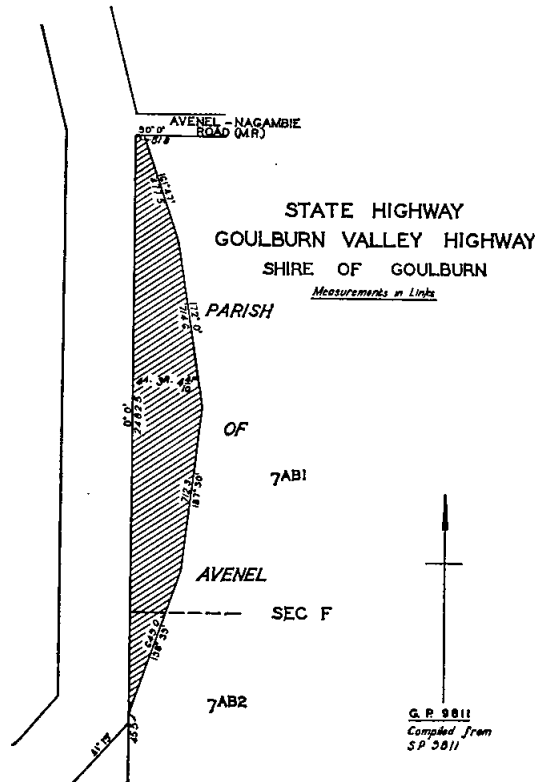

Resolution dated the Twelfth day of May, One thousand nine hundred and seventy-one, made pursuant to sections 21 and 74 of the *Country Roads Act 1958*, declaring the widening of the North-Western Highway in the Shire of Karkaroc as shown hatched on Plan numbered G.P.7229 hereunder to be part of a State highway within the meaning and for the purposes of the said Act.

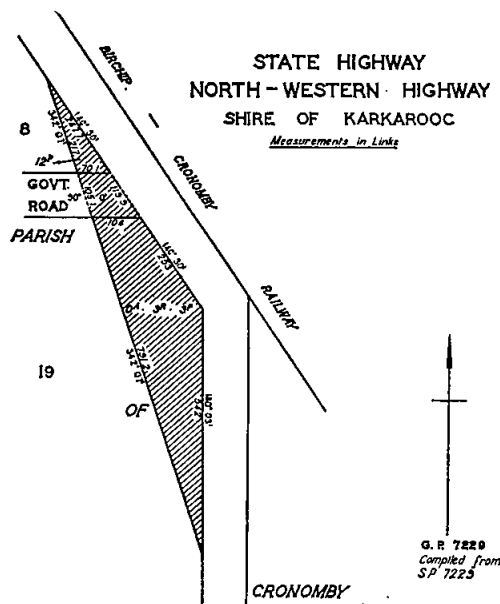

Resolution dated the Twelfth day of May, One thousand nine hundred and seventy-one, made pursuant to sections 21 and 74 of the *Country Roads Act 1958*, declaring the widening of the Princes Highway in the Shire of Rosedale as shown hatched on Plan numbered G.P.9984 hereunder to be part of a State highway within the meaning and for the purposes of the said Act.

STATE HIGHWAY
PRINCES HIGHWAY
SHIRE OF ROSEDALE
Measurements in Links

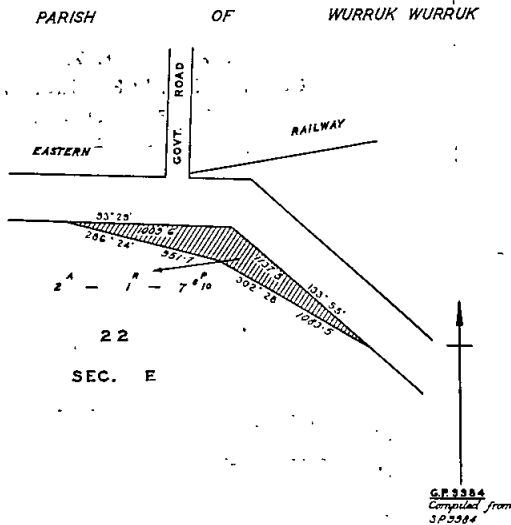

Main Roads.

Resolution dated the Twelfth day of May, One thousand nine hundred and seventy-one, made pursuant to section 21 of the *Country Roads Act 1958*, declaring the widening of the Apsley-Natimuk road in the Shire of Arapiles as shown hatched on Plan numbered G.P.5972 hereunder to be part of a main road within the meaning and for the purposes of the said Act.

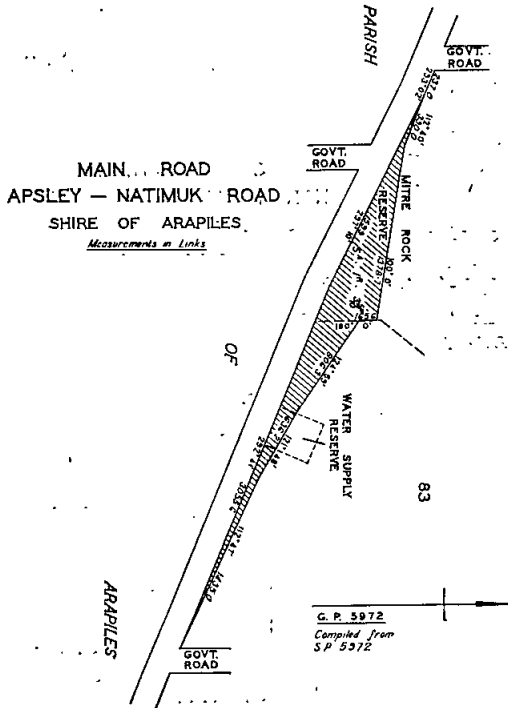

Resolution dated the Twelfth day of May, One thousand nine hundred and seventy-one, made pursuant to section 21 of the *Country Roads Act 1958*, declaring the widening of Torquay-road in the Shires of Barrabool and South Barwon as shown hatched on Plan numbered G.P.7298 hereunder to be part of a main road within the meaning and for the purposes of the said Act.

MAIN ROAD
TORQUAY ROAD
SHIRES OF BARRABOOL
AND SOUTH BARWON
Measurements in Links

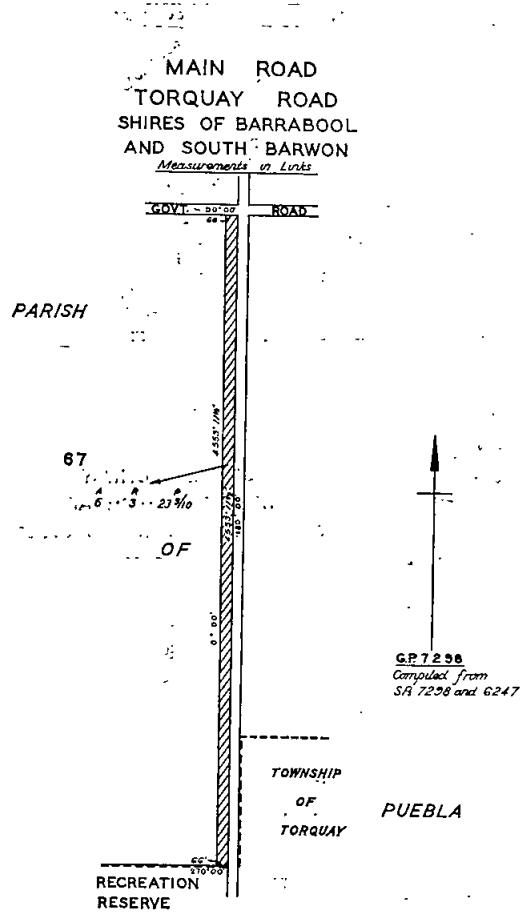

Resolution dated the Twelfth day of May, One thousand nine hundred and seventy-one, made pursuant to section 21 of the *Country Roads Act 1958*, declaring the widening of Torquay-road in the Shires of Barrabool and South Barwon as shown hatched on Plan numbered G.P.9857 hereunder to be part of a main road within the meaning and for the purposes of the said Act.

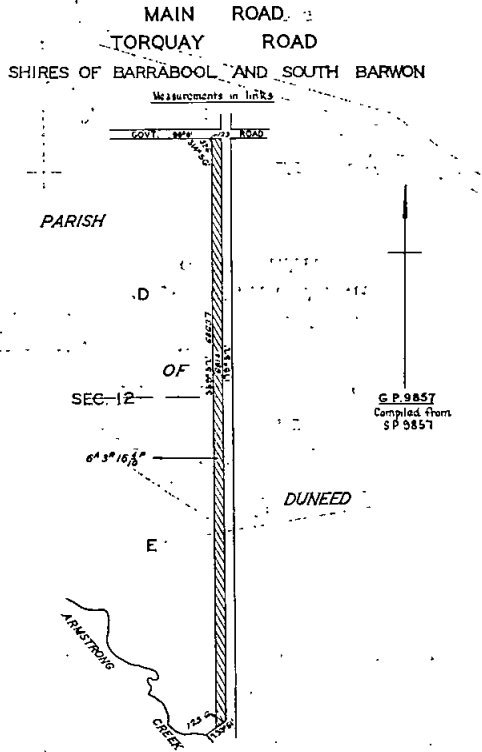

Resolution dated the Twelfth day of May, One thousand nine hundred and seventy-one, made pursuant to section 21 of the *Country Roads Act 1958*, declaring the widening of the St. Arnaud-Dunolly road in the Shire of Kara Kara as shown hatched on Plan numbered G.P.9068 hereunder to be part of a main road within the meaning and for the purposes of the said Act.

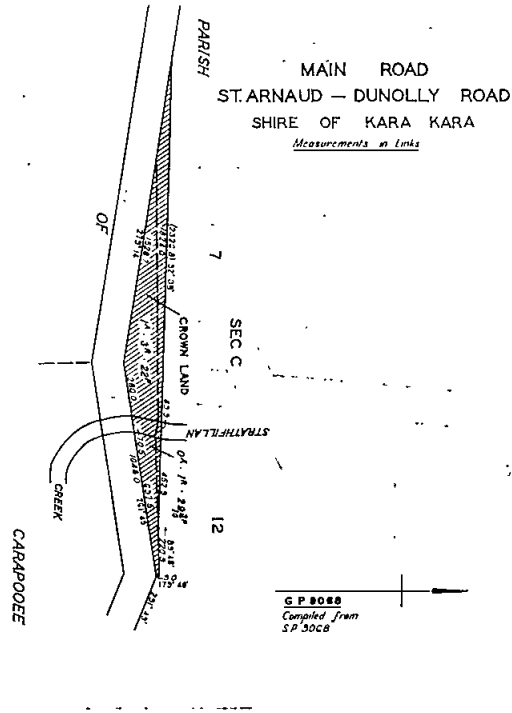

Resolution dated the Twelfth day of May, One thousand nine hundred and seventy-one, made pursuant to section 21 of the *Country Roads Act 1958*, declaring the widening of the Bright-Tawonga road in the Shire of Bright as shown hatched on Plan numbered G.P.7908 hereunder to be part of a main road within the meaning and for the purposes of the said Act.

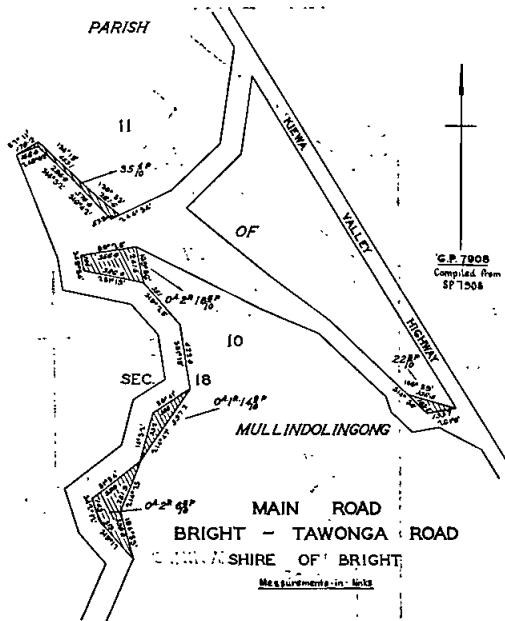

Resolution dated the Twelfth day of May, One thousand nine hundred and seventy-one, made pursuant to section 21 of the *Country Roads Act 1958*, declaring the widening of the Hopetoun-Rainbow road in the Shire of Karkaroc as shown hatched on Plan numbered G.P.7645 hereunder to be part of a main road within the meaning and for the purposes of the said Act.

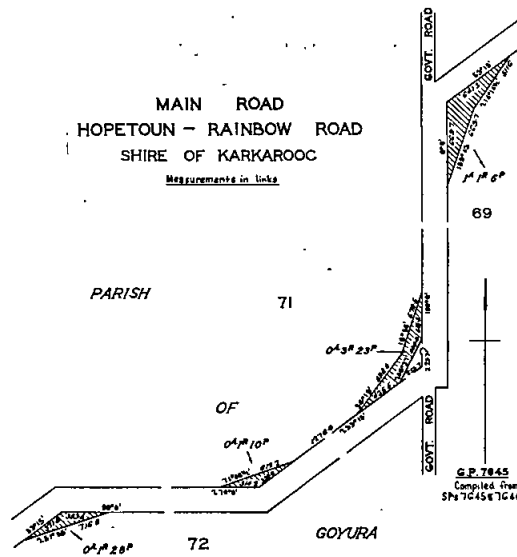

Resolution dated the Twelfth day of May, One thousand nine hundred and seventy-one, made pursuant to section 21 of the *Country Roads Act 1958*, declaring the widening of the Maffra-Newry road in the Shire of Maffra as shown hatched on Plan numbered G.P.11917 hereunder to be part of a main road within the meaning and for the purposes of the said Act.

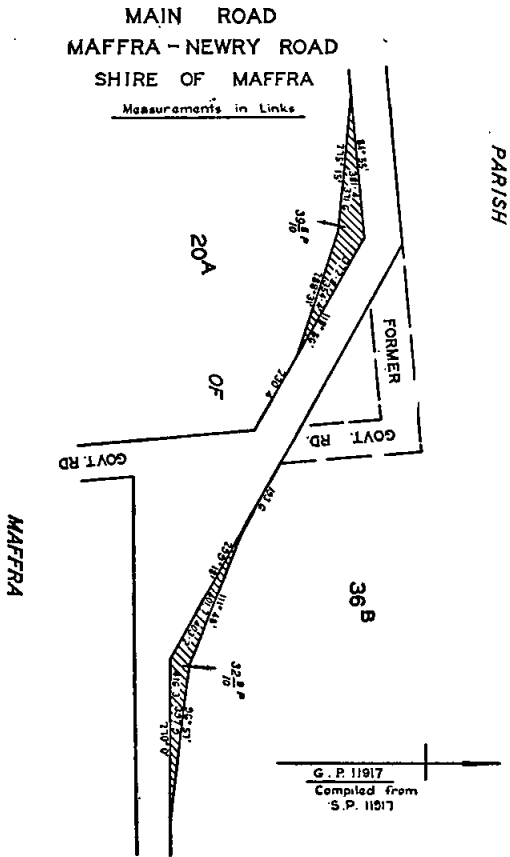

Resolution dated the Twelfth day of May, One thousand nine hundred and seventy-one, made pursuant to section 21 of the *Country Roads Act 1958*, declaring the widening of Happy Valley-road in the Shire of Myrtleford as shown hatched on Plans numbered G.P.8512 and G.P.9384 hereunder to be part of a main road within the meaning and for the purposes of the said Act.

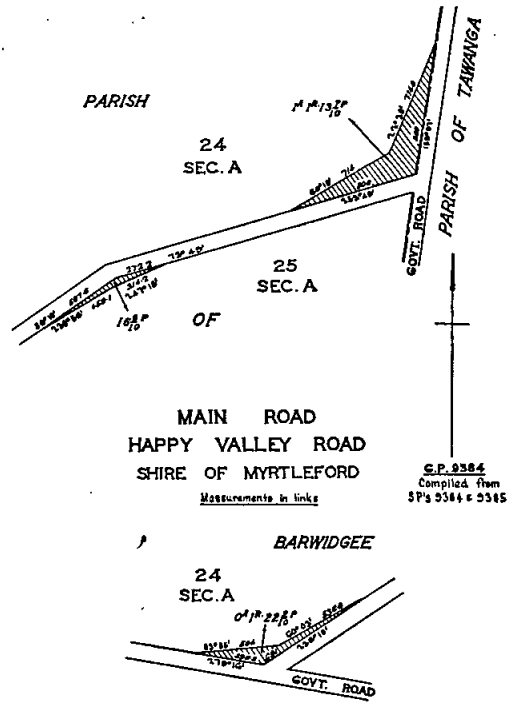
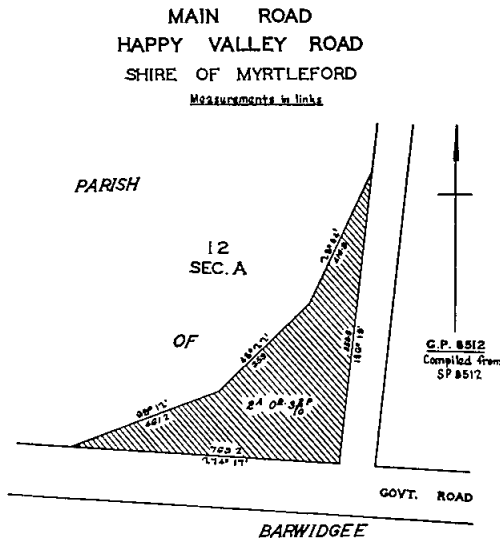

Resolution dated the Twelfth day of May, One thousand nine hundred and seventy-one, made pursuant to section 21 of the *Country Roads Act 1958*, declaring the widening of Creswick-road in the Shire of Newstead as shown hatched on Plan numbered G.P.8322 hereunder to be part of a main road within the meaning and for the purposes of the said Act.

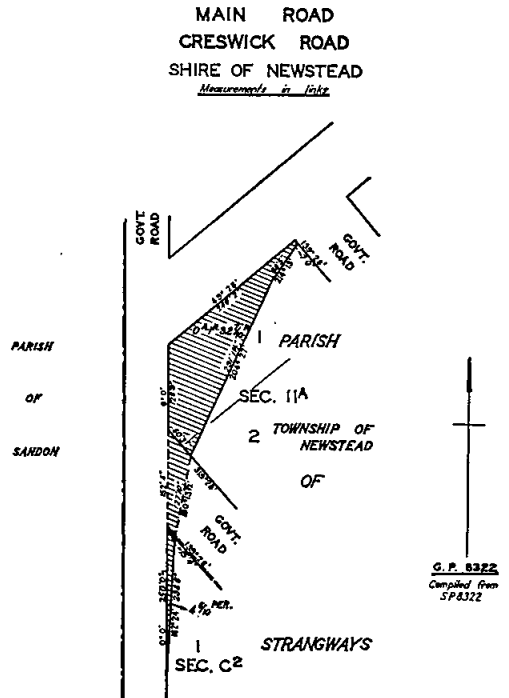

Resolution dated the Twelfth day of May, One thousand nine hundred and seventy-one, made pursuant to section 21 of the *Country Roads Act 1958*, declaring the widening of the Beaufort-Amphitheatre road in the Shire of Ripon as shown hatched on Plan numbered G.P.10438 hereunder to be part of a main road within the meaning and for the purposes of the said Act.

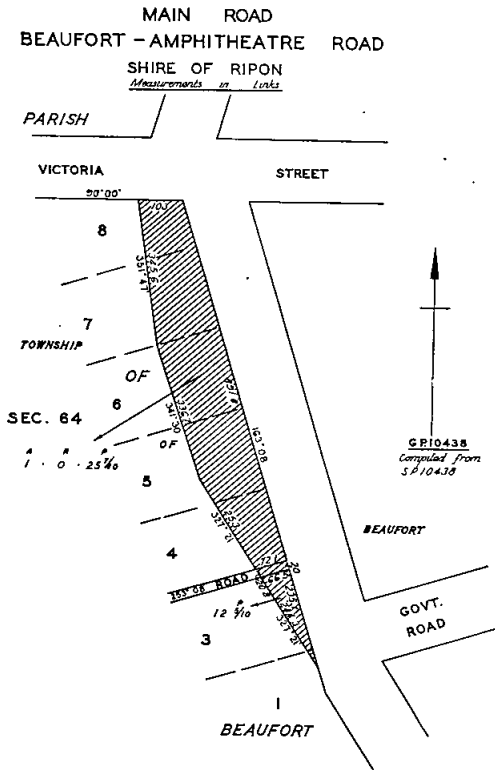

Resolution dated the Twelfth day of May, One thousand nine hundred and seventy-one, made pursuant to sections 21 and 58 of the *Country Roads Act 1958*, declaring the deviation from Bona Vista-road in the Shire of Warragul as indicated by diagonal hatching on Plan numbered G.P.1473 hereunder to be part of a main road within the meaning and for the purposes of the said Act, and also declaring that such deviation shall be in lieu of the existing road or part thereof indicated by cross-hatching on the said plan.

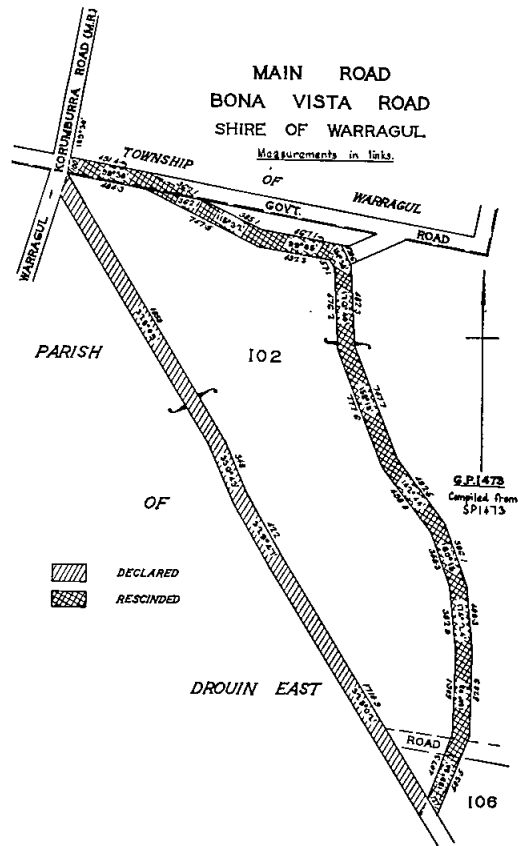

Resolution dated the Twelfth day of May, One thousand nine hundred and seventy-one, made pursuant to section 21 of the *Country Roads Act 1958*, declaring the widening of Barrabool-road in the Shire of South Barwon as shown hatched on Plan numbered G.P.7574 hereunder to be part of a main road within the meaning and for the purposes of the said Act.

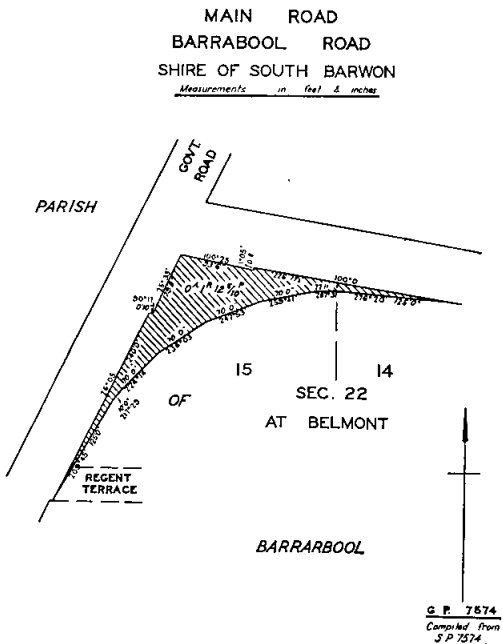

Freeway.

Resolution dated the Twelfth day of May, One thousand nine hundred and seventy-one, made pursuant to sections 21 and 101 of the *Country Roads Act 1958*, declaring the road in the Shire of Portland as shown hatched on Plans numbered G.P.10903A and G.P.10904 hereunder to be a freeway (Princes Freeway) within the meaning and for the purposes of the said Act.

COUNTRY ROADS BOARD.

RESOLUTIONS OF THE COUNTRY ROADS BOARD.

THE Country Roads Board, in pursuance of the provisions of the Country Roads Act 1958, has passed Resolutions the dates whereof and the terms of which are scheduled hereunder:—

SCHEDULE.

State Highways.

Resolution dated the Seventeenth day of May, One thousand nine hundred and seventy-one, made pursuant to sections 21, 58 and 74 of the Country Roads Act 1958 declaring the deviation from the Pyrenees Highway in the Shire of Avoca as indicated by diagonal hatching on Plan numbered G.P.12386 hereunder to be part of a State highway within the meaning and for the purposes of the said Act, and also declaring that such deviation shall be in lieu of the existing road or part thereof indicated by cross-hatching and horizontal hatching on the said plan which part indicated by cross-hatching on the said plan shall be discontinued.

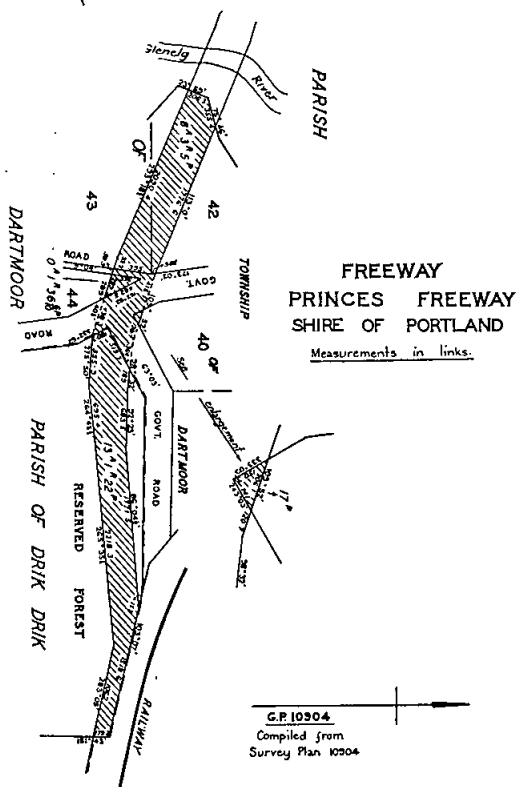
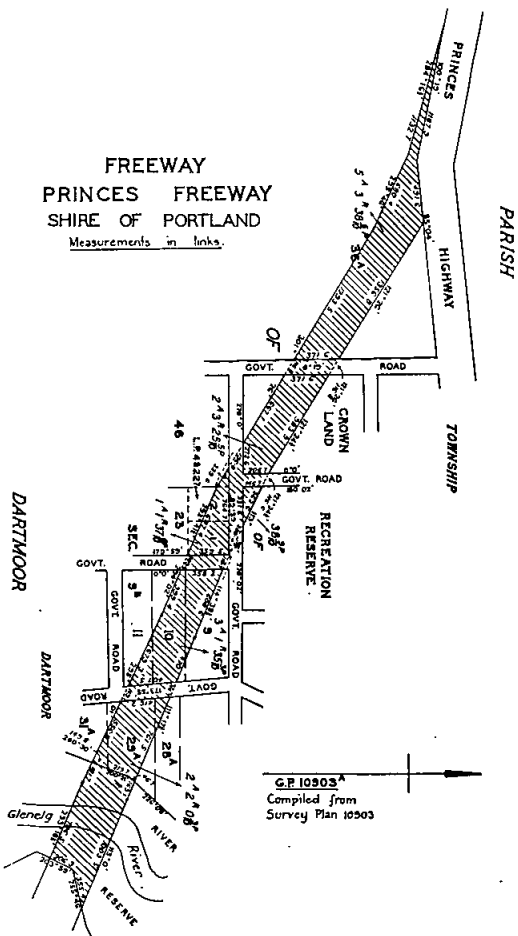

STATE HIGHWAY
PYRENEES HIGHWAY
SHIRE OF AVOCA
Measurements in links

-  DECLARED
-  CLOSED
-  RESCUDED

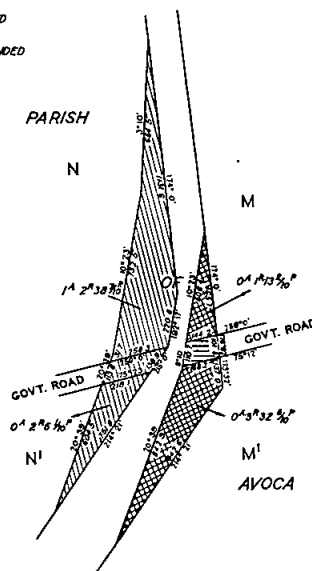

Resolution dated the Seventeenth day of May, One thousand nine hundred and seventy-one, made pursuant to sections 21 and 74 of the Country Roads Act 1958, declaring the widening of the Midland Highway in the Shire of Benalla as shown hatched on Plan numbered G.P.12274 hereunder to be part of a State highway within the meaning and for the purposes of the said Act.

14th May, 1971.

N. L. ALLANSON,
Secretary.

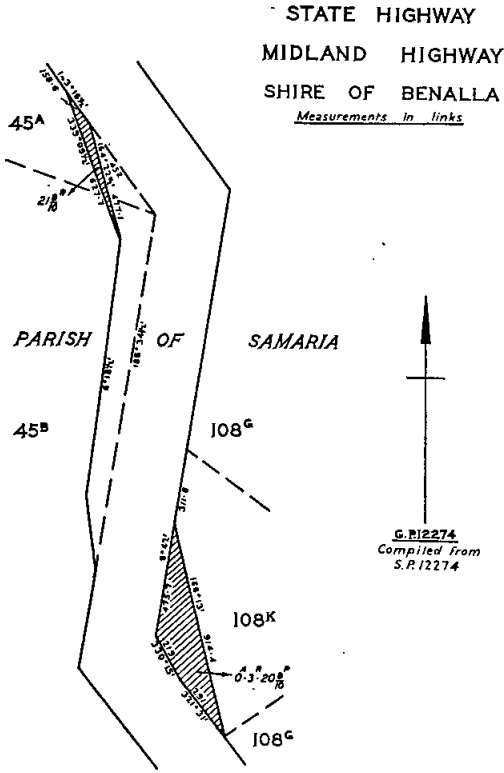

Resolution dated the Seventeenth day of May, One thousand nine hundred and seventy-one, made pursuant to sections 21 and 74 of the *Country Roads Act 1958*, declaring the widening of the Glenelg Highway in the Shire of Glenelg as shown hatched on Plan numbered G.P.5999 hereunder to be part of a State highway within the meaning and for the purposes of the said Act.

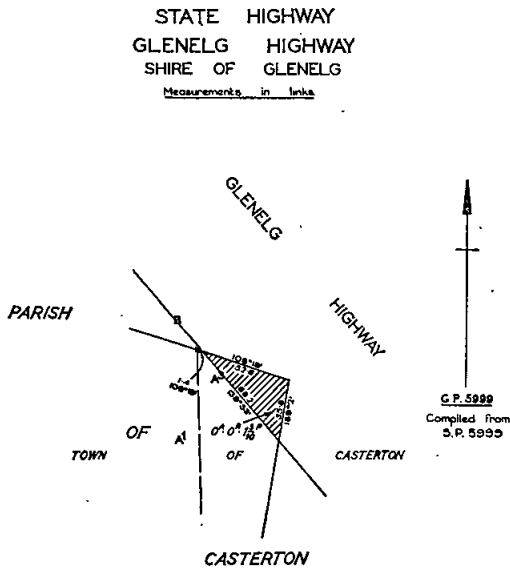

Resolution dated the Seventeenth day of May, One thousand nine hundred and seventy-one, made pursuant to sections 21 and 74 of the *Country Roads Act 1958*, declaring the widening of the Murray Valley Highway in the Shire of Kerang as shown hatched on Plan numbered G.P.11946 hereunder to be part of a State highway within the meaning and for the purposes of the said Act.

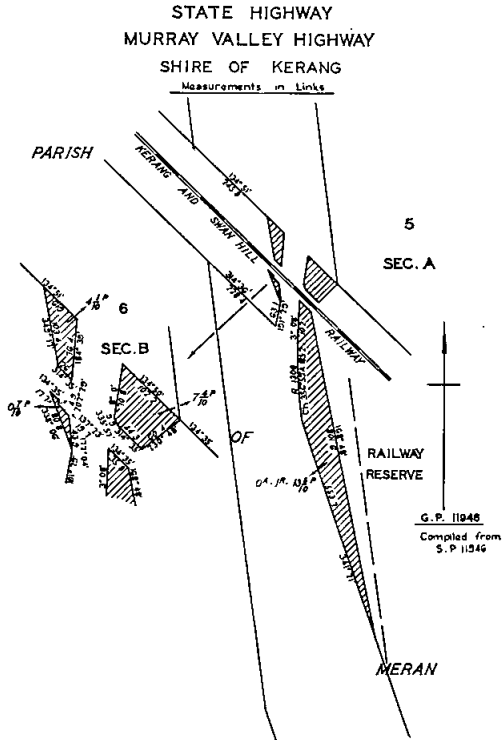

Resolution dated the Seventeenth day of May, One thousand nine hundred and seventy-one, made pursuant to sections 21, 58 and 74 of the *Country Roads Act 1958* declaring the deviation from the McIvor Highway in the Shire of McIvor as indicated by diagonal hatching on Plans numbered G.P.9519 and G.P.9520 hereunder to be part of a State highway within the meaning and for the purposes of the said Act, and also declaring that such deviation shall be in lieu of the existing road or part thereof indicated by cross-hatching on Plan numbered G.P.9519.

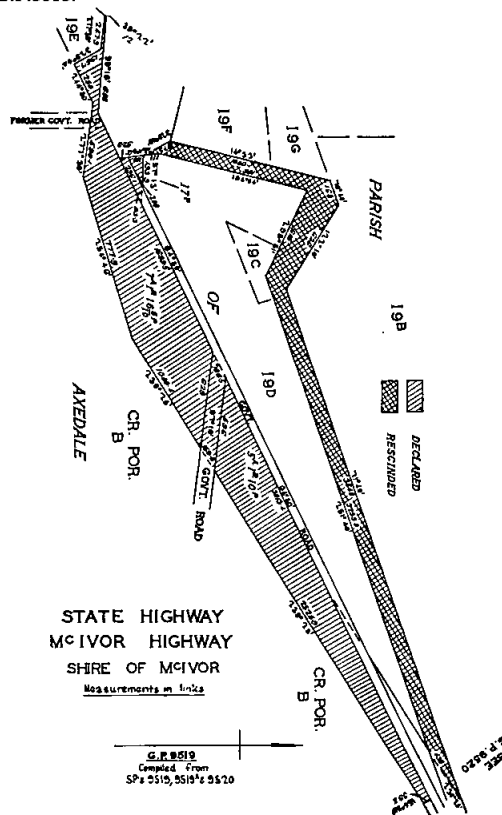

Resolution dated the Seventeenth day of May, One thousand nine hundred and seventy-one, made pursuant to sections 21 and 74 of the *Country Roads Act 1958*, declaring the widening of the Murray Valley Highway in the Shire of Kerang as shown hatched on Plan numbered G.P.11946 hereunder to be part of a State highway within the meaning and for the purposes of the said Act.

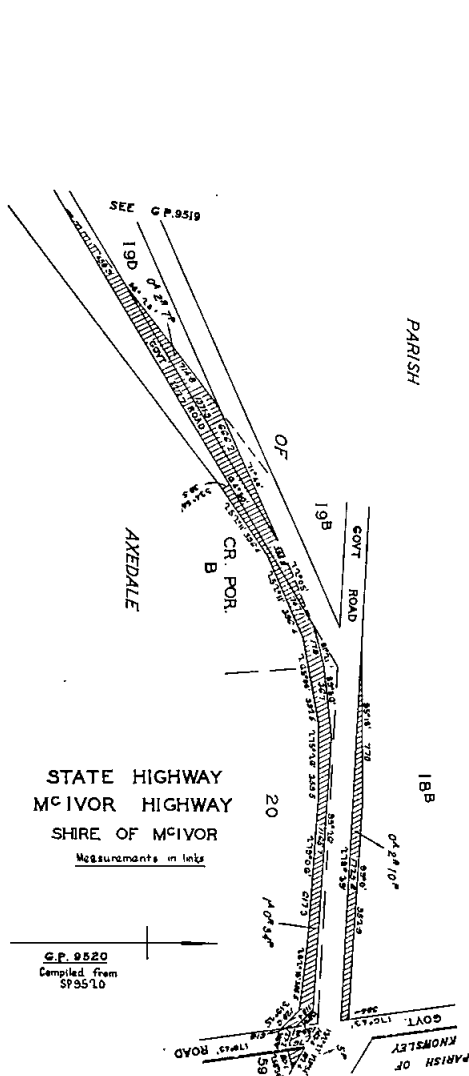

Resolution dated the Seventeenth day of May, One thousand nine hundred and seventy-one, made pursuant to sections 21 and 74 of the Country Roads Act 1958, declaring the widening of the Hume Highway in the Shire of Seymour as shown hatched on Plan numbered G.P.9088A hereunder to be part of a State highway within the meaning and for the purposes of the said Act.

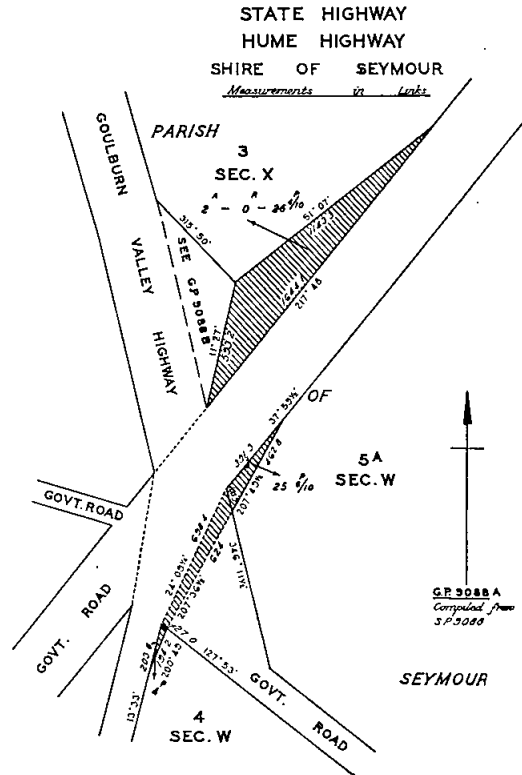

Resolution dated the Seventeenth day of May, One thousand nine hundred and seventy-one, made pursuant to sections 21 and 74 of the Country Roads Act 1958, declaring the widening of the Goulburn Valley Highway in the Shire of Seymour as shown hatched on Plan numbered G.P.9088B hereunder to be part of a State highway within the meaning and for the purposes of the said Act.

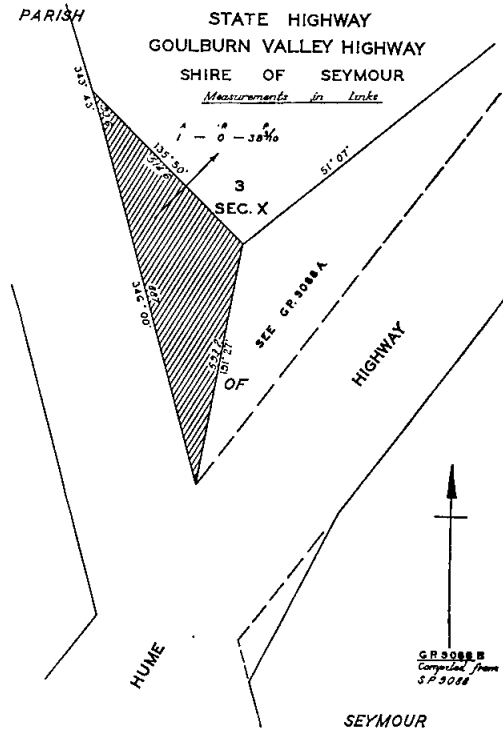

Resolution dated the Seventeenth day of May, One thousand nine hundred and seventy-one, made pursuant to sections 21 and 74 of the Country Roads Act 1958, declaring the widening of the Calder Highway in the Shire of Walpeup as shown hatched on Plans numbered G.P.7680, G.P.7681 and G.P.7793 hereunder to be part of a State highway within the meaning and for the purposes of the said Act.

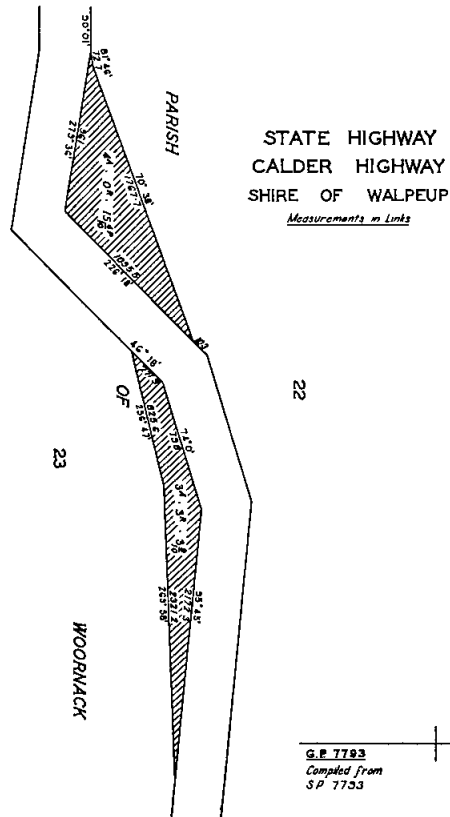
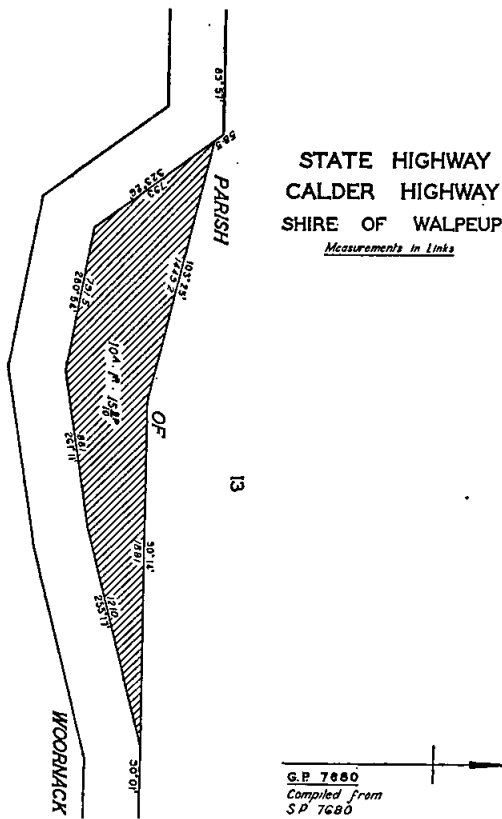

Main Roads.

Resolution dated the Seventeenth day of May, One thousand nine hundred and seventy-one, made pursuant to sections 21 and 58 of the Country Roads Act 1958, declaring the deviation from the Longwarry-Drouin road in the Shire of Buln Buln as indicated by diagonal hatching on Plan numbered G.P.12498 hereunder to be part of a main road within the meaning and for the purposes of the said Act, and also declaring that such deviation shall be in lieu of the existing road or part thereof indicated by cross-hatching and horizontal hatching on the said plan which part indicated by cross-hatching on the said plan shall be discontinued.

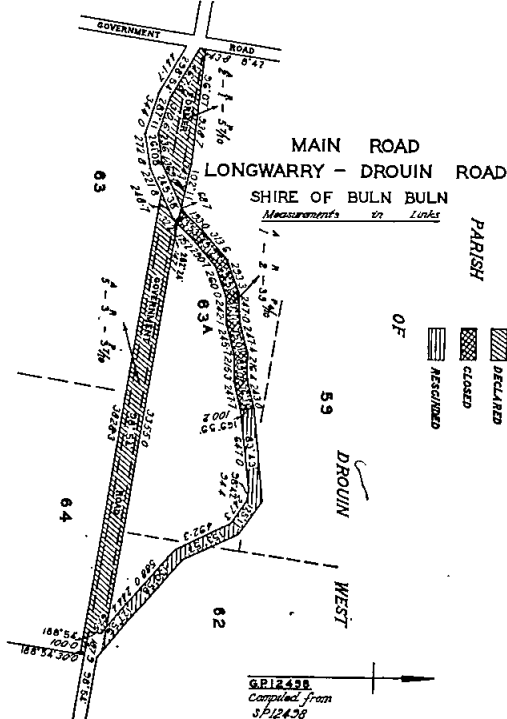
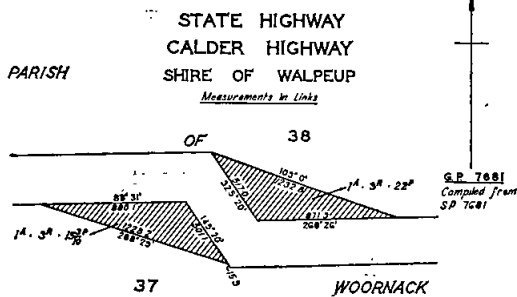

Resolution dated the Seventeenth day of May, One thousand nine hundred and seventy-one, made pursuant to section 21 of the *Country Roads Act 1958*, declaring the widening of Moorooduc-road in the Shires of Mornington and Flinders as shown hatched on Plan numbered G.P.5808 hereunder to be part of a main road within the meaning and for the purposes of the said Act.

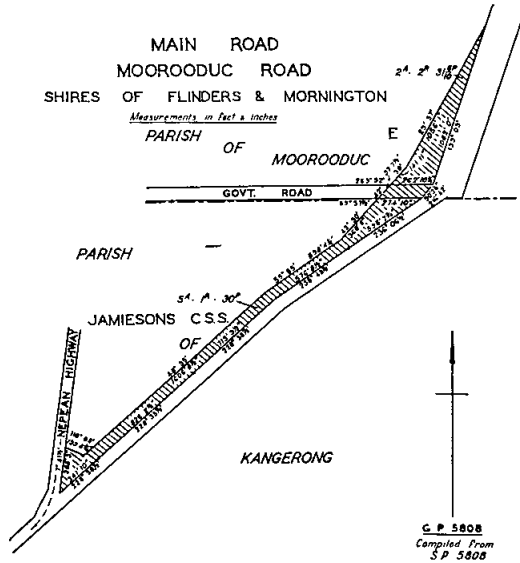

Resolution dated the Seventeenth day of May, One thousand nine hundred and seventy-one, made pursuant to section 21 of the *Country Roads Act 1958*, declaring the widening of the Waaia-Bearii road in the Shires of Nathalia and Numurkah as shown hatched on Plans numbered G.P.5089A, G.P.5089B, G.P.5090A, G.P.5090B, G.P.5091A and G.P.5091B hereunder to be part of a main road within the meaning and for the purposes of the said Act.

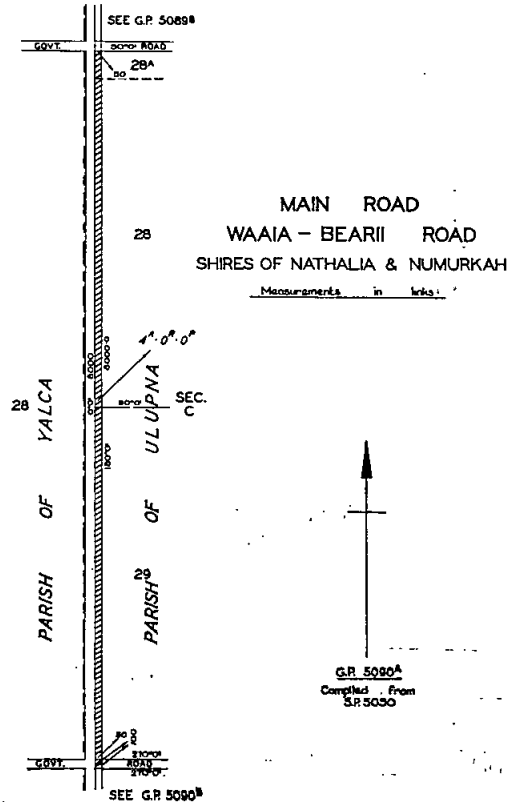
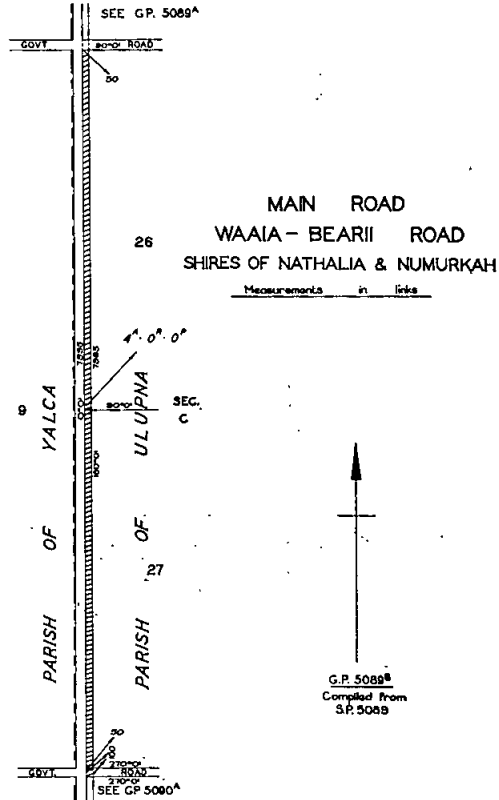
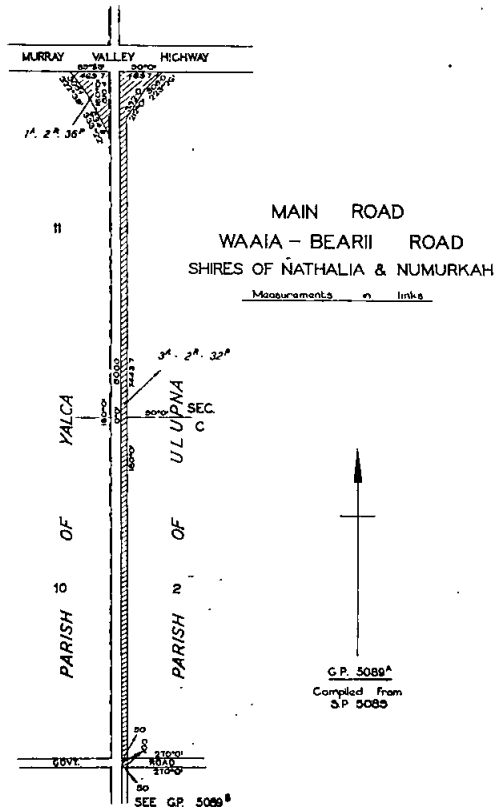

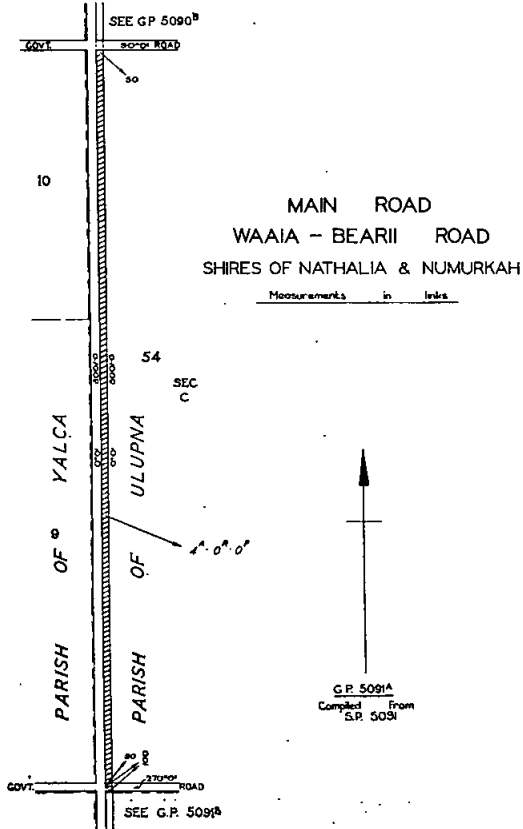
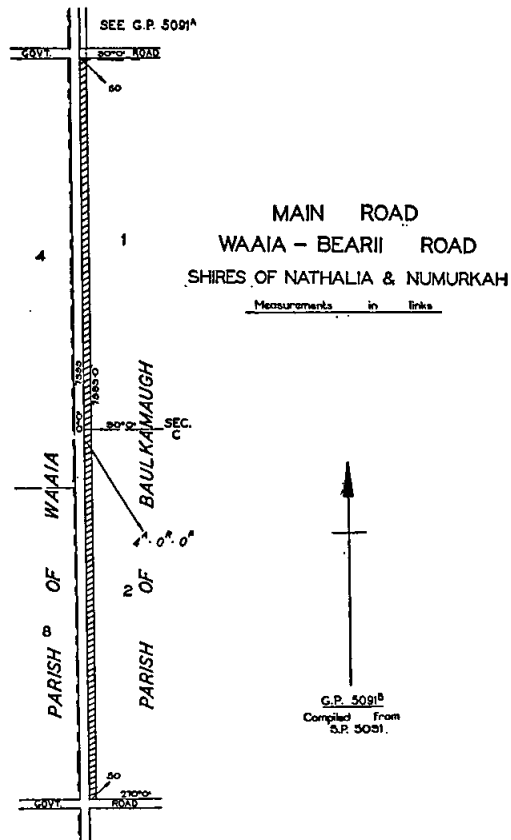
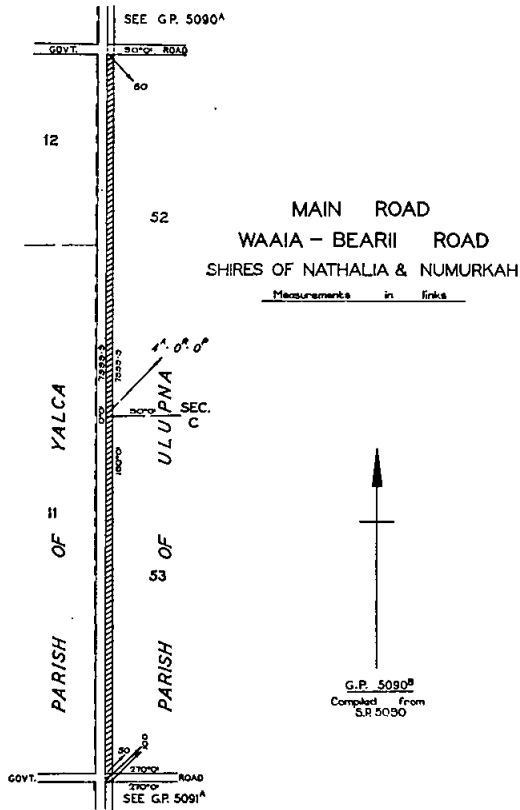

Resolution dated the Seventeenth day of May, One thousand nine hundred and seventy-one, made pursuant to section 21 of the *Country Roads Act 1958*, declaring the widening of the Gembrook-Launching Place road in the Shire of Upper Yarra as shown hatched on Plans numbered G.P.9858 and G.P.9859 hereunder to be part of a main road within the meaning and for the purposes of the said Act.

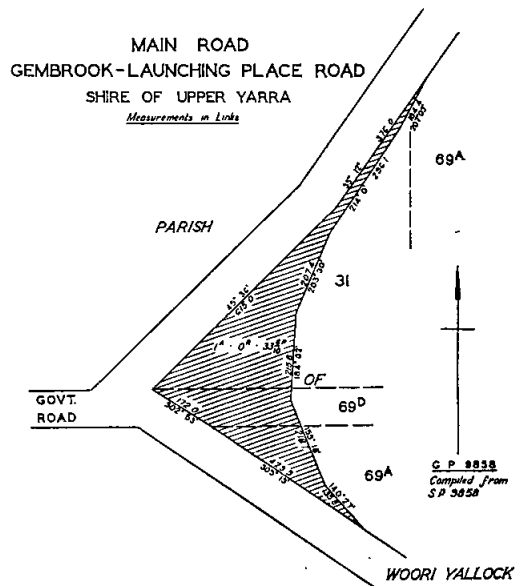

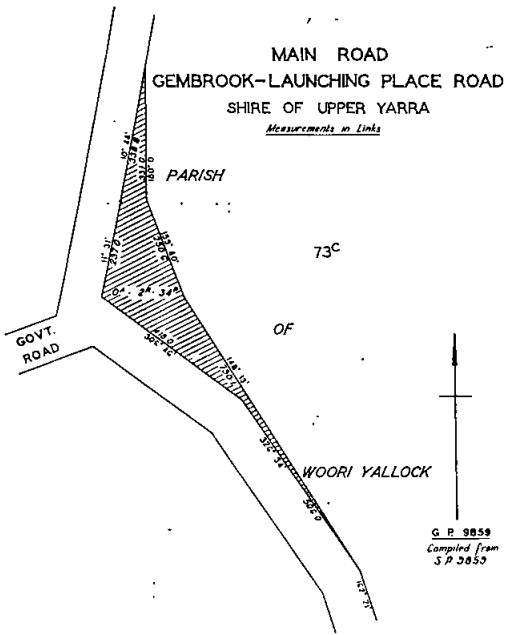

Resolution dated the Seventeenth day of May, One thousand nine hundred and seventy-one, made pursuant to section 21 of the *Country Roads Act 1958*, declaring the widening of Wallan-road in the Shire of Whittlesea as shown hatched on Plan numbered G.P.9055 hereunder to be part of a main road within the meaning and for the purposes of the said Act.

MAIN ROAD
WALLAN ROAD
SHIRE OF WHITTLESEA
Measurements in links.

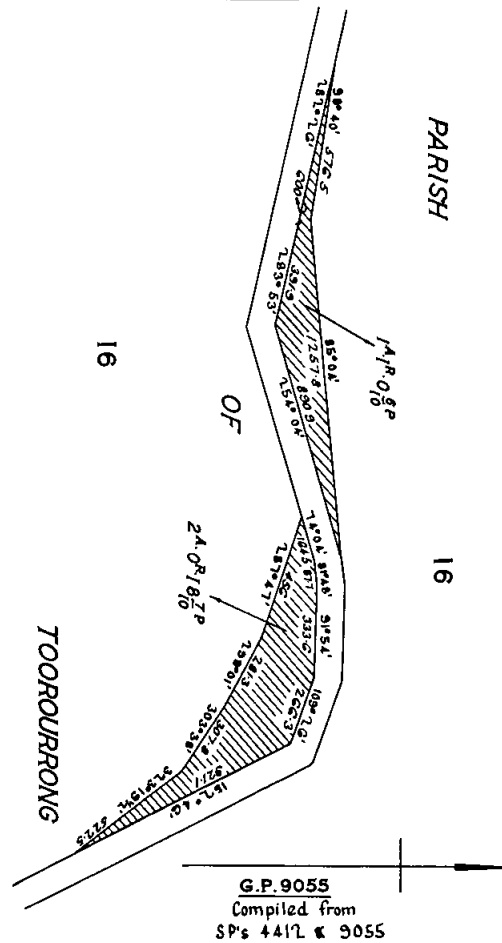

Resolution dated the Seventeenth day of May, One thousand nine hundred and seventy-one, made pursuant to section 21 of the *Country Roads Act 1958*, declaring the widening of Epping-road in the Shire of Whittlesea as shown hatched on Plan numbered G.P.10160 hereunder to be part of a main road within the meaning and for the purposes of the said Act.

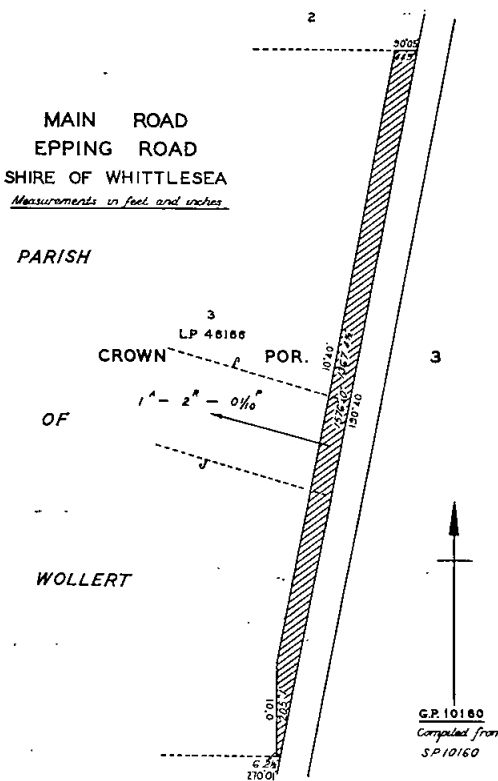

Resolution dated the Seventeenth day of May, One thousand nine hundred and seventy-one, made pursuant to section 21 of the *Country Roads Act 1958*, declaring the widening of Main Whittlesea-road in the Shire of Whittlesea as shown hatched on Plan numbered G.P.9262 hereunder to be part of a main road within the meaning and for the purposes of the said Act.

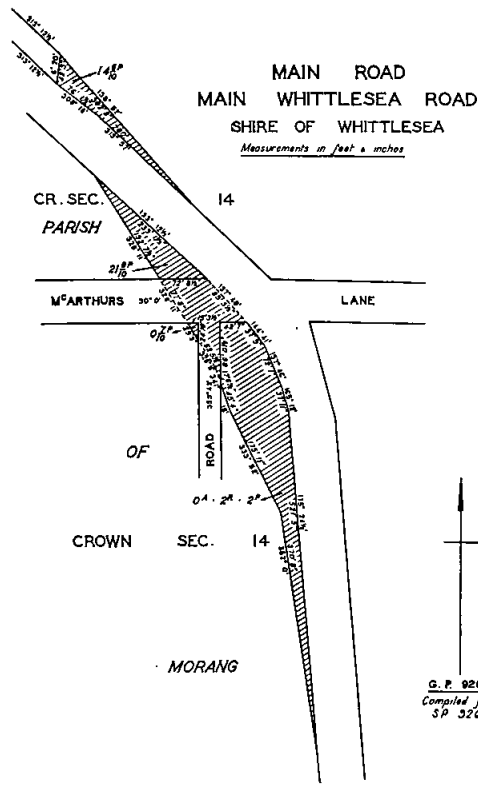

Resolution dated the Seventeenth day of May, One thousand nine hundred and seventy-one, made pursuant to section 21 of the *Country Roads Act 1958*, declaring the widening of the Horsham-Lubeck road in the Shire of Wimmera as shown hatched on Plan numbered G.P.8232 hereunder to be part of a main road within the meaning and for the purposes of the said Act.

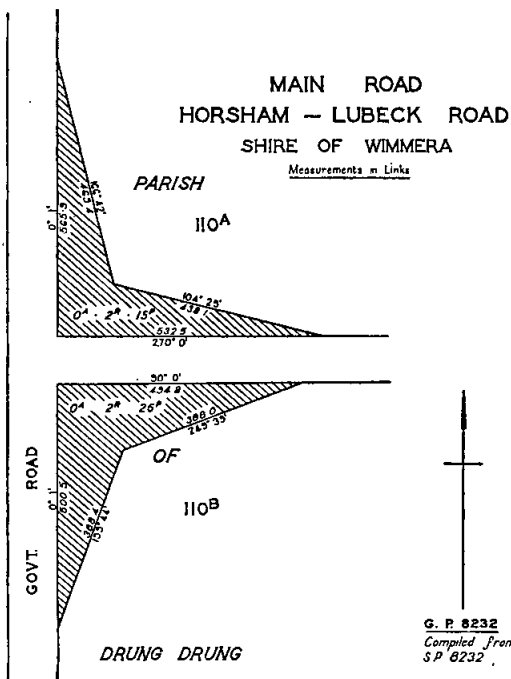

Unclassified Road.

Resolution dated the Seventeenth day of May, One thousand nine hundred and seventy-one, made pursuant to sections 21, 58 and 110 of the *Country Roads Act 1958*, declaring the deviation from Tootal-road in the City of Springvale as indicated by diagonal hatching on Plan numbered G.P.10813B hereunder to be part of a road within the meaning and for the purposes of the said Act, and also declaring that such deviation shall be in lieu of the existing road or part thereof indicated by cross-hatching on the said plan and that such part of the said existing road shall be discontinued.

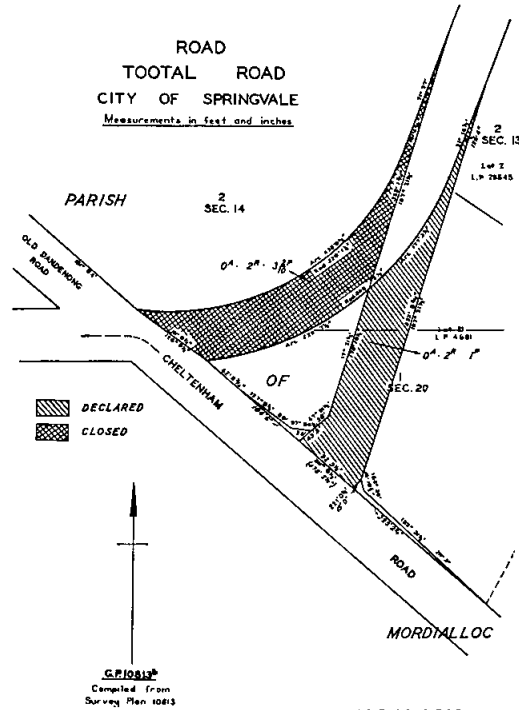

18th May, 1971.

N. L. ALLANSON,
Secretary.

Melbourne and Metropolitan Tramways Act 1958, No. 6311.
NOTICE CALLING UPON THE EMPLOYEES OF THE MELBOURNE AND METROPOLITAN TRAMWAYS BOARD TO NOMINATE A REPRESENTATIVE ON THE APPEAL BOARD.

NOTICE is hereby given, in accordance with the provisions of the *Melbourne and Metropolitan Tramways Act 1958*, and the Regulations relating thereto, calling upon the employees of the Melbourne and Metropolitan Tramways Board to nominate a person to represent them on the Appeal Board.

Nominations, in accordance with the said Act and Regulations, must be received by me not later than Wednesday, the 23rd June, 1971.

2nd June, 1971.

F. L. KUFFER, Registrar, Tramways Appeal Board, care of Melbourne and Metropolitan Tramways Board, 616 Little Collins-street, Melbourne.

Co-operation Act 1958.

JORDANVILLE SOUTH STATE SCHOOL CO-OPERATIVE LIMITED.

NOTICE is hereby given, in pursuance of section 78 (7) of the *Co-operation Act 1958*, and section 308 (2) of the *Companies Act 1961*, that at the expiration of three months from the date hereof, the name of the aforementioned society will, unless cause is shown to the contrary, be struck off the register and the society will be dissolved.

Dated this twenty-fifth day of May, 1971.

M. V. HAMMOND,
Deputy Registrar.

Metropolitan Fire Brigades Act 1958.

METROPOLITAN FIRE BRIGADES BOARD.

LIST OF FIRE INSURANCE COMPANIES CARRYING ON BUSINESS AND INSURING PROPERTY IN VICTORIA.

PURSUANT to the provisions of the *Metropolitan Fire Brigades Act 1958*, and the *Metropolitan Fire Brigades General Regulations 1951*, I, Rupert James Hamer, being the Chief Secretary of Victoria and the Minister Administering the said Act, hereby publish the list hereunder of insurance companies carrying on business and insuring property in Victoria; and notify that any such insurance company omitted from such list may be inserted therein on application to me within seven days from the date of publication hereof; and that such list, with the name of any insurance company so added, shall be taken to be the roll of insurance companies entitled to vote at the forthcoming extraordinary election of insurance companies' representatives on the Metropolitan Fire Brigades Board.

R. J. HAMER,
Chief Secretary.

Chief Secretary's Office,
Melbourne, 31st May, 1971.

LIST OF INSURANCE COMPANIES—MAY, 1971.

1. A.C.I. Insurance Pty. Ltd.
2. A.M.P. Fire & General Ins. Co. Ltd.
3. A.P.A. Fire & General Ins. Co. Ltd.
4. Affiliated Reinsurances Pty. Ltd.
5. Ajax Ins. Co. Ltd.
6. Albion Insurance Co. Ltd.
7. Leslie N. Allen Pty. Ltd.
8. Alliance Assurance Co. Ltd.
9. American Home Assurance Co.
10. American International.
11. Ansva Insurance Co. Ltd.
12. Antony Gibbs Reinsurance Pty. Ltd.
13. Associated General Cont. Ins. Co. Ltd.
14. Associated Securities.
15. Associated National Ins. Co. Ltd.
16. Assurance & Thrift Assn. Ltd.
17. Atlas Assurance Co. Ltd.
18. Aust. & Eastern Ins. Co. Ltd.
19. The Australian Alliance Assurance Co. Ltd.
20. The Australian Equitable Ins. Co. Ltd.
21. Australian General Ins. Co. Ltd.
22. Australian Mutual Fire Insurance Society Ltd.
23. Australian & International Insurances Ltd.
24. Australian National Assn. Co. Ltd.
25. Australian Natives Assn. Ins. Co. Ltd.
26. Australian Reinsurance Co. Ltd.
27. A.F.G. Insurances Limited.
28. Accident Insurance Mutual Ltd.
29. Victor Aghion & Sons Pty. Ltd.
30. Leslie N. Allen Reinsurance Pty. Ltd.
31. Baillieu Ins. Vic. Pty. Ltd.
32. Baltica Ins. Co. Ltd.
33. Bankers & Traders Ins. Co. Ltd.
34. The Bishopsgate Ins. Co. Ltd.
35. Boral.
36. C. T. Bowring & Swain Reinsurance Pty. Ltd.
37. C. T. Bowring & Swain Vic. Pty. Ltd.
38. British Crown Assurance Corp. Ltd.
39. British & Foreign Marine Ins. Co. Ltd.
40. British Traders Insurance Co. Ltd.
41. British Equitable Assurance Co. Ltd.
42. British General Insurance Co. of Aust. Ltd.
43. Baillieu Reinsurances Pty. Ltd.
44. C.G.A. Fire & Accident Insurance Co. Ltd.
45. C.M.L. Fire & General Ins. Co. Ltd.
46. Caladonian Insurance Co.
47. The Catholic Church Insurances Limited.
48. The Central Insurance Co. Ltd.
49. The Century Ins. Co. Ltd.
50. The Chamber of Manufacturers Ins. Ltd.
51. The City Mutual Fire Insur. Co. Ltd.
52. City Mutual General Ins. Ltd.
53. T. P. Clark & Chapman Pty. Ltd.
54. The Colonial Mutual Fire Insur. Co. Ltd.
55. Commercial & Industrial Insurance Ltd.
56. Commercial of Aust. Ins. Co. Ltd.
57. Commercial Union Australia Group.
58. Consolidated Insurances of Aust. Ltd.
59. The Co-operative Ins. Co. of Aust. Ltd.
60. The Copenhagen Reinsurance Co. Aust. Ltd.
61. Cornhill Ins. Co. Ltd.
62. Cosmopolitan Insurance Co. Ltd.
63. The Country Traders Mutual Insurance Ltd.
64. Cumis Insurance.
65. Cayzer Steel Brothers & Harlock Pty. Ltd.
66. The Derwent & Tamar Assurance Co. Ltd.
67. The Dominion Insurance Co. Ltd.
68. Eagle Star Ins. Co. Ltd.
69. Ecclesiastical Prop. Ins. Co. Pty. Ltd.
70. Economic Insurance Co. Ltd.
71. Employers Liability Ass. Corp. of Aust. Ltd.
72. The Farmers & Graziers Co-operative Co. Ltd.
73. The Farmers & Settlers Co-operative Ins. Co. of Aust. Ltd.
74. The Federation Ins. Ltd.
75. The Federal Mutual Ins. Co. of Aust. Ltd.
76. Fire & All Risks Insurance Co. Ltd.
77. Forsikringsaktieselskapet.
78. General Accident Fire & Life Ass. Corp. Ltd.
79. Glanvill Holland Pty. Ltd.
80. Greater Pacific General.
81. Gresham Fire & Accident Ins. Soc. Ltd.
82. Grieve & Irwin Aust. Pty. Ltd.
83. Guardian Royal Exchange Assurance Co. Ltd.
84. The Guild Ins. Co. Ltd.
85. The Guildhall Ins. Co. Ltd.
86. General Mutual Insurance Co. Ltd.
87. The Hanover Ins. Co. New York.
88. Hartford Fire Insurance.
89. Harvey Trinder Southern.
90. Harvey Trinder Vic. Pty. Ltd.
91. Hogg Robinson & Gardiner.
92. Home Insurance Co.
93. Indemnity Marine Ass. Co. of Aust. Ltd.
94. Insurance Co. of North America.
95. Insurance Corp. of Ireland Ltd.
96. The Insurance Office of Aust. Ltd.
97. The Invincible Life & General Ins. Co. Ltd.
98. The Lancashire Ins. Co. Ltd.
99. Law Union & Rock Ins. Co. Ltd.
100. Legal & General Ass. Soc. Ltd.
101. The Legal Insurance Co. Ltd.
102. L.E.P. Insurance Brokers Pty. Ltd.
103. The Licenses & General Ins. Co. Ltd.
104. Lombard Ins. Co. Ltd.
105. The Liverpool London & Globe Ins. Co. Ltd.
106. London Guarantee & Accident Co. of Australia Ltd.
107. London Assurance.
108. London & Overseas.
109. The London & Lancashire Ins. Co. Ltd.
110. London & Scottish Ass. Corp. of Aust. Ltd.
111. Edward Lumley & Sons N.S.W. Pty. Ltd.
112. Edward Lumley & Sons Vic. Pty. Ltd.
113. The M.L.C. Fire & General Ins. Co. Pty. Ltd.
114. Colin McDonald Pty. Ltd.
115. Manchester Unity Fire Ins. Co. of Vic. Ltd.
116. Maritime Ins. Co. Ltd.
117. Master Builders Ins. Co. Ltd.
118. Matthews Wrightson & Strapp Aust. Pty. Ltd.
119. Melbourne Fire Office Ltd.
120. The Mercantile & General Reinsurance Co. of Aust. Ltd.
121. Mercantile Mutual Ins. Co. Ltd.
122. Milford Ins. Co. Ltd.
123. J. H. Minet & Co. A.N.Z. Pty. Ltd.
124. Munich Reinsurance Co. of Aust.
125. The Monarch Ins. Co. Ltd.
126. National Co-op. Ins. Soc. Ltd.
127. National Employers Mutual General Ins. Assn. Ltd.
128. National & General Ins. Co. Ltd.
129. The National Ins. Co. of New Zealand Ltd.
130. National Mutual Fire Ins. Co. Ltd.
131. New Reinsurance Geneva Pty. Ltd.
132. The New Zealand Ins. Co. Ltd.
133. The Nippon Fire & Marine Ins. Co. Ltd.
134. Henry G. Nicholson (Aust.) Pty. Ltd.
135. North British & Mercantile Ass. Co. of Aust. Ltd.
136. Northumberland Ins. Co. Ltd.
137. Northern Assurance Co. of Aust. Ltd.
138. Norwich Union Fire Ins. Soc. Ltd.
139. The Ocean Accident & Guarantee Corp. of Aust. Ltd.
140. Omnibus & General Ins. Brokers Pty. Ltd.
141. Godfrey Orton Insurance Pty. Ltd.
142. Orion Insurance Co. Ltd.
143. Sirius Insurance Company Limited.
144. Palatine Ins. Co. of Aust. Ltd.
145. The Pacific Ins. Co. Ltd.
146. The Patriotic Ins. Co. Ltd.
147. Pearl Ass. Co. Ltd.
148. Phoenix Ass. Co. of Aust. Ltd.
149. H. G. Poland Aust. Pty. Ltd.
150. Price Forbes Leslie Pty. Ltd.
151. Price Forbes Leslie Reinsurance Pty. Ltd.
152. The Provident Fire Ins. Co. of Aust. Ltd.
153. Provincial Ins. Co. Ltd.
154. Prudential Ass. Co. Ltd.
155. Queensland Ins. Co. Ltd.
156. Fire Department-Regent Ins. Ltd.
157. The Real Australia Insurance Co. Ltd.
158. Reinsurance Co. of Australasia.
159. Reliance Marine Ass. Co. Ltd.

List of Insurance Companies—*continued.*

160. Royal Exchange Ass.
161. Royal Ins. Co. Ltd.
162. Rural Finance & Settlement Commission.
163. Scottish Ins. Corp. Ltd.
164. The Scottish Union & National Ins. Co.
165. The Security & General Ins. Co. Ltd.
166. The Sea Ins. Co. Ltd.
167. Security Life Ass. Ltd.
168. Sedgwick Collins Vic. Pty. Ltd.
169. Skandia Ins. Co. Ltd.
170. South Aust. Ins. Co. Ltd.
171. The South British Ins. Co. Ltd.
172. The Southern Union Commercial Ins. Co. of Aust. Ltd.
173. The State Assurance Co. Ltd.
174. The State Savings Bank Ins. Trust Fund.
175. The Steadfast Ins. Co. Ltd.
176. Steeves Agnew & Co. Vic. Pty. Ltd.
177. Stenhouse Reinsurance Pty. Ltd.
178. Stenhouse Scott North Aust. Ltd.
179. Sun Alliance & London Ins. Group.
180. Surrey Ins. Co. Ltd.
181. Swann Insurance Limited.
182. Switzerland General Ins. Co. Ltd.
183. T. & G. Fire & General Ins. Co. Ltd.
184. Taisho Marine & Fire Ins. Co. Ltd.
185. Stanley Taylor & Co.
186. The Thames & Mersey Ins. Co. Ltd.
187. The Tokio Marine & Fire Ins. Co. Ltd.
188. R. H. Tolley & Gardner Pty. Ltd.
189. Traders Prudent Ins. Co. Ltd.
190. Transport Industries Insurance Co. Pty. Ltd.
191. Transport & General Ins. Co. Ltd.
192. Triumph Insurance Co. (Aust.) Ltd.
193. Triton Ins. Co. Ltd.
194. Underwriting & Ins. Ltd.
195. The United Ins. Co. Ltd.
196. The Union Ass. Co. of Aust. Ltd.
197. The Union Ins. Co. of Canton Ltd.
198. L' Union Des Assurance De Paris.
199. Vanguard Insurance Co. Ltd.
200. Vehicle & General Ins. Co. Aust. Ltd.
201. The Victoria Ins. Co. Ltd.
202. Vic. Auto. Chamber of Commerce Ins. Co. Ltd.
203. The Victory Reinsurance Co. of Aust. Ltd.
204. J. H. Wackerbarth Aust. Pty. Ltd.
205. Western Assurance Co.
206. The Western Aust. Ins. Co. Canberra Ltd.
207. Westminster Insurance Co. Ltd.
208. Wheatgrowers & General Ins. Co.
209. Waltons Insurances Co. Ltd.
210. Westchester Fire Insurance Co.
211. Willis Faber Johnson & Higgins Vic. Pty. Ltd.
212. The Yorkshire Ins. Co. Ltd.

DANDENONG VALLEY REGIONAL LIBRARY SERVICE.

NOTICE OF APPROVAL OF AGREEMENT.

THE agreement made between the Mayor, Councillors and Citizens of the City of Dandenong, the Mayor, Councillors and Citizens of the City of Springvale, the President, Councillors and Ratepayers of the Shire of Berwick, and the President, Councillors and Ratepayers of the Shire of Cranbourne for the provision of a joint library service in the municipal districts of the said municipalities was approved by the Governor in Council, pursuant to the provisions of section 799 of the *Local Government Act 1958*, on the 25th day of May, 1971.

JOHN A. HORLOCK,
Acting Clerk of the Executive Council.
At the Executive Council Chamber,
Melbourne, 25th May, 1971.

Drainage Areas Act.

SPECIAL MAINTENANCE CHARGE MADE BY THE SHIRE OF MINHAMITE COUNCIL IN RESPECT OF THE MOYNE DRAINAGE AREA.

NOTICE is hereby given that, on the 25th day of May, 1971, in pursuance of the provisions of section 36 of the *Drainage Areas Act 1958*, the Governor in Council approved of the estimate of the cost of proposed maintenance works in the Moyne Drainage Area submitted by the Minhamite Shire Council, and of the making by the Council of a Special Maintenance Charge on properties within the said drainage area for the year ending 30th September, 1971.

JOHN A. HORLOCK,
Acting Clerk of the Executive Council.
At the Executive Council Chamber,
Melbourne, 25th May, 1971.

Melbourne and Metropolitan

BOARD OF WORKS.

NOTICE TO THE OWNERS OF TENEMENTS IN THE UNDERMENTIONED STREETS AND THE PRIVATE STREETS, LANES, COURTS AND ALLEYS OPENING THERETO.

THE main pipe in the said streets being laid down, the owners of all tenements situated as under are hereby required on or before the 5th July, 1971, to cause a proper pipe and stopcocks to be laid so as to supply water within such tenements from the main pipe.

W. C. S. ELLIS,
Secretary.

25th May, 1971.

STREET AND POSITION.

Broadmeadows.

Station-road, from 66 feet south-east of Cartwright-street south-eastwards 150 feet.

Pearson-crescent, from 550 feet west of Kyabram-street westwards 20 feet.

Croydon.

Swanley-avenue, from Hamilton-road to Pointside-avenue. Pointside-avenue, from Swanley-avenue north-westwards 120 feet.

Pointside-avenue, from Swanley-avenue south-eastwards 330 feet.

Diamond Valley.

Plenty River-drive, from Diamond Creek-road north-westwards 630 feet.

Tarwarri-court, from Plenty River-drive northwards 160 feet.

Avandina-crescent, from Plenty River-drive eastwards 220 feet.

Manatunga-circuit, from Plenty River-drive south-westwards 300 feet.

Doncaster and Templestowe.

Nonda-avenue, from Blackburn-road to Woorarra-avenue.

Essendon.

Glen-street, from 200 feet south of Marco Polo-street southwards and eastwards 140 feet.

Footscray.

Canterbury-street, from Willis-street westwards 70 feet.

Heidelberg.

Turnham-avenue, from Station-street southwards 140 feet. Northern-road, from 320 feet west of Korong-road westwards 70 feet.

Keilor.

Bulla-road, from Tullamarina-avenue to Carol-grove. Sharps-road, from 280 feet west of Coonamar-street westwards 1,210 feet.

Fisher-grove, from Sharps-road northwards 580 feet.

Dianne-drive, from Fisher-grove to Dawson-street.

Larissa-avenue, from Fisher-grove to Dawson-street.

Remo-place, from Larissa-avenue northwards 260 feet.

Dawson-street, from Sharps-road north-westwards 1,000 feet.

McLaren-street, from Dawson-street north-eastwards 230 feet.

Sexton-street, from Parer-road to Moore-road.

South-street, from Highlands-avenue to McNamara-avenue. Parer-road, from 180 feet west of Louis-street westwards 400 feet.

McIntosh-street, from 230 feet west of Matthews-avenue westwards 1,150 feet.

King-street, from Matthews-avenue westwards 400 feet.

Fraser-street, from Matthews-avenue westwards 430 feet.

Kingsley-road, from Hilbert-road northwards 240 feet.

Knox.

Patterson-street, from 20 feet east of Tamar-street eastwards 660 feet.

Cousin-drive, from Patterson-street southwards 60 feet.

Dendori-court, from Patterson-street, southwards 400 feet.

Leona-drive, from Patterson-street northwards 600 feet.

Bevan-court, from Leona-drive westwards and northwards 500 feet.

Mint-street, from Lantana-street southwards 230 feet.

Dorset-road (east side), from Currawa-drive, southwards 500 feet.

Currawa-drive, from Dorset-road to Cedar-crescent.

Sycamore-crescent, from Currawa-drive south-eastwards 280 feet.

Rothan-avenue, from 850 feet eastwards and southwards of Dorset-road, southwards 120 feet.

Lillydale.

Hayrick-lane, from Old Kent-road northwards 880 feet.
 Biala-court, from 290 feet west of Hayrick-lane westwards 130 feet.
 Tibarri-court, from Hayrick-lane westwards 460 feet.
 Kadina-court, from Hayrick-lane eastwards 560 feet.
 Greenwood-lane, from Mountain-drive south-westwards 500 feet.
 Mountain-drive, from Greenwood-lane northwards 230 feet.
 Mountain-drive, from Greenwood-lane southwards 220 feet.

Mordialloc.

Edward-street, from McDonald-street to Woods-avenue.
 Woods-avenue, from Edward-street westwards 90 feet.
 Bear-street, from 150 feet east of Steedman-street eastwards 70 feet.

Nunawading.

Cantley-lane, from Terrara-road to Nurlendi-street.
 Nurlendi-street, from 230 feet south of Cantley-lane southwards 160 feet.
 Hawthorn-road, from Joan-crescent to Robinlee-avenue.
 Fulview-court, from Central-road northwards 290 feet.

Springvale.

Amron-street, from Norman-avenue north-eastwards 340 feet.
 Norman-avenue, from 380 feet north-west of Seventh-avenue to Amron-street.
 Wirilda-court, from Harold-road northwards 650 feet.
 Eden-avenue, from Rosa-avenue to Gunthür-avenue.

Sunshine.

Bronwyn-court, from 20 feet west of Birchwood-boulevard westwards 280 feet.
 Phyllis-parade, from 20 feet west of Birchwood-boulevard westwards 250 feet.
 Birchwood-boulevard, from 150 feet north of Phyllis-parade northwards 640 feet.
 Ferris-avenue, from 10 feet north of Tasman-avenue northwards 670 feet.
 Erindale-avenue, from Tasman-avenue northwards 620 feet.
 Mawson-avenue, from Erindale-avenue eastwards 610 feet.
 Throsby-crescent, from Erindale-avenue eastwards 610 feet.
 Booral-drive, from Canoon-street to Wright-street.
 Nurla-court, from Booral-drive south-eastwards 490 feet.
 Della-place, from Booral-drive westwards 220 feet.

Waverley.

Zodiac-street, from Morton-road eastwards 600 feet.
 Octavia-court, from Zodiac-street northwards 310 feet.
 Iberia-court, from Morton-road eastwards 270 feet.

Whittlesea.

Casey-drive, from Dallas-drive southwards 90 feet.
 Casey-drive, from Dallas-drive north-westwards 920 feet.
 Dallas-drive, from 50 feet south of Boston-road to Casey-drive.
 Watson-court, from Casey-drive north-eastwards 360 feet.

Wheat Marketing Act 1969.

DETERMINATION OF FORMULA FOR ALLOCATION OF WHEAT QUOTAS FOR THE SEASON 1971-1972.

IN pursuance of the powers conferred upon me by section 17 (3) of the *Wheat Marketing Act 1969*, I, William Archibald Borthwick, the Acting Minister of Agriculture for the time being of the State of Victoria, after consultation with the Victorian Farmers' Union, do hereby determine that the formula in accordance with which the Wheat Quota Committee shall allocate to landowners in respect of their land quotas for deliveries of wheat in respect of the season 1971-1972 shall be as follows:—

$$\frac{56.25}{63.7} \times \frac{Q}{1}$$

where Q is the landowner's quota or quota entitlement in respect of the season 1969-1970 plus any special quota allocated to him for that season under sub-paragraphs 1 and 2 of section 34 (1) (a) of the *Wheat Marketing Act 1969*.

W. BORTHWICK,

Acting Minister of Agriculture.

1st June, 1971.

Town and Country Planning Act 1961.

CITY OF MOE PLANNING SCHEME 1966.

REVOCATION No. 2, 1971.

Notice of Revocation.

IN pursuance of the powers conferred by sub-section 4 of section 32 of the *Town and Country Planning Act 1961*, the Governor in Council, by and with the advice of Executive Council on the 25th May, 1971—

- (i) revoked the City of Moe Planning Scheme 1966 in so far as it affected Railway Lot 19 at Gunn's Gully, Moe; and
- (ii) prohibited the use or development of the land described in (i) except with the consent of the Council of the City of Moe.

A copy of the revocation may be inspected during office hours at the office of the Town and Country Planning Board, 235 Queen-street, Melbourne, and at the office of the council of the City of Moe, at Moe.

W. H. CRAIG, Secretary,
 Town and Country Planning Board.

Town and Country Planning Act 1961.

CITY OF ARARAT PLANNING SCHEME.

REVOCATION No. 3.

Notice of Revocation.

IN pursuance of the powers conferred by sub-section 4 of section 32 of the *Town and Country Planning Act 1961*, the Governor in Council, by and with the advice of Executive Council on the 25th May, 1971—

- (i) revoked the City of Ararat Planning Scheme in so far as it affected Crown allotment 13M, section 14, Parish of Ararat; and
- (ii) prohibited the use or development of the land described in (i) except with the consent of the Council of the City of Ararat.

A copy of the revocation may be inspected during office hours at the office of the Town and Country Planning Board, 235 Queen-street, Melbourne, and at the office of the council of the City of Ararat, at Ararat.

W. H. CRAIG, Secretary,
 Town and Country Planning Board.

Town and Country Planning Act 1961.

CITY OF KNOX PLANNING SCHEME 1965.

AMENDMENT No. 79, 1970.

Notice of Approval.

IN pursuance of the powers conferred by the *Town and Country Planning Act 1961*, the Governor in Council on the 25th May, 1971, approved a planning scheme entitled the City of Knox Planning Scheme 1965, Amendment No. 79, 1970, in respect of part of the municipal district of the City of Knox, and such planning scheme comes into operation on the date this notice of approval is published in the *Government Gazette*.

A copy of the planning scheme as approved may be inspected free of charge during office hours at the office of the Town and Country Planning Board, 235 Queen-street, Melbourne; at the office of the Council of the City of Knox, at Fern Tree Gully; and when available, at the Office of Titles, Melbourne, and at the Central Plan Office of the Department of Crown Lands and Survey, Melbourne.

W. H. CRAIG, Secretary,
 Town and Country Planning Board.

WOORI YALLOCK-LAUNCHING PLACE WATERWORKS TRUST.

AUTHORITY TO OBTAIN BANK OVERDRAFT.

HIS Excellency the Governor of the State of Victoria, by and with the advice of the Executive Council thereof, doth by Order made on the 1st day of June, 1971, authorize the Woori Yallock-Launching Place Waterworks Trust, to obtain during the year 1971, in pursuance of the provisions of section 286 of the *Water Act 1958* (No. 6413), an advance or advances by overdraft of the Trust's current account, the amount owing in respect of such overdraft not to exceed at any one time the sum of Five thousand dollars (\$5,000).

J. ROSSITER,
 Clerk of the Executive Council.

At the Executive Council Chamber,
 Melbourne, 1st June, 1971.

Pipelines Act 1967, No. 7541.
APPLICATION FOR A PERMIT TO OWN AND USE
A PIPELINE.

MINISTRY OF FUEL AND POWER.
Notice.

1. In accordance with the provisions of section 11 (1) of the *Pipelines Act 1967*, notice is given that an application has been received by me from the Gas and Fuel Corporation of Victoria for a permit to own and use a pipeline for the purpose of conveying natural gas from Branch Valve No. 4 on the Longford to Dandenong trunkline at Tyers to Australian Paper Manufacturers' paper pulp mill at Maryvale.

2. The proposed route of the pipeline is as follows:— A steel pipeline 3.4 miles long with an outer diameter of 6½ inches and designed to operate at a maximum pressure of 1,000 p.s.i.g., commencing at Branch Valve No. 4 on the Longford to Dandenong natural gas trunkline and located 3 feet inside the east boundary fence of Tyers-road, Tyers, on allotment 6, Parish of Boola Boola; thence entering Tyers-road and proceeding in a south-westerly direction along such road to Littley-lane; thence turning to enter and continue in a southerly direction along such lane for approximately 7,800 feet; thence turning to enter and continue in a westerly direction for approximately 3,100 feet across part allotment 9, Parish of Boola Boola; thence turning to enter and continue in a generally south-westerly direction across allotments 1A and A1 and part allotment A, Parish of Boola Boola to the Crown land river frontage reserve along the Latrobe River; thence crossing such reserve, the Latrobe River and another Crown land river frontage reserve on the southern side of the river; thence continuing in a generally southerly direction across allotments 30A and 30B and part allotments 26, 26A, 27, 28, 29, 30, 84 and 95C, Parish of Maryvale, owned by Australian Paper Manufacturers Ltd., to terminate at a regulator at that company's paper pulp mill at Maryvale.

3. Plans of the proposed route of the pipeline may be inspected commencing Thursday, 27th May, 1971, between the hours of 10 a.m. and 4 p.m., on Mondays to Fridays (excluding public holidays) at—

- (a) Ministry of Fuel and Power,
15th Floor, 171 Flinders-street, Melbourne.
- (b) Gas and Fuel Corporation of Victoria,
8th Floor, 171 Flinders-street, Melbourne.
- (c) Gas and Fuel Corporation of Victoria's Branch
Office,
89 Seymour-street, Traralgon.

Additional copies of plans are not available and detailed route plans can be seen only at the Gas and Fuel Corporation's Head Office, Melbourne.

4. Any objection to the proposed route of the pipeline must be addressed to me and reach the office of the Ministry no later than Friday, 2nd July, 1971.

J. C. M. BALFOUR,
Minister for Fuel and Power.

27th May, 1971.

Stamps Act 1958.
ANNUAL LICENCE.

NOTIFICATION PURSUANT TO SECTION 97.

I HEREBY notify that stamp duty has been paid for a licence under section 96 of the Stamps Act to carry on assurance and insurance business in Victoria from 1st June, 1971 to 31st December, 1971, by the following:—

HALLMARK GENERAL INSURANCE CO. LTD.

R. M. PHIBBS,
Comptroller of Stamps.

Chief Office for Stamp Duties,
Melbourne, 2nd June, 1971.

THE LIQUOR CONTROL ACT 1968.

WHEREAS the Hotelkeeper's licence for the licensed premises known as the Woodend Hotel, situate at Woodend, has been surrendered as from 31st December, 1970, notice is hereby given that the amount of compensation payable to the owner of such premises pursuant to the provisions of the *Liquor Control Act 1968* is as under:—

Owner—\$11,900.00.

Dated at Melbourne this 28th day of May, 1971.

J. E. TAYLOR, Deputy Secretary,
Liquor Control Commission.

DEPARTMENT OF MINES.

APPLICATION FOR MINING LEASE DECLARED
ABANDONED.

8983, Mineral; Henry Owen Rodwell; 70 acres, Parish of Yehrip.

MINING LEASE GRANTED.

8922, Mineral; Doogalook Mining Pty. Ltd.; 6a. Or. 13p., Parish of Yea.

MINING LEASES TRANSFERRED.

8420, Mineral; From John Gordon Antliff to Valley Tin N.L.
8421, Mineral; From John Gordon Antliff to Valley Tin N.L.

APPLICATION FOR EXPLORATION LICENCES
REFUSED.

- 379, Exploration Licence; Waalt Corporation Pty. Ltd.; 25 square miles, Parishes of Kinypanial, Powlett, Korong, Borung.
- 381, Exploration Licence; Comstock Minerals Ltd.; 488 square miles, County of Benambra.
- 383, Exploration Licence; Caravale Ltd.; 488 square miles, County of Benambra.

EXPLORATION LICENCES CANCELLED.

- 121, Exploration Licence; Gippsland Minerals No Liability; 282 square miles, County of Croajingolong.
- 122, Exploration Licence; Gippsland Minerals No Liability; 285 square miles, County of Bogong, Benambra.
- 159, Exploration Licence; Pickands Mather & Co. International; 51 square miles, Parish of Wibenduck.
- 229, Exploration Licence; Stanley Irvine Lincoln, Roy Alan Borchers; 14 square miles, Parish of Bullengarook.

EXPLORATION LICENCES GRANTED.

- 285, Exploration Licence; George Milton; 355 square miles, Counties of Tambo, Dargo.
- 317, Exploration Licence; Coopers Creek Mining & Exploration N.L.; 33 square miles, Parishes of Matlock, Goulburn, Moolpah.

TERMS OF EXPLORATION LICENCES EXTENDED.

- 70, Exploration Licence; Western Mining Corporation Limited; 181 square miles, Counties of Bendigo, Dalhousie, Rodney.
- 115, Exploration Licence; George Milton; 25 square miles, County of Tambo.

MINERAL SEARCH LICENCES EXPIRED.

- 885, Mineral Search Licence; Sedimentary Uranium N.L.; 710 square miles, Counties of Gladstone, Kara Kara, Tatchera.
- 886, Mineral Search Licence; Sedimentary Uranium N.L.; 802 square miles, Counties of Bendigo, Gladstone, Gunbower, Tatchera.
- 887, Mineral Search Licence; Sedimentary Uranium N.L.; 913 square miles, Counties of Borung, Gladstone, Kara Kara, Karkaroc, Tatchera.

APPLICATION FOR EXTRACTIVE INDUSTRY LICENCES
REFUSED.

- 58, Extractive Industry Licence; Roy Gladwin Wales; 637 acres, Parish of Wuri-Youage.
- 93, Extractive Industry Licence; Alexander Peter Warren; 700 acres, Parish of Wuri-Youage.

EXTRACTIVE INDUSTRY LICENCES GRANTED.

- 325, Extractive Industry Licence; Southern Sand and Gravel Pty. Ltd.; 84a. 3r. 35p., Parish of Eumemmerring.
- 519, Extractive Industry Licence; Ready Mixed Concrete (Victoria) Pty. Limited; 4a. Or. 12p., Parish of Koo-Wee-Rup.

J. C. M. BALFOUR,
Minister of Mines.

CONTRACTS ACCEPTED.—(Series 1970-71.)**GENERAL STORES.**

Gazette No. 63, 26th June, 1970, Schedule No. 25, Chemicals, &c. For rates shown opposite Item No. 14 in *Gazette* No. 48 of 19th May, 1971, substitute the following, as from 5th May, 1971:—1-9 x 56 lb., \$387 per ton; 10-19 x 56 lb., \$372; 20-39 x 56 lb., \$356; 1 ton and over, \$342.

PROVISIONS.

Gazette No. 53, 3rd June, 1970, Schedule No. 9, Sub-schedule No. 1, Bread. For rates shown opposite the following items, substitute the rates as set out hereunder, as from 5th May, 1971:—Item No. 1, \$6.06 per cental; Item No. 2, \$4.925 per cental.

Gazette No. 53, 3rd June, 1970, Schedule No. 1, Sub-schedule No. 7, Groceries, Metropolitan. For rates shown opposite the following items, substitute the rates as set out hereunder, as from 1st June, 1971:—Item No. 21, Bread-crumbs Terra, \$1.07 doz.; Item No. 33, \$0.60 lb.; Item No. 58, \$0.26 each; Item No. 59, \$0.44 each; Item No. 60, \$0.80 each; Item No. 64, \$0.33 each; Item No. 65, \$0.59 each; Item No. 72, "Marshalls", \$4.00 doz.; Item No. 111, 60 lb., "Archibald" \$8.50 each; Item No. 112, 5 lb., "Archibald" \$0.84 each; Item No. 113, 2 lb., "Archibald" \$4.48 doz.; Item No. 124, \$1.37 each; Item No. 153, 26 oz. T/P \$5.00 doz.; Item No. 162, \$1.85 doz.; Item No. 196, \$2.05 doz.; Item No. 203, \$2.05 doz.

E. P. WATSON, Secretary to the Tender Board. 31.5.71.

ORDERS IN COUNCIL.—(Series 1970-71.)**PUBLIC WORKS.**

1267. Melbourne, State Government Offices, Treasury Reserve, night-watching services for the period 1st June, 1971, to 31st May, 1972, \$21,314.64.—Australian Watching Co. Pty. Ltd.—(P.84.)

1268. South Melbourne, Hospitals and Charities Commission, 9 Queens-road, supply and installation of a P.A.B.X. System, \$30,802.00.—Standard Telephones and Cables Pty. Ltd.—(P.314.)

Approved by the Governor in Council, 25th May, 1971.—
JOHN A. HORLOCK, Acting Clerk of the Executive Council.

APPOINTMENTS AND RESIGNATIONS**APPOINTMENTS.**

HIS Excellency the Governor of the State of Victoria, by and with the advice of the Executive Council thereof, has, by Orders made on the 25th day of May, 1971, been pleased to make the under-mentioned appointments, viz.:—

CROWN LANDS AND SURVEY DEPARTMENT.*Bailiffs of Crown Lands.*

TREVOR JAMES STRUDWICK, and

PETER JOHN OSWALD,

to be Bailiffs of Crown Lands, without salary, with respect to the Crown Lands in the Parish of Balnarring, known as the "Point Leo Foreshore and Public Park Reserves", pursuant to section 30 of the *Land Act 1958*.

MINISTRY OF HEALTH.*Deputy Chairman of the Hospitals and Charities Commission.*

ROBERT LEONARD EDWIN THOMAS, B.Comm., A.A.S.A., to be Deputy Chairman of the Hospitals and Charities Commission, pursuant to section 12 of the *Hospitals and Charities Act 1958*, to act from and inclusive of the 24th May, 1971, until the return to Victoria of A. J. McLellan.

Member of Clean Air Committee.

LESLIE CHARLES ROLLS

to be a Member of Clean Air Committee, for the period ending the 28th February, 1972, pursuant to the provisions of section 10 (2) (b) (ii) of the *Clean Air Act 1958*.

Members of Committees of Management of Hospitals.

WILLIAM FRANCIS RASHLEIGH

to be the Government Appointee on Committee of Management of the Royal Talbot General Rehabilitation Hospital, for a period of three years commencing the 12th June, 1971, pursuant to the provisions of section 48 (1) (a) (ii) of the *Hospitals and Charities Act 1958*;

ARTHUR GORDON OLDHAM

to be the Government Appointee on Committee of Management of the Royal Victorian Eye and Ear Hospital, for a

period of three years commencing the 19th June, 1971, pursuant to the provisions of section 48 (1) (a) (ii) of the *Hospitals and Charities Act 1958*; and

BRUCE WEMYSS

to be the Government Appointee on Committee of Management of the Geelong Hospital, for a period of three years commencing the 19th June, 1971, pursuant to the provisions of section 48 (1) (a) (ii) of the *Hospitals and Charities Act 1958*.

President of the Dental Board of Victoria.

PETER ROBERT FINCH

to be President of the Dental Board of Victoria, pursuant to the provisions of section 46 (1) of the *Medical Act 1958*, for the period ending the 28th February, 1972.

LAW DEPARTMENT.*Commissioners for Taking Declarations, &c.*

GEOFFREY LEE BALES, care of Commercial Banking Company of Sydney Limited, 32 Glenferrie-road, Malvern, and

STUART DAVID SOUTHWICK, Cedel Products (Australia) Pty. Ltd., Doherty's-road, Derrimut, to be Commissioners for taking Declarations and Affidavits, pursuant to the provisions of the *Evidence Act 1958*, to resign upon ceasing to occupy their present positions; and

LORENZO MODICA, 78 Melbourne-road, Dandenong,

ROBERT JOHN McVEY, Flat 4, 368 Dryburgh-street,

North Melbourne,

DOUGLAS GORDON BANKS, 31 Glenmore-crescent, Black

Rock,

EMMANUEL PIUS BUGEJA, Flat 3, 5 Headley-street,

North Coburg,

LESLIE LIONEL MILLER, 181 Middleborough-road, Box

Hill, and

RONALD MASTERS, Jumbuk-road, Jeeralang Junction.

to be Commissioners for taking Declarations and Affidavits, pursuant to the provisions of the *Evidence Act 1958*, to resign upon removing from the neighbourhood of the addresses stated.

SOCIAL WELFARE DEPARTMENT.*Stipendiary Probation Officer, &c.*

PRUDENCE COLLETTE WARD (Mrs.),

pursuant to the provisions of sections 507 (1) and 533 (3) of the *Crimes Act 1958*, and section 9 (2) of the *Children's Court Act 1958*, and section 165 (1) of the *Social Welfare Act 1970*, to be a Stipendiary Probation Officer for every Children's Court, Stipendiary Probation Officer and Stipendiary Parole Officer and Stipendiary Youth Parole Officer, respectively. Mrs. Ward was previously appointed on 23rd February, 1971, to the same offices in her maiden name of Prudence Collette Duncan. She has now by marriage acquired the name of Prudence Collette Ward.

DEPARTMENT OF THE TREASURER.*Collector of Imposts (Acting).*

IAN JOSEPH HOYNE

to act temporarily as Collector of Imposts, Division of Tourism, Department of State Development, vice A. C. Anderson, on leave.

JOHN A. HORLOCK,

Acting Clerk of the Executive Council.

At the Executive Council Chamber,

Melbourne, 25th May, 1971.

*Vegetation and Vine Diseases Act 1958—Fruit and Vegetables Act 1958.***APPOINTMENT OF INSPECTORS.**

THE Public Service Board, by certificate dated the 12th May, 1971, appointed the under-mentioned officers and employee to be Inspectors under the provisions of the *Vegetation and Vine Diseases Act 1958*, and the *Fruit and Vegetables Act 1958*, without additional salary—

Name; Designation.

BLACK, JOHN DONALD; Senior District Horticultural Officer, Class "SO-7", Professional Division.

RICH, OWEN GEOFFREY; Agricultural Officer, Class "AO-1", Professional Division.

LITTLEJOHN, DAVID BRUCE; Horticultural Inspector, Grades 96-117A inclusive, Technical and General Division.

MOXOM, GARRY ROBERT; Horticultural Inspector, Grades 96-117A inclusive, Technical and General Division.

WORSLEY, BRIAN CLIFTON; Horticultural Inspector.

D. S. WISHART,

Director of Agriculture.

STATE FORESTS DEPARTMENT.

APPOINTMENT OF MEMBERS OF COMMITTEE OF MANAGEMENT OF "THE OLINDA GOLF COURSE AREA".

WHEREAS by section 50 of the *Forests Act 1958* (No. 6254), it is provided that the Minister of Forests may, on the recommendation of the Forests Commission, appoint any number of persons, not less than three, to be a Committee of Management of any land forming part of any reserved forest, such land being set aside as a Golf Course Area, and may remove any of those persons: Now, therefore, I, Edward Raymond Meagher, Her Majesty's Minister of Forests for the State of Victoria, on the recommendation of the Forests Commission, do hereby appoint—

VERA STEWART DODD,
ALLAN PERCY DODD,
FRANCIS STEWART BANKIN,
JAMES ANTOINE MARTY,
JAMES CAMPBELL WESTCOTT,
ROY VICTOR BUTLER,
HENRY EDWIN RICH,
JAMES FRANCIS LUCAS, and
ATHOL HODGSON,

as members of the Committee of Management until the 19th day of June, 1974, of the land forming part of the reserved forest in the Parish of Monbulk, County of Evelyn, described in the accompanying Schedule, and known as "The Olinda Golf Course Area".

SCHEDULE ABOVE REFERRED TO.

Parish of Monbulk, County of Evelyn, 125 acres, more or less, being the area shown by pink colour on the plan marked A.58/1462 over 28.9.62 in file of correspondence No. 67/720 of the Forests Department.

Dated at Melbourne, the 28th day of May, 1971.

E. R. MEAGHER,
Minister of Forests.

STATE FORESTS DEPARTMENT.

APPOINTMENT OF COMMITTEE OF MANAGEMENT OF "MT. MISERY GARDEN AND BERRINGA FLORA AND FAUNA RESERVE".

WHEREAS by section 50 of the *Forests Act 1958* (No. 6254), it is provided that the Minister of Forests may, on the recommendation of the Forests Commission, appoint any number of persons, not less than three, to be a Committee of Management of any land forming part of any reserved forest, such land being set aside as a flora and fauna reserve, and may remove any of those persons: Now, therefore, I, Edward Raymond Meagher, Her Majesty's Minister of Forests for the State of Victoria, on the recommendation of the Forests Commission, do hereby appoint—

STELLA AMELIA BEDGOOD,
MYRTLE STRANGE,
ROBERT MAXWELL WARNEKE,
JEFFREY PETER BRISBANE,

as members of the Committee of Management until the 19th day of May, 1974, of the land forming part of the reserved forest in the Parish of Lynchfield, County of Grenville, described in the accompanying Schedule, and known as "Mt. Misery Garden and Berringa Flora and Fauna Reserve".

SCHEDULE ABOVE REFERRED TO.

Parish of Lynchfield, County of Grenville, comprising 900 acres, more or less, being the areas shown by pink colour on plan marked A64/1241 over 20.5.65 on the file of correspondence No. 64/1241 of the Forests Department.

Dated at Melbourne, the 28th day of May, 1971.

E. R. MEAGHER,
Minister of Forests.

STATE FORESTS DEPARTMENT.

APPOINTMENT OF COMMITTEE OF MANAGEMENT OF "LEAGHUR FOREST PARK".

WHEREAS by section 50 of the *Forests Act 1958* (No. 6254), it is provided that the Minister of Forests may, on the recommendation of the Forests Commission, appoint any number of persons, not less than three, to be a Committee of Management of any land forming part of any reserved forest, such land being set aside and declared to be a Forest Park, and may remove any of those persons: Now, therefore, I, Edward Raymond Meagher, Her Majesty's Minister of Forests for the State of Victoria, on the recommendation of the Forests Commission, do hereby appoint—

HOWARD BRUCE HUNTER
vice L. J. Lowery transferred, as a member of the Committee of Management until the 30th day of September,

1973, of the land forming part of the reserved forest in the Parishes of Leaghur and Meering, County of Tatchera, described in the accompanying Schedule, and known as the "Leaghur Forest Park".

SCHEDULE ABOVE REFERRED TO.

Parishes of Leaghur and Meering, County of Tatchera, comprising 4,000 acres, more or less, being the area shown coloured green and hatched blue on plan marked A over 25.3.70, on file of correspondence No. 70/472, of the Forests Department.

Dated at Melbourne the 10th day of May, 1971.

E. R. MEAGHER,
Minister of Forests.

RESIGNATIONS.

HIS Excellency the Governor of the State of Victoria, by and with the advice of the Executive Council thereof, has, by Orders made on the 25th day of May, 1971, accepted the resignations of the persons named hereunder of the offices mentioned, viz.:—

LAW DEPARTMENT.

Commissioners for Taking Declarations, &c.

JOHN CARL JANICKE,
IAN JAMES SANGWELL, and
MICHAEL MCKEOWN,

as Commissioners for taking Declarations and Affidavits, pursuant to the provisions of the *Evidence Act 1958*.

Justice of the Peace.

JAMES ROBERT LAHN, from the Commission of the Peace for the State of Victoria.

SOCIAL WELFARE DEPARTMENT.

Probation and Parole Officer.

SALVATORE STEFANO GIOVANNI PINZONE, Probation and Parole Officer, pursuant to the provisions of sections 507 (1) and 533 (3) of the *Crimes Act 1958*, and section 9 (2) of the *Children's Court Act 1958*, and section 165 (1) of the *Social Welfare Act 1970*.

JOHN A. HORLOCK,
Acting Clerk of the Executive Council.

At the Executive Council Chamber,
Melbourne, 25th May, 1971.

ORDERS IN COUNCIL

BOARD OF INQUIRY INTO THE TEACHING SERVICE.

At the Executive Council Chamber, Melbourne, the twenty-fifth day of May, 1971.

PRESENT:

His Excellency the Governor of Victoria.

Mr. Reid	Mr. Borthwick
Mr. Rafferty	Mr. Hunt.

HIS Excellency the Governor of the State of Victoria, in the Commonwealth of Australia, by and with the advice of the Executive Council of the said State, and in pursuance of the powers conferred by the Public Accounts and Stores Regulations made under the provisions of the *Audit Act 1958*, and all other powers him thereunto enabling, doth by this Order sanction a maximum expenditure of the sum of Forty-four thousand two hundred dollars (\$44,200) by the Board of Inquiry into the Teaching Service.

And the Honorable Rupert James Hamer, Her Majesty's Chief Secretary for the State of Victoria, shall give the necessary directions herein accordingly.

JOHN A. HORLOCK,
Acting Clerk of the Executive Council.

Land Act 1958, Section 208.

DEPARTMENT OF CROWN LANDS AND SURVEY.

At the Executive Council Chamber, Melbourne, the twenty-fifth day of May, 1971.

PRESENT:

His Excellency the Governor of Victoria.
 Mr. Reid | Mr. Borthwick
 Mr. Rafferty | Mr. Hunt.

LAND ACCEPTED BY THE CROWN FOR ROAD PURPOSES IN EXCHANGE FOR CROWN LAND IN THE PARISH OF BOGALARA.

HIS Excellency the Governor of the State of Victoria, by and with the advice of the Executive Council thereof, in pursuance of the powers conferred by section 208 of the Land Act 1958, doth accept for road purposes—
 Four acres 3 roods 25 perches, Parish of Bogalara, County of Follett, indicated by hatching on plan hereunder, in exchange for 4 acres 3 roods 17 perches, Parish of Mageppa, County of Follett, indicated by cross-hatching on plan hereunder.—(B.651^(*)) (J.33476).

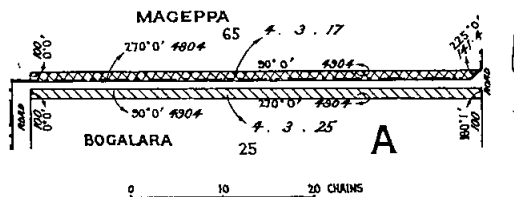

And the Honorable William Archibald Borthwick, Her Majesty's Minister of Lands for the State of Victoria, shall give the necessary directions herein accordingly.

JOHN A. HORLOCK,
 Acting Clerk of the Executive Council.

Land Act 1958.

DEPARTMENT OF CROWN LANDS AND SURVEY.

At the Executive Council Chamber, Melbourne, the twenty-fifth day of May, 1971.

PRESENT:

His Excellency the Governor of Victoria.
 Mr. Reid | Mr. Borthwick
 Mr. Rafferty | Mr. Hunt.

REVOCATION OF TEMPORARY RESERVATION OF LAND BY ORDER IN COUNCIL.

HIS Excellency the Governor of the State of Victoria, by and with the advice of the Executive Council thereof, doth hereby, in pursuance of the provisions of the Land Act 1958, revoke the temporary reservation of land by Order in Council hereinafter referred to, viz.:—

KIATA.—The temporary reservation by Order in Council of the 31st May, 1886, of 5 acres of land in the Township of Kiata, as a site for a State School.—(K.131^(*)) (86.E.13019) (M.62729).

And the Honorable William Archibald Borthwick, Her Majesty's Minister of Lands for the State of Victoria, shall give the necessary directions herein accordingly.

JOHN A. HORLOCK,
 Acting Clerk of the Executive Council.

DEPARTMENT OF CROWN LANDS AND SURVEY.

At the Executive Council Chamber, Melbourne, the twenty-fifth day of May, 1971.

PRESENT:

His Excellency the Governor of Victoria.
 Mr. Reid | Mr. Borthwick
 Mr. Rafferty | Mr. Hunt.

UNUSED ROADS CLOSED.

HIS Excellency the Governor of the State of Victoria, by and with the advice of the Executive Council thereof, doth hereby direct that, in pursuance of the provisions of section 349 of the Land Act 1958, the unused roads referred to hereunder be closed, viz.:—

Parish of Wehla, County of Gladstone, being the road forming the western boundary of allotment 19, section B.—(W.282^(*)) (W.86344).
 Parish of Wellsford, County of Bendigo, being the road forming the northern boundary of allotment 59A.—(W.268^(*)) (W.88487).
 Parish of Yaughar, County of Polwarth, being the road between allotments 18k and 18q, section A.—(Y.115^(*)) (Misc. 3868).
 Parish of Willung, County of Buln Buln, being the road indicated by hatching on plan hereunder.—(W.342⁽¹⁰⁾) (45/155).

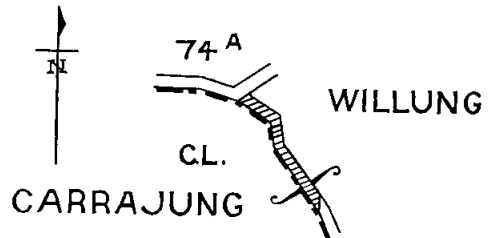

Township of Bannockburn, Parish of Wabdallah, County of Grant, being the roads indicated by hatching on plan hereunder.—(B.35^(*)) (G.68129).

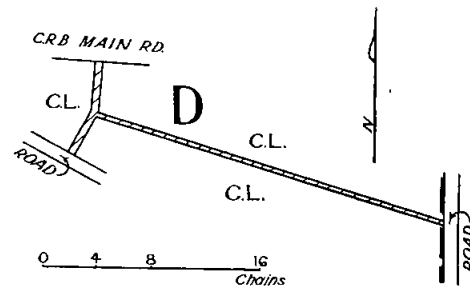

Township of Goornong, Parish of Goornong, County of Bendigo, being the portion of the width of the road, indicated by hatching on plan hereunder.—(G.98^(*)) (W.89054).

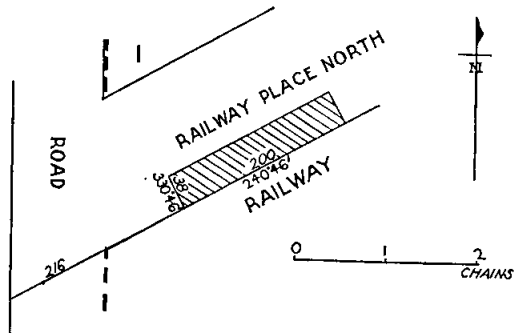

Parish of Gorae, County of Normanby, being the road indicated by hatching on plan hereunder.—(G.210⁽²⁾) (J.31773).

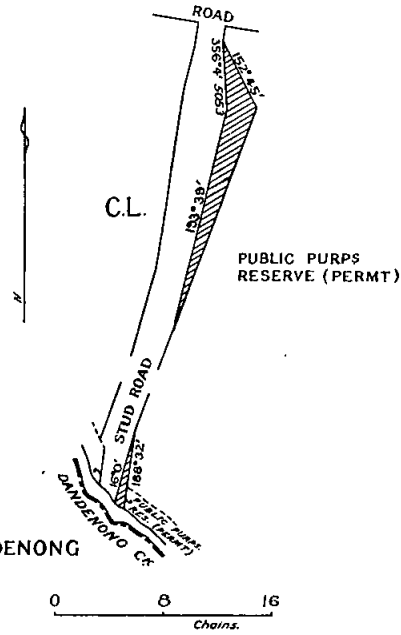
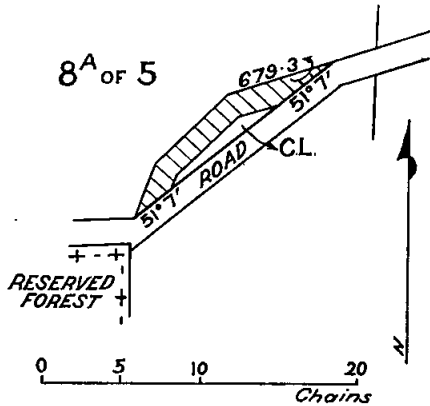

Township of Koondrook, Parish of Murrabit, County of Gunbower, being the road indicated by hatching on plan hereunder.—(K.163⁽²⁾) (W.89143).

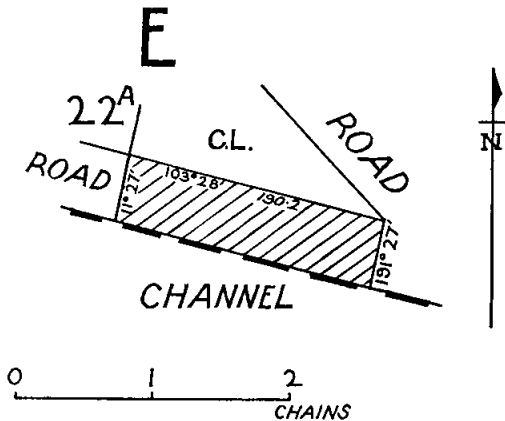

Parish of Moorbanool, County of Polwarth, being the road indicated by hatching on plan hereunder.—(M.536⁽²⁾) (G.62213).

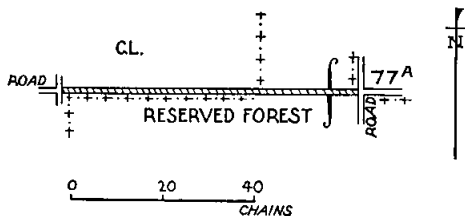

Parish of Narree Worrان, County of Mornington, being the portions of the width of the road indicated by hatching on plan hereunder.—(N.19⁽²⁾) (G.61223).

No. 54.—4671/71.—3

And the Honorable William Archibald Borthwick, Her Majesty's Minister of Lands for the State of Victoria, shall give the necessary directions herein accordingly.

JOHN A. HORLOCK,
Acting Clerk of the Executive Council.

DEPARTMENT OF CROWN LANDS AND SURVEY.

At the Executive Council Chamber, Melbourne, the
twenty-fifth day of May, 1971.

PRESENT:

His Excellency the Governor of Victoria.

Mr. Reid | Mr. Borthwick
Mr. Rafferty | Mr. Hunt.

LANDS TEMPORARILY RESERVED AS SITES.

HIS Excellency the Governor of the State of Victoria, by and with the advice of the Executive Council thereof, doth hereby, in pursuance of section 14 of the Land Act 1958, reserve temporarily from sale, from being leased, and from having a licence granted in respect thereof, and also except from occupation for mining purposes under any miner's right, the lands hereinafter described:—

ALBERTON EAST.—Site for Public purposes (Preservation of Native Flora and Fauna), 75 acres, more or less, Parish of Alberton East, County of Buln Buln, as indicated by hatching on plan hereunder.—(A.14⁽¹²⁾) (Rs.9469).

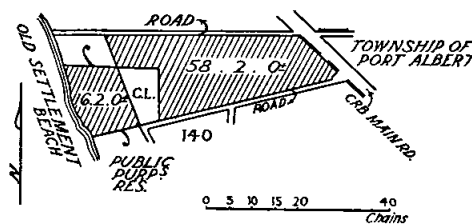

Total Area of Hatched Portions 75.0.0±

ALBERTON EAST.—Site for Public purposes (Removal of Road-making Material), 8 acres 20 perches, more or less, Parish of Alberton East, County of Buln Buln, as indicated by hatching on plan hereunder.—(A.14⁽¹²⁾) (Rs.9470).

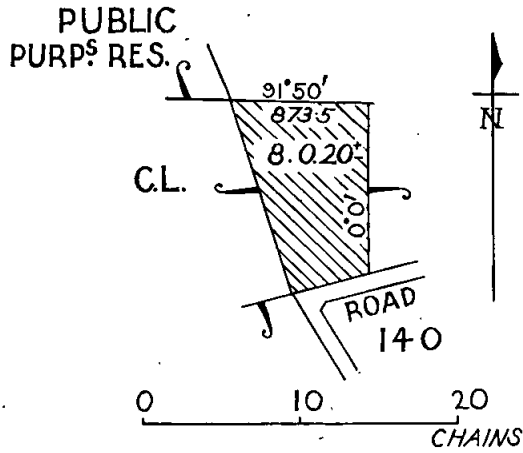

BAIRNSDALE.—Site for Public purposes (Departmental Residence), 35 perches, Township of Bairnsdale, Parish of Bairnsdale, County of Tanjil, being the land indicated by hatching on plan hereunder.—(B.66⁽¹¹⁾) (Rs.9472).

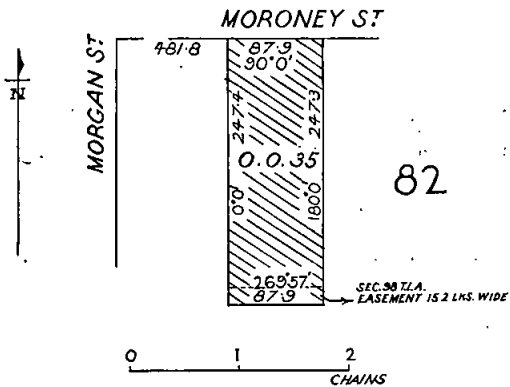

DANDENONG.—Site for Public purposes (Departmental Residence), 23 perches, Parish of Dandenong, County of Bourke, as indicated by hatching on plan hereunder.—(D.19⁽⁸⁾) (Rs.9480).

CANN RIVER.—Site for Public purposes (Bush Nursing Centre), 1 road 24 perches, Township of Cann River, Parish of Noorinbee, County of Croajingolong, as indicated by hatching on plan hereunder.—(N.156⁽⁸⁾) (Rs.9235).

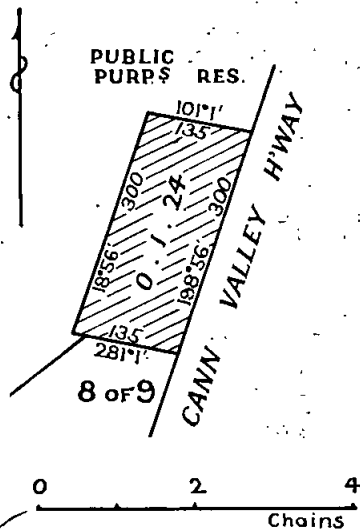

CRESWICK.—Site for a State School (Forest Plantation), 4 acres, Parish of Creswick, County of Talbot, as indicated by hatching on plan hereunder.—(C.400(A¹⁰)) (Rs.9103).

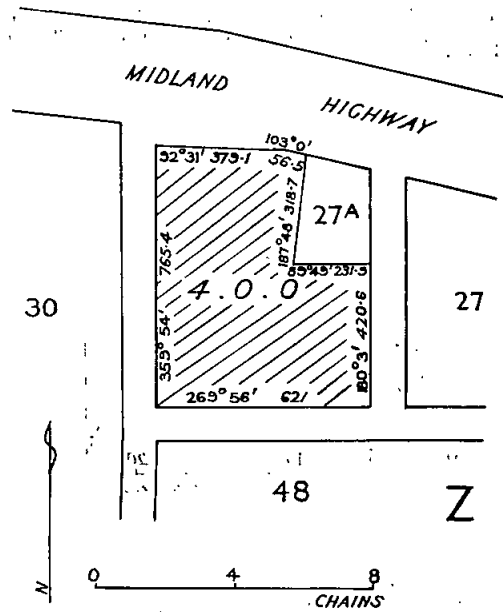

GORYA.—Site for Public Recreation, 4 acres 3 roods 24 perches, Parish of Gorya, County of Karkaroc, as indicated by hatching on plan hereunder.—(G.241⁽⁸⁾) (Rs.1768).

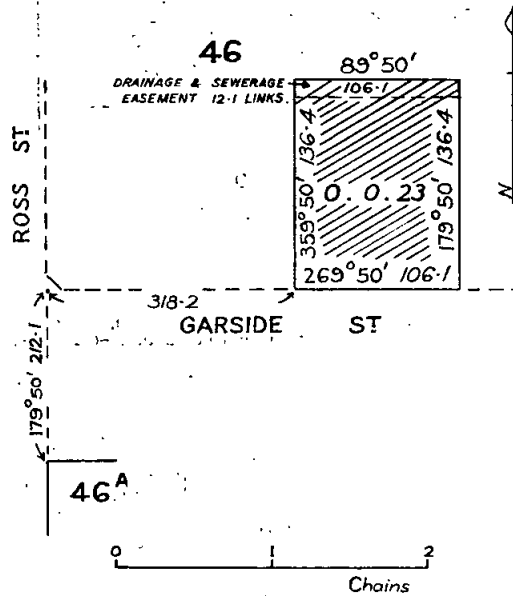

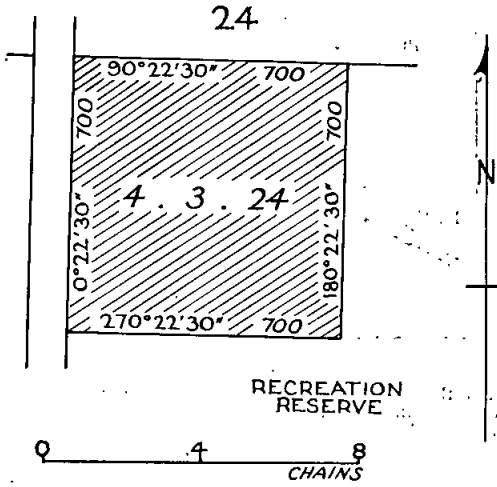

TERANG.—Site for Public purposes (Municipal Purposes), 1 rood 6 perches, Township of Terang, Parish of Terang, County of Hampden, as indicated by hatching on plan hereunder.—(T.85⁽³⁾) (Rs.2970).

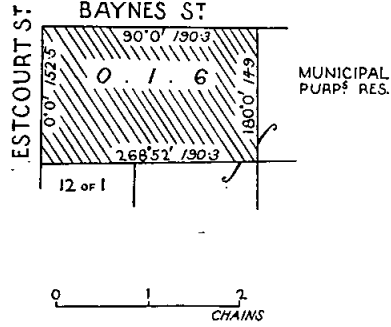

MILDURA.—Site for Public purposes (Lookout), 1 acre 20 perches, more or less, Parish of Mildura, County of Karkaroc, as indicated by hatching on plan hereunder.—(M.556⁽¹¹⁾) (Rs.9476).

WALWA.—Site for Public Recreation, 23 acres 3 roods 37 perches, Parish of Walwa, County of Benambra, as indicated by hatching on plan hereunder.—(W.296⁽³⁾) (Rs.3900).

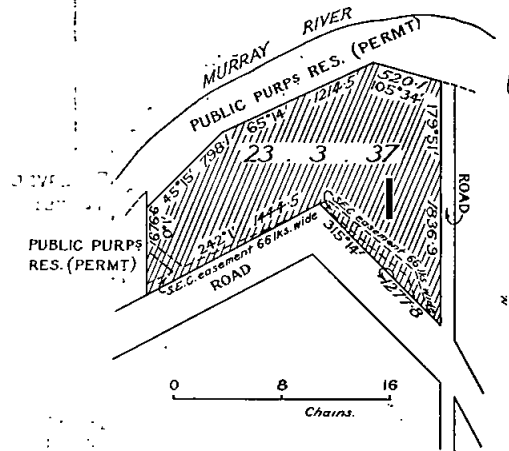
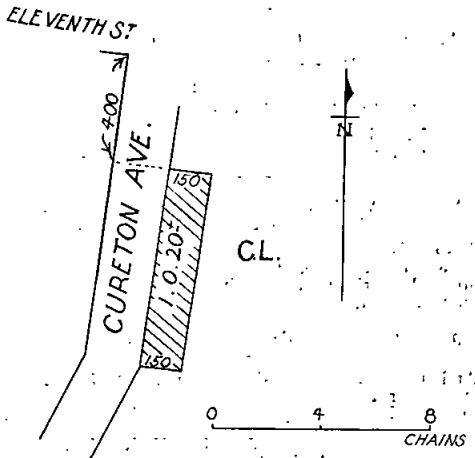

SANDHURST.—Site for Public purposes (Municipal Offices and Civic Centre), 2 acres 30 perches, Parish of Sandhurst, County of Bendigo, as indicated by hatching on plan hereunder.—(S.371⁽⁴⁸⁾) (Rs.1755).

WANGARATTA NORTH.—Site for Public purposes (Departmental Residence), 22 perches, Parish of Wangaratta North, County of Moira, as indicated by hatching on plan hereunder.—(W.85⁽⁷⁾) (Rs.9479).

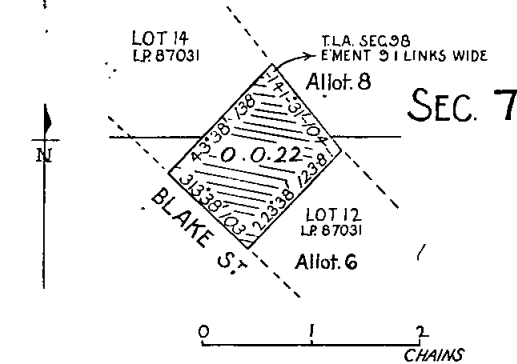
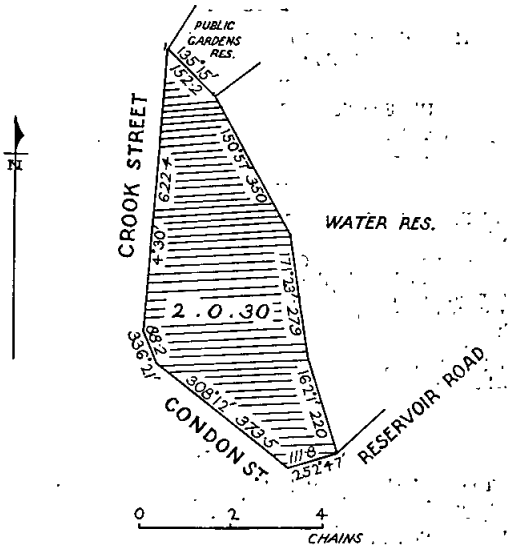

WATAEPOOLAN.—Site for Public purposes (Conservation of Wildlife), 129 acres 25 perches, Parish of Wataepoolan, County of Normanby, as indicated by hatching on plan hereunder.—(W.285⁽⁴⁾) (Rs.9448).

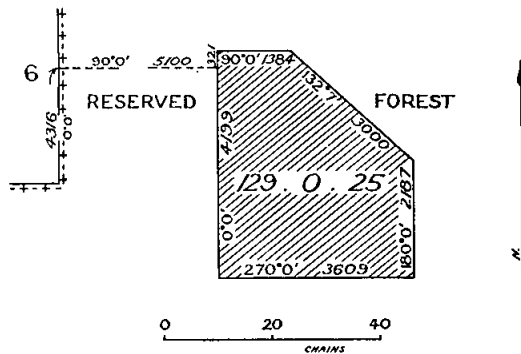

WHROO.—Site for Public Recreation, 1 acre 3 roods 33 perches, Township of Whroo, Parish of Whroo, County of Rodney, as indicated by hatching on plan hereunder.—(W.139^(*)) (Rs.9420).

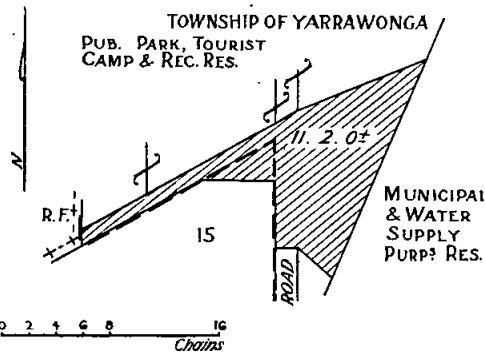

And the Honorable William Archibald Borthwick, Her Majesty's Minister of Lands for the State of Victoria, shall give the necessary directions herein accordingly.

JOHN A. HORLOCK,
Acting Clerk of the Executive Council.

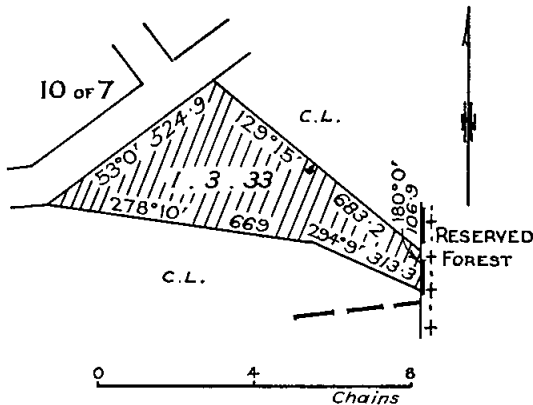

WODONGA.—Site for Public purposes (Picnic Ground and Recreation purposes), 15 acres 1 rood 20 perches, more or less, Township of Wodonga, Parish of Wodonga, County of Bogong, as indicated by hatching on plan hereunder.—(W.308^(S)) (Rs.6600).

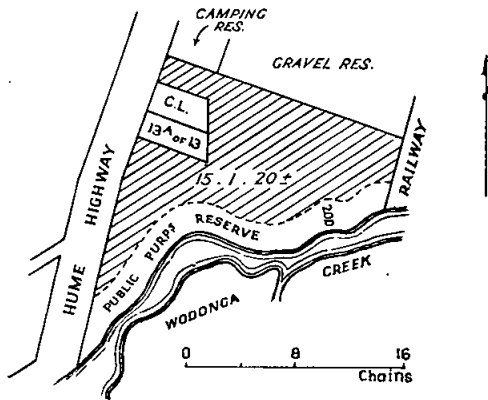

YARROWONGA.—Site for Public Park, Tourist Camp and Recreation purposes, 11 acres 2 roods, more or less, Township of Yarrowonga and Parish of Yarrowonga, County of Moira, as indicated by hatching on plan hereunder.—(Y.86^(*)) (Rs.2054).

COUNTRY ROADS ACT 1958.

At the Executive Council Chamber, Melbourne, the twenty-fifth day of May, 1971.

PRESENT:

His Excellency the Governor of Victoria.	
Mr. Reid	Mr. Borthwick
Mr. Rafferty	Mr. Hunt.

RE-APPOINTMENT OF A MEMBER AND CHAIRMAN OF THE COUNTRY ROADS BOARD.

PURSUANT to the provisions of section 4 of the Country Roads Act 1958, His Excellency the Governor of the State of Victoria, by and with the advice of the Executive Council thereof, hereby re-appoints Ian John O'Donnell as a Member and Chairman of the Country Roads Board for the period ending the 31st day of August, 1971.

And the Honorable Alan John Hunt, Her Majesty's Minister for Local Government for the State of Victoria, shall give the necessary directions herein accordingly.

JOHN A. HORLOCK,
Acting Clerk of the Executive Council.

COUNTRY ROADS BOARD.

At the Executive Council Chamber, Melbourne, the twenty-fifth day of May, 1971.

PRESENT:

His Excellency the Governor of Victoria.	
Mr. Reid	Mr. Borthwick
Mr. Rafferty	Mr. Hunt.

ORDER APPROVING OF LAND BEING ACQUIRED AND ROADS, DEVIATIONS OR WIDENINGS BEING MADE.

HIS Excellency the Governor of the State of Victoria, by and with the advice of the Executive Council thereof, being satisfied that there are funds legally available for acquiring the land, doth hereby approve the acquiring of the land described in the Schedule hereunder and the making of new roads and deviations from and widenings of existing roads referred to in the said Schedule.

SCHEDULE.
Main Roads.

The land shown hatched on Plan numbered G.P.12510 hereunder required for the deviation from the Chiltern-Beechworth road in the Shire of Chiltern and making of the deviation thereon.

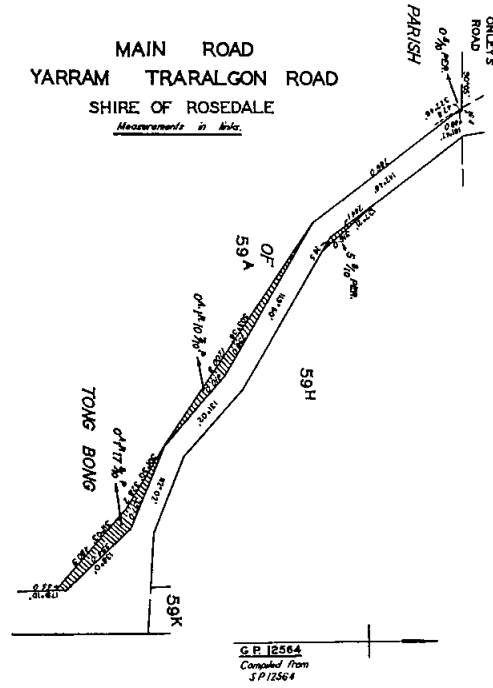
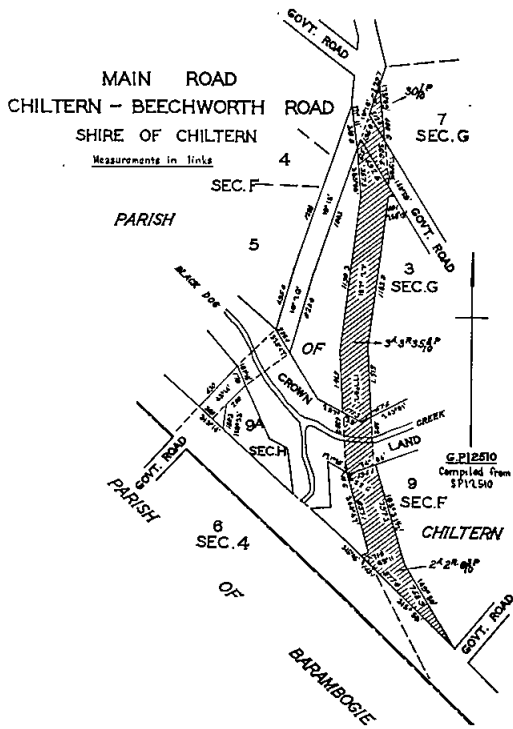

The land shown hatched on Plans numbered G.P.12563 and G.P.12564 hereunder required for the widening of the Yarram-Traralgon road in the Shire of Rosedale and making of the widening thereon.

The land shown hatched on Plan numbered G.P.12545 hereunder required for the widening of Torquay-road in the Shire of South Barwon and making of the widening thereon.

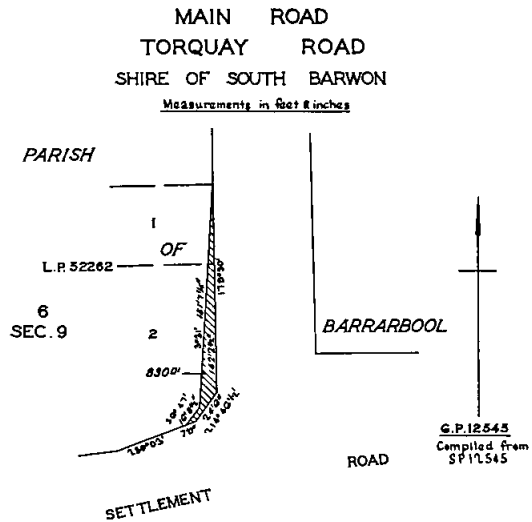
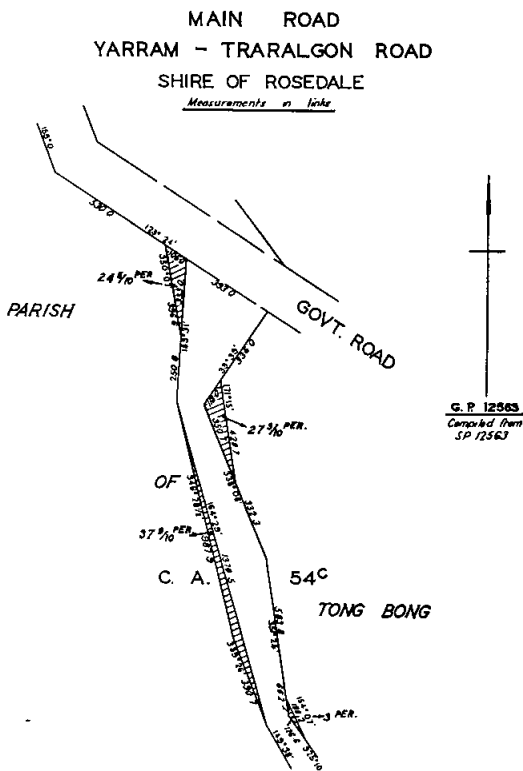

The land shown hatched on Plan numbered G.P.12586 hereunder required for the widening of the Warragul-Korumburra road in the Shire of Warragul and making of the widening thereon.

MAIN ROAD
WARRAGUL - KORUMBURRA ROAD
SHIRE OF WARRAGUL
Measurements in Links

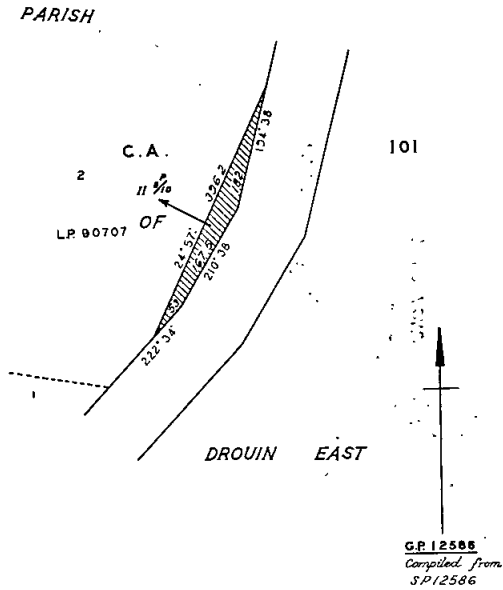

And the Honorable Alan John Hunt, Her Majesty's Minister for Local Government for the State of Victoria, shall give the necessary directions herein accordingly.

JOHN A. HORLOCK,
Acting Clerk of the Executive Council.

COUNTRY ROADS BOARD.

At the Executive Council Chamber, Melbourne, the twenty-fifth day of May, 1971.

PRESENT:

His Excellency the Governor of Victoria.	
Mr. Reid	Mr. Borthwick
Mr. Rafferty	Mr. Hunt.

ORDER CONFIRMING RESOLUTIONS OF THE COUNTRY ROADS BOARD.

HIS Excellency the Governor of the State of Victoria, by and with the advice of the Executive Council thereof, doth hereby, in pursuance of the provisions of the Country Roads Act 1958, confirm the resolutions of the Country Roads Board, the dates whereof and the terms of which are scheduled hereunder:—

SCHEDULE.

State Highway.

Resolution dated the Twelfth day of May, One thousand nine hundred and seventy-one, made pursuant to section 70 of the Country Roads Act 1958 rescinding the resolution passed by the Country Roads Board on the First day of July, One thousand nine hundred and twenty-five and confirmed by an Order in Council published in the Government Gazette of the Eighth day of July, One thousand nine hundred and twenty-five on pages 2371-2373 declaring the highway to be a State highway (Princes Highway) in the Shire of Portland, so far as it relates to the part of the said State highway indicated by cross-hatching on Plan numbered G.P.489T² hereunder.

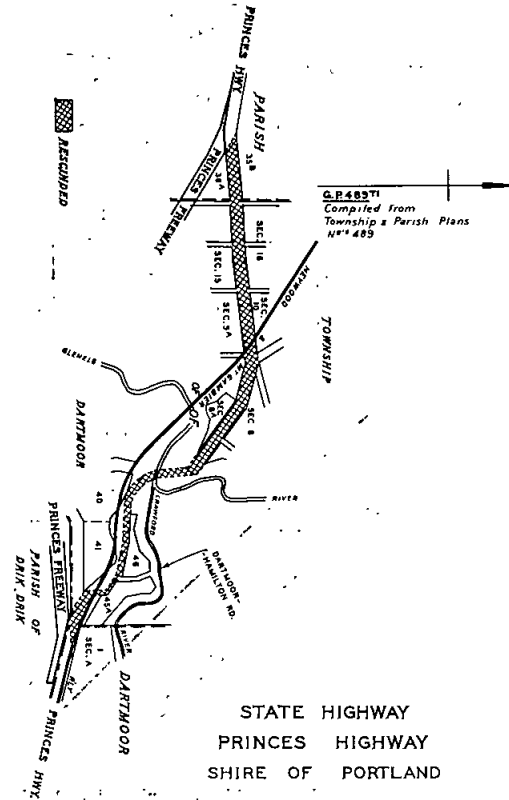

Main Road.

Resolution dated the Twelfth day of May, One thousand nine hundred and seventy-one, made pursuant to section 18 of the Country Roads Act 1958 declaring the highway in the Shire of Portland as shown hatched on Plan numbered G.P.489T² hereunder to be a main road (Dartmoor-Hamilton road) within the meaning and for the purposes of the said Act.

MAIN ROAD
DARTMOOR - HAMILTON ROAD
SHIRE OF PORTLAND

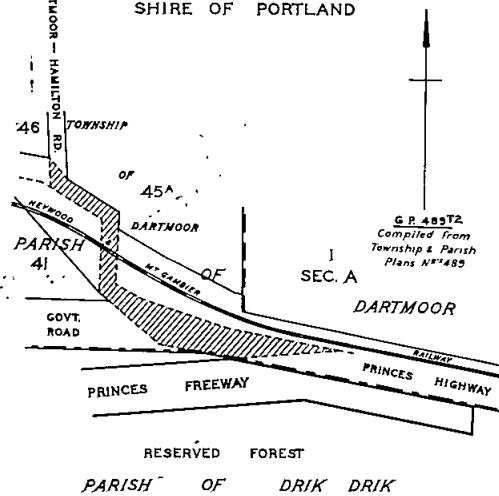

And the Honorable Alan John Hunt, Her Majesty's Minister for Local Government for the State of Victoria, shall give the necessary directions herein accordingly.

JOHN A. HORLOCK,
Acting Clerk of the Executive Council.

LOCAL GOVERNMENT DEPARTMENT.

At the Executive Council Chamber, Melbourne, the twenty-fifth day of May, 1971.

PRESENT:

His Excellency the Governor of Victoria.	
Mr. Reid	Mr. Borthwick
Mr. Rafferty	Mr. Hunt.

ROADS DISCONTINUED.—CITY OF MELBOURNE.

WHEREAS it is provided in section 528 (2) of the *Local Government Act 1958*, that where a road (whether or not a public highway but not being a road set out on land of the Crown) or any part thereof is not required for public use, the Governor in Council, on the request of the Council of the municipality in which such road is situated made not less than one month after publishing in a newspaper generally circulating in the district and posting to the registered proprietor (if any) of the land and the owners and occupiers (if any) of lands abutting or immediately adjacent to the road notice of intention to make such a request may by Order published in the *Government Gazette* direct that such road or part shall be discontinued and thereupon such road or part shall be discontinued accordingly:

And whereas the Council of the City of Melbourne has requested that the Governor in Council direct that Errol-place and portion of a right-of-way off Arden-street, North Melbourne, be discontinued and not less than one month previously, has published in a newspaper generally circulating in the district and posted to the registered proprietor of the land in the said roads and to the owners and occupiers of lands abutting or immediately adjacent to the roads notice of intention to make such request.

Now therefore, His Excellency the Governor of the State of Victoria, by and with the advice of the Executive Council thereof, hereby directs that the said roads which are shown hatched on the plan hereunder shall be discontinued and that the lands may be sold by the Council of the City of Melbourne by agreement.

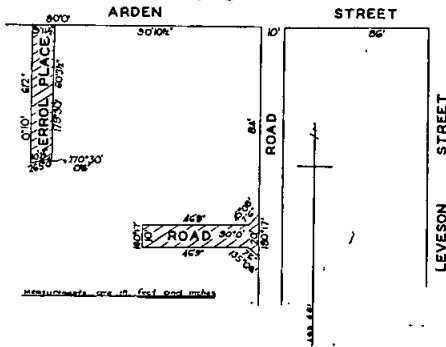

And the Honorable Alan John Hunt, Her Majesty's Minister for Local Government for the State of Victoria, shall give the necessary directions herein accordingly.

JOHN A. HORLOCK,
Acting Clerk of the Executive Council.

LOCAL GOVERNMENT DEPARTMENT.

At the Executive Council Chamber, Melbourne, the twenty-fifth day of May, 1971.

PRESENT:

His Excellency the Governor of Victoria.	
Mr. Reid	Mr. Borthwick
Mr. Rafferty	Mr. Hunt.

CONSENT TO SALE OF RESERVE BY THE WAVERLEY CITY COUNCIL.

WHEREAS certain land being the Reserve for Municipal Purposes on plan of subdivision No. 68228 lodged in the Office of Titles was transferred to the Council of the City of Waverley pursuant to the provisions of section 569B (8) (L) of the *Local Government Act 1958*, or a corresponding previous enactment.

And whereas the said Council is now of the opinion that the land is no longer required for the purpose for which it was reserved and has requested that, pursuant to the provisions of section 569BA (2) of the *Local Government Act 1958*, the Governor in Council consent to the sale of the land.

And whereas the said Council has—

- (a) published in a newspaper generally circulating in the municipal district a notice describing the land and the proposal for the sale of the land and stating that at the next ordinary meeting of the Council after the expiration of 40 days after publication of the notice the Council would consider any objection to the proposal and would receive any representations as to the disposal of any purchase money;
- (b) served a copy of the said notice upon those persons whom the Council considered should be served; and
- (c) posted a similar notice upon the land in question.

And whereas no person has objected to the proposed sale of the land.

Now therefore, His Excellency the Governor of the State of Victoria, by and with the advice of the Executive Council thereof and in pursuance of the provisions of section 569BA (2) of the *Local Government Act 1958*, hereby consents to the Council of the City of Waverley selling and conveying by private treaty the Reserve for Municipal Purposes coloured green and green-hatched on plan of subdivision No. 68228 lodged in the Office of Titles, Parish of Mulgrave.

And the Honorable Alan John Hunt, Her Majesty's Minister for Local Government for the State of Victoria, shall give the necessary directions herein accordingly.

JOHN A. HORLOCK,
Acting Clerk of the Executive Council.

PUBLIC AUTHORITIES MARKS ACT 1958.

At the Executive Council Chamber, Melbourne, the twenty-fifth day of May, 1971.

PRESENT:

His Excellency the Governor of Victoria.	
Mr. Reid	Mr. Borthwick
Mr. Rafferty	Mr. Hunt.

DECLARATION OF AN AUTHORITY FOR THE PURPOSES OF THE PUBLIC AUTHORITIES MARKS ACT 1958.

WHEREAS it is provided by the *Public Authorities Marks Act 1958* that the Governor in Council may declare any local authority within the meaning of the *Public Contracts Act 1958* to be an authority for the purpose of the said *Public Authorities Marks Act 1958*:

And whereas the Numurkah Sewerage Authority is an authority within the meaning of the *Public Contracts Act 1958* and has requested that the Authority be declared an authority for the purpose of the said Act;

Now therefore, I, the Governor of the State of Victoria, by and with the advice of the Executive Council thereof hereby declare the Numurkah Sewerage Authority to be an authority for the purposes of the *Public Authorities Marks Act 1958*.

And the Honorable Alan John Hunt, Her Majesty's Minister for Local Government for the State of Victoria, shall give the necessary directions herein accordingly.

JOHN A. HORLOCK,
Acting Clerk of the Executive Council.

SOIL CONSERVATION AND LAND UTILIZATION ACT.

At the Executive Council Chamber, Melbourne, the twenty-fifth day of May, 1971.

PRESENT:

His Excellency the Governor of Victoria.	
Mr. Reid	Mr. Borthwick
Mr. Rafferty	Mr. Hunt.

DISTRICT ADVISORY COMMITTEE.—PYRENEES SOIL CONSERVATION DISTRICT.

WHEREAS a vacancy exists on the Pyrenees Soil Conservation District Advisory Committee due to the resignation of Leonard Dean Garside, being the person elected to represent the Soil Conservation Authority: Now, therefore, I, the Governor of the State of Victoria, by and with the advice of the Executive Council thereof, and in pursuance of the provisions of section 15 of the Soil Conservation and Land Utilization Act do hereby remove the said Leonard Dean Garside from office and appoint the following person to such vacancy for a period up to and including the 20th day of June, 1972:—

JAMES FREDERICK ALLINSON,
being the person appointed to represent the Soil Conservation Authority.

And the Honorable William Archibald Borthwick, Her Majesty's Minister for Conservation for the State of Victoria, shall give the necessary directions herein accordingly.

JOHN A. HORLOCK,
Acting Clerk of the Executive Council.

TATURA SEWERAGE AUTHORITY.

At the Executive Council Chamber, Melbourne, the first day of June, 1971.

PRESENT:

His Excellency the Governor of Victoria:	
Mr. Wilcox	Mr. Dickie.
Mr. Borthwick	

AMENDMENT OF ORDER CONSTITUTING THE AUTHORITY. SPECIFICATION OF LIMIT OF BORROWING POWER AND FIXING LIMIT OF BANK OVERDRAFT.

UNDER the powers conferred by the Sewerage Districts Act and all other powers enabling him in that behalf, His Excellency the Governor of the State of Victoria, by and with the advice of the Executive Council of the said State—

- (a) Amends the Order in Council constituting the Tatura Sewerage Authority, made on 14th March, 1947, and published in the *Government Gazette* dated 19th March, 1947, as amended by Order made on 4th December, 1962, and published in the *Government Gazette* dated 5th December, 1962, by deleting clause (a) and substituting therefor "(a) the estimated cost of carrying out the proposed works is \$650,000";
- (b) Specifies that the amount which the said Authority may owe at any time in respect of moneys borrowed and reborrowed at interest by mortgage of the general fund or the issue of debentures pursuant to sections 61 and 62 of the *Sewerage Districts Act 1958* shall not exceed Five hundred and twenty thousand dollars (\$520,000); and
- (c) Specifies that the amount which the said Authority may owe at any time in respect of moneys borrowed by overdraft of current account pursuant to sections 78 and 79 of the *Sewerage Districts Act* shall not exceed Fifteen thousand dollars (\$15,000) and Twenty thousand dollars (\$20,000) respectively.

And the Honorable Roberts Christian Dunstan, Her Majesty's Minister of Water Supply for the State of Victoria, shall give the necessary directions herein accordingly.

J. ROSSITER,
Clerk of the Executive Council.

Water Act 1958.

STATE RIVERS AND WATER SUPPLY COMMISSION.

At the Executive Council Chamber, Melbourne, the first day of June, 1971.

PRESENT:

His Excellency the Governor of Victoria.	
Mr. Wilcox	Mr. Dickie.
Mr. Borthwick	

MERBEIN IRRIGATION DISTRICT.—PORTION EXCISED.

UNDER the powers conferred by the *Water Act 1958* and all other powers enabling him in that behalf, His Excellency the Governor of the State of Victoria, with the advice of the Executive Council of the said State, on the recommendation of the State Rivers and Water Supply Commission, doth hereby declare, order and direct as follows:—

That there shall be excised from the Merbein Irrigation District that portion of the same set out and described in the Schedule hereto which portion, as from the 30th day of June, 1971, shall be deemed to be excised accordingly.

SCHEDULE.

The whole of the land comprised in Certificate of Title volume 8181, folio 229, being part of allotment 37, section A, Parish of Mildura.

The portion set out and described in the foregoing Schedule is shown on a plan approved by the Governor in Council, and deposited in the office of the State Rivers and Water Supply Commission, Melbourne.—(Corr. No. 70/172).

And the Honorable Roberts Christian Dunstan, Her Majesty's Minister of Water Supply for the State of Victoria, shall give the necessary directions herein accordingly.

J. ROSSITER,
Clerk of the Executive Council.

Water Act 1958.

STATE RIVERS AND WATER SUPPLY COMMISSION.

At the Executive Council Chamber, Melbourne, the first day of June, 1971.

PRESENT:

His Excellency the Governor of Victoria.	
Mr. Wilcox	Mr. Dickie.
Mr. Borthwick	

GOULBURN-MURRAY IRRIGATION DISTRICT.—PORTION EXCISED.—SHEPPARTON IRRIGATION AREA.—BOUNDARIES VARIED.

UNDER the powers conferred by the *Water Act 1958* and all other powers enabling him in that behalf, His Excellency the Governor of the State of Victoria, with the advice of the Executive Council of the said State, on the recommendation of the State Rivers and Water Supply Commission, doth hereby declare, order and direct as follows:—

That there shall be excised from the Goulburn-Murray Irrigation District that portion of the same set out and described in the Schedule hereto and that the boundaries of the Shepparton Irrigation Area be varied to excise from the said Area the aforesaid portion, which portion shall be deemed to be excised from the said Irrigation District and Irrigation Area as from the 30th day of June, 1971.

SCHEDULE.

The whole of lots 1 and 2, on lodged plan of subdivision No. 29905, being parts of allotments 8A and 8B, Parish of Shepparton.

The lands set out and described in the foregoing Schedule are shown on a plan approved by the Governor in Council, and deposited in the Office of the State Rivers and Water Supply Commission, Melbourne.—(Corr. No. 71/1389.)

And the Honorable Roberts Christian Dunstan, Her Majesty's Minister of Water Supply for the State of Victoria, shall give the necessary directions herein accordingly.

J. ROSSITER,
Clerk of the Executive Council.

DANDENONG SEWERAGE AUTHORITY.

At the Executive Council Chamber, Melbourne, the first day of June, 1971.

PRESENT:

His Excellency the Governor of Victoria.
Mr. Wilcox | Mr. Dickie.
Mr. Borthwick

CONSENT TO BORROWING \$50,000.

UNDER the powers conferred by the Sewerage Districts Act and all other powers enabling him in that behalf, His Excellency the Governor of the State of Victoria, by and with the advice of the Executive Council of the said State, doth hereby consent to the Dandenong Sewerage Authority borrowing at interest by mortgage of the General Fund the sum of Fifty thousand dollars (\$50,000) to meet the cost of sewerage works as set forth in the detailed statement bearing date 26th May, 1971.

And the Honorable Roberts Christian Dunstan, Her Majesty's Minister of Water Supply for the State of Victoria, shall give the necessary directions herein accordingly.

J. ROSSITER,
Clerk of the Executive Council.

GEELONG WATERWORKS AND SEWERAGE TRUST.

At the Executive Council Chamber, Melbourne, the first day of June, 1971.

PRESENT:

His Excellency the Governor of Victoria.
Mr. Wilcox | Mr. Dickie.
Mr. Borthwick

CONSENT TO BORROWING \$328,000.

UNDER the powers conferred by the Geelong Waterworks and Sewerage Act and all other powers enabling him in that behalf, His Excellency the Governor of the State of Victoria, by and with the advice of the Executive Council of the said State, doth hereby consent to the Geelong Waterworks and Sewerage Trust borrowing at interest, the sum of Three hundred and twenty-eight thousand dollars (\$328,000) in two amounts of Two hundred and twenty-eight thousand dollars (\$228,000) and One hundred thousand dollars (\$100,000) for the conversion of Loans Nos. 86, 129 and 134 respectively.

And the Honorable Roberts Christian Dunstan, Her Majesty's Minister of Water Supply for the State of Victoria, shall give the necessary directions herein accordingly.

J. ROSSITER,
Clerk of the Executive Council.

GEELONG WATERWORKS AND SEWERAGE TRUST.

At the Executive Council Chamber, Melbourne, the first day of June, 1971.

PRESENT:

His Excellency the Governor of Victoria.
Mr. Wilcox | Mr. Dickie.
Mr. Borthwick

CONSENT TO BORROWING \$150,000.

UNDER the powers conferred by the Geelong Waterworks and Sewerage Act and all other powers enabling him in that behalf, His Excellency the Governor of the State of Victoria, by and with the advice of the Executive Council of the said State, doth hereby consent to the Geelong Waterworks and Sewerage Trust borrowing at interest, subject to the Geelong Waterworks and Sewerage Act, the sum of One hundred and fifty thousand dollars (\$150,000) in two amounts of One hundred thousand dollars (\$100,000) and Fifty thousand dollars (\$50,000) for the conversion of part of loan 000 and all of loan L7 respectively.

And the Honorable Roberts Christian Dunstan, Her Majesty's Minister of Water Supply for the State of Victoria, shall give the necessary directions herein accordingly.

J. ROSSITER,
Clerk of the Executive Council.

DANDENONG VALLEY AUTHORITY.

At the Executive Council Chamber, Melbourne, the first day of June, 1971.

PRESENT:

His Excellency the Governor of Victoria.
Mr. Wilcox | Mr. Dickie.
Mr. Borthwick

CONSENT TO BORROWING \$150,000.

UNDER the powers conferred by the Dandenong Valley Authority Act and all other powers enabling him in that behalf, His Excellency the Governor of the State of Victoria, by and with the advice of the Executive Council of the said State, doth hereby consent to the Dandenong Valley Authority borrowing at interest by mortgage of the General Fund the sum of One hundred and fifty thousand dollars (\$150,000) to meet the cost of river improvement and drainage works.

And the Honorable Roberts Christian Dunstan, Her Majesty's Minister of Water Supply for the State of Victoria, shall give the necessary directions herein accordingly.

J. ROSSITER,
Clerk of the Executive Council.

WEST MOORABOOL WATER BOARD ACT 1968.

At the Executive Council Chamber, Melbourne, the first day of June, 1971.

PRESENT:

His Excellency the Governor of Victoria.
Mr. Wilcox | Mr. Dickie.
Mr. Borthwick

APPOINTMENT OF MEMBERS AND DEPUTY MEMBERS AND CHAIRMAN AND VICE-CHAIRMAN OF THE WEST MOORABOOL WATER BOARD.

IN exercise of the powers conferred on him by the West Moorabool Water Board Act 1968, His Excellency the Governor of the State of Victoria, by and with the advice of the Executive Council thereof, hereby appoints the persons named in the Schedule hereto to be Members and Deputy Members of the West Moorabool Water Board, to hold the positions shown in the Schedule, for a period of three years, as from 4th June, 1971:—

SCHEDULE.

Name of Person.	Position.
Thomas Mayo Conroy ..	Member and Chairman.
John Dunbeth Lang ..	Member and Vice-Chairman.
Thomas Gerard Gleeson ..	Member.
John Stewart Frank Rogerson	Deputy for John Dunbeth Lang as a Member and Vice-Chairman.
Michael Neil Priddle ..	Deputy for Thomas Gerard Gleeson as a Member.

And the Honorable Roberts Christian Dunstan, Her Majesty's Minister of Water Supply for the State of Victoria, shall give the necessary directions herein accordingly.

J. ROSSITER,
Clerk of the Executive Council.

Water Act 1958.

STATE RIVERS AND WATER SUPPLY COMMISSION.

At the Executive Council Chamber, Melbourne, the first day of June, 1971.

PRESENT:

His Excellency the Governor of Victoria,
Mr. Wilcox | Mr. Dickie.
Mr. Borthwick

GOULBURN-MURRAY IRRIGATION DISTRICT—
DISTRICT EXTENDED.—KERANG IRRIGATION
AREA—BOUNDARIES VARIED.

UNDER the powers conferred by the Water Act 1958 and all other powers enabling him in that behalf, His Excellency the Governor of the State of Victoria, with the advice of the Executive Council of the said State, on the recommendation of the State Rivers and Water Supply Commission, doth hereby declare, order and direct that the Goulburn-Murray Irrigation District be extended and the boundaries of the Kerang Irrigation Area be varied by adding to the said District and Area the lands shown by blue colour on a plan approved by the Governor in Council and deposited in the Office of the State Rivers and Water Supply Commission, Melbourne (Corr. No. 69/2563) and as on and from the 1st day of July, 1971 such District shall be deemed to be so extended and the boundaries of such Area shall be so varied.

And the Honorable Roberts Christian Dunstan, Her Majesty's Minister of Water Supply for the State of Victoria, shall give the necessary directions herein accordingly.

J. ROSSITER,
Clerk of the Executive Council.

WATER ACT 1958.

At the Executive Council Chamber, Melbourne, the first day of June, 1971.

PRESENT:

His Excellency the Governor of Victoria,
Mr. Wilcox | Mr. Dickie.
Mr. Borthwick

SHEPPARTON URBAN WATERWORKS TRUST.—
EXTENT OF DISTRICT INCREASED.

UNDER the powers conferred by the Water Act 1958 and all other powers enabling him in that behalf, His Excellency the Governor of the State of Victoria, with the advice of the Executive Council of the said State, doth hereby declare, order and direct as follows:—

That the extent of the Waterworks District of the Shepparton Urban Waterworks Trust be increased by adding to the same the land set out and described in the Schedule hereto, and as on and from the 1st day of July, 1971, the extent of such District shall be deemed to be increased accordingly.

SCHEDULE.

The whole of lots 1 and 2, on lodged plan of subdivision No. 29905, being parts of allotments 8A and 8B, Parish of Shepparton.

The lands set out and described in the foregoing Schedule are shown on a plan approved by the Governor in Council, and deposited in the Office of the State Rivers and Water Supply Commission, Melbourne.—(Corr. No. 71/1389.)

And the Honorable Roberts Christian Dunstan, Her Majesty's Minister of Water Supply for the State of Victoria, shall give the necessary directions herein accordingly.

J. ROSSITER,
Clerk of the Executive Council.

HOUSING ACT 1958.

At the Executive Council Chamber, Melbourne, the first day of June, 1971.

PRESENT:

His Excellency the Governor of Victoria,
Mr. Wilcox | Mr. Dickie.
Mr. Borthwick

DECLARATION OF A RECLAMATION AREA AT SOUTH
MELBOURNE.

WHEREAS within an area in the City of South Melbourne described in the Schedule hereto there are houses which—

- (a) are unfit for human habitation, and/or
- (b) are in the opinion of Housing Commission insanitary or unhealthy by reason of—
 - (i) The excessive number of buildings within the area; and/or
 - (ii) the bad arrangement of buildings within the area; and/or
 - (iii) the bad arrangement or narrowness of the streets within the area.

And whereas Housing Commission considers that housing conditions within the area cannot be satisfactorily dealt with unless the said area is dealt with under Part III. of the Housing Act 1958 (No. 6275) as a Reclamation Area and has recommended that the said area should be constituted a Reclamation Area.

And whereas Housing Commission having duly complied with the provisions of sub-section (3) of section 67 of the said Act has submitted to the Governor in Council its recommendation that the said area should be constituted a Reclamation Area.

Now therefore His Excellency the Governor of the State of Victoria, in the Commonwealth of Australia, by and with the advice of the Executive Council of the said State doth hereby declare the said area to be a Reclamation Area.

SCHEDULE.

All that piece of land situate in the municipality of the City of South Melbourne, being Crown allotments 1 to 7 (both inclusive), 24, and part of Crown allotment 8, section 30, City of South Melbourne, Parish of Melbourne South, and bounded as follows:—

- On the north-west, by the south-eastern alignment of Raglan-street,
- On the north-east, by the south-western alignment of Moray-street,
- On the south-east, by the north-western alignment of Thomson-street, and
- On the south-west, by the north-eastern alignment of Raglan-place.

And the Honorable Edward Raymond Meagher, Her Majesty's Minister of Housing for the State of Victoria, shall give the necessary directions herein accordingly.

J. ROSSITER,
Clerk of the Executive Council.

WHEAT MARKETING ACT 1969.

At the Executive Council Chamber, Melbourne, the first day of June, 1971.

PRESENT:

His Excellency the Governor of Victoria,
Mr. Wilcox | Mr. Dickie.
Mr. Borthwick

IN pursuance of the powers conferred by section 5 of the Wheat Marketing Act 1969 and all other powers him thereunto enabling, His Excellency the Governor of the State of Victoria, by and with the advice of the Executive Council thereof and on the recommendation of the Acting Minister of Agriculture after consultation with the Victorian Farmers' Union, doth hereby determine that the quantity of the Victorian Wheat Quota for the season 1971-1972 shall be 57,000,000 bushels and, of that quantity, doth hereby specify that 56,250,000 bushels shall be available for allocation by the Wheat Quota Committee as quotas and 750,000 bushels shall be available for allocation by the Wheat Quota Review Committee as special quotas.

And the Honorable William Archibald Borthwick, Her Majesty's Acting Minister of Agriculture for the State of Victoria, shall give the necessary directions herein accordingly.

J. ROSSITER,
Clerk of the Executive Council.

LANDS DEPARTMENT NOTICES

APPROACHING LAND SALES.

SALES of Crown Lands, in fee-simple, will be held at the under-mentioned places and dates, viz.:-

Euroa.—Thursday, 3rd June, 1971 ..	No. of Gazette. 39
------------------------------------	--------------------

AUCTION OF RIGHT TO LEASE CROWN LAND. Melbourne.—Wednesday, 16th June, 1971 ..	45
---	----

**COMMITTEE OF MANAGEMENT OF RESERVE.
APPOINTMENT.**

NOTICE is hereby given that, in pursuance of section 221 of the Land Act 1958, the following appointment of a Committee of Management of reserved Crown lands has been made by the Minister of Lands.

**THE SITE FOR PUBLIC PURPOSES (PUBLIC REFUGE HUT)
MACALISTER SPRINGS.**

Neilma Baillieu Gantner, Carillo Baillieu Gantner, Edwin Philip Kennon, Christopher John Aylward Game, Michael Grant Sedgley, Robert Alsop Gilder, John Mayston Béchervaise, David Greenwood Witham and John Stuart Henthorn as a Committee of Management for a period of three (3) years of the land in the County of Wonnangatta at Macalister Springs, temporarily reserved by Order in Council dated the 6th April, 1971, as a site for Public purposes (Public Refuge Hut).—(Corres. No. Rs.9477.)

W. BORTHWICK,
Minister of Lands.

Department of Crown Lands and Survey,
Melbourne, 31st May, 1971.

**PROPOSED REVOCATIONS OF TEMPORARY
RESERVATIONS OF LANDS BY ORDERS IN
COUNCIL.**

IN pursuance of the provisions of the Land Act 1958, notice is hereby given that it is the intention of the Governor in Council to revoke the temporary reservations of lands by Orders in Council hereunder referred to, viz.:-

The following Notices were published 1^o on the 2nd June, 1971, pursuant to Orders of the 25th May, 1971.

BOHO.—The temporary reservation by Order in Council of the 21st September, 1891, of 2 acres of land in the Parish of Boho as a site for a State School, is about to be revoked.—(B.431⁽⁸⁾) (90.E.13814).

CARISBROOK.—The temporary reservation by Order in Council of the 14th August, 1951, of 3 roods 10 perches, more or less, of land in the Township of Carisbrook as a site for a Rubbish Depot, is about to be revoked.—(C.132⁽⁸⁾) (Rs.6692).

FOSTERVILLE.—The temporary reservation by Order in Council of the 8th June, 1900, of 1 acre 2 roods 16 perches of land in the Township of Fosterville as a site for a State School, is about to be revoked.—(F.106⁽¹⁾) (C.12017).

SANDHURST (AT BENDIGO).—The temporary reservation as a site for Water Channel and the withholding from sale, leasing and licensing by Order in Council of 1st October, 1877, of 1 rood 14 4/10 perches of land at Bendigo, Parish of Sandhurst (formerly, in the City of Sandhurst), are about to be revoked so far only as the portion containing 11 perches, indicated by hatching on plan hereunder, is concerned.—(S.372⁽¹¹⁸⁾) (C.96931).

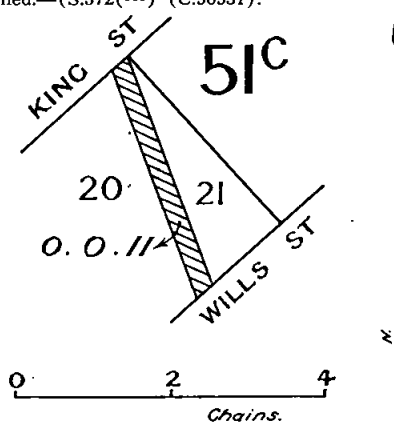

COBUNGRA.—The temporary reservation as a site for Camping and affording Access to Water and the withholding from sale, leasing and licensing by Order in Council of the 9th August, 1881, of 46 acres 23 perches of land in the Parish of Cobungra, are about to be revoked so far only as the portion containing 2 acres 32 perches, indicated by hatching on plan hereunder, is concerned.—(C.372⁽⁸⁾) (C.77202).

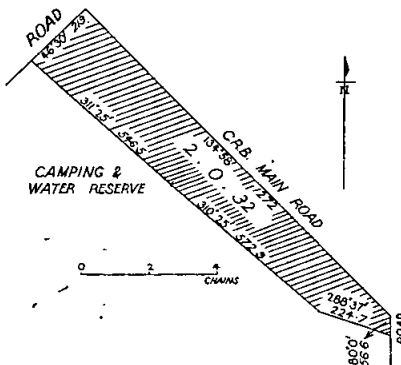

DRYSDALE.—The temporary reservation by Order in Council of the 4th May, 1915, of 30 acres 1 rood 9 perches of land in the Township of Drysdale as a site for Public purposes, is about to be revoked so far only as the portion containing 3 roods 5 perches indicated by hatching on plan hereunder is concerned.—(D.99⁽⁸⁾) (Rs.711).

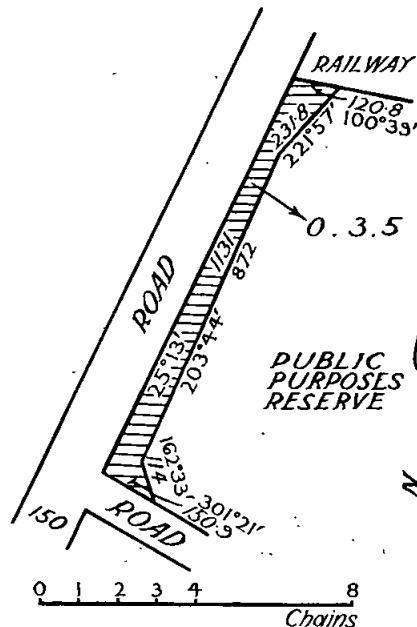

JERUK.—The temporary reservation by Order in Council of the 17th April, 1956, of 8 acres, more or less, of land in the Parish of Jeruk as a site for Public Hall and Plantation, is about to be revoked so far only as the portion containing 6 perches, indicated by hatching on plan hereunder, is concerned.—(J.35⁽⁸⁾) (Rs.7445).

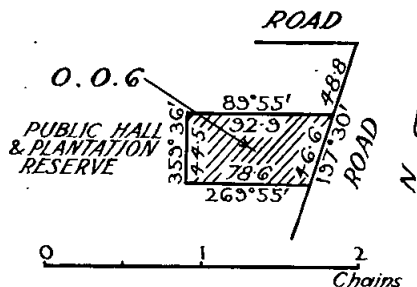

ECHUCA.—The temporary reservation by Order in Council of the 21st December, 1921, of 7 acres 1 rood 17 perches of land in the Township of Echuca as a site for Public purposes, revoked as to part by various Orders, is about to be revoked so far only as the portion containing 16 perches, more or less, indicated by hatching on plan hereunder, is concerned.—(E.3^(*)) (Rs.6175).

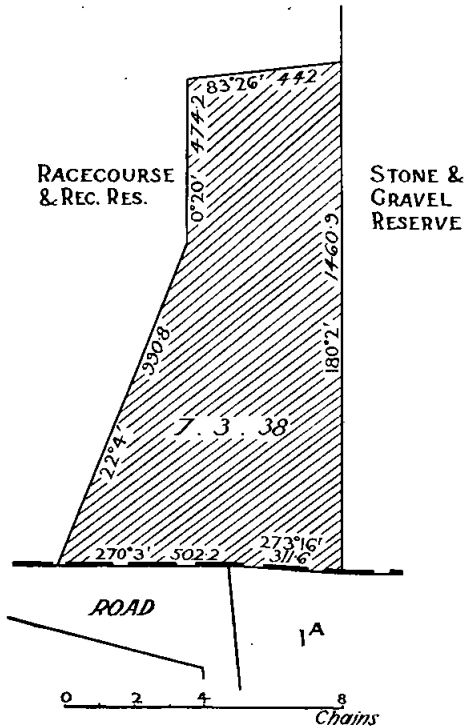
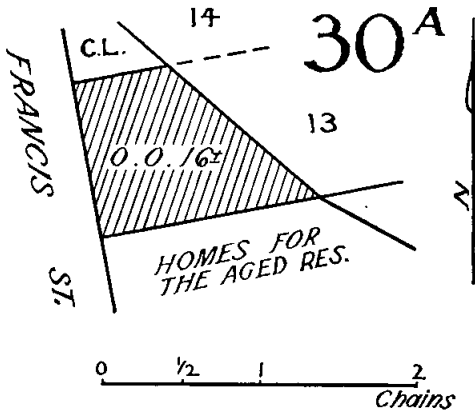

OMEO.—The temporary reservation by Order in Council of the 6th October, 1953, of 2 acres 2 roods, more or less, of land in the Township of Omeo as a site for Public purposes, is about to be revoked so far only as the portion containing 3 roods 3 perches, indicated by hatching on plan hereunder, is concerned.—(O.19^(*)) (Rs.7159).

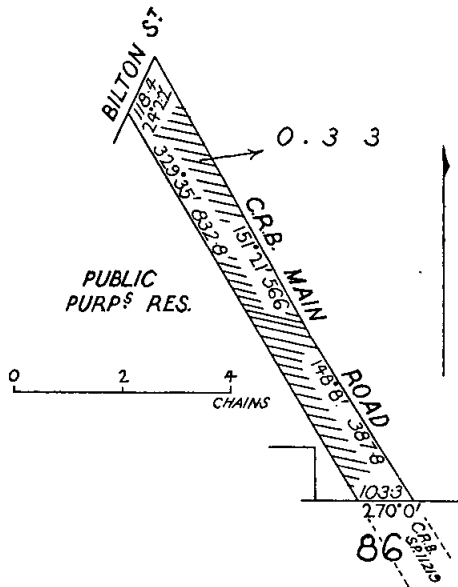

PYRAMID HILL.—The temporary reservation by Order in Council of the 22nd October, 1888, of 62 acres 3 roods 22 perches of land in the Township of Pyramid Hill (named Parish of Terrick Terrick West, at Pyramid Hill, in Order) as a site for Supply of Stone and Gravel, revoked as to part by various orders, is about to be revoked so far as the balance thereof containing 55 acres 2 roods 14 perches is concerned.—(P.171^(*)) (Rs.4153).

WINCHELSEA.—The temporary reservation by Order in Council of the 8th November, 1887, of 8 acres 1 rood 33 perches of land in the Township of Winchelsea as a site for a Cemetery, is about to be revoked so far only as the portion containing 1 acre 2 roods 22 perches, indicated by hatching on plan hereunder, is concerned.—(W.168^(*)) (C.55870).

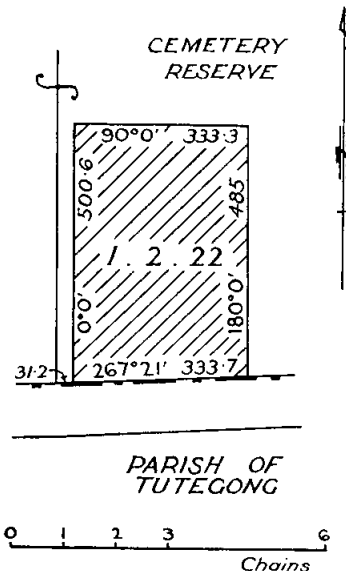

PYRAMID HILL.—The temporary reservation by Order in Council of the 22nd July, 1908, of 105 acres 28 perches of land in the Township of Pyramid Hill as a site for a Racecourse and other purposes of Public Recreation, is about to be revoked so far only as the portion containing 7 acres 3 roods 38 perches, indicated by hatching on plan hereunder, is concerned.—(P.171^(*)) (Rs.1295).

THARANBEGGA.—The temporary reservation as a site for the supply of Gravel and Stone and the withholding from sale, leasing and licensing by Order in Council of the 16th

August, 1881, of 21 acres 2 roods 15 perches of land in the Parish of Tharanbegg, are about to be revoked so far only as the portion containing 6 acres 38 perches, indicated by hatching on plan hereunder, is concerned.—(T.216⁽³⁾) (Rs.4715).

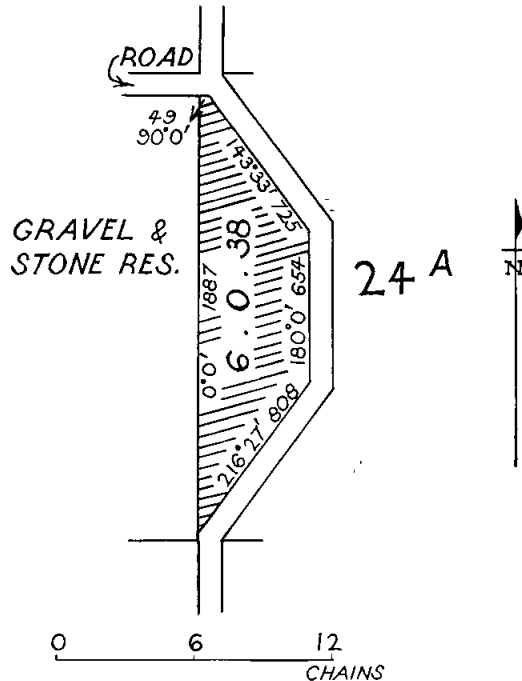

ANAKIE.—The temporary reservation by Order in Council of the 24th December, 1866, of 57 acres 2 roods 38 perches of land in the Parish of Anakie as a site for Public purposes, and the temporary reservation by Order in Council of the 26th November, 1888, of the same land as a site for the Growth and Preservation of Timber, are about to be revoked so far only as the portions containing 3 roods, indicated by hatching on plan hereunder, are concerned.—(A.31⁽²⁾) (Rs.5315).

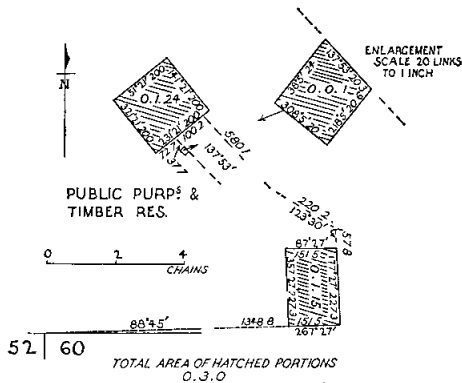

W. BORTHWICK,
Minister of Lands.

TENDERS

PUBLIC WORKS DEPARTMENT

TENDERS will be received at Public Works Department, 2 Treasury-place, Melbourne, until **TWO** p.m. on dates shown and for purposes mentioned hereunder.

Particulars and tender forms available at Contracts Office, Room 8, Building Division, Parliament-place and at places indicated in brackets hereunder.

Abbreviations in brackets mean:—W.O.—Inspector of Works Office; P.S.—Police Station; C.S.—Consolidated School; H.E.S.—Higher Elementary School; H.S.—High School; Pr.S.—Primary School; T.S.—Technical School.

Tenders to be submitted on the Department's printed Tender Form and will not be received by telephone. All tenders must be on a "Firm Tender" basis. The lowest or any tender will not necessarily be accepted.

Address tenders to the Minister of Public Works, and endorse the envelope containing the tender "Tender for , closing Tuesday, "

Hand delivered tenders to be placed in the Tender Box of the Public Works Department, located on the wall of the centre entrance foyer, Ground Floor, 2 Treasury-place, Melbourne.

No preliminary deposit is required with any tender, but a successful tenderer will be required to pay a deposit for any accepted tender of \$4,000 or over.

Tuesday, 8th June, 1971.

Building, Electrical and Mechanical Works.

Altona North.—Renewal of roofing, T.S.

Furniture and Furnishings.

Various.—Supply of fixed library shelving, H.S.
Warragul.—Supply and installation of furniture, T.S.

Miscellaneous.

Various.—Supply of fire extinguishers for the period 1st July, 1971, to 30th June, 1972—Schools and other Government Departments.

Wednesday, 16th June, 1971.

Building, Electrical and Mechanical Works.

Burwood.—Roofing repairs and external renovations, T.S.

Camperdown.—Re-modelling of library, H.S. (W.O., Camperdown.)

Stonyford.—Erection of replacement L.T.C. class-room, &c., Pr.S.3506. (W.O., Camperdown and Geelong.)

Werribee.—Internal and external renovations, G.S. Gordon Cereal Laboratory and Administration Building, Research Farm. (W.O., Geelong.)

Site Works.

Southvale.—Site works, Pr.S.4859.

Miscellaneous.

Port Melbourne.—Supply and delivery of fire hose, P.W.D. Storeyard.

Tuesday, 22nd June, 1971.

Building, Electrical and Mechanical Works.

Hadfield.—Erection of new brick library building, H.S.

Hadfield.—Mechanical services, Library, H.S.

Hadfield.—Electrical services, Library, H.S.

Hume Weir.—Supply and erection of fruit fly control shelter, Road Block. (W.O., Wangaratta.) (Re-advertised.)

Tuesday, 29th June, 1971.

Building, Electrical and Mechanical Works.

Melbourne.—P.A.B.X. telephone installation—Stage II, State Insurance Centre, 480 Collins-street.

MURRAY BYRNE,
Minister of Public Works.

Public Works Department,
Melbourne, 3002, 31st May, 1971.

DEPARTMENT OF CROWN LANDS & SURVEY.
AERIAL PHOTOGRAPHY IN VICTORIA.

QUOTATIONS will be received until noon, 18th June, 1971 for aerial photography as required by the Department of Crown Lands and Survey during the period 1st August, 1971 to 31st July, 1972.

The lowest or any tender will not necessarily be accepted.

Full particulars may be obtained from—

The Surveyor-General,
Department of Crown Lands & Survey,
2 Treasury-place,
Melbourne, 3002.

Teaching Service Act 1958.

TEACHING SERVICE (CLASSIFICATION, SALARIES AND ALLOWANCES) REGULATIONS.

AMENDMENT NO. 201 (C.S. & A. 4).

THE Teachers Tribunal, in pursuance of the powers conferred by the *Teaching Service Act 1958*, hereby amends the Teaching Service (Classification, Salaries and Allowances) Regulations in the manner following, that is to say:—

PART III.—SECONDARY SCHOOLS DIVISION.

1. Rescind clause 15 and substitute therefor the following new clause:—

“15. The total number of Senior Teacher positions shall be determined in accordance with the following table:—

<i>Confirmed Enrolment.</i>	<i>Number.</i>
1,100 and above	6
1,000–1,099	5
900–999	5
800–899	4
700–799	3
600–699	3
500–599	2
400–499	2
300–399	2
200–299	1
Below 200	1

Provided that the number appointed to a specific school shall be determined not in terms of enrolment only, but having regard for need as assessed by the Director-General.

Provided further that the Tribunal may approve additional Senior Teacher positions required for special purposes.”

2. Rescind clause 16 and substitute therefor the following new clause:—

“16. The total number of Senior Assistant positions shall be determined in accordance with the following table:—

<i>Confirmed Enrolment.</i>	<i>Number.</i>
1,100 and above	12
1,000–1,099	11
900–999	9
800–899	8
700–799	7
600–699	6
500–599	5
400–499	5
300–399	4
200–299	3
Below 200	2

Provided that the number appointed to a specific school shall be determined not in terms of enrolment only, but having regard for subject needs or other special requirements as assessed by the Director-General.

Provided further that the Tribunal may approve additional Senior Assistant positions required for special purposes.”

W. E. SAMPSON, Chairman.
A. F. LE CLERCQ, Secretary.

Office of the Teachers Tribunal,
Melbourne, 25th May, 1971.

Teaching Service Act 1958.
**TEACHING SERVICE (TEACHERS TRIBUNAL)
 REGULATIONS.**

AMENDMENT No. 202 (T.T. 21).

THE Teachers Tribunal, in pursuance of the powers conferred by the *Teaching Service Act 1958*, hereby amends Regulation 19 of the Teaching Service (Teachers Tribunal) Regulations in the manner following, that is to say:—

REGULATION 19.

Rescind Regulation 19 and substitute therefor the following new Regulation:—

REGULATION 19.

RELATIVE NUMBERS OF POSITIONS FOR TEACHERS IN EACH CLASS OF THE SECONDARY SCHOOLS DIVISION.

The relative numbers of positions for teachers in each class of the Secondary Schools Division from the 1st January, 1972, shall be as follows:—

<i>Class.</i>	<i>Numbers of Positions.</i>	
Principal—Principals	261	
Deputy Principals	179	440
Senior Teacher		804
Senior Assistant		1,757
Assistant		8,500

W. E. SAMPSON, Chairman.
 A. F. LE CLERCQ, Secretary.

Office of the Teachers Tribunal,
 Melbourne, 25th May, 1971.

PUBLIC SERVICE NOTICE

No. 742.

PUBLIC SERVICE ACT 1958.

THE Public Service Board, in pursuance of the powers conferred by the *Public Service Act 1958*, hereby amends the Public Service (Public Service Board) Regulations as follows:—

PART VI.—TRAVELLING AND OTHER EXPENSES.

DIVISION I.—REIMBURSEMENT OF PERSONAL EXPENSES—

SPECIAL GROUPS.

Regulation 176.

Department of Crown Lands and Survey.

Sub-regulation (9) is revoked and the following sub-regulation is inserted in lieu thereof:—

“(9) Inspectors of Land Settlement . . \$656 a year”.

A. J. A. GARDNER, Chairman.
 R. H. DURRANT, Acting Secretary.

Office of the Public Service Board,
 Melbourne, 18th May, 1971.

PRIVATE ADVERTISEMENTS

CITY OF ALTONA.

By-Law No. 43.

Adoption of Portion of the 15th Schedule By-Law.

NOTICE is hereby given that the Council of the City of Altona has made By-Law No. 43—Adoption of Portion of the 15th Schedule By-Law by Special Order by resolution passed on April 6, 1971, and confirmed on May 11, 1971.

The purpose of the By-Law is:

(a) Prescribing the following portions of the 15th Schedule, Local Government Act to apply throughout the City—

<i>Part</i>	<i>Table of Clauses</i>	<i>Subjects contained in such Clauses</i>
I	8, 8A, 10 & 11	To enable street naming and numbering to take place.

<i>Part</i>	<i>Table of Clauses</i>	<i>Subjects contained in such Clauses</i>
I	15 to 26 incl.	Specification of cost of crossings over footways and channels.
	41 to 45 incl.	To authorise the impounding of cattle in the detention yard and the subsequent disposal of such cattle.
VI	1 to 4 incl.	Control and Licensing of buildings for public meetings and amusement.

(b) Repealing By-Law No. 27.

The By-Law operates throughout the whole of the City from the 3rd June 1971, following notice of its making published in the *Government Gazette*. Copies of the By-Law are available for inspection and may be purchased at the office of the Council during normal office hours.

488

JAMES W. WATERS, Town Clerk.

Local Government Act 1958.

CITY OF BENALLA.

DECLARATION OF PRIVATE STREET AS PUBLIC HIGHWAY.

IN pursuance of the power conferred by section 587 (3) of the *Local Government Act 1958* the Council of the City of Benalla on the application of the owners of so many of the premises as in rateable value are the greater part of all the premises fronting on the street hereinafter mentioned being a private street within the municipal district of the City of Benalla more than 15 feet in width constructed to the satisfaction of the Council, but not constructed pursuant to Division 10 of Part XIX. or Part XLII. of the *Local Government Act 1958* or any corresponding previous enactment hereby declares such street to be dedicated to the public as a public highway.

The street in respect of which this declaration is made is:—

Meadows-avenue East (Lots 1-6), lodged plan 85417.

In witness whereof the common seal of the Mayor, Councillors and Citizens of the City of Benalla was hereto affixed, this 24th day of May, 1971, in the presence of—

R. S. C. COGGER, Mayor.
 J. H. SMITH, Councillor.
 L. A. HEMLEY, Town Clerk.

(SEAL)

561

CITY OF COLLINGWOOD.

Notice of Intention to Borrow the Sum of \$50,000 for Road Construction and Drainage Works.

NOTICE is hereby given that the Council of the City of Collingwood proposes to borrow the principal sum of \$50,000 (Fifty thousand dollars) secured by a charge over the general rates of the municipality, such sum to be raised by the grant of a mortgage in accordance with the provisions of the *Local Government Act 1958*.

1. The maximum rate of interest that may be paid is 7.4 per cent. per annum.
2. The purposes for which the loan is to be applied are:—

Road construction and drainage works in Valiant, Hunter and Paterson streets, Abbotsford.

3. The period of the loan is to be twenty (20) years.
4. The moneys borrowed shall be repayable by providing out of the municipal fund 40 half-yearly instalments of \$2,414.52 each, including principal and interest, on the 1st day of February and the 1st day of August in each year, during the currency of the loan. The first instalment shall be payable on the 1st day of February, 1972.

5. Such moneys shall be repayable to the Australian Mutual Provident Society, 535 Bourke-street, Melbourne.

The plans, specifications and estimates of the proposed works and a statement showing the proposed expenditure of the moneys to be borrowed are open for inspection at the office of the Council, 140 Hoddle-street, Abbotsford, during office hours.

566

L. D. COOK, Town Clerk.

CITY OF CROYDON.

LOAN No. 99.

Notice of Intention to Borrow the Sum of \$50,000 for Permanent Works and Undertakings.

NOTICE is hereby given that the Council of the City of Croydon proposes to borrow the principal sum of \$50,000, secured by a charge over the general rates of the municipality, such sum to be raised by the grant of a mortgage in accordance with the provisions of the *Local Government Act 1958*.

1. The maximum rate of interest that may be paid is 7.4 per cent. per annum.
2. The purpose for which the loan is to be applied is:—

(1) Garbage Tip—		
Purchase of extension areas	\$6,800	
Final payment to Shire of Lillydale	15,000	\$21,800
(2) Hughes Park Oval reconstruction	8,000	
(3) Purchase of public open space (contingency)	10,000	
(4) Main drainage, Brew-road to Dorest-road (to complete)	2,500	
(5) Parrs-road outfall	3,200	
(6) Swimming pool, reconstruction of main pool	4,500	
		\$50,000

3. The period of the loan shall be 40 years.
4. The money borrowed shall be repayable by providing out of the municipal fund half-yearly instalments of approximately \$1,956.98 each, including principal and interest on the 1st day of February and the 1st day of August, during the currency of the loan. The first instalment shall be payable on the 1st day of February, 1972.

5. Such moneys shall be repayable to the Australian Mutual Provident Society, Victoria Branch, 535 Bourke-street, Melbourne, 3000.

The plans and specifications and the estimate of the cost of the proposed works and a statement showing the proposed expenditure of the moneys to be borrowed, are open for inspection at the office of the Council of the City of Croydon, at Foch-avenue, Croydon.

490

K. A. MCKAY, Town Clerk.

CITY OF DANDENONG.

CHANGING OF STREET NAME.

NOTICE is hereby given that the Council of the City of Dandenong at a meeting held on the 26th April, 1971, passed a Resolution changing the name of the street as set out hereunder:—

Old Name.—Christine-avenue (as laid out on Plan of Subdivision No. 80172).

New Name.—Jacana-street.

567

C. A. ELLIOTT, Town Clerk.

CITY OF FRANKSTON.

NOTICE OF INTENTION TO ACQUIRE LAND COMPULSORILY.

NOTICE is hereby given that the Council of the City of Frankston has deemed it expedient to exercise its powers of taking compulsorily the land described hereunder for the following works or undertakings (part only):—

- (a) Providing a car parking area on land fronting Beach-street, Evelyn-street, Ritchie-street and Dandenong-road, known as the "North of Beach-street Car Parking Scheme", and
- (b) Providing a Secondary Road as reserved on the Melbourne Metropolitan Planning Scheme Map 74, Amendment No. 7.

The said Council has caused to be prepared and approved a map and other papers showing the general description of the undertaking for which the land proposed to be taken is to be used, the description of the lands proposed to be so taken and the names of the owners or reputed owners, lessees or reputed lessees, mortgagees and occupiers of those lands so far as those names are known to or can be ascertained by the Council and such map and other papers have been deposited at the office of the Council, Civic Centre, Davey-street, Frankston, and are open for inspection by all persons interested at all reasonable hours for forty (40) clear days after publication of this notice in the *Victoria Government Gazette*.

The purport of the said map and other papers is the acquisition of land hereinafter described for the following works and undertakings (part only):—

- (a) Providing a car parking area on land fronting Beach-street, Evelyn-street, Ritchie-street and Dandenong-road, known as the "North of Beach-street Car Parking Scheme", and
- (b) Providing a Secondary Road as reserved on the Melbourne Metropolitan Planning Scheme Map 74, Amendment No. 7.

The land to be acquired is indicated in hatching and shown dotted on the said map. The lands proposed to be taken comprise the whole of lots 14 and 16 on plan of subdivision 8386, part of Crown allotment 7, section B, Township and Parish of Frankston and being the land contained in certificates of title, volume 8533, folio 753 and volume 6485, folio 1296813 respectively and contained within the following metes and bounds:—

- (i) Lot 14—
Commencing at a point on the northern building line of Beach-street, such point being located 59 feet westerly from the western intersection of Beach and Ritchie streets; thence by lines bearing—
289 deg. 15 min. for 59 feet,
19 deg. 15 min. for 140 feet,
109 deg. 15 min. for 59 feet,
199 deg. 15 min. for 140 feet,
to the point of commencement.
- (ii) Lot 16—
Commencing at the north-easterly corner of the intersection of Beach and Ritchie streets; thence by lines bearing—
19 deg. 15 min. for 140 feet,
109 deg. 15 min. for 59 feet,
199 deg. 15 min. for 140 feet,
289 deg. 15 min. for 59 feet,
to the point of commencement.

Now notice is hereby given to all persons affected by the proposed taking of the said land to set forth, in writing, addressed to the said Council or to its municipal clerk within 40 clear days of the publication of this notice in the *Victoria Government Gazette*, all objections which they may have to the taking of the said land.

G. C. PENTLAND, Town Clerk.

Civic Centre, Frankston.

503

CITY OF FRANKSTON.

LOAN No. 143.

Notice of Intention to Borrow the Sum of \$20,000.

NOTICE is hereby given that the Council of the City of Frankston intends to borrow the sum of Twenty thousand dollars (\$20,000), secured by a charge over the general rates of the municipality by the grant of a mortgage in accordance with the provisions of the *Local Government Act 1958*.

In connexion therewith, the following information is stated:—

- (a) The amount of the principal moneys which it is proposed to borrow is Twenty thousand dollars.

- (b) The maximum rate of interest that may be paid is 7.4 per centum per annum.
- (c) The times which moneys borrowed are to be repayable are the 1st days of February and August, during the years 1972 to 1986 inclusive, and the place such moneys shall be repayable is at the office of the Commissioners of the State Savings Bank of Victoria, corner Elizabeth and Bourke streets, Melbourne.
- (d) The purposes for which the loan is to be applied are:—
- | | |
|--|----------|
| (i) Violet-street outfall drain (completion) .. . | \$4,000 |
| (ii) Mountain-avenue-Moorooduc-road (drainage) .. . | 6,000 |
| (iii) Surfacing of Balmoral-street and Balmoral car park (part) .. . | 5,000 |
| (iv) Construction of set back, Heatherhill-road shops .. . | 5,000 |
| | <hr/> |
| | \$20,000 |
- (e) The manner in which the loan is to be liquidated is by provision out of the municipal fund of 30 half-yearly instalments of \$1,114.61, including principal and interest.

The plans and specifications and estimates of the cost of the works and a statement showing the proposed expenditure of the moneys to be borrowed, are open for inspection at the Civic Centre, Frankston.

G. C. PENTLAND, Town Clerk.

Civic Centre, Frankston. 489

CITY OF KNOX.

NOTICE OF CHANGE IN STREET NAMES.

NOTICE is hereby given that, in pursuance of powers conferred by the *Local Government Act 1958*, the Council of the City of Knox, at a meeting held on 4th May, 1971, resolved to make the following changes in street names:—

Old Names; Location; New Names.

Railway-road, from Forest-road to Butlers-road; Fern Tree Gully; Forest-road.
Butlers-road, from Railway-road to Forest-road; Fern Tree Gully; Forest-road.

493 N. G. HAYNES, Town Clerk.

CITY OF MARYBOROUGH.

LOAN No. 35.

Notice of Intention to Borrow the Sum of \$75,000 for Permanent Works and Undertakings.

NOTICE is hereby given that the Council of the City of Maryborough proposes to borrow the principal sum of Seventy-five thousand dollars (\$75,000), secured by a charge over the general rates of the municipality, such sum to be raised by the grant of a mortgage in accordance with the provisions of the *Local Government Act 1958*.

- The maximum rate of interest that may be paid is 7.4 per cent. per annum.
- The purpose for which the loan is to be applied is the erection of an industrial building, pursuant to Part XLA., *Local Government Act 1958*—\$75,000.
- The period of the loan shall be twenty years.
- The moneys borrowed shall be repayable by providing out of the municipal fund half-yearly instalments of approximately \$3,622 each, including principal and interest, on the 6th day of February and the 6th day of August, during the currency of the loan. The first instalment shall be payable on the 6th day of February, 1972.
- Such moneys shall be repayable to the Australian Mutual Provident Society at the office of the said society, 535 Bourke-street, Melbourne.

The plans and specifications and the estimate of the cost of the proposed works and a statement showing the proposed expenditure of the moneys to be borrowed are open for inspection at the office of the Council of the City of Maryborough, at Neill-street, Maryborough.

Dated 25th May, 1971.

481 E. S. MOORE, Town Clerk.

No. 54.—4671/71.—4

CITY OF NUNAWADING.

No. 1549.

LOAN No. 118.

Notice of Intention to Borrow.

NOTICE is hereby given that the Council of the City of Nunawading intends to borrow Fifty thousand dollars (\$50,000) secured by a charge over the general rates of the municipality by the grant of a mortgage in accordance with the provisions of the *Local Government Acts*.

In connection therewith the following information is stated:—

- The amount of the principal moneys which it is proposed to borrow is Fifty thousand dollars.
- The maximum rate of interest that may be paid is \$7.40 per centum per annum.
- The period of the loan shall be fifteen years.
- The moneys borrowed shall be repayable by providing out of the municipal fund half-yearly instalments of \$2,787.11 each including principal and interest on the 15th day of June and the 15th day of December during the currency of the loan. The first such instalment shall be payable on the 15th day of December, 1971.
- The purpose for which the loan is to be applied is:—
Construction of Central Library (part cost) .. . \$50,000
- Such moneys shall be repayable at the office of the Local Authorities Superannuation Board, "Rigby House", 15 Queens-road, Melbourne, or such other place or places as the lender from time to time may require.

The plans and specifications and estimate of cost of the works and a statement showing the proposed expenditure of the moneys to be borrowed are open for inspection at the Municipal Offices, Nunawading.

Dated this 22nd day of May, 1971.

529 J. H. BROWN, Town Clerk.

CITY OF RICHMOND.

LOAN No. 54.

Notice of Intention to Borrow.

NOTICE is hereby given that the Council of the City of Richmond intends to borrow Forty thousand dollars (\$40,000), secured by a charge over the general rates of the municipality, by the grant of a mortgage in accordance with the provisions of the *Local Government Acts*.

In connexion therewith the following information is stated:—

- The amount of the principal moneys which it is proposed to borrow is \$40,000.
- The maximum rate of interest that may be paid is \$7.40 per centum per annum.
- The times which the moneys borrowed are to be repayable are the 3rd day of February, 1972, and the 3rd days of February and August, during the years 1972-1986 inclusive, and that the place such moneys shall be repayable is at the Bank of New South Wales, Richmond.
- The purpose for which the loan is to be applied is:—
Purchase of the Globe Theatre site, corner of Church-street and Charlotte-street, Richmond, for municipal purposes.
- The manner in which the loan is to be liquidated is by provision out of the municipal fund in each half-year during the currency of the loan of the sum of \$2,229.69, which includes principal and interest.

The plans and specifications and estimate of the cost of the works and a statement showing the proposed expenditure of the moneys to be borrowed, are open for inspection at the Town Hall.

Dated this 26th day of May, 1971.

509 CHAS. C. EYRES, Town Clerk.

CITY OF SALE.

LOAN No. 52.

Notice of Intention to Borrow the Sum of \$20,000 for Permanent Works and Undertakings.

NOTICE is hereby given that the Council of the City of Sale proposes to borrow the principal sum of \$20,000, secured by a charge over the general rates of the municipality, such sum to be raised by the grant of a mortgage in accordance with the provisions of the *Local Government Act 1958*.

1. The maximum rate of interest that may be paid is 7.1 per cent. per annum.

2. The purposes for which the loan is to be applied are:—

Plant purchase:—	
Street sweeper and motor truck ..	\$17,000
Part construction indoor, heated swimming pool ..	3,000
	\$20,000

3. The period of the loan shall be five years.

4. The moneys borrowed shall be repayable by providing out of the municipal fund half-yearly instalments of approximately \$2,410.90 each, including principal and interest, on the 1st day of February and the 1st day of August, during the currency of the loan. The first instalment shall be payable on the 1st day of February, 1972.

5. Such moneys shall be repayable to the Commissioners of the State Savings Bank of Victoria, at the office of the said Commissioners, corner Elizabeth and Bourke streets, Melbourne.

The plans and specifications and the estimate of the cost of the proposed works and a statement showing the proposed expenditure of the moneys to be borrowed are open for inspection at the office of the Council of the City of Sale, at Macalister-street, Sale.

Dated 27th May, 1971.

484 J. R. RAY, Town Clerk.

CITY OF SANDRINGHAM.

LOAN No. 104.

Notice of Intention to Borrow the Sum of Seventy-five Thousand Dollars (\$75,000) for Permanent Works and Undertakings in the City of Sandringham.

NOTICE is hereby given that the Council of the City of Sandringham proposes to borrow on the credit of the general rates of the municipality of the City of Sandringham the sum of Seventy-five thousand dollars (\$75,000), such sum to be raised by the grant of a mortgage in accordance with the provisions of the Local Government Acts.

The maximum rate of interest that may be paid is 7.40 per centum per annum.

The money borrowed shall be repayable, together with interest at the Australian Mutual Provident Society, 535 Bourke-street, Melbourne, 3000, by equal half-yearly instalments on 30th July and 30th January in each year, the loan to have a currency of 40 years, the first payment to be made on the 30th January, 1972, and the final payment on the 30th July, 2011.

The purposes for which the loan is to be applied shall be:—

Road Works—

Grout-street; Gillies-street; Gordon-street; Bolton-avenue (additional provision); Crisp-street and Kerferd-street—\$75,000.

The loan is to be liquidated by appropriating out of the municipal fund eighty (80) equal half-yearly payments of \$2,935.46 each, covering principal and interest during the term of the loan.

The plans, specifications and estimate of cost of the works referred to above, and statement showing the proposed expenditure of the money to be borrowed, are open for inspection during office hours of the Council at the Municipal Offices, Royal-avenue, Sandringham.

Dated this 27th day of May, 1971.

501 J. L. ANDERSON, Town Clerk.

BOROUGH OF QUEENSCLIFFE.

NOTICE is hereby given that the Council of the Borough of Queenscliffe intends to confirm the adoption of By-law No. 41 as set out hereunder, at the Ordinary Meeting of Council to be held on Tuesday, 22nd June, 1971.

BY-LAW No. 41.

A By-law of the Borough of Queenscliffe made under the provisions of Section 197 of the *Local Government Act 1958* and numbered 41 for amending By-law number 40 in relation to the special restricted area, Point Lonsdale Bight.

Pursuant to the powers conferred by Section 197 of the *Local Government Act 1958* and every other power enabling it in that behalf, The Mayor, Councillors and Burgesses of the Borough of Queenscliffe hereby order as follows:

Section 7 of By-law Number 40 of the Borough of Queenscliffe shall be amended as follows:

(a) By deleting the words "and from Easter Friday to Easter Monday in each year" and

(b) by adding at the end thereof after the words "high water" the words "except on such occasions between the hours of 6 p.m. and 9 a.m. as the Authorised Officer shall from time to time determine".

Resolution for passing this By-law was agreed to by the Council of the Borough of Queenscliffe on the 27th day of April, 1971.

533

R. T. FORBES, Town Clerk.

SHIRE OF BELFAST.

NOTICE is hereby given that the Council of the Shire of Belfast has appointed Senior Constable Peter Morris, No. 11998, as Prosecuting Officer for the Shire of Belfast, in place of Senior Constable Allan Briggs.

BRIAN MOLONEY, Deputy Shire Secretary, Shire Hall, Port Fairy. 526

SHIRE OF BRIGHT.

LOAN No. 47.

Notice of Intention to Borrow the Sum of \$24,000 for Permanent Works and Undertakings.

NOTICE is hereby given that the Council of the Shire of Bright proposes to borrow the principal sum of \$24,000 secured by a charge over the general rates of the municipality, such sum to be raised by a grant of a mortgage in accordance with the provisions of the *Local Government Act 1958*.

1. The maximum rate of interest that may be paid is 7.3 per cent. per annum.

2. The purpose for which the loan is to be applied is the construction and sealing of roads in the Township of Bright, i.e.:—

Mountbatten-avenue	\$12,000
Elm-court	2,500
Orana-avenue	2,000
Railway-avenue	4,000
Brooks-street	2,000
Camp-street	1,500
	\$24,000

3. The period of the loan shall be ten years.

4. The moneys borrowed shall be repayable by providing out of the municipal fund twenty half-yearly instalments of \$3,423.34 each, including principal and interest, on the 1st day of January and the 1st day of July, during the currency of the loan. The first instalment shall be payable on the 1st day of January, 1972.

5. Such moneys shall be repayable at the Australia and New Zealand Bank, Melbourne.

The plans and specifications and the estimate of the cost of the proposed works and a statement showing the proposed expenditure of the moneys to be borrowed are open for inspection at the office of the Council of the Shire of Bright, at Ireland-street, Bright.

Dated the 8th April, 1971.

565

H. G. HAYMES, Shire Secretary.

SHIRE OF COLAC.

ORDER OF COUNCIL.

IN pursuance of the powers conferred by section 522 of the *Local Government Act 1958*, the Council of the Shire of Colac doth hereby direct that the lands described in the Schedule hereto, which have been purchased by it, shall be public highways from and after the date of publication of this order in the *Government Gazette*.

The corporate seal of the President, Councillors and Ratepayers of the Shire of Colac was hereto affixed this 9th day of March, 1971, in the presence of—

(SEAL) JOHN CALVERT, President.
K. D. PATON, Councillor.
W. J. MAUNSELL, Secretary.

SCHEDULE REFERRED TO.

All those pieces of land on the plans hereunder being:—
Firstly.—That part of Crown allotment 38a, Parish of Candare, comprised in certificate of title, volume 8856, folio 272.

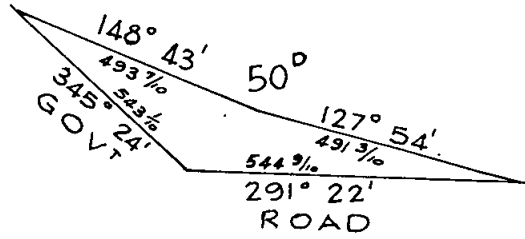
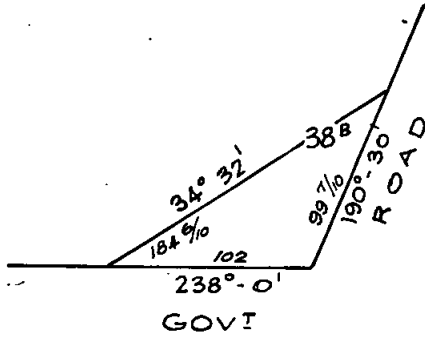

Sixthly.—That part of a former Government road, Parish of Dreeite, County of Grenville, comprised in certificate of title, volume 8864, folio 061.

Secondly.—One acre 1 rood 89/10 perches, or thereabouts, being that part of Crown allotment 67c, Parish of Dreeite, comprised in certificate of title, volume 8856, folio 395.

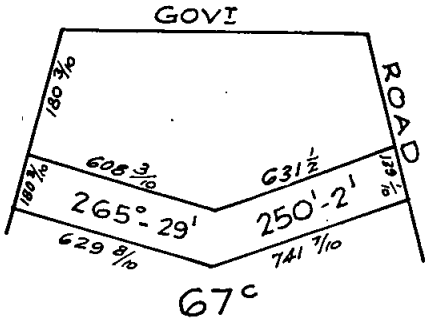

Thirdly.—That part of lot 3A on plan of subdivision No. 4265, and that part of subdivision A of Crown allotment 50, Parish of Dreeite, comprised in certificate of title, volume 8858, folio 699.

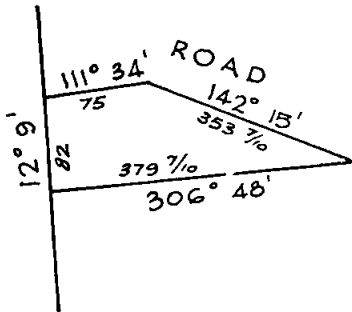

Fourthly.—That part of Crown allotment 50c, Parish of Dreeite, comprised in certificate of title, volume 8858, folio 698.

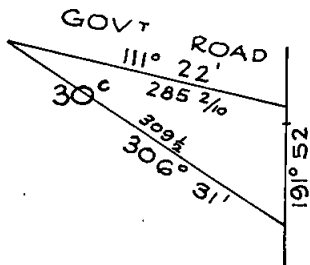

Fifthly.—That part of Crown allotment 50d, Parish of Dreeite, comprised in certificate of title, volume 8858, folio 697.

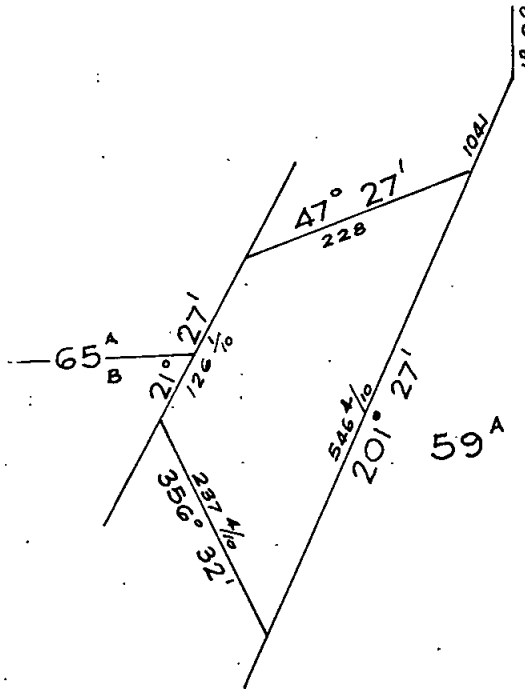

Seventhly.—That part of lot 5 on plan of subdivision No. 4265, and being part of subdivisions A and B of Crown allotment 60, Parish of Dreeite, comprised in certificate of title, volume 8858, folio 719.

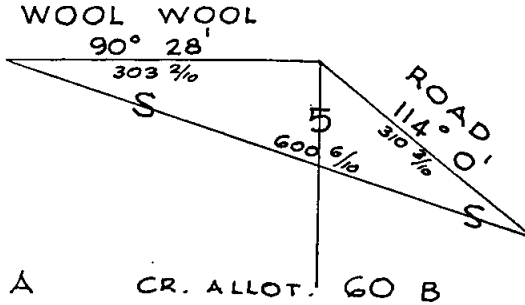

486

SHIRE OF HASTINGS.

By-Law No. 18.

A By-Law of the Shire of Hastings, made under the provisions of Part VII. Division 1 Section 197, Paragraph XXX.VII. of the Local Government Act 1958, No. 6299 as amended, and all other powers enabling it, and numbered 18 for the following purposes:—

- (a) Prohibiting or regulating the use of private property situate at the junction of streets or roads for the growing of trees, shrubs or hedges, within a distance of 30 feet from the junction of any streets or roads.

- (b) Requiring the removal or reduction in height of trees, shrubs or hedges (whether planted before or after the commencement of the *Local Government Act 1958*) from or on private property so situate where such trees, shrubs or hedges are within a distance of 30 feet from the junction of any streets or roads.
- (c) Requiring the reduction to a height not exceeding 3 ft. 6 in. of any portion of a fence within 30 feet of the junction of any streets or roads.
- (d) Authorising the Council of the said Shire, at the expense of the owner (the amount of which expense may be recovered by the Council in a Court of Petty Sessions as a civil debt recoverable summarily:—)
 - (i) To remove or reduce in height trees, shrubs or hedges growing or being on private property so situate which are not removed or reduced in height as required by or under any By-Law made under paragraph (b) hereof;
 - (ii) To reduce in height any portion of a fence which is not reduced in height as required by or under any By-Law made under paragraph (c) hereof.

IN pursuance of the powers conferred by the Local Government Act and every other power enabling them in that behalf, the President, Councillors and Ratepayers of the Shire of Hastings order as follows:—

1. That this By-Law shall come into effect immediately after its publication in the *Victoria Government Gazette*.

2. No person shall on any property situate at the junction of streets or roads use any portion of such property which is within a distance of 30 feet from such junction, for the growing of any trees, shrubs or hedges, unless for a distance of 30 feet from such junction each part of any such tree, shrub or hedge shall be kept at a height not greater than 3 ft. 6 in. above the surface level of the street or road nearest to such tree, shrub or hedge.

3. The owner of any private property situate at the junction of any streets or roads upon which property any trees, shrubs or hedges are growing within a distance of 30 feet from such a junction shall, if such trees, shrubs or hedges be of a greater height than 3 ft. 6 in. from the surface level of the street or road nearest to any such tree, shrub or hedge, upon notice in writing under the hand of the Shire Secretary of the said Shire, and within the time therein specified, remove or reduce in height, or cause to be removed or reduced in height, all trees, shrubs or hedges (whether planted before or after the commencement of the *Local Government Act 1958*), to such extent as may be necessary to bring such trees, shrubs or hedges into conformity with the requirements of the preceding clause hereof.

4. The owner of any private property situate at the junction of any streets or roads upon which private property there is a fence within 30 feet from the junction of such streets or roads shall, if such fence be of a greater height than 3 ft. 6 in. from the surface level of the street or road nearest to such fence, upon notice in writing under the hand of the Shire Secretary of the said Shire and within the time therein specified, cause to be reduced to a height not exceeding 3 ft. 6 in. above the surface level of the street or road nearest such fence any portion of such fence within 30 feet of the junction of such streets or roads.

5. Upon default being made by the owner of private property situate at the junction of any streets or roads in complying with any notice under this By-Law and notwithstanding the imposition or recovery of any penalty the said Council may, by its engineer, or other authorised officer, enter upon such private property with a sufficient number of workmen and may remove or reduce in height, trees, shrubs or hedges growing or being thereon which have not been removed or reduced in height as required by such notice, or reduce in height any portion of a fence which has not been reduced in height as required by such notice, and the expenses incurred by the said Council in so doing shall be forthwith paid by the owner of such private property to the said Council and in default of such payment may be recovered by the said Council as a civil debt recoverable summarily.

6. For the purpose of this By-Law—

- (a) the word "junction" shall mean the point at which the building line of a street or road meets the building line of another street or road, and in cases where the corner has been rounded off or splayed, the word "junction" shall mean and include the whole of the arc or line to which such corner has been rounded off or splayed;

- (b) the word "surface level" shall mean—
 - (i) where the footway on the side of the street or road which abuts on the private property in question is paved, the level of that part of the paved portion of such footway nearest to the private property in question;
 - (ii) if such footway is not paved and the level of the street or road abutting on such private property has been fixed in accordance with the provisions of Division 9 of Part XIX. of the *Local Government Act 1958*, or any previous or subsequent Act of Parliament of a like nature, the level as so fixed of that part of such street or road nearest to the private property in question;
 - (iii) otherwise the actual level of that part of such street or road nearest to the private property in question.

7. This By-Law shall apply to and have operation throughout the whole of the Municipal District of the Shire of Hastings.

Resolution for passing this By-Law agreed to by the Council of the Shire of Hastings on 6th April, 1971, and confirmed on 4th May, 1971.

The common seal of the President, Councillors and Ratepayers of the Shire of Hastings, was hereunto affixed this 4th day of May, 1971.

R. P. MAIR, President.
T. J. SINCLAIR, Councillor.
L. A. WALKER, Secretary.

483

Dog Act 1970.
SHIRE OF KANIVA.
SHOPPING AREA SPECIFIED.

NOTICE is given that Council, at a meeting held on the 19th January, 1971, resolved as follows:—

"That in accordance with the provisions of section 16 (3) of the *Dog Act 1970*, all that section of Commercial-street between Baker-street and Madden-street in the Township of Kaniva and within the municipal district of the Shire of Kaniva be specified as a shopping area in which dogs must be under the effective control of some person by means of a chain, cord or leash."

534 G. J. WALKER, Shire Secretary.

SHIRE OF KARA KARA.
LOAN No. 15.

Notice of Intention to Borrow the Sum of \$10,000 for Permanent Works and Undertakings.

NOTICE is hereby given that the Council of the Shire of Kara Kara proposes to borrow the principal sum of \$10,000, secured by a charge over the general rates of the municipality, such sum to be raised by the grant of a mortgage in accordance with the provisions of the *Local Government Act 1958*.

- 1. The maximum rate of interest that may be paid is 7.4 per cent. per annum.
- 2. The purposes for which the loan is to be applied are as follows:—

Infant welfare flat (Shire proportion) ..	\$3,000
Two-way radio installation	2,250
Council depot construction	3,750
Soil conservation works (Council proportion) ..	1,000
	\$10,000

- 3. The period of the loan shall be fifteen years.
- 4. The moneys borrowed shall be repayable by providing out of the municipal fund half-yearly instalments of approximately \$57.43 each, including principal and interest, on the 1st day of March and the 1st day of September, during the currency of the loan. The first instalment shall be payable on the 1st day of March, 1972.

5. Such moneys shall be repayable to the C.B.C. Savings Bank Limited, 251 Collins-street, Melbourne.

The plans and specifications and the estimate of cost of the proposed works and a statement showing the proposed expenditure of the moneys to be borrowed are open for inspection at the Shire Office, St. Arnaud, 3478.

Dated 5th May, 1971.

492

PAUL JAMES, Shire Secretary.

SHIRE OF LILLYDALE PLANNING SCHEME 1958.

NOTICE THAT A PLANNING SCHEME HAS BEEN PREPARED AND IS AVAILABLE FOR INSPECTION.

Amendment No. 21, 1971.

NOTICE is hereby given that the Shire of Lillydale, in pursuance of its powers under the *Town and Country Planning Act 1961*, has prepared a Planning Scheme for portion of the Shire of Lillydale for the purpose of amending the Principal Scheme (Shire of Lillydale Planning Scheme, 1958).

A copy of the Scheme has been deposited at the Shire Offices, Lillydale, and at the office of the Town and Country Planning Board, 235 Queen-street, Melbourne, and will be open for inspection during office hours by any person free of charge.

Any persons affected by the Planning Scheme are required to set forth in writing, all objections they may have, addressed to the Shire Secretary, Shire of Lillydale, Shire Offices, Lillydale-Monbulk road, Lillydale, on or before the 2nd day of September, 1971, and to state whether they wish to be heard in respect of their objections.

521 F. O. KENT, Shire Secretary.

Town and Country Planning Act 1961 (Twelfth Schedule).
SHIRE OF TAMBO.—LAKES ENTRANCE PLANNING SCHEME.

NOTICE THAT A PLANNING SCHEME HAS BEEN PREPARED AND IS AVAILABLE FOR INSPECTION.

NOTICE is hereby given that the Council of the Shire of Tambo, in pursuance of its powers under the *Town and Country Planning Act 1961*, has prepared a Planning Scheme for an area in the Parish of Colquhoun, extending from Maringa Creek to Lake Tyers Beach (including the Townships of Kalimna, Lakes Entrance, Cunninghame and East Cunninghame), for the purpose of regulating the development of the area and for other purposes.

A copy of the Scheme has been deposited at—

- (1) the office of the Town and Country Planning Board, 235 Queen-street, Melbourne,
- (2) the Shire Offices, Bruthen, and
- (3) the office of the Lakes Entrance Waterworks Trust, Devitt-street, Lakes Entrance

and will be open for inspection during office hours by any person free of charge.

Any persons affected by the Planning Scheme are required to set forth, in writing, all objections they may have, addressed to the Shire Secretary, Shire of Tambo, Bruthen, 3885, on or before the 1st day of September, 1971, and to state whether they wish to be heard in respect of their objections.

532 G. W. RIDSDALE, F.I.M.A., J.P., Shire Secretary.

SHIRE OF TAMBO.

NOTICE OF CHANGING OF STREET NAME.

NOTICE is hereby given that the Council of the Shire of Tambo has made an order changing the name of a street in the Township of Lakes Entrance, as follows:—

Location.—Township of Lakes Entrance on lodged plan No. 43321.

Old Name.—Archer-street.

New Name.—Archer-court.

496 G. W. RIDSDALE, F.I.M.A., J.P., Shire Secretary.

SHIRE OF WOORAYL.

LOAN No. 34.

Notice of Intention to Borrow the Sum of \$130,000 for Permanent Works and Undertakings.

NOTICE is hereby given that the Council of the Shire of Woorayl proposes to borrow the principal sum of \$130,000, secured by a charge over the general rates of the municipality, such sum to be raised by the grant of a mortgage in accordance with the provisions of the *Local Government Act 1958*.

1. The maximum rate of interest that may be paid is 7.4 per centum per annum.

2. The purposes for which the loan is to be applied are as follows:—

(a) Assistance to Decentralized Industry ..	\$35,000
(b) Land acquisition: Car parking ..	38,400
(c) Construction pre-school centre—Dumbalk:	
Council contribution ..	13,000
(d) Establishment of tip ..	5,000
(e) Purchase of residence ..	18,600

(f) Construction of Senior Citizens Club—
Leongatha: Council contribution ..

20,000

\$130,000

3. The period of the loan shall be fifteen years.

4. The moneys borrowed shall be repayable by providing out of the municipal fund half-yearly instalments of \$7,246.49 each, including principal and interest, on the 15th day of June and the 15th day of December of each year during the currency of the loan. The first instalment shall be payable on the 15th day of December, 1971.

5. Such money shall be repayable at the office of the Local Authorities Superannuation Board, Melbourne.

Plans and specifications and the estimate of the cost of the proposed works and a statement showing the proposed expenditure of the moneys are open for inspection at the office of the Council of the Shire of Woorayl, at Leongatha.

482 R. G. STANLEY, Shire Secretary.

Town and Country Planning Act 1961.

SHIRE OF YEA PLANNING SCHEME.

NOTICE THAT A PLANNING SCHEME HAS BEEN PREPARED AND IS AVAILABLE FOR INSPECTION.

NOTICE is hereby given that the Shire of Yea, in pursuance of its powers under the *Town and Country Planning Act 1961*, has prepared a Planning Scheme to provide for the planned development of the municipal district.

A copy of the Scheme is deposited for inspection at the Shire Office, Civic Centre, Yea, and at the office of the Town and Country Planning Board, 235 Queen-street, Melbourne, and will be open for inspection by any person free of charge during office hours.

Any persons affected by the Planning Scheme are required to set forth, in writing, all objections they may have, addressed to the Shire Secretary, Shire of Yea, Yea, 3717, on or before the 2nd September, 1971, and to state whether they wish to be heard in respect of their objections.

491 F. F. BERKERY, Shire Secretary.

WARRNAMBOOL GOLF CLUB.

NOTICE is hereby given that the Warrnambool Golf Club has applied for a lease under section 134, *Land Act 1958*, for a term of 21 years in respect of allotment 9, section 74, Township of Warrnambool, containing 126 acres approx., as a site for amusement and recreation (Golf Club).

J. S. TAIT & CO., solicitors, Warrnambool. 316

NOTICE is hereby given that Leo Fink, Jack Fink, Sydney Fink and Wolf Fink have applied for a replacement lease pursuant to sections 134 and 135 of the *Land Act 1958*, for a term of 75 years in respect of allotments 1 and 2, section D, City of South Melbourne, containing 1 acre 0 roods 6 perches as a site for offices, showrooms, warehousing and merchandising. 386

LAND ACT 1958.

NOTICE is hereby given that Elizabeth Ann McDonald, David Ian Trace, and Charlotte Sara Trace, as trustees of Heiden Ski Club, intend to apply for a lease under section 134 of the *Land Act 1958* for a term of 21 years in respect of an area of 1 rood 14 perches, being allotment 5, section 1, Parish of Yertoo, as a site for a Ski Club Lodge.

E. A. McDONALD, Trustee.

D. I. TRACE, Trustee.

C. S. TRACE, Trustee.

589

NOTICE is hereby given that Dargo Ski Lodge has applied for a lease under section 134 of the *Land Act 1958*, for a term of 21 years in respect of allotment 14, section 1, Parish of Yertoo, as a site for a Ski Club Lodge. 577

NOTICE OF INTENTION TO APPLY FOR A LICENCE TO DIVERT WATER AND CUT RACE (RE-ISSUE) FROM THE RIVER MURRAY, AT NATYA.

WE hereby give notice that we intend to apply for a licence empowering us to divert water for a term of fifteen years to the extent of 1,515 acre-feet per annum at a maximum rate of 48 acre-feet per day of 24 hours for the irrigation of 505 acres, being part of allotments 24 and 25, Parish of Burra, and to occupy certain Crown lands for works of diversion, and to cut a race thereon.

Any objection to such application must be forwarded, in writing, to reach the State Rivers and Water Supply Commission, Melbourne, before 2nd July, 1971, being 30 days from the first publication of this notice.

PIAMBIE FARM PTY. LTD.

P.O. Box 188, Bendigo, Vic. 3550. 500

DANDENONG SEWERAGE AUTHORITY.

GENERAL NOTICE.

THE above-mentioned Sewerage Authority having made provision for carrying of the sewage from each and every property which, or any part of which is within the sewerage areas hereinafter described, doth hereby declare that on and after the 1st day of June, 1971, each and every property which, or any part of which is within the said sewerage areas shall be deemed to be a sewered property within the meaning of the *Sewerage Districts Act 1958*.

The boundaries of the Sewerage Areas hereinbefore referred to are:—

Sewerage Area No. 238.

All those pieces of land being lots 48 to 54 inclusive and 114 to 118 inclusive on lodged plan of subdivision No. 83577, lots 55 to 58 inclusive on lodged plan of subdivision No. 85904; lots 87 to 89 inclusive on plan of subdivision No. 5959 lodged at the office of the City of Dandenong.

Parts of streets concerned in this area are Purley-drive, Morris-court, Milan-court and Shalimar-crescent.

Sewerage Area No. 239.

All those pieces of land being lots 64 to 72 inclusive, 79 to 87 inclusive and 91 to 98 inclusive on lodged plan of subdivision No. 84693; lots 91 to 98 inclusive on plan of subdivision No. 5943, lodged at the office of the City of Dandenong; lots 173 to 184 inclusive on lodged plan of subdivision No. 89572.

Parts of streets concerned in this area are Dava-court, Delia-court, Glencoe-grove and First-avenue.

Sewerage Area No. 240.

All those pieces of land being lots 195 to 202 inclusive; 208 and 221 to 225 inclusive, on lodged plan of subdivision No. 91586.

Parts of streets concerned in this area are First-avenue, Howard-court and Belinda-court.

Unless otherwise specified herein the lodged plans of subdivision hereinbefore referred to shall be taken as those lodged at the Office of Titles, Melbourne.

By order of the Dandenong Sewerage Authority,

M. G. JARVIS, Chairman.
A. R. EDWARDS, Secretary.

568

WARRNAMBOOL SEWERAGE AUTHORITY.

GENERAL NOTICE.

THE above-mentioned Sewerage Authority, having made sewers for carrying off the sewage from each and every property which, or any part of which abuts on the streets or parts of streets, in which such sewers are laid, and which are included within the Sewerage Area herein-after described, doth hereby declare that, on and after the 1st day of July, 1971, each and every property which, or any part of which abuts on the said streets or part of streets shall be deemed to be sewered property within the meaning of the *Sewerage Districts Act 1958*.

The boundaries of the Sewerage Areas hereinbefore referred to are:

Sewer Area No. 80.

That portion of the Warrnambool Sewerage District, being part of Crown allotments 83 and 84, Parish of Wangoom, County of Villiers, which is adjacent and to the south of Sewer Area No. 77 and is bounded on the west by Walsh-road, on the south-west by Giffen-street and on the east by Morriss-road and which consists of lots 115 to 124 and lots 126 to 129 Giffen-street, lots 53 to 56 and lots 61 to 65 Bradley-street, lots 57 to 60 Bateman-court, lots 156 to 165, lots 107, 108 and the balance of lot 106 Archibald-street, lots 85 to 95 Helpmann-court, lot 84 Morriss-road, lots 109 to 114 and lot 125 Mack-street together with those sections of road reserves which are adjacent to all of the aforementioned lots.

Sewer Area No. 81.

That portion of the Warrnambool Sewerage District being parts of Crown allotments 68, 69 and 70, Parish of Wangoom, County of Villiers, which is adjacent and to the north of Declared Sewer Areas Nos. 62 and 58 and which consists of lots 138 to 155 Examiner-crescent and

lots 136 and 137 Morriss-road, together with those sections of road reserves which are adjacent to all of the aforementioned lots.

Sewer Area No. 82.

That portion of the Warrnambool Sewerage District, being part of Crown allotments 77 and 78, Parish of Wangoom, County of Villiers, which is adjacent and to the north of Declared Sewer Area No. 66 and which consists of lots 95, 96 and 109 Pecten-avenue, lots 97 to 100 and lots 104, 105 and 108 Humphreys-street, together with the balance of Humphreys-street road reserve.

Sewer Area No. 83.

That portion of the Warrnambool Sewerage District being part of Crown allotment 38, Parish of Wangoom, County of Villiers, which is adjacent to the north of Declared Sewer Area No. 66 and which consists of lots 2, 3, 8 and 9 Laverock-road and lots 4, 5, 6 and 7 Dalton's-road, together with that section of Laverock-road reserve which is adjacent to the aforementioned lots.

Sewer Area No. 84.

That portion of the Warrnambool Sewerage District being Crown allotment 96 and part of Crown allotments 94, 95 and 106 City of Warrnambool, Parish of Wangoom, which is bounded to the west by Declared Sewer Area No. 30 to the north-east by Flaxman-street and to the south by the northern boundary of the south-western Railway Reserve.

Sewer Area No. 85.

That portion of the Warrnambool Sewerage District which is bounded by a line which commences at the north-west corner of Declared Sewer Area No. 76 being also the south-eastern corner of Barber's-lane and Wentworth-street and then proceeds in a clockwise direction to the south along the western boundaries of Declared Sewer Areas 76 and 44, to the west along the northern boundaries of Areas No. 15 and No. 14, to the north along the east boundary of Area No. 37 to a point which is 94 feet south of the production of the south building line of Conn's-lane, then east across Ardlie-street and to a point 235 ft. east of the east building line of Ardlie-street, then north as far as the north building line of Conn's lane then east along the north building line of Conn's-lane to a point 200 feet west of the west building line of Wentworth-street then north for a distance of 228 feet then east to and across the end of Wentworth-street as far as the east building line of Wentworth-street then south along said building line to the starting point.

R. A. MITCHELL, Chairman.
K. L. ARNEL, Secretary.

505

BANNOCKBURN DISTRICT WATERWORKS TRUST.

NOTICE to owners of tenements in the following streets or parts of streets in the Township of Lethbridge.

High-street, lot 33 to lot 2, section 10.
Russell-street, lot 32 to lot 36.
Station-place West, lot 2a to lot 36.
Station-place East, lot 35 to lot 1, section 14.
Stephenson-street, lot 4, section 18 to lot 2, section 14.
Lethbridge Maude-road, lot 2, section 18 to lot 35.

The main pipe in the said streets being laid down the owners of all tenements situated as above are hereby required on or before the 1st August, 1971, to cause a proper pipe and stop cock to be laid so as to supply water within such tenements from the main pipe.

This notice is issued to comply with the requirements of the Eighth Schedule of the *Water Act 1958*.

502

K. T. MIDDLETON, Trust Secretary.

GEELONG WATERWORKS AND SEWERAGE TRUST.

PURSUANT to section 60 of the *Geelong Waterworks and Sewerage Act 1958* (No. 6263) the Trust has prepared plans to indicate the particulars of sewers and underground works in or adjacent to the following localities within the Drainage Area.

Sullivan-court, Belmont; Shire of South Barwon.
Glenleith-court, Drumcondra; City of Geelong West.

Notice is hereby given that the plans indicated above are open for public inspection at the Trust's Offices, Ryrie-street, Geelong, between the hours of 9 a.m. and 5 p.m. from Monday to Friday, public holidays excepted, by the owners and occupiers of land or premises within the Drainage Area.

495

B. C. HENSHAW, Secretary.

THE BALLARAT SEWERAGE AUTHORITY.

PURSUANT to section 119 (2) of the *Sewerage Districts Act 1958* (No. 6368), notice is hereby given of the intention to construct sewers to provide for properties situated in:—

Borough of Sebastopol, Shire of Buninyong; in the vicinity of Docwra and Albert streets; more particularly as shown on maps which are open for inspection at this Office between the hours of 9 a.m. and 4 p.m., Monday to Friday, inclusive.

Dated 25th May, 1971.

498 CHAS. H. CLAMP, Secretary.

NOTICE is hereby given that at an Extraordinary General Meeting of Stanpak Pty. Ltd., held at Melbourne, on the 24th day of May, 1971, the following Resolution was passed as a Special Resolution:—

"That the company be placed in voluntary liquidation."

Dated this 24th day of May, 1971.

J. B. HUTCHINS, Liquidator.

Wilson, Bishop, Bowes & Craig, chartered accountants, 191 Queen-street, Melbourne, Vic. 3000. 552

NOTICE is hereby given that at an Extraordinary General Meeting of D. C. Aldridge & Co. Pty. Ltd., held at Melbourne, on the 24th day of May, 1971, the following Resolution was passed as a Special Resolution:—

"That the company be placed in voluntary liquidation."

Dated this 24th day of May, 1971.

J. B. HUTCHINS, Liquidator.

Wilson, Bishop, Bowes & Craig, chartered accountants, 191 Queen-street, Melbourne, Vic. 3000. 553

NOTICE is hereby given that at an Extraordinary General Meeting of Albert Park Properties Pty. Ltd., held at Melbourne, on the 24th day of May, 1971, the following Resolution was passed as a Special Resolution:—

"That the company be placed in voluntary liquidation."

Dated this 24th day of May, 1971.

J. B. HUTCHINS, Liquidator.

Wilson, Bishop, Bowes & Craig, chartered accountants, 191 Queen-street, Melbourne, Vic. 3000. 554

The Companies Act 1961.

S. YATES PTY. LIMITED.

NOTICE OF SPECIAL RESOLUTION PURSUANT TO SECTION 254 (2) (b).

AT an Extraordinary General Meeting of the members of S. Yates Pty. Limited, duly convened and held at 436 Queen-street, Melbourne, 20th day of May, 1971, the following Special Resolution was duly passed:—

"That the company be wound up voluntarily as a members voluntary winding up."

At the said meeting the members appointed Arthur Rivers Millis, of 436 Queen-street, Melbourne, liquidator for the purpose of winding up the affairs and distributing the assets of the company.

555 S. L. YATES, Director.

Notice of Winding-up Order.—In the matter of TARPETTI PTY. LTD.

WINDING-UP order made the 26th day of May, 1971.

Name and address of official liquidator, Jack Bastian, of the firm of J. Bastian & Co., Suite 25, 545 St. Kilda-road, Melbourne.

J. CANNY, Deputy Commissioner of Taxation of the Commonwealth of Australia. 586

Companies Act 1961.

ARROW METAL PRODUCTS PROPRIETARY LIMITED.

NOTICE OF RESOLUTION.

To the Registrar of Companies.

AT a General Meeting of the members of Arrow Metal Products Proprietary Limited, duly convened and held at 113 Marriage-road, East Brighton, on the 28th day of May, 1971, the Special Resolution set out below was duly passed:—

"All shareholders being present, it was resolved by Special Resolution that the company go into voluntary liquidation forthwith."

Dated this 28th day of May, 1971.

578

In the matter of the *Companies Act 1961*; and in the matter of AUSTIN PRINTING PTY. LTD.; and in the matter of a scheme of arrangement made under section 181 of the said Act between the company and certain of its unsecured creditors.

NOTICE is hereby given that a meeting of creditors of the company to whom debts were due and owing by the company at twelve o'clock midnight on 3rd February, 1970, will be held at the offices of the Chamber of Commerce, 21st Floor, 60 Market-street, Melbourne, on Friday, the 4th of June, 1971, at 2.30 p.m.

The meeting is convened for the purpose of considering the position of the company's affairs and operations since the scheme of arrangement approved by the Supreme Court of Victoria on the 25th day of November, 1970, and if deemed expedient, to seek approval of the aforesaid creditors to either—

- (1) sell the assets and business of the company as a going concern, or
- (2) determine any other course of action deemed acceptable by the aforesaid creditors.

L. P. SMART, Supervisor.

For and on behalf of the Supervisory Committee Austin Printing Pty. Ltd. 585

The *Companies Act 1961*.—In the matter of RANIL INVESTMENTS PROPRIETARY LIMITED.—Notice of Final Meeting.

NOTICE is hereby given that, pursuant to section 272 of the *Companies Act 1961*, a general meeting of the members of the above-named company will be held at 8 Gurner-street, St. Kilda, on Thursday, the 15th day of July, 1971, at 10 o'clock in the forenoon for the purpose of having an account laid before them showing the manner in which the winding up has been conducted and the property of the company disposed of, and of hearing any explanation that may be given by the liquidator.

Dated the 28th day of May, 1971.

560 JOHN M. FILCOCK, Liquidator.

In the Supreme Court of Victoria.—1971, No. Co. 8119.—In the matter of Part X. of the *Companies Act 1961*; and in the matter of BOND LEASING PROPRIETARY LIMITED.

NOTICE is hereby given that a petition for the winding up of the above-named company by the Supreme Court was, on the 13th day of May, 1971, presented by Roach & Co.; And that the said petition is directed to be heard before the Court sitting at the Fourteenth Court, Law Courts, William-street, Melbourne, at the hour of 10.30 o'clock in the forenoon, on the 28th day of June, 1971; and any creditor or contributory of the said company desiring to support or oppose the making of an order on the said petition may appear at the time of hearing by himself or his counsel for that purpose; and a copy of the petition will be furnished to any creditor or contributory of the said company requiring the same by the undersigned on payment of the regulated charge for the same.

The petitioner's address is 379 Collins-street, Melbourne.

The petitioner's solicitors are Messrs. Sackville, Wilks & Co., of 100 Collins-street, Melbourne.

SACKVILLE, WILKS & CO., solicitors for the petitioner.

NOTE.—Any person who intends to appear on the hearing of the said petition must serve on or send by post to the above-named Sackville, Wilks & Co., notice in writing of his intention to do so. The notice must state the name and address of the person or, if a firm, the name and address of the firm, and must be signed by the person or firm, or his or their solicitor (if any), and must be served, or, if posted, must be sent by post in sufficient time to reach the abovenamed not later than 4 o'clock in the afternoon of the 25th day of June, 1971. 563

The *Companies Act 1961*.—In the matter of STEVENSON DAVIES PTY. LTD.—Notice Re Meeting of Creditors, Pursuant to Section 260.

NOTICE is hereby given that a meeting of creditors of the above-named company will be held at the offices of Kennedy, Smail & Middlemiss, 296 Little Lonsdale-street, Melbourne, at 2.30 p.m. on the 9th day of June, 1971, the company having convened a meeting of its members for the same day for the purpose of considering a Resolution that the company be wound up voluntarily.

Dated this 1st day of June, 1971.

H. TEMPEST, Director.

Kennedy, Smail & Middlemiss, 296 Little Lonsdale-street, Melbourne. 588

Unclaimed Moneys Act 1962.

REGISTER of Unclaimed Moneys held by the—

Name of Owner on Books and Last Known Address.	Total Amount Due to Owner.	Description of Unclaimed Moneys.	Date when Amount first became Payable.
\$			
HUTTONS LIMITED.			
Hogan, Geoffrey S., 56 Bellevue-terrace, Clayfield, Qld.	11.00	1968 Dividends	22.11.68
Whait, John E. (estate of), c/o Huttons Limited, 65 High-street, Preston	49.92	" "	"
Greening, Ann C. (Mrs.), c/o R. D. Greening, 22 Noble-street, Mosman, N.S.W.	165.00	" "	"
White, Gilbert S., Marine Parade Stores, Marine-parade, Timaru, New Zealand	68.00	" "	"
Whait, John E. (estate of), c/o Huttons Limited, 65 High-street, Preston	24.96	1969 Dividend	25.7.69
Reuben, N. and Co. Ltd., c/o Mercantile Bank Limited, 15 Gracechurch-street, London, England	153.37	" "	"
White, Gilbert S., Marine Parade Stores, Marine-parade, Timaru, New Zealand	34.00	" "	"
Angell, Roslyn (Miss), c/o National Bank of Aust., 84 Glenferrie-road, Malvern	20.62	1969 Final Dividend ..	30.1.70
Hunter, Jeremy M., 35 Monash-avenue, Balwyn.	82.50	" " " "	"
Whait, John E. (estate of), c/o Huttons Limited, 65 High-street, Preston	24.96	" " " "	"
White, Gilbert S., Marine Parade Stores, Marine-parade, Timaru, New Zealand	34.00	" " " "	"
Lindsay, Barbara F. (Mrs.), Mt. Leonard, Windorah, Qld. . .	41.25	" " " "	"
478			
GODFREY PHILLIPS HOLDINGS LIMITED.			
Bourne, Edna (estate of), c/o W. A. Rowe, 92 Pitt-street, Sydney, N.S.W.	102.70	Preference Capital Redemption A/c. Principal and Dividend	13.6.69
Farey, Arthur A., Melrose Hotel, 363 Flemington-road, North Melbourne	410.78	" " " "	"
Mitton, Mildred C. (estate of), c/o Alderman, Clark, Ligertwood and Rice, 13 Grenfell-street, Adelaide, S.A.	205.39	" " " "	"
Reed, Isabel D. (Mrs.), 8 George-street, Black Rock	410.78	" " " "	"
Tyrie, Edwin (Dr.), and Clara M. (estate of), Unit 20, 17 The Esplanade, Cronulla, N.S.W.	1,026.96	" " " "	"
479			

THE GUNBOWER CO-OPERATIVE BUTTER FACTORY AND TRADING COY. LTD.

AT an Extraordinary General Meeting of the members of Gunbower Co-operative Butter Factory and Trading Company Limited, duly convened and held in the Board Room of Mid-Murray Dairy Co. Limited, McMillans-road, Cohuna, on the 25th day of May, 1971, the Special Resolution set out below was duly passed:—

"That, the directors having lodged a declaration of solvency in terms of section 257 of the Companies Act 1961, it is hereby resolved that the company be wound up voluntarily, and that Mr. Donald H. Carne, of 270 Campbell-street, Swan Hill, be hereby appointed liquidator."

Dated this 25th day of May, 1971.
487 A. R. APPLEBY, Secretary.

Companies Act 1961.—In the matter of AUSTRAMOORE PTY. LTD. (in Voluntary Liquidation).

NOTICE is hereby given that, at an Extraordinary General Meeting of the members of the above-named company, held on 21st May, 1971, a Special Resolution was passed that the company be wound up voluntarily, and it resolved that Mr. Hugh Cameron Muldoon be liquidator of the company and he was thereby appointed.

24th May, 1971.
477 H. C. MULDOON, Liquidator.

The Companies Act 1961.—In the matter of HERMETIC INDUSTRIES PTY. LTD.—Notice Re Meeting of Creditors, Pursuant to Section 260.

NOTICE is hereby given that a meeting of creditors of the above-named company will be held at the offices of Kennedy, Smail & Middlemiss, 296 Little Lonsdale-street, Melbourne, at 10.30 a.m. on the 15th day of June, 1971, the company having convened a meeting of its members for the same day for the purpose of considering a Resolution that the company be wound up voluntarily.

Dated this 3rd day of June, 1971.
GEORGE SMITH, Director.

Kennedy, Smail & Middlemiss, 296 Little Lonsdale-street, Melbourne.
587

BANNER INVESTMENTS PTY. LTD. (IN LIQUIDATION).

NOTICE is hereby given, in pursuance of section 272 of the Companies Act 1961, that a General Meeting of members of the above-named company will be held at the offices of Marshman, Saunders and Company, 79 Moorabool-street, Geelong, on the 30th day of June, 1971, at 10 a.m., for the purpose of having the liquidator's account laid before them, showing the manner in which the winding-up has been conducted and the property of the company disposed of, and of hearing any explanation that may be given by the liquidator.

Dated this 26th day of May, 1971.
476 B. N. MARSHMAN, Liquidator.

Companies Act 1961.

NOTICE OF MEETING OF CREDITORS OF THE STANLEY PRINTING & PUBLISHING CO. PTY. LTD. (FORMERLY SURREY HALL PRINTERS PTY. LTD.).

NOTICE is hereby given that, pursuant to section 261 of the Companies Act 1961, a meeting of the creditors of The Stanley Printing & Publishing Co. Pty. Ltd., will be held at the offices of Hudson Pitt Associates, Suite 14, 30 Queens-road, Melbourne, 3004, on the 7th day of June, 1971, at 11 a.m., the company having convened a meeting of its members for the same day for the purpose of considering and if thought fit, passing a Special Resolution that the company be wound up voluntarily and that Hudson Bernard Pitt, of 30 Queens-road, Melbourne, be appointed liquidator.

Dated this 25th day of May, 1971.
512 P. M. WORTHINGTON, Director.

The Companies Act 1961, Pursuant to Section 254 (2).

G. K. INDUSTRIES PTY. LTD. (IN LIQUIDATION).

NOTICE is hereby given that at an Extraordinary General Meeting of members of the above-named company duly held on Friday, 28th May, 1971, the following Special Resolution was duly passed:—

"That the company be and is hereby wound up as a members' voluntary winding up and that Maxwell George Gee be and is hereby appointed liquidator to wind the company up and attend to all matters relative thereto in accordance with the Companies Act 1961."

536 M. G. GEE, Liquidator.

The Companies Act 1961.—In the matter of HILLVIEW PLANT HIRE PTY. LIMITED (in Voluntary Liquidation).—Creditors' Winding Up.

NOTICE is hereby given that at the Extraordinary General Meeting of Hillview Plant Hire Pty. Limited, duly convened and held at 461 Bourke-street, Melbourne, in the State of Victoria, on the 27th day of May, 1971, the following Resolution was proposed and passed as a Special Resolution:—

"That the company be wound up voluntarily."

Dated this 28th day of May, 1971.

523

R. W. BETTS, Liquidator.

ARMOND MFRS & DISTRIBUTORS PTY. LTD. (IN VOLUNTARY LIQUIDATION).

NOTICE is hereby given that Armond Mfrs & Distributors Pty. Ltd., registered office 389 Brunswick-street, Fitzroy, was put as from 5th May, 1971, into voluntary liquidation (members') and Alfred G. Blondell, of 147 Bamba-road, Caulfield, was appointed liquidator.

525

A. G. BLONDELL, Liquidator.

FRED JONES & CO. PROPRIETARY LIMITED.

SPECIAL RESOLUTION TO WIND UP, PURSUANT TO SECTION 254 OF THE COMPANIES ACT 1961.

AT an Extraordinary General Meeting of the above-named company, duly convened and held at Golf Links-road, Lakes Entrance, on the 22nd day of May, 1971, the following Resolution was duly passed as a Special Resolution:—

"That the company be wound up voluntarily."

And at such last-mentioned meeting Wilfred Thomas Jones was appointed liquidator for the purpose of the winding up.

Dated this 22nd day of May, 1971.

507

W. T. JONES, Liquidator.

The Companies Act 1961.—In the matter of BALAS & LAVERY PTY. LTD.

NOTICE is hereby given that at an Extraordinary Meeting of the members of the above-named company held on the 26th day of May, 1971, it was resolved that the company be wound up voluntarily and at a meeting of creditors held on the same day, pursuant to section 260, it was resolved that for such purposes, Everett Thomson Bent, of Suite 18, 545 St. Kilda-road, Melbourne, accountant, be appointed liquidator.

Notice is also given that after 21 days from this date I shall proceed to distribute the assets. All creditors having any claims against the company should furnish particulars of same by that date, otherwise I shall proceed to distribute the assets without regard to their claim.

Dated this 26th day of May, 1971.

E. T. BENT, Liquidator.

Bent & Cogle, public accountants, Suite 18, 545 St. Kilda-road, Melbourne, 3004. 510

KENNETH MUNRO FRASER, late of 57 Union-road, Surrey Hills, gentleman, DECEASED (who died on 16th February, 1971).

CREDITORS, next of kin and all other persons having claims against the estate of the deceased are required by the executrices of his will, Katharine Emilie Fraser, widow, and Margaret Alison Fraser, architect, both of 57 Union-road, Surrey Hills, to send particulars thereof to them, care of the under-mentioned solicitors, before 6th August, 1971, after which date they may distribute the assets of the deceased, having regard only to the claims of which they then have notice.

COLTMAN WYATT & ANDERSON, solicitors, of 379 Collins-street, Melbourne. 537

HERMIONE CHRISTINA PAULINE EVA, late of Queen Elizabeth Homes, Ascot-street, Ballarat, widow, DECEASED (who died on 21st February, 1971).

CREDITORS, next of kin and all other persons having claims against the estate of the deceased are required by the executor of her will, John Peter Sidney Eva, of 13 Bulla-road, North Essendon, bank manager, to send particulars thereof to him, care of the under-mentioned solicitors, before 6th August, 1971, after which date he may distribute the assets of the deceased, having regard only to the claims of which he then has notice.

COLTMAN WYATT & ANDERSON, solicitors, of 379 Collins-street, Melbourne. 538

HALDANE STEWART MCCOLL, late of 10 McRae-street, Seaford, retired gentleman, DECEASED (who died on 29th January, 1971).

CREDITORS, next of kin and all other persons having claims against the estate of the deceased are required by the executor of his will, William Tuxford Atkin, the Secretary for the time being of the Churches of Christ Department of Social Services, of 217 Lonsdale-street, Melbourne, to send particulars thereof to him, care of the under-mentioned solicitors, before 6th August, 1971, after which date he may distribute the assets of the deceased, having regard only to the claims of which he then has notice.

COLTMAN WYATT & ANDERSON, solicitors, of 379 Collins-street, Melbourne. 539

RALPH LOCH GARRETT, late of "Gwandalan", Main-road, Ferny Creek, gentleman, DECEASED (who died on 5th June, 1970).

CREDITORS, next of kin and all other persons having claims against the estate of the deceased are required by the executors of his will, John Hayward Garrett, of 59 Mount-street, Heidelberg, civil engineer, and Thomas Craig Garrett, of Isobel-avenue, East Ringwood, builder, to send particulars thereof to them, care of the under-mentioned solicitors, before 6th August, 1971, after which date they may distribute the assets of the deceased, having regard only to the claims of which they then have notice.

COLTMAN WYATT & ANDERSON, solicitors, of 379 Collins-street, Melbourne. 540

ARVIDS BALODIS, formerly of 36 Barossa-road, Glenorchy, Tasmania, builder, but late of 32 Linacre-road, Hampton, Victoria, carpenter, DECEASED (who died on the 24th February, 1971).

CREDITORS, next of kin and all other persons having claims against the estate of the deceased are required by the executor, Peteris Kajons, to send particulars to him, care of the undersigned, on or before the 1st August, 1971, after which date he will distribute the assets, having regard only to the claims of which he then has notice.

I. DIZGALVIS & CO., solicitors, 390 Lonsdale-street, Melbourne, Victoria 3000. 541

LLEWELLYN SYDNEY GRIFFITH, late of 26 Tramway-parade, Beaumaris, gentleman, DECEASED (who died on 23rd February, 1971).

CREDITORS, next of kin and all other persons having claims against the estate of the deceased are required by the executors of his will, Gladys Griffith, of 26 Tramway-parade, Beaumaris, widow, Ronald Llewellyn Griffith, of Flat 3, 292 Nepean Highway, Seaford, laboratory technician, and Jennifer Cowin Archer, of 62 Cliff-road, Frankston, married woman, to send particulars thereof to them, care of the under-mentioned solicitors, before 6th August, 1971, after which date they may distribute the assets of the deceased, having regard only to the claims of which they then have notice.

COLTMAN WYATT & ANDERSON, solicitors, of 379 Collins-street, Melbourne. 542

CREDITORS, next of kin and others having claims in respect of the estate of Leslie Harris, late of Bacchus Marsh, in the State of Victoria, labourer, deceased (who died on the 24th day of January, 1971, and probate of whose will has been granted to Olive Irene Harris, of 25 Parwan-road, Bacchus Marsh, in the said State, widow), are required to send particulars of their claims to the said executrix, care of the under-mentioned solicitors, by the 28th day of July, 1971, after which date she will distribute the assets, having regard only to the claims of which she then has notice.

PEARCE & WEBSTER, solicitors, of 430 Little Collins-street, Melbourne. 543

REGINALD STONE, late of 3 Urso-street, North Balwyn, civil engineer, DECEASED.

CREDITORS, next of kin and others having claims in respect of the estate of the deceased (who died on the 8th February, 1971), are required by the executor, The Equity Trustees, Executors and Agency Company Limited, of 472 Bourke-street, Melbourne, to send particulars to it, by the 10th August, 1971, after which date the executor may distribute the estate, having regard only to the claims of which it then has notice.

W. B. & O. McCUTCHEON, solicitors, 150 Queen-street, Melbourne. 544

ETHEL ELIZABETH RAMSAY, late of 18 Margate-avenue, Frankston, in the State of Victoria, retired speech therapist, DECEASED.

CREDITORS, next of kin and others having claims in respect of the estate of the deceased (who died on the 13th day of August, 1970), are required by Keith William Ramsay, of 45 Caulfield-avenue, Cumberland Park, in the State of South Australia, manufacturer's agent, to send particulars of their claims to him, care of the under-mentioned solicitor by the 30th day of July, 1971, after which date the trustee may convey or distribute the assets, having regard only to the claims of which he then has notice.

Dated the 31st day of May, 1971.

R. F. M. HOLLOW, solicitor, 42 Beach-street, Frankston, Victoria. 474

CREDITORS, next of kin and others having claims in respect of the estate of Kenneth Imison, late of 5 Crowther-place, Brighton, director, deceased (who died on the 25th day of April, 1970), are requested to send particulars of their claims to The Union-Fidelity Trustee Company of Australia Limited, of 100 Exhibition-street, Melbourne, Robert Kenneth Imison and Brian Anthony Imison, the executors of the will of the said deceased, in care of the said company by the 15th day of August, 1971, after which date the executors will distribute the assets, having regard only to the claims of which they have notice.

KENNETH J. CLEMENTS & SON, solicitors, 255 Glen-huntly-road, Elsternwick. 494

CHARLES LESLIE FORTINGTON, late of 121 Cochrane-street, Gardenvale, bookmaker.

CREDITORS, next of kin and others having claims in respect of the estate of the deceased (who died on 23rd July, 1970), are required by the administrator, Leslie Kenneth William Fortington, formerly of 3 Dight-avenue, North Balwyn, but now of 175 Doncaster-road, North Balwyn, bookmaker, to send particulars to him, care of the undersigned by the 14th day of August, 1971, after which date the administrator may convey or distribute the assets, having regard only to the claims of which he then has notice.

JAMES KELLEHER, LL.B., solicitor, 20 Bank-place, Melbourne. 506

HILDA MARY MILNE, late of 34 Hutton-street, Thornbury, widow, DECEASED.

CREDITORS, next of kin and others having claims in respect of the estate of the deceased (who died on the 16th day of September, 1968), are required by the administrator, Mabel Hambly Seccull, of 489 Gilbert-road, West Preston, to send particulars to her, care of the undersigned, by the 7th day of August, 1971, after which the trustee may convey or distribute the assets, having regard only to the claims of which she then has notice.

JAMES KELLEHER, LL.B., barrister and solicitor, 20 Bank-place, Melbourne. 504

Notice Pursuant to *Trustee Act 1958*, Section 33.—Re estate of VERA GLADYS BOWLEY, late of Centennial House, Freemasons Homes, 313 Punt-road, Prahran, widow, DECEASED.

CREDITORS, next of kin and others having claims in respect of the estate of the deceased (who died on the 6th day of November, 1970), are required by The Trustees, Executors and Agency Company Limited, of 401 Collins-street, Melbourne, the administrator with the will annexed, to whom letters of administration of the estate of the said deceased were granted by the Supreme Court of Victoria, on the 26th day of May, 1971, to send particulars of their claims to the said company, by the 11th day of August, 1971, after which date the said company will convey and distribute the assets, having regard only to the claims of which it then has notice.

Dated this 1st day of June, 1971.

F. R. E. DAWSON & SON, 84 William-street, Melbourne, solicitors for the administrator. 562

CREDITORS, next of kin and others having claims in respect of the will of Grant Stuart Ross, late of 180 Bellair-street, Kensington, army captain (who died on the 9th February, 1971), are requested to send particulars of their claims to the executor, Clive Henry Baker, care of the undermentioned solicitor, by the 11th day of August, 1971, after which date he will distribute the assets, having regard only as to the claims of which he then has notice.

JOHN STEWART, solicitor, of 290 Racecourse-road, Newmarket. 531

ORMOND JACK WARD, late of Kingston, farmer, DECEASED (who died on the 28th February, 1971).

CREDITORS, next of kin and all persons having claims against the estate of the deceased, are required to send particulars to the executors, The Union-Fidelity Trustee Company of Australia Limited, of 101 Lydiard-street north, Ballarat, on or before the 3rd August, 1971, after which date it will distribute the assets, having regard only to the claims of which it shall then have notice.

HEINZ & GORDON, solicitors, 209 Dana-street, Ballarat.

497

TRUSTEE ACT 1958.

CREDITORS, next of kin and others having claims against the estates specified below, are required to send particulars in writing of such claims to the personal representative of such estate in care of Messrs. Morrison & Teare, solicitors, Numurkah, on or before 16th August, 1971, after which date the assets of the estate will be conveyed or distributed among the persons entitled thereto, having regard only to the claims to which the representative shall then have had notice:—

Arthur Alister Cock, late of Wangaratta, in the State of Victoria, retired farmer, deceased (died 28th February, 1971).

Alexander Samuel Hobley, late of Numurkah, in the State of Victoria, sharefarmer, deceased (died 4th January, 1971).

MORRISON & TEARE, solicitors, Numurkah. 475

CREDITORS, next of kin and others having claims against the estate of Thomas Walter, late of Callawadda, farmer, deceased (who died on the 14th day of February, 1970), are required by the executors of the will of the said deceased to send to them addressed care of the undersigned solicitors, particulars thereof on or before the 12th day of July, 1971, after which date they will distribute the estate of the said deceased, having regard only to the claims of which they shall then have notice.

BRIGGS & O'DRISCOLL, solicitors, Stawell. 480

AFTER fourteen clear days, application will be made to the Supreme Court that probate of the will of Claude Bruce Newman, late of 75 Rossmoyne-street, Thornbury, in the State of Victoria, retired storeman, deceased (who died on the 9th day of May, 1971), be granted to National Trustees, Executors and Agency Company of Australasia Limited, of 95 Queen-street, Melbourne, the executors named in the will of the said deceased.

Dated the 25th day of May, 1971.

GRAEME STEINFORT, solicitor, 580 High-street, Thornbury. 472

AFTER fourteen clear days, application will be made to the Supreme Court that probate of the will, dated 29th day of October, 1968, of Ethel May Hughes, late of 27 Queen-street, Reservoir, home duties, deceased, be granted to Claude John Hughes (junior), of 27 Queen-street, Reservoir, the executor appointed by the said will.

JAMES KELLEHER, LL.B., solicitor, 20 Bank-place, Melbourne. 508

CREDITORS, next of kin and others having claims against the estate of Theresa Mary Beard, late of 5 Armstrong-avenue, Drouin, widow (who died on the 5th day of October, 1969), are requested to send particulars of their claims to James Albert Beard of Waterloo-road, Trafalgar, the executor appointed by the deceased's will, in care of the undersigned, by the 28th day of July, 1971, after which date they will distribute the assets, having regard only to the claims of which they then shall have had notice.

M. DAVINE & CO., solicitors, Warragul. 516

CREDITORS, next of kin and others having claims against the estate of Henry Brooke Lawrence Gipps, late of "Hughenden", Main Drain-road, Iona (who died on the 25th day of November, 1970), are requested to send particulars of their claims to Stella Elizabeth Helen Gipps, widow, and Helen Gwenda Gipps, clerk, both of Main Drain-road, Iona, the executors appointed by the deceased's will, in care of the undersigned, by the 28th day of July, 1971, after which date they will distribute the assets, having regard only to the claims of which they then shall have had notice.

M. DAVINE & CO., solicitors, Warragul. 518

CREDITORS, next of kin and others having claims in respect of the estate of Doris Oakley Wilkinson, late of 16 Beaumont-avenue, Canterbury, in the State of Victoria, spinster, deceased (who died on the 29th day of March, 1971), are required by the executor, The Union-Fidelity Trustee Company of Australia Limited, of 100 Exhibition-street, Melbourne, in the State of Victoria, to send particulars of their claims to the executor, care of the undersigned solicitors, by the 6th day of August, 1971, after which date it will distribute the assets, having regard only to the claims of which it then has notice.

FREDERICK OWEN & ASSOCIATES, solicitors, 84 William-street, Melbourne. 546

CREDITORS, next of kin and others having claims in respect of the estate of Roland Bruce Hallett, late of 296 Alma-road, North Caulfield, in the State of Victoria, retired builder, deceased (who died on the 15th day of March, 1971), are required by the executors, Maxwell Bruce Hallett, of 8 Birralee-street, Mount Waverley, in the State of Victoria, director, and Walter Vincent, junior, of 11 Willow-avenue, Mitcham, in the said State, accountant, to send particulars of their claims to the executors, care of the undersigned solicitors, by the 6th day of August, 1971, after which date they will distribute the assets, having regard only to the claims of which they then have notice.

FREDERICK OWEN & ASSOCIATES, solicitors, 84 William-street, Melbourne. 547

CREDITORS, next of kin and others having claims in respect of the estate of James Ronald Milner, late of 10 McConchie-avenue, East Kew, in the State of Victoria, superintendent of police, deceased (who died on the 30th day of December, 1970), are required by the executrix, Mavis Agnes Milner, of 10 McConchie-avenue, East Kew, in the State of Victoria, widow, to send particulars of their claims to the executrix, care of the undersigned solicitors, by the 6th day of August, 1971, after which date she will distribute the assets, having regard only to the claims of which she then has notice.

FREDERICK OWEN & ASSOCIATES, solicitors, 84 William-street, Melbourne. 548

CREDITORS, next of kin and others having claims in respect of the estate of Leslie Gordon Barnes, late of 3 Lynch-court, Balwyn, in the State of Victoria, retired accountant, deceased (who died on the 19th day of January, 1971), are required by the executrix, Nancy Dorothy Barnes, of 3 Lynch-court, Balwyn, in the State of Victoria, widow, to send particulars of their claims to the executrix, care of the undersigned solicitors, by the 6th day of August, 1971, after which date she will distribute the assets, having regard only to the claims of which she then has notice.

FREDERICK OWEN & ASSOCIATES, solicitors, 84 William-street, Melbourne. 549

PURSUANT to the *Trustee Act 1958*, notice is hereby given that all persons having claims against the estate of Jean Jones, late of 577 Whitehorse-road Mitcham, in the State of Victoria, widow, deceased (who died on 5th April, 1971), and probate of whose will was granted by the Supreme Court of Victoria, in its probate jurisdiction on 20th May, 1971, to The Equity Trustees, Executors and Agency Company Limited, of 472 Bourke-street, Melbourne, are hereby required to send particulars in writing of such claims to the said The Equity Trustees, Executors and Agency Company Limited, at its above-mentioned address, on or before 31st July, 1971, after which date the said company will proceed to distribute the assets of the said Jean Jones, deceased, which shall have come to its hands amongst the persons entitled thereto, having regard only to the claims of which it shall then have had notice. And notice is further given that the said company will not be liable for the assets so distributed, or any part thereof to any person of whose claim it shall not have notice as aforesaid.

Dated this 25th day of May, 1971.

G. F. PITCHER & BUTT, solicitors, 406 Lonsdale-street, Melbourne. 550

PERCY REED, late of 415 Murray-road, West Preston, retired, DECEASED.

CREDITORS, next of kin and others having claims in respect of the estate of the deceased (who died on the 25th April, 1971), are requested to send particulars of their claims to the executors, Elsie May Reed, Ronald Percy Reed and Alwyn Elsie Williamson, care of the undersigned solicitor, by the 3rd day of August, 1971, after

which date the said executors will proceed to distribute the estate, having regard only to the claims of which they then have notice.

MARJORY C. COATES, solicitor of 422 Collins-street, Melbourne, 3000. 551

CREDITORS, next of kin and others having claims in respect of the estate of Albert Edward Blakiston, late of 11 Veronica-street, South Oakleigh, in the State of Victoria, gentleman, deceased (who died on the 20th day of September, 1969), are to send particulars of their claims to Florence Nicol Blakiston, care of the under-mentioned solicitors by the 2nd day of August, 1971, after which date she will distribute the assets, having regard only to the claims to which she then has notice.

Dated this 25th day of May, 1971.

REGINALD C. BUTLER & CO., solicitors, 312 Centre-road, Bentleigh. 511

FRANCES IRENE RUSSELL, late of Lake Boga, married woman, DECEASED.

CREDITORS, next of kin and others having claims in respect of the estate of the deceased (who died on the 2nd day of December, 1970), are required by the executor, Aubrey William Alexander Russell, of Lake Boga, to send particulars to him, care of the undersigned by the 2nd day of August, 1971, after which date the executor may convey or distribute the assets, having regard only to the claims of which he then has notice.

ALEC M. HAYES, solicitor, 148 Campbell-street, Swan Hill. 485

CREDITORS, next of kin and others having claims in respect of the estate of Hubert Arthur Relph, late of 16 Glendearg-grove, Malvern, gentleman, deceased (who died on the 5th day of September, 1969, and probate of whose will has been granted to Athol Leslie Relph, of Gibney-street, Maffra, manager, and Joan Meta Elliston, of 16 Glendearg-grove, Malvern, married woman), are required to send particulars of their claims to the said executors, care of the under-mentioned solicitors, by the 9th day of August, 1971, after which date they will distribute the assets, having regard only to the claims of which they have notice.

PEARCE & WEBSTER, solicitors, of 430 Little Collins-street, Melbourne. 545

CREDITORS, next of kin and all other persons having claims against the estate of Albert Edward Fisher, formerly of 502 Doveton-street, Ballarat, but late of 604 Howitt-street, Ballarat, textile worker (who died on the 3rd December, 1970), are required by the executor, Geoffrey Walter Cunningham, of 2 Lydiard-street South, Ballarat, estate agent, to send detailed particulars of their claims in respect of the said estate to the undermentioned firm on or before the 6th day of August, 1971, after which date the executor will proceed to distribute the said estate, having regard only to the claims of which he then has notice.

Dated the 31st day of May, 1971.

RAMSAY, GAUNT & FRASER, solicitors, 41 Lydiard-street South, Ballarat, 3350. 524

LILLIAN ELIZA MILLS, late of 97 Gladstone-avenue, Northcote, widow, DECEASED.

CREDITORS, next of kin and others having claims in respect of the estate of the deceased (who died on the 28th day of October, 1970), are required to send particulars of their claims to Hugh Charles Gulliver, c/o F. P. & M. J. WALSH, solicitors, of 452 High-street, Northcote, before the 4th day of August, 1971, after which date he will distribute the assets, having regard only to the claims of which he then has notice.

F. P. & M. J. WALSH, solicitors, 452 High-street, Northcote. 520

CREDITORS, next of kin and others having claims in respect of the estate of Robert Arthur Roberts, formerly of Lindenow South, but late of 44 Wilson-street, Berwick, postmaster (who died on the 17th day of August, 1970), are requested to send particulars of their claims to The Union Fidelity Trustee Company of Australia Limited, of 100 Exhibition-street, Melbourne, and Lillian Agnes Roberts, of 44 Wilson-street, Berwick, widow, by the 28th day of July, 1971, in care of The Union Fidelity Trustee Company of Australia Limited, of 100 Exhibition-street, Melbourne, after which date the executors will distribute the assets, having regard only to the claims of which they then have had notice.

M. DAVINE & CO., solicitors, Warragul. 517

Trustee Act 1958.

NOTICE TO CLAIMANTS.

PURSUANT to the Trustee Act 1958, creditors, next of kin and all other persons having claims in respect of the estate of any deceased person named below are required to send particulars to the legal personal representative or representatives at the addresses stated, after which date the representative or representatives will distribute the assets, having regard only to the claims of which notice has been received:—

David McGowan Nichol, late of 40 Ararat-street, North Altona, retired railway employee, deceased, died on the 28th day of March, 1971.—Claims to the executrix, Martha Scott McGowan Henry, of 40 Ararat-street, North Altona, married woman, care of John F. Carroll, of 4 Paisley-street, Footscray, solicitor, by the 4th day of August, 1971.—John F. Carroll, LL.B., solicitor, 4 Paisley-street, Footscray. 570

CREDITORS, next of kin and all other persons having claims against the estate of Ida Amelia Anderson, formerly of 49 Jupiter-street, South Caulfield, but late of Evancourt Hospital Pty. Ltd., 1015 Dandenong-road, East Malvern, in the State of Victoria, spinster, deceased (who died on the 24th day of December, 1970, probate of whose will has been applied for to the Supreme Court of the said State in its Probate Jurisdiction by The Union-Fidelity Trustee Company of Australia Limited (in the will called The Fidelity Trustee Company Limited), of 100 Exhibition-street, Melbourne), are requested to send particulars of their claims, in writing, to the said The Union-Fidelity Trustee Company of Australia Limited, of 100 Exhibition-street, Melbourne, on or before the 4th day of August, 1971, after which date the said The Union-Fidelity Trustee Company of Australia Limited will distribute the assets, having regard only to the claims of which it then will have had notice. And notice is hereby further given that the said The Union-Fidelity Trustee Company of Australia Limited will not be liable for the assets so distributed or any part thereof to any person of which claim they have not had notice aforesaid.

ROY L. YELLAND & CO., solicitors, 37 Swanston-street, Melbourne. 583

CREDITORS, next of kin and others having claims against the estate of Harold Arthur Fleming, late of "The Cottage", San Remo, retired civil servant, deceased (who died on the 13th day of February, 1971), are to send particulars of their claims to The Equity Trustees, Executors and Agency Company Limited, of 472 Bourke-street, Melbourne, by the 4th day of August, 1971, after which date it will distribute the assets, having regard only to the claims of which it then has notice.

BIRCH, ROSS, BARLOW & WOINARSKI, solicitors, Wonthaggi. 571

CREDITORS, next of kin and others having claims in respect of the estate of Mary Muriel Drain, formerly of 8 Derrick-street, Kew, late of Flat 1, No. 2 Eyre-street, Balwyn, in the State of Victoria, widow, deceased (who died on the 13th day of December, 1970), are to send particulars of their claims to the executors, Frank Gwydyr Marrie and Timothy Gwydyr Marrie, care of the under-mentioned solicitors, on or before the 21st day of July, 1971, after which date the said executors will distribute the assets, having regard only to the claims of which notice has been received.

A. L. C. FLINT & MARRIE, of 171 William-street, Melbourne, the solicitors for the applicants. 572

CREDITORS, next of kin and others having claims in respect of the estate of Mary Maude Forrester, late of 283 Queen-street, Altona, widow, deceased, intestate (who died on the 25th November, 1970), are required by the administratrix, Margaret Edith Forrester, of 155 Queen-street, Altona, widow, to send particulars of their claims to her, in care of the under-mentioned solicitors, prior to the 11th August, 1971, after which date the said administratrix will distribute the assets of the deceased, having regard only to the claims of which she then shall have had notice.

ROGERS & GAYLARD, solicitors, 51 Queen-street, Melbourne. 579

ULRIC NICHOLAS, late of 8 Wellman-street, Box Hill South, in the State of Victoria, retired carpenter, DECEASED.

CREDITORS, next of kin and all others having claims in respect of the estate of the above-named deceased (who died on the 29th day of January, 1971), are required to send particulars thereof to the executors, care of the under-mentioned solicitor, on or before the 3rd day of

August, 1971, after which date the said executors may convey or distribute the assets, having regard only to the claims of which they then have notice.

K. P. REES, B.A., LL.B., solicitor, 118 Queen-street, Melbourne. 580

DULCIE EILEEN OGIER, late of 9 Sycamore-street, Caulfield, spinster, DECEASED.

CREDITORS, next of kin and others having claims in respect of the estate of the deceased (who died on the 23rd day of September, 1970), are required by the trustee, John Willoughby Kenny, care of Graham Scouler, solicitor, 366 La Trobe-street, Melbourne, to send particulars to him by the 4th day of August, 1971, after which date the trustee may convey or distribute the assets, having regard only to the claims of which he then has notice.

GRAHAM SCOLLER, solicitor, 366 La Trobe-street, Melbourne, solicitor for the trustee. 581

AGNES GILLESPIE CZULAK, late of 61 Grey-street, East Melbourne, medical practitioner, DECEASED.

CREDITORS, next of kin and others having claims in respect of the estate of the deceased (who died on 6th August, 1970), are required by the executors of her will, Ainslie Meares, of 1 Whernside-avenue, Toorak, medical practitioner, Keith Cameron Cargill Rankin, of 472 Bourke-street, Melbourne, solicitor, and The Equity Trustees, Executors and Agency Company Limited, of 472 Bourke-street, Melbourne, to send particulars thereof to them, care of the office of the said The Equity Trustees, Executors and Agency Company Limited, situated at 472 Bourke-street, Melbourne aforesaid, before 20th August, 1971, after which date the said executors may convey or distribute the assets, having regard only to the claims of which they then have notice.

K. CARGILL RANKIN, solicitor, of 472 Bourke-street, Melbourne. 582

ALFRED MELBOURNE HYLAND, late of 68 Gardenvale-road, Gardenvale, in the State of Victoria, retired butcher, DECEASED.

CREDITORS, next of kin and others having claims in respect of the estate of the deceased (who died on the 16th day of February, 1971), are required by his executor, The Equity Trustees, Executors and Agency Company Limited, of 472 Bourke-street, Melbourne, to send particulars to it, by the 3rd day of August, 1971, after which date the said executor may convey or distribute the assets, having regard only to the claims of which it then has notice.

HADEN SMITH & FITCHETT, solicitors, 405 Collins-street, Melbourne. 584

CREDITORS, next of kin and others having claims against the estate of William Patrick Hackett, late of Longwarry, farmer (who died on the 21st day of April, 1970), are requested to send particulars of their claims to Ellen May Hackett, widow, and Anthony William Hackett, engineer, both of Longwarry, the executors appointed by the deceased's will, in care of the undersigned, by the 28th day of July, 1971, after which date they will distribute the assets, having regard only to the claims of which they then shall have had notice.

M. DAVINE & CO., solicitors, Warragul. 519

CREDITORS, next of kin and others having claims against the estate of Eileen Mary Mueller, late of 38 Hopetoun-street, Bendigo, in the State of Victoria, spinster, deceased (who died on the 5th day of February, 1971), are required to send particulars thereof to National Trustees Executors and Agency Company of Australasia Limited, of 46 Queen-street, Bendigo, in the said State, by the 7th day of August, 1971, after which date the said company will distribute the assets of the said deceased, having regard only to the claims of which it then has notice.

WATSON JAMES & ROGERS, solicitors, Bull-street, Bendigo. 522

CREDITORS, next of kin and others having claims in respect of the will of Ian Gordon Parkes, late of 91 Spencer-street, Essendon, airworthiness surveyor (who died on the 12th June, 1970), are requested to send particulars of their claims to the executors, Maberly Parkes, and Joan Carmel Parkes, care of the undermentioned solicitor, by the 11th August, 1971, after which date they will distribute the assets, having regard only as to the claims of which they then have notice.

EDWARD CURMI, solicitor, of 440 Victoria-street, North Melbourne. 530

In the Supreme Court of the State of Victoria.

SALE BY THE SHERIFF.

ON Friday, the 23rd of July, 1971, at 10 a.m., at the Police Station, Pascoe Vale (unless process be stayed or satisfied):—

All the estate and interest (if any) of Rosario Tabone, builder, of 58 Eastgate-street, Pascoe Vale, as joint proprietor with Rosetta Tabone of an estate in fee-simple in the land described in certificate of title, volume 8199, folio 288, upon which is erected a brick dwelling, known as No. 58 Eastgate-street, Pascoe Vale.

Registered mortgages Nos. C.960337 and D.124871 affect the said estate and interest.

Terms: Cash only.

H. BUETTNER, Sheriff's Officer.

27th May, 1971. 573

In the Supreme Court of the State of Victoria.

SALE BY THE SHERIFF.

ON Wednesday, the 21st of July, 1971, at 10 a.m. at the Police Station, Altona (unless process be stayed or satisfied):—

All the estate and interest (if any) of Mircea Lazarescu, fitter, of 35 Marigold-avenue, North Altona, as joint proprietor with Irena Lazarescu of an estate in fee-simple in the land described in certificate of title, volume 8364, folio 990, upon which is erected a brick dwelling, known as No. 35 Marigold-avenue, North Altona.

Registered mortgage No. D.57356 affects the said estate and interest.

Terms: Cash only.

H. BUETTNER, Sheriff's Officer.

27th May, 1971. 574

In the Supreme Court of the State of Victoria.

SALE BY THE SHERIFF.

ON Thursday, the 8th day of July, 1971, at 2 p.m., at the Police Station, Benalla (unless process be stayed or satisfied):—

All the estate and interest (if any) of Keith Alexander McNee, stock transport operator, as joint proprietor with Joyce Thelma McNee, married woman, both of 12 Kent-street, Benalla, of an estate in fee-simple in the land described in Crown grant, volume 2267, folio 306, upon which is erected a weatherboard dwelling-house known as No. 12 Kent-street, Benalla.

Terms: Cash only.

Sergeant K. R. VALE, Sheriff's Officer.

2nd June, 1971. 575

In the Supreme Court of the State of Victoria.

SALE BY THE SHERIFF.

ON Friday, the 23rd of July, 1971, at 10 a.m. at the Police Station, Avondale Heights (unless process be stayed or satisfied):—

All the estate and interest (if any) of Agostino Raschilla, of 13 Skewes-street, Avondale Heights, as proprietor of an estate in fee-simple in the land described in certificate of title, volume 8264, folio 610, upon which is erected a dwelling-house, known as No. 13 Skewes-street, Avondale Heights.

Registered mortgages Nos. C.941351 and C.955851, and which is erected a weatherboard dwelling-house, known as

Terms: Cash only.

DOUGLAS S. HALL, Sheriff's Officer.

2nd June, 1971. 576

INSOLVENCY NOTICES

Bankruptcy Act 1966.

WILSON & THOMAS, No. 87 OF 1970X.

NOTICE OF FIRST AND FINAL DIVIDEND.

A FIRST and Final Dividend is to be distributed in the estate of Wilson & Thomas, on the 25th June, 1971. Creditors having claims against the estate and who have not proved their debt, are requested to lodge their proof of debt with the trustee by Friday, 18th June, 1971.

473

E. P. TAYLOR, Trustee.

Bankruptcy Act 1966, Part X.—Bankruptcy District of the State of Victoria.—No. 46 of 1971, Part X.—Re: JOHN FRANCIS YOUNG.

AT a meeting of creditors of the above-named debtor, held on Tuesday, 25th May, 1971, the following Special Resolution was duly passed:—

“That the debtor execute a deed of assignment as set out in the Fourth Schedule of the Bankruptcy Act 1966, and that Maxwell George Gee be appointed the trustee under the said deed.”

Both the debtor and the trustee executed the deed on the 25th May, 1971.

MAXWELL GEORGE GEE, Registered Trustee.

Max Gee and Co., 325 Warrigal-road, Burwood, 3125. Telephone 288 5109. 535

IMPOUNDINGS

BENALLA.—Impounded in Benalla Pound, by Mr. J. S. Stickland (Ranger), on 28th May, 1971, at 3.45 p.m.

1 crossbred two-tooth wether, red raddle on back, nick out of top right ear

1 crossbred ewe lamb, green raddle on back

If not claimed and expenses paid, to be sold on 17th June, 1971.

C. H. WALLACE,

Poundkeeper.

558—\$3.15

BENALLA.—Impounded in Benalla Pound, by Mr. J. S. Stickland (Ranger), on 28th May, 1971, at 2.30 p.m.

1 Friesian cross steer, one year old, nick out of bottom of left ear, no visible brand

If not claimed and expenses paid, to be sold on 17th June, 1971.

C. H. WALLACE,

Poundkeeper.

557—\$2.80

BENALLA.—Impounded in Benalla Pound, by Mr. R. Hunter (C.R.B. Inspector), on 25th May, 1971, at 8.50 a.m.

1 wether with horns, “V” on back, various ear marks

If not claimed and expenses paid, to be sold on 17th June, 1971.

C. H. WALLACE,

Poundkeeper.

556—\$2.80

HAWKESDALE.—Impounded in Hawkesdale Pound.

1 crossbred ewe, back and front notch off ear, no visible brand

2 crossbred wethers, 2 tooth, back and front notch off ear, no visible brand

If not claimed and expenses paid, to be sold on 17th June, 1971.

C. EDWARDS,

Poundkeeper.

564—\$3.15

HOPETOUN.—Impounded in Hopetoun Pound, from Henty Highway, by H. Hardingham, on 17th and 18th May, 1971.

11 rams, 34 sheep and 12 lambs, no visible brands except 1 ram, blue JH conjoined.

If not claimed and expenses paid, to be sold on 10th June, 1971.

T. C. ROBERTS,

Poundkeeper.

499—\$3.15

INGLEWOOD.—Impounded in Inglewood Pound by A. L. Dehnert.

1 aged Border Leicester ram, no visible brand

If not claimed and expenses paid, to be sold on 17th June, 1971.

L. G. FRY,

Poundkeeper.

591—\$2.45

KEILOR.—Impounded in Keilor Pound.

1 Dorset Horn cross ram, red raddle mark on back

If not claimed and expenses paid to be sold on 17th June, 1971.

C. M. MISSEN,

Poundkeeper.

569—\$2.10

LANCEFIELD.—Impounded in Lancefield Pound on Monday, 31st May, 1971, by J. T. Green from Bolinda-Darraweit road.
1 young Friesian bull, dehorned, nick out of near ear, no visible brand
If not claimed and expenses paid, to be sold on 25th June, 1971.
J. NICHOLLS,
Poundkeeper.
590—\$3.15

OXLEY.—Impounded in Oxley Pound, from Hume Highway, near Wangaratta.
2 wethers, one with horns, no visible brands
If not claimed and expenses paid, to be sold on 14th June, 1971.
M. PERKINS,
Poundkeeper.
527—\$2.45

OXLEY.—Impounded in Oxley Pound, from Ovens Highway, near Tarrawingee.
1 wether with horns, nick out of right ear, no visible brand
If not claimed and expenses paid, to be sold on 14th June, 1971.
M. PERKINS,
Poundkeeper.
528—\$2.45

PAKENHAM.—Impounded in Pakenham Pound, from Main Drain-road, Iona.
1 silver Jersey cow, dehorned, no visible brand
If not claimed and expenses paid, to be sold on 16th June, 1971.
H. SMITH,
Poundkeeper.
592—\$2.45

WINSLOW.—Impounded in Winslow Pound.
1 yellow Jersey cow, no visible brand
If not claimed and expenses paid, to be sold on 9th June, 1971.
D. MATHESON,
Poundkeeper.
559—\$2.10

Subordinate Legislation Act 1962.

NOTICE OF MAKING OF STATUTORY RULES.

IN pursuance of the provisions of the *Subordinate Legislation Act 1962* and the Regulations made thereunder, notice is given of the making of the following statutory rules:—

No.	Game Act 1958.	Price.
98/1971.	Sanctuary for Native Game at Mansfield	10c
	<i>Game Act 1958.</i>	
99/1971.	Revocation of Proclamation Respecting Sanctuary for Native Game at Mansfield	10c
	<i>Supreme Court Act 1958.</i>	
100/1971.	Supreme Court (Issue of Writs) Rules 1971	10c
	<i>Supreme Court Act 1958.—Companies Act 1961.</i>	
101/1971.	Supreme Court (Companies) Rules 1971	10c
	<i>Securities Industry Act 1970.</i>	
102/1971.	Securities Industry (Amendment) Regulations 1971	30c
	<i>Supreme Court Act 1958.</i>	
103/1971.	Supreme Court (Service of Writs) Rules 1971	10c
	<i>Local Government Act 1958.</i>	
104/1971.	Uniform Building (Amendment) Regulations 1971 No. 2	10c
	<i>Second-hand Dealers Act 1958.</i>	
105/1971.	Second-hand Dealers (Exemption No. 5) Regulations 1971	10c
	<i>Mildura Irrigation and Water Trusts Act 1958.</i>	
106/1971.	First Mildura Irrigation Trust (Commissioners' Fees and Travelling Expenses) (Amendment) Regulations 1971	10c
	<i>Education Act 1958.</i>	
107/1971.	Education Department (Amendment) Regulations 1971	15c

No.	Marine Act 1958.	Price.
108/1971.	Amendment to Port Rule Applicable to Westernport Harbor Services (Rates and Charges)	10c

Copies of these statutory rules may be purchased at the Sale of Publications Section of the Government Printing Office, located at Macarthur-street, Melbourne, 3002. If ordered by mail, remittance should be addressed to "The Government Printer, Box 203, P.O., North Melbourne, 3051", and should include 6c extra for postage. If a credit account is held at this office, no remittance is required with the mail order.

The annual subscription rate for Statutory Rules (including Bound Volumes) is \$23, payable in advance. The subscription year commences on 1st January.

C. H. RIXON,
Government Printer.

STATE ACTS, 1970

COPIES of the following Acts of Parliament of Victoria may be obtained at the Government Printing Office, Sale of Publications Branch, off Parliament-place, Melbourne, phone 63 0321, extension 6181, or from any accredited agent, at the price set opposite to each (these prices do not include postage).

The annual subscription for State Acts 1969 et seq. is \$8 payable in advance.

Bound Volumes of State Acts are also available on a subscription basis of \$15 per annum.

No.		Price.
7933.	Evidence (Boards and Commissions)	\$0.10
7934.	The Constitution Act Amendment	\$0.10
7935.	Coroners (Amendment)	\$0.10
7936.	Town and Country Planning (Appeals Tribunal)	\$0.10
7937.	Melbourne (Veterinary Schools) Lands	\$0.10
7938.	Board of Inquiry (Corrupt Practices)	\$0.10
7939.	Cabrini Private Hospital (Guarantees)	\$0.10
7940.	Judges' Salaries and Allowances	\$0.10
7941.	Instruments (Amendment)	\$0.10
7942.	La Trobe University (Amendment)	\$0.10
7943.	Business Names (Amendment)	\$0.10
7944.	Acts Interpretation (Nationality)	\$0.10
7945.	Dairy Products (Board Membership)	\$0.10
7946.	Melbourne Harbor Trust (Amendment)	\$0.10
7947.	Aboriginal Affairs (Amendment)	\$0.10
7948.	River Murray Waters	\$0.15
7949.	River Murray Waters (Dartmouth Reservoir)	\$0.10
7950.	Western Port (Steel Works)	\$0.25
7951.	Extractive Industries (Licences)	\$0.10
7952.	Stamps (Salary or Wages)	\$0.10
7953.	Melbourne Lands Exchange	\$0.10
7954.	Public Officers Salaries and Allowances	\$0.15
7955.	Ballarat (Sovereign Hill) Land	\$0.15
7956.	Wombat Bonuses	\$0.10
7957.	Richmond and Hawthorn Lands	\$0.15
7958.	Solicitor-General (Pensions)	\$0.10
7959.	Australia and New Zealand Banking Group	\$0.25
7960.	Mildura Irrigation and Water Trusts (Amendment)	\$0.10
7961.	Land Settlement (Financial)	\$0.10
7962.	Securities Industry	\$0.35
7963.	Mildura College Lands (Amendment)	\$0.10
7964.	Door to Door (Sales) (Amendment)	\$0.15
7965.	Consumer Protection	\$0.10
7966.	Justices (Alternative Procedure)	\$0.15
7967.	Summary Offences	\$0.10
7968.	Local Government (Amendment)	\$0.30
7969.	Motor Car (Falsification of Mileage)	\$0.10
7970.	Marketable Securities	\$0.25
7971.	Carriers and Innkeepers (Amendment)	\$0.10
7972.	Cemeteries (Coburg Public Cemetery)	\$0.10
7973.	Judges Pensions	\$0.10
7974.	Victoria Institute of Colleges (Affiliated Colleges)	\$0.10
7975.	Town and Country Planning (Responsible Authority)	\$0.10
7976.	Wheat Marketing (Special Quotas)	\$0.10
7977.	Joint Select Committee (Meat Industry)	\$0.10
7978.	Joint Select Committee (Road Safety)	\$0.10
7979.	Consolidated Revenue (Supply—July to September 1969-70)	\$0.10
7980.	Consolidated Revenue (Supplementary Estimates 1969-70)	\$0.10
7981.	Consolidated Revenue (Supply October to December, 1970)	\$0.10
7982.	Home Finance (Amendment)	\$0.10
7983.	Co-operative Housing Societies (Amendment)	\$0.10
7984.	Soldier Settlement	\$0.10

STATE ACTS 1970—continued.	
No.	Price.
7985. Judges' Pensions (Amendment) ..	\$0.10
7986. Civil Aviation (Carriers' Liability) ..	\$0.10
7987. Road Traffic (Amendment) ..	\$0.15
7988. West Melbourne Market Land (Amendment)	\$0.15
7989. West Gate Bridge Royal Commission ..	\$0.10
7990. Motor Car (Amendment) ..	\$0.10
7991. Discharged Servicemen's Preference (Amendment)	\$0.10
7992. Labour and Industry (Shop Closing) ..	\$0.10
7993. Country Fire Authority (Borrowing Powers)	\$0.10
7994. Crimes (Amendment) ..	\$0.10
7995. Lotteries Gaming and Betting (Amendment)	\$0.10
7996. River Improvement (Amendment) ..	\$0.10
7997. Hospitals Superannuation (Amendment) ..	\$0.15
7998. Trustee Companies (Perpetual Trustees Australia Limited)	\$0.10
7999. Gas and Fuel Corporation (Borrowing) ..	\$0.10
8000. Victorian Inland Meat Authority (Amendment)	\$0.10
8001. Auditor (Auditor-General) ..	\$0.10
8002. Public Service (Amendment) ..	\$0.10
8003. Evidence (Scientific Tests) ..	\$0.10
8004. Boilers and Pressure Vessels ..	\$0.30
8005. Coal Mines (Pensions Increase) ..	\$0.10
8006. Stamps Act ..	\$0.15
8007. Methodist Church (Victoria) Property Trust	\$0.20
8008. Land Conservation ..	\$0.20
8009. River Entrance Docks Railway Construction	\$0.10
8010. Legal Profession Practice (Amendment) ..	\$0.15
8011. Juries Compensation Act 1970 ..	\$0.10
8012. Public Account Act 1970 ..	\$0.15
8013. Sewerage Districts (Amendment) Act 1970	\$0.10
8014. Revocation and Excision of Crown Reservations Act 1970	\$0.15
8015. State Forests Works and Services Act 1970	\$0.10
8016. Money Lenders (Prescribed Interest) Act 1970	\$0.10
8017. Gas and Fuel Corporation (The Gas Supply Company Limited) Act 1970	\$0.30
8018. Labour and Industry (Amendment) Act 1970	\$0.10
8019. Metropolitan Fire Brigades (Amendment) Act 1970	\$0.15
8020. Stamps (Receipt Duty Abolition) Act 1970	\$0.10
8021. Apprenticeship (Amendment) Act 1970 ..	\$0.10
8022. Water (Amendment) Act 1970 ..	\$0.10
8023. Melbourne Underground Rail Loop Act 1970	\$0.40
8024. Westernport Development Act 1970 ..	\$0.15
8025. Vermin and Noxious Weeds (Amendment) Act 1970	\$0.20
8026. Commonwealth Places (Administration of Laws) Act 1970	\$0.15
8027. Hairdressers Registration (Amendment) Act 1970	\$0.10
8028. Lifts and Cranes (Amendment) Act 1970 ..	\$0.15
8029. Wodonga Lands Exchange Act 1970 ..	\$0.10
8030. Second-hand Dealers (Charity Collectors) Act 1970	\$0.15
8031. Water Supply Works and Services Act 1970	\$0.25
8032. East Melbourne Land Act 1970 ..	\$0.10
8033. The Constitution Act Amendment (Responsible Ministers) Act 1970	\$0.10
8034. Justices (Bail and Appeals) Act 1970 ..	\$0.10
8035. Forests (Amendment) Act 1970 ..	\$0.10
8036. Maintenance (Amendment) Act 1970 ..	\$0.10
8037. Hire Purchase (Insurance) Act 1970 ..	\$0.10
8038. Marketable Securities (Amendment) Act 1970	\$0.15
8039. Mines (Compensation) Act 1970 ..	\$0.10
8040. Railways Land Act 1970 ..	\$0.15
8041. Probate Duty Act 1970 ..	\$0.10
8042. Teaching Service (Tribunal) Act 1970 ..	\$0.10
8043. Employers and Employés (Attachment of Wages) Act 1970	\$0.10
8044. Aboriginal Lands Act 1970 ..	\$0.25
8045. Railway Works and Services Act 1970 ..	\$0.10
8046. Water (Further Amendment) Act 1970 ..	\$0.15
8047. Superannuation (Amendment) Act 1970 ..	\$0.20
8048. Motor Car (Fees) Act 1970 ..	\$0.10
8049. Public Works and Services Act 1970 ..	\$0.15
8050. Western Port Steel Works (Development Control) ..	\$0.10
8051. Housing (Amendment) ..	\$0.20
8052. Urban Renewal ..	\$0.40
8053. Wheat Marketing (Amendment) ..	\$0.10
8054. Local Authorities Superannuation (Disability Benefits) ..	\$0.20
8055. Land Tax ..	\$0.15
8056. Environment Protection ..	\$0.50
8057. Gas Franchises ..	\$0.15
8058. Road Traffic (Road Safety and Traffic Authority) ..	\$0.15
8059. Securities Industry (Amendment) ..	\$0.30
8060. Land (Amendment) ..	\$0.10

STATE ACTS 1970—continued.	
No.	Price.
8061. Medical Practitioners ..	\$0.40
8062. Teacher Housing ..	\$0.20
8063. Criminal Appeals ..	\$0.10
8064. Groundwater (Amendment) ..	\$0.10
8065. Summary Offences (Trespass to Farms) ..	\$0.10
8066. Registration of Births Deaths and Marriages (Amendment) ..	\$0.10
8067. Tomato Processing Industry (Amendment) ..	\$0.15
8068. Weights and Measures (Amendment) ..	\$0.10
8069. Aerial Spraying Control (Amendment) ..	\$0.10
8070. Science Museum of Victoria ..	\$0.20
8071. Melbourne and Metropolitan Board of Works	\$0.15
8072. National Museum of Victoria Council ..	\$0.20
8073. Footwear Regulation ..	\$0.15
8074. Motor Car (Safety) ..	\$0.10
8075. Summary Offences ..	\$0.10
8076. Fertilizers and Stock Foods (Labelling) ..	\$0.10
8077. Architects (Amendment) ..	\$0.10
8078. Stock Diseases (Amendment) ..	\$0.10
8079. Dog Act ..	\$0.20
8080. Racing (Amendment) ..	\$0.15
8081. State Development ..	\$0.30
8082. Statutory Salaries ..	\$0.10
8083. National Parks ..	\$0.20
8084. Workers Compensation ..	\$0.15
8085. Summary Offences (Trespassers) ..	\$0.10
8086. Parliamentary Salaries ..	\$0.10
8087. Consolidated Revenue (Final Supplementary Estimates) ..	\$0.10
8088. Appropriation ..	\$2.10
8089. Social Welfare ..	\$1.10

C. H. RIXON,
Government Printer.

AGENTS FOR THE "VICTORIA GOVERNMENT
GAZETTE".

THE following have been appointed agents to receive Advertisements and Subscriptions for the *Victoria Government Gazette*:—

ARMSTRONG'S AGENCY, 217 Queen-street, Melbourne, Victoria 3000.

ARNALL & JACKSON, 390 Barkly-street, Brunswick, Victoria 3056.

BAIRNSDALE AUTHORIZED NEWSAGENCY, 132 Main-street, Bairnsdale, Victoria 3875.

BICKNELL, M. J., Authorized Newsagent, 196 Timor-street, Warrambool, Victoria 3280.

BLANE'S AUTHORIZED NEWSAGENTS, 162 Murray-street, Colac, Victoria 3250.

CARTER, R. G., ADVERTISING SERVICE PTY. LTD., Suite 24, 65 Queens-road, Melbourne, Victoria 3004.

DAVIES, G. & M. V., 112 Gray-street, Hamilton, Victoria 3300.

DAVIS, WM. (MILDURA) PTY. LTD., 126 Eighth-street, Mildura, Victoria 3500.

DIXON'S NEWSAGENCY, 89 Firebrace-street, Horsham, Victoria 3400.

EDGARS' AUTHORIZED NEWSAGENCY, 45 Bridge-street, Benalla, Victoria 3672.

FRANKS, H., & CO., 184 Ryrie-street, Geelong, Victoria 3220.

GATLEY, A. & J., 250 Lonsdale-street, Dandenong, Victoria 3175.

GORDON & GOTCH AUSTRALASIA LTD., 467 Collins-street, Melbourne, Victoria 3000.

GULLAN'S NEWSAGENCY, 88 Bridge-street, Ballarat, Victoria 3350.

HAMPTON, A. C., 243 Mitchell-street, Bendigo, Victoria 3550.

HARSTON, PARTRIDGE & CO. PTY. LTD., 455 Little Collins-street, Melbourne, Victoria 3000.

KYNETON GUARDIAN PTY. LTD., P.O. Box 18, Kyneton, Victoria 3444.

LATIMER'S, Newsagents, 45 Station-street, Malvern, Victoria 3144.

LIVINGSTON'S SHEPPARTON NEWSAGENCY, 246 Wyndham-street, Shepparton, Victoria 3630.

THE MERCANTILE EXCHANGE, 34 Queen-street, Melbourne, Victoria 3000.

McGILL'S AUTHORIZED NEWSAGENCY, 183-5 Elizabeth-street, Melbourne, Victoria 3000.

POWNEYS AUTHORIZED NEWSAGENCY, 293 Hargreaves-street, Bendigo, Victoria 3550.

PURDIE, J., & CO., 138 Moorabool-street, Geelong, Victoria 3220.

SALE AUTHORIZED NEWSAGENCY, 142 Raymond-street, Sale, Victoria 3850.

SKINNER'S AUTHORIZED NEWSAGENCY, 49-51 Franklin-street, Traralgon, Victoria 3844.

STEVENS, A. C. & M., NEWSAGENTS, 132 Henty-street, Casterton, Victoria 3311.
 VANCE'S AUTHORIZED NEWSAGENCY, 83 Murray-street, Wangaratta, 3677.
 VERNONS OF RICHMOND, 162 Bridge-road, Richmond, Victoria 3121.
 VIEW POINT AUTHORIZED NEWSAGENCY, 4 View-Point, Bendigo, Victoria 3550.

A copy of the Gazette filed at each place for public reference.

C. H. RIXON,
 Government Printer.

PUBLICATION OF OFFICIAL MATTER.

ATTENTION is invited to the following procedure in relation to the publication of official matter in the *Government Gazette*—

Publication will be facilitated by the submission of carbon copies for the use of the *Gazette* Officer.

1. *Matter submitted to the Executive Council.*

Matter submitted to the Executive Council which requires gazettal will normally be published in the issue of the following week.

Where urgent gazettal is required, special arrangements should be made with the *Gazette* Officer, Room 9, first floor, Old Treasury Building.

2. *Other matter.*

(a) All other matter duly certified by a responsible officer for publication should be lodged with the *Gazette* Officer not later than half-past Nine a.m. on Tuesday.

(b) Lengthy or involved notices should be forwarded several days before publication.

(c) Proofs, which will be supplied only when specifically requested or at the direction of the *Gazette* Officer, should be returned promptly to avoid delay in publication.

(d) No additions or amendments to matter for publication will be accepted by telephone.

THE "VICTORIA GOVERNMENT GAZETTE".

SUBSCRIPTIONS.—The subscription, including postage, is \$22.50 per annum, or \$11.25 per half year, payable in advance.

Subscriptions are required for whole months, and must cover at least a half year.

Single copies are 30 cents, posted 48 cents. Subscribers do not receive the Acts of Parliament with the GAZETTE.

GAZETTES are held in stock for five years only.

PRIVATE ADVERTISEMENTS.—The charge for insertion is 35 cents per line single column, and 70 cents per line double column. The title forms one or more lines as a heading. On an average ten words make a line of single column. Every signature must likewise be counted as a line. The final words of a paragraph, though only portion of a line, must be counted as one line. Signatures (in particular) and proper names must be written very plainly in the text; ONE SIDE ONLY of each sheet of paper should be WRITTEN UPON. The charge for a full page is \$50.

All documents illegibly written will be returned unpublished, and where brands occur unprovided for by the ordinary letters of the alphabet, a worded explanatory description must be furnished.

THE VICTORIA GOVERNMENT GAZETTE is published on WEDNESDAY EVENING in each week, and Notices for insertion will be received by the Government Printer at or before ONE p.m. at ordinary rates, and late advertisements between ONE p.m. and FOUR p.m. at double rates on the day preceding the day of publication.

PAYMENTS.—Unless the advertiser has a credit account, all payments are required in advance. Remittances should be made by cheque, postal order, or money order payable to "GOVERNMENT PRINTER".

ADDRESS.—All communications should be addressed to "The Government Printer, Box 203, P.O., North Melbourne", 3051.

CONTENTS

	PAGE
Acts of Parliament on Sale at the Government Printing Office	1900
Appointments	1868
Bank Half-Holiday	1843
Contracts	1868
Country Roads Board	1850
Estates of Deceased Persons	1849
Government Notices	1843
Honours	1847
Impoundings	1899
Insolvency Notices	1899
Lands	1881
Levee at Parliament House, Melbourne	1839
Melbourne and Metropolitan Board of Works— Notice	1865
Mining	1867
Notice to Mariners	1843
Notice of Making of Statutory Rules	1900
Orders in Council— Acts—Audit; Land; Country Roads; Local Government; Public Authorities Marks; Water; Sewerage Districts; Geelong Waterworks and Sewerage; Dandenong Valley Authority; West Moorabool Water Board; Housing; Wheat Marketing.	1869 et seq
Private Advertisements	1885
Proclamations	1840
Public Half-Holiday	1842
Public Holiday—Queen's Birthday	1843
Public Service Notice	1885
Regulations— Acts—Teaching Service	1884
Resignations	1869
Tenders	1883
Transport Regulation Board—Public Hearings	1844
Waterworks Trust	1866