

[2193]



# VICTORIA GOVERNMENT GAZETTE

Published by Authority

No. 51]

WEDNESDAY, JUNE 21

[1972

## PROCLAMATIONS

### PUBLIC HIGHWAY.—SHIRE OF BERWICK.

#### PROCLAMATION

By His Excellency the Governor of the State of Victoria and its Dependencies in the Commonwealth of Australia, &c., &c., &c.

Whereas by the *Local Government Act 1958*, Section 519 it is amongst other things enacted that it shall be lawful for the Governor in Council at any time and from time to time upon the request of the Council of any municipality by notice in the *Government Gazette* to proclaim any land reserved used or by purchase or exchange acquired for a street road highway thoroughfare bridge square court alley or right-of-way or any street road lane or passage made or laid out or proposed to be made or laid out on any land of which a plan of subdivision delineating that street road lane or passage has been sealed with the seal of the municipality under subdivision (3) of Division 9 of Part XIX of the *Local Government Act 1958*, as amended, or a corresponding previous enactment to be a public highway and that such land shall thereupon and thenceforth from the date of such proclamation become and be absolutely dedicated to the public as a public highway within the meaning of any law then or thereafter in force.

And whereas the Council of the Shire of Berwick has requested that the land hereinafter mentioned, being a street road lane or passage made or laid out or proposed to be made or laid out on land of which a plan of subdivision delineating that street road lane or passage has been sealed with the seal of the municipality under subdivision (3) of Division 9 of Part XIX of the *Local Government Act 1958*, or a corresponding previous enactment, be so declared to be a public highway.

Now therefore, I, the Governor of the State of Victoria in the Commonwealth of Australia by and with the advice of the Executive Council of the said State, do by this Proclamation declare that Gardenia-street, coloured brown on Plan of Subdivision No. 62861 lodged in the Office of Titles shall be a public highway within the meaning of the said Act.

Given under my Hand and the Seal of the State of Victoria aforesaid, at Melbourne, this fourteenth day of June, in the year of our Lord One

thousand nine hundred and seventy-two, and in the twenty-first year of the reign of Her Majesty Queen Elizabeth II.

(L.S.) ROHAN DELACOMBE.

By His Excellency's Command,

A. J. HUNT,  
Minister for Local Government.

GOD SAVE THE QUEEN!

### PUBLIC HIGHWAY.—CITY OF CROYDON.

#### PROCLAMATION

By His Excellency the Governor of the State of Victoria and its Dependencies in the Commonwealth of Australia, &c., &c., &c.

Whereas by the *Local Government Act 1958*, Section 519 it is amongst other things enacted that it shall be lawful for the Governor in Council at any time and from time to time upon the request of the Council of any municipality by notice in the *Government Gazette* to proclaim any land reserved used or by purchase or exchange acquired for a street, road, highway, thoroughfare, bridge, square, court, alley or right-of-way or any street, road, lane or passage made or laid out or proposed to be made or laid out on any land of which a plan of subdivision delineating the street, road, lane or passage has been sealed with the seal of the municipality under Subdivision (3) of Division 9 of Part XIX of the *Local Government Act 1958*, or a corresponding previous enactment to be a public highway and that such land shall thereupon and thenceforth from the date of such proclamation become and be absolutely dedicated to the public as a public highway within the meaning of any law then or thereafter in force.

And whereas the Council of the City of Croydon has requested that the land hereinafter mentioned, being a street, road, lane or passage made or laid out or proposed to be made or laid out on land of which a plan of subdivision delineating the street, road, lane or passage has been sealed with the seal of the municipality under subdivision (3) of Division 9 of Part XIX of the *Local Government Act 1958*, or a corresponding previous enactment, be so declared to be a public highway.

Now therefore, I, the Governor of the State of Victoria, in the Commonwealth of Australia, by and with the advice of the Executive Council of the said State, do by this Proclamation declare that Pointside-avenue coloured brown and yellow on Plan of Subdivision No. 54541 lodged in the Office of Titles shall be a public highway within the meaning of the said Act.

Given under my Hand and the Seal of the State of Victoria aforesaid, at Melbourne, this fourteenth day of June, in the year of our Lord One thousand nine hundred and seventy-two, and in the twenty-first year of the reign of Her Majesty Queen Elizabeth II.

(L.S.) ROHAN DELACOMBE.

By His Excellency's Command,

A. J. HUNT,  
Minister for Local Government.

GOD SAVE THE QUEEN !

And whereas the Council of the Shire of Eltham has requested that the land hereinafter mentioned being land used for a street or road or being a street, road, lane, or passage made or laid out or proposed to be made or laid out on land of which a plan of subdivision delineating the street, road, lane or passage has been sealed with the seal of the municipality under subdivision (3) of Division 9 of Part XIX of the *Local Government Act 1958*, or a corresponding previous enactment, be so declared to be a public highway.

Now therefore, I, the Governor of the State of Victoria, in the Commonwealth of Australia, by and with the advice of the Executive Council of the said State, do by this Proclamation declare that the roads coloured brown on Plans of Subdivision No. 5096, 10400 and 18240 and the reserve shown at the south end of Beard-street on Plan of Subdivision No. 5096 together with the lands shown hatched on the plan hereunder shall be public highways within the meaning of the said Act.

ADOPTION OF CHILDREN (AMENDMENT) ACT 1972,  
No. 8245.

DATE OF COMING INTO OPERATION.

PROCLAMATION

By His Excellency the Governor of the State of Victoria and its Dependencies in the Commonwealth of Australia, &c., &c., &c.

Whereas by an Act of Parliament of the State of Victoria passed in the twenty-first year of the reign of Her Majesty Queen Elizabeth II. intitled *Adoption of Children (Amendment) Act 1972 No. 8245*, it is amongst other things enacted that the said Act shall come into operation on a day to be fixed by Proclamation of the Governor in Council published in the *Government Gazette*:

Now therefore I, the Governor of the State of Victoria, acting by and with the advice of the Executive Council thereof, do by this my proclamation fix Saturday the 1st day of July One thousand nine hundred and seventy-two as the day upon which the *Adoption of Children (Amendment) Act 1972 No. 8245* shall come into operation.

Given under my Hand and the Seal of the State of Victoria aforesaid, at Melbourne, this fourteenth day of June, in the year of our Lord One thousand nine hundred and seventy-two, and in the twenty-first year of the reign of Her Majesty Queen Elizabeth II.

(L.S.) ROHAN DELACOMBE.

By His Excellency's Command,

E. R. MEAGHER,  
Acting Attorney-General.

GOD SAVE THE QUEEN !

PUBLIC HIGHWAYS.—SHIRE OF ELTHAM.

PROCLAMATION

By His Excellency the Governor of the State of Victoria and its Dependencies in the Commonwealth of Australia, &c., &c., &c.

Whereas by the *Local Government Act 1958*, Section 519 it is amongst other things enacted that it shall be lawful for the Governor in Council at any time and from time to time upon the request of the Council of any municipality by notice in the *Government Gazette* to proclaim any land reserved used or by purchase or exchange acquired for a street, road, highway, thoroughfare, bridge, square, court, alley or right-of-way or any street, road, lane or passage made or laid out or proposed to be made or laid out on any land of which a plan of subdivision delineating that street, road, lane or passage has been sealed with the seal of the municipality under subdivision (3) of Division 9 of Part XIX of the *Local Government Act 1958*, or a corresponding previous enactment to be a public highway and that such land shall thereupon and thenceforth from the date of such proclamation become and be absolutely dedicated to the public as a public highway within the meaning of any law then or thereafter in force.

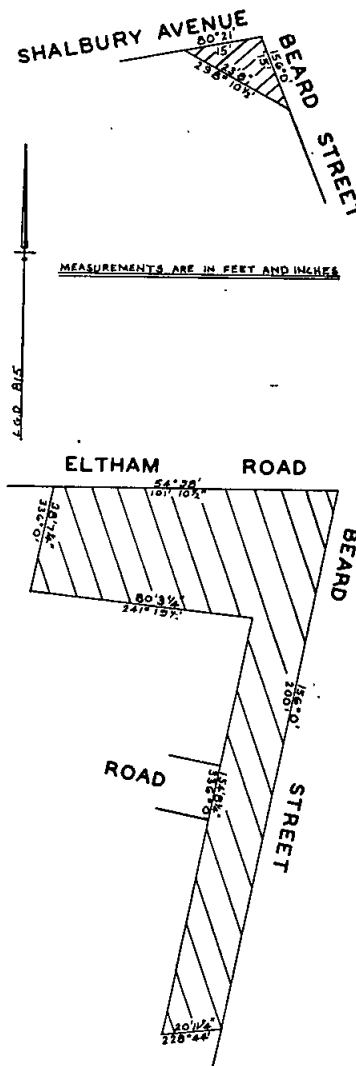

Given under my Hand and the Seal of the State of Victoria aforesaid, at Melbourne, this fourteenth day of June, in the year of our Lord One thousand nine hundred and seventy-two, and in the twenty-first year of the reign of Her Majesty Queen Elizabeth II.

(L.S.) ROHAN DELACOMBE.

By His Excellency's Command,

A. J. HUNT,  
Minister for Local Government.

GOD SAVE THE QUEEN !

**PUBLIC HIGHWAY.—SHIRE OF SOUTH GIPPSLAND.**

**PROCLAMATION**

By His Excellency the Governor of the State of Victoria and its Dependencies in the Commonwealth of Australia, &c., &c., &c.

Whereas by the *Local Government Act 1958*, Section 519 it is amongst other things enacted that it shall be lawful for the Governor in Council at any time and from time to time upon the request of the Council of any municipality by notice in the *Government Gazette* to proclaim any land reserved used or by purchase or exchange acquired for a street, road, highway, thoroughfare, bridge, square, courts, alley, or right-of-way or any street, road, lane or passage made or laid out or proposed to be made or laid out on any land of which a plan of subdivision delineating that street, road, lane or passage has been sealed with the seal of the municipality under subdivision (3) of Division 9 of Part XIX of the *Local Government Act 1958*, or a corresponding previous enactment to be a public highway and that such land shall thereupon and thenceforth from the date of such proclamation become and be absolutely dedicated to the public as a public highway within the meaning of any law then or thereafter in force.

And whereas the Council of the Shire of South Gippsland has requested that the land hereinafter mentioned, being a street, road, lane or passage made or laid out or proposed to be made or laid out on land of which a plan of subdivision delineating the street, road, lane or passage has been sealed with the seal of the Municipality under subdivision (3) of Division 9 of Part XIX of the *Local Government Act 1958*, or a corresponding previous enactment, be so declared to be a public highway.

Now therefore, I, the Governor of the State of Victoria, in the Commonwealth of Australia, by and with the advice of the Executive Council of the said State, do by this Proclamation declare that Gale-street, Waratah Bay shown hatched on the plan hereunder shall be a public highway within the meaning of the said Act.

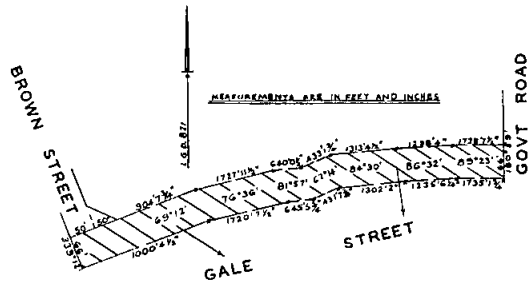

Given under my Hand and the Seal of the State of Victoria aforesaid, at Melbourne, this fourteenth day of June, in the year of our Lord One thousand nine hundred and seventy-two, and in the twenty-first year of the reign of Her Majesty Queen Elizabeth II.

(L.S.) **ROHAN DELACOMBE.**

By His Excellency's Command,

**A. J. HUNT,**  
Minister for Local Government.

GOD SAVE THE QUEEN!

**GOVERNMENT NOTICES**

**Co-operation Act 1958.**

**NOTICE OF DISSOLUTION OF SOCIETY.**

**CASTERTON CO-OPERATIVE SOCIETY LIMITED (IN VOLUNTARY LIQUIDATION).**

Notice is hereby given that I have this day registered the dissolution of the above-named society and cancelled its registration under the above-named Act.

Dated at Melbourne, this 7th day of June, 1972.

**R. F. SCOLLARD,**  
Deputy Registrar of Co-operative Societies.

**Cemeteries Act 1958.**

**SCALE OF FEES OF FOOTSCRAY GENERAL CEMETERY.**

In pursuance of the powers conferred upon them by the Cemeteries Act the trustees of the Footscray General Cemetery hereby make the following scale of fees, which shall come into operation upon publication in the *Government Gazette*, and from and after such publication every scale of fees heretofore made by the said trustees shall be and is hereby rescinded to the extent to which it conflicts with this scale.

Lawn grave land, 8 ft. x 4 ft. . . . .	\$60.00
Beam lawn grave land, 8 ft. x 4 ft. . . . .	\$70.00
All other land, 8 ft. x 4 ft. . . . .	\$50.00
Stone plaques supplied and fitted by masons in lawn—5 per cent. of cost with minimum of \$5.	

**J. W. BACON, J.P.,** Trustee.  
**G. J. BENTLEY,** Trustee.  
**O. G. JONES,** Trustee.

Approved by the Governor in Council, 14th June, 1972.—  
**J. ROSSITER,** Clerk of the Executive Council.

**Cemeteries Act 1958.**

**SCALE OF FEES OF PLEASANT CREEK PUBLIC CEMETERY.**

In pursuance of the powers conferred upon them by the Cemeteries Act the trustees of the Pleasant Creek Public Cemetery hereby make the following scale of fees, which shall come into operation upon publication in the *Government Gazette*, and from and after such publication every scale of fees heretofore made by the said trustees shall be and is hereby rescinded to the extent to which it conflicts with this scale.

**Interment of Ashes in Lawn Section.**

First interment including Rose Tree . . . . .	\$35.00
First interment including Flowering Gum Tree . . . . .	\$35.00
Each interment thereafter . . . . .	\$10.00

**L. R. ERWIN,** Trustee.  
**K. ROBSON,** Trustee.  
**A. HOWELLS,** Trustee.

Approved by the Governor in Council, 14th June, 1972.—  
**J. ROSSITER,** Clerk of the Executive Council.

**Cemeteries Act 1958.**

**SCALE OF FEES OF GISBORNE PUBLIC CEMETERY.**

In pursuance of the powers conferred upon them by the Cemeteries Act the trustees of the Gisborne Public Cemetery hereby make the following scale of fees, which shall come into operation upon publication in the *Government Gazette*, and from and after such publication every scale of fees heretofore made by the said trustees shall be and is hereby rescinded to the extent to which it conflicts with this scale.

**Lawn Cemetery (Undenominational).**

Lawn Grave 8 feet x 4 feet . . . . .	\$70.00
Own selection of land (extra) . . . . .	\$6.00
For each interment therein . . . . .	\$35.00
Bronze plaque for each interment 15 in. x 11 in. . . . .	\$25.00
Bronze plaque for each interment 22 in. x 12 in. . . . .	\$50.00
Flower container supplied by Trust . . . . .	\$10.00
Ashes buried in lawn area . . . . .	\$12.00

**A. McKIMM,** Trustee.  
**C. WOOD,** Trustee.  
**J. P. MONAGHAN,** Trustee.

Approved by the Governor in Council, 14th June, 1972.—  
**J. ROSSITER,** Clerk of the Executive Council.

**GRAIN ELEVATORS BOARD, VICTORIA.**

**SHIPPING OF WHEAT EX PORTLAND HARBOR TRUST TERMINAL.**

By virtue of the provisions of section 3A (1) of the *Portland Harbor Trust Act 1958*, the Grain Elevators Board of Victoria hereby declares that for the period between the 1st July, 1972, and the 31st December, 1972, or until a later date which may be determined by the Board and, subject to the terms, conditions, restrictions and exceptions specified hereunder, the *Portland Harbor Trust Act* shall operate and have effect in relation to wheat as if any reference to grain included a reference to wheat.

The terms, conditions, restrictions and exceptions herebefore referred to are:—

The wheat for shipment shall be F.A.Q. weevil free and having a moisture content of not more than 12 per cent. unless wheat of any other quality is specified in writing by the Board.

**K. H. TURNBULL,**  
Chairman.

Commercial Goods Vehicles Act.  
TRANSPORT REGULATION BOARD.

HEARING OF APPLICATIONS.

Notice is hereby given that the following applications will be considered by the Transport Regulation Board at its offices at the corner Lygon and Princes streets, Carlton, at 10 a.m., on Wednesday, 12th July, 1972.

**A.N.Z. BANKING GROUP LIMITED**, Data Processing Department, 177 Toorak-road, South Yarra, 3141. Two commercial goods vehicles (L/C. 10 cwt. each) to operate throughout the State of Victoria in the course of business as "Bankers" for the purpose of servicing and maintaining office equipment at branch premises throughout the State of Victoria—tools of trade, used accounting machines, typewriters, office equipment for own use, stationery and materials incidental to servicing and maintenance.

**ARMoured ESCORTS PTY. LTD.**, corner Arden and Lothian streets, North Melbourne, 3051. One commercial goods vehicle (L/C. 20 cwt.) to operate throughout the State of Victoria as an armoured vehicle for the purposes of making special deliveries in the course of business as "Armoured Escorts".

**BALLANTYNE, K. L., PTY. LTD.**, 295 Grant-street, South Melbourne, 3205. One commercial goods vehicle (L/C. 70 cwt.) to operate within a 50-mile radius of own premises at Bendigo and to Cohuna, Kerang, Wycheproof, Donald and St. Arnaud and places en route in a specially constructed refrigerated vehicle in course of business as "Dairy Produce Manufacturers and Distributors"—own dairy produce goods.

**BEETON, A. D. & D. L.**, 292 Lawrence-road, Mt. Waverley, 3149. One commercial goods vehicle (L/C. 195 cwt.) to operate within a 50-mile radius of the premises of Ready Mixed Concrete (Vic.) Pty. Ltd., situated at Nunawading, solely on behalf of the said company—premixed concrete in a specially constructed agitator vehicle.

**BRYDEN, J. T.** (trading as Bryden Bros. Tyre Service), 95 Percy-street, Portland, 3305. One commercial goods vehicle (L/C. 14 cwt.) to operate: (a) Within a 50-mile radius of own premises at Portland in the course of business as "Tyre Retreaders and Distributors"—new and secondhand tyres, tubes and batteries. (b) Within a 70-mile radius of own premises at Portland in the course of business as "Tyre Retreaders and Distributors"—tyres and tubes for repair and reconditioning or having been repaired or reconditioned.

**CLARK & GREENWAY REFRIGERATED TRANSPORT PTY. LTD.**, Grant-road, Somerville, 3912. One commercial goods vehicle (L/C. 40 cwt.) to operate throughout the State of Victoria in a specially constructed refrigerated vehicle—frozen poultry, frozen processed vegetables, frozen fish, fresh cream, fruit juice and up to 2 cwt. of cheese and 5 cwt. of yoghurt.

**COMMONWEALTH INDUSTRIAL GASES LTD., THE**, 90 Bell-street, Preston, 3072. One commercial goods vehicle (L/C. 96 cwt.) to operate throughout the State of Victoria in course of business as "Industrial Gas Manufacturers" as a specially constructed tanker—liquid carbon dioxide at a temperature of -20°F.

**D'ABACO, G.**, 12 Chandler-road, Noble Park, 3174. One commercial goods vehicle (L/C. 56 cwt.) to operate: (a) Within a 50-mile radius of own premises at Noble Park in course of business as "Sand, Screening and Garden Supplier"—own goods. (b) From private properties at Castlemaine, Harcourt, Epsom and Spring Gully to own premises at Noble Park—own paving slate.

**EARTHLIFT PTY. LTD.**, 5 Rosebank-avenue, Ringwood, 3134. One commercial goods vehicle (L/C. 311 cwt.) to operate within a 50-mile radius of own premises at Ringwood in course of business as "Earthmoving Contractor"—own earthmoving equipment and own tools of trade.

**WILLIAMS, C. A.** (trading as G. & W. Constructions), 54 Montgomery-crescent, Bendigo, 3550. One commercial goods vehicle (L/C. 42 cwt.) to operate: (a) Within a 100-mile radius of own premises at Bendigo in course of business as "Builder"—own tools of trade. (b) Within a 50-mile radius of own premises at Bendigo—building materials required for the completion of own contracts.

**GALLOWAY, P. F.**, 323 Forest-road, The Basin, 3154. One commercial goods vehicle (L/C. 252 cwt.) to operate within a 35-mile radius of the G.P.O. Melbourne, on behalf of Consolidated Quarries Ltd.—sand, soil, screenings, premix and quarry products.

**JENNINGS, C. V.**, Mt. Napier-road, Hamilton, 3300. One commercial goods vehicle (L/C. 147 cwt.) to operate: (a) Within a 50-mile radius of the post office at Hamilton in the course of trade as Earthmoving Contractor—own tools of trade, earthmoving equipment, sand and screenings, soil and gravel. (b) Throughout the State of Victoria on behalf of the Soil Conservation Authority—own tools of trade and earthmoving equipment. (c) Within a 20-mile radius of the site of own contract on which currently engaged pursuant to part (b) or to such site from the railway station nearest thereto—materials for use on such contract.

**K.M.M. PTY. LTD.**, 461 Bourke-street, Melbourne, 3000. One commercial goods vehicle (L/C. 148 cwt.) to operate within a 50-mile radius from own premises at Kensington in the course of business as "Flour Millers"—own goods but excluding operations to or from places within an 8-mile radius of the chief post office at Geelong. Subject to the cancellation of licence No. D.A.6317/2 in the name of W. S. Kimpton & Sons Pty. Ltd.

**KENNEDY, J. H.**, 47 Ashwood-drive, Nunawading, 3131. One commercial goods vehicle (L/C. 240 cwt.) to operate: (a) Within a 25-mile radius of own premises at Nunawading in course of business as "Soil, Sand and Screenings and Garden Supply"—own goods. (b) From Powelltown to own premises at Nunawading—own mountain soil.

**MARTIN, D. L.**, 80 McIvor-road, Bendigo, 3550. One commercial goods vehicle (L/C. 21 cwt.) to operate within a 50-mile radius of the chief post office in the City of Bendigo solely on behalf of F. Fergusson Wool Co. Pty. Ltd. at Bendigo as "Managing Director" of the said company—wool, hides, skins and tallow.

**MORIAC BULLDOZERS PTY. LTD.**, Moriac, 3240. One commercial goods vehicle (L/C. 227 cwt.) to operate throughout the State of Victoria in the course of business as "Earthmoving Contractors"—own tools of trade, own equipment and own earthmoving machinery.

**MCENTEE, K. J.**, 55 High-street, Terang, 3264. One commercial goods vehicle (L/C. 8 cwt. and trailer) to operate: (a) Within a 25-mile radius from the post office at Terang in the course of business as "Store-keeper"—own goods. (b) From the City of Melbourne to own premises at Terang—own fresh fruit and vegetables provided that not more than six (6) bags of potatoes and six (6) bags of onions be carried on any one trip between Melbourne and Terang.

**NICHOLAS, R. L.**, "Eloura", Thornton, 3712. One commercial goods vehicle (L/C. 244 cwt.) to operate: (a) Within a 50-mile radius of the post office at Thornton as a "Road Contractor"—roadmaking plant and materials. (b) Within a 25-mile radius of the post office at Thornton—general goods, provided that no goods shall be carried whether by one stage or by more than one stage between places within the above radius which are more than thirty (30) road miles apart by the nearest practicable route.

**NIELD, F. H. J.** (trading as F. & J. Nield), Macarthur, 3286. One commercial goods vehicle (L/C. 83 cwt.) to operate: (a) Within a 25-mile radius of the post office at Macarthur—general goods, provided that no goods shall be carried whether by one stage or by more than one stage between places within the above radius which are more than thirty (30) road miles apart by the nearest practicable route. (b) Within a 50-mile radius of the Post Office at Macarthur in the course of business as "Primary Producer"—own goods. (c) Within a 50-mile radius of the Post Office at Macarthur—livestock.

**PARKIN, C. J.** (trading as C. J. & M. J. Parkin), 6 Crinan-street, Kilsyth, 3137. One commercial goods vehicle (L/C. 148 cwt.) to operate within a 70-mile radius of the premises of Atlas Industries Australia Ltd., at Springvale, on behalf of the said company—roofing tiles.

**PICTON HOPKINS & SON PTY. LTD.**, 130 Church-street, Richmond, 3121. One commercial goods vehicle (L/C. 8 cwt.) to operate, in the course of business as "Plaster Craftsmen": (a) Within a 25-mile radius of the post office at Richmond—own goods; (b) (i) Throughout the State of Victoria—fibrous plaster sheeting, mouldings, sisal and a quantity of plaster sufficient only for the fixings of the said plaster sheets and mouldings, also battens, nails, and insulating materials; viz; insulwool and rockwool suspended ceilings, component parts and associated acoustic tiles and sprayed finishes. (ii) Terazzo slabs and/or

materials incidental to fixing of same, stone dust, sand, and a quantity of cement sufficient only for setting purposes and associated materials necessary to carry out solid plastering contracts, vinyl and lino tiles and adhesives, scaffolding plant and tools of trade for use in own building contracts. (c) Within a 20-mile radius of own branch premises at Hernes Oak—own goods. (d) Within a 20-mile radius of the site of any contract upon which applicant is currently engaged or to such site from the railway station nearest thereto—materials for use on such contracts.

**PIZZEY LTD.**, 410 Whitehorse-road, Mitcham, 3132. Three commercial goods vehicles (L/C 12, 10, 10 cwt.) to operate as "Merchants, Manufacturers, Distributors"—(a) Within a 50-mile radius from own premises at Mitcham in the course of business as "Merchants, Manufacturers and Distributors"—own goods. (b) Throughout the State of Victoria as "Manufacturers of Agricultural Machinery" for the purpose of servicing and demonstrating agricultural equipment; agricultural equipment for demonstration or for repair or having been repaired, also tools of trade, spare parts and materials required for servicing and maintenance of such equipment in the field only.

**ROSE, K. J.**, 8 Attenborough-road, Aspendale, 3195. One commercial goods vehicle (L/C 80 cwt.) to operate throughout the State of Victoria in the course of business as "Marine Dealer"—special wares, marine stores and old metals as defined in the *Marine Stores and Old Metals Act 1958*, No. 6303, part 1, section 3, provided that the combined load capacity of the prime mover and any trailer attached thereto does not exceed 120 cwt.

**WEIGHT'S FUNERALS PTY. LTD.**, 91 Ferguson-street, Williamstown, 3016. One commercial goods vehicle (L/C 7 cwt.) to operate throughout the State of Victoria as a "Mortuary Vehicle" in the course of business as "Funeral Directors".

**WODONGA CONSTRUCTIONS PTY. LTD.**, Melbourne-road, Wodonga, 3690. One commercial goods vehicle (L/C 120 cwt.) to operate: (a) Within a 50-mile radius of the post office at Wodonga—plant the property of a contractor and required for use in connexion with the construction or maintenance of some specific, existing or proposed road, street, footpath, bridge, wharf, pier, weir or channel and also the following materials viz.: metal, stones, screenings, ashes, gravel, sand and earth. (b) Within a 25-mile radius of the post office at Wodonga—general goods, provided that no goods shall be carried whether by one stage or more than one stage between places within the above radius which are more than thirty (30) road miles apart by the nearest practicable route. (c) Within a 100-mile radius of own premises at Wodonga as a "House Remover"—own goods.

#### RENEWALS.

Applications for renewal of licences as shown by persons listed hereunder to operate under the same terms and conditions from the expiry shown in each case.

**ANDERTON, J. T.**, 6 Opie-street, Ferntree Gully, 3156; D.A.40895; 28th November, 1972; 138 cwt.

**BASCH, L.**, 44 Murray-road, Ormond, 3204; D.A.613; 15th November, 1972; 10 cwt.

**BEAUREPAIRE TYRE SERVICE PTY. LTD.**, 102 Victoria-street, Carlton, 3053; D.A.629/53; 14th November, 1972; 15 cwt.

**BEAUREPAIRE TYRE SERVICE PTY. LTD.**, 102 Victoria-street, Carlton, 3053; D.A.629/107; 9th November, 1972; 15 cwt.

**BEAUREPAIRE TYRE SERVICE PTY. LTD.**, 102 Victoria-street, Carlton, 3053; D.A.629/109; 9th November, 1972; 14 cwt.

**BEAUREPAIRE TYRE SERVICE PTY. LTD.**, 102 Victoria-street, Carlton, 3053; D.A.629/132; 8th November, 1972; 14 cwt.

**BENNETT, N. W.**, 12 Dally-street, Northcote, 3070; D.A.28559; 8th September, 1972; 113 cwt.

**BIRCH, E. C. PTY. LTD.**, 84-94 Flinders-lane, Melbourne, 3000; D.A.23853/8; 25th November, 1972; 10 cwt.

**CLEANAIR PTY. LTD.**, corner Park-road and Charlton-avenue, Cheltenham, 3192; D.A.62334; 25th November, 1972; 13 cwt.

**CrAVEN ENGINEERING SERVICE PTY. LTD.**, 101-103 Bay-street, Port Melbourne, 3207; D.A. 62312; 18th November, 1972; 11 cwt.

**D'ABACO, G.**, 12 Chandler-road, Noble Park, 3174; D.A.46772/3; 17th November, 1972; 55 cwt.

**Downey ENGINEERING PTY. LTD.**, 224 High-street, Northcote, 3070; D.A.65394; 19th November, 1972; 10 cwt.

**GREGORY, H. P. (Vic.) PTY. LTD.**, 141 Palmer-street, Richmond, 3121; D.A.61639/3; 25th November, 1972; 8 cwt.

**HINGSTON, C. E.**, 43 Dennis-street, Northcote, 3070; D.A.1304/1; 14th November, 1972; 67 cwt.

**HOPPER, K. H.**, 25 Uonga-road, Moorabbin, 3189; D.A.41096; 21st November, 1972; 17 cwt.

**HUTCHINSON, ROBERT, LTD.**, Hartington-street, Glenroy, 3046; T.D.A.27836/50; 9th November, 1972; 210 cwt.

**JENNINGS, A. V., INDUSTRIES (AUST.) LTD.**, 690 Springvale-road, Mulgrave, 3170; D.A.37756/4; 28th November, 1972; 86 cwt.

**JENNINGS, A. V., INDUSTRIES (AUST.) LTD.**, 690 Springvale-road, Mulgrave, 3170; D.A.37756/5; 14th November, 1972; 143 cwt.

**KEENAN, M. J. O.**, 40 Edinburgh-street, Richmond, 3031; D.A.1411; 15th November, 1972; 77 cwt.

**MATTHEWS, F. C.**, 60 Emu-street, Maidstone, 3012; D.A.1576; 12th November, 1972; 65 cwt.

**MAYNE NICKLESS LTD.**, 94 York-street, South Melbourne, 3205; D.A.19753/5; 19th November, 1972; 34 cwt.

**MICHELL, J. W. & R. G., PTY. LTD.**, 7 Murphy-street, Bendigo, 3550; D.A.47469/1; 18th November, 1972; 13 cwt.

**MOBILCO LTD.**, 410 Whitehorse-road, Mitcham, 3132; D.A.48327/24; 18th November, 1972; 14 cwt.

**NANGLE, L. A., PTY. LTD.**, 5 Peel-street, Collingwood, 3066; D.A.40349/6; 18th November, 1972; 21 cwt.

**NITSCHKE, M. G.**, Noradjuna, 3406; D.A.28231/1; 26th October, 1972; 10 cwt.

**PATERSONS PTY. LTD.**, 152 Bourke-street, Melbourne, 3000; D.A.1782/15; 18th November, 1972; 14 cwt.

**PATERSONS PTY. LTD.**, 152 Bourke-street, Melbourne, 3000; D.A.1782/16; 18th November, 1972; 54 cwt.

**PEEK FREAN (AUST.) PTY. LTD.**, 282 Bay-road, Cheltenham, 3192; D.A.52796/1; 29th July, 1972; 8 cwt.; D.A.52796/4; 29th July, 1972; 10 cwt.; D.A.52796/6; 29th July, 1972; 11 cwt.; D.A.52796/7; 29th July, 1972; 11 cwt.; D.A.52796/8; 29th July, 1972; 8 cwt.; D.A.52796/9; 29th July, 1972; 11 cwt.

**PLATEAU CARTAGE PTY. LTD.**, 14 Plateau-road, Reservoir, 3073; D.A.62321; 18th November, 1972; 17 cwt.; D.A.62321/1; 18th November, 1972; 34 cwt.; D.A.62321/2; 18th November, 1972; 8 cwt.; D.A.62321/3; 18th November, 1972; 17 cwt.; D.A.62321/4; 18th November, 1972; 55 cwt.

**PRINCES LAUNDRY PTY. LTD.**, 74 Warrigal-road, Mentone, 3194; D.A.62138/2; 18th November, 1972; 50 cwt.

**PRONTO MIXED CONCRETE Co. PTY. LTD.**, 46 Maroondah Highway, Ringwood, 3134; D.A.53130/10; 18th November, 1972; 331 cwt.

**REPLACEMENT PARTS PTY. LTD.**, 618 Elizabeth-street, Melbourne, 3000; D.A.1907/54; 18th November, 1972; 14 cwt.

**SANDERS, J. W.**, 39 Madden-street, Kaniva, 3419; D.A.53279; 9th November, 1972; 11 cwt.

**7X BEVERAGES (CENTRAL) PTY. LTD.**, 16 First-avenue, Sunshine, 3020; T.D.A.61307/10; 4th November, 1972; 65 cwt.; T.D.A.61307/11; 4th November, 1972; 64 cwt.

**SMALL, A. S.**, 66 Gardenvale-road, Gardenvale, 3185; D.A.62165; 5th November, 1972; 22 cwt.

**STREETS ICE CREAM PTY. LTD.**, 615 Warrigal-road, Ashburton, 3147; D.A.2011/27; 9th November, 1972; 8 cwt.

**WATERS, R. H.**, 209 Waverley-road, Mt. Waverley, 3149; D.A.41042; 14th November, 1972; 118 cwt.

**WEIRE, G. L.**, 61 Golf Links-avenue, Oakleigh, 3166; D.A.61796; 27th May, 1972; 198 cwt.

#### TOW TRUCK RENEWAL.

**AARJENT TOWING & SALVAGE SERVICE PTY. LTD.**, 22-30 Warwick-street, North Melbourne, 3051; D.A.35190/3; 28th November, 1972; 37 cwt.

#### RENEWALS WITH VARIATION.

Applications made by the persons listed hereunder for renewal of the licences listed with variation of conditions in the manner set out opposite the names.

**BEAUREPAIRE TYRE SERVICE PTY. LTD.**, 102 Victoria-street, Carlton, 3053; D.A.629/54; 14th November, 1972; Application to renew and vary the conditions of licence No. D.A.629/54 (L/C. 15 cwt.) by deleting the existing conditions and adding in lieu—"Within a 50-mile radius from the licence holders own branch premises at Wangaratta in the course of business as Tyre Retreaders and Distributors"—tyres and tubes for sale and delivery, used tyres for repair or retreading or having been repaired or retreaded, batteries, oil and motor car accessories."

PASA, R. & B., 616 Drummond-street, North Carlton, 3054; D.A.53766; 9th November, 1972; Application to renew and vary the conditions of licence No. D.A.53766 (L/C. 350 cwt.) by deleting the existing conditions and adding in lieu—“(a) From pits at Bacchus Marsh to the premises of Independent Mining Pty. Ltd. solely on behalf of the said company at Williamstown—quarry materials and sand. (b) From the premises of Independent Mining Pty. Ltd. at Williamstown to other plants of the said company within a 25-mile radius of Williamstown—quarry materials and sand.”

Notice of any objection should be forwarded to reach the Secretary of the Board not later than Wednesday, 5th July, 1972.

Applicants are advised that it will not be necessary to appear on the hearing date specified above, unless advised, in writing, by the Board.

B. P. KAY,  
Secretary.

Corner Lygon and Princes streets, Carlton, 3053,  
21st June, 1972.

Transport Regulation Act.  
TRANSPORT REGULATION BOARD.  
HEARING OF APPLICATIONS.

Notice is hereby given that the following applications will be considered by the Transport Regulation Board at its offices at the corner of Lygon and Princes streets, Carlton, at 10.15 a.m., on Wednesday, 12th July, 1972.

KENNEDY, K. T. & J. P., 2 Elizabeth-street, Hastings. One commercial passenger vehicle with seating capacity for five persons to operate under the same terms and conditions as existing country taxi cab licences held by the applicants and operating at Hastings.

SMIT, F. H., 145 Settlement-road, Bundoora. Application for variation of conditions of licence T.P.245 to include the ability to extend the route from Keon Park Railway Station to the corner of Purinuan and Cheddar roads, Reservoir, via Keon-parade, Cheddar-road, Carrol and Whitelaw streets, Broadway, Boldrewood-parade, Rathcown-road and Purinuan-road to Cheddar-road.

Frequency: One return trip, Monday to Friday.  
Fares: To be determined.

TULLAMARINE BUS LINES PTY. LTD., 7 Louis-street, Airport West. Nine commercial passenger vehicles with large seating capacity to operate on routes 478 (Moonee Ponds-Bulla) and 479 (City-Sunbury) as presently operated under M.O. licences with the ability to extend service from the corner of Sunbury-road and Barkly-street, via Barkly-street to the Sunbury Mental Hospital; thence via Barkly and Station streets, Gap-road to Preston-street, returning via Gap-road, Evans Brook and O'Shanassy streets to Sunbury-road and normal route.

TIME-TABLE.

8.55 a.m. ex Moonee Ponds.  
1.15 p.m. ex Moonee Ponds (to last passenger).

Additional Sections.

Corner Barkly and Station streets to—

- (1) Mental Hospital.
- (2) Corner Gap-road and Evans-street.
- (3) Preston-street.

Application for renewal of licences as shown, by persons listed hereunder, to operate under the same terms and conditions.

FLORENCE, H. H. (Mrs.), 356 Glen Eira-road, Elsternwick; T.P.134.

BALLINGER, M. R. (Mrs.), 53 Greensborough-road, Macleod; T.P.158.

PANNELL, M. C. R., 58 Clarendon-street, Thornbury; T.P.104.

TREWECK, W. J., Jun., 105 Evans-street, Sunbury; T.S.1271.

SMITH, J. H., 101 Wyndham-street, Shepparton; C.T.778, C.T.623.

GEYER, G. S., 69 Power-street, Hawthorn; M.T.2802.

PHAIR, H., (estate of), 66 Muriel-street, Niddrie, M.T.2792.

DAWSON, R. L., 44 Newton-street, East Reservoir; M.T.2812.

MATSIAS, G. S., 36 Roberts-street, Sunshine; M.T.4343.

PEARCE, R. M., 18 Reading-avenue, North Balwyn; M.T.2780.

BANKS, W. H., 34 Nockolds-crescent, Noble Park; M.T.2778.

MAURO, D., 64 Park-crescent, North Caulfield; M.T.1715.

DEPARTMENT OF AGRICULTURE, Dookie; T.P.56, T.P.174.

FIELDING, W. V. & N. G., P.O. Box 61, Lockington, 3563; T.S.923, T.S.253, T.S.254.

SOUTH, F. R., High-street, Woodend; T.P.228.

LAWLER, C. P., 65 Ballarat-road, Hamilton; C.T.642.

SMITH, J. H., 101 Wyndham-street, Shepparton; C.T.556, C.T.547.

JACKSON, E. L., 7 Cynga-street, East Preston; M.T.2852.

STEWART, D. L., 74 Ruskin-street, Elwood; M.T.2834.

CARLISLE, H. T., 29 Glencara-street, Avondale Heights; M.T.2873.

SUNDERLAND, B. C., Gifford's-road, P.O. Box 16, Warburton; M.T.2784.

LEVIN, I., 3 Wenden-street, East St. Kilda; M.T.1893.

FIESCHI, G., 22 Coburg-street, Coburg; M.T.1862.

LUPONE, O., 103 Rennie-street, Coburg; M.T.2790.

GOLD, H., 22 Lincoln-drive, Bulleen; M.T.2869.

SHIELDS, S. J., 16 Weroona-avenue, Hamlyn Heights, North Geelong; U.T.754.

LAWSON, L., 5 Bungay-street, Watsonia; M.T.2870.

WANDEL, K., 44 Rugby-street, Belmont, Geelong; U.T.640.

LAWTON, E. A. T., 2 Everett-street, Brunswick West; M.T.2859.

ATHANASSIOU, A., 2 Jocelyn-street, North Balwyn; M.T.2831.

GREEN, W. B. C., 115 Martins-lane, East Rosanna; M.T.2843.

FORAN, H. J., 2 Glenleigh-avenue, West Geelong; U.T.688.

CALDER, S. E., 1 Donald-street, East Geelong; U.T.649.

KEIGHRAN, L. V., 12 Larnook-street, Windsor; M.T.2785.

SMALL, R. D., 22 Harrison-street, Box Hill; M.T.2803.

KING, D. G., 22 Wellington-street, Maryborough; C.T.554.

Notice of any objection should be forwarded to reach the Secretary of the Board not later than Wednesday, 5th July, 1972.

Applicants are advised that it will not be necessary to appear on the hearing date specified above, unless advised, in writing, by the Board.

B. P. KAY,  
Secretary.

Corner Lygon and Princes streets, Carlton, Wednesday,  
21st June, 1972.

Aboriginal Affairs Act 1967.

APPOINTMENT OF SIX MEMBERS OF ABORIGINAL  
AFFAIRS ADVISORY COUNCIL.

In pursuance of the powers conferred by the *Aboriginal Affairs Act 1967*, I, Edward Raymond Meagher, Her Majesty's Minister for Aboriginal Affairs for the State of Victoria, do hereby appoint the persons named hereunder, being persons having special knowledge of Aborigines or having experience in other fields of special value to the Council, to be members of the Aboriginal Affairs Advisory Council:—

WILLIAM KELVIN ALLEN,  
ELIZABETH MAY CAMERON,  
THOMAS LESLIE WILLIAM EMERSON,  
DR. PETER WARREN JOSEPH LEIGHTON,  
Pastor DOUGLAS RALPH NICHOLLS,  
MARGARET ELIZABETH TUCKER.

And I do hereby specify a period of three years commencing on the second day of July, 1972, and ending on the first day of July, 1975, as the period for which each such member shall hold office.

Given under my hand this fourth day of May, 1972.

E. R. MEAGHER,  
Minister for Aboriginal Affairs.

Ministry of Aboriginal Affairs,  
Melbourne.

Aboriginal Affairs Act 1967.

DECLARATION OF RESULT OF ABORIGINAL AFFAIRS  
ADVISORY COUNCIL ELECTIONS, 1972.

Pursuant to the Aboriginal Affairs Advisory Council Elections Regulations 1968, I, Edward Raymond Meagher, Her Majesty's Minister for Aboriginal Affairs for the State of Victoria, do hereby declare that the Aborigines named hereunder were elected members of the Aboriginal Affairs Advisory Council for the term of office of three years ending on the first day of July, 1975, as representatives for the respective Electoral Regions set out hereunder opposite their names:—

East Gippsland Region: PHILIP PEPPER,  
Mallee Region: DAVID ROBERT ANDERSON,  
Metropolitan Region: MERLE ROBERTHA JACKOMOS,  
Murray-Goulburn Region: EMANUEL AUSTON COOPER,  
Wimmera-Western Region: IVAN KENNETH COUZENS,  
West Gippsland Region: No candidate nominated.

Dated this 15th day of June, 1972.

E. R. MEAGHER,  
Minister for Aboriginal Affairs.

Ministry of Aboriginal Affairs,  
Melbourne.

COUNTRY ROADS BOARD.

RESOLUTIONS OF THE COUNTRY ROADS BOARD.

The Country Roads Board, in pursuance of the provisions of the *Country Roads Act 1958*, has passed Resolutions the dates whereof and the terms of which are scheduled hereunder:—

SCHEDULE.

Main Roads.

Resolution dated the Twenty-ninth day of May, One thousand nine hundred and seventy-two, made pursuant to section 21 of the *Country Roads Act 1958*, declaring the widening of the Melbourne-Lancefield road in the Shire of Bulla as shown hatched on Plan numbered G.P.9151 hereunder to be part of a main road within the meaning and for the purposes of the said Act.

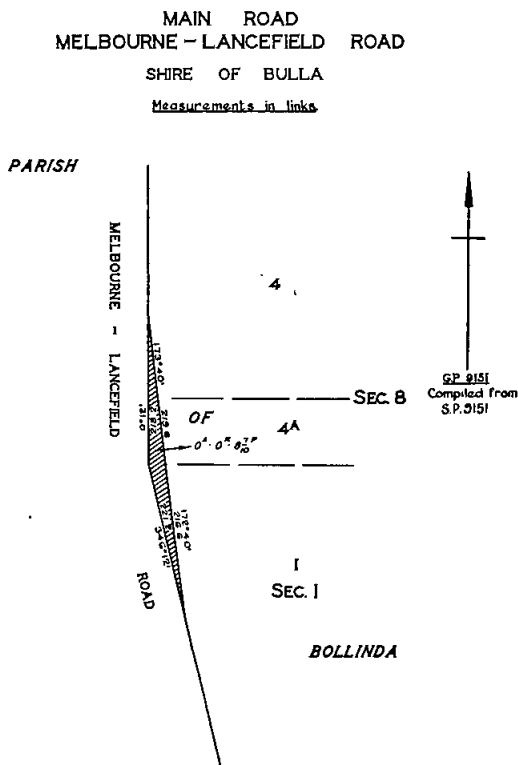

within the meaning and for the purposes of the said Act, and also declaring that such deviation shall be in lieu of the existing road or part thereof indicated by cross-hatching and vertical hatching on the said plan which part indicated by cross-hatching on the said plan shall be discontinued.

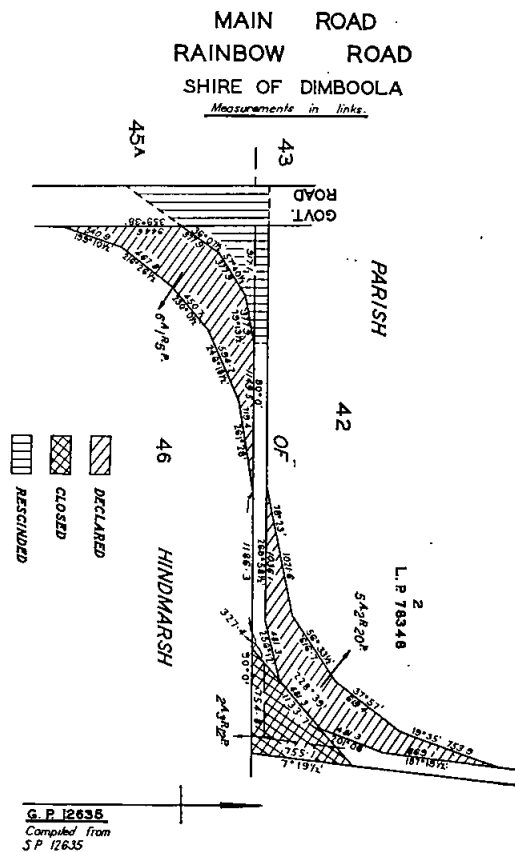

Resolution dated the Twenty-ninth day of May, One thousand nine hundred and seventy-two, made pursuant to sections 21 and 58 of the *Country Roads Act 1958*, declaring the deviation from Rainbow-road in the Shire of Dimboola as indicated by diagonal hatching on Plan numbered G.P.12635 hereunder to be part of a main road

Resolution dated the Twenty-ninth day of May, One thousand nine hundred and seventy-two, made pursuant to section 21 of the *Country Roads Act 1958*, declaring the widening of the Heidelberg-Doncaster road in the City of Doncaster and Templestowe as shown hatched on Plan numbered G.P.9244 hereunder to be part of a main road within the meaning and for the purposes of the said Act.

MAIN ROAD  
HEIDELBERG - DONCASTER ROAD  
CITY OF DONCASTER AND TEMPLESTOWE

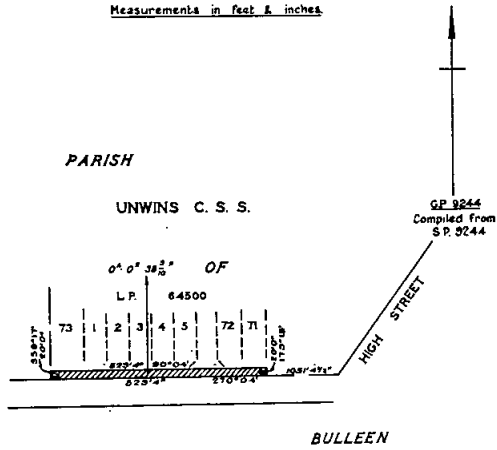

widening of the Euroa-Arcadia road in the Shire of Euroa as shown hatched on Plan numbered G.P.9294 hereunder to be part of a main road within the meaning and for the purposes of the said Act.

MAIN ROAD  
EUROA - ARCADIA ROAD  
SHIRE OF EUROA

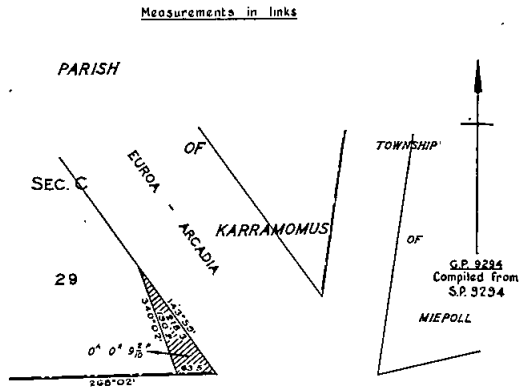

Resolution dated the Twenty-ninth day of May, One thousand nine hundred and seventy-two, made pursuant to section 21 of the *Country Roads Act 1958*, declaring the widening of the Heidelberg-Kinglake road in the Shire of Eltham as shown hatched on Plan numbered G.P.9246 hereunder to be part of a main road within the meaning and for the purposes of the said Act.

MAIN ROAD  
HEIDELBERG - KINGLAKE ROAD  
SHIRE OF ELTHAM

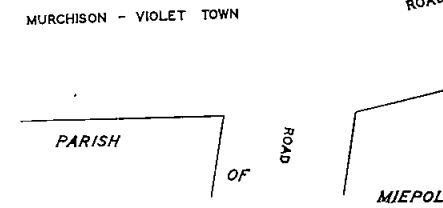
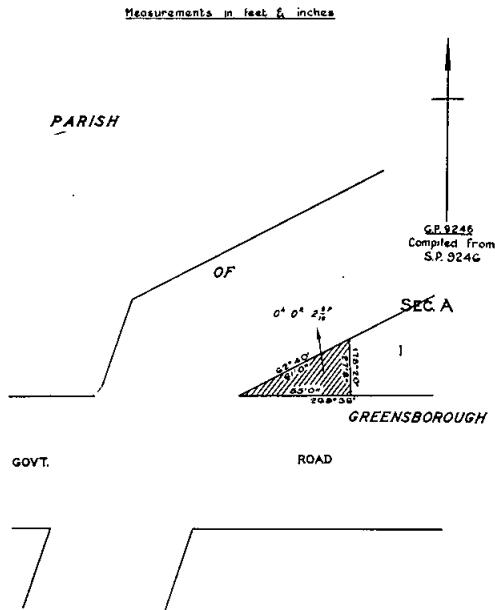

Resolution dated the Twenty-ninth day of May, One thousand nine hundred and seventy-two, made pursuant to section 21 of the *Country Roads Act 1958*, declaring the widening of the Hopetoun-Woomelang-Sea Lake road in the Shire of Karkaroc as shown hatched on Plan numbered G.P.9277 hereunder to be part of a main road within the meaning and for the purposes of the said Act.

MAIN ROAD  
HOPETOUN-WOOMELANG-SEA LAKE ROAD  
SHIRE OF KARKAROOC

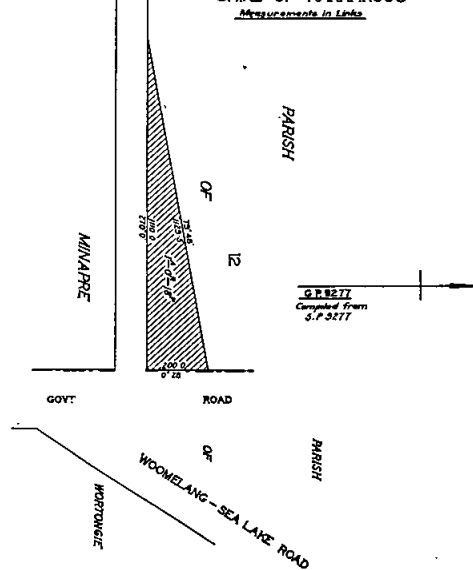

Resolution dated the Twenty-ninth day of May, One thousand nine hundred and seventy-two, made pursuant to section 21 of the *Country Roads Act 1958*, declaring the



Resolution dated the Twenty-ninth day of May, One thousand nine hundred and seventy-two, made pursuant to section 21 of the *Country Roads Act 1958*, declaring the widening of the Daylesford-Trentham road in the Shire of Kyneton as shown hatched on Plan numbered G.P.9196 hereunder to be part of a main road within the meaning and for the purposes of the said Act.

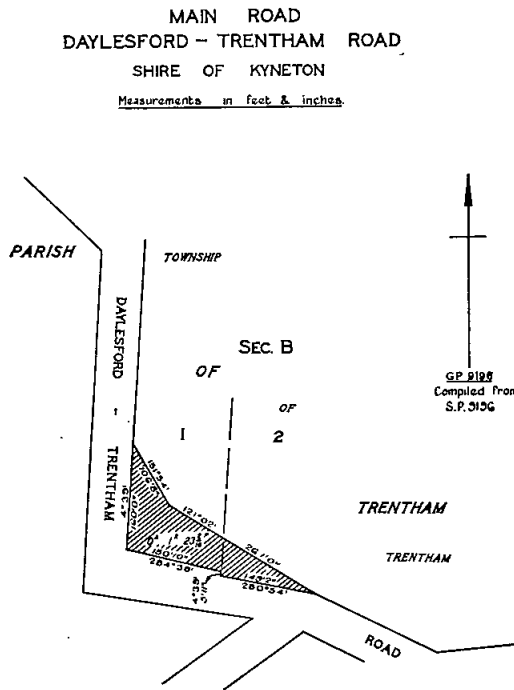

Resolution dated the Twenty-ninth day of May, One thousand nine hundred and seventy-two, made pursuant to sections 21 and 58 of the *Country Roads Act 1958*, declaring the deviation from the Mansfield-Woods Point road in the Shire of Mansfield as indicated by diagonal hatching on Plan numbered G.P.9144 hereunder to be part of a main road within the meaning and for the purposes of the said Act, and also declaring that such deviation shall be in lieu of the existing road or part thereof indicated by cross-hatching on the said plan.

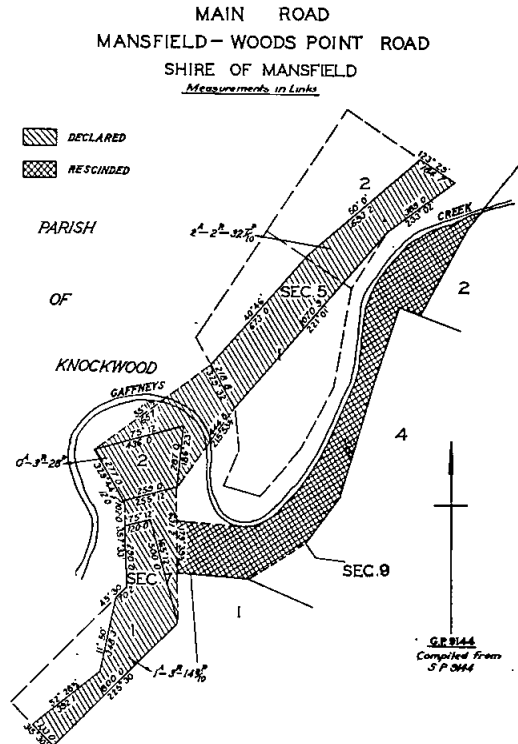

Resolution dated the Twenty-ninth day of May, One thousand nine hundred and seventy-two, made pursuant to section 21 of the *Country Roads Act 1958*, declaring the widening of the Mortlake-Ararat road in the Shire of Mortlake as shown hatched on Plan numbered G.P.9300 hereunder to be part of a main road within the meaning and for the purposes of the said Act.

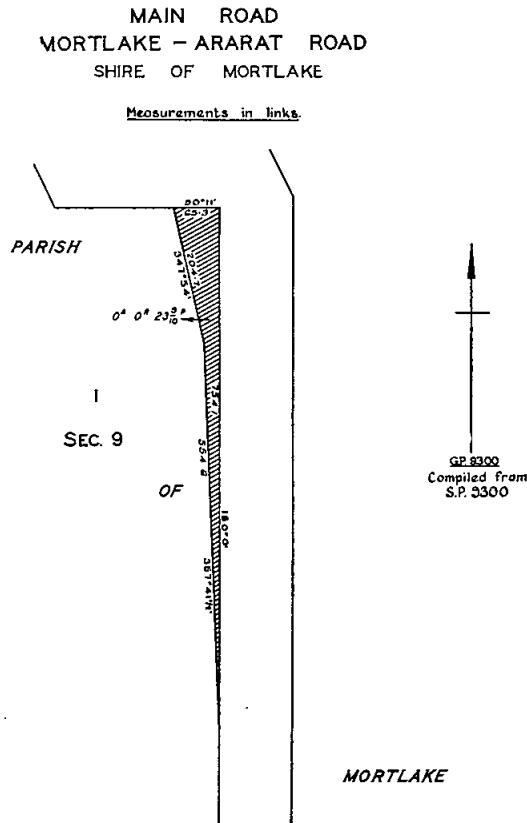

Resolution dated the Twenty-ninth day of May, One thousand nine hundred and seventy-two, made pursuant to section 21 of the *Country Roads Act 1958*, declaring the widening of the Vaughan Springs-road in the Shire of Newstead as shown hatched on Plan numbered G.P.9314 hereunder to be part of a main road within the meaning and for the purposes of the said Act.

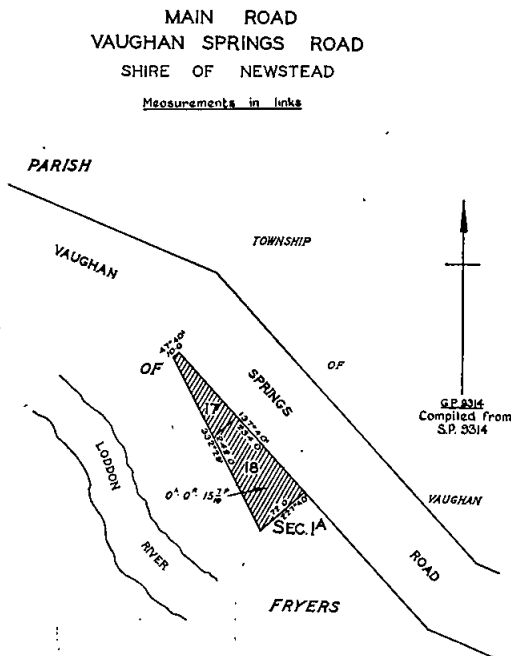

Resolution dated the Twenty-ninth day of May, One thousand nine hundred and seventy-two, made pursuant to sections 21 and 58 of the *Country Roads Act 1958*, declaring the deviation from the Portland-Casterton road in the Shire of Portland as indicated by diagonal hatching on Plans numbered G.P.8214, and G.P.8215 hereunder to be part of a main road within the meaning and for the purposes of the said Act, and also declaring that such deviation shall be in lieu of the existing road or part thereof indicated by cross-hatching on the said plans.

MAIN ROAD  
PORTLAND-CASTERTON ROAD  
SHIRE OF PORTLAND  
*Measurements in Links*

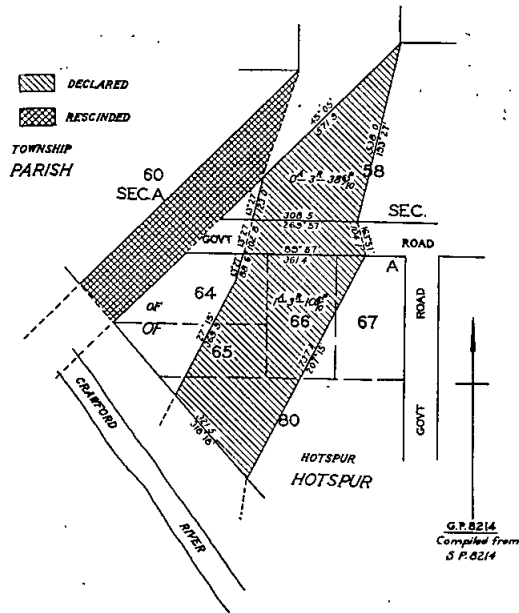

MAIN ROAD  
PORTLAND-CASTERTON ROAD  
SHIRE OF PORTLAND  
*Measurements in Links*

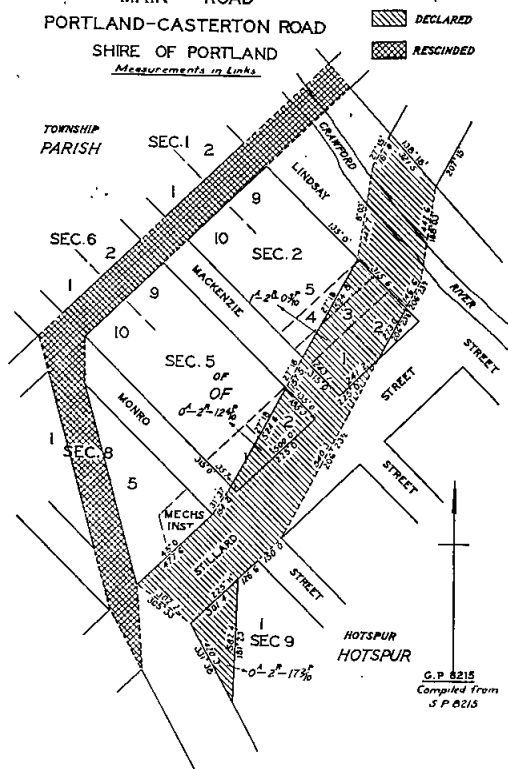

Resolution dated the Twenty-ninth day of May, One thousand nine hundred and seventy-two, made pursuant to section 21 of the *Country Roads Act 1958*, declaring the widening of the Lancefield-Tooborac road in the Shires of Pyalong and McIvor as shown hatched on Plans numbered G.P.9212 and G.P.9213 hereunder to be part of a main road within the meaning and for the purposes of the said Act.

MAIN ROAD  
LANCEFIELD-TOOBORAC ROAD  
SHIRE OF PYALONG  
Measurements in links

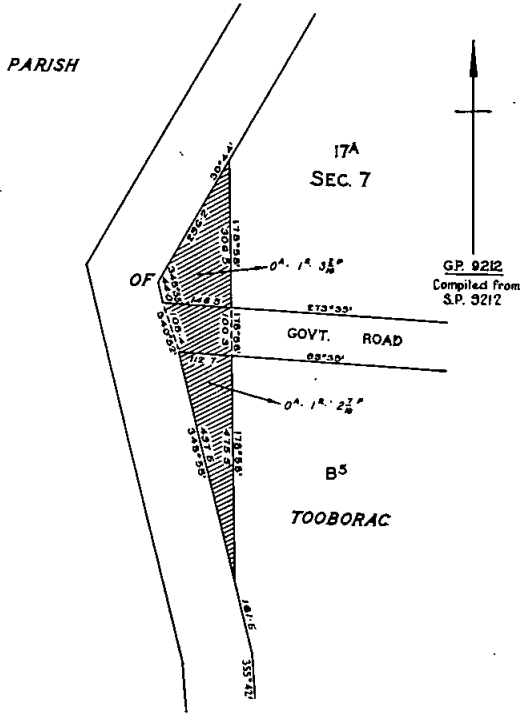

MAIN ROAD  
CHELTENHAM ROAD  
CITY OF SPRINGVALE  
Measurements in feet & inches

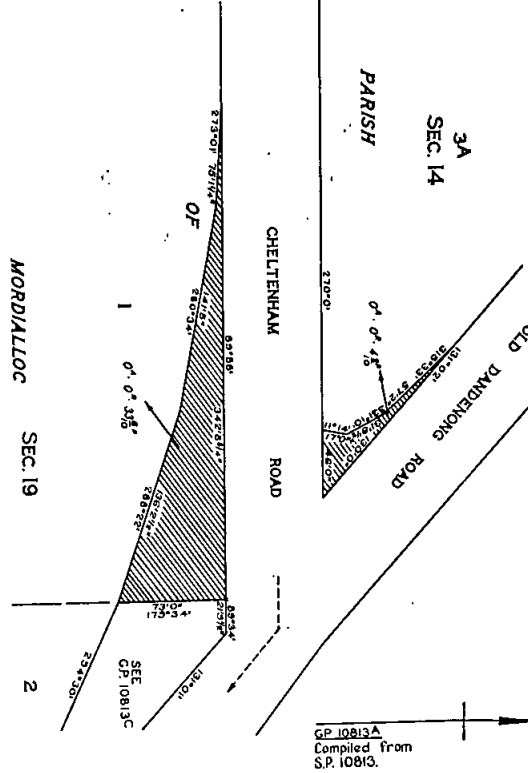

MAIN ROAD  
LANCEFIELD-TOOBORAC ROAD  
SHIRES OF PYALONG & MCVOR  
Measurements in links

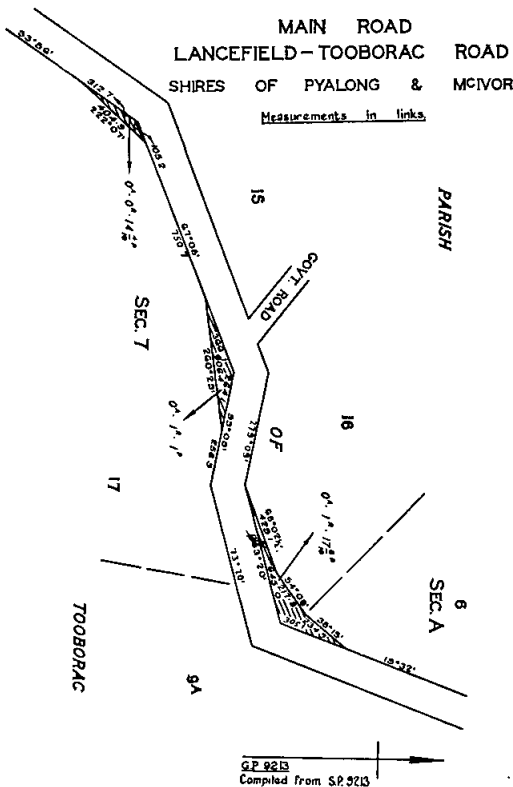

MAIN ROAD  
CHELTENHAM ROAD  
CITY OF SPRINGVALE  
Measurements in feet & inches

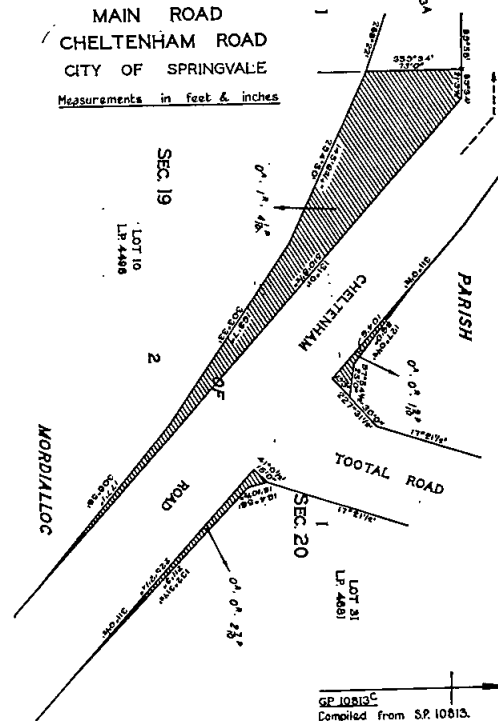

Resolution dated the Twenty-ninth day of May, One thousand nine hundred and seventy-two, made pursuant to section 21 of the *Country Roads Act 1958*, declaring the widening of Cheltenham-road in the City of Springvale as shown hatched on Plans numbered G.P.10813A and G.P.10813C hereunder to be part of a main road within the meaning and for the purposes of the said Act.

Resolution dated the Twenty-ninth day of May, One thousand nine hundred and seventy-two, made pursuant to section 21 of the *Country Roads Act 1958*, declaring the widening of the Inverloch-Lower Tarwin road in the Shire

of Woorayl as shown hatched on Plans numbered G.P.8752A and G.P.8752B hereunder to be part of a main road within the meaning and for the purposes of the said Act.

Resolution dated the Twenty-ninth day of May, One thousand nine hundred and seventy-two, made pursuant to section 21 of the *Country Roads Act 1958*, declaring the widening of the Inverloch-Leongatha road in the Shire of Woorayl as shown hatched on Plan numbered G.P.12804 hereunder to be part of a main road within the meaning and for the purposes of the said Act.

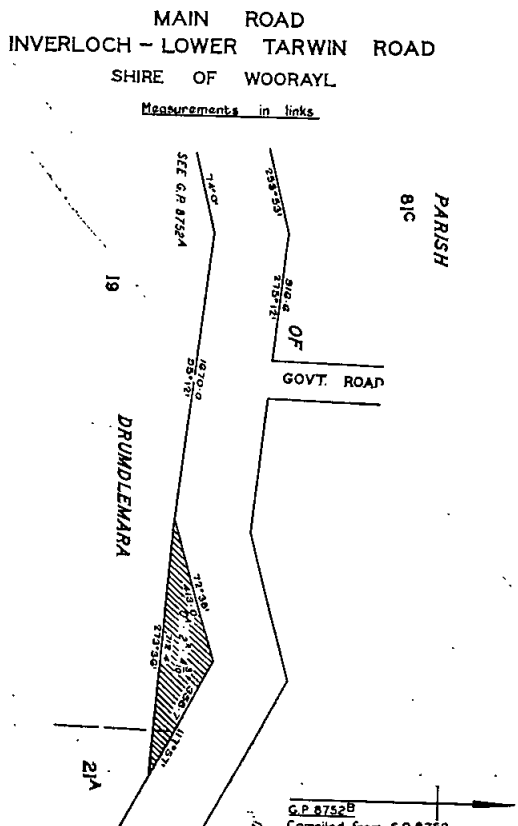
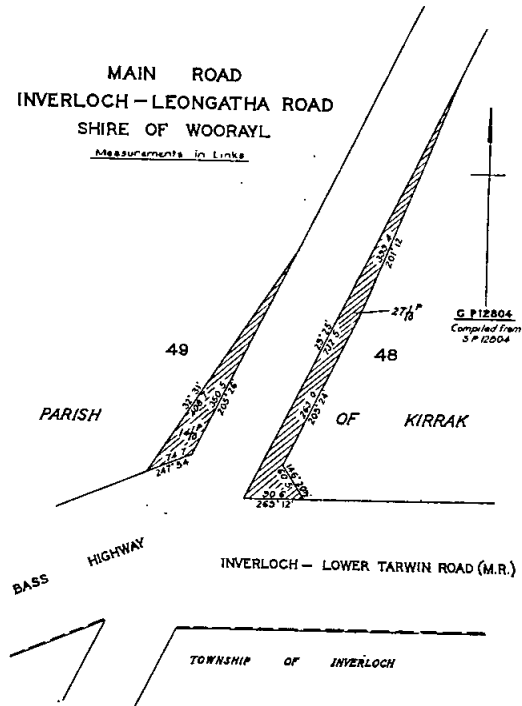
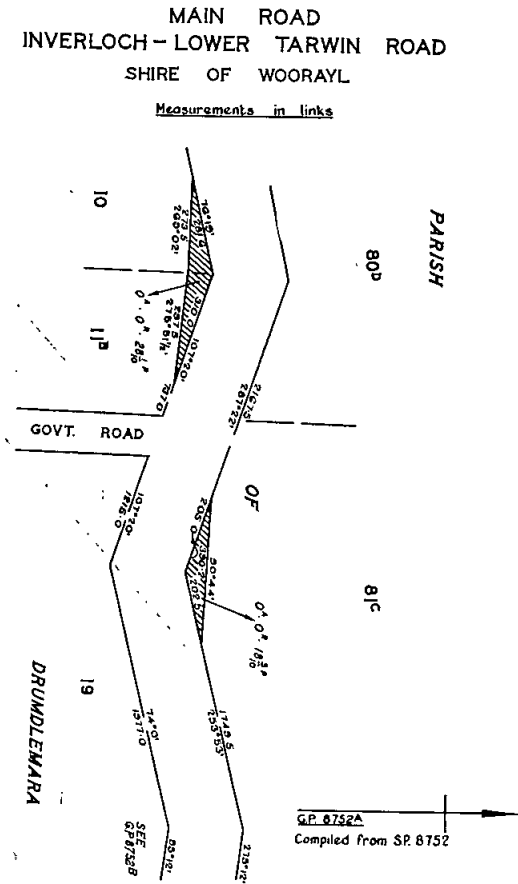

**Unclassified Road.**  
Resolution dated the Twenty-ninth day of May, One thousand nine hundred and seventy-two, made pursuant to sections 21 and 110 of the *Country Roads Act 1958*, declaring the road in the Shire of Ballan as shown hatched on Plan numbered G.P.12471 hereunder to be a road (Molesworth-road) within the meaning and for the purposes of the said Act.

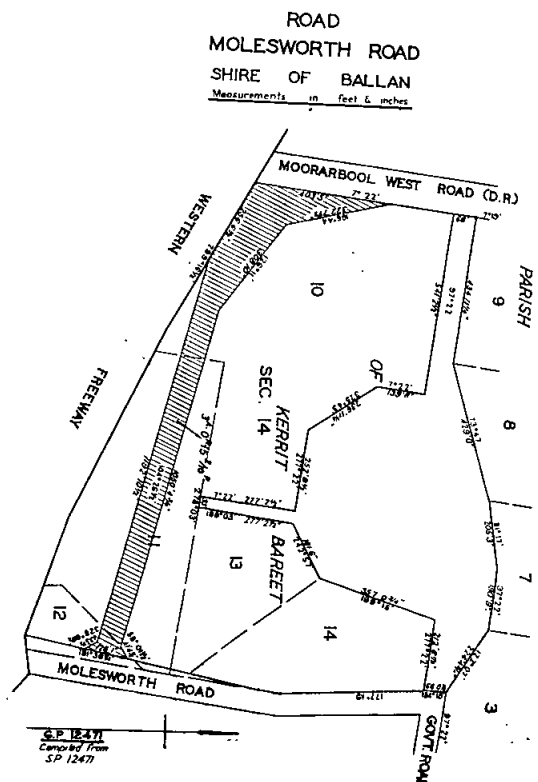

Tourists' Road.

Resolution dated the Twenty-ninth day of May, One thousand nine hundred and seventy-two, made pursuant to sections 21 and 88 of the Country Roads Act 1958, declaring the widening of Mount Dandenong-road in the Shire of Sherbrooke as shown hatched on Plans numbered G.P.11860A, G.P.11860B and G.P.11861 hereunder to be part of a tourists' road within the meaning and for the purposes of the said Act.

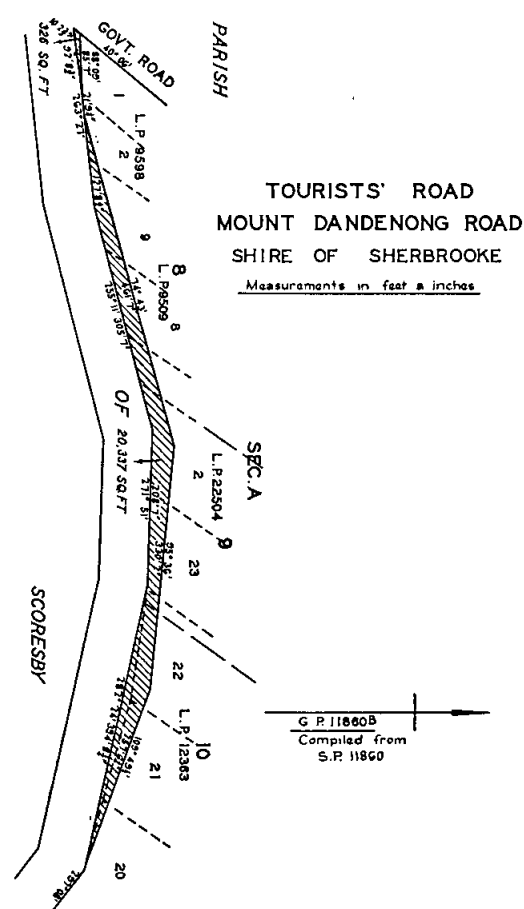
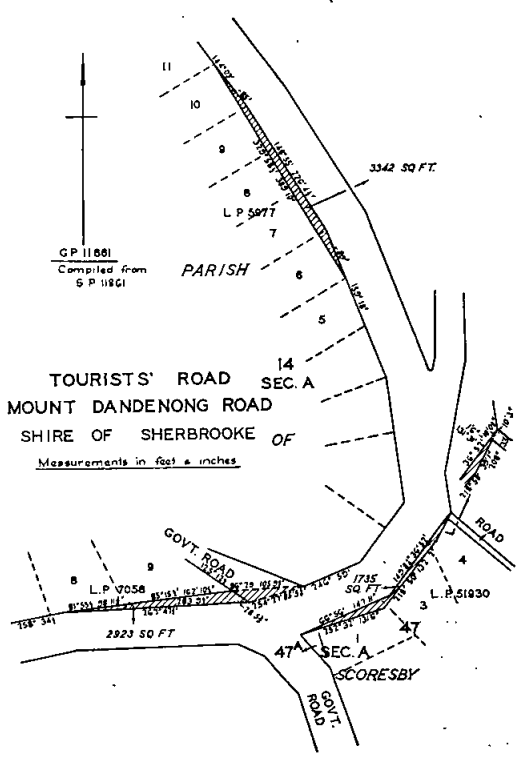
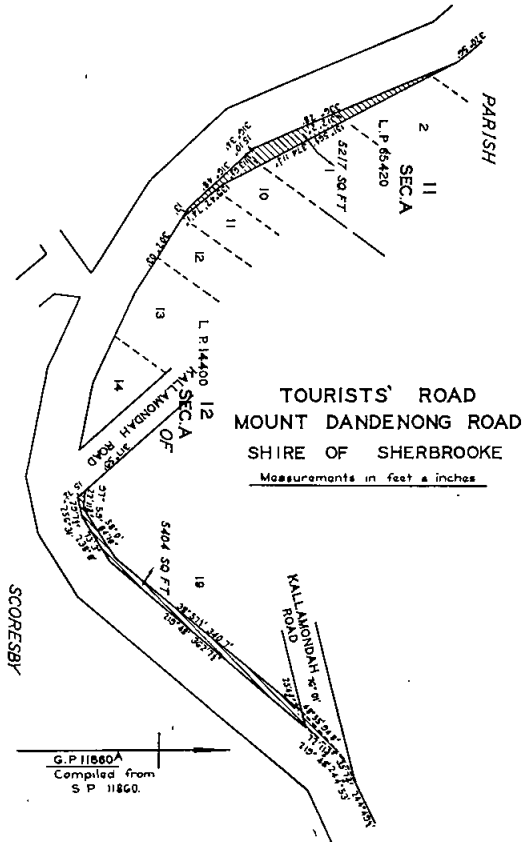

N. L. ALLANSON,  
Secretary.  
1st June, 1972.

COUNTRY ROADS BOARD.  
RESOLUTIONS OF THE COUNTRY ROADS BOARD.

The Country Roads Board, in pursuance of the provisions of the Country Roads Act 1958, has passed Resolutions the dates whereof and the terms of which are scheduled hereunder:—

SCHEDULE.  
State Highways.

Resolution dated the Twenty-second day of May, One thousand nine hundred and seventy-two, made pursuant to sections 21 and 74 of the Country Roads Act 1958, declaring the widening of the Murray Valley Highway in the Shire of Deakin as shown hatched on Plan numbered G.P.9208 hereunder to be part of a State highway within the meaning and for the purposes of the said Act.

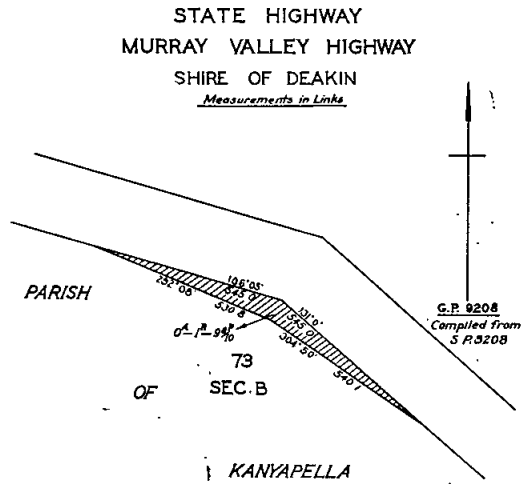

Resolution dated the Twenty-second day of May, One thousand nine hundred and seventy-two, made pursuant to sections 21 and 74 of the *Country Roads Act 1958* declaring the widening of the Loddon Valley Highway in the Shire of Kerang as shown hatched on Plan numbered G.P.11857 hereunder to be part of a State highway within the meaning and for the purposes of the said Act.

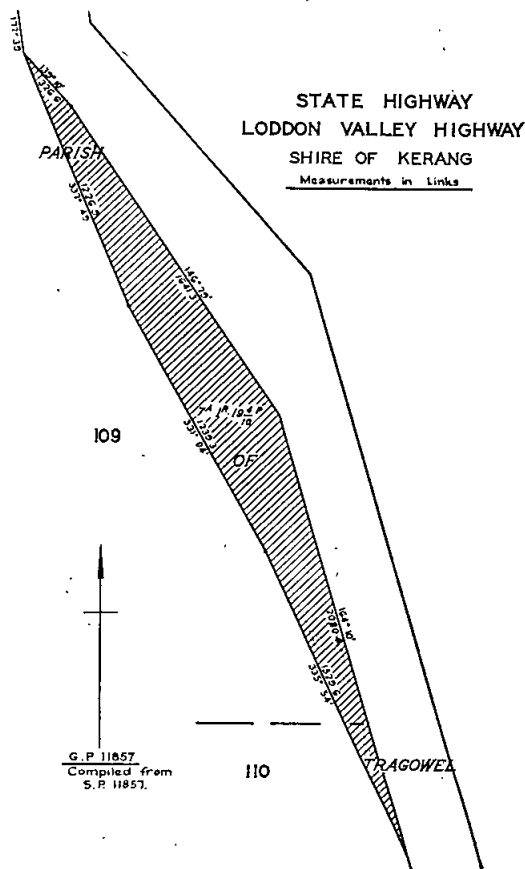

*Main Roads.*

Resolution dated the Twenty-second day of May, One thousand nine hundred and seventy-two, made pursuant to section 21 of the *Country Roads Act 1958*, declaring the widening of the Maryborough-Natte Yallock road in the Shire of Avoca as shown hatched on Plan numbered G.P.9209 hereunder to be part of a main road within the meaning and for the purposes of the said Act.

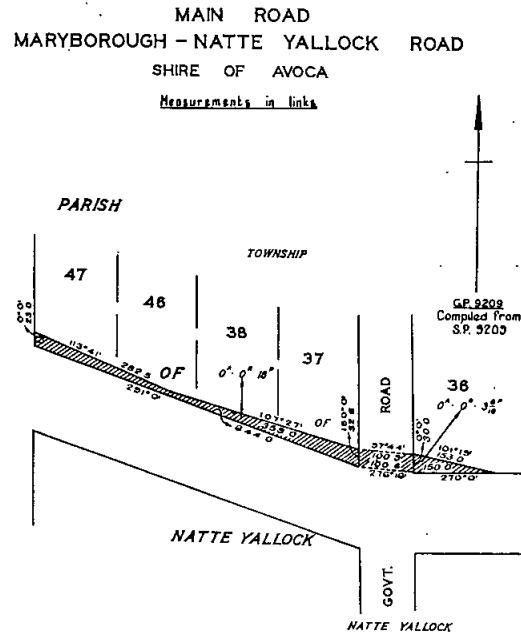

Resolution dated the Twenty-second day of May, One thousand nine hundred and seventy-two, made pursuant to section 21 of the *Country Roads Act 1958*, declaring the widening of the Daylesford-Ballarat road in the Shire of Bungaree as shown hatched on Plan numbered G.P.9077 hereunder to be part of a main road within the meaning and for the purposes of the said Act.

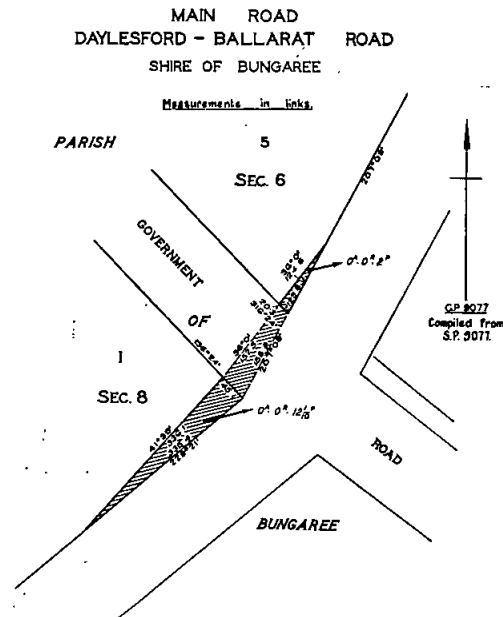

Resolution dated the Twenty-second day of May, One thousand nine hundred and seventy-two, made pursuant to section 21 of the *Country Roads Act 1958*, declaring the widening of the Hepburn-Newstead road in the Shire of

Daylesford and Glenlyon as shown hatched on Plan numbered G.P.9152, hereunder to be part of a main road within the meaning and for the purposes of the said Act.

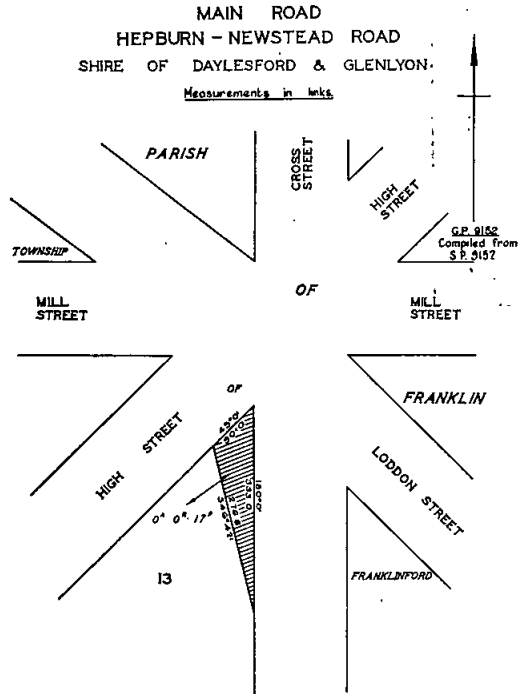

Resolution dated the Twenty-second day of May, One thousand nine hundred and seventy-two, made pursuant to section 21 of the Country Roads Act 1958, declaring the widening of the Merton-Strathbogie road in the Shire of Euroa as shown hatched on Plan numbered G.P.12799 hereunder to be part of a main road within the meaning and for the purposes of the said Act.

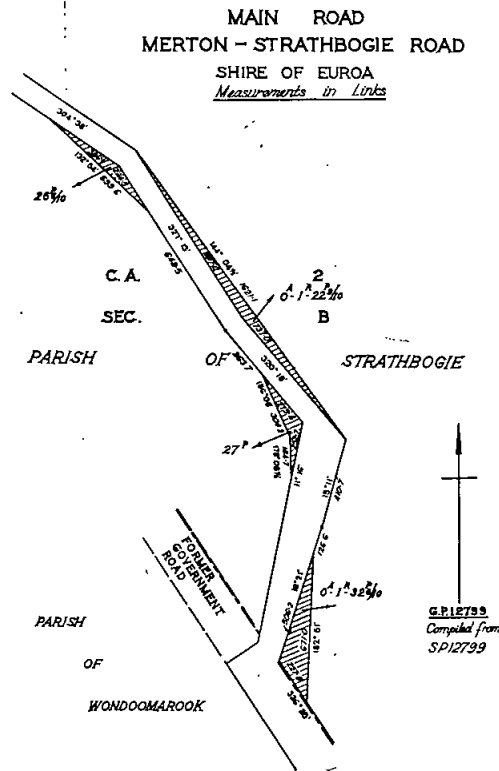

Resolution dated the Twenty-second day of May, One thousand nine hundred and seventy-two, made pursuant to section 21 of the Country Roads Act 1958, declaring the widening of the Euroa-Arcadia road in the Shire of Euroa as shown hatched on Plan numbered G.P.12684 hereunder to be part of a main road within the meaning and for the purposes of the said Act.

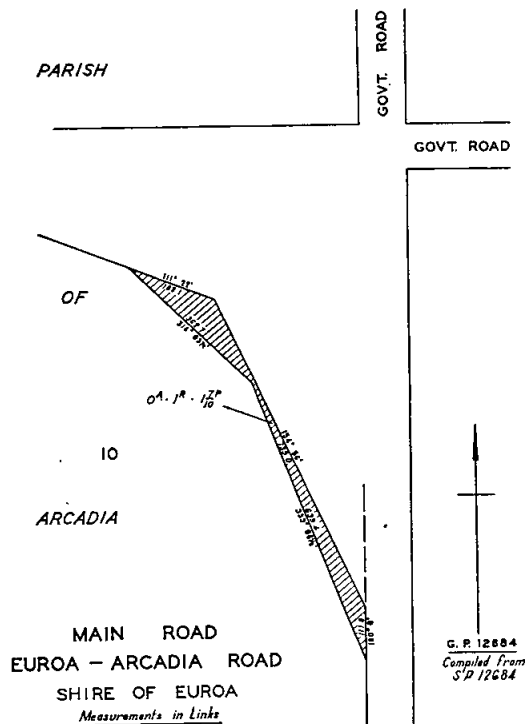

Resolution dated the Twenty-second day of May, One thousand nine hundred and seventy-two, made pursuant to section 21 of the Country Roads Act 1958, declaring the widening of the Maffra-Briagolong road in the Shire of Maffra as shown hatched on Plans numbered G.P.8891, G.P.8892 and G.P.9153 hereunder to be part of a main road within the meaning and for the purposes of the said Act.

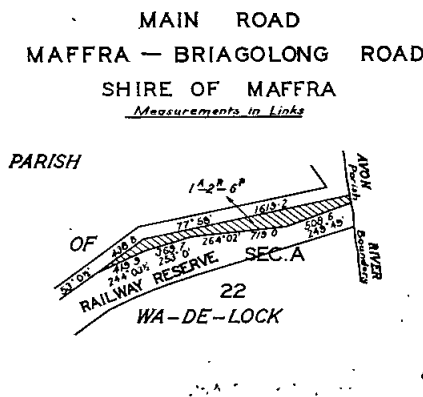

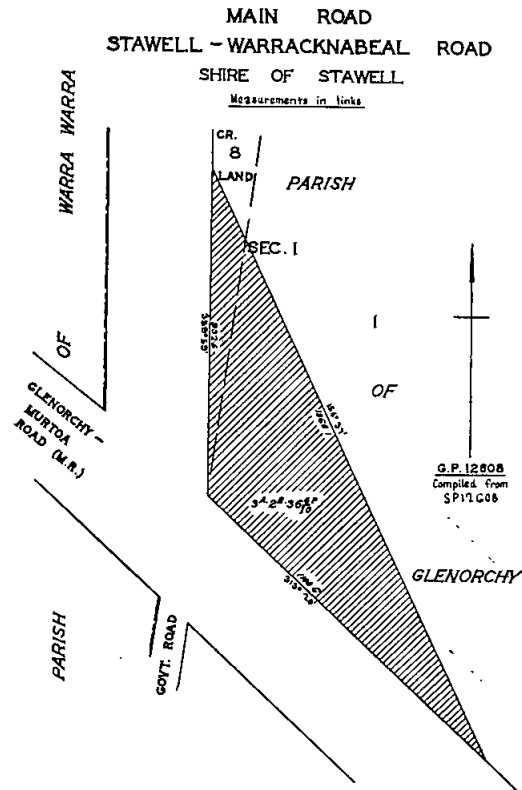
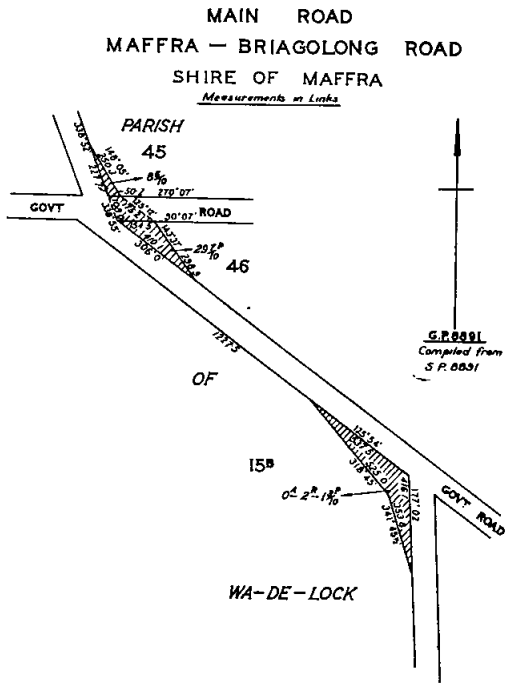

Resolution dated the Twenty-second day of May, One thousand nine hundred and seventy-two, made pursuant to section 21 of the *Country Roads Act 1958*, declaring the widening of the Ouyen-Piangil road in the Shire of Swan Hill as shown hatched on Plan numbered G.P.9065A hereunder to be part of a main road within the meaning and for the purposes of the said Act.

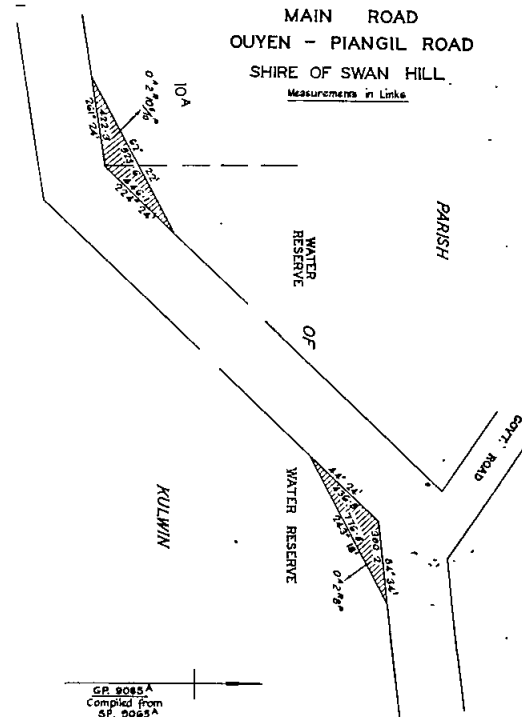
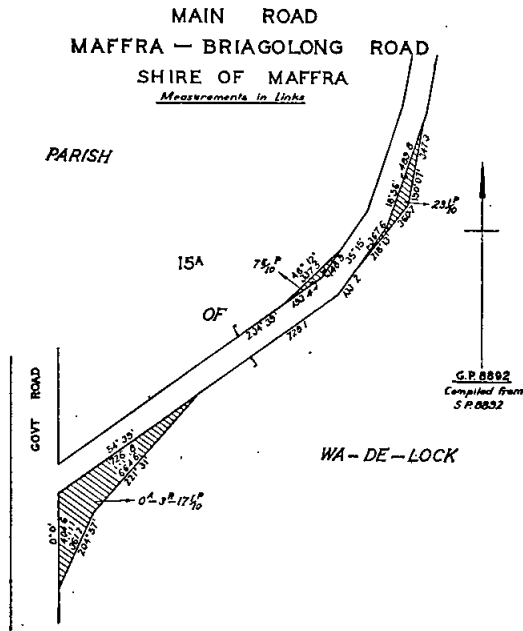

Resolution dated the Twenty-second day of May, One thousand nine hundred and seventy-two, made pursuant to section 21 of the *Country Roads Act 1958*, declaring the widening of the Stawell-Warracknabeal road in the Shire of Stawell as shown hatched on Plan numbered G.P.12608 hereunder to be part of a main road within the meaning and for the purposes of the said Act.

N. L. ALLANSON,  
Secretary.



COUNTRY ROADS BOARD.

RESOLUTIONS OF THE COUNTRY ROADS BOARD.

The Country Roads Board, in pursuance of the provisions of the *Country Roads Act 1958*, has passed Resolutions the dates whereof and the terms of which are scheduled hereunder:—

SCHEDULE.

Main roads.

Resolution dated the Fifth day of June, One thousand nine hundred and seventy-two, made pursuant to sections 21 and 58 of the *Country Roads Act 1958*, declaring the deviation from The Grand Ridge-road in the Shire of Alberton as indicated by diagonal hatching on Plans numbered G.P.12606 and G.P.12607 hereunder to be part of a main road within the meaning and for the purposes of the said Act, and also declaring that such deviation shall be in lieu of the existing road or part thereof indicated by cross-hatching and vertical hatching on the said plans which part indicated by cross-hatching on the said plans shall be discontinued.

MAIN ROAD  
THE GRAND RIDGE ROAD  
SHIRE OF ALBERTON  
*Measurements in links*

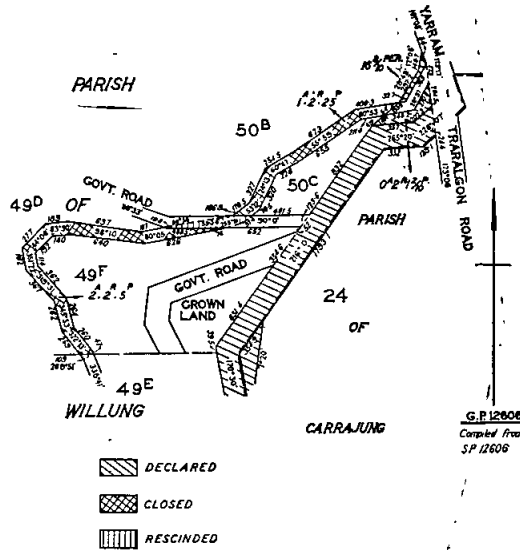

Resolution dated the Fifth day of June, One thousand nine hundred and seventy-two, made pursuant to section 21 of the *Country Roads Act 1958*, declaring the widening of the Koo-Wee-Rup-Longwarry road in the Shire of Cranbourne as shown hatched on Plan numbered G.P.9308 hereunder to be part of a main road within the meaning and for the purposes of the said Act

MAIN ROAD  
KOO-WEE-RUP — LONGWARRY ROAD  
SHIRE OF CRANBOURNE  
*Measurements in links*

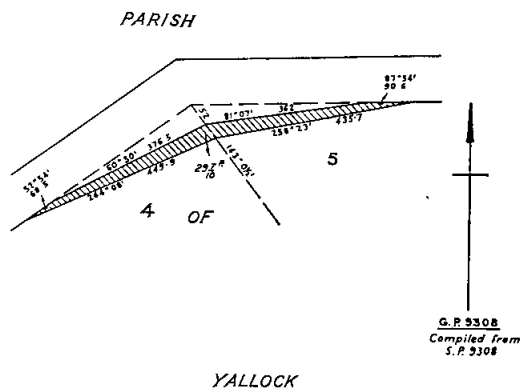

Resolution dated the Fifth day of June, One thousand nine hundred and seventy-two, made pursuant to section 21 of the *Country Roads Act 1958*, declaring the widening of the Castlemaine-Ballarat road in the Shire of Creswick as shown hatched on Plan numbered G.P.12702 hereunder to be part of a main road within the meaning and for the purposes of the said Act.

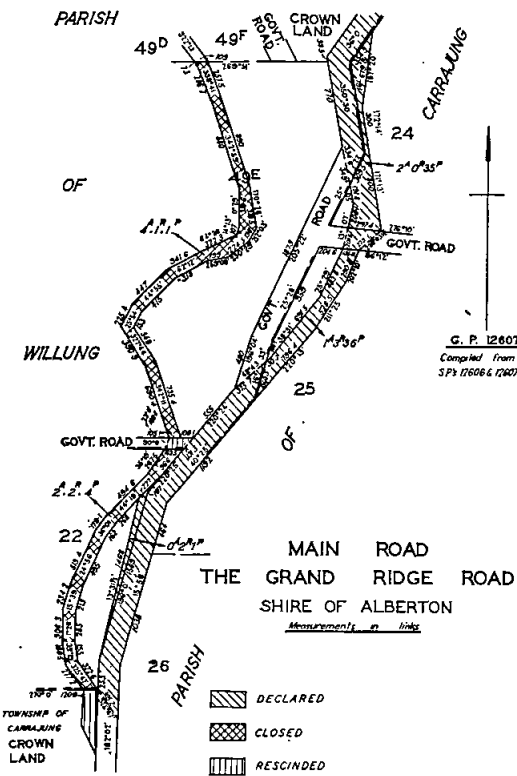

**MAIN ROAD  
CASTLEMAINE — BALLARAT ROAD**  
SHIRE OF CRESWICK  
*Measurements in Links*

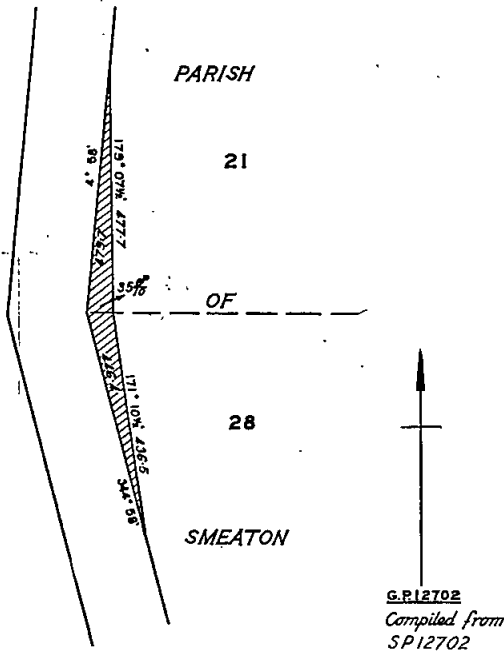

Resolution dated the Fifth day of June, One thousand nine hundred and seventy-two, made pursuant to section 21 of the *Country Roads Act 1958*, declaring the widening of the Portland-Casterton road in the Shires of Portland and Glenelg as shown hatched on Plan numbered G.P.9393 hereunder to be part of a main road within the meaning and for the purposes of the said Act.

**MAIN ROAD  
PORTLAND—CASTERTON ROAD**  
SHIRES OF PORTLAND & GLENELG  
*Measurements in Links*

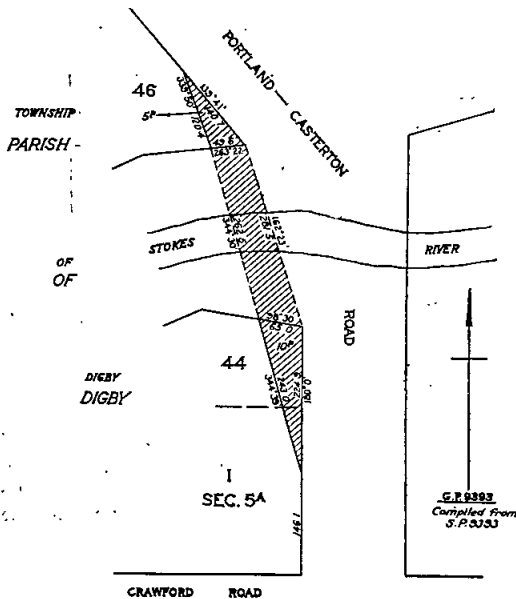

Resolution dated the Fifth day of June, One thousand nine hundred and seventy-two, made pursuant to section 21 of the *Country Roads Act 1958*, declaring the widening of the Hopetoun-Patchewollock road in the Shire of Karkaroc as shown hatched on Plan numbered G.P.9171 hereunder to be part of a main road within the meaning and for the purposes of the said Act.

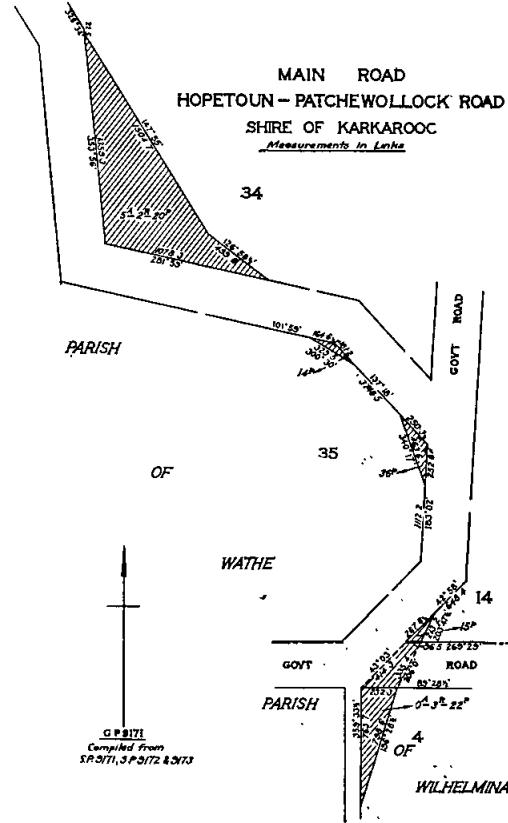

Resolution dated the Fifth day of June, One thousand nine hundred and seventy-two, made pursuant to section 21 of the *Country Roads Act 1958*, declaring the widening of Strathfieldsaye-road in the Shire of Strathfieldsaye as shown hatched on Plan numbered G.P.9182 hereunder to be part of a main road within the meaning and for the purposes of the said Act.

**MAIN ROAD  
STRATHFIELDSAYE ROAD**  
SHIRE OF STRATHFIELDSAYE  
*Measurements in Links*

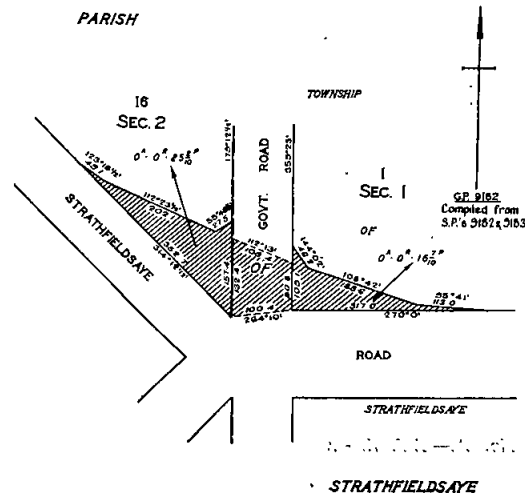

Resolution dated the Fifth day of June, One thousand nine hundred and seventy-two, made pursuant to section 21 of the *Country Roads Act 1958*, declaring the widening of the Warragul-Korumburra road in the Shire of Warragul as shown hatched on Plan numbered G.P.12671A hereunder to be part of a main road within the meaning and for the purposes of the said Act.

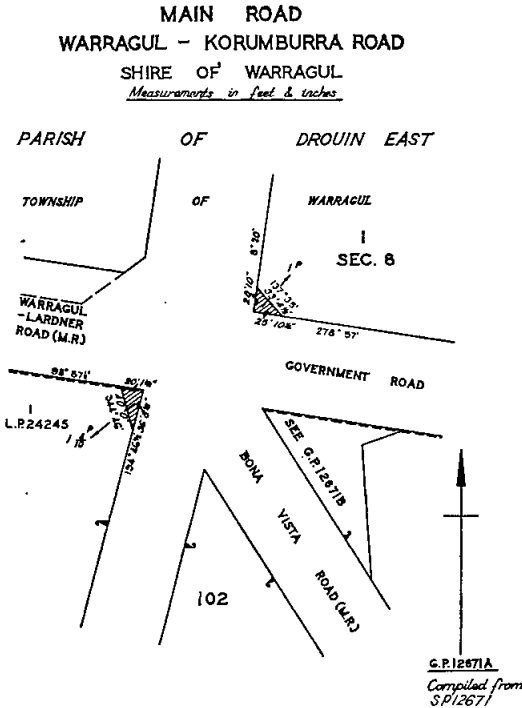

Resolution dated the Fifth day of June, One thousand nine hundred and seventy-two, made pursuant to section 21 of the *Country Roads Act 1958*, declaring the widening of the Bona Vista-road in the Shire of Warragul as shown hatched on Plan numbered G.P.12671B hereunder to be part of a main road within the meaning and for the purposes of the said Act.

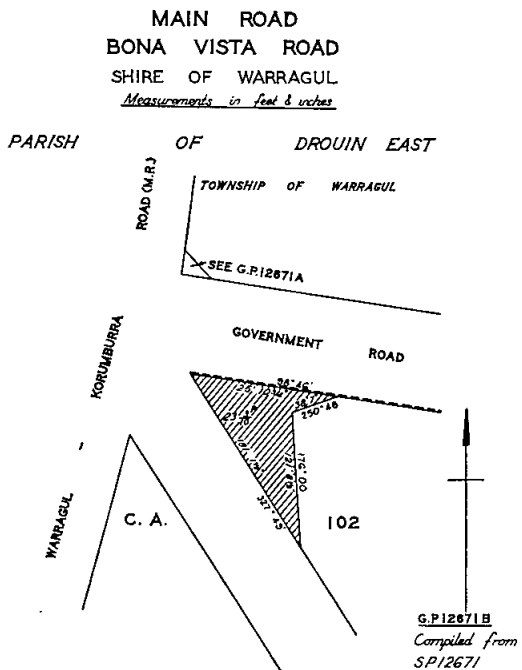

*Unclassified Road.*

Resolution dated the Fifth day of June, One thousand nine hundred and seventy-two, made pursuant to sections 21 and 110 of the *Country Roads Act 1958* declaring the road in the Shire of Ballan as shown hatched on Plan numbered G.P.11943 hereunder to be a road (Cartons-road) within the meaning and for the purposes of the said Act.

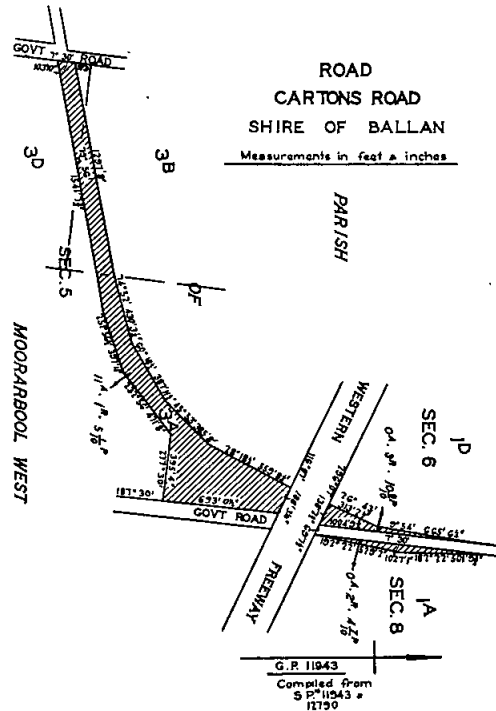

N. L. ALLANSON,  
Secretary.

8th June, 1972.

*Labour and Industry Act 1958.*

**ORDER OF EXEMPTION UNDER SECTION 80c.**

Whereas pursuant to section 80c of the *Labour and Industry Act 1958* as amended by the *Labour and Industry (Further Amendment) Act 1969* the Council of the Shire of Bacchus Marsh has applied to the Minister for an order exempting certain shopkeepers of a shop in its municipal district from being required to close and keep closed their shop in accordance with the provisions of Part VI. of the said Act.

And whereas I have considered the report of the Minister for Tourism obtained in accordance with the provisions of sub-section (4) of section 80c of the said Act:

Now therefore, I, Vernon Francis Wilcox, Her Majesty's Acting Minister of Labour and Industry in the State of Victoria, do pursuant to the aforesaid section 80c of the *Labour and Industry Act 1958* make this order granting exemption to:

Timothy Holdsworth Hewitson and Anne Patricia Hewitson of 135 Main-street, Bacchus Marsh, being shopkeepers within the Township of Bacchus Marsh from being required to close and keep closed their shop on—

Saturdays between the hours of 1 p.m. and 6 p.m. and Sundays and public holidays between the hours of 9 a.m. and 6 p.m., provided that such exemption shall not apply to Good Friday or Anzac Day.

Dated at Melbourne, this 15th day of June, 1972.

V. F. WILCOX,  
Acting Minister of Labour and Industry.

*Private Agents Act 1966.*

**NOTICE OF RECEIPT OF APPLICATIONS FOR LICENCES UNDER THE PROVISIONS OF THE PRIVATE AGENTS ACT 1966.**

The Clerk(s) of the Magistrates' Court(s) as listed hereunder hereby give notice that applications, as under, have been lodged for hearing by the said Court(s) on the date(s) specified.

Any person desiring to object to any of such applications must—

- (a) lodge with the respective Clerk of the Magistrates' Court a notice in the prescribed form of his objection and of the grounds thereof;
- (b) cause a copy of such notice to be served personally or by post upon the applicant at least three days before the hearing of the application; and
- (c) send or deliver—
  - (i) where the objection is not made by the officer in charge of the police district in which the Court is situated—a copy of the notice to such officer; and
  - (ii) where the objection is not made by the Registrar or Deputy Registrar—a copy to the Registrar.

Full Name of Applicant or in the Case of a Firm or Corporation, of the Nominee.	Place of Abode of Applicant or Nominee.	Name of Firm or Corporation.	Address for Registration.	Type of Licence.	Date of Hearing of Application.
<b>MAGISTRATES' COURT, HORSHAM.</b>					
Andrews, Graeme Edward ..	23 Lynnott-street, Horsham	.. .. .	14 Railway-avenue, Horsham	Watchman	28.6.72
Dated at Horsham this 6th day of June, 1972.					
P. W. WESTMORE, Clerk of the Magistrates' Court.					
<b>MAGISTRATES' COURT, MORNINGTON.</b>					
Crawley, Neil Arthur ..	464 The Esplanade, Mt. Martha	.. .. .	701 Nepean Highway, McCrae	Watchman	5.7.72
Dated at Mornington this 2nd day of June, 1972.					
D. O'KEEFE, Clerk of the Magistrates' Court.					
<b>MAGISTRATES' COURT, BALLARAT.</b>					
Eltringham, Cyril Kingsford ..	1 Coonatta-street, Alfredton	.. .. .	1 Coonatta-street, Alfredton	Process Server	29.6.72
Dated at Ballarat this 7th day of June, 1972.					
E. N. KINCHINGTON, Clerk of the Magistrates' Court.					
<b>MAGISTRATES' COURT, CAMBERWELL.</b>					
Anderson, Ian Stuart ..	494 Hawthorn-road, Caulfield	.. .. .	250 Canterbury-road, Surrey Hills	Inquiry Agent	27.6.72
Dated at Camberwell this 6th day of June, 1972.					
J. C. TOBIN, Clerk of the Magistrates' Court.					
<b>MAGISTRATES' COURT, CHELTENHAM.</b>					
Stillman, Terence Richard ..	84 East Boundary-road, East Bentleigh	.. .. .	84 East Boundary-road, East Bentleigh	Process Server (Individual)	7.7.72
Dated at Cheltenham this 13th day of June, 1972.					
J. T. FERGUSON, Clerk of the Magistrates' Court.					
<b>MAGISTRATES' COURT, OAKLEIGH.</b>					
Burrowes, Eric John ..	122 Bedford-road, East Ringwood	.. .. .	6 Hamilton-place, Mt. Waverley	Watchman	30.6.72
Dated at Oakleigh this 8th day of June, 1972.					
G. MEEHAN, Clerk of the Magistrates' Court.					
<b>MAGISTRATES' COURT, FOOTSCRAY.</b>					
Lacoste, Pierre ..	18 Vincent-street, Coburg	.. .. .	18 Vincent-street, Coburg	Watchman	6.7.72
Dated at Footscray this 13th day of June, 1972.					
D. A. THOMPSON, Clerk of the Magistrates' Court.					
<b>MAGISTRATES' COURT, BROADMEADOWS.</b>					
Eymond, Lewis Henry ..	1 Flynn-crescent, Broadmeadows	.. .. .	7 Deakin-court, Broadmeadows	Watchman	5.7.72
Dated at Broadmeadows this 13th day of June, 1972.					
P. LIVINGSTONE, Clerk of the Magistrates' Court.					
<b>MAGISTRATES' COURT, MELBOURNE.</b>					
Schramm, Graeme Paul ..	28 Sheldon-avenue, Mooroolbark	Corporate Associates Pty. Ltd.	5th Floor, Bank of Adelaide Building, 267 Collins-street, Melbourne	Commercial Agent (Nominee)	5.7.72
Schramm, Graeme Paul ..	" " "	" " "	" " "	Process Server (Nominee)	"
Schramm, Graeme Paul ..	" " "	" " "	" " "	Inquiry Agent (Nominee)	"
Schramm, Graeme Paul ..	" " "	" " "	" " "	Commercial Sub-Agent (Individual)	"
Schramm, Graeme Paul ..	" " "	" " "	" " "	Process Server (Individual)	"
Schramm, Graeme Paul ..	" " "	" " "	" " "	Inquiry Agent (Individual)	"
Dated at Melbourne this 13th day of June, 1972.					
G. L. WEBSTER, Clerk of the Magistrates' Court.					

PRIVATE AGENTS—continued.

Full Name of Applicant or in the Case of a Firm or Corporation, of the Nominee.	Place of Abode of Applicant or Nominee.	Name of Firm or Corporation.	Address for Registration.	Type of Licence.	Date of Hearing of Application.
<b>MAGISTRATES' COURT, MELBOURNE.</b>					
Smith, Dorothy Margaret ..	85 Martin-street, Gardenvale	Complete Mercantile Agency	5th Floor, Mitchell House, 358 Lonsdale-street, Melbourne	Commercial Agent	5.7.72
Warriner, Richard ..	101 New-street, Ringwood	Security Watching Co. Pty. Ltd.	2nd Floor, 561 Bourke-street, Melbourne	Watchman ..	5.7.72
Dated at Melbourne this 15th day of June, 1972.					
G. L. WEBSTER, Clerk of the Magistrates' Court.					
<b>MAGISTRATES' COURT, SPRINGVALE.</b>					
Hastie, Ralph Basil ..	Lot 55 Railway-avenue, Beaconsfield	A. Starvaggi ..	21 Clarke-road, Springvale North	Watchman ..	4.7.72
Dated at Springvale this 13th day of June, 1972.					
J. B. DENNIS, Clerk of the Magistrates' Court.					
<b>MAGISTRATES' COURT, BENDIGO.</b>					
Callaway, Kevin Percival ..	St. Killians-road, White Hills, Bendigo	.. .. .	27 Queens-street, Bendigo	Watchman ..	3.7.72
Frise, Walter John Henry ..	6 Graham-street, Kangaroo Flat, Bendigo	.. .. .	" " "	" ..	7.7.72
Dated at Bendigo this 9th day of June, 1972.					
K. G. MASON, Clerk of the Magistrates' Court.					
<b>MAGISTRATES' COURT, SOUTH MELBOURNE.</b>					
Jackson, Fred Duncan ..	4/13 Glenhuntly-road, Elwood ..	Dunlops Automotive Montague, Melbourne	c/o. Mr. T. Anderson, Chief Security Officer, Dunlops Automotive Division, Montague, Melbourne	Watchman ..	5.7.72
Dated at South Melbourne this 15th day of June, 1972.					
R. J. McALLISTER, Clerk of the Magistrates' Court.					

**DEPARTMENT OF MINES.**  
 Subject to any necessary excisions &c., it is proposed to grant the following mining leases:—  
 7147, Maryborough; Walter Lewis Griffiths, Peter G. Griffiths; 20a. 3r. 4p., Parish of Maryborough.  
 9010, Mineral; Roland Walton, Cecil John Bock, William James Marshall; 368a. 3r. 10p., Parish of Boorgunyah.  
 9122, Mineral; Roland Walton, Cecil John Bock, William James Marshall; 577a. 0r. 30p., Parish of Boorgunyah.  
 9165, Mineral; Shaw River Alluvials No Liability; 354a. 2r. 26p., Parish of Burrowye.  
 9192, Mineral; Gippsland Minerals No Liability; 35a. 0r. 14p., Parish of Deddick.

**APPLICATIONS FOR MINING LEASES DECLARED ABANDONED.**  
 11405, Bendigo; E. F. McKenzie & Sons; 43 acres, Parish of Axedale.  
 5652, Gippsland; Brian William Eastwood, Charles Raymond Illingworth, Arthur Banbrook, Keith James Whitting, Charlie Golya, Charles David Illingworth; 110 acres, Parish of Tanjil.  
 8960, Mineral; Eastern Prospectors Pty. Ltd.; 636a. 0r. 10p., Parishes of Costerfield, Heathcote.  
 8993, Mineral; Stanley Irvine Lincoln, Ray Alan Borchers, Duncan Robert McLean, Arthur Maxwell Hamilton; 160 acres, Parish of Redbank.

**APPLICATION FOR MINING LEASE REFUSED:**  
 8840, Mineral; Maxwell Thomas Goode, Phillip Langdon Goode; 20 acres, Parish of Tanjil East.

**MINING LEASES TRANSFERRED.**  
 5648, Gippsland; from Frank Edward Evans to Toombon Proprietary Limited.  
 5649, Gippsland; from Frank Edward Evans to Toombon Proprietary Limited.

**MINING LEASE EXPIRED.**  
 8634, Mineral; Henry Owen Rodwell; 3a. 1r. 10p., Parish of Yehrip.

**EXPLORATION LICENCE CANCELLED.**  
 215, Exploration Licence; Bulleen Investments Pty. Limited; 72 square miles, Counties of Anglesey, Evelyn.

**TAILINGS LICENCES GRANTED.**  
 3773, Tailings Licence; Malcolm John McClure; to remove tailings from the "Ajax Shaft" dump, Parish of Castlemaine.  
 3788, Tailings Licence; William Akers; to remove tailings from the "Caledonia Mine" dump, Parish of Dunolly.

**APPLICATIONS FOR EXTRACTIVE INDUSTRY LICENCES REFUSED.**  
 408, Extractive Industry Licence; Roy Roylance; 140 acres, Parish of Toora.  
 414, Extractive Industry Licence; A. M. Dobson, B. C. Dobson; 30 acres, Parish of Acheron.

**APPLICATION FOR EXTRACTIVE INDUSTRY LICENCE DECLARED ABANDONED.**  
 205, Extractive Industry Licence; Hoffman Brick & Potteries Pty. Ltd.; 17 acres, Parish of Tanjil East.

**EXTRACTIVE INDUSTRY LICENCES GRANTED.**  
 69, Extractive Industry Licence; Campbellfield Clay Co. Pty. Limited; 46a. 1r.±, Parish of Will-will-rook.  
 139, Extractive Industry Licence; Brick and Pipe Industries Limited; 17a. 3r. 19p.±, Parish of Mulgrave.  
 299, Extractive Industry Licence; Albert Henry Bicknell, Bruce Alfred Heywood, 23a. 2r. 19p., Parish of Maryvale.  
 310, Extractive Industry Licence; Charles Frederick Henderson; 10 acres±, Parish of Glencoe.  
 576, Extractive Industry Licence; Edward Matthew Fitzpatrick, Patrick Joseph Fitzpatrick; 51a. 3r. 10p.±, Parish of Katunga.

J. C. M. BALFOUR,  
 Minister of Mines.

COMMONWEALTH OF AUSTRALIA.  
Petroleum (Submerged Lands) Act 1967-1968.

STATE OF VICTORIA.  
Petroleum (Submerged Lands) Act 1967.

VARIATION OF PIPELINE LICENCE VIC/PL1.

I, James Charles Murray Balfour, the Designated Authority in respect of the area specified as being adjacent to the State of Victoria, have considered all matters submitted to me in connexion with the application by Hematite Petroleum Proprietary Limited and Esso Exploration and Production Australia Inc. of 500 Bourke-street, Melbourne, Victoria, and 380 Lonsdale-street, Melbourne, Victoria respectively for the variation of the pipeline licence in respect of the pipeline from the Barracouta "A" platform to the shore at mean low water level and I hereby vary the pipeline licence as follows:—

FIRST SCHEDULE.

Pipeline Route.

The existing schedule is to be deleted and the following substituted:—

"The route of the pipeline shall be along a line no point on which is more than 150 metres from the line commencing at the Barracouta Platform located at or about a point latitude 38 deg. 17 min. 53 sec. south, longitude 147 deg. 40 min. 29 sec. east; thence on a bearing 301 deg. 24 min. 40 sec. for a distance of 24,402.3 metres on which point the line intersects the coast at mean low water level at or about latitude 38 deg. 11 min. 05 sec. south, longitude 147 deg. 26 min. 10 sec. east."

Dated this 15th day of June, 1972.

Made under the Petroleum (Submerged Lands) Act 1967-1968 of the Commonwealth of Australia. Made under the Petroleum (Submerged Lands) Act 1967 of the State of Victoria.

JIM BALFOUR,  
Designated Authority.

COMMONWEALTH OF AUSTRALIA.  
Petroleum (Submerged Lands) Act 1967-1968.

STATE OF VICTORIA.  
Petroleum (Submerged Lands) Act 1967.

VARIATION OF PIPELINE LICENCE No. VIC/PL4.

I, James Charles Murray Balfour, the Designated Authority in respect of the area specified as being adjacent to the State of Victoria, have considered all matters submitted to me in connexion with the application by Hematite Petroleum Proprietary Limited and Esso Exploration and Production Australia Inc. of 500 Bourke-street, Melbourne, Victoria, and 380 Lonsdale-street, Melbourne, Victoria respectively for the variation of the pipeline licence in respect of the pipeline from the Barracouta "A" platform to the shore at mean low water level and I hereby vary the pipeline licence as follows:—

FIRST SCHEDULE.

Route of Pipeline.

The existing Schedule shall be deleted and the following substituted:—

"The route of the pipeline shall be along a line no point on which is more than 150 metres from the line commencing at the Barracouta Platform located at or about a point latitude 38 deg. 17 min. 53 sec. south, longitude 147 deg. 40 min. 29 sec. east; thence on a bearing 314 deg. 30 min. 51 sec. for a distance of 23,642.0 metres at which point the line intersects the coast at mean low water level at or about latitude 38 deg. 08 min. 59 sec. south, longitude 147 deg. 28 min. 52 sec. east."

SECOND SCHEDULE.

Specification.

Clause E of the specification shall be deleted and the following amended clause included:—

"(E) Trenching and Burial

- (a) From the point of intersection of the pipeline with the coast at mean low water to a point 305 metres seaward of that point the pipeline shall be buried to a depth of at least 1.2 metres. In addition to the 1.2 metre burial, pipeline anchors whose design and installation procedures have been approved by the Director, Oil and Gas Division, Mines Department shall be installed at 15 metre centres over this 305 metre section.
- (b) Seaward from the 305 metre mark mentioned in sub-paragraph (a) above to the 1,700 metre mark, pipeline anchors whose design and installation procedures have been approved by the said Director, Oil and Gas Division, shall be installed at 15 metre centres along the pipeline.
- (c) Seaward from the said 1,700 metre mark to the 11,590 metre mark, pipeline anchors whose design and installation procedures have been approved by the said Director, Oil and Gas Division, shall be installed at 24 metre centres along the pipeline.
- (d) From the said 11,590 metre mark to the Barracouta "A" platform, pipeline anchors whose design and installation procedures have been approved by the said Director, Oil and Gas Division, shall be installed at 30 metre centres along the pipeline."

Dated this 15th day of June, 1972.

Made under the Petroleum (Submerged Lands) Act 1967-1968 of the Commonwealth of Australia. Made under the Petroleum (Submerged Lands) Act 1967 of the State of Victoria.

JIM BALFOUR,  
Designated Authority.

COMMONWEALTH OF AUSTRALIA.

*Petroleum (Submerged Lands) Act 1967-1968.*

STATE OF VICTORIA.

*Petroleum (Submerged Lands) Act 1967.*

## VARIATION OF PIPELINE LICENCE VIC/PL5.

I, James Charles Murray Balfour, the Designated Authority in respect of the area specified as being adjacent to the State of Victoria, have considered all matters submitted to me in connexion with the application by Hematite Petroleum Proprietary Limited and Esso Exploration and Production Australia Inc. of 500 Bourke-street, Melbourne, Victoria, and 380 Lonsdale-street, Melbourne, Victoria respectively for the variation of the pipeline licence in respect of the pipeline from the Halibut 'A' platform to the shore at mean low water level and I hereby vary the pipeline licence as follows:—

## FIRST SCHEDULE.

*Route of Pipeline.*

The existing Schedule is to be deleted and the following substituted:—

"The route of the pipeline shall be along a line no point on which is more than 150 metres from a line commencing at the south-western corner of the Halibut 'A' platform which is located at or about a point latitude 38 deg. 24 min. 21 sec. south, longitude 148 deg. 19 min. 10 sec. east, and bearing west 269 deg. 22 min. 33 sec. for a distance of 366.4 metres; thence swinging in a north-westerly direction along an arc the radius of which is 3,048 metres for a distance of 4,090.10 metres; thence bearing 344 deg. 49 min. 58 sec. for a distance of 1,426.6 metres; thence bearing 347 deg. 50 min. 03 sec. for a distance of 3,973.7 metres; thence bearing 345 deg. 14 min. 35 sec. for a distance of 3,892.4 metres; thence bearing 339 deg. 18 min. 52 sec. for a distance of 1,118.9 metres; thence bearing 04 deg. 25 min. 12 sec. for a distance of 1,559.8 metres; thence bearing 331 deg. 49 min. 04 sec. for a distance of 1,412.4 metres; thence bearing 346 deg. 13 min. 38 sec. for a distance of 2,510.6 metres; thence bearing 355 deg. 56 min. 15 sec. for a distance of 1,446.6 metres; thence bearing 325 deg. 11 min. 56 sec. for a distance of 1,927.8 metres; thence bearing 298 deg. 24 min. 57 sec. for a distance of 5,762.0 metres; thence bearing 299 deg. 24 min. 44 sec. for a distance of 38,389.6 metres; thence bearing 293 deg. 42 min. 08 sec. for a distance of 3,371.6 metres; thence bearing 299 deg. 25 min. 20 sec. for a distance of 4,114.1 metres, at which point the pipeline intersects the coast at mean low water level at or about latitude 38 deg. 00 min. 00 sec. south, longitude 147 deg. 42 min. 11 sec. east."

## SECOND SCHEDULE.

*Specification.*

Clause (E) Trenching and Burial, sub-clause (1) is to be deleted and the following substituted:—

- (i) "From the point of intersection of the pipeline with the foreshore at mean low water to a point 300 metres seaward of that point the pipeline shall be buried to a minimum depth of 1.2 metres below the natural seabed and in addition subsoil pipeline anchors, whose design and installation procedures have been approved by the Director, Oil and Gas Division, Mines Department shall be installed at 24 metre intervals along this section of the pipeline. From the 300 metre mark mentioned above and seaward to the 7,230 metre mark the pipeline shall be buried to provide a minimum depth of cover of 0.6 metres below the natural seabed.

From the 7,230 metre mark to the Halibut 'A' platform the pipeline shall be laid on the natural seabed."

Dated this 15th day of June, 1972.

Made under the *Petroleum (Submerged Lands) Act*  
1967-1968 of the Commonwealth of Australia.

Made under the *Petroleum (Submerged Lands) Act*  
1967 of the State of Victoria.

JIM BALFOUR,

Designated Authority.

COMMONWEALTH OF AUSTRALIA.

*Petroleum (Submerged Lands) Act 1967-1968.*

STATE OF VICTORIA.

*Petroleum (Submerged Lands) Act 1967.*

## VARIATION OF PIPELINE LICENCE VIC/PL2.

I, James Charles Murray Balfour, the Designated Authority in respect of the area specified as being adjacent to the State of Victoria, have considered all matters submitted to me in connexion with the application by Hematite Petroleum Proprietary Limited and Esso Exploration and Production Australia Inc. of 500 Bourke-street, Melbourne, Victoria, and 380 Lonsdale-street, Melbourne, Victoria respectively for the variation of the pipeline licence in respect of the pipeline from the Marlin 'A' platform to the shore at mean low water level and I hereby vary the pipeline licence as follows:—

## FIRST SCHEDULE.

*Pipeline Route.*

The existing Schedule is to be deleted and the following substituted:—

"The route of the pipeline shall be along a line no point on which is more than 150 metres from a line commencing from the south-west corner of the Marlin platform, which is located at or about a point latitude 38 deg. 13 min. 55 sec. south, longitude 148 deg. 13 min. 10 sec. east and bearing west 264 deg. 53 min. 22 sec. for a distance of 373.6 metres; thence swinging in a north-westerly direction along an arc, the radius of which is 3,048 metres for a distance of 1,832.4 metres to a line bearing 303 deg. 49 min. 52 sec. for a distance of 7,713.1 metres; thence bearing 299 deg. 24 min. 41 sec. for a distance of 19,106.7 metres; thence bearing 303 deg. 05 min. 08 sec. for a distance of 1,122.4 metres; thence bearing 295 deg. 48 min. 51 sec. for a distance of 1,146.5 metres; thence bearing 299 deg. 24 min. 49 sec. for a distance of 21,285.4 metres; at which point the line intersects the coast at mean low water level at or about latitude 38 deg. 00 min. 16 sec. south, longitude 147 deg. 41 min. 45 sec. east."

## SECOND SCHEDULE.

## Conditions.

Condition 10 (6) shall be deleted and the following amended condition substituted:—

- “(a) From the point of intersection of the pipeline with the coast at mean low water to a point 305 metres seaward of that point the pipeline shall be buried to a depth of at least 1.2 metres. In addition to the 1.2 metre burial, pipeline anchors whose design and installation procedures have been approved by the Director, Oil and Gas Division, Mines Department shall be installed at 18 metre centres over this 305 metre section.
- (b) From the 305 metre mark to a point on the pipeline 17,150 metres seaward or to the water depth contour of 45 metre closest to the Marlin platform the pipeline shall be buried to a minimum depth of 0.6 metres.
- (c) From the point on the pipeline determined by sub-paragraph (b) above to the said Marlin platform the pipeline shall be laid on the natural seabed.”

Dated this 15th day of June, 1972.

Made under the *Petroleum (Submerged Lands) Act*  
1967–1968 of the Commonwealth of Australia.

Made under the *Petroleum (Submerged Lands) Act*  
1967 of the State of Victoria.

JIM BALFOUR,  
Designated Authority.

## COMMONWEALTH OF AUSTRALIA.

*Petroleum (Submerged Lands) Act* 1967–1968.

## STATE OF VICTORIA.

*Petroleum (Submerged Lands) Act* 1967.

## VARIATION OF PIPELINE LICENCE VIC/PL6.

I, James Charles Murray Balfour, the Designated Authority in respect of the area specified as being adjacent to the State of Victoria, have considered all matters submitted to me in connexion with the application by Hematite Petroleum Proprietary Limited and Esso Exploration and Production Australia Inc. of 500 Bourke-street, Melbourne, Victoria, and 380 Lonsdale-street, Melbourne, Victoria respectively for the variation of the pipeline licence in respect of the pipeline from the Kingfish 'A' platform to the Kingfish 'B' platform and I hereby vary the pipeline licence as follows:—

## FIRST SCHEDULE.

## Pipeline Route.

The existing Schedule is to be deleted and the following substituted:—

“The route of the pipeline shall be along a line no point on which is more than 150 metres from a line commencing from a point on the Kingfish 'A' platform which point on the platform is located at or about a point of latitude 38 deg. 35 min. 52.5 sec. south, longitude 148 deg. 08 min. 38.8 sec. east; thence bearing west 82 deg. 18 min. 15 sec. for a distance of 921.9 metres; thence bearing west 90 deg. 08 min. 07 sec. for a distance of 2,876.4 metres to a point on the Kingfish 'B' platform which point on the platform is located at or about a point of latitude 38 deg. 35 min. 54.7 sec. south, longitude 148 deg. 11 min. 15.5 sec east.”

Dated this 15th day of June, 1972.

Made under the *Petroleum (Submerged Lands) Act*  
1967–1968 of the Commonwealth of Australia.

Made under the *Petroleum (Submerged Lands) Act*  
1967 of the State of Victoria.

JIM BALFOUR,  
Designated Authority.

## COMMONWEALTH OF AUSTRALIA.

*Petroleum (Submerged Lands) Act* 1967–1968.

## STATE OF VICTORIA.

*Petroleum (Submerged Lands) Act* 1967.

## VARIATION OF PIPELINE LICENCE No. VIC/PL7.

I, James Charles Murray Balfour, the Designated Authority in respect of the area specified as being adjacent to the State of Victoria, have considered all matters submitted to me in connexion with the application by Hematite Petroleum Proprietary Limited and Esso Exploration and Production Australia Inc. of 500 Bourke-street, Melbourne, Victoria, and 380 Lonsdale-street, Melbourne, Victoria respectively for the variation of the pipeline licence in respect of the pipeline from the Kingfish 'B' platform to the Halibut 'A' platform, and I hereby vary the pipeline licence as follows:—

## FIRST SCHEDULE.

## Route of Pipeline.

The existing Schedule shall be deleted and the following substituted:—

“The route of the pipeline shall be along a line no point on which is more than 150 metres from the line commencing at the Halibut 'A' platform located at or about a point latitude 38 deg. 24 min. 21 sec. south, longitude 148 deg. 19 min. 10 sec. east; thence on a bearing 188 deg. 43 min. 16 sec. for a distance of 956.8 metres; thence bearing 204 deg. 29 min. 07 sec. for a distance of 2,896.7 metres; thence bearing 203 deg. 53 min. 16 sec. for a distance of 11,928.1 metres; thence bearing 210 deg. 29 min. 31 sec. for a distance of 875.4 metres; thence bearing 199 deg. 07 min. 32 sec. for a distance of 1,257.6 metres; thence bearing 204 deg. 18 min. 41 sec. for a distance of 3,598.3 metres; thence bearing 219 deg. 25 min. 05 sec. for a distance of 1,122.2 metres; thence bearing 248 deg. 24 min. 17 sec. for a distance of 1,634.6 metres; thence bearing 267 deg. 01 min. 06 sec. for a distance of 1,045.6 metres to Kingfish 'B' platform which is located at or about a point latitude 38 deg. 35 min. 55 sec. south, longitude 148 deg. 11 min. 15 sec. east.

Dated this 15th day of June, 1972.

Made under the *Petroleum (Submerged Lands) Act*  
1967–1968 of the Commonwealth of Australia.

Made under the *Petroleum (Submerged Lands) Act*  
1967 of the State of Victoria.

JIM BALFOUR,  
Designated Authority.



**TERM OF PETROLEUM EXPLORATION PERMIT EXTENDED.**

68. Petroleum Exploration Permit; Leon James Charles Say and Pursuit Oil No Liability; 149 square miles, County of Grant.

J. C. M. BALFOUR,  
Minister of Mines.

**COMPANIES ACT 1961.**

Notice is hereby given that in pursuance of section 308 (4) of the Companies Act 1961, the names of the companies referred to below have been struck off the Register, and on publication of this notice in the Government Gazette the said companies will be dissolved.

Dated this 16th day of June, 1972.

E. B. MITCHAM,  
Deputy Registrar of Companies.

Companies Office,  
Melbourne.

**COMPANIES ABOVE REFERRED TO:**

Name of Company.	Number of Registration.
W. E. Loft's Park Garage Pty. Ltd.	13811
A. Glover and Sons Pty. Ltd.	15546
Britannia Cycle Company Pty. Ltd.	25760
Woolcot Weaving Mills Pty. Ltd.	30677
Upper Yarra Transport Pty. Ltd.	33180
H.D.A. Vinal Pty. Ltd.	34447
Northcote Motors Pty. Ltd.	39493
J. Rahaley (Victoria) Pty. Ltd.	41027
Motormasters Pty. Ltd.	44091
P.J.B. Nominees Pty. Ltd.	49342
F. Baylis Pty. Ltd.	49475
Balzary Holdings Pty. Ltd.	49742
Dunric Pty. Ltd.	50459
Home Freezer-Foods Pty. Ltd.	50649
Amana Food Products Pty. Ltd.	51096
Ansell Distributors (S.A.) Pty. Ltd.	53125
Nutex Export Corporation Pty. Ltd.	53126
Acardo Pty. Ltd.	53679
Phoenix Ventilation Co. (Vic.) Pty. Ltd.	58427
Evergreen Memorial Park Pty. Ltd.	58459
T. J. Power's Engineering Pty. Ltd.	59695
Austalent Pty. Ltd.	61916
Robinson Field Welding Service Pty. Ltd.	64654
Bronhill Finny Productions Pty. Ltd.	64827
Elros Trading Pty. Ltd.	65244
George Wishart Investments Pty. Ltd.	66003
M.B.A. (Credits) Pty. Ltd.	68595
J. G. Rouda & Associates Pty. Ltd.	69870
Wilton Constructions Pty. Ltd.	69921
Continental Plastics (Asia) Pty. Ltd.	71090
Namrec Pty. Ltd.	71251
Aeroplan Airtel Pty. Ltd.	71746
Atsfatamp Pty. Ltd.	73731
Diamond Valley Taxis Ltd.	75275
Freeman and O'Loughlin Pty. Ltd.	77050
Coldhaul Transport Pty. Ltd.	77868
Adee Sportswear Pty. Ltd.	86437
Leets Pty. Ltd.	87682

**FODDER SUBSIDY SCHEME.**

**GIPPSLAND DROUGHT AREAS.**

It is hereby notified that farmers engaged in a sheep or predominantly sheep enterprise who purchase wheat, oats or barley to feed livestock being depastured on their home farms situated in any Municipality which has been declared a drought area, are eligible to apply for a subsidy in respect of purchased grain fed to livestock, such subsidy being 15 cents per bushel for oats and barley and 25 cents per bushel for wheat.

The procedure to be followed to obtain the subsidy varies in respect of grain purchased prior to 21st June, 1972 and grain purchased after that date. Full details are set out in an explanatory brochure, copies of which, together with application forms, are obtainable from local Shire Offices, Department of Agriculture Offices or the Offices of the Rural Finance and Settlement Commission at 325 Collins-street, Melbourne and its Regional Office, Warragul.

M. J. CRONIN,  
Secretary.

Rural Finance and Settlement Commission,  
Melbourne, 21st June, 1972.

**LOCAL GOVERNMENT DEPARTMENT.**

**ORDER CONFIRMED.—SHIRE OF BULLA.**

The Minister of the Crown administering the Local Government Act 1958, on the 2nd day of June, 1972, confirmed the Order hereinafter referred to in pursuance of section 514 of the said Act namely—

An Order of the Council of the Shire of Bulla made on the 5th April, 1972, directing the compulsory taking of part of Crown portion 14, Parish of Bulla Bulla, being the land shown by hachure on the plan hereunder for the purpose of constructing; portion of Gellies-road, Sunbury.

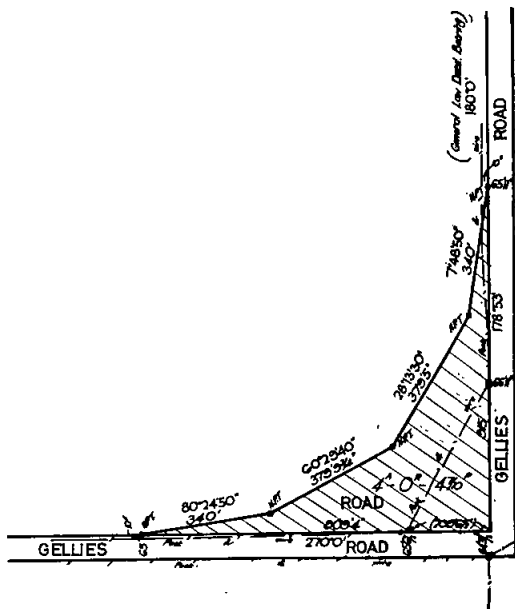

A. J. HUNT,  
Minister for Local Government.

Local Government Department,  
Melbourne (1341313).

**Liquor Control Act 1968.**

**APPOINTMENT OF LICENSING INSPECTORS.**

In accordance with the authority conferred upon me by sub-section (1) of section 22 of the Liquor Control Act 1968; I, Reginald Jackson, Chief Commissioner of Police, hereby appoint the following Officers of Police as Licensing Inspectors for the Divisions of the Police Districts as shown:—

*Division Number; Police District; Rank and Name.*

One; Westernport; Superintendent Albert Verdun Thomson.

One; Wimmera; Chief Inspector Stanley McKenzie (vice Superintendent A. V. Thomson).

15th June, 1972.

R. JACKSON,  
Chief Commissioner of Police.

**Melbourne and Metropolitan**

**BOARD OF WORKS.**

**GENERAL NOTICE.**

The Melbourne and Metropolitan Board of Works having made provision for carrying off the sewage of each and every property which or any part of which is situate in the Sewerage Areas hereinafter described doth hereby declare that on and after the 21st day of July, 1972, each and every property so situate shall be deemed to be a sewered property within the meaning of the Melbourne and Metropolitan Board of Works Act 1958.

The Sewerage Areas hereinbefore referred to are:—

**Sewerage Area No. 2479.**

**City of Sunshine.**—Commencing at the junction of Meadowbank-drive and Furlong-road; thence westerly along Furlong-road; northerly along the western

boundaries of lots 1 Furlong-road and 10 to 20 and 57 Meadowbank-drive, easterly along the northern boundaries of lots 57 and 99 Meadowbank-drive, northerly along portion of the western boundary of lot 97 Shipley-court, easterly along Shipley-court, south-easterly along the north-eastern boundary of lot 92 Shipley-court, northerly along portion of the western boundary of lot 1 Furlong-road, easterly along the northern boundary of the said lot 1, southerly along Cooke-avenue, westerly along Furlong-road to the commencing point.

Sewerage Area No. 2480.

*Shire of Whittlesea.*—Commencing at the junction of Acacia-street and Alexander-avenue on the boundary of Sewerage Area No. 2064; thence westerly and generally northerly following the said boundary to The Boulevard, north-easterly along The Boulevard, southerly along Dalton-road, westerly along Alison-street, southerly along Brock-street, westerly along Heyington-avenue to the boundary of Sewerage Area No. 2064, north-easterly and westerly following the said boundary to the commencing point.

Sewerage Area No. 2481.

*City of Doncaster and Templestowe.*—Commencing at the eastern extremity of Woolamai-court on the boundary of Sewerage Area No. 1978; thence southerly, generally westerly and northerly following the said boundary to the junction of High-street and Ayr-street, easterly along the northern boundary of lot 137 High-street, northerly along portion of the western boundary of lot 93 Stutt-avenue, easterly along Stutt-avenue, north-easterly along the north-western boundaries of lots 96 Stutt-avenue and 97 to 108 Tullamore-avenue, easterly along the northern boundaries of lots 108 to 113 Tullamore-avenue, northerly along Golf Hill-avenue, easterly along Eastern-avenue to its eastern extremity, northerly and easterly along the boundaries of the Eastern Golf Club property to the southern extremity of Link-street, northerly along Link-street, easterly along Fairway-road, south-easterly along the north-eastern boundary of lot 25 Fairway-road to its south-eastern angle, south-westerly by a line to the south-eastern angle of lot 13 Golf Hill-avenue, westerly along the southern boundary of the said lot 13, further westerly and south-westerly along Tullamore-avenue to the boundary of Sewerage Area No. 1978 in Stutt-avenue, southerly, westerly and southerly following the said area boundary to the commencing point.

Sewerage Area No. 2482.

*City of Waverley.*—Commencing at the junction of Stableford-avenue and Wedge-court; thence northerly and westerly along Wedge-court, north-westerly along the south-western boundary of lot 33 Wedge-court, northerly along the western boundary of the said lot 33 and a line in continuation to Scotchmans Creek, generally easterly and generally south-easterly along the said creek and Glen Waverley Drain to Waverley-road, westerly along Waverley-road, northerly along the western boundary of lot 148 Waverley-road, westerly along the southern boundary of lot 151 Lilian-street, northerly and north-westerly along Lilian-street, north-easterly along the north-western boundary of lot 165 Lilian-street, north-westerly along the south-western boundary of lot 66 Crosby-drive, further north-westerly and westerly along Stableford-avenue to the commencing point.

By order of the Board,

W. C. S. ELLIS,  
Secretary.

425 Collins-street, Melbourne, 3001, 20th June, 1972.

*Police Regulation Act 1958, Section 122.*  
SALE OF UNCLAIMED MOTOR VEHICLE.

An owner is required for a 1961 model, grey Holden Panel Van, ex-registered No. KEZ-105, engine No. B89097.

The vehicle came into possession of Police on 24th July, 1970, and if not claimed will be sold by public auction at Sunshine C.I.D., Sun-court, Sunshine, at 2 p.m. on 10th July, 1972.

R. JACKSON,  
Chief Commissioner of Police.

*Police Regulation Act 1958, Section 122.*  
SALE OF UNCLAIMED MOTOR VEHICLE.

An owner is required for a 1954 model, red Morris Panel Van ex-registered No. GOL-192, engine No. 60121.

The vehicle came into possession of Police on 3rd December, 1968, and if not claimed will be sold by public auction at the Richmond Police Station, Bridge-road, Richmond, at 2 p.m. on 3rd July, 1972.

R. JACKSON,  
Chief Commissioner of Police.

*Police Regulation Act 1958, Section 122.*

SALE OF UNCLAIMED MOTOR VEHICLE.

An owner is required for a fawn coloured 1957 Holden FE model Station Sedan, engine No. L390650.

This vehicle came into the possession of Police on the 31st January, 1972, and if not claimed, will be sold by public auction at the Wangaratta Police Station, Faithful-street, Wangaratta, at 2 p.m. on Tuesday, the 4th July, 1972.

R. JACKSON,  
Chief Commissioner of Police.

Sewerage Districts Act.

WERRIBEE SEWERAGE AUTHORITY.

TRANSFER OF RESPONSIBILITIES TO THE MELBOURNE AND METROPOLITAN BOARD OF WORKS.

WHEREAS:

- (1) the Werribee Sewerage Authority was constituted under the provisions of the Sewerage Districts Act for the construction and management of sewerage works within the Werribee Sewerage District;
- (2) the Werribee Sewerage Authority desires that its responsibilities in respect of the Werribee Sewerage District be transferred to the Melbourne and Metropolitan Board of Works;
- (3) the Board is prepared to accept responsibility as from a date to be fixed for sewerage of the Werribee Sewerage District;
- (4) the Government of Victoria has agreed in principle to such transfer being made;
- (5) a submission is being made by the Board seeking the necessary extension of the Metropolis for sewerage purposes; and
- (6) it is not expedient that the Werribee Sewerage District be immediately abolished and the Werribee Sewerage Authority dissolved.

His Excellency the Governor of the State of Victoria by and with the advice of the Executive Council thereof doth by Order made on the 20th day of June, 1972, authorize the Werribee Sewerage Authority to enter into an agreement with the Melbourne and Metropolitan Board of Works providing for the transfer from the Authority to the Board with effect from a date to be fixed of all the assets and liabilities of the Authority and of survey plans, drawings, designs, documents, investments, property, easements and other rights, interests or privileges in over or affecting any land within the Werribee Sewerage District, and that the Authority from the date agreed upon shall be deemed to have no further responsibility whatsoever in relation to the provision of sewerage services to such District.

J. ROSSITER,  
Clerk of the Executive Council.

At the Executive Council Chamber,  
Melbourne, 20th June, 1972.

*Stamps Act 1958.*

ANNUAL LICENCE.

NOTIFICATION PURSUANT TO SECTION 97.

I hereby notify that stamp duty has been paid for a licence under section 96 of the Stamps Act to carry on assurance and insurance business in Victoria from 1st July, 1972, to 31st December, 1972, by the following:—

“THE SEVEN PROVINCES” INSURANCES UNDERWRITERS LIMITED.

R. M. PHIBBS,  
Comptroller of Stamps.

Stamp Duties Office,  
Melbourne, 21st June, 1972.

*Stamps Act 1958.*

Stamps (Exemptions) Regulations 1971.

NOTICE.

Pursuant to the provisions of the Stamps (Exemptions) Regulations 1971, I hereby declare,

MERCHANT BILLS CORPORATION LIMITED, to be for the purpose of sub-division (13A) of Division 3 of Part II. of the *Stamps Act 1958*, a dealer in the unofficial short term money market.

R. M. PHIBBS,  
Comptroller of Stamps.

Stamp Duties Office,  
Melbourne, 21st June, 1972.

*Town and Country Planning Act 1961.*  
CITY OF KNOX PLANNING SCHEME 1965.  
AMENDMENT No. 96, 1971.

*Notice of Approval.*

In pursuance of the powers conferred by the *Town and Country Planning Act 1961*, the Governor in Council on the 14th June, 1972, approved a planning scheme entitled the City of Knox Planning Scheme 1965, Amendment No. 96, 1971, in respect of part of the municipal district of the City of Knox and such planning scheme comes into operation on the date this notice of approval is published in the *Government Gazette*.

A copy of the planning scheme as approved may be inspected free of charge during office hours at the office of the Town and Country Planning Board, 235 Queen-street, Melbourne; at the office of the City of Knox at Fern Tree Gully; and when available, at the office of Titles, Melbourne, and at the Central Plan Office of the Department of Crown Lands and Survey, Melbourne.

W. H. CRAIG, Secretary,  
Town and Country Planning Board.

*Town and Country Planning Act 1961.*  
SHIRE OF MORNINGTON PLANNING SCHEME 1959.  
AMENDMENT No. 66, 1971.

*Notice of Approval.*

In pursuance of the powers conferred by the *Town and Country Planning Act 1961*, the Governor in Council on the 14th June, 1972, approved a planning scheme entitled the Shire of Mornington Planning Scheme 1959, Amendment No. 66, 1971, in respect of part of the municipal district of the Shire of Mornington and such planning scheme comes into operation on the date this notice of approval is published in the *Government Gazette*.

A copy of the planning scheme as approved may be inspected free of charge during office hours at the office of the Town and Country Planning Board, 235 Queen-street, Melbourne; at the office of the Mornington Shire Council, Queen-street, Mornington, and when available, at the Office of Titles, Melbourne, and at the Central Plan Office of the Department of Crown Lands and Survey, Melbourne.

W. H. CRAIG, Secretary,  
Town and Country Planning Board.

*Town and Country Planning Act 1961.*  
SHIRE OF MORNINGTON PLANNING SCHEME 1959.  
AMENDMENT No. 57, 1970.

*Notice of Approval.*

In pursuance of the powers conferred by the *Town and Country Planning Act 1961*, the Governor in Council on the 14th June, 1972, approved a planning scheme entitled the Shire of Mornington Planning Scheme 1959, Amendment No. 59, 1970, in respect of part of the municipal district of the Shire of Mornington and such planning scheme comes into operation on the date this notice of approval is published in the *Government Gazette*.

A copy of the planning scheme as approved may be inspected free of charge during office hours at the office of the Town and Country Planning Board, 235 Queen-street, Melbourne; at the office of the Council of the Shire of Mornington, Queen-street, Mornington, and when available, at the Office of Titles, Melbourne, and at the Central Plan Office of the Department of Crown Lands and Survey, Melbourne.

W. H. CRAIG, Secretary,  
Town and Country Planning Board.

Water Act.  
SHIRE OF WERRIBEE.  
WATER SUPPLY DISTRICT.

*Transfer of Responsibilities to the Melbourne and Metropolitan Board of Works.*

WHEREAS:

- (1) the Werribee Shire Council was constituted a Local Governing Body under the provisions of the Water Act for the construction and management of water supply works within the Werribee Shire Council Water Supply District;
- (2) the said Council desires that its responsibilities in respect of providing water supplies to the Werribee Water Supply District be transferred to the Melbourne and Metropolitan Board of Works;

- (3) the Board is prepared to accept this responsibility as from a date to be fixed;
- (4) the Government of Victoria has agreed in principle to such transfer being made;
- (5) a submission is being made by the Board seeking the necessary extension of the Metropolis for water supply purposes; and
- (6) it is not expedient that the Werribee Water Supply District be immediately abolished and the Werribee Shire Council's constitution as a Local Governing Body for this District be rescinded,

His Excellency the Governor of the State of Victoria by and with the advice of the Executive Council thereof doth by Order made on the 20th day of June, 1972, authorize the Council to enter into an agreement with the Melbourne and Metropolitan Board of Works providing for the transfer from the Council to the Board with effect from a date to be fixed of all the assets and liabilities of the Council in respect to the Werribee Water Supply District and of survey plans, drawings, designs, documents, investments, property, easements and other rights, interests or privileges in over or affecting any land within the Werribee Shire Council Water Supply District and that the Council from the date agreed upon shall be deemed to have no further responsibility whatsoever in relation to the provisions of water services to such District.

J. ROSSITER,  
Clerk of the Executive Council.

At the Executive Council Chamber,  
Melbourne, 20th June, 1972.

PUBLIC TRUSTEE ACT 1958 (No. 6350), SECTION 17.

I hereby give notice that on the 30th May, 1972, the Public Trustee filed elections to administer the following deceased persons' estates, in accordance with section 17 of the *Public Trustee Act 1958*.

HOPKINS, JANE, also known as Janie Hopkins, late of 81 Gipps-street, East Melbourne, married woman, died 26th April, 1972.

HUDSWELL, REGINALD, formerly of 12 Birdwood-street, Footscray, late of Mont Park, retired railway employee, died 18th February, 1972.

SMART, JOHN CHRISTOPHER, late of 8 Albert-crescent, Surrey Hills, marine engineer, died on or about 6th October, 1971.

N. P. BRODY,  
Public Trustee.

256 Flinders-street, Melbourne, 3000, 14th June, 1972.

NOTICE.

Creditors, next of kin and others having claims against the estate of any of the under-mentioned deceased persons are required to send particulars of their claims to the Public Trustee, 256 Flinders-street, Melbourne, Vic. 3000, the personal representative, on or before the 28th August, 1972, after which date the Public Trustee may convey or distribute the assets, having regard only to the claims of which the Public Trustee then has notice:—

COLLETT, NORMAN THOMAS, formerly of 19 Invermay-grove, Rosanna, late of 683 Sackville-street, Albury, New South Wales, retired P.M.G. employee, died 15th February, 1972.

FIELDUS, ALAN CHARLES, late of 122 Highbury-road, Burwood, retired plumber, died 24th February, 1972.

FITZGERALD, EVELYN, late of 30 Goulburn-avenue, Reservoir, widow, died 11th March, 1972.

GIRVEN, JAMES HELSBY, late of 3 Rose-street, Sandringham, retired accountant, died 11th April, 1972.

HOPKINS, JANE, also known as Janie Hopkins, late of 81 Gipps-street, East Melbourne, married woman, died 26th April, 1972.

HUDSON, HENRY JOHN, late of 18 Orrong-avenue, Reservoir, retired surgical bootmaker, died 26th March, 1972.

HUDSWELL, REGINALD, formerly of 12 Birdwood-street, Footscray, late of Mont Park, retired railway employee, died 18th February, 1972.

JONES, HARRY HATHERELL, formerly of 22 Hill-street, Bellerive, Tasmania, late of 210 Orrong-road, Toorak, gentleman, died 23rd August, 1971.

KEATING, MAURICE, also known as Morris Keating, late of 8 Fashoda-street, Hawthorn, retired bootmaker, died 7th March, 1972.

MOORE, JOHN WALTER, formerly of Elmore-road, Rochester, late of Flat 1, 596 High-street, Syndal, retired civil engineer, died 19th March, 1972.

MCCARTHY, MYRTLE GOODWIN, late of 24 Stanley-street, Frankston, widow, died 22nd February, 1972.

MCNAB, ROBERT, late of 8 Delaware-street, Reservoir, retired tram driver, died 19th November, 1971.

POORE, HERBERT WILLIAM, late of 1 formerly 3, Levantostreet, Mentone, retired butcher, died 17th February, 1972.

SCOTT, JESSIE GLADYS, late of 7 Lorraine-street, Essendon, spinster, died 9th September, 1971.

SMART, JOHN CHRISTOPHER, late of 8 Albert-crescent, Surrey Hills; marine engineer, died on or about 6th October, 1971.

WILLIAMS, BRYN LLOYD, late of Flat 19, 11A Argyle-street, St. Kilda, clerk, died 25th March, 1972.

N. P. BRODY,  
Public Trustee.

Melbourne, 14th June, 1972.

#### CONTRACTS ACCEPTED.—(Series 1971-72.)

##### VICTORIAN RAILWAYS.

110. Supply and delivery tamping machines points and crossings 5 ft. 3 in. gauge, at rates (Contract 63781).—Tampor (Aust.) Pty. Ltd. 111. Removing of departmental residence No. 3020 from Telford and re-assembling at Yarrowonga together with outbuilding, for the amount of \$1,480.00 (Contract 63786).—M. Diedrich "Hansa Homes". 112. Design of circuits and manufacture, supply, delivery, construction, erection, and installation of road traffic signals (Co-ordinated with automatic boom barriers) at Poath-road, Hughesdale, at rates (Contract 63810).—Eagle Signal Co. of Australia Pty. Ltd.

C. S. MORRIS, Secretary. 16.6.72.

#### ORDERS IN COUNCIL.—(Series 1971-72.)

##### PUBLIC WORKS.

1323. Birregurra, Primary School 723, asphalt paving and drainage works, \$4,504.24.—J. Keen.—(W.155491.)

1324. Crib Point, Westernport Refinery, construction and installation of a gangway on jetty, \$12,830.00.—B.P. Australia-Westernport Refinery.—(P. & H. 136586.)

1325. Hawthorn, 801 Glenferrie-road, Road Safety and Traffic Authority, supply and installation of P.A.B.X. telephone system, \$17,697.00.—Standard Telephones and Cables Pty. Ltd.—(P.1140.)

1326. Kew, Mental Hospital, renovations to rear of Administration Building and Wards F1, F2, G1 and G2, \$5,300.00.—J. P. McElligott & Co. Pty. Ltd.—(P.C.27446 (P.G.3).)

1327. Melbourne, 5 Parliament-place, State Laboratories, alterations and additions to ground floor and to upper car park toilets, \$13,975.00.—W. J. Cody & Quinn Pty. Ltd.—(P.C.26195 (I & D).)

Approved by the Governor in Council, 14th June, 1972.  
—J. ROSSITER, Clerk of the Executive Council.

#### APPOINTMENTS AND RESIGNATIONS

*Vermin and Noxious Weeds Act 1958.*

##### APPOINTMENT OF INSPECTORS.

It is hereby notified that the Public Service Board, in exercise of its powers, has appointed the under-mentioned persons as Inspectors under the provisions of section 4 of the *Vermin and Noxious Weeds Act 1958*, without additional salary:

ALLAN MATTHEW EMMERSON.

ERIC THOMAS GEORGE CAULFIELD.

C. E. MIDDLETON,  
Acting Secretary for Lands.

Melbourne, 13th June, 1972.

##### APPOINTMENT.

His Excellency the Governor of the State of Victoria, by and with the advice of the Executive Council thereof, has, by Order made on the 14th day of June, 1972, been pleased to make the under-mentioned appointment, viz.:—

DEPARTMENT OF CROWN LANDS AND SURVEY.

*Secretary for Lands.*

COLIN EDWARD MIDDLETON  
to be Secretary for Lands from and inclusive of the 17th June, 1972, vice Alan Judge Holt.

J. ROSSITER,  
Clerk of the Executive Council.

At the Executive Council Chamber,  
Melbourne, the 14th day of June, 1972:

#### APPOINTMENTS.

His Excellency the Governor of the State of Victoria, by and with the advice of the Executive Council thereof, has, by Orders made on the 14th day of June, 1972, been pleased to make the under-mentioned appointments, viz.:—

##### CROWN LANDS AND SURVEY DEPARTMENT.

###### *Bailiff of Crown Lands.*

JACK ROBINSON OSWIN  
to be a bailiff of Crown lands with respect to the "Phillip Island Koala Reserves", in the place of Kenneth J. Pound (resigned), pursuant to section 30 of the *Land Act 1958*.

##### MINISTRY OF HEALTH.

###### *Member of Committee of Management of Hospital.*

ALEXANDER FOXCROFT BOTTOMLEY, J.P.,  
to be the Government Appointee on Committee of Management of Hampton Hospital, for a term of three years commencing the 9th July, 1972, pursuant to provisions of subparagraph (ii) of paragraph (a) of the proviso to subsection (1) of section 48 of the *Hospitals and Charities Act 1958*.

###### *Trustees of Public Cemeteries.*

JOSEPH TOOHEY, and  
KEITH RUSSELL EASTWOOD,  
to be Trustees of the Gordon Public Cemetery, additional trustees;

NEIL MCERVALE,  
ARCHIBALD MCGARRY,  
KENNETH STACEY,  
PATRICK CONLAN, and  
EDWARD PARKINSON  
to be Trustees of the Nandaly Public Cemetery, vice W. Parkinson, A. McErvale, and L. McInerney, resigned, and additional trustees;

ROBERT WILLIAM FISHER, and  
MAURICE JOSEPH FITZGERALD,  
to be Trustees of the Korumburra Public Cemetery, vice W. Fisher, and P. Beyer, resigned; and

RONALD BULLEN, and  
RONALD REITER  
to be Trustees of the Kilcunda Public Cemetery, additional trustees.

##### LAW DEPARTMENT.

###### *Commissioners for Taking Declarations, &c.*

RAYMOND ROBERT DON, care of Chief Secretary's Department, Old Treasury Building, Spring-street, Melbourne,

EDWARD STONE, care of Chief Secretary's Department, Old Treasury Building, Spring-street, Melbourne,

HAROLD ROSS RAMUS, care of Chief Secretary's Department, Old Treasury Building, Spring-street, Melbourne,

DONALD THOMAS TAYLOR, care of Social Welfare Department, 1 Macarthur-street, Melbourne,

JAMES PATRICK MCHARDY, care of Social Welfare Department, 1 Macarthur-street, Melbourne,

KEITH DOUGLAS MCRAE, care of S.E.C. Communication Workshop, 25 Kavanagh-street, South Melbourne, and

GARY JAMES HALLAM, care of Department of Agriculture, 3 Treasury-place, Melbourne,

to be Commissioners for Taking Declarations and Affidavits, pursuant to the *Evidence Act 1958*, to refrain from charging fees and to resign upon ceasing to occupy their present positions;

RONALD TREVOR JONES, care of Farnback, Burnham and Co., 50 Pier-street, Altona, and

DAVID KINGSLEY LINLEY, care of Robertson, Darling and Wolfenden, A.M.P. Tower, 535 Bourke-street, Melbourne,

to be Commissioners for taking Declarations and Affidavits, pursuant to the *Evidence Act 1958*, to resign upon ceasing to occupy their present positions;

GORDON ROSSLYN COULTHARD, 14 Akuna-avenue, Tallangatta,

to be a Commissioner for taking Declarations and Affidavits, pursuant to the *Evidence Act 1958*, to resign upon leaving the neighbourhood of the address stated; and

JAMES BROUGHTON BRUCE, care of McPherson's Ltd., 546 Collins-street, Melbourne,

to be a Commissioner for taking Declarations and Affidavits, pursuant to the provisions of the *Evidence Act 1958*, to resign upon ceasing to occupy his present position.

###### *Justices of the Peace.*

LEON ALLAN GRAY, Station-street, Lake Boga, and  
MURRAY WILLIAM CAMPBELL, 3 Glenfern-avenue, Doncaster,

to keep the Peace in the State of Victoria.

SOCIAL WELFARE DEPARTMENT.

Stipendiary Probation Officers, &c.

ELIZABETH HAMILTON FRASER (Mrs.), Flat 2, 4  
Claremont-crescent, Canterbury,  
DIANA SUE HOLTEN (Miss), 40 Carlton-street, Carlton,  
HELEN JUNE LAVENDER (Miss), 39 Denmark-street,  
Kew,  
YVONNE MUTTON (Miss), 31A Comas-grove, Thornbury,  
and  
CHRISTOPHER JOHN TROTTER (Mr.), Flat 3, 254  
Waverley-road, Mount Waverley,  
pursuant to the provisions of sections 507 (1) and 533 (3)  
of the Crimes Act 1958 and section 9 (2) of the Children's  
Court Act 1958 and section 165 (1) of the Social Welfare  
Act 1970, to be Stipendiary Probation Officers for every  
Children's Court, Stipendiary Probation Officers and Stipen-  
diary Parole Officers and Stipendiary Youth Parole Officers,  
respectively.

DEPARTMENT OF THE TREASURER.

Collectors of Imposts (Acting).

ANTHONY PATRICK CLIFFORD  
to act temporarily as Collector of Imposts, Department of  
Agriculture, vice W. D. J. Gray, transferred; and

JOHN ANTHONY BARNES  
to act temporarily as Collector of Imposts, Children's Court,  
vice G. J. Condon, on leave.

Receiver of Revenue (Acting).

BARRY JOHN BOLTON  
to act temporarily as Receiver of Revenue, Castlemaine,  
vice P. J. O'Grady, on leave.

DEPARTMENT OF WATER SUPPLY.

Sewerage Authority Member.

HENDRIK HERMAN VAN WEGAN  
to be a Member of the Coleraine Sewerage Authority, to  
hold such position from the date hereof, until the date of  
expiry of the present term of office of Keith Kelso, as a  
Councillor of the Shire of Wannan, subject to the pro-  
visions of the Sewerage Districts Act.

Waterworks Trust Commissioner.

HERBERT DOUGLAS HATELEY  
to be a Commissioner of the Murtoa Waterworks Trust, to  
hold such position for a period of four years from 18th  
June, 1972, subject to the provisions of the Water Act.

J. ROSSITER,  
Clerk of the Executive Council.

At the Executive Council Chamber,  
Melbourne, 14th June, 1972.

Evidence Act 1958.

COMMISSIONER FOR TAKING DECLARATIONS, ETC.—  
AMENDMENT TO APPOINTMENT.

His Excellency the Governor of the State of Victoria,  
by and with the advice of the Executive Council thereof,  
doth by Order made on the 14th day of June, 1972, amend  
the Order made on the 23rd May, 1972, appointing Peter  
John Knowles as a Commissioner for taking Declarations  
and Affidavits, pursuant to the provisions of the Evidence  
Act 1958, by the substitution of the name PETER JAMES  
KNOWLES for that of Peter John Knowles.

J. ROSSITER,  
Clerk of the Executive Council.

At the Executive Council Chamber,  
Melbourne, 14th June, 1972.

Liquor Control Act 1968.

APPOINTMENT OF LICENSING INSPECTOR.

In accordance with the authority conferred upon me by  
sub-section (1) of section 22 of the Liquor Control Act 1968,  
I, Reginald Jackson, Chief Commissioner of Police, hereby  
appoint the following Officer of Police as Licensing Inspector  
for the Division of the Police District as shown:—

Division Number.	Police District.	Rank and Name.
3	Yarra .. ..	Inspector Charles Leslie Keating (from 5.6.72 to 30.6.72)

R. JACKSON,  
Chief Commissioner of Police.

Evidence Act 1958.

APPOINTMENTS OF COMMISSIONERS FOR TAKING  
DECLARATIONS, ETC. REVOKED.

His Excellency the Governor of the State of Victoria,  
by and with the advice of the Executive Council thereof,  
doth by Order made on the 14th day of June, 1972, revoke  
the appointments of:

Francis Charles Alway, John Harmon Beasy, Eric James  
Butcher, James Carstairs, Samuel Gordon Clark,  
Harold William Thomas Courtney, Maxwell Clark  
Dupuy, Alan Keith Fraser, Terence Leslie Richard  
Glazebrook, William Henry Lodge James, Walter  
James Johnson, Kenneth Peter King, Maxwell  
Curnow Lee, Thomas Patrick Lynch, William Bryan  
Mayo, Bernard Moloney, Stanley Lionel Mottram,  
John Francis Murray, Maxwell Leslie McNamara,  
Hugh Purves Neil, Sidney Raymond Noble, Hubert  
Paul Parsons, Harold Thomas Victor Spalding,  
James Kenneth Thompson, Bertram Ian Trinnell,  
as Commissioners for taking Declarations and Affidavits,  
pursuant to the provisions of the Evidence Act 1958.

J. ROSSITER,

Clerk of the Executive Council.

At the Executive Council Chamber,  
Melbourne, 14th June, 1972.

RESIGNATIONS.

His Excellency the Governor of the State of Victoria,  
by and with the advice of the Executive Council thereof,  
has, by Orders made on the 14th day of June, 1972, accep-  
ted the resignations of the persons named hereunder  
of the offices mentioned, viz.:—

LAW DEPARTMENT.

Commissioner for Taking Declarations &c.

WILLIAM CLIVE SMALLEY ELLIS,  
as a Commissioner for taking Declarations and  
Affidavits pursuant to the provisions of the  
Evidence Act 1958.

J. ROSSITER,  
Clerk of the Executive Council.

At the Executive Council Chamber,  
Melbourne, 14th June, 1972.

ORDERS IN COUNCIL

ABORIGINAL AFFAIRS ACT 1967.

At the Executive Council Chamber, Melbourne, the  
fourteenth day of June, 1972.

PRESENT:

His Excellency the Governor of Victoria.  
Sir Gilbert Chandler | Mr. Balfour.  
Mr. Borthwick

APPOINTMENT OF RETURNING OFFICER.

In accordance with the provisions of the Aboriginal  
Affairs Advisory Council Elections Regulations 1968, His  
Excellency the Governor of the State of Victoria in the  
Commonwealth of Australia by and with the advice of the  
Executive Council of the said State doth by this Order  
appoint:—

Eric Lawrence Richardson to be Returning Officer to  
conduct the forthcoming extraordinary election of an  
Aboriginal member to represent the West Gippsland Region  
to fill a vacancy in the Aboriginal Affairs Advisory Council  
that is due to occur on the 1st day of July, 1972.

And the Honorable Edward Raymond Meagher, Her  
Majesty's Minister for Aboriginal Affairs for the State of  
Victoria, shall give the necessary directions herein  
accordingly.

J. ROSSITER,  
Clerk of the Executive Council.

COUNTRY ROADS BOARD.

At the Executive Council Chamber, Melbourne, the fourteenth day of June, 1972.

PRESENT:

His Excellency the Governor of Victoria.

Sir Gilbert Chandler | Mr. Balfour.  
Mr. Borthwick

ORDER APPROVING OF LAND BEING ACQUIRED AND ROADS, DEVIATIONS OR WIDENINGS BEING MADE.

His Excellency the Governor of the State of Victoria, by and with the advice of the Executive Council thereof, being satisfied that there are funds legally available for acquiring the land, doth hereby approve the acquiring of the land described in the Schedule hereunder and the making of new roads and deviations from and widenings of existing roads referred to in the said schedule.

SCHEDULE.

Main Roads.

The land shown hatched on Plan numbered G.P.12928 hereunder required for the deviation from the Hamilton-Port Fairy road in the Shire of Dundas and making of the widening thereon.

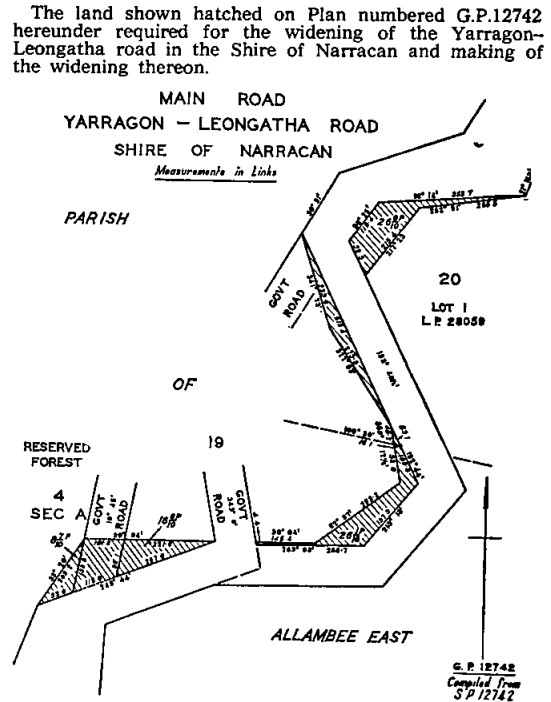
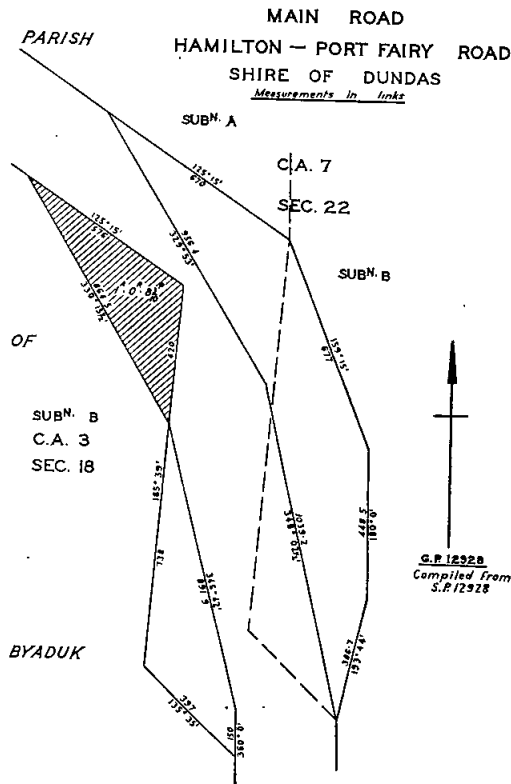

Freeway.

The land shown hatched on Plans numbered G.P.12874A, G.P.12874B, G.P.12875A, G.P.12876, G.P.12936A, G.P.12937, G.P.12938 and G.P.12939A, hereunder required for the making of a new freeway (Hume Freeway) in the Shire of Broadford.

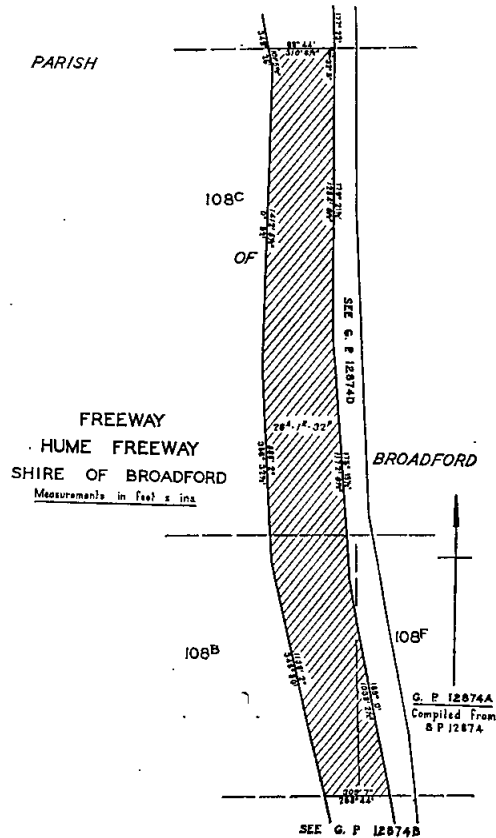

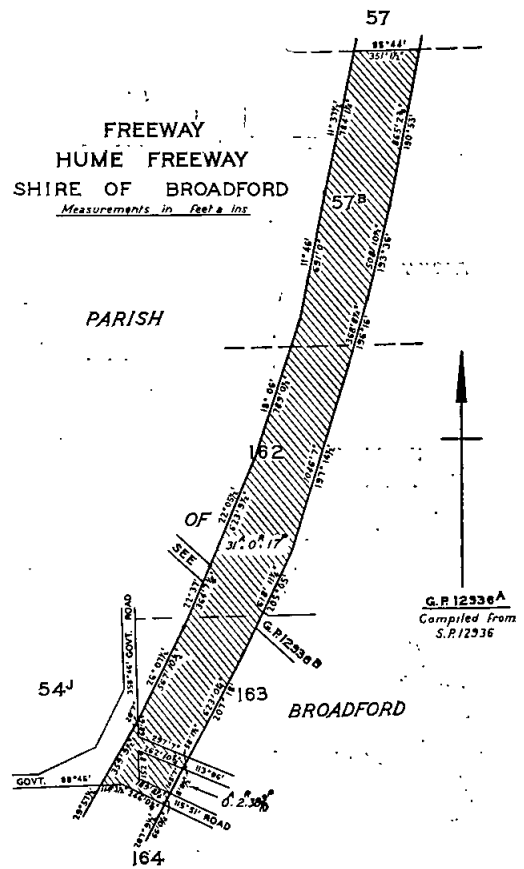
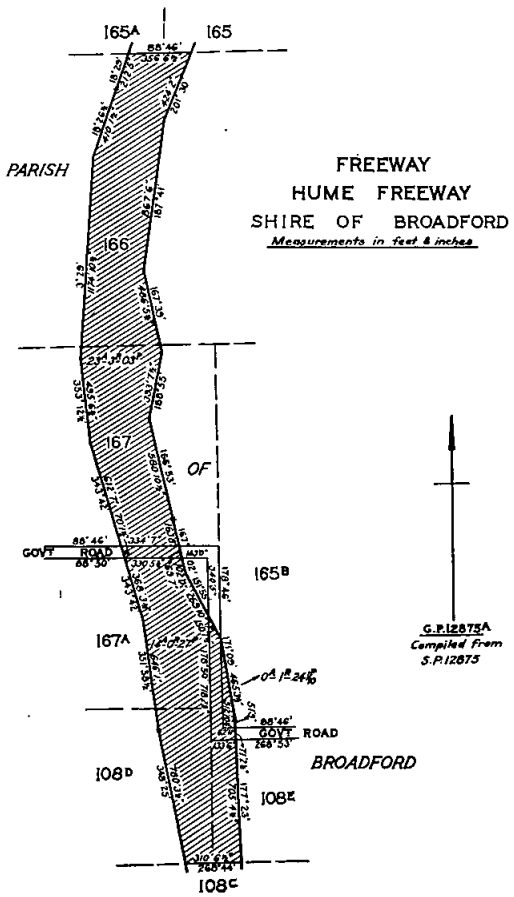
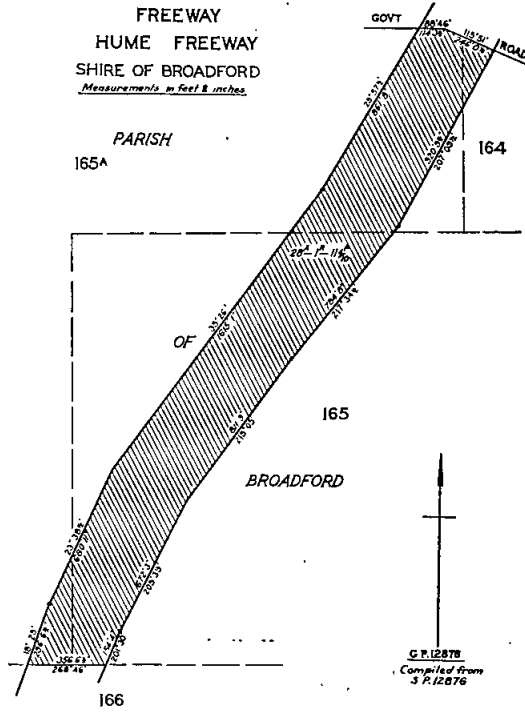
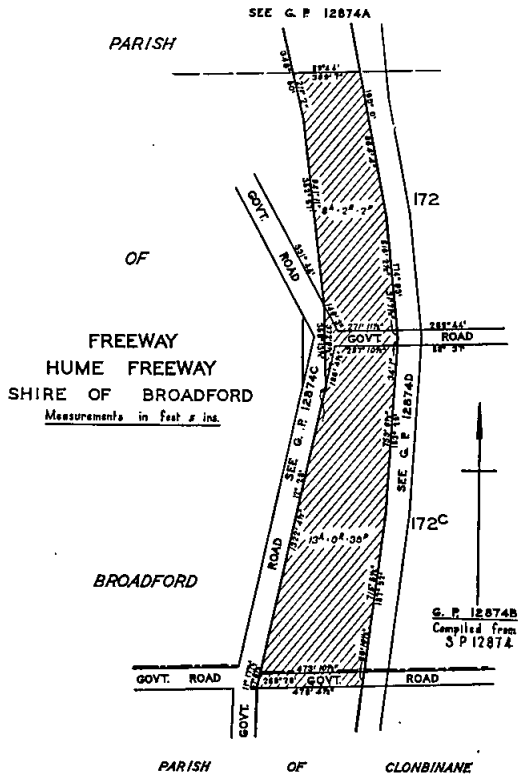

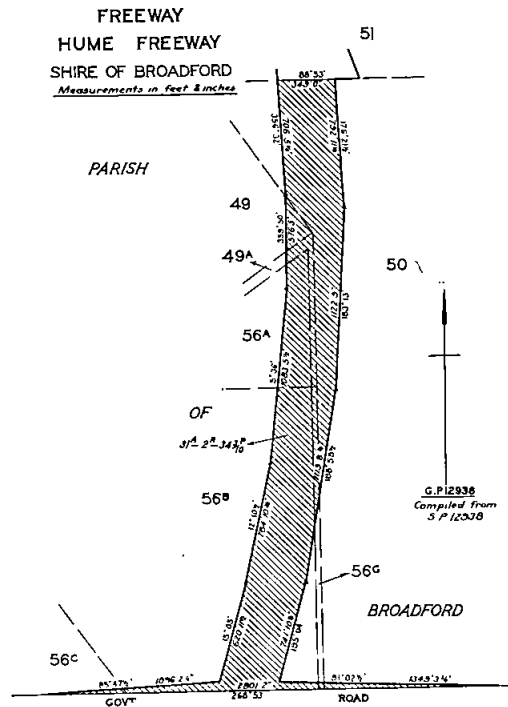
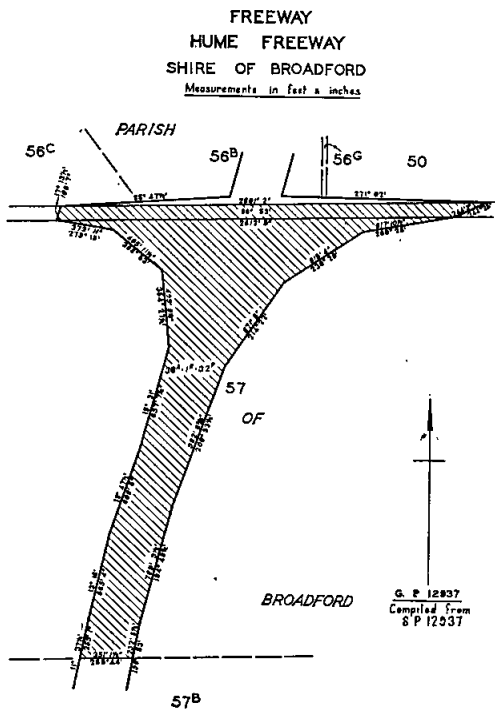

*Unclassified Roads.*

The land shown hatched on Plans numbered G.P.12874c and G.P.12875c hereunder required for the widening of a road in the Shire of Broadford, and making of the widening thereon.

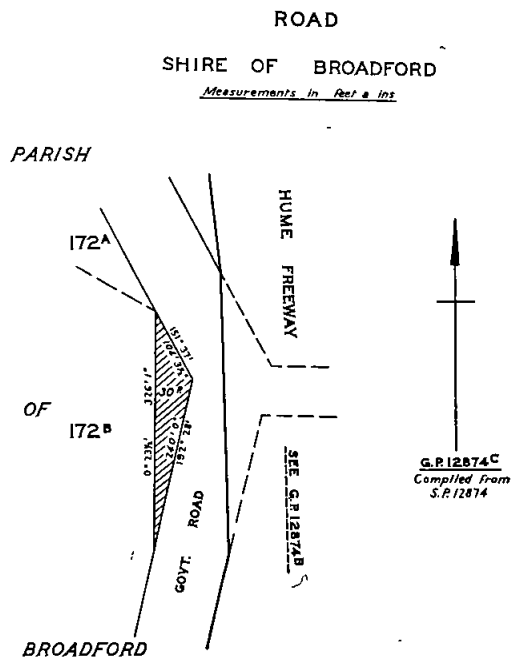
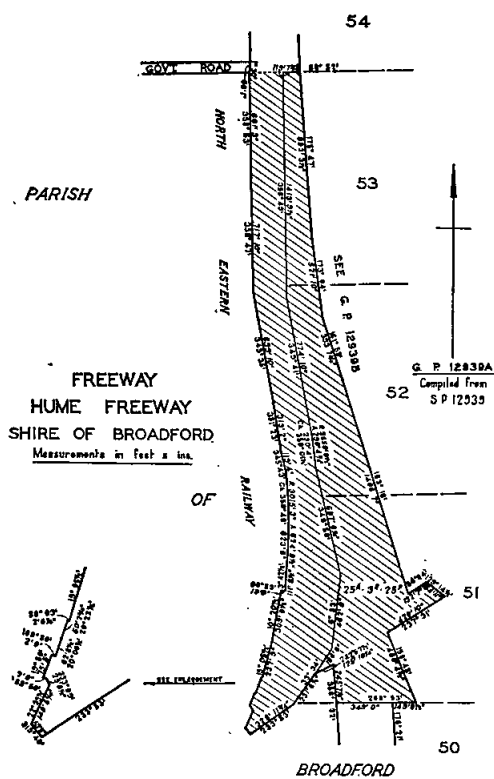



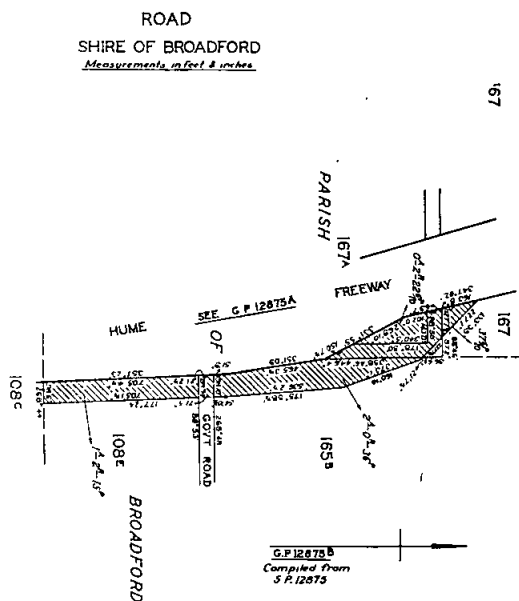
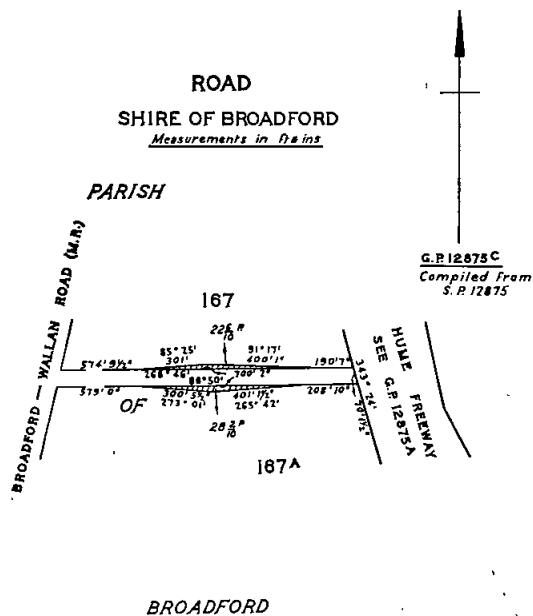

The land shown hatched on Plans numbered G.P.12874D, G.P.12875B, G.P.12936C, G.P.12939B and G.P.12940B here-under required for the making of a new road in the Shire of Broadford.

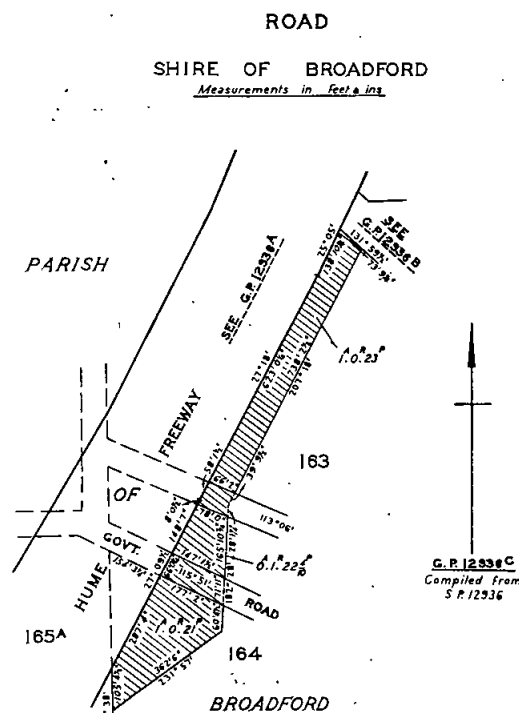
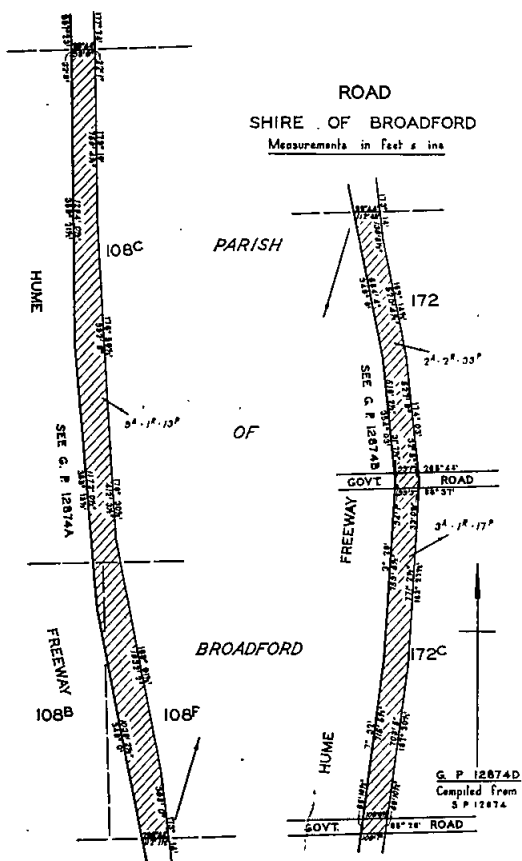

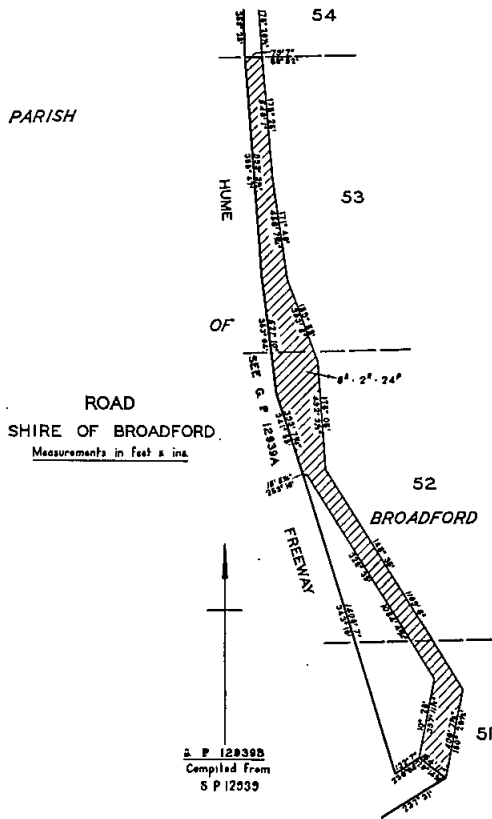

The land shown hatched on Plan numbered G.P.12936B hereunder required for the deviation from a road in the Shire of Broadford and making of the deviation thereon.

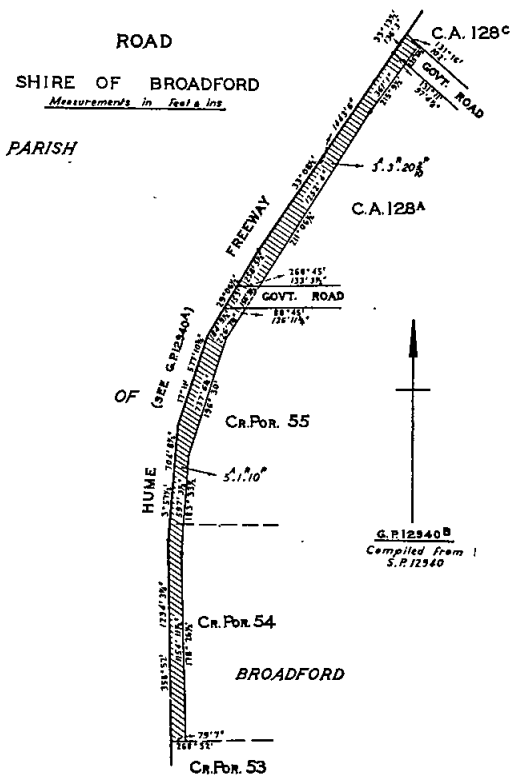
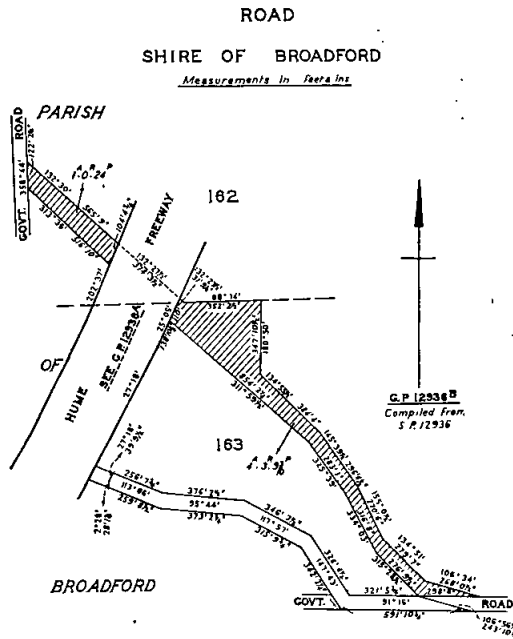

And the Honorable Alan John Hunt, Her Majesty's Minister for Local Government for the State of Victoria shall give the necessary directions herein accordingly.

J. ROSSITER,  
Clerk of the Executive Council.

DRIED FRUITS ACT 1958.

At the Executive Council Chamber, Melbourne, the fourteenth day of June, 1972.

PRESENT:

His Excellency the Governor of Victoria.  
Sir Gilbert Chandler | Mr. Balfour.  
Mr. Borthwick

APPOINTMENT OF MEMBER AND CHAIRMAN OF THE VICTORIAN DRIED FRUITS BOARD.

In pursuance of the powers conferred by section 5 of the Dried Fruits Act 1958, and all other powers him thereto enabling His Excellency the Governor of the State of Victoria, by and with the advice of the Executive Council thereof, doth by this Order hereby appoint Gay Vandeleur Tolhurst, who has been nominated by the Minister of Agriculture, as a member and Chairman of the Victorian Dried Fruits Board for a period of three (3) years from and inclusive of the 14th June, 1972, vice Albert Edward Woodward, resigned.

And the Honorable Sir Gilbert Lawrence Chandler, Her Majesty's Minister of Agriculture for the State of Victoria, shall give the necessary directions herein accordingly.

J. ROSSITER,  
Clerk of the Executive Council.

## HEALTH ACT 1958 (No. 6270).

At the Executive Council Chamber, Melbourne,  
the fourteenth day of June, 1972.

## PRESENT:

His Excellency the Governor of Victoria.  
Sir Gilbert Chandler | Mr. Balfour.  
Mr. Borthwick

DIVISION 1 OF PART V. OF THE HEALTH ACT 1958  
(No. 6270), RELATING TO PIGGERIES, BE EXTENDED  
TO THE WHOLE OF THE MUNICIPAL DISTRICT OF  
THE SHIRE OF BANNOCKBURN.

Under the powers conferred by the *Health Act 1958* (No. 6270), His Excellency the Governor of the State of Victoria, by and with the advice of the Executive Council thereof, on the request of the Council of the Shire of Bannockburn, and on the recommendation of the Commission of Public Health, doth hereby order that the provisions of Division 1 of Part V. of the said Act, so far as those provisions are applicable to piggeries, shall be extended and apply to the whole of the municipal district of the Shire of Bannockburn.

And the Honorable Roberts Christian Dunstan, Her Majesty's Acting Minister of Health for the State of Victoria, shall give the necessary directions herein accordingly.

J. ROSSITER,  
Clerk of the Executive Council.

## HEALTH ACT 1958 (No. 6270).

At the Executive Council Chamber, Melbourne,  
the fourteenth day of June, 1972.

## PRESENT:

His Excellency the Governor of Victoria.  
Sir Gilbert Chandler | Mr. Balfour.  
Mr. Borthwick

DIVISION 1 OF PART V. OF THE HEALTH ACT 1958  
(No. 6270), RELATING TO PIGGERIES, BE EXTENDED  
TO THE WHOLE OF THE MUNICIPAL DISTRICT OF  
THE SHIRE OF RUTHERGLEN.

Under the powers conferred by the *Health Act 1958* (No. 6270), His Excellency the Governor of the State of Victoria, by and with the advice of the Executive Council thereof, on the request of the Council of the Shire of Rutherglen, and on the recommendation of the Commission of Public Health, doth hereby order that the provisions of Division 1 of Part V. of the said Act, so far as those provisions are applicable to piggeries, shall be extended and apply to the whole of the municipal district of the Shire of Rutherglen.

And the Honorable Roberts Christian Dunstan, Her Majesty's Acting Minister of Health for the State of Victoria, shall give the necessary directions herein accordingly.

J. ROSSITER,  
Clerk of the Executive Council.

## LABOUR AND INDUSTRY ACT 1958.

At the Executive Council Chamber, Melbourne, the  
fourteenth day of June, 1972.

## PRESENT:

His Excellency the Governor of Victoria.  
Sir Gilbert Chandler | Mr. Balfour.  
Mr. Borthwick

VARIATION OF POWERS OF THE ENGINEERS  
(SKILLED) BOARD.

In pursuance of the powers conferred by the *Labour and Industry Act 1958*, His Excellency the Governor of the State of Victoria, by and with the advice of the Executive Council

thereof, doth hereby vary the powers of the Engineers (Skilled) Board so that in substitution for the powers heretofore conferred on the said Engineers (Skilled) Board it shall be appointed for—

- (a) skilled persons employed in the trade of—
- (i) a brassfounder or brassfinisher;
  - (ii) a mechanical engineer, including—
    - (1) a patternmaker
    - (2) an iron or brass turner
    - (3) a fitter
    - (4) a blacksmith
    - (5) a planer
    - (6) a slotter
    - (7) a borer
    - (8) a milling machinist;
  - (iii) a maker of scientific instruments, fire-proof safes, strong-room doors, safe locks (four or more levers) or locks of the same quality;
  - (iv) preparing iron or steel material for reinforcing concrete for building or other purposes;
  - (v) a coppersmith, but excluding any occupation subject to the Tinsmiths Board or the Plumbers Board;
  - (vi) moulding, casting, dressing, fitting, or machining any articles made of cast aluminium or from aluminium alloys;
  - (vii) fitting or machining any articles made from sheet aluminium or from aluminium alloy sheets heavier (in either case) than 10 gauge; or
  - (viii) making or repairing typewriters, book-keeping machines, adding machines, calculating machines, cash registers, duplicating machines or similar machines;
- (b) the trade of making or repairing bicycles, tricycles or motor cycles, or making or repairing any part or parts (other than tyres) of bicycles, tricycles or motor cycles.

And the Honorable Joseph Anstice Rafferty, Her Majesty's Minister of Labour and Industry for the State of Victoria, shall give the necessary directions herein accordingly.

J. ROSSITER,  
Clerk of the Executive Council.

## LABOUR AND INDUSTRY ACT 1958.

At the Executive Council Chamber, Melbourne,  
the fourteenth day of June, 1972.

## PRESENT:

His Excellency the Governor of Victoria.  
Sir Gilbert Chandler | Mr. Balfour.  
Mr. Borthwick

EXTENSION OF POWERS OF THE PEST CONTROL  
BOARD.

In pursuance of the powers conferred by the *Labour and Industry Act 1958*, His Excellency the Governor of the State of Victoria, by and with the advice of the Executive Council thereof, doth hereby extend the powers of the Pest Control Board so that in substitution for the powers heretofore conferred on the said Pest Control Board it shall be appointed for the trades of eradication and control of—

- (a) weeds and fungi;
- (b) termites, borers, and other insect pests;
- (c) rodents (rats, mice, rabbits); and
- (d) other pests

by spraying, fumigating, poisoning, trapping, or any other method, as appropriate to the pest, but excluding any trade subject to the Determination of any Wages Board heretofore appointed.

And the Honorable Joseph Anstice Rafferty, Her Majesty's Minister of Labour and Industry for the State of Victoria, shall give the necessary directions herein accordingly.

J. ROSSITER,  
Clerk of the Executive Council.

## Land Act 1958.

## DEPARTMENT OF CROWN LANDS AND SURVEY.

At the Executive Council Chamber, Melbourne, the  
fourteenth day of June, 1972.

## PRESENT:

His Excellency the Governor of Victoria.  
Sir Gilbert Chandler | Mr. Balfour.  
Mr. Borthwick

REVOCATION OF TEMPORARY RESERVATIONS OF  
LANDS BY ORDERS IN COUNCIL.

His Excellency the Governor of the State of Victoria, by and with the advice of the Executive Council thereof, doth hereby, in pursuance of the provisions of the *Land Act 1958*, revoke the temporary reservations of lands by Orders in Council hereinafter referred to, viz.:—

**CASTERTON.**—The temporary reservation, as a site for quarry and the withholding from sale, leasing and licensing by Order in Council of the 17th September, 1877, of 11 acres 1 rood 6 perches of land in the Township of Casterton.—(C.177<sup>(\*)</sup>) (Rs.6389).

**DOUITTA GALLA (KEILOR EAST).**—The temporary reservation, by Order in Council of the 27th November, 1957, of 24 perches of land in the Parish of Douтта Galla as a site for Police purposes.—(D.85<sup>(\*)</sup>) (Rs.7677).

**LEONGATHA.**—The temporary reservation, by Order in Council of the 5th November, 1894, of 5 acres of land in the Township of Leongatha as a site for Nightsoil and Manure Depot.—(L.167<sup>(\*)</sup>) (Rs.6869).

**NARRAWONG.**—The temporary reservation, by Order in Council of the 8th July, 1902, of 25 acres 2 roods 37 perches of land in the Parish of Narrawong as a site for Supply of Gravel for Railway purposes.—(N.33<sup>(\*)</sup>) (Rs.4760).

**WOOD'S POINT.**—The temporary reservation, by Order in Council of the 23rd April, 1940, of 22 perches of land in the Township of Wood's Point as a site for a Public Hall.—(W.207<sup>(\*)</sup>) (Rs.5034).

**ARARAT.**—The temporary reservation, by Order in Council of the 14th July, 1959, of 1 acre 2 roods of land in the Township of Ararat as a site for the purposes of the Children's Welfare Department, so far only as the portion containing 2 roods, more or less concerned, as defined by description published in the *Government Gazette* of 17th May, 1972.—(A.148<sup>(\*)</sup>) (Rs.7839).

**BARWONGEMOONG.**—The temporary reservation, by Order in Council of the 19th July, 1966, of 3 acres 3 roods 35 perches of land in the Parish of Barwongemoong as a site for Public purposes (State Forests Department purposes), so far only as the portions containing 1 acre 3 roods 19 perches indicated by hatching on plan and description published in the *Government Gazette* of 17th May, 1972.—(B.742<sup>(\*)</sup>) (Rs.8492).

**DUNMUNKLE (BOOLITE).**—The temporary reservation, by Order in Council of the 26th May, 1902, of 29 acres 3 roods 29 perches of land in the Village of Boolite (now Parish of Dunmunkle), as a site for Public Recreation, and the temporary reservation by Order of the 7th September, 1948, for the additional purpose of a Public Hall, so far only as the portion containing 1 acre 2 roods 37 perches indicated by hatching on plan and description published in the *Government Gazette* of 17th May, 1972.—(D.180<sup>(C\*)</sup>) (Rs.6221).

**EPSOM.**—The temporary reservation, by Order in Council of the 24th September, 1968, of 16 acres 31 perches of land in the Township of Epsom as a site for Public purposes (Regional Agricultural Centre), so far only as the portion containing 6 perches indicated by hatching on plan and description published in the *Government Gazette* of 17th May, 1972.—(E.119<sup>(\*)</sup>) (Rs.9066).

**SEYMOUR.**—The temporary reservation, by Order in Council of the 29th February, 1864 (see *Government Gazette* of 8th March, 1864, page 573), of 1 acre 17 perches of land at Seymour (now Township of Seymour), as a site for Police purposes, so far only as the portion containing 1 rood 20 perches, more or less, indicated by hatching on plan and description published in the *Government Gazette* of 17th May, 1972.—(S.261<sup>(\*)</sup>) (Rs.9365).

**STAWELL.**—The temporary reservation, by Order in Council of the 19th August, 1935, of 2 roods 23 6/10 perches of land in the Parish of Stawell as a site for Municipal purposes.—(S.329<sup>(17)</sup>) (Rs.4472).

And the Honorable William Archibald Borthwick, Her Majesty's Minister of Lands for the State of Victoria, shall give the necessary directions hereon accordingly.

J. ROSSITER,  
Clerk of the Executive Council.

## LOCAL GOVERNMENT DEPARTMENT.

At the Executive Council Chamber, Melbourne, the  
fourteenth day of June, 1972.

## PRESENT:

His Excellency the Governor of Victoria.  
Sir Gilbert Chandler | Mr. Balfour.  
Mr. Borthwick

CONFIRMATION OF SEPARATE RATE.—BOROUGH OF  
KYABRAM.

In pursuance of the provisions of section 287 of the *Local Government Act 1958*, His Excellency the Governor of the State of Victoria, by and with the advice of the Executive Council thereof, hereby confirms a separate rate of 22 cents in the dollar on the net annual value of the rateable properties specified hereunder, which rate was made by the Council of the Borough of Kyabram on the 11th April, 1972, for the purpose of providing a paved rear access road to serve properties in a section of the Albion-street Shopping Centre, Kyabram, in the municipal district of the Borough of Kyabram.

## Properties to be Rated.

All those rateable properties in Albion-street, Kyabram, being numbers 22, 24, 26, 28, 30A, 30B, 30C and 32.

And the Honorable Alan John Hunt, Her Majesty's Minister for Local Government for the State of Victoria, shall give the necessary directions hereon accordingly.

J. ROSSITER,  
Clerk of the Executive Council.

## LOCAL GOVERNMENT DEPARTMENT.

At the Executive Council Chamber, Melbourne, the  
fourteenth day of June, 1972.

## PRESENT:

His Excellency the Governor of Victoria.  
Sir Gilbert Chandler | Mr. Balfour.  
Mr. Borthwick

## ROAD DISCONTINUED.—SHIRE OF ELTHAM.

Whereas it is provided in section 528 (2) of the *Local Government Act 1958*, that where a road (whether or not a public highway but not being a road set out on land of the Crown) or any part thereof is not required for public use, the Governor in Council on the request of the Council of the municipality in which such road is situated made not less than one month after publishing in a newspaper generally circulating in the district and posting to the registered proprietor (if any) of the land and the owners and occupiers (if any) of lands abutting or immediately adjacent to the road notice of intention to make such a request may by Order published in the *Government Gazette* direct that such road or part shall be discontinued and thereupon such road or part shall be discontinued accordingly:

And whereas the Council of the Shire of Eltham has requested that the Governor in Council direct that portion of Dawson-street, Briar Hill, be discontinued and not less than one month previously has published in a newspaper generally circulating in the district and posted to the registered proprietor of the land in the road and to the owners and occupiers of lands abutting or immediately adjacent to the road notice of intention to make such request.

Now therefore, His Excellency the Governor of the State of Victoria, by and with the advice of the Executive Council thereof, hereby directs:

- (a) that the portion of the said road, which is shown by hachure and cross-hachure on the plan hereunder, shall be discontinued;
- (b) that notwithstanding such discontinuance the Melbourne and Metropolitan Board of Works shall continue to have and possess the same right title power authority or interest in or in relation to the whole of the land shown by cross-hachure on the said plan as it had or possessed prior to such discontinuance with respect to or in connexion with any drains or pipes laid or erected in on or over such land for the purpose of drainage or sewerage;

(c) that, subject to any such right title power authority or interest the land in the said road may be retained by the Council of the Shire of Eltham for municipal purposes.

And whereas the Council of the City of Springvale has requested that the Governor in Council direct that a road between Second and Third avenues, Chelsea Heights, be discontinued and not less than one month previously has published in a newspaper generally circulating in the district and posted to the registered proprietor of the land in the road and to the owners and occupiers of lands abutting or immediately adjacent to the road notice of intention to make such request:

Now therefore, His Excellency the Governor of the State of Victoria, by and with the advice of the Executive Council thereof, hereby directs that the said road, which is shown hatched on the plan hereunder, shall be discontinued and that the land may be sold by the Council of the City of Springvale by agreement.

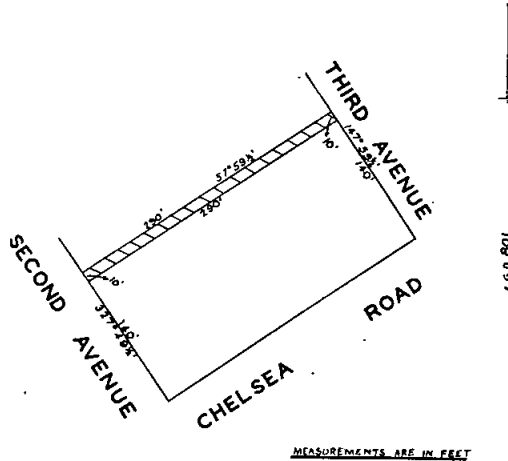
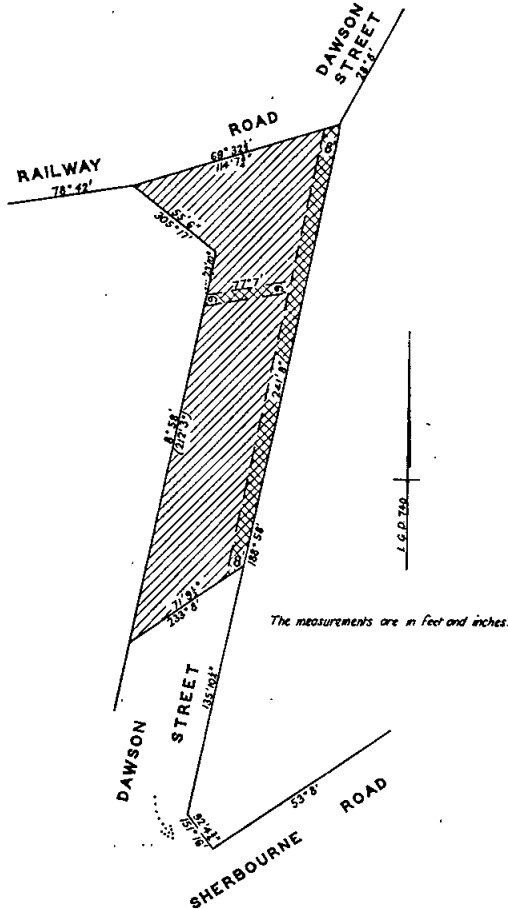

And the Honorable Alan John Hunt, Her Majesty's Minister for Local Government for the State of Victoria, shall give the necessary directions herein accordingly.

J. ROSSITER,  
Clerk of the Executive Council.

LOCAL GOVERNMENT DEPARTMENT.

At the Executive Council Chamber, Melbourne, the fourteenth day of June, 1972.

PRESENT:  
His Excellency the Governor of Victoria.  
Sir Gilbert Chandler | Mr. Balfour.  
Mr. Borthwick

ROAD DISCONTINUED.—CITY OF SPRINGVALE.

Whereas it is provided in section 528 (2) of the Local Government Act 1958, that where a road (whether or not a public highway but not being a road set out on land of the Crown) or any part thereof is not required for public use, the Governor in Council, on the request of the Council of the municipality in which such road is situated made not less than one month after publishing in a newspaper, generally circulating in the district and posting to the registered proprietor (if any) of the land and the owners and occupiers (if any) of lands abutting or immediately adjacent to the road, notice of intention to make such request may by Order published in the Government Gazette direct that such road or part shall be discontinued and thereupon such road or part shall be discontinued accordingly:

And the Honorable Alan John Hunt, Her Majesty's Minister for Local Government for the State of Victoria, shall give the necessary directions herein accordingly.

J. ROSSITER,  
Clerk of the Executive Council.

STAMPS ACT 1958, No. 6375.

At the Executive Council Chamber, Melbourne, the fourteenth day of June, 1972.

PRESENT:  
His Excellency the Governor of Victoria.  
Sir Gilbert Chandler | Mr. Balfour.  
Mr. Borthwick

His Excellency the Governor of the State of Victoria, by and with the advice of the Executive Council thereof, doth by this Order made, pursuant to section 131C of the Stamps Act 1958, No. 6375, revoke the declaration made on 7th July, 1970, and published in the Government Gazette on 15th July, 1970, declaring certain persons to be "approved vendors" for the purposes of subdivision (14) of Division 3 of Part II. of the Stamps Act 1958 in so far as the said declaration refers to the under-mentioned person:—

253. SAFEWAY FINANCE CO. PTY. LTD.

And the Honorable Sir Henry Edward Bolte, Her Majesty's Treasurer for the State of Victoria, shall give the necessary directions herein accordingly.

J. ROSSITER,  
Clerk of the Executive Council.

TORQUAY SEWERAGE AUTHORITY.

At the Executive Council Chamber, Melbourne, the fourteenth day of June, 1972.

PRESENT:  
His Excellency the Governor of Victoria.  
Sir Gilbert Chandler | Mr. Balfour.  
Mr. Borthwick

AMENDMENT OF ORDER.

Under the powers conferred by the Sewerage Districts Act and all other powers enabling him in that behalf, His Excellency the Governor of the State of Victoria, by and with the advice of the Executive Council of the said State,

doth hereby amend as follows the Order in Council made on 26th April, 1972, and published in the *Victoria Government Gazette* dated 3rd May, 1972, appointing Archibald Laurence Dean a Member of the Torquay Sewerage Authority.

For the expression "for a period of four years from the date hereof" there shall be substituted the expression "for a period of two years from the date hereof".

And the Honorable Roberts Christian Dunstan, Her Majesty's Minister of Water Supply for the State of Victoria, shall give the necessary directions herein accordingly.

J. ROSSITER,  
Clerk of the Executive Council.

Transport Regulation Acts.  
TRANSPORT REGULATION BOARD.

At the Executive Council Chamber, Melbourne, the fourteenth day of June, 1972.

PRESENT:

His Excellency the Governor of Victoria.  
Sir Gilbert Chandler | Mr. Balfour.  
Mr. Borthwick

APPOINTMENT OF MEMBER AND CHAIRMAN OF THE  
TRANSPORT REGULATION BOARD.

In pursuance of the powers in that behalf, conferred by the *Transport Regulation Act 1958*, His Excellency the Governor of the State of Victoria, by and with the advice of the Executive Council thereof, doth by this Order hereby appoint Benjamin Patrick Kay as a Member of the Transport Regulation Board as from and including the first day of July, 1972, until the thirty-first day of December, 1972:

And doth hereby appoint the said Benjamin Patrick Kay as Chairman of the Board as from and including the first day of July, 1972 until the thirty-first day of December, 1972.

And the Honorable Vernon Francis Wilcox, Her Majesty's Minister of Transport for the State of Victoria, shall give the necessary directions herein accordingly.

J. ROSSITER,  
Clerk of the Executive Council.

BENALLA SEWERAGE AUTHORITY.

At the Executive Council Chamber, Melbourne, the twentieth day of June, 1972.

PRESENT:

His Excellency the Governor of Victoria.  
Mr. Smith | Mr. Hunt.

CONSENT TO BORROWING \$7,600.

Under the powers conferred by the Sewerage Districts Act and all other powers enabling him in that behalf, His Excellency the Governor of the State of Victoria, by and with the advice of the Executive Council of the said State, doth hereby consent to the Benalla Sewerage Authority borrowing the sum of Seven thousand six hundred dollars (\$7,600), for the conversion of Loan No. 4.

And the Honorable Roberts Christian Dunstan, Her Majesty's Minister of Water Supply for the State of Victoria, shall give the necessary directions herein accordingly.

J. ROSSITER,  
Clerk of the Executive Council.

BENALLA WATERWORKS TRUST.

At the Executive Council Chamber, Melbourne, the twentieth day of June, 1972.

PRESENT:

His Excellency the Governor of Victoria.  
Mr. Smith | Mr. Hunt.

CONSENT TO BORROWING \$100,000.

Under the powers conferred by the Water Act and all other powers enabling him in that behalf, His Excellency the Governor of the State of Victoria, by and with the

advice of the Executive Council of the said State, doth hereby consent to the Benalla Waterworks Trust borrowing the sum of One hundred thousand dollars (\$100,000), to meet the cost of water supply works.

And the Honorable Roberts Christian Dunstan, Her Majesty's Minister of Water Supply for the State of Victoria, shall give the necessary directions herein accordingly.

J. ROSSITER,  
Clerk of the Executive Council.

CASTLEMAINE SEWERAGE AUTHORITY.

At the Executive Council Chamber, Melbourne, the twentieth day of June, 1972.

PRESENT:

His Excellency the Governor of Victoria.  
Mr. Smith | Mr. Hunt.

CONSENT TO BORROWING \$5,700.

Under the powers conferred by the Sewerage Districts Act and all other powers enabling him in that behalf, His Excellency the Governor of the State of Victoria, by and with the advice of the Executive Council of the said State, doth hereby consent to the Castlemaine Sewerage Authority borrowing the sum of Five thousand seven hundred dollars (\$5,700), for the conversion of Loan No. 6.

And the Honorable Roberts Christian Dunstan, Her Majesty's Minister of Water Supply for the State of Victoria, shall give the necessary directions herein accordingly.

J. ROSSITER,  
Clerk of the Executive Council.

GEELONG WATERWORKS AND SEWERAGE TRUST.

At the Executive Council Chamber, Melbourne, the twentieth day of June, 1972.

PRESENT:

His Excellency the Governor of Victoria.  
Mr. Smith | Mr. Hunt.

CONSENT TO BORROWING \$794,000.

Under the powers conferred by the Geelong Waterworks and Sewerage Act and all other powers enabling him in that behalf, His Excellency the Governor of the State of Victoria, by and with the advice of the Executive Council of the said State, doth hereby consent to the Geelong Waterworks and Sewerage Trust borrowing the sum of Seven hundred and ninety-four thousand dollars (\$794,000), in three amounts of Four hundred thousand dollars (\$400,000), Two hundred and seven thousand dollars (\$207,000) and One hundred and eighty-seven thousand dollars (\$187,000) respectively for the conversion of Loan Nos. K.5, U.5, V.5, Z.5, T.7 and X.7.

And the Honorable Roberts Christian Dunstan, Her Majesty's Minister of Water Supply for the State of Victoria, shall give the necessary directions herein accordingly.

J. ROSSITER,  
Clerk of the Executive Council.

GEELONG WATERWORKS AND SEWERAGE TRUST.

At the Executive Council Chamber, Melbourne, the twentieth day of June, 1972.

PRESENT:

His Excellency the Governor of Victoria.  
Mr. Smith | Mr. Hunt.

CONSENT TO BORROWING \$185,000.

Under the powers conferred by the Geelong Waterworks and Sewerage Act and all other powers enabling him in that behalf, His Excellency the Governor of the State of

Victoria, by and with the advice of the Executive Council of the said State, hereby consents to the Geelong Waterworks and Sewerage Trust borrowing the sum of One hundred and eighty-five thousand dollars (\$185,000), in two amounts of Ninety thousand dollars (\$90,000), and Ninety-five thousand dollars (\$95,000), respectively, for the conversion of Loan Nos. 73 and 96.

And the Honorable Roberts Christian Dunstan, Her Majesty's Minister of Water Supply for the State of Victoria, shall give the necessary directions herein accordingly.

J. ROSSITER,  
Clerk of the Executive Council.

#### MYRTLEFORD SEWERAGE AUTHORITY.

*At the Executive Council Chamber, Melbourne, the twentieth day of June, 1972.*

PRESENT:

His Excellency the Governor of Victoria.  
Mr. Smith | Mr. Hunt.

#### EXTENSION TO SEWAGE TREATMENT WORKS SITE AND COMPULSORY ACQUISITION OF LAND.

Under the powers conferred by the Sewerage Districts Act and all other powers enabling him in that behalf, His Excellency the Governor of the State of Victoria, by and with the advice of the Executive Council of the said State, doth hereby declare order and direct that the extent of the proposed sewage treatment works site of the Myrtleford Sewerage Authority be extended and approve the compulsory acquisition of the necessary land, such extension and land being shown on a plan approved by the Governor in Council by and with this Order and deposited in the office of the State Rivers and Water Supply Commission, Melbourne (Corr. 70/3088/59).

And the Honorable Roberts Christian Dunstan, Her Majesty's Minister of Water Supply for the State of Victoria, shall give the necessary directions herein accordingly.

J. ROSSITER,  
Clerk of the Executive Council.

#### NEERIM SOUTH WATERWORKS TRUST.

*At the Executive Council Chamber, Melbourne, the twentieth day of June, 1972.*

PRESENT:

His Excellency the Governor of Victoria.  
Mr. Smith | Mr. Hunt.

#### EXTENSION OF URBAN DISTRICT.

Under the powers conferred by the Water Act and all other powers enabling him in that behalf, His Excellency the Governor of the State of Victoria, by and with the advice of the Executive Council of the said State, doth hereby declare, order and direct that the extent of the Urban District of the Neerim South Waterworks Trust be increased by adding to the same the lands comprised within the area shaded pink on the plan approved by the Governor in Council by and with this Order and deposited in the office of the State Rivers and Water Supply Commission, Melbourne (Corr. No. 69/4311/28) and as on and from the date hereof, the extent of such District shall be and be deemed to be increased accordingly.

And the Honorable Roberts Christian Dunstan, Her Majesty's Minister of Water Supply for the State of Victoria, shall give the necessary directions herein accordingly.

J. ROSSITER,  
Clerk of the Executive Council.

#### RIVER IMPROVEMENT ACT 1958.

*At the Executive Council Chamber, Melbourne, the twentieth day of June, 1972.*

PRESENT:

His Excellency the Governor of Victoria.  
Mr. Smith | Mr. Hunt.

#### CONSENT TO THE BENDIGO CREEK IMPROVEMENT TRUST CARRYING OUT AND MAINTAINING RIVER IMPROVEMENT WORKS ON LAND OUTSIDE THE BENDIGO CREEK IMPROVEMENT DISTRICT.

Whereas the Bendigo Creek Improvement Trust desires to carry out and maintain river improvement works in the Reedy Creek from its confluence with Bendigo Creek upstream to the eastern boundary of Crown allotment 2, section 9, Parish of Bagshot:

And whereas, in pursuance of the provisions of section 23 (3) of the *River Improvement Act 1958*, a River Improvement Trust may with the consent of the Governor in Council carry out and maintain river improvement works on any land which is not within its river improvement district:

Now, therefore, His Excellency the Governor of Victoria, acting by and with the advice of the Executive Council thereof and in pursuance of the said Act and all other powers thereunto him enabling, hereby consents to the Bendigo Creek Improvement Trust carrying out and maintaining river improvement works in the Reedy Creek from its confluence with Bendigo Creek upstream to the eastern boundary of Crown allotment 2, section 9, Parish of Bagshot.

And the Honorable Roberts Christian Dunstan, Her Majesty's Minister of Water Supply for the State of Victoria, shall give the necessary directions herein accordingly.

J. ROSSITER,  
Clerk of the Executive Council.

#### TERANG SEWERAGE AUTHORITY.

*At the Executive Council Chamber, Melbourne, the twentieth day of June, 1972.*

PRESENT:

His Excellency the Governor of Victoria.  
Mr. Smith | Mr. Hunt.

#### CONSENT TO BORROWING \$20,000.

Under the powers conferred by the Sewerage Districts Act and all other powers enabling him in that behalf, His Excellency the Governor of the State of Victoria, by and with the advice of the Executive Council of the said State, doth hereby consent to the Terang Sewerage Authority borrowing the sum of Twenty thousand dollars (\$20,000), for the carrying out of works in accordance with the provisions of sections 95, 130 and 137 of the *Sewerage Districts Act 1958*. All moneys received by the said Authority in payment of costs and expenses of the said works, or any of them, shall be set aside for the purpose of and applied in repayment to the said sum so borrowed.

And the Honorable Roberts Christian Dunstan, Her Majesty's Minister of Water Supply for the State of Victoria, shall give the necessary directions herein accordingly.

J. ROSSITER,  
Clerk of the Executive Council.

#### THE BALLARAT WATER COMMISSIONERS.

*At the Executive Council Chamber, Melbourne, the twentieth day of June, 1972.*

PRESENT:

His Excellency the Governor of Victoria.  
Mr. Smith | Mr. Hunt.

#### APPROVAL OF PLAN OF SITE OF PIPE HEAD BASIN.

Under the powers conferred by the Water Act and all other powers enabling him in that behalf, His Excellency the Governor of the State of Victoria, by and with the

advice of the Executive Council of the said State, doth hereby approve a plan showing the site of a pipe head basin to be constructed by the Ballarat Water Commissioners, the said plan being deposited in the office of the State Rivers and Water Supply Commission, Melbourne.—(Corr. No. 71/846/92.)

And the Honorable Roberts Christian Dunstan, Her Majesty's Minister of Water Supply for the State of Victoria, shall give the necessary directions herein accordingly.

J. ROSSITER,  
Clerk of the Executive Council.

WARRAGUL SEWERAGE AUTHORITY.

At the Executive Council Chamber, Melbourne, the  
twentieth day of June, 1972.

PRESENT:

His Excellency the Governor of Victoria.  
Mr. Smith | Mr. Hunt.

CONSENT TO BORROWING \$19,000.

Under the powers conferred by the Sewerage Districts Act and all other powers enabling him in that behalf, His Excellency the Governor of the State of Victoria, by and with the advice of the Executive Council of the said State, doth hereby consent to the Warragul Sewerage Authority borrowing the sum of Nineteen thousand dollars (\$19,000), for the conversion of Loan No. 21.

And the Honorable Roberts Christian Dunstan, Her Majesty's Minister of Water Supply for the State of Victoria, shall give the necessary directions herein accordingly.

J. ROSSITER,  
Clerk of the Executive Council.

SUNBURY SEWERAGE AUTHORITY.

At the Executive Council Chamber, Melbourne, the  
twentieth day of June, 1972.

PRESENT:

His Excellency the Governor of Victoria.  
Mr. Smith | Mr. Hunt.

CONSENT TO BORROWING \$100,000.

Under the powers conferred by the Sewerage Districts Act and all other powers enabling him in that behalf, His Excellency the Governor of the State of Victoria, by and with the advice of the Executive Council of the said State, doth hereby consent to the Sunbury Sewerage Authority borrowing a sum of One hundred thousand dollars (\$100,000), to meet the cost of sewerage works as set forth in the detailed statement bearing date 15th June, 1972.

And the Honorable Roberts Christian Dunstan, Her Majesty's Minister of Water Supply for the State of Victoria, shall give the necessary directions herein accordingly.

J. ROSSITER,  
Clerk of the Executive Council.

Water Act 1958.

STATE RIVERS AND WATER SUPPLY COMMISSION.

At the Executive Council Chamber, Melbourne, the  
twentieth day of June, 1972.

PRESENT:

His Excellency the Governor of Victoria.  
Mr. Smith | Mr. Hunt.

WIMMERA AND UPPER WIMMERA WATERWORKS DISTRICTS UNITED TO FORM WIMMERA WATERWORKS DISTRICT.

Under the powers conferred by the Water Act 1958 and all other powers enabling him in that behalf, His Excellency the Governor of the State of Victoria, with the advice of

the Executive Council of the said State, on the recommendation of the State Rivers and Water Supply Commission, doth hereby declare, order, and direct as follows:—

- (1) That as on and from the 1st day of July, 1972, the Wimmera Waterworks District and the Upper Wimmera Waterworks District shall be united so as to form one district to be known as the Wimmera Waterworks District and that the said Wimmera Waterworks District shall comprise the whole of the lands which, on the 30th day of June, 1972, were included within the boundaries of the said Wimmera Waterworks District and the Upper Wimmera Waterworks District.
- (2) That all property income assets rights and liabilities standing in the name of the said Wimmera and Upper Wimmera Waterworks Districts shall upon the union of those Districts as hereinbefore provided stand in the name of the Wimmera Waterworks District.
- (3) That the scheme of works for the service of the Wimmera Waterworks District consists of a system of channels with appurtenant structures and pumping plants to serve areas of high lands.
- (4) The total estimated cost of such scheme is \$14,000,000.
- (5) That the sources from which the Wimmera Waterworks District is to be supplied with water are the Wimmera River and the Grampians Reservoirs.—(Corres. No. 60/6496.)

And the Honorable Roberts Christian Dunstan, Her Majesty's Minister of Water Supply for the State of Victoria, shall give the necessary directions herein accordingly.

J. ROSSITER,  
Clerk of the Executive Council.

Water Act 1958.

STATE RIVERS AND WATER SUPPLY COMMISSION.

At the Executive Council Chamber, Melbourne, the  
twentieth day of June, 1972.

PRESENT:

His Excellency the Governor of Victoria.  
Mr. Smith | Mr. Hunt.

UPPER WIMMERA WATERWORKS DISTRICT—DISTRICT EXTENDED.

Under the powers conferred by the Water Act 1958 and all other powers enabling him in that behalf, His Excellency the Governor of the State of Victoria, with the advice of the Executive Council of the said State, on the recommendation of the State Rivers and Water Supply Commission, doth hereby declare, order and direct that the Upper Wimmera Waterworks District be extended by adding to the same the lands shown by blue colour on a plan approved by the Governor in Council and deposited in the office of the State Rivers and Water Supply Commission, Melbourne (Corr. No. 60/6496) and as on and from the 30th day of June, 1972, such district shall be deemed to be so extended.

And the Honorable Roberts Christian Dunstan, Her Majesty's Minister of Water Supply for the State of Victoria, shall give the necessary directions herein accordingly.

J. ROSSITER,  
Clerk of the Executive Council.

Water Act 1958.

STATE RIVERS AND WATER SUPPLY COMMISSION.

At the Executive Council Chamber, Melbourne, the  
twentieth day of June, 1972.

PRESENT:

His Excellency the Governor of Victoria.  
Mr. Smith | Mr. Hunt.

MALLEE WATERWORKS DISTRICT—PORTION EXCISED.

Under the powers conferred by the Water Act 1958 and all other powers enabling him in that behalf, His Excellency the Governor of the State of Victoria, with the advice of



the Executive Council of the said State, on the recommendation of the State Rivers and Water Supply Commission, doth hereby declare, order and direct that there shall be excised from the Mallee Waterworks District that portion of the same shown by green colour on a plan approved by the Governor in Council and deposited in the office of the State Rivers and Water Supply Commission, Melbourne (Corr. No. 60/6496) and as on and from the 29th day of June, 1972, such portion shall be deemed to be excised accordingly.

And the Honorable Roberts Christian Dunstan, Her Majesty's Minister of Water Supply for the State of Victoria, shall give the necessary directions herein accordingly.

J. ROSSITER,  
Clerk of the Executive Council.

Water Act 1958.

STATE RIVERS AND WATER SUPPLY COMMISSION.

*At the Executive Council Chamber, Melbourne, the twentieth day of June, 1972.*

PRESENT:

His Excellency the Governor of Victoria.  
Mr. Smith | Mr. Hunt.

OTWAY AND SIMPSON URBAN DISTRICTS UNITED  
TO FORM OTWAY URBAN DISTRICT.

Under the powers conferred by the Water Act 1958 and all other powers enabling him in that behalf, His Excellency the Governor of the State of Victoria, with the advice of the Executive Council of the said State, on the recommendation of the State Rivers and Water Supply Commission, doth hereby declare, order, and direct as follows:—

1. That as on and from the 1st day of July, 1972, the Otway Urban District and Simpson Urban District be united so as to form one District to be known as the Otway Urban District.

2. The said Otway Urban District so formed shall comprise the lands which were within the boundaries of the aforesaid Otway and Simpson Urban Districts on 1st July, 1972.

3. That all property, income, assets, rights and liabilities standing in the name of the said Otway and Simpson Urban Districts shall upon the union of those districts as hereinbefore provided stand in the name of the Otway Urban District so formed.—(Corr. No. 71/2947).

And the Honorable Roberts Christian Dunstan, Her Majesty's Minister of Water Supply for the State of Victoria, shall give the necessary directions herein accordingly.

J. ROSSITER,  
Clerk of the Executive Council.

Water Act 1958.

STATE RIVERS AND WATER SUPPLY COMMISSION.

*At the Executive Council Chamber, Melbourne, the twentieth day of June, 1972.*

PRESENT:

His Excellency the Governor of Victoria.  
Mr. Smith | Mr. Hunt.

GOULBURN - MURRAY IRRIGATION DISTRICT —  
DISTRICT EXTENDED.—DINGEE IRRIGATION AREA  
—BOUNDARIES VARIED.

Under the powers conferred by the Water Act 1958 and all other powers enabling him in that behalf, His Excellency the Governor of the State of Victoria, with the advice of the Executive Council of the said State, on the recommendation of the State Rivers and Water Supply Commission, doth hereby declare, order and direct that the Goulburn-Murray Irrigation District be extended and the boundaries of the Dingee Irrigation Area be varied by adding to the said District and Area the land shown by blue colour on a plan approved by the Governor in Council and deposited in the office of the State Rivers and Water Supply Commission, Melbourne (Corr. No. 67/4426) and as on and from the 1st day of July, 1972, such District shall be deemed to be so extended and the boundaries of such area shall be so varied.

And the Honorable Roberts Christian Dunstan, Her Majesty's Minister of Water Supply for the State of Victoria, shall give the necessary directions herein accordingly.

J. ROSSITER,  
Clerk of the Executive Council.

Water Act 1958.

STATE RIVERS AND WATER SUPPLY COMMISSION.

*At the Executive Council Chamber, Melbourne, the twentieth day of June, 1972.*

PRESENT:

His Excellency the Governor of Victoria.  
Mr. Smith | Mr. Hunt.

GREEN'S LAKE RECREATIONAL AREA.—BOUNDARIES  
VARIED.

Under the powers conferred by the Water Act 1958 and all other powers enabling him in that behalf, His Excellency the Governor of the State of Victoria, with the advice of the Executive Council of the said State, on the recommendation of the State Rivers and Water Supply Commission, doth hereby declare, order, and direct that as on and from the 30th day of June, 1972, the boundaries of the Green's Lake Recreational Area shall be varied by excising from the said Area that portion of the same shown by green colour on a plan approved by the Governor in Council and deposited in the Office of the State Rivers and Water Supply Commission, Melbourne.—(Corr. No. 66/4748).

And the Honorable Roberts Christian Dunstan, Her Majesty's Minister of Water Supply for the State of Victoria, shall give the necessary directions herein accordingly.

J. ROSSITER,  
Clerk of the Executive Council.

Water Act 1958.

STATE RIVERS AND WATER SUPPLY COMMISSION.

*At the Executive Council Chamber, Melbourne, the twentieth day of June, 1972.*

PRESENT:

His Excellency the Governor of Victoria.  
Mr. Smith | Mr. Hunt.

MALLEE AND NORTHERN MALLEE WATERWORKS  
DISTRICTS UNITED TO FORM MALLEE WATER-  
WORKS DISTRICT.

Under the powers conferred by the Water Act 1958 and all other powers enabling him in that behalf, His Excellency the Governor of the State of Victoria, with the advice of the Executive Council of the said State, on the recommendation of the State Rivers and Water Supply Commission, doth hereby declare, order and direct as follows:—

(1) That as on and from the 1st day of July, 1972, the Mallee Waterworks District and the Northern Mallee Waterworks District shall be united so as to form one district to be known as the Mallee Waterworks District and that the said Mallee Waterworks District shall comprise the whole of the lands which, on the 30th day of June, 1972, were included within the boundaries of the said Mallee Waterworks District and the Northern Mallee Waterworks District.

(2) That all property income assets rights and liabilities standing in the name of the said Mallee and Northern Mallee Waterworks Districts shall upon the union of those Districts as hereinbefore provided stand in the name of the Mallee Waterworks District.

(3) That the scheme of works for the service of the Mallee Waterworks District consists of a system of channels with appurtenant structures, pumping plants to serve isolated areas of high lands, and a number of bore installations in the former Northern Mallee Waterworks District.

(4) That the total estimated cost of such scheme is \$10,000,000.

(5) That the sources from which the Mallee Waterworks District is to be supplied with water are the Wimmera River and the Grampians Reservoirs and natural underground source in the former Northern Mallee Waterworks District.—(Corr. No. 60/6496).

And the Honorable Roberts Christian Dunstan, Her Majesty's Minister of Water Supply for the State of Victoria, shall give the necessary directions herein accordingly.

J. ROSSITER,  
Clerk of the Executive Council.

## LANDS DEPARTMENT NOTICES

### APPROACHING LAND SALE.

Sale of Crown Land, in fee-simple, will be held at the under-mentioned place and date, viz.:—

	No. of Gazette.
Ultima.—Thursday, 29th June, 1972 ..	.. 32

### COMMITTEES OF MANAGEMENT OF RESERVES.

#### APPOINTMENTS.

Notice is hereby given that, in pursuance of section 221 of the Land Act 1958, the following appointments of Committees of Management of reserved Crown lands have been made by the Minister of Lands:—

#### "BINGINWARRI RECREATION RESERVE."

Edward Bryant Roberts, Geoffrey Bryant Roberts, Graham James Roberts, Gordon Angus Kay, Hadyn David Ross, John William Michie and Robert William Gordon Pretty as a Committee of Management for a period of three (3) years from the 5th May, 1972, of the land in the Parish of Binginwarri temporarily reserved by Orders in Council dated the 3rd March, 1915, and 31st December, 1918, as sites for Public Recreation and together known as the "Binginwarri Recreation Reserve".—(Corres. No. Rs.691.)

#### "BOBINAWARRAH MEMORIAL HALL RESERVE."

Harold John Wilkinson, Lindsay McDonald Simpson, Raymond James McAlicee, Duncan Kenneth McCallum, Neville John McInnes, Rex Gibb, Robert Charles Charlton, Norman Allan Francis Gibb and Ian Francis Simpson as a Committee of Management for a period of three (3) years from the 7th March, 1972, of the land in the Parish of Moyhu temporarily reserved by Order in Council dated the 9th April, 1925, as a site for a Public Hall and known as the "Bobinawarrah Memorial Hall".—(Corres. No. Rs.3097.)

#### "BOORT RACECOURSE AND RECREATION RESERVE."

E. M. Lanyon, Robert H. Webb, James S. Potter, Frank L. Boyle, R. M. Sutton, F. G. Hill and E. W. Fitzpatrick as a Committee of Management for a period of three (3) years from the 28th May, 1972, of the land in the Parish of Boort permanently reserved by Order in Council dated the 13th October, 1931, as a site for a Racecourse and other purposes of Public Recreation, and known as the "Boort Racecourse and Recreation Reserve".—(Corres. No. Rs.650.)

#### "SCOTT RECREATION RESERVE", AT COBRAM.

Sidney Murray Scott, Hiram Edgar White, Cyril John White, Ernest James Stewart, Denis William Brooks, Ian Perrin, Patrick Keating Parnell, Robin Dean Briggs and William Roy Denson as a Committee of Management for a period of three (3) years from the 11th May, 1972, of the land in the Township of Cobram temporarily reserved by Order in Council dated the 14th February, 1888, as a site for Cricket and purposes of Public Recreation and known as the "Scott Recreation Reserve".—(Corres. No. Rs.659.)

#### "CULGOA RECREATION RESERVE."

S. K. Sutton, F. J. Casey, H. V. Shirley, W. T. Casey, B. G. Barry, C. R. Currie, J. P. McNamara, W. H. T. Bath and B. D. Aldenhoven as a Committee of Management for a period of three (3) years from the 1st June, 1972, of

the remaining portion of the land in the Township of Culgoa temporarily reserved by Order in Council dated the 24th April, 1933, as a site for Public Recreation and known as the "Culgoa Recreation Reserve".—(Corres. No. Rs.2071.)

#### "LOST CHILDREN'S CAIRN MEMORIAL RESERVE."

Stanley George Hoath, Frederick William Stanley Verey, John Edmund Menadue, Archibald Frederick Goodman and George William Anderson Barron (being the nominees of the Daylesford and District Historical Society) as a Committee of Management for a period of three (3) years from the 8th January, 1972, of the land in the Township of Daylesford West temporarily reserved by Order in Council dated the 21st December, 1971, and known as the "Lost Children's Cairn Memorial Reserve".—(Corres. No. Rs.9575.)

#### "DELVINE PUBLIC HALL RESERVE."

Andrew J. H. Mactier, Archibald D. Macarthur and Brian J. Shugg as a Committee of Management for a period of three (3) years from the 27th May, 1972, of the land in the Parish of Coongulmerang temporarily reserved by Order in Council dated the 28th January, 1896, as a site for a Mechanics' Institute and known as the "Delvine Public Hall Reserve".—(Corres. No. Rs.3116.)

#### "DUNLUCE PUBLIC RECREATION AND PLAYGROUND RESERVE."

Benjamin Harold Mortlock, P. A. Mortlock, Donald William Mortlock, Colin David Gordon, Allan George Gordon and Bernard Anthony Lanfranchi as a Committee of Management for a period of three (3) years from the 16th May, 1972, of the land in the Parish of Natteyallock temporarily reserved by Order in Council dated the 25th May, 1965, as a site for Public Recreation and Playground purposes.—(Corres. No. Rs.8438.)

#### "KOORLONG PUBLIC HALL RESERVE."

Arthur Allan O'Connor, Walter Leslie Scott, Philip Sydney Beverley, Ilario Dichiera, Charles Maxwell Cooke, Harold Mackenzie Miller and Donald Mathew O'Sullivan as a Committee of Management for a period of three (3) years from the 29th May, 1972, of the land in the Parish of Mildura (at Koorlong), temporarily reserved by Order in Council dated the 15th June, 1915, as a site for a Public Hall and known as the "Koorlong Public Hall Reserve".—(Corres. No. Rs.5530.)

#### PUBLIC PURPOSES (PRESERVATION OF NATURAL RESOURCES) RESERVE, PARISH OF MILDURA.

Ian Henry Thomas Jobling, John F. Murfitt, Charles Robert Langford, Desmond McNamara and Lindsay Jones (for so long as they shall continue to be the elect of the Education Department) as a Committee of Management of the land in the Parish of Mildura, temporarily reserved by Order in Council, dated the 9th May, 1972, as a site for Public purposes (Preservation of Natural Resources).—(Corres. No. Rs.9609.)

#### "MUDGEEGONGA PUBLIC HALL RESERVE."

David John Carroll, George Ivor Johnson, John Murray Blewett, John Frederick Wood, Desmond John Larkin, Keith Thomas Hammat, James Raymond Hicks, John Dudley Thomas Carroll and Thomas Joseph Carroll as a Committee of Management for a period of three (3) years from the 26th May, 1972, of the land in the Township of Mudgeegonga, temporarily reserved by Order in Council, dated the 26th November, 1941, as a site for a Public Hall and known as the "Mudgeegonga Public Hall Reserve".—(Corres. No. Rs.5030.)

#### "MURCHISON CARAVAN PARK."

Thomas Keith Gregory, E. N. Smith, Matthew Drayton Patterson, Arthur James Trevaskis, Roy Albert Lyons, James Thomas Finnigan, John Ambrose Tierney, Albert Edward Hammond and Reginald John Orr as a Committee of Management for a period of three (3) years from the 13th May, 1972, of the preserved Crown land at Murchison shown bordered red on plan "M/14.2.69 attached to Lands Department correspondence Rs.1864A and known as the "Murchison Caravan Park".—(Corres. No. Rs.1864A.)

**"LADY FORSTER FREE KINDERGARTEN RESERVE", PORT MELBOURNE.**

Raymond Frank Julier (for so long only as he shall continue to be the Mayor of the City of Port Melbourne) and Bertha Ballantyne, Jean Winifred Crane, Dorothy Margaret John and William Leslie Dick (for the period ending the 19th April, 1975) as a Committee of Management of the land in the City of Port Melbourne, temporarily reserved by Order in Council, dated the 19th October, 1926, as a site for an Institution for Public Instruction (Kindergarten) and known as the "Lady Forster Free Kindergarten Reserve".—(Corres. No. Rs.3376.)

**"REDBANK RACECOURSE RESERVE."**

Charles Roberts Egan, William Wolfe Irwin, Kevin Bernard Ryan, Ian Alexander Grant, Kevin Cornelius Meagher and Kenneth Francis Grant as a Committee of Management for a period of three (3) years from the 30th May, 1972, of the land in the Parish of Redbank, temporarily reserved by Orders in Council, dated the 30th June, 1873 and 26th September, 1881, as sites for Racing and Recreation purposes and together known as the "Redbank Racecourse Reserve".—(Corres. No. Rs.2175.)

**"STRATHBOGIE NORTH RECREATION RESERVE."**

Wesley M. Gardiner, Frederick William Jacka, Norman John Watkins, Lindsay Douglas Simpson and Keith Roy Anderson as a Committee of Management for a period of three (3) years from the 23rd March, 1972, of the land in the Parish of Strathbogrie, temporarily reserved by Order in Council, dated the 22nd November, 1921, as a site for Recreation purposes and known as the "Strathbogrie North Recreation Reserve".—(Corres. No. Rs.2432.)

**"TOOMUNG RECREATION RESERVE."**

John Douglas Black, William M. Bishop, William Arthur Bishop, Robert B. Sutton, Kevin William Silvester, Alfred John Foster, Edgar Charles Holmes, Oliver Orton Thompson and Leonard John Pump as a Committee of Management for a period of three (3) years from the 22nd April, 1972, of the lands in the Township of Callignee, temporarily reserved by Orders in Council, dated the 27th May, 1930 and 24th February, 1959, as sites for Public Recreation and known as the "Toomung Recreation Reserve".—(Corres. No. Rs.3997.)

**"WOORINEN NORTH RECREATION RESERVE."**

Alan George Roberts, Harold Ian Lawson, Geoffrey David Heighway, Ian Heighway and Robin Lawler Ray as a Committee of Management for a period of three (3) years from the 29th April, 1972, of the land in the Parish of Tyntynder West, temporarily reserved by Order in Council, dated the 5th March, 1946, as a site for Public Recreation purposes and known as the "Woorinen North Recreation Reserve".—(Corres. No. Rs.5745.)

**"YARRA GLEN RECREATION AND SHOWGROUNDS RESERVE."**

Benjamin Stevenson Whitwell (for so long only as he shall continue to be a Councillor and the elect of the Council of the Shire of Healesville) and John A. Ellis, Hank Vandenham and Alexander Lamont White (as the representatives of the Yarra Glen Agricultural and Horticultural Society) together with John Andrew Williamson, John P. Bourke and Charles A. K. Donald (as the representatives of the Public) as a Committee of Management for a period of three (3) years ending the 23rd April, 1975, of the reserved Crown lands in the Parish of Tarrawarra as are indicated by red colour on plan "T/12.4.46" attached to Lands Department correspondence No. Rs.934 and known as the "Yarra Glen Recreation and Showgrounds Reserve".—(Corres. No. Rs.934.)

**PUBLIC PURPOSES (SUPPLY OF GRAVEL) RESERVE, PARISH OF YINNAR.**

The Corporation of the Shire of Morwell as the Committee of Management of the land in the Parish of Yinnar, temporarily reserved by Order in Council, dated the 11th April, 1972, as a site for Public purposes (Supply of Gravel).—(Corres. No. Rs.9594.)

W. BORTHWICK,  
Minister of Lands.

Department of Crown Lands and Survey,  
Melbourne, 13th June, 1972.

**COMMITTEES OF MANAGEMENT OF RESERVES. APPOINTMENTS.**

Notice is hereby given that, in pursuance of section 221 of the *Land Act 1958*, the following appointments of Committees of Management of reserved Crown lands have been made by the Minister of Lands:—

**"APOLLO BAY FREE LIBRARY AND PUBLIC HALL RESERVE."**

Albert John Cockerell, Keith Frederick Leorke and Raymond Eric Albert Barton as a Committee of Management for a period of three (3) years from the 31st March, 1972, of the land in the Parish of Krambruck, temporarily reserved by Order in Council dated the 23rd November, 1885, as a site for a Free Library and by Order in Council dated the 28th February, 1950, as a site for a Public Hall, and known as the "Apollo Bay Free Library and Public Hall Reserve".—(Corres. No. Rs.1757.)

**"APOLLO BAY FORESHORE RESERVE AND THE CARISBROOK FALLS RECREATION RESERVE."**

Herbert Victor Biddle and Roy Horace Tuckett (in the places of E. Johnstone and S. B. Harrison) as members of the Committee of Management for a period ending the 7th May, 1973 of—

- (a) the land in the Parish of Wongarra, temporarily reserved as a site for Public Recreation by Order in Council of the 13th February, 1894, and known as the "Carisbrook Falls Recreation Reserve";
- (b) the reserved Crown land as indicated in red colour on plan marked "K/14.3.30", attached to Lands Department correspondence Rs.4917;
- (c) the land in the Parish of Krambruk temporarily reserved by Order in Council dated the 25th May, 1965, as a site for Public purposes.—(Corres. No. Rs.4917.)

**"AVOCA PUBLIC PARK."**

Donald Roy Farnsworth, Noel Vincent Jess, Alan John Chalkley, Reginald Steven Pora, Myrza Wesley Dawson, Bruce Andrew Field, Robert David Peck, Allan Thomas Mitchell, Leslie Thomas Jolly as a Committee of Management for a period of three (3) years from the 1st June, 1972, of the land in the Township of Avoca, temporarily reserved by Order in Council dated the 5th May, 1885, as a site for Public Park, and known as the "Avoca Public Park".—(Corres. No. Rs.404.)

**WATER SUPPLY PURPOSES, PARISH OF BETKA.**

The Mallaoota Waterworks Trust as the Committee of Management of the lands in the Parish of Betka, temporarily reserved by Orders in Council dated the 23rd May, 1972, as sites for Water Supply purposes.—(Corres. No. Rs.9613.)

**"FENTON'S CREEK RECREATION RESERVE."**

Oliver Richard Poole, Barry Charles Finch, Harold Mervin Collins, James Oxley Poole, Eric Herbert Holt and Eric William Walker as a Committee of Management for a period of three (3) years from the 20th April, 1972, of the land in the Parish of Berrimal, temporarily reserved by Order in Council dated the 27th October, 1910, as a site for Public Recreation and by Order in Council dated the 1st June, 1948, for the additional purpose of Public Hall, and known as the "Fenton's Creek Recreation Reserve".—(Corres. No. Rs.23.)

**"GOSCHEN PUBLIC HALL AND RECREATION RESERVE."**

Douglas Brown, Ronald Davies, Peter Fox, Douglas Hucker, Mackley Fox, John Chisholm, Carl Fox, Alan Mason and Donald Holmes as a Committee of Management for a period of three (3) years from the 30th March, 1972, of the land in the Township of Goschen, temporarily reserved by Orders in Council dated the 12th September, 1898 and 16th August, 1937 as sites for Public Recreation and Public Hall, and known as the "Goschen Public Hall and Recreation Reserve".—(Corres. No. Rs.4626.)

**"INVERLEIGH MECHANICS' INSTITUTE RESERVE."**

Terrell G. Pell, Leslie Duncan Savage, Leonard Phillip Maher, Charles John Morgan and William Francis Hart as a Committee of Management for a period of three (3) years from the 25th May, 1972 of the land in the Township of Inverleigh, permanently reserved by Order in Council dated the 2nd September, 1902, as a site for a Mechanics' Institute, and known as the "Inverleigh Mechanics' Institute Reserve".—(Corres. No. Rs.5110.)

**"MANSFIELD (LORDS) CRICKET AND RECREATION RESERVE."**

Kenneth Norman Marks, J. Fogarty, Norman George Walker, M. Harrison, Cyril Gordon McMillan, Hugh Geoffrey Ross, James Clifford McCormack, John Joseph Reardon and Norman Douglas Pook as a Committee of Management for a period of three (3) years from the 28th April, 1972, of the land in the Township of Mansfield, temporarily reserved by Order in Council dated the 28th November, 1887, as a site for Cricket and Public Recreation, and known as the "Mansfield (Lords) Cricket and Recreation Reserve."—(Corres. No. Rs.2021.)

**"MORKALLA HALL RESERVE."**

Leslie Ernest Gray, Bruce Nunn, Leslie Oscar Mattschoss, Mortimer Mattschoss and Reginald Walter Gray as a Committee of Management for a period of three (3) years from the 11th May, 1972, of the land in the Township of Morkalla, temporarily reserved by Order in Council dated the 25th August, 1959, as a site for a Public Hall, and known as the "Morkalla Public Hall Reserve".—(Corres. No. Rs.7847.)

**"NERRENA PUBLIC HALL RESERVE."**

Ronald I. Christoffersen, Herb Wildes, John Raymond Allen, Edward Harvey Bawden, Thomas Kindellan, Oswald Geoffrey Brewster, Eric William Caple, Eric Samuel Allen, Thomas William Clark and Charles John Christoffersen as a Committee of Management for a period of three (3) years of the land in the Parish of Nerrena, temporarily reserved by Order in Council dated the 27th February, 1900, as a site for a Public Hall, and known as the "Nerrena Public Hall Reserve".—(Corres. No. Rs.5834.)

**"NEWTOWN RECREATION RESERVE."**

Frederick Weybury, Thomas James Carey, James Carey and Joseph Sharp as a Committee of Management for a period of three (3) years from the 17th May, 1972, of the land in the Parish of Scarsdale, temporarily reserved by Order in Council dated the 26th February, 1872, as a site for Recreation Ground and Mustering Paddock (excepting the area occupied by the Mustering Yards), and known as the "Newtown Recreation Reserve".—(Corres. No. Rs.1001.)

**"PENSHURST RACECOURSE RESERVE."**

Amos Benjamin Burow, Laurence James Anderson, Norman Kinnealy, Daniel Maxwell Ewing and William John Lewis as a Committee of Management for a period of three (3) years from the 28th May, 1972, of the land in the Parish of Yalimba, temporarily reserved by Order in Council dated the 17th October, 1864, as a site for a Racecourse and other purposes of Public Recreation, and known as the "Penshurst Racecourse and Recreation Reserve".—(Corres. No. Rs.974.)

**"WANNON AND NIGRETТА PARK RESERVES."**

John Leslie Clement Young, Horace Neil Fry, Martin Joseph Blake, Stanley Peter John Falkenberg, Ian Ponsford McTaggart, John Robert O'Dea, William Frederick Larmour, Kenneth Clive Gittins and James Ross Griffin as a Committee of Management for a period of three (3) years from the 27th April, 1972, of the land in the Parish of Bochara, temporarily reserved by Orders in Council dated the 24th February, 1915, 20th March, 1917, 12th February, 1924, 27th July, 1925 and 19th December, 1967, as sites for Public Recreation, and of the land in the Parish of Bochara, permanently reserved by Order in Council dated the 23rd January, 1912, as a site for the Recreation, Convenience and Amusement of the People, together with the Crown lands 150 links from each bank of the Wannon River, permanently reserved for Public purposes, abutting the said reservations, such lands being known as the "Wannon and Nigretta Park Reserves".—(Corres. Nos. Rs.576, Rs.1911.)

**"YALLOURN NORTH RECREATION RESERVE."**

Norman William Casey, David James Roberts, Gordon William Cook, Reginald Vermont Stallworthy, Allan Lyell Vickery, E. J. Keating, N. B. Thomson, E. A. Cox and Donald H. Evans as a Committee of Management for a period of three (3) years of the land in the Parish of Tanjil East, temporarily reserved by Order in Council dated the 30th June, 1964, as a site for Public Recreation and known as the "Yallourn North Recreation Reserve".—(Corres. No. Rs.8331.)

**PUBLIC PURPOSES (PRESERVATION OF FLORA AND FAUNA) RESERVE, AT YANIPY.**

Richard Walter Rowe, Alexander John Hicks, William George Avelyn Coutts, Victor George Champness, Barry Albert Schache, Desmond Wilson, John Cliffy Grant, Jabez Jagger Potts and Geoffrey James Walker as a Committee of Management for a period of three (3) years from the 2nd June, 1972, of the land in the Parish of Yanipy, temporarily reserved by Order in Council dated the 11th May, 1965, as a site for Public purposes (Preservation of Flora and Fauna).—(Corres. No. Rs.8440.)

W. BORTHWICK,  
Minister of Lands.

Department of Crown Lands and Survey,  
Melbourne, 16th June, 1972.

**PROPOSED REVOCATIONS OF TEMPORARY RESERVATIONS OF LANDS BY ORDERS IN COUNCIL.**

In pursuance of the provisions of the *Land Act 1958*, notice is hereby given that it is the intention of the Governor in Council to revoke the temporary reservations of lands by Orders in Council hereunder referred to, viz.:

The following Notices were published 1° on the 31st May, 1972, pursuant to Orders of the 23rd May, 1972.

**MARONG.**—The temporary reservation as a site for Public purposes (State School) and the withholding from sale, leasing and licensing by Order in Council of the 20th November, 1876 (see *Government Gazette* 24th November, 1876, page 2157) of 2 acres of land in the Parish of Marong are about to be revoked.—(M.32<sup>(s)</sup>) (Rs.7127).

**MARONG.**—The temporary reservation by Order in Council of the 29th August, 1905, of 1 acre 2 roods 33 perches of land in the Parish of Marong as a site for a State School is about to be revoked.—(M.32<sup>(s)</sup>) (Rs.7127).

**CALIVIL.**—The temporary reservation as a site for Public purposes (State School) and the withholding from sale, leasing and licensing by Order in Council of the 8th October, 1877, of 2 acres of land in the Parish of Calivil are about to be revoked.—(C.354<sup>(s)</sup>) (W.90872).

**CRANBOURNE.**—The temporary reservation by Order in Council of the 8th December, 1873 (see *Government Gazette* of the 12th December, 1873, page 2163) of 2 acres 1 rood 15 perches of land in the Township of Cranbourne as a site for Police purposes revoked as to part by Order of the 15th January, 1877, is about to be revoked so far only as the portion containing 1 rood 34 perches indicated by hatching on plan hereunder, is concerned.—(C.329<sup>(s)</sup>) (Rs.5854).

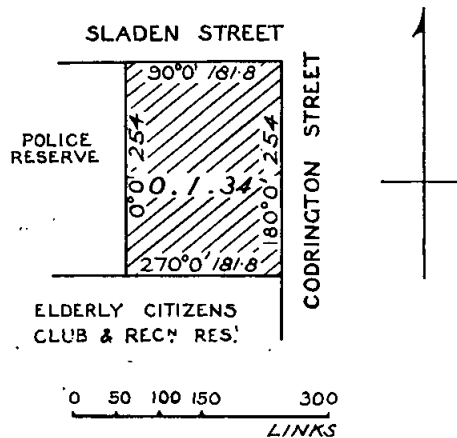

W. BORTHWICK,  
Minister of Lands.

**PROPOSED PERMANENT RESERVATION OF LAND AS A SITE.**

In pursuance of sections 14 and 21 of the *Land Act 1958*, notice is hereby given that it is the intention of the Governor in Council to reserve permanently from sale, from being leased and from having a licence granted in respect thereof the land hereinafter described:—

The following Notice was published 1° on the 31st May, 1972, pursuant to Order of the 23rd May, 1972.

Land proposed to be permanently reserved as a site for Public purposes, unreserved Crown land forming the bed of the Beika River and 200 links from each bank, from its source to its mouth on the shore of Bass Strait.—(Rs.9613.)

W. BORTHWICK,  
Minister of Lands.

#### PROPOSED REVOCATIONS OF TEMPORARY RESERVATIONS OF LANDS BY ORDERS IN COUNCIL.

In pursuance of the provisions of the *Land Act 1958*, notice is hereby given that it is the intention of the Governor in Council to revoke the temporary reservations of lands by Orders in Council hereunder referred to, viz.:—

The following Notices were published 1° on the 7th June, 1972, pursuant to Orders of the 30th May, 1972.

**ANAKIE.**—The temporary reservation by Order in Council of the 19th February, 1889 (see *Government Gazette*, 22nd February, 1889, page 685), of 130 acres of land in the Parish of Anakie, as a site for Water Supply purposes, is about to be revoked.—(A.31<sup>(2)</sup>) (C.98135).

**WONDOOMAROOK.**—The temporary reservation at a site for Public purposes (State School), and the withholding from sale, leasing and licensing by Order in Council of the 18th March, 1879, of 2 acres of land in the Parish of Wondoomarook, are about to be revoked.—(W.347<sup>(6)</sup>) (Rs.9628).

**ANAKIE.**—The temporary reservation by Order in Council of the 17th January, 1872 (see *Government Gazette*, 26th January, 1872, page 187), of 3 acres 3 roods 38 perches of land in the Parish of Anakie, as a site for Victorian Water Supply purposes, is about to be revoked.—(A.31<sup>(2)</sup>) (C.98135).

**BAMBRA.**—The temporary reservation by Order in Council of the 14th April, 1930, of 2 acres 2 roods 38 perches of land in the Parish of Bamba, as a site for a State School, revoked as to part by Order of the 19th May, 1942, is about to be revoked, so far as the balance thereof, containing 2 acres 1 rood 1 perch, is concerned.—(B.90<sup>(D2)</sup>) (Rs.2584).

W. BORTHWICK,  
Minister of Lands.

### TENDERS

#### PUBLIC WORKS DEPARTMENT

Tenders will be received at Public Works Department, 2 Treasury-place, Melbourne, until **TWO** p.m. on dates shown and for purposes mentioned hereunder.

Particulars and tender forms available at Contracts Office, Room 8, Building Division, Parliament-place and at places indicated in brackets hereunder.

Abbreviations in brackets mean:—W.O.—Inspector of Works Office; P.S.—Police Station; C.S.—Consolidated School; H.E.S.—Higher Elementary School; H.S.—High School; Pr.S.—Primary School; T.S.—Technical School.

Tenders to be submitted on the Department's printed Tender Form and will not be received by telephone. All tenders must be on a "Firm Tender" basis. The lowest or any tender will not necessarily be accepted.

Address tenders to the Minister of Public Works, and endorse the envelope containing the tender "Tender for \_\_\_\_\_, closing Tuesday, \_\_\_\_\_".

Hand delivered tenders to be placed in the Tender Box of the Public Works Department, located on the wall of the centre entrance foyer, Ground Floor, 2 Treasury-place, Melbourne.

No preliminary deposit is required with any tender, but a successful tenderer will be required to pay a deposit for any accepted tender of \$4,000 or over.

**Tuesday, 27th June, 1972.**

#### Building, Electrical and Mechanical Works.

**BELLEVUE.**—External and internal renovations, Pr.S. BELLEVOUE.—External and internal renovations, Pr.S. BENDIGO.—Erection of standard assembly hall type 572c, Girls' H.S. (Re-advertised). (W.O., Bendigo.)

**DAYLESFORD.**—Boundary Fencing, Pr.S.1609. (Re-advertised). (W.O., Ballarat, Bendigo, Kyneton.)

**NATHALIA.**—Internal and external repairs and painting, Pr.S.2060. (W.O., Bendigo, Shepparton.)

**RICHMOND.**—Alterations to library, Girls' H.S.

**WANGARATTA.**—External renovations, H.S. (W.O., Wangaratta.)

**WERRIBEE.**—Re-roofing and storm water drainage—five buildings, Research Farm.

**WEST MELBOURNE.**—Erection of new toilet block, Pr.S.1689.

#### Site Works.

**COOINDA.**—Site works, Pr.S.5018.

**PORT MELBOURNE.**—Re-surface existing asphalt pavement, Pr.S.2932.

**Tuesday, 4th July, 1972.**

#### Building, Electrical and Mechanical Works.

**BALLARAT.**—Improved lighting, Girls' H.S. (W.O., Ballarat.)

**BAYSWATER.**—Internal renovations, H.S.

**BLACKBURN.**—External renovations, Pr.S.2923. (Re-advertised.)

**FAWKNER.**—Internal renovations, H.S.

**FOSTER.**—Internal and external renovations, H.S. (W.O., Korumburra.)

**HOPETOUN.**—Internal and external renovations, H.S. (W.O., Warracknabeal.)

**HOPETOUN.**—External repairs and painting, &c., Pr.S.3167. (W.O., Warracknabeal.)

**MERLYNSTON.**—External renovations and painting, Pr.S.4328.

**NEWLANDS.**—Internal and external renovations, H.S.

**QUARRY HILL.**—External and internal renovations and new fittings to toilet block, &c., Pr.S.1165. (W.O., Ballarat and Bendigo.)

**SCORESBY.**—Refrigeration services, Laboratory, Horticultural Research Station. (Re-advertised.)

**TALLANGATTA.**—Internal renovations, H.S. (W.O., Wangaratta.)

**VARIOUS.**—Electrical services, alterations and additions, H.S.'s Brunswick and Richmond.

**VARIOUS.**—Mechanical services, alterations and additions, H.S.'s Brunswick and Richmond.

#### Site Works.

**MINYIP.**—Site works, Pr.S.2167. (W.O., Horsham.)

**MURRAYVILLE.**—Site works, C.S. (W.O., Swan Hill.)

**Tuesday, 11th July, 1972.**

#### Building, Electrical and Mechanical Works.

**BROWN HILL.**—Renewal of slate roofing, Pr.S.35. (W.O., Ballarat.)

**MOORABBIN.**—External renovations, Pr.S.1111.

**ORBOST.**—Additional office accommodation, Public Offices. (Re-advertised.) (W.O., Bairnsdale and Orbost.)

**RAINBOW.**—Alterations and additions to trade block, H.S. (W.O., Horsham.)

**SHEPPARTON.**—Erection of new primary school in brick veneer, Pr.S.5020. (W.O., Shepparton and Wangaratta.)

#### Site Works.

**BANYULE.**—Site works, Pr.S.4746.

**ELTHAM EAST.**—Asphalt repairs, drainage and associated works, Pr.S.4897.

MURRAY BYRNE,  
Minister of Public Works

Public Works Department,  
Melbourne, 3002, 19th June, 1972.

**PUBLIC SERVICE NOTICES**

No. 238.

*Public Service Act 1958, Section 50.*

**REGULATIONS.—PART IV.—SALARIES AND INCREMENTS.**

The Public Service Board, in pursuance of the powers conferred by the *Public Service Act 1958*, hereby amends its Regulations as shown below :—

**THIRD SCHEDULE.**

**PART B.**

**PROFESSIONAL DIVISION.**

*Scale of Rates of Annual Salaries.*

TRAINING OFFICERS, INSTITUTE OF SOCIAL WELFARE, SOCIAL WELFARE DEPARTMENT AND MENTAL HYGIENE BRANCH, DEPARTMENT OF HEALTH.

The salary scale shown is deleted and the following salary scale is inserted in lieu thereof :—

Class.	Annual Salary of Each Subdivision of Each Class.				
	1.	2.	3.	4.	5.
	\$	\$	\$	\$	\$
TO-1 ..	6,112	6,418	6,795	7,209	7,633
TO-2 ..	8,104	8,361	8,740	..	..
TO-3 ..	9,249	..	..	..	..
TO-4 ..	11,762	..	..	..	..

**SIXTH SCHEDULE.**

**TEMPORARY EMPLOYEES.**

*Designations of Positions and Rates of Salaries.*

Department and Designation of Position.	Yearly Rate of Salary.		Increments (Annual).
	Minimum.	Maximum.	
DEPARTMENT OF HEALTH. MENTAL HYGIENE.	\$	\$	
<i>Delete—</i> Training Officer .. ..	7,896	8,361	w
<i>Add—</i> Training Officer .. ..	..	9,249	..
w Increments in accordance with the scale of rates of salaries as set out for Training Officer, Class "TO-3" in Part B of the Third Schedule.			
SOCIAL WELFARE DEPARTMENT. INSTITUTE OF SOCIAL WELFARE.			
<i>Delete—</i> Training Officer .. ..	5,413	6,844	**
<i>Add—</i> Training Officer .. ..	6,112	7,633	**

*This Regulation shall have effect as on and from the 14th May, 1972.*

A. H. RIGG, Acting Chairman.  
R. H. DURRANT, Acting Secretary.

Office of the Public Service Board,  
Melbourne, 22nd May, 1972.

No. 245.

*Public Service Act 1958, Section 50.*

**REGULATIONS.—PART IV.—SALARIES AND INCREMENTS.**

The Public Service Board, in pursuance of the powers conferred by the *Public Service Act 1958*, hereby amends its Regulations as shown below :—

**FIFTH SCHEDULE.**

**TEMPORARY EMPLOYEES.**

**DEPARTMENT OF HEALTH.**

**MENTAL HYGIENE.**

*Designations of Positions and Rates of Salaries.*

Designation of Position.	Yearly Rate of Salary.		Increments (Annual).
	Minimum.	Maximum.	
	\$	\$	
<i>Delete—</i> Butcher .. ..	3,129	3,496	A
<i>Add—</i> Butcher .. ..	3,253	3,617	A

*This Regulation shall have effect as on and from the 4th June, 1972.*

A. H. RIGG, Acting Chairman.  
R. H. DURRANT, Acting Secretary.

Office of the Public Service Board,  
Melbourne, 5th June, 1972.

No. 246.

*Public Service Act 1958, Section 50.*

**REGULATIONS.—PART IV.—SALARIES AND INCREMENTS.**

The Public Service Board, in pursuance of the powers conferred by the *Public Service Act 1958*, hereby amends its Regulations as shown below :—

**SIXTH SCHEDULE.**

**TEMPORARY EMPLOYEES.**

*Designations of Positions and Rates of Salaries.*

Department and Designation of Position.	Yearly Rate of Salary.		Increments (Annual).
	Minimum.	Maximum.	
	\$	\$	
GENERAL.			
<i>Delete—</i> Lift Attendant .. ..	3,129	3,455	A
<i>Add—</i> Lift Attendant .. ..	3,354	3,693	A

*This Regulation shall have effect as on and from the 11th June 1972.*

A. H. RIGG, Acting Chairman.  
R. H. DURRANT, Acting Secretary.

Office of the Public Service Board,  
Melbourne, 9th June, 1972.

No. 239.

*Public Service Act 1958, Section 50.*

REGULATIONS.—PART IV.—SALARIES AND INCREMENTS

The Public Service Board, in pursuance of the powers conferred by the *Public Service Act 1958*, hereby amends its Regulations as shown below—

THIRD SCHEDULE.

PART B.

PROFESSIONAL DIVISION.

*Scale of Rates of Annual Salaries.*

The heading "TRAINING OFFICERS, INSTITUTE OF SOCIAL WELFARE, SOCIAL WELFARE DEPARTMENT and MENTAL HYGIENE BRANCH, DEPARTMENT OF HEALTH" is deleted and the heading "TRAINING OFFICERS" is inserted in lieu thereof.

A. H. RIGG, Acting Chairman.  
R. H. DURRANT, Acting Secretary.

Office of the Public Service Board,  
Melbourne, 1st June, 1972.

No. 242.

PUBLIC SERVICE ACT 1958.

The Public Service Board, in pursuance of the powers conferred by the *Public Service Act 1958*, hereby amends the Public Service (Public Service Board) Regulations as follows:—

PART IV.—SALARIES AND INCREMENTS.

DIVISION I.—GENERAL.

*Regulation 99.*

The proviso to this Regulation is deleted and the following is inserted in lieu thereof—

"Provided that, where an office to which no junior rates are prescribed is occupied by a male minor or a female minor, the rate of salary shall be as determined by the Board.

Provided further that in no case shall the total emolument payable to a married male minor be less than \$2,962 a year."

This Regulation shall have effect as on and from the 28th May, 1972.

A. H. RIGG, Acting Chairman.  
R. H. DURRANT, Acting Secretary.

Office of the Public Service Board,  
Melbourne, 2nd June, 1972.

No. 243.

PUBLIC SERVICE ACT 1958.

The Public Service Board, in pursuance of the powers conferred by the *Public Service Act 1958*, hereby amends the Public Service (Public Service Board) Regulations as follows:—

PART V.—ALLOWANCES.

DIVISION V.—OTHER ALLOWANCES.

*Department of Health.—Mental Hygiene Branch.*

Regulation 172 is deleted and the following Regulation is inserted in lieu thereof—

"172. An officer of the Mental Hygiene Branch occupying one of the under-mentioned offices who is required to take charge of the hospital or centre shall for each shift when required to take charge be paid an allowance at the rates set out hereunder—

Training Assistant, Sandhurst Boys' Centre, Bendigo— at the rate of \$208 a year.

Ward Assistant, St. Nicholas Hospital, Carlton— at the rate of \$208 a year.

Nurse, Hobson Park Hospital, Traralgon—

- 1st year—at the rate of \$1,522 a year
- 2nd year—at the rate of \$1,339 a year
- 3rd year—at the rate of \$1,155 a year
- 4th year—at the rate of \$971 a year
- 5th and subsequent years—at the rate of \$787 a year."

A. H. RIGG, Acting Chairman.  
R. H. DURRANT, Acting Secretary.

Office of the Public Service Board,  
Melbourne, 29th May, 1972.

No. 244.

*Public Service Act 1958, Section 50.*

REGULATIONS.—PART IV.—SALARIES AND INCREMENTS.

The Public Service Board, in pursuance of the powers conferred by the *Public Service Act 1958*, hereby amends its Regulations as shown below:—

SIXTH SCHEDULE.

TEMPORARY EMPLOYEES.

*Designations of Positions and Rates of Salaries.*

Department and Designation of Position.	Yearly Rate of Salary.		Increments (Annual).
	Minimum.	Maximum.	
GENERAL.	\$	\$	
<i>Delete—</i>			
Laboratory Assistant (Female), Grade I.— Junior—			
At 17 years of age..	..	1,877	..
At 18 years of age..	..	2,190	..
At 19 years of age..	..	2,534	..
At 20 years of age..	..	2,846	..
Adult .. ..	3,128	3,341	Σ
<i>Add—</i>			
Laboratory Assistant (Female), Grade I.— Junior—			
At 16 years of age..	..	1,564	..
At 17 years of age..	..	1,877	..
At 18 years of age..	..	2,190	..
At 19 years of age..	..	2,534	..
At 20 years of age..	..	2,846	..
Adult .. ..	3,128	3,341	Σ
<i>with effect as on and from 18th April, 1972.</i>			
GENERAL.			
<i>Delete—</i>			
Laboratory Assistant (Female), Grade I.— Junior—			
At 17 years of age..	..	1,939	..
At 18 years of age..	..	2,263	..
At 19 years of age..	..	2,618	..
At 20 years of age..	..	2,941	..
Adult .. ..	3,232	3,445	B
<i>Add—</i>			
Laboratory Assistant (Female), Grade I.— Junior—			
At 16 years of age..	..	1,616	..
At 17 years of age..	..	1,939	..
At 18 years of age..	..	2,263	..
At 19 years of age..	..	2,618	..
At 20 years of age..	..	2,941	..
Adult .. ..	3,232	3,445	B
<i>with effect as on and from 28th May, 1972.</i>			

A. H. RIGG, Acting Chairman.  
R. H. DURRANT, Acting Secretary.

Office of the Public Service Board,  
Melbourne, 2nd June, 1972.

No. 240.

*Public Service Act 1958, Section 50.*

**REGULATIONS.—PART IV.—SALARIES AND INCREMENTS.**

The Public Service Board, in pursuance of the powers conferred by the *Public Service Act 1958*, hereby amends its Regulations as shown below :—

**FIFTH SCHEDULE.**

TEMPORARY EMPLOYEES.

DEPARTMENT OF HEALTH.

MENTAL HYGIENE.

*Designations of Positions and Rates of Salaries.*

Designation of Position.	Yearly Rate of Salary.		Increments (Annual).
	Minimum.	Maximum.	
	\$	\$	
<i>Delete—</i> Supervisor and Caretaker, (Male) Marlborough House <sup>θ</sup>	2,962	3,294	A
<i>Add—</i> Supervisor and Caretaker, (Male) Marlborough House <sup>θ</sup>	3,655	4,004	A

*This Regulation shall have effect as on and from the 28th May, 1972.*

A. H. RIGG, Acting Chairman.  
R. H. DURRANT, Acting Secretary.

Office of the Public Service Board,  
Melbourne, 29th May, 1972.

No. 241.

*Public Service Act 1958, Section 50.*

**REGULATIONS.—PART IV.—SALARIES AND INCREMENTS.**

The Public Service Board, in pursuance of the powers conferred by the *Public Service Act 1958*, hereby amends its Regulations as shown below :—

**SIXTH SCHEDULE.**

TEMPORARY EMPLOYEES.

*Designations of Positions and Rates of Salaries.*

Department and Designation of Position.	Yearly Rate of Salary.		Increments (Annual).
	Minimum.	Maximum.	
	\$	\$	
SOCIAL WELFARE DEPARTMENT. FAMILY WELFARE DIVISION.			
<i>Delete—</i> Handcraft Instructor (Female)	2,910	3,270	B
<i>Add—</i> Activities Officer (Male)	4,500	5,153	A

A. H. RIGG, Acting Chairman.  
R. H. DURRANT, Acting Secretary.

Office of the Public Service Board,  
Melbourne, 29th May, 1972.

No. 237.

*Public Service Act 1958, Section 50.*

**REGULATIONS.—PART IV.—SALARIES AND INCREMENTS.**

The Public Service Board, in pursuance of the powers conferred by the *Public Service Act 1958*, hereby amends its Regulations as shown below :—

**THIRD SCHEDULE.**

PART B.

PROFESSIONAL DIVISION.

*Scale of Rates of Annual Salaries.*

NATIONAL GALLERY OFFICERS, CHIEF SECRETARY'S DEPARTMENT.

The salary scale shown is deleted and the following salary scale is inserted in lieu thereof :—

Class.	Annual Salary of Each Subdivision of Each Class.					
	1.	2.	3.	4.	5.	6.
	\$	\$	\$	\$	\$	\$
NG-1	4,293	4,430	4,520	4,747	..	..
NG-2	5,578	5,832	6,013	..	..	..
NG-3	6,362	6,588	6,744	7,156	7,315	7,580
NG-4	7,156	7,315	7,580	8,104	..	..
NG-5	9,578	..	..	..	..	..
NG-6	10,478	..	..	..	..	..

**SIXTH SCHEDULE.**

TEMPORARY EMPLOYEES.

*Designations of Positions and Rates of Salaries.*

Department and Designation of Position.	Yearly Rate of Salary.		Increments (Annual).
	Minimum.	Maximum.	
	\$	\$	
CHIEF SECRETARY'S DEPARTMENT.			
STATE LIBRARY, NATIONAL GALLERY, NATIONAL MUSEUM AND SCIENCE MUSEUM.			
<i>Delete—</i> Curator Assistant	..	4,747	..
<i>Add—</i> Curator Assistant	..	5,578	..

*This Regulation shall have effect as on and from the 21st May, 1972.*

A. H. RIGG, Acting Chairman.  
R. H. DURRANT, Acting Secretary.

Office of the Public Service Board,  
Melbourne, 22nd May, 1972.

**PRIVATE ADVERTISEMENTS**

CITY OF CAMBERWELL.

LOAN No. 91.

*Notice of Intention to Borrow the Sum of \$150,000 for Permanent Works and Undertakings.*

Notice is hereby given that the Council of the City of Camberwell proposes to borrow the sum of \$150,000, secured by a charge over the general rates of the municipality, such sum to be raised by the grant of a mortgage in accordance with the provisions of the *Local Government Act 1958*.

- The maximum rate of interest that may be paid is 6.3 per cent. per annum.
- The purposes for which the loan is to be applied are as follows:—

A. Street Construction and Re-construction Works .. \$111,990

- Riversdale-road—
  - Elphin-grove to Quantock-street.
  - Verdun-street to Graham-street.
- Glen Iris-road—Intersection treatment at Toorak-road.



3. Carramar-avenue—Reconstruction.
  4. Council's proportion C.R.B. Works—
    - (a) Bulleen-road re-construction.
    - (b) Burke/Doncaster roads intersection.
    - (c) Union-road re-construction.
    - (d) Camberwell Junction by-pass road (part).
- B. Traffic Control Lights .. .. . 12,050
5. Push Button Signals—
    - (a) Doncaster-road—west of Greythorn-road.
    - (b) Belmore-road at Northern Swimming Pool.
  6. Pedestrian Scramble Lights—High-street-Ward-street to Marquis-street.
- C. Car Park Construction .. .. . 5,000
7. Greythorn Shopping Centre.
- D. Land Acquisition .. .. . 20,960
8. For road works—
    - (a) Camberwell Junction by-pass road (part)
    - (b) High-street, Glen Iris.

---

\$150,000

3. The period of the loan shall be fifteen (15) years.

4. The moneys borrowed shall be repayable by providing out of the municipal fund 30 half-yearly instalments of approximately \$7802.01 each, including principal and interest, on 1st January and 1st July, during the currency of the loan. The first instalment shall be payable on 1st January, 1973.

5. Such moneys shall be repayable to the Commercial Savings Bank of Australia Ltd., at the Head Office of the Bank in Melbourne or at such other place as the said bank may require.

The plans and specifications and the estimate of the cost of the proposed expenditure of the money to be borrowed are open for inspection at the office of the Council, City Engineer's Department, Camberwell and Inglesby roads, Camberwell, during office hours.

6801 L. F. CHEFFERS, Chief Administrator.

CITY OF CROYDON.

LOAN No. 109.

*Private Street Construction.*

Notice is hereby given that at the meeting of the Council of the City of Croydon, held at the Council Chambers on the 15th day of May, 1972, the said Council did agree to the following resolution, that is to say:—

"That the Council do by Special Order and it does hereby resolve to borrow the sum of \$100,000 on the credit of the municipal revenues of the Mayor, Councillors and Citizens of the said City, such sum to be raised by the grant of a mortgage, in accordance with the provisions of the *Local Government Act 1958*.

The rate of interest to be paid shall be 6.3 per centum per annum and the said loan shall be liquidated by 30 half-yearly payments of principal and interest, at the Bank of New South Wales, Croydon, on the several days and in the several amounts specified in the schedule of payments.

The purposes for which the said loan shall be applied are for the construction of private streets under the provision of Division 10 of Part XIX. of the *Local Government Act 1958*, and the loan shall be liquidated from the receipts of money payable under scheme under the said division."

Notice is hereby further given that at a meeting of the said Council held at the Council Chambers on the 19th day of June, 1972, the said Resolution was confirmed.

6808 R. BURTON, Town Clerk.

CITY OF DONCASTER AND TEMPLESTOWE.

LOAN No. 165.

*Notice of Intention to Borrow the Sum of \$50,000 for Permanent Works and Undertakings.*

Notice is hereby given that the Council of the City of Doncaster and Templestowe proposes to borrow the principal sum of Fifty thousand dollars (\$50,000) secured by a charge over the general rates of the municipality, such sum to be raised by the grant of a mortgage in accordance with the provisions of the *Local Government Act 1958*.

1. The maximum rate of interest that may be paid is 6.4 per centum per annum.

No. 51.—5182/72.—4

2. The purpose for which the loan is to be applied is—  
Purchase of land adjoining Dorney Reserve, Park Orchards for recreational purposes—\$50,000.
  3. The period of the loan shall be twenty years.
  4. The moneys borrowed shall be repayable in one amount on the 1st day of August, 1992, by the creation of a sinking fund, pursuant to the provisions of section 428A of the *Local Government Act 1958* and an amount of \$1,512.13 will be set aside annually out of the municipal fund for such purpose.
  5. Interest at the rate of 6.4 per centum per annum shall be payable on the 1st day of February and the 1st day of August in each year during the currency of the loan. The first payment to be made on the 1st day of February, 1973.
  6. Such moneys shall be repayable to The National Mutual Life Association of Australasia Limited, at 447 Collins-street, Melbourne.
- The plans and specifications and the estimate of the cost of the proposed works and a statement showing the proposed expenditure of the moneys to be borrowed are open for inspection at the office of the Council of the City of Doncaster and Templestowe at Municipal Offices, Doncaster-road, Doncaster.

6784 H. M. F. MEARS, Acting Town Clerk.

CITY OF DONCASTER AND TEMPLESTOWE.

APPOINTMENT OF PROSECUTING OFFICER.

Notice is hereby given that Senior Sergeant P. Hearn, No. 10387, has been appointed as Prosecuting Officer, in lieu of Senior Constable B. Brain, No. 9760. 6785

*Health Act 1958.*

CITY OF FOOTSCRAY.

TO THE OWNER OR OWNERS OF VACANT LAND AT NUMBER 75 ALBERT-STREET, FOOTSCRAY.

Take notice that at the Ordinary Meeting of the Council of the City of Footscray, on the 22nd day of May, 1972, the Council was satisfied of the existence of a nuisance at 75 Albert-street, Footscray, and it directed that the owner abate the nuisance by the 21st day of July 1972, by removing all refuse and rubbish from the said land.

If the owner fails to execute this order then the Council shall enter and take steps to abate the nuisance and any costs and expenses incurred by the Council shall be and remain a charge upon the land.

13th June, 1972.

6793 W. H. SWABY, Town Clerk.

CITY OF GEELONG.

By-Law No. 157.

A By-Law of the City of Geelong made under the provisions of section 197 of the *Local Government Act 1958* and numbered 157 for amending By-Law No. 147 of the City of Geelong.

In pursuance of the powers conferred by the *Local Government Act 1958* and of every other power enabling it in that behalf the Mayor Councillors and Citizens of the City of Geelong order as follows:—

1. Clause 3 of By-Law No. 147 shall be and the same is hereby repealed and the following substituted therefor—

"3. Except in accordance with a permit issued pursuant to the provisions of this By-Law no person shall sell any goods from any stall, motor car, cart, truck, barrow, box, basket, crate bag or other vehicle or receptacle standing or placed on any street, road or public place or within or upon any vacant land (not being Crown land or land under the care and management of the Municipality) or land which is not ordinarily occupied by the seller of the goods."

2. In Clause 5 of By-Law No. 147 after the words "public place or vacant land" there shall be inserted the words "or land which is not ordinarily occupied by the seller of the goods."

3. In Clause 11 of By-Law No. 147 for the words "forty dollars" there shall be substituted the words "one hundred dollars".

Resolution for passing this By-Law agreed to by the Council this 14th day of December, 1971, and confirmed on the 25th day of January, 1972.

The common seal of the Mayor, Councillors and Citizens of the City of Geelong was affixed hereto in the presence of—

(SEAL) J. H. MACGREGOR DOWSETT, Mayor.  
6804 L. L. WALTER, Town Clerk.

## CITY OF KEW.

## LOAN No. 68.

*Notice of Intention to Resolve to Borrow Principal Moneys Amounting to \$100,000 for Permanent Works and Undertakings.*

Notice is hereby given that the Council of the City of Kew proposes to resolve to borrow principal moneys amounting to \$100,000 secured by a charge over the general rates of the municipality, such moneys to be raised by the grant of a mortgage in accordance with the provisions of the Local Government Acts.

1. The maximum rate of interest that may be paid is 6.4 per centum per annum.

2. The period of the loan shall be 40 years.

3. The moneys borrowed shall be repayable by providing out of the municipal fund 80 half-yearly instalments of \$3,480.03 each, including principal and interest on the 4th day of February and the 4th day of August, during the currency of the loan. The first instalment shall be payable on the 4th day of February, 1973.

4. Such moneys shall be repayable to the Australian Mutual Provident Society at the office of the said Society for the time being in Melbourne.

5. The purposes for which the loan is to be applied are—

*Places of Resort and Recreation—*

Improvements to Hay's Paddock/Kilby Reserve and Willsmere Park . . . \$70,000

*Reconstruction of Roads—*

Disraeli-street, Oswin-street, Irymple-avenue . . . 25,000  
Municipal Depot Improvements . . . 5,000

\$100,000

The plans and specifications and the estimate of the cost of the proposed works, and a statement showing the proposed expenditure of the moneys to be borrowed are open for inspection at the Municipal Offices, Charles-street, Kew.

Dated this 21st day of June, 1972.

6779 J. L. JOHNSON, Town Clerk.

## CITY OF KNOX.

## LOAN No. 94.

*Notice of Intention to Borrow the Sum of \$50,000 for Permanent Works and Undertakings.*

Notice is hereby given that the Council of the City of Knox, in pursuance of powers conferred by the Local Government Acts, intends to borrow the sum of \$50,000 secured by a charge over the general rates of the municipality, such sum to be raised by the grant of a mortgage, in accordance with the said Acts and states—

(a) The amount of principal moneys it is proposed to borrow is \$50,000.

(b) The maximum rate of interest that may be paid is 6.2 per cent. per annum.

(c) The period of the loan will be ten years and the time or times at which the moneys borrowed are to be repayable is on the 10th day of February and the 10th day of August in each year during the currency of the loan, commencing on the 10th day of February, 1973, until the final payment on the 10th day of August, 1982.

(d) The purpose for which the loan is to be applied is for permanent works and undertakings, viz.—Council contribution to Private Street Construction.

(e) The loan is to be liquidated by half-yearly payments of approximately \$3,391.93, including principal and interest, payable out of the municipal fund.

(f) The place of repayment will be The Commercial Savings Bank of Australia Limited, 335 Collins-street, Melbourne.

Plans and specifications and an estimate of the cost of such works and undertakings, and a statement showing the proposed expenditure of the money to be borrowed, are open for inspection by ratepayers, during office hours, at the City Offices, Fern Tree Gully, for one month after the publication of this notice.

Dated at Fern Tree Gully this 15th day of June, 1972.

6790 N. G. HAYNES, Town Clerk.

## CITY OF SUNSHINE.

## LOAN No. 103.

*Notice of Intention to Borrow the Sum of \$100,000 for Permanent Works and Undertakings.*

Notice is hereby given that the Council of the City of Sunshine proposes to borrow the principal sum of \$100,000 secured by a charge over the general rates of the municipality, such sum to be raised by the grant of a mortgage in accordance with the provisions of the Local Government Act 1958.

1. The maximum rate of interest that may be paid is 6.4 per centum per annum.

2. The purpose for which the loan is required is the purchase of land at St. Albans.

3. The period of the loan shall be forty (40) years.

4. The moneys borrowed shall be repayable by providing out of the municipal fund half-yearly instalments of \$3,480.03, including principal and interest, on the 28th day of January and the 28th day of July, during the currency of the loan. The first instalment shall be payable on the 28th day of January, 1973.

5. Such moneys shall be repayable at the office of the Australian Mutual Provident Society, Victorian Branch, A.M.P. Square, 535 Bourke-street, Melbourne.

The plans and specifications and the estimate of the proposed work and a statement showing the proposed expenditure of the moneys to be borrowed are open for inspection at the office of the Council of the City of Sunshine at the Municipal Offices, Alexandra-avenue, Sunshine.

6782

T. W. DEUTSCHMANN, Town Clerk.

## SHIRE OF BELLARINE.

## BY-LAW No. 60.

*Keeping of Animals.*

A By-law of the Shire of Bellarine made under Section 93 of the Health Act 1958 and Section 197 of the Local Government Act 1958 and numbered 60, for or with respect to:—

(a) The regulating of the keeping of animals or birds and the regulating or prohibiting of the keeping of any place or the storage of any things which in the opinion of the Council may be offensive injurious to health or dangerous.

(b) Fixing the distance from any dwelling within which it shall be unlawful to keep any animal or store any such thing.

(c) The provision use and control of receptacles for the deposit and collection of refuse and rubbish and prescribing the size and shape of and the materials to be used in the construction of such receptacles.

(d) Providing for the health of residents in the municipal district and against the spreading of contagious or infectious diseases.

(e) Suppressing nuisances.

In pursuance of the powers conferred by the Local Government Act 1958 and by the Health Act 1958 and every other Act or power enabling them in that behalf the President, Councillors and Ratepayers of the Shire of Bellarine order as follows:—

## PART I.

*Introduction.*

1. In this By-law unless inconsistent with the context or subject matter:—

"Cattle" has the same meaning as is assigned to it in sub-section (1) of Section 3 of the Local Government Act 1958 but does not include any horse.

"Council" means the Council of the Shire of Bellarine.

"Dwelling" includes a living room, sleep out, or tent and all rooms used for sleeping, living or cooking.

"Horse" includes stallion, mare, filly, foal, gelding, colt, ass and mule.

"Person" in respect of any property or premises includes the owner or occupier or the person in charge of such property or premises.

"Dog" shall not include any pup less than sixteen weeks old.

"Cat" shall not include any kitten less than 10 weeks old.

2. For the purposes of this By-law all areas within the municipality other than areas:—

- (a) Zoned "agricultural" in any Town Planning Scheme under the Town and Country Planning Act or any amendment thereof or any Act substituted therefor.
- (b) Shown on a provisional Town Planning Scheme (if any) zoned "agricultural" and to which said area an Interim Development Order under the Town and Country Planning Act or any amendment thereof or any Act substituted therefor applies,

are hereby declared to be populous or residential areas.

#### PART II.

1. No person shall keep or permit or suffer to be kept more than two (2) dogs as defined in Part I hereof on any premises having a dwelling erected thereon the curtilage of which is less than 8000 square feet without being the holder of a permit in writing from the Council.

2. No person shall keep or cause or permit or suffer to be kept on any premises more than two (2) cats as defined in Part I hereof without being the holder of a permit in writing from the Council.

3. No person shall keep or cause or permit or suffer to be kept on any premises except in an approved pigeon loft any pigeon and the number of pigeons so kept shall not exceed the number of birds which may be kept in the said pigeon loft as determined and approved by the Council.

4. Any person desiring the consent of the Council pursuant to any of the preceding clauses of this Part shall deliver to the Shire Secretary a written request for such consent and every request shall set out a full description of the premises concerned showing in particular the provisions made for drainage and sanitation and shall also set out the number and description of the dogs, cats or pigeons (as the case may be) intended to be kept thereon and such consent shall not be given unless the Council is satisfied that the keeping of the dogs, cats or pigeons (as the case may be) as described in the request on the premises therein referred to will not constitute a nuisance or be dangerous or offensive or injurious to the health of any person.

5. Any consent given by the Council pursuant to the previous clause may be given subject to such conditions if any as the Council in the particular case considers advisable; such condition shall be stated in the consent and if they are not complied with the Council may withdraw the consent.

#### PART III.

##### *Horses and Cattle.*

1. No person shall keep or cause or permit or suffer to be kept any horse on any premises unless either:—

- (a) Such horse is stabled in an approved stable on those premises, or
- (b) Such person has a written permit from the Council issued in accordance with clause 3 hereof to keep that horse on those premises and such permit has not been revoked.

2. No person shall keep or cause or permit to be kept any cattle on any premises except with the previous written consent of the Council.

3. Any person desiring a permit from the Council to keep any horse (other than in an approved stable) or any cattle on any premises shall deliver to the Shire Secretary a written application for such permit setting out a full and detailed description of the premises concerned and of the animal in respect of which the application is made. The Council shall not be required to grant any such application, unless:—

- (a) The premises concerned in which any such animal is intended to be kept shall provide at all times an unrestricted area for the keeping of such animal of at least 8000 square feet.
- (b) The premises concerned have an adequate water supply.
- (c) The premises concerned are properly and securely fenced on all sides.
- (d) Proper provision is made for the storage of feed and the dispensing thereof.
- (e) The situation and drainage of the premises is such that the animal may be properly kept.
- (f) The keeping of such an animal in all the circumstances would not in the opinion of the Council be likely to constitute a nuisance, be dangerous or offensive or injurious to the health of any person.

4. For the purpose of Clause (1) hereof an approved stable shall be a stable which complies with the Uniform Building Regulations for the construction of stables or if being a stable which was erected prior to the commencement of these Regulations and not complying with the requirements thereof has been approved in writing by the Council for the purposes of this By-law.

5. Any person seeking the approval of the Council to a stable for the purposes of the preceding clause shall deliver to the Shire Secretary a written request for such approval setting out a full and detailed description of the premises and the stable concerned showing in particular the provisions made for drainage and sanitation, and such approval shall not be given unless the Council is satisfied that the keeping of a horse in such a stable will not constitute a nuisance or be dangerous or offensive or injurious to the health of any person.

6. The owner or occupier of any premises on which a stable is erected shall:—

- (a) Cause all manure, refuse and rubbish therein to be placed in a properly constructed receptacle with brickwork walls at least 9 inches in thickness or concrete walls at least 4 inches in thickness with brick or concrete floor at least 6 inches in thickness, and lined throughout internally with cement rendering composed of two and a half parts sand to one part cement.
- (b) Maintain such receptacle at all times in such good state of repair as is necessary to prevent any escape or leakage of the contents thereof.
- (c) Keep such receptacle wholly covered with an effective cover at all times except when manure, refuse or rubbish is actually being deposited therein or being taken therefrom.
- (d) Effectively deodorize such receptacle and the contents thereof from time to time as may be necessary to prevent its becoming a nuisance, offensive or injurious or dangerous to health.
- (e) Cause all the contents of such receptacle to be removed from such property at least once every week.
- (f) Keep such stable at all times effectively and thoroughly repaired and cleansed in such a manner as may be necessary to prevent its constituting a nuisance or becoming dangerous or offensive or injurious to the health of any resident in the municipality.

#### PART IV.

##### *General.*

1. Where in the opinion of the Council the circumstances and conditions existing at the time when a permit was granted have materially changed or any condition contained in any such permit has not been complied with, the Council may, by notice in writing addressed to the holder of the permit at the address shown therein or otherwise served on him, without in any way effecting any other right or power of the Council revoke such permit.

2. Any person who shall commit any wilful act or default contrary to any provision of this By-law shall be liable on conviction to a penalty of not more than forty dollars (\$40) for each offence, and in the case of a continuing offence to a further penalty of not more than ten dollars (\$10) per day for each day on which the offence is continued after a conviction or order by any Court.

#### PART V.

##### *Operation of By-law.*

1. This By-law shall apply to and have operation throughout the whole of the municipal district excepting:—

- (a) Any area zoned "agricultural" in any Town Planning Scheme under the Town and Country Planning Act or any amendment thereof or any Act substituted therefor.
- (b) Areas shown on a provisional Town Planning Scheme (if any) zoned "agricultural" and to which said area an Interim Development Order under the Town and Country Planning Act or any amendment thereof or any Act substituted therefor applies.
- (c) To any premises in which any animal is or is intended to be kept as the case may be which provides at all times an unrestricted area for the keeping of such animal of at least one acre.

The whole of By-law No. 45 is hereby repealed.

Resolution for passing this By-law was agreed to by the Council of the Shire of Bellarine on the 15th day of November, 1971, and confirmed on the 17th day of January, 1972.

The common seal of the President, Councillors and Ratepayers of the Shire of Bellarine was hereto affixed on the 17th day of January, 1972, in the presence of—

(SEAL) CHAS. J. TERRIER, President.  
B. J. CROWE, Councillor.  
H. A. WILLIAMS, Shire Secretary.

Submitted to the Commission of Public Health on the 7th March, 1972.—A. T. GARDNER, Secretary, Commission of Public Health.

Approved by the Governor in Council, 30th May, 1972.—  
J. ROSSITER, Clerk of the Executive Council. 6809

#### SHIRE OF BELLARINE.

##### By-Law No. 61.

##### Keeping of Poultry.

A By-Law of the Shire of Bellarine made under Section 93, of the *Health Act 1958* and Section 197 of the *Local Government Act 1958*, and numbered 61 for or with respect to:—

- (a) The regulating of the keeping of poultry and the regulating or prohibiting of the keeping of any place or the storage of any things which in the opinion of the Council may be offensive injurious to health or dangerous.
- (b) Fixing the distance from any dwelling within which it shall be unlawful to keep any poultry or store any such thing.
- (c) The provision use and control of receptacles for the deposit and storage of food for consumption by poultry.
- (d) Providing for the health of residents in the municipal district and against the spreading of contagious or infectious diseases.
- (e) Suppressing nuisances.

In pursuance of the powers conferred by the *Local Government Act 1958*, and by the *Health Act 1958* and every other Act or power enabling them in that behalf the President, Councillors and Ratepayers of the Shire of Bellarine order as follows:—

#### PART I.

##### Introduction.

1. In this By-law unless inconsistent with the context or subject matter:—

“Act” means *Health Act 1958*, or *Local Government Act 1958*.

“Approved” means approved by Council.

“Battery Laying Cage” means a wire and metal mesh cage divided into one or more compartments in which laying fowls are kept.

“Council” means the Council of the Shire of Bellarine.

“Dwelling” includes a living room, sleep-out or tent and all rooms used for sleeping, living or cooking.

“Litter” includes wood shaving, tan bark, straw or dry grass clippings or other similar suitable clean material.

“Poultry” includes any fowl, chicken, turkey, goose, gander, duck and duckling.

“Poultry Run” means any area attached to a poultry house, enclosed and maintained in such a way as to prevent the escape of poultry therefrom.

“Poultry House” means any building used or intended to be used for the purpose of confining, protecting or sheltering poultry.

“Poultry Farm” means any premises on which there is kept at any time a greater number of mature birds than twelve (12).

2. For the purposes of this By-law, all areas within the municipality other than areas:—

(a) Zoned “agricultural” in any Town Planning Scheme under the Town and Country Planning Act or any amendment thereof or any act substituted therefor.

(b) Shown on a provisional Town Planning Scheme (if any) zoned “agricultural” and to which said area an Interim Development Order under the Town and Country Planning Act or any amendments thereof or any Act substituted therefor applies, are hereby declared to be a populous or residential area.

#### PART II.

##### General Provisions.

1. The By-law shall apply and have operation throughout the Shire of Bellarine to all premises on which poultry is kept except to premises registered under the Act as poultry killing or cleaning or dressing premises when so exempted by the Council.

2. The owner or occupier shall:—

(a) Keep the area of land within five (5) feet of any poultry house, enclosure or battery laying cage system free from all dry grass, weeds, refuse or other materials capable of harbouring rats or other vermin, and

(b) cause the poultry house, poultry run or battery laying cage system to be thoroughly cleansed as often as may be necessary so as to not create offensive conditions or cause, permit or allow the breeding of flies at any stage of the life cycle.

3. No person shall keep or store or cause or permit to be kept or stored on any property where poultry is kept any food for consumption by poultry unless such food is kept or stored in rat proof receptacles or buildings.

4. The owner or occupier shall ensure that all poultry droppings, litter and refuse are disposed of in such a manner so as to not create offensive conditions or permit the breeding of flies at any stage of the life cycle.

#### PART III.

##### Provisions Relating to Populous or Residential Zones.

1. Subject to the provisions of Clause 6 of this Part, no person shall keep or cause or permit to be kept on any premises situated in a populous or residential zone more than twelve (12) head of poultry.

2. No person shall keep or cause or permit to be kept on any premises situated in a populous or residential zone any poultry in a battery laying cage or battery laying cage system.

3. No person shall keep or cause or permit to be kept on any premises situated in a populous or residential zone any poultry except in a poultry house constructed in accordance with this By-law provided that a poultry house may have attached thereto for the use of the poultry a poultry run.

4. No person shall keep or cause or permit to be kept in any poultry house situated in a populous or residential zone a number of poultry greater than the number produced by dividing the area in square feet of such poultry house by three.

5. No person shall on any land, keep or cause or permit to be kept in a populous or residential zone any poultry within a distance of:—

(a) 75 feet from any street or road to which such land has a frontage.

(b) 10 feet from any other street or road.

(c) 5 feet from the boundary of any adjoining land.

(d) 40 feet from any dwelling.

6. No person shall keep or cause or permit to be kept at any one premises in any populous or residential zone more than two (2) turkeys, ducks or geese.

7. Every poultry house situated in a populous or residential zone shall:—

(a) Be roofed with galvanised iron or other approved impervious material and such roof shall be provided with guttering and spouting leading to adequate storm water drains.

(b) Have all external walls constructed of approved rat proof material.

(c) Be rendered rat proof by placing galvanised iron, jointed brickwork or concrete around the foundation to a depth of at least eighteen inches below ground level.

(d) Be paved with approved impervious material the surface level of which shall be at all points at least three inches above the level of the ground.

(e) Be constructed so as to be capable of holding litter to a depth of at least six inches.

#### PART IV.

##### Provisions Relating to Poultry Farms.

1. No person shall keep or cause or permit poultry to be kept on any poultry farm otherwise than in a poultry house or battery laying cage system provided that there may be attached thereto for the use of the poultry a poultry run.

2. No person shall on any poultry farm keep or cause or permit to be kept any poultry within a distance of:—

- (a) 75 feet from any street or road to which such poultry farm has a frontage.
- (b) 10 feet from any other street or road.
- (c) 10 feet from the boundary of any adjoining land.
- (d) 100 feet from any dwelling excepting only that the owner or occupier may erect incubators or brooder houses not less than 40 feet from any dwelling.

3. Every poultry house or battery laying cage system shall be roofed with galvanised iron or other approved impervious material and such roof shall be provided with guttering and spouting and the ground surrounding such houses shall be well drained, portable houses for growing stock being excluded.

4. Every poultry house or the area beneath every battery laying cage system shall be paved with approved durable impervious material the surface level of which shall be at all points at least three inches above the level of the ground.

#### PART V.

##### General.

Any person doing any act forbidden to be done or failing to do any act directed to be done by this By-law shall be liable for any such offence to a penalty of not more than Forty Dollars and in the case of a continuing offence to a further daily penalty of not more than ten dollars per day for each day on which the offence is continued after a conviction or order by any Court.

#### PART VI.

##### Operation of By-Law.

1. This By-law shall apply to and have operation throughout the municipal district of the Shire of Bellarine.

2. The whole of By-law No. 45 is hereby repealed.

Resolution for passing this By-law was agreed to by the Council of the Shire of Bellarine on the 15th day of November, 1971, and confirmed on the 17th day of January, 1972.

The common seal of the President, Councillors and Ratepayers of the Shire of Bellarine was hereto affixed on the 17th day of January, 1972, in the presence of—

(SEAL) CHAS. J. TERRIER, President.  
B. J. CROWE, Councillor.  
H. A. WILLIAMS, Shire Secretary.

Submitted to the Commission of Public Health on the 7th March, 1972.—A. T. GARDNER, Secretary, Commission of Public Health.

Approved by the Governor in Council, 30th May, 1972.—  
J. ROSSITER, Clerk of the Executive Council. 6810

#### SHIRE OF CRESWICK.

##### Notice of Intention to Take Land Compulsorily.

Notice is hereby given—

(1) That the Council of the Shire of Creswick has deemed it expedient to exercise its power of taking compulsorily the land described hereunder for the work or undertaking of extending the Municipal Depot at Creswick.

(2) The said Council has caused to be prepared and has approved maps and other papers showing the general description of the work or undertaking for which the land proposed to be taken is to be used, the description of the land proposed to be so taken and the names of the owners or reputed owners, lessees or reputed lessees, mortgages and occupiers of the said land so far as those names are known to or can be ascertained by the Council.

(3) Such maps and other papers have been deposited at the office of the Council, Town Hall, Creswick, and are open for inspection by all persons interested at all reasonable hours for 40 clear days after the publication of this notice in the *Government Gazette*.

(4) The land proposed to be taken is Crown allotment 5b, section 10, Township and Parish of Creswick, County of Talbot and being the land described in Crown grant, volume 461, folio 050.

(5) All persons affected by the proposed taking of the said land are required to set forth, in writing, addressed to the Council or the Shire Secretary of the Shire of Creswick within 40 clear days from the publication of this notice in the *Government Gazette*, all objections which they may have to the taking of the said land.

Dated this 15th day of June, 1972.

6806

B. C. REES, Shire Secretary.

#### SHIRE OF DIAMOND VALLEY.

This is to certify that Sergeant Douglas Wolfeten Simpson, No. 11598, has been appointed Prosecuting Officer for the South West, South East and Central Ridings of the Shire of Diamond Valley.

6799

B. J. MORGAN, Secretary.

#### Town and Country Planning Act 1961 (Twelfth Schedule).

##### SHIRE OF FLINDERS PLANNING SCHEME 1962.

NOTICE THAT A PLANNING SCHEME HAS BEEN PREPARED AND IS AVAILABLE FOR INSPECTION.

##### Amendment No. 50, 1972.

Notice is hereby given that the Shire of Flinders in pursuance of its powers under the *Town and Country Planning Act 1961*, has prepared a Planning Scheme for the purpose of rezoning land generally bounded by Eastbourne-road, Jetty-road, Mornington Peninsula Freeway and Boneo-road, Rosebud, and the land having frontage to Illaroo-street, Cain-street, Orana-crescent, Attuna-crescent, Coleman-crescent, Wingara-drive and parts of Mawarra-avenue, Tawarri-avenue, Allambi-avenue and the land having frontage to Boneo-road, Rosebud, adjacent thereto, from Residential "A" to Residential "C" Zone.

A copy of the scheme has been deposited at the office of the Responsible Authority, Shire Office, Nepean Highway, Dromana, and at the Office of the Town and Country Planning Board, 235 Queen-street, Melbourne, and will be open for inspection during office hours by any person free of charge.

Any persons affected by the Planning Scheme are required to set forth in writing all objections they may have to the scheme, addressed to the Shire Secretary, Shire of Flinders, Shire Office, Nepean Highway, Dromana, 3936, on or before the 21st day of July, 1972, and state whether they wish to be heard in respect of these objections.

6778

P. S. PARKINSON, Shire Engineer.

#### SHIRE OF KYNETON.

##### BYLAW No. 60.

A Bylaw of the Shire of Kyneton made under the provisions of the *Local Government Act 1958* and numbered 60 for prohibiting the erection of verandahs other than cantilever and requiring the removal of verandahs not conforming to Bylaw number 54 of the Shire of Kyneton.

In pursuance of the powers conferred by the *Local Government Acts* and every other power enabling it in that behalf, the President, Councillors and Ratepayers of the Shire of Kyneton order as follows:—

In Clause 2 of Bylaw number 54 for the words "on or before the first day of August, 1974" the following words will be substituted—"on or before the first day of August, 1979".

The resolution for passing this bylaw was agreed to by the Council of the Shire of Kyneton on the 20th October, 1971 and confirmed at a meeting of the Council held on the 15th December, 1971.

The common seal of the President, Councillors and Ratepayers of the Shire of Kyneton was hereto affixed this 15th day of December, 1971, in pursuance of a Resolution of the Council and in the presence of—

(SEAL) H. E. ROLLINSON, President.  
J. F. LEVICK, Councillor.  
S. G. PORTER, Secretary.

6813

#### Town and Country Planning Act 1961 (Twelfth Schedule).

##### SHIRE OF MORNINGTON PLANNING SCHEME 1959.

NOTICE THAT A PLANNING SCHEME HAS BEEN PREPARED AND IS AVAILABLE FOR INSPECTION.

##### Amendment No. 77, 1972.

Notice is hereby given that the Council of the Shire of Mornington in pursuance of its powers under the *Town and Country Planning Act 1961* has prepared a Planning Scheme for the following areas and purposes:—

Land in the Residential "A" Zone—Ordinance Amendment to provide for child minding centre as a consent use.

A copy of the scheme has been deposited at the office of the Council, Queen-street, Mornington, and at the office of the Town and Country Planning Board, 235 Queen-street, Melbourne, and will be open for inspection during office hours by any person free of charge.

Any persons affected by the Planning Scheme are required to set forth in writing all objections they may have, addressed to the Shire Secretary, Mornington Shire

Council, P.O. Box 78, Mornington, 3931, on or before the 21st day of July, 1972, and to state whether they wish to be heard in respect of their objections.

6787 D. G. COLLINGS, Shire Secretary.

*Town and Country Planning Act 1961 (Twelfth Schedule).*  
SHIRE OF MORNINGTON PLANNING SCHEME 1959.

NOTICE THAT A PLANNING SCHEME HAS BEEN PREPARED  
AND IS AVAILABLE FOR INSPECTION.

Amendment No. 78, 1972.

Notice is hereby given that the Council of the Shire of Mornington in pursuance of its powers under the *Town and Country Planning Act 1961* has prepared a Planning Scheme for the following areas and purposes:—

Land shown on plan No. 232/PP/1 in the office of the Council, located at the corner of Nepean Highway and Koetong-parade, Mount Eliza being the site of "St. James the Less", Church of England—Rezoning from Public Open Space Reserve-Creek Reserve to Special Uses "A" Zone.

A copy of the scheme has been deposited at the office of the Council, Queen-street, Mornington, and at the office of the Town and Country Planning Board, 235 Queen-street, Melbourne, and will be open for inspection during office hours by any person free of charge

Any persons affected by the Planning Scheme are required to set forth in writing all objections they may have, addressed to the Shire Secretary, Mornington Shire Council, P.O. Box 78, Mornington, 3931, on or before the 21st day of September, 1972, and to state whether they wish to be heard in respect of their objections.

6788 D. G. COLLINGS, Shire Secretary.

SHIRE OF NEWSTEAD.

BY-LAW No. 29.

Notice is hereby given that the Council of the Shire of Newstead has made a BY-LAW numbered 29 under section 197 of the *Local Government Act*, for the purpose of repealing BY-LAW No. 27, and prohibiting within the whole Shire the erection or adaption for use of any building where toilet facilities are normally required, unless such building is connected to a septic tank system.

The resolution for passing this BY-LAW was agreed to on the 7th October 1971, and was confirmed on the 11th November 1971.

The BY-LAW was approved by the Governor in Council on the 23rd May, 1972.

Copies of the BY-LAW are open for inspection free of charge during office hours, at the office of the Council which is situated in Lyons Street, Newstead.

6805 D. R. BROAD, Shire Secretary.

SHIRE OF SHERBROOKE.

NOTICE OF INTENTION TO ACQUIRE LAND COMPULSORILY.

Notice is given that the Council of the Shire of Sherbrooke deems it expedient to exercise its powers of taking land compulsorily for the purpose of providing a Road Reserve, and that in the opinion of Council, such compulsory taking of land is necessary and desirable.

That Council intends to acquire part of that piece of land being lot 7, Mast Gully-road, Ferny Creek, on plan of subdivision No. 7705, being part of Crown allotments 48 and 48A, section A, Parish of Scoresby, County of Mornington, being part of the land more particularly described in certificate of title, volume 6040, folio 994.

The Council has caused to be prepared maps and other papers showing the general description of the said land and the exact sites and measurements thereof, together with the names of the owners or reputed owners, lessees or reputed lessees, mortgagees and occupiers of those lands as far as these names can be ascertained by Council.

The said maps and other papers are deposited at the Shire Office, Glenfern-road, Upwey, and shall be kept open for inspection by all persons interested at all reasonable hours, for a space of 40 clear days after publication of this notice in the *Government Gazette*.

All persons affected by the proposed taking of the land are hereby called to set forth, in writing, addressed to the Council or Shire Secretary of the Shire of Sherbrooke, within 40 clear days from the publication of this notice in the *Government Gazette*, all objections which they may have to the taking of the said land.

Dated 5th day of June, 1972.

By order of the Council,

6848 K. E. MATSON, Shire Secretary.

SHIRE OF SOUTH GIPPSLAND.

APPOINTMENT OF PROSECUTING OFFICER.

Notice is hereby given that Sergeant James Naughton Lowe, No. 12705, has been appointed Prosecuting Officer for the Shire of South Gippsland as from 8th June, 1972.

6803 H. R. LOMAX, Shire Secretary.

SHIRE OF WARRAGUL.

LOAN No. 74.

*Notice of Intention to Borrow the Sum of \$15,000 for Permanent Works and Undertakings.*

Notice is hereby given that the Council of the Shire of Warragul proposes to borrow the principal sum of Fifteen thousand dollars (\$15,000) secured by a charge over the general rates of the municipality, such sum to be raised by the grant of a mortgage in accordance with the provisions of the *Local Government Act 1958*.

1. The maximum rate of interest that may be paid is 6.2 per cent. per annum.

2. The purpose for which the loan is to be applied is—  
Warragul Caravan Park Extensions—\$10,000.

Part Construction Geoff Watt Memorial Athletic Track—\$5,000.

3. The period of the loan shall be ten years.

4. The moneys borrowed shall be repayable by providing out of the municipal fund half-yearly instalments of approximately \$1,018 each, including principal and interest on the 1st day of February and the 1st day of August, during the currency of the loan. The first instalment shall be repayable on the 1st day of February, 1973.

5. Such moneys shall be repayable to the Commissioners of the State Savings Bank of Victoria, at the office of the said Commissioners, corner Elizabeth and Bourke streets, Melbourne.

The plans and specifications and the estimate of the cost of the proposed works and a statement showing the proposed expenditure of the moneys to be borrowed are open for inspection at the office of the Council of the Shire of Warragul, Municipal Offices, Civic-place, Warragul.

Dated 7th June, 1972.

6781 D. MCADIE, Shire Secretary.

Sixth Schedule.

SEYMOUR SEWERAGE AUTHORITY.

GENERAL NOTICE.

The above-mentioned Sewerage Authority, having made provision for carrying of the sewage from each and every property which or any part of which is within the Sewerage Area No. 3A hereinafter described, doth hereby declare that on and after the 1st day of July, 1972, each and every property which or any part of which is within the said Sewerage Area No. 3A shall be deemed to be a seweraged property within the meaning of the *Sewerage Districts Act 1958*.

The boundaries of the Sewerage Area No. 3A hereinbefore referred to are—

North-east along the north side of High-street from Number 119 to the North-west corner of Redbank-road; then north along west side of Redbank-road to Number 17; then east to railway line; then south along railway line to Whiteheads Creek.

By Order of the Seymour Sewerage Authority.

6786 T. G. WILKINSON, Chairman.  
F. TRAINOR, Secretary.

WONTHAGGI SEWERAGE AUTHORITY.

Notice is hereby given that the Wonthaggi Sewerage Authority intends to compulsorily acquire an easement for the Main Outfall Sewer.

Approval for this Acquisition was given on the 13th May, 1972, by the Governor in Council.

The easement is fifteen (15) links wide along the southern boundary of lot 3 West-street and lot 22 Powlett-street, L.P.5718, part of Crown allotment 26A, Parish of Wonthaggi.

Copies of the plan and a description of the proposed works are open for free inspection during office hours at the Wonthaggi Town Hall.

6450 T. H. LARKINS, Secretary.

**GEMBROOK, COCKATOO AND EMERALD  
WATERWORKS TRUST.**

**NOTICE TO OWNERS OF TENEMENTS IN THE STREETS  
LISTED HEREUNDER.**

The main pipes in the said streets being laid down the owners of all tenements in these streets are required, on or before the 1st day of August, 1973, to cause a proper pipe and stop-cocks to be laid so as to supply water within such tenements from the main pipe.

*Avonsleigh.*

Avon-road, from Margaret-road, 350 feet northerly to a point opposite lot No. 1 L.P. 86131.  
Fairway-street, from Belgrave-Emerald road, 550 feet northerly to a point opposite lot No. 7.  
Macclesfield-road, from the end of existing main at 150 feet south of Christians-avenue, 600 feet northerly to a point opposite lot 25.

*Emerald.*

Ambrose-street, from William-street to the right of way approximately 1,200 feet southerly.  
Como-street, from Belgrave-Gembrook road, 20 feet northerly to a point opposite lot No. 4.  
Emerald Lake-road, from Royal-parade, 1,100 feet north-easterly to a point opposite lot No. 2 L.P. 61023.  
Right of Way, from Station-street to Ambrose-street.  
Station-street, from William-street, 200 feet southerly to a point opposite lot 83.

*Cockatoo.*

Garden-street, from Station-street, 200 feet north-westerly to lot No. 161c.  
Naughton-road, from 100 feet south of Carawa-street to 350 feet southerly to a point opposite lot No. 3.  
6776 BEATRICE THOMAS, Trust Secretary.

**MACEDON WATERWORKS TRUST.**

Notice to owners of land and tenements in Calder Highway and Nortons-road abutting the Railway Reserve between McBean-avenue and Cowper-avenue, Railway-place between McBean-avenue and English-street and land abutting the Railway Reserve between English-street and Nursery-road, Macedon.

Control of the main pipe along Railway property having been transferred to the Macedon Waterworks Trust the owners of all tenements situated as above may cause a proper pipe and stop cocks to be laid so as to supply water within such tenements from the main pipe.  
6798 C. GOODWIN, Secretary.

*Water Act 1958.*

**REDBANK WATERWORKS TRUST.  
EIGHTH SCHEDULE.**

Notice to owners of tenements in the following streets or parts of streets:—

High-street, northerly from the south-east corner of Crown allotment 6b, section 1, Parish of Redbank, to the north-east corner of Crown allotment 9, section 3, Township of Redbank.

Government road, westerly off High-street adjacent to Crown allotments 7 and 8, section 14, Township of Redbank, for a distance of about 8 chains.

Government road, westerly off High-street adjacent to Crown allotment 9, section 14, Township of Redbank, for a distance of about 4 chains.

Navarre-street, from Crown allotment 3, section 6, Township of Redbank westerly to a point about 1 chain west of the north-west corner of Crown allotment 29, section 2, Township of Redbank.

Government road, crossing Navarre-street, southerly and westerly from Recreation Reserve to the boundary of Crown allotment 3, section 14, Township of Redbank.

The main pipe in the said streets or parts of streets being laid down, the owners of all tenements situated as above are hereby required, on or before the 21st day of July, 1972, to cause a proper pipe and stop cock to be laid so as to supply water within such tenements from the main pipe.

F. C. S. EDWARDS, Secretary,  
Redbank Waterworks Trust.

Shire Office, Avoca.

6836

Notice is hereby given that the partnership between David John Langworthy, of 8 Monteith-street, Croydon, Rodney Davis Hutchins, of 12A Imperial-avenue, Bayswater, and Daryl Lindsay Hutchins, of 29 Morotai-avenue, Ashburton, carrying on business as printers, at 42 Barry-street, Bayswater, under the style or name of G.D.R. Press, has been dissolved as from the 17th day of November, 1971, so far as concerns the said David John Langworthy who retired from the firm on that date.

Dated the 8th day of June, 1972.

6821

DAVID LANGWORTHY.

TO: ALLAN ESLER STORY, of Emu Creek, Victoria; ANDY ESLER STORY, of Emu Creek, Victoria; and ELSIE EVANGALINE STORY, of Emu Creek, Victoria.

Take notice that the partnership heretofore existing between and carried on by the above-named persons and myself as equal partners at Emu Creek in the State of Victoria and Dingee in the State of Victoria, is hereby dissolved as from the 26th day of June, 1972, and I hereby require the above-named persons to join with me in the sale of the farming business and freehold and the payments to me of my half share of the nett proceeds thereof and my half share of the profits of the business to the date of sale.

Dated the 14th day of June, 1972.

Signed by Noel Irving Story, of Dingee in the State of Victoria, by his solicitor and agent, Max Beck, B. Juris LL.B., 238A Hargreaves-street, Bendigo.

6811

MAX BECK.

I, Christos Kiritopoulos, hereby give notice I have withdrawn from the partnership Matadolil Fashions and am not responsible for any debts incurred since 30th April, 1972.  
6789

Notice is hereby given that the partnership heretofore subsisting between the undersigned, Wilfred Eric Heard and Kevin Francis White and Phil Shiells, carrying on business as "W. & E. Heard" at 9 Autumn-street, Geelong West, has been dissolved by mutual consent as from the 17th day of March, 1972. All debts due to and owing by the said late firm will be received and paid by the said Wilfred Eric Heard and the said Kevin Francis White, who will continue to carry on the business at the same place.

Dated at Geelong, the 17th day of March, 1972.

W. E. HEARD.  
K. F. WHITE.  
P. SHIELLS.

Witness to above signatures—R. BRYCE.

Donald A. Ingpen & Co., solicitors, 54 Malop-street, Geelong. 6847

*The Companies Act 1961.*

JOSEPH WALTON & SONS PTY. LTD. (IN MEMBERS VOLUNTARY LIQUIDATION).

Notice is hereby given that at an Extraordinary Meeting of the members of the above-named company held on Monday, the 12th day of June, 1972, it was resolved that the company be wound up voluntarily and that for such purpose Mr. Geoffrey Ormond Harrison, chartered accountant, of Hall & Rose, 395 Collins-street, Melbourne, be appointed liquidator.

Dated this 14th day of June, 1972.

G. O. HARRISON, Liquidator.

Hall & Rose, chartered accountants, 395 Collins-street, Melbourne. 6818

*Companies Act 1961.*

GENERAL PROVEDORS (AUST.) PTY. LTD.

PURSUANT TO SECTION 254 (2).

At an Extraordinary General Meeting of the above-named company duly convened and held at Grants-road, Somerville, on the 13th day of June, 1972, the following Resolution was duly passed:—

"That the company be wound up voluntarily and that the liquidator be authorized to distribute assets of the company in kind in accordance with article 120 of the company's articles of association."

And at such meeting, Raymond Bernard Brennan, of the firm of Fitzgerald Gunn & Partners, 10th Floor, 470 Collins-street, Melbourne, was appointed liquidator for the purpose of the winding up.

Dated this 13th day of June, 1972.

6831

P. A. PLANNER, Secretary.

## Form 92.

The Companies Act 1961, Companies Regulations.  
RESELLERS TRADING CO. PTY. LTD. (IN LIQUIDATION).  
NOTICE CONVENING FINAL MEETING OF CREDITORS, PURSUANT  
TO SECTION 272 (2).

Notice is hereby given that a meeting of the creditors and contributories of Resellers Trading Co. Pty. Ltd., will be held at the offices of Messrs. Peat, Marwick, Mitchell & Co., 447 Collins-street, Melbourne, on Tuesday, the 25th July, 1972, at 10.30 a.m., for the purposes of laying before the meeting the liquidator's account, showing how the winding up has been conducted and how the property of the company has been disposed of, and giving any explanation thereof.

Dated the 20th day of June, 1972.

D. A. CRAWFORD, Liquidator.

Peat, Marwick, Mitchell & Co., 447 Collins-street,  
Melbourne, 3000, telephone 62 1411. 6860

## Companies Act 1961.

TAREIKA BUILDERS PROPRIETARY LIMITED (IN  
VOLUNTARY LIQUIDATION).

Notice is hereby given, pursuant to section 272 of the Companies Act 1961, that an Extraordinary General Meeting of members of the above-named company will be held at the office of Kenneth D. Doig, 13 Ardgour-street, North Balwyn, on Thursday, the 27th day of July, 1972, at 10.30 a.m. for the purpose of having an account laid before them, showing the manner in which the winding up has been conducted and the property of the company disposed of, and of hearing any explanations that may be given by the liquidator.

Dated this 20th day of June, 1972.

6867 KENNETH D. DOIG, Liquidator.

## Companies Act 1961, Section 260.

STARQUEEN HATCHERY PTY. LTD.

NOTICE OF MEETING OF CREDITORS.

Notice is hereby given that a meeting of Creditors of the above-named company will be held at the Meeting Room of the Institute of Chartered Accountants in Australia, 140 Queen-street, Melbourne, on Tuesday, 27th June, 1972, at 10 a.m., the company having convened a meeting of its members for the same day for the purpose of considering a Resolution that the company be wound up voluntarily.

## AGENDA:

To consider and if thought fit, resolve—

1. The company be wound up voluntarily and that Mr. Peter William Harvey, chartered accountant, of 447 Collins-street, Melbourne, be appointed liquidator.
2. The liquidator be paid remuneration in accordance with the scale of fees from time to time paid by the Institute of Chartered Accountants in Australia.

Dated this 16th day of June, 1972.

R. FALLON, Director.

A. L. Royce and Warne-Smith, chartered accountants,  
447 Collins-street, Melbourne, 3000 6868

## Companies Act 1961, Section 260.

FALLON FARMS PTY. LTD.

NOTICE OF MEETING OF CREDITORS.

Notice is hereby given that a meeting of creditors of the above-named company will be held at the Meeting Room of the Institute of Chartered Accountants in Australia, 140 Queen-street, Melbourne, on Tuesday, 27th June, 1972, at 9.30 a.m., the company having convened a meeting of its members for the same day for the purpose of considering a Resolution that the company be wound up voluntarily.

## AGENDA:

To consider and if thought fit, resolve—

1. The company be wound up voluntarily and that Mr. Peter William Harvey, chartered accountant, of 447 Collins-street, Melbourne, be appointed liquidator.
2. The liquidator be paid remuneration in accordance with the scale of fees from time to time paid by the Institute of Chartered Accountants in Australia.

Dated this 16th day of June, 1972.

R. FALLON, Director.

A. L. Royce and Warne-Smith, chartered accountants,  
447 Collins-street, Melbourne, 3000. 6869

## Companies Act 1961.

NOTICE OF MEETING OF MEMBERS OF DYASON  
INVESTMENTS PTY. LTD.

COMPANIES ACT REGULATIONS—REGULATION 28 (2) (b).

Registered Office: The Office of Hornemann, Macaw & Oldfield, 6th Floor, 395 Collins-street, Melbourne.

Notice is hereby given that an Extraordinary General Meeting of the members of the above-named company will be held at 375 Beach-road, Beaumaris, on Friday, 30th June, 1972, at 8.30 o'clock in the evening.

## AGENDA:

To consider, and if thought fit, pass a Special Resolution winding up the above-named company, and appointing Douglas Orson Oldfield, registered liquidator, as the liquidator of the company.

Melbourne, 21st June, 1972.

6870 ALAN PREBBLE DYASON, Director.

## F. R. WALKER INVESTMENTS PTY. LTD.

Take notice that at an Extraordinary General Meeting of F. R. Walker Investments Pty. Ltd., held at 111 Charles-street, Prahran, on the 14th day of June, 1972, it was resolved as a Special Resolution that the company be wound up voluntarily.

Dated this 21st day of June, 1972.

R. G. B. SKINNER, LL.B., A.A.S.A., 111 Charles-street,  
Prahran, solicitor for F. R. Walker Investments Pty. Ltd.

6871

## SEAHOLME HOUSING ESTATES PTY. LTD.

NOTICE PURSUANT TO SECTION 254 (2) (b) OF  
THE COMPANIES ACT, 1961.

Notice of Resolution.

At the Extraordinary General Meeting of members of Seaholme Housing Estates Pty. Ltd., held on the 16th June, 1972, a Special Resolution was passed that the company be wound up voluntarily and that William Hugh Renwick, of 98 Collins-street, Melbourne, be appointed liquidator of the company.

Dated this 16th day of June, 1972.

6859 W. H. RENWICK, Liquidator.

In the Supreme Court of Victoria.—1972 C.O.8379.—In the matter of the Companies Act 1961; and in the matter of GIANCOLA AND DI BERARDINO PTY. LIMITED.

Notice is hereby given that a petition for the winding-up of the above-named company by the Supreme Court was on the 13th day of June 1972, presented by Leo Thomas FitzGerald, Deputy Commissioner of Taxation of the Commonwealth of Australia and that the said petition is directed to be heard before the Court sitting at the Fourteenth Court, Law Courts, William-street, Melbourne, at the hour of 10.30 o'clock in the forenoon on the 19th day of July, 1972, and any creditor or contributory of the said company desiring to support or oppose the making of an order on the said petition may appear at the time of hearing by himself or his Counsel for the purpose; and a copy of the said petition will be furnished to any creditor or contributory of the said company requiring the same by the undersigned on payment of the regulated charge for the same.

The petitioner's official address is 350 Collins-street, Melbourne.

The petitioner's solicitor is Robert Burns Hutchison, Crown Solicitor for the Commonwealth, of 99 Queen-street, Melbourne.

R. B. HUTCHISON.

NOTE.—Any person who intends to appear on the hearing of the said petition must serve on or send by post to the above-named R. B. Hutchison, notice in writing of his intention so to do. The notice must state the name and address of the person, or, if a firm, the name and address of the firm, and must be signed by the person or firm, or his, or their solicitor (if any), and must be served or, if posted, must be sent by post in sufficient time to reach the above-named not later than 4 o'clock in the afternoon of the 18th day of July, 1972. 6832

In the matter of MCKENZIE COPE & CO. PTY. LIMITED.—  
Notice of Winding-Up Order.

Winding-up order made the 14th day of June, 1972.

Name and address of official liquidator, Reginald Wilfrid Ellis, care of Fell & Starkey, 351 Collins-street, Melbourne.

L. T. FITZGERALD, Deputy Commissioner of Taxation  
of the Commonwealth of Australia. 6833



## The Companies Act 1961.

## TYPO-ART PRINTING COMPANY PROPRIETARY LIMITED (IN LIQUIDATION).

## NOTICE CONVENING FINAL MEETING OF MEMBERS AND CREDITORS, PURSUANT TO SECTION 272.

Notice is hereby given, pursuant to section 272 of the Companies Act 1961, that a General Meeting of the members and creditors of the above-named company will be held in the offices of Kennedy, Smail & Middlemiss, 296-304 Little Lonsdale-street, Melbourne, on Wednesday, the 19th day of July, 1972, at 10.30 a.m., for the purpose of having an account laid before them, showing the manner in which the winding up has been conducted and the property of the company disposed of and of hearing any explanations that may be given by the liquidator.

Dated this 15th day of June, 1972.

J. M. WALSH, Liquidator.

Kennedy, Smail & Middlemiss, 296-304 Little Lonsdale-street, Melbourne, 3000. 6834

## Companies Act 1961.

## BARP PROPRIETARY LIMITED (IN VOLUNTARY LIQUIDATION).

At an Extraordinary General Meeting of the above-named company duly convened and held at 461 Bourke-street, Melbourne, on the 13th day of June, 1972, the following Special Resolution was passed:

"That the company be wound up voluntarily and that Jack Kennedy, of 9th Floor, 461 Bourke-street, Melbourne, be appointed liquidator for the purposes of such winding up and that the remuneration of the liquidator be fixed at a fee not exceeding the scale of fees recommended by the Institute of Chartered Accountants in Australia and that the liquidator be authorized to distribute the assets of the company in specie."

Dated the 14th day of June, 1972.

6835 J. KENNEDY, Liquidator.

## STRATHEARN PTY. LTD. (IN VOLUNTARY LIQUIDATION).

At an Extraordinary General Meeting of the company, duly convened and held at 5 Tynefield-court, Elwood, on the 16th day of June, 1972, the following Resolution was passed as a Special Resolution:—

That the company be wound up voluntarily and that Keith James Coghlan be appointed liquidator.

6796 K. J. COGHLAN, Liquidator.

## The Companies Act 1961.

## NUPERFORM AUTO SERVICES PTY. LTD. (IN LIQUIDATION).

## NOTICE TO CREDITORS OF INTENTION TO DECLARE FIRST AND FINAL DIVIDEND.

A First and Final Dividend is intended to be declared in the above matter. Creditors who have not lodged a proof of debt by the 7th day of July, 1972, will be excluded from the dividend.

M. J. O'KEEFE, Liquidator.

M. J. O'Keefe & Co., 162A High-street, Ashburton, 3147. 6797

## L.M.A. INDUSTRIES PROPRIETARY LIMITED.

## SPECIAL RESOLUTION TO WIND UP, PURSUANT TO SECTION 254 OF THE COMPANIES ACT 1961.

At an Extraordinary General Meeting of the above-named company, duly convened and held at 5 Kilsyth-avenue, Toorak, on the 8th day of June, 1972, the following Resolution was passed as a Special Resolution:—

"Resolved that in accordance with the provisions of section 254 of the Companies Act 1961, the company be wound up voluntarily."

And at such last-mentioned meeting Percival Russell Devenish, care of A. H. G. Clarke & Co., 1st Floor, 460 Bourke-street, Melbourne, was appointed liquidator for the purposes of the winding up.

Dated this 9th day of June, 1972.

6791 ALAN PERRY, Chairman.

The Companies Act 1961.—In the matter of the following companies (in voluntary Liquidation).—Members Winding up:—

BARNET GLASS RUBBER CO. PTY. LTD.  
KENCO RUBBER RECLAIM PTY. LTD.  
MACKINTOSH SOLID TYRES PTY. LTD.  
TIME PAYMENT TYRES PTY. LTD.

R. M. CROCKETT & SON PTY. LTD.  
KENWORTH RUBBER PTY. LTD.  
DUNLOP ABBOTSFORD PTY. LTD.  
BATTERY MANUFACTURERS PTY. LTD.  
AUTOMOBILE FINANCE CO. PTY. LTD.  
VERSAILLES PTY. LTD.  
SHOPWELL ACCEPTANCE PTY. LTD.  
FACTORS HOUSE PTY. LTD.

Notice is hereby given that at the Extraordinary General Meeting of each of the above-named companies duly convened and held at 108 Flinders-street, Melbourne, in the State of Victoria, on the 15th day of June, 1972, the following Resolution was proposed and passed as a Special Resolution:—

"That the company be wound up voluntarily".

Dated this 16th day of June, 1972.

6792 R. W. BETTS, Liquidator.

## Companies Act 1971, Section 254.

## BANDOR PROPRIETARY LIMITED.

Notice is hereby given that at a General Meeting of the above company held at 8 Weir-street, Glen Iris, on Friday, 9th June, 1972, the following Special Resolution was passed:—

"That the company should go into liquidation and that a Members' Voluntary Winding Up be commenced immediately."

Dated this 13th day of June, 1972.

H. P. WILLIAMS, liquidator, 620 High-street, East Kew, 3102. 6783

## Companies Act 1961.

## WANTIRNA ESTATE AGENCY PTY. LTD.

Notice is hereby given, in accordance with section 260 of the Companies Act 1961, that a meeting of creditors of Wantirna Estate Agency Pty. Ltd. will be held at the office of Pascoe & Whitaker, public accountants, 8 Station-street, Ringwood, on Friday, 30th June, 1972, at 10.30 a.m.

By order of the Board,

6838 J. A. BRADLEY, Director.

The Companies Act 1961.—In the matter of AVOCA HOTELS PROPRIETARY LIMITED.—Notice of Final Meeting.

Notice is hereby given that, pursuant to section 272 of the Companies Act 1961, a General Meeting of the members of the above-named company will be held at Hall's Gap on Thursday, the 3rd of August, 1972, at 10 o'clock in the forenoon, for the purpose of having an account laid before them showing the manner in which the winding up has been conducted and the property of the company disposed of, and of hearing any explanation that may be given by the liquidator.

Dated the 16th day of June, 1972.

6839 K. J. McDONALD, Liquidator.

## E. A. COOK PROPRIETARY LIMITED.

## SPECIAL RESOLUTION TO WIND UP, PURSUANT TO SECTION 254 OF THE COMPANIES ACT 1961.

At an Extraordinary General Meeting of the above-named company, duly convened and held at 56 Webster-street, Ballarat, on the 17th day of June, 1972, the following Resolution was duly passed as a Special Resolution:—

"That the company be wound up voluntarily."

And at such last-mentioned meeting John Ritchie was appointed liquidator for the purpose of the winding up.

Notice is hereby given that, after 21 days from this date, I shall proceed to distribute the assets. All creditors having any claims against the company should furnish particulars of same by that date, otherwise I shall proceed to distribute the assets without regard to their claim.

Dated this 17th day of June, 1972.

J. RITCHIE, Liquidator.

198-200 Little Lonsdale-street, Melbourne, Victoria 3000. 6840

Notice is hereby given, pursuant to section 272 of the Companies Act 1961, that the Final Meeting of the company and the creditors of Peninsula Marine & Land Services Pty. Ltd. (in Liquidation) will be held at the Honorary Justices' Association, 528 Collins-street, Melbourne, on 28th July, 1972, at 10.30 a.m., for the purpose of laying before it the final account, and conduct of the liquidation.

JOHN F. RUFFIN, liquidator, 100 Mount Eliza-way, Mt. Eliza. 6844

## Unclaimed Moneys Act 1962.

## Register of Unclaimed Moneys held by the—

Name of Owner on Books and Last Known Address.	Total Amount Due to Owner.	Description of Unclaimed Moneys.	Date when Amount first became Payable
§			
NATIONAL CONSOLIDATED LIMITED.			
Innes, Sydney, 12 Grassmere-road, Lindfield, N.S.W.	10.80	Dividend	—
Taylor, Graeme John, Barastoc Farm, Central-avenue, Croydon	10.80	"	—
Burley, Jocelyn Anne, (Miss), P.O. Box 7, Otahuhu, New Zealand	42.84	"	—
6656			
VICTORIAN WHEATGROWERS CORPORATION LIMITED.			
Coote, Charles William (estate of), 16 Waterloo-street, Camberwell	20.00	Interest cheque	— 9.70
Fawcett, Ronald George, "Lord Clyde", Clunes	15.00	"	"
Hucker, William (estate of), "Fairview", Lake Bolac	15.00	"	"
Lehmann Bros., Concordia P.B. Horsham	13.30	"	"
Paterson, Alan, "Bellevue", Lake Bolac	10.00	"	"
Watson, Verner Lancelot, Nyah	20.00	"	"
6657			
MORWELL BUS LINES LTD. and TRARALGON BUS LINES LTD. Trading as Latrobe Valley Bus Lines.			
Hickman, Leslie Morris, 13 Bridges-avenue, Traralgon	42.00	Dividend	30.4.69
6658			
A. C. GOODE & CO.			
Blackman, Robert James (Dr.), Room 801, 8th Level, Tower Building, Australia Square, Sydney	51.49	Proceeds of Sale of Shares	18.6.70
Lynch, John A., 11 Keera-street, Coorparoo, Qld.	60.97	"	2.12.69
Thompson, Clifford Alan, 4/14 Dongala-road, West Footscray	30.00	Deposit towards purchases	15.9.70
6659			
PLASTIC COATINGS LTD. (Subsidiary of Overseas Corporation (Australia) Limited.)			
Jack, Joyce E. (Mrs.), 48 Hillcrest-avenue, Wavell Heights, Qld.	73.38	Dividend	1963-65
6660			
METALS EXPLORATION N.L.			
Aird, Reginald W., Unit 4, Gumtip Lodge, Railway-parade, Glenfield, N.S.W.	30.25	Proceeds of forfeited shares	19.8.70
Baumgartner, Frank (estate of), c/o K. Baumgartner, 17 Caringal-avenue, Doncaster	6,050.00	"	"
Boscacci, John, c/o Bank of New South Wales, Mount Isa, Qld.	605.00	"	"
Cunningham, Joseph H., 27 Growden-street, Merredin, W.A.	121.00	"	"
Gray, Laurence B., 29 Benaroon-avenue, St. Ives, N.S.W.	1,512.50	"	"
Halliday, Francis J., 43 Alice-street, Turramurra, N.S.W.	605.00	"	"
Hancock, Jennifer M. (Mrs.), 16 Beresford-street, Mont Albert	314.60	"	"
Hannagan, John E., Brett-avenue, Labrador, South Coast, Qld.	1,210.00	"	"
Harvy, Sarah (Mrs.), 5 Belmore-terrace, Woodville, S.A.	193.60	"	"
Jones, Peter W., 5 Sunset-court, Mount Isa, Qld.	121.00	"	"
Larsson, John A. & R. J. A., George-road, Athelstone, South Australia	605.00	"	"
Macintosh, Marjorie G. (Mrs.), 26 Eringa-avenue, Glenunga, S.A.	1,210.00	"	"
Moore, John, 47 Dalrymple-avenue, Chatswood, N.S.W.	242.00	"	"
McCarogher, Joan Frances (Miss), 64 Rose-street, Armadale	2,420.00	"	"
James, Colin, & Quinn, Heather Lilian (Mrs.), P.O. Box 658 Fort Valley, Qld.	605.00	"	"
Rough, Ian McColl, 12 Namur-street, East Kew	605.00	"	"
Sippe, Richard Ernest (Dr.), Mater Hospital, South Brisbane, Qld.	605.00	"	"
Smith, Marjorie C. S. (Mrs.), 37 Victoria-street, Stanton Hill, Townsville, Qld.	605.00	"	"
Sprigg, Margaret (Miss), 5 Baker-street, Somerton Park, S.A.	605.00	"	"
Taylor, Arthur R. (estate of), c/o R. E. Lewis Orr & Gibson, 406 Lonsdale-street, Melbourne	60.50	"	"
Teagle, Doreen M. (Mrs.), G.P.O. Box 978, Darwin, N.T.	726.00	"	"
Walker, Keith S., Sunning Park, Latrobe-parade, Dromana	1,452.00	"	"
Colyer, Edward W., 65 Mail-road, London, S.E. 26, U.K.	60.50	"	"
Franks, Julian, 21 Chessington-avenue, London, N.13, England	332.75	"	"
Hallward, Colin Grenville (Dr.), 10 The Avenue, Clifton, Bristol 8, U.K.	302.50	"	"
Kerr, William Benjamin, 105 West Green-road, Tottenham, London, N.15, U.K.	2,008.60	"	"
Maurice, Brian A., Croft Lodge, Bayhau-road, Tunbridge Wells, Kent, U.K.	605.00	"	"
Pigot, Thomas Adrian McEwan, Salters, Jarvis Brook, Crowborough, Sussex, U.K.	84.70	"	"
Smyth, Patrick, Newtown Bagenalstown, Co. Carlow, U.K.	121.00	"	"
Stirling, Charmain, Calmsdon Cottage, Nr. Cirencester Glos., England	302.50	"	"
Wigmore, Beverly F. A., 158 Goddington-road, Orphington, Kent, U.K.	605.00	"	"
Williams, Trevor E. J., 36 Tudor Way, Crown Hill Estates, Llantwit Fardre, Pontypridd, Glamorgan, U.K.	211.75	"	"
Wright, Raymond, 20 Chamberlain-street, West Somerset, U.K.	302.50	"	"
York, Ian R., 6 Kingsley-street, Battersey, London, U.K.	24.20	"	"
A. C. Goode & Co. Nominees Pty., 395 Collins-street, Melbourne	121.00	"	"
Sprigg, Douglas P., 5 Baker-street, Somerton Park, S.A.	605.00	"	"
6661			
MYER EMPORIUM PENSION FUND.			
Viergever, J., 1/22 High-street, Prahran	34.00	Members Contributions	13.3.70
6662			

## Unclaimed Moneys Act 1962.

## Register of Unclaimed Moneys held by the—

Name of Owner on Books and Last Known Address.	Total Amount Due to Owner.	Description of Unclaimed Moneys.	Date when Amount first became Payable.
5			
OVERSEAS CORPORATION (AUSTRALIA) LIMITED.			
Breaks, Charles L. & Doris M. (estate of), c/o Henderson & Lahey, 293 Queen-street, Brisbane, Qld.	34.56	Dividend .. .. .	30.4.70
Clendinnen, Catherine W. (Mrs.), c/o C. L. Woodrow, 49 Moseley-street, Glenelg, S.A.	54.00	" .. .. .	"
Hathaway, Thomas W. (estate of), c/o Norris, Coates & Co., 422 Collins-street, Melbourne	15.60	" .. .. .	"
Knapman, Leslie G., c/o McIntyres Pharmacy, 152 High-street, Wodonga	206.70	" .. .. .	"
Mowbray, John W., c/o Agricultural Bank of Tasmania, Currie, Tas. . .	36.00	" .. .. .	"
McIntosh, John D., Flat 5, 1314 Mair-street, Ballarat .. .	13.26	" .. .. .	"
Willis, John E. C., Woorookoobanya, Majorca .. .	15.60	" .. .. .	"
McBeath, Edith M. (estate of), 10 McMahon-street, Willoughby, N.S.W.	14.07	" .. .. .	30.10.70
Muir, Alan G., 480 Barkers-road, Hawthorn .. .	42.00	" .. .. .	"
Tillman, Elvira (Mrs.), 14 Carrara-road, Vaucluse, N.S.W.	16.80	" .. .. .	"
Peck, Menie F. (Miss), c/o Thomas, Bonnin, Linn & Buttery, 33 Pirie-street, Adelaide, S.A.	30.80	" .. .. .	"
6654			
CATERPILLAR OF AUSTRALIA LTD.			
Lehane, L., 212 Pascoe Vale-road, Essendon .. .. .	21.43	Unclaimed Wages .. .. .	—
Puclin, J., 37 Eireno-crescent, Airport West .. .. .	124.80	Retirement Plan Contributions Refund .. .. .	—
George, P., 152 Wright-street, Sunshine .. .. .	10.40	" .. .. .	—
Charles, William G., c/o R. Murray, 2/12 Stafford-street, West Preston	15.76	" .. .. .	—
Rice, Jeanette D., 89 Marshall-road, Airport West .. .. .	10.08	" .. .. .	—
Nolan, William J., 15 Coonamar-street, Tullamarine .. .. .	12.96	" .. .. .	—
6655			
E.Z. INDUSTRIES LIMITED.			
Allen, Caroline, 135 Jersey-road, Woollahra, N.S.W. .. .	10.00	Dividend .. .. .	27.11.70
Anderson, Frank L. (estate of), c/o Hutchison Elliffe Davies & Anderson & Co., P.O. Box 696 Christchurch, New Zealand	30.00	" .. .. .	30.4.70
Anderson, Hugh C., 140 Wycombe-road, Neutral Bay, N.S.W. .. .	30.00	" .. .. .	"
Anderson, Marion D. B., c/o A.N.Z. Bank Limited, 68 Pitt-street, Sydney, N.S.W.	264.00	" .. .. .	27.11.70
Anderson, William T. (estate of), c/o Permanent Trustee Co. of N.S.W. Limited, 23 O'Connell-street, Sydney, N.S.W.	207.00	" .. .. .	30.4.70
Angus, Judith P., 28 Lisson-grove, Hawthorn .. .. .	10.00	" .. .. .	27.11.70
Armstrong, Elsie M. (estate of), c/o J. W. Armstrong & Sons, G.P.O. Box N 1012 Perth, W.A.	138.60	" .. .. .	30.4.70
Arrott-Watt, Robert, Flat 4, 40 Paisley-street, South Yarra .. .	10.00	" .. .. .	27.11.70
Atkins, Keith D. (estate of), c/o Gerald W. O. Atkins, 30 Monastreet, Hobart, Tas.	45.00	" .. .. .	30.4.70
Bacash, Frederick (estate of), c/o Paul C. Nunan & Bloom, 343 Little Collins-street, Melbourne	400.00	" .. .. .	27.11.70
Bailey, Vera D., 233 Gale-road, Maroubra, N.S.W. .. .	30.00	" .. .. .	"
Ballardie, Jane M., Linfield, Linton-lane, Wetherby, U.K. .. .	25.95	" .. .. .	"
Banks, John F., c/o F. M. Hart & Co., G.P.O. Box 534 Brisbane, Qld.	300.00	" .. .. .	"
Bannon, Charles J., 30 Mary-street, Hunters Hill, N.S.W. .. .	20.00	" .. .. .	"
Barsby, Donald R., 9 Fairway-avenue, St. Ives, N.S.W. .. .	95.10	" .. .. .	"
Bascomb, Vera F., 380 Auburn-road, Hawthorn .. .. .	90.00	" .. .. .	"
Bayly, Edward J. P., 22 Hooper-street, Randwick, N.S.W. .. .	138.60	" .. .. .	"
Bayly, John P. (estate of), c/o Sly & Russell, G.P.O. Box 3872, Sydney, N.S.W.	300.00	" .. .. .	30.4.70
Beaumont, Beverley, Flat 11, 22 Denbigh-road, Armadale .. .	243.00	" .. .. .	"
Benjafield, Vera E. (estate of), c/o Archer Guy Jackson & Dockray, P.O. Box 215, Devonport, Tas.	123.60	" .. .. .	27.11.70
Bennell, Neil F., c/o Sam Bagley & Son., 430 Little Collins-street, Melbourne	10.00	" .. .. .	"
Bennett, Bevan, 141 Bridge-street, Port Macquarie, N.S.W. .. .	37.50	" .. .. .	"
Blomfield, Helen T. (estate of), c/o Maxwell & Boyd, 141 Elizabeth-street, Sydney, N.S.W.	415.80	" .. .. .	30.4.70
Boulton, Ena I. (estate of), c/o Roscoe W. G. Hoyle & Co., 10 Martin-place, Sydney, N.S.W.	600.00	" .. .. .	27.11.70
Bovill, Harry Y. (estate of), c/o Archer Guy Jackson & Dockray, P.O. Box 215, Devonport, Tas.	60.00	" .. .. .	"
Brady, Desmond V., c/o McCoy Grove & Atkinson, 82 Elizabeth-street, Sydney, N.S.W.	135.00	" .. .. .	30.4.70
Brand, Albert E. (estate of), c/o Page & Axtens, P.O. Box 99, Lismore, N.S.W.	40.00	" .. .. .	27.11.70
Brice, Emilie U. (estate of), c/o Executor Trustee & Agency Co. of S.A. Ltd., G.P.O. Box 363b, Adelaide, S.A.	70.80	" .. .. .	"
Brockhoff, Maude E. (estate of), c/o Sly & Russell, G.P.O. Box 3872, Sydney, N.S.W.	75.00	" .. .. .	30.4.70
Browne, Mervyn E., 22 Fishburn-street, Red Hill, A.C.T. .. .	20.00	" .. .. .	27.11.70
Buchanan, Felicia M., 231 Cotham-road, Kew .. .. .	10.00	" .. .. .	30.4.70
Bulcock, Colin L. L., Temple House, The Acres, Barrow, Blackburn, Lancs.	36.12	" .. .. .	"
Bull, Rose (estate of), c/o Gaden Bowen & Stewart, 86 Pitt-street, Sydney, N.S.W.	30.00	" .. .. .	27.11.70
Burns, Ronald B. (estate of), c/o Garland Seaborn & Abbott, 4/6 Bligh-street, Sydney, N.S.W.	30.00	" .. .. .	30.4.70
Baldwin, Frances E. R. (estate of), c/o Butler McIntyre & Butler, G.P.O. Box 980K Hobart, Tas.	387.00	" .. .. .	"
Byerlee, W. (Mrs.), 111 Gower-street, Toowong, Qld. .. .	10.00	" .. .. .	27.11.70
Cahill, Beverley A., 1 Bogan-avenue, Sylvania Waters, N.S.W. .. .	10.00	" .. .. .	30.4.70

## Unclaimed Moneys Act 1962.

## Register of Unclaimed Moneys held by the—

Name of Owner on Books and Last Known Address.	Total Amount Due to Owner.	Description of Unclaimed Moneys.	Date when Amount first became Payable.
§			
E.Z. INDUSTRIES LIMITED— <i>continued.</i>			
Campbell Cullen Pty. Ltd., c/o W. B. Lynam, 21 Stuart-crescent, Blakehurst, N.S.W.	10.00	Dividend .. .. .	27.11.70
Campbell, William (estate of), c/o G. K. Campbell, G.P.O. Box 258 Wanganui, New Zealand	207.00	" .. .. .	30.4.70
Carrick, William B., (estate of), c/o Jean Carrick (Mrs.) and William Davies, 14 Bridges-avenue, Croydon, N.S.W.	135.00	" .. .. .	"
Carter, Fenella, S. W., 208 Allambie Heights-road, Allambie Heights, N.S.W.	10.00	" .. .. .	27.11.70
Cashmore, Joan M., 43 Lammermoor-drive, St. Helliers, Auckland, N.Z.	31.66	" .. .. .	"
Chapman, Jean C., c/o D. M. Bennett and Co., 406 Collins-street, Melbourne	10.00	" .. .. .	"
Charlton, Ernest (estate of), c/o Mahony O'Brien and Duggan, 37-41 Queen-street, Melbourne	468.00	" .. .. .	30.4.70
Chartier, Gertrude H., Home for Incurables, Fisher-street, Fullarton, S.A.	68.40	" .. .. .	27.4.70
Charrterton, John E., 661 Military-road, Mosman, N.S.W.	10.00	" .. .. .	"
Childs, Muriel M., 15 Balfour-road, Rose Bay, N.S.W.	69.60	" .. .. .	30.4.70
Chomley, Dorothy B., Flat 6, 74 Denbigh-road, Armadale	10.00	" .. .. .	27.11.70
Clark, Cecil O. (estate of), c/o J. P. Sullivan, 14 Main-street, Blacktown, N.S.W.	30.00	" .. .. .	30.4.70
Cleaver, Eveleen (estate of), c/o John C. Streeter, National Mutual Centre, 447 Collins-street, Melbourne	30.00	" .. .. .	"
Clifton, Jessie D., Oaklands-avenue, Ashfield, N.S.W.	156.60	" .. .. .	"
Cockburn, James P. (estate of), c/o Frank C. Kirkpatrick and Son, 66 Pitt-street, Sydney, N.S.W.	30.00	" .. .. .	27.11.70
Cocks, Thomas E., 24 Park-road, Kensington Park, S.A.	30.00	" .. .. .	"
Cole, Winifred E., Wentworth Towers, Wentworth Place, Point Piper, N.S.W.	600.00	" .. .. .	30.4.70
Colley, James, Lot 5, Gregory-street, Berkeley Vale, N.S.W.	50.00	" .. .. .	27.11.70
Collis and Thornton, Thelma M. and Geoffrey W., 185 Elizabeth-street, Sydney, N.S.W.	119.00	" .. .. .	"
Cook, Heather B., 69 Murrarar-road, Towradgi, N.S.W.	30.00	" .. .. .	30.4.70
Cooney, Leonard J., Three Mile Lane, Burnie, Tasmania	10.00	" .. .. .	27.11.70
Cooper, William J., 6 Trident-street, Mansfield, Qld.	77.90	" .. .. .	"
Corbett, Flora E., 50 North Rocks-road, North Rocks, N.S.W.	60.00	" .. .. .	30.4.70
Corney, Albert (estate of), c/o C. R. Biddulph and Co., 49 York-street, Sydney, N.S.W.	100.00	" .. .. .	27.11.70
Cornille, Cyrielle B. H., Groote Hemme, Ramcapelle, Belgium	21.00	" .. .. .	30.4.70
Courtice, Annie, 88 Warragul-road, Turramurra, N.S.W.	10.00	" .. .. .	"
Cowling, Alfred (estate of), c/o Sladden & Stuart, P.O. Box 734, Wellington, New Zealand	48.60	" .. .. .	"
Craven, Alexia J., (nee Mosedale) 27 Pineridge-terrace, Takapuna, Auckland, N.Z.	12.75	" .. .. .	"
Daley, Henry C., 66 Arthur-street, Randwick, N.S.W.	40.00	" .. .. .	27.11.70
Davidson, Michael C. I., 56 Riverside-drive, Fulham, S.A.	10.00	" .. .. .	"
Davies, Betty T., 6 Ulmus-street, Mt. Isa, Qld.	20.00	" .. .. .	"
Dawes, Leslie T., Southmead House, Western-road, Wilmslow, Cheshire U.K.	21.62	" .. .. .	"
Dawson, Gwendoline M. & Derrick M., Julia-street, Pahiatua, N.Z.	58.65	" .. .. .	30.4.70
Dickson, Elsie (estate of), c/o Cleary & Lee, P.O. Box 75, Toowoomba, Qld.	345.60	" .. .. .	27.11.70
Dobrinski, Beryl M., c/o Saville Row, 181 George-street, Sydney, N.S.W.	10.00	" .. .. .	30.4.70
Dorney, Marie L. (estate of), c/o Wilson, Ryam & Grose, P.O. Box 1113, Townsville, Qld.	180.00	" .. .. .	27.11.70
Draper, Patricia J., c/o Commercial Trading Bank of Australia, Darwin, N.T.	10.00	" .. .. .	30.4.70
Dwyer, John S., c/o Burns Philp N. G. Ltd., Lae, T.P.N.G.	10.00	" .. .. .	27.11.70
Edwards, Jocelyn M., 182 Victoria-street, Kings Cross, N.S.W.	10.00	" .. .. .	"
E. K. Agencies Pty. Ltd., 5th Floor, 82 Elizabeth-street, Sydney, N.S.W.	20.00	" .. .. .	"
Elliott, Norman M., 116 Manchester-road, Gympie, N.S.W.	70.00	" .. .. .	"
Ellis, William J., 225 Eastern-road, Wahroonga, N.S.W.	10.00	" .. .. .	"
Erickson, Ernest O. (estate of), c/o Henry Davis York & Co., 44-46 Martin-place, Sydney, N.S.W.	60.00	" .. .. .	"
Fagan, Beryl G. G., 9 Boundary-street, Roseville, N.S.W.	103.50	" .. .. .	30.4.70
Fawns, Geoffrey C. (estate of), c/o McLaren Jeeves & Seacome, Longwood House, Bayshill-road, Cheltenham, Glos. G.L.S.O. Bae, U.K.	69.30	" .. .. .	"
Ferguson, Charmain M., 13 Sutherland-street, Paddington, N.S.W.	20.00	" .. .. .	27.11.70
Ferrier, Marjorie R. (estate of), c/o The N.Z. Insurance Co. Ltd., Trust Department, 96 Hereford-street, Christchurch, N.Z.	14.40	" .. .. .	"
Fogarty, Marillyn G., (address unknown)	30.00	" .. .. .	30.4.70
Forbes, Mary, 32 Cityview-road, North Balwyn	10.00	" .. .. .	27.11.70
Forge, Leslie R., 5A Tom-street, Yarrowonga	50.00	" .. .. .	"
Fox, Phyllis I., c/o Daryl E. I. Simpson, c/o John Sweeney & Co., Level 43, Australia Square, Sydney, N.S.W.	30.00	" .. .. .	30.4.70
Fox, Reginald V. (estate of), 16 Edward-street, Bondi, N.S.W.	100.00	" .. .. .	27.11.70
Fraser, Albert B., 1/7 Tower-street, Hawthorn East	10.00	" .. .. .	"
Freeman, William A. A. (estate of) c/o Maxwell & Boyd, 155 Castle-reagh-street, Sydney, N.S.W.	300.00	" .. .. .	30.4.70
Fuller, Mary L. (estate of), c/o Miss E. M. Bennett, c/o Norman Thom Macdonald & Co., P.O. Box 111, Auckland, N.Z.	104.40	" .. .. .	"
Gaitskell, John D. (estate of) c/o Stevens Jacobs Mellor & Bollen, G.P.O. Box 74, Adelaide, S.A.	20.00	" .. .. .	27.11.70
Gason, Gwendoline M., Flat 12A, 4 Stonehaven-court, Toorak	15.00	" .. .. .	30.4.70
Gibbons, Yvonne S., 13A Box Hill, Khandallah, Wellington, N.Z.	30.96	" .. .. .	"

## Unclaimed Moneys Act 1962.

Register of Unclaimed Moneys held by the—

Name of Owner on Books and Last Known Address.	Total Amount Due to Owner.	Description of Unclaimed Moneys.	Date when Amount first became Payable.
§			
E.Z. INDUSTRIES LIMITED—continued.			
Glanville, Zoe, Glenmalure, Main-road, Sassafras .. .. .	110.40	Dividend .. .. .	27.11.70
Golding, Rose E., 21 Pacific-street, Carinbah, N.S.W. .. .. .	40.00	" .. .. .	" .. .. .
Goverd, William H., 8 Wenden-street, Fairfield, N.S.W. .. .. .	20.00	" .. .. .	" .. .. .
Graham, John H., c/o Roberts & Graham, P.O. Box 56, Dromana .. .. .	50.00	" .. .. .	" .. .. .
Greig, Beryl L. (estate of), c/o Maurice Ryan & Francis Greene, 374 Little Collins-street, Melbourne .. .. .	15.00	" .. .. .	" .. .. .
Griffin, Marjorie A. (estate of), c/o C. C. Griffin, 69 Robert-street, Bentleigh .. .. .	10.00	" .. .. .	" .. .. .
Grimson, Doris (estate of), Maunder & Jeffrey, 143 Castlereagh-street, Sydney, N.S.W. .. .. .	40.00	" .. .. .	" .. .. .
Grubb, Winifred M. (estate of), c/o Ritchie & Parker Alfred Green & Co., 81 St. John-street, Launceston, Tas. .. .. .	52.50	" .. .. .	30.4.70
Guerin, Robert (estate of), c/o Knox & Hargrave, 32 Pirie-street, Adelaide, S.A. .. .. .	10.00	" .. .. .	27.11.70
Gummow, Ida (estate of), 2 O'Connell-street, Sydney, N.S.W. .. .. .	375.00	" .. .. .	" .. .. .
Gurner, Roberta, 14A Hanson-avenue, Heathpool, S.A. .. .. .	10.00	" .. .. .	30.4.70
Guthrie, Sidney M., 40 Upper Clifford-avenue, Fairfield, N.S.W. .. .. .	69.50	" .. .. .	27.11.70
Hands, Helen M., 11 Parkside-avenue, Balwyn .. .. .	25.00	" .. .. .	" .. .. .
Harding, Andrew R. & Manners, Thomas J., Dowgate Hill House, The Old Taphouse Wooton, Basingstoke, Hampshire, U.K. .. .. .	19.46	" .. .. .	" .. .. .
Harding, Peter R., Mount Vernon, Waipukrau, N.Z. .. .. .	10.81	" .. .. .	" .. .. .
Hatton, David T., Flat 1, 25 Camperdown-street, East Brighton .. .. .	25.00	" .. .. .	" .. .. .
Henderson, Elizabeth K., c/o H. L. Yuncken & Yuncken, 443 Little Collins-street, Melbourne .. .. .	20.00	" .. .. .	" .. .. .
Hey, Peter G., 2 Taylor-road, Mitcham, S.A. .. .. .	60.00	" .. .. .	30.4.70
Hibberd, Joan L., 17 Sorrett-avenue, Malvern .. .. .	30.00	" .. .. .	" .. .. .
Hickey, Helen M., Berrigan, N.S.W. .. .. .	52.20	" .. .. .	" .. .. .
Hickey, Vincent J. (estate of), c/o J. J. Carroll Cecil O'Dea & Co., 82 Elizabeth-street, Sydney, N.S.W. .. .. .	50.00	" .. .. .	27.11.70
Higgs, Henry G., 28 Kerford-street, Glen Iris .. .. .	50.00	" .. .. .	" .. .. .
Hills, Malcolm, 15 Were-street, Brighton Beach .. .. .	10.00	" .. .. .	" .. .. .
Hiscox, Patricia J., 8 Centenary-avenue, Hunters Hill, N.S.W. .. .. .	10.00	" .. .. .	" .. .. .
Hollis, Clarice A., c/o Miller & Poulgrain, P.O. Box 411, Thames, N.Z. .. .. .	69.60	" .. .. .	" .. .. .
Howard, Ronald J., c/o Mrs. Sarah K. Howard, c/o William O. Lahy & Jack V. Doyle, 1A Bateman-avenue, Launceston, Tas. .. .. .	975.00	" .. .. .	30.4.70
Hughes, Elsie M. K. (estate of), c/o Mrs. Joy M. E. Gordon, 4 Bellevue-place, Unley Park, S.A. .. .. .	120.00	" .. .. .	27.11.70
Humphris, Marie P., 24 Marne-street, South Yarra .. .. .	10.00	" .. .. .	" .. .. .
Hutchins, Charles D. M. (estate of), c/o Flower & Hart, G.P.O. Box 219 Brisbane, Q'd. .. .. .	10.00	" .. .. .	" .. .. .
Hyson, Colin (estate of), c/o Mr. A. McIlveen, C. J. Jones & J. C. Hyson, Goonoo Goonoo-road, Tamworth, N.S.W. .. .. .	75.00	" .. .. .	30.4.70
Irvin, Oswald B. (estate of), c/o Osborne Allen & Holt, 75-77 Pitt-street, Sydney, N.S.W. .. .. .	45.00	" .. .. .	" .. .. .
James, Frederick H., 12 Belmont-avenue, Kew .. .. .	150.00	" .. .. .	" .. .. .
Jeffrey, Tad J., (estate of), c/o Robilliard & Robilliard, 21 George-street, Parramatta, N.S.W. .. .. .	75.00	" .. .. .	" .. .. .
Jenkins, Henry R., 7 High-street, Cwmgrwrach, 1 Neath, Glamorgan, Wales .. .. .	17.30	" .. .. .	27.11.70
Jones, Arthur F. W. (estate of), c/o J. R. Allison, 53 Cathedral Square, Christchurch, 1, N.Z. .. .. .	221.40	" .. .. .	30.4.70
Jones, Sarah E., (estate of), 40 Weka-street, Fendalton, Christchurch, N.Z. .. .. .	581.11	" .. .. .	" .. .. .
Jones, William (estate of), c/o Annie Jones, c/o Barbour & Arnold, 405 Bourke-street, Melbourne .. .. .	10.00	" .. .. .	27.11.70
Keeshan, Martin J., Unit 2, 16 Joubert-street, Hunters Hill, N.S.W. .. .. .	50.00	" .. .. .	30.4.70
Kenny, Bernard V. & Anor, c/o Catholic Presbytery .. .. .	1,400.00	" .. .. .	27.11.70
Kinross, Elizabeth A., 56 Eton-road, Lindfield, N.S.W. .. .. .	60.00	" .. .. .	30.4.70
Knuckey, Marie E. (address unknown) .. .. .	30.00	" .. .. .	" .. .. .
Kovocs, Emery, 435 Old South Head-road, Rose Bay, N.S.W. .. .. .	10.00	" .. .. .	27.11.70
Krasicki, George H., 147 Canterbury-road, Toorak .. .. .	10.00	" .. .. .	" .. .. .
Kremmer, Beatrice L. (estate of), c/o Murdoch Clarke Cosgrove & Drake, G.P.O. Box 408D, Hobart, Tas. .. .. .	210.00	" .. .. .	" .. .. .
Lawes, Norma J., 5 Tedder-street, Dunedin, N.Z. .. .. .	33.40	" .. .. .	" .. .. .
Lawler, Edward P., 32 Shirley-street, Karori, Wellington, N.Z. .. .. .	25.95	" .. .. .	" .. .. .
Lawrence, Marjorie I. D., Mount Hilton, Harwarden, North Canterbury, N.Z. .. .. .	178.02	" .. .. .	30.4.70
Leahy, John (estate of), c/o Mr. B. P. Woodward, 9 Hunter-street, Sydney, N.S.W. .. .. .	30.00	" .. .. .	" .. .. .
Learoyd, Walter R., 137 Elphin-road, Launceston, Tas. .. .. .	45.00	" .. .. .	" .. .. .
Lee, Beryl, (estate of), c/o Eric W. Gifford, 13 Minimbah-road, North Bridge, N.S.W. .. .. .	138.00	" .. .. .	27.11.70
Lester, Gladys R. (estate of), c/o Mr. F. K. Lester & Mr. A. H. Lester, 14 Florence-street, Carnegie .. .. .	70.50	" .. .. .	" .. .. .
Lewcock, Edith V., The Nook, P.O. Box 164, Lucindale, S.A. .. .. .	10.00	" .. .. .	" .. .. .
Lincoln, Ernest R. & Una J., Huonville, Tas. .. .. .	45.00	" .. .. .	30.4.70
MacAnsh, Ann De H. (estate of), c/o Maxwell & Boyd, 155-159 Castlereagh-street, Sydney, N.S.W. .. .. .	390.00	" .. .. .	" .. .. .
MacDonald, Wallace J., Flat 3, 26 Cremorne-road, Cremorne, N.S.W. .. .. .	10.00	" .. .. .	27.11.70
MacDougall, Agnes B. (estate of), c/o A. D. Ellison & Son, 20 O'Connell-street, Sydney, N.S.W. .. .. .	45.00	" .. .. .	30.4.70
MacGillivray, Ian S., c/o The Chartered Bank Naval Base Branch, Singapore .. .. .	30.27	" .. .. .	27.11.70
Maddox, Frederick J. (estate of), c/o Button Williams & Co., 66 Best-street, Devonport, Tas. .. .. .	38.10	" .. .. .	30.4.70
Madsen, Gwenda N., 43 Outlook-drive, Eaglemont .. .. .	20.00	" .. .. .	27.11.70

## Unclaimed Moneys Act 1962.

## Register of Unclaimed Moneys held by the—

Name of Owner on Books and Last Known Address.	Total Amount Due to Owner.	Description of Unclaimed Moneys.	Date when Amount first became Payable.
\$			
E.Z. INDUSTRIES LIMITED— <i>continued.</i>			
Malone, William, 17 Little-street, Daylesford	30.00	Dividend .. .. .	27.11.70
Mansergh, Dennis B. (estate of), c/o Frechill Hollingdale & Page, 187-191 Macquarie-street, Sydney, N.S.W.	45.00	" .. .. .	30.4.70
Marshall, Loris M., 41 Bromborough-road, Roseville, N.S.W.	10.00	" .. .. .	27.11.70
Mason, Anthony F. & Burns, Noel R., c/o Anthony F. Mason & Noel R. Burns, c/o Garland Seaborn & Abbott, 4-6 Bligh-street, Sydney, N.S.W.	80.00	" .. .. .	"
Meehan, Norman J. (estate of), c/o The New Zealand Insurance Co. Ltd., Trust Department, P.O. Box 9, Christchurch, N.Z.	535.20	" .. .. .	"
Melogonis, Constantine (estate of), c/o Mr. Leslie R. Ross, Dorney Building, Chinchilla-street, Chinchilla, Q'ld.	10.00	" .. .. .	"
Mellor, Carol E., c/o Coates Brothers Aust. Pty. Ltd., 323 Chisholm-road, Auburn, N.S.W.	10.00	" .. .. .	"
Melzer, Leo (estate of), c/o Bernard Curran McHugh & Co., Bank of Adelaide Building, George & Margaret-streets, Sydney, N.S.W.	10.00	" .. .. .	"
Menlove, Neville V., 160 Castlereagh-street, Sydney, N.S.W.	30.00	" .. .. .	30.4.70
Menzel, Stanley W. O., c/o Iplex Plastics Ind. Pty. Ltd., 87-95 Angas-street, Adelaide, S.A.	20.00	" .. .. .	27.11.70
Merivale, Nella E. (estate of), c/o Cooper Brothers & Co., G.P.O. Box 2650, Sydney, N.S.W.	40.00	" .. .. .	30.4.70
Miller, Kathleen E., 16 Whiteleaf-crescent, Glengowrie, S.A.	10.00	" .. .. .	27.11.70
Millington-Drake, Manon Byways, Lyne Lane, near Chertsey, Surrey, U.K.	42.24	" .. .. .	30.4.70
Monson, Matilda J., c/o Pigott Stinson & Co., G.P.O. Box 3380, Sydney, N.S.W.	170.00	" .. .. .	27.11.70
Moore, Brooke (estate of), c/o McIntosh McPhillamy & Co., P.O. Box 33, Bathurst, N.S.W.	90.00	" .. .. .	30.4.70
Moore, Ethel R., c/o G. E. Moore, 147 Macquarie-street, Sydney, N.S.W.	70.00	" .. .. .	27.11.70
Moore, William J., 16 Kings-road, Cornwall, U.K.	43.25	" .. .. .	"
Morgan, Charles A., 120 Pitt-street, Sydney, N.S.W.	25.00	" .. .. .	30.4.70
Morris, Barbara E., 118 Victoria-drive, London, 3 W 19, U.K.	29.75	" .. .. .	"
Morris, Isabella C. (estate of), 57 Mountainview-road, North Balwyn	156.60	" .. .. .	"
Moulton, Ronald S. (estate of), c/o Mr. C. McC. Smith, P.O. Box 51, Miranda, N.S.W.	30.00	" .. .. .	"
Murdoch, Valerie B., 114 Old Burleigh-road, Broadbeach, Q'ld.	30.00	" .. .. .	27.11.70
Murphy, Lynette M., Koornang-crescent, Warrandyte	20.00	" .. .. .	"
Murray, William A. K. & Anor, 173 St. Vincent-street, Glasgow, Scotland	14.53	" .. .. .	"
McCauley, Jean E. (address unknown)	10.00	" .. .. .	"
McCleary, Annie J., c/o Mrs. B. V. Furzer, 159 Balaclava-road, North Caulfield	60.00	" .. .. .	30.4.70
McCormick, Peter, 220 Cardigan-street, Carlton	30.00	" .. .. .	27.11.70
McGilvray, James J., 37 Dalrymple-avenue, Chatswood, N.S.W.	10.00	" .. .. .	"
McIver, Deana L., Flat 6, 17 Mercer-road, Armadale	20.00	" .. .. .	"
Nash, Katie F. G. (estate of), c/o Ivor A. T. Sheffield, 1 Bridge-road, Belmore, N.S.W.	180.00	" .. .. .	30.4.70
Newton, Alexander S., 7/371 Liverpool-road, South Strathfield, N.S.W.	10.00	" .. .. .	27.11.70
Nicholls, Elizabeth R., 9 Hamilton-avenue, Tolworth, Surbiton, Surrey, U.K.	38.70	" .. .. .	30.4.70
Nicol, Alan A. & Anor, c/o Dowling Taylor Pratt & Nicol, 70 Pitt-street, Sydney, N.S.W.	40.00	" .. .. .	27.11.70
Norton-Knight, Mary W., Markt Pongau, R.M.B. 58, Harden, N.S.W.	10.00	" .. .. .	"
Oldham, Christopher J. E., The Old Oast, Speldhurst, Tunbridge Wells, Kent, U.K.	17.30	" .. .. .	"
Orr, Ulric G., 17 Billyard-avenue, Elizabeth Bay, N.S.W.	75.00	" .. .. .	30.4.70
Parker, Kenneth H., 41 Ponsonby-parade, Seaforth, N.S.W.	30.00	" .. .. .	27.11.70
Parker, Lydia, 65 Ocean-avenue, Double Bay, N.S.W.	25.00	" .. .. .	30.4.70
Parsons, Ronald G. R. (estate of), c/o C. R. Sweeting & Co., King York House, 32-34 York-street, Sydney, N.S.W.	10.00	" .. .. .	27.11.70
Pearson, Robert G., 130 Victoria-avenue, Chelmer, Q'ld.	15.00	" .. .. .	30.4.70
Peck, Ivy J., Tudor Lodge, Dorset-road, Croydon	10.00	" .. .. .	27.11.70
Perkins, Marie M. (estate of), c/o Lawrence & Lawrence, G.P.O. Box 1616, Sydney, N.S.W.	108.60	" .. .. .	30.4.70
Perkins, Winifred B., 21 Euston Terrace, Croydon, S.A.	180.00	" .. .. .	"
Pildra Investments Pty. Ltd., P.O. Box 332, Broadway, N.S.W.	80.00	" .. .. .	27.11.70
Plumb, Gwendoline J., 103 Squadron Tower, 21 Elamang-avenue, Kirribilli, N.S.W.	20.00	" .. .. .	"
Pratt, Hilda (estate of), c/o Francis Taylor & Ferguson, 120 Clarence-street, Sydney, N.S.W.	855.00	" .. .. .	30.4.70
Prescott, Alwyn W., The Rectory, Brownley-street, Mossvale, N.S.W.	30.00	" .. .. .	"
Prescott, Dora M. (estate of), c/o G. D. Campbell & Co., 92 Pitt-street, Sydney, N.S.W.	30.00	" .. .. .	"
Price, Grace W. (estate of), c/o Billing Little Fookes, Strombom & Dean, P.O. Box 243, New Plymouth, N.Z.	397.20	" .. .. .	27.11.70
Price, Owen H., c/o George T. Winter Pty. Ltd., 222 Torrens-road, Renown Park, S.A.	11.10	" .. .. .	"
Priest, Lawrence B., c/o Mr. L. B. & S. C. Priest, 186 East Risdon-road, Lindsifarne, Tas.	70.00	" .. .. .	"
Reinbach, Hans P., c/o Lignite Authority, Samsen-road, Bangkok, Thailand	32.40	" .. .. .	30.4.70
Rentoul, Sandra H., 35 Rocklea-drive, Torquay	10.00	" .. .. .	27.11.70
Richards, Robert A., P.O. Box 201, Gladstone, Q'ld.	10.00	" .. .. .	"
Richardson, Lilian M., c/o A.N.Z. Bank Limited, 351 Collins-street, Melbourne	30.00	" .. .. .	"
Richardson, Robert L., 49 Tryon-road, Lindfield, N.S.W.	15.00	" .. .. .	"

## Unclaimed Moneys Act 1962.

## Register of Unclaimed Moneys held by the—

Name of Owner on Books and Last Known Address.	Total Amount Due to Owner.	Description of Unclaimed Moneys.	Date when Amount first became Payable
\$			
E.Z. INDUSTRIES LIMITED—continued.			
Rigg, Alison C., c/o Dr. J. R. A. Rigg, c/o L. I. Iles & Co., Charter House, 4 Bank-place, Melbourne	10.00	Dividend .. .. .	27.11.70
Rillstone, Nicole U., Geo. Peko, P.O. Box 1890, Darwin, N.T.	30.00	" .. .. .	30.4.70
Esteb, R. N., Pty. Limited, Suite No. 36, 65 Queens-road, Melbourne	70.00	" .. .. .	27.11.70
Roberts, Eugenie M. (estate of), c/o Perpetual Trustee Co. Ltd. & A. F. Roberts, 33-39 Hunter-street, Sydney, N.S.W.	50.00	" .. .. .	"
Roberts, Herbert G., 16 Lyle-avenue, West Lindfield, N.S.W.	20.00	" .. .. .	30.4.70
Rosenhain, Pamela S., Flat 3, 4 Keen-avenue, East Glenelg, S.A.	20.00	" .. .. .	27.11.70
Ross, Roderick, c/o Mrs. Mary D. Ross, Flat 9, Glyndebourne-avenue, Toorak	30.00	" .. .. .	"
Rottell, Bernard, 35 The Avenue, Windsor	10.00	" .. .. .	"
Russell, Sudyard H., Mills, Thomas M., 8 New-square, Lincolns Inn, London, W.C. 2, U.K.	38.25	" .. .. .	30.4.70
Ryan, Robert C., 38 Grieve-street, Macleod West	20.00	" .. .. .	27.11.70
Sale, John P.L. (estate of), c/o Union Fidelity Trustee Co. of Aust. Ltd., & T. G. Sale & J. R. Sale, 400 Queen-street, Brisbane, Q'ld.	20.00	" .. .. .	"
Savage, Lillia E. E., J. A. Murray & Worthy, 9 Smith-street, Kempsey, N.S.W.	161.10	" .. .. .	"
Saywell, Tom A. R. (estate of), c/o Mr. T. R. Saywell & Miss C. C. Saywell, 51 New South Head-road, Vaucluse, N.S.W.	120.00	" .. .. .	"
Seaton, Arthur M., 28 Commercial-road, Hyde Park, S.A.	10.00	" .. .. .	"
Service, George M., Ashcroft, Bridge of Allan, Stirlingshire, U.K.	21.62	" .. .. .	"
Shackelford, Martin, c/o Brown Bliss & Co., Warnford-court, London, E.C. 2, U.K.	34.60	" .. .. .	"
Shain, Barbara M. (address unknown)	37.50	" .. .. .	30.4.70
Shapcott, Harold S., c/o Midland Bank Limited, Stock Exchange Branch, 122 Old Broad-street, London, E.C. 2, U.K.	21.62	" .. .. .	27.11.70
Sheil, Wilhelmina R. A. (estate of), c/o Maxwell & Boyd, 155 Castlereagh-street, Sydney, N.S.W.	450.00	" .. .. .	30.4.70
Shelton, Ronald B., Gozo, Boggabilla, N.S.W.	10.00	" .. .. .	27.11.70
Shortis, Mary, c/o Medical Missionaries of Mary, Clonmel, Co. Tipperary, Eire.	12.26	" .. .. .	"
Skeahan, John G. (estate of), c/o Richard S. Haynes & Co., St. George's House, 115 St. George's-terrace, Perth, W.A.	30.00	" .. .. .	30.4.70
Skeoch, Robert L. (estate of), c/o Moule Hamilton & Derham, 224 Queen-street, Melbourne	42.00	" .. .. .	27.11.70
Smith, Harold Mc.I. (estate of), c/o Mrs. M. J. Smith & Mr. R. L. W. Smith & Miss H. Mc.I. Brown, 19 Adams-street, Maitland, N.S.W.	118.80	" .. .. .	30.4.70
Smith, Ivo A. (estate of), c/o MacPhillamy Cummins & Gibson, P.O. Box 628, Canberra City, A.C.T.	220.00	" .. .. .	27.11.70
Smith, Keith S., Flat 5, 30 Powlett-street, East Melbourne	20.00	" .. .. .	"
Smith, Lorna M., c/o Caltex Road House, Corrigan, W.A.	20.00	" .. .. .	"
Smith, Rosabella J. G., 1022 Drummond-street, North Carlton	30.00	" .. .. .	30.4.70
Smith, Sylvia F. (estate of), G. D. Campbell & Co., 155 King-street, Sydney, N.S.W.	120.00	" .. .. .	"
Solomons, Walter C. R. (estate of), c/o Watson & McNamara, P.O. Box 434 Armidale, N.S.W.	10.00	" .. .. .	27.11.70
Squire, Francklyn (estate of), c/o Mrs. Marjorie Murray, 15 Ratho-street, Lenah Valley, Tas.	576.40	" .. .. .	"
Stapleton, Rosa M. G., 120 Carrington-road, Waverley, N.S.W.	69.60	" .. .. .	"
Steiner, Angela (estate of), c/o Mr. Otto Singer, 924 Waverley-road, Glen Waverley	45.00	" .. .. .	30.4.70
Stirzaker, Jessie R. (estate of), c/o The Elders Trustee & Executor Co. Ltd., G.P.O. Box 494 Adelaide, S.A.	145.00	" .. .. .	27.11.70
Stokes, Clement S., 36 Fuller-street, Walkerville, S.A.	10.00	" .. .. .	"
Stoller, Julian A., 348 Dandenong-road, East St. Kilda	40.00	" .. .. .	"
Swan, Hilda M., 18 Gloucester-street, Glenelg, S.A.	138.00	" .. .. .	"
Swannell, John E. C., c/o John E. Swannell, Jr., 671 Forest Hill-avenue, Albury, N.S.W.	25.00	" .. .. .	30.4.70
Synnot, David M., c/o Department of Agriculture, 133 Gawler-place, Adelaide, S.A.	20.00	" .. .. .	"
Taubman, Alan C. (address unknown)	90.00	" .. .. .	"
Taylor, Edwin, Marsden House, High Moor-lane, Wrightington, nr. Wigan, Lancs., U.K.	17.00	" .. .. .	"
Timms, Dorothy, 16 Main-parade, Clearview, S.A.	20.00	" .. .. .	27.11.70
Treadrea, Lawrence L., 2 Hanley-street, Morphetville, S.A.	10.00	" .. .. .	"
Trechman, Alice B., c/o Commonwealth Bank of Australia, Martin-place, Sydney, N.S.W.	34.80	" .. .. .	30.4.70
Turner, Florence (estate of), c/o Laurencé & Laurence, G.P.O. Box 1616, Sydney, N.S.W.	105.00	" .. .. .	"
Tyson, John L. (estate of), The Tasmanian Permanent Exors. & Trustees Assoc. Ltd., P.O. Box 286c, Launceston, Tas.	70.80	" .. .. .	"
Valentine, Ronald J. H. (estate of), c/o Stephen Jaques & Stephen, A.M.P. Building, Circular Quay, Sydney, N.S.W.	10.00	" .. .. .	27.11.70
Vaughton, Desmond B. & Lois A., 147 Burbridge-road, Brooklyn Park, S.A.	10.00	" .. .. .	"
Wakelin, Vincent J., 3 Halcyon-avenue, Wahroonga, N.S.W. (Now unknown)	31.05	" .. .. .	30.4.70
Walker, Jean M., 40 Trafalgar-avenue, Roseville, N.S.W.	10.00	" .. .. .	27.11.70
Wallman, Elizabeth A., 95 Church-terrace, Walkerville, S.A.	30.00	" .. .. .	"
Walsh, Muriel C. (estate of), c/o Union Fidelity Trustee Co. of Aust. Ltd., G.P.O. Box 493, Sydney, N.S.W.	100.00	" .. .. .	"
Wardleworth, John C. J., Plessey-Ate-Telecomunicacoes, S.A.A.V., Ipiranga 318 Conjunto 1002, Caixa Postal 7821, Sao Paulo, Brazil	18.25	" .. .. .	"
Watchorn, Erskine C. (estate of), 10 Fisher-avenue, Sandy Bay, Tas.	105.00	" .. .. .	30.4.70
Watson, Albert M., Suite 301, 20 Bridge-street, Sydney, N.S.W.	20.00	" .. .. .	27.11.70

## Unclaimed Moneys Act 1962.

## Register of Unclaimed Moneys held by the—

Name of Owner on Books and Last Known Address.	Total Amount Due to Owner.	Description of Unclaimed Moneys.	Date when Amount first became Payable.
5			
E.Z. INDUSTRIES LIMITED—continued.			
Watson, John B., c/o Sam B. Bagley & Son, 430 Little Collins-street, Melbourne	30.00	Dividend .. .. .	27.11.70
Watts, Patricia, c/o Mrs. M. P. Watts, Grassdale P.O. Branholme	30.00	" .. .. .	" .. .. .
Webb, Nicholas, 3/39 Morrah-street, Parkville .. .. .	10.00	" .. .. .	30.4.70
Webb, Victor R., (estate of), c/o George A. Raves & Poole, 109 Pitt-street, Sydney, N.S.W.	45.00	" .. .. .	" .. .. .
Weller, Ronald H., The Vicarage, Broxbourne, Herts, U.K. .. .	17.30	" .. .. .	27.11.70
Whistler, Phyllis E., Paterangi, 3 R.D. Ohaupo, N.Z. .. .	51.90	" .. .. .	" .. .. .
White, Sarah A., 10 York Court Flats, York-place, Dunedin, N.Z. ..	119.37	" .. .. .	" .. .. .
Wilkinson, Richard L., 6 Ferguson-street, Glen Iris .. .	10.00	" .. .. .	" .. .. .
Willis, Natalie A. (estate of), c/o N. A. Kneale Fowler & Co., 210 Pitt-street, Sydney, N.S.W.	45.00	" .. .. .	30.4.70
Woodruff, David S., c/o Trinity College, University of Melbourne, Parkville	20.00	" .. .. .	27.11.70
Woollard, Stanley K. D., 148 Pampisford-road, South Croydon, Surrey, U.K.	10.38	" .. .. .	" .. .. .
Worrell, John A. C. & Worrell, Beryl M., Flat 5, 110 Walpole-street, Kew	30.00	" .. .. .	30.4.70
W.W. Investments Pty. Ltd., 38 Hector-road, Willoughby, N.S.W.	10.00	" .. .. .	27.11.70
Wyatt, Alfred N. (estate of), c/o Union Fidelity Trustee Co. of Aust. Ltd., 400 Queen-street, Brisbane, Qld.	60.00	" .. .. .	" .. .. .
Young, Nellie A. De (nee Robb), 5 Bella Vista-road, Glen Iris ..	1,050.00	" .. .. .	30.4.70
Barnes, Laurence S. (estate of), c/o Richard, Zande & Assoc., P.O. Box 42, Ipswich, Qld.	10.00	" .. .. .	27.11.70
Douglas, Andrew S., Selkirk, St. Vincent-road, Greenwich, N.S.W.	30.00	" .. .. .	" .. .. .
Mackay, Rachel M. J., Thimble Lodge, Green-lane, Prestwood Great Missenden Bucks, U.K.	10.62	" .. .. .	30.4.70
6645			
THE MYER EMPORIUM LIMITED.			
<i>Adelaide Register.</i>			
Bayne, Amelia (Mrs.), 22 Edinburgh-avenue, Stonyfell, S.A. .. .	11.25	Dividend .. .. .	26.5.70
Brown, Helen D. (Miss), 38 Marlborough-street, College Park, S.A.	11.25	" .. .. .	" .. .. .
Dundon, Elizabeth G. (Mrs.), 80 Broadway, Glenelg, S.A. .. .	10.31	" .. .. .	" .. .. .
Grant, Lady Kate M., 56 Fourth-avenue, St. Peters, S.A. .. .	10.31	" .. .. .	" .. .. .
Holst, Mabel J. (Mrs.), 50 Victoria-terrace, Hawthorn, S.A. .. .	10.31	" .. .. .	" .. .. .
Leane, Edith L. (Mrs.), Flat 1, Trammere House, 3 Kings-grove, Trammere, S.A.	20.63	" .. .. .	" .. .. .
Lendon, Colin, Redwalls, Birch-road, Mount Lofty, S.A. .. .	22.50	" .. .. .	" .. .. .
Martin, Robert W., 35 Morialta-road, Rostrevor, S.A. .. .	19.69	" .. .. .	" .. .. .
Morish, William J., Mount Eba Station, via Woomera, S.A. .. .	12.90	" .. .. .	" .. .. .
Shearer, Lionel Leslie K., 6 Whistler-avenue, Unley Park, S.A. ..	10.31	" .. .. .	" .. .. .
Worrall, Wendy D. (Mrs.), 4 Wilsden-street, Walkerville, S.A. ..	11.25	" .. .. .	" .. .. .
<i>Brisbane Register.</i>			
Devlin, Irene M. (Mrs.), 13 Stephens-street, Annerley, Qld. .. .	28.13	" .. .. .	" .. .. .
Quilty, Lillian L. (Mrs.), 36 Waratah-road, Clayfield, Qld. .. .	38.25	" .. .. .	" .. .. .
Nimmo, Robert W. J., 5323 Myrtle-avenue, Glendale, Arizona, U.S.A.	15.94	" .. .. .	" .. .. .
Weeks, Forster B., Tanga House, 5 Princess-road, Tamavua P.O. Box 704, Suva, Fiji	13.12	" .. .. .	" .. .. .
Beresford, Elizabeth (Mrs.), c/o Mrs. D. Kemp, 182 Annerley-street, Dutton Park, Qld.	25.88	" .. .. .	" .. .. .
<i>Canberra Register.</i>			
Clark, Peter W., Box 330 G.P.O., North Sydney, N.S.W. .. .	10.31	" .. .. .	" .. .. .
Cook, Edward B., Flat 3, 1 Lemington-avenue, Seacliffe, S.A. .. .	18.75	" .. .. .	" .. .. .
Stephens, Margaret G. Ogaard (Mrs.), Cheviot, Grenfell, N.S.W. ..	18.75	" .. .. .	" .. .. .
Wolfe, Harry T., 3 Simmonds-court, East Bentleigh .. .	11.25	" .. .. .	" .. .. .
Heidenstam, Jane (Mrs.), 23 Russell-road, London, U.K. .. .	13.39	" .. .. .	" .. .. .
Lymington, The Hon. Ruth V. W., Fernhill Stoney Cross, NR. Lyndhurst, Hampshire, U.K.	19.12	" .. .. .	" .. .. .
Phillpotts, Alan F., c/o Messrs. Hunters, 9 New Square, Lincolns Inn, London, U.K.	25.50	" .. .. .	" .. .. .
Saville, Rt. Hon. George H. Baron, c/o Messrs. Hunters, 9 New Square, Lincolns Inn, London, U.K.	74.91	" .. .. .	" .. .. .
<i>Melbourne Register.</i>			
Curtis, Phyllis J. (Mrs.), c/o J. R. Palmer, 96 Pitt-street, Sydney, N.S.W.	34.88	" .. .. .	" .. .. .
De Garis, Valerie F. (Mrs.), 83 Clendon-road, Toorak .. .	15.00	" .. .. .	" .. .. .
Glass, Y. (Miss), c/o Schaiowitz, 18 Sargood-street, Toorak .. .	22.50	" .. .. .	" .. .. .
O'Donoghue, James, 27 Victoria-street, Brighton .. .	22.50	" .. .. .	" .. .. .
Schultz, Marea A. (Mrs.), Broadway-street, Cobram .. .	15.45	" .. .. .	" .. .. .
Jennings, Helen J. (Mrs.), Beechfield, 58 Watford-road, Radlett, Hertfordshire, U.K.	12.75	" .. .. .	" .. .. .
Kay, Harry R., Flat 1, 36 Palace Gardens Terrace, London, U.K. ..	11.95	" .. .. .	" .. .. .
Messrs. Gilmour, Shaw & Co., A/c Eric R. M. Milne, 10 Hill-street, Edinburgh, U.K.	15.94	" .. .. .	" .. .. .
Fass, Arthur, Longridge, Sleetmoor Lane, Swanwick, Derbyshire, U.K.	22.31	" .. .. .	" .. .. .
<i>Sydney Register.</i>			
Andronico, Charles (estate of), c/o Laurence & Laurence, M.L.C. Building, Cnr. Martin-place and Castlereagh-street, Sydney, N.S.W.	14.06	" .. .. .	" .. .. .
Cole, Winifred E. (Mrs.), Wentworth House, Wentworth-place, Point Piper, N.S.W.	37.50	" .. .. .	" .. .. .
Swaddling, Lola Macey (Mrs.), 13 Paradise-avenue, Roseville, N.S.W.	20.63	" .. .. .	" .. .. .
Whittingham, Zella T. (Miss), Unit E2, 295 Edgecliff-road, Woollahara, N.S.W.	146.25	" .. .. .	" .. .. .



## Unclaimed Moneys Act 1962.

## Register of Unclaimed Moneys held by the—

Name of Owner on Books and Last Known Address.	Total Amount Due to Owner.	Description of Unclaimed Moneys.	Date when Amount first became Payable.
<b>\$</b>			
<b>THE MYER EMPORIUM LIMITED.—continued.</b>			
Fletcher, John H., The Pines, Caswell Bay-road, Swansea, Glamorgan, U.K.	15.94	Dividend .. .. .	26.5.70
West, Noel, 13 Moorlands Devizes, Wilts., U.K.	15.94	" .. .. .	"
<i>Melbourne Register.</i>			
Fraser, Florence (Mrs.), 67 Were-street, Brighton .. .. .	18.00	" .. .. .	31.7.70
McLean, Alice G. (Miss), 25 Redan-street, St. Kilda .. .. .	45.00	" .. .. .	"
McFarlane, John, Collamolong, Cooma, N.S.W. .. .. .	18.90	" .. .. .	"
<i>Adelaide Register.</i>			
Brown, Helen D. (Miss), 38 Marlborough-street, College Park, S.A. ..	21.75	" .. .. .	5.11.70
Grant, Lady Kate M., 56 Fourth-avenue, St. Peters, S.A. .. .. .	19.94	" .. .. .	"
Harris, Ellinor M. (Mrs.), Aldergate Flat 190, Felixstone-road, Payneham, S.A.	19.94	" .. .. .	"
H. Chapman Investments Pty. Ltd., 106 Payneton-road, Stepney, S.A.	39.88	" .. .. .	"
Holst, Mabel J. (Mrs.), 50 Victoria-terrace, Hawthorn, S.A. .. .. .	19.94	" .. .. .	"
Shearer, Lionel Leslie K., 6 Whistler-avenue, Unley Park, S.A. ..	19.94	" .. .. .	"
<i>Brisbane Register.</i>			
Beresford, Elizabeth (Mrs.), c/o Mrs. Kemp, 182 Annerley-road, Dutton Park, Qld.	50.03	" .. .. .	"
Daniel, Ethne M. J. (Miss), c/o Commonwealth Trading Bank, Queen-street, Brisbane, Qld.	18.13	" .. .. .	"
Dean, Thomas H. (estate of), c/o F. A. Signorini, 19 Bullen-street, Tully, Qld.	27.70	" .. .. .	"
Devlin, Irene M. (Mrs.), 13 Stephens-street, Annerley, Qld. ..	54.38	" .. .. .	"
Selvage, Jack, 20 Palmer-street, North Mackay, Qld. .. .. .	14.50	" .. .. .	"
Nimmo, Robert W. J., 5323 Myrtle-avenue, Glendale, Arizona, 85301, U.S.A.	30.81	" .. .. .	"
Weeks, Forster B., Tanga House, 5 Princess-road, Tamavua P.O. Box 704, Suva, Fiji	25.37	" .. .. .	"
<i>Canberra Register.</i>			
Cook, Edward B., 3/1 Leamington-avenue, Sealcliffe, S.A. .. .. .	36.25	" .. .. .	"
Stephens, Margaret G. Ogaard (Mrs.), Cheviot, Grenfell, N.S.W. ..	36.25	" .. .. .	"
Stephens, Osborne H. J. Ogaard, Cheviot, Grenfell, N.S.W. .. ..	14.50	" .. .. .	"
France, Edith A. (Mrs.), Cornborough Villa, Sherrif Hutton, York, U.K.	61.62	" .. .. .	"
Leamington, The Hon. Ruth V. W., Fernhill Sidney Cross, nr. Lyndhurst, Hampshire, U.K.	36.97	" .. .. .	"
Short, James R., 30 Garrick Close, Walton-on-Thames, Surrey, England	12.32	" .. .. .	"
<i>Melbourne Register.</i>			
Arena, Roma D. (Mrs.), 2KA Branksome Gardens, City Beach, W.A.	10.88	" .. .. .	"
Bailey, John H. & Elizabeth E. (Mrs.), The Bluff, St. Leonards ..	14.50	" .. .. .	"
Burgess, Loris (Mrs.), 85 Queen-street, Melbourne .. .. .	14.50	" .. .. .	"
Curry, Nancy F. (Mrs.), 20 Hodgson-street, Kew .. .. .	14.50	" .. .. .	"
De Garis, Valerie F. (Mrs.), 83 Clendon-road, Toorak .. .. .	29.00	" .. .. .	"
Glass, Yette (Mrs.), c/o Schaiowitz, 18 Sargood-street, Toorak ..	43.50	" .. .. .	"
Holmes, Stanton E., 10 Naroo-street, Balwyn .. .. .	10.88	" .. .. .	"
Donoghue, James, 27 Victoria-street, Brighton .. .. .	43.50	" .. .. .	"
Schultz, Maree A. (Mrs.), Broadway-street, Cobram .. .. .	29.87	" .. .. .	"
Swetnam, Clement A., c/o The Manager, A.N.Z. Bank Limited, Pitt & Hunter-streets, Sydney, N.S.W.	73.95	" .. .. .	"
Thorpe, Dinah (Mrs.), 82 Collins-street, Melbourne .. .. .	21.75	" .. .. .	"
Agar, Patrick & John Sisson & Gladys Scarlett M.C.A., A/c, c/o Hichens Harrison & Co., 4 London Wall Buildings, Blomfield-street, London, U.K.	13.56	" .. .. .	"
Biggadike, Ernest R., 112, Britannia-road, Ketterine Nort, Jants, U.K.	16.95	" .. .. .	"
The Manager, The A.N.Z. Bank Ltd., Deposit A/c Dept. H. M. Curry, Martin-place & Pitt-street, Sydney, N.S.W.	12.32	" .. .. .	"
Gordon, Mabel P., 24 Victoria-avenue, Dannevirke, New Zealand	12.32	" .. .. .	"
Kay, Ada M. (Mrs.), W. G. Kay & P. C. Kay, c/o Bank of Scotland, 30 Bishopsgate, London, U.K.	40.06	" .. .. .	"
Kay, Harry R., Flat 1, 36 Palace Gardens Terrace, London, U.K. ..	23.11	" .. .. .	"
Muirhead, Rosemary (Mrs.), Foular, 11 High-street, Billericay, Essex, England	18.49	" .. .. .	"
Patel, Mahendra Dahyabhai, 15 Blackall-road, Exeter, Devon, U.K. ..	18.49	" .. .. .	"
Salka, Maurice L., 78 Heaton Park-drive, Beadford 9, Yorkshire, U.K.	30.81	" .. .. .	"
Stoop, Michael, The Old House, Hare House, Twyford, Berks., U.K.	77.65	" .. .. .	"
Miles, Alice A. & Arthur D., 50 Melrose-street, Box Hill .. .. .	36.98	" .. .. .	"
<i>Sydney Register.</i>			
Cole, Winifred E. (Mrs.), Wentworth Towers, Wentworth-place, Point Piper, N.S.W.	72.50	" .. .. .	"
McGrath, Patricia (Mrs.), 2 Hermoyne-street, West Ryde, N.S.W. ..	10.88	" .. .. .	"
Bond, Peter D. R., Appledown, Hambrook, Chichester, Sussex, U.K.	12.32	" .. .. .	"
Levinson, Asher Meyer, 6 Langtree-avenue, Whitecraigs, Renfrewshire, U.K.	24.65	" .. .. .	"
Patel, Mahendra Dahyabhai, 15 Blackall-road, Exeter, Devon, U.K. ..	12.32	" .. .. .	"
<i>Melbourne Register.</i>			
Adams, Mary L. (Mrs.), 751 Canterbury-road, Surrey Hills .. .. .	18.00	" .. .. .	31.1.71
Glass, Ieene, 16 The Glen, Ferntree Gully .. .. .	22.50	" .. .. .	"
McLean, Alice B. (Miss), 25 Redan-street, St. Kilda .. .. .	45.00	" .. .. .	"
Parrett, Lily A. (Miss), 112 Avenue-road, Mosman, N.S.W. .. .. .	27.00	" .. .. .	"
Weigall, James H., 22 Kardella-street, East Malvern .. .. .	39.60	" .. .. .	"
McFarlane, John A. H., Collamatong, Cooma, N.S.W. .. .. .	18.90	" .. .. .	"

## Companies Act 1961.

## CRESSWELL GEORGE ASSOCIATES PTY. LTD. (IN VOLUNTARY LIQUIDATION).

## NOTICE CONVENING FINAL MEETING, PURSUANT TO SECTION 272 (1).

Notice is hereby given that the adjourned General Meeting of the company and the creditors of the above-named company will be held at 3rd Floor, 1 Little Collins-street, Melbourne, on Friday, 28th July, 1972, at 12.30 p.m., for the purpose of laying before the meeting an account showing how the winding up has been conducted and the property of the company has been disposed of, and giving any explanation thereof.

Dated this 19th day of June, 1972.

6846

A. B. McMULLIN, Liquidator.

ABRHAMS FABRICS PTY. LIMITED (IN LIQUIDATION).  
GENERAL DYE COLORS PROPRIETARY LIMITED (IN LIQUIDATION).

## RAYON SILK AND CALICO PRINTERS OF AUSTRALIA PROPRIETARY LIMITED (IN LIQUIDATION).

## ROBERT MORTON AND SONS. (SUCCESSORS) PROPRIETARY LIMITED (IN LIQUIDATION).

## THERMOPLASTICS PROPRIETARY LIMITED (IN LIQUIDATION).

## MEMBERS' FINAL MEETING.

Notice is hereby given that, in terms of section 272 of the Companies Act 1961, as amended, the Final General Meetings of the above companies will be held at the office of the liquidator, 23rd level, 6 O'Connell-street, Sydney, at 11, 11.10, 11.20, 11.30 and 11.40 respectively on 24th July, 1972, for the purpose of having laid before them by the liquidator an account showing how the winding up of each company has been conducted and the property of the company disposed of.

J. G. DUFF, Liquidator.

31st May, 1972.

6849

## The Companies Act 1961.

## BUDGET FILM PRODUCTIONS PTY. LTD. (IN LIQUIDATION).

## NOTICE CONVENING FINAL MEETING OF MEMBERS AND CREDITORS, PURSUANT TO SECTION 272.

Notice is hereby given, in pursuance of section 272 of the Companies Act 1961, that a meeting of the members and creditors of the above-named company will be held on the 17th day of July, 1972, at 3 p.m., at the offices of Hall & Rose, 395 Collins-street, Melbourne, for the purpose of having an account laid before them, showing the manner in which the winding up has been conducted and the property of the company disposed of, and of hearing any explanations that may be given by the liquidator.

Dated this 19th day of June, 1972.

S. M. NUNAN, Liquidator.

Hall & Rose, chartered accountants, 395 Collins-street, Melbourne. 6851

## The Companies Act 1961.—In the matter of GREAT EASTERN CIRCUITS PROPRIETARY LIMITED (in Liquidation).

Notice is hereby given that at an Extraordinary General Meeting of Great Eastern Circuits Proprietary Limited, duly convened and held at 623 Collins-street, Melbourne, on the 20th day of June, 1972, the following Resolution was duly passed as a Special Resolution:—

"That the company be wound up voluntarily as a members' voluntary winding up and that Alan Henry Spicer, of 623 Collins-street, Melbourne, be and is hereby appointed liquidator for the purpose of such winding up."

Dated this 20th day of June, 1972.

6852

A. H. SPICER, Liquidator.

## Companies Act 1961.

## B.P.F. PROPERTIES PTY. LTD. (IN LIQUIDATION).

## MEMBERS' VOLUNTARY WINDING UP 2.254.

The following Special Resolutions were duly adopted and passed by the above-named company on the 16th day of June, 1972:—

1. That the company be wound up voluntarily.

2. That Andrew Ian Sinclair be appointed liquidator for the purpose of such winding up.

Dated this 16th day of June, 1972.

ANDREW IAN SINCLAIR, Liquidator.

Duesbury & Johnston, chartered accountants, 446 Collins-street, Melbourne, 3000. 6872

Creditors, next of kin and others having claims against the estate of Joseph Puniard, late of Lakeside Hospital, Ballarat, in the State of Victoria, pensioner, deceased (who died on the 9th day of December, 1971), are requested by the executor of the will of the said deceased, The Union-Fidelity Trustee Company of Australia Limited, of 101 Lydiard-street north, Ballarat, in the said State, to send particulars of their claims to the said company, on or before the 30th day of August, 1972, after which the executor will distribute the assets, having regard only to the claims of which it shall then have had notice.

CUTHBERT, MORROW, MUST & SHAW, solicitors, Ballarat. 6841

## NICHOLAS IAN TURNER, late of 372 Dorset-road, Boronia, in the State of Victoria, carrier, DECEASED, intestate.

Creditors, next of kin and others having claims in respect of the estate of the said deceased, intestate (who died on the 6th day of April, 1972, as a result of road accident), are required by the administratrix, Carol Ann Turner, of 372 Dorset-road, Boronia, aforesaid, to send particulars thereof to her, addressed care of her solicitors, Messrs. Laurence G. Ralph & Morrey, "Dorset House", 236 Dorset-road, Boronia, aforesaid, by the 30th September, 1972, after which date the administratrix may convey or distribute the assets, having regard only to the claims of which she then shall have had notice.

Dated this 23rd day of June, 1972.

LAURENCE G. RALPH & MORREY, solicitors, as above.

6842

Creditors, next of kin and others having claims in respect of the estate of Amy Frances Lewis, late of Lancewood Private Hospital, 880 Glenferrie-road, Kew, in the State of Victoria, spinster, deceased (who died on the 3rd day of April, 1972, are required to send particulars of their claims to the trustees, The Trustees, Executors and Agency Company Limited, of 401 Collins-street, Melbourne, in the said State, and Sidney Edward Singleton, of 28 Packham-crescent, Glen Waverley, in the said State, accountant, at the address of the said company, by the 21st day of August, 1972, after which date the trustees may convey or distribute the assets, having regard only to the claims of which they then have notice.

B. J. T. STONE & LEIGHTON, solicitors, 221 High-street, Kew. 6845

## THOMAS GEORGE TATHAM, formerly of 16 Wells-street, Surrey Hills, but late of "Beverleigh", Bendoc, in the State of Victoria, retired civil servant, DECEASED.

Creditors, next of kin and others having claims in respect of the estate of the deceased (who died on the 22nd April, 1969), are required by the executor, Barry George Tatham, of 21 Coomleigh-avenue, Glen Waverley, in the State of Victoria, school teacher, to send particulars to him, care of the undersigned solicitors, by the 7th September, 1972, after which date he may convey or distribute the assets, having regard only to the claims of which he then has notice.

GIBSON, McINTOSH & ASSOCIATES, 825 Burke-road, Camberwell. 6853

## RONALD CLARE PINKNEY, formerly of 406 Dorcas-street, South Melbourne, but late of 29 Yarraford-avenue, Alphington, in the State of Victoria, widower, DECEASED.

Creditors, next of kin and others having claims in respect of the estate of the above-named deceased (who died on the 3rd day of October, 1971), are required by The Equity Trustees Executors and Agency Company Limited, of 472 Bourke-street, Melbourne, the applicant for a grant of probate, to send particulars of their claims to the said applicant at the above address by the 22nd day of August, 1972, after which date the trustee may convey or distribute the assets, having regard only to the claims of which it then has notice.

K. P. REES, B.A., LL.B., solicitor, 118 Queen-street, Melbourne. 6861

ANNIE MATILDA RAINBOW, late of 3 Albion-street, St. Kilda, spinster, DECEASED.

Creditors, next of kin and others having claims in respect of the estate of the deceased (who died on the 5th day of March, 1972), are required by The Perpetual Executors and Trustees Association of Australia Limited, of 100-104 Queen-street, Melbourne, to send particulars of their claim to the said company by the 22nd day of August, 1972, after which date it will convey or distribute the assets, having regard only to the claims of which the company then has notice.

RYLAH & RYLAH, solicitors, 349 Collins-street, Melbourne. 6862

MARY MARGARET ALLEN, late of 11 Kent-street, Hawthorn, spinster, DECEASED, intestate.

Creditors, next of kin and others having claims against the estate of the deceased (who died on 26th December, 1971), are required by the administratrix, Mary Eileen Hartigan, of 625 Toorak-road, Toorak, gentlewoman, to send particulars of their claims to the administratrix, care of the undersigned solicitors, on or before 23rd August, 1972, after which date she will convey or distribute the assets, having regard only to the claims of which she then has notice.

HOME, WILKINSON & LOWRY, solicitors, of 401 Collins-street, Melbourne. 6863

Creditors, next of kin and others having claims in respect of the estate of Betty Howard Richardson, late of 5 Stubbs-avenue, North Geelong, spinster, deceased (who died on the 19th April, 1972), are to send particulars of their claims to The Trustees, Executors and Agency Company Limited, of 401 Collins-street, Melbourne, by the 25th August, 1972, after which date it will distribute the assets, having regard only to the claims of which it then has notice.

MOULE, HAMILTON & DERHAM, 224 Queen-street, Melbourne. 6864

HAZEL WILHELMINA LARSEN, late of 117 Atkinson-street, Oakleigh, widow, DECEASED.

Creditors, next of kin and others having claims against the estate of the said deceased (who died on 24th January, 1972), are to send particulars of their claims to Arthur Joseph Larsen, care of 120 William-street, Melbourne, by the 25th day of August, 1972, after which date they will distribute the assets, having regard only to the claims of which they then have notice.

BLAKE & RIGGALL, solicitors, 120 William-street, Melbourne. 6865

Creditors, next of kin and others having claims in respect of the estate of Stanley Charles Butler, late of 523 Riversdale-road, Surrey Hills, in the State of Victoria, gentleman, deceased (who died on the 15th day of October, 1971), are required to send particulars of their claims to the executor of the estate, Edith Vaughan Butler, care of Messrs. Corr & Kempson, solicitors, of 491 Bourke-street, Melbourne, by the 23rd day of August, 1972, after which date the said executor may distribute the assets of the said estate, having regard only to claims of which he then has notice.

CORR & KEMPSON, solicitors, 491 Bourke-street, Melbourne. 6866

Pursuant to the *Trustee Act 1958* all persons having claims against the property or estate of Annie Christina Lewis, late of 64 South-road, Brighton Beach, spinster, deceased, intestate (who died on the 7th day of June, 1971), and letters of administration of whose estate were granted by the Supreme Court of Victoria to Ernest Dudley Lewis, of 13 Robinson-lane, Woollahra, New South Wales, salesman, are hereby required to send particulars of such claims to the said administrator, addressed to the care of Graham Scouller, solicitor, 366 La Trobe-street, Melbourne, on or before the 23rd day of August, 1972, after the expiration of which time the said administrator will proceed to distribute the assets of the said deceased amongst the persons entitled thereto, having regard only to the claims of which he shall have had notice.

GRAHAM SCOULLER, solicitor, 366 La Trobe-street, Melbourne. 6824

FERENC LOWY, formerly of 26 Acland-street, St. Kilda, in the State of Victoria, but late of Flat 5, 641 Toorak-road, Toorak, in the said State, retired dealer, DECEASED.

Creditors, next of kin and others having claims in respect of the estate of the deceased (who died on 2nd November, 1971), are required by the trustee, Irene Helen

Lowy, of Flat 5, 641 Toorak-road, Toorak, in the said State, widow, to send particulars to her by the 31st day of August, 1972, after which date the trustee will distribute the assets, having regard only to the claims of which she then has notice.

SLATER & GORDON, solicitors, of 395 Collins-street, Melbourne, 3000. 6825

JESSIE CAMERON TISDALE SMART, late of corner of Bridge-street and Sherbourne-road, Eltham, widow, DECEASED.

Creditors, next of kin and others having claims in respect of the estate of the deceased (who died on the 16th day of February, 1972), are required by the Perpetual Executors and Trustees Association of Australia Limited, of 100-104 Queen-street, Melbourne, to send particulars of their claims to the said company by the 21st day of September, 1972, after which date it will convey or distribute the assets, having regard only to the claims of which the company then has notice.

BEST, HOOPER, RINTOUL & SHALLARD, solicitors, 377 Little Collins-street, Melbourne. 6826

MINNIE SMITH, late of 42 Medway-street, Box Hill, widow, DECEASED.

Creditors, next of kin and others having claims in respect of the estate of the above-named deceased (who died on the 25th day of December, 1972), are required by the executor, Raymond Watson Smith, to send particulars to him, care of the under-mentioned solicitors, by the 21st day of August, 1972, after which date he will distribute the assets, having regard only to the claims of which he then has notice.

UPTON & ETTIELSON, solicitors, 100 Queen-street, Melbourne. 6827

MARGARET KNIGHT KNEWSTUB, late of "Chenils", Riddell's Creek, Victoria, married woman, DECEASED.

Creditors, next of kin and others having claims in respect of the estate of the deceased (who died on 7th March, 1972), are required by the personal representative, Caspar John Knewstub, of "Chenils" aforesaid farmer, to send particulars of their claims to him by 31st August, 1972, after which date he may convey or distribute the assets, having regard only to the claims of which he then has notice.

HEDDERWICK, FOOKES & ALSTON, 121 William-street, Melbourne. 6828

In the estate of LYNETTE JEAN WILLMAN, late of 144 Roberts-street, Essendon, school teacher, DECEASED, intestate.

Creditors, next of kin and others having claims in respect of the estate of the deceased (who died on 15th January, 1972), are required by Robert George Willman, of 144 Roberts-street, Essendon, being the father of the deceased and the administrator, of her estate to send particulars of their claims to him, on or before the 28th day of August, 1972, after which date the administrator will convey or distribute the assets, having regard only to the claims of which he has then notice.

KIDDLE BRIGGS & WILLOX, 406 Collins-street, Melbourne, solicitors for the administrator. 6829

Creditors, next of kin and others having claims in respect of the estate of Laszlo Lindner, late of Wilglen Private Hospital, 3 Moule-avenue, Brighton, caretaker, deceased (who died on the 7th May, 1970), are to send particulars of their claims to the executrix, Maria Labady, care of the undersigned solicitors, in the said State, by 18th August, 1972, after which date she will distribute the assets, having regard only to the claims of which she then has notice.

NOEL J. ROWAN & MARTIN, solicitors, 305 La Trobe-street, Melbourne. 6830

Creditors, next of kin and others having claims in respect of the estate of Thomas Christopher Stephens, late of 164 The Parade, Ascot Vale, retired leather worker (who died on the 13th April, 1972), are to send particulars of their claims to The Union-Fidelity Trustee Company of Australia Limited, of 100 Exhibition-street, Melbourne, by the 22nd August, 1972, after which date it will distribute the assets, having regard only to the claims of which it then has notice.

RYLAH & RYLAH, solicitors, 349 Collins-street, Melbourne. 6823

ETHEL MAY HARDING (also known as Ethel May HARDINGE), late of 43 Clive-road, Upper Hawthorn, in the State of Victoria, widow, DECEASED.

Creditors, next of kin and others having claims in respect of the estate of the deceased (who died on the 24th May, 1972), are required by the executor, Brian Redmond Smyth, formerly of 230 Collins-street, Melbourne, but now of 140 Flinders-street, Melbourne, solicitor, to send particulars to the under-mentioned firm by 15th September, 1972, after which date the said executor may convey or distribute the assets, having regard only to the claims of which notice has by then been given.

SETON WILLIAMS & SMYTH, solicitors, 954 Main-road, Eltham. 6800

Creditors, next of kin and others having claims against the estate of Thomas Browne, late of Warrnambool, in the State of Victoria, Catholic priest, deceased (who died on the 30th day of August, 1971), are required to send particulars of their claims to Byrne, Jones & Torney, of 38 Lydiard-street south, Ballarat, in the said State, the solicitors of the estate of the said deceased, by the 16th day of August, 1972, after which date the said solicitors will distribute the assets, having regard only to the claims of which it then has notice.

BYRNE, JONES & TORNEY, solicitors, Ballarat. 6802

Alan Frederick Gurr, of 39 (formerly and in the will hereinafter mentioned known as 9) Shackleton-street, Belmont, Geelong, gentleman, as executor of the will, dated 5th May, 1965, of Alfred Allen Julian, late of 12 Garden-street, East Geelong, gentleman, deceased (who died on the 6th day of May, 1972), requires all creditors next of kin and others having claims against the property or estate of the said deceased to send to him, care of his solicitors at the address shown hereunder, particulars in writing of such claims on or before the 23rd day of August, 1972, after which date the said executor intends to convey transfer and distribute such property or estate to or among the persons entitled thereto, having regard only to the claims of which he shall then have notice.

CRAWCOUR & FIKKERS, solicitors, 87 Yarra-street, Geelong. 6814

ALFRED HARRIS, late of Nyah West in the State of Victoria, retired orchardist, DECEASED (who died on the 20th day of February, 1972).

Creditors, next of kin and all other persons having claims against the estate of the deceased, are required by the executors of the will, William George Holloway, to send particulars to him, care of the undersigned, on or before the 13th day of September, 1972, after which date they will distribute the assets, having regard only to the claims of which they then have notice.

GARDEN & GREEN, solicitors, 4 McCallum-street, Swan Hill. 6812

After fourteen days application will be made to the Supreme Court of Victoria that probate of the will dated the 26th day of September, 1969, of Edith Adelaide Jupp, formerly of 33 Park-street, Middle Brighton, in the State of Victoria, but late of Mowbray House Convalescent Hospital, 40 Normanby-street, Brighton, in the said State, gentlewoman, deceased be granted to Margaret Anne Watts (described in the will as Margaret Watts), married woman, of 96 Ludstone-street, Hampton, in the said State and Barbara Elizabeth Salter (described in the will as Barbara Salter), married woman, of 45 Tulip-street, Black Rock, in the said State, nieces of the deceased and the executrices named therein.

DAVID BRISTOL, LEVINE & CO., solicitors, 549 Hampton-street, Hampton. 6794

After fourteen days application will be made to the Supreme Court of Victoria that probate of the will dated the 21st day of September, 1950, of Frank Ritchie, late of 112 Thomas-street, Hampton, in the State of Victoria, retired driver, deceased be granted to Irene May Ritchie, of 112 Thomas-street, Hampton, in the said State, the widow of the deceased and the sole executrix named therein.

DAVID BRISTOL, LEVINE & CO., solicitors, 549 Hampton-street, Hampton. 6795

SARAH OLIVE MAGGS, late of 32 Windsor-avenue, Springvale, home duties, DECEASED.

Creditors, next of kin and others having claims in respect of the estate of the above-named deceased, (who died on the 29th day of April, 1972), are required by the

executor, John Andrew Threlfall, of 152 Stud-road, Dandenong, builder, to send particulars to him, in the care of the undersigned, by the 1st day of September, 1972, after which date the executor may convey or distribute the assets, having regard only to the claims of which he then has notice.

MACPHERSON & KELLEY, solicitors, 229 Thomas-street, Dandenong. 6807

ALAN MAURICE SABER, late of Balnarring Beach, in the State of Victoria, gentleman, DECEASED (who died on 19th January, 1972).

Creditors, next of kin and all other persons having claims against the estate of the deceased, are required by the executor of his will, Graham Robert Fuller, of 379 Collins-street, Melbourne, in the said State, solicitor, to send particulars thereof to him, care of the undermentioned solicitors, before 26th August, 1972, after which date he may distribute the assets of the deceased, having regard only to the claims of which he then has notice.

COLTMAN, WYATT & ANDERSON, solicitors, 379 Collins-street, Melbourne. 6815

EMILIE MABEL ILLERETT DUNSTAN, late of 125 The Right, Eaglemont, in the State of Victoria, widow, DECEASED.

Creditors, next of kin and others having claims in respect of the estate of the above-named deceased (who died on the 13th day of March, 1972), are required by the trustees, Kenneth William Dunstan, of 3a Woolwich-road, Hunters Hill, in the State of New South Wales, gentleman, and Geoffrey Bruce Dunstan, of 85 South-road, Brighton, in the State of Victoria, manager, to send particulars to the said Geoffrey Bruce Dunstan, by the 1st day of September, 1972, after which date the trustees may convey and distribute the assets, having regard only to the claims of which they then have notice.

EGGLESTON CLIFTON-JONES & CO., solicitors, of 20 Queen-street, Melbourne. Vic. 3000. 6816

GEORGE HENRY NOONAN, late of "Vaucluse", Hume Highway, Benalla, grazier, DECEASED.

Creditors, next of kin and others having claims in respect of the estate of the deceased (who died on the 26th February, 1972), are required by The Union-Fidelity Trustee Company of Australia Limited, of 100 Exhibition-street, Melbourne, the applicant for a grant of probate, to send particulars to it, by the 31st August, 1972, after which date the said company may convey or distribute the assets, having regard only to the claims of which it then has notice.

W. B. & O. McCUTCHEON, solicitors, 150 Queen-street, Melbourne. 6817

Creditors, next of kin and others having claims in respect of the estate of Dorothy Blanche Enid Newbery, late of Lyndock House, Warrnambool, widow, deceased (who died on 26th day of February, 1971), are required to send particulars of their claims to the Trustees, Executors and Agency Company Limited, of 401 Collins-street, Melbourne, by the 24th day of August, 1972, after which date it will distribute the assets, having regard only to the claims of which it then has notice.

NEWELL, MARSH & LEWIS, solicitors, 358 Lonsdale-street, Melbourne. 6819

Creditors, next of kin and other persons having claims against the estate of Hermine Emma Bernhardt, late of 102 Longview-road, North Balwyn, in the State of Victoria, widow (who died on the 14th December, 1971), are required to send particulars of their claims to the executor, The Union-Fidelity Trustee Company of Australia Limited, of 100 Exhibition-street, Melbourne, by the 31st August, 1972, after which date the executor will distribute the assets, having regard only for the claims of which it then had notice. 6820

MURIEL EDITH JENKINS, late of Eventide Homes for the Aged, Hastings-street, Stawell, in the State of Victoria, widow.

Creditors, next of kin and others having claims in respect of the estate of the above-named deceased (who died on the 1st day of October, 1971), are required by Elder's Trustee and Executor Company Limited, of 172 North-terrace, Adelaide, in the State of South Australia, Ronald Dane, of 15 Boodera-road, Palm Beach, in the State of Queensland, and Kenneth Wallace Paul Marshall, of Unit 9, Belle-close, 6 Belle-avenue, Brighton, in the State of Victoria, the executors to whom probate of the will of the

said deceased was granted, to send particulars of their claims to them, in the care of the said company, by the 25th day of August, 1972, after which date they will convey or distribute the assets of the said deceased, having regard only to the claims of which they then have notice.

Dated the 20th day of June, 1972.

MADDEN, BUTLER, EDLER & GRAHAM, solicitors, 31 Queen-street, Melbourne. 6822

ADA VEENIE TRANSI MACKINNON (also known as and in the will called Veenie Ada Transi-Mackinnon), late of 35 Lee-avenue, Syndal, in the State of Victoria, widow, DECEASED.

Creditors, next of kin and others having claims in respect of the estate of the deceased (who died on the 1st day of December, 1971), are required by the executors, Clive Maxwell Mackinnon, of 35 Lee-avenue, Syndal, and Robert Henry Minter, of 4 Orford-road, Ashburton, to send particulars of their claims to them, in the care of the under-mentioned solicitor, by the 25th day of August, 1972, after which date they will distribute the assets, amongst the persons entitled thereto, having regard only to the claims of which they then have notice.

RICHARD K. PITMAN, solicitor, corner Kings Way and Railway-parade, Glen Waverley, 3150. 6780

Creditors, next of kin and others having claims in respect of the estate of Michael Patrick O'Connell, late of "Mt. View", Casterton, retired grazier, deceased (who died on 4th March, 1972), are required to send particulars of their claims to the executors, Mary Gnanville O'Connell, and Michael Charles O'Connell, at 31 Douglas-street, Blackburn North, 3130, by the 31st August, 1972, after which date they will distribute the assets, having regard only to the claims of which they then have notice.

M. C. O'CONNELL, 31 Douglas-street, Blackburn North, 3130. 6774

Creditors, next of kin and others having claims in respect of the estate of Thomas Rainey Francis Joseph Raynor, late of 44 Stanhope-street, Malvern, retired orchardist, deceased (who died on the 15th day of November, 1971), are to send particulars of their claims to National Trustees, Executors and Agency Company of Australasia Limited, of 95 Queen-street, Melbourne, by the 22nd day of August, 1972, after which date it will distribute the assets, having regard only to the claims of which it then has notice.

J. P. HENNESSY, solicitor, 186 Elgin-street, Carlton, 6775

WILLIAM HENRY HAWTHORN, late of Nyah, in the State of Victoria, retired farmer, DECEASED (who died on the 19th day of January, 1972).

Creditors, next of kin and all other persons having claims against the estate of the deceased are required by the executor, of the will, William Thomas Hawthorn, to send particulars to him, care of the undersigned on or before the 13th day of September, 1972, after which date they will distribute the assets, having regard only to the claims of which they then have notice.

GARDEN & GREEN, solicitors, 14 McCallum-street, Swan Hill. 6777

#### Trustee Act 1958.

#### NOTICE TO CLAIMANTS.

Pursuant to the Trustee Act 1958, creditors next of kin and all other persons having claims in respect of the estate of any deceased person named below are required to send particulars to the legal personal representative or representatives at the addresses stated, after which date the representatives will distribute the assets, having regard only to the claims of which notice has been received:—

Linda Annie Davidge, late of 51 Hamilton-street, Footscray, widow, deceased, died on the 25th day of April, 1972.—Claims to the executors, Ethel Harriet Hollings, married woman, and Robert Hollings, fitter, both of 4 Chapman-street, Footscray, care of John F. Carroll, of 4 Paisley-street, Footscray, solicitor, by the 23rd day of August, 1972.—John F. Carroll, LL.B., solicitor, 4 Paisley-street, Footscray. 6850

In the Supreme Court of the State of Victoria.

#### SALE BY THE SHERIFF.

On Friday, the 4th of August, 1972, at 10 a.m., at the Police Station, Mitcham (unless process be stayed or satisfied):—

All the estate and interest (if any) of Neil Gerald O'Lughlen, administrative officer, of 7 Gibson-street, Mitcham, as joint proprietor with Berenice Ann O'Lughlen,

of an estate in fee-simple in the land described in certificate of title, volume 8105, folio 390, upon which is erected a dwelling-house, known as No. 7 Gibson-street, Mitcham.

Registered mortgage No. C.435938 and covenant in instrument of transfer A.68312 affects the said estate and interest.

Terms: Cash only.

H. BUETTNER, Sheriff's Officer.

21st June, 1972. 6854

In the Supreme Court of the State of Victoria.

#### SALE BY THE SHERIFF.

On Friday, the 21st of July, 1972, at 10 a.m., at the Police Station, Fawkner (unless process be stayed or satisfied):—

All the estate and interest (if any) of Peter Constanti (also known as Petros), presser, of 259 Albert-street, Brunswick, as joint proprietor with Mary Constanti, of an estate in fee-simple in the land described in certificate of title, volume 8037, folio 969, upon which is erected an uncompleted dwelling, known as No. 18 Bruce-street, Fawkner.

Registered mortgage No. B.564482 affects the said estate and interest.

Terms: Cash only.

DOUGLAS S. HALL, Sheriff's Officer.

13th June, 1972. 6855

In the Supreme Court of the State of Victoria.

#### SALE BY THE SHERIFF.

On Friday, the 4th of August, 1972, at 12 noon, at the Police Station, North Melbourne (unless process be stayed or satisfied):—

All the estate and interest (if any) of Jillian Simmonds, married woman, of 39 Richmond-terrace, Richmond, and Jacqueline Wallis, married woman, of 20A Walsh-street, Carnegie, as joint proprietors of an estate in fee-simple in the land described in certificate of title, volume 8470, folio 623, upon which is erected a single fronted brick terrace house, known as No. 58 Arden-street, North Melbourne.

Registered mortgage No. D.904435 and caveat No. D.825700 affects the said estate and interest.

Terms: Cash only.

H. BUETTNER, Sheriff's Officer.

21st June, 1972. 6856

In the Supreme Court of the State of Victoria.

#### SALE BY THE SHERIFF.

On Friday, the 4th of August, 1972, at 11 a.m., at the Police Station, Emerald (unless process be stayed or satisfied):—

All the estate and interest (if any) of Triphon Chernischoff (also known as Triphon Chernisheff and Treson Chernaschoff), labourer, of 55 Margaret-street, Clayton, as proprietor of an estate in fee-simple in the land described in certificate of title, volume 8552, folio 491, which is land located off Marks-lane, which crosses the apex of Madeline-court, at a distance of 950 feet from Hepner-road and approximately 4 miles from Emerald and is known as lot No. 22 Madeline-court, Emerald.

Registered mortgage No. E.290027 affects the said estate and interest.

Terms: Cash only.

DOUGLAS S. HALL, Sheriff's Officer.

21st June, 1972. 6857

In the Supreme Court of the State of Victoria.

#### SALE BY THE SHERIFF.

On Friday, the 28th of July, 1972, at 10 a.m., at the Police Station, Heidelberg (unless process be stayed or satisfied):—

All the estate and interest (if any) of Mile Bulatovic, labourer, of 259 Gore-street, and Zora Bulatovic, of 93 Green-street, Ivanhoe, as joint proprietors of an estate in fee-simple in the land described in certificate of title, volume 6223, folio 521, upon which is erected a part timber part brick dwelling, known as No. 93 Green-street, Ivanhoe.

Registered caveats Nos. D.352661 and E.175667 affects the said estate and interest.

Terms: Cash only.

DOUGLAS S. HALL, Sheriff's Officer.

21st June, 1972. 6858

**INSOLVENCY NOTICE**

**Bankruptcy Act 1966.**—Bankruptcy District of the State of Victoria.—No. 31 of 1970, Part X.—Re: GARY RICHARD NESSEL.—Notice to Creditors of Intention to Declare Dividend.

Notice is hereby given of my intention to declare a First and Final Dividend in the separate estate of the above-named debtor and it is proposed that such dividend shall be distributed on Friday, 28th July, 1972. I hereby set Friday, 7th July, 1972, as the latest date on which creditors may lodge proofs of debt. Any creditor who has not lodged a proof of debt by that date shall be excluded from the dividend and I shall proceed to distribute the dividend without regard to any debt that has not been proved.

Dated this 21st day of June, 1972.

M. G. GEE, Trustee.

Max Gee & Co., public accountants, 325 Warrigal-road, Burwood, Victoria 3125. Telephone 288 5109. 6837

**IMPOUNDING**

**KEILOR.**—Impounded in Keilor Pound by Ranger, of the City of Essendon.

1 white female pig, no visible brand

If not claimed and expenses paid, to be sold on 6th July, 1972.

6843—\$2.45

C. M. MISSEN,  
Poundkeeper.

*Subordinate Legislation Act 1962.***NOTICE OF MAKING OF STATUTORY RULES.**

In pursuance of the provisions of the *Subordinate Legislation Act 1962* and the Regulations made thereunder, notice is given of the making of the following statutory rules:—

No.	Health Act 1958 (No. 6270).	Price.
169/1972.	Cinematograph Operators' (Fees) Regulations 1972	10c
	<i>Racing Act 1958.</i>	
170/1972.	Racing (Greyhound Racing Control Board) Regulations 1972	10c
	<i>Racing Act 1958.</i>	
171/1972.	Trotting Control Board (Fees and Travelling Expenses) Regulations 1972	10c
	<i>Education Act 1958.</i>	
172/1972.	Adult Education (Salaries) Regulations 1972, No. 5	10c
	<i>Country Fire Authority Act 1958.</i>	
173/1972.	Country Fire Authority (General Amendment No. 1) Regulations 1972	10c

Copies of these statutory rules may be purchased at the Sale of Publications Section of the Government Printing Office, located at 7A Parliament-place, Melbourne, 3002. If ordered by mail, remittance should be addressed to "The Government Printer, Box 203, P.O., North Melbourne, 3051", and should include 7c extra for postage. If a credit account is held at this office, no remittance is required with the mail order.

The annual subscription rate for Statutory Rules (including Bound Volumes) is \$23, payable in advance. The subscription year commences on 1st January.

C. H. RIXON,  
Government Printer.

**STATE ACTS, 1971**

Copies of the following Acts of Parliament of Victoria may be obtained at the Government Printing Office, Sale of Publications Branch, off Parliament-place, Melbourne, phone 63 0321, extension 6181, or from any accredited agent, at the price set opposite to each (these prices do not include postage).

The annual subscription for State Acts 1971 et seq. is \$12 50 payable in advance.

Bound Volumes of State Acts are also available on a subscription basis of \$17 50 per annum.

**STATE ACTS, 1971—continued.**

No.		Price.
8090.	Municipal Association (Amendment)	\$0.10
8091.	Transfer of Land (Duplicate Certificates)	\$0.10
8092.	Firearms	\$0.10
8093.	Geelong Land (Special Grant)	\$0.10
8094.	Churchill Water and Sewerage Works	\$0.10
8095.	Superannuation (Railway Service)	\$0.10
8096.	Vermin and Noxious Weeds (Amendment)	\$0.10
8097.	Police Regulation (Amendment)	\$0.10
8098.	Snowy Mountains Engineering Corporation (Victoria)	\$0.10
8099.	Albert Park Land	\$0.10
8100.	Local Government (Municipalities Assistance Fund)	\$0.10
8101.	Health (Tuberculosis Arrangement)	\$0.10
8102.	Presbyterian Church of Australia	\$0.20
8103.	Marketing of Primary Products (Amendment)	\$0.10
8104.	Gas and Fuel Corporation (Geelong Gas)	\$0.15
8105.	Local Authorities Superannuation (Disability Benefits) (Commencement)	\$0.10
8106.	Building Societies (Amendment)	\$0.20
8107.	Survey Co-ordination (Place Names)	\$0.10
8108.	Howard Florey Institute of Experimental Physiology and Medicine	\$0.30
8109.	Superannuation (Transitional Provisions)	\$0.10
8110.	New Broken Hill Consolidated, Limited	\$0.15
8111.	Litter (Proceedings for Offences)	\$0.10
8112.	Justices (Service of Summonses)	\$0.10
8113.	Stock (Artificial Breeding) (Amendment)	\$0.10
8114.	Alcoa of Australia (W.A.) N.L.	\$0.40
8115.	Victoria Institute of Colleges (Amendment)	\$0.10
8116.	Cemeteries (Fawkner Crematorium and Memorial Park)	\$0.10
8117.	Trustee Companies (Equity Trustees)	\$0.10
8118.	Parliamentary Superannuation	\$0.10
8119.	Ehrenhaus Retail Bottled Liquor Licence	\$0.10
8120.	Melbourne University Land	\$0.10
8121.	Forests (Bowater-Scott Agreement)	\$0.20
8122.	Gas and Fuel Corporation (Pipelines)	\$0.15
8123.	Coal Mines (Pensions)	\$0.10
8124.	Crown Proceedings (Forfeited Recognisances)	\$0.10
8125.	Public Trustee (Amendment)	\$0.15
8126.	Geelong Waterworks and Sewerage (Rates)	\$0.10
8127.	Subordinate Legislation (Powers)	\$0.10
8128.	Barley Marketing	\$0.10
8129.	Stamps (Credit Business)	\$0.15
8130.	Land (Surrender to the Crown)	\$0.10
8131.	Pipelines (Amendment)	\$0.10
8132.	County Court (Jurisdiction)	\$0.10
8133.	Grassmere Land	\$0.10
8134.	Supply (Supplementary Estimates)	\$0.10
8135.	Town and Country Planning (Amendment)	\$0.15
8136.	Seeds	\$0.40
8137.	Imperial Acts Application (Repeals)	\$0.10
8138.	Audit (Recovery of Overpayments)	\$0.10
8139.	Evidence (Registration of Commissioners)	\$0.10
8140.	Country Roads (Amendment)	\$0.15
8141.	Protection of Animals (Rodeos)	\$0.10
8142.	Soil Conservation and Land Utilization (Amendment)	\$0.15
8143.	Motor Car (Driving Offences)	\$0.30
8144.	Fisheries (Amendment)	\$0.15
8145.	Appeal Costs Fund	\$0.10
8146.	Scaffolding	\$0.30
8147.	Liquor Control (Amendment)	\$0.15
8148.	Supply (July to September)	\$0.10
8149.	Local Government (Further Amendment)	\$0.40
8150.	Supply (Supplementary Estimates)	\$0.10
8151.	Supply (October to December)	\$0.10
8152.	Police Regulation (Chief Commissioner)	\$0.10
8153.	Ground-water	\$0.10
8154.	Pay-Roll Tax	\$0.50
8155.	Moonee Ponds (Queens Park) Land	\$0.10
8156.	Commonwealth Places (Administration of Laws)	\$0.10
8157.	Stamps	\$0.20
8158.	Mercy Private Hospital (Guarantee)	\$0.10
8159.	Daylight Saving	\$0.10
8160.	Co-operative Housing Societies (Indemnities)	\$0.10
8161.	Films	\$0.30
8162.	Lotteries, Gaming and Betting (Pre-Post Betting)	\$0.10
8163.	Vegetation and Vine Diseases (Amendment)	\$0.10
8164.	Melbourne and Metropolitan Board of Works (Amendment)	\$0.10
8165.	Statutory Salaries	\$0.10
8166.	Newhaven Land	\$0.10
8167.	Land Tax	\$0.10
8168.	Water Authorities Accident Insurance	\$0.10
8169.	Building Societies (Special Advances)	\$0.10
8170.	Juries (Compensation)	\$0.10
8171.	Coal Mines (Pensions Increase)	\$0.10

## STATE ACTS 1971—continued.

No.	Price.
8172. Exhibition (Borrowing Powers)	\$0.10
8173. Sunday Entertainment (Cinematograph Films)	\$0.10
8174. Apprenticeship (Amendment)	\$0.15
8175. Labor and Industry (Shop Trading Hours)	\$0.10
8176. Gift Duty	\$0.50
8177. Aboriginal Lands (Amendment)	\$0.10
8178. Lutheran Church of Australia, Victoria District Incorporation	\$0.40
8179. Police Regulations (Amendment) (No. 2)	\$0.20
8180. Railways (Amendment)	\$0.10
8181. Statute Law Revision	\$0.40
8182. State Electricity Commission (Newport Power Station)	\$0.10
8183. Judges Salaries and Allowances	\$0.10
8184. Magistrates' Courts	\$0.30
8185. Companies	\$2.10
8186. Water (Amendment)	\$0.20
8187. Essendon (Recreation Ground) Land	\$0.10
8188. Brotherhood of St. Laurence (Incorporation)	\$0.30
8189. State Forests Works and Services	\$0.10
8190. Evidence (Boards and Commissions)	\$0.10
8191. Public Authorities (Contributions) (Amendment)	\$0.10
8192. Road Traffic (Penalties)	\$0.10
8193. Grain Elevators (Amendment)	\$0.10
8194. Flinders-street Station Area Redevelopment	\$0.20
8195. Buninyong (Recreation Reserve) Land	\$0.10
8196. Health Services (Fees and Penalties)	\$0.15
8197. Motor Car (Breath Tests)	\$0.10
8198. Instruments (Amendment)	\$0.15
8199. Melbourne Harbor Trust (Amendment)	\$0.15
8200. Revocation and Excision of Crown Reservations	\$0.15
8201. Yarragon Lands Exchange	\$0.10
8202. Gift Duty (Rates and Rebates)	\$0.15
8203. Stamps (Gifts and Settlements)	\$0.10
8204. Eastern Freeway Lands	\$0.15
8205. Land (Surrenders)	\$0.10
8206. Housing (Amendment)	\$0.15
8207. Land (Amendment)	\$0.10
8208. Landlord and Tenant (Amendment)	\$0.20
8209. Racing (Amendment)	\$0.30
8210. National Parks (Amendment)	\$0.30
8211. Labour and Industry (Amendment)	\$0.15
8212. Public Works and Services	\$0.15
8213. Wheat Marketing	\$0.15
8214. Public Works and State Development Committees	\$0.10
8215. Water Supply Works and Services	\$0.30
8216. Bees	\$0.20
8217. Agricultural Colleges (Amendment)	\$0.10
8218. Chiropodists (Registration)	\$0.10
8219. Portland Harbor Trust (Amendment)	\$0.10
8220. Harbor Boards (Amendment)	\$0.10
8221. Veterinary Surgeons (Amendment)	\$0.10
8222. Scaffolding (Amendment)	\$0.10
8223. Stock Diseases (Composite Licences)	\$0.10
8224. Justices (Civil Proceedings)	\$0.10
8225. Closer Settlement	\$0.10
8226. Summary Offences (Amendment)	\$0.10
8227. Sewerage Districts (Amendment)	\$0.10
8228. Evidence (Documents)	\$0.20
8229. Mildura Irrigation & Water Trusts (Amendment)	\$0.10
8230. Farm Produce Merchants & Commission Agents (Employment)	\$0.10
8231. Latrobe Valley (Amendment)	\$0.10
8232. Hire Purchase (Form)	\$0.10
8233. Poisons (Amendment)	\$0.10
8234. Geelong Harbor Trust (Amendment)	\$0.10
8235. Eastern Railway Construction	\$0.15
8236. Milk and Dairy Supervision (Amendment)	\$0.10
8237. Educational Grants (Amendment)	\$0.10
8238. Railway Works and Services	\$0.10
8239. Education (Teacher Registration)	\$0.15
8240. Supply (Final Supplementary Estimates)	\$0.10
8241. Appropriation	\$2.20

C. H. RIXON,  
Government Printer.

## STATE ACTS, 1972

Copies of the following Acts of Parliament of Victoria may be obtained at the Government Printing Office, Sale of Publications Branch, off Parliament-place, Melbourne, phone 63 0321, extension 6181, or from any accredited agent, at the price set opposite to each (these prices do not include postage).

The annual subscription for State Acts 1972 et seq. is \$12.50 payable in advance.

Bound Volumes of State Acts are also available on a subscription basis of \$17.50 per annum.

No.	Price:
8242. Seamen's (Amendment)	\$0.10
8243. Land (Greyhound Racing)	\$0.10
8244. Melbourne Land (Royal Melbourne Institute of Technology)	\$0.10
8245. Adoption of Children (Amendment)	\$0.10
8246. Disposal of Uncollected Goods (Amendment)	\$0.15
8247. Crimes (Powers of Arrest)	\$0.15
8248. Trustee Companies (Sandhurst and Northern District Trustees Executors and Agency Company Limited)	\$0.10
8249. Victorian Arts Centre	\$0.10
8250. Road Traffic (Amendment)	\$0.10
8251. Trustee Companies (National Trustees)	\$0.10
8252. Game Act	\$0.10
8253. Vermin and Noxious Weeds (Allowances)	\$0.10

C. H. RIXON,  
Government Printer.

## THE "VICTORIA GOVERNMENT GAZETTE".

SUBSCRIPTIONS.—The subscription, including postage, is \$22.50 per annum, or \$11.25 per half year, payable in advance.

Subscriptions are required for whole months, and must cover at least a half year.

Single copies are 30 cents, posted 48 cents. Subscribers do not receive the Acts of Parliament with the GAZETTE.

GAZETTES are held in stock for five years only.

PRIVATE ADVERTISEMENTS.—The charge for insertion is 35 cents per line single column, and 70 cents per line double column. The title forms one or more lines as a heading. On an average ten words make a line of single column. Every signature must likewise be counted as a line. The final words of a paragraph, though only portion of a line, must be counted as one line. Signatures (in particular) and proper names must be written very plainly in the text; ONE SIDE ONLY of each sheet of paper should be WRITTEN UPON. The charge for a full page is \$50.

All documents illegibly written will be returned unpublished, and where brands occur unprovided for by the ordinary letters of the alphabet, a worded explanatory description must be furnished.

THE VICTORIA GOVERNMENT GAZETTE is published on WEDNESDAY EVENING in each week, and Notices for insertion will be received by the Government Printer at or before ONE p.m. at ordinary rates, and late advertisements between ONE p.m. and FOUR p.m. at double rates on the day preceding the day of publication.

PAYMENTS.—Unless the advertiser has a credit account, all payments are required in advance. Remittances should be made by cheque, postal order, or money order payable to "GOVERNMENT PRINTER".

ADDRESS.—All communications should be addressed to "The Government Printer, Box 203, P.O., North Melbourne, 3051."

## AGENTS FOR THE "VICTORIA GOVERNMENT GAZETTE".

The following have been appointed agents to receive Advertisements and Subscriptions for the Victoria Government Gazette:—

- ARMSTRONG'S AGENCY, 217 Queen-street, Melbourne, Victoria 3000.
- ARNALL & JACKSON, 390 Barkly-street, Brunswick, Victoria 3056.
- BAIRNSDALE AUTHORIZED NEWSAGENCY, 132 Main-street, Bairnsdale, Victoria 3875.
- BICKNELL, M. J., Authorized Newsagent, 196 Timor-street, Warrnambool, Victoria 3280.
- BLANE'S AUTHORIZED NEWSAGENTS, 162 Murray-street, Colac, Victoria 3250.
- CARTER, R. G., ADVERTISING SERVICE PTY. LTD., Suite 24, 65 Queens-road, Melbourne, Victoria 3004.
- DAVIES, G. & M. V., 112. Gray-street, Hamilton, Victoria 3300.
- DAVIS, WM. (MILDURA) PTY. LTD., 126 Eighth-street, Mildura, Victoria 3500.
- DIXON'S NEWSAGENCY, 89 Firebrace-street, Horsham, Victoria 3400.
- EDGAR'S AUTHORIZED NEWSAGENCY, 45 Bridge-street, Benalla, Victoria 3672.
- FRANKS, H. & CO., 184 Ryrie-street, Geelong, Victoria 3220.

	<b>CONTENTS</b>	PAGE
GATLEY, A. & J., 250 Lonsdale-street, Dandenong, Victoria 3175.		
GORDON & GOTCH AUSTRALASIA LTD., 434 St. Kilda-road, Melbourne, Victoria 3004.	Acts of Parliament on Sale at the Government Printing Office .. .. .	2262
GULLAN'S NEWSAGENCY, 88 Bridge-street, Ballarat, Victoria 3350.	Appointments .. .. .	2220
HAMPTON, A. C., 243 Mitchell-street, Bendigo, Victoria 3550.	Cemeteries—Scale of Fees .. .. .	2195
HARSTON, PARTRIDGE & CO. PTY. LTD., 455 Little-Collins-street, Melbourne, Victoria 3000.	Companies Act 1961—Notice .. .. .	2217
KYNETON GUARDIAN PTY. LTD., P.O. Box 18, Kyneton, Victoria 3444.	Contracts .. .. .	2220
LATIMER'S Newsagents, 45 Station-street, Malvern, Victoria 3144.	Country Roads Board .. .. .	2199
LIVINGSTON'S SHEPPARTON NEWSAGENCY, 246 Wyndham-street, Shepparton, Victoria 3630.	Estates of Deceased Persons .. .. .	2219
THE MERCANTILE EXCHANGE, 34 Queen-street, Melbourne, Victoria 3000.	Government Notices .. .. .	2195
McGILL'S AUTHORIZED NEWSAGENCY, 183-5 Elizabeth-street, Melbourne, Victoria 3000.	Impounding .. .. .	2262
POWNEY'S AUTHORIZED NEWSAGENCY, 293 Hargreaves-street, Bendigo, Victoria 3550.	Insolvency Notice .. .. .	2262
PURDIE, J., & CO., 138 Moorabool-street, Geelong, Victoria 3220.	Lands .. .. .	2234
SALE AUTHORIZED NEWSAGENCY, 142 Raymond-street, Sale, Victoria 3850.	Melbourne and Metropolitan Board of Works—Notice .. .. .	2217
SKINNER'S AUTHORIZED NEWSAGENCY, 49-51 Franklin-street, Traralgon, Victoria 3844.	Mining .. .. .	2213, 2217
STEVENSON, A. C. & M., NEWSAGENTS, 132 Henty-street, Casterton, Victoria 3311.	Notice of Making of Statutory Rules .. .. .	2262
VANCE'S AUTHORIZED NEWSAGENCY, 83 Murray-street, Wangaratta, 3677.	Orders in Council—	
VERNONS OF RICHMOND, 162 Bridge-road, Richmond, Victoria 3121.	Acts—Aboriginal Affairs; Country Roads; Dried Fruits; Health; Labour and Industry; Land; Local Government; Stamps; Sewerage Districts; Transport Regulation; Water; Geelong Waterworks and Sewerage; River Improvement.	2221, et seq
VIEW POINT AUTHORIZED NEWSAGENCY, 4 View-Point, Bendigo, Victoria 3550.	Petroleum (Submerged Lands) Act .. .. .	2214
	Police Sales .. .. .	2218
	Private Advertisements .. .. .	2240
	Proclamations .. .. .	2193
	Public Service Notices .. .. .	2238
	Resignations .. .. .	2221
	Tenders .. .. .	2237
	Transport Regulation Board—Public Hearings .. .. .	2196

A copy of the Gazette is filed at each place for public reference.





VICTORIA  
GOVERNMENT GAZETTE

Published by Authority

---

No. 52]

FRIDAY, JUNE 23

[1972

---

The Teachers Tribunal, in pursuance of the powers conferred by the *Teaching Service Act 1958*, hereby repeals Part I.—Professional Officers—of the Teaching Service (Classification, Salaries, and Allowances) Regulations and makes the following Regulation, to take effect on the 30th April, 1972.

TEACHING SERVICE—PROFESSIONAL (CLASSIFICATION, SALARIES, AND ALLOWANCES) REGULATION.

1. This Regulation may be cited as the "Teaching Service—Professional (Classification, Salaries, and Allowances) Regulation".

2. The provisions of the Teaching Service (Classification, Salaries, and Allowances) Regulations shall not apply to professional officers of the Teaching Service.

3. *Salaries and Allowances.*

- (a) Unless specified otherwise all salaries and allowances prescribed in this Regulation are annual rates.
- (b) The term "subdivision" in this Regulation means salary subdivision and represents a point of the salary scale on which a professional officer must serve for a minimum of one year before being eligible to progress to any higher subdivision within the range prescribed for the position held.
- (c) Within the salary range prescribed for any professional position, the occupant, subject to satisfactory service, shall proceed by annual increments from the minimum to the maximum of the range.  
Provided that the Tribunal may determine that an appointee shall commence at a rate other than the minimum.
- (d) A professional officer currently occupying a position specified in this Regulation shall receive the conversion salary prescribed in Schedule "A" and, where applicable, shall retain his former incremental date, irrespective of whether he had attained the maximum of his previous range.

Provided that a professional officer who had attained the maximum of his previous range by the 30th April, 1971, shall proceed, where applicable, to the next higher subdivision than that to which he would be entitled under Schedule "A", and the 30th April shall be deemed to be his future incremental date.

#### 4. Schedule of Rates.

Excluding the rates prescribed in Clause 6 of this Regulation, the salaries of professional officers shall be prescribed within the following schedule of rates:—

Subdivision.	Annual Salary.
	\$
1 .. .. .	6,850
2 .. .. .	7,200
3 .. .. .	7,550
4 .. .. .	7,950
5 .. .. .	8,350
6 .. .. .	8,750
7 .. .. .	9,250
8 .. .. .	9,750
9 .. .. .	10,250
10 .. .. .	10,750
11 .. .. .	11,250
12 .. .. .	11,750
13 .. .. .	12,250
14 .. .. .	12,750
15 .. .. .	13,250
16 .. .. .	13,750
17 .. .. .	14,250
18 .. .. .	15,000
19 .. .. .	16,000
20 .. .. .	17,500

#### 5. Specified Positions.

The following rates are prescribed for the various professional positions:—

	Subdivision or subdivisional range.
(a) <i>Directors, Assistant Directors, and Inspectors.</i>	
Director of Education (Primary, Secondary, Technical) .. .. .	20
Director of Special Services; Director of Teacher Education .. .. .	19
Assistant Director of Education (Primary, Secondary, Technical); Regional Director of Education .. .. .	17
Assistant Director of Teacher Education; Staff Inspector .. .. .	15
Inspector of Schools (Primary, Secondary, Technical) .. .. .	10 – 14
(b) <i>Principals and Staffs of Teachers' Colleges and Training Institutions.</i>	
(i) <i>Principal:</i>	
Melbourne College of Education .. .. .	18
Burwood, Coburg, Frankston, Geelong, Melbourne, Monash, Secondary, Technical, Toorak Teachers' Colleges .. .. .	17
Ballarat, Bendigo, Larnook Teachers' Colleges; Teachers' College, La Trobe University; Training Centre for Teachers of the Deaf and "Glendonald" School for Deaf Children .. .. .	15

	Subdivision or subdivisional range.
(ii) <i>Vice-Principal:</i> Ballarat, Bendigo, Burwood, Coburg, Frankston, Geelong, Larnook, Melbourne, Monash, Secondary, Technical, Toorak Teachers' Colleges .. .. .	12
(iii) <i>Lecturer, Grade I.</i> .. .. .	7 - 10
(iv) <i>Lecturer, Grade II.</i> .. .. .	1 - 7
(c) <i>Tertiary Staff—Technical Colleges.</i> Lecturer, Grade II. . . . .	1 - 6
(d) <i>Other Positions.</i>	
(i) Curriculum and Research Officer; Editor, Departmental Publications; Principal Psychologist and Guidance Officer; Supervisor of Audio-Visual Educa- tion; Supervisor of Physical Education; Supervisor of School Libraries .. .	10 - 14
(ii) Assistant Editor, Departmental Publications; Assistant Principal Psychologist and Guidance Officer; Assistant Supervisor of Audio- Visual Education; Assistant Supervisor of Physical Education; Curriculum Officer, Grade I.; Principal Speech Therapist; Research Officer, Grade I.; Special Education Officer; Supervisor of Art (Primary Schools); Supervisor of Education of Back- ward Children; Supervisor of Education of Physi- cally Handicapped Children; Supervisor of Music; Supervisor of School Forestry; Survey and Statistics Officer; Teacher Education Officer .. .	7 - 10
(iii) Assistant Supervisor of Education of Backward Children; Assistant Supervisor of Education of Physically Handicapped Chil- dren; Assistant Supervisor of School Libraries (Post Primary); Assistant Supervisor of School Libraries (Primary); * Camp Director—Children's School Camp; Curriculum Officer, Grade II.; † Design-Research Officer; † Guidance Officer; Publications Officer; Research Officer, Grade II.; Statistics Officer; Supervisor of Homecrafts (Pri- mary); Survey Officer .. . . . .	3 - 8

\* The Camp Director—Children's School Camp, Bogong, shall be paid an annual allowance in addition to salary in accordance with the following rates:—

Married.	Unmarried.
\$150	\$100

† The positions of Design-Research Officer, Grade II., and Guidance Officer, Grades I. and II., have been re-designated Design-Research Officer and Guidance Officer respectively.

6. Assistant to Departmental Psychologist.

The following shall be the rates of salaries for the position of Assistant to Departmental Psychologist:—

Subdivisions.						
1	2	3	4	5	6	7
\$4,976	5,288	5,578	5,875	6,208	6,476	6,795

7. Higher Duties.

- (a) Where a member of the Teaching Service is assigned the duties of a professional position carrying a higher remuneration than that applicable to his permanent position, and the Tribunal has consented to such duties being assigned for a period of one month or longer, he shall be paid a higher duties allowance in accordance with this clause.
- (b) A member assigned to a position carrying a total remuneration of less than \$13,250 a year shall receive an allowance equivalent to the minimum of the salary attributable to the position to which he has been assigned.

Provided that, if his current salary exceeds or is equivalent to the minimum of the salary attributable to the position to which he has been assigned, he shall receive an allowance equivalent to the nearest subdivisional rate within the range of the position to which assigned which will result in an increase in his normal remuneration.

- (c) A member assigned to a position carrying a total remuneration of \$13,250 a year, or more, shall be paid a higher duties allowance as determined by the Tribunal.
- (d) Where a member temporarily occupies a higher position, but does not perform the whole of the duties usually performed by the holder of that position he may be paid such allowance as may be determined by the Tribunal.
- (e) Without the prior approval of the Tribunal, no member shall be assigned the duties of any position for a period exceeding one calendar year.

W. E. SAMPSON, Chairman.

A. F. LE CLERCQ, Secretary.

Office of the Teachers Tribunal,  
Melbourne, 25th April, 1972.

SCHEDULE "A".

Conversion Table.

Salaries paid immediately prior to the effective date of this Regulation shall be converted to a subdivisional point of the schedule of rates detailed in clause 4, in accordance with the following Table:—

Current Annual Salary.					Conversion Point
\$	\$	\$	\$	\$	Subdivision.
7,050	7,100				3
7,250	7,300	7,450	7,500		4
7,650	7,700	7,850	7,900	7,950	5
8,050	8,200	8,250			6
8,300	8,450	8,550	8,700	8,750	7
9,000	9,050	9,250	9,300	8,800	8
9,500	9,550				9
9,750	10,000				10
10,250	10,500				11
10,750	11,000				12
11,500					13
11,750	12,000				15
13,000					17
13,900					19
15,000					20

(Salaries of Assistants to Departmental Psychologists shall convert to those prescribed in clause 6 for their existing subdivisions.)