



VICTORIA

GOVERNMENT GAZETTE

Published by Authority

No. 96]

WEDNESDAY, NOVEMBER 8

[1972

PROCLAMATIONS

ACTS OF PARLIAMENT.

PROCLAMATION

By His Excellency the Governor of the State of Victoria and its Dependencies in the Commonwealth of Australia, &c., &c., &c.

I, the Governor of the State of Victoria, in the Commonwealth of Australia, do hereby declare that I have this day assented, in Her Majesty's name, to the Bills passed by the Parliament of the said State, the titles whereof are hereunder set forth, together with the short titles, that is to say:—

- No. 8308. "An Act to amend *The Constitution Act Amendment Act 1958* with respect to the Holding and Conduct of Conjoint Elections." (*The Constitution Act Amendment (Conjoint Elections) Act 1972.*)
- No. 8309. "An Act to authorize the Grant of Leases of certain Land in the City of Ringwood and for other purposes." (*Ringwood (Recreation Reserve) Land Act 1972.*)
- No. 8310. "An Act to amend the *Land Act 1958* to make Provision for Licences for Jetties, Landing Stages and other Structures, for the Establishment of the Aquatic Clearance Fund, for the Construction of Marinas and for other purposes." (*Land (Jetties and Marinas) Act 1972.*)

Given under my Hand and the Seal of the State of Victoria aforesaid, at Melbourne, this thirty-first day of October, in the year of our Lord One thousand nine hundred and seventy-two, and in the twenty-first year of the reign of Majesty Queen Elizabeth II.

(L.S.) ROHAN DELACOMBE.

By His Excellency's Command,

R. J. HAMER,
Premier.

☞
GOD SAVE THE QUEEN!

BANK HOLIDAY.

PROCLAMATION

By His Excellency the Governor of the State of Victoria and its Dependencies in the Commonwealth of Australia, &c., &c., &c.

In pursuance of the provisions of the *Bank Holidays Act 1958*, I, the Governor of the State of Victoria, in the Commonwealth of Australia, do by this my Proclamation appoint the day and date named hereunder a special day to be observed as a Bank Half-Holiday at the place mentioned, that is to say:—

Bank Half-Holiday from the Hour of eleven a.m.

WEDNESDAY, THE 8TH NOVEMBER, 1972 at Kyneton.

Given under my Hand and the Seal of the State of Victoria aforesaid, at Melbourne, this sixth day of November, in the year of our Lord One thousand nine hundred and seventy-two, and in the twenty-first year of the reign of Her Majesty Queen Elizabeth II.

(L.S.) ROHAN DELACOMBE.

By His Excellency's Command,

W. BORTHWICK,
for Chief Secretary.

GOD SAVE THE QUEEN!

Health Act 1958 (No. 6270), Section 94.
DECLARATION OF TANNERIES TO BE AN
OFFENSIVE TRADE.

PROCLAMATION

By His Excellency the Governor of the State of Victoria and its Dependencies in the Commonwealth of Australia, &c., &c., &c.

By virtue of the powers conferred by the *Health Act 1958 (No. 6270)*, I, the Governor of the State of Victoria, in the Commonwealth of Australia, on the recommenda-

tion of the Commission of Public Health, and by and with the advice of the Executive Council of the said State, do by this my Proclamation declare Tanneries to be an Offensive Trade for the purposes of the Health Act 1958.

Given under my Hand and the Seal of the State of Victoria aforesaid, at Melbourne, this thirty-first day of October, in the year of our Lord One thousand nine hundred and seventy-two, and in the twenty-first year of the reign of Her Majesty Queen Elizabeth II.

(L.S.) ROHAN DELACOMBE.

By His Excellency's Command,

J. F. ROSSITER,
Minister of Health.

GOD SAVE THE QUEEN!

DEPARTMENT OF CROWN LANDS AND SURVEY.
TOWNSHIP OF BALLARAT EAST EXTENDED.

PROCLAMATION

By His Excellency the Governor of the State of Victoria and its Dependencies in the Commonwealth of Australia, &c., &c., &c.

I, the Governor of the State of Victoria, in the Commonwealth of Australia, by and with the advice of the Executive Council of the said State, and in pursuance of the provisions of Section 25 of the Land Act 1958, do, by this Proclamation extend the Township of Ballarat East, proclaimed as such on the 11th August, 1953, by the addition thereto of the portion indicated by hatching on plan hereunder.—(B.128⁽⁶²⁾ (C.93051.)

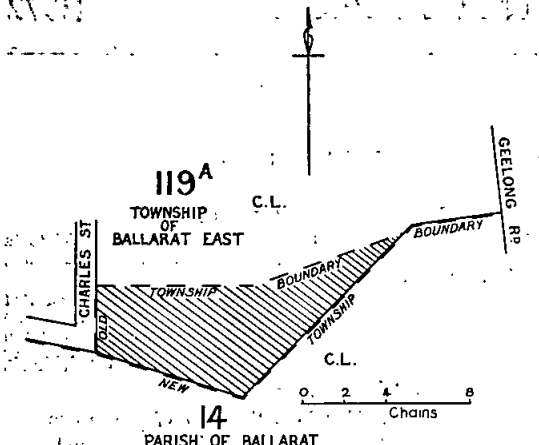

Given under my Hand and the Seal of the State of Victoria aforesaid, at Melbourne, this thirty-first day of October, in the year of Our Lord One thousand nine hundred and seventy-two and in the twenty-first year of the reign of Her Majesty Queen Elizabeth II.

(L.S.) ROHAN DELACOMBE.

By His Excellency's Command,

W. BORTHWICK,
Minister of Lands.

GOD SAVE THE QUEEN!

ROADS PROCLAIMED.

PROCLAMATION

By His Excellency the Governor of the State of Victoria and its Dependencies in the Commonwealth of Australia, &c., &c., &c.

In pursuance of the provisions of Section 25 (3) (c) of the Land Act 1958, I the Governor of the State of Victoria, by and with the advice of the Executive Council of the said State, do hereby proclaim as roads the under-mentioned lands:

Elwood, Parish of Prahran, County of Bourke, being the land indicated by hatching on plan hereunder.—(S.226⁽⁵¹⁾ (G.61952.)

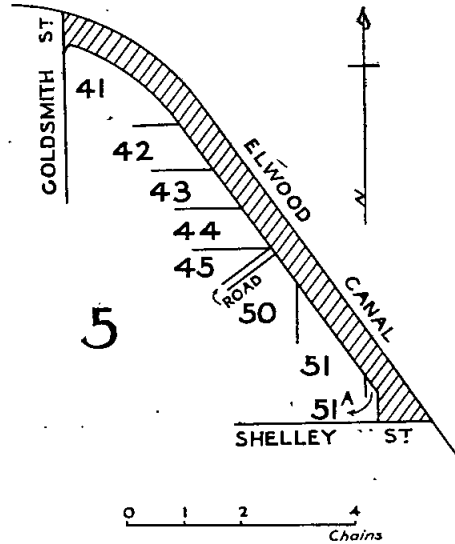

City of Port Melbourne, Parish of Melbourne South, County of Bourke, being the land indicated by hatching on plan hereunder.—(M.334⁽²²⁾ (C.93765.)

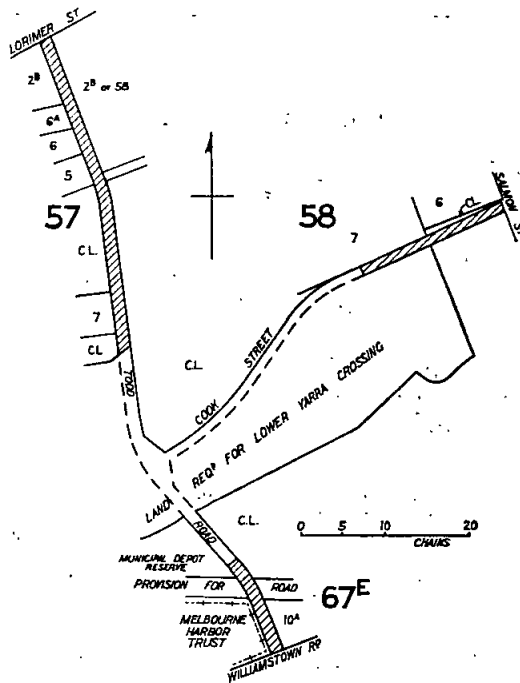

Given under my Hand and the Seal of the State of Victoria aforesaid, at Melbourne, this thirty-first day of October, in the year of Our Lord One thousand nine hundred and seventy-two and in the twenty-first year of the reign of Her Majesty Queen Elizabeth II.

(L.S.) ROHAN DELACOMBE.

By His Excellency's Command,

W. BORTHWICK,
Minister of Lands.

GOD SAVE THE QUEEN!

GOVERNMENT NOTICES*Education Act 1958.***TEACHER REGISTRATION BOARD ELECTIONS
(PRIMARY).**

Pursuant to the provisions of the Teacher Registration Board Elections Regulations, I hereby give notice that the elections conducted by me on 9th October, 1972, for election of Members and Deputy Members of the Primary Teachers' Registration Board have resulted in—

(a) REX ALFRED PITTS (Footscray West Primary School), and
JOHN MAXWELL WOOD (Box Hill South Primary School),

being elected by school principals as Members of the said Board; and

RONALD COOPER (Tottenham North Primary School), and

BRUCE SPRATLING (Warracknabeal Primary School),

being elected as the deputies of such Members.

(b) JOHN MICHAEL LAWLOR (Wangaratta West Primary School),

JOHN FRANCIS MCCARTNEY (Armata Primary School),

ALAN WILLIAM MILL (Ripponlea Primary School), and

DONALD THOMAS REEVES (Donvalé Primary School),

being elected by classified primary teachers, other than school principals, as Members of the said Board.

I further advise that at the election for deputies to such Members—

BARTLEY ROBERT DINSMORE (Thomastown Primary School), and

TREVOR STUART WAITE (Numurkah Primary School), were the only candidates duly nominated, and I therefore declare the said Bartley Robert Dinsmore and Trevor Stuart Waite to be duly elected as deputies of such Members.

J. T. MINTER,
Returning Officer.

Education Department,
Melbourne, 31st October, 1972.

*Education Act 1958.***TEACHER REGISTRATION BOARD ELECTIONS
(SECONDARY).**

Pursuant to the provisions of the Teacher Registration Board Elections Regulations, I hereby give notice that the elections conducted by me on 9th October, 1972, for election of Members and Deputy Members of the Secondary Teachers' Registration Board have resulted in—

(a) JOHN JOSEPH BISHOP (Moe High School), and
EDWARD ROBERT JOHNSON (Doveton High School),

being elected by school principals as Members of the said Board; and

KEVIN WILLIAM GEORGE MURRAY (Niddrie High School), and

MAXWELL HENRY WILKINSON (St. Albans High School),

being elected as the deputies of such Members.

(b) DOUGLAS JAMES COCKS (Maroondah High School),

HUGH GLYN EVANS (Glenroy High School),

DAVID VICTOR JENSZ (Hadfield High School), and

MERVYN KARL VOGT (Chadstone High School),

being elected by classified secondary teachers, other than school principals, as Members of the said Board; and

HAROLD DAVID CHAMBERS (Hallam High School),

WAYNE ROBERT HARRIS (Hadfield High School),

KATHLEEN ANNE SPARK (Footscray Girls High School), and

WALTER MAXWELL STEPHENS (Niddrie High School),

being elected as the deputies of such Members.

(c) ROY UREN (Melbourne College of Education), being elected by professional staffs of specified Colleges as a Member of the said Board.

J. T. MINTER,
Returning Officer.

Education Department,
Melbourne, 31st October, 1972.

*Education Act 1958.***TEACHER REGISTRATION BOARD ELECTIONS
(TECHNICAL).**

Pursuant to the provisions of the Teacher Registration Board Elections Regulations, I hereby give notice that the elections conducted by me on 9th October, 1972, for election of Members and Deputy Members of the Technical Teachers' Registration Board have resulted in—

(a) GEORGE ALFRED LAWSON (Preston Technical School), and

EDWARD NOEL SCHONFELDER (Monterey Technical School),

being elected by school principals as Members of the said Board, and

STANLEY BARKER ALLEN (Macleod Technical School), and

RONALD STANLEY GAMBLE (Doveton Technical School),

being elected as the deputies of such Members.

(b) DOUGLAS VAN REEIN ALKEMADE (Ringwood Technical School),

PHYLLIS EVELYN CAMIER (Swinburne Technical School),

HARRY C. GILHAM (Lalor Technical School), and

KENNETH WILLIAM MASSON (Noble Park Technical School),

being elected by classified technical teachers, other than principals, as Members of the said Board, and

FREDERICK T. CRABTREE (Caulfield Institute of Technology),

MARGARET ELIZABETH HERRON (Glenroy Technical School),

ALICE LILIAN MAJOR (Emily McPherson College), and

ROBERT KINGSLEY GEORGE MARTIN (Essendon Technical School),

being elected as the deputies of such Members.

(c) RONALD CECIL SHARP (Technical Teachers College),

being elected by the professional staff of the Technical Teachers College as a Member of the said Board, and

EDWARD BESFORD (Technical Teachers College), being elected as the deputy to such Member.

J. T. MINTER,
Returning Officer.

Education Department,
Melbourne, 31st October, 1972.

*Soil Conservation and Land Utilization Act 1958,
(No. 6372).***DIAPUR No. 1 GROUP CONSERVATION AREA.**

Notice is hereby given that I, William Archibald Borthwick, Her Majesty's Minister for Conservation for the State of Victoria under powers conferred by Division 1A, section 24A of the *Soil Conservation and Land Utilization Act 1958* (No. 6372) hereby declare to be a Group Conservation Area, the land embraced by the Crown allotments listed below, together with the Road Reserves in the Parishes of Lawloit and Tarranginnie as particularly designated in Drawing Nos. 2413, 2414 and 2416, marked GA/65, and lodged at the office of the Soil Conservation Authority, 378 Cotham-road, Kew, and do further declare that it shall be known as the Diapur No. 1 Group Conservation Area.

Parish of Lawloit, Crown allotments 24 and 97; Parish of Tarranginnie, Crown allotments 30, 173, 174, 175, 176, 177, 178, 178A, 190, 190B, 193A, part 248, 251, 279, 281, 282, 282A, 283, part 285, 286.

And those road reserves and Crown land in the aforementioned Parishes lying within the area designated in Drawing Nos. 2413, 2414 and 2416.

25th October, 1972.

W. A. BORTHWICK,
Minister for Conservation.

WESTERN PORT REGIONAL PLANNING AUTHORITY**APPLICATION FOR LEASE.**

Notice is hereby given that the Western Port Regional Planning Authority has applied for a lease under section 134 of the *Land Act 1958*, for a term of 50 years, in respect of an area of 2 acres, Township of Cranbourne, as a site for offices.

12th October, 1972.

A. QUAYLE,
Secretary.

Health Act 1958.

VICTORIA—DEPARTMENT OF HEALTH.

NOTICE TO ATTEND FOR RADIOLOGICAL EXAMINATION.

To all persons aged twenty-one years and over enrolled or resident in the subdivisions specified hereunder in the State Electoral District of BENTLEIGH.

Take notice that you are required to attend at a Department of Health X-ray Unit sited in the public street at or as near as possible to the main entrance to the premises specified in this notice, at any time between the hours specified on one of the days specified and during the period specified in respect of those premises, and thereat to submit yourself to radiological examination of the chest for the purpose of ascertaining whether you may be suffering from pulmonary tuberculosis. If you have had a Chest X-ray within the last twelve months and for this reason do not wish to be examined now, you should attend the unit as directed and submit particulars of the previous examination.

SPECIFIED SUBDIVISIONS, PREMISES, PERIODS, DAYS AND HOURS.

Subdivision.	Premises.	Period.	Days.	Hours.
Bentleigh North	Gillan's Pharmacy, 173 McKinnon-road, McKinnon	Thursday, 23rd November, 1972 to Thursday, 30th November, 1972 (inclusive)	Each day during the period except Saturday, Sunday and Public Holidays	From 10 a.m. to 8.30 p.m.
	O'Shea's Butchery, 223 Tucker-road, McKinnon	Thursday, 23rd November, 1972 to Monday, 27th November, 1972 (inclusive)	Each day during the period except Saturday, Sunday and Public Holidays	From 10 a.m. to 8.30 p.m.
	Paul's Continental Hair-dressing Salon, 888 North-road, Bentleigh East	Friday, 24th November, 1972 and Monday, 27th November, 1972	Friday, 24th November, 1972 Monday, 27th November, 1972	From 10 a.m. to 8.30 p.m.
		Ziino's Drapery, 77 Mackie-road, Bentleigh East	Tuesday, 28th November, 1972 to Thursday, 7th December, 1972 (inclusive)	Each day during the period except Saturday, Sunday and Public Holidays
	Cnr. Melva-street and North-road, Bentleigh East	Tuesday, 28th November, 1972 and Wednesday, 29th November, 1972	Tuesday, 28th November, 1972 Wednesday, 29th November, 1972	From 10 a.m. to 8.30 p.m.
Coatesville ..		Georgina Beauty Salon, 947 Centre-road, Bentleigh East	Thursday, 30th November, 1972 to Tuesday, 5th December, 1972 (inclusive)	Each day during the period except Saturday, Sunday and Public Holidays
	Maunder's Milk Bar, 167 East Boundary-road, Bentleigh East	Friday, 8th December, 1972 to Wednesday, 13th December, 1972 (inclusive)	Each day during the period except Saturday, Sunday and Public Holidays	From 10 a.m. to 8.30 p.m.
Bentleigh East	Shopping Centre, cnr. Bignell and Matthews roads, Bentleigh East	Friday, 1st December, 1972 to Tuesday, 5th December, 1972 (inclusive)	Each day during the period except Saturday, Sunday and Public Holidays	From 10 a.m. to 8.30 p.m.
	Fox's Pharmacy, 301 Chesterville-road, Bentleigh East	Wednesday, 6th December, 1972 to Tuesday, 12th December, 1972 (inclusive)	Each day during the period except Saturday, Sunday and Public Holidays	From 10 a.m. to 8.30 p.m.
	C.J. Furnishings, 9 Scanlan-street, Bentleigh East	Wednesday, 6th December, 1972 and Thursday, 7th December, 1972	Wednesday, 6th December, 1972 Thursday, 7th December, 1972	From 10 a.m. to 8.30 p.m.
		Eastmoor Auto Service, Cnr. East Boundary-road and Clarence-street, Bentleigh East	Friday, 8th December, 1972 to Tuesday, 12th December, 1972 (inclusive)	Each day during the period except Saturday, Sunday and Public Holidays
	St. John's Church of England, cnr. Tucker and Centre roads, Bentleigh East	Thursday, 14th December, 1972 to Thursday, 21st December, 1972 (inclusive)	Each day during the period except Saturday, Sunday and Public Holidays	From 10 a.m. to 8.30 p.m.
Bentleigh ..	(1) Post Office, cnr. Centre-road and Lorraine-street, Bentleigh (2) Woolworths Store, 413-417 Centre-road, Bentleigh	Wednesday, 13th December, 1972 to Thursday, 21st December, 1972 (inclusive)	Each day during the period except Saturday, Sunday and Public Holidays	From 10 a.m. to 8.30 p.m.

NOTE.—Any person to whom this notice applies and who without reasonable excuse fails to comply with the requirements of the notice shall be guilty of an offence, and shall be liable to a penalty of not more than five hundred dollars.

Dated this Eleventh day of October, One thousand nine hundred and seventy-two.

W. J. STEVENSON, Chief Health Officer.

COUNTRY ROADS BOARD.

RESOLUTIONS OF THE COUNTRY ROADS BOARD.

The Country Roads Board, in pursuance of the provisions of the Country Roads Act 1958, has passed Resolutions the dates whereof and the terms of which are scheduled hereunder:—

SCHEDULE.

State Highways.

Resolution dated the Twenty-third day of October, One thousand nine hundred and seventy-two, made pursuant to sections 21 and 74 of the Country Roads Act 1958 declaring the widening of the Hume Highway in the City of Coburg as shown hatched on Plan numbered G.P.9926B hereunder to be part of a State highway within the meaning and for the purposes of the said Act.

STATE HIGHWAY
HUME HIGHWAY
CITY OF COBURG

Measurements in feet & inches

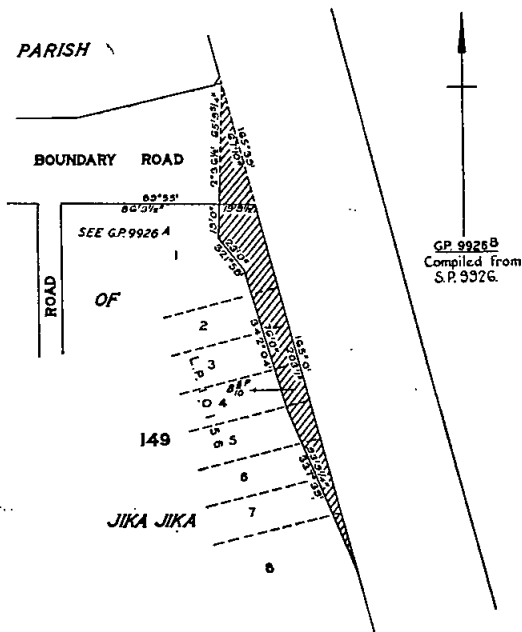

Resolution dated the Twenty-third day of October, One thousand nine hundred and seventy-two, made pursuant to sections 21 and 74 of the Country Roads Act 1958 declaring the widening of the Western Highway in the City of Sunshine as shown hatched on Plan numbered G.P.9944 hereunder to be part of a State highway within the meaning and for the purposes of the said Act.

STATE HIGHWAY
WESTERN HIGHWAY
CITY OF SUNSHINE

Measurements in feet & inches

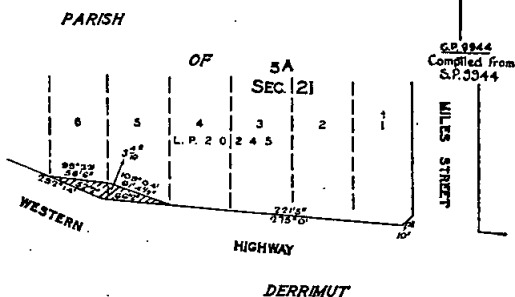

Main Roads.

Resolution dated the Twenty-third day of October, One thousand nine hundred and seventy-two, made pursuant to section 21 of the Country Roads Act 1958, declaring the widening of the Indigo Creek-road in the Shire of Chiltern as shown hatched on Plan numbered G.P.10232 hereunder to be part of a main road within the meaning and for the purposes of the said Act.

MAIN ROAD
INDIGO CREEK ROAD
SHIRE OF CHILTERN

Measurements in Links

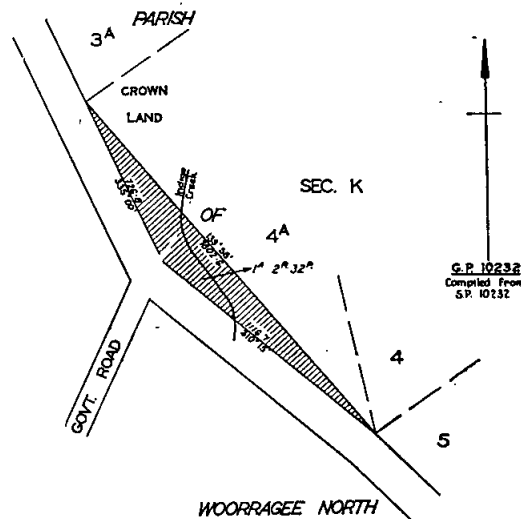

Resolution dated the Twenty-third day of October, One thousand nine hundred and seventy-two, made pursuant to section 21 of the Country Roads Act 1958, declaring the widening of Jeeralang West-road in the Shire of Morwell as shown hatched on Plan numbered G.P.10000 hereunder to be part of a main road within the meaning and for the purposes of the said Act.

MAIN ROAD
JEERALANG WEST ROAD
SHIRE OF MORWELL

Measurements in Links

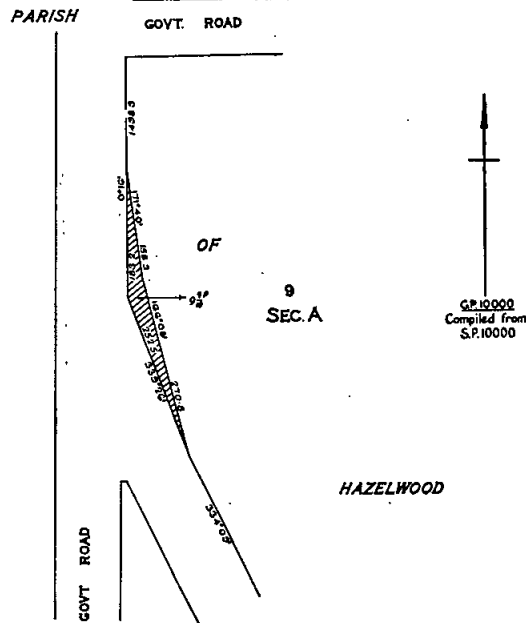

Resolution dated the Twenty-third day of October, One thousand nine hundred and seventy-two, made pursuant to section 21 of the Country Roads Act 1958, declaring the widening of Wellington-road in the Shire of Sherbrooke as shown hatched on Plan numbered G.P.10120 hereunder to be part of a main road within the meaning and for the purposes of the said Act.

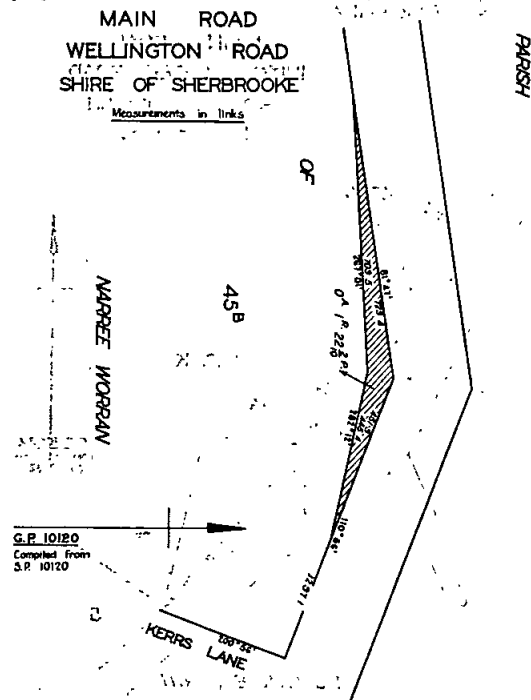

Unclassified Road.
Resolution dated the Twenty-third day of October, One thousand nine hundred and seventy-two, made pursuant to sections 21 and 110 of the Country Roads Act 1958 declaring the widening of Boundary-road in the City of Coburg as shown hatched on Plan numbered G.P.9926A hereunder to be part of a road within the meaning and for the purposes of the said Act.

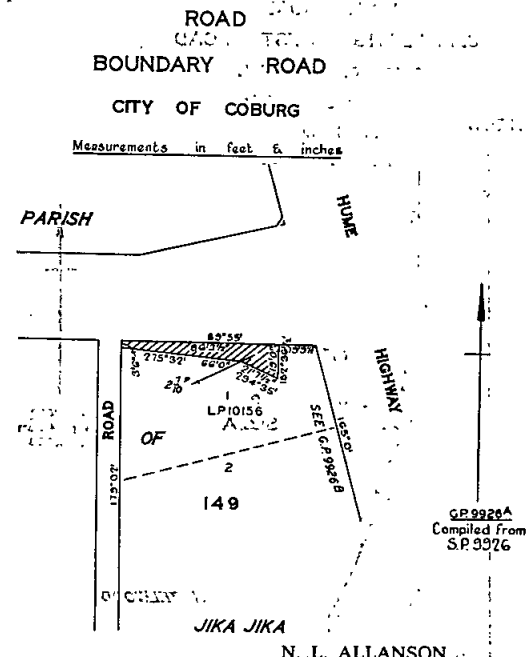

26th October, 1972.

N. L. ALLANSON, Secretary.

Survey Co-ordination Act 1958.

NOTICE OF ASSIGNMENT OF A NAME.

Pursuant to the powers conferred under section 29 of the above Act, and pursuant to a decision of the Minister under section 28 (5) of that Act, the Place Names Committee hereby gives notice of the assignment of the following name to the locality mentioned hereunder:—

Municipality.—City of Nunawading.

Location.—Situating in the south-eastern corner of the City, north of Highbury-road, and east of Springvale-road.

Name Assigned.—Vermont South.

By order of the Committee,

S. S. BOARDMAN,
Acting Secretary.

30th October, 1972.

Survey Co-ordination Act 1958.

NOTICE OF ASSIGNMENT OF A NAME.

Pursuant to the powers conferred under section 29 of the above Act, and pursuant to a decision of the Minister under section 28 (5) of that Act, the Place Names Committee hereby gives notice of the assignment of the following name to the locality mentioned hereunder:—

Municipality.—City of Knox.

Location.—Situating in the Parish of Scoresby between Ferny Creek and Fern Tree Gully-road near the junction of that road with the Burwood Highway.

Name Assigned.—Mountain Gate.

By order of the Committee,

S. S. BOARDMAN,
Acting Secretary.

30th October, 1972.

Town and Country Planning Act 1961.

GEELONG PLANNING SCHEME 1959.

AMENDMENT NO. 11, 1971.

(SHIRE OF BELLARINE).

Notice of Approval.

In pursuance of the powers conferred by the Town and Country Planning Act 1961, the Governor in Council on the 31st October, 1972, approved a Planning Scheme entitled the Geelong Planning Scheme 1959, Amendment No. 11, 1971 (Shire of Bellarine), in respect of part of the municipal district of the Shire of Bellarine, and such Planning Scheme comes into operation on the date this notice of approval is published in the Government Gazette.

A copy of the Planning Scheme as approved may be inspected free of charge during office hours at the office of the Town and Country Planning Board, 235 Queen-street, Melbourne; at the office of the Shire of Bellarine at Drysdale; and when available, at the Office of Titles, Melbourne, and at the Central Plan Office of the Department of Crown Lands and Survey, Melbourne.

W. H. CRAIG, Secretary,
Town and Country Planning Board.

Town and Country Planning Act 1961.

GEELONG PLANNING SCHEME 1959.

AMENDMENT NO. 11A, 1971.

(SHIRE OF BELLARINE):

Notice of Amendment.

In pursuance of the powers conferred by sub-section 6 of section 32 of the Town and Country Planning Act 1961, the Governor in Council, by and with the advice of the Executive Council on the 31st October, 1972, amended the Geelong Planning Scheme 1959, by rezoning a small triangle of land created by the divergence of the Geelong, Portarlington and Point Henry roads from industrial "B" zone to agricultural "B" zone.

A copy of the amendment may be inspected during office hours at the office of the Town and Country Planning Board, 235 Queen-street, Melbourne; at the office of the Council of the Shire of Bellarine at Drysdale; and when available, at the Office of Titles, Melbourne, and at the Central Plan Office of the Department of Crown Lands and Survey, Melbourne.

W. H. CRAIG, Secretary,
Town and Country Planning Board.

AUCTION SALES ACT.

List of persons to whom Auctioneers' Licences have been issued during the month of September, 1972 and prior months.

Name.	Address.	Date of Issue.
Bartley, William Charles	10 Norman-court, Mount Waverley	10.7.72
Beck, Hughie Joseph	24 Anderson-street, Pascoe Vale	7.8.72
*Berryman, Ian Raymond	5 Robinson-street, Camperdown	8.9.72
Bray, Clifford Max	Railway-terrace south, Pinnaroo, S.A.	20.6.72
Brooks, Leo Thomas	40 Owens-street, Doncaster East	29.8.72
Burke, Marcus	1 Royal-crescent, Armadale	1.8.72
Byron, John Kenneth	"Bevlyn Park", Golf Link-road, Berwick	8.8.72
Cameron, Gregory Alan	16 Acheron-street, Doncaster	1.8.72
Cleary, John Ernest	3 Viewbank-road, Glen Iris	4.8.72
Collins, Anthony Gerard	19 Church-street, Wodonga	20.7.72
Colville, Neville John	5 White-street, Benalla	2.10.72
Cooper, Leslie Robert	22 Leslie-street, Elsternwick	9.8.72
Croft, John Michael	Jolly-street, Wycheproof	19.7.72
Crough, Gerald Patrick	3 Armstrong-court, Vermont	21.8.72
Deane-Johns, Temple Kenneth	525 Whitehorse-road, Surrey Hills	5.7.72
Dickinson, John Grano	292 Springvale-road, Glen Waverley	29.9.72
Driscoll, Graham Russell	157 Game-street, Merbein	24.8.72
Fielding, Peter Bernard	25 Morinda-crescent, East Doncaster	8.9.72
Finn, David Edward	6 Claremont-court, Glen Waverley	25.7.72
Gardiner, Roy Edward John	193 Murray-road, Preston	31.7.72
Golden, John	151 Railway-street, Altona	8.8.72
Gray, Raymond Leslie	37 Rose-street, Armadale	13.9.72
Houston, Lindsay John	34 Terrigal-avenue, South Oakleigh	21.9.72
Ireland, Peter	55 Were-street, Brighton	18.7.72
†Jackson, Arthur John	18 Myrtle-grove, Reservoir	20.7.72
Johnstone, Noel Alexander	320c Bluff-road, Sandringham	4.9.72
Jones, Adrian Oxley	19A Wentworth-avenue, Canterbury	28.8.72
Kennedy, Alwyn Arthur	80 Shaftsbury-street, Coburg	6.7.72
Lawrence, Robert Alan	101 Wimbledon-avenue, Mount Eliza	18.9.72
Leed, Darrel Crawford	59 Victoria-street, Coburg	11.8.72
Leonard, John	70 Spring-road, Moorabbin	22.9.72
Luckman, Albert Llewellyn	1 Francis-street, Moe	26.9.72
Lynch, Peter Marshall	25 Denbigh-road, Armadale	14.8.72
McIntyre, Duncan Alexander	Flat 4, 65 Wellington-street, Kew	5.9.72
McKenzie-Smith, Hugh Laughlin	"Somerset Park", Pound-road, Berwick	26.7.72
McMillan, Geoffrey Allan	"Binbirrin", Gembrook-road, Pakenham	24.7.72
Macpherson, John Dugald	46 Coghill-street, Yarrowonga	10.8.72
Mactier, Bruce Neil	5 Backhaus-street, Hampton	15.9.72
Massey, Robert Derick	5 Steven-street, Mildura	6.9.72
Murnane, Michael Terrance	Willatook	25.7.72
Newbery, Kenneth	5 Juliet-court, Dandenong North	15.9.72
O'Shaughnessy, Brian Xavier	17 Cochran-avenue, Camberwell	14.8.72
Palmer, James Martyn	57 Smith-street, Stawell	29.8.72
Pike, Alan David	18 Mimosa-avenue, Mildura	26.9.72
Pillios, Jim Spiro	57 Edgar-street, Glen Iris	13.7.72
Pouliot, Ronald Edward	22 Warkil-street, Cobram	9.8.72
Prato, Leslie James	371 Canterbury-road, Bayswater	16.8.72
Prior, Stanley George	29 Thea-grove, Doncaster East	21.8.72
Richards, Archelaus Barry	43 Alma-road, St. Kilda	14.7.72
Richards, Clifford Douglas	50 Hampshire-road, Sunshine	22.9.72
Ring, Terence Michael	14 Carson-street, Kew	7.8.72
Ritter, Dudley Wilbur	27 Wellman-street, Box Hill	21.8.72
Rotheram, David Darley	10 Plunkett-road, Dandenong	31.7.72
†Sloan, Geoffrey Charles	219 Balaclava-road, Caulfield	30.8.72
Spano, Anthony	6 Alexander-street, Avondale Heights	3.8.72
Sylvester, Ronald William	325 High-street, Ashburton	31.7.72
Tattersson, Norman John	Craig-road, Cranbourne	14.9.72
Veitch, Victor Ronald James	44 Catherine-avenue, Chelsea	7.8.72
Ward, Roger John	Flat 4, 7 Ormond-esplanade, Elwood	5.7.72
Wray, Brian Walter	3 Adelaide-street, Footscray	31.7.72
Yates, Neale Raymond	1087 Yarramba-crescent, North Albury, N.S.W.	16.8.72

* Transferred from A. A. Sloane.
 † Transferred from J. A. H. Brenneris for period 20.7.72 to 15.9.72.
 ‡ Transferred from H. E. Hulme.

The Treasury,
 Melbourne, 3002,

E. W. COATES,
 Director of Finance.

AUCTION SALES ACT 1958.

MOE.—Notice is hereby given that the Annual Meeting of Justices for the Licensing of Auctioneers will be held at the Magistrates Court, Moe, on Tuesday, the 28th day of November, 1972, at the hour of Ten-thirty o'clock in the forenoon. Dated at Moe this 27th day of October, 1972.—S. G. MACKIE, Clerk of the Magistrates Court, Moe.

Imitation Milk Act 1969.

STATE OF VICTORIA.
 NOTICE.

In pursuance of the powers conferred on me by the Imitation Milk Act 1969, I, Sir Gilbert Lawrence Chandler, Minister of Agriculture, do by this Notice specify the product known as "Robert's Soy Compound", the composition of which is set out hereunder, as a product exempted from the operation of the Imitation Milk Act 1969.

"ROBERT'S SOY COMPOUND."

"Robert's Soy Compound" is made from soya beans, maltose and lactose. The analysis is as follows:—

Protein	26.90	per cent.
Carbohydrate	53.00	per cent.
Fat	5.80	per cent.
Ash	6.00	per cent.
Moisture	4.20	per cent.
Fibre	.30	per cent.
Calcium	.60	per cent.
Phosphorus	.70	per cent.
Iron	.008	per cent.

G. L. CHANDLER,
 Minister of Agriculture.

REVOCATION OF APPOINTMENTS OF
COMMISSIONERS FOR TAKING DECLARATIONS, ETC.

His Excellency the Governor of the State of Victoria, by and with the advice of the Executive Council thereof, doth by Order made on the 31st day of October, 1972, revoke the appointments of Dudley James Edward Gale, William Carr Hutton, Terence Walter Rooney, Barry William Walder and Raymond John White, as Commissioners for taking Declarations and Affidavits, pursuant to the provisions of the Evidence Act 1958.

T. J. FORRISTAL,
Clerk of the Executive Council.

At Government House,
Melbourne, 31st October, 1972.

NOTICE TO MARINERS.

[No. 26 OF 1972.]

AUSTRALIA.—VICTORIA.

CORNER INLET.

1. Entrance Buoys altered.
2. Demarcation of Toora Channel.
3. Directional Light established.

1. Former Notice No. 16 (T) of 1971.

Remarks.—No. 1 light-buoy has been fitted with a radar reflector. Nos. 2, 4 and 6 buoys have been altered to cone shaped buoys and fitted with radar reflectors. Buoy stations and other details remain unaltered.

2. Reference Barries Point Light, Lat. 38 deg. 43 min. S., Long. 146 deg. 23 min. E. (approx.) Position:

Light-Beacon positions.—

No. 2—156 deg. 44 min. distant 1.84 miles from above reference position.

No. 4—179 deg. 12 min. distant 1.30 miles from above reference position.

Light-buoy stations.—

Latrobe—136 deg. 53 min. distant 3.69 miles from above reference position.

No. 1—148 deg. 58 min. distant 2.67 miles from above reference position.

No. 3—165 deg. 18 min. distant 1.96 miles from above reference position.

No. 5—185 deg. 23 min. distant 1.38 miles from above reference position.

No. 6—233 deg. 05 min. distant 0.75 miles from above reference position.

No. 7—231 deg. 24 min. distant 0.90 miles from above reference position.

Description.—

No. 2 Beacon.—Single steel pile beacon painted black and numbered 2, showing a flashing white light every 4 seconds.

No. 4 Beacon.—Single steel pile beacon painted black and numbered 4, showing a flashing white light every 5 seconds.

Latrobe buoy.—Light-buoy coloured red and white horizontal stripes and unnumbered, showing a flashing red light every 2 seconds. The buoy is moored in 62 feet (18m9) water.

No. 1 buoy.—Light-buoy coloured red and numbered 1, showing a flashing red light every 5 seconds. The buoy is moored in 43 feet (13m1) water.

No. 3 buoy.—Light-buoy coloured red and numbered 3, showing a flashing red light every 4 seconds. The buoy is moored in 43 feet (13m1) water.

No. 5 buoy.—Light-buoy coloured red and numbered 5, showing a flashing red light every 5 seconds. The buoy is moored in 52 feet (15m8) water.

No. 6 buoy.—Light-buoy coloured black and numbered 6, showing a flashing white light every 4 seconds. The buoy is moored in 22 feet (6m7) water.

No. 7 buoy.—Light-buoy coloured red and numbered 7, showing a flashing red light every 5 seconds. The buoy is moored in 38 feet (11m6) water.

Elevation.—Nos. 2 and 4 beacons 26 feet (7m9) respectively. Latrobe Nos. 1, 3, 5, 6, 7 buoys 9 feet (2m7) respectively.

Visibility.—Nos. 2 and 4 beacons and No. 6 buoy 5 miles. Latrobe Nos. 1, 3, 5, 7 buoys 3 miles.

Abridged description.—

No. 2 light-beacon Fl. 4 sec. 26 ft. (7m9) 5 M.

No. 4 light-beacon Fl. 5 sec. 26 ft. (7m9) 5 M.

Latrobe light-buoy Fl. R. 2 sec. 9 ft. (2m7) 3 M.

No. 1 light-buoy Fl. R. 5 sec. 9 ft. (2m7) 3 M.

No. 3 light-buoy Fl. R. 4 sec. 9 ft. (2m7) 3 M.

No. 5 light-buoy Fl. R. 5 sec. 9 ft. (2m7) 3 M.

No. 6 light-buoy Fl. 4 sec. 9 ft. (2m7) 5 M.

No. 7 light-buoy Fl. R. 5 sec. 9 ft. (2m7) 3 M.

Remarks.—Latrobe buoy has been established as a bifurcation buoy and marks the junction of Toora Channel with Main Channel. Nos. 2 and 4 light beacons and No. 6 light-buoy mark the northern side of Toora Channel.

Nos. 1, 3, 5 and 7 light-buoys mark the southern side of Toora Channel.

Nos. 6 and 7 light-buoys also mark the junction of Barries Beach Channel with Toora Channel.

3. Reference As in 2 above.

Position.—

Light position.—330 degrees distant 0.5 miles from above reference position.

Description.—Directional light with green, green and white, white, red and white and red sectors:

Characteristics.—Fixed green from 013 deg. 50 min. to 020 deg. 50 min. Alternating white and green from 020 deg. 50 min. to 022 deg. 50 min. Fixed white from 022 deg. 50 min. to 023 deg. 50 min. Alternating white and red from 023 deg. 50 min. to 025 deg. 50 min. Fixed red from 025 deg. 50 min. to 032 deg. 50 min.

Elevation.—60 feet (18m3).

Visibility.—Eight miles.

Abridged Description.—F. & Alt. G.W.R. Dir.

Remarks.—The light has been established as a leading light with the centre of the white sector aligned along the centre line of Barries Beach Channel bearing 023 deg. 20 min.

Charts Affected.—Aus. 801, 357.

Publication.—Sailing Directions, Victoria, 1970, pages 446, 447, 469, 471 and 665.

A. J. WAGGLEN,
Port Officer in Victoria.

Public Works Department,
Ports and Harbors Division,
2 Treasury-place,
Melbourne, 3002, 31st October, 1972.

Country Fire Authority Act 1958.

FIRE DANGER PERIOD IN RESPECT OF SPECIFIED
PARTS OF THE COUNTRY AREA OF VICTORIA.

Whereas by section 4 of the Country Fire Authority Act 1958, it is enacted that the Chief Secretary of Victoria, after consultation with the Minister of Forests, may from time to time by declaration published in the Government Gazette, declare any period to be the fire danger period in respect of the country area of Victoria, or any specified part or parts thereof and, without affecting the generality of the foregoing, may declare different periods to be the fire danger period in respect of different parts of the said country area:

And whereas the Chief Secretary and the Minister of Forests have consulted accordingly:

Now therefore I, the Chief Secretary of Victoria, do hereby declare the period commencing at midnight on the 12th November, 1972, and ending at midnight on the 30th April, 1973, to be the fire danger period in respect of the parts of the country area of Victoria situated within the municipal districts or parts of municipal districts, being portion of the Eighteenth Fire Control Region specified in the Schedule hereunder:—

SCHEDULE No. 1.

Municipalities:

City of Mildura.

Shires of Karkaroc and Walpeup.

Part Shire of Mildura (excluding those portions which lie within the Parishes of Mildura and Merbein).

V. F. WILCOX,
Acting Chief Secretary.

Chief Secretary's Office,
Melbourne, 3rd November, 1972.

Private Agents Act 1966.

NOTICE OF RECEIPT OF APPLICATIONS FOR LICENCES UNDER THE PROVISIONS OF THE PRIVATE AGENTS ACT 1966.

The Clerk(s) of the Magistrates' Court(s) as listed hereunder hereby give notice that applications, as under, have been lodged for hearing by the said Court(s) on the date(s) specified.

Any person desiring to object to any of such applications must—

- (a) lodge with the respective Clerk of the Magistrates' Court a notice in the prescribed form of his objection and of the grounds thereof;
- (b) cause a copy of such notice to be served personally or by post upon the applicant at least three days before the hearing of the application; and
- (c) send or deliver—
 - (i) where the objection is not made by the officer in charge of the police district in which the Court is situated— a copy of the notice to such officer; and
 - (ii) where the objection is not made by the Registrar or Deputy Registrar—a copy to the Registrar.

Full Name of Applicant or in the Case of a Firm or Corporation, of the Nominee.	Place of Abode of Applicant or Nominee.	Name of Firm or Corporation.	Address for Registration.	Type of Licence.	Date of Hearing of Application.
---	---	------------------------------	---------------------------	------------------	---------------------------------

MAGISTRATES' COURT, BROADMEADOWS.

Patford, Leslie George ..	197 Barrys-road, Campbellfield	197 Barrys-road, Campbellfield	Inquiry Agent ..	4.12.72
---------------------------	--------------------------------	---------	--------------------------------	------------------	---------

Dated at Broadmeadows this 30th day of October, 1972.

P. J. LIVINGSTONE, Clerk of the Magistrates' Court.

MAGISTRATES' COURT, MOE.

Williams, Rodney ..	32 Hunt-street, Morwell	Latrobe Security Services	71 Wirraway-street, Moe	Watchman ..	16.11.72
---------------------	-------------------------	---------------------------	-------------------------	-------------	----------

Dated at Moe this 30th day of October, 1972.

S. G. MACKIE, Clerk of the Magistrates' Court.

MAGISTRATES' COURT, SALE.

Spencer, Royce James ..	Myrtlebank via Sale..	Sale Security Patrol	1 Nicholson-street, Sale	Watchman ..	21.11.72
-------------------------	-----------------------	----------------------	--------------------------	-------------	----------

Dated at Sale this 27th day of October, 1972.

D. R. WALKER, Clerk of the Magistrates' Court.

MAGISTRATES' COURT, CRANBOURNE.

Ellis, Maurice Raymond ..	35 Dorothy-avenue, Glenhuntly	Consolidated Process Servicer	35 Dorothy-avenue, Glenhuntly	Process Server ..	22.11.72
Ellis, Maria Antoinette ..	" " "	" " "	" " "	" " "	"

Dated at Dandenong this 1st day of November, 1972.

K. O'HARE, Clerk of the Magistrates' Court.

MAGISTRATES' COURT, MELBOURNE.

Balabin, Alexander ..	Flat 1, 23 Chapman-street, North Melbourne	Inge Detective Agency	380 Victoria-parade, East Melbourne	Process Server ..	29.11.72
" " " "	" " "	" " "	" " "	Inquiry Agent ..	"

Dated at Melbourne this 2nd day of November, 1972.

L. W. HUSSEY, Clerk of the Magistrates' Court.

MAGISTRATES' COURT, CAMBERWELL.

Cawsey, Geoffrey Myiel ..	64 Rowen-street, Burwood	64 Rowen-street, Burwood	Guard Agent ..	7.12.72
" " " "	" " "	" " "	" " "	Inquiry Agent ..	"

Dated at Camberwell this 23rd day of October, 1972.

J. C. TOBIN, Clerk of the Magistrates' Court.

MAGISTRATES' COURT, SPRINGVALE.

Rae, George William ..	1 Upwey-avenue, Springvale	21 Clarke-road, Springvale	Watchman ..	17.11.72
------------------------	----------------------------	---------	----------------------------	-------------	----------

Dated at Springvale this 27th day of October, 1972.

J. B. DENNIS, Clerk of the Magistrates' Court.

MAGISTRATES' COURT, GEELONG.

Shore, John Charles..	40 Fitzroy-street, East Geelong	Geelong Armed Escort	55 The Esplanade, North Shore	Watchman ..	21.11.72
-----------------------	---------------------------------	----------------------	-------------------------------	-------------	----------

Dated at Geelong this 31st day of October, 1972.

J. E. REILLY, Clerk of the Magistrates' Court.

MAGISTRATES' COURT, MELBOURNE.

Rover, Rolf Paul Oscar ..	1 Elizabeth-street, Elsternwick	Mayne Nickless Limited	94 York-street, South Melbourne	Watchman ..	22.11.72
White, Norman Owen ..	10 Bristow-drive, Forest Hill	Wormald International Security	340 Abbotsford-street, North Melbourne	" ..	"
Browne, Archie Lynn ..	94 Koonung-road, Blackburn	" "	" "	" ..	"
Nunn, Kelvin Edward ..	5 Scotland-avenue, Greensborough	" "	" "	" ..	"
Hanlen, Robert Joseph ..	Flat 8, 119 O'Shanassy-street, North Melbourne	" "	" "	" ..	"
Dekeizer, Gerard ..	1 Cecily-street, Springvale South	" "	" "	" ..	"
Bimmore, Reginald Edward ..	61 McCracken-street, Essendon	" "	" "	" ..	"

Dated at Melbourne this 31st day of October, 1972.

L. W. HUSSEY, Clerk of the Magistrates' Court.

Transport Regulation Board.

TRANSPORT REGULATION ACT.

HEARING OF APPLICATIONS.

Notice is hereby given that the following applications will be considered by the Transport Regulation Board at its offices at the corner of Lygon and Princes streets, Carlton, at 10.15 a.m. on Wednesday, 29th November, 1972.

FLORENCE, J. R., 2 Clarke-street, Orbost. Application for variation of T.S. licence conditions to operate extended Educational Group Tours in association with Victorian Railways—with pick-up from Bairnsdale Railway Station as follows:—

1. *Mountain District Safari Hike—5 days.* From Bairnsdale Railway Station thence to Buchan Caves, Murrindal, Gelantipy, Wulgumerang, Black Mountain Station, Mt. Wombargo, Little River, McKillops Crossing, Orbost, back to Bairnsdale Railway Station.

NOTE.—During various stages of the tour, the groups would hike from and to various points along the route. Bus journeys and hikes would be organised in conjunction with the hiring party.

2. *Coastal Safari Hike—5 days.* From Bairnsdale Railway Station thence to Lakes Entrance, Nowa Nowa, Orbost, Marlo, Cape Conran, Sydenham Inlet, Pt. Hicks, Mallacoota, Genoa back to Bairnsdale Railway Station.

LEES, R. G., & W. T. NOSKE (trading as Baroona Tours), 206 Deakin-avenue Mildura. Application for variation of "T.O." licence conditions to include the ability to conduct day tours to Swan Hill as and when required.

Fares: \$8.00.

Timetable: Depart Mildura 8.00 a.m. return 6.00 p.m., (approximately).

NORTHERN BUS LINES PTY. LTD., 1 Walter-street, Glenroy. Application for variation of "M.C." licence conditions to include the ability to operate package week-end and holiday weekend tours to Paynesville, at separate and distinct fares, from the metropolitan charter pick-up zone.

SWIFT, G. A. & L. V., 517 Napier-street, White Hills. Application for one commercial passenger vehicle with seating capacity for eleven persons to operate a tour from Williamson-street Tourist Stand in Bendigo via Pall Mall, High, Forest, Rowan, Wattle, High, Lily, Chum and Booth streets, Calder Highway, Happy Valley-road, Wells-street, Mt. Koorong-road, Barnard, Lucan, Caledonia, Thunder and Finn streets, Holdsworth-road, Plumridge and Raglan streets and Midland Highway to the Bendigo Pottery, returning via Midland Highway, Napier and McCrae streets.

Timetable:

Depart Williamson-street 10.00 a.m.

Return:

1.00 p.m. (approximately).

Fares:

Adult—\$2.30.

Children—\$1.75.

Notice of any objection should be forwarded to reach the Secretary of the Board not later than 22nd November, 1972.

Applicants are advised that it will not be necessary to appear on the hearing date specified, unless advised in writing by the Board.

A. V. C. COOK,
Acting Secretary.

Corner Lygon and Princes streets, Carlton, Wednesday, 8th November, 1972.

Commercial Goods Vehicles Act.

TRANSPORT REGULATION BOARD.

HEARING OF APPLICATIONS.

Notice is hereby given that the following applications will be considered by the Transport Regulation Board at its offices at the corner of Lygon and Princes streets, Carlton, at 10 a.m., on Wednesday, 29th November, 1972.

ATLAS INDUSTRIES AUST. LTD., Toolals-road, Springvale, 3171. Three commercial goods vehicles (L/C. 177 cwt. each) to operate: (a) Within a 25-mile radius of own premises at Springvale in the course of business as "Tile Manufacturers"—own goods. (b) Within a 70-mile radius of own premises at Springvale—own tiles, roofing battens and tile fixing materials.

AYLING, F. M., 92 Rochester-road, Balwyn, 3103. One commercial goods vehicle (L/C. 158 cwt.) to operate: (a) Within a 30-mile radius of the premises of Ready Mixed Concrete (Vic.) Pty. Ltd. situated at High-street Epping solely on behalf of the said company—quarry products. (b) Within a 50-mile radius of the premises of Ready Mixed Concrete (Vic.) Pty. Ltd. situated at Thomastown solely on behalf of the said company—hot asphalt.

ORENSHAW, K. A. (trading as Barry & Orenshaw), King-street, Yarra Glen, 3775. One commercial goods vehicle (L/C. 180 cwt.) to operate: (a) Within a 25-mile radius from own premises at Yarra Glen in course of business as "Soil, Screenings and Gravel Suppliers"—own goods. (b) From own premises at Yarra Glen to and from places within a 20-mile radius from the post office at the corner of Bourke and Elizabeth streets in the City of Melbourne—own goods. (c) From own premises at Yarra Glen to consignees at Frankston—own goods. (d) From pits at Cranbourne to own premises at Yarra Glen—own sand.

BAINBRIDGE, I., Flat 2, 17 French-street, Thomastown, 3074. One commercial goods vehicle (L/C. 157 cwt.) to operate: (a) Within a 30-mile radius of the premises of Ready Mixed Concrete (Vic.) Pty. Ltd. situated at Epping solely on behalf of the said company—quarry products. (b) Within a 50-mile radius of the premises of Ready Mixed Concrete (Vic.) Pty. Ltd. situated at Thomastown solely on behalf of the said company—hot asphalt.

BEAUMONT, D. M., Gong Gong-road, Ballarat, 3350. One commercial goods vehicle (L/C. 14 cwt.) to operate within that part of the State of Victoria west of a line drawn through Geelong and Echuca in the course of business as "Air Conditioning Contractor" for the purposes of servicing and installation of Air Conditioning Units—tools of trade and materials incidental thereto.

BOMAR INDUSTRIES PTY. LTD., 31 Headingly-road, Mt. Waverley, 3149. One commercial goods vehicle (L/C. 142 cwt.) to operate: (a) Within a 25-mile radius of own premises at South Box Hill in course of business as "Landscape Gardening"—own goods. (b) From Toolangi to own premises at South Box Hill—own mountain soil. (c) From Bacchus Marsh to own premises at South Box Hill—own rock, own sand and own river pebbles. (d) From Sunbury to own premises at South Box Hill—own rock.

BONNEY, F. L., & CO. (GROUP TRADING) PTY. LTD., 77 Lime-avenue, Mildura, 3500. One commercial goods vehicle (L/C. 15 cwt.) to operate throughout the State of Victoria in the course of business as "Pest Exterminators"—tools of trade, equipment and materials incidental to own contracts but excluding any operations to or from places within a 25-mile radius of the post office at the corner of Bourke and Elizabeth streets, Melbourne.

BORDER TRACKS & BEARINGS PTY. LTD., 5 Watson-street, Wodonga, 3690. One commercial goods vehicle (L/C. 10 cwt.) to operate within that part of the State of Victoria east of a line drawn north and south through Shepparton and north of a line drawn east and west through Benalla in the course of business as "Mobile Crane and Forklift Serviceman"—tools of trade and spare parts incidental to on-site repair of Mobile Cranes and Equipment.

CROXFORD, A. R. (trading as A. R. & R. N. Croxford), Flat 1, 43 Skewe-street, Shepparton, 3630. One commercial goods vehicle (L/C. 240 cwt.) to operate: (a) Within a 50-mile radius from the post office at Shepparton as a "Road Contractor"—road-making plant and materials. (b) Within a 25-mile radius of the post office at Shepparton—general goods, provided that no goods shall be carried whether by one stage or by more than one stage between places within the above radius, which are more than thirty (30) road miles apart by the nearest practicable route.

DELIGARIS, C., 32 Oakes-avenue, Clayton, 3168. One commercial goods vehicle (L/C. 202 cwt.) to operate within a 50-mile radius of the G.P.O., Melbourne, on behalf of Consolidated Quarries Ltd.—premixed concrete in a specially-constructed agitator vehicle.

DYERS TRANSPORT PTY. LTD., York-street South, Sale, 3850. One commercial goods vehicle (L/C. 380 cwt.) to operate: (a) Within a 25-mile radius of the post office at Sale—general goods, provided that no goods shall be carried whether by one stage or by more than one stage between places within the above radius which are more than thirty (30) road miles apart by the nearest practicable route. (b) From the Metropolitan area of Melbourne to the premises of Yarragon

- Textile Mills Pty. Ltd., at Moe, an approved decentralized secondary industry (textiles) empty cartons and raw materials for use by the said company in the manufacturing processes of such decentralized secondary industry. (c) From the decentralized secondary industry premises at Yarragon Textile Mills Pty. Ltd. at Moe, to the Metropolitan area of Melbourne—finished cotton yarn.
- FELLOWS, B. W., 277 Pascoe Vale-road, Essendon, 3040. One commercial goods vehicle (L/C. 79 cwt.) to operate throughout the State of Victoria in the course of business as "Marine Collector and Scrap Tyre Dealers"—special wares as designated in the *Marine Stores and Old Metals Act 1958* (No. 6303), Part 1, Section (3), and also, scrap tyres with the proviso that no trailer shall be hauled in conjunction with the said vehicle.
- This application replaces licence No. D.A.42665/1 held in the same name which expired 23rd March, 1972.
- HAYLOCK, E. L., 75 Gipps-street, Port Fairy, 3284. Application to vary the conditions of licence No. D.A.1276 (L/C. 98 cwt.) by deleting the existing conditions and adding in lieu—"Within that part of the State of Victoria south of a line drawn due east and west through the Township of Macarthur, west of a line drawn due north and south through the Township of Allansford and east of a line drawn due north and south through the Township of Heywood—superphosphate and lime for spreading purposes only."
- HAYLOCK, E. L., 75 Gipps-street, Port Fairy, 3284. Application to vary the conditions of licence No. D.A.8875/3, D.A.8875/5 (L/C. 122, 139 cwt.) by deleting the existing conditions and adding in lieu new conditions—"Within that part of the State of Victoria south of a line drawn due east and west through the Township of Macarthur, west of a line drawn due north and south through the Township of Allansford and east of a line drawn due north and south through the Township of Heywood—superphosphate and lime for spreading purposes only."
- HAYLOCK, E. L. & R., 75 Gipps-street, Port Fairy, 3284. Application to vary the conditions of licence No. D.A.8875/6 (L/C. 150 cwt.) by deleting the existing conditions and adding in lieu new conditions—"Within that part of the State of Victoria south of a line drawn due east and west through the Township of Macarthur, west of a line drawn due north and south through the Township of Allansford and east of a line drawn due north and south through the Township of Heywood—superphosphate and lime for spreading purposes only."
- HESZ, E. (trading as S. & E. Hesz), Mary-street, Heyfield, 3858. Two commercial goods vehicles (L/C. 350, 316 cwt.) to operate from forest landings situated within a 25-mile radius of the post office situated at Erica to the premises of Thompson River Sawmills Pty. Ltd. at Erica—mill logs.
- HULSTON, S. B., 10 Byng-avenue, Cheltenham, 3192. Two commercial goods vehicles (L/C. 166 cwt each) to operate within a 50-mile radius of the G.P.O., Melbourne on behalf of Albion Reid Pty. Ltd.—premixed concrete in a specially constructed agitator vehicle.
- KENT INSTRUMENTS (AUSTRALIA) PTY. LTD., 61 Betula-avenue, Vermont, 3133. One commercial goods vehicle (L/C. 10 cwt) to operate throughout the State of Victoria in the course of business as "Instrument Manufacturers" for the purpose of installing and servicing instruments in industry—tools of trade and spare parts incidental to on-site servicing.
- MERCER, L. L., 229 King-street, Bendigo, 3550. One commercial goods vehicle (L/C. 7 cwt.) to operate throughout the State of Victoria in the course of business as "Marine Collector"—special wares, marine stores and old metals as designated in the *Marine Stores and Old Metals Act 1958* (No. 6303) Part 1, section (3), but excluding the carriage of any such goods to wharves, docks or ships for shipment or export purposes with the proviso that the combined load capacity of the prime mover and any trailer attached thereto does not exceed 120 cwt.
- BURNS, J. C. (trading as Miller & Burns), Nagambie, 3608. Application to vary the conditions of licence No. D.A.60711/1 (L/C. 102 cwt.) by adding an additional paragraph (b)—"(b) Within a 25-mile radius of own premises at Nagambie—general goods, provided that no goods shall be carried whether by one stage or by more than one stage between places within the above radius which are more than thirty (30) road miles apart by the nearest practicable route."
- MILLER, C. & V. F., & J. F. BURNS, Nagambie, 3608. Application to vary the conditions of licence No. D.A.60711 (L/C. 139 cwt.) by adding an additional paragraph (b)—"(b) Within a 25-mile radius of own premises at Nagambie—general goods, provided that no goods shall be carried whether by one stage or by more than one stage between places within the above radius which are more than thirty (30) road miles apart by the nearest practicable route."
- MITROPOULOS, S., 95 Williams-road, Prahran, 3181. One commercial goods vehicle (L/C. 223 cwt.) to operate within a 50-mile radius of the premises of Albion Reid Pty. Ltd. at North Melbourne on behalf of the said company—road-making plant, hot asphalt, premix and road-making materials but excluding the carriage of cement and lime from places within an 8-mile radius of the chief post office in the City of Geelong.
- DI NICOLANTONIO, A. (trading as Monash Garden Supplies), 585 Blackburn-road, Notting Hill, 3168. One commercial goods vehicle (L/C. 152 cwt.) to operate: (a) Within a 25-mile radius of own premises at Notting Hill in the course of business as "Sand, Soil, Screenings and Garden Suppliers"—own goods. (b) From Powelltown and Toolangi to own premises at Notting Hill—own mountain soil. (c) From Nar Nar Goon to own premises at Notting Hill—own sand. (d) From Bacchus Marsh to own premises at Notting Hill—own river pebbles.
- MOTOR SPARES PTY. LTD., 28 Faithful-street, Wangaratta, 3677. One commercial goods vehicle (L/C. 13 cwt.) to operate within a 50-mile radius of own branch premises at Wangaratta in the course of business as "Automotive and Spare Parts Distributor"—motor spare parts and accessories.
- MCLEOD, I. S., 16 Allen-crescent, Stawell, 3380. One commercial goods vehicle (L/C. 326 cwt.) to operate within that part of the State of Victoria west of a north/south line drawn through Bacchus Marsh in the course of business as an "Earth-moving Contractor"—own earth-moving plant and equipment, tools of trade and a maximum of 3 x 44 gallon drums of fuel for the operation of own earth-moving equipment on site.
- PETTS, P. (trading as Petts & Hazendonk), 819 Howitt-street, Ballarat, 3350. One commercial goods vehicle (L/C. 72 cwt.) to operate within a 50-mile radius of own premises in Ballarat and to Ararat and Stawell serving places *en route* in the course of business as "Aerated Water Distributor"—bottled and canned aerated waters, empty return crates and bottles solely on behalf of Passiona Bottling Co. Melbourne Ltd. provided that all goods carried are initially consigned by rail to Ballarat and no operations shall occur to or from places within an 8-mile radius of the chief post office in the City of Geelong.
- C.S.A. INVESTMENTS, PTY. LTD. (trading as Phillips & Stone), 288 Main-street, Bairnsdale, 3875. One commercial vehicle (L/C. 76 cwt.) to operate within that part of the State of Victoria east of a line drawn due north and south through the Township of Warragul and south of an east/west line going through the Township of Omeo, for the carriage of goods as follows: (a) Own aerated waters in the course of business as "Cordial Manufacturers". (b) Milk bar syrups, malted milk powder, drinking straws, food-stuffs, Devondale Cider and "Purap", paper bags, wrappings, paper cups and plates and canned aerated waters in the course of business as "Milk Bar and Catering Suppliers" but subject to the condition that all such goods so carried shall have been initially consigned by rail to either Bairnsdale or Orbost Railway Stations. (c) Sawmill waste to own factories at either Bairnsdale or Orbost from sawmills situated within a 20-mile radius of the particular factory.
- PRYOR, J. R., 226 Dawson-street south, Ballarat, 3350. Two commercial goods vehicles (L/C. 13, 14 cwt.) to operate: (a) Within a 50-mile radius of own premises at Ballarat in the course of business as "Builders"—own goods. (b) Throughout the State of Victoria—tools of trade and builder's equipment. (c) Within a 20-mile radius of any contract currently engaged upon or from the nearest railway station thereto—materials incidental to the completion of such contract.
- MOON, M. H. & D. E. A. (trading as R. J. Reeves), 194 Koroit-street, Warrnambool, 3280. One commercial goods vehicle (L/C. 50 cwt.) to operate in the course of business as an approved decentralized secondary industry at Warrnambool (manufacturing aerated waters and cordials) as follows: (a) From the Cities of Melbourne, Geelong and Ballarat to own premises at Warrnambool—own goods and materials for use

- in the manufacturing processes of such decentralized secondary industry. (b) From own premises at Warrnambool to places within a 55-mile radius of such premises—own manufactured products of such decentralized industry and agency lines.
- SAY, L. J. C., 138 Flinders-street, Melbourne, 3000. One commercial goods vehicle (L/C. 37 cwt.) to operate: (a) From Bairnsdale to mines at Benambra, Deddick, Licola, Mt. Murphy and Harrierville as Managing Director of Gippsland Minerals N.L.—goods the property of Gippsland Minerals N.L. (b) Throughout the State of Victoria—tools of trade, mining plant, mining equipment and ore samples for assay purposes.
- STEFFAN, L. J., Springvale-road, Mordialloc, 3195. Two commercial goods vehicles (L/C. 56, 140 cwt.) to operate throughout the State of Victoria in the course of business as "Marine Haulage"—boats and sailing craft on a specially constructed trailer.
- TERRILL, J. S., 12 Johnston-drive, Ferntree Gully, 3156. One commercial goods vehicle (L/C. 147 cwt.) to operate: (a) Within a 70-mile radius from the brick-works of City Brick Works Co. Pty. Ltd. at Malvern on behalf of the said company—bricks. (b) Within a 25-mile radius of the G.P.O., Melbourne—general goods.
- LADIGES, K. (trading as Tholad Plumbing), Dereel, 3350. One commercial goods vehicle (L/C. 19 cwt.) to operate: (a) Throughout the State of Victoria in course of business as "Plumbing Contractor"—own tools of trade and equipment. (b) Within a 10-mile radius of any contract currently engaged upon—small amounts of materials for use on such contract.
- TILLEY, L., 175 8th-street, Mildura, 3500. One commercial goods vehicle (L/C. 10 cwt.) to operate throughout the State of Victoria in the course of business as "Second-hand Dealer"—second-hand goods.
- TRANS-WEST HAULAGE (MELB.) PTY. LTD., 202 Station-street, Norlane, 3214. Three commercial goods vehicles (L/C. 290, 292, 289 cwt.) to operate: (a) Within a 25-mile radius from the post office at Springvale—general goods, provided that no goods shall be carried whether by one stage or by more than one stage between places within the above radius which are more than thirty (30) road miles apart by the nearest practicable route. (b) Within a 70-mile radius from each of the plants of Brick and Pipe Industries Limited at Burwood, Northcote and Scoresby respectively—bricks and on return journeys empty pallets and excess bricks to such of the above plants as may be appropriate. (c) From Columbia Concrete Masonry Pty. Ltd. at Springvale to consignees within a 70-mile radius therefrom—concrete masonry and on return journeys empty pallets and excess concrete masonry to the said plant, provided that the concrete blocks shall not weigh more than 40 lb. each.
- WATERS, S. H., & Co. PTY. LTD., 160 Firebrace-street, Horsham, 3400. One commercial goods vehicle (L/C. 30 cwt.) to operate within a 50-mile radius of own branch premises in the City of Horsham in the course of business as "Wool and Skin Merchants"—own goods.
- ZEVEN, T., 12 Lowndes-street, Bendigo, 3550. One commercial goods vehicle (L/C. 16 cwt.) to operate within a 100-mile radius of the post office at Bendigo and to and from Swan Hill in the course of business as "Building Contractor"—tools of trade and materials incidental to the completion of own contracts but excluding the carriage of any goods to or from places within a 25-mile radius of the G.P.O., Melbourne.
- FOX, A. H., PTY. LTD., 493 Mt. Alexander-road, Moonee Ponds, 3039; D.A.35308/2; 14th March, 1973; 10 cwt.
- GOW, L. H., Leitchville, 3567; D.A.55368; 21st April, 1973; 104 cwt.
- HARBIG, P. & M. (AUST.) PTY. LTD., 267 Flinders-lane, Melbourne, 3000; D.A.2762; 30th March, 1973; 10 cwt.
- HUTTON, J. C., PTY. LTD., 65 High-street, Preston, 3072; D.A.48355/35; 3rd March, 1973; 82 cwt.
- JACKSON, W., 318 Pascoe Vale-road, Essendon, 3040; D.A.53060; 5th October, 1972; 140 cwt.
- JENNINGS, L. A., off Mount Napier-road, Hamilton, 3300; D.A.65711; 18th November, 1972; 139 cwt.
- LEISURE & ALLIED INDUSTRIES PTY. LTD., 199 Albion-street, Brunswick, 3056; D.A.64946; 20th March, 1973; 14 cwt.
- LONG, J. & W., BROS. PTY. LTD., 55 Chifley-drive, East Preston, 3072; D.A.29337/1; 4th March, 1973; 240 cwt.
- MATTHEWS, T. C. L., Strickland-road, East Bendigo, 3550; D.A.52629/5; 22nd March, 1973; 106 cwt.
- METAL FABRICATIONS PTY. LTD., 28 Percy-street, West Heidelberg, 3081; D.A.62601; 3rd March, 1973; 39 cwt.
- MOBBS, J., 13 Knox-street, Daylesford, 3460; D.A.62192; 17th February, 1973; 74 cwt.
- MORRISSEY, M. G., 803 Dana-street, Ballarat, 3350; D.A.60413/1; 10th April, 1973; 20 cwt.
- MUTIMER, W. R. & G. M., 11 Clyde-street, Lilydale, 3140; D.A.54890; 15th March, 1973; 234 cwt.
- NATIONAL CASH REGISTER CO. PTY. LTD., 124 Russell-street, Melbourne, 3000; D.A.1707/31; 22nd March, 1973; 17 cwt.
- PATRICK, R. P. (trading as R. P. & E. Patrick), 28 Taylor-street, Wangaratta, 3677; D.A.62561/1; 3rd February, 1973; 45 cwt.
- PEARCE, R. O. (trading as R. & J. Pearce Motors), Bethanga, 3691; D.A.55154; 29th March, 1973; 158 cwt.
- PRINCIOTTA, S., 29 Miller-street, Thornbury, 3071; T.D.A.64765; 2nd November, 1972; 42 cwt.
- QUEEN'S BRIDGE MOTOR & ENGINEERING CO. PTY. LTD., corner Salmon and Plummer streets, Port Melbourne, 3207; D.A.1783/50; 1st December, 1972; 13 cwt.
- QUEEN'S BRIDGE MOTOR & ENGINEERING CO. PTY. LTD., 359 Plummer-street, Port Melbourne, 3207; D.A.1783/51; 2nd February, 1973; 14 cwt.
- READY MIXED CONCRETE (VIC.) PTY. LTD., 68 Burwood-road, Burwood, 3125; D.A.39437/19; 1st March, 1973; 127 cwt.
- READY MIXED CONCRETE (VIC.) PTY. LTD., 68 Burwood-road, Burwood, 3125; T.D.A.48531/56; 4th March, 1973; 318 cwt.; T.D.A.48531/57; 4th March, 1973; 322 cwt.
- READY MIXED CONCRETE (VIC.) PTY. LTD., 68 Burwood-road, Burwood, 3125; D.A.48531/75; 17th March, 1973; 14 cwt.
- READY MIXED CONCRETE (VIC.) PTY. LTD., 68 Burwood-road, Burwood, 3125; D.A.48531/76; 17th March, 1973; 267 cwt.
- READY MIXED CONCRETE (VIC.) PTY. LTD., 68 Burwood-road, Burwood, 3125; T.D.A.48531/96; 2nd March, 1973; 334 cwt; T.D.A.48531/97; 16th March, 1973; 331 cwt.
- READY MIXED CONCRETE (VIC.) PTY. LTD., 68 Burwood-road, Burwood, 3125; T.D.A.48531/131; 2nd March, 1973; 335 cwt.
- SELKIRK FREIGHT LINES PTY. LTD., 630 Howitt-street, Ballarat, 3350; D.A.11450/21; 10th April, 1973; 221 cwt.
- 7 X BEVERAGES (CENTRAL) PTY. LTD., 16 First-avenue, Sunshine, 3020; D.A.63354/24; 27th March, 1973; 20 cwt.
- 7 X BEVERAGES (CENTRAL) PTY. LTD., 16 First-avenue, Sunshine, 3020; T.D.A.63354/23; 27th March, 1973; 20 cwt.
- 7 X BEVERAGES (CENTRAL) PTY. LTD., 16 First-avenue, Sunshine, 3020; T.D.A.63354/22; 27th March, 1973; 20 cwt.
- HENRY SYKES PUMPS AUSTRALIA PTY. LTD., Dynon-road, Footscray, 3011; D.A.62627/1; 17th March, 1973; 76 cwt.
- TAYLOR, J. M. (trading as Max Taylor Piano Tuner), 7 Wawunna-road, Horsham, 3400; D.A.35353/1; 29th March, 1973; 14 cwt.
- THOMAS, H. E., Browns-road, Main Ridge, 3928; D.A.2147/4; 22nd March, 1973; 252 cwt.
- TILLEY, R. C., 1229 Nepean Highway, Highett, 3190; D.A.62668; 17th March, 1973; 140 cwt.
- TOORALAC MILK PRODUCTS PTY. LTD., Bridge-road, Dandenong, 3175; D.A.56830/20; 11th March, 1973; 321 cwt.
- TOWERS, R., 101 Harley-street, Knoxfield, 3180; D.A.54718; 1st March, 1973; 134 cwt.
- VENNELL, R. J., Wonga-road, Millgrove, 3139; D.T.1441; 17th March, 1973; 273 cwt.
- VICTORIA GRAINS STORE PTY. LTD., 48 Wellington-street, Collingwood, 3066; D.A.40149/18; 17th March, 1973; 272 cwt; D.A.40149/19; 17th March, 1973; 272 cwt.
- VASILAITIS, B., 13 Berkshire-road, North Sunshine, 3020; D.A.28102/3; 5th October, 1972; 210 cwt. Approx.

RENEWALS.

Applications for renewal of licences as shown by persons listed hereunder to operate under the same terms and conditions from the expiry shown in each case.

- BULAT, I., 13 Millicent-avenue, North Balwyn, 3104; D.A.62492; 11th March, 1973; 10 cwt.
- CARLTON & UNITED BREWERIES LTD., 16 Bouverie-street, Carlton, 3053; D.A.808/42; 3rd March, 1973; 10 cwt.
- CARLTON & UNITED BREWERIES LTD., 16 Bouverie-street, Carlton, 3053; T.D.A.808/54; 14th March, 1973; 152 cwt.; T.D.A.808/55; 14th March, 1973; 155 cwt.; T.D.A.808/56; 14th March, 1973; 150 cwt.
- CASTLES, T., 1 Kinkooka-road, Blackburn, 3130; D.A.43496; 20th March, 1973; 66 cwt.
- COLLINS, J., 100 Argyle-street, Fawkner, 3060; D.A.40580; 14th March, 1973; 16 cwt.
- DALGETY LTD., 461 Bourke-street, Melbourne, 3000; D.A.46170/44; 21st December, 1972; 14 cwt.
- ELLIOTT, A., 4 Gilmour-street, Burwood, 3125; D.A.2350; 23rd March, 1973; 89 cwt.

WOODALL, B. A., 22 Clarence-avenue, Noble Park, 3174; D.A.62654; 17th March, 1973; 131 cwt.
 WILSON, S. M., Box 151, Heywood, 3304; D.A.62634; 3rd March, 1973; 131 cwt.
 WRIGHT, W. H., PRY. LTD., Sudholz-street, West Melbourne, 3003; D.A.19947/7; 22nd March, 1973; 281 cwt.

TOW TRUCKS.

PIANTA, A. R. (trading as Pianta Motors), 96 High-street, Heathcote, 3606; D.A.27210/1; 12th April, 1973; 27 cwt.

SHARPE, W., 220 Broadway, Reservoir, 3073; D.A.57646; 7th March, 1973; 38 cwt.

Notice of any objection should be forwarded to reach the Secretary of the Board not later than 22nd November, 1972.

Applicants are advised that it will not be necessary to appear on the hearing date specified above, unless advised in writing by the Board.

A. V. C. COOK,
Acting Secretary.

Corner Lygon and Princes streets, Carlton, Vic., 3053, Wednesday, 8th November, 1972.

PUBLIC TRUSTEE ACT 1958 (No. 6350), SECTION 17.

I hereby give notice that on the 16th October, 1972, the Public Trustee filed elections to administer the following deceased persons' estates in accordance with section 17 of the Public Trustee Act 1958.

BELL, ALICE VERA, late of 49 Gower-street, Kensington, widow, died 25th August, 1972.

BURNES, JEAN ISABEL, formerly of 48 Francis-street, Colingwood, late of Flat 3, 37 Stafford-street, Abbotsford, spinster, died between the 10th and 12th of August, 1972.

COHEN, ROY MOSS, late of 1 Lexton-grove, Armadale, retired public servant, died 14th June, 1972.

DE ROSS, GOWER RAE DALMORE, formerly of 709 High-street, Regent, late of Lots 2 and 3, McGlynn-avenue, South Morang, machinist, died 13th August, 1972.

DONOHUE, JOSEPH SAMUEL, late of 6 Charlton-crescent, East Reservoir, retired shoemaker, died 23rd June, 1972.

FOWLER, JACK BERESFORD, late of 97 Graham-street, Albert Park, retired actor, died 17th July, 1972.

HARRIS, JOHN, late of Kew, pensioner, died 24th June, 1972.

MATTHEWS, VIOLET ELIZABETH, formerly of 30 Greig-street, Albert Park, late of Kew, widow, died 19th June, 1972.

WADDELL, IDA MARY, formerly of 26 Melrose-street, Box Hill, late of 78 Queen-street, Bendigo, widow, died 11th January, 1968.

WALKER, CLARENCE, late of 93 Kent-street, Richmond, pensioner, died 26th June, 1972.

N. P. BRODY,
Public Trustee.

256 Flinders-street, Melbourne, 3000, 1st November, 1972.

NOTICE.

Creditors, next of kin and others having claims against the estate of any of the under-mentioned deceased persons are required to send particulars of their claims to the Public Trustee, 256 Flinders-street, Melbourne, Vic. 3000, the personal representative, on or before the 15th January, 1973, after which date the Public Trustee may convey or distribute the assets, having regard only to the claims of which the Public Trustee then has notice:—

BANKS, ALBERT CAMPBELL, late of 68 Gordon-street, West Coburg, retired clerk, died 18th August, 1972.

BELL, ALICE VERA, late of 49 Gower-street, Kensington, widow, died 25th August, 1972.

BOMBADERI, STEPHEN LEWIS, late of School-road, Silvan, picker, died 28th June, 1972.

BURNES, JEAN ISABEL, formerly of 48 Francis-street, Colingwood, late of Flat 3, 37 Stafford-street, Abbotsford, spinster, died between the 10th and 12th of August, 1972.

BURRELL, MARY, also known as Molly Burrell, late of 35 Union-street, Armadale, widow, died 12th July, 1972.

CHRISFIELD, WILLIAM PEARCE, formerly of Salonika-street, Sorrento, late of Judge Book Memorial Village, Diamond-street, Eltham, retired P.M.G. employee, died 24th June, 1972.

COHEN, ROY MOSS, late of 1 Lexton-grove, Armadale, retired public servant, died 14th June, 1972.

DANIELS, MARY EILEEN, also known as Mary Eileen Daniel, late of 263 Inkerman-street, St. Kilda, married woman, died 12th May, 1972.

DE ROSS, GOWER RAE DALMORE, formerly of 709 High-street, Regent, late of Lots 2 and 3, McGlynn-avenue, South Morang, machinist, died 13th August, 1972.

DONOHUE, JOSEPH SAMUEL, late of 6 Charlton-crescent, East Reservoir, retired shoemaker, died 23rd June, 1972.

FITTON, FREDERICK WILLS, late of 14 James-street, Surrey Hills, retired mechanic, died 24th July, 1972.

FOWLER, JACK BERESFORD, late of 97 Graham-street, Albert Park, retired actor, died 17th July, 1972.

HAZELWOOD, WILLIAM JAMES, formerly No. VX11323, 2/8th Battalion A.I.F., late of 178 Miller-street, North Fitzroy, labourer, died 12th January, 1957.

HARRIS, JOHN, late of Kew, pensioner, died 24th June, 1972.

HAYES, MERTON ELLISTON, late of 196 Burwood-road, Hawthorn, retired public servant, died 9th July, 1972.

HENSCHEN, MARGARETE JOHANNA, also known as Margaret Henschchen, formerly of 40 Traill-street, Northcote and Flat 4, 17 Clyde-street, Kew, late of Kew, married woman, died 10th April, 1972.

JORDAN, RAYNOR GLADSTONE, formerly of Hokitika, New Zealand, late of Nelson, New Zealand, retired accountant, died on or about 19th May, 1972.

KEATING, JAMES PATRICK, late of Wellington, New Zealand, retired grocer, died on or about 27th March, 1972.

MATTHEWS, VIOLET ELIZABETH, formerly of 30 Greig-street, Albert Park, late of Kew, widow, died 19th June, 1972.

RAVEN, FRANK CLIVE, late of Unit 2, 23 Royal-avenue, Glenhuntly, egg board inspector, died 1st August, 1972.

SMELLIE, ESTHER AVIS, formerly of 187 Abbott-street, Sandringham, late of Elgar Private Hospital, Elgar-road, Box Hill, spinster, died 2nd June, 1972.

WADDELL, IDA MARY, formerly of 26 Melrose-street, Box Hill, late of 78 Queen-street, Bendigo, widow, died 11th January, 1968.

WALKER, CLARENCE, late of 93 Kent-street, Richmond, pensioner, died 26th June, 1972.

N. P. BRODY,
Public Trustee.

Melbourne, 1st November, 1972.

FORESTS ACT 1958, No. 6254.

In pursuance of the powers conferred by section 3 of the Forests Act 1958, I, Edward Raymond Meagher, Her Majesty's Minister of Forests in the State of Victoria, hereby declare the period commencing at midnight between the tenth and eleventh days of November, 1972, and ending at midnight between the thirtieth day of April and the first day of May, 1973, to be a prohibited period in respect of any fire protected area (other than a State Forest or National Park) situated in the municipalities specified in the Schedule hereto:—

SCHEDULE.

The Shires of:

Arapiles
 Ararat
 Avoca
 Bacchus Marsh
 Ballan
 Ballarat
 Bannockburn
 Bungaree
 Buninyong
 Corio
 Creswick
 Daylesford and Glenlyon
 Dundas
 Gisborne
 Grenville
 Kyneton
 Kowree
 Leigh
 Lexton
 Melton
 Mt. Rouse
 Newham and Woodend
 Ripon
 Romsey
 Wannon
 Wimmera
 Stawell
 Glenelg—that portion north of the Glenelg Highway.

E. R. MEAGHER,
Minister of Forests.

CONTRACTS ACCEPTED.—(Series 1972-73.)**SOIL CONSERVATION AUTHORITY.**

CONTRACT NO. 7203. SUPPLY OF TREATED PINE FENCE POSTS.

599. (1) (a) 6 ft. x 3 in.—4 in. posts \$55.90 per 100, less 7½ per cent. less 2½ per cent. cash 30 days, (b) 6 ft. x 4 in.—5 in. posts \$85.55 per 100, less 7½ per cent. less 2½ per cent. cash 30 days; (2) 7 ft. 6 in. x 5 in.—6 in. strainers \$1.70 each, less 7½ per cent. less 2½ per cent. cash 30 days; (3) 10 ft. x 3½ in.—4½ in. stays \$0.90 each less 7½ per cent. less 2½ per cent. cash 30 days; (4) Pointing of posts 3 in.—4 in. \$0.04 each, less 7½ per cent. less 2½ per cent. cash 30 days; 4 in.—5 in. \$0.05 each, less 7½ per cent. less 2½ per cent. cash 30 days.—Alstergren Pty. Ltd., 131 Queens Bridge-square, South Melbourne, Vic. 3205.

P. J. McCALLUM, Secretary.

ORDERS IN COUNCIL.—(Series 1972-73.)**PUBLIC WORKS.**

595. Dimboola, High School, construction of 30,000 gallon capacity concrete storage tank, \$5,793.00.—Concrete Tanks (S.A.) Pty. Ltd.—(W.157803.)

596. Shepparton, Primary School 5020, mechanical services, \$5,635.50.—Chadstone Airconditioning Services Pty. Ltd.—(N.43522b.)

597. Ports and Harbors Division, supply of 26-ft. fibreglass work boat, for use as an inspection and pollution investigation launch, \$16,823.00.—J. J. Savage & Sons Pty. Ltd.—(P. & H. 166619.)

598. Ports and Harbors Division, supply of special spare parts for dredge "Matthew Flinders", \$4,503.00.—I.H.C. Holland (Australia) Pty. Ltd.—(P. & H. 166638.)

Approved by the Governor in Council, 31st October, 1972.—T. J. FORRISTAL, Clerk of the Executive Council.

APPOINTMENTS AND RESIGNATIONS**APPOINTMENTS.**

His Excellency the Governor of the State of Victoria, by and with the advice of the Executive Council thereof, has, by Orders made on the 31st day of October, 1972, been pleased to make the under-mentioned appointments, viz.:—

MINISTRY OF HEALTH.**Members of Committees of Management of Hospitals.**

ROBERT DARYL FREEMAN to be Government appointee on the Committee of Management of Manangatang and District Hospital, for a period of three years, pursuant to the provisions of sub-paragraph (ii) of paragraph (a) of the proviso to sub-section (1) of section 48 of the *Hospitals and Charities Act 1958*; and

RICHARD EDWARD GUNDRY to be Government appointee on the Committee of Management of Nathalia District Hospital, re-appointed for a period of three years, commencing the 22nd November, 1972, pursuant to sub-paragraph (ii) of paragraph (a) of the proviso to sub-section (1) of section 48 of the *Hospitals and Charities Act 1958*.

LAW DEPARTMENT.**Judge of the County Court.**

BRUCE FINLAY McNAB, LL.M., a Barrister at Law who has practised as a Barrister in Victoria for a period of seven years, to be a Judge of the County Court of Victoria, to take effect from the date of commencement of duty.

Justices of the Peace.

ALFRED WILLIAM OVEREND, 77 Parkstone-avenue, Pascoe Vale South,

WALTER GEORGE DRINKWATER, 27 Autumn-street, West Coburg,

GORDON REX CHAMBERLAIN, 13 Pollard-street, Wodonga,

ALLAN GEORGE NORTON, 23 Robinson-street, Camperdown,

IRIS FAYE MENCK, "Gainsborough", 1102 Malvern-road, Armadale,

MICHAEL ALEXANDER TALBOT, 16 Henderson-street, South Melbourne,

LESLIE BURNETT WENDORFF, 101 Severn-street, Box Hill,

KEVIN CHARLES LEAR, 12 Standard-avenue, Box Hill, and

JOHN INCHQUIN TAYLOR, 10 The Close, Mt. Waverley, to keep the Peace in the State of Victoria.

Commissioners for Taking Declarations, &c.

SYDNEY LAWRENCE TYLER, care of A.G.C. (Advances) Ltd., 170 Queen-street, Melbourne,

FRANCIS MARSHALL SOMERVILLE (Rev.), care of Prince Henry's Hospital, St. Kilda-road, Melbourne,

BARRY FREDERICK CAMERON, care of A.G.C. (Advances) Ltd., 170 Queen-street, Melbourne,

WARWICK JAMES ARMSTRONG, care of Ingersoll-Rand (Australia) Ltd., 42 Moray-street, South Melbourne,

GEORGE REYNELL LANSDOWN, care of H.E.P. Steel, 9 Dundas-lane, Albert Park,

LEONARD COLIN FRANCIS (Br.), care of Christian Brothers Trinity Regional College, Saxon-street, Brunswick,

MALCOLM ARTHUR CRANG, care of Bank of New South Wales, 368 Collins-street, Melbourne,

KEITH HENRY NILSSON, care of Shire of Berwick, Pakenham,

GYULA MOLNAR, care of Molnar's Migrant Service, 303 Springvale-road, Springvale, and

JEFFREY ALAN JOHNSON, care of Associated Securities Finance Ltd., 376 Sydney-road, Coburg,

to be Commissioners for taking Declarations and Affidavits, pursuant to the provisions of the *Evidence Act 1958*, to resign upon ceasing to occupy their present positions;

RONALD PHILLIPS, 48 Elizabeth-street, East Coburg, to be a Commissioner for taking Declarations and Affidavits, pursuant to the provisions of the *Evidence Act 1958*, to resign upon leaving the neighbourhood of the address stated; and

ALFRED GEORGE HARRIS, care of State Electricity Commission of Victoria, Monash House, 15 William-street, Melbourne,

to be a Commissioner for, taking Declarations and Affidavits, pursuant to the provisions of the *Evidence Act 1958*, to refrain from charging fees, and to resign upon ceasing to occupy his present position.

PUBLIC WORKS DEPARTMENT.**Wharf Managers.**

Sergeant KENNETH FRANCIS McLEAN, No. 11022, to be Wharf Manager at Dromana, to carry out that portion of Part II. of the *Marine Act 1958*, which relates to the Management of Public Wharves, and to be an officer under section 19 of such Act, to levy and collect wharfage rates thereat, vice Sergeant Keith Charles MacDonald, No. 12024, transferred; and

Sergeant LIONEL STANLEY BAUM, No. 13351, to be Wharf Manager at Mallacoota, Gipsy Point and Sydenham Inlet, to carry out that portion of Part II. of the *Marine Act 1958*, which relates to the management of Public Wharves, and to be an officer under section 19 of such Act, to levy and collect wharfage rates thereat, vice Senior Constable David Frank Hilton-Wood, No. 12328, transferred; and

Sergeant DEREK STUART ROBINSON, No. 14242, to be Wharf Manager at Port Welshpool-Port Franklin, to carry out that portion of Part II. of the *Marine Act 1958*, which relates to the management of Public Wharves, and to be an officer under section 19 of such Act, to levy and collect wharfage rates thereat, vice Senior Constable Ralph Edward Young, No. 12041, transferred.

SOCIAL WELFARE DEPARTMENT.**Honorary Probation Officers.**

EUGENE AHERN, 140 Westbourne-grove, Northcote, RONALD WILLIAM BENNETT, 176 Mitchell-street, Northcote,

PETER BROOKS, 70 Hilda-street, Glenroy, FRANCIS JAMES BROWN, 58 Lloyd-street, Strathmore, PAULINE MARY DANAEHER, 3 Marlborough-street, East Bentleigh,

HUGO STREITBERGER GORDON, care of Officers' Mess, R.A.A.F. Base, Laverton,

WILLIAM HARGREAVES, Findlay-street, Leitchville, MAXWELL JOHN JACKSON, Foster-street, Stawell, and

ANDREW WEISS, 37 Outlook-road, Mt. Waverley,

pursuant to the provisions of section 507 (2) of the *Crimes Act 1958*, and section 10 (1) of the *Children's Court Act 1958*, to be Honorary Probation Officers for all Adult and Children's Courts in Victoria; and

GILBERT REX SHARRAD, 258 San Mateo-avenue, Mildura, pursuant to the provisions of section 10 (1) of the *Children's Court Act 1958*, to be Honorary Probation Officer for all Children's Courts in Victoria.

DEPARTMENT OF THE TREASURER.

Receivers of Revenue.

ROSS ALAN BRAMLEY
to be Receiver of Revenue, Maryborough, vice R. J. Canning, transferred;

RICHARD JOHN CANNING
to be Receiver of Revenue, Bairnsdale, vice G. H. Schmidt, transferred; and

GEORGE HENRY SCHMIDT
to be Receiver of Revenue, Mildura, vice I. M. Griffiths, promoted.

Collectors of Imposts (Acting).

JAMES MALCOLM PAWSON
to act temporarily as Collector of Imposts, State Tender Board, vice E. P. Watson, on leave;

HENRY WALKER THOMPSON
to act temporarily as Collector of Imposts, Police Department, vice B. N. Benedict, on leave; and

BRUCE VAUGHT McDONALD
to act temporarily as Collector of Imposts, Forests Commission, Victoria, vice R. A. Saunders, on leave.

DEPARTMENT OF WATER SUPPLY.

Drainage Trust Commissioner.

SAMUEL JOHN HINES
to be a Commissioner of the Strathdownie Drainage Trust, to hold such position for a period of four years from the date hereof, subject to the provisions of the River Improvement Act.

Improvement Trust Commissioner.

RÓY THORNTON HILL
to be a Commissioner of the Broken River Improvement Trust, to hold such position for a period of four years from 6th November, 1972, subject to the provisions of the River Improvement Act.

Sewerage Authority Members.

EDWARD JOHN MOLLOY,
KENNETH DAVID MURDOCH, and
TREVOR WILLIAM TAYLOR,
to be Members of the Wycheproof Sewerage Authority, to hold such position for a period of four years from 6th November, 1972, subject to the provisions of the Sewerage Districts Act.

Waterworks Trusts Commissioners.

MAXWELL ELLIOT FISHER
to be a Commissioner of the Apollo Bay Waterworks Trust, to hold such position for a period of four years from the date hereof, subject to the provisions of the Water Act;

DAVID WILLIAM SNEDDON
to be a Commissioner of the Beaufort Waterworks Trust, to hold such position for a period of four years from the date hereof, subject to the provisions of the Water Act;

RONALD JAMES HENDERSON, and
FRANCIS PETER MOSCHETTI,
to be Commissioners of the Bowenvale-Timor Waterworks Trust, to hold such position for a period of four years from the date hereof, subject to the provisions of the Water Act;

LEWIS RUPERT JAMES SHARROCK
to be a Commissioner of the Shire of Dundas Waterworks Trust, to hold such position for a period of four years, subject to the provisions of the Water Act;

CHARLES ROBERT WOOD
to be a Commissioner of the Katamatite Waterworks Trust, to hold such position for a period from the date hereof until 12th October, 1973, subject to the provisions of the Water Act;

EDWARD JOHNSTON
to be a Commissioner of the Lindenow Waterworks Trust, to hold such position for a period of four years from the date hereof, subject to the provisions of the Water Act;

FREDERICK WILLIAM BENJAMIN RAYNER
to be a Commissioner of the Myrtleford Waterworks Trust, to hold such position for a period of four years from the date hereof, subject to the provisions of the Water Act; and

LEO SMITH
to be a Commissioner of the St. Arnaud Waterworks Trust, to hold such position for the period from the date hereof until 21st February, 1976, subject to the provisions of the Water Act.

T. J. FORRISTAL,
Clerk of the Executive Council.

At Government House,
Melbourne, 31st October, 1972.

Liquor Control Act 1968.

APPOINTMENT OF LICENSING INSPECTOR.

In accordance with the authority conferred upon me by section 6 of the Police Regulation Act 1958, I, Angus Lindsay Carmichael, Deputy Commissioner of Police, do hereby appoint under subsection (1) of section 22 of the Liquor Control Act 1968, the following Officer of Police as a Licensing Inspector for the Division of the Police District as shown:—

Division No.	Police District.	Rank and Name.
2	Flinders	Inspector Herbert Richard Rowe (from 17.10.72 to 1.11.72)

A. L. CARMICHAEL,
Deputy Commissioner of Police.

27.10.72.

RESIGNATIONS.

His Excellency the Governor of the State of Victoria, by and with the advice of the Executive Council thereof, has, by Orders made on the 31st day of October, 1972, accepted the resignations of the persons named hereunder of the offices mentioned, viz.:—

LAW DEPARTMENT.

Justice of the Peace.

JACK MONTGOMERY WHITE
as a Justice of the Peace for the State of Victoria.
Commissioners for Taking Declarations, &c.

JOHN CAREY,
WALTER GEORGE DRINKWATER,
BRUCE ROBERT LARKIN,
FREDERICK WILLIAM STORIE PAGE, and
STEPHEN REGINALD JOHN PAGRAM,
as Commissioners for taking Declarations and Affidavits, pursuant to the provisions of the Evidence Act 1958.

T. J. FORRISTAL,
Clerk of the Executive Council.

At Government House,
Melbourne, 31st October, 1972.

ORDERS IN COUNCIL

MELBOURNE UNDERGROUND RAIL LOOP ACT 1970,
No. 8023.

At Government House, Melbourne, the thirty-first day of October, 1972.

PRESENT:

His Excellency the Governor of Victoria.
Sir George Reid Mr. Dickie.
Mr. Dunstan

Whereas His Excellency the Governor of the State of Victoria by and with the advice of the Executive Council thereof has this day consented pursuant to the provisions of the Melbourne Underground Rail Loop Act 1970 to the Melbourne Underground Rail Loop Authority raising by way of a loan the sum of One million dollars (\$1,000,000); And whereas His Excellency the Governor in Council is satisfied that a sufficient proportion of the loan to be raised will fall due and be repaid in each year during the currency of the proposed loan; Now therefore it is directed pursuant to the provisions of section 16 (3) of the said Act, that it shall not be necessary to provide a sinking fund in connexion with such loan.

And the Honorable Rupert James Hamer, Her Majesty's Treasurer for the State of Victoria, shall give the necessary directions herein accordingly.

T. J. FORRISTAL,
Clerk of the Executive Council.

ROAD TRAFFIC ACT 1958.

At Government House, Melbourne, the thirty-first day of October, 1972.

PRESENT:

His Excellency the Governor of Victoria.
 Sir George Reid | Mr. Dickie.
 Mr. Dunstan

In pursuance of the powers conferred by the Road Traffic Act 1958, His Excellency the Governor of the State of Victoria, in the Commonwealth of Australia, by and with the advice of the Executive Council of the said State, and at the request in writing of the Council of the City of Camberwell, doth by this Order extend the provisions of the said Act to the area of land controlled by the City of Camberwell commencing on the western building line of Fermanagh-road 10 feet north of the north building line of Riversdale-road; thence northerly for a distance of 105 feet on a bearing of 0 deg. 01 min.; thence westerly for a distance of 60 feet on a bearing of 269 deg. 20 min.; thence southerly for a distance of 115 feet on a bearing of 180 deg. 02 min.; thence easterly for a distance of 50 feet on a bearing of 269 deg. 20 min.; thence north-easterly for a distance of 14 ft. 3 in. on a bearing of 44 deg. 41 min. to the commencement point, such land being shown by hachure on the plan hereunder.

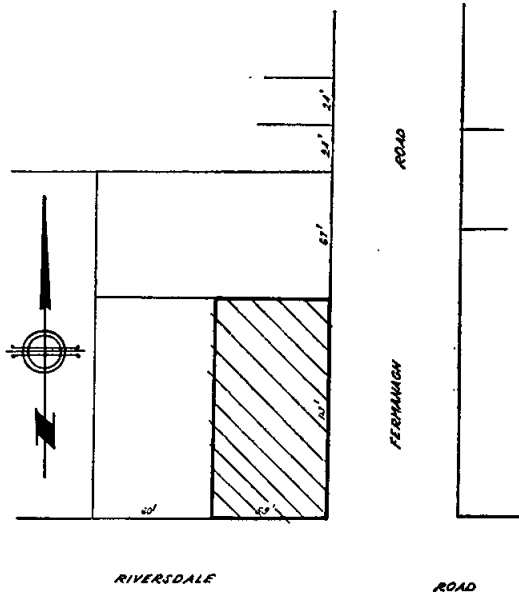

And the Honorable Edward Raymond Meagher, Her Majesty's Chief Secretary for the State of Victoria, shall give the necessary directions herein accordingly.

T. J. FORRISTAL,
 Clerk of the Executive Council.

ROAD TRAFFIC ACT 1958.

At Government House, Melbourne, the thirty-first day of October, 1972.

PRESENT:

His Excellency the Governor of Victoria.
 Sir George Reid | Mr. Dickie.
 Mr. Dunstan

In pursuance of the powers conferred by the Road Traffic Act 1958, His Excellency the Governor of the State of Victoria, in the Commonwealth of Australia, by and with the advice of the Executive Council of the said State, and at the request in writing of the Council of the City of Camberwell, doth by this Order extend the provisions of the said Act to the area of land controlled by the City of Camberwell commencing on the western building line of Butler-street at 130 feet south of the south building

line of Riversdale-road; thence southerly for a distance of 50 feet on a bearing of 180 deg. 04 min.; thence westerly for a distance of 110 feet on a bearing of 269 deg. 40 min.; thence northerly for a distance of 50 feet on a bearing of 0 deg. 04 min.; thence easterly for a distance of 110 feet on a bearing of 89 deg. 40 min. to the commencing point, such land being shown by hachure on the plan hereunder.

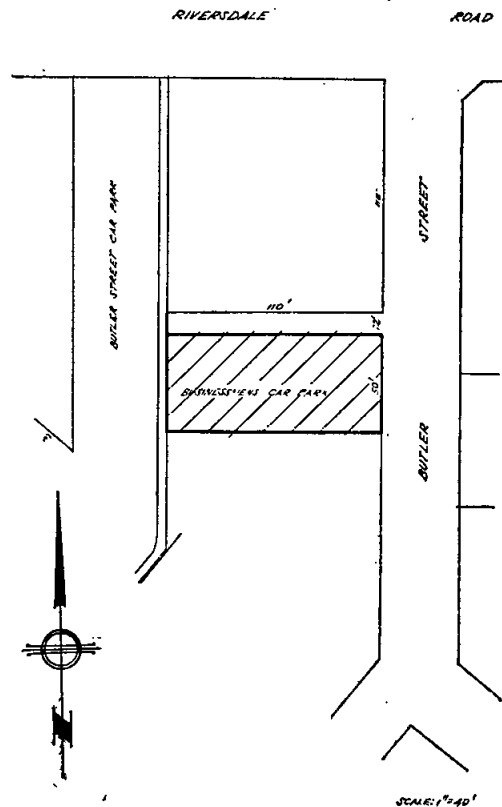

And the Honorable Edward Raymond Meagher, Her Majesty's Chief Secretary for the State of Victoria, shall give the necessary directions herein accordingly.

T. J. FORRISTAL,
 Clerk of the Executive Council.

HOUSING ACT 1958.

At Government House, Melbourne, the thirty-first day of October, 1972.

PRESENT:

His Excellency the Governor of Victoria.
 Sir George Reid | Mr. Dickie.
 Mr. Dunstan

DECLARATION OF PRIVATE STREETS AS PUBLIC HIGHWAYS WITHIN THE BOROUGH OF EAGLE-HAWK.

Whereas pursuant to section 107 of the Housing Act 1958 it is among other things enacted that where works have been carried out in accordance with an agreement for the full construction of any roads, pavements, culverts or drains made pursuant to the provisions of the said section 107 such roads, pavements, culverts or drains shall be under the care and management of the municipality which shall be liable for the cost of any maintenance, repair, alteration or reconstruction thereof and the Governor in Council may by Order published in the Government Gazette declare any road so constructed to be a public highway.

And whereas by Order dated the first day of December, 1970, the Governor in Council consented to an agreement between the Housing Commission and the Borough of Eaglehawk regarding street and drainage construction in Oswald-street, Roy-court, Meggs-court, Davies-court and

Truscott-avenue in the Eaglehawk Estate situate in the municipality of the Borough of Eaglehawk and the carrying out of the works enumerated in the said Agreement.

And whereas the works of road pavements, culvert and drainage construction have now been carried out in accordance with the said agreement between the Housing Commission and the Borough of Eaglehawk.

Now therefore His Excellency the Governor of the State of Victoria by and with the advice of the Executive Council of the said State and in pursuance of the powers conferred by section 107 of the Housing Act and upon recommendation of the Housing Commission doth by this order declare the streets more particularly delineated and shown hatched on the plan hereunder to be absolutely dedicated to the public as Public Highways within the meaning of any law now or hereafter in force and that the Council of the municipality in which the streets are situate shall hereafter be liable for all cost of any maintenance, repair, alteration or reconstruction thereof.

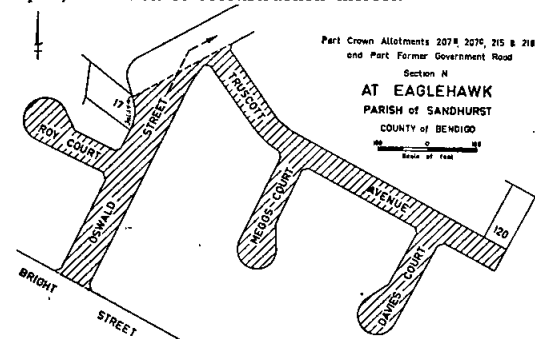

And the Honorable Vance Oakley Dickie, Her Majesty's Minister of Housing for the State of Victoria, shall give the necessary directions herein accordingly.

T. J. FORRISTAL,
Clerk of the Executive Council.

HOUSING ACT 1958.

At Government House, Melbourne, the thirty-first day of October, 1972.

PRESENT:
His Excellency the Governor of Victoria.
Sir George Reid | Mr. Dickie.
Mr. Dunstan

DECLARATION OF PRIVATE STREETS AS PUBLIC HIGHWAYS WITHIN THE CITY OF WARRNAMBOOL.

Whereas pursuant to section 107 of the Housing Act 1958 it is among other things enacted that where works have been carried out in accordance with an agreement for the full construction of any roads, pavements, culverts or drains made pursuant to the provisions of the said section 107 such roads, pavements, culverts or drains shall be under the care and management of the municipality which shall be liable for the cost of any maintenance, repair, alteration or reconstruction thereof and the Governor in Council may by Order published in the *Government Gazette* declare any roads so constructed to be a public highway.

And whereas by Order dated the thirteenth day of May, 1970, the Governor in Council consented to an agreement between the Housing Commission and the City of Warrnambool regarding street and drainage construction in Bradley-street, Osborne-court, Bateman-court and Mack-street in the Warrnambool Estate situate in the municipality of the City of Warrnambool and the carrying out of the works enumerated in the said Agreement.

And whereas the works of road pavements, culvert and drainage construction have now been carried out in accordance with the said agreement between the Housing Commission and the City of Warrnambool.

Now therefore His Excellency the Governor of the State of Victoria by and with the advice of the Executive Council of the said State and in pursuance of the powers conferred by section 107 of the Housing Act and upon recommendation of the Housing Commission doth by this order declare the streets more particularly delineated and shown hatched on the plan hereunder to be absolutely

dedicated to the public as Public Highways within the meaning of any law now or hereafter in force and that the Council of the municipality in which the streets are situate shall hereafter be liable for all cost of any maintenance, repair, alteration or reconstruction thereof.

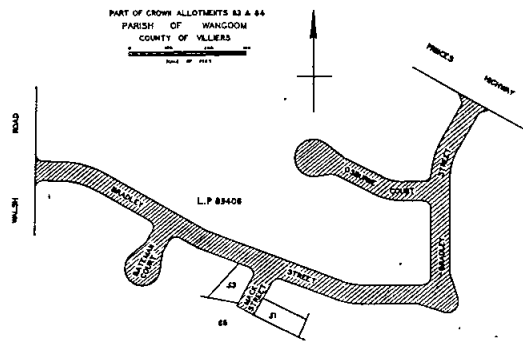

And the Honorable Vance Oakley Dickie, Her Majesty's Minister of Housing for the State of Victoria, shall give the necessary directions herein accordingly.

T. J. FORRISTAL,
Clerk of the Executive Council.

HOUSING ACT 1958.

At Government House, Melbourne, the thirty-first day of October, 1972.

PRESENT:
His Excellency the Governor of Victoria.
Sir George Reid | Mr. Dickie.
Mr. Dunstan

DECLARATION OF PRIVATE STREETS AS PUBLIC HIGHWAYS WITHIN THE CITY OF FRANKSTON.

Whereas pursuant to section 107 of the Housing Act 1958 it is among other things enacted that where works have been carried out in accordance with an agreement for the full construction of any roads, pavements, culverts or drains made pursuant to the provisions of the said section 107 such roads, pavements, culverts or drains shall be under the care and management of the municipality which shall be liable for the cost of any maintenance, repair, alteration or reconstruction thereof and the Governor in Council may by Order published in the *Government Gazette* declare any road so constructed to be a public highway.

And whereas by Order dated the first day of September, 1970, the Governor in Council consented to an agreement between the Housing Commission and the City of Frankston regarding street and drainage construction in Excelsior-drive, Monterey Boulevard, Tilia-court, Caley-street, Rosemary-crescent, Indigo-court and Ivy-court in the Frankston Forest Estate situate in the municipality of the City of Frankston and the carrying out of the works enumerated in the said Agreement.

And whereas the works of road pavements, culvert and drainage construction have now been carried out in accordance with the said agreement between the Housing Commission and the City of Frankston.

Now therefore His Excellency the Governor of the State of Victoria by and with the advice of the Executive Council of the said State and in pursuance of the powers conferred by section 107 of the Housing Act and upon recommendation of the Housing Commission doth by this order declare the streets more particularly delineated and shown hatched on the plans hereunder to be absolutely dedicated to the public as Public Highways within the meaning of any law now or hereafter in force and that the Council of the municipality in which the streets are situate shall hereafter be liable for all cost of any maintenance, repair, alteration or reconstruction thereof.

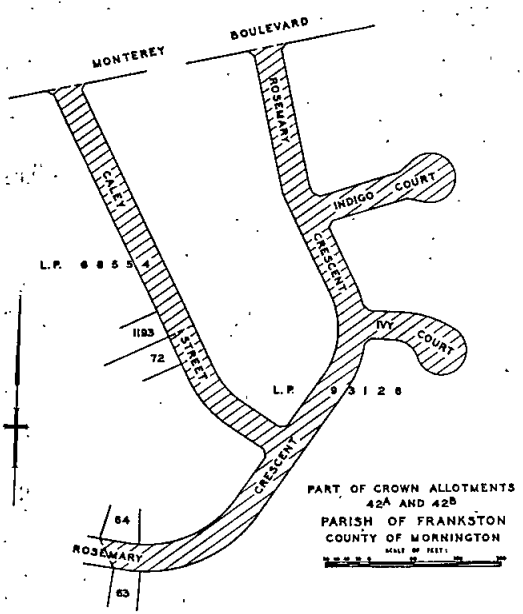
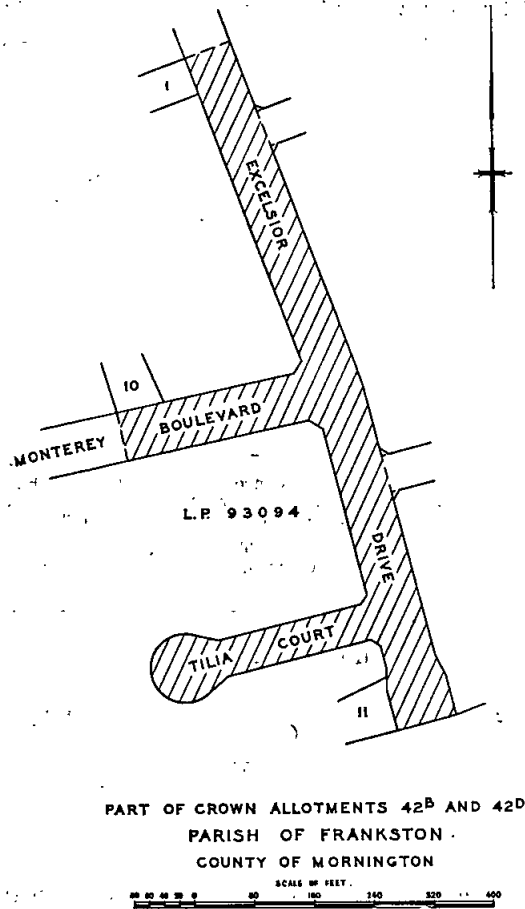

And the Honorable Vance Oakley Dickie, Her Majesty's Minister of Housing for the State of Victoria, shall give the necessary directions herein accordingly.

T. J. FORRISTAL,
Clerk of the Executive Council.

Land Act 1958.
DEPARTMENT OF CROWN LANDS AND SURVEY.

At Government House, Melbourne, the
thirty-first day of October, 1972.

PRESENT:

His Excellency the Governor of Victoria,
Sir George Reid | Mr. Dickie.
Mr. Dunstan

REVOCATION OF TEMPORARY RESERVATIONS OF
LANDS BY ORDERS IN COUNCIL.

His Excellency the Governor of the State of Victoria, by and with the advice of the Executive Council thereof, doth hereby in pursuance of the provisions of the Land Act 1958 revoke the temporary reservation of lands by Orders in Council hereinafter referred to, viz.:

LANGWARRIN.—the temporary reservation by Order in Council of the 27th August, 1907 of 38 acres 1 rood 7 perches of land in the Parish of Langwarrin, as a site for a Public Park and other purposes of Public Recreation, so far only as regards the portion thereof comprised with the boundaries published in the *Government Gazette* of the 4th October, 1972, and containing 1 rood 12 perches.—(Rs.3660) (L.16(F¹)). p. 2287

SCORESBY.—the temporary reservation by Order in Council of the 11th July, 1923, of 1 acre 2 roods 37 perches of land in the Parish of Scoresby, as a site for obtaining road-making material, so far only as regards the balance thereof comprised within the boundaries published in the *Government Gazette* of the 4th October, 1972 and containing 1 acre 22 perches.—(Rs.2739) (S.250(A⁶)).

SEDGWICK.—the temporary reservation by Order in Council of the 16th December, 1947, of 1 acre 3 roods 30 perches of land in the Parish of Sedgwick, as a site for a Public Hall and Public Recreation, so far only as regards the portion thereof comprised within the boundaries published in the *Government Gazette* of the 4th October, 1972, and containing 1 rood 20 perches.—(Rs.6071) (S.253(B³)).

SEDGWICK.—the temporary reservation by Order in Council of the 16th December, 1947, of 2 roods 20 perches of land in the Parish of Sedgwick, as a site for Water Supply purposes, so far only as regards the portion thereof comprised within the boundaries published in the *Government Gazette* of the 4th October, 1972, and containing 15 perches, more or less.—(Rs.6072) (S.253(B³)).

And the Honorable William Archibald Borthwick, Her Majesty's Minister of Lands for the State of Victoria, shall give the necessary directions herein accordingly.

T. J. FORRISTAL,
Clerk of the Executive Council.

DEPARTMENT OF CROWN LANDS AND SURVEY.

At Government House, Melbourne, the
thirty-first day of October, 1972.

PRESENT:

His Excellency the Governor of Victoria,
Sir George Reid | Mr. Dickie.
Mr. Dunstan

REVOCATION OF PERMANENT RESERVATION OF
LAND.

In pursuance of the provisions of section 15 (2) (a) of the Land Act 1958, His Excellency the Governor of the State of Victoria, by and with the advice of the Executive Council thereof, doth hereby revoke the permanent reservation of land by Order in Council hereinafter referred to, viz.:

JIKA JIKA (Carlton).—The permanent reservation by Order in Council of the 28th September, 1863, of certain sites for Common Schools, so far only as regards that site at Carlton, Parish of Jika Jika, being Crown allotments 14, 15 and 16, Section 39 (called block 39 in the Order) containing 2 roods 16 perches (see *Government Gazette* 20th October, 1863, page 2356).—(M.314(1¹)) (Rs.7210.)

And the Honorable William Archibald Borthwick, Her Majesty's Minister of Lands for the State of Victoria, shall give the necessary directions herein accordingly.

T. J. FORRISTAL,
Clerk of the Executive Council.

Land Act 1958.
DEPARTMENT OF CROWN LANDS AND SURVEY.

At Government House, Melbourne, the
thirty-first day of October, 1972.

PRESENT:
His Excellency the Governor of Victoria.
Sir George Reid, Mr. Dickie.
Mr. Dunstan

LANDS TEMPORARILY RESERVED AS SITES.

His Excellency the Governor of the State of Victoria by and with the advice of the Executive Council thereof, doth hereby, in pursuance of the provisions of section 14 of the Land Act 1958, reserve temporarily from sale, from being leased, and from having a licence granted in respect thereof, and also except from occupation for mining purposes under any miner's right the lands hereinafter described, viz.:

ARE.—Site for Public Recreation purposes, 13 acres, more or less, Parish of Aire, County of Polwarth, as indicated by hatching on plan hereunder.—(A.176⁽⁵⁾) (Rs.9653.)

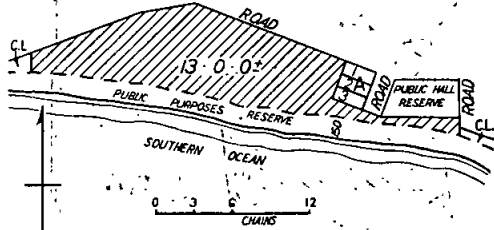

BALLARAT.—Site for Public purposes (Departmental Residence), 26 perches, Parish of Ballarat, County of Grenville as indicated by hatching on plan hereunder.—(B.126⁽¹¹⁾) (Rs.9660.)

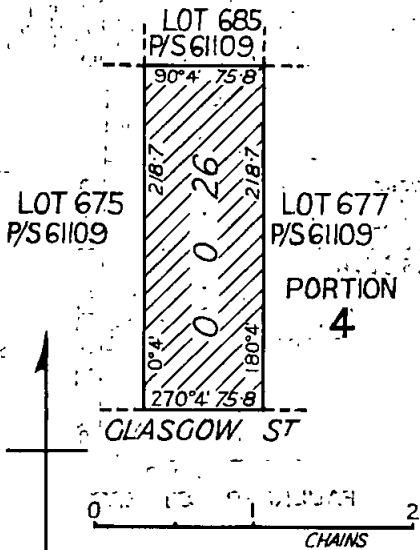

BAMBRA.—Site for Public purposes (Hall and Recreation), 1 acre 1 rood 21 perches, Parish of Bambra, County of Polwarth as indicated by hatching on plan hereunder.—(B.90(D²)) (Rs.2584.)

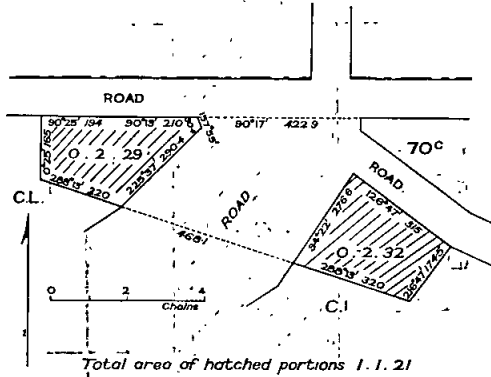

BAMBRA.—Site for Public purposes (State School Forest Plantation), 3 acres 3 roods 13 perches, Parish of Bambra, County of Polwarth as indicated by hatching on plan hereunder.—(B.90(D²)) (Rs.9675.)

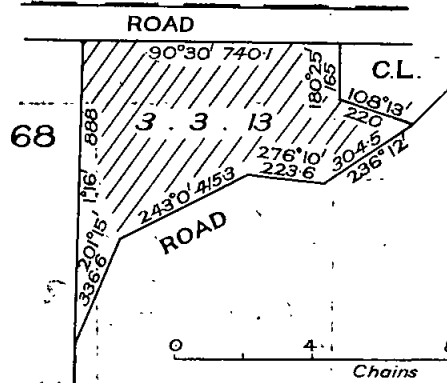

BENALLA.—Site for Public Recreation, 1 acre, 30 perches, more or less, Township of Benalla, Parish of Benalla, County of Delatite as indicated by hatching on plan hereunder.—(B.390⁽⁸⁾) (Rs.4055.)

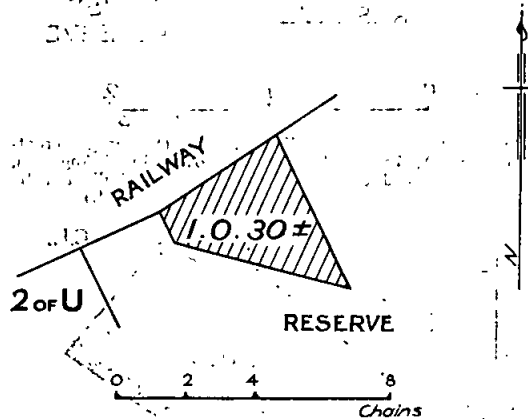

BURUPGA (Sea Lake).—Site for Public purposes (Departmental Residence), 38 perches, Parish of Burupga, County of Karkaroc, as indicated by hatching on plan hereunder.—(B.741⁽⁸⁾) (Rs.9681.)

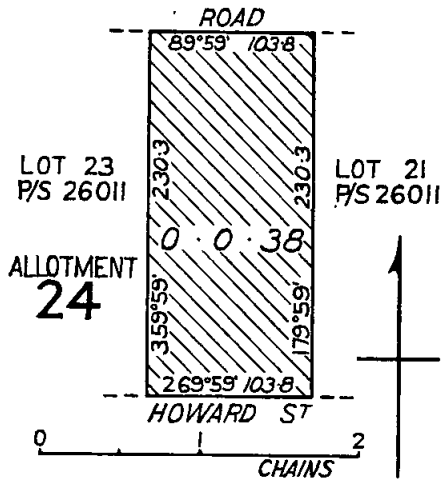

HORSHAM.—Site for Public purposes (Public Buildings), 1 rood 25 perches, more or less, Township of Horsham, Parish of Horsham, County of Borung, as indicated by hatching on plan hereunder.—(H.91⁽⁸⁾) (Rs.9253.)

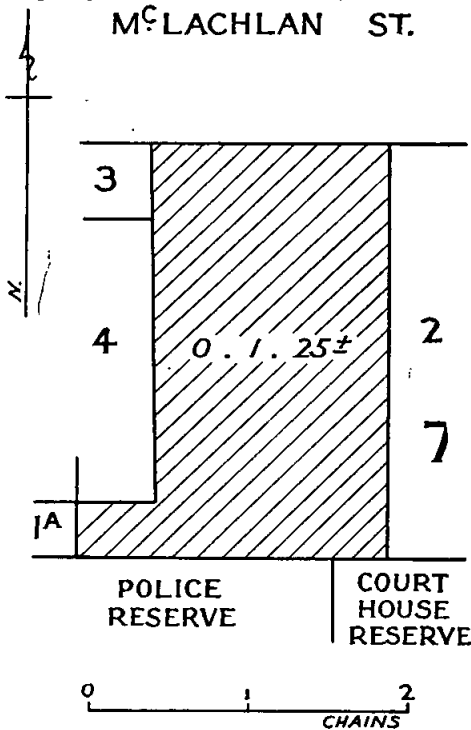

ANGLESEA.—Site for Public purposes (Sewerage Treatment Works), 5 acres, 26 perches, Township of Anglesea, Parish of Jan Juc, County of Grant, as indicated by hatching on plan hereunder.—(A183⁽³⁾) (Rs.9684.)

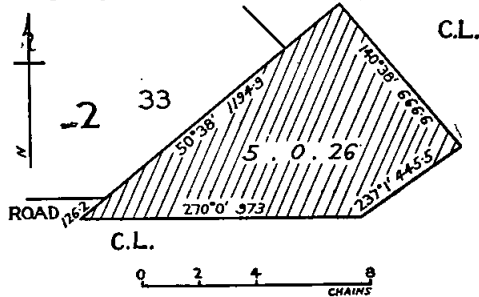

KANGERONG.—Site for Water Supply purposes, 1 rood 4 perches, Parish of Kangerong, County of Mornington, as indicated by hatching on plan hereunder.—(K.7⁽⁴⁾) (Rs.9680.)

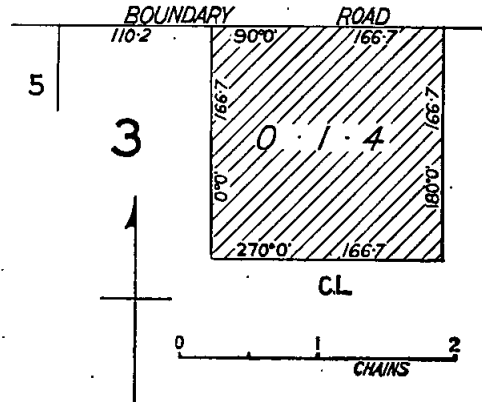

MANDURANG.—Site for Public Recreation, 2 roods 34 perches, Parish of Mandurang, County of Bendigo as indicated by hatching on plan hereunder.—(M.29⁽¹⁰⁾) (Rs.9676.)

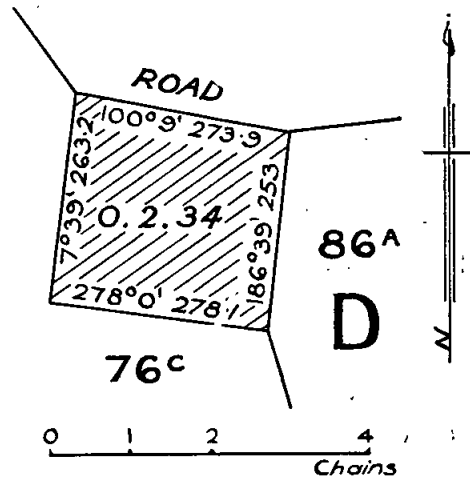

NUNAWADING (Forest Hill).—Site for Public purposes (Social Welfare Department purposes), 23 perches, Parish of Nunawading, County of Bourke as indicated by hatching on plan hereunder.—(N.79⁽⁷⁾) (Rs.9659.)

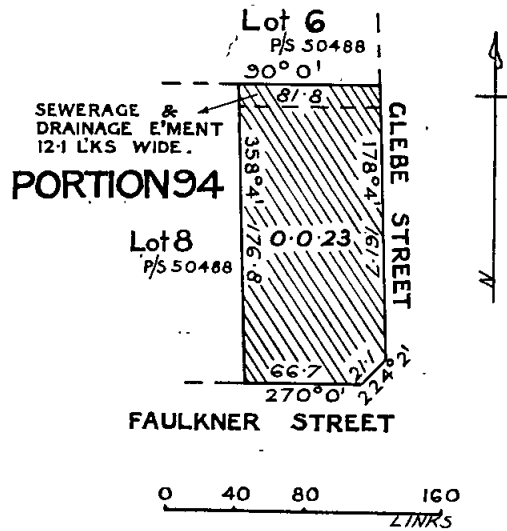

And the Honorable William Archibald Borthwick, Her Majesty's Minister of Lands for the State of Victoria, shall give the necessary directions herein accordingly.

T. J. FORRISTAL,
Clerk of the Executive Council.

LAND ACT 1958.

At Government House, Melbourne, the
thirty-first day of October, 1972.

PRESENT:

His Excellency the Governor of Victoria,
Sir George Reid | Mr. Dickie.
Mr. Dunstan |

UNUSED ROADS CLOSED.

In pursuance of the provisions of section 349 of the Land Act 1958, His Excellency the Governor of Victoria, by and with the advice of the Executive Council thereof, and the concurrences in writing of the Councils of the municipalities concerned, doth hereby close the unused roads referred to hereunder viz.:

Parish of Belvoir West, County of Bogong, being the road indicated by hatching on plan hereunder.—(B.367⁽⁴⁾) (H.029360.)

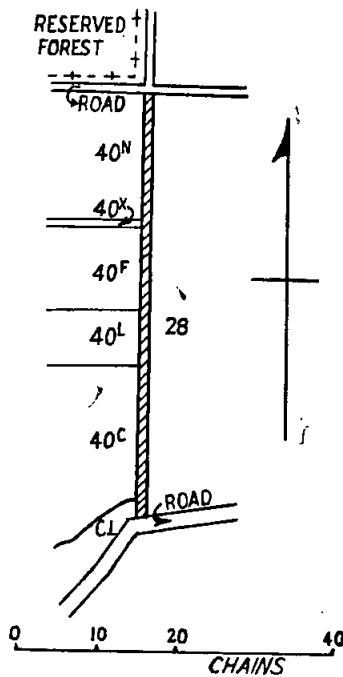

Parish of Moreep, County of Grant, being the road indicated by hatching on plan hereunder.—(M.468⁽³⁾) (C.98135.)

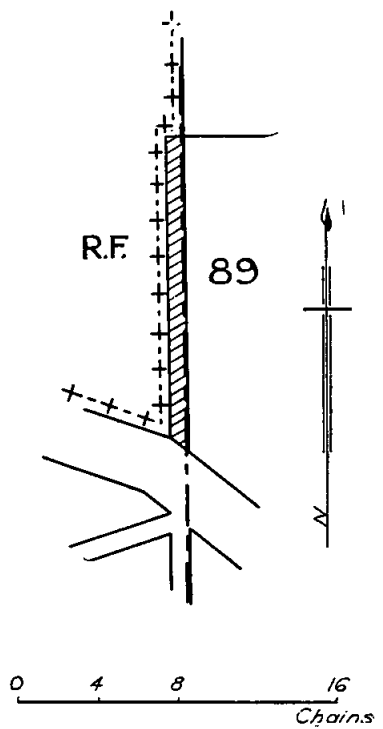
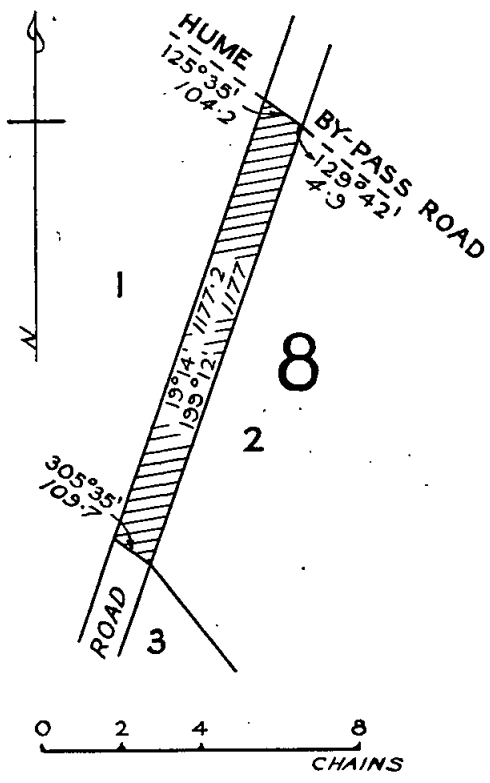

Parish of Yehrip, County of Kara Kara—being the road as indicated by hatching on plan hereunder.—(Y.83⁽²⁾) (W.88154.)

And the Honorable William Archibald Borthwick, Her Majesty's Minister of Lands for the State of Victoria, shall give the necessary directions herein accordingly.

T. J. FORRISTAL,
Clerk of the Executive Council.

COUNTRY ROADS BOARD.

At Government House, Melbourne, the thirty-first day of October, 1972.

PRESENT:

His Excellency the Governor of Victoria.
Sir George Reid | Mr. Dickie.
Mr. Dunstan

ORDER APPROVING OF LAND BEING ACQUIRED AND ROADS, DEVIATIONS OR WIDENINGS BEING MADE.

His Excellency the Governor of the State of Victoria, by and with the advice of the Executive Council thereof, being satisfied that there are funds legally available for acquiring the land, doth hereby approve the acquiring of the land described in the schedule hereunder and the making of new roads and deviations from and widenings of existing roads referred to in the said Schedule.

SCHEDULE.

State Highway

The land shown hatched on Plans numbered G.P.13137A and G.P.13137B hereunder required for the deviation from the Omeo Highway in the Shire of Towong and making of the deviation thereon.

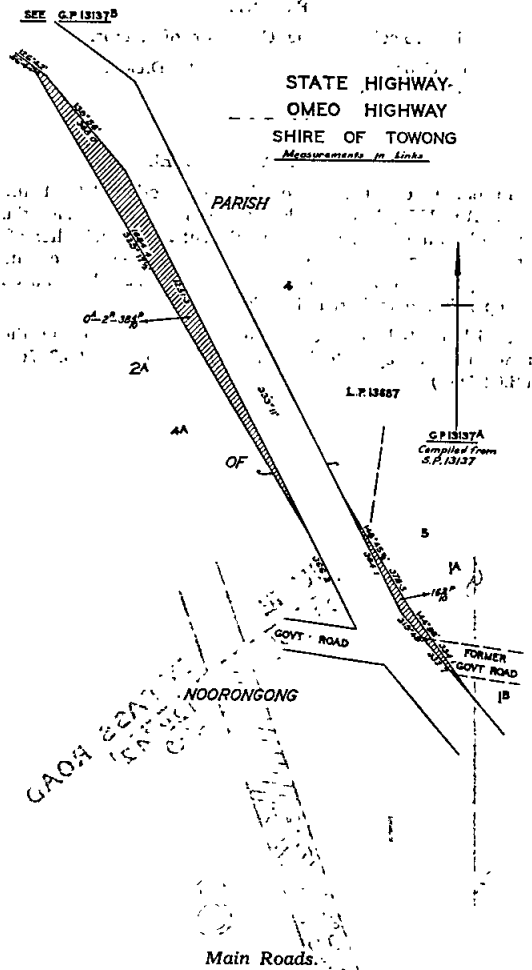
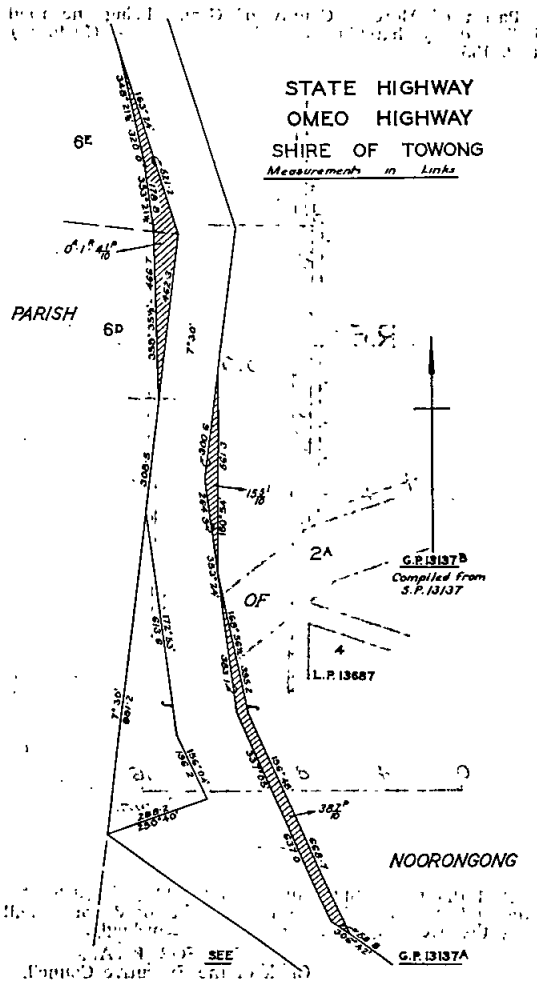

The land shown hatched on Plans numbered G.P.12957 and G.P.12958 hereunder required for the widening of the Bairnsdale-Dargo road in the Shire of Bairnsdale and making of the widening thereon.

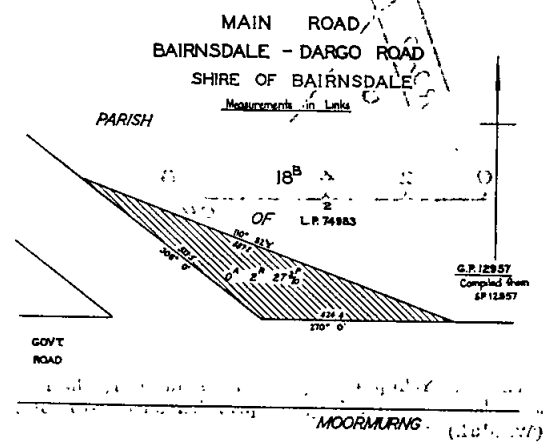

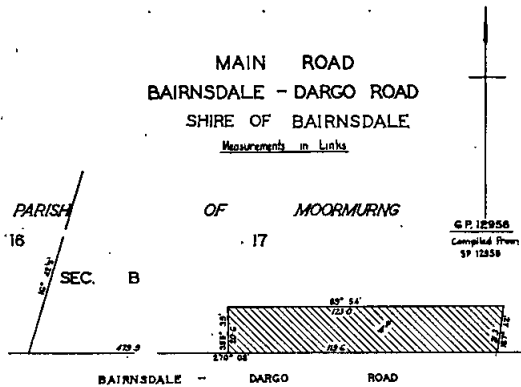

The land shown hatched on Plan numbered G.P.13073 hereunder required for the widening of Mount Dandenong-road in the City of Croydon and making of the widening thereon.

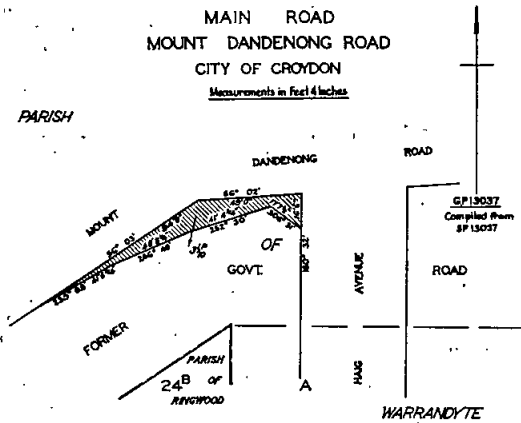

The land shown hatched on Plan numbered G.P.12915 hereunder required for the widening of Marlo-road in the Shire of Orbost and making of the widening thereon.

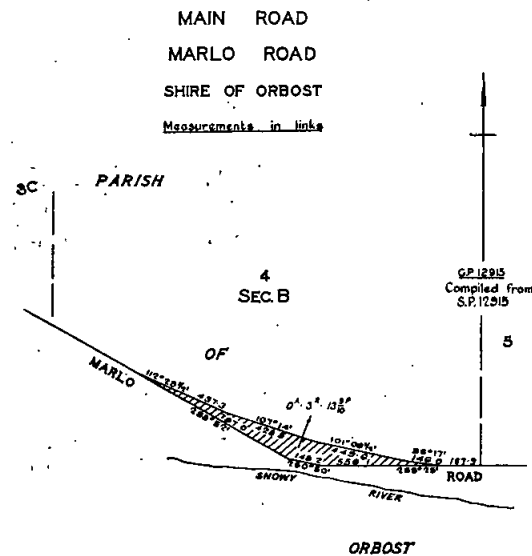

The land shown hatched on Plan numbered G.P.13047 hereunder required for the widening of the Seymour-Tooborac road in the Shire of Seymour and making of the widening thereon.

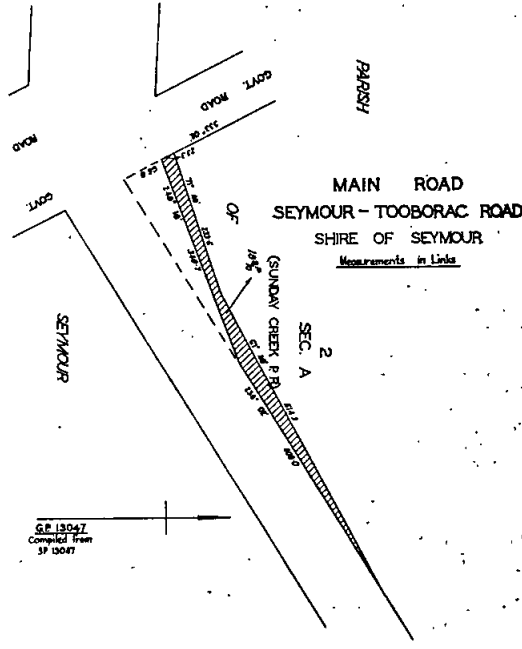

And the Honorable Alan John Hunt, Her Majesty's Minister for Local Government for the State of Victoria, shall give the necessary directions herein accordingly.

T. J. FORRISTAL,
Clerk of the Executive Council.

COUNTRY FIRE AUTHORITY ACT 1958.

At Government House, Melbourne, the thirty-first day of October, 1972.

PRESENT:

His Excellency the Governor of Victoria.
Sir George Reid | Mr. Dickie.
Mr. Dunstan

CONSENT TO BORROWING ONE HUNDRED THOUSAND DOLLARS BY THE COUNTRY FIRE AUTHORITY.

Whereas by section 82 of the Country Fire Authority Act 1958, it is enacted that the Country Fire Authority with the consent of the Governor in Council may, from time to time, borrow such moneys as it deems necessary in order to enable it to carry out and perform the powers, authorities and duties vested in or conferred or imposed upon it by the said Act:

And whereas the Country Fire Authority deems it necessary to borrow the sum of One hundred thousand dollars for the purposes aforesaid:

Now therefore, His Excellency the Governor of the State of Victoria, in the Commonwealth of Australia, by and with the advice of the Executive Council of the said State and in pursuance of the powers conferred by the said section 82 of the Country Fire Authority Act 1958 and all other powers him thereunto enabling, doth by this order consent to the borrowing by the Country Fire Authority of the sum of \$100,000 (One hundred thousand dollars) for a period of Twenty (20) years to be liquidated by half yearly repayments of the sum of Four thousand four hundred and sixty-seven dollars twenty cents (\$4,467.20) being proportion of the principal and interest at the rate of 6.4 per centum per annum, such sum being payable at Melbourne on the last day of each half year period during the term of the loan.

And the Honorable Edward Raymond Meagher, Her Majesty's Chief Secretary for the State of Victoria, shall give the necessary directions herein accordingly.

T. J. FORRISTAL,
Clerk of the Executive Council.

HOSPITALS AND CHARITIES ACT 1958, SECTION 5 (3).

At Government House, Melbourne, the thirty-first day of October, 1972.

PRESENT:

His Excellency the Governor of Victoria.
Sir George Reid | Mr. Dickie.
Mr. Dunstan

Whereas the corporate name of the institution known as the Glenelg Base Hospital has been changed to Hamilton Base Hospital;

And whereas such change has been approved by the Hospitals and Charities Commission;

And whereas such change and approval has been notified in the *Government Gazette* No. 87 of the 4th October, 1972, on page 3256;

And whereas pursuant to sub-section (3) of section 5 of the *Hospitals and Charities Act 1958* (No. 6274) the Governor in Council may by Order published in the *Government Gazette* declare that the name of any institution referred to in the Second Schedule of that Act has been changed and thereupon the said Schedule may be deemed to be amended accordingly;

Now therefore His Excellency the Governor of the State of Victoria, by and with the advice of the Executive Council of the said State, doth hereby declare that the name of the institution referred to in the Second Schedule of the *Hospitals and Charities Act 1958* as the Glenelg Base Hospital has been changed to Hamilton Base Hospital and the Second Schedule shall be deemed to be amended accordingly.

And the Honorable John Frederick Rossiter, Her Majesty's Minister of Health for the State of Victoria, shall give the necessary directions herein accordingly.

T. J. FORRISTAL,
Clerk of the Executive Council.

MARINE STORES AND OLD METALS ACT 1958.

At Government House, Melbourne, the thirty-first day of October, 1972.

PRESENT:

His Excellency the Governor of Victoria.
Sir George Reid | Mr. Dickie.
Mr. Dunstan

Whereas by section 4 of the *Marine Stores and Old Metals Act 1958* it is enacted that the Governor in Council may from time to time upon the petition of any Shire Council within Victoria make an Order directing that the provisions of Part II. of the said Act shall be extended to that Shire;

And whereas the Council of the Shire of Kara Kara has petitioned the Governor in Council to extend the provisions of Part II. of the said Act to the Shire of Kara Kara;

Now therefore His Excellency the Governor of the State of Victoria, in the Commonwealth of Australia, by and with the advice of the Executive Council of the said State, doth hereby direct that the provisions of Part II. of the *Marine Stores and Old Metals Act 1958* shall be extended to and shall be in force from the first day of December, 1972, within and throughout the boundaries of the Shire of Kara Kara.

And the Honorable Edward Raymond Meagher, Her Majesty's Chief Secretary for the State of Victoria, shall give the necessary directions herein accordingly.

T. J. FORRISTAL,
Clerk of the Executive Council.

LANDS DEPARTMENT NOTICES

APPROACHING LAND SALES.

Sale of Crown Land, in fee-simple, will be held at the under-mentioned places and dates, viz.:—

	No. of Gazette.
Bendigo.—Tuesday, 19th December, 1972	96
Natimuk.—Thursday, 23rd November, 1972	88

SALE OF CROWN LAND BY AUCTION.

The land will be offered for sale in fee-simple, and subject to the provisions of the Land Act and Regulations thereunder.

The upset price is the sum at which bidding will start, and no bid below that sum can be accepted. The highest bidder at or above that sum shall be the purchaser, subject to signature of contract and any necessary payment.

TERMS:

A deposit of at least 12½% of the purchase price must be paid at the sale, either in cash or by cheque.

The residue is payable in half-yearly instalments, in accordance with the following scale, or may be paid off at any earlier time.

Over \$40, and not exceeding \$100,	8 instalments.
Over \$100, and not exceeding \$200,	10 instalments.
Over \$200, and not exceeding \$400,	12 instalments.
Over \$400, and not exceeding \$600,	14 instalments.
Over \$600, and not exceeding \$800,	16 instalments.
Over \$800, and not exceeding \$1,000,	18 instalments.
Over \$1,000,	20 instalments.

Interest at the rate of 5% per annum is payable with all payments of residue, and is computed for each instalment from the date of sale to the date of such payment. Additional interest is charged if any instalment is not paid on or before the due date.

If paid off within 30 days of sale, no interest is payable. FEES, ETC.:

Also payable at the sale, in addition to the deposit, are the survey fee and, if applicable, the valuation of improvements (if purchaser be not the owner thereof).

Payable with balance of purchase money—

Crown Grant fee—\$3.

Assurance Fund Contribution.—One cent in every Five dollars or part thereof of purchase price. (This is a fund established to guarantee the validity of freehold titles.)

Transfer of interest prior to completion of payment may be allowed on payment of \$2 fee and subject to stamp duty.

If unable to attend personally, a prospective purchaser may arrange for another person to bid as his agent.

Attention is drawn to section 95, *Land Act 1958*, which provides that the purchaser shall be deemed to be the owner for the purposes of other Acts; also to an amendment to the Local Government Act providing for Government roads in certain circumstances, to be declared "private streets", thus making the purchaser liable to contribute to the cost of street construction.

W. BORTHWICK,
Minister of Lands.

Office of Crown Lands and Survey,
Melbourne, 8th November, 1972.

BENDIGO.—Sale (No. 12140) of Crown land in fee-simple, by auction, will be held at the SOLDIER'S MEMORIAL HALL, PALL MALL, BENDIGO, on TUESDAY, the 19TH day of DECEMBER, 1972, at Ten o'clock a.m. To be conducted by T. A. COMTE, Land Officer, Bendigo.

Lot 1.

AT EAGLEHAWK, PARISH OF NERRING, COUNTY OF BENDIGO.

Fronting the west side of Kirkwood-road about 4 chains north-east of Honeysuckle-street.

Upset price \$450 the lot. Survey fee \$55.

Area 1r. 38p., allotment 332A of section A. Subject to State Electricity Commission Easement 36 links wide.

NOTE.—Subject to the Borough of Eaglehawk Planning Scheme.—(W.90271.)

Lot 2.

AT EAGLEHAWK, PARISH OF SANDHURST, COUNTY OF BENDIGO.

Fronting the west side of Willan-street about 3 chains north of Bright-street.

Upset price \$700 the lot. Survey fee \$55.

Area 1r. 12p., allotment 7A of section 39.—(W.90371.)

Lot 3.

AT EAGLEHAWK, PARISH OF SANDHURST, COUNTY OF BENDIGO.
Fronting the south side of Simpsons-road about 11 chains
north-east of Butts-road.

Upset price \$400 the lot. Survey fee \$12.

Area 34 perches, allotment 299A of section N. Valuation
of improvements \$1,600 (House and shed) (W. H. Crawford).—(W.89623.)

Lot 4.

AT BENDIGO, PARISH OF SANDHURST, COUNTY OF BENDIGO.

At the south-east corner of Wilmot and Pallett streets.

Upset price \$650 the lot. Survey fee \$15.

Area 2r. 33p., allotment 18c of section 41b. Subject to
drainage easement 25 links wide through allotment.—
(W.90192.)

Lot 5.

PARISH OF SANDHURST, COUNTY OF BENDIGO.

Fronting the south side of a Government road about
4 chains west of Spring Gully State School Reserve.

Upset price \$225 the lot. Survey fee \$50.

Area 32 perches, allotment 267c of section H. Subject to
Shire of Strathfieldsaye Planning Scheme.—(W.90644.)

Lot 6.

PARISH OF SANDHURST, COUNTY OF BENDIGO.

At the eastern corner of Maiden Gully-road and Albert-
street.

Upset price \$350 the lot. Survey fee \$60.

Area 3r. 9p., allotment 604g of section M. Subject to
drainage easement 15 links wide and Shire of Marong
Planning Scheme.—(W.90408.)

Lot 7.

TOWNSHIP OF EDDINGTON, PARISH OF EDDINGTON, COUNTY OF
TALBOT.

Fronting the north side of Playfair Street about 2 chains
west of Hector-street.

Upset price \$165 the lot. Survey fee \$15.

Area 2r. 35p., allotment 8 of section 7.

Lot 8.

At the north-west corner of Hector and Playfair streets.

Upset price \$165 the lot. Survey fee \$15.

Area 2r. 35p., allotment 9 of section 7.

Lot 9.

At the south-west corner of Murchison and Hector streets.

Upset price \$420 the lot. Survey fee \$19.25.

Area 5a. 0r. 20p., allotment 10 of section 7.

Lot 10.

Fronting the north side of Playfair-street.

Upset price \$600 the lot. Survey fee \$19.25.

Area 8a. 1r. 2p., allotment 11 of section 7.—(W.88036.)

Lot 11.

TOWNSHIP OF INGLEWOOD, PARISH OF INGLEWOOD, COUNTY OF
GLADSTONE.

At the south corner of Weeah-street and Tarnagulla-road.

Upset price \$100 the lot. Survey fee \$16.

Area 1a. 0r. 21p., allotment 24 of section 19. One month
allowed for removal of improvements.—(W.90606.)

Lot 12.

PARISH OF RUNNYMEDE, COUNTY OF RODNEY.

Being the former Colbinabbin West State School in the
south-east corner of the Parish.

Upset price \$190 the lot. Survey fee \$70.

Area 2 acres, allotment 123A.

NOTE.—Improvements comprise old school building, the
valuation of which is included in the upset price.—
(W.89926.)

PROPOSED REVOCATION OF TEMPORARY RESERVATION OF LAND BY ORDER IN COUNCIL.

In pursuance of the provisions of the Land Act 1958,
notice is hereby given that it is the intention of the
Governor in Council to revoke the temporary reservation
of land by Order in Council hereunder referred to,
viz.:

The following Notice was published 1° on the 25th Octo-
ber, 1972, pursuant to Order of the 17th October, 1972.

BUMBANG (ROBINVALE).—The temporary reservation by
Order in Council of the 22nd April, 1964, of 100 acres, more
or less, of land in the Parish of Bumbang, as a site for an
Aircraft Landing Ground is about to be revoked.—
(B.660^(s)) (Rs.8283).

W. BORTHWICK,
Minister of Lands.

PROPOSED REVOCATION OF TEMPORARY RESERVATION OF LAND BY ORDER IN COUNCIL.

In pursuance of the provisions of the Land Act 1958,
notice is hereby given that it is the intention of the
Governor in Council to revoke the temporary reservation
of land by Order in Council hereunder referred to, viz.:

The following Notice was published 1° on the 1st
November, 1972, pursuant to Order of the 24th October,
1972.

SANDHURST (BENDIGO).—The temporary reservation as
a site for Water Channel and the withholding from sale,
leasing and licensing by Order in Council of the 1st
October, 1877, of 1 rood 14 4/10 perches of land in the
City of Sandhurst (now at Bendigo, Parish of Sandhurst),
revoked as to part by Order of the 3rd August, 1971, are
about to be revoked so far only as the portion containing
9 perches, indicated by hatching on plan hereunder, is
concerned.—(S.372^(11s)) (C.96931).

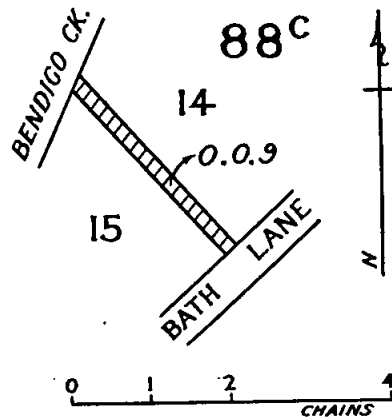

W. BORTHWICK,
Minister of Lands.

PROPOSED REVOCATIONS OF TEMPORARY RESERVATIONS OF LANDS BY ORDERS IN COUNCIL.

In pursuance of the provisions of the Land Act 1958,
notice is hereby given that it is the intention of the
Governor in Council to revoke the temporary reservations
of lands by Orders in Council hereunder referred to,
viz.:

The following Notices were published 1° on the 8th
November, 1972, pursuant to Orders of the 31st October,
1972.

KEELBUNDORA.—The temporary reservation by Order in
Council of the 23rd April, 1912, of 1,289 acres of land in
the Parish of Keelbundora, as a site for a Mental Hos-
pital, revoked as to part by various Orders, is about to
be revoked so far as the balance thereof, containing 653
acres 3 roods 9 2/10 perches, more or less, is concerned.—
(K.25^(s)) (Rs.1436).

KEELBUNDORA.—The temporary reservation by Order in
Council of the 31st May, 1966, of 11 acres 0 roods 35
perches of land in the Parish of Keelbundora, as a site
for Mental Hospital purposes, is about to be revoked.—
(K.25^(s)) (Rs.1436).

KEWELL WEST (WALLUP EAST).—The temporary reserva-
tion by Order in Council of the 21st December, 1960, of
3 acres, more or less, of land in the Parish of Kewell
West, as a site for State School purposes, is about to
be revoked.—(K.127⁽¹¹⁾) (Rs.8005).

TRUGANINA.—The temporary reservation as a site for
Quarry and for affording access to water and the with-
holding from sale, leasing and licensing by Order in
Council of the 26th February, 1877, of 6 acres, more or
less, of land in the Parish of Truganina, are about to be
revoked.—(T.109^(e)) (Rs.8139).

BALMATTUM.—The temporary reservation by Order in Council of the 7th August, 1928, of 2 acres 0 roods 14 perches of land in the Parish of Balmattum, as a site for Public purposes (State School Forest Plantation), is about to be revoked.—(B.68(*) (Rs.3691).

LAURISTON.—The temporary reservation by Order in Council of the 24th April, 1888, of 2 roods of land in the Village of Lauriston (now Township of Lauriston), as a site for a State School, is about to be revoked.—(L.32(*) (Rs.7015).

WATCHUPGA.—The temporary reservation by Order in Council of the 23rd September, 1935, of 1 rood 5/10 perches of land in the Parish of Watchupga, as a site for Public Hall, is about to be revoked.—(W.392(*) (Rs.4480).

WATCHUPGA.—The temporary reservation by Order in Council of the 27th May, 1903, of 1 acre of land in the Parish of Watchupga, as a site for a State School and the temporary reservation by Order of the 21st February, 1928, of 2 acres of land as an addition thereto, revoked as to part by Order of the 9th September, 1935, are about to be revoked, so far as the balance thereof, containing 2 acres 2 roods 34/10 perches, is concerned.—(W.392(*) (Rs.2369).

LEONGATHA.—The temporary reservation by Order in Council of the 21st May, 1912, of 40 acres of land in the Parish of Leongatha, as a site for the purposes of an Agricultural High School, revoked as to part by Order of the 19th September, 1950, is about to be revoked, so far only as the portion containing 12 perches, indicated by hatching on plan hereunder, is concerned.—(L.167(*) (Rs.1332).

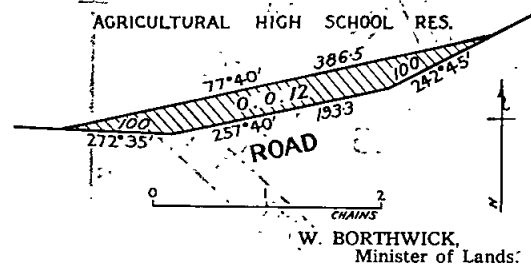

COMMITTEES OF MANAGEMENT OF RESERVES.

APPOINTMENTS.

Notice is hereby given that in pursuance of section 221 of the Land Act 1958, the following appointments of Committees of Management of reserved Crown lands have been made by the Minister of Lands:—

"SWIFT'S CREEK CAMPING RESERVE."

The Corporation of the Shire of Omeo as the Committee of Management of the land in the Parish of Tongio-Munjee-East temporarily reserved by Order in Council dated the 27th April, 1955, as a site for Public Purposes together with the abutting permanent reserve, such lands being together known as the "Swift's Creek Camping Reserve".—(Corres. No. Rs.7361.)

PUBLIC PURPOSES (SUPPLY OF GRAVEL) RESERVE, PARISH OF NARRAWONG.

The Corporation of the Shire of Portland as the Committee of Management of the land in the Parish of Narrawong temporarily reserved by Order in Council dated the 22nd August, 1972, as a site for Public Purposes (Supply of Gravel).—(Corres. No. Rs.4760.)

W. BORTHWICK,

Minister of Lands.

Department of Crown Lands and Survey,
Melbourne, 2nd November, 1972.

REGULATIONS FOR THE CARE, PROTECTION AND MANAGEMENT OF CERTAIN LAND TEMPORARILY RESERVED FOR NATIONAL PARKS PURPOSES.

I, William Archibald Borthwick, Her Majesty's Minister of Lands in and for the State of Victoria, in pursuance of the powers conferred on me by section 218 of the Land

Act 1958 do hereby make the following Regulations for or with respect to the land referred to in the Schedule hereunder (hereinafter referred to singly as "the Reserve"):

SCHEDULE.

Lands of the Crown deemed pursuant to section 5 (5) of the National Parks Act 1970 to be temporarily reserved as a site for a National Park—"Jordan's Block", allotments 37, 37A and 38, Parish of Woraigworm (199 acres 3 roods and 34 perches). (National Parks reference: 7/24/9.2.) (Lands reference: Rs.7401.)

Clarke's Block, Crown allotments 8, 10 and 11, section 19, Township of Kiata (4 acres 0 roods and 19 perches). Lands of the Crown deemed pursuant to section 5 (5) of the National Parks Act 1970 to be temporarily reserved as a site for a National Park. (National Parks reference: 7/24/9.7.) (Lands reference: Rs.7401.)

Lands of the Crown temporarily reserved as a site for Public purposes (purposes of the National Parks Service) by Order in Council dated the 16th November, 1971, 5 acres, Township of Kiata, as indicated by plan on page 3707 of the Government Gazette of the 24th November, 1971. (National Parks reference: 7/24/9.7.) (Lands reference: Rs.9562.)

An area of 35 perches in the Township of Port Campbell (part Crown allotment 9, section 6) temporarily reserved as a site for Public purposes (National Parks Services purposes) by Order in Council dated the 9th April, 1968, and as notified in the Government Gazette of the 19th April, 1968, on page 1212. (National Parks reference: 5/2/5.) (Lands reference: Rs.8915.)

An area of 36 perches in the Township of Port Campbell (being former Police Station in Morris-street), temporarily reserved as a site for Public purposes (National Parks Services purposes) by Order in Council dated the 19th December, 1967, and as notified in the Government Gazette dated the 10th January, 1968, on page 49. (National Parks reference: 5/21/5.1.) (Lands reference: Rs.8915.)

Land referred to in a letter dated 2nd August, 1965, from the Secretary, Public Works Department, to the Secretary for Lands, that is, lot 2, being part of Crown allotment 4, Parish of Mallacoota, and being part of the land described in certificate of title, volume 7240, folio 854. (National Parks reference: 5/12/5.) (Lands reference: C.99743.)

An area of 38 acres 1 rood and 4 perches or thereabouts being part of Crown allotment 4, section 4, Parish of Wau Wauka and being the land described in the Register Book of the Office of Titles, volume 8165, folio 796 (deemed to be temporarily reserved as a site for a National Park, pursuant to section 5 (5) of the National Parks Act 1970). (National Parks reference: 7/12/9.2.) (Lands reference: C.97287.)

Purchased land in the Parish of Scoresby deemed to be temporarily reserved pursuant to section 5 (5) of the National Parks Act 1970, being lot Nos. 570, 841 and 857 on Plan of Subdivision No. 26962. (National Parks reference: 7/5/9.3.) (Lands reference: Rs.142A.)

Purchased land in the Township of Port Campbell, being Crown allotment 6, section 10, deemed to be temporarily reserved, pursuant to section 5 (5) of the National Parks Act 1970. (National Parks reference: 7/21/9.3.) (Lands reference: Rs.2308.)

Land in the Parish of Scoresby, County of Mornington reserved as a site for a National Park by Order in Council, dated the 21st December, 1971, and as is indicated by hatching on plan published on page 24 of the Government Gazette of the 7th January, 1972. (National Parks reference 7/5/9.2.) (Lands reference: Rs.142.)

REGULATIONS.

- The Director of National Parks or his authorized officers are empowered to have carried out such works and improvements considered necessary for the management of the Reserve as a site for a national park and for the control of the public within the Reserve.
- Without the consent, in writing, of the Director of National Parks or his authorized officers, no person shall—
 - Camp within the Reserve or light or maintain any fire therein.
 - Deposit any rubbish, debris or material of any kind.
 - Interfere with or remove or damage or destroy any tracks, signs, buildings, or any improvements or structures in the Reserve.
 - Deposit on or construct within the Reserve any fence, shed, structure or equipment. Any fence, shed, structure or other equipment located within the Reserve without permission will be dismantled and removed from the Reserve.

(e) Carry a firearm of any description or any weapon or instrument capable of discharging a missile, shoot at, or kill, or injure any animal, bird or other wildlife in the Reserve.

(f) Carry any poison, traps or snares in the Reserve.

(g) Poison, trap, snare, catch or otherwise destroy, interfere with or disturb any bird or other animal, or have in his or her possession any skin, egg, feathers or nests or part thereof in or from the Reserve.

(h) Bring or allow any animal of any kind into the Reserve. Any dog shall be liable to be destroyed. Any "cattle" as defined by section 3 of the Pounds Act 1958, found trespassing within the Reserve shall be liable to be impounded.

(i) Pluck, cut, dig, pick up, damage or otherwise interfere with or have in his or her possession the whole or any part of any shrubs, flowers, grasses, trees or plants of any kind.

(j) Dig or remove any sand, soil or other material in or from the Reserve.

(k) Drive any vehicle on the reserve other than on a road or roads provided for the purpose.
Given under my hand, at Melbourne, on the 3rd day of November, 1972.

W. BORTHWICK,
Minister of Lands.

Every person who contravenes or fails to comply with these Regulations shall, in accordance with the provisions of section 218 of the Land Act 1958, for each offence be liable to a penalty of not more than Fifty Dollars, and every person who contravenes or fails to comply with any such Regulations, and who, after he has been warned by any bailiff of Crown lands or by any member of the Police Force, does not desist therefrom may be forthwith apprehended by such Bailiff or member of the Police Force and taken before some justice to be dealt with according to law and shall be liable to a penalty of not more than One Hundred Dollars, provided that every person who contravenes any regulation may under the said section for or with respect to prohibiting the depositing and leaving of any unwanted material or thing or rubbish of any kind on any land to which this section relates shall for each offence be liable to a penalty of not more than Two Hundred Dollars.

Land Act 1958.

LEASE SURRENDERED.

Notice is hereby given that the Governor in Council has accepted the surrender of the Lease mentioned in the schedule hereunder for the reason specified.

District.	Corr. No.	Name.	Section of Land Act under which Leased.	Parish.	Allotment.	Section.	Area.	Reason.
Mallee	1231/241	State Rivers and Water Supply Commission	241	Waitchie	Part former Mallee allot. B.		A. R. P. 13 0 8	Lease surrendered— Selection in Purchase Lease to issue.

Department of Crown Lands and Survey,
Melbourne, 31st October, 1972

W. BORTHWICK,
Minister of Lands.

Land Act 1958.

LEASES DECLARED VOID.

Notice is hereby given that the Governor in Council has declared void the Leases mentioned in the Schedule hereunder for the reason specified in each case.

District.	Corr. No.	Name.	Section of Land Act under which Leased.	Parish.	Allotment.	Section.	Area.	Annual Rental.	Reason.
Echuca	2048/134	M. O'Leary, A. R. King and W. P. Rabbitt	134	Rochester West	8	1A	A. R. P. 0 0 24	\$ 10	Non-payment of rental
Kerang	2182/134	M. Leeninga	134	Kunat Kunat	6A	2	23 0 0	800	Non-payment of rent.
Melbourne	0716/134	Penthill House Pty. Ltd.	134	Wonthaggi	4C	117	4 2 9	2,575	To be purchased under provisions of Section 378 Land Act
Mallee	10/134	Cheetham Limited	134	Portion of Lake Tyrell abutting frontage to allotments 8, 17 and 27 Parish of Bourka			1900 0 0	200	Lease expired as at 31st August, 1972
Mallee	11/134	Cheetham Limited	134	Portion of Lake Tyrell abutting frontage to allotments 5, 6, 27 and 28, Parish of Bimbourie allotment 67, Parish of Pier Millan			2470 0 0	150	Lease expired as at 31st August, 1972

Department of Crown Lands and Survey,
Melbourne, 31st October, 1972

W. BORTHWICK,
Minister of Lands.

TENDERS

Tuesday, 21st November, 1972.

PUBLIC WORKS DEPARTMENT

Tenders will be received at Public Works Department, 2 Treasury-place, Melbourne, until **TWO** p.m. on dates shown and for purposes mentioned hereunder.

Particulars and tender forms available at Contracts Office, Room 8, Building Division, Parliament-place and at places indicated in brackets hereunder.

Abbreviations in brackets mean:—W.O.—Inspector of Works Office; P.S.—Police Station; C.S.—Consolidated School; H.E.S.—Higher Elementary School; H.S.—High School; Pr.S.—Primary School; T.S.—Technical School.

Tenders to be submitted on the Department's printed Tender Form and will not be received by telephone. All tenders must be on a "Firm Tender" basis. The lowest or any tender will not necessarily be accepted.

Address tenders to the Minister of Public Works, and endorse the envelope containing the tender "Tender for closing Tuesday."

Hand delivered tenders to be placed in the Tender Box of the Public Works Department, located on the wall of the centre entrance foyer, Ground Floor, 2 Treasury-place, Melbourne.

No preliminary deposit is required with any tender, but a successful tenderer will be required to pay a deposit for any accepted tender of \$4,000 or over.

Tuesday, 14th November, 1972.

Building, Electrical and Mechanical Works.

BUNDOORA.—Remodelling wards S8, S9, S10 and S11, Kingsbury Training Centre.

BUNINYONG.—External and internal renovations, Court House. (W.O., Ballarat, and P.S., Buninyong.)

FOOTSCRAY NORTH.—Electrical services—Demonstration Unit, Pr.S.4160.

FOOTSCRAY NORTH.—Mechanical services—Demonstration Unit, Pr.S.4160.

MALMSBURY.—Electrical services—Gymnasium, Youth Training Centre. (W.O., Ballarat and Bendigo.)

MALMSBURY.—Mechanical services—Gymnasium, Youth Training Centre. (W.O., Ballarat and Bendigo.)

MERRIGUM.—External repairs and painting, Pr.S.1874. (W.O., Shepparton.)

NUMURKAH.—Internal and external renovations, H.S. (W.O., Shepparton.)

SHEPPARTON.—Internal and external renovations, H.S. (W.O., Shepparton.)

SUNBURY.—Reblocking, repairs and renovations, Mental Hospital Residence.

VARIOUS.—Supply and installation of L.P. gas services in portable classrooms 1972/73, Pr.S., Technical and High Schools.

VARIOUS.—Additional classrooms etc., Bulk Contract 1972/73, Part 2, Western Region, Pr.s. (W.O., Ballarat, Geelong and Maryborough.)

Furniture and Furnishings.

COLLINGWOOD.—Built-in fitments, Education Centre.

PRESTON EAST.—Benches and cupboards, T.S.

Miscellaneous.

HEIDELBERG.—Maintenance cleaning from 1st December, 1972, to 30th November, 1975, Arthur Rylah Institute.

MELBOURNE.—Maintenance cleaning from 1st December, 1972, to 30th November, 1975, Ministry of Aboriginal Affairs.

PORT MELBOURNE.—Supply and delivery of five (5) ton chassis and cabin fitted with furniture van body, Plant Depot.

VARIOUS.—Supply of stoneware pipes and fittings for the period 1st December, 1972, to 30th November, 1973, Public Works Department. (Re-advertised.)

Building, Electrical and Mechanical Works.

ALEXANDRA.—Electrical installation, H.S. (W.O., Alexandra, Benalla, Shepparton and H.S., Alexandra.)

ALEXANDRA.—Mechanical services, H.S. (W.O., Bendigo and Wangaratta.)

ARARAT.—External renovations, Aradale Training Centre. (W.O., Ararat.)

BALLARAT.—Conversion of administration block to hair-dressing and dental unit, Lakeside Hospital. (W.O., Ballarat.)

BALLARAT.—Electrical services, conversion of administration block, Lakeside Hospital. (W.O., Ballarat.)

BALLARAT.—Mechanical services, conversion of administration block, Lakeside Hospital. (W.O., Ballarat.)

BENTLEIGH EAST.—External and internal renovations, Pr.S.2083 and Residence.

BRAYBROOK.—Internal repairs and painting, H.S.

CASTERTON.—Extensions to mechanical services, H.S. (W.O., Horsham and Warrnambool.)

COLAC.—Automatic sprinklers and fire alarm system, Training Centre.

COLAC.—Coolroom installation, Training Centre.

FRANKSTON.—External and internal renovations, H.S. (Re-advertised, Amended Specification.)

KEW.—Internal and external repairs and painting, The Gables Children's Home.

KEW.—Electrical services, Ward F5, Mental Hospital.

KEW.—Mechanical services, Ward F5, Mental Hospital.

KOONUNG.—New science wing in brick veneer, H.S. (Amended Specification.)

KOONUNG.—Mechanical services, Science Wing, H.S. (Amended Specification.)

LILYDALE.—Staff and administration improvements, toilet block and connexion to sewer, H.S.

MANSFIELD.—Internal and external repairs and painting, Pr.S.1112. (W.O., Alexandra and Benalla.)

MOOMBA PARK.—External and internal renovations, Pr.S.4876. (Amended Specification.)

MORTLAKE.—Mechanical services, extensions and modifications, H.S. (W.O., Ballarat, Geelong and Warrnambool.)

MORWELL.—External painting and repairs, H.S. (W.O., Traralgon.)

NATHALIA.—New toilet block, H.S. (W.O., Shepparton and Wangaratta.)

NEWBOROUGH EAST.—Chalkboards, internal repairs and painting, Pr.S.4670. (W.O., Traralgon.) (Re-advertised, Amended Specification.)

NUMURKAH.—Electrical installation of fluorescent lighting, H.S. (W.O., Shepparton and Wangaratta.)

RINGWOOD.—Electrical installation, alterations and additions, T.S.

RINGWOOD.—Mechanical services, alterations and additions, T.S.

SWAN HILL NORTH.—External and internal repairs and painting, Pr.S.4743. (W.O., Swan Hill.)

TOTTENHAM.—External and internal repairs and painting, T.S.

WONTHAGGI.—Internal and external repairs and painting, Pr.S.3650. (W.O., Korumburra.)

WONTHAGGI.—Supply and installation of L.P. gas heating, Pr.S.3650. (W.O., Korumburra.)

Site Works.

BALWYN.—Resurfacing of existing asphalt pavements and construction of concrete pavement, Pr.S.1026.

HORSHAM.—Asphalt repairs, T.S. (W.O., Horsham.)

LALOR EAST.—Site works, Pr.S.4976.

MARYVALE.—Site works, H.S. (W.O., Bairnsdale and Traralgon.)

MONASH.—Site works, H.S.

Miscellaneous.

MELBOURNE.—Construction of 65-ft. single-screw steel fisheries research vessel.

Tuesday, 28th November, 1972.

Building, Electrical and Mechanical Works.

BAIRNSDALE.—Erection of new wing and additional classrooms, &c., H.S. (W.O., Bairnsdale.)

BAIRNSDALE.—Mechanical services, additions, &c., H.S. (W.O., Bairnsdale.)

BAIRNSDALE.—Electrical services, additions, &c., H.S. (W.O., Bairnsdale.)

CHESHUNT.—Interior and exterior repairs and painting, new shelter shed, toilets, &c., Pr.S.2553. (W.O., Benalla and Wangaratta.)

EAGLEHAWK.—Erection of new wing and extensions, H.S. (W.O., Bendigo.)

EAGLEHAWK NORTH.—Internal and external repairs and painting, Pr.S.1428. (W.O., Bendigo.)

HOTHAM HEIGHTS.—Erection of warden's headquarters, Alpine Resort. (W.O. Bairnsdale and Wangaratta.)

LONGERENONG.—Erection of animal building, Agricultural College. (W.O., Horsham.)

OUYEN.—Non party fencing, H.S. (W.O., Mildura.)

VARIOUS.—Supply and delivery of test panels for electrical practices and motor mechanics workshops, T.S.'s Apendale, Ferntree Gully, Geelong East, Kyneton and Templestowe.

WESTBREEN.—External and internal renovations, Pr.S.4158.

Site Works.

SALE.—Construction of light-duty concrete pavement, underground drainage, landscaping, &c., H.S. (W.O., Traralgon.)

ROBERTS DUNSTAN,
Minister of Public Works.

Public Works Department,
Melbourne, 3002, 3rd November, 1972.

PUBLIC SERVICE NOTICES

No. 314.

Public Service Act 1958, Section 50.

REGULATIONS.—PART IV.—SALARIES AND INCREMENTS.

The Public Service Board, in pursuance of the powers conferred by the Public Service Act 1958, hereby amends its Regulations as shown below:—

SIXTH SCHEDULE.

TEMPORARY EMPLOYEES.

Designations of Positions and Rates of Salaries.

Department and Designation of Position.	Yearly Rate of Salary.		Increments (Annual).
	Minimum.	Maximum.	
LAW DEPARTMENT.	\$	\$	
Add— Attendant, Coroner's Court	4,902	5,016	A

This Regulation shall have effect as on and from the 26th October, 1972.

A. J. A. GARDNER, Chairman
P. CARRIGAN, Secretary.

Office of the Public Service Board,
Melbourne, 30th October, 1972.

No. 310.

Public Service Act 1958, Section 50.

REGULATIONS.—PART IV.—SALARIES AND INCREMENTS.

The Public Service Board, in pursuance of the powers conferred by the Public Service Act 1958, hereby amends the Public Service (Public Service Board) Regulations as follows:—

THIRD SCHEDULE.

PART B.

PROFESSIONAL DIVISION.

Scale of Rates of Annual Salaries.

LEGAL OFFICERS.

The salary scale shown is deleted and the following salary scale is inserted in lieu thereof—

Class	Annual Salary of Each Subdivision of Each Class.					
	1.	2.	3.	4.	5.	6.
	\$	\$	\$	\$	\$	\$
LO-1	4,220	4,397	4,624	4,761
LO-2	5,306	5,517	5,640
LO-3	5,851	6,070	6,409	6,798	7,101	7,577
LO-4	8,208	8,730	9,128	9,571
LO-5	9,956
LO-6	10,446
LO-7	11,429
LO-8	11,921
LO-9	12,718
LO-10	13,513

PARLIAMENTARY COUNSEL.

The salary scale shown is deleted and the following salary scale is inserted in lieu thereof—

Class	Annual Salary of Each Subdivision of Each Class.		
	1.	2.	3.
	\$	\$	\$
PA-1	9,956	10,446	11,429
PA-2	11,921	12,718	13,513

SIXTH SCHEDULE.

TEMPORARY EMPLOYEES.

Designations of Positions and Rates of Salaries.

Department and Designation of Position.	Yearly Rate of Salary.		Increments (Annual).
	Minimum.	Maximum.	
	\$	\$	
<i>Delete the existing yearly rates of salary for the following positions and insert the rates shown hereunder in lieu thereof—</i>			
CHIEF SECRETARY'S DEPARTMENT.			
Legal Officer, Grade I.**=	5,851	7,577	y (ii)
LAW DEPARTMENT.			
Legal Officer, Grade II.=	8,208	9,571	y (iii)
Legal Officer, Grade I.*=	5,851	7,577	y (ii)
Professional Assistant (Male)	5,851	6,409	1 of \$219 and 1 of \$339

This Regulation shall have effect as on and from the 22nd October, 1972.

A. J. A. GARDNER, Chairman.
R. H. DURRANT, Acting Secretary.

Office of the Public Service Board,
Melbourne, 23rd October, 1972.

No. 311.

Public Service Act 1958, Section 50.

REGULATIONS.—PART IV.—SALARIES AND INCREMENTS.

The Public Service Board, in pursuance of the powers conferred by the Public Service Act 1958, hereby amends its Regulations as shown below:—

SIXTH SCHEDULE.

TEMPORARY EMPLOYEES.

Designations of Positions and Rates of Salaries.

Department and Designation of Position.	Yearly Rate of Salary.		Increments (Annual).
	Minimum.	Maximum.	
PUBLIC WORKS DEPARTMENT	\$	\$	
Add— Technical Assistant (Female)		4,294	

This Regulation shall have effect as on and from the 4th November, 1972.

A. J. A. GARDNER, Chairman.
P. CARRIGAN, Secretary.

Office of the Public Service Board,
Melbourne, 30th October, 1972.

No. 313.

PUBLIC SERVICE ACT 1958.

The Public Service Board, in pursuance of the powers conferred by the Public Service Act 1958, hereby amends the Public Service (Public Service Board) Regulations as follows:—

PART III.—PROMOTIONS AND TRANSFERS.

DIVISION III.—SPECIAL REQUIREMENTS.

TECHNICAL AND GENERAL DIVISION.

Regulation 97A and the heading "Department of State Development—Environment Protection Authority" immediately prior thereto are deleted.

A. J. A. GARDNER, Chairman.
R. H. DURRANT, Acting Secretary.

Office of the Public Service Board,
Melbourne, 20th October, 1972.

No. 312.

Public Service Act 1958, Section 50.

REGULATIONS.—PART IV.—SALARIES AND INCREMENTS.

The Public Service Board, in pursuance of the powers conferred by the Public Service Act 1958, hereby amends the Public Service (Public Service Board) Regulations as follows:—

SECOND SCHEDULE.

TECHNICAL AND GENERAL DIVISION.

GRADES AND SALARY SCALES.

JUNIOR GRADES.

Delete the existing salary rates shown for the under-mentioned grades and insert the salary rates shown hereunder in lieu thereof:—

FEMALES.

Grade.	Yearly Rate of Salary at Each Age in Years.				
	Under 17.	17.	18.	19.	20.
	\$	\$	\$	\$	\$
JF-5			1,704	1,947	2,624
JF-8	1,496	1,795	2,094	2,394	3,126

SIXTH SCHEDULE.

TEMPORARY EMPLOYEES.

Designations of Positions and Rates of Salaries.

Department and Designation of Position.	Yearly Rate of Salary.		Increments (Annual).
	Minimum.	Maximum.	
	\$	\$	
<i>Delete the existing yearly rates of salary for the following positions and insert the rates shown hereunder in lieu thereof:—</i>			
DEPARTMENT OF AGRICULTURE.			
<i>Dookie Agricultural College.</i>			
Cook	4,224	4,580	A
Houseman, Senior	3,354	3,674	A
Houseman, Waiter	3,334	3,616	A
Waitress	2,867	3,132	B
<i>Longerenong Agricultural College.</i>			
Cook	4,224	4,580	A
SOCIAL WELFARE DEPARTMENT.			
<i>Family Welfare Division.</i>			
Cook, Grade III.=	3,750	4,044	A
Cook, Grade II.=	3,617	3,906	A
Cook, Grade I.=	3,435	3,712	A
Domestic—			
Junior—			
At 18 years of age		1,704	
At 19 years of age		1,947	
At 20 years of age		2,624	
Adult	2,867	3,132	B
General Reliever (Female)—			
Junior—			
Under 17 years of age		1,496	
At 17 years of age		1,795	
At 18 years of age		2,094	
At 19 years of age		2,394	
At 20 years of age		3,126	
Adult	3,425	3,698	B
<i>Youth Welfare Division.</i>			
Cook, Grade IV.=	4,224	4,580	A
Cook, Grade III.=	3,750	4,044	A
Cook, Grade II.=	3,617	3,906	A
Cook, Grade I.=	3,435	3,712	A
Domestic—			
Junior—			
At 18 years of age		1,704	
At 19 years of age		1,947	
At 20 years of age		2,624	
Adult	2,867	3,132	B
General Reliever (Female)—			
Junior—			
Under 17 years of age		1,496	
At 17 years of age		1,795	
At 18 years of age		2,094	
At 19 years of age		2,394	
At 20 years of age		3,126	
Adult	3,425	3,698	B

This Regulation shall have effect as on and from the 22nd October, 1972.

A. J. A. GARDNER, Chairman.
P. CARRIGAN, Secretary.

Office of the Public Service Board,
Melbourne, 30th October, 1972.

No. 307.

Public Service Act 1958, Section 50.

REGULATIONS.—PART IV.—SALARIES AND INCREMENTS.

The Public Service Board, in pursuance of the powers conferred by the *Public Service Act 1958*, hereby amends the Public Service (Public Service Board) Regulations as follows:—

THIRD SCHEDULE.

PART B.

PROFESSIONAL DIVISION.

Scale of Rates of Annual Salaries.

PROBATION AND PAROLE OFFICERS.

The salary scale shown is deleted and the following salary scale is inserted in lieu thereof—

Class.	Annual Salary of Each Subdivision of Each Class.								
	1.	2.	3.	4.	5.	6.	7.	8.	
PO-1	\$ 4,397	\$ 4,578	\$ 4,761	\$ 4,987	\$ 5,392	\$ 5,979	\$ 6,312	\$ 6,580	\$ 6,899
PO-2	4,624	5,080	5,392	5,682	5,979	6,312	6,580	6,899	
PO-3	7,049	7,260	7,895						
PO-4	7,471	7,684							
PO-5	8,259	8,677							
PO-6	9,014	9,408							
PO-7	10,685								

This Regulation shall have effect as on and from the 22nd October, 1972.

A. J. A. GARDNER, Chairman.
R. H. DURRANT, Acting Secretary.

Office of the Public Service Board,
Melbourne, 23rd October, 1972.

No. 308.

Public Service Act—1958, Section 50.

REGULATIONS.—PART IV.—SALARIES AND INCREMENTS.

The Public Service Board, in pursuance of the powers conferred by the *Public Service Act 1958*, hereby amends the Public Service (Public Service Board) Regulations as follows:—

THIRD SCHEDULE.

PART B.

PROFESSIONAL DIVISION.

Scale of Rates of Annual Salaries.

ASSISTANTS, NATIONAL MUSEUM, CHIEF SECRETARY'S DEPARTMENT.

The salary scale shown is deleted and the following salary scale is inserted in lieu thereof—

Class.	Annual Salary of Each Subdivision of Each Class.					
	1.	2.	3.	4.	5.	6.
AN-1	\$ 4,095	\$ 4,179	\$ 4,262	\$ 4,397	\$ 4,534	\$ 5,392
AN-2	4,761	4,897	5,033	5,170	5,261	

WATER DISTRIBUTION OFFICERS, WATER SUPPLY DEPARTMENT.

The salary scale shown is deleted and the following salary scale is inserted in lieu thereof—

Class.	Annual Salary of Each Subdivision of Each Class.			
	1.	2.	3.	4.
WD-1	\$ 7,206	\$ 7,419	\$ 7,684	\$ 8,208
WD-2	9,241			
WD-3	10,720			

This Regulation shall have effect as on and from the 10th September, 1972.

A. J. A. GARDNER, Chairman.
R. H. DURRANT, Acting Secretary.

Office of the Public Service Board,
Melbourne, 24th October, 1972.

No. 316.

PUBLIC SERVICE ACT—1958.

The Public Service Board, in pursuance of the powers conferred by the *Public Service Act 1958*, hereby amends the Public Service (Public Service Board) Regulations as follows:—

PART V.—ALLOWANCES.

DIVISION V.—OTHER ALLOWANCES.

The heading "Chief Secretary's Department—National Gallery" immediately prior to Regulation 166 is deleted and the heading "Chief Secretary's Department—National Gallery and Office of the Chief Commissioner of Police" is inserted in lieu thereof.

A. J. A. GARDNER, Chairman.
P. CARRIGAN, Secretary.

Office of the Public Service Board,
Melbourne, 30th October, 1972.

No. 309.

Public Service Act 1958, Section 50.

REGULATIONS.—PART IV.—SALARIES AND INCREMENTS.

The Public Service Board, in pursuance of the powers conferred by the *Public Service Act 1958*, hereby amends its Regulations as shown below:—

SIXTH SCHEDULE.

TEMPORARY EMPLOYEES.

Designations of Positions and Rates of Salaries.

Department and Designation of Position.	Yearly Rate of Salary.		Increments (Annual).
	Minimum.	Maximum.	
	\$	\$	
STATE FORESTS DEPARTMENT.			
<i>Central Workshop.</i>			
Delete— Mobile Crane Driver	3,617	3,906	A
Add— Mobil Crane Driver	3,655	3,945	A

This Regulation shall have effect as on and from the 22nd October, 1972.

A. J. A. GARDNER, Chairman.
R. H. DURRANT, Acting Secretary.

Office of the Public Service Board,
Melbourne, 23rd October, 1972.

No. 315.

Public Service Act 1958, Section 50.

REGULATIONS.—PART IV.—SALARIES AND INCREMENTS.

The Public Service Board, in pursuance of the powers conferred by the *Public Service Act 1958*, hereby amends the Public Service (Public Service Board) Regulations as follows:—

THIRD SCHEDULE.

PART B.

PROFESSIONAL DIVISION.

Scale of Rates of Annual Salaries.

ARCHIVISTS.

Class.	Annual Salary of Each Subdivision of Each Class.						
	1.	2.	3.	4.	5.	6.	7.
Delete— AV-3	\$ 9,014	\$	\$	\$	\$	\$	\$
Add— AV-3	10,737						

This Regulation shall have effect as on and from the 27th October, 1972.

A. J. A. GARDNER, Chairman.
P. CARRIGAN, Secretary.

Office of the Public Service Board,
Melbourne, 30th October, 1972.

No. 306.

Public Service Act 1958, Section 50.

REGULATIONS.—PART IV.—SALARIES AND INCREMENTS.

The Public Service Board, in pursuance of the powers conferred by the *Public Service Act 1958*, hereby amends the Public Service (Public Service Board) Regulations as follows:—

THIRD SCHEDULE.

PART B.

PROFESSIONAL DIVISION.

Scale of Rates of Annual Salaries.

SOCIAL WORKERS.

Class	Annual Salary of Each Subdivision of Each Class.			
	1.	2.	3.	4.
	\$	\$	\$	\$
<i>Delete—</i> SW-1	3,847	4,011	4,137	4,624
<i>Add—</i> SW-1	4,397	4,578	4,761	4,987

SIXTH SCHEDULE.

TEMPORARY EMPLOYEES.

Designations of Positions and Rates of Salaries.

Department and Designation of Position.	Yearly Rate of Salary.		Increments (Annual).
	Minimum.	Maximum	
GENERAL.	\$	\$	
<i>Delete—</i> Social Worker, Assistant=	3,847	4,624	n
<i>Add—</i> Social Worker=	4,397	4,987	n
SOCIAL WELFARE DEPARTMENT.			
PROBATION AND PAROLE DIVISION			
<i>Delete—</i> Probation and Parole Officer=	3,847.	4,624	n (i)
<i>Add—</i> Probation and Parole Officer	4,397	4,987	n (i)

This Regulation shall have effect as on and from the 22nd October, 1972.

A. J. A. GARDNER, Chairman.
R. H. DURRANT, Acting Secretary.

Office of the Public Service Board,
Melbourne, 20th October, 1972.

PRIVATE ADVERTISEMENTS

CITY OF COBURG.

NAMING OF STREET.

Notice is hereby given that a short section of unnamed road located between Reynard-street at the Tullamarine Freeway and The Boulevard, Pascoe Vale South, has been named "Turnbull-drive".

By order of the Coburg City Council,
9095 G. W. HARMAN, Town Clerk.

CITY OF CROYDON.

LOAN No. 112.

Private Street Construction.

Notice is hereby given that at the meeting of the Council of the City of Croydon, held at the Council Chamber, Municipal Offices, on the 2nd day of October, 1972, the

said Council did agree to the following Resolution, that is to say:—

"That the Council make a Special Order to borrow the sum of \$50,000 for the purposes of liquidating amounts due to a Bank from which it has obtained an advance by overdraft on current account for construction of private streets under Division 10, Part XIX. of the Local Government Acts.

The rate of interest to be paid shall be 6.2 per cent. Such moneys shall be repayable to the Croydon Branch of the Commercial Bank of Australia Ltd., 8 Hewish-road, Croydon.

The loan shall be liquidated by payment of half-yearly instalments of approximately \$3,391.93 each, including principal and interest, on the 10th day of June and the 10th day of December during the currency of the loan. The first instalment shall be payable on the 10th day of June, 1973.

The purpose for which the loan is to be applied is to liquidate the whole or part of overdraft on Council's Private Street Bank Account at the National Bank of Australasia, Croydon."

Notice is hereby further given that at a meeting of the said Council held at the Council Chamber, Municipal Offices, on the 6th day of November, 1972, the said Resolution was confirmed.

9100 R. BURTON, Town Clerk.

CITY OF CROYDON.

LOAN No. 113.

Private Street Construction.

Notice is hereby given that at the meeting of the Council of the City of Croydon, held at the Council Chamber, Foch-avenue, Croydon, on the 2nd day of October, 1972, the said Council did agree to the following Resolution, that is to say:—

"That the Council borrow the sum of \$100,000 for the purposes of liquidating amounts due to a Bank from which it has obtained an advance by overdraft of current account for construction of private streets under Division 10, Part XIX. of the Local Government Acts.

The rate of interest to be paid shall be 6.2 per cent. Such moneys shall be repayable to the Australian and New Zealand Savings Bank Limited, 394-396 Collins-street, Melbourne.

The loan shall be liquidated by payment of half-yearly instalments of approximately \$6,783.87 each, including principal and interest on the 8th day of May and the 8th day of November, during the currency of the loan. The first instalment shall be payable on the 8th day of May, 1973.

The purpose for which the loan is to be applied is to liquidate the whole or part of overdraft on Council's Private Street Bank Account at the National Bank of Australasia Limited, Croydon."

Notice is hereby further given that at a meeting of the said Council held at the Council Chamber, Foch-avenue, Croydon, on the 6th day of November, 1972, the said Resolution was confirmed.

9101 R. BURTON, Town Clerk.

CITY OF CROYDON.

LOAN No. 115.

Notice of Intention to Borrow the Sum of \$100,000 for Permanent Works and Undertakings.

Notice is hereby given that the Council of the City of Croydon proposes to borrow the principal sum of One hundred thousand dollars (\$100,000), secured by a charge over the general rates of the municipality, such sum to be raised by the grant of a mortgage in accordance with the provisions of the *Local Government Act 1958*.

1. The maximum rate of interest that may be paid is 6.4 per centum per annum.

2. The purpose for which the loan is to be applied is:—

- (a) Purchase of Land for Public Purposes (Amending Planning Scheme No. 18) Extended Tip Area (Estimated) .. \$30,000
- (b) Purchase of land for Public Open Space (Amending Planning Scheme No. 2) (Estimated) .. \$53,000
- (c) Scout Hall—Belmont Park (Part) (Estimated) .. \$3,000
- (d) Town Park—Toilet Block and Changing Complex (Part) (Estimated) .. \$14,000

\$100,000

3. The period of the loan shall be 40 years.

4. The moneys borrowed shall be repayable by 80 half-yearly instalments of approximately \$3,480.03, including principal and interest on the 2nd day of February and the 2nd day of August, during the currency of the loan. The first instalment shall be repayable on the 2nd day of August, 1973.

5. Such moneys shall be repayable at the Australian Mutual Provident Society, 535 Bourke-street, Melbourne.

The plans and specifications and the estimate of the cost of the proposed works and a statement showing the proposed expenditure of the moneys to be borrowed are open for inspection at the office of the Council of the City of Croydon at City Offices, Foch-avenue, Croydon.

9111

R. BURTON, Town Clerk.

Town and Country Planning Act 1961 (Twelfth Schedule).

CITY OF ECHUCA PLANNING SCHEME 1964.

NOTICE THAT A PLANNING SCHEME HAS BEEN PREPARED AND IS AVAILABLE FOR INSPECTION.

Amendment Sixteen 1972.

Notice is hereby given that the City of Echuca in pursuance of its powers under the *Town and Country Planning Act 1961* has prepared a planning scheme for the purpose of re-zoning the following areas:—

- (1) All that piece of land comprised in certificate of title, volume 8597, folio 491, being Crown allotment 4A, Township of Echuca, Parish of Echuca North, County of Rodney;
- (2) All that piece of land comprised in certificate of title, volume 8597, folio 492, being Crown allotment 13A, Township of Echuca, Parish of Echuca North, County of Rodney.

A copy of the scheme has been deposited at the City Offices, corner Hare and Heygarth streets, Echuca, and at the office of the Town and Country Planning Board, Fifth Floor, 235 Queen-street, Melbourne, and will be open for inspection during office hours by any person free of charge.

Any persons affected by the planning scheme are required to set forth in writing all objections they may have addressed to the Town Clerk, City of Echuca, corner Hare and Heygarth streets, Echuca, on or before the 9th day of February, 1973, and to state whether they wish to be heard in respect of their objections.

Dated this 3rd day of November, 1972.

9177

K. F. McCARTNEY, Town Clerk.

CITY OF HEIDELBERG.

LOAN No. 166.

Notice of Intention to Borrow the Sum of \$100,000 for Permanent Works and Undertakings.

Notice is hereby given that the Council of the City of Heidelberg intends to borrow the sum of \$100,000 (One hundred thousand dollars), secured by a charge over the general rates of the municipality, such sum to be raised by the grant of a mortgage in accordance with the provisions of the *Local Government Act 1958*.

1. The maximum rate of interest that may be paid is 6.3 per centum per annum.
2. The purpose for which the loan is to be applied is:—
Electricity Supply Capital Works—\$100,000.
3. The period of the loan shall be fifteen (15) years.
4. The moneys borrowed shall be repayable by providing out of the municipal fund thirty (30) half-yearly instalments of \$5,201.35 each, including principal and interest, on the 1st day of January and the 1st day of July in each year during the currency of the loan. The first instalment shall be payable on the 1st day of July, 1973.
5. Such moneys shall be repayable to the Commonwealth Savings Bank of Australia, Melbourne.

The plans and specifications and the estimate of the cost of the proposed works and a statement showing the proposed expenditure of the money to be borrowed, are open for inspection at the office of the Council, Town Hall, Ivanhoe.

9154

ALAN JONES, Town Clerk.

CITY OF HEIDELBERG.

LOAN No. 167.

Notice of Intention to Borrow the Sum of \$100,000 for Permanent Works and Undertakings.

Notice is hereby given that the Council of the City of Heidelberg intends to borrow the sum of \$100,000 (One hundred thousand dollars), secured by a charge over the

general rates of the municipality, such sum to be raised by the grant of a mortgage in accordance with the provisions of the *Local Government Act 1958*.

1. The maximum rate of interest that may be paid is 6.3 per centum per annum.

2. The purposes for which the loan is to be applied are:—

Thoresby-grove—construction	\$22,500
Alandale-road	25,900
Chapman-street	12,600
Yallambie Park change rooms	12,000
Council proportion C.R.B. works	27,000
			<hr/>
			\$100,000

3. The period of the loan shall be fifteen (15) years.

4. The moneys borrowed shall be repayable by providing out of the municipal fund thirty (30) half-yearly instalments of \$5,201.35 each, including principal and interest, on the 1st day of January and the 1st day of July in each year during the currency of the loan. The first instalment shall be payable on the 1st day of July, 1973.

5. Such moneys shall be repayable to the Commonwealth Savings Bank of Australia, Melbourne.

The plans and specifications and the estimate of the cost of the proposed works and a statement showing the proposed expenditure of the money to be borrowed, are open for inspection at the office of the Council, Town Hall, Ivanhoe.

9155

ALAN JONES, Town Clerk.

CITY OF KNOX.

Whereas the Council of the City of Knox deems it expedient to execute the work or undertaking of providing the land described hereunder; And whereas for the purpose thereof the exercise of the power of taking land compulsorily will in the opinion of the Council be necessary and desirable; And whereas the Council has caused to be prepared maps and other papers showing a general description of the work or undertaking for which the land proposed to be taken is to be used, a description of the lands proposed to be taken and the names of the owners or reputed owners lessees reputed lessees mortgagees occupiers of such lands so far as those names are known to or can be ascertained by the Council; And whereas such maps and other papers are deposited at the office of the said council situate at Fern Tree Gully and are open for inspection by all persons affected by the proposed taking of lands during normal office hours for the space of forty clear days after the publication of this notice in the *Government Gazette*, now notice is hereby given to all persons affected by the proposed taking of the said land to set forth in writing addressed to the Council or the Town Clerk within forty clear days of the publication of this notice in the *Government Gazette* all objections which they may have to the taking of the said land.

THE LAND REFERRED TO.

All that piece of land being part of Crown allotment 46, Parish of Scoresby, as shown on plan hereunder.

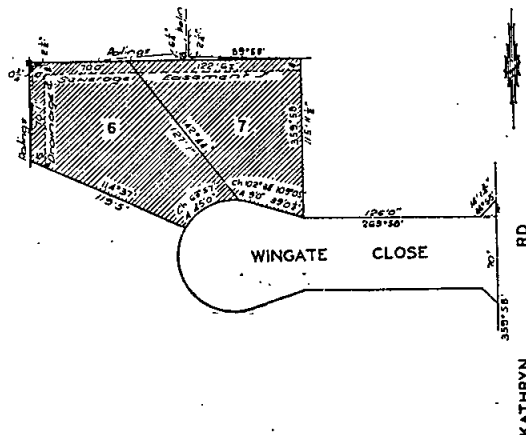

Dated this 31st day of October, 1972.

By Order of Council,

9118

N. G. HAYNES, Town Clerk.

CITY OF NUNAWADING.

Notice is hereby given that, in pursuance of the powers conferred by the Local Government Act, the Council of the City of Nunawading did at a meeting held on the 2nd October, 1972, order that the following alteration be made in the name of the street as under, and that such order take effect from the date of this publication in the *Victoria Government Gazette*:—

Old Name.—Somerset-street.

New Name.—Somerset-court.

9159 J. H. BROWN, Town Clerk.

CITY OF PRAHRAN.

LOAN NO. 65.

Notice of Intention to Borrow the Sum of \$100,000 for Permanent Works and Undertakings.

Notice is hereby given that the Council of the City of Prahran proposes to borrow the principal sum of \$100,000, secured by a charge over the general rates of the municipality, such sum to be raised by the grant of a mortgage in accordance with the provisions of the *Local Government Act 1958*.

The maximum rate of interest that may be paid is 6.3 per centum per annum.

Purpose for which the loan is to be applied is the construction of the Toorak/South-Yarra Library Complex.

Period of the loan shall be fifteen years.

The moneys borrowed shall be repayable by providing out of the municipal fund half-yearly instalments of \$5,201.35 each, including the principal and interest, on the 30th day of June and the 31st day of December during the currency of the loan. The first instalment shall be payable on the 30th day of June, 1973.

Such moneys shall be repayable to the Bank of New South Wales Savings Bank Limited, 383 Chapel-street, South Yarra.

The plans and specifications and the estimate of the cost of the proposed works and a statement showing the proposed expenditure of the moneys to be borrowed are open for inspection at the office of the Council of Prahran, Chapel-street, Prahran.

9180 JOHN A. LUCAS, Town Clerk.

CITY OF PRAHRAN.

LOAN NO. 66.

Notice of Intention to Borrow the Sum of \$100,000 for Permanent Works and Undertakings.

Notice is hereby given that the Council of the City of Prahran proposes to borrow the principal sum of \$100,000, secured by a charge over the general rates of the municipality, such sum to be raised by the grant of a mortgage in accordance with the provisions of the *Local Government Act 1958*.

The maximum rate of interest that may be paid is 6.3 per centum per annum.

Purpose for which the loan is to be applied is the construction of the Toorak/South-Yarra Library Complex.

Period of the loan shall be fifteen years.

The moneys borrowed shall be repayable by providing out of the municipal fund half-yearly instalments of \$5,201.35 each, including the principal and interest, on the 30th day of June and the 31st day of December during the currency of the loan. The first instalment shall be payable on the 30th day of June, 1973.

Such moneys shall be repayable to the Australia & New Zealand Savings Bank Ltd., 394-396 Collins-street, Melbourne.

The plans and specifications and the estimate of the cost of the proposed works and a statement showing the proposed expenditure of the moneys to be borrowed are open for inspection at the office of the Council of Prahran, Chapel-street, Prahran.

9181 JOHN A. LUCAS, Town Clerk.

CITY OF SPRINGVALE.

LOAN NO. 155.

Special Order to Borrow the Sum of \$100,000.

Notice is hereby given that the Council, at an Ordinary Meeting held on Monday, 16th October, 1972, at 7 p.m., passed the following Resolution as a Special Order:—

"That—

1. (a) This Council borrow moneys by the grant of a mortgage upon the credit of the municipality pursuant to section 585 of the *Local Government Act 1958*:

(b) The amount of the principal moneys to be borrowed be \$100,000.

(c) The rate of interest to be paid be 6.2 per cent. per annum.

(d) The moneys borrowed be repayable by twenty equal instalments payable respectively on the 5th day of June and on the 5th day of December of each year, the first such instalment being repayable on the 5th day of June, 1973.

(e) The moneys borrowed be repayable at the Australia and New Zealand Bank Limited, Springvale.

(f) The loan be applied for the purposes of liquidating or of partly liquidating the amount due on overdraft of current account to the Council's bankers in respect of the execution of private street construction schemes pursuant to Division 10 of Part XIX. of the *Local Government Acts*.

(g) The loan be liquidated by providing out of the municipal fund, on the 5th day of June and on the 5th day of December of each year the sum necessary to pay the half-yearly instalment and the interest then due in respect of the loan.

2. The Council directs that this Resolution be brought forward for confirmation as a Special Order at a meeting of the Council to be held on the 27th day of November, 1972, at 7 o'clock in the afternoon."

Notice is hereby given that the said Resolution will be submitted for confirmation at the Ordinary Meeting of the Council to be held on Monday, 27th November, 1972, at 7 p.m., in the Council Chambers, Civic Centre, Springvale:

9175

H. L. WILLIAMS, Town Clerk.

SHIRE OF FLINDERS.

Notice is hereby given that Sergeant Kenneth Francis McLean, No. 11022, has been appointed by the Council as Prosecuting Officer for the Matthew Riding of the Shire of Flinders.

9199

S. WILLIAMS, Shire Secretary.

SHIRE OF HEYTESBURY.

APPOINTMENT OF POUNDKEEPER, TIMBOON.

Notice is hereby given that Ernest Clyde Stephens has been appointed as Poundkeeper to the Timboon Pound, in the Shire of Heytesbury, in place of Mr. John McLeod, deceased.

9106

P. J. NORTHEAST, Shire Secretary.

Water Act.

SHIRE OF LEIGH.

PROPOSED ROKEWOOD WATERWORKS TRUST.

Notice is hereby given that the Leigh and Buninyong Shire Councils have made application to the Honourable the Minister of Water Supply for the constitution of a Waterworks Trust, and for the construction, maintenance, and continuance of Water Supply Works within that District under the provisions of the *Water Act*.

A general plan and description of the proposed works have been submitted with the application, and copies of same may be seen at the Shire Offices at Rokewood and Buninyong.

Dated at Rokewood the 17th day of October, 1972.

8911

C. G. HALLUM, Acting Secretary.

Town and Country Planning Act 1961.

SHIRE OF MANSFIELD.—EILDON RESERVOIR PLANNING SCHEME 1959.

(SHIRE OF MANSFIELD).

AMENDMENT NO. 9, 1972.

Notice is hereby given that the Council of the Shire of Mansfield, in pursuance of its powers under the *Town and Country Planning Act 1961*, has prepared a Planning Scheme for variation of frontage requirements throughout the whole of the area affected by the Eildon Reservoir Planning Scheme 1959.

A copy of the scheme has been deposited at the office of the Mansfield Shire Council, 33 Highett-street, Mansfield, and at the office of the Town and Country Planning Board, 235 Queen-street, Melbourne, and will be open for inspection during office hours by any person, free of charge.

Any persons affected by the Planning Scheme are required to set forth, in writing, all objections they may have, addressed to the Secretary, Shire of Mansfield, 33 Highett-street, Mansfield, on or before the 6th day of December, 1972, and to state whether they wish to be heard in respect of their objections.

9108

E. CAIRNS, Shire Secretary.

SHIRE OF MANSFIELD.

BY-LAW No. 56.

Regulation and Imposing Charges for the Use of the Mansfield Swimming Pool.

Notice is hereby given that the Council of the Shire of Mansfield has made a By-Law numbered 56 under section 756 of the *Local Government Act 1958*, as amended, for the purpose of repealing By-Law No. 44 of the Shire of Mansfield and regulating and imposing charges for the use of the Mansfield Swimming Pool.

The resolution for passing this By-law was agreed to on the 22nd day of December, 1971, and confirmed on the 26th day of January, 1972.

Copies of the By-Law are open for inspection, free of charge, during office hours at the office of the Council, Highett-street, Mansfield.

9109

E. CAIRNS, Shire Secretary.

Dog Act 1970.

SHIRE OF MANSFIELD.

Notice is hereby given that the Council of the Shire of Mansfield has appointed Douglas Keith Shipard, General Inspector of the Shire of Mansfield, as a Proper Officer under section 27 of the *Dog Act 1970*, No. 8079.

9110

E. CAIRNS, Shire Secretary.

SHIRE OF SWAN HILL.

LOAN No. 55.

Notice of Intention to Borrow the Sum of \$150,000 for Permanent Works and Undertakings.

ROBINVALE PUBLIC HALL AND CULTURAL BUILDING.

Notice is hereby given that the Council of the Shire of Swan Hill proposes to borrow the principal sum of \$150,000, secured by a charge over the general rates of the municipality, such sum to be raised by the grant of a mortgage in accordance with the provisions of the *Local Government Act* and under the following conditions:—

1. The maximum rate of interest that may be paid is 6.4 per cent. per annum.

2. The purpose for which the loan is to be applied is:—
Construction of a public hall and cultural building including theatre, to be financed as follows:—

Loan No. 55	\$150,000
Unemployment Relief subsidy	60,000
Public Hall subsidy	9,000

Total Estimated Cost (including architect's fees) \$219,000

3. The period of the loan shall be twenty years.

4. The moneys borrowed shall be repayable by providing out of the municipal fund 40 half-yearly instalments of \$6,700.82 each, including principal and interest on the 1st day of April and the 1st day of October, during the currency of the loan. The first instalment shall be payable on the 1st day of October, 1973.

5. Such moneys shall be repayable at the Commonwealth Savings Bank of Australia, Melbourne.

Plans and specifications and estimates of cost of the proposed works and a statement showing the proposed expenditure of the money to be borrowed, are open for inspection at the Office of the Council of the Shire of Swan Hill, Beveridge-street, Swan Hill, and at the Office of the Robinvale Sewerage Authority, Moore-street, Robinvale.

Dated this 1st day of November, 1972.

9122

J. D. LAURITZ, Shire Secretary.

SHIRE OF TAMBO.

APPOINTMENT OF PROSECUTING OFFICER.

Council of the Shire of Tambo has appointed Snr. Sgt. D. S. Grimer, No. 11226, as its Prosecuting Officer in lieu of Sgt. W. W. McKay, No. 10155.

9166

W. J. HOBSON, Shire Secretary.

SHIRE OF WALPEUP.

LOAN No. 40.

Notice of Intention to Borrow the Sum of \$25,000 for Permanent Works and Undertakings.

Notice is hereby given that the Council of the Shire of Walpeup proposes to borrow the principal sum of \$25,000, secured by a charge over the general rates of the municipality, such sum to be raised by the grant of a mortgage, in accordance with the provisions of the *Local Government Act 1958*.

1. The maximum rate of interest that may be paid is 6.3 per cent. per annum.

2. The purpose for which the loan is to be applied is:—
Public Resort and Recreation Facilities.

3. The period of the loan shall be fifteen years.

4. The moneys borrowed shall be repayable by providing out of the municipal fund half-yearly instalments of \$1,300.34 each, including principal and interest, on the 1st day of January and the 1st day of July, during the currency of the loan. The first instalment shall be payable on the 1st day of July, 1973.

5. Such moneys shall be repayable to the Australian and New Zealand Savings Bank, Oke-street, Ouyen, 3490.

The plans and specifications and the estimate of the cost of the proposed works, and a statement showing the proposed expenditure of the moneys borrowed, are open for inspection at the office of the Council of the Shire of Walpeup, Ouyen, 3490.

9173

B. W. CROSS, Shire Secretary.

SHIRE OF WERRIBEE.

LOAN No. 80.

Notice of Intention to Borrow the Sum of One Hundred Thousand Dollars (\$100,000) for Permanent Works and Undertakings.

Notice is hereby given that the Council of the Shire of Werribee proposes to borrow the principal sum of One hundred thousand dollars (\$100,000), secured by a charge over the general rates of the municipality, such sum to be raised by the grant of a mortgage in accordance with the provisions of the *Local Government Act 1958*.

1. The maximum rate of interest that may be paid is 6.4 per cent. per annum.

2. The purposes for which the loan is to be applied are:—

(i) Improvements, Galvin Park	\$56,000
(ii) D-1 Drainage Scheme	31,500
(iii) Pavilion, Price Reserve	6,000
(iv) Boat ramp, Werribee South	2,000
(v) Kerb and channel, McLeans-road, Little River	4,500

\$100,000

3. The period of the loan shall be twenty (20) years.

4. The moneys borrowed shall be repayable by providing out of the municipal fund half-yearly instalments of approximately \$4,467.21 each, including principal and interest, on the 1st day of June and the 1st day of December during the currency of the loan. The first instalment shall be payable on the 1st day of June, 1973.

5. Such moneys shall be repayable to the Local Authorities Superannuation Board, Rigby House, 15 Queens-road, Melbourne.

The plans and specifications and the estimate of the cost of the proposed works and a statement showing the proposed expenditure of the moneys to be borrowed are open for inspection at the office of the Council of the Shire of Werribee, Watton-street, Werribee.

Dated 2nd November, 1972.

9124

J. T. KERR, Shire Secretary.

OCEAN GROVE SEWERAGE AUTHORITY.

SEWER CONSTRUCTION—STAGE 4.

Notice is hereby given that it is the Authority's intention to construct sewers in stage 4 of the district being the area bounded generally by Tuckfield-street, Wyatt-street, Kalinga-road, Lake-avenue, Geelong/Ocean Grove-road and Thacker-street.

Maps showing the precise location of the sewers may be inspected at the works office of the authority, 75b The Terrace, Ocean Grove, or at the Shire Office, Drysdale, between the hours of 9 a.m. and 5 p.m. Mondays to Fridays.

9169

D. L. PARKER, Acting Secretary.

NUMURKAH SEWERAGE AUTHORITY.

GENERAL NOTICE.
Sewerage Area 3.

The above-mentioned Sewerage Authority, having made provision for the carrying off from each and every property which, or any part of which is within the Sewerage Area hereinafter described, doth hereby declare that on and after the 1st day of November, 1972, each and every property which, or any part of which is within the said Sewerage District, shall be deemed to be a seweraged property within the meaning of the *Sewerage Districts Act 1958*.

The boundaries of the Sewerage Area hereinafter referred to are:—

“North of the Numurkah—Picola Railway Line and west of the Tocumwal Railway Line.”

By order of the Authority.

R. H. ROBINSON, Chairman.
L. G. MITCHELL, Secretary.

9116

RUSHWORTH WATERWORKS TRUST.

BY-LAW No. 2/72.

Notice is hereby given that the Rushworth Waterworks Trust has made a By-Law numbered 2/72 for the purposes of:—

- (a) regulating the mode, form, strength, material, construction, dimensions and arrangement of pipes and other works supplying water from the pipes of the Trust to the premises of consumers and the time of executing and notice to be given for such works and the superintending thereof and the making good ground which may be displaced thereby and for inspecting all services whether within or without any buildings at all reasonable times and for requiring works to be executed by qualified or licensed persons only;
- (b) regulating the construction, disposition, custody and inspection of meters;
- (c) preventing the waste or misuse of water supplied by the Trust;
- (d) causing persons using the same to keep their pipes and fittings in good repair;
- (e) preventing any tampering with or altering such pipes or fittings without notice to the Trust.

The By-Law was made by the Trust on 8th August, 1972, and was approved by the Governor in Council on 10th October, 1972.

A copy of the By-Law is open for inspection free of charge at the office of the Trust, High Street, Rushworth, during normal office hours.

9107.

G. K. CALDER, Secretary.

GEELONG WATERWORKS AND SEWERAGE TRUST.

Pursuant to section 60 of the *Geelong Waterworks and Sewerage Act 1958* (No. 6263) the Trust has prepared plans to indicate the particulars of sewers and underground works in or adjacent to the following locality within the Drainage Area.

Station-street, Norlane; Shire of Corio.

Corner Cox-road and Cobham-street, Norlane; Shire of Corio.

Marathon-avenue, Hamlyn Heights; Shire of Corio.

Beauford-avenue, Bell Post Hill; Shire of Corio.

Darriwill-street, Bell Post Hill; Shire of Corio.

Notice is hereby given that the plans indicated above are open for public inspection at the Trust's Offices, Ryrie-street, Geelong, between the hours of 9 a.m. and 5 p.m. from Monday to Friday (public holidays excepted), by the owners and occupiers of land or premises within the Drainage Area.

9158

B. C. HENSHAW, Secretary.

Notice is hereby given that the Victoria Bowling Club, Victoria-street, Ballarat, has applied for a lease under section 134 of the *Land Act 1958*, for a term of 21 years, in respect of an area of 0.15 acres in the Township of Ballarat East, as a site for amusement and recreation (Bowling Club).

9044

P. J. HETHERINGTON, Honorary Secretary.

NOTICE OF INTENTION TO APPLY FOR A LICENCE TO DIVERT WATER AND CUT RACE FROM THE KING RIVER, AT OXLEY.

I hereby give notice that I intend to apply for a licence empowering me to divert water for a term of four years to the extent of 30 acre-feet per annum at a maximum

rate of 1 acre-foot per day of 24 hours for the irrigation of 20 acres of pasture, being allotments 3, 3A, 4, section 11, allotments 1-7, section 10, Parish of Laceby, and to occupy certain Crown lands for works of diversion, and to cut a race thereon.

Any objection to such application must be forwarded, in writing to reach the State Rivers and Water Supply Commission, Melbourne, before 8th December, 1972, being 30 days from the first publication of this notice.

KEVIN FRANCIS XAVIER MULCAHY.

16 Murdoch-road, Wangaratta, 3677.

9112

NOTICE OF INTENTION TO APPLY FOR A LICENCE TO DIVERT WATER AND CUT RACE (RE-ISSUE) FROM THE RIVER MURRAY AT ROBINVALE.

I hereby give notice that I intend to apply for a licence empowering me to divert water for a term of fifteen years to the extent of 9 acre-feet per annum at a maximum rate of 2 acre-feet per day of 24 hours for the irrigation of pastures and shelter trees being allotment 31, Township and Parish of Bumbang, and to occupy certain Crown lands for works of diversion, and to cut a race thereon.

Any objection to such application must be forwarded, in writing to reach the State Rivers and Water Supply Commission, Melbourne, before 4th December, 1972, being 30 days from the first publication of this notice.

—FRANCIS WILLIAM SMITH.

Box 74, Robinvale, 3549.

9125

I, Joy Beatrice Craig, of 8 Werrill-street, Swan Hill, in the State of Victoria, married woman, do hereby for my daughter Rosslyn Joy Craig, heretofore known by the name of Rosslyn Joy Truman, give notice that on the 18th day of August, 1972, I renounced and abandoned the use of the said surname of Truman and assumed in lieu thereof the surname of Craig and further that such change of name is evidenced by a deed, dated the 18th day of August, 1972, duly executed by me and attested and registered.

Dated this 31st day of November, 1972.

9113

JOY BEATRICE CRAIG.

Partnership Act 1958, Section 41.

NOTICE OF DISSOLUTION OF PARTNERSHIP.

Notice is hereby given that the partnership previously carried on by Lachlan Alexander Lawson and James Clayton Joseph Collins, under the firm name “Collins & Lawson Farriers”, at Flemington Racecourse, Epsom-road, Flemington, was dissolved on the 30th day of September, 1972.

Dated this 10th day of October, 1972.

CLIFFORD CHESSUN, solicitor, of 437 Gaffney-street, Pascoe Vale. 9182

Notice is hereby given that the partnership heretofore subsisting between the undersigned, Marjorie Esma Dickson and Graeme Alexander Dickson, carrying on business as farmers under the name of M. A. & G. A. Dickson, has been dissolved by mutual consent as from the 30th day of June, 1972. All debts due to and owing by the said late firm will be received and paid by Graeme Alexander Dickson who will continue to carry on business at the same place.

Dated at Bacchus Marsh the 30th day of July, 1972.

MARJORIE ESMA DICKSON.

GRAEME ALEXANDER DICKSON.

Witness—J. McD. JONES.

J. McD. Jones & Purcell, of 76 Dudley-street, Melbourne West; solicitors for both parties. 9183

Take notice that the partnership heretofore existing between Steven Koulousianis, of 92 Best-street, North Fitzroy, in the State of Victoria, Pasquale Lopresti, of 4 Glenora-avenue, East Coburg, in the said State, Salvatore Sciaccia, of 3 Hurley-street, Reservoir, in the said State, and Haralambos Maltezos, of 6 Ashmore-street, Brunswick, in the said State, as manufacturers of caravans, at 13 Milton-crescent, Preston, was dissolved on the 31st day of October, 1972, and further that the said business shall continue to be carried on by the said Steven Koulousianis, Pasquale Lopresti and Salvatore Sciaccia. All accounts and claims against the dissolved partnership are to be sent to Steven Koulousianis, Pasquale Lopresti and Salvatore Sciaccia, at 13 Milton-crescent, Preston.

N. C. GAY & CO., solicitors for the above-named parties. 9176

Take notice that the partnership previously subsisting between Arnold Holst, Edward Holst and Richard Giffen Holst, who carried on business at 389-393 Flinders-lane, Melbourne, as stock and share brokers, under the name A. Holst & Co., has been dissolved as from the 20th September, 1972, the said Arnold Holst and the said Richard Giffen Holst, having retired therefrom. The said Edward Holst will continue to carry on business under the name A. Holst & Co., at the same address from that date.

Dated the 19th day of October, 1972.

A. HOLST.
E. HOLST.
R. HOLST.

OSWALD BURT & CO., solicitors, 389-393 Lonsdale-street, Melbourne. 9135

Companies Act 1961.—In the matter of W. BERNAL PROPRIETARY LIMITED.

Notice is hereby given that at an Extraordinary General Meeting of W. Bernal Proprietary Limited, held at 697 Burke-road, Camberwell, on the 26th day of October, 1972, at 11 a.m., the following Resolutions were passed as a Special Resolution and Ordinary Resolution respectively:—

"That the company be wound up voluntarily."

"That Rose Monica McCook be appointed the liquidator for the purpose of the winding up."

9149 R. M. McCOOK, Liquidator.

No. of Company: 30426.—In the matter of the *Companies Act 1961*; and ALFRED FOWLER PROPRIETARY LIMITED.

Notice is hereby given that a General Meeting of the company will be held at 4 o'clock in the afternoon on the 8th day of December, 1972, at Room 1, 10th Floor, 422 Collins-street, Melbourne, to receive the final account of the liquidator.

9143 PETER S. RANDALL, Liquidator.

Companies Act 1961.

CROMBEAU INVESTMENTS PTY. LTD. (IN VOLUNTARY LIQUIDATION).

Notice is hereby given that creditors having claims against the above-mentioned company should lodge proofs of debt with the liquidator, P. S. Randall, Room 1, 10th Floor, 422 Collins-street, Melbourne, before the 29th November, 1972.

Dated this 2nd day of November, 1972.

9142 PETER S. RANDALL, Liquidator.

Companies Act 1961.—In the matter of R. H. CARROLL CONTRACTING CO. PTY. LIMITED (in Liquidation).

Notice is hereby given that creditors of the above-mentioned company, which is being voluntarily woundup, are required on or before the 29th day of November, 1972, being the day for that purpose fixed by me, the undersigned, the liquidator of the company, to send their names and addresses and particulars of the debts or claims and the names and addresses of their solicitors, if any, to the undersigned, and if so required in writing from me and by their solicitors, to come in and prove their said debts and claims at such time and place as shall be specified in such notice or in default thereof they will be excluded from the benefit of any distribution made before such debts are proved.

Dated this 6th day of November, 1972.

L. P. SMART, Liquidator,

R. H. Carroll Contracting Co. Pty. Ltd. (in Liquidation).
Marquand & Co., 51 Queen-street, Melbourne, 3000. 9136

Companies Act 1961, Section 272 (2).

THE LEASOWES PROPRIETARY LIMITED (IN VOLUNTARY LIQUIDATION).

NOTICE OF FINAL MEETING OF MEMBERS.

Notice is hereby given that the above meeting will be held at Villa 5, 11 Albany-road, Toorak, on the 8th day of December, 1972, at 8 p.m.

The object of this meeting is to submit the liquidator's final accounts showing how the winding up has been conducted and the property of the company has been disposed of, and to give any explanation thereof.

Dated 3rd day of November, 1972.

9137 P. C. SIMMONS, Liquidator.

Companies Act 1961.

NORMAN H. CORNFOT PROPRIETARY LIMITED (IN LIQUIDATION).

NOTICE CONVENING FINAL MEETING OF MEMBERS AND CREDITORS, PURSUANT TO SECTION 272.

Notice is hereby given, pursuant to section 272 of the *Companies Act 1961*, that a General Meeting of the members and creditors of the above-named company will be held in the office of Kennedy, Smail & Middlemiss, 296 Little Lonsdale-street, Melbourne, on Wednesday, the 6th December, 1972, at 11.30 a.m., for the purpose of having an account laid before them showing the manner in which the winding up has been conducted and the property of the company disposed of, and hearing any explanations that may be given by the liquidator.

Dated this 2nd day of November, 1972.

A. M. HORSBURGH, Liquidator.

Kennedy, Smail & Middlemiss, 296-304 Little Lonsdale-street, Melbourne, 3000. 9138

The *Companies Act 1961.*—In the matter of FASHIONS INCORPORATED PTY. LTD.—Notice Re Meeting of Creditors, Pursuant to Section 260.

Notice is hereby given that a meeting of creditors of the above-named company will be held at the offices of Kennedy, Smail & Middlemiss, 296 Little Lonsdale-street, Melbourne, at 11 a.m., on the 14th day of November, 1972, the company having convened a meeting of its members for the same day, for the purpose of considering a Resolution that the company be wound up voluntarily.

Dated this 6th day of November, 1972.

M. H. GARDNER, Director.

Kennedy, Smail & Middlemiss, 296 Little Lonsdale-street, Melbourne, 3000. 9139

The *Companies Act 1961.*—In the matter of G.V.A. TV RADIO SALES & SERVICE PTY. LTD.

Notice is hereby given that at an Extraordinary General Meeting of the members of the above-named company, held on the 26th day of October, 1972, it was resolved that the company be wound up voluntarily and at a meeting of creditors held on the same day, pursuant to section 260 it was resolved that for such purpose John Martin Walsh, of 296 Little Lonsdale-street, Melbourne, accountant, be appointed liquidator.

Notice is also given that after 21 days from this date I shall proceed to distribute the assets. All creditors having any claims against the company should furnish particulars of same by that date, otherwise I shall proceed to distribute the assets without regard to their claims.

Dated this 6th day of November, 1972.

J. M. WALSH, Liquidator.

Kennedy, Smail & Middlemiss, 296 Little Lonsdale-street, Melbourne, 3000. 9140

MURRAY (A.N.Z.) PROPRIETARY LIMITED.

Notice is hereby given, pursuant to section 254 (2) (b) of the *Companies Act 1961*, that at an Extraordinary General Meeting of members of Murray (A.N.Z.) Proprietary Limited, duly convened and held at 37 Herbert-street, St. Leonards, New South Wales, on the 27th day of October, 1972, the special resolution set out below was duly passed—

"That the company be wound up voluntarily and that Maxwell James Scott, of 419 Lonsdale-street, Melbourne, be appointed liquidator for the purpose of winding up."

Dated this 27th day of October, 1972.

9131 M. J. SCOTT, Liquidator.

BELL BRYANT (REFRIGERATION) PROPRIETARY LIMITED.

Notice is hereby given, pursuant to section 254 (2) (b) of the *Companies Act 1961*, that at an Extraordinary General Meeting of members of Bell Bryant (Refrigeration) Proprietary Limited, duly convened and held at 37 Herbert-street, St. Leonards, New South Wales on the 27th day of October, 1972, the special resolution set out below was duly passed—

"That the company be wound up voluntarily and that Maxwell James Scott, of 419 Lonsdale-street, Melbourne, be appointed liquidator for the purpose of winding up."

Dated this 27th day of October, 1972.

9132 M. J. SCOTT, Liquidator.

Companies Act 1961.—In the matter of G. BEST & CO. PTY. LTD. (in Liquidation).

Notice is hereby given that a Final Meeting of members and creditors of the above-named company will be held at 2.00 p.m. on Monday, 11th December, 1972, at the office of Lewis Luckins & Co., 1st Floor, 130 Flinders-street, Melbourne, pursuant to section 272 of the Companies Act 1961 for the purpose of laying before the meeting an account showing how the winding up has been conducted and how the assets have been disposed of, and also passing a Resolution in compliance with section 284 (2) of the Companies Act 1961.

Dated this 8th day of November, 1972.

LEWIS LUCKINS, F.C.A., Liquidator.

Lewis Luckins & Co., chartered accountants, 130 Flinders-street, Melbourne, 3000. Telephone: 63 8827 9198

BELL BRYANT (TRADING) PROPRIETARY LIMITED.

Notice is hereby given, pursuant to section 254 (2) (b) of the Companies Act 1961, that at an Extraordinary General Meeting of members of Bell Bryant (Trading) Proprietary Limited duly convened and held at 37 Herbert-street, St. Leonards, New South Wales, on the 27th day of October, 1972, the Special Resolution set out below was duly passed—

"That the company be wound up voluntarily and that Maxwell James Scott, of 419 Lonsdale-street, Melbourne, be appointed liquidator for the purpose of winding up."

Dated this 27th day of October, 1972.

9133 M. J. SCOTT, Liquidator.

The Companies Act 1961.—In the matter of HAMETH INVESTMENTS PROPRIETARY LIMITED (in Voluntary Liquidation).—Notice of Final Meeting.

Notice is hereby given that pursuant to section 272 (2) of the Companies Act 1961, an Extraordinary General Meeting of members of the above-named company will be held at the office of Parkhill, Lithgow and Gibson, 500 Collins-street, Melbourne, on Monday, 11th December, 1972, at 11 a.m., for the purpose of having an account laid before them, showing the manner in which the winding up has been conducted and the property of the company disposed of and of hearing any explanation that may be given by the liquidator.

Dated this 3rd day of November, 1972.

9134 B. W. LITHGOW, Liquidator.

Companies Act 1961.—In the matter of GAS MOTORS PTY. LTD. (in Liquidation).

Notice is hereby given that at an Extraordinary Meeting of the members of the above-named company, held on the 31st October, 1972 it was resolved that the company be wound up voluntarily and at a meeting of creditors, held on the same day, pursuant to section 260, it was resolved that for such purpose, Everett Thomson Bent, of Suite 18, 545 St. Kilda-road, Melbourne, public accountant, be appointed liquidator.

Notice is also given that after 21 days from this date I shall proceed to distribute the assets. All creditors having any claims against the company should furnish particulars of same by that date, otherwise I shall proceed to distribute the assets without regard to their claim.

Dated this 31st day of October, 1972.

E. T. BENT, Liquidator.

Bent & Cogle, public accountants, Suite 18, 545 St. Kilda-road, Melbourne, 3004. 9114

ASSOCIATED TOBACCO COMPANIES.

CO-OPERATIVE HOUSING SOCIETY NO. 2 LIMITED (IN LIQUIDATION).

Take notice that the affairs of the above-named society are now fully wound up and that in pursuance of section 272 (1) of the Companies Act 1961 and of the Co-operative Housing Societies Act 1958, a general meeting of the society will be held at the Training Room, W. D. & H. O. Wills (Australia) Limited, 246 East Boundary-road, East Bentleigh, at 1.30 p.m. on Wednesday, 13th December, 1972, for the purposes of—

- (i) laying before it an account showing how the winding up has been conducted and the property of the society disposed of and giving any explanations thereof; and
- (ii) passing a resolution that the books and papers of the said society of the liquidator relevant to the affairs of the society be destroyed after a period of 12 months from the date of the meeting.

Dated the 1st day of November, 1972.

9153 F. A. RIPPER, Liquidator.

Form 92.

In the matter of the Companies Act 1961, section 260 (1) Regulation 28 (2) (b); and in the matter of BEEF-A-ROO PTY. LTD.—Notice of Meeting of Creditors.

Notice is hereby given that a meeting of creditors of Beef-A-Roo Pty. Ltd., will be held at the offices of The Institute of Chartered Accountants in Australia, 140 Queen-street, Melbourne, in the State of Victoria, at 11 o'clock in the forenoon of the 22nd day of November, 1972.

The company having called a meeting of its members for the same day the purpose of the meeting is to consider a Special Resolution that the company be wound up voluntarily and that a liquidator be appointed for the purpose of the winding up.

A creditor is not entitled to vote at a meeting of creditors unless he has lodged with the Chairman of the meeting a proof of debt which claims to be due to him from the company.

Dated this 2nd day of November, 1972.

M. E. GREEN,
Chairman of Directors.

9117

The Companies Act 1961.

MAX DAWS MENS WEAR PROPRIETARY LIMITED (IN LIQUIDATION).

NOTICE CONVENING FINAL MEETING OF MEMBERS AND CREDITORS PURSUANT TO SECTION 272.

Notice is hereby given pursuant to section 272 of the Companies Act, 1961, that a General Meeting of the members and creditors of the above-named company will be held in the office of Kennedy, Smail & Middlemiss, 296 Little Lonsdale-street, Melbourne, on Wednesday the 6th December, 1972, at 11.00 a.m., for the purpose of having an account laid before them showing the manner in which the winding up has been conducted and the property of the company disposed of and hearing any explanations that may be given by the Liquidator.

Dated this 30th day of October, 1972.

A. M. HORSBURGH, Liquidator.

Kennedy, Smail & Middlemiss, 296-304 Little Lonsdale-street, Melbourne, 3000. 9147

Companies Act 1961. Section 272.

BARONET REFRIGERATION SUPPLIES PTY. LTD. (IN LIQUIDATION).

NOTICE OF FINAL MEETING OF MEMBERS AND CREDITORS.

Notice is hereby given that the final meeting of members and creditors of the above-named company shall be held on Monday, 11th December, 1972, at 1.30 p.m. at the offices of Max Gee & Co., 325 Warrigal-road, Burwood, 3125.

Agenda.

1. Presentation by the liquidator of an account, showing how the winding up has been conducted and the property of the company has been disposed of, and to give any explanation of the account.

2. The meeting to consider the following resolution:—
"That immediately after the dissolution of the company the liquidator may destroy the books and papers of the company pursuant to section 284 of the Act."

Dated this 8th day of November, 1972.

M. G. GEE, Liquidator.

Max Gee & Co., 325 Warrigal-road, Burwood, Victoria, 3125. Telephone 288 5109. 9170

Companies Act 1961.

BORUNGA PASTORAL CO. PTY. LTD. (IN VOLUNTARY LIQUIDATION).

Notice is hereby given that the affairs of the above-named company are now fully wound up and that in pursuance of section 272 (1) of the Companies Act 1961, a General Meeting of the company will be held on Thursday, 14th December, 1972, at 10 a.m.; at the office of Green, Taylor & Greenall, chartered accountants, 35 McLachlan-street, Horsham, for the purpose of laying before it an account, showing how the winding up has been conducted and the property of the company, disposed of and giving any explanation thereof.

Dated this 3rd day of November, 1972.

M. H. J. TAYLOR, Liquidator.

Green, Taylor & Greenall, chartered accountants, 35 McLachlan-street, Horsham. 9172

The Companies Act 1961.

EDGARS' NEWSAGENCY PTY. LTD. (IN MEMBERS VOLUNTARY LIQUIDATION).

Notice is hereby given that at an Extraordinary Meeting of the Members of the above-named company, held on Thursday, the 26th day of October, 1972, it was resolved that the company be wound up voluntarily and that for such purpose Mr. Geoffrey Ormond Harrison, chartered accountant, of Hall & Rose, 395 Collins-street, Melbourne, be appointed liquidator.

Dated this 8th day of November, 1972.

G. O. HARRISON, Liquidator.

Hall & Rose, chartered accountants, 395 Collins-street, Melbourne, Vic. 3000. 9184

The Companies Act 1961.

EDGARS' NEWSAGENCY (INVESTMENTS) PTY. LTD. (IN MEMBERS VOLUNTARY LIQUIDATION).

Notice is hereby given that at an Extraordinary Meeting of the Members of the above-named company, held on Thursday, the 26th day of October, 1972, it was resolved that the company be wound up voluntarily and that for such purpose Mr. Geoffrey Ormond Harrison, chartered accountant, of Hall & Rose, 395 Collins-street, Melbourne, be appointed liquidator.

Dated this 8th day of November, 1972.

G. O. HARRISON, Liquidator.

Hall & Rose, 395 Collins-street, Melbourne, Vic. 3000. 9185

Companies Act 1961, Section 272 (2).

ROSYTH PROPRIETARY LIMITED (IN VOLUNTARY LIQUIDATION).

NOTICE OF FINAL MEETING.

Notice is hereby given that a General Meeting of the members of the above-named company will be held at 7 Scotsburn-grove, Toorak, on Monday, 18th December, 1972, at 8 p.m. for the purpose of having an account laid before them, showing the manner in which the winding up has been conducted and the property of the company disposed of, and of hearing any explanation that may be given by the liquidator.

Dated this 1st day of November, 1972.

9186 G. D. H. SARGOOD, Liquidator.

Companies Act 1961.

F. G. MILLER PTY. LTD. (IN LIQUIDATION).

Notice is hereby given that a first and final dividend to preferential creditors is intended to be declared in this matter. Preferential creditors who have not proved their debts and claims by 30th November, 1972, will be excluded from this dividend.

Dated this 3rd day of November, 1972.

W. N. JOHANSON, Liquidator:

National Bank Chambers, Pall Mall, Bendigo, 3550. 9187

EASTERN INVESTMENTS PTY. LIMITED (IN VOLUNTARY LIQUIDATION).

NOTICE CONVENING FINAL MEETING PURSUANT TO SECTION 272 OF THE COMPANIES ACT 1961.

Pursuant to section 272 of the Companies Act 1961, a General Meeting of the members of the above-mentioned company will be held at the office of the liquidator, 2nd Floor, 339 Collins-street, Melbourne, on Monday, the 11th day of December, 1972, at 10 a.m., for the purpose of having an account laid before them, showing the manner in which the winding up has been conducted and the property of the company disposed of, and of hearing any explanations that may be given by the liquidator.

Dated this 6th day of November, 1972.

9188 E. E. FOOKES, Liquidator.

The Companies Act 1961.—In the matter of W. WALKER PROPRIETARY LIMITED.—Notice of Final Meeting.

Notice is hereby given that, pursuant to section 272 of the Companies Act 1961, a General Meeting of the members of the above-named company will be held at High-street, Lancefield, on Monday, the 11th day of December, 1972, at 9 o'clock in the forenoon, for the purpose of having an account laid before them, showing the manner in which the winding up has been conducted and the property of the company disposed of, and of hearing any explanation that may be given by the liquidator.

Dated the 1st day of November, 1972.

9161 WM. H. WALKER, Liquidator.

In the Supreme Court of Victoria.—1972 No. Co. 8481.—In the matter of the Companies Act 1961; and in the matter of ENROH FREEHOLDS PTY. LTD.

Notice is hereby given that a petition for the winding up of the above-named company by the Supreme Court was, on the 17th day of October, 1972, presented by Wardle & Turnbull Pty. Ltd. And that the said petition is directed to be heard before the Court, sitting at the Fourteenth Court Law Courts, William-street, Melbourne, on the 5th day of December, 1972; and any creditor or contributory of the said company desiring to support or oppose the making of an order on the said petition may appear at the time of hearing by himself or his counsel for that purpose; and a copy of the petition will be furnished to any creditor or contributory of the said company requiring the same by the undersigned on payment of the regulated charge for the same.

The petitioner's registered office is situate at 19 Drummond-street, Carlton.

The petitioner's solicitors are Rodda, Ballard & Vroland, of 430 Little Collins-street, Melbourne.

RODDA, BALLARD & VROLAND.

NOTE.—Any person who intends to appear on the hearing of the said petition must serve or send by post to the above-named solicitors, notice in writing of his intention so to do. The notice must state the name and address of the person, or if a firm, the name and address of the firm, and must be signed by the person or firm, or his or their solicitors (if any), and must be served, or, if posted, must be sent by post in sufficient time to reach the above named not later than four o'clock in the afternoon, of the 4th day of December, 1972 (the day before the day appointed for the hearing of the petition or the Friday preceding the day appointed for the hearing of the petition if such day is a Monday or a Tuesday following a public holiday). 9130

The Companies Act 1961.

BIDDIE ENTERPRISES PTY. LTD.

MEMBERS' VOLUNTARY WINDING UP.

Notice is hereby given that at a meeting of the members of the above-named company, held on Monday, 30th October, 1972, it was resolved that the company be wound up and it was resolved that for such purpose, Brian Geoffrey Thom, of 54 Malop-street, Geelong, public accountant, be appointed liquidator.

Dated this 30th day of October, 1972.

B. G. THOM, public accountant.

B. G. Thom, public accountant, 54 Malop-street, Geelong; 3220. 9104

HOLDENSON & NIELSON MARKETING PTY. LIMITED. (IN VOLUNTARY LIQUIDATION):

NOTICE OF FINAL MEETING OF MEMBERS.

Notice is hereby given that the final meeting of the members of Holdenson & Nielson Marketing Pty. Limited (in Voluntary Liquidation) will be held at the office of C. R. B. James & Sons, chartered accountants, 37 Queen-street, Melbourne, on the 8th day of December, 1972, at 11 o'clock in the forenoon.

AGENDA.

1. The accounts of the liquidator, showing how the winding-up has been conducted and the property of the company disposed of is to be laid before the meeting.

Dated this 2nd day of November, 1972.

9178 R. S. JAMES, Liquidator.

The Companies Act 1961.

CONSOLIDATED TRANSPORT COMPANY PROPRIETARY LIMITED (IN LIQUIDATION).

NOTICE CONVENING FINAL MEETING OF MEMBERS AND CREDITORS PURSUANT TO SECTION 272.

Notice is hereby given pursuant to section 272 of the Companies Act, 1961, that a General Meeting of the members and creditors of the above-named company will be held in the office of Kennedy, Smail & Middlemiss, 296 Little Lonsdale-street, Melbourne, on Wednesday the 6th December, 1972; at 10.30 a.m., for the purpose of having an account laid before them showing the manner in which the winding up has been conducted and the property of the company disposed of and hearing any explanations that may be given by the Liquidator.

Dated this 30th day of October, 1972.

E. R. SMAIL, Liquidator.

Kennedy, Smail & Middlemiss, 296-304 Little Lonsdale-street, Melbourne, 3000. 9148

Creditors, next of kin and others having claims in respect of the estate of Jean Robertson, formerly of 27 Orford-street, Moonee Ponds, but late of 23 Learmonth-street, Moonee Ponds, home duties (who died on the 29th of May, 1972), are to send particulars of their claims to the executor, National Trustees, Executors and Agency Company of Australasia Limited, of 95 Queen-street, Melbourne, by 19th January, 1973, after which date it will commence to distribute the assets, having regard only to the claims of which it then has notice.

RENNICK & GAYNOR, solicitors, 481 Riversdale-road, Hawthorn East. 9150

CATHERINE MARY PINSENT, late of 410 Wattletree-road, East Malvern, widow, DECEASED.

Creditors, next of kin and others having claims in respect of the estate of the deceased (who died on the 24th day of June, 1972), are required by the trustees, Jack Eadley Hambleton, of 43 Nicholas-street, Ashburton, and Ronald Francis Pinsent, of 15 Elora-street, Oakleigh, to send particulars to them, care of Best Hooper Rintoul & Shallard, solicitors, 377 Little Collins-street, Melbourne, by the 10th day of January, 1973, after which date the trustees may convey or distribute the assets, having regard only to the claims of which they then have notice.

BEST, HOOPER, RINTOUL & SHALLARD, solicitors, 377 Little Collins-street, Melbourne, 3000. 9151

Creditors, next of kin and others having claims in respect of the estate of Eva Leonie Allison, late of 34 Bangalore-street, Kensington, widow, deceased (who died on the 23rd August, 1972), are required by the executor, Francis John Lyons, of 31 Beaconsfield-parade, Albert Park, panelbeater, to send particulars of their claims to him in care of the under-mentioned solicitors prior to the 17th January, 1973, after which date the said executor will distribute the assets of the deceased, having regard only to the claims of which he then shall have had notice.

ROGERS & GAYLARD, solicitors, 51 Queen-street, Melbourne. 9152

ELLA MAY MORLEY, late of 56 Birdwood-street, Balwyn (formerly of 2 Argus-street, Balwyn), widow, DECEASED.

Creditors, next of kin and others having claims in respect of the estate of the deceased (who died on the 19th May, 1972), are required by The Equity Trustees, Executors and Agency Company Limited, of 472 Bourke-street, Melbourne, to send particulars of their claims to the said company by the 15th day of January, 1973, after which date it will convey or distribute the assets, having regard only to the claims of which the company then has notice.

STEDMAN, CAMERON, MEARES & HALL, solicitors, 339 Collins-street, Melbourne. 9144

GAETANO SCOLLO, formerly of Lakes Entrance, Victoria, but late of Via Natale Cappello Bucceri Siracus, Italy, retired farmer, DECEASED, intestate.

Creditors, next of kin and all other persons having claims against the estate of the deceased, are required by the administratrix of the deceased's estate, Anna Maria Scollo Vona, of 6 Reidford-street, West Preston, to send particulars to her or care of the under-signed Rylah & Rylah, on or before the 10th January, 1972, after which date she will distribute the assets, having regard only to the claims of which she then has notice and the said administratrix Anna Maria Scollo Vona will not be liable to any persons of whose claim she has not then received notice.

RYLAH & RYLAH, solicitors, 349 Collins-street, Melbourne. 9145

Creditors, next of kin and others having claims in respect of the estate of John Francis O'Meara, late of 14 Heller-street, Brunswick, T.P.I. pensioner, deceased (who died on the 14th day of September, 1972), are to send particulars of their claims to the executor Stanley Gordon Roberts, care of the under-mentioned solicitors, by the 11th day of January, 1973, after which date the executor will distribute the assets, having regard only to the claims of which he then has notice.

MARTIN & MARTIN, solicitors, 37 Queen-street, Melbourne. 9146

Creditors, next of kin and others having claims in respect of the estate of Ruth Gwendoline Willan Armstrong, late of 19 Grange-road, Kew, spinster, deceased (who died on the 21st June, 1972), are to send particulars of their claims to The Trustees, Executors and Agency Company limited, of 401 Collins-street, Melbourne, the executor

of the will of the said deceased, by the 11th day of January, 1973, after which date it will distribute the assets, having regard only to the claims of which it then has notice.

BEST, HOOPER, RINTOUL & SHALLARD, solicitors, 377 Little Collins-street, Melbourne, 3000. 9141

CLIFFORD WERLIN ANDERSEN, late of 8 Violet-grove, East Kew, accountant, DECEASED.

Creditors, next of kin and others having claims in respect of the estate of the deceased (who died on the 29th April, 1972), are required by the executors Caroline Everard Andersen, of 8 Violet-grove, East Kew, widow, and The Equity Trustees, Executors and Agency Company Limited, of 472 Bourke-street, Melbourne, to send particulars to them, care of the said company, by the 16th January, 1973, after which date the executors may distribute the estate, having regard only to the claims of which they then have notice.

W. B. & O. MCCUTCHEON, solicitors, 150 Queen-street, Melbourne. 9126

Creditors, next of kin and others having claims in respect of the estate of Leslie James McCormick, formerly of 67 Hardiman-street, Kensington, but late of 42 Heller-street, West Brunswick, retired metal machinist (who died on the 2nd day of July, 1972), are to send particulars of their claims to the executor company, The Equity Trustees, Executors & Agency Co. Ltd., of 472 Bourke-street, Melbourne, by the 19th day of January, 1973.

PRENDERGAST & ROBINSON, PARKINSON & HART, solicitors, 406 Lonsdale-street, Melbourne. 9127

MICHAEL STEPHEN RYDAR (also known as Michael Stephen Ryder), late of 25 Muswell Hill, Glen Iris, retired clerk, DECEASED.

Creditors, next of kin and others having claims in respect of the estate of the deceased (who died on the 18th May, 1972), are required by the executrices, Gertrude Maude Ryder, of 25 Muswell Hill, Glen Iris, widow, and Joan Ursula Bell, of 33 Hansen-street, Mount Waverley, married woman, to send particulars to them, care of Keith Hercules & Sons, of 443 Little Collins-street, Melbourne, by the 15th day of January, 1973, after which date the said executrices may convey or distribute the assets, having regard only to the claims of which they then have notice.

KEITH HERCULES & SONS, solicitors, 443 Little Collins-street, Melbourne. 9128

FLORA GERTRUDE ROCHE, late of 40 Mathoura-road, Toorak, spinster, DECEASED.

Creditors, next of kin and others having claims in respect of the estate of the deceased (who died on the 1st day of April, 1972), are required by The Perpetual Executors and Trustees Association of Australia Limited, of 100-104 Queen-street, Melbourne, in the State of Victoria, and Ian Wright Lissett, company director, care of P.O. Box 710, Carnarvon, in the State of Western Australia, the applicants for a grant of administration to send particulars of their claims to the said applicants in the care of the said company, by the 22nd day of January, 1973, after which date they will convey or distribute the assets, having regard only to the claims of which they then have notice.

HENDERSON & BALL, of 430 Little Collins-street, Melbourne. 9129

Creditors, next of kin and others having claims in respect of the estate of Roy Frederick Bobbitt, late of 96 Valley-parade, Glen Iris, in the State of Victoria, fork lift driver, deceased (who died on the 13th day of August, 1972), are to send particulars of their claims to Margaret Mary Bobbitt, of 96 Valley-parade, Glen Iris, in the said State, widow, the executrix appointed by the will of the said deceased, by the 9th day of February, 1973.

J. & S. SHATIN, solicitors of 224 Queen-street, Melbourne. 9121

Creditors, next of kin and others having claims in respect of the estate of Ernest Alexander Prentice, late of flat 4, 25 Hampden-road, Armadale, newsagent, deceased (who died on 11th September, 1972), are to send particulars of their claims to The Equity Trustees, Executors and Agency Company Limited, of 472 Bourke-street, Melbourne, by 12th January, 1973, after which date it will distribute the assets, having regard only to the claims of which it then has notice.

R. C. H. BEATTIE, solicitor, 270 Waverley-road, East Malvern. 9157

Creditors, next of kin and others having claims to the estate of Harold Wall, late of 72 Evan-street, Parkdale, gentleman, deceased (who died on the 29th day of January, 1972, and probate of whose will was granted by the Supreme Court of Victoria, on the 11th day of October, 1972, and probate of whose will was granted by the Brighton, solicitor), are to send particulars of their claims to the said executor, care of the below mentioned solicitors, by the 1st February, 1973, after which date he will distribute the assets of the deceased, having regard only to the claims of which he has notice.

Dated the 1st day of November, 1972.

HASSALL & BILLINGS, solicitors, 360 South-road, Moorabbin, 9102

Creditors, next of kin and all other persons having claims in respect of the estate of Douglas Alexander Patterson, late of "Wave Hill", Stanley-road, Red Hill South, gentleman, deceased (who died on the 11th day of April, 1970), are required to send particulars of their claims to the executor, William Edward Sheehan, of "San Jose", Shoreham, farmer, care of the under-mentioned firm of solicitors, by the 8th day of January, 1973, after which date they will distribute the assets, having regard only to the claims of which they shall then have had notice.

ABBOTT, STILLMAN & WILSON, solicitors, 406 Lonsdale-street, Melbourne, 3000. 9103

Creditors, next of kin and others having claims in respect of the estate of James Patrick Monaghan, late of Howey-street, Gisborne, in the State of Victoria, retired, deceased (who died on the 16th day of June, 1972), are to send particulars of their claims to The Equity Trustees, Executors and Agency Company Limited, of 472 Bourke-street, Melbourne, by the 15th January, 1973, after which date it will distribute the assets, having regard only to the claims of which it then has notice.

ARMSTRONG, COLLINS & DELACY, solicitors, Kyneton, 9094

JOHN HORACE GRAYSON, late of Glengarry, farmer and grazier, DECEASED.

Creditors, next of kin and others having claims in respect of the estate of the deceased (who died on 24th August, 1972), are required by the executrices, Gladys May Cook, of 27 Meek-street, Dubbo, in the State of New South Wales, Norma Florence Wallace, of 1 Cluney-court, Blackburn South, in the State of Victoria, and Iris Gwenda Swan, of Liddiard-road, Traralgon, in said State, to send particulars to them, care of the below mentioned solicitors, by the 25th day of January, 1973, after which date they may convey or distribute the assets, having regard only to the claims of which they then have notice.

Dated this 31st day of October, 1972.

BRUCE, LITTLETON & HACKFORD, solicitors, Traralgon, 9097

Creditors, next of kin and others having claims in respect of the estate of Leslie Edmund Bond, late of Glengarry, farmer, deceased (who died on the 15th day of July, 1972, and probate of whose will has been granted by the Supreme Court of Victoria, on the 17th day of October, 1972, to Edgar Thomas Bond, of 29 McLean-street, Morwell, funeral director), are to send particulars of their claims to the said executor, care of the below-mentioned solicitors, by the 31st January, 1973, after which date he will distribute the assets of the deceased, having regard only to the claims of which he then has notice.

BRUCE, LITTLETON & HACKFORD, solicitors, Traralgon, 9098

CHARLES FORRESTER GREAVES, late of Manuka-road, Beaconsfield, in the State of Victoria, retired grazier, DECEASED.

Creditors, next of kin and others having claims in respect of the estate of the deceased (who died on the 17th day of July, 1971), are required by the executors, Mercy Imogene Greaves, of Manuka-road, aforesaid, widow, and William McLellan Greaves of "Warrook", Monomeith, in the said State, grazier, to send particulars of their claims to them, care of the under-mentioned solicitors, on or before the 15th day of January, 1973, after which date the executors will distribute the assets, having regard only to the claims of which they shall then have notice.

T. A. RANK & ROBINSON, solicitors, 388 Bourke-street, Melbourne, 9162

Creditors, next of kin and others having claims in respect of the estate of Alick James Rowley, deceased, intestate, late of 21 Queens-parade, Traralgon, in the State of Victoria, contractor (who died on the 25th day of February, 1972), are required by the administratrix, Miriam Frances Rowley, to send particulars to her, care of the under-mentioned solicitors, by the 8th January, 1973, after which date the administratrix will distribute the assets, having regard only to the claims of which she then has notice.

RICHES & DAVINE, solicitors, 96 Hotham-street, Traralgon, 9115

KATHLEEN VALBA FAULKS, late of Mansfield, widow, DECEASED.

Creditors, next of kin and others having claims in respect of the deceased (who died on the 4th day of June, 1972), are required by her trustees, Sheila Anne Higgins, of Old Warburton-road, Warburton, married woman, and Eleanor Elizabeth Riddington, of 45 Elvins-street, Mansfield, married woman, to send particulars to them, care of the under-mentioned firm of solicitors, by the 22nd day of January, 1973, after which date the trustees may convey and distribute the assets, having regard only to the claims of which they then have notice.

MAL. RYAN & GLEN, 9 High-street, Mansfield, solicitors for the trustees, 9119

LESLIE NANKERVIS, late of 13 Mansfield-street, Blackburn, engineer, DECEASED.

Creditors, next of kin and others having claims in respect of the estate of the above-named Leslie Nankervis, deceased (who died on the 19th of April, 1972), are to send particulars of their claims to The Trustees, Executors and Agency Company Limited, of 401 Collins-street, Melbourne, the executor appointed by the will of the said deceased, by the 6th day of January, 1973, after which date the executor will distribute the assets, having regard only to the claims of which it shall then have notice.

MORRIS GLICKMAN & CO., solicitors, 672A Glenferrie-road, Hawthorn, 9120

Creditors, next of kin and others having claims in respect of the estate of William Albert Ramm, late of 2 Cardigan-street north, Ballarat, retired driver, deceased (who died on 16th September, 1972), are required to send particulars of their claims to the executor, The Union-Fidelity Trustee Company of Australia Limited, at its address, 101 Lydiard-street north, Ballarat, by 9th January, 1973, after which date the said company will distribute the assets, having regard only to the claims of which it then has notice.

BAIRD & MCGREGOR, solicitors, Ballarat, 9163

DARRELL JOHN BLAKE, late of 11 Wynnstay-road, Seaford, in the State of Victoria, photo-engraver, DECEASED, intestate.

Creditors, next of kin and others having claims in respect of the estate of the deceased (who died on 10th day of September, 1972), are required by the administratrix, Caterina Lucy Blake, of 49 Spruzen-avenue, Kew, in the said State, to send particulars in writing to her at the office of the under-signed, by the 8th day of January, 1973, after which date the administratrix may convey or distribute the assets, having regard only to the claims of which she then has notice. And notice is hereby further given that the said Caterina Lucy Blake will not be liable for the assets so distributed or any part thereof to any person of whose claims she shall not have had notice as aforesaid.

Dated this 27th day of October, 1972.

STRUGNELL & STRUGNELL, 106 Bell-street (P.O. Box 62), Coburg, 3058, solicitors for the estate of the said Darrell John Blake, deceased intestated, 9171

WILLIAM DANIEL TUBB, late of Tamleugh via Violet Town, in the State of Victoria, farmer, DECEASED.

Creditors, next of kin and others having claims in respect of the deceased (who died on the 14th day of August, 1970), are required by his executors, Alexander George Walker and Raymond William Walker, both of Tamleugh, farmers, to send particulars to them, care of the under-mentioned solicitor, by the 13th day of January, 1973, after which date the executors may convey and distribute the assets, having regard only to the claims of what they then have notice.

F. KIERCE O'LOUGHLIN, solicitor, Euroa, 9179

GEORGE HERBERT JAMES GILLINGHAM, late of Iluka-avenue, Malua Bay, in the State of New South Wales, retired company manager, DECEASED.

Creditors, next of kin and others having claims in respect of the estate of the above deceased (who died on the 8th day of August, 1972), are required by the trustees, Peter Balmford and Aubrey Galway Schrader, both of 166 Queen-street, Melbourne, in the State of Victoria, solicitors to send particulars to them, care of the undersigned by the 17th day of January, 1973, after which date the trustees may convey or distribute the assets, having regard only to the claims of which they then have notice.

WHITING & BYRNE, solicitors, 166 Queen-street, Melbourne. 9192

ROBERTA MAY ELLIOTT, late of lot 17, Old Coach-road, Montrose, in the State of Victoria, widow, DECEASED.

Creditors, next of kin and others having claims in respect of the estate of the above deceased (who died on the 25th day of July, 1972), are required by the trustee, Doris Turner, of Main-road, Mount Dandenong, in the said State, married woman, to send particulars to her, care of the undersigned by the 17th day of January, 1973, after which date the trustee may convey or distribute the assets, having regard only to the claims of which she then has notice.

WHITING & BYRNE, solicitors, 166 Queen-street, Melbourne. 9191

WILLIAM SIDNEY BRASH, late of 32 Alwyn-street, Mitcham, in the State of Victoria, retired, DECEASED.

Creditors, next of kin and others having claims in respect of the estate of the above-named deceased (who died on the 19th day of April, 1972), are required by the administrator, The Equity Trustees, Executors and Agency Company Limited, of 472 Bourke-street, Melbourne, in the said State, to send particulars of such claims to the said company, by the 11th day of January, 1973, after which date the said company may convey or distribute the assets, having regard only to the claims of which it then has notice.

DAVIES, CAMPBELL & PIESSE, solicitors, 401 Collins-street, Melbourne. 9190

CHARLES MARSH, formerly of 5 Bright-street, East Brighton, but late of 7 Mair-street, Brighton Beach, retired, DECEASED.

Creditors, next of kin and others having claims in respect of the estate of the deceased (who died on the 22nd day of June, 1972), are required by the personal representative, Mavis Sutherland Bowskill, of 5 Bright-street, East Brighton, to send particulars to her, care of the under-mentioned solicitors, Leach & Thomson, of 472 Bourke-street, Melbourne, by the 16th day of January, 1973, after which date the personal representative may convey or distribute the assets, having regard only to the claims of which she then has notice.

LEACH & THOMSON, solicitors, 472 Bourke-street, Melbourne. 9156

INSOLVENCY NOTICES

The Bankruptcy Act 1966-70,
COMMONWEALTH OF AUSTRALIA.

A First Dividend is intended to be declared in the under-mentioned estate. Creditors who have not proved their debts by the 16th day of November, 1972, will be excluded from the dividend.

Jean Merle Turner, of Buckingham-avenue, Springvale.
Dated this 2nd day of November, 1972.

R. D. WIDDOWS, trustee, 703 South-road, Moorabbin, Victoria, 3189. 9123

Bankruptcy Act 1966.—Part X.—In the matter of ROBERT KEITH HOPGOOD and ANDREW BROWN McALOON (trading as Rodene Contracting).

Notice is hereby given that a second dividend is intended to be declared in the above matter. Creditors who have not proved their debts by the 22nd day of November, 1972, may be excluded from this dividend.

Dated this 31st day of October, 1972.

I. K. MACKINNON, Registered Trustee.

John MacKinnon & Co., chartered accountants, Suite 12, 562 St. Kilda-road, Melbourne. Telephone 51 2178. 9105

Bankruptcy Act 1966.

Bankruptcy District of the State of Victoria, No. 47 of 1970, Part X. Re: Darrell Crofton Canet.

DARRELL CROFTON CANET FORMERLY TRADING AS WALTZING MATILDA HOTEL AT BROOKE-STREET, SMYTHESDALE, VICTORIA.

NOTICE TO CREDITORS OF INTENTION TO DECLARE DIVIDEND.

Notice is hereby given of my intention to declare a first and final dividend in the estate of the above-named debtor. I hereby set Friday, 24th November, 1972 as the latest date on which creditors may lodge proofs of debt. Any creditor who has not lodged a proof of debt by that date shall be excluded from the dividend and I shall proceed to distribute the dividend without regard to any debt that has not been proved.

Dated this 8th day of November, 1972.

M. G. GEE, Trustee.

Max Gee & Co., public accountants, 325 Warrigal-road, Burwood, Victoria, 3125. Telephone 288 5109. 9160

In the Supreme Court of the State of Victoria.

SALE BY THE SHERIFF.

On Friday, the 15th of December, 1972, at 10 a.m., at the Police Station, Springvale (unless process be stayed or satisfied):—

All the estate and interest (if any) of Leslie Thomas Mills, buyer, of 27 Donald-street, Springvale, and Beverley Joan Mills, as joint proprietors of an estate in fee-simple in the land described in certificate of title, volume 8642, folio 161, upon which is erected a brick veneer dwelling, known as No. 27 Donald-street, Springvale.

Registered mortgages Nos. D.231092 and D.481071 affect the said estate and interest.

Terms: Cash only.

H. BUETTNER, Sheriff's Officer.

3rd November, 1972.

9193

In the Supreme Court of the State of Victoria.

SALE BY THE SHERIFF.

On Friday, the 8th of December, 1972, at 3.30 p.m., at the Police Station, Yarraville (unless process be stayed or satisfied):—

All the estate and interest (if any) of Wlavymir Hnatejko (also known as Wladymir Hnatejko) labourer, and Ella Hnatejko, married woman (shown on certificate of title as Ella Gisela Hnatejko), both of 32 Kingston-street, Yarraville, as joint proprietors of an estate in fee-simple in the land described in certificate of title, volume 2530, folio 865, upon which is erected a single fronted weatherboard dwelling-house, known as No. 32, Kingston-street, Yarraville.

Registered mortgages Nos. A.26241 and A.218236 affect the said estate and interest.

Terms: Cash only.

DOUGLAS S. HALL, Sheriff's Officer.

8th November, 1972.

9194

IMPOUNDINGS

BEARS LAGOON.—Impounded in Bears Lagoon Pound.

2 roan steers, nick off both ears, no visible brand
1 red poll steer, R.W. on rump
1 red steer, "N" left ear, R.W. on rump
1 red steer, notch left ear, R.W. on rump
2 red poll steers, R.W. on rump
2 white steers, nick left ear, no visible brand
1 black and white steer, nick left ear, no visible brand

2 red poll steers, nick both ears, no visible brand
 1 blue roan steer, no visible brand
 1 bald face black steer, no visible brand
 2 roan steers, no visible brand
 2 red and white steers, nick or W on left ear, no visible brand

1 poll roan steer, W left ear, no visible brand
 2 red steers, W left ear, no visible brand

If not claimed and expenses paid, to be sold on 22nd November, 1972.

9164—\$7.00
 G. TURNER,
 Poundkeeper.

CAMPERDOWN.—Impounded in Camperdown Pound, from Camperdown—Ballarat road.

6 Jersey heifers

2 Jersey crossbred heifers

One Jersey has notches out of near ear, seven with notches out of both ears, all about twelve months old

If not claimed and expenses paid, to be sold on Tuesday, 21st November, 1972.

9099—\$3.50
 L. BREEN,
 Poundkeeper.

COLERAINE.—Impounded in Coleraine Pound, by the Shire Herdsman, from Tarrenlea-road.

Nos. 1, 2 & 3. 3 Shorthorn steers, 15 months old, various ear marks, no visible brand

Nos. 4, 5 & 6. 3 Hereford Shorthorn cross steers, 15 months old, yellow ear tags, no visible brand

If not claimed and expenses paid, to be sold on 25th November, 1972.

9197—\$3.50
 GEO. SPONG,
 Poundkeeper.

FLINDERS.—Impounded in Flinders Shire Pound, Eastbourne-road, Rosebud, by Shire Ranger.

1 horned X breed Hereford cow, red and white, no visible brand

1 X breed Hereford calf, black and white, no visible brand

If not claimed and expenses paid, to be sold on 22nd November, 1972.

9167—\$3.15
 L. MOULDEN,
 Poundkeeper.

KORUMBURRA.—Impounded in Korumburra Pound, by the Shire Ranger, 28th October, 1972.

1 red Hereford steer, right ear notched, no visible brand

1 black Hereford cross steer, right ear notched, no visible brand

Impounded by G. H. Staben, Poowong East, on 30th October, 1972.

1 white billy goat, no visible brand

If not claimed and expenses paid, to be sold on 1st December, 1972.

9165—\$4.20
 R. N. CLARK,
 Poundkeeper.

KYNETON.—Impounded at Kyneton Pound, on 1st November, 1972, from the Golf Course-road.

18 full mouth crossbred ewes and lambs at foot, red and blue circle on back

If not claimed and expenses paid, to be sold on 28th November, 1972.

9096—\$2.80
 L. GRADY,
 Poundkeeper.

MANSFIELD.—Impounded in Mansfield Pound.

6 sheep, 2 shorn, 1 half shorn and 3 woolies, various ear marks, no visible brand

If not claimed and expenses paid, to be sold on Friday, 25th November, 1972.

9196—\$2.45
 N. PREST,
 Poundkeeper.

OXLEY.—Impounded in Oxley Pound, from Markwood.

1 black baldy poll heifer, 2 notches under off ear

2 black poll cows, 2 notches under off ear

1 brindle poll steer, 2 notches under off ear

3 black poll steers, 2 notches under off ear

1 black poll heifer, 2 notches under off ear

If not claimed and expenses paid, to be sold on 23rd November, 1972.

9168—\$3.50
 M. PERKINS,
 Poundkeeper.

WINSLOW.—Impounded in Winslow Pound, off Ibbs-road.
 1 black Poll bull

If not claimed and expenses paid, to be sold on 15th November, 1972.

9174—\$2.10
 D. MATHESON,
 Poundkeeper.

Subordinate Legislation Act 1962.

NOTICE OF MAKING OF STATUTORY RULES.

In pursuance of the provisions of the *Subordinate Legislation Act 1962* and the Regulations made thereunder, notice is given of the making of the following statutory rules:—

No.	Education Act 1958.	Price.
284/1972.	Education Department (Amendment) Regulations 1972	10c
	<i>Cadet Surveyors Act 1964.</i>	
285/1972.	Cadet Surveyors (State Forests Department) Second Amendment Regulations 1972	10c
	<i>Country Fire Authority Act 1958.</i>	
286/1972.	Country Fire Authority (Loan No. 92) Regulations 1972	10c
	<i>Mental Health Act 1959 (No. 6605).</i>	
287/1972.	Mental Health (Mileage Rates) Regulations 1972	10c
	<i>Railways Act 1958.</i>	
288/1972.	Victorian Railways Commissioners Amendment to Regulation No. 93	10c

Copies of these statutory rules may be purchased at the Sale of Publications Section of the Government Printing Office, located at 7A Parliament-place, Melbourne, 3002. If ordered by mail, remittance should be addressed to "The Government Printer, Box 203, P.O., North Melbourne, 3051", and should include 7c extra for postage. If a credit account is held at this office, no remittance is required with the mail order.

The annual subscription rate for Statutory Rules (including Bound Volumes) is \$25, payable in advance. The subscription year commences on 1st January.

C. H. RIXON,
 Government Printer.

AGENTS FOR THE "VICTORIA GOVERNMENT GAZETTE".

The following have been appointed agents to receive Advertisements and Subscriptions for the *Victoria Government Gazette*:—

- ARMSTRONG'S AGENCY, 217 Queen-street, Melbourne, Victoria 3000.
 ARNALL & JACKSON, 390 Barkly-street, Brunswick, Victoria 3056.
 BAIRNSDALE AUTHORIZED NEWSAGENCY, 132 Main-street, Bairnsdale, Victoria 3875.
 BICKNELL, M. J., Authorized Newsagent, 196 Timor-street, Warrnambool, Victoria 3280.
 BLANE'S AUTHORIZED NEWSAGENTS, 162 Murray-street, Colac, Victoria 3250.
 CARTER, R. G., ADVERTISING SERVICE PTY. LTD. Suite 24, 65 Queens-road, Melbourne, Victoria 3004.
 DAVIES, G. & M. V., 112 Gray-street, Hamilton, Victoria 3300.
 DAVIS, WM. (MILDURA) PTY. LTD., 126 Eighth-street, Mildura, Victoria 3500.
 DIXON'S NEWSAGENCY, 89 Firebrace-street, Horsham, Victoria 3400.
 EASTHALL ASSOCIATES, 934 Whitehorse-road, Box Hill, Victoria 3128.
 EDGARS' AUTHORIZED NEWSAGENCY, 45 Bridge-street, Benalla, Victoria 3672.
 FRANKS, H. & CO., 184 Ryrie-street, Geelong, Victoria 3220.
 GATLEY, A. & J., 250 Lonsdale-street, Dandenong, Victoria 3175.
 GORDON & GOTCH AUSTRALASIA LTD., 434 St. Kilda-road, Melbourne, Victoria 3004.
 GULLAN'S NEWSAGENCY, 88 Bridge-street, Ballarat, Victoria 3350.
 HAMPTON, A. C., 243 Mitchell-street, Bendigo, Victoria 3550.

HARSTON, PARTRIDGE & CO. PTY. LTD., 455 Little Collins-street, Melbourne, Victoria 3000.

KYNETON GUARDIAN PTY. LTD., P.O. Box 18, Kyneton, Victoria 3444.

LATIMER'S, Newsagents, 45 Station-street, Malvern, Victoria 3144.

LIVINGSTON'S SHEPPARTON NEWSAGENCY, 246 Wyndham-street, Shepparton, Victoria 3630.

THE MERCANTILE EXCHANGE, 34 Queen-street, Melbourne, Victoria, 3000.

McGILL'S AUTHORIZED NEWSAGENCY, 183-5 Elizabeth-street, Melbourne, Victoria 3000.

POWNEYS AUTHORIZED NEWSAGENCY, 293 Hargreaves-street, Bendigo, Victoria 3550.

PURDIE, J., & CO., 138 Moorabool-street, Geelong, Victoria 3220.

SALE AUTHORIZED NEWSAGENCY, 142 Raymond-street, Sale, Victoria 3850.

SKINNER'S AUTHORIZED NEWSAGENCY, 49-51 Franklin-street, Traralgon, Victoria 3844.

STEVENSON, A. C. & M., NEWSAGENTS, 132 Henty-street, Casterton, Victoria 3311.

VANCE'S AUTHORIZED NEWSAGENCY, 83 Murray-street, Wangaratta, 3677.

VERNONS OF RICHMOND, 162 Bridge-road, Richmond, Victoria 3121.

VIEW POINT AUTHORIZED NEWSAGENCY, 4 View-Point, Bendigo, Victoria 3550.

A copy of the Gazette filed at each place for public reference.

PUBLICATION OF OFFICIAL MATTER.

Attention is invited to the following procedure in relation to the publication of official matter in the *Government Gazette*:—

Publication will be facilitated by the submission of carbon copies for the use of the *Gazette Officer*.

1. Matter submitted to the Executive Council.

Matter submitted to the Executive Council which requires gazettal will normally be published in the issue of the following week.

Where urgent gazettal is required, special arrangements should be made with the *Gazette Officer*, Room 9, first floor, Old Treasury Building.

2. Other matter.

(a) All other matter duly certified by a responsible officer for publication should be lodged with the *Gazette Officer* not later than half-past Nine a.m. on Tuesday.

(b) Lengthy or involved notices should be forwarded several days before publication.

(c) Proofs, which will be supplied only when specifically requested or at the direction of the *Gazette Officer*, should be returned promptly to avoid delay in publication.

(d) No additions or amendments to matter for publication will be accepted by telephone.

31

THE "VICTORIA GOVERNMENT GAZETTE".

SUBSCRIPTIONS.—The subscription, including postage, is \$22.50 per annum, or \$11.25 per half year, payable in advance.

Subscriptions are required for whole months, and must cover at least a half year.

Single copies are 30 cents, posted 48 cents. Subscribers do not receive the Acts of Parliament with the *GAZETTE*.

GAZETTES are held in stock for five years only.

PRIVATE ADVERTISEMENTS.—The charge for insertion is 35 cents per line single column, and 70 cents per line double column. The title forms one or more lines as a heading. On an average ten words make a line of single column. Every signature must likewise be counted as a line. The final words of a paragraph, though only portion of a line, must be counted as one line. Signatures (in particular) and proper names must be written very plainly in the text; ONE SIDE ONLY of each sheet of paper should be WRITTEN UPON. The charge for a full page is \$50.

All documents illegibly written will be returned unpublished, and where brands occur unprovided for by the ordinary letters of the alphabet, a worded explanatory description must be furnished.

THE VICTORIA GOVERNMENT GAZETTE is published on WEDNESDAY EVENING in each week, and Notices for insertion will be received by the Government Printer at or before ONE p.m. at ordinary rates, and late advertisements between ONE p.m. and FOUR p.m. at double rates on the day preceding the day of publication.

PAYMENTS.—Unless the advertiser has a credit account, all payments are required in advance. Remittances should be made by cheque, postal order, or money order payable to "GOVERNMENT PRINTER".

ADDRESS.—All communications should be addressed to "The Government Printer, Box 203, P.O., North Melbourne", 3051.

CONTENTS

	PAGE
Acts of Parliament	3557
Appointments	3570
Auction Sales Act	3563
Bank Holiday	3557
Contracts	3570
Country Roads Board	3561
Estates of Deceased Persons	3569
Government Notices	3559
Impoundings	3598
Insolvency Notices	3598
Lands	3580
Notice to attend for Radiological Examination	3560
Notice to Mariners	3564
Notice of Making of Statutory Rules	3599
Orders in Council—	
Acts—Melbourne Underground Rail Loop; Road Traffic; Housing; Land; Country Roads; Country Fire Authority; Hospitals and Charities; Marine Stores and Old Metals.	3571 et seq
Private Advertisements	3588
Proclamations	3557
Public Service Notices	3585
Resignations	3571
Tenders	3584
Transport Regulation Board—Public Hearings	3566